



2018 PRICE LIST



**Freight Minimums**

- Free freight on all orders of 5 or more chairs
- \$20 per chair for all orders of 4 chairs or less

Sophie Series Chairs:  
\$120 per shipment for Sophie orders of 3 chair model units or less

[www.9to5Seating.com](http://www.9to5Seating.com)

3211 Jack Northrop Avenue, Hawthorne, CA 90250 | 310.220.2500

Follow us for more information:   

9to5 seating

**3%  
Tariff  
Surcharge**  
Effective  
11/1/2018

*The difference is in the details*

# 2018 PRICE LIST

**Effective January 1, 2018**

Please refer to our online price book at [www.9to5Seating.com/download](http://www.9to5Seating.com/download) for the latest changes including product drops and additions.

# table of contents

## INFORMATION

2	about 9to5 Seating
4	green practice
6	lifetime warranty
8	general information
9	condition of sale
10	dimensions / lead time
12	order procedure
13	packaging codes / upholstery selection
14	customer material program
16	CAL TB 133 fire code
17	two tone option
18	custom embroidery submission form

## SEATING PRODUCTS

20	new for 2018!
22	acclaim: 2780
24	agent: 1425, 1426, 1428, 1660, 1666, 1668
36	aria: 1860,1866, 1868, 1880, 1885
40	axis: 2600, 2610
44	bella: 1310, 1315, 1320, 1325, 1326, 1328, 1360, 1365, 1370, 1375, 1376, 1378
64	brio: 2060, 2066, 2068
68	bristol: 2360, 2366, 2368, 2380
74	cayman: 2800, 2810
78	core: 2260, 2266, 2268
82	cortina: 2900, 2910
86	cosmo: 3250, 3260, 3220, 3230
90	cydia: 3300, 3306, 3308, 3310, 3315, 3316
104	diddy: 2450
106	indy: 1010, 1020
112	kelly: 1060, 1066, 1070, 1076
116	lilly: 9101, 9111, 9131, 9121
118	link: 1410, 1415
124	logic: 1725, 1726, 1728, 1760, 1766, 1768, 1780, 1790
138	luna: 3460, 3466, 3468
142	mimi: 1030, 1040, 1050, 1051, 1054, 1055
150	neo: 3160, 3166, 3168
154	shuttle: 1210, 1215, 1230, 1250, 1260, 1265, 1280
178	sol: 3680
180	sophie: 8111, 8112, 8113, 8118, 8119, 8122, 8123, 8102, 8103, 8104
188	sophie tables & accessories: 8170, 8190, 8191, 8192, 8193, 8194, 8195, 8196
190	strata: 1545, 1546, 1548, 1555, 1560, 1566, 1568, 1580
194	strata mesh: 1535, 1536, 1537, 1538, 1570, 1576, 1578, 1590
200	theory: 2160, 2166, 2168, 2170, 2176, 2178, 2180, 2190
220	vault: 1460, 1466, 1468, 1480
226	vesta: 3060, 3061, 3063, 3065, 3066, 3068, 3080, 3085
230	zoom: 1115, 1125, 1126, 1128
236	@NCE: 103B, 103S, 176, 203, 216, 217

## ACCESSORIES

238	arm guide
242	caster guide
244	glide guide
245	cylinder guide
246	accessories
250	control selection guide
254	BIFMA ultimate test for fit (UTFF)
255	care and maintenance instructions
256	notes

# about 9to5 Seating

## About Us

Founded in 1986, 9to5 Seating is a vertically-integrated, privately owned company, which specializes in the design and production of ergonomic office seating to accommodate the rigorous demands of today's office environments. 9to5 Seating presents an extensive collection of executive, task, guest, conference, stool and lounge seating.

Take a closer look at one of our chairs and you can see the quality is apparent in every stitch. But we don't stop with the details of the chairs themselves. 9to5 Seating combines its state-of-the-art, in-house manufacturing systems with a commitment to continuous improvements in all phases of the operation. With over 500,000 sq. ft. of manufacturing resources, we are confidently empowered to deliver products offered at unparalleled pricing, quality built into every phase of manufacturing, customization and numerous upholstery options, express shipping and the best warranty possible.

Our dedication to becoming the leader in office furniture requires a deliberate and focused approach that extends beyond our chairs, in order to exceed customer expectations. When every detail is attended to the result is a better choice. And that's exactly what you get with 9to5 Seating.

Why are we so mindful of every aspect of our process? Because by doing all the little things right, we're able to offer you a better chair at an impressive value. We think that's pretty huge.

9to5 Seating. The difference is in the details.



### RESPONSIBLE

We are dedicated to eco-friendly and American manufacturing.



### FORWARD THINKING

We believe in staying ahead of the curve when it comes to manufacturing and design.



### UNCOMPROMISING

We never settle. We insist on sourcing our own materials, utilizing cutting-edge technology, providing superior value, and completely satisfying our customers.

## 10 Factories Under One Roof

9to5 Seating is able to control the quality of our products because of our vertically integrated business model. Our wholly owned factories are essentially "10 factories under one roof," which translates into our ability to control every part of the manufacturing process. We challenge you to find another U.S.-based office seating manufacturer doing this all under one roof with the state-of-the-art equipment and socially responsible business practices that are at the core of 9to5 Seating.

1. CAD DESIGN
2. CNC MOLD & DIE FABRICATION
3. PLASTIC INJECTION MOLDING
4. FOAM INJECTION MOLDING
5. TUBULAR METAL BENDING & WELDING
6. CNC WIRE ROD BENDING & WELDING
7. ALUMINUM DIE CASTING
8. ALUMINUM POLISHING
9. POWDER COAT FINISHING
10. FINISHED CHAIR PRODUCTION

Companies today demand the most for their money and 9to5 Seating is prepared to deliver the highest quality product without sacrificing selection or speed of delivery.



### ROCK SOLID

We have built top quality products for over 30 years – chairs that are built to last.



### CUSTOMIZATION

We allow our customers to customize their chair to best suit their style and needs.

## Below are some highlights of the program

- Lead Time: 5 Business Day Quick Ship and Standard 15 Day Lead time
- Textiles: Choose from thousands of commercial grade designer textiles from Architex, Arcom, CF Stinson, Designtex, Lindsey & Hall, Maharam, Mayer, and Momentum Textiles
- Leather: Select from a wide range of leather colors including 10 colors in leather/vinyl combinations
- Lifetime Manufacturer's Warranty
- Premium Quality Components
- Nylon Bases are made from 100% virgin glass reinforced nylon
- All task, executive, and conference seating incorporate molded foam cushions

## Value Propositions

### Thoughtful Product



#### Unsurpassed Value

Providing service, price and quality without compromise.



#### High Design

Meticulous attention to detail results in chairs that are aesthetically pleasing, ergonomic, and built for the demands of daily use.



#### Customization

Our adaptive designs and inhouse operations allows for customizable and build-to-order product, with thousands of textile options.



#### Lifetime Warranty

We stand behind our products. Lifetime warranty on all structural and mechanical parts. Five-year warranty on leather, fabric and foam.

### Purposeful Practices



#### Perpetually Forward Thinking

Vertical integration means every chair is built from the ground up. We source our own materials and invest in state-of-the-art technology to minimize cost while elevating quality.



#### U.S. Based Facilities

Committed to bringing hundreds of jobs back to the states.



#### Green Philosophy

We offer GREENGUARD Certified products, were awarded the prestigious LEED® NC Gold Certification, and we generate electricity via a solar photovoltaic panel system.



#### Shipping Speed and Efficiency

Fast 5 day shipping. Always timely.

### Committed



#### Family Values

Family culture throughout our organization.



#### Service-Oriented

Technically savvy service reps and integrated systems provide total visibility of account activities for timely order processing and thorough after-sales service support.



# green practice

## 9to5 Seating Commits to Think & Act Green

9to5 Seating is committed to sustainable and environmentally responsible business practices. This global perspective is endorsed and executed throughout every aspect of our corporate culture, and within our warehousing, manufacturing and office facilities. We are proud to demonstrate our commitment by offering GREENGUARD Certified products, participating in the U.S. Environmental Protection Agency's Waste Wise Program, and have been awarded the prestigious LEED® NC Gold Certification for our factory and corporate headquarters.

## Environmental Commitment in Action

9to5 Seating's corporate headquarters uses a rooftop photovoltaic panel system to generate electricity for the facility. To view how much power we are generating in real-time visit our solar portal at [www.9to5seating.com/solar](http://www.9to5seating.com/solar)

### Over 30 years, the system will offset:

- 6,102,370 lbs of CO2 | a leading cause of global climate change
- 4,192 lbs of NOx | a leading cause of smog
- 1,048 lbs of SO2 | a leading cause of acid rain
- 1,215 lbs of particulates | a leading cause of asthma

6,102,370 lbs of CO2 is equivalent to the amount absorbed by 13 acres of trees over their lifetime

## GREENGUARD Certified

Our entire product line earned GREENGUARD Indoor Air Quality Certification issued by the GREENGUARD Environmental Institute. The GREENGUARD Indoor Air Quality Certification Program assures that products designed for use in office environments and other indoor spaces meet strict chemical emissions limits.

9to5 Seating products:

- Contribute to healthier interior environments.
- Add points for LEED Certification.
- Offer fabrics made from 100% recycled content. (Fabrics made from recycled content are identified with the symbol in the Grade-In section of this price book pages 14 – 23.)
- Manufactured using plastic, nylon, steel, aluminum and polypropylene components that are 100% recyclable.
- Use suppliers that share an earth-friendly philosophy.
- Certified below chemical emissions limits for TVOC, Formaldehyde, Total Aldehydes, Individual VOCs, 4-phenylcyclohexene.



Environmental Data Sheets for all 9to5 Seating products can be found at our web site [www.9to5seating.com](http://www.9to5seating.com). For more information about GREENGUARD programs visit [www.greenguard.org](http://www.greenguard.org).

## LEED®

At its core, a green building is a better performing building. It uses fewer resources and offers a better place to work through improved energy and water efficiency, better air quality, and access to natural daylight. We have been awarded the LEED® NC Gold Certification for our newly constructed corporate headquarters and manufacturing facility.

Sustainable aspects of 9to5 Seating's headquarters building design contributing to LEED Gold Certification include:

- Rooftop photovoltaic panel system generating approximately 90% of electricity required for facility operation.
- Reduction of energy consumption through increased natural day lighting to enable factory to operate during an average day with lights off.
- Use of LED lighting throughout office space for further energy savings.
- Site selection promoting development density and community connectivity.
- Providing alternative transportation including access to public transportation, parking for low emitting and fuel-efficient vehicles.
- Quality control of storm water runoff.
- Decrease in heat island effect.
- Use of water efficient landscaping.
- Reduction of water usage by 40%
- Optimization of energy performance through a 28% improvement over 2011 California Title 24 code.
- Recycling or salvaging 75% of construction waste.
- Use of recycled content and regional building materials.
- Increased ventilation to promote indoor environmental quality.
- Use of low-emitting adhesives, sealants, paints, coatings and flooring systems.

## Manufacturing

We are committed to reducing, reusing and recycling the by-products and waste generated during our manufacturing process through our membership in WasteWise. WasteWise is an U.S. Environmental Protection Agency's program in which organizations track their waste reduction efforts to benefit the environment.

9to5 Seating's efforts to reduce manufacturing waste include:

- Optimize machinery cycle times to manufacture parts in minimal time increments.
- Evaluate environmental effects before pursuing new products or purchasing equipment to ensure alignment with environmental commitments.
- Select materials that reduce or eliminate toxic and environmentally damaging materials from the manufacturing equation.
- Utilize water-based, environmentally friendly adhesives throughout our manufacturing facilities.
- Use of recycled raw materials in the production urethane components when possible.
- Sort and recycle rejected plastic components via five re-grind machines.
- Employ molded foam production in over 95% of products, greatly reducing scrap urethane.
- Work exclusively with plywood suppliers that participate in forest restoration.
- Collect and recycle all excess fabric, dacron and leather.
- Accurately determined the current carbon footprint through Life Cycle Assessment (LCA).
- Identified hot-spots in energy consumption and associated CO2 emissions.
- Optimized energy efficiency and reduced CO2 and GHG emissions contribution from production processes.
- Identified solutions to neutralize CO2 emissions that cannot be eliminated through energy saving measures.

# lifetime warranty

9to5 Seating products are manufactured with meticulous attention to detail to achieve a level of quality that is free from defects in material and workmanship. In an effort to stand behind this philosophy, 9to5 Seating warrants to the original purchaser of the product and from the original date of sale, the following:

For All Series Except @nce, Logic Plus, and chairs that include the Heavy Duty (HD) option in the Aria, Logic, Strata™ and Theory Series: Lifetime Warranty to the original end user; the company will repair or replace, at its option, factory defective structural and mechanical parts with comparable product, without charge. This warranty is for a single shift, standard commercial usage, defined as a standard 8-hour work day, five days a week. Weight limitations vary by product.

Upholstery fabric and foam are warranted against wear through and deterioration during normal usage for a period of five (5) years. However, the company does not warrant leather against routine scratching and scuffing, as all leather is subject to minor blemishes during use. COM and COL are not warranted. Due to natural variations in material, furniture containing leather is sold subject to normal variations and/or irregularities of color, texture, and grain.

For the @nce Series: 9to5 Seating warrants the @nce series of chairs for a period of five (5) years of single-shift use to the original purchaser; the company will repair or replace at its option factory defective structural and mechanical parts with comparable product, without charge. This warranty is for a single shift, standard commercial usage, defined as a standard 8 hour work day, five days a week. Weight limitations vary by product.

For Logic Plus Large Occupant Series: 9to5 Seating warrants the Logic Plus Large Occupant chairs for a period of ten (10) years of single-shift use to the original purchaser; the company will repair or replace at its option factory defective structural and mechanical parts with comparable product, without charge. This warranty is for single-shift applications with persons weighing less than 500 lbs.

For the chairs that include the Heavy Duty (HD) option in the Aria, Logic, Strata™ and Theory Series: 9to5 Seating warrants the aforementioned chairs for a period of ten (10) years of multi-shift use to the original purchaser; the company will repair or replace at its option factory defective structural and mechanical parts with comparable product, without charge. This warranty is for multi-shift applications with persons weighing less than 350 lbs.

Only Upholstery fabrics with an abrasion resistance performance rating of 150,000 double rubs or more are warranted against wear through and foam deterioration for a three (3) year period of multiple shift use.

## Claim Process

Should parts fail for any model during normal use within the applicable warranty period, please fill out a Warranty Request Form on the website here: <https://9to5seating.com/warranty-request/>. Provide 9to5 Seating with a description of the failure and proof of purchase (Sales Order number located on the bottom of the chair). If requested by the company, the original purchaser must return the part or product with freight or other shipping charges prepaid, together with a copy of original sales receipt. Please do not send parts without prior authorization.

Send Parts to:  
9to5 Seating - Warranty Department  
3211 Jack Northrop Avenue  
Hawthorne, CA 90250

9to5 Seating will inspect the part in question, repair or replace with a comparable product at its option any defective part at no charge to the original purchaser and return defective item thereafter. This warranty does not apply to product or parts of the product that have been subjected to misuse or abuse, accident, alteration, unauthorized repair or which have been damaged in transit. You agree to indemnify and hold harmless 9to5 Seating, its officers, directors, shareholders, employees, and agents from any actions, claims, demands, damages, liabilities, costs, and strict liability in tort or contract, or any other legal theory arising out of the misuse or abuse, alteration, or damage in transit of the product. Under no circumstances will the company be liable for injuries or damages arising from the use of the product.

## Limitation of Liability

Under no circumstance, including but not limited to breach of contract, breach of warranty or negligence, shall 9to5 Seating be liable for lost profits, loss of goodwill, stored data, general, special, consequential or exemplary damages, even if 9to5 Seating had notice of these damages or they were foreseeable. 9to5 Seating shall not be responsible for verifying dealer's or customer's description of needs, data, or the fitness for a particular purpose of goods. 9to5 Seating's Liability in all cases shall be limited to repair or replacement of the defective parts with a comparable product. Should a comparable replacement not be available, 9to5 seating maximum liability will be limited to the original purchase price of the product. Damages resulting from misuse, abuse, alteration, negligence, or accidents are not covered under this warranty.

9to5 Seating makes no warranty that any of its products are suitable for any particular purpose and makes no other warranties, express or implied, other than those set out here. As codes and standards vary from one jurisdiction to another, references to compliance are solely for convenience and without any representation as to accuracy or suitability. Users must verify the suitability of such information or product for their specific application. In no event shall 9to5 Seating be liable in either tort

or contract for any loss or direct, special, incidental, consequential, or exemplary, damages.

EXCEPT AS OTHERWISE PROVIDED, 9to5 Seating MAKES NO OTHER WARRANTIES, EXPRESSED OR IMPLIED, INCLUDING BUT NOT LIMITED TO THE WARRANTIES OF MERCHANTABILITY AND FITNESS FOR A PARTICULAR PURPOSE.

## Labor Reimbursement

For products ordered on or after July 1, 2017, 9to5 Seating will pay the pre-approved labor costs to repair or replace defective parts, up to 12-months from the date of shipment from 9to5 Seating, excluding the @nce series product. All payments for such pre-approved labor cost will be in the form of a credit to an active company account.

## ANSI/BIFMA

The Business and Institutional Furniture Manufacturer's Association (BIFMA) has developed tests which have been approved by the American National Standards Institute (ANSI) for determining the strength and durability of seating in its everyday use. This statement does not serve as a warranty or guarantee, however 9to5 Seating products found within this price list generally meet or exceed applicable BIFMA and ANSI standards.

## Warranty Exceptions:

- Color-fastness or matching of colors, or textures occurring in leather, or other materials that naturally exhibit inherent color variations
- COM/COL textiles
- Damage of textiles from exposure to sunlight and UV rays.
- Variation of texture and natural markings such as neck wrinkles, scratches, backbone marks and stretch marks in leather
- Color matching of textiles exactly to samples, swatches or prior purchases
- Minor variations of color in textiles
- Minor irregularities of color, surface, grain and texture
- Creasing and/or gathering of textiles during upholstery application process
- Product normal wear and tear, which is to be expected over the course of ownership
- Damage caused by the carrier in-transit, which will be handled as separate terms and/or claims against the carrier
- Damage caused by delivery/installation contractors, which will be handled as claims against the designated company
- Failures and damage which result from negligence, abuse, accident or misuse
- Damage by markings or staining; damage by sharp objects or

imprinting from instruments

- The warranty is limited to replacement or repair and does not cover cost of transportation, labor or installation.
- Products exposed to extreme hot and cold temperatures or excessive dry environments
- Products that have been modified or altered and any attachments to the product
- Products or parts not used, maintained or installed in accordance with the Company's installation, maintenance and/or applicable guidelines
- Floor samples or display models
- Products purchased "as is" and/or secondhand
- Products sold by unauthorized dealers

9to5 Seating reserves the right to make changes in design and construction or discontinue products without prior notice. 9to5 Seating reserves the right to make changes to the lifetime warranty or price book.

Since textiles vary in weave, thickness and memory, some creasing and/or gathering may occur during the upholstery application process. Due to natural variations over which we have no control, all chairs are sold subject to minor irregularities of color, surface, grain, and texture. Textiles are sold subject to minor variations of color. Because leather is a natural product, variations of texture are common and should be expected. Leather will contain natural markings such as neck wrinkles, scratches, backbone marks and stretch marks. These distinctions give leather its unique characteristics and are considered to be part of the natural beauty of leather.

# general information

## Hours

**Order Desk: Monday - Friday - 6:00 a.m. to 5:00 p.m. P.S.T.**  
**Shipping & Receiving: 8:00 a.m. to 4:30 p.m. P.S.T.**  
**Tel: 888.925 SEAT (7328)**  
**www.9to5Seating.com**

**Visit our new Chair Designer, on our website, to build custom chairs to your project specs.**

## Condition of Sale

Possession of this price book does not necessarily constitute authority to purchase.

## Minimum Order Size

No minimum order required. Orders of 4 chairs or less will be charged \$20 per chair net shipping charge with the exception of the Sophie series which requires a 4 model unit minimum (excluding tables and accessories). A shipping surcharge of \$120 net will apply to shipments of 3 model units or less.

## Payment

9to5 Seating accepts all major credit cards, company checks, cash, and terms payment for approved accounts. Credit card payments are subject to a 3% service charge. A \$35.00 fee will be charged for returned checks.

## Terms

Standard terms are net 30 days from date of invoice. Please respect these terms in order to protect your competitive pricing. Credit terms may be changed or canceled at 9to5 Seating's discretion.

1. All new accounts are required to remit a 50% deposit of the initial order's total dollar value prior to the order entry and the balance must be paid at the time of pick up or release to common carrier. A line of credit may be established upon acceptance of satisfactory references and the completion and signing of credit application.
2. The customer will be liable for any cost incurred in attempting collection of past due amounts, including attorney fees, whether or not a lawsuit is filed. Past due accounts are subject to a 2% per month (24% per annum) late charge, or maximum amount permitted under local law, for each thirty days, or part thereof; the outstanding balance remains unpaid beyond the thirtieth day after invoice date. Withholding of payments, because of carrier damages, shortages or other disputes is illegal and subject to charges.
3. Orders delayed due to credit hold will be rescheduled for production once the order has been credit released. A new lead time will be given at that time. Please contact customer service to coordinate details.

## Prices

All prices are suggested retail and are subject to change without notice. We make every effort to notify all customers of such changes. Prices in effect at the time of shipment will prevail. Please refer to our online price book for the latest changes including product drops and additions.

## Order Acknowledgement

An order acknowledgement will be emailed to you upon receipt of the order to confirm quantities, items ordered, and prices effective at the time of the order acceptance (prices may vary from the published list) unless there is a credit issue or you are otherwise contacted. Be sure to read these acknowledgements and contact us immediately if incorrect.

## Shipping

Complete and specific instructions for shipping should be given at the time an order is placed. Orders that do not have specific instructions will be routed by the best method of shipment in accordance with the judgement of our traffic department. ANY changes to shipping instructions must be faxed into our office. Shipping weight and cubic dimensions shown in our price list are subject to variation. Standard shipments are made via common carrier unless otherwise requested by the customer. Special routing requests made by the customer or the consignee may result in additional charges. Standard deliveries are dock-to-dock and are scheduled to occur Monday through Friday between 8:00 AM to 4:30 PM. 9to5 Seating reserves the right to charge the customer for non-standard customer delivery requirements that may include delivery appointments, drop shipments, inside deliveries, residential, limited access, or requests for trucks with lift gates. Additional charges may also be incurred for redeliveries or re-consignments if the initial delivery cannot be made for any reason. 9to5 Seating will not be held responsible for issues or costs to the customer arising from carrier transit delays or missed appointments. For information concerning these charges, please contact Customer Service.

## Service Charges

Below is a list of frequently requested Service Charges:

- Call prior to delivery for verification. This is not a delivery appointment (no charge).
- Reconsignment fee of \$50 will be applied when changing consignee address after shipment has been tendered to a carrier
- Lift gate delivery (no dock) \$65 flat fee.
- Shipments to schools, churches, military bases, residential addresses \$65 flat fee.
- In the event that no one is available to receive a shipment and a redelivery is necessary, a charge of \$65 to \$150 will be billed to customer for redelivery. Charge depends on carrier.
- 9to5 Seating strives to use the best shipping method possible for every shipment. The factory may ship an order fully assembled and bagged; however, this is not standard for all shipments. If you require blanket wrap delivery, you must contact 9to5 Seating to confirm this shipment method and confirm that the order acknowledgement sent to you reflects 'AB' as the shipment method. Additional charges may apply.
- Limited access locations where a dock is difficult to access with a 53 ft. trailer will be charged minimum \$65 flat fee.

## Guaranteed Delivery and Delivery Appointment

Shipments are not guaranteed. Guaranteed service is available at an additional cost. Please contact Customer Service for more information. We will work to arrange a specific delivery time with the carrier. Service guarantees contracted with carrier are done solely at the request of the customer and 9to5 Seating in no way assumes responsibility financially or otherwise for any costs incurred by the customer as a result of a carrier's failure on a guaranteed shipment. In the event of a carrier's failure on a guaranteed shipment, the associated guaranteed service fee will be removed.

## Expedited Freight

Expedited service is available at an additional cost. Please contact Customer Service for more information.

## Drop Shipments

9to5 Seating will not drop ship without prior approval. Additional charges may apply; contact Customer Service for additional information.

# condition of sale

## Will Call

Will Call orders will receive notification once orders are ready to be picked up. Customer will have 3 business days from notification to pick up the order. If the order is not picked up within this time frame, the order will be invoiced and storage charges will start at a rate of \$30 per each business day until order has been picked up.

## Freight Damage or Shortage

Before accepting a shipment from the carrier, check the boxes for visible damages. If a shortage or damage occurs during transit, it should be noted on the freight bill of lading at the time of delivery, and a claim filed within 7 days from receipt of product. If concealed damage is discovered after delivery, request inspection from the delivering carrier IMMEDIATELY and save all packing materials until inspection is made. Contact customer service as soon as possible to report damage or shortage.

For all Will Call orders, make sure to inspect merchandise thoroughly. 9to5 Seating will not be liable for any damage or shortage to merchandise after it has been signed for at our dock.

9to5 Seating will not be liable for any installation costs that result from freight damage.

## Cancellations & Returns

Due to immediate production scheduling, orders which have entered any stage of production cannot be cancelled. All 9to5 Seating chairs are made to order, custom designed chairs and are not "off the shelf". Requests for cancellation are not accepted until confirmed by 9to5 Seating. Product may only be returned after receiving a Return Merchandise Authorization number from 9to5 Seating. Returns are subject to restocking charge equivalent to 35% of the net order plus freight. Unauthorized returns will be refused.

## Replacement Parts

When ordering a replacement part, call Parts Department at 1.888.925.7328 or e-mail to parts@9to5seating.com. For your convenience you can also submit warranty requests through our website by navigating to the warranty page and selecting the Warranty Request Form. As a helpful tip, have your 9to5 Seating Sales Order number available and please reference your instructions sheet to properly identify the correct part for your 9to5 Seating product.

Replacement parts are shipped within 48 hours from time of request. 9to5 Seating does not reimburse for labor and installation costs related to warranty replacements. Replacement parts needed to repair freight damage can be granted only if the request is received within 5 business days of receipt of the merchandise.

## Product Design

9to5 Seating reserves the right to make alterations in design and construction or to discontinue products without prior notice.

# dimensions

## Outside Width (W)

Distance measured at widest point of chair.

## Outside Depth (D)

With the outside back of chair against wall, the distance from the wall to the front edge of seat.

## Outside Height (H)

Distance from floor to highest point of back.

## Seat Width (SW)

Distance measured at widest point of seat's side edges.

## Seat Depth (SD)

Distance is measured using the Bifma CMD ( Chair Measuring Device ) from the most prominent point of the lumbar to the front edge of the seat

## Seat Height (SH)

Distance is measured using the Bifma CMD ( Chair Measuring Device ) from the floor to the bottom of the device on the front edge of the seat. The CMD weighs 100 lbs.

## Back Width (BW)

Distance measured at widest point of back's side edges.

## Back Height (BH)

Distance measured from inside edge of rear seat to top edge of back.

## Inside Arm Width

Distance between arm, typically measured from mid-point.

## Arm Height

Measured from the floor to top edge of arm.

# lead time

9to5 Seating intends to have all approved orders ready for shipment within the below guidelines. However, there may be delays due to causes beyond our control. Orders received after Noon, PST will be considered as having been received the following day. Credit must be cleared before processing. 9to5 Seating is not responsible for late deliveries from freight carriers.

## Lead Times

@NCE ships in 24 hours.

**5 Business Day ExpressShip** includes Grades A, B, C, D, and L3 selections found in the current ExpressShip fabric card programs. Quantity is restricted to twenty-five (25) chairs total per order.

Please specify "5 Day Quick Ship" on a separate purchase order to ensure proper handling and delivery time. DO NOT COMBINE with any other purchase order. In the event that a purchase order is not marked, order will be scheduled per our standard lead time below. Standard 10 business days Express Ship is ten (10) business days or less and includes ExpressShip Fabrics (Momentum Swift, 9to5 Signature and L4 Leather). Built-to-order in any configuration shown in the price list up to 50 chairs.

**Standard 15 Day Lead Time** Standard 15 business days Express Ship is fifteen (15) business days or less and includes hundreds of fabric, leather, mesh, vinyl or polyurethane upholstery options, as well as L5 Leather and COM, with shipment date determined from receipt of material. Built-to-order in any configuration shown in the price list up to 150 chairs.

15-days standard lead time applies up to 25 seats in Metallic Brown, Gunmetal, Dover Gray or White frame color option, with up to 150 chairs in Silver or Black finish. Sophie series not available in 15-day shipping program.

**Standard 25 Day Lead Time** Receive all of the above plus graded-in upholstery selections from our programs with CF Stinson, Designtex, Maharam and Momentum.

Built-to-order in any configuration shown in the price list up to 250 chairs/order.

All Sophie frame finishes ship in 25-days standard lead time with up to 25 seats available in 20 days, only in ExpressShip Fabrics.

**Please call Customer Service for lead times on orders over 251 chairs.**

**On-Hold Orders** Orders that are "On Hold" will begin production only when all holds are released.

## Types of holds include:

- Credit Hold- waiting for payment before producing items (or "Waiting to clear issues related to billing and invoicing")
- Shipment Hold- Waiting for payment before shipping items
- Waiting for Fabric -Fabric on back order. Waiting for fabric to be available and received
- Part Delay- Out of stock parts. Waiting for receipt of part(s)
- Problem- Need Resolution (PNR)
  - Pricing Hold - The purchase order and price guide do not match
  - Incomplete Hold - Missing specification in the purchase order
  - Fabric Hold - Missing the fabric pattern and the color within order # or non-standard fabric
  - Configurator Hold- Missing or incorrect options/pricing in the configurator

# order procedure

## To Place Order

Follow one of the following two choices to place order:

1. Fax your order to: **866.925.SEAT**
2. E-mail your order to: **sales@9to5seating.com** or your dedicated customer service representative.

Specify complete model number, color, quantity, ship to address, payment method and purchase order number. In the event that an error is made in production of the chair, the hard copy of the purchase order will be used as the resolution document.

## Model Number Structure

When ordering, please create model number in accordance with the nomenclature below. Refer to Creating Series Model Number in the top right hand corner of specific model's price book page.

### Acclaim

MODEL NUMBER	CONTROL	ARMS	GRADE	BASE	CASTERS	PACKAGING	OPTIONS
2780	Y5	A27	L5	BA	C7S		

\* GT MODELS DO NOT HAVE A CASTER CODE

### Core

MODEL NUMBER	CONTROL	ARMS	PLASTIC COLOR	GRADE	BASE	CASTERS	PACKAGING	OPTIONS
2260	Y5	A23	PGA	C	BA	C22B	PAC	12S

\* GT MODELS DO NOT HAVE A CASTER CODE

### Diddy

MODEL NUMBER	CONTROL	ARMS	GRADE	BASE	CASTERS	PACKAGING
2450	S3	A24	C	BA	C6S	BAC

\* FOR ARMLESS CODE USE A00

### Sophie

MODEL NUMBER	CONTROL	ARMS	FRAME FINISH	GRADE	PACKAGING	OPTIONS
8111	GT	A80	MB	F	AC	

### Zoom

MODEL NUMBER	CONTROL	FRAME COLOR	PLASTIC COLOR	UPHOLSTERY	GRADE	CASTERS	PACKAGING
1115	B2	SF	P	AP	D	C12	AB

\* FOR ARMLESS CODE USE A00      \* ONLY SELECT CASTER CODE FOR MODEL 1215, 1265

## Order Acknowledgement

Unless there is a credit issue or you are otherwise contacted, an order acknowledgement will be faxed or emailed to you upon receipt of the order to confirm quantities, items ordered, and prices effective at the time of the order acceptance (prices may vary from the published list). Be sure to read these acknowledgements and contact us immediately if incorrect.

## Shipment Notification

Upon shipment of an order a shipment notification will be faxed or emailed with carrier information.

# packaging codes

## How to Specify

9to5 Seating offers several packaging methods for most models. Please note not all packaging codes are available for each model. Reference the price book page for the model in question to view the packaging methods available. All available packaging methods and their corresponding prices can be found at the top of the price book page.

After determining the appropriate packaging method please add the packaging code to the model nomenclature of the model as it appears on your purchase order.  
(example: 1725-M1-A4-101-**AB**)

### AB - Assembled in Bag for Will Call and Blanket Wrapped

The chair will be fully assembled and covered with a clear plastic bag for protection from dust. Chairs shipping via blanket wrap carrier will be produced with packing method "AB" as the chairs will be picked up at the dock fully assembled in the will call area.

### PAC - Partially Assembled in Carton

The chair will be produced and packed partially assembled typically with seat and back separated, arms and controls pre-assembled in a shipping carton. Specially designed spacers are used to position all chairs in the carton and prevent freight damage.

### BAC - Back Assembled in Carton

The chair will be fully assembled with exception of the base, gas lift and casters removed and packed into a specially designed carton for this hardware. The chair may be removed, casters placed in the base, gas lift placed in the base and the remaining chair set on top of the cylinder. No tools are required

### AC - Assembled in Carton

The chair will be fully assembled and placed in a carton. This applies primarily to guest chairs which must ship fully assembled to accommodate chair design. Some guest chairs ship with multiple chairs in one carton

# upholstery selection

## Fabrics

Choose from thousands of different fabrics, comprised of varying price grades offered through 9to5 Seating's fabric cards. If you still can't find what you are looking for, you may choose from any of the textiles offered by one of our textile partners. There are thousands of patterns and colors to choose from. To make this easy for you, we have graded-in their entire product lines. Please see pages 16 to 33 of this Price Book.

## Leather

9to5 seating offers three grades of leather. L3 and L4 all are upholstered with leather on the seating surface and vinyl on the back and side boxing. L5 is an ALL leather cover.

9to5 also has COL (customer own leather) program

L3 is a glove-soft, top grain European hide, available in Black

L4 is also a glove-soft, top grain Italian cowhide leather available in colors. L4 executive chairs are available in 9to5 Seating premium leather colors.

L5 is a luxurious Italian full grain semi-aniline dye leather with a soft hand and smooth supple surface with even coloration throughout the entire hide. Available in 39 colors.

## Two-Tone Contrasting Seat and Back

When the seat and back fabric or vinyl are different on a single chair, clearly indicate your selection for both the seat and back on your purchase order. All fabric upholstered chairs may be ordered with two-tone upholstery for no additional charge. **If the two upholstery selections are of different grades, the chair will price at the higher of the two grades.**



# customer material program

com = customer's own material  
col = customer's own leather

## Ordering Instructions

Contact customer service for inquiries regarding COM/COL or follow the instructions below to assure the best results to produce your COM/COL order.

1. Complete 9to5 Seating COM/COL form (see opposite page or download from website) and send it to 9to5 Seating along with fabric sample.
2. All COM/COL fabrics must be approved by 9to5 Seating and will not be scheduled for production until the entire yardage/ square footage requirements have been received. Approval can be completed by 9to5 Seating in 24 hours. 9to5 Seating will not return any excess COM/COL material.
3. For non-directional, plain, solid colors or non-patterned fabrics, please follow COM yardage requirements as specified under each individual model number in our price list. For fabrics which require special application or direction, please attach a sample of the COM fabric to our COM form. Include all information and return to 9to5 Seating at address shown below.
4. **All COM textiles received at 9to5 Seating must be clearly marked with customer's name, purchase order number, 9to5 Seating sales order number (if available) and any special instructions for application of textile.**

Send fabric to:

9to5 Seating  
Attn: COM Fabric Receiving  
3211 Jack Northrop Ave.  
Hawthorne, CA 90250

5. Upon receipt of COM textile, a production date will be given to the order and you will receive an acknowledgement by fax or e-mail.

## Notes:

1. COM/COL EXCESS YARDAGE - 9to5 Seating is not responsible for yardage submitted to 9to5 Seating beyond the required amount. Excess COM/COL materials will be discarded at the discretion of 9to5 Seating unless otherwise instructed by the customer at the time of order placement. If a customer requires the COM/COL excess yardage returned, they must contact Sales Support before order placement to make return COM/COL arrangements. The customer will be responsible for all COM/COL return delivery charges.
2. The yardage figures shown throughout the price list are estimates only. Calculations are based on 54" wide material with no repeat and cut in the woven way cutting direction for a single chair. For specific yardage based on width of material, chair model, and quantity, please contact 9to5 Seating.
3. For large quantity orders please contact customer service for more precise yardage requirement. Actual yardage requirement per chair often decreases with larger orders.
4. To calculate COM yardage, use the chart below as a guide and add appropriate amounts to the generic yardage requirements listed in the pricer

FABRIC		2"-14"	15"-27"	28"-36"
WIDTH	GENERIC YARDAGE	REPEAT	REPEAT	REPEAT
54"		+20%	+30%	+40%

5. COL: Leather quality can vary depending on the size of the hides. Larger hides ( 50 to 60 SQ FT ) tend to be higher quality and yield. Smaller hides ( 40 to 50 SQ FT ) tend to have more quality issues that may cause smaller yields, requiring the need for additional hides to be ordered
6. For all COL orders, 9to5 Seating cannot take responsibility for the need to order additional COL due to quality issues and related small material yields

## PLEASE SEND A COMPLETED PHOTOCOPY OF THIS PAGE TO 9TO5 SEATING

DATE:	ACCOUNT NUMBER:
DEALER NAME:	PURCHASE ORDER NUMBER:
ADDRESS	CITY/ZIP CODE
9TO5 ORDER NUMBER (IF AVAILABLE)	PHONE NUMBER
MODEL NUMBER	DEALER CONTACT
QUANTITY	



## TEXTILE INFORMATION

MILL	FABRIC NAME/NUMBER
FABRIC COLOR	TOTAL YARDAGE SHIPPED

## APPLICATION

IS THERE A DESIRED TOP AND BOTTOM TO THE FABRIC?	IS THE FABRIC STRIPE OR TWO-COLOR PLAID?
YES   NO	YES   NO

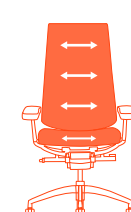
## CHECK APPROPRIATE BOX FOR YOUR CHOICE OF FABRIC DIRECTION

<p><b>HORIZONTAL</b></p> <input type="checkbox"/> 	<p><b>TOP</b></p> <p>ATTACH SAMPLE TEXTILE HERE WITH DESIRED FACE AND DIRECTION DISPLAYED. IF THERE IS A PATTERN OR REPEAT, THE SAMPLE SHOULD BE LARGE ENOUGH TO SHOW ENTIRE REPEAT.</p> <p><b>BOTTOM</b></p>
<p><b>VERTICAL</b></p> <input type="checkbox"/> 	

# CAL TB 133 fire code

9to5 Seating's entire line of office seating meets California Technical Bulletin 117-2013 (CAL TB 117-2013) which has been in effect since January 1, 2015. This is a standard by which upholstered furniture has been tested for approval to meet a minimum fire standard. 9to5 Seating's standard product is not designed to meet California Technical Bulletin 133. However, upon special request, most 9to5 Seating products can be manufactured to meet the California Technical Bulletin 133 (CAL TB 133).

## CAL TB 133

CAL TB 133 is the standard of furniture flammability required by the California Bureau of Home Furnishings and Thermal Insulation for furniture used in public buildings. New requirements proposed for furniture used in public buildings such as:

Healthcare Facilities, Convalescent Homes, Public Assembly Areas of Hotels and Motels, Hospitals, Board and Care Homes, Stadiums, Licensed Child Care Facilities, Prisons and Jails

## CAL TB 133 Test

CAL TB 133 is a full scale fire test for furniture manufactured for use in public buildings. The standards do not specify how to construct furniture, but only how it should perform when tested by the following procedures:

A finished piece of furniture, never single components, is placed in a 10' x 12' x 8' chamber and is tested by applying a gas flame for 80 seconds. Then measurements are taken for the rate and amount of heat generated, temperature of the test room while furniture is burning, smoke capacity, amount of carbon monoxide generated and mass loss of the furniture for one hour or until the fire is completely extinguished.

A solution to pass this fire standard test is to sandwich a fire blocking liner between the foam and fabric of our chairs. This liner acts as a 'fire extinguisher' by smothering the flame. As a response to CAL TB 133, and in order to meet customer's needs, 9to5 Seating has designed a variety of models and fabrics that can be combined to meet this new standard.

## CAL 133 Models

The following models when combined with approved textiles and blocker meet the CAL 133 standard: All plastic models of Shuttle and Bella are also approved.

Acclaim: 2780

Agent: 1425, 1426, 1428, 1660, 1666, 1668

Aria: 1860, 1866, 1868, 1880

Bella: 1310, 1315, 1320, 1325, 1326, 1328, 1360, 1365, 1370, 1375, 1376, 1378

Bristol: 2360, 2366, 2368, 2380

Cayman: 2800, 2800-GT, 2810

Cortina: 2900, 2900-GT, 2910

Cosmo: 3250, 3260, 3250-GT

Cydia: 3300, 3300-GT, 3310, 3310-GT, 3306, 3308, 3315, 3316

Diddy: 2450, 2450-GT

Kelley: 1060, 1066, 1070, 1076

Link: 1410, 1415

Logic: 1725, 1726, 1728, 1725-GT, 1760, 1766, 1768, 1780, 1790

Neo: 3160, 3166, 3168

Shuttle: 1210, 1215, 1250

Sophie: 8102, 8103, 8104, 8111, 8112, 8113, 8118, 8119, 8122, 8123

Strata: 1545, 1546, 1548, 1555, 1560, 1565, 1580, 1585, 1560-GT, 1566, 1568, 1561, 1563

Vault: 1460, 1466, 1468

Vesta: 3060, 3061, 3063, 3065, 3066, 3068, 3080, 3085

Zoom: 1115, 1125, 1126, 1128

## COM CAL TB 133

COM compliance for CAL 133 models listed above can be determined by specifying upholstery with the exact characteristics as approved 9to5 Seating fabrics or by conducting a full chair burn test. The non-discountable test fee for each chair-fabric combination is \$500.00 net.

## CAL TB 133 Upcharge

- 1 - 49 chairs: \$100 List Upcharge
- 50 + chairs: \$50 List Upcharge

## To Order CAL TB 133

Clearly specify CAL TB 133 on order, choose your desired fabric, from options above, then add the indicated amount above to the standard list price. Standard lead times apply.

## To Check Purchased Seating For CAL 133

To determine whether your current 9to5 Seating chair meets CAL TB 133, or to check an order you have recently received, check the bottom of the chair seat pan for the label shown below.

If your chair does not show this tag below, then your chair does NOT meet CAL TB 133

## NOTICE

This article is manufactured for use in public occupancies and meets the flammability requirements of California Bureau of Home Furnishings Technical Bulletin 133. Care should be exercised near open flame or with burning cigarettes.

# two tone option

## Ordering Instructions

Two Tone Contrasting Seat and Back

When the seat and back fabric or vinyl are different on a single chair, clearly indicate your selection for each on your purchase order. If the two selections are from different grades, price the chair(s) at the higher of the two grades.

## Available on:

Agent, Bella, Brio, Bristol, Core, Logic, Shuttle and Sophie.

DATE:
DEALER NAME:
DEALER CONTACT:
PO NUMBER
1. BACK FABRIC
2. SEAT FABRIC

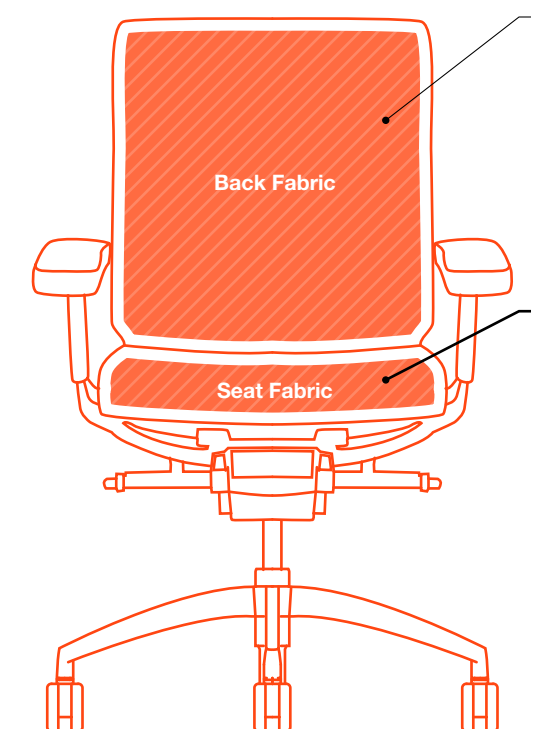

# custom embroidery form

Custom embroidery is a great way to display your company logo on upholstered chair backs. Embroidery can be done in multiple colors, shapes and size to suit your needs for a very reasonable cost and lead-time. To obtain a quote for embroidered upholstery, please fill out the adjacent form completely as possible. You will need a graphic file, preferable in Ai, EPS or other graphic format. Generally, higher resolution art (greater than 300 dpi) will be easier to work with. There will be a set-up charge to create a digitized file if you do not have one available. We will also need a PMS color number for each color thread required. 9to5 is not responsible for poorly digitized files or graphic files from the requestor. If the logo is NOT to be in the back center; the location of the logo needs to be specified as an offset from the center of the back, vertically and horizontally. (see form)

Keep in mind, embroidery is not a one to one replacement for printing, patches or heat transfer vinyl lettering. Embroidery thread is heavier, stronger and tighter density than the surrounding fabric and may pull or pucker on loosely woven fabric. Embroidery will always look best on strong, closely knit fabrics or vinyl. It is best to always get a sample for approval before placing the full production order.

All logos are trademarks of their respective owners. 9to5 Seating is not responsible for obtaining permission or use of copyrighted logos. Before you use, reproduce or distribute in any manner you must first receive the express permission of the holder of the copyright or trademark of that logo. Failure to obtain such permission is a violation under international law.

**Note:** Dimensional tolerance of logo placement is  $\pm 1/2$ " vertical and  $\pm 1/4$ " horizontal.

PLEASE SEND A COMPLETED PHOTOCOPY OF THIS PAGE TO 9T05 SEATING

FILLABLE FORMS LOCATED ON 9T05SEATING.COM/DOWNLOADS

DATE:	ACCOUNT NUMBER:
DEALER NAME:	PURCHASE ORDER NUMBER:
DEALER CONTACT NAME:	CITY/ZIP CODE
PROJECT(END-USER):	PHONE NUMBER
MODEL NUMBER	DEALER CONTACT
TOTAL PROJECT QUANTITY	TOTAL PROJECT NET:

COMMENTS:

IS THE EMBROIDERY FOR A BID ?	IS A SAMPLE REQUIRED FOR CUSTOMER REVIEW PRIOR TO PRODUCTION OF ORDER?
YES   NO	YES   NO

IS A LOGO/GRAPHIC FILE AVAILABLE?	LOGO/GRAPHIC FILE TYPE?
YES   NO	AI   EPS   PDF   JPEG   PNG   OTHER:

STANDARD MODEL	QTY	HEIGHT	WIDTH	COLOR/PMS EQUIVALENT	TEXTILE MILL/PATTERN/COLOR

## LOGO/IMAGE LOCATION (FROM LOGO CENTER TO CHAIR BACK CENTER)

VERTICAL OFFSET FROM CENTER:	HORIZONTAL OFFSET FROM CENTER:
INCHES	INCHES

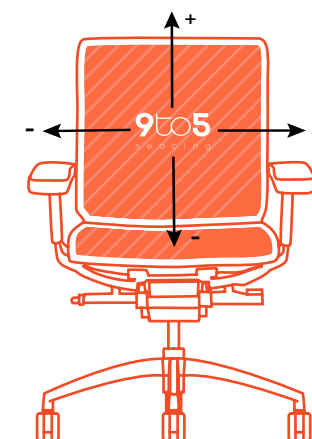

TOP

---

ATTACH SAMPLE LOGO/GRAPHIC HERE.

---

BOTTOM

# new for 2018

9to5 Seating is excited to showcase 5 new products for 2018 including Task, Conference and Lounge.



The difference is in the details



## Luna

### HIGH DESIGN MEETS SUPREME ERGONOMICS

- Task, stool, conference and collaborative seating
- Sleek contemporary design
- Aluminum accents standard
- Ergonomic features including multiple synchro controls, adjustable arms, adjustable lumbar

Available Q1 2018

See page 138

### STYLE, FLEXIBILITY AND VERSATILITY

- Stacking chair ideal for training, collaborative and meeting spaces
- Sled and 4 leg models
- Flex back movement with pelvic support
- 12 plastic colors and 2 frame colors

Available Q1 2018

See page 142



## Mimi

### THE NEW WAY TO WORK

- Task, stool, conference and collaborative seating
- Simple, clean design lines
- Ergonomic features including multiple synchro controls, adjustable arms, adjustable lumbar and seat slider

Available Q1 2018

See page 150



## Neo



## Sol

### THE FUTURE AT A GLANCE

- Task, executive and conference seating
- Modern, elegant design with aluminum accents
- Flexible back promotes movement
- Ergonomic features including weight balances synchro, adjustable arms, adjustable lumbar and seat slider

Available Q1 2018

See page 178



## Lilly

### CLASSIC, SOPHISTICATED AND SUPREMELY COMFORTABLE

- Ideal for collaborative, lounge and touchdown workspaces
- Versatile with four base options
- Comfortable with roomy back

Available Q1 2018

See page 116

### ROCKING TILT

- For lounge, guest and collaboration applications
- Rocking motion tilts right, left, front and back
- Available with Cydia Lounge and Diddy Guest

Available Q1 2018

See page 250



## R2

Cosmo Mesh Back - All mesh styles now available M1, M2, M3  
Cosmo Upholstered Back - All Fabric grades now available

Bella - 12 plastic colors now available  
(Black only on mesh back models)

# acclaim

contemporary european styling yet subtle detailing

## HIGH-BACK

GSA SIN # 711-18

- Conference and executive seating
- Sleek rectilinear design with fine stitching
- Dual density foam provides firm profile with plush comfortable interior
- Multiple synchro controls available
- Polished arm with upholstered pad available
- Warranted to 300 lbs.
- CAL TB 133 Fire Code approved



### CREATING ACCLAIM MODEL NUMBER

MODEL NUMBER CONTROL ARMS GRADE BASE CASTERS PACKAGING OPTIONS

2 7 8 0 - - A - - - B A - - - C - - - - -

\* FOR ARMLESS CODE USE ADD      \* IF BASE AND CASTER MODEL NUMBERS ARE LEFT BLANK THEN STANDARD OPTION WILL BE ASSUMED      \* GT MODELS DO NOT HAVE A CASTER CODE

### PACKAGING NOTES

CODE	DESCRIPTION	LIST UPCHARGE
AB	ASSEMBLED IN BAG	\$0
PAC	PARTIALLY ASSEMBLED IN CARTON	\$0
BAC	BACK ASSEMBLED IN CARTON	\$40

MODEL	CONTROL	DESCRIPTION	ARM	FABRIC/LEATHER	FEATURES	DIMENSIONS	ARM OPTIONS	CASTERS																																																																						
2780	W2	<b>HIGH-BACK ADVANCED WEIGHT BALANCED SYNCHRO</b>  Use for a variety of general office seating, including private office and conference room seating	ARMLESS A10 A19 A27 A36 A37	<table border="1"> <thead> <tr> <th>A/COM</th> <th>B</th> <th>C</th> <th>D</th> <th>E</th> <th>F</th> <th>G</th> <th>L3/COL</th> <th>L4</th> <th>L5</th> </tr> </thead> <tbody> <tr><td>495</td><td>550</td><td>585</td><td>640</td><td>700</td><td>770</td><td>845</td><td>675</td><td>720</td><td>940</td></tr> <tr><td>580</td><td>635</td><td>670</td><td>725</td><td>785</td><td>855</td><td>930</td><td>760</td><td>805</td><td>1025</td></tr> <tr><td>695</td><td>750</td><td>785</td><td>840</td><td>900</td><td>970</td><td>1045</td><td>875</td><td>920</td><td>1140</td></tr> <tr><td>675</td><td>730</td><td>765</td><td>820</td><td>880</td><td>950</td><td>1025</td><td>855</td><td>900</td><td>1120</td></tr> <tr><td>600</td><td>655</td><td>690</td><td>745</td><td>805</td><td>875</td><td>950</td><td>780</td><td>825</td><td>1045</td></tr> <tr><td>620</td><td>675</td><td>710</td><td>765</td><td>825</td><td>895</td><td>970</td><td>800</td><td>845</td><td>1065</td></tr> </tbody> </table>	A/COM	B	C	D	E	F	G	L3/COL	L4	L5	495	550	585	640	700	770	845	675	720	940	580	635	670	725	785	855	930	760	805	1025	695	750	785	840	900	970	1045	875	920	1140	675	730	765	820	880	950	1025	855	900	1120	600	655	690	745	805	875	950	780	825	1045	620	675	710	765	825	895	970	800	845	1065	<ul style="list-style-type: none"> <li>• Pneumatic seat height adjustment</li> <li>• Weight balanced synchro control</li> <li>• 4 position back-recline limiting lock</li> <li>• Warranted to 300 lbs.</li> </ul>	<p>WIDTH: 27.5</p> <p>DEPTH: 26.5</p> <p>HEIGHT: 44.5-49.0</p> <p>SEAT WIDTH: 20.0</p> <p>SEAT DEPTH: 17.0</p> <p>SEAT HEIGHT: 18.0-23.0</p> <p>BACK WIDTH: 21.5</p> <p>BACK HEIGHT: 44.5</p> <p>COM: 1.8 YD</p> <p>COL: 27 SQ FT</p> <p>WEIGHT: 48.0 LB</p>	<p><b>A10</b> \$85 Soft Touch C-Shaped Arm</p> <p><b>A19</b> \$200 Polished Aluminum C-Shape Arm with Black Urethane Surface</p> <p><b>A36</b> \$105 Height Adjustable Pivot/Slide Arm</p> <p><b>A27</b> \$180 Polished Aluminum C-Shape Arm with Matching Upholstered Pad</p> <p><b>A37</b> \$125 Height/Width Adjustable Pivot/Slide Arm</p>	<p><b>N/C</b> STD 60mm Hoodless Casters</p> <p><b>C6S</b> \$35 60mm Hoodless Hard Floor Casters</p> <p><b>C7</b> STD 60mm Hoodless Chrome Accented Casters</p>
A/COM	B	C	D	E	F	G	L3/COL	L4	L5																																																																					
495	550	585	640	700	770	845	675	720	940																																																																					
580	635	670	725	785	855	930	760	805	1025																																																																					
695	750	785	840	900	970	1045	875	920	1140																																																																					
675	730	765	820	880	950	1025	855	900	1120																																																																					
600	655	690	745	805	875	950	780	825	1045																																																																					
620	675	710	765	825	895	970	800	845	1065																																																																					
2780	Y2	<b>HIGH-BACK HEAVY DUTY SYNCHRO</b>  Use for a variety of general office seating, including private office and conference room seating	ARMLESS A10 A19 A27 A36 A37	<table border="1"> <thead> <tr> <th>A/COM</th> <th>B</th> <th>C</th> <th>D</th> <th>E</th> <th>F</th> <th>G</th> <th>L3/COL</th> <th>L4</th> <th>L5</th> </tr> </thead> <tbody> <tr><td>555</td><td>610</td><td>645</td><td>700</td><td>760</td><td>830</td><td>905</td><td>735</td><td>780</td><td>1000</td></tr> <tr><td>640</td><td>695</td><td>730</td><td>785</td><td>845</td><td>915</td><td>990</td><td>820</td><td>865</td><td>1085</td></tr> <tr><td>755</td><td>810</td><td>845</td><td>900</td><td>960</td><td>1030</td><td>1105</td><td>935</td><td>980</td><td>1200</td></tr> <tr><td>735</td><td>790</td><td>825</td><td>880</td><td>940</td><td>1010</td><td>1085</td><td>915</td><td>960</td><td>1180</td></tr> <tr><td>660</td><td>715</td><td>750</td><td>805</td><td>865</td><td>935</td><td>1010</td><td>840</td><td>885</td><td>1105</td></tr> <tr><td>680</td><td>735</td><td>770</td><td>825</td><td>885</td><td>955</td><td>1030</td><td>860</td><td>905</td><td>1125</td></tr> </tbody> </table>	A/COM	B	C	D	E	F	G	L3/COL	L4	L5	555	610	645	700	760	830	905	735	780	1000	640	695	730	785	845	915	990	820	865	1085	755	810	845	900	960	1030	1105	935	980	1200	735	790	825	880	940	1010	1085	915	960	1180	660	715	750	805	865	935	1010	840	885	1105	680	735	770	825	885	955	1030	860	905	1125	<ul style="list-style-type: none"> <li>• Pneumatic seat height adjustment</li> <li>• Side tension control</li> <li>• Synchro control</li> <li>• 4 position back lock</li> <li>• Warranted to 300 lbs.</li> </ul>	<p>WIDTH: 27.5</p> <p>DEPTH: 26.5</p> <p>HEIGHT: 45.0-49.5</p> <p>SEAT WIDTH: 20.0</p> <p>SEAT DEPTH: 17.0</p> <p>SEAT HEIGHT: 18.0-23.0</p> <p>BACK WIDTH: 21.5</p> <p>BACK HEIGHT: 44.5</p> <p>COM: 1.8 YD</p> <p>COL: 27 SQ FT</p> <p>WEIGHT: 50.0 LB</p>	<p><b>SS</b> \$60 Seat Slider 2.5" Side Paddle Activated (for Models with Y2 Control Only)</p>	
A/COM	B	C	D	E	F	G	L3/COL	L4	L5																																																																					
555	610	645	700	760	830	905	735	780	1000																																																																					
640	695	730	785	845	915	990	820	865	1085																																																																					
755	810	845	900	960	1030	1105	935	980	1200																																																																					
735	790	825	880	940	1010	1085	915	960	1180																																																																					
660	715	750	805	865	935	1010	840	885	1105																																																																					
680	735	770	825	885	955	1030	860	905	1125																																																																					
2780	Y5	<b>HIGH-BACK ENHANCED SYNCHRO WITH BACK ANGLE ADJUSTMENT</b>  High function synchro control with independent back angle adjustment. Use for general office, task or management	ARMLESS A10 A19 A27 A36 A37	<table border="1"> <thead> <tr> <th>A/COM</th> <th>B</th> <th>C</th> <th>D</th> <th>E</th> <th>F</th> <th>G</th> <th>L3/COL</th> <th>L4</th> <th>L5</th> </tr> </thead> <tbody> <tr><td>575</td><td>630</td><td>665</td><td>720</td><td>780</td><td>850</td><td>925</td><td>755</td><td>800</td><td>1020</td></tr> <tr><td>660</td><td>715</td><td>750</td><td>805</td><td>865</td><td>935</td><td>1010</td><td>840</td><td>885</td><td>1105</td></tr> <tr><td>775</td><td>830</td><td>865</td><td>920</td><td>980</td><td>1050</td><td>1125</td><td>955</td><td>1000</td><td>1220</td></tr> <tr><td>755</td><td>810</td><td>845</td><td>900</td><td>960</td><td>1030</td><td>1105</td><td>935</td><td>980</td><td>1200</td></tr> <tr><td>680</td><td>735</td><td>770</td><td>825</td><td>885</td><td>955</td><td>1030</td><td>860</td><td>905</td><td>1125</td></tr> <tr><td>700</td><td>755</td><td>790</td><td>845</td><td>905</td><td>975</td><td>1050</td><td>880</td><td>925</td><td>1145</td></tr> </tbody> </table>	A/COM	B	C	D	E	F	G	L3/COL	L4	L5	575	630	665	720	780	850	925	755	800	1020	660	715	750	805	865	935	1010	840	885	1105	775	830	865	920	980	1050	1125	955	1000	1220	755	810	845	900	960	1030	1105	935	980	1200	680	735	770	825	885	955	1030	860	905	1125	700	755	790	845	905	975	1050	880	925	1145	<ul style="list-style-type: none"> <li>• Pneumatic seat height adjustment</li> <li>• Enhanced synchro with independent back angle adjustment</li> <li>• 4 position back lock</li> <li>• Side tension control</li> <li>• Standard seat slider adds 3" adjustment</li> <li>• Warranted to 300 lbs.</li> </ul>	<p>WIDTH: 27.5</p> <p>DEPTH: 26.5</p> <p>HEIGHT: 44.5-49.0</p> <p>SEAT WIDTH: 20.0</p> <p>SEAT DEPTH: 17.0</p> <p>SEAT HEIGHT: 18.0-22.5</p> <p>BACK WIDTH: 21.5</p> <p>BACK HEIGHT: 44.5</p> <p>COM: 1.8 YD</p> <p>COL: 27 SQ FT</p> <p>WEIGHT: 51.0 LB</p>	<p><b>BA11B</b> STD 27" Mid-Profile Nylon Base - Black</p> <p><b>BA12P</b> \$100 27" Mid-Profile Aluminum Base - Polished (C7 Chrome Accented Hoodless Casters Standard with Polished Base)</p>	
A/COM	B	C	D	E	F	G	L3/COL	L4	L5																																																																					
575	630	665	720	780	850	925	755	800	1020																																																																					
660	715	750	805	865	935	1010	840	885	1105																																																																					
775	830	865	920	980	1050	1125	955	1000	1220																																																																					
755	810	845	900	960	1030	1105	935	980	1200																																																																					
680	735	770	825	885	955	1030	860	905	1125																																																																					
700	755	790	845	905	975	1050	880	925	1145																																																																					

# agent

lending comfort, durability, and value to every project

## LOW-BACK

GSA SIN # 711-18

- Task, conference and stool seating
- Ratchet back height adjustment on P1, R1, M1 and Y2 models
- Warranted to 300 lbs.
- CAL TB 133 Fire Code approved



### CREATING AGENT MODEL NUMBER

MODEL NUMBER CONTROL ARMS GRADE BASE CASTERS PACKAGING OPTIONS

1 4 2 5 - - A - - B A 1 B - C - - - -

\* FOR ARMLESS CODE USE A00 \* IF BASE AND CASTER MODEL NUMBERS ARE LEFT BLANK THEN STANDARD OPTION WILL BE ASSUMED

### PACKAGING NOTES

CODE	DESCRIPTION	LIST UPCHARGE
AB	ASSEMBLED IN BAG	\$0
PAC	PARTIALLY ASSEMBLED IN CARTON	\$0
BAC	BACK ASSEMBLED IN CARTON	\$40

MODEL	CONTROL	DESCRIPTION	ARM	FABRIC/LEATHER							FEATURES	DIMENSIONS	ARM OPTIONS	CASTER OPTIONS	
				A/COM	B	C	D	E	F	G					
1425	B2	<b>BASIC TASK</b> Our basic control has simple adjustments. Ideal for clerical, casual meetings and general office use	ARMLESS	280	305	325	350	380	415	450	<ul style="list-style-type: none"> <li>• 360-degree swivel</li> <li>• Pneumatic seat height adjustment</li> <li>• No seat and back tilt</li> <li>• Adjustable back depth</li> <li>• Warranted to 300 lbs.</li> </ul>	<b>WIDTH:</b> 27 <b>DEPTH:</b> 26.5 <b>HEIGHT:</b> 31.5-36.0 <b>SEAT WIDTH:</b> 19.5 <b>SEAT DEPTH:</b> 15.5 <b>SEAT HEIGHT:</b> 17.5-22.0 <b>BACK WIDTH:</b> 16.5 <b>BACK HEIGHT:</b> 16.5 <b>COM:</b> 0.8 YDS <b>WEIGHT:</b> 33.0 LB	<b>A1</b> \$70	<b>A4</b> \$75 <b>A5</b> \$95	<b>C1</b> STD
A1	350		375	395	420	450	485	520							
A4	355		380	400	425	455	490	525							
A5	375		400	420	445	475	510	545							
A6	410		435	455	480	510	545	580							
A7	430		455	475	500	530	565	600							
A16	380		405	425	450	480	515	550							
A36	385		410	430	455	485	520	555							
A37	405	430	450	475	505	540	575								
1425	S2	<b>SWIVEL TILT</b> Use for a variety of general office seating, including private office and conference room seating	ARMLESS	325	350	370	395	425	460	495	<ul style="list-style-type: none"> <li>• Pneumatic seat height adjustment</li> <li>• Tilt tension control</li> <li>• Seat and back tilt as a unit</li> <li>• Upright position tilt lock</li> <li>• 360-degree swivel</li> <li>• Adjustable back depth</li> <li>• Warranted to 300 lbs.</li> </ul>	<b>WIDTH:</b> 27.0 <b>DEPTH:</b> 26.5 <b>HEIGHT:</b> 31.5-36.0 <b>SEAT WIDTH:</b> 19.5 <b>SEAT DEPTH:</b> 15.5 <b>SEAT HEIGHT:</b> 17.5-22.0 <b>BACK WIDTH:</b> 16.5 <b>BACK HEIGHT:</b> 16.5 <b>COM:</b> 0.8 YDS <b>WEIGHT:</b> 35.0 LB	<b>A6</b> \$130 <b>A7</b> \$150	<b>A16</b> \$100	<b>C1S</b> \$35
A1	395		420	440	465	495	530	565							
A4	400		425	445	470	500	535	570							
A5	420		445	465	490	520	555	590							
A6	455		480	500	525	555	590	625							
A7	475		500	520	545	575	610	645							
A16	425		450	470	495	525	560	595							
A36	430		455	475	500	530	565	600							
A37	450	475	495	520	550	585	620								
				<b>SEAT SLIDER (SS) - ADD \$60</b>											
1425	P1	<b>POSTURE BACK</b> The articulating back provides proper support for moderate tasking applications	ARMLESS	365	390	410	435	465	500	535	<ul style="list-style-type: none"> <li>• Pneumatic seat height adjustment</li> <li>• Infinite back angle adj. with free float</li> <li>• Back tilt adjustment</li> <li>• Ratchet back height lumbar adjustment</li> <li>• Warranted to 300 lbs.</li> </ul>	<b>WIDTH:</b> 27.0 <b>DEPTH:</b> 26.5 <b>HEIGHT:</b> 31.5-39.0 <b>SEAT WIDTH:</b> 19.5 <b>SEAT DEPTH:</b> 15.5 <b>SEAT HEIGHT:</b> 17.5-22.0 <b>BACK WIDTH:</b> 16.5 <b>BACK HEIGHT:</b> 16.5-19.5 <b>COM:</b> 0.8 YDS <b>WEIGHT:</b> 37.0 LB	<b>BA1B</b> STD	<b>BASE OPTIONS</b>	
A1	435		460	480	505	535	570	605							
A4	440		465	485	510	540	575	610							
A5	460		485	505	530	560	595	630							
A6	495		520	540	565	595	630	665							
A7	515		540	560	585	615	650	685							
A16	465		490	510	535	565	600	635							
A36	470		495	515	540	570	605	640							
A37	490	515	535	560	590	625	660								
				<b>SEAT SLIDER (SS) - ADD \$60</b>											
1425	R1	<b>ROCKING TILT</b> For managerial and task applications. Similar to a swivel tilt control, with the added comfort of infinite back angle and tilt adjustment	ARMLESS	375	400	420	445	475	510	545	<ul style="list-style-type: none"> <li>• Pneumatic seat height adjustment</li> <li>• Tilt tension control</li> <li>• Seat and back tilt as a unit</li> <li>• Floating seat position tilt lock</li> <li>• Infinite back angle adj. w/ free float</li> <li>• Ratchet back height lumbar adjustment</li> <li>• Warranted to 300 lbs.</li> </ul>	<b>WIDTH:</b> 27.0 <b>DEPTH:</b> 26.5 <b>HEIGHT:</b> 31.5-36.0 <b>SEAT WIDTH:</b> 19.5 <b>SEAT DEPTH:</b> 15.5 <b>SEAT HEIGHT:</b> 17.5-22.0 <b>BACK WIDTH:</b> 16.5 <b>BACK HEIGHT:</b> 16.5 <b>COM:</b> 0.8 YDS <b>WEIGHT:</b> 33.0 LB	<b>EF1</b> \$30	<b>MF1</b> \$50	<b>SS</b> \$60
A1	445		470	490	515	545	580	615							
A4	450		475	495	520	550	585	620							
A5	470		495	515	540	570	605	640							
A6	505		530	550	575	605	640	675							
A7	525		550	570	595	625	660	695							
A16	475		500	520	545	575	610	645							
A36	480		505	525	550	580	615	650							
A37	500	525	545	570	600	635	670								
				<b>SEAT SLIDER (SS) - ADD \$60</b>											

### ADDITIONAL OPTIONS

	<b>EF1</b>	<b>\$30</b>
	<b>MF1</b>	<b>\$50</b>
	<b>SS</b>	<b>\$60</b>
	<b>BT</b>	<b>\$15</b>

Replace Knob with Bolt (for B2 or S2 Controls ONLY)

# agent

lending comfort, durability, and value to every project

## LOW-BACK

GSA SIN # 711-18

- Task, conference and stool seating
- Ratchet back height adjustment on P1, R1, M1 and Y2 models
- Warranted to 300 lbs.
- CAL TB 133 Fire Code approved



### CREATING AGENT MODEL NUMBER

MODEL NUMBER CONTROL ARMS GRADE BASE CASTERS PACKAGING OPTIONS

1 4 2 5 - [ ] [ ] - A [ ] [ ] - B A 1 B - C [ ] [ ] [ ] [ ] [ ] [ ] [ ] [ ]

\* FOR ARMLESS CODE USE A00 \*IF BASE AND CASTER MODEL NUMBERS ARE LEFT BLANK THEN STANDARD OPTION WILL BE ASSUMED

### PACKAGING NOTES

CODE	DESCRIPTION	LIST UPCHARGE
AB	ASSEMBLED IN BAG	\$0
PAC	PARTIALLY ASSEMBLED IN CARTON	\$0
BAC	BACK ASSEMBLED IN CARTON	\$40

MODEL	CONTROL	DESCRIPTION	ARM	FABRIC/LEATHER	FEATURES	DIMENSIONS	ARM OPTIONS	CASTER OPTIONS																																																																						
1425	M1	<b>MULTI-FUNCTION</b> Fully articulating seat and back for the highest level of ergonomic needs. Forward seat pitch adjustment from 0 to 6 degrees	<ul style="list-style-type: none"> <li>ARMLESS</li> <li>A1</li> <li>A4</li> <li>A5</li> <li>A6</li> <li>A7</li> <li>A16</li> <li>A36</li> <li>A37</li> </ul>	<table border="1"> <thead> <tr> <th>A/COM</th> <th>B</th> <th>C</th> <th>D</th> <th>E</th> <th>F</th> <th>G</th> </tr> </thead> <tbody> <tr><td>425</td><td>450</td><td>470</td><td>495</td><td>525</td><td>560</td><td>595</td></tr> <tr><td>495</td><td>520</td><td>540</td><td>565</td><td>595</td><td>630</td><td>665</td></tr> <tr><td>500</td><td>525</td><td>545</td><td>570</td><td>600</td><td>635</td><td>670</td></tr> <tr><td>520</td><td>545</td><td>565</td><td>590</td><td>620</td><td>655</td><td>690</td></tr> <tr><td>555</td><td>580</td><td>600</td><td>625</td><td>655</td><td>690</td><td>725</td></tr> <tr><td>575</td><td>600</td><td>620</td><td>645</td><td>675</td><td>710</td><td>745</td></tr> <tr><td>525</td><td>550</td><td>570</td><td>595</td><td>625</td><td>660</td><td>695</td></tr> <tr><td>530</td><td>555</td><td>575</td><td>600</td><td>630</td><td>665</td><td>700</td></tr> <tr><td>550</td><td>575</td><td>595</td><td>620</td><td>650</td><td>685</td><td>720</td></tr> </tbody> </table> <p>SEAT SLIDER (SS) - ADD \$60</p>	A/COM	B	C	D	E	F	G	425	450	470	495	525	560	595	495	520	540	565	595	630	665	500	525	545	570	600	635	670	520	545	565	590	620	655	690	555	580	600	625	655	690	725	575	600	620	645	675	710	745	525	550	570	595	625	660	695	530	555	575	600	630	665	700	550	575	595	620	650	685	720	<ul style="list-style-type: none"> <li>• Pneumatic seat height adjustment</li> <li>• Tilt tension control</li> <li>• Seat and back tilt as a unit</li> <li>• Floating seat position tilt lock</li> <li>• Infinite back angle adj. w/ free float</li> <li>• Seat pivots from 0° to 6° forward</li> <li>• Ratchet back height lumbar adjustment</li> <li>• Warranted to 300 lbs.</li> </ul>	<p><b>WIDTH:</b> 27.0 <b>DEPTH:</b> 26.5 <b>HEIGHT:</b> 31.5-39.0 <b>SEAT WIDTH:</b> 19.5 <b>SEAT DEPTH:</b> 15.5 <b>SEAT HEIGHT:</b> 17.5-22.0 <b>BACK WIDTH:</b> 16.5 <b>BACK HEIGHT:</b> 16.5-19.5 <b>COM:</b> 0.8 YDS <b>WEIGHT:</b> 43.0 LB</p>	<p><b>A1</b> \$70 Soft Touch Loop Arm</p> <p><b>A4</b> \$75 <b>A5</b> \$95 A4 - Height Adjustable Arm A5 - Height/Width Adjustable Arm</p> <p><b>A6</b> \$130 <b>A7</b> \$150 A6 - Height Adjustable Pivot Slide Arm A7 - Height/width Adjustable Pivot Slide Arm</p> <p><b>A36</b> \$105 Height Adjustable Pivot/Slide Arm</p> <p><b>A16</b> \$100 Soft Touch C-Shape Arm</p> <p><b>A37</b> \$125 Height/Width Adjustable Pivot/Slide Arm</p>	<p><b>C1</b> STD 50mm Hooded Casters</p> <p><b>C1S</b> \$35 50mm Hooded Hard Floor Casters</p> <p><b>C2S</b> \$35 50mm Hooded Self-Lock Hard Floor Casters</p>
A/COM	B	C	D	E	F	G																																																																								
425	450	470	495	525	560	595																																																																								
495	520	540	565	595	630	665																																																																								
500	525	545	570	600	635	670																																																																								
520	545	565	590	620	655	690																																																																								
555	580	600	625	655	690	725																																																																								
575	600	620	645	675	710	745																																																																								
525	550	570	595	625	660	695																																																																								
530	555	575	600	630	665	700																																																																								
550	575	595	620	650	685	720																																																																								
1425	Y2-SS	<b>HEAVY DUTY SYNCHRO</b> Use for general office, task or management	<ul style="list-style-type: none"> <li>ARMLESS</li> <li>A1</li> <li>A4</li> <li>A5</li> <li>A6</li> <li>A7</li> <li>A16</li> <li>A36</li> <li>A37</li> </ul>	<table border="1"> <thead> <tr> <th>A/COM</th> <th>B</th> <th>C</th> <th>D</th> <th>E</th> <th>F</th> <th>G</th> </tr> </thead> <tbody> <tr><td>465</td><td>490</td><td>510</td><td>535</td><td>565</td><td>600</td><td>635</td></tr> <tr><td>535</td><td>560</td><td>580</td><td>605</td><td>635</td><td>670</td><td>705</td></tr> <tr><td>540</td><td>565</td><td>585</td><td>610</td><td>640</td><td>675</td><td>710</td></tr> <tr><td>560</td><td>585</td><td>605</td><td>630</td><td>660</td><td>695</td><td>730</td></tr> <tr><td>595</td><td>620</td><td>640</td><td>665</td><td>695</td><td>730</td><td>765</td></tr> <tr><td>615</td><td>640</td><td>660</td><td>685</td><td>715</td><td>750</td><td>785</td></tr> <tr><td>565</td><td>590</td><td>610</td><td>635</td><td>665</td><td>700</td><td>735</td></tr> <tr><td>570</td><td>595</td><td>615</td><td>640</td><td>670</td><td>705</td><td>740</td></tr> <tr><td>590</td><td>615</td><td>635</td><td>660</td><td>690</td><td>725</td><td>760</td></tr> </tbody> </table> <p>SEAT SLIDER (SS) - STANDARD</p>	A/COM	B	C	D	E	F	G	465	490	510	535	565	600	635	535	560	580	605	635	670	705	540	565	585	610	640	675	710	560	585	605	630	660	695	730	595	620	640	665	695	730	765	615	640	660	685	715	750	785	565	590	610	635	665	700	735	570	595	615	640	670	705	740	590	615	635	660	690	725	760	<ul style="list-style-type: none"> <li>• Pneumatic seat height adjustment</li> <li>• Side tilt tension control</li> <li>• Back and seat tilt in 2:1 ratio</li> <li>• 4 locking positions</li> <li>• Safety tilt release</li> <li>• Ratchet back height lumbar adjustment</li> <li>• Seat slider standard</li> <li>• Warranted to 300 lbs.</li> </ul>	<p><b>WIDTH:</b> 27.0 <b>DEPTH:</b> 26.5 <b>HEIGHT:</b> 31.5-36.0 <b>SEAT WIDTH:</b> 19.5 <b>SEAT DEPTH:</b> 15.5 <b>SEAT HEIGHT:</b> 17.5-22.0 <b>BACK WIDTH:</b> 16.5 <b>BACK HEIGHT:</b> 16.5 <b>COM:</b> 0.8 YDS <b>WEIGHT:</b> 35.0 LB</p>	<p><b>BA1B</b> STD 26" Nylon Base - Black</p>	<p><b>EF1</b> \$30 1" Extra Foam on Seat</p> <p><b>MF1</b> \$50 1" Visco Elastic Memory Foam on Seat</p> <p><b>SS</b> \$60 Seat Slider 2.5" Side Paddle Activated (Standard with Y2 Control)</p> <p><b>BT</b> \$15 Replace Knob with Bolt (for B2 or S2 Controls Only)</p>
A/COM	B	C	D	E	F	G																																																																								
465	490	510	535	565	600	635																																																																								
535	560	580	605	635	670	705																																																																								
540	565	585	610	640	675	710																																																																								
560	585	605	630	660	695	730																																																																								
595	620	640	665	695	730	765																																																																								
615	640	660	685	715	750	785																																																																								
565	590	610	635	665	700	735																																																																								
570	595	615	640	670	705	740																																																																								
590	615	635	660	690	725	760																																																																								

# agent

lending comfort, durability, and value to every project

## LOW-BACK STOOL

GSA SIN # 711-18

- Task, conference and stool seating
- Ratchet back height adjustment on P1, R1, M1 and Y2 models
- Warranted to 300 lbs.
- CAL TB 133 Fire Code approved



### CREATING AGENT MODEL NUMBER

MODEL NUMBER CONTROL ARMS GRADE BASE CASTERS PACKAGING OPTIONS

1 4 2 - - - A - - - B A 1 B - C - - - -

\* FOR ARMLESS CODE USE A00 \*\* IF BASE AND CASTER MODEL NUMBERS ARE LEFT BLANK THEN STANDARD OPTION WILL BE ASSUMED

### PACKAGING NOTES

CODE	DESCRIPTION	LIST UPCHARGE
AB	ASSEMBLED IN BAG	\$0
PAC	PARTIALLY ASSEMBLED IN CARTON	\$0
BAC	BACK ASSEMBLED IN CARTON	\$40

MODEL	CONTROL	DESCRIPTION	ARM	FABRIC/LEATHER	FEATURES	DIMENSIONS	ARM OPTIONS	CASTER OPTIONS																																																																						
1426	B2	<b>10" STOOL BASIC TASK</b> Use for work surfaces up to 42 inches high	ARMLESS A1 A4 A5 A6 A7 A16 A36 A37	<table border="1"> <thead> <tr> <th>A/COM</th> <th>B</th> <th>C</th> <th>D</th> <th>E</th> <th>F</th> <th>G</th> </tr> </thead> <tbody> <tr><td>405</td><td>430</td><td>450</td><td>475</td><td>505</td><td>540</td><td>575</td></tr> <tr><td>475</td><td>500</td><td>520</td><td>545</td><td>575</td><td>610</td><td>645</td></tr> <tr><td>480</td><td>505</td><td>525</td><td>550</td><td>580</td><td>615</td><td>650</td></tr> <tr><td>500</td><td>525</td><td>545</td><td>570</td><td>600</td><td>635</td><td>670</td></tr> <tr><td>535</td><td>560</td><td>580</td><td>605</td><td>635</td><td>670</td><td>705</td></tr> <tr><td>555</td><td>580</td><td>600</td><td>625</td><td>655</td><td>690</td><td>725</td></tr> <tr><td>505</td><td>530</td><td>550</td><td>575</td><td>605</td><td>640</td><td>675</td></tr> <tr><td>510</td><td>535</td><td>555</td><td>580</td><td>610</td><td>645</td><td>680</td></tr> <tr><td>530</td><td>555</td><td>575</td><td>600</td><td>630</td><td>665</td><td>700</td></tr> </tbody> </table>	A/COM	B	C	D	E	F	G	405	430	450	475	505	540	575	475	500	520	545	575	610	645	480	505	525	550	580	615	650	500	525	545	570	600	635	670	535	560	580	605	635	670	705	555	580	600	625	655	690	725	505	530	550	575	605	640	675	510	535	555	580	610	645	680	530	555	575	600	630	665	700	<ul style="list-style-type: none"> <li>• 360-degree swivel</li> <li>• Pneumatic seat height adjustment</li> <li>• Adjustable back depth</li> <li>• No seat and back tilt</li> <li>• Height adjustable footring</li> <li>• Warranted to 300 lbs.</li> </ul>	<b>WIDTH:</b> 27.0 <b>DEPTH:</b> 26.5 <b>HEIGHT:</b> 40.5-50.5 <b>SEAT WIDTH:</b> 19.5 <b>SEAT DEPTH:</b> 15.5 <b>SEAT HEIGHT:</b> 26.5-36.5 <b>BACK WIDTH:</b> 16.5 <b>BACK HEIGHT:</b> 16.5 <b>COM:</b> 0.8 YDS <b>WEIGHT:</b> 38.0 LB	<b>A1</b> \$70 Soft Touch Loop Arm <b>A4</b> \$75 <b>A5</b> \$95 A4 - Height Adjustable Arm A5 - Height/Width Adjustable Arm <b>A6</b> \$130 <b>A7</b> \$150 A6 - Height Adjustable Pivot Slide Arm A7 - Height/width Adjustable Pivot Slide Arm <b>A36</b> \$105 Height Adjustable Pivot/Slide Arm <b>A37</b> \$125 Height/Width Adjustable Pivot/Slide Arm	<b>C1</b> STD 50mm Hooded Casters <b>C1S</b> \$35 50mm Hooded Hard Floor Casters <b>C2S</b> \$35 50mm Hooded Self-Lock Hard Floor Casters
A/COM	B	C	D	E	F	G																																																																								
405	430	450	475	505	540	575																																																																								
475	500	520	545	575	610	645																																																																								
480	505	525	550	580	615	650																																																																								
500	525	545	570	600	635	670																																																																								
535	560	580	605	635	670	705																																																																								
555	580	600	625	655	690	725																																																																								
505	530	550	575	605	640	675																																																																								
510	535	555	580	610	645	680																																																																								
530	555	575	600	630	665	700																																																																								
				SEAT SLIDER (SS) - NOT AVAILABLE																																																																										
1426	P1	<b>10" STOOL POSTURE BACK</b> Use for work surfaces up to 42 inches high	ARMLESS A1 A4 A5 A6 A7 A16 A36 A37	<table border="1"> <thead> <tr> <th>A/COM</th> <th>B</th> <th>C</th> <th>D</th> <th>E</th> <th>F</th> <th>G</th> </tr> </thead> <tbody> <tr><td>490</td><td>515</td><td>535</td><td>560</td><td>590</td><td>625</td><td>660</td></tr> <tr><td>560</td><td>585</td><td>605</td><td>630</td><td>660</td><td>695</td><td>730</td></tr> <tr><td>565</td><td>590</td><td>610</td><td>635</td><td>665</td><td>700</td><td>735</td></tr> <tr><td>585</td><td>610</td><td>630</td><td>655</td><td>685</td><td>720</td><td>755</td></tr> <tr><td>620</td><td>645</td><td>665</td><td>690</td><td>720</td><td>755</td><td>790</td></tr> <tr><td>640</td><td>665</td><td>685</td><td>710</td><td>740</td><td>775</td><td>810</td></tr> <tr><td>590</td><td>615</td><td>635</td><td>660</td><td>690</td><td>725</td><td>760</td></tr> <tr><td>595</td><td>620</td><td>640</td><td>665</td><td>695</td><td>730</td><td>765</td></tr> <tr><td>615</td><td>640</td><td>660</td><td>685</td><td>715</td><td>750</td><td>785</td></tr> </tbody> </table>	A/COM	B	C	D	E	F	G	490	515	535	560	590	625	660	560	585	605	630	660	695	730	565	590	610	635	665	700	735	585	610	630	655	685	720	755	620	645	665	690	720	755	790	640	665	685	710	740	775	810	590	615	635	660	690	725	760	595	620	640	665	695	730	765	615	640	660	685	715	750	785	<ul style="list-style-type: none"> <li>• Pneumatic seat height adjustment</li> <li>• Infinite back angle adjusts with free float</li> <li>• Ratchet back height lumbar adjustment</li> <li>• Height adjustable footring</li> <li>• Warranted to 300 lbs.</li> </ul>	<b>WIDTH:</b> 27.0 <b>DEPTH:</b> 26.5 <b>HEIGHT:</b> 40.5-53.5 <b>SEAT WIDTH:</b> 19.5 <b>SEAT DEPTH:</b> 15.5 <b>SEAT HEIGHT:</b> 26.5-36.5 <b>BACK WIDTH:</b> 16.5 <b>BACK HEIGHT:</b> 16.5-19.5 <b>COM:</b> 0.8 YDS <b>WEIGHT:</b> 42.0 LB	<b>A6</b> \$130 <b>A7</b> \$150 A6 - Height Adjustable Pivot Slide Arm A7 - Height/width Adjustable Pivot Slide Arm <b>A36</b> \$105 Height Adjustable Pivot/Slide Arm <b>A37</b> \$125 Height/Width Adjustable Pivot/Slide Arm	<b>C1S</b> \$35 50mm Hooded Hard Floor Casters <b>C2S</b> \$35 50mm Hooded Self-Lock Hard Floor Casters
A/COM	B	C	D	E	F	G																																																																								
490	515	535	560	590	625	660																																																																								
560	585	605	630	660	695	730																																																																								
565	590	610	635	665	700	735																																																																								
585	610	630	655	685	720	755																																																																								
620	645	665	690	720	755	790																																																																								
640	665	685	710	740	775	810																																																																								
590	615	635	660	690	725	760																																																																								
595	620	640	665	695	730	765																																																																								
615	640	660	685	715	750	785																																																																								
				SEAT SLIDER (SS) - NOT AVAILABLE																																																																										
1428	B2	<b>8" STOOL BASIC TASK</b> Use for work surfaces up to 36 inches high	ARMLESS A1 A4 A5 A6 A7 A16 A36 A37	<table border="1"> <thead> <tr> <th>A/COM</th> <th>B</th> <th>C</th> <th>D</th> <th>E</th> <th>F</th> <th>G</th> </tr> </thead> <tbody> <tr><td>405</td><td>430</td><td>450</td><td>475</td><td>505</td><td>540</td><td>575</td></tr> <tr><td>475</td><td>500</td><td>520</td><td>545</td><td>575</td><td>610</td><td>645</td></tr> <tr><td>480</td><td>505</td><td>525</td><td>550</td><td>580</td><td>615</td><td>650</td></tr> <tr><td>500</td><td>525</td><td>545</td><td>570</td><td>600</td><td>635</td><td>670</td></tr> <tr><td>535</td><td>560</td><td>580</td><td>605</td><td>635</td><td>670</td><td>705</td></tr> <tr><td>555</td><td>580</td><td>600</td><td>625</td><td>655</td><td>690</td><td>725</td></tr> <tr><td>505</td><td>530</td><td>550</td><td>575</td><td>605</td><td>640</td><td>675</td></tr> <tr><td>510</td><td>535</td><td>555</td><td>580</td><td>610</td><td>645</td><td>680</td></tr> <tr><td>530</td><td>555</td><td>575</td><td>600</td><td>630</td><td>665</td><td>700</td></tr> </tbody> </table>	A/COM	B	C	D	E	F	G	405	430	450	475	505	540	575	475	500	520	545	575	610	645	480	505	525	550	580	615	650	500	525	545	570	600	635	670	535	560	580	605	635	670	705	555	580	600	625	655	690	725	505	530	550	575	605	640	675	510	535	555	580	610	645	680	530	555	575	600	630	665	700	<ul style="list-style-type: none"> <li>• 360-degree swivel</li> <li>• Pneumatic seat height adjustment</li> <li>• Adjustable back depth</li> <li>• No seat and back tilt</li> <li>• Height adjustable footring</li> <li>• Warranted to 300 lbs.</li> </ul>	<b>WIDTH:</b> 27.0 <b>DEPTH:</b> 26.5 <b>HEIGHT:</b> 35.0-43.0 <b>SEAT WIDTH:</b> 19.5 <b>SEAT DEPTH:</b> 15.5 <b>SEAT HEIGHT:</b> 21.5-29.5 <b>BACK WIDTH:</b> 16.5 <b>BACK HEIGHT:</b> 16.5 <b>COM:</b> 0.8 YDS <b>WEIGHT:</b> 37.0 LB	<b>BA1B</b> STD 26" Nylon Base - Black	
A/COM	B	C	D	E	F	G																																																																								
405	430	450	475	505	540	575																																																																								
475	500	520	545	575	610	645																																																																								
480	505	525	550	580	615	650																																																																								
500	525	545	570	600	635	670																																																																								
535	560	580	605	635	670	705																																																																								
555	580	600	625	655	690	725																																																																								
505	530	550	575	605	640	675																																																																								
510	535	555	580	610	645	680																																																																								
530	555	575	600	630	665	700																																																																								
				SEAT SLIDER (SS) - NOT AVAILABLE																																																																										
1428	P1	<b>8" STOOL POSTURE BACK</b> Use for work surfaces up to 36 inches high	ARMLESS A1 A4 A5 A6 A7 A16 A36 A37	<table border="1"> <thead> <tr> <th>A/COM</th> <th>B</th> <th>C</th> <th>D</th> <th>E</th> <th>F</th> <th>G</th> </tr> </thead> <tbody> <tr><td>490</td><td>515</td><td>535</td><td>560</td><td>590</td><td>625</td><td>660</td></tr> <tr><td>560</td><td>585</td><td>605</td><td>630</td><td>660</td><td>695</td><td>730</td></tr> <tr><td>565</td><td>590</td><td>610</td><td>635</td><td>665</td><td>700</td><td>735</td></tr> <tr><td>585</td><td>610</td><td>630</td><td>655</td><td>685</td><td>720</td><td>755</td></tr> <tr><td>620</td><td>645</td><td>665</td><td>690</td><td>720</td><td>755</td><td>790</td></tr> <tr><td>640</td><td>665</td><td>685</td><td>710</td><td>740</td><td>775</td><td>810</td></tr> <tr><td>590</td><td>615</td><td>635</td><td>660</td><td>690</td><td>725</td><td>760</td></tr> <tr><td>595</td><td>620</td><td>640</td><td>665</td><td>695</td><td>730</td><td>765</td></tr> <tr><td>615</td><td>640</td><td>660</td><td>685</td><td>715</td><td>750</td><td>785</td></tr> </tbody> </table>	A/COM	B	C	D	E	F	G	490	515	535	560	590	625	660	560	585	605	630	660	695	730	565	590	610	635	665	700	735	585	610	630	655	685	720	755	620	645	665	690	720	755	790	640	665	685	710	740	775	810	590	615	635	660	690	725	760	595	620	640	665	695	730	765	615	640	660	685	715	750	785	<ul style="list-style-type: none"> <li>• Pneumatic seat height adjustment</li> <li>• Infinite back angle adjusts with free float</li> <li>• Ratchet back height lumbar adjustment</li> <li>• Height adjustable footring</li> <li>• Warranted to 300 lbs.</li> </ul>	<b>WIDTH:</b> 27.0 <b>DEPTH:</b> 26.5 <b>HEIGHT:</b> 35.0-46.0 <b>SEAT WIDTH:</b> 19.5 <b>SEAT DEPTH:</b> 15.5 <b>SEAT HEIGHT:</b> 21.5-29.5 <b>BACK WIDTH:</b> 16.5 <b>BACK HEIGHT:</b> 16.5-19.5 <b>COM:</b> 0.8 YDS <b>WEIGHT:</b> 41.0 LB	<b>EF1</b> \$30 1" Extra Foam on Seat <b>MF1</b> \$50 1" Visco Elastic Memory Foam on Seat <b>BT</b> \$15 Replace Knob with Bolt (for B2 or S2 Controls Only)	
A/COM	B	C	D	E	F	G																																																																								
490	515	535	560	590	625	660																																																																								
560	585	605	630	660	695	730																																																																								
565	590	610	635	665	700	735																																																																								
585	610	630	655	685	720	755																																																																								
620	645	665	690	720	755	790																																																																								
640	665	685	710	740	775	810																																																																								
590	615	635	660	690	725	760																																																																								
595	620	640	665	695	730	765																																																																								
615	640	660	685	715	750	785																																																																								
				SEAT SLIDER (SS) - NOT AVAILABLE																																																																										



# agent

lending comfort, durability, and value to every project

## MID-BACK

GSA SIN # 711-18

- Task, conference and stool seating
- Ratchet back height adjustment on P1, R1, M1 and Y2 models
- Warranted to 300 lbs.
- CAL TB 133 Fire Code approved



### CREATING AGENT MODEL NUMBER



### PACKAGING NOTES

CODE	DESCRIPTION	LIST UPCHARGE
AB	ASSEMBLED IN BAG	\$0
PAC	PARTIALLY ASSEMBLED IN CARTON	\$0
BAC	BACK ASSEMBLED IN CARTON	\$40

MODEL	CONTROL	DESCRIPTION	ARM	FABRIC/LEATHER	FEATURES	DIMENSIONS	ARM OPTIONS	CASTER OPTIONS																																																																						
1660	B2	<b>BASIC TASK</b> Our basic control has simple adjustments. Ideal for clerical, casual meetings and general office use	ARMLESS A1 A4 A5 A6 A7 A16 A36 A37	<table border="1"> <thead> <tr> <th>A/COM</th> <th>B</th> <th>C</th> <th>D</th> <th>E</th> <th>F</th> <th>G</th> </tr> </thead> <tbody> <tr><td>345</td><td>375</td><td>395</td><td>425</td><td>460</td><td>500</td><td>540</td></tr> <tr><td>415</td><td>445</td><td>465</td><td>495</td><td>530</td><td>570</td><td>610</td></tr> <tr><td>420</td><td>450</td><td>470</td><td>500</td><td>535</td><td>575</td><td>615</td></tr> <tr><td>440</td><td>470</td><td>490</td><td>520</td><td>555</td><td>595</td><td>635</td></tr> <tr><td>475</td><td>505</td><td>525</td><td>555</td><td>590</td><td>630</td><td>670</td></tr> <tr><td>495</td><td>525</td><td>545</td><td>575</td><td>610</td><td>650</td><td>690</td></tr> <tr><td>445</td><td>475</td><td>495</td><td>525</td><td>560</td><td>600</td><td>640</td></tr> <tr><td>450</td><td>480</td><td>500</td><td>530</td><td>565</td><td>605</td><td>645</td></tr> <tr><td>470</td><td>500</td><td>520</td><td>550</td><td>585</td><td>625</td><td>665</td></tr> </tbody> </table>	A/COM	B	C	D	E	F	G	345	375	395	425	460	500	540	415	445	465	495	530	570	610	420	450	470	500	535	575	615	440	470	490	520	555	595	635	475	505	525	555	590	630	670	495	525	545	575	610	650	690	445	475	495	525	560	600	640	450	480	500	530	565	605	645	470	500	520	550	585	625	665	<ul style="list-style-type: none"> <li>• 360-degree swivel</li> <li>• Pneumatic seat height adjustment</li> <li>• No back and seat tilt</li> <li>• Adjustable back depth</li> <li>• Warranted to 300 lbs.</li> </ul>	<b>WIDTH:</b> 26.5 <b>DEPTH:</b> 26.5 <b>HEIGHT:</b> 40.0-44.5 <b>SEAT WIDTH:</b> 22.0 <b>SEAT DEPTH:</b> 17.0 <b>SEAT HEIGHT:</b> 18.5-23.0 <b>BACK WIDTH:</b> 19.5 <b>BACK HEIGHT:</b> 23.0-26.0 <b>COM:</b> 0.9 YDS <b>WEIGHT:</b> 40.0 LB	<b>A1</b> \$70 Soft Touch Loop Arm <b>A4</b> \$75 <b>A5</b> \$95 A4 - Height Adjustable Arm A5 - Height/Width Adjustable Arm <b>A6</b> \$130 <b>A7</b> \$150 A6 - Height Adjustable Pivot Slide Arm A7 - Height/width Adjustable Pivot Slide Arm <b>A36</b> \$105 <b>A37</b> \$125 Height Adjustable Pivot/Slide Arm Height/Width Adjustable Pivot/Slide Arm	<b>C1</b> STD 50mm Hooded Casters <b>C1S</b> \$35 50mm Hooded Hard Floor Casters <b>C2S</b> \$35 50mm Hooded Self-Lock Hard Floor Casters
A/COM	B	C	D	E	F	G																																																																								
345	375	395	425	460	500	540																																																																								
415	445	465	495	530	570	610																																																																								
420	450	470	500	535	575	615																																																																								
440	470	490	520	555	595	635																																																																								
475	505	525	555	590	630	670																																																																								
495	525	545	575	610	650	690																																																																								
445	475	495	525	560	600	640																																																																								
450	480	500	530	565	605	645																																																																								
470	500	520	550	585	625	665																																																																								
1660	S2	<b>SWIVEL TILT</b> Use for a variety of general office seating, including private office and conference room seating	ARMLESS A1 A4 A5 A6 A7 A16 A36 A37	<table border="1"> <thead> <tr> <th>A/COM</th> <th>B</th> <th>C</th> <th>D</th> <th>E</th> <th>F</th> <th>G</th> </tr> </thead> <tbody> <tr><td>390</td><td>420</td><td>440</td><td>470</td><td>505</td><td>545</td><td>585</td></tr> <tr><td>460</td><td>490</td><td>510</td><td>540</td><td>575</td><td>615</td><td>655</td></tr> <tr><td>465</td><td>495</td><td>515</td><td>545</td><td>580</td><td>620</td><td>660</td></tr> <tr><td>485</td><td>515</td><td>535</td><td>565</td><td>600</td><td>640</td><td>680</td></tr> <tr><td>520</td><td>550</td><td>570</td><td>600</td><td>635</td><td>675</td><td>715</td></tr> <tr><td>540</td><td>570</td><td>590</td><td>620</td><td>655</td><td>695</td><td>735</td></tr> <tr><td>490</td><td>520</td><td>540</td><td>570</td><td>605</td><td>645</td><td>685</td></tr> <tr><td>495</td><td>525</td><td>545</td><td>575</td><td>610</td><td>650</td><td>690</td></tr> <tr><td>515</td><td>545</td><td>565</td><td>595</td><td>630</td><td>670</td><td>710</td></tr> </tbody> </table>	A/COM	B	C	D	E	F	G	390	420	440	470	505	545	585	460	490	510	540	575	615	655	465	495	515	545	580	620	660	485	515	535	565	600	640	680	520	550	570	600	635	675	715	540	570	590	620	655	695	735	490	520	540	570	605	645	685	495	525	545	575	610	650	690	515	545	565	595	630	670	710	<ul style="list-style-type: none"> <li>• Pneumatic seat height adjustment</li> <li>• Tilt tension control</li> <li>• Seat and back tilt as a unit</li> <li>• 360-degree swivel</li> <li>• Upright position tilt lock</li> <li>• Adjustable back depth</li> <li>• Warranted to 300 lbs.</li> </ul>	<b>WIDTH:</b> 26.5 <b>DEPTH:</b> 26.5 <b>HEIGHT:</b> 40.0-44.5 <b>SEAT WIDTH:</b> 22.0 <b>SEAT DEPTH:</b> 17.0 <b>SEAT HEIGHT:</b> 18.5-23.0 <b>BACK WIDTH:</b> 19.5 <b>BACK HEIGHT:</b> 23.0-26.0 <b>COM:</b> 0.9 YDS <b>WEIGHT:</b> 42.0 LB	<b>A6</b> \$130 <b>A7</b> \$150 A6 - Height Adjustable Pivot Slide Arm A7 - Height/width Adjustable Pivot Slide Arm <b>A36</b> \$105 <b>A37</b> \$125 Height Adjustable Pivot/Slide Arm Height/Width Adjustable Pivot/Slide Arm	<b>C1</b> STD 50mm Hooded Casters <b>C1S</b> \$35 50mm Hooded Hard Floor Casters <b>C2S</b> \$35 50mm Hooded Self-Lock Hard Floor Casters
A/COM	B	C	D	E	F	G																																																																								
390	420	440	470	505	545	585																																																																								
460	490	510	540	575	615	655																																																																								
465	495	515	545	580	620	660																																																																								
485	515	535	565	600	640	680																																																																								
520	550	570	600	635	675	715																																																																								
540	570	590	620	655	695	735																																																																								
490	520	540	570	605	645	685																																																																								
495	525	545	575	610	650	690																																																																								
515	545	565	595	630	670	710																																																																								
1660	P1	<b>POSTURE BACK</b> The articulating back provides proper support for moderate tasking applications	ARMLESS A1 A4 A5 A6 A7 A16 A36 A37	<table border="1"> <thead> <tr> <th>A/COM</th> <th>B</th> <th>C</th> <th>D</th> <th>E</th> <th>F</th> <th>G</th> </tr> </thead> <tbody> <tr><td>430</td><td>460</td><td>480</td><td>510</td><td>545</td><td>585</td><td>625</td></tr> <tr><td>500</td><td>530</td><td>550</td><td>580</td><td>615</td><td>655</td><td>695</td></tr> <tr><td>505</td><td>535</td><td>555</td><td>585</td><td>620</td><td>660</td><td>700</td></tr> <tr><td>525</td><td>555</td><td>575</td><td>605</td><td>640</td><td>680</td><td>720</td></tr> <tr><td>560</td><td>590</td><td>610</td><td>640</td><td>675</td><td>715</td><td>755</td></tr> <tr><td>580</td><td>610</td><td>630</td><td>660</td><td>695</td><td>735</td><td>775</td></tr> <tr><td>530</td><td>560</td><td>580</td><td>610</td><td>645</td><td>685</td><td>725</td></tr> <tr><td>535</td><td>565</td><td>585</td><td>615</td><td>650</td><td>690</td><td>730</td></tr> <tr><td>555</td><td>585</td><td>605</td><td>635</td><td>670</td><td>710</td><td>750</td></tr> </tbody> </table>	A/COM	B	C	D	E	F	G	430	460	480	510	545	585	625	500	530	550	580	615	655	695	505	535	555	585	620	660	700	525	555	575	605	640	680	720	560	590	610	640	675	715	755	580	610	630	660	695	735	775	530	560	580	610	645	685	725	535	565	585	615	650	690	730	555	585	605	635	670	710	750	<ul style="list-style-type: none"> <li>• Pneumatic seat height adjustment</li> <li>• Infinite back angle adj. with free float</li> <li>• Back tilt adjustment</li> <li>• Ratchet back height lumbar adjustment</li> <li>• Warranted to 300 lbs.</li> </ul>	<b>WIDTH:</b> 26.5 <b>DEPTH:</b> 26.5 <b>HEIGHT:</b> 40.0-47.5 <b>SEAT WIDTH:</b> 22.0 <b>SEAT DEPTH:</b> 17.0 <b>SEAT HEIGHT:</b> 18.5-23.0 <b>BACK WIDTH:</b> 19.5 <b>BACK HEIGHT:</b> 23.0-26.0 <b>COM:</b> 0.9 YDS <b>WEIGHT:</b> 44.0 LB	<b>BA1B</b> STD 26" Nylon Base - Black	
A/COM	B	C	D	E	F	G																																																																								
430	460	480	510	545	585	625																																																																								
500	530	550	580	615	655	695																																																																								
505	535	555	585	620	660	700																																																																								
525	555	575	605	640	680	720																																																																								
560	590	610	640	675	715	755																																																																								
580	610	630	660	695	735	775																																																																								
530	560	580	610	645	685	725																																																																								
535	565	585	615	650	690	730																																																																								
555	585	605	635	670	710	750																																																																								
1660	R1	<b>ROCKING TILT</b> For managerial and task applications. Similar to a swivel tilt control, with the added comfort of infinite back angle and tilt adjustment	ARMLESS A1 A4 A5 A6 A7 A16 A36 A37	<table border="1"> <thead> <tr> <th>A/COM</th> <th>B</th> <th>C</th> <th>D</th> <th>E</th> <th>F</th> <th>G</th> </tr> </thead> <tbody> <tr><td>440</td><td>470</td><td>490</td><td>520</td><td>555</td><td>595</td><td>635</td></tr> <tr><td>510</td><td>540</td><td>560</td><td>590</td><td>625</td><td>665</td><td>705</td></tr> <tr><td>515</td><td>545</td><td>565</td><td>595</td><td>630</td><td>670</td><td>710</td></tr> <tr><td>535</td><td>565</td><td>585</td><td>615</td><td>650</td><td>690</td><td>730</td></tr> <tr><td>570</td><td>600</td><td>620</td><td>650</td><td>685</td><td>725</td><td>765</td></tr> <tr><td>590</td><td>620</td><td>640</td><td>670</td><td>705</td><td>745</td><td>785</td></tr> <tr><td>540</td><td>570</td><td>590</td><td>620</td><td>655</td><td>695</td><td>735</td></tr> <tr><td>545</td><td>575</td><td>595</td><td>625</td><td>660</td><td>700</td><td>740</td></tr> <tr><td>565</td><td>595</td><td>615</td><td>645</td><td>680</td><td>720</td><td>760</td></tr> </tbody> </table>	A/COM	B	C	D	E	F	G	440	470	490	520	555	595	635	510	540	560	590	625	665	705	515	545	565	595	630	670	710	535	565	585	615	650	690	730	570	600	620	650	685	725	765	590	620	640	670	705	745	785	540	570	590	620	655	695	735	545	575	595	625	660	700	740	565	595	615	645	680	720	760	<ul style="list-style-type: none"> <li>• Pneumatic seat height adjustment</li> <li>• Tilt tension control</li> <li>• Seat and back tilt as a unit</li> <li>• Floating seat position tilt lock</li> <li>• Infinite back angle adj. w/ free float</li> <li>• Ratchet back height lumbar adjustment</li> <li>• Warranted to 300 lbs.</li> </ul>	<b>WIDTH:</b> 26.5 <b>DEPTH:</b> 26.5 <b>HEIGHT:</b> 40.0-47.5 <b>SEAT WIDTH:</b> 22.0 <b>SEAT DEPTH:</b> 16.0 <b>SEAT HEIGHT:</b> 18.5-23.0 <b>BACK WIDTH:</b> 19.5 <b>BACK HEIGHT:</b> 23.0-26.0 <b>COM:</b> 0.9 YDS <b>WEIGHT:</b> 46.0 LB	<b>EF1</b> \$30 1" Extra Foam on Seat <b>MF1</b> \$50 1" Visco Elastic Memory Foam on Seat <b>SS</b> \$60 Seat Slider 2.5" Side Paddle Activated (Standard with Y2 Control) <b>BT</b> \$15 Replace Knob with Bolt (for B2 or S2 Controls Only)	
A/COM	B	C	D	E	F	G																																																																								
440	470	490	520	555	595	635																																																																								
510	540	560	590	625	665	705																																																																								
515	545	565	595	630	670	710																																																																								
535	565	585	615	650	690	730																																																																								
570	600	620	650	685	725	765																																																																								
590	620	640	670	705	745	785																																																																								
540	570	590	620	655	695	735																																																																								
545	575	595	625	660	700	740																																																																								
565	595	615	645	680	720	760																																																																								

# agent

lending comfort, durability, and value to every project

## MID-BACK

GSA SIN # 711-18

- Task, conference and stool seating
- Ratchet back height adjustment on P1, R1, M1 and Y2 models
- Warranted to 300 lbs.
- CAL TB 133 Fire Code approved



### CREATING AGENT MODEL NUMBER



### PACKAGING NOTES

CODE	DESCRIPTION	LIST UPCHARGE
AB	ASSEMBLED IN BAG	\$0
PAC	PARTIALLY ASSEMBLED IN CARTON	\$0
BAC	BACK ASSEMBLED IN CARTON	\$40

MODEL	CONTROL	DESCRIPTION	ARM	FABRIC/LEATHER	FEATURES	DIMENSIONS	ARM OPTIONS	CASTER OPTIONS																																																																																																																																																								
1660	M1	<b>MULTI-FUNCTION</b> Fully articulating seat and back for the highest level of ergonomic needs. Forward seat pitch adjustment from 0 to 6 degrees	<table border="1"> <tr><td>ARMLESS</td><td>490</td><td>520</td><td>540</td><td>570</td><td>605</td><td>645</td><td>685</td></tr> <tr><td>A1</td><td>560</td><td>590</td><td>610</td><td>640</td><td>675</td><td>715</td><td>755</td></tr> <tr><td>A4</td><td>565</td><td>595</td><td>615</td><td>645</td><td>680</td><td>720</td><td>760</td></tr> <tr><td>A5</td><td>585</td><td>615</td><td>635</td><td>665</td><td>700</td><td>740</td><td>780</td></tr> <tr><td>A6</td><td>620</td><td>650</td><td>670</td><td>700</td><td>735</td><td>775</td><td>815</td></tr> <tr><td>A7</td><td>640</td><td>670</td><td>690</td><td>720</td><td>755</td><td>795</td><td>835</td></tr> <tr><td>A16</td><td>590</td><td>620</td><td>640</td><td>670</td><td>705</td><td>745</td><td>785</td></tr> <tr><td>A36</td><td>595</td><td>625</td><td>645</td><td>675</td><td>710</td><td>750</td><td>790</td></tr> <tr><td>A37</td><td>615</td><td>645</td><td>665</td><td>695</td><td>730</td><td>770</td><td>810</td></tr> </table>	ARMLESS	490	520	540	570	605	645	685	A1	560	590	610	640	675	715	755	A4	565	595	615	645	680	720	760	A5	585	615	635	665	700	740	780	A6	620	650	670	700	735	775	815	A7	640	670	690	720	755	795	835	A16	590	620	640	670	705	745	785	A36	595	625	645	675	710	750	790	A37	615	645	665	695	730	770	810	<table border="1"> <tr><td>A/COM</td><td>B</td><td>C</td><td>D</td><td>E</td><td>F</td><td>G</td><td></td></tr> <tr><td>490</td><td>520</td><td>540</td><td>570</td><td>605</td><td>645</td><td>685</td><td></td></tr> <tr><td>560</td><td>590</td><td>610</td><td>640</td><td>675</td><td>715</td><td>755</td><td></td></tr> <tr><td>565</td><td>595</td><td>615</td><td>645</td><td>680</td><td>720</td><td>760</td><td></td></tr> <tr><td>585</td><td>615</td><td>635</td><td>665</td><td>700</td><td>740</td><td>780</td><td></td></tr> <tr><td>620</td><td>650</td><td>670</td><td>700</td><td>735</td><td>775</td><td>815</td><td></td></tr> <tr><td>640</td><td>670</td><td>690</td><td>720</td><td>755</td><td>795</td><td>835</td><td></td></tr> <tr><td>590</td><td>620</td><td>640</td><td>670</td><td>705</td><td>745</td><td>785</td><td></td></tr> <tr><td>595</td><td>625</td><td>645</td><td>675</td><td>710</td><td>750</td><td>790</td><td></td></tr> <tr><td>615</td><td>645</td><td>665</td><td>695</td><td>730</td><td>770</td><td>810</td><td></td></tr> </table>	A/COM	B	C	D	E	F	G		490	520	540	570	605	645	685		560	590	610	640	675	715	755		565	595	615	645	680	720	760		585	615	635	665	700	740	780		620	650	670	700	735	775	815		640	670	690	720	755	795	835		590	620	640	670	705	745	785		595	625	645	675	710	750	790		615	645	665	695	730	770	810		<ul style="list-style-type: none"> <li>• Pneumatic seat height adjustment</li> <li>• Tilt tension control</li> <li>• Seat and back tilt as a unit</li> <li>• Floating seat position tilt lock</li> <li>• Infinite back angle adj. w/ free float</li> <li>• Seat pivots from 0° to 6° forward</li> <li>• Ratchet back height lumbar adjustment</li> <li>• Warranted to 300 lbs.</li> </ul>	<b>WIDTH:</b> 26.5 <b>DEPTH:</b> 26.5 <b>HEIGHT:</b> 38.5-44.0 <b>SEAT WIDTH:</b> 22.0 <b>SEAT DEPTH:</b> 17.5-20.5 <b>SEAT HEIGHT:</b> 18.5-23.0 <b>BACK WIDTH:</b> 19.5 <b>BACK HEIGHT:</b> 23.0-26.0 <b>COM:</b> 0.9 YDS <b>WEIGHT:</b> 52.0 LB	<b>A1</b> \$70 Soft Touch Loop Arm <b>A4</b> \$75 <b>A5</b> \$95 A4 - Height Adjustable Arm A5 - Height/Width Adjustable Arm <b>A6</b> \$130 <b>A7</b> \$150 A6 - Height Adjustable Pivot Slide Arm A7 - Height/width Adjustable Pivot Slide Arm <b>A36</b> \$105 Height Adjustable Pivot/Slide Arm <b>A37</b> \$125 Height/Width Adjustable Pivot/Slide Arm	<b>C1</b> STD 50mm Hooded Casters <b>C1S</b> \$35 50mm Hooded Hard Floor Casters <b>C2S</b> \$35 50mm Hooded Self-Lock Hard Floor Casters
ARMLESS	490	520	540	570	605	645	685																																																																																																																																																									
A1	560	590	610	640	675	715	755																																																																																																																																																									
A4	565	595	615	645	680	720	760																																																																																																																																																									
A5	585	615	635	665	700	740	780																																																																																																																																																									
A6	620	650	670	700	735	775	815																																																																																																																																																									
A7	640	670	690	720	755	795	835																																																																																																																																																									
A16	590	620	640	670	705	745	785																																																																																																																																																									
A36	595	625	645	675	710	750	790																																																																																																																																																									
A37	615	645	665	695	730	770	810																																																																																																																																																									
A/COM	B	C	D	E	F	G																																																																																																																																																										
490	520	540	570	605	645	685																																																																																																																																																										
560	590	610	640	675	715	755																																																																																																																																																										
565	595	615	645	680	720	760																																																																																																																																																										
585	615	635	665	700	740	780																																																																																																																																																										
620	650	670	700	735	775	815																																																																																																																																																										
640	670	690	720	755	795	835																																																																																																																																																										
590	620	640	670	705	745	785																																																																																																																																																										
595	625	645	675	710	750	790																																																																																																																																																										
615	645	665	695	730	770	810																																																																																																																																																										
				<b>SEAT SLIDER (SS) - ADD \$60</b>																																																																																																																																																												
1660	Y2-SS	<b>HEAVY DUTY SYNCHRO</b> Use for general office, task or management	<table border="1"> <tr><td>ARMLESS</td><td>530</td><td>560</td><td>580</td><td>610</td><td>645</td><td>685</td><td>725</td></tr> <tr><td>A1</td><td>600</td><td>630</td><td>650</td><td>680</td><td>715</td><td>755</td><td>795</td></tr> <tr><td>A4</td><td>605</td><td>635</td><td>655</td><td>685</td><td>720</td><td>760</td><td>800</td></tr> <tr><td>A5</td><td>625</td><td>655</td><td>675</td><td>705</td><td>740</td><td>780</td><td>820</td></tr> <tr><td>A6</td><td>660</td><td>690</td><td>710</td><td>740</td><td>775</td><td>815</td><td>855</td></tr> <tr><td>A7</td><td>680</td><td>710</td><td>730</td><td>760</td><td>795</td><td>835</td><td>875</td></tr> <tr><td>A16</td><td>630</td><td>660</td><td>680</td><td>710</td><td>745</td><td>785</td><td>825</td></tr> <tr><td>A36</td><td>635</td><td>665</td><td>685</td><td>715</td><td>750</td><td>790</td><td>830</td></tr> <tr><td>A37</td><td>655</td><td>685</td><td>705</td><td>735</td><td>770</td><td>810</td><td>850</td></tr> </table>	ARMLESS	530	560	580	610	645	685	725	A1	600	630	650	680	715	755	795	A4	605	635	655	685	720	760	800	A5	625	655	675	705	740	780	820	A6	660	690	710	740	775	815	855	A7	680	710	730	760	795	835	875	A16	630	660	680	710	745	785	825	A36	635	665	685	715	750	790	830	A37	655	685	705	735	770	810	850	<table border="1"> <tr><td>A/COM</td><td>B</td><td>C</td><td>D</td><td>E</td><td>F</td><td>G</td><td></td></tr> <tr><td>530</td><td>560</td><td>580</td><td>610</td><td>645</td><td>685</td><td>725</td><td></td></tr> <tr><td>600</td><td>630</td><td>650</td><td>680</td><td>715</td><td>755</td><td>795</td><td></td></tr> <tr><td>605</td><td>635</td><td>655</td><td>685</td><td>720</td><td>760</td><td>800</td><td></td></tr> <tr><td>625</td><td>655</td><td>675</td><td>705</td><td>740</td><td>780</td><td>820</td><td></td></tr> <tr><td>660</td><td>690</td><td>710</td><td>740</td><td>775</td><td>815</td><td>855</td><td></td></tr> <tr><td>680</td><td>710</td><td>730</td><td>760</td><td>795</td><td>835</td><td>875</td><td></td></tr> <tr><td>630</td><td>660</td><td>680</td><td>710</td><td>745</td><td>785</td><td>825</td><td></td></tr> <tr><td>635</td><td>665</td><td>685</td><td>715</td><td>750</td><td>790</td><td>830</td><td></td></tr> <tr><td>655</td><td>685</td><td>705</td><td>735</td><td>770</td><td>810</td><td>850</td><td></td></tr> </table>	A/COM	B	C	D	E	F	G		530	560	580	610	645	685	725		600	630	650	680	715	755	795		605	635	655	685	720	760	800		625	655	675	705	740	780	820		660	690	710	740	775	815	855		680	710	730	760	795	835	875		630	660	680	710	745	785	825		635	665	685	715	750	790	830		655	685	705	735	770	810	850		<ul style="list-style-type: none"> <li>• Pneumatic seat height adjustment</li> <li>• Side tilt tension control</li> <li>• Back and seat tilt in 2:1 ratio</li> <li>• 4 locking positions</li> <li>• Safety tilt release</li> <li>• Ratchet back height lumbar adjustment</li> <li>• Seat slider standard</li> <li>• Warranted to 300 lbs.</li> </ul>	<b>WIDTH:</b> 26.5 <b>DEPTH:</b> 26.5 <b>HEIGHT:</b> 38.5-44.0 <b>SEAT WIDTH:</b> 22.0 <b>SEAT DEPTH:</b> 17.5-20.5 <b>SEAT HEIGHT:</b> 18.5-23.0 <b>BACK WIDTH:</b> 19.5 <b>BACK HEIGHT:</b> 23.0-26.0 <b>COM:</b> 0.9 YDS <b>WEIGHT:</b> 52.0 LB	<b>A6</b> \$130 <b>A7</b> \$150 A6 - Height Adjustable Pivot Slide Arm A7 - Height/width Adjustable Pivot Slide Arm <b>A36</b> \$105 Height Adjustable Pivot/Slide Arm <b>A37</b> \$125 Height/Width Adjustable Pivot/Slide Arm	<b>C1</b> STD 50mm Hooded Casters <b>C1S</b> \$35 50mm Hooded Hard Floor Casters <b>C2S</b> \$35 50mm Hooded Self-Lock Hard Floor Casters
ARMLESS	530	560	580	610	645	685	725																																																																																																																																																									
A1	600	630	650	680	715	755	795																																																																																																																																																									
A4	605	635	655	685	720	760	800																																																																																																																																																									
A5	625	655	675	705	740	780	820																																																																																																																																																									
A6	660	690	710	740	775	815	855																																																																																																																																																									
A7	680	710	730	760	795	835	875																																																																																																																																																									
A16	630	660	680	710	745	785	825																																																																																																																																																									
A36	635	665	685	715	750	790	830																																																																																																																																																									
A37	655	685	705	735	770	810	850																																																																																																																																																									
A/COM	B	C	D	E	F	G																																																																																																																																																										
530	560	580	610	645	685	725																																																																																																																																																										
600	630	650	680	715	755	795																																																																																																																																																										
605	635	655	685	720	760	800																																																																																																																																																										
625	655	675	705	740	780	820																																																																																																																																																										
660	690	710	740	775	815	855																																																																																																																																																										
680	710	730	760	795	835	875																																																																																																																																																										
630	660	680	710	745	785	825																																																																																																																																																										
635	665	685	715	750	790	830																																																																																																																																																										
655	685	705	735	770	810	850																																																																																																																																																										
				<b>SEAT SLIDER (SS) - STANDARD</b>																																																																																																																																																												
1660	GT	<b>GUEST</b> Well suited for guest seating	<table border="1"> <tr><td>ARMLESS</td><td>325</td><td>355</td><td>375</td><td>405</td><td>440</td><td>480</td><td>520</td></tr> <tr><td>A1</td><td>395</td><td>425</td><td>445</td><td>475</td><td>510</td><td>550</td><td>590</td></tr> </table>	ARMLESS	325	355	375	405	440	480	520	A1	395	425	445	475	510	550	590	<table border="1"> <tr><td>A/COM</td><td>B</td><td>C</td><td>D</td><td>E</td><td>F</td><td>G</td><td></td></tr> <tr><td>325</td><td>355</td><td>375</td><td>405</td><td>440</td><td>480</td><td>520</td><td></td></tr> <tr><td>395</td><td>425</td><td>445</td><td>475</td><td>510</td><td>550</td><td>590</td><td></td></tr> </table>	A/COM	B	C	D	E	F	G		325	355	375	405	440	480	520		395	425	445	475	510	550	590		<ul style="list-style-type: none"> <li>• Cantilever base design</li> <li>• Warranted to 300 lbs.</li> </ul>	<b>WIDTH:</b> 26.5 <b>DEPTH:</b> 26.5 <b>HEIGHT:</b> 40.0 <b>SEAT WIDTH:</b> 22.0 <b>SEAT DEPTH:</b> 17.0 <b>SEAT HEIGHT:</b> 17.0 <b>BACK WIDTH:</b> 19.5 <b>BACK HEIGHT:</b> 23.0 <b>COM:</b> 0.9 YDS <b>WEIGHT:</b> 42.0 LB	<b>BA1B</b> STD 26" Nylon Base - Black																																																																																																																	
ARMLESS	325	355	375	405	440	480	520																																																																																																																																																									
A1	395	425	445	475	510	550	590																																																																																																																																																									
A/COM	B	C	D	E	F	G																																																																																																																																																										
325	355	375	405	440	480	520																																																																																																																																																										
395	425	445	475	510	550	590																																																																																																																																																										
				<b>SHIPS PARTIALLY ASSEMBLED PAC OR AB</b>																																																																																																																																																												
								<b>EF1</b> \$30 1" Extra Foam on Seat <b>MF1</b> \$50 1" Visco Elastic Memory Foam on Seat <b>SS</b> \$60 Seat Slider 2.5" Side Paddle Activated (Standard with Y2 Control) <b>BT</b> \$15 Replace Knob with Bolt (for B2 or S2 Controls Only)																																																																																																																																																								

# agent

lending comfort, durability, and value to every project

## MID-BACK STOOL

GSA SIN # 711-18

- Task, conference and stool seating
- Ratchet back height adjustment on P1, R1, M1 and Y2 models
- Warranted to 300 lbs.
- CAL TB 133 Fire Code approved



### CREATING AGENT MODEL NUMBER

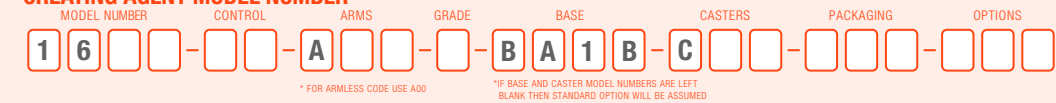

### PACKAGING NOTES

CODE	DESCRIPTION	LIST UPCHARGE
AB	ASSEMBLED IN BAG	\$0
PAC	PARTIALLY ASSEMBLED IN CARTON	\$0
BAC	BACK ASSEMBLED IN CARTON	\$40

MODEL	CONTROL	DESCRIPTION	ARM	FABRIC/LEATHER	FEATURES	DIMENSIONS	ARM OPTIONS	CASTER OPTIONS																																																																						
1666	B2	<b>10" STOOL BASIC TASK</b> Use for work surfaces up to 42 inches high	ARMLESS A1 A4 A5 A6 A7 A16 A36 A37	<table border="1"> <thead> <tr> <th>A/COM</th> <th>B</th> <th>C</th> <th>D</th> <th>E</th> <th>F</th> <th>G</th> </tr> </thead> <tbody> <tr><td>470</td><td>500</td><td>520</td><td>550</td><td>585</td><td>625</td><td>665</td></tr> <tr><td>540</td><td>570</td><td>590</td><td>620</td><td>655</td><td>695</td><td>735</td></tr> <tr><td>545</td><td>575</td><td>595</td><td>625</td><td>660</td><td>700</td><td>740</td></tr> <tr><td>565</td><td>595</td><td>615</td><td>645</td><td>680</td><td>720</td><td>760</td></tr> <tr><td>600</td><td>630</td><td>650</td><td>680</td><td>715</td><td>755</td><td>795</td></tr> <tr><td>620</td><td>650</td><td>670</td><td>700</td><td>735</td><td>775</td><td>815</td></tr> <tr><td>570</td><td>600</td><td>620</td><td>650</td><td>685</td><td>725</td><td>765</td></tr> <tr><td>575</td><td>605</td><td>625</td><td>655</td><td>690</td><td>730</td><td>770</td></tr> <tr><td>595</td><td>625</td><td>645</td><td>675</td><td>710</td><td>750</td><td>790</td></tr> </tbody> </table>	A/COM	B	C	D	E	F	G	470	500	520	550	585	625	665	540	570	590	620	655	695	735	545	575	595	625	660	700	740	565	595	615	645	680	720	760	600	630	650	680	715	755	795	620	650	670	700	735	775	815	570	600	620	650	685	725	765	575	605	625	655	690	730	770	595	625	645	675	710	750	790	<ul style="list-style-type: none"> <li>• 360-degree swivel</li> <li>• Pneumatic seat height adjustment</li> <li>• No seat and back tilt</li> <li>• Adjustable back depth</li> <li>• Height adjustable footring</li> <li>• Warranted to 300 lbs.</li> </ul>	<b>WIDTH:</b> 26.5 <b>DEPTH:</b> 26.5 <b>HEIGHT:</b> 47.5-57.5 <b>SEAT WIDTH:</b> 22.0 <b>SEAT DEPTH:</b> 17.0 <b>SEAT HEIGHT:</b> 26.5-36.5 <b>BACK WIDTH:</b> 19.5 <b>BACK HEIGHT:</b> 23.0 <b>COM:</b> 0.9 YDS <b>WEIGHT:</b> 46.0 LB	<b>A1</b> \$70 Soft Touch Loop Arm <b>A4</b> \$75 <b>A5</b> \$95 A4 - Height Adjustable Arm A5 - Height/Width Adjustable Arm <b>A6</b> \$130 <b>A7</b> \$150 A6 - Height Adjustable Pivot Slide Arm A7 - Height/width Adjustable Pivot Slide Arm <b>A36</b> \$105 <b>A37</b> \$125 Height Adjustable Pivot/Slide Arm Height/Width Adjustable Pivot/Slide Arm	<b>C1</b> STD 50mm Hooded Casters <b>C1S</b> \$35 50mm Hooded Hard Floor Casters <b>C2S</b> \$35 50mm Hooded Self-Lock Hard Floor Casters
A/COM	B	C	D	E	F	G																																																																								
470	500	520	550	585	625	665																																																																								
540	570	590	620	655	695	735																																																																								
545	575	595	625	660	700	740																																																																								
565	595	615	645	680	720	760																																																																								
600	630	650	680	715	755	795																																																																								
620	650	670	700	735	775	815																																																																								
570	600	620	650	685	725	765																																																																								
575	605	625	655	690	730	770																																																																								
595	625	645	675	710	750	790																																																																								
				SEAT SLIDER (SS) - NOT AVAILABLE																																																																										
1666	P1	<b>10" STOOL POSTURE BACK</b> Use for work surfaces up to 42 inches high	ARMLESS A1 A4 A5 A6 A7 A16 A36 A37	<table border="1"> <thead> <tr> <th>A/COM</th> <th>B</th> <th>C</th> <th>D</th> <th>E</th> <th>F</th> <th>G</th> </tr> </thead> <tbody> <tr><td>555</td><td>585</td><td>605</td><td>635</td><td>670</td><td>710</td><td>750</td></tr> <tr><td>625</td><td>655</td><td>675</td><td>705</td><td>740</td><td>780</td><td>820</td></tr> <tr><td>630</td><td>660</td><td>680</td><td>710</td><td>745</td><td>785</td><td>825</td></tr> <tr><td>650</td><td>680</td><td>700</td><td>730</td><td>765</td><td>805</td><td>845</td></tr> <tr><td>685</td><td>715</td><td>735</td><td>765</td><td>800</td><td>840</td><td>880</td></tr> <tr><td>705</td><td>735</td><td>755</td><td>785</td><td>820</td><td>860</td><td>900</td></tr> <tr><td>655</td><td>685</td><td>705</td><td>735</td><td>770</td><td>810</td><td>850</td></tr> <tr><td>660</td><td>690</td><td>710</td><td>740</td><td>775</td><td>815</td><td>855</td></tr> <tr><td>680</td><td>710</td><td>730</td><td>760</td><td>795</td><td>835</td><td>875</td></tr> </tbody> </table>	A/COM	B	C	D	E	F	G	555	585	605	635	670	710	750	625	655	675	705	740	780	820	630	660	680	710	745	785	825	650	680	700	730	765	805	845	685	715	735	765	800	840	880	705	735	755	785	820	860	900	655	685	705	735	770	810	850	660	690	710	740	775	815	855	680	710	730	760	795	835	875	<ul style="list-style-type: none"> <li>• Pneumatic seat height adjustment</li> <li>• Infinite back angle adj. with free float</li> <li>• Ratchet back height lumbar adjustment</li> <li>• Height adjustable footring</li> <li>• Warranted to 300 lbs.</li> </ul>	<b>WIDTH:</b> 26.5 <b>DEPTH:</b> 26.5 <b>HEIGHT:</b> 47.5-61.0 <b>SEAT WIDTH:</b> 22.0 <b>SEAT DEPTH:</b> 17.0 <b>SEAT HEIGHT:</b> 26.5-36.5 <b>BACK WIDTH:</b> 19.5 <b>BACK HEIGHT:</b> 23.0-26.0 <b>COM:</b> 0.9 YDS <b>WEIGHT:</b> 50.0 LB	<b>A6</b> \$130 <b>A7</b> \$150 A6 - Height Adjustable Pivot Slide Arm A7 - Height/width Adjustable Pivot Slide Arm <b>A36</b> \$105 <b>A37</b> \$125 Height Adjustable Pivot/Slide Arm Height/Width Adjustable Pivot/Slide Arm	<b>C1</b> STD 50mm Hooded Casters <b>C1S</b> \$35 50mm Hooded Hard Floor Casters <b>C2S</b> \$35 50mm Hooded Self-Lock Hard Floor Casters
A/COM	B	C	D	E	F	G																																																																								
555	585	605	635	670	710	750																																																																								
625	655	675	705	740	780	820																																																																								
630	660	680	710	745	785	825																																																																								
650	680	700	730	765	805	845																																																																								
685	715	735	765	800	840	880																																																																								
705	735	755	785	820	860	900																																																																								
655	685	705	735	770	810	850																																																																								
660	690	710	740	775	815	855																																																																								
680	710	730	760	795	835	875																																																																								
				SEAT SLIDER (SS) - NOT AVAILABLE																																																																										
1668	B2	<b>8" STOOL BASIC TASK</b> Use for work surfaces up to 36 inches high	ARMLESS A1 A4 A5 A6 A7 A16 A36 A37	<table border="1"> <thead> <tr> <th>A/COM</th> <th>B</th> <th>C</th> <th>D</th> <th>E</th> <th>F</th> <th>G</th> </tr> </thead> <tbody> <tr><td>470</td><td>500</td><td>520</td><td>550</td><td>585</td><td>625</td><td>665</td></tr> <tr><td>540</td><td>570</td><td>590</td><td>620</td><td>655</td><td>695</td><td>735</td></tr> <tr><td>545</td><td>575</td><td>595</td><td>625</td><td>660</td><td>700</td><td>740</td></tr> <tr><td>565</td><td>595</td><td>615</td><td>645</td><td>680</td><td>720</td><td>760</td></tr> <tr><td>600</td><td>630</td><td>650</td><td>680</td><td>715</td><td>755</td><td>795</td></tr> <tr><td>620</td><td>650</td><td>670</td><td>700</td><td>735</td><td>775</td><td>815</td></tr> <tr><td>570</td><td>600</td><td>620</td><td>650</td><td>685</td><td>725</td><td>765</td></tr> <tr><td>575</td><td>605</td><td>625</td><td>655</td><td>690</td><td>730</td><td>770</td></tr> <tr><td>595</td><td>625</td><td>645</td><td>675</td><td>710</td><td>750</td><td>790</td></tr> </tbody> </table>	A/COM	B	C	D	E	F	G	470	500	520	550	585	625	665	540	570	590	620	655	695	735	545	575	595	625	660	700	740	565	595	615	645	680	720	760	600	630	650	680	715	755	795	620	650	670	700	735	775	815	570	600	620	650	685	725	765	575	605	625	655	690	730	770	595	625	645	675	710	750	790	<ul style="list-style-type: none"> <li>• 360-degree swivel</li> <li>• Pneumatic seat height adjustment</li> <li>• No seat and back tilt</li> <li>• Adjustable back depth</li> <li>• Height adjustable footring</li> <li>• Warranted to 300 lbs.</li> </ul>	<b>WIDTH:</b> 26.5 <b>DEPTH:</b> 26.5 <b>HEIGHT:</b> 43.5-51.5 <b>SEAT WIDTH:</b> 22.0 <b>SEAT DEPTH:</b> 17.0 <b>SEAT HEIGHT:</b> 22.5-30.5 <b>BACK WIDTH:</b> 19.5 <b>BACK HEIGHT:</b> 23.0 <b>COM:</b> 0.9 YDS <b>WEIGHT:</b> 45.0 LB	<b>BA1B</b> STD 26" Nylon Base - Black	
A/COM	B	C	D	E	F	G																																																																								
470	500	520	550	585	625	665																																																																								
540	570	590	620	655	695	735																																																																								
545	575	595	625	660	700	740																																																																								
565	595	615	645	680	720	760																																																																								
600	630	650	680	715	755	795																																																																								
620	650	670	700	735	775	815																																																																								
570	600	620	650	685	725	765																																																																								
575	605	625	655	690	730	770																																																																								
595	625	645	675	710	750	790																																																																								
				SEAT SLIDER (SS) - NOT AVAILABLE																																																																										
1668	P1	<b>8" STOOL POSTURE BACK</b> Use for work surfaces up to 36 inches high	ARMLESS A1 A4 A5 A6 A7 A16 A36 A37	<table border="1"> <thead> <tr> <th>A/COM</th> <th>B</th> <th>C</th> <th>D</th> <th>E</th> <th>F</th> <th>G</th> </tr> </thead> <tbody> <tr><td>555</td><td>585</td><td>605</td><td>635</td><td>670</td><td>710</td><td>750</td></tr> <tr><td>625</td><td>655</td><td>675</td><td>705</td><td>740</td><td>780</td><td>820</td></tr> <tr><td>630</td><td>660</td><td>680</td><td>710</td><td>745</td><td>785</td><td>825</td></tr> <tr><td>650</td><td>680</td><td>700</td><td>730</td><td>765</td><td>805</td><td>845</td></tr> <tr><td>685</td><td>715</td><td>735</td><td>765</td><td>800</td><td>840</td><td>880</td></tr> <tr><td>705</td><td>735</td><td>755</td><td>785</td><td>820</td><td>860</td><td>900</td></tr> <tr><td>655</td><td>685</td><td>705</td><td>735</td><td>770</td><td>810</td><td>850</td></tr> <tr><td>660</td><td>690</td><td>710</td><td>740</td><td>775</td><td>815</td><td>855</td></tr> <tr><td>680</td><td>710</td><td>730</td><td>760</td><td>795</td><td>835</td><td>875</td></tr> </tbody> </table>	A/COM	B	C	D	E	F	G	555	585	605	635	670	710	750	625	655	675	705	740	780	820	630	660	680	710	745	785	825	650	680	700	730	765	805	845	685	715	735	765	800	840	880	705	735	755	785	820	860	900	655	685	705	735	770	810	850	660	690	710	740	775	815	855	680	710	730	760	795	835	875	<ul style="list-style-type: none"> <li>• Pneumatic seat height adjustment</li> <li>• Infinite back angle adj. with free float</li> <li>• Ratchet back height lumbar adjustment</li> <li>• Height adjustable footring</li> <li>• Warranted to 300 lbs.</li> </ul>	<b>WIDTH:</b> 26.5 <b>DEPTH:</b> 26.5 <b>HEIGHT:</b> 43.5-55.0 <b>SEAT WIDTH:</b> 22.0 <b>SEAT DEPTH:</b> 17.0 <b>SEAT HEIGHT:</b> 22.5-30.5 <b>BACK WIDTH:</b> 19.5 <b>BACK HEIGHT:</b> 23.0-26.0 <b>COM:</b> 0.9 YDS <b>WEIGHT:</b> 49.0 LB	<b>EF1</b> \$30 1" Extra Foam on Seat <b>MF1</b> \$50 1" Visco Elastic Memory Foam on Seat <b>BT</b> \$15 Replace Knob with Bolt (for B2 or S2 Controls Only)	
A/COM	B	C	D	E	F	G																																																																								
555	585	605	635	670	710	750																																																																								
625	655	675	705	740	780	820																																																																								
630	660	680	710	745	785	825																																																																								
650	680	700	730	765	805	845																																																																								
685	715	735	765	800	840	880																																																																								
705	735	755	785	820	860	900																																																																								
655	685	705	735	770	810	850																																																																								
660	690	710	740	775	815	855																																																																								
680	710	730	760	795	835	875																																																																								
				SEAT SLIDER (SS) - NOT AVAILABLE																																																																										

# aria

provides revolutionary comfort

## MESH BACK

GSA SIN # 711-18

- Task, stool, management and conference seating
- Suspension seat incorporates a flexible high performance mesh with a molded high density foam overlay
- Choice of 18 back mesh colors
- Integrated handle in chair back
- Optional height adjustable lumbar
- Warranted to 300 lbs.
- CAL TB 133 Fire Code approved



### CREATING ARIA MODEL NUMBER

MODEL NUMBER	CONTROL	ARMS	BACK MESH COLOR	GRADE	BASE	CASTERS	PACKAGING	OPTIONS
186	Y	A	M		B	A	C	

\* FOR ARMLESS CODE USE A00  
\* IF BASE AND CASTER MODEL NUMBERS ARE LEFT BLANK THEN STANDARD OPTION WILL BE ASSUMED

### PACKAGING NOTES

CODE	DESCRIPTION	LIST UPCHARGE
AB	ASSEMBLED IN BAG	\$0
PAC	PARTIALLY ASSEMBLED IN CARTON	\$0
BAC	BACK ASSEMBLED IN CARTON	\$40

MODEL	CONTROL	DESCRIPTION	ARM	FABRIC/LEATHER	FEATURES	DIMENSIONS	ARM OPTIONS	CASTER OPTIONS	ADDITIONAL OPTIONS																																																																																
1860	Y1	<b>MID-BACK SIMPLE SYNCHRO</b> Use for a variety of general office seating, including private office and conference room seating	ARMLESS A6 A8B / A8S A10 A36 A40 A41	<table border="1"> <thead> <tr> <th>A/COM</th> <th>B</th> <th>C</th> <th>D</th> <th>E</th> <th>F</th> <th>G</th> <th>L3/COL</th> <th>L4</th> <th>L5</th> </tr> </thead> <tbody> <tr><td>500</td><td>530</td><td>550</td><td>580</td><td>615</td><td>655</td><td>695</td><td>560</td><td>630</td><td>660</td></tr> <tr><td>630</td><td>660</td><td>680</td><td>710</td><td>745</td><td>785</td><td>825</td><td>690</td><td>760</td><td>790</td></tr> <tr><td>585</td><td>615</td><td>635</td><td>665</td><td>700</td><td>740</td><td>780</td><td>645</td><td>715</td><td>745</td></tr> <tr><td>585</td><td>615</td><td>635</td><td>665</td><td>700</td><td>740</td><td>780</td><td>645</td><td>715</td><td>745</td></tr> <tr><td>605</td><td>635</td><td>655</td><td>685</td><td>720</td><td>760</td><td>800</td><td>665</td><td>735</td><td>765</td></tr> <tr><td>610</td><td>640</td><td>660</td><td>690</td><td>725</td><td>765</td><td>805</td><td>670</td><td>740</td><td>770</td></tr> <tr><td>630</td><td>660</td><td>680</td><td>710</td><td>745</td><td>785</td><td>825</td><td>690</td><td>760</td><td>790</td></tr> </tbody> </table>	A/COM	B	C	D	E	F	G	L3/COL	L4	L5	500	530	550	580	615	655	695	560	630	660	630	660	680	710	745	785	825	690	760	790	585	615	635	665	700	740	780	645	715	745	585	615	635	665	700	740	780	645	715	745	605	635	655	685	720	760	800	665	735	765	610	640	660	690	725	765	805	670	740	770	630	660	680	710	745	785	825	690	760	790	<ul style="list-style-type: none"> <li>• Pneumatic seat height adjustment</li> <li>• Tilt tension control</li> <li>• Back and seat tilt in 3:1 ratio</li> <li>• Upright position tilt lock</li> <li>• Molded foam suspension seat</li> <li>• Optional height adjustable lumbar</li> <li>• Warranted to 300 lbs.</li> </ul>	<p>WIDTH: 26.5 DEPTH: 27.5 HEIGHT: 36.0-40.5</p> <p>SEAT WIDTH: 21.0 SEAT DEPTH: 16.5 SEAT HEIGHT: 18.0-22.5 BACK WIDTH: 19.0 BACK HEIGHT: 18.5</p> <p>COM: 0.9 YDS COL: 8.0 SQ FT WEIGHT: 36.0 LB</p>	<p><b>A6</b> \$130 Height Adjustable Pivot/Slide Arm</p> <p><b>A8B/S</b> \$85 Height Adjustable Arm A8B - Black A8S - Silver</p>	<p><b>C6</b> STD 60mm Hoodless Casters</p> <p><b>C6S</b> \$35 60mm Hoodless Hard Floor Casters</p> <p><b>C7</b> \$35 60mm Hoodless Chrome Accented Casters</p>	
A/COM	B	C	D	E	F	G	L3/COL	L4	L5																																																																																
500	530	550	580	615	655	695	560	630	660																																																																																
630	660	680	710	745	785	825	690	760	790																																																																																
585	615	635	665	700	740	780	645	715	745																																																																																
585	615	635	665	700	740	780	645	715	745																																																																																
605	635	655	685	720	760	800	665	735	765																																																																																
610	640	660	690	725	765	805	670	740	770																																																																																
630	660	680	710	745	785	825	690	760	790																																																																																
1860	Y3	<b>FULL SYNCHRO</b> Use for a variety of general office seating, including private office and conference room seating	ARMLESS A6 A8B / A8S A10 A36 A40 A41	<table border="1"> <thead> <tr> <th>A/COM</th> <th>B</th> <th>C</th> <th>D</th> <th>E</th> <th>F</th> <th>G</th> <th>L3/COL</th> <th>L4</th> <th>L5</th> </tr> </thead> <tbody> <tr><td>570</td><td>600</td><td>620</td><td>650</td><td>685</td><td>725</td><td>765</td><td>630</td><td>700</td><td>730</td></tr> <tr><td>700</td><td>730</td><td>750</td><td>780</td><td>815</td><td>855</td><td>895</td><td>760</td><td>830</td><td>860</td></tr> <tr><td>655</td><td>685</td><td>705</td><td>735</td><td>770</td><td>810</td><td>850</td><td>715</td><td>785</td><td>815</td></tr> <tr><td>655</td><td>685</td><td>705</td><td>735</td><td>770</td><td>810</td><td>850</td><td>715</td><td>785</td><td>815</td></tr> <tr><td>675</td><td>705</td><td>725</td><td>755</td><td>790</td><td>830</td><td>870</td><td>735</td><td>805</td><td>835</td></tr> <tr><td>680</td><td>710</td><td>730</td><td>760</td><td>795</td><td>835</td><td>875</td><td>740</td><td>810</td><td>840</td></tr> <tr><td>700</td><td>730</td><td>750</td><td>780</td><td>815</td><td>855</td><td>895</td><td>760</td><td>830</td><td>860</td></tr> </tbody> </table>	A/COM	B	C	D	E	F	G	L3/COL	L4	L5	570	600	620	650	685	725	765	630	700	730	700	730	750	780	815	855	895	760	830	860	655	685	705	735	770	810	850	715	785	815	655	685	705	735	770	810	850	715	785	815	675	705	725	755	790	830	870	735	805	835	680	710	730	760	795	835	875	740	810	840	700	730	750	780	815	855	895	760	830	860	<ul style="list-style-type: none"> <li>• Pneumatic seat height adjustment</li> <li>• Tilt tension control</li> <li>• Back and seat tilt in 2:1 ratio</li> <li>• 3 locking positions</li> <li>• Safety tilt release</li> <li>• Injection molded suspension seat</li> <li>• Optional height adjustable lumbar</li> <li>• Warranted to 300 lbs.</li> </ul>	<p>WIDTH: 26.5 DEPTH: 27.5 HEIGHT: 36.0-40.5</p> <p>SEAT WIDTH: 21 SEAT DEPTH: 16.5 SEAT HEIGHT: 18.0-22.5 BACK WIDTH: 19 BACK HEIGHT: 18.5</p> <p>COM: 0.9 YDS COL: 8.0 SQ FT WEIGHT: 38.0 LB</p>	<p><b>A10</b> \$85 Soft Touch C-Shaped Arm</p> <p><b>A36</b> \$105 Height Adjustable Pivot/Slide Arm</p> <p><b>A40</b> \$110 Height Adjustable Arm</p> <p><b>A41</b> \$130 Height Adjustable Slide Arm</p>		
A/COM	B	C	D	E	F	G	L3/COL	L4	L5																																																																																
570	600	620	650	685	725	765	630	700	730																																																																																
700	730	750	780	815	855	895	760	830	860																																																																																
655	685	705	735	770	810	850	715	785	815																																																																																
655	685	705	735	770	810	850	715	785	815																																																																																
675	705	725	755	790	830	870	735	805	835																																																																																
680	710	730	760	795	835	875	740	810	840																																																																																
700	730	750	780	815	855	895	760	830	860																																																																																
1866	Y1	<b>10" STOOL SIMPLE SYNCHRO</b> Use for work surfaces up to 42 inches high	ARMLESS A6 A8B / A8S A10 A36 A40 A41	<table border="1"> <thead> <tr> <th>A/COM</th> <th>B</th> <th>C</th> <th>D</th> <th>E</th> <th>F</th> <th>G</th> <th>L3/COL</th> <th>L4</th> <th>L5</th> </tr> </thead> <tbody> <tr><td>625</td><td>655</td><td>675</td><td>705</td><td>740</td><td>780</td><td>820</td><td>685</td><td>755</td><td>785</td></tr> <tr><td>755</td><td>785</td><td>805</td><td>835</td><td>870</td><td>910</td><td>950</td><td>815</td><td>885</td><td>915</td></tr> <tr><td>710</td><td>740</td><td>760</td><td>790</td><td>825</td><td>865</td><td>905</td><td>770</td><td>840</td><td>870</td></tr> <tr><td>710</td><td>740</td><td>760</td><td>790</td><td>825</td><td>865</td><td>905</td><td>770</td><td>840</td><td>870</td></tr> <tr><td>730</td><td>760</td><td>780</td><td>810</td><td>845</td><td>885</td><td>925</td><td>790</td><td>860</td><td>890</td></tr> <tr><td>735</td><td>765</td><td>785</td><td>815</td><td>850</td><td>890</td><td>930</td><td>795</td><td>865</td><td>895</td></tr> <tr><td>755</td><td>785</td><td>805</td><td>835</td><td>870</td><td>910</td><td>950</td><td>815</td><td>885</td><td>915</td></tr> </tbody> </table>	A/COM	B	C	D	E	F	G	L3/COL	L4	L5	625	655	675	705	740	780	820	685	755	785	755	785	805	835	870	910	950	815	885	915	710	740	760	790	825	865	905	770	840	870	710	740	760	790	825	865	905	770	840	870	730	760	780	810	845	885	925	790	860	890	735	765	785	815	850	890	930	795	865	895	755	785	805	835	870	910	950	815	885	915	<ul style="list-style-type: none"> <li>• Pneumatic seat height adjustment</li> <li>• Tilt tension control</li> <li>• Back and seat tilt in 3:1 ratio</li> <li>• Upright position tillock</li> <li>• Molded foam suspension seat</li> <li>• Optional height adjustable lumbar</li> <li>• Height adj 20" diameter footing</li> <li>• Warranted to 300 lbs.</li> </ul>	<p>WIDTH: 26.5 DEPTH: 27.5 HEIGHT: 45.5-55.5</p> <p>SEAT WIDTH: 21 SEAT DEPTH: 16.5 SEAT HEIGHT: 27.5-37.5 BACK WIDTH: 19 BACK HEIGHT: 18.5</p> <p>COM: 0.9 YDS COL: 8.0 SQ FT WEIGHT: 44.0 LB</p>	<p><b>BA9B</b> STD 26" High Profile Nylon Base - Black</p> <p><b>BA10B</b> \$100 26" High Profile Aluminum Base - Black Powder Coat</p>	<p><b>LB</b> \$30 Height Adjustable Lumbar Support (Factory Installed)</p>	
A/COM	B	C	D	E	F	G	L3/COL	L4	L5																																																																																
625	655	675	705	740	780	820	685	755	785																																																																																
755	785	805	835	870	910	950	815	885	915																																																																																
710	740	760	790	825	865	905	770	840	870																																																																																
710	740	760	790	825	865	905	770	840	870																																																																																
730	760	780	810	845	885	925	790	860	890																																																																																
735	765	785	815	850	890	930	795	865	895																																																																																
755	785	805	835	870	910	950	815	885	915																																																																																
1868	Y1	<b>8" STOOL SIMPLE SYNCHRO</b> Use for work surfaces up to 36 inches high	ARMLESS A6 A8B / A8S A10 A36 A40 A41	<table border="1"> <thead> <tr> <th>A/COM</th> <th>B</th> <th>C</th> <th>D</th> <th>E</th> <th>F</th> <th>G</th> <th>L3/COL</th> <th>L4</th> <th>L5</th> </tr> </thead> <tbody> <tr><td>625</td><td>655</td><td>675</td><td>705</td><td>740</td><td>780</td><td>820</td><td>685</td><td>755</td><td>785</td></tr> <tr><td>755</td><td>785</td><td>805</td><td>835</td><td>870</td><td>910</td><td>950</td><td>815</td><td>885</td><td>915</td></tr> <tr><td>710</td><td>740</td><td>760</td><td>790</td><td>825</td><td>865</td><td>905</td><td>770</td><td>840</td><td>870</td></tr> <tr><td>710</td><td>740</td><td>760</td><td>790</td><td>825</td><td>865</td><td>905</td><td>770</td><td>840</td><td>870</td></tr> <tr><td>730</td><td>760</td><td>780</td><td>810</td><td>845</td><td>885</td><td>925</td><td>790</td><td>860</td><td>890</td></tr> <tr><td>735</td><td>765</td><td>785</td><td>815</td><td>850</td><td>890</td><td>930</td><td>795</td><td>865</td><td>895</td></tr> <tr><td>755</td><td>785</td><td>805</td><td>835</td><td>870</td><td>910</td><td>950</td><td>815</td><td>885</td><td>915</td></tr> </tbody> </table>	A/COM	B	C	D	E	F	G	L3/COL	L4	L5	625	655	675	705	740	780	820	685	755	785	755	785	805	835	870	910	950	815	885	915	710	740	760	790	825	865	905	770	840	870	710	740	760	790	825	865	905	770	840	870	730	760	780	810	845	885	925	790	860	890	735	765	785	815	850	890	930	795	865	895	755	785	805	835	870	910	950	815	885	915	<ul style="list-style-type: none"> <li>• Pneumatic seat height adjustment</li> <li>• Tilt tension control</li> <li>• Back and seat tilt in 3:1 ratio</li> <li>• Upright position tillock</li> <li>• Molded foam suspension seat</li> <li>• Optional height adjustable lumbar</li> <li>• Height adj 20" diameter footing</li> <li>• Warranted to 300 lbs.</li> </ul>	<p>WIDTH: 26.5 DEPTH: 27.5 HEIGHT: 40.5-48.5</p> <p>SEAT WIDTH: 21 SEAT DEPTH: 16.5 SEAT HEIGHT: 22.5-30.5 BACK WIDTH: 19 BACK HEIGHT: 18.5</p> <p>COM: 0.9 YDS COL: 8.0 SQ FT WEIGHT: 43.0 LB</p>	<p><b>BA10S</b> \$100 26" High Profile Aluminum Base - Silver Powder Coat</p> <p><b>BA10P</b> \$100 26" High Profile Aluminum Base - Polished</p>		
A/COM	B	C	D	E	F	G	L3/COL	L4	L5																																																																																
625	655	675	705	740	780	820	685	755	785																																																																																
755	785	805	835	870	910	950	815	885	915																																																																																
710	740	760	790	825	865	905	770	840	870																																																																																
710	740	760	790	825	865	905	770	840	870																																																																																
730	760	780	810	845	885	925	790	860	890																																																																																
735	765	785	815	850	890	930	795	865	895																																																																																
755	785	805	835	870	910	950	815	885	915																																																																																

# aria

provides revolutionary comfort

## MESH BACK

GSA SIN # 711-18

- Task, stool, management and conference seating
- Suspension seat incorporates a flexible high performance mesh with a molded high density foam overlay
- Choice of 18 back mesh colors
- Integrated handle in chair back
- Optional height adjustable lumbar
- Warranted to 300 lbs.
- CAL TB 133 Fire Code approved



### CREATING ARIA MODEL NUMBER

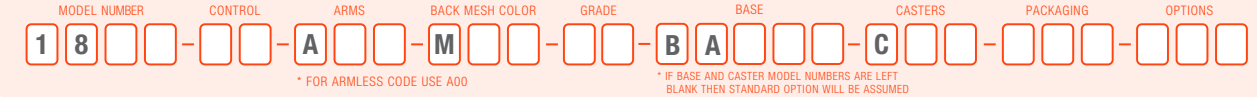

### PACKAGING NOTES

CODE	DESCRIPTION	LIST UPCHARGE
AB	ASSEMBLED IN BAG	\$0
PAC	PARTIALLY ASSEMBLED IN CARTON	\$0
BAC	BACK ASSEMBLED IN CARTON	\$40

MODEL	CONTROL	DESCRIPTION	ARM	FABRIC/LEATHER	FEATURES	DIMENSIONS	ARM OPTIONS	CASTER OPTIONS																																																																																
1880	Y4	<b>HIGH-BACK INTENSIVE SYNCHRO</b>  Use for a variety of general office task seating, including private office and conference room seating	ARMLESS	<table border="1"> <thead> <tr> <th>A/COM</th> <th>B</th> <th>C</th> <th>D</th> <th>E</th> <th>F</th> <th>G</th> <th>L3/COL</th> <th>L4</th> <th>L5</th> </tr> </thead> <tbody> <tr> <td>625</td> <td>655</td> <td>675</td> <td>705</td> <td>740</td> <td>780</td> <td>820</td> <td>685</td> <td>755</td> <td>785</td> </tr> <tr> <td>A6</td> <td>755</td> <td>785</td> <td>805</td> <td>835</td> <td>870</td> <td>910</td> <td>950</td> <td>815</td> <td>915</td> </tr> <tr> <td>A8B / A8S</td> <td>710</td> <td>740</td> <td>760</td> <td>790</td> <td>825</td> <td>865</td> <td>905</td> <td>770</td> <td>840</td> </tr> <tr> <td>A10</td> <td>710</td> <td>740</td> <td>760</td> <td>790</td> <td>825</td> <td>865</td> <td>905</td> <td>770</td> <td>840</td> </tr> <tr> <td>A36</td> <td>730</td> <td>760</td> <td>780</td> <td>810</td> <td>845</td> <td>885</td> <td>925</td> <td>790</td> <td>860</td> </tr> <tr> <td>A40</td> <td>735</td> <td>765</td> <td>785</td> <td>815</td> <td>850</td> <td>890</td> <td>930</td> <td>795</td> <td>865</td> </tr> <tr> <td>A41</td> <td>755</td> <td>785</td> <td>805</td> <td>835</td> <td>870</td> <td>910</td> <td>950</td> <td>815</td> <td>885</td> </tr> </tbody> </table>	A/COM	B	C	D	E	F	G	L3/COL	L4	L5	625	655	675	705	740	780	820	685	755	785	A6	755	785	805	835	870	910	950	815	915	A8B / A8S	710	740	760	790	825	865	905	770	840	A10	710	740	760	790	825	865	905	770	840	A36	730	760	780	810	845	885	925	790	860	A40	735	765	785	815	850	890	930	795	865	A41	755	785	805	835	870	910	950	815	885	<ul style="list-style-type: none"> <li>• Pneumatic seat height adjustment</li> <li>• Side tilt tension control</li> <li>• Back and seat tilt in 2:1 ratio</li> <li>• 4 locking positions</li> <li>• Safety tilt release</li> <li>• Forward seat pitch adjustment</li> <li>• Standard seat slider</li> <li>• Injection molded suspension seat</li> <li>• Optional height adjustable lumbar</li> <li>• Warranted to 300 lbs.</li> </ul>	WIDTH: 26.5 DEPTH: 27.5 HEIGHT: 40.0-43.0 SEAT WIDTH: 21.0 SEAT DEPTH: 17.0-19.5 SEAT HEIGHT: 18.5-21.5 BACK WIDTH: 19.0 BACK HEIGHT: 23.0 COM: 0.9 YD COL: 8.0 SQ FT WEIGHT: 44.0 LB	 <b>A6</b> \$130  <b>A8B/S</b> \$85	 <b>C6</b> STD  <b>C6S</b> \$35
A/COM	B		C	D	E	F	G	L3/COL	L4	L5																																																																														
625	655		675	705	740	780	820	685	755	785																																																																														
A6	755		785	805	835	870	910	950	815	915																																																																														
A8B / A8S	710		740	760	790	825	865	905	770	840																																																																														
A10	710		740	760	790	825	865	905	770	840																																																																														
A36	730	760	780	810	845	885	925	790	860																																																																															
A40	735	765	785	815	850	890	930	795	865																																																																															
A41	755	785	805	835	870	910	950	815	885																																																																															
1885	Y4	<b>HIGH-BACK W/ HEADREST INTENSIVE SYNCHRO</b>  Use for a variety of general office task seating, including private office and conference room seating	ARMLESS	<table border="1"> <thead> <tr> <th>A/COM</th> <th>B</th> <th>C</th> <th>D</th> <th>E</th> <th>F</th> <th>G</th> <th>L3/COL</th> <th>L4</th> <th>L5</th> </tr> </thead> <tbody> <tr> <td>710</td> <td>740</td> <td>760</td> <td>790</td> <td>825</td> <td>865</td> <td>905</td> <td>770</td> <td>840</td> <td>870</td> </tr> <tr> <td>A6</td> <td>840</td> <td>870</td> <td>890</td> <td>920</td> <td>955</td> <td>995</td> <td>1035</td> <td>900</td> <td>1000</td> </tr> <tr> <td>A8B / A8S</td> <td>795</td> <td>825</td> <td>845</td> <td>875</td> <td>910</td> <td>950</td> <td>990</td> <td>855</td> <td>925</td> </tr> <tr> <td>A10</td> <td>795</td> <td>825</td> <td>845</td> <td>875</td> <td>910</td> <td>950</td> <td>990</td> <td>855</td> <td>925</td> </tr> <tr> <td>A36</td> <td>815</td> <td>845</td> <td>865</td> <td>895</td> <td>930</td> <td>970</td> <td>1010</td> <td>875</td> <td>945</td> </tr> <tr> <td>A40</td> <td>820</td> <td>850</td> <td>870</td> <td>900</td> <td>935</td> <td>975</td> <td>1015</td> <td>880</td> <td>950</td> </tr> <tr> <td>A41</td> <td>840</td> <td>870</td> <td>890</td> <td>920</td> <td>955</td> <td>995</td> <td>1035</td> <td>900</td> <td>970</td> </tr> </tbody> </table>	A/COM	B	C	D	E	F	G	L3/COL	L4	L5	710	740	760	790	825	865	905	770	840	870	A6	840	870	890	920	955	995	1035	900	1000	A8B / A8S	795	825	845	875	910	950	990	855	925	A10	795	825	845	875	910	950	990	855	925	A36	815	845	865	895	930	970	1010	875	945	A40	820	850	870	900	935	975	1015	880	950	A41	840	870	890	920	955	995	1035	900	970	<ul style="list-style-type: none"> <li>• Pneumatic seat height adjustment</li> <li>• Side tilt tension control</li> <li>• Back and seat tilt in 2:1 ratio</li> <li>• 4 locking positions</li> <li>• Safety tilt release</li> <li>• Forward seat pitch adjustment</li> <li>• Standard seat slider</li> <li>• Injection molded suspension seat</li> <li>• Optional height adjustable lumbar</li> <li>• Warranted to 300 lbs.</li> </ul>	WIDTH: 26.5 DEPTH: 27.5 HEIGHT: 47-50 SEAT WIDTH: 21.0 SEAT DEPTH: 17.0-19.5 SEAT HEIGHT: 18.5-21.5 BACK WIDTH: 19.0 BACK HEIGHT: 30.0 COM: 0.9 YD COL: 8.0 SQ FT WEIGHT: 45.0 LB	 <b>A10</b> \$85  <b>A36</b> \$105  <b>A40</b> \$110  <b>A41</b> \$130	 <b>C6</b> STD  <b>C6S</b> \$35  <b>C7</b> \$35
A/COM	B		C	D	E	F	G	L3/COL	L4	L5																																																																														
710	740		760	790	825	865	905	770	840	870																																																																														
A6	840		870	890	920	955	995	1035	900	1000																																																																														
A8B / A8S	795		825	845	875	910	950	990	855	925																																																																														
A10	795		825	845	875	910	950	990	855	925																																																																														
A36	815	845	865	895	930	970	1010	875	945																																																																															
A40	820	850	870	900	935	975	1015	880	950																																																																															
A41	840	870	890	920	955	995	1035	900	970																																																																															
1860	GT	<b>GUEST</b>  Black four leg steel frame side chair	SWA	<table border="1"> <thead> <tr> <th>A/COM</th> <th>B</th> <th>C</th> <th>D</th> <th>E</th> <th>F</th> <th>G</th> <th>L3/COL</th> <th>L4</th> <th>L5</th> </tr> </thead> <tbody> <tr> <td>460</td> <td>490</td> <td>510</td> <td>540</td> <td>575</td> <td>615</td> <td>655</td> <td>540</td> <td>590</td> <td>670</td> </tr> <tr> <td></td> <td></td> <td></td> <td></td> <td></td> <td></td> <td></td> <td></td> <td></td> <td></td> </tr> <tr> <td></td> <td></td> <td></td> <td></td> <td></td> <td></td> <td></td> <td></td> <td></td> <td></td> </tr> </tbody> </table>	A/COM	B	C	D	E	F	G	L3/COL	L4	L5	460	490	510	540	575	615	655	540	590	670																					<ul style="list-style-type: none"> <li>• Black four leg style frame</li> <li>• Warranted to 300 lbs.</li> </ul>	WIDTH: 24.5 DEPTH: 24.0 HEIGHT: 35.5 SEAT WIDTH: 21.0 SEAT DEPTH: 17.0 SEAT HEIGHT: 17.5 BACK WIDTH: 19.0 BACK HEIGHT: 18.5 COM: 0.9 YD COL: 8.0 SQ FT WEIGHT: 26.5	 <b>BA9B</b> STD  <b>BA10B</b> \$100  <b>BA10S</b> \$100  <b>BA10P</b> \$100	 <b>LB</b> \$30																																								
A/COM	B		C	D	E	F	G	L3/COL	L4	L5																																																																														
460	490		510	540	575	615	655	540	590	670																																																																														
				SHIPS PARTIALLY ASSEMBLED PAC OR AB / SWA - STANDARD WITH ARMS																																																																																				

# axis

great design never goes out of style

## MID-BACK

GSA SIN # 711-18

- Conference and executive seating
- Warranted to 300 lbs



### CREATING AXIS MODEL NUMBER



### MESH COLORS

BLACK M21	GRAY M22	WHITE M23	GREEN M24
RED M25	BLUE M26	ORANGE M27	AQUA M28

### PACKAGING NOTES

CODE	DESCRIPTION	LIST UPCHARGE
AB	ASSEMBLED IN BAG	\$0
PAC	PARTIALLY ASSEMBLED IN CARTON	\$0
BAC	BACK ASSEMBLED IN CARTON	\$40

MODEL	CONTROL	DESCRIPTION	ARM	FABRIC/LEATHER	FEATURES	DIMENSIONS	ARM OPTIONS	CASTER OPTIONS																																																																											
2600	S1	<b>MID-BACK SWIVEL TILT</b>  Use for a variety of general office seating, including private office and conference room seating	<table border="1"> <tr><td>ARMLESS</td><td>525</td><td>605</td><td>655</td><td>735</td><td>825</td><td>925</td><td>1040</td><td>575</td><td>675</td><td>1265</td></tr> <tr><td>A4</td><td>600</td><td>680</td><td>730</td><td>810</td><td>900</td><td>1000</td><td>1115</td><td>650</td><td>750</td><td>1340</td></tr> <tr><td>A8B</td><td>610</td><td>690</td><td>740</td><td>820</td><td>910</td><td>1010</td><td>1125</td><td>660</td><td>760</td><td>1350</td></tr> <tr><td>A8S</td><td>610</td><td>690</td><td>740</td><td>820</td><td>910</td><td>1010</td><td>1125</td><td>660</td><td>760</td><td>1350</td></tr> <tr><td>A16</td><td>625</td><td>705</td><td>755</td><td>835</td><td>925</td><td>1025</td><td>1140</td><td>675</td><td>775</td><td>1365</td></tr> <tr><td>A16P</td><td>675</td><td>755</td><td>805</td><td>885</td><td>975</td><td>1075</td><td>1190</td><td>725</td><td>825</td><td>1415</td></tr> <tr><td>A36</td><td>630</td><td>710</td><td>760</td><td>840</td><td>930</td><td>1030</td><td>1145</td><td>680</td><td>780</td><td>1370</td></tr> </table>	ARMLESS	525	605	655	735	825	925	1040	575	675	1265	A4	600	680	730	810	900	1000	1115	650	750	1340	A8B	610	690	740	820	910	1010	1125	660	760	1350	A8S	610	690	740	820	910	1010	1125	660	760	1350	A16	625	705	755	835	925	1025	1140	675	775	1365	A16P	675	755	805	885	975	1075	1190	725	825	1415	A36	630	710	760	840	930	1030	1145	680	780	1370	<ul style="list-style-type: none"> <li>• Pneumatic seat height adjustment</li> <li>• Tilt tension control</li> <li>• Seat and back tilt as a unit</li> <li>• 360-degree swivel</li> <li>• Upright position tilt lock</li> <li>• Warranted to 300 lbs.</li> </ul>	<b>WIDTH:</b> 24.0 <b>DEPTH:</b> 29.5 <b>HEIGHT:</b> 39.0-43.5 <b>SEAT WIDTH:</b> 20.0 <b>SEAT DEPTH:</b> 19.5 <b>SEAT HEIGHT:</b> 17.0-21.5 <b>BACK WIDTH:</b> 23.0 <b>BACK HEIGHT:</b> 20.0 <b>COM:</b> 2.9 YD <b>COL:</b> 37.0 SQ FT <b>WEIGHT:</b> 54.5 LB	       
ARMLESS	525	605	655	735	825	925	1040	575	675	1265																																																																									
A4	600	680	730	810	900	1000	1115	650	750	1340																																																																									
A8B	610	690	740	820	910	1010	1125	660	760	1350																																																																									
A8S	610	690	740	820	910	1010	1125	660	760	1350																																																																									
A16	625	705	755	835	925	1025	1140	675	775	1365																																																																									
A16P	675	755	805	885	975	1075	1190	725	825	1415																																																																									
A36	630	710	760	840	930	1030	1145	680	780	1370																																																																									
2600	K1	<b>MID-BACK KNEE TILT</b>  Ultimate seating comfort suited for the executive or manager. Allows for a full range of movement with a sharp, simple look	<table border="1"> <tr><td>ARMLESS</td><td>575</td><td>655</td><td>705</td><td>785</td><td>875</td><td>975</td><td>1090</td><td>625</td><td>725</td><td>1315</td></tr> <tr><td>A4</td><td>650</td><td>730</td><td>780</td><td>860</td><td>950</td><td>1050</td><td>1165</td><td>700</td><td>800</td><td>1390</td></tr> <tr><td>A8B</td><td>660</td><td>740</td><td>790</td><td>870</td><td>960</td><td>1060</td><td>1175</td><td>710</td><td>810</td><td>1400</td></tr> <tr><td>A8S</td><td>660</td><td>740</td><td>790</td><td>870</td><td>960</td><td>1060</td><td>1175</td><td>710</td><td>810</td><td>1400</td></tr> <tr><td>A16</td><td>675</td><td>755</td><td>805</td><td>885</td><td>975</td><td>1075</td><td>1190</td><td>725</td><td>825</td><td>1415</td></tr> <tr><td>A16P</td><td>725</td><td>805</td><td>855</td><td>935</td><td>1025</td><td>1125</td><td>1240</td><td>775</td><td>875</td><td>1465</td></tr> <tr><td>A36</td><td>680</td><td>760</td><td>810</td><td>890</td><td>980</td><td>1080</td><td>1195</td><td>730</td><td>830</td><td>1420</td></tr> </table>	ARMLESS	575	655	705	785	875	975	1090	625	725	1315	A4	650	730	780	860	950	1050	1165	700	800	1390	A8B	660	740	790	870	960	1060	1175	710	810	1400	A8S	660	740	790	870	960	1060	1175	710	810	1400	A16	675	755	805	885	975	1075	1190	725	825	1415	A16P	725	805	855	935	1025	1125	1240	775	875	1465	A36	680	760	810	890	980	1080	1195	730	830	1420	<ul style="list-style-type: none"> <li>• Pneumatic seat height adjustment</li> <li>• Tilt tension control</li> <li>• Seat and back tilt as a unit</li> <li>• 5 locking positions</li> <li>• Safety tilt release</li> <li>• Reduced rise of front of seat</li> <li>• Warranted up to 300 lbs.</li> </ul>	<b>WIDTH:</b> 24.0 <b>DEPTH:</b> 29.5 <b>HEIGHT:</b> 39.5-42.5 <b>SEAT WIDTH:</b> 20.0 <b>SEAT DEPTH:</b> 19.5 <b>SEAT HEIGHT:</b> 17.5-20.5 <b>BACK WIDTH:</b> 23.0 <b>BACK HEIGHT:</b> 20.0 <b>COM:</b> 2.9 YD <b>COL:</b> 37.0 SQ FT <b>WEIGHT:</b> 59.5 LB	       
ARMLESS	575	655	705	785	875	975	1090	625	725	1315																																																																									
A4	650	730	780	860	950	1050	1165	700	800	1390																																																																									
A8B	660	740	790	870	960	1060	1175	710	810	1400																																																																									
A8S	660	740	790	870	960	1060	1175	710	810	1400																																																																									
A16	675	755	805	885	975	1075	1190	725	825	1415																																																																									
A16P	725	805	855	935	1025	1125	1240	775	875	1465																																																																									
A36	680	760	810	890	980	1080	1195	730	830	1420																																																																									
2600	GT	<b>GUEST</b>  Well suited for guest seating. Comes standard with non-marring glides	<table border="1"> <tr><td>ARMLESS</td><td>505</td><td>585</td><td>635</td><td>715</td><td>805</td><td>905</td><td>1020</td><td>555</td><td>655</td><td>1245</td></tr> <tr><td>A16</td><td>605</td><td>685</td><td>735</td><td>815</td><td>905</td><td>1005</td><td>1120</td><td>655</td><td>755</td><td>1345</td></tr> <tr><td>A16P</td><td>655</td><td>735</td><td>785</td><td>865</td><td>955</td><td>1055</td><td>1170</td><td>705</td><td>805</td><td>1395</td></tr> </table>	ARMLESS	505	585	635	715	805	905	1020	555	655	1245	A16	605	685	735	815	905	1005	1120	655	755	1345	A16P	655	735	785	865	955	1055	1170	705	805	1395	<ul style="list-style-type: none"> <li>• Cantilever frame design</li> <li>• Non-warring floor glides</li> <li>• Warranted to 300 lbs.</li> </ul>	<b>WIDTH:</b> 26.0 <b>DEPTH:</b> 29.5 <b>HEIGHT:</b> 40.0 <b>SEAT WIDTH:</b> 20.0 <b>SEAT DEPTH:</b> 19.5 <b>SEAT HEIGHT:</b> 18.0 <b>BACK WIDTH:</b> 23.0 <b>BACK HEIGHT:</b> 20.0 <b>COM:</b> 2.9 YD <b>COL:</b> 37.0 SQ FT <b>WEIGHT:</b> 50.0 LB	   																																												
ARMLESS	505	585	635	715	805	905	1020	555	655	1245																																																																									
A16	605	685	735	815	905	1005	1120	655	755	1345																																																																									
A16P	655	735	785	865	955	1055	1170	705	805	1395																																																																									

SHIPS FULLY ASSEMBLED EITHER AC OR AB

# axis

great design never goes out of style

## HIGH-BACK

GSA SIN # 711-18

- Conference and executive seating
- Warranted to 300 lbs



### CREATING AXIS MODEL NUMBER



### MESH COLORS

BLACK M21	GRAY M22	WHITE M23	GREEN M24
RED M25	BLUE M26	ORANGE M27	AQUA M28

### PACKAGING NOTES

CODE	DESCRIPTION	LIST UPCHARGE
AB	ASSEMBLED IN BAG	\$0
PAC	PARTIALLY ASSEMBLED IN CARTON	\$0
BAC	BACK ASSEMBLED IN CARTON	\$40

#### MODEL CONTROL DESCRIPTION

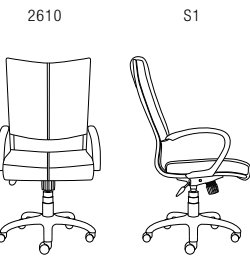

#### HIGH-BACK SWIVEL TILT

Use for a variety of general office seating, including private office and conference room seating

#### ARM FABRIC/LEATHER

ARM	A/COM	B	C	D	E	F	G	L3/COL	L4	L5
ARMLESS	575	665	720	810	910	1025	1150	625	750	1675
A4	650	740	795	885	985	1100	1225	700	825	1750
A8B	660	750	805	895	995	1110	1235	710	835	1760
A8S	660	750	805	895	995	1110	1235	710	835	1760
A16	675	765	820	910	1010	1125	1250	725	850	1775
A16P	725	815	870	960	1060	1175	1300	775	900	1825
A36	680	770	825	915	1015	1130	1255	730	855	1780

#### FEATURES

- Pneumatic seat height adjustment
- Tilt tension control
- Seat and back tilt as a unit
- 360-degree swivel
- Upright position tilt lock
- Warranted to 300 lbs.

#### DIMENSIONS

**WIDTH:** 24.0  
**DEPTH:** 29.5  
**HEIGHT:** 43.0-47.5  
**SEAT WIDTH:** 20.0  
**SEAT DEPTH:** 19.5  
**SEAT HEIGHT:** 17.0-21.5  
**BACK WIDTH:** 23.0  
**BACK HEIGHT:** 24.0  
**COM:** 3.2 YD  
**COL:** 54.0 SQ FT  
**WEIGHT:** 56.0 LB

#### ARM OPTIONS

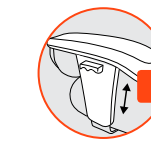

#### CASTER OPTIONS

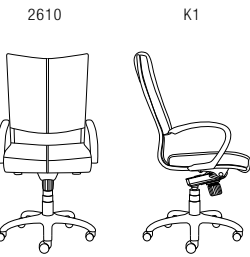

#### HIGH-BACK KNEE TILT

Ultimate seating comfort suited for the executive or manager. Allows for a full range of movement with a sharp, simple look

ARM	A/COM	B	C	D	E	F	G	L3/COL	L4	L5
ARMLESS	625	715	770	860	960	1075	1200	675	800	1725
A4	700	790	845	935	1035	1150	1275	750	875	1800
A8B	710	800	855	945	1045	1160	1285	760	885	1810
A8S	710	800	855	945	1045	1160	1285	760	885	1810
A16	725	815	870	960	1060	1175	1300	775	900	1825
A16P	775	865	920	1010	1110	1225	1350	825	950	1875
A36	730	820	875	965	1065	1180	1305	780	905	1830

- Pneumatic seat height adjustment
- Seat and back tilt as a unit
- 5 locking positions
- Safety tilt release
- Reduced rise of front of seat
- Warranted to 300 lbs.

**WIDTH:** 24.0  
**DEPTH:** 29.5  
**HEIGHT:** 42.5-45.5  
**SEAT WIDTH:** 20.0  
**SEAT DEPTH:** 19.5  
**SEAT HEIGHT:** 17.0-20.5  
**BACK WIDTH:** 23.0  
**BACK HEIGHT:** 24.0  
**COM:** 3.2 YD  
**COL:** 54.0 SQ FT  
**WEIGHT:** 61 LB

#### BASE OPTIONS



#### ADDITIONAL OPTIONS



# bella

name your game, bella is ready to play

## ALL PLASTIC - AP

GSA SIN # 711-19

- Multi-purpose seating including stacking, nesting, task and task stool models
- Perfect for collaborative, meeting, training and break rooms spaces
- Back styles include: all plastic, upholstered, or mesh
- Choice of plastic or upholstered seat
- 6 powder coat frame colors
- 12 plastic colors (black only on mesh back models)
- Warranted to 300 lbs.
- CAL TB 133 Fire Code approved



### CREATING BELLA MODEL NUMBER

MODEL NUMBER CONTROL ARMS FRAME COLOR UPHOLSTERY MESH COLOR PLASTIC COLOR CASTERS PACKAGING OPTIONS

1 3 - GT - A - AP - M - P - C5 -

\* FOR ARMLESS CODE USE A00 \* ONLY SELECT FOR MODELS 1360/1365 \* ONLY SELECT CASTER CODE FOR MODELS 1315/1365

### PACKAGING NOTES

CODE	DESCRIPTION	LIST UPCHARGE
AB	ASSEMBLED IN BAG	\$0
AC	ASSEMBLED IN CARTON	\$0

BELLA STACK CHAIRS SHIP UP TO 3 PER CARTON

MODEL	CONTROL	DESCRIPTION	ARM	PLASTIC	FEATURES	DIMENSIONS	ARM OPTIONS	CASTERS
1310	GT	<b>GUEST STACKING</b> Plastic back with plastic seat	ARMLESS A12 A14 TAB-A00 TAB-A12 TAB-A14	P 220 265 300 340 365 380	<ul style="list-style-type: none"> <li>• Non-marring floor glides</li> <li>• Stacks 4 high on floor</li> <li>• Stacks 10 high on optional dolly</li> <li>• Wall saver back legs</li> <li>• Integrated handle in back of chair</li> <li>• Arm pad and glide color will be black with all plastic shell color choices</li> <li>• Warranted to 300 lbs.</li> </ul>	<b>ARMLESS</b> <b>W/ ARMS</b> <b>WIDTH:</b> 21.0    25.0 <b>DEPTH:</b> 26.0    26.0 <b>HEIGHT:</b> 33.0    33.0 <b>SEAT WIDTH:</b> 18.0    18.0 <b>SEAT DEPTH:</b> 16.0    16.0 <b>SEAT HEIGHT:</b> 18.0    18.0 <b>BACK WIDTH:</b> 19.0    19.0 <b>BACK HEIGHT:</b> 17.5    17.5 <b>COM:</b> N/A    N/A <b>WEIGHT:</b> 13.0 LB    15.0 LB	<b>A12</b> \$45 Fixed Arm <b>A14</b> \$80 Reinforced Soft Touch Extended Arm <b>TAB-A00</b> \$120 Right Folding Tablet in Black Laminate. Tablet Arm in Black Color Only. Available in 6 Frame Colors. Tablet Size: 15.5"x11.25"x.25" <b>TAB-A14</b> \$160 Right Folding Tablet Arm w/ A14 Left Arm. Tablet Arm in Black Color only. Available in 6 Frame Colors. Tablet Size: 15.5"x11.25"x.25"	<b>C5</b> STD 50mm Hooded Casters <b>C5S</b> \$30 50mm Hoodless Hard Floor Casters
1315	GT	<b>GUEST STACKING WITH CASTERS</b> Plastic back with plastic seat	ARMLESS A12 A14 TAB-A00 TAB-A12 TAB-A14	P 265 310 345 385 410 425	<ul style="list-style-type: none"> <li>• 50mm hooded casters</li> <li>• Stack 4 high on floor</li> <li>• Stacks 10 high on optional dolly</li> <li>• Integrated handle in back of chair</li> <li>• Arm pads black with all plastic shell colors</li> <li>• Warranted to 300 lbs.</li> </ul>	<b>WIDTH:</b> 21.0    25.0 <b>DEPTH:</b> 26.0    26.0 <b>HEIGHT:</b> 33.0    33.0 <b>SEAT WIDTH:</b> 18.0    18.0 <b>SEAT DEPTH:</b> 16.0    16.0 <b>SEAT HEIGHT:</b> 18.0    18.0 <b>BACK WIDTH:</b> 19.0    19.0 <b>BACK HEIGHT:</b> 17.5    17.5 <b>COM:</b> N/A    N/A <b>WEIGHT:</b> 13.0 LB    15.0 LB	<b>BSK</b> \$60 Side Hanging Wire Basket for model 1310, 1315, 1360, 1365. Attach to left or right side <b>DL1</b> \$250 Stacking Dolly Stack Chair 10 High <b>GC1</b> \$30 Ganging Clip - 2 per Set GC1 - Armless-to-Armless <b>GC2</b> \$30 GC2 - Arm-to-Arm	
1360	GT	<b>GUEST STACKING</b> Mesh back with plastic seat	ARMLESS A12 A14 TAB-A00 TAB-A12 TAB-A14	P 285 330 365 405 430 445	<ul style="list-style-type: none"> <li>• Non-marring floor glides</li> <li>• Stacks 4 high on floor</li> <li>• Stacks 10 high on optional dolly</li> <li>• Wall saver back legs</li> <li>• Choice of 6 mesh back colors</li> <li>• Arm and glide color will be black with all plastic shell color choices</li> <li>• Warranted to 300 lbs.</li> </ul>	<b>WIDTH:</b> 21.0    25.0 <b>DEPTH:</b> 26.0    26.0 <b>HEIGHT:</b> 33.0    33.0 <b>SEAT WIDTH:</b> 18.0    18.0 <b>SEAT DEPTH:</b> 16.0    16.0 <b>SEAT HEIGHT:</b> 18.0    18.0 <b>BACK WIDTH:</b> 19.0    19.0 <b>BACK HEIGHT:</b> 17.5    17.5 <b>COM:</b> N/A    N/A <b>WEIGHT:</b> 13.0 LB    15.0 LB		
1365	GT	<b>GUEST STACKING WITH CASTERS</b> Mesh back with plastic seat	ARMLESS A12 A14 TAB-A00 TAB-A12 TAB-A14	P 330 375 410 450 475 490	<ul style="list-style-type: none"> <li>• 50mm hooded casters</li> <li>• Stacks 4 high on floor</li> <li>• Stacks 10 high on optional dolly</li> <li>• Choice of 6 mesh back colors</li> <li>• Arm pads black with all plastic shell colors</li> <li>• Warranted to 300 lbs.</li> </ul>	<b>WIDTH:</b> 21.0    25.0 <b>DEPTH:</b> 26.0    26.0 <b>HEIGHT:</b> 33.0    33.0 <b>SEAT WIDTH:</b> 18.0    18.0 <b>SEAT DEPTH:</b> 16.0    16.0 <b>SEAT HEIGHT:</b> 18.0    18.0 <b>BACK WIDTH:</b> 19.0    19.0 <b>BACK HEIGHT:</b> 17.5    17.5 <b>COM:</b> N/A    N/A <b>WEIGHT:</b> 13.0 LB    15.0 LB		

ONLY AVAILABLE IN M1

ONLY AVAILABLE IN M1

\*Standard lead time applies to Metallic Brown, Gunmetal, Dover Gray and White frame color options.

Black and Silver frame colors available as Express Ship

(BACK AND SEAT)

\*\*Mesh back models available only in P01 Black

Careless stacking of chairs may scratch and damage frames. Due to the nature of vinyl upholstery, stacking may cause impressions on the seat. 9to5 Seating does not warrant the effects of the stacking on vinyl upholstery.



# bella

name your game, bella is ready to play

## ALL PLASTIC - AP

GSA SIN # 711-19

- Multi-purpose seating including stacking, nesting, task and task stool models
- Perfect for collaborative, meeting, training and break rooms spaces
- Back styles include: all plastic, upholstered, or mesh
- Choice of plastic or upholstered seat
- 6 powder coat frame colors
- 12 plastic colors (black only on mesh back models)
- Warranted to 300 lbs.
- CAL TB 133 Fire Code approved



### CREATING BELLA MODEL NUMBER

MODEL NUMBER CONTROL ARMS FRAME COLOR UPHOLSTERY MESH COLOR PLASTIC COLOR CASTERS PACKAGING

1 3 - G T - A - - - - A P - M - - - - P - - - - C 5 - - - -

\* FOR ARMLESS CODE USE A00      \* ONLY SELECT FOR MODEL 1370

### PACKAGING NOTES

CODE	DESCRIPTION	LIST UPCHARGE
AB	ASSEMBLED IN BAG	\$0
AC	ASSEMBLED IN CARTON	\$0

BELLA NESTING CHAIRS SHIP UP TO 2 PER CARTON

MODEL	CONTROL	DESCRIPTION	ARM	PLASTIC	FEATURES	DIMENSIONS																						
1320	GT	<b>GUEST NESTING</b> Plastic back with plastic seat	ARMLESS A12 A14	P 285 330 365	<ul style="list-style-type: none"> <li>• Flip up seat for nesting and compact storage</li> <li>• 50mm hooded casters</li> <li>• Integrated handle in back of chair</li> <li>• Arm pads black with all plastic shell colors</li> <li>• Warranted to 300 lbs.</li> </ul>	<table border="1"> <thead> <tr> <th>ARMLESS</th> <th>W/ ARMS</th> </tr> </thead> <tbody> <tr> <td>WIDTH: 21.0</td> <td>25.0</td> </tr> <tr> <td>DEPTH: 26.0</td> <td>26.0</td> </tr> <tr> <td>HEIGHT: 33.0</td> <td>33.0</td> </tr> <tr> <td>SEAT WIDTH: 18.0</td> <td>18.0</td> </tr> <tr> <td>SEAT DEPTH: 16.0</td> <td>16.0</td> </tr> <tr> <td>SEAT HEIGHT: 18.0</td> <td>18.0</td> </tr> <tr> <td>BACK WIDTH: 19.0</td> <td>19.0</td> </tr> <tr> <td>BACK HEIGHT: 17.5</td> <td>17.5</td> </tr> <tr> <td>COM: N/A</td> <td>N/A</td> </tr> <tr> <td>WEIGHT: 19.0 LB</td> <td>22.0 LB</td> </tr> </tbody> </table>	ARMLESS	W/ ARMS	WIDTH: 21.0	25.0	DEPTH: 26.0	26.0	HEIGHT: 33.0	33.0	SEAT WIDTH: 18.0	18.0	SEAT DEPTH: 16.0	16.0	SEAT HEIGHT: 18.0	18.0	BACK WIDTH: 19.0	19.0	BACK HEIGHT: 17.5	17.5	COM: N/A	N/A	WEIGHT: 19.0 LB	22.0 LB
ARMLESS	W/ ARMS																											
WIDTH: 21.0	25.0																											
DEPTH: 26.0	26.0																											
HEIGHT: 33.0	33.0																											
SEAT WIDTH: 18.0	18.0																											
SEAT DEPTH: 16.0	16.0																											
SEAT HEIGHT: 18.0	18.0																											
BACK WIDTH: 19.0	19.0																											
BACK HEIGHT: 17.5	17.5																											
COM: N/A	N/A																											
WEIGHT: 19.0 LB	22.0 LB																											
1370	GT	<b>GUEST NESTING</b> Mesh back with plastic seat	ARMLESS A12 A14	P 350 395 430	<ul style="list-style-type: none"> <li>• Flip up seat for nesting and compact storage</li> <li>• 50mm hooded casters</li> <li>• Choice of 6 mesh back colors</li> <li>• Arm pads black with all plastic shell colors</li> <li>• Warranted to 300 lbs.</li> </ul>	<table border="1"> <thead> <tr> <th>ARMLESS</th> <th>W/ ARMS</th> </tr> </thead> <tbody> <tr> <td>WIDTH: 21.0</td> <td>25.0</td> </tr> <tr> <td>DEPTH: 26.0</td> <td>26.0</td> </tr> <tr> <td>HEIGHT: 33.0</td> <td>33.0</td> </tr> <tr> <td>SEAT WIDTH: 18.0</td> <td>18.0</td> </tr> <tr> <td>SEAT DEPTH: 16.0</td> <td>16.0</td> </tr> <tr> <td>SEAT HEIGHT: 18.0</td> <td>18.0</td> </tr> <tr> <td>BACK WIDTH: 19.0</td> <td>19.0</td> </tr> <tr> <td>BACK HEIGHT: 17.5</td> <td>17.5</td> </tr> <tr> <td>COM: N/A</td> <td>N/A</td> </tr> <tr> <td>WEIGHT: 19.0 LB</td> <td>22.0 LB</td> </tr> </tbody> </table>	ARMLESS	W/ ARMS	WIDTH: 21.0	25.0	DEPTH: 26.0	26.0	HEIGHT: 33.0	33.0	SEAT WIDTH: 18.0	18.0	SEAT DEPTH: 16.0	16.0	SEAT HEIGHT: 18.0	18.0	BACK WIDTH: 19.0	19.0	BACK HEIGHT: 17.5	17.5	COM: N/A	N/A	WEIGHT: 19.0 LB	22.0 LB
ARMLESS	W/ ARMS																											
WIDTH: 21.0	25.0																											
DEPTH: 26.0	26.0																											
HEIGHT: 33.0	33.0																											
SEAT WIDTH: 18.0	18.0																											
SEAT DEPTH: 16.0	16.0																											
SEAT HEIGHT: 18.0	18.0																											
BACK WIDTH: 19.0	19.0																											
BACK HEIGHT: 17.5	17.5																											
COM: N/A	N/A																											
WEIGHT: 19.0 LB	22.0 LB																											

ONLY AVAILABLE IN M1

### ARM OPTIONS

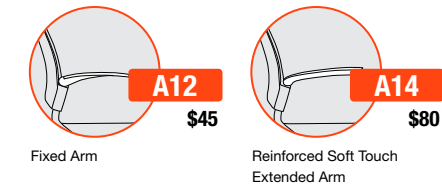

### CASTERS

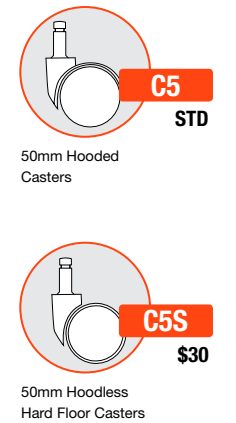

### NESTING FOOTPRINT

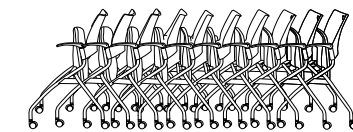

First Chair 24", Each Additional Chair, Add 6"  
CAUTION: Careless nesting of chairs may scratch and damage frames

### FRAME COLORS

BLACK BF	SILVER SF	METALLIC BROWN* MBF	GUNMETAL* GMF	DOVER GRAY* DGF	WHITE* WF
-------------	--------------	------------------------	------------------	--------------------	--------------

(FRAME)

### MESH COLORS

BLACK M11	GRAY M12	SILVER M13	GREEN M14	RED M15	BLUE M16
--------------	-------------	---------------	--------------	------------	-------------

### PLASTIC COLORS\*\*

BLACK SWAN P01	WHITE WHISPER P05	FEDERAL BLUE P11	CRIMSON RED P12	LEMON YELLOW P13	DOVE GRAY P14
CLOUD GRAY P15	LAGOON BLUE P16	APPLE GREEN P17	TANGERINE ORANGE P18	LATTE P19	AZURE BLUE P20

(BACK AND SEAT)

\*\*Mesh back models available only in P01 Black  
Careless stacking of chairs may scratch and damage frames. Due to the nature of vinyl upholstery, stacking may cause impressions on the seat. 9to5 Seating does not warrant the effects of the stacking on vinyl upholstery.

\*Standard lead time applies to Metallic Brown, Gunmetal, Dover Gray and White frame color options.

Black and Silver frame colors available as Express Ship

# bella

name your game, bella is ready to play

## ALL PLASTIC - AP

GSA SIN # 711-19

- Multi-purpose seating including stacking, nesting, task and task stool models
- Perfect for collaborative, meeting, training and break rooms spaces
- Back styles include: all plastic, upholstered, or mesh
- Choice of plastic or upholstered seat
- 6 powder coat frame colors
- 12 plastic colors (black only on mesh back models)
- Warranted to 300 lbs.
- CAL TB 133 Fire Code approved



### CREATING BELLA MODEL NUMBER

MODEL NUMBER CONTROL ARMS FRAME COLOR UPHOLSTERY MESH COLOR PLASTIC COLOR BASE CASTERS PACKAGING

1 3 5 - A - A P - M - P - B A - C 6 -

\* FOR ARMLESS CODE USE A00 \* ONLY SELECT FOR MODEL'S 1375

### PACKAGING NOTES

CODE	DESCRIPTION	LIST UPCHARGE
AB	ASSEMBLED IN BAG	\$0
BAC	BACK ASSEMBLED IN CARTON	\$0

MODEL	CONTROL	DESCRIPTION	ARM	PLASTIC	FEATURES	DIMENSIONS
1325	B2	<b>LOW-BACK BASIC TASK</b> Plastic back with plastic seat	ARMLESS A12 A14	P 345 390 425	<ul style="list-style-type: none"> <li>• Pneumatic seat height adjustment</li> <li>• Basic control swivels 360-degrees</li> <li>• No seat and back tilt</li> <li>• Arm pad black with all plastic shell colors</li> <li>• Warranted to 300 lbs.</li> </ul>	<b>WIDTH:</b> 26.0 <b>DEPTH:</b> 26.0 <b>HEIGHT:</b> 32.5-37.5 <b>SEAT WIDTH:</b> 18.0 <b>SEAT DEPTH:</b> 16.0 <b>SEAT HEIGHT:</b> 18-23 <b>BACK WIDTH:</b> 19.0 <b>BACK HEIGHT:</b> 17.5 <b>COM:</b> N/A <b>WEIGHT:</b> 24.5 LB
1325	S3	<b>LOW-BACK SWIVEL TILT</b> Plastic back with plastic seat	ARMLESS A12 A14	P 380 425 460	<ul style="list-style-type: none"> <li>• Pneumatic seat height adjustment</li> <li>• Tilt tension control</li> <li>• Seat and back tilt as a unit</li> <li>• Upright position tilt lock</li> <li>• Arm pad black with all plastic shell colors</li> <li>• Warranted to 300 lbs.</li> </ul>	<b>WIDTH:</b> 26.0 <b>DEPTH:</b> 26.0 <b>HEIGHT:</b> 33-37.5 <b>SEAT WIDTH:</b> 18.0 <b>SEAT DEPTH:</b> 16.0 <b>SEAT HEIGHT:</b> 17.0 -21.5 <b>BACK WIDTH:</b> 19.0 <b>BACK HEIGHT:</b> 17.5 <b>COM:</b> N/A <b>WEIGHT:</b> 25.5 LB
1375	B2	<b>LOW-BACK BASIC TASK</b> Mesh back with plastic seat	ARMLESS A12 A14	P 410 455 490	<ul style="list-style-type: none"> <li>• Pneumatic seat height adjustment</li> <li>• Basic control swivels 360-degrees</li> <li>• No seat and back tilt</li> <li>• Choice of 6 mesh back colors</li> <li>• Arm pad black with all plastic shell colors</li> <li>• Warranted to 300 lbs.</li> </ul>	<b>WIDTH:</b> 26.0 <b>DEPTH:</b> 26.0 <b>HEIGHT:</b> 32.5-37.5 <b>SEAT WIDTH:</b> 18.0 <b>SEAT DEPTH:</b> 16.0 <b>SEAT HEIGHT:</b> 18-23 <b>BACK WIDTH:</b> 19.0 <b>BACK HEIGHT:</b> 17.5 <b>COM:</b> N/A <b>WEIGHT:</b> 24.5 LB
1375	S3	<b>LOW-BACK SWIVEL TILT</b> Mesh back with plastic seat	ARMLESS A12 A14	P 445 490 525	<ul style="list-style-type: none"> <li>• Pneumatic seat height adjustment</li> <li>• Tilt tension control</li> <li>• Seat and back tilt as a unit</li> <li>• 360-degree swivel</li> <li>• Upright position tilt lock</li> <li>• Choice of 6 mesh back colors</li> <li>• Arm pad black with all plastic shell colors</li> <li>• Warranted to 300 lbs.</li> </ul>	<b>WIDTH:</b> 26.0 <b>DEPTH:</b> 26.0 <b>HEIGHT:</b> 33-37.5 <b>SEAT WIDTH:</b> 18.0 <b>SEAT DEPTH:</b> 16.0 <b>SEAT HEIGHT:</b> 17.0 -21.5 <b>BACK WIDTH:</b> 19.0 <b>BACK HEIGHT:</b> 17.5 <b>COM:</b> N/A <b>WEIGHT:</b> 25.5 LB

ARM OPTIONS	CASTER OPTIONS
<b>A12</b> \$45 Fixed Arm	<b>A14</b> \$80 Reinforced Soft Touch Extended Arm
<b>C6</b> STD 60mm Hoodless Casters	<b>C6S</b> \$35 60mm Hoodless Hard Floor Casters
BASE OPTIONS	
<b>BA9B</b> STD 26" High Profile Nylon Base - Black	<b>BA10B</b> \$100 26" High Profile Aluminum Black Powder-Coat
<b>BA10S</b> \$100 26" High Profile Aluminum Silver Powder-Coat	<b>BA10P</b> \$100 26" High Profile Aluminum Polished

### FRAME COLORS

BLACK BF	SILVER SF	METALLIC BROWN* MBF	GUNMETAL* GMF	DOVER GRAY* DGF	WHITE* WF
-------------	--------------	------------------------	------------------	--------------------	--------------

(FRAME)

### MESH COLORS

BLACK M11	GRAY M12	SILVER M13	GREEN M14	RED M15	BLUE M16
--------------	-------------	---------------	--------------	------------	-------------

### PLASTIC COLORS\*\*

BLACK SWAN P01	WHITE WHISPER P05	FEDERAL BLUE P11	CRIMSON RED P12	LEMON YELLOW P13	DOVE GRAY P14
CLOUD GRAY P15	LAGOON BLUE P16	APPLE GREEN P17	TANGERINE ORANGE P18	LATTE P19	AZURE BLUE P20

(BACK AND SEAT)  
\*\*Mesh back models available only in P01 Black

\*Standard lead time applies to Metallic Brown, Gunmetal, Dover Gray and White frame color options.  
Black and Silver frame colors available as Express Ship

# bella

name your game, bella is ready to play

## ALL PLASTIC - AP

GSA SIN # 711-19

- Multi-purpose seating including stacking, nesting, task and task stool models
- Perfect for collaborative, meeting, training and break rooms spaces
- Back styles include: all plastic, upholstered, or mesh
- Choice of plastic or upholstered seat
- 6 powder coat frame colors
- 12 plastic colors (black only on mesh back models)
- Warranted to 300 lbs.
- CAL TB 133 Fire Code approved



### CREATING BELLA MODEL NUMBER

MODEL NUMBER CONTROL ARMS FRAME COLOR UPHOLSTERY MESH COLOR PLASTIC COLOR BASE CASTERS PACKAGING

1 3 [ ] [ ] - B 2 - A [ ] [ ] - [ ] [ ] - A P - M [ ] [ ] - P [ ] [ ] - B A [ ] [ ] - C 6 [ ] [ ] [ ] [ ]

\* FOR ARMLESS CODE USE A00 \*\* ONLY SELECT FOR MODELS 1316/1378

### PACKAGING NOTES

CODE	DESCRIPTION	LIST UPCHARGE
AB	ASSEMBLED IN BAG	\$0
BAC	BACK ASSEMBLED IN CARTON	\$0

MODEL	CONTROL	DESCRIPTION	ARM	PLASTIC	FEATURES	DIMENSIONS
1326	B2	<b>10" STOOL BASIC TASK</b> Use for work surfaces up to 42 inches high. Plastic back with plastic seat	ARMLESS A12 A14	P 470 515 550	<ul style="list-style-type: none"> <li>• Pneumatic seat height adjustment</li> <li>• No seat and back tilt</li> <li>• Height adj. 20" diameter footring</li> <li>• Arm pad black with all plastic shell colors</li> <li>• Warranted to 300 lbs.</li> </ul>	<b>WIDTH:</b> 26.0 <b>DEPTH:</b> 26.0 <b>HEIGHT:</b> 40-50 <b>SEAT WIDTH:</b> 18.0 <b>SEAT DEPTH:</b> 16.0 <b>SEAT HEIGHT:</b> 25.5-35.5 <b>BACK WIDTH:</b> 19.0 <b>BACK HEIGHT:</b> 17.5 <b>COM:</b> N/A <b>WEIGHT:</b> 30.5 LB
1328	B2	<b>8" STOOL BASIC TASK</b> Use for work surfaces up to 36 inches high. Plastic back with plastic seat	ARMLESS A12 A14	P 470 515 550	<ul style="list-style-type: none"> <li>• Pneumatic seat height adjustment</li> <li>• No seat and back tilt</li> <li>• Height adj. 20" diameter footring</li> <li>• Arm pad black with all plastic shell colors</li> <li>• Warranted to 300 lbs.</li> </ul>	<b>WIDTH:</b> 26.0 <b>DEPTH:</b> 26.0 <b>HEIGHT:</b> 36-44 <b>SEAT WIDTH:</b> 18.0 <b>SEAT DEPTH:</b> 16.0 <b>SEAT HEIGHT:</b> 21.5-29.5 <b>BACK WIDTH:</b> 19.0 <b>BACK HEIGHT:</b> 17.5 <b>COM:</b> N/A <b>WEIGHT:</b> 29.5 LB
1376	B2	<b>10" STOOL BASIC TASK</b> Use for work surfaces up to 42 inches high. Mesh back with plastic seat	ARMLESS A12 A14	P 535 580 615	<ul style="list-style-type: none"> <li>• Pneumatic seat height adjustment</li> <li>• No seat and back tilt</li> <li>• Height adj. 20" diameter footring</li> <li>• Choice of 6 mesh back colors</li> <li>• Arm pad black with all plastic shell colors</li> <li>• Warranted to 300 lbs.</li> </ul>	<b>WIDTH:</b> 26.0 <b>DEPTH:</b> 26.0 <b>HEIGHT:</b> 40-50 <b>SEAT WIDTH:</b> 18.0 <b>SEAT DEPTH:</b> 16.0 <b>SEAT HEIGHT:</b> 25.5-35.5 <b>BACK WIDTH:</b> 19.0 <b>BACK HEIGHT:</b> 17.5 <b>COM:</b> N/A <b>WEIGHT:</b> 30.5 LB
1378	B2	<b>8" STOOL BASIC TASK</b> Use for work surfaces up to 36 inches high. Mesh back with plastic seat	ARMLESS A12 A14	P 535 580 615	<ul style="list-style-type: none"> <li>• Pneumatic seat height adjustment</li> <li>• No seat and back tilt</li> <li>• Height adj. 20" diameter footring</li> <li>• Choice of 6 mesh back colors</li> <li>• Arm pad black with all plastic shell colors</li> <li>• Warranted to 300 lbs.</li> </ul>	<b>WIDTH:</b> 26.0 <b>DEPTH:</b> 26.0 <b>HEIGHT:</b> 36-44 <b>SEAT WIDTH:</b> 18.0 <b>SEAT DEPTH:</b> 16.0 <b>SEAT HEIGHT:</b> 21.5-29.5 <b>BACK WIDTH:</b> 19.0 <b>BACK HEIGHT:</b> 17.5 <b>COM:</b> N/A <b>WEIGHT:</b> 29.5 LB

### ARM OPTIONS

**A12**  
\$45

**A14**  
\$80

### BASE OPTIONS

**BA9B**  
STD

**BA10B**  
\$100

**BA10S**  
\$100

**BA10P**  
\$100

### CASTER OPTIONS

**C6**  
STD

**C6S**  
\$35

### FRAME COLORS

BLACK BF	SILVER SF	METALLIC BROWN* MBF	GUNMETAL* GMF	DOVER GRAY* DGF	WHITE* WF
-------------	--------------	------------------------	------------------	--------------------	--------------

(FRAME)

### MESH COLORS

BLACK M11	GRAY M12	SILVER M13	GREEN M14	RED M15	BLUE M16
--------------	-------------	---------------	--------------	------------	-------------

### PLASTIC COLORS\*\*

BLACK SWAN P01	WHITE WHISPER P05	FEDERAL BLUE P11	CRIMSON RED P12	LEMON YELLOW P13	DOVE GRAY P14
CLOUD GRAY P15	LAGOON BLUE P16	APPLE GREEN P17	TANGERINE ORANGE P18	LATTE P19	AZURE BLUE P20

(BACK AND SEAT)

\*Standard lead time applies to Metallic Brown, Gunmetal, Dover Gray and White frame color options.  
Black and Silver frame colors available as Express Ship

\*\*Mesh back models available only in P01 Black

# bella

name your game, bella is ready to play

## UPHOLSTERED SEAT - US

GSA SIN # 711-19

- Multi-purpose seating including stacking, nesting, task and task stool models
- Perfect for collaborative, meeting, training and break rooms spaces
- Back styles include: all plastic, upholstered, or mesh
- Choice of plastic or upholstered seat
- 6 powder coat frame colors
- 12 plastic colors (black only on mesh back models)
- Warranted to 300 lbs.
- CAL TB 133 Fire Code approved



### CREATING BELLA MODEL NUMBER

MODEL NUMBER CONTROL ARMS FRAME COLOR UPHOLSTERY MESH COLOR GRADE PLASTIC COLOR CASTERS PACKAGING OPTIONS

1 3 - GT - A - U - S - M - P - C 6

\* FOR ARMLESS CODE USE A00 \* ONLY SELECT FOR MODELS 1360/1365 \* ONLY SELECT CASTER CODE FOR MODELS 1315/1365

### PACKAGING NOTES

CODE	DESCRIPTION	LIST UPCHARGE
AB	ASSEMBLED IN BAG	\$0
AC	ASSEMBLED IN CARTON	\$0

BELLA STACK CHAIRS SHIP UP TO 3 PER CARTON

MODEL	CONTROL	DESCRIPTION	ARM	FABRIC	FEATURES	DIMENSIONS
1310	GT	<b>GUEST STACKING</b> Plastic back with upholstered seat	ARMLESS	A/COM: 270, B: 295, C: 315, D: 340, E: 370, F: 405, G: 440	<ul style="list-style-type: none"> <li>• Non-marring floor glides</li> <li>• Stack 4 high on floor</li> <li>• Stacks 10 high on optional dolly</li> <li>• Wall saver back legs</li> <li>• Integrated handle in back of chair</li> <li>• Arm pad and glide color will be black with all plastic shell color choices</li> <li>• Warranted to 300 lbs.</li> </ul>	<b>ARMLESS</b> WIDTH: 21.0, DEPTH: 26.0, HEIGHT: 33.0 <b>W/ ARMS</b> SEAT WIDTH: 18.0, SEAT DEPTH: 16.0, SEAT HEIGHT: 18.0, BACK WIDTH: 19.0, BACK HEIGHT: 17.5 COM: 0.7 YD, WEIGHT: 15.0 LB
			A12	270, 295, 315, 340, 370, 405, 440		
			A14	315, 340, 360, 385, 415, 450, 485		
			TAB-A00	350, 375, 395, 420, 450, 485, 520		
			TAB-A12	390, 415, 435, 460, 490, 525, 560		
			TAB-A14	415, 440, 460, 485, 515, 550, 585		
			TAB-A14	430, 455, 475, 500, 530, 565, 600		
1315	GT	<b>GUEST STACKING WITH CASTERS</b> Plastic back with upholstered seat	ARMLESS	A/COM: 315, B: 340, C: 360, D: 385, E: 415, F: 450, G: 485	<ul style="list-style-type: none"> <li>• 50mm hooded casters</li> <li>• Stack 4 high on floor</li> <li>• Stacks 10 high on optional dolly</li> <li>• Integrated handle in back of chair</li> <li>• Arm pads black with all plastic shell colors</li> <li>• Warranted to 300 lbs.</li> </ul>	<b>ARMLESS</b> WIDTH: 21.0, DEPTH: 26.0, HEIGHT: 33.0 <b>W/ ARMS</b> SEAT WIDTH: 18.0, SEAT DEPTH: 16.0, SEAT HEIGHT: 18.0, BACK WIDTH: 19.0, BACK HEIGHT: 17.5 COM: 0.7 YD, WEIGHT: 15.0 LB
			A12	315, 340, 360, 385, 415, 450, 485		
			A14	360, 385, 405, 430, 460, 495, 530		
			TAB-A00	395, 420, 440, 465, 495, 530, 565		
			TAB-A12	435, 460, 480, 505, 535, 570, 605		
			TAB-A12	460, 485, 505, 530, 560, 595, 630		
			TAB-A14	475, 500, 520, 545, 575, 610, 645		
1360	GT	<b>GUEST STACKING</b> Mesh back with upholstered seat	ARMLESS	A/COM: 335, B: 360, C: 380, D: 405, E: 435, F: 470, G: 505	<ul style="list-style-type: none"> <li>• Non-marring floor glides</li> <li>• Stack 4 high on floor</li> <li>• Stacks 10 high on optional dolly</li> <li>• Wall saver back legs</li> <li>• Choice of 6 mesh back colors</li> <li>• Arm pad and glide color will be black with all plastic shell color choices</li> <li>• Warranted to 300 lbs.</li> </ul>	<b>ARMLESS</b> WIDTH: 21.0, DEPTH: 26.0, HEIGHT: 33.0 <b>W/ ARMS</b> SEAT WIDTH: 18.0, SEAT DEPTH: 16.0, SEAT HEIGHT: 18.0, BACK WIDTH: 19.0, BACK HEIGHT: 17.5 COM: 0.7 YD, WEIGHT: 15.0 LB
			A12	335, 360, 380, 405, 435, 470, 505		
			A14	380, 405, 425, 450, 480, 515, 550		
			TAB-A00	415, 440, 460, 485, 515, 550, 585		
			TAB-A12	455, 480, 500, 525, 555, 590, 625		
			TAB-A12	480, 505, 525, 550, 580, 615, 650		
			TAB-A14	495, 520, 540, 565, 595, 630, 665		
<b>ONLY AVAILABLE IN M1</b>						
1365	GT	<b>GUEST STACKING WITH CASTERS</b> Mesh back with upholstered seat	ARMLESS	A/COM: 380, B: 405, C: 425, D: 450, E: 480, F: 515, G: 550	<ul style="list-style-type: none"> <li>• 50mm hooded casters</li> <li>• Stack 4 high on floor</li> <li>• Stacks 10 high on optional dolly</li> <li>• Choice of 6 mesh back colors</li> <li>• Arm pads black with all plastic shell colors</li> <li>• Warranted to 300 lbs.</li> </ul>	<b>ARMLESS</b> WIDTH: 21.0, DEPTH: 26.0, HEIGHT: 33.0 <b>W/ ARMS</b> SEAT WIDTH: 18.0, SEAT DEPTH: 16.0, SEAT HEIGHT: 18.0, BACK WIDTH: 19.0, BACK HEIGHT: 17.5 COM: 0.7 YD, WEIGHT: 15.0 LB
			A12	380, 405, 425, 450, 480, 515, 550		
			A14	425, 450, 470, 495, 525, 560, 595		
			TAB-A00	460, 485, 505, 530, 560, 595, 630		
			TAB-A12	500, 525, 545, 570, 600, 635, 670		
			TAB-A12	525, 550, 570, 595, 625, 660, 695		
			TAB-A14	540, 565, 585, 610, 640, 675, 710		
<b>ONLY AVAILABLE IN M1</b>						

### ARM OPTIONS

**A12**  
\$45

**A14**  
\$80

**C5**  
STD

**TAB-A00**  
\$120

**TAB-A14**  
\$160

**C5S**  
\$30

### ACCESSORIES

**BSK**  
\$60

**DL1**  
\$250

**GC1**  
\$30  
**GC2**  
\$30

### FRAME COLORS

BLACK BF	SILVER SF	METALLIC BROW* MBF	GUNMETAL* GMF	DOVER GRAY* DGF	WHITE* WF
----------	-----------	--------------------	---------------	-----------------	-----------

(FRAME)

### MESH COLORS

BLACK M11	GRAY M12	SILVER M13	GREEN M14	RED M15	BLUE M16
-----------	----------	------------	-----------	---------	----------

### PLASTIC COLORS\*\*

BLACK SWAN P01	WHITE WHISPER P05	FEDERAL BLUE P11	CRIMSON RED P12	LEMON YELLOW P13	DOVE GRAY P14
CLOUD GRAY P15	LAGOON BLUE P16	APPLE GREEN P17	TANGERINE ORANGE P18	LATTE P19	AZURE BLUE P20

(BACK)

\*\*Mesh back models available only in P01 Black  
 Careless stacking of chairs may scratch and damage frames. Due to the nature of vinyl upholstery, stacking may cause impressions on the seat. 9to5 Seating does not warrant the effects of the stacking on vinyl upholstery.

\*Standard lead time applies to Metallic Brown, Gunmetal, Dover Gray and White frame color options.

Black and Silver frame colors available as Express Ship

# bella

name your game, bella is ready to play

## UPHOLSTERED SEAT - US

GSA SIN # 711-19

- Multi-purpose seating including stacking, nesting, task and task stool models
- Perfect for collaborative, meeting, training and break rooms spaces
- Back styles include: all plastic, upholstered, or mesh
- Choice of plastic or upholstered seat
- 6 powder coat frame colors
- 12 plastic colors (black only on mesh back models)
- Warranted to 300 lbs.
- CAL TB 133 Fire Code approved



### CREATING BELLA MODEL NUMBER

MODEL NUMBER CONTROL ARMS FRAME COLOR UPHOLSTERY MESH COLOR GRADE PLASTIC COLOR CASTERS PACKAGING

1 3 - GT - A - U - S - M - P - C5 -

\* FOR ARMLESS CODE USE A00      \*\* ONLY SELECT FOR MODEL 1370

### PACKAGING NOTES

CODE	DESCRIPTION	LIST UPCHARGE
AB	ASSEMBLED IN BAG	\$0
AC	ASSEMBLED IN CARTON	\$0

BELLA NESTING CHAIRS SHIP UP TO 2 PER CARTON

MODEL	CONTROL	DESCRIPTION	ARM	FABRIC	FEATURES	DIMENSIONS																																																
1320	GT	<b>GUEST NESTING</b> Plastic back with upholstered seat	ARMLESS A12 A14	<table border="1"> <thead> <tr> <th>A/COM</th> <th>B</th> <th>C</th> <th>D</th> <th>E</th> <th>F</th> <th>G</th> </tr> </thead> <tbody> <tr> <td>335</td> <td>360</td> <td>380</td> <td>405</td> <td>435</td> <td>470</td> <td>505</td> </tr> <tr> <td>380</td> <td>405</td> <td>425</td> <td>450</td> <td>480</td> <td>515</td> <td>550</td> </tr> <tr> <td>415</td> <td>440</td> <td>460</td> <td>485</td> <td>515</td> <td>550</td> <td>585</td> </tr> </tbody> </table>	A/COM	B	C	D	E	F	G	335	360	380	405	435	470	505	380	405	425	450	480	515	550	415	440	460	485	515	550	585	<ul style="list-style-type: none"> <li>• Flip up seat for nesting and compact storage</li> <li>• 50mm hooded casters</li> <li>• Integrated handle in back of chair</li> <li>• Arm pads black with all plastic shell colors</li> <li>• Warranted to 300 lbs.</li> </ul>	<table border="1"> <thead> <tr> <th>ARMLESS</th> <th>W/ ARMS</th> </tr> </thead> <tbody> <tr> <td><b>WIDTH:</b> 21.0</td> <td>25.0</td> </tr> <tr> <td><b>DEPTH:</b> 26.0</td> <td>26.0</td> </tr> <tr> <td><b>HEIGHT:</b> 33.0</td> <td>33.0</td> </tr> <tr> <td><b>SEAT WIDTH:</b> 18.0</td> <td>18.0</td> </tr> <tr> <td><b>SEAT DEPTH:</b> 16.0</td> <td>16.0</td> </tr> <tr> <td><b>BACK WIDTH:</b> 19.0</td> <td>19.0</td> </tr> <tr> <td><b>BACK HEIGHT:</b> 17.5</td> <td>17.5</td> </tr> <tr> <td><b>COM:</b> 0.7 YD</td> <td>0.7 YD</td> </tr> <tr> <td><b>WEIGHT:</b> 21.0 LB</td> <td>24.0 LB</td> </tr> </tbody> </table>	ARMLESS	W/ ARMS	<b>WIDTH:</b> 21.0	25.0	<b>DEPTH:</b> 26.0	26.0	<b>HEIGHT:</b> 33.0	33.0	<b>SEAT WIDTH:</b> 18.0	18.0	<b>SEAT DEPTH:</b> 16.0	16.0	<b>BACK WIDTH:</b> 19.0	19.0	<b>BACK HEIGHT:</b> 17.5	17.5	<b>COM:</b> 0.7 YD	0.7 YD	<b>WEIGHT:</b> 21.0 LB	24.0 LB
A/COM	B	C	D	E	F	G																																																
335	360	380	405	435	470	505																																																
380	405	425	450	480	515	550																																																
415	440	460	485	515	550	585																																																
ARMLESS	W/ ARMS																																																					
<b>WIDTH:</b> 21.0	25.0																																																					
<b>DEPTH:</b> 26.0	26.0																																																					
<b>HEIGHT:</b> 33.0	33.0																																																					
<b>SEAT WIDTH:</b> 18.0	18.0																																																					
<b>SEAT DEPTH:</b> 16.0	16.0																																																					
<b>BACK WIDTH:</b> 19.0	19.0																																																					
<b>BACK HEIGHT:</b> 17.5	17.5																																																					
<b>COM:</b> 0.7 YD	0.7 YD																																																					
<b>WEIGHT:</b> 21.0 LB	24.0 LB																																																					
1370	GT	<b>GUEST NESTING</b> Mesh back with upholstered seat	ARMLESS A12 A14	<table border="1"> <thead> <tr> <th>A/COM</th> <th>B</th> <th>C</th> <th>D</th> <th>E</th> <th>F</th> <th>G</th> </tr> </thead> <tbody> <tr> <td>400</td> <td>425</td> <td>445</td> <td>470</td> <td>500</td> <td>535</td> <td>570</td> </tr> <tr> <td>445</td> <td>470</td> <td>490</td> <td>515</td> <td>545</td> <td>580</td> <td>615</td> </tr> <tr> <td>480</td> <td>505</td> <td>525</td> <td>550</td> <td>580</td> <td>615</td> <td>650</td> </tr> </tbody> </table>	A/COM	B	C	D	E	F	G	400	425	445	470	500	535	570	445	470	490	515	545	580	615	480	505	525	550	580	615	650	<ul style="list-style-type: none"> <li>• Flip up seat for nesting and compact storage</li> <li>• 50mm hooded casters</li> <li>• Choice of 6 mesh back colors</li> <li>• Arm pads black with all plastic shell colors</li> <li>• Warranted to 300 lbs.</li> </ul>	<table border="1"> <thead> <tr> <th>ARMLESS</th> <th>W/ ARMS</th> </tr> </thead> <tbody> <tr> <td><b>WIDTH:</b> 21.0</td> <td>25.0</td> </tr> <tr> <td><b>DEPTH:</b> 26.0</td> <td>26.0</td> </tr> <tr> <td><b>HEIGHT:</b> 33.0</td> <td>33.0</td> </tr> <tr> <td><b>SEAT WIDTH:</b> 18.0</td> <td>18.0</td> </tr> <tr> <td><b>SEAT DEPTH:</b> 16.0</td> <td>16.0</td> </tr> <tr> <td><b>BACK WIDTH:</b> 18.0</td> <td>18.0</td> </tr> <tr> <td><b>BACK HEIGHT:</b> 17.5</td> <td>17.5</td> </tr> <tr> <td><b>COM:</b> 0.7 YD</td> <td>0.7 YD</td> </tr> <tr> <td><b>WEIGHT:</b> 21.0 LB</td> <td>24.0 LB</td> </tr> </tbody> </table>	ARMLESS	W/ ARMS	<b>WIDTH:</b> 21.0	25.0	<b>DEPTH:</b> 26.0	26.0	<b>HEIGHT:</b> 33.0	33.0	<b>SEAT WIDTH:</b> 18.0	18.0	<b>SEAT DEPTH:</b> 16.0	16.0	<b>BACK WIDTH:</b> 18.0	18.0	<b>BACK HEIGHT:</b> 17.5	17.5	<b>COM:</b> 0.7 YD	0.7 YD	<b>WEIGHT:</b> 21.0 LB	24.0 LB
A/COM	B	C	D	E	F	G																																																
400	425	445	470	500	535	570																																																
445	470	490	515	545	580	615																																																
480	505	525	550	580	615	650																																																
ARMLESS	W/ ARMS																																																					
<b>WIDTH:</b> 21.0	25.0																																																					
<b>DEPTH:</b> 26.0	26.0																																																					
<b>HEIGHT:</b> 33.0	33.0																																																					
<b>SEAT WIDTH:</b> 18.0	18.0																																																					
<b>SEAT DEPTH:</b> 16.0	16.0																																																					
<b>BACK WIDTH:</b> 18.0	18.0																																																					
<b>BACK HEIGHT:</b> 17.5	17.5																																																					
<b>COM:</b> 0.7 YD	0.7 YD																																																					
<b>WEIGHT:</b> 21.0 LB	24.0 LB																																																					

ONLY AVAILABLE IN M1

### ARM OPTIONS

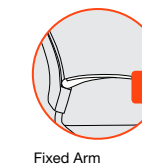

Fixed Arm

**A12**  
\$45



Reinforced Soft Touch Extended Arm

**A14**  
\$80



50mm Hooded Casters

**C5**  
STD



50mm Hoodless Hard Floor Casters

**C5S**  
\$30

### NESTING FOOTPRINT

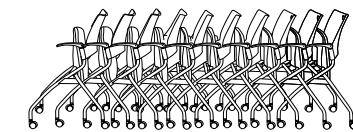

First Chair 24", Each Additional Chair, Add 6"  
CAUTION: Careless nesting of chairs may scratch and damage frames

### FRAME COLORS

BLACK BF	SILVER SF	METALLIC BROWN* MBF	GUNMETAL* GMF	DOVER GRAY* DGF	WHITE* WF
-------------	--------------	------------------------	------------------	--------------------	--------------

(FRAME)

### MESH COLORS

BLACK M11	GRAY M12	SILVER M13	GREEN M14	RED M15	BLUE M16
--------------	-------------	---------------	--------------	------------	-------------

### PLASTIC COLORS\*\*

BLACK SWAN P01	WHITE WHISPER P05	FEDERAL BLUE P11	CRIMSON RED P12	LEMON YELLOW P13	DOVE GRAY P14
CLOUD GRAY P15	LAGOON BLUE P16	APPLE GREEN P17	TANGERINE ORANGE P18	LATTE P19	AZURE BLUE P20

(BACK)

\*\*Mesh back models available only in P01 Black  
Careless stacking of chairs may scratch and damage frames.  
Due to the nature of vinyl upholstery, stacking may cause impressions on the seat. 9to5 Seating does not warrant the effects of the stacking on vinyl upholstery.

\*Standard lead time applies to Metallic Brown, Gunmetal, Dover Gray and White frame color options.

Black and Silver frame colors available as Express Ship

# bella

name your game, bella is ready to play

## UPHOLSTERED SEAT - US

GSA SIN # 711-19

- Multi-purpose seating including stacking, nesting, task and task stool models
- Perfect for collaborative, meeting, training and break rooms spaces
- Back styles include: all plastic, upholstered, or mesh
- Choice of plastic or upholstered seat
- 6 powder coat frame colors
- 12 plastic colors (black only on mesh back models)
- Warranted to 300 lbs.
- CAL TB 133 Fire Code approved



### CREATING BELLA MODEL NUMBER

MODEL NUMBER CONTROL ARMS FRAME COLOR UPHOLSTERY MESH COLOR GRADE PLASTIC COLOR BASE CASTERS PACKAGING

1 3 5 - A - U S - M - P - B A - C 6

\* FOR ARMLESS CODE USE A00 \*\* ONLY SELECT FOR MODELS 1375

### PACKAGING NOTES

CODE	DESCRIPTION	LIST UPCHARGE
AB	ASSEMBLED IN BAG	\$0
BAC	BACK ASSEMBLED IN CARTON	\$0

MODEL	CONTROL	DESCRIPTION	ARM	FABRIC	FEATURES	DIMENSIONS
1325	B2	<b>LOW-BACK BASIC TASK</b> Plastic back with upholstered seat	ARMLESS	A/COM: 395, B: 420, C: 440, D: 465, E: 495, F: 530, G: 565	<ul style="list-style-type: none"> <li>• Pneumatic seat height adjustment</li> <li>• Basic control swivels 360 degrees</li> <li>• No seat and back tilt</li> <li>• Arm pads black with all plastic shell colors</li> <li>• Warranted to 300 lbs.</li> </ul>	WIDTH: 26.0 DEPTH: 26.0 HEIGHT: 32.5-37.5 SEAT WIDTH: 18.0 SEAT DEPTH: 16.0 SEAT HEIGHT: 18.0-23.0 BACK WIDTH: 19.0 BACK HEIGHT: 17.5 COM: 0.7 YD WEIGHT: 26.5 LB
			A12	A/COM: 440, B: 465, C: 485, D: 510, E: 540, F: 575, G: 610		
A14	A/COM: 475, B: 500, C: 520, D: 545, E: 575, F: 610, G: 645					
1325	S3	<b>LOW-BACK SWIVEL TILT</b> Plastic back with upholstered seat	ARMLESS	A/COM: 430, B: 455, C: 475, D: 500, E: 530, F: 565, G: 600	<ul style="list-style-type: none"> <li>• Pneumatic seat height adjustment</li> <li>• Tilt tension control</li> <li>• Seat and back tilt as a unit</li> <li>• 360-degree swivel</li> <li>• Upright position tilt lock</li> <li>• Arm and glide color will be black with all plastic shell color choices</li> <li>• Warranted to 300 lbs.</li> </ul>	WIDTH: 26.0 DEPTH: 26.0 HEIGHT: 33-37.5 SEAT WIDTH: 18.0 SEAT DEPTH: 16.0 SEAT HEIGHT: 17.0 -21.5 BACK WIDTH: 19.0 BACK HEIGHT: 17.5 COM: 0.7 YD WEIGHT: 27.5 LB
			A12	A/COM: 475, B: 500, C: 520, D: 545, E: 575, F: 610, G: 645		
A14	A/COM: 510, B: 535, C: 555, D: 580, E: 610, F: 645, G: 680					
1375	B2	<b>LOW-BACK BASIC TASK</b> Mesh back with upholstered seat	ARMLESS	A/COM: 460, B: 485, C: 505, D: 530, E: 560, F: 595, G: 630	<ul style="list-style-type: none"> <li>• Pneumatic seat height adjustment</li> <li>• Basic control swivels 360 degrees</li> <li>• No seat and back tilt</li> <li>• Choice of 6 mesh back colors</li> <li>• Arm pads black with all plastic shell colors</li> <li>• Warranted to 300 lbs.</li> </ul>	WIDTH: 26.0 DEPTH: 26.0 HEIGHT: 32.5-37.5 SEAT WIDTH: 18.0 SEAT DEPTH: 16.0 SEAT HEIGHT: 18.0-23.0 BACK WIDTH: 19.0 BACK HEIGHT: 17.5 COM: 0.7 YD WEIGHT: 26.5 LB
			A12	A/COM: 505, B: 530, C: 550, D: 575, E: 605, F: 640, G: 675		
A14	A/COM: 540, B: 565, C: 585, D: 610, E: 640, F: 675, G: 710					
				<b>ONLY AVAILABLE IN M1</b>		
1375	S3	<b>LOW-BACK SWIVEL TILT</b> Mesh back with upholstered seat	ARMLESS	A/COM: 495, B: 520, C: 540, D: 565, E: 595, F: 630, G: 665	<ul style="list-style-type: none"> <li>• Pneumatic seat height adjustment</li> <li>• Tilt tension control</li> <li>• Seat and back tilt as a unit</li> <li>• 360-degree swivel</li> <li>• Upright position tilt lock</li> <li>• Choice of 6 mesh back colors</li> <li>• Arm and glide color will be black with all plastic shell color choices</li> <li>• Warranted to 300 lbs.</li> </ul>	WIDTH: 26.0 DEPTH: 26.0 HEIGHT: 33-37.5 SEAT WIDTH: 18.0 SEAT DEPTH: 16.0 SEAT HEIGHT: 17.0 -21.5 BACK WIDTH: 19.0 BACK HEIGHT: 17.5 COM: 0.7 YD WEIGHT: 27.5 LB
			A12	A/COM: 540, B: 565, C: 585, D: 610, E: 640, F: 675, G: 710		
A14	A/COM: 575, B: 600, C: 620, D: 645, E: 675, F: 710, G: 745					
				<b>ONLY AVAILABLE IN M1</b>		

### ARM OPTIONS

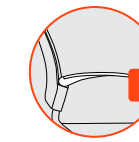

Fixed Arm

**A12**  
\$45

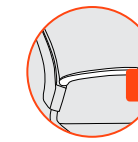

Reinforced Soft Touch Extended Arm

**A14**  
\$80

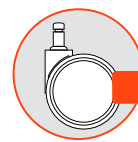

60mm Hoodless Casters

**C6**  
STD

### BASE OPTIONS



26" High Profile Nylon Base - Black

**BA9B**  
STD



26" High Profile Aluminum Black Powder-Coat

**BA10B**  
\$100

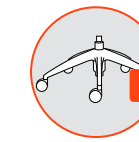

26" High Profile Aluminum Silver Powder-Coat

**BA10S**  
\$100



26" High Profile Aluminum Polished

**BA10P**  
\$100

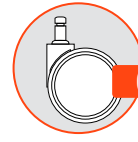

60mm Hoodless Hard Floor Casters

**C6S**  
\$35

### FRAME COLORS

BLACK BF	SILVER SF	METALLIC BROWN* MBF	GUNMETAL* GMF	DOVER GRAY* DGF	WHITE* WF
-------------	--------------	------------------------	------------------	--------------------	--------------

(FRAME)

### MESH COLORS

BLACK M11	GRAY M12	SILVER M13	GREEN M14	RED M15	BLUE M16
--------------	-------------	---------------	--------------	------------	-------------

### PLASTIC COLORS\*\*

BLACK SWAN P01	WHITE WHISPER P05	FEDERAL BLUE P11	CRIMSON RED P12	LEMON YELLOW P13	DOVE GRAY P14
CLOUD GRAY P15	LAGOON BLUE P16	APPLE GREEN P17	TANGERINE ORANGE P18	LATTE P19	AZURE BLUE P20

(BACK)

\*\*Mesh back models available only in P01 Black

\*Standard lead time applies to Metallic Brown, Gunmetal, Dover Gray and White frame color options.

Black and Silver frame colors available as Express Ship

# bella

name your game, bella is ready to play

## UPHOLSTERED SEAT - US

GSA SIN # 711-19

- Multi-purpose seating including stacking, nesting, task and task stool models
- Perfect for collaborative, meeting, training and break rooms spaces
- Back styles include: all plastic, upholstered, or mesh
- Choice of plastic or upholstered seat
- 6 powder coat frame colors
- 12 plastic colors (black only on mesh back models)
- Warranted to 300 lbs.
- CAL TB 133 Fire Code approved



### CREATING BELLA MODEL NUMBER

MODEL NUMBER CONTROL ARMS FRAME COLOR UPHOLSTERY MESH COLOR GRADE PLASTIC COLOR BASE CASTERS PACKAGING

1 3 - B 2 - A - U S - M - P - B A - C 6

\* FOR ARMLESS CODE USE A00 \*\* ONLY SELECT FOR MODELS 1316/1378

### PACKAGING NOTES

CODE	DESCRIPTION	LIST UPCHARGE
AB	ASSEMBLED IN BAG	\$0
BAC	BACK ASSEMBLED IN CARTON	\$0

MODEL	CONTROL	DESCRIPTION	ARM	FABRIC	FEATURES	DIMENSIONS																												
1326	B2	<b>10" STOOL BASIC TASK</b> Use for work surfaces up to 42 inches high. Plastic back with upholstered seat	ARMLESS A12 A14	<table border="1"> <thead> <tr> <th>A/COM</th> <th>B</th> <th>C</th> <th>D</th> <th>E</th> <th>F</th> <th>G</th> </tr> </thead> <tbody> <tr> <td>520</td> <td>545</td> <td>565</td> <td>590</td> <td>620</td> <td>655</td> <td>690</td> </tr> <tr> <td>565</td> <td>590</td> <td>610</td> <td>635</td> <td>665</td> <td>700</td> <td>735</td> </tr> <tr> <td>600</td> <td>625</td> <td>645</td> <td>670</td> <td>700</td> <td>735</td> <td>770</td> </tr> </tbody> </table>	A/COM	B	C	D	E	F	G	520	545	565	590	620	655	690	565	590	610	635	665	700	735	600	625	645	670	700	735	770	<ul style="list-style-type: none"> <li>• Pneumatic seat height adjustment</li> <li>• No seat and back tilt</li> <li>• Height adj. 20" diameter footring</li> <li>• Arm pads black with all plastic shell colors</li> <li>• Warranted to 300 lbs.</li> </ul>	<p><b>WIDTH:</b> 26.0 <b>DEPTH:</b> 26.0 <b>HEIGHT:</b> 40-50 <b>SEAT WIDTH:</b> 18.0 <b>SEAT DEPTH:</b> 16.0 <b>SEAT HEIGHT:</b> 25.5-35.5 <b>BACK WIDTH:</b> 19.0 <b>BACK HEIGHT:</b> 17.5 <b>COM:</b> 0.7 YD <b>WEIGHT:</b> 32.5 LB</p>
A/COM	B	C	D	E	F	G																												
520	545	565	590	620	655	690																												
565	590	610	635	665	700	735																												
600	625	645	670	700	735	770																												
1328	B2	<b>8" STOOL BASIC TASK</b> Use for work surfaces up to 36 inches high. Plastic back with upholstered seat	ARMLESS A12 A14	<table border="1"> <thead> <tr> <th>A/COM</th> <th>B</th> <th>C</th> <th>D</th> <th>E</th> <th>F</th> <th>G</th> </tr> </thead> <tbody> <tr> <td>520</td> <td>545</td> <td>565</td> <td>590</td> <td>620</td> <td>655</td> <td>690</td> </tr> <tr> <td>565</td> <td>590</td> <td>610</td> <td>635</td> <td>665</td> <td>700</td> <td>735</td> </tr> <tr> <td>600</td> <td>625</td> <td>645</td> <td>670</td> <td>700</td> <td>735</td> <td>770</td> </tr> </tbody> </table>	A/COM	B	C	D	E	F	G	520	545	565	590	620	655	690	565	590	610	635	665	700	735	600	625	645	670	700	735	770	<ul style="list-style-type: none"> <li>• Pneumatic seat height adjustment</li> <li>• No seat and back tilt</li> <li>• Height adj. 20" diameter footring</li> <li>• Arm pads black with all plastic shell colors</li> <li>• Warranted to 300 lbs.</li> </ul>	<p><b>WIDTH:</b> 26.0 <b>DEPTH:</b> 26.0 <b>HEIGHT:</b> 36-44 <b>SEAT WIDTH:</b> 18.0 <b>SEAT DEPTH:</b> 16.0 <b>SEAT HEIGHT:</b> 21.5-29.5 <b>BACK WIDTH:</b> 19.0 <b>BACK HEIGHT:</b> 17.5 <b>COM:</b> 0.7 YD <b>WEIGHT:</b> 31.5 LB</p>
A/COM	B	C	D	E	F	G																												
520	545	565	590	620	655	690																												
565	590	610	635	665	700	735																												
600	625	645	670	700	735	770																												
1376	B2	<b>10" STOOL BASIC TASK</b> Use for work surfaces up to 42 inches high. Mesh back with upholstered seat	ARMLESS A12 A14	<table border="1"> <thead> <tr> <th>A/COM</th> <th>B</th> <th>C</th> <th>D</th> <th>E</th> <th>F</th> <th>G</th> </tr> </thead> <tbody> <tr> <td>585</td> <td>610</td> <td>630</td> <td>655</td> <td>685</td> <td>720</td> <td>755</td> </tr> <tr> <td>630</td> <td>655</td> <td>675</td> <td>700</td> <td>730</td> <td>765</td> <td>800</td> </tr> <tr> <td>665</td> <td>690</td> <td>710</td> <td>735</td> <td>765</td> <td>800</td> <td>835</td> </tr> </tbody> </table>	A/COM	B	C	D	E	F	G	585	610	630	655	685	720	755	630	655	675	700	730	765	800	665	690	710	735	765	800	835	<ul style="list-style-type: none"> <li>• Pneumatic seat height adjustment</li> <li>• No seat and back tilt</li> <li>• Height adj. 20" diameter footring</li> <li>• Choice of 6 mesh back colors</li> <li>• Arm pads black with all plastic shell colors</li> <li>• Warranted to 300 lbs.</li> </ul>	<p><b>WIDTH:</b> 26.0 <b>DEPTH:</b> 26.0 <b>HEIGHT:</b> 40-50 <b>SEAT WIDTH:</b> 18.0 <b>SEAT DEPTH:</b> 16.0 <b>SEAT HEIGHT:</b> 25.5-35.5 <b>BACK WIDTH:</b> 19.0 <b>BACK HEIGHT:</b> 17.5 <b>COM:</b> 0.7 YD <b>WEIGHT:</b> 32.5 LB</p>
A/COM	B	C	D	E	F	G																												
585	610	630	655	685	720	755																												
630	655	675	700	730	765	800																												
665	690	710	735	765	800	835																												
1378	B2	<b>8" STOOL BASIC TASK</b> Use for work surfaces up to 36 inches high. Mesh back with upholstered seat	ARMLESS A12 A14	<table border="1"> <thead> <tr> <th>A/COM</th> <th>B</th> <th>C</th> <th>D</th> <th>E</th> <th>F</th> <th>G</th> </tr> </thead> <tbody> <tr> <td>585</td> <td>610</td> <td>630</td> <td>655</td> <td>685</td> <td>720</td> <td>755</td> </tr> <tr> <td>630</td> <td>655</td> <td>675</td> <td>700</td> <td>730</td> <td>765</td> <td>800</td> </tr> <tr> <td>665</td> <td>690</td> <td>710</td> <td>735</td> <td>765</td> <td>800</td> <td>835</td> </tr> </tbody> </table>	A/COM	B	C	D	E	F	G	585	610	630	655	685	720	755	630	655	675	700	730	765	800	665	690	710	735	765	800	835	<ul style="list-style-type: none"> <li>• Pneumatic seat height adjustment</li> <li>• No seat and back tilt</li> <li>• Height adj. 20" diameter footring</li> <li>• Choice of 6 mesh back colors</li> <li>• Arm pads black with all plastic shell colors</li> <li>• Warranted to 300 lbs.</li> </ul>	<p><b>WIDTH:</b> 26.0 <b>DEPTH:</b> 26.0 <b>HEIGHT:</b> 36-44 <b>SEAT WIDTH:</b> 18.0 <b>SEAT DEPTH:</b> 16.0 <b>SEAT HEIGHT:</b> 21.5-29.5 <b>BACK WIDTH:</b> 19.0 <b>BACK HEIGHT:</b> 17.5 <b>COM:</b> 0.7 YD <b>WEIGHT:</b> 31.5 LB</p>
A/COM	B	C	D	E	F	G																												
585	610	630	655	685	720	755																												
630	655	675	700	730	765	800																												
665	690	710	735	765	800	835																												

### ARM OPTIONS

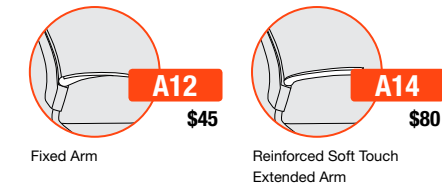

### CASTER OPTIONS

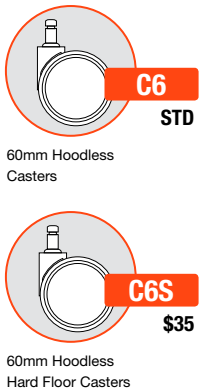

### BASE OPTIONS

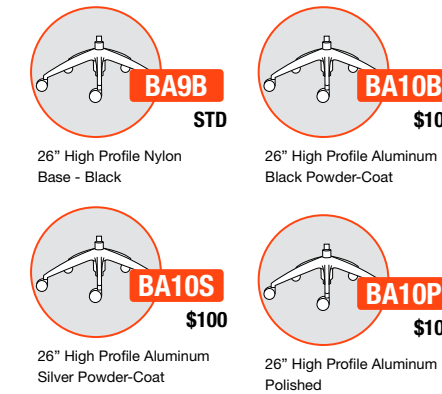

### FRAME COLORS

BLACK BF	SILVER SF	METALLIC BROWN* MBF	GUNMETAL* GMF	DOVER GRAY* DGF	WHITE* WF
----------	-----------	---------------------	---------------	-----------------	-----------

(FRAME)

### MESH COLORS

BLACK M11	GRAY M12	SILVER M13	GREEN M14	RED M15	BLUE M16
-----------	----------	------------	-----------	---------	----------

### PLASTIC COLORS\*\*

BLACK SWAN P01	WHITE WHISPER P05	FEDERAL BLUE P11	CRIMSON RED P12	LEMON YELLOW P13	DOVE GRAY P14
CLOUD GRAY P15	LAGOON BLUE P16	APPLE GREEN P17	TANGERINE ORANGE P18	LATTE P19	AZURE BLUE P20

(BACK)

\*\*Mesh back models available only in P01 Black

\*Standard lead time applies to Metallic Brown, Gunmetal, Dover Gray and White frame color options.

Black and Silver frame colors available as Express Ship

# bella

name your game, bella is ready to play

## FULLY UPHOLSTERED - UP

GSA SIN # 711-19

- Multi-purpose seating including stacking, nesting, task and task stool models
- Perfect for collaborative, meeting, training and break rooms spaces
- Back styles include: all plastic, upholstered, or mesh
- Choice of plastic or upholstered seat
- 6 powder coat frame colors
- 12 plastic colors (black only on mesh back models)
- Warranted to 300 lbs.
- CAL TB 133 Fire Code approved



### CREATING BELLA MODEL NUMBER

MODEL NUMBER CONTROL ARMS FRAME COLOR UPHOLSTERY GRADE PLASTIC COLOR CASTERS PACKAGING OPTIONS

1 3 - GT - A - UP - P - C5

\* FOR ARMLESS CODE USE A00 \* ONLY SELECT CASTER CODE FOR MODELS 1315/1365

### PACKAGING NOTES

CODE	DESCRIPTION	LIST UPCHARGE
AB	ASSEMBLED IN BAG	\$0
AC	ASSEMBLED IN CARTON	\$0

BELLA STACK CHAIRS SHIP UP TO 3 PER CARTON

MODEL	CONTROL	DESCRIPTION	ARM	FABRIC	FEATURES	DIMENSIONS
1310	GT	<b>GUEST STACKING</b> Upholstered back with upholstered seat	ARMLESS	A/COM 325, B 355, C 375, D 405, E 440, F 480, G 520	<ul style="list-style-type: none"> <li>• Non-marring floor glides</li> <li>• Stack 4 high on floor</li> <li>• Stacks 10 high on optional dolly</li> <li>• Wall saver back legs</li> <li>• Integrated handle in back of chair</li> <li>• Arm pad and glide color will be black with all plastic shell color choices</li> <li>• Warranted to 300 lbs.</li> </ul>	<b>ARMLESS</b> WIDTH: 21.0, DEPTH: 26.0, HEIGHT: 33.0 <b>W/ ARMS</b> WIDTH: 25.0, DEPTH: 26.0, HEIGHT: 33.0 SEAT WIDTH: 18.0, SEAT DEPTH: 16.0, SEAT HEIGHT: 18.0, BACK WIDTH: 19.0, BACK HEIGHT: 17.5 COM: 0.7 YDS, WEIGHT: 17.0 LB
	A12		370, 400, 420, 450, 485, 525, 565			
	A14		405, 435, 455, 485, 520, 560, 600			
	TAB-A00		445, 475, 495, 525, 560, 600, 640			
	TAB-A12		470, 500, 520, 550, 585, 625, 665			
	TAB-A14	485, 515, 535, 565, 600, 640, 680				
1315	GT	<b>GUEST STACKING WITH CASTERS</b> Upholstered back with upholstered seat	ARMLESS	A/COM 370, B 400, C 420, D 450, E 485, F 525, G 565	<ul style="list-style-type: none"> <li>• 50mm hooded casters</li> <li>• Stacks 4 high on floor</li> <li>• Stacks 10 high on optional dolly</li> <li>• Integrated handle in back of chair</li> <li>• Arm pads black with all plastic shell colors</li> <li>• Warranted to 300 lbs.</li> </ul>	<b>ARMLESS</b> WIDTH: 21.0, DEPTH: 26.0, HEIGHT: 33.0 <b>W/ ARMS</b> WIDTH: 25.0, DEPTH: 26.0, HEIGHT: 33.0 SEAT WIDTH: 18.0, SEAT DEPTH: 16.0, SEAT HEIGHT: 18.0, BACK WIDTH: 19.0, BACK HEIGHT: 17.5 COM: 0.7 YDS, WEIGHT: 17.0 LB
	A12		415, 445, 465, 495, 530, 570, 610			
	A14		450, 480, 500, 530, 565, 605, 645			
	TAB-A00		490, 520, 540, 570, 605, 645, 685			
	TAB-A12		515, 545, 565, 595, 630, 670, 710			
	TAB-A14	530, 560, 580, 610, 645, 685, 725				
1320	GT	<b>GUEST NESTING</b> Upholstered back with upholstered seat	ARMLESS	A/COM 390, B 420, C 440, D 470, E 505, F 545, G 585	<ul style="list-style-type: none"> <li>• Flip up seat for nesting and compact storage</li> <li>• 50mm hooded casters</li> <li>• Integrated handle in back of chair</li> <li>• Arm pads black with all plastic shell colors</li> <li>• Warranted to 300 lbs.</li> </ul>	<b>ARMLESS</b> WIDTH: 21.0, DEPTH: 26.0, HEIGHT: 33.0 <b>W/ ARMS</b> WIDTH: 25.0, DEPTH: 26.0, HEIGHT: 33.0 SEAT WIDTH: 18.0, SEAT DEPTH: 16.0, SEAT HEIGHT: 18.0, BACK WIDTH: 19.0, BACK HEIGHT: 17.5 COM: 0.7 YDS, WEIGHT: 24.0 LB
	A12		435, 465, 485, 515, 550, 590, 630			
	A14		470, 500, 520, 550, 585, 625, 665			

**A12**  
\$45

Fixed Arm

**A14**  
\$80

Reinforced Soft Touch Extended Arm

**C5**  
STD

50mm Hooded Casters

**TAB-A00**  
\$120

Right Folding Tablet Arm w/ Laminate. Tablet Arm in Black Color Only. Available in 6 Frame Colors. Tablet Size: 15.5"x11.25"x.25"

**TAB-A14**  
\$160

Right Folding Tablet Arm w/ A14 Left Arm. Tablet Arm in Black Color only. Available in 6 Frame Colors. Tablet Size: 15.5"x11.25"x.25"

**C5S**  
\$30

50mm Hoodless Hard Floor Casters

### ACCESSORIES

**BSK**  
\$60

Side Hanging Wire Basket for model 1310, 1315, 1360, 1365. Attach to left or right side

**DL1**  
\$250

Stacking Dolly Stack Chair 10 High

**GC1**  
\$30  
**GC2**  
\$30

Ganging Clip - 2 per Set  
GC1 - Armless-to-Armless  
GC2 - Arm-to-Arm

### FRAME COLORS

BLACK BF	SILVER SF	METALLIC BROWN* MBF	GUNMETAL* GMF	DOVER GRAY* DGF	WHITE* WF
-------------	--------------	------------------------	------------------	--------------------	--------------

(FRAME)

### PLASTIC COLORS

BLACK SWAN P01	WHITE WHISPER P05	FEDERAL BLUE P11	CRIMSON RED P12	LEMON YELLOW P13	DOVE GRAY P14
CLOUD GRAY P15	LAGOON BLUE P16	APPLE GREEN P17	TANGERINE ORANGE P18	LATTE P19	AZURE BLUE P20

(BACK)

Careless stacking of chairs may scratch and damage frames. Due to the nature of vinyl upholstery, stacking may cause impressions on the seat. 9to5 Seating does not warrant the effects of the stacking on vinyl upholstery.

\*Standard lead time applies to Metallic Brown, Gunmetal, Dover Gray and White frame color options.

Black and Silver frame colors available as Express Ship



# bella

name your game, bella is ready to play

## FULLY UPHOLSTERED - UP

GSA SIN # 711-19

- Multi-purpose seating including stacking, nesting, task and task stool models
- Perfect for collaborative, meeting, training and break rooms spaces
- Back styles include: all plastic, upholstered, or mesh
- Choice of plastic or upholstered seat
- 6 powder coat frame colors
- 12 plastic colors (black only on mesh back models)
- Warranted to 300 lbs.
- CAL TB 133 Fire Code approved



### CREATING BELLA MODEL NUMBER

MODEL NUMBER CONTROL ARMS FRAME COLOR UPHOLSTERY GRADE PLASTIC COLOR BASE CASTERS PACKAGING OPTIONS

1 3 2 - - - A - - - - U P - - P - - B A - - - C 6 - - - -

\* FOR ARMLESS CODE USE A00 \* ONLY SELECT CASTER CODE FOR MODELS 1315/1365

### PACKAGING NOTES

CODE	DESCRIPTION	LIST UPCHARGE
AB	ASSEMBLED IN BAG	\$0
BAC	BACK ASSEMBLED IN CARTON	\$0

MODEL	CONTROL	DESCRIPTION	ARM	FABRIC	FEATURES	DIMENSIONS
1325	B2	<b>LOW-BACK BASIC TASK</b>  Upholstered back with upholstered seat	ARMLESS	A/COM 450, B 480, C 500, D 530, E 565, F 605, G 645	<ul style="list-style-type: none"> <li>• Pneumatic seat height adjustment</li> <li>• No seat and back tilt</li> <li>• Basic control swivels 360 degrees</li> <li>• Arm pads black with all plastic shell colors</li> <li>• Warranted to 300 lbs.</li> </ul>	WIDTH: 26.0 DEPTH: 26.0 HEIGHT: 32.5-37.5 SEAT WIDTH: 18.0 SEAT DEPTH: 16.0 SEAT HEIGHT: 18-23 BACK WIDTH: 19.0 BACK HEIGHT: 17.5 COM: 0.7 YD WEIGHT: 30.0 LB
			A12	495, 525, 545, 575, 610, 650, 690		
A14	530, 560, 580, 610, 645, 685, 725					
1325	S3	<b>LOW-BACK SWIVEL TILT</b>  Upholstered back with upholstered seat	ARMLESS	A/COM 485, B 515, C 535, D 565, E 600, F 640, G 680	<ul style="list-style-type: none"> <li>• Pneumatic seat height adjustment</li> <li>• Tilt tension control</li> <li>• Seat and back tilt as a unit</li> <li>• 360-degree swivel</li> <li>• Upright position tilt lock</li> <li>• Arm and glide color will be black with all plastic shell color choices</li> <li>• Warranted to 300 lbs.</li> </ul>	WIDTH: 26.0 DEPTH: 26.0 HEIGHT: 33-37.5 SEAT WIDTH: 18.0 SEAT DEPTH: 16.0 SEAT HEIGHT: 17.0-21.5 BACK WIDTH: 19.0 BACK HEIGHT: 17.5 COM: 0.7 YD WEIGHT: 31.0 LB
			A12	530, 560, 580, 610, 645, 685, 725		
A14	565, 595, 615, 645, 680, 720, 760					
1326	B2	<b>10" STOOL BASIC TASK</b>  Use for work surfaces up to 42 inches high. Upholstered back with upholstered seat	ARMLESS	A/COM 575, B 605, C 625, D 655, E 690, F 730, G 770	<ul style="list-style-type: none"> <li>• Pneumatic seat height adjustment</li> <li>• No seat and back tilt</li> <li>• Height adj. 20" diameter footring</li> <li>• Arm pads black with all plastic shell colors</li> <li>• Warranted to 300 lbs.</li> </ul>	WIDTH: 26.0 DEPTH: 26.0 HEIGHT: 40-50 SEAT WIDTH: 18.0 SEAT DEPTH: 16.0 SEAT HEIGHT: 25.5-35.5 BACK WIDTH: 19.0 BACK HEIGHT: 17.5 COM: 0.7 YD WEIGHT: 36.0 LB
			A12	620, 650, 670, 700, 735, 775, 815		
A14	655, 685, 705, 735, 770, 810, 850					
1328	B2	<b>8" STOOL BASIC TASK</b>  Use for work surfaces up to 36 inches high. Upholstered back with upholstered seat	ARMLESS	A/COM 575, B 605, C 625, D 655, E 690, F 730, G 770	<ul style="list-style-type: none"> <li>• Pneumatic seat height adjustment</li> <li>• No seat and back tilt</li> <li>• Height adj. 20" diameter footring</li> <li>• Arm pads black with all plastic shell colors</li> <li>• Warranted to 300 lbs.</li> </ul>	WIDTH: 26.0 DEPTH: 26.0 HEIGHT: 36-44 SEAT WIDTH: 18.0 SEAT DEPTH: 16.0 SEAT HEIGHT: 21.5-29.5 BACK WIDTH: 19.0 BACK HEIGHT: 17.5 COM: 0.7 YD WEIGHT: 35.0 LB
			A12	620, 650, 670, 700, 735, 775, 815		
A14	655, 685, 705, 735, 770, 810, 850					

**A12**  
\$45

Fixed Arm

**A14**  
\$80

Reinforced Soft Touch Extended Arm

**C6**  
STD

60mm Hoodless Casters

**TAB-A00**  
\$120

Right Folding Tablet in Black Laminate. Tablet Arm in Black Color Only. Available in 6 Frame Colors. Tablet Size: 15.5"x11.25"x.25"

**TAB-A14**  
\$160

Right Folding Tablet Arm w/ A14 Left Arm. Tablet Arm in Black Color only. Available in 6 Frame Colors. Tablet Size: 15.5"x11.25"x.25"

**C6S**  
\$35

60mm Hoodless Hard Floor Casters

### BASE OPTIONS

**BA9B**  
STD

26" High Profile Nylon Base - Black

**BA10B**  
\$100

26" High Profile Aluminum Black Powder-Coat

**BSK**  
\$60

Side Hanging Wire Basket for model 1310, 1315, 1360, 1365. Attach to left or right side.

**BA10S**  
\$100

26" High Profile Aluminum Silver Powder-Coat

**BA10P**  
\$100

26" High Profile Aluminum Polished

**DL1**  
\$250

Stacking Dolly Stack Chair 10 High

### FRAME COLORS

BLACK BF	SILVER SF	METALLIC BROWN* MBF	GUNMETAL* GMF	DOVER GRAY* DGF	WHITE* WF
----------	-----------	---------------------	---------------	-----------------	-----------

(FRAME)

### PLASTIC COLORS

BLACK SWAN P01	WHITE WHISPER P05	FEDERAL BLUE P11	CRIMSON RED P12	LEMON YELLOW P13	DOVE GRAY P14
CLOUD GRAY P15	LAGOON BLUE P16	APPLE GREEN P17	TANGERINE ORANGE P18	LATTE P19	AZURE BLUE P20

(BACK)

\*Standard lead time applies to Metallic Brown, Gunmetal, Dover Gray and White frame color options.

Black and Silver frame colors available as Express Ship

# brio

mesh chairs tailored to you

## MESH BACK

GSA SIN # 711-18

- Task, stool, management and conference seating
- Mesh back
- Rolling flex back follows user's shoulder movements
- Reverse seat slider for more petite seat, standard on all models
- Optional height adjustable lumbar
- Warranted to 300 lbs.













### CREATING BRIO MODEL NUMBER



### PACKAGING NOTES

CODE	DESCRIPTION	LIST UPCHARGE
AB	ASSEMBLED IN BAG	\$0
BAC	BACK ASSEMBLED IN CARTON	\$0

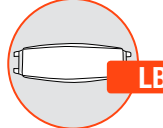
MODEL	CONTROL	DESCRIPTION	ARM	FABRIC	FEATURES	DIMENSIONS	ARM OPTIONS	CASTER OPTIONS						
2060	Y1	<b>MID-BACK SIMPLE SYNCHRO</b>  Use for a variety of general office task seating, including private office and conference room seating	ARMLESS	T01	<ul style="list-style-type: none"> <li>• Pneumatic seat height adjustment</li> <li>• Tilt tension control</li> <li>• Back and seat tilt in 3:1 ratio</li> <li>• Upright position tilt lock</li> <li>• Molded foam seat</li> <li>• Optional height adjustable lumbar</li> <li>• Warranted to 300 lbs.</li> </ul>	<b>WIDTH:</b> 25.0 <b>DEPTH:</b> 26.0 <b>HEIGHT:</b> 38-42.5 <b>SEAT WIDTH:</b> 20.0 <b>SEAT DEPTH:</b> 14.5-17.0 <b>SEAT HEIGHT:</b> 17.0-21.5 <b>BACK WIDTH:</b> 18.0 <b>BACK HEIGHT:</b> 22.0 <b>COM:</b> 0.8 YDS <b>WEIGHT:</b> 37 LB	 <b>A2</b> \$80 Height Adjustable Arm	 <b>A8B/S</b> \$85 Height Adjustable Arm	 <b>C6</b> STD Standard 60mm Hoodless Casters					
	A2		T01											
	A8B / A8S		T01											
	A9B / A9S		T01											
	A10		T01											
2060	Y3	<b>MID-BACK FULL SYNCHRO</b>  Use for a variety of general office task seating, including private office and conference room seating	ARMLESS	T01	<ul style="list-style-type: none"> <li>• Pneumatic seat height adjustment</li> <li>• Tilt tension control</li> <li>• Back and seat tilt in 2:1 ratio</li> <li>• 3 locking positions</li> <li>• Safety tilt release</li> <li>• Molded foam seat</li> <li>• Optional height adjustable lumbar</li> <li>• Warranted to 300 lbs.</li> </ul>	<b>WIDTH:</b> 25.0 <b>DEPTH:</b> 26.0 <b>HEIGHT:</b> 39.0-43.5 <b>SEAT WIDTH:</b> 20.0 <b>SEAT DEPTH:</b> 15.5-18.0 <b>SEAT HEIGHT:</b> 16.5-21.0 <b>BACK WIDTH:</b> 18.0 <b>BACK HEIGHT:</b> 22.0 <b>COM:</b> 0.8 YDS <b>WEIGHT:</b> 38.0 LB	 <b>A9B/S</b> \$105 Height/Width Adjustable Arm	 <b>A10</b> \$85 Soft Touch C-Shaped Arm	 <b>C6S</b> \$35 60mm Hoodless Hard Floor Casters					
	A2		T01											
	A8B / A8S		T01											
	A9B / A9S		T01											
	A10		T01											
2060	M1	<b>MID-BACK MULTI-FUNCTION</b>  Fully articulating seat and back for the highest level of ergonomic needs. Control allows user to pivot seat forward from 0° to 6°	ARMLESS	T01	<ul style="list-style-type: none"> <li>• Pneumatic seat height adjustment</li> <li>• Tilt tension control</li> <li>• Seat and back tilt as a unit</li> <li>• Floating seat position tilt lock</li> <li>• Infinite back angle adj. w/free float</li> <li>• Seat pivots from 0° to 6° forward</li> <li>• Molded foam seat</li> <li>• Optional height adjustable lumbar</li> <li>• Warranted to 300 lbs.</li> </ul>	<b>WIDTH:</b> 25.0 <b>DEPTH:</b> 26 <b>HEIGHT:</b> 39.0-43.5 <b>SEAT WIDTH:</b> 20.0 <b>SEAT DEPTH:</b> 14.5-17.0 <b>SEAT HEIGHT:</b> 17.0-21.5 <b>BACK WIDTH:</b> 18.0 <b>BACK HEIGHT:</b> 22.0 <b>COM:</b> 0.8 YDS <b>WEIGHT:</b> 44.0 LB	 <b>A36</b> \$105 Height Adjustable Pivot/Slide Arm	 <b>A37</b> \$125 Height/Width Adjustable Pivot/Slide Arm	 <b>BA9B</b> STD 26" High Profile Nylon Base - Black					
	A2		T01											
	A8B / A8S		T01											
	A9B / A9S		T01											
	A10		T01											
	A36						 <b>BA10S</b> \$100 26" High Profile Aluminum Silver Powder-Coat	 <b>LB</b> \$30 Height Adjustable Lumbar Support						
	A37													

# brio

mesh chairs tailored to you

## STOOL

GSA SIN # 711-18

- Task, stool, management and conference seating
- Mesh back
- Rolling flex back follows user's shoulder movements
- Reverse seat slider for more petite seat, standard on all models
- Optional height adjustable lumbar
- Warranted to 300 lbs.





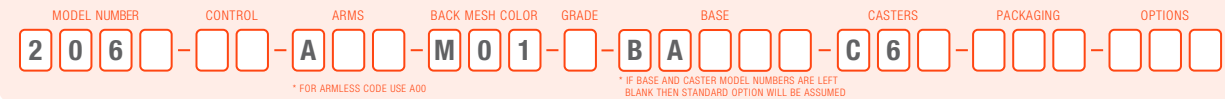





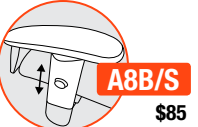

### CREATING BRIO MODEL NUMBER



### PACKAGING NOTES

CODE	DESCRIPTION	LIST UPCHARGE
AB	ASSEMBLED IN BAG	\$0
BAC	BACK ASSEMBLED IN CARTON	\$0

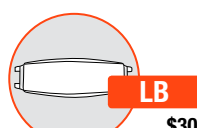
MODEL	CONTROL	DESCRIPTION	ARM	FABRIC	FEATURES	DIMENSIONS	ARM OPTIONS	CASTER OPTIONS	
2066	Y1	<b>10" STOOL SIMPLE SYNCHRO TILT</b> Use for work surfaces up to 42 inches high	ARMLESS	<b>T01</b> 565 615 640 660 685 715 750 785	<ul style="list-style-type: none"> <li>• Pneumatic seat height adjustment</li> <li>• Tilt tension control</li> <li>• Back and seat tilt in 3:1 ratio</li> <li>• Upright position tilt lock</li> <li>• Molded foam seat</li> <li>• Optional height adjustable lumbar</li> <li>• Knobless height adjustable 20" diameter footring</li> <li>• Warranted to 300 lbs.</li> </ul>	<b>WIDTH:</b> 25.0 <b>DEPTH:</b> 26.0 <b>HEIGHT:</b> 48.5-58.5 <b>SEAT WIDTH:</b> 20.0 <b>SEAT DEPTH:</b> 14.5-17.0 <b>SEAT HEIGHT:</b> 26.6-36.5 <b>BACK WIDTH:</b> 18.0 <b>BACK HEIGHT:</b> 22.0 <b>COM:</b> 0.8 YD <b>WEIGHT:</b> 43.0 LB	 <b>A2</b> \$80  <b>A8B/S</b> \$85  <b>C6</b> STD	 <b>C6S</b> \$35	
			A2	A/COM 645 695 720 740 765 795 830 865					A9B / A9S 670 720 745 765 790 820 855 890
2066	P1	<b>10" STOOL POSTURE BACK</b> Use for work surfaces up to 42 inches high	ARMLESS	<b>T01</b> 600 650 675 695 720 750 785 820	<ul style="list-style-type: none"> <li>• Pneumatic seat height adjustment</li> <li>• Infinite back angle with free float</li> <li>• Optional height adjustable lumbar</li> <li>• Knobless height adjustable 20" diameter footring</li> <li>• Warranted to 300 lbs.</li> </ul>	<b>WIDTH:</b> 25.0 <b>DEPTH:</b> 26.0 <b>HEIGHT:</b> 48.5-58.5 <b>SEAT WIDTH:</b> 20.0 <b>SEAT DEPTH:</b> 14.5-17.0 <b>SEAT HEIGHT:</b> 26.6-36.5 <b>BACK WIDTH:</b> 18.0 <b>BACK HEIGHT:</b> 22.0 <b>COM:</b> 0.8 YD <b>WEIGHT:</b> 46.0 LB	 <b>A2</b> \$105  <b>A8B/S</b> \$85	 <b>A36</b> \$105  <b>A37</b> \$125	
			A2	A/COM 680 730 755 775 800 830 865 900					A9B / A9S 705 755 780 800 825 855 890 925
2068	Y1	<b>8" STOOL SIMPLE SYNCHRO TILT</b> Use for work surfaces up to 36 inches high	ARMLESS	<b>T01</b> 565 615 640 660 685 715 750 785	<ul style="list-style-type: none"> <li>• Pneumatic seat height adjustment</li> <li>• Tilt tension control</li> <li>• Back and seat tilt in 3:1 ratio</li> <li>• Upright position tilt lock</li> <li>• Molded foam seat</li> <li>• Optional height adjustable lumbar</li> <li>• Knobless height adjustable 20" diameter footring</li> <li>• Warranted to 300 lbs.</li> </ul>	<b>WIDTH:</b> 25.0 <b>DEPTH:</b> 26.0 <b>HEIGHT:</b> 44.5-52.5 <b>SEAT WIDTH:</b> 20.0 <b>SEAT DEPTH:</b> 14.5-17.0 <b>SEAT HEIGHT:</b> 22.5-30.5 <b>BACK WIDTH:</b> 18.0 <b>BACK HEIGHT:</b> 22.0 <b>COM:</b> 0.8 YD <b>WEIGHT:</b> 42.0 LB	 <b>BA9B</b> STD  <b>BA10B</b> \$100  <b>BA10P</b> \$100	 <b>BA10S</b> \$100	
			A2	A/COM 645 695 720 740 765 795 830 865					A9B / A9S 670 720 745 765 790 820 855 890
2068	P1	<b>8" STOOL POSTURE BACK</b> Use for work surfaces up to 36 inches high	ARMLESS	<b>T01</b> 600 650 675 695 720 750 785 820	<ul style="list-style-type: none"> <li>• Pneumatic seat height adjustment</li> <li>• Infinite back angle with free float</li> <li>• Optional height adjustable lumbar</li> <li>• Knobless height adjustable 20" diameter footring</li> <li>• Warranted to 300 lbs.</li> </ul>	<b>WIDTH:</b> 25.0 <b>DEPTH:</b> 26.0 <b>HEIGHT:</b> 44.5-52.5 <b>SEAT WIDTH:</b> 20.0 <b>SEAT DEPTH:</b> 14.5-17.0 <b>SEAT HEIGHT:</b> 22.5-30.5 <b>BACK WIDTH:</b> 18.0 <b>BACK HEIGHT:</b> 22.0 <b>COM:</b> 0.8 YD <b>WEIGHT:</b> 45.0 LB	 <b>LB</b> \$30		
			A2	A/COM 680 730 755 775 800 830 865 900				A9B / A9S 705 755 780 800 825 855 890 925	A10 685 735 760 780 805 835 870 905

# bristol

seamless integration into your office's architecture

GSA SIN # 711-18

- Management, task, stool, and conference seating
- Ratchet back height adjustment on all models
- Warranted to 300 lbs.
- CAL TB 133 Fire Code approved



## CREATING BRISTOL MODEL NUMBER

MODEL NUMBER	CONTROL	ARMS	GRADE	BASE	CASTERS	PACKAGING	OPTIONS
2360		A		B A			

\* FOR ARMLESS CODE USE A00  
\* IF BASE AND CASTER MODEL NUMBERS ARE LEFT BLANK THEN STANDARD OPTION WILL BE ASSUMED

## PACKAGING NOTES

CODE	DESCRIPTION	LIST UPCHARGE
AB	ASSEMBLED IN BAG	\$0
PAC	PARTIALLY ASSEMBLED IN CARTON	\$0
BAC	BACK ASSEMBLED IN CARTON	\$40

## MID-BACK

MODEL	CONTROL	DESCRIPTION	ARM	FABRIC/LEATHER	FEATURES	DIMENSIONS	ARM OPTIONS	CASTER OPTIONS	
									A/COM
2360	S2	<b>MID-BACK SWIVEL TILT</b>  Use for a variety of general office task seating, including private office and conference room seating	ARMLESS	520 565 595 640 690 750 815 690 770 915	<ul style="list-style-type: none"> <li>• Pneumatic seat height adjustment</li> <li>• Tilt tension control</li> <li>• Seat and back tilt as a unit</li> <li>• 360-degree swivel</li> <li>• Upright position tilt lock</li> <li>• Ratchet back height lumbar adjustment</li> <li>• Warranted to 300 lbs.</li> </ul>	WIDTH: 25.0 DEPTH: 26.0 HEIGHT: 38.0-45.0 SEAT WIDTH: 20.0 SEAT DEPTH: 19.0 SEAT HEIGHT: 17.0-21.5 BACK WIDTH: 20.0 BACK HEIGHT: 19.0-21.5 COM: 1.4 YDS COL: 20.0 SQ FT WEIGHT: 30.0 LB	<b>A8B/S</b> \$85 Height Adjustable Arm A8B-Black A8S-Silver	<b>A9B/S</b> \$105 Height/Width Adjustable Arm A9B-Black A9S-Silver	<b>C6</b> STD 60mm Hoodless Casters
			A8B / A8S	605 650 680 725 775 835 900 775 855 1000					
			A9B / A9S	625 670 700 745 795 855 920 795 875 1020					
			A10	605 650 680 725 775 835 900 775 855 1000					
			A19	720 765 795 840 890 950 1015 890 970 1115					
2360	R1	<b>MID-BACK ROCKING TILT</b>  For managerial and task applications. Similar to a swivel tilt control, with the added comfort of infinite back angle and tilt adjustment	ARMLESS	570 615 645 690 740 800 865 740 820 965	<ul style="list-style-type: none"> <li>• Pneumatic seat height adjustment</li> <li>• Tilt tension control</li> <li>• Seat and back tilt as a unit</li> <li>• Floating seat position tilt lock</li> <li>• Infinite back angle adj. w/ free float</li> <li>• Ratchet back height lumbar adjustment</li> <li>• Optional height adjustable lumbar</li> <li>• Warranted to 300 lbs.</li> </ul>	WIDTH: 25.0 DEPTH: 26.0 HEIGHT: 39.0-46.0 SEAT WIDTH: 20.0 SEAT DEPTH: 19.0 SEAT HEIGHT: 18.0-22.5 BACK WIDTH: 20.0 BACK HEIGHT: 19.0-21.5 COM: 1.4 YDS COL: 20.0 SQ FT WEIGHT: 35.0 LB	<b>A10</b> \$85 Soft Touch C-Shaped Arm	<b>A19</b> \$200 Polished Aluminum C-Shape Arm	<b>C6S</b> \$35 60mm Hoodless Hard Floor Casters
			A8B / A8S	655 700 730 775 825 885 950 825 905 1050					
			A9B / A9S	675 720 750 795 845 905 970 845 925 1070					
			A10	655 700 730 775 825 885 950 825 905 1050					
			A19	770 815 845 890 940 1000 1065 940 1020 1165					
2360	Y2	<b>MID-BACK HEAVY DUTY SYNCHRO</b>  Use for a variety of general office task seating, including private office and conference room seating	ARMLESS	600 645 675 720 770 830 895 770 850 995	<ul style="list-style-type: none"> <li>• Pneumatic seat height adjustment</li> <li>• Side tilt tension control</li> <li>• Back and seat tilt in 2:1 ratio</li> <li>• 4 locking positions</li> <li>• Safety tilt release</li> <li>• Ratchet back height lumbar adjustment</li> <li>• Warranted to 300 lbs.</li> </ul>	WIDTH: 25.0 DEPTH: 26.0 HEIGHT: 39.0-46.0 SEAT WIDTH: 20.0 SEAT DEPTH: 19.0 SEAT HEIGHT: 18.0-22.5 BACK WIDTH: 20.0 BACK HEIGHT: 19.0-21.5 COM: 1.4 YDS COL: 20.0 SQ FT WEIGHT: 37.0 LB	<b>BA9B</b> STD 26" High Profile Nylon Base - Black	<b>BA10B</b> \$100 26" High Profile Aluminum Base - Black Powder Coat	<b>BA10P</b> \$100 26" High Profile Aluminum Base - Polished (C7 Chrome Accented Hoodless Casters Standard with Polished Base)
			A8B / A8S	685 730 760 805 855 915 980 855 935 1080					
			A9B / A9S	705 750 780 825 875 935 1000 875 955 1100					
			A10	685 730 760 805 855 915 980 855 935 1080					
			A19	800 845 875 920 970 1030 1095 970 1050 1195					
2360	M1	<b>MID-BACK MULTI-FUNCTION</b>  Fully articulating seat and back for the highest level of ergonomic needs. Control allows user to pivot seat forward from 0° to 6°	ARMLESS	620 665 695 740 790 850 915 790 870 1015	<ul style="list-style-type: none"> <li>• Pneumatic seat height adjustment</li> <li>• Tilt tension control</li> <li>• Seat and back tilt as a unit</li> <li>• Floating seat position tilt lock</li> <li>• Infinite back angle adj. w/ free float</li> <li>• Seat pivots from 0° to 6° forward</li> <li>• Ratchet back height lumbar adjustment</li> <li>• Warranted to 300 lbs.</li> </ul>	WIDTH: 25.0 DEPTH: 26.0 HEIGHT: 39.0-46.0 SEAT WIDTH: 20.0 SEAT DEPTH: 19.0 SEAT HEIGHT: 18.0-22.5 BACK WIDTH: 20.0 BACK HEIGHT: 19.0-21.5 COM: 1.4 YDS COL: 20.0 SQ FT WEIGHT: 39.0 LB	<b>BA10S</b> \$100 26" High Profile Aluminum Base - Silver Powder Coat	<b>SS</b> \$60 Seat Slider 2.5" Side Paddle Activated	<b>BN1</b> \$35 <b>BN2</b> N/C Upholstered Outer Back in Black Ballistic Nylon BN1 - with Grade A ONLY BN2 - with Grade B and Up
			A8B / A8S	705 750 780 825 875 935 1000 875 955 1100					
			A9B / A9S	725 770 800 845 895 955 1020 895 975 1120					
			A10	705 750 780 825 875 935 1000 875 955 1100					
			A19	820 865 895 940 990 1050 1115 990 1070 1215					



# bristol

seamless integration into your office's architecture

GSA SIN # 711-18

- Management, task, stool and conference seating
- Ratchet back height adjustment on all models
- Warranted up to 300 lbs.
- CAL 133 approved in fabric
- Knobless height adjustable 20" diameter footring



## STOOL

### CREATING BRISTOL MODEL NUMBER



### PACKAGING NOTES

CODE	DESCRIPTION	LIST UPCHARGE
AB	ASSEMBLED IN BAG	\$0
PAC	PARTIALLY ASSEMBLED IN CARTON	\$0
BAC	BACK ASSEMBLED IN CARTON	\$40

MODEL	CONTROL	DESCRIPTION	ARM	FABRIC/LEATHER	FEATURES	DIMENSIONS	ARM OPTIONS	CASTER OPTIONS																																																																																																																																																													
2366	P1	<b>10" STOOL WITH POSTURE BACK</b> Use for work surfaces up to 42 inches high	<table border="1"> <thead> <tr> <th>ARMLESS</th> <th>A8B / A8S</th> <th>A9B / A9S</th> <th>A10</th> <th>A19</th> <th>A36</th> <th>A37</th> </tr> </thead> <tbody> <tr> <td></td> <td>770</td> <td>790</td> <td>770</td> <td>885</td> <td>790</td> <td>810</td> </tr> <tr> <td></td> <td>820</td> <td>840</td> <td>820</td> <td>935</td> <td>840</td> <td>860</td> </tr> <tr> <td></td> <td>850</td> <td>870</td> <td>850</td> <td>965</td> <td>870</td> <td>890</td> </tr> <tr> <td></td> <td>900</td> <td>920</td> <td>900</td> <td>1015</td> <td>920</td> <td>940</td> </tr> <tr> <td></td> <td>955</td> <td>975</td> <td>955</td> <td>1070</td> <td>975</td> <td>995</td> </tr> <tr> <td></td> <td>1015</td> <td>1035</td> <td>1015</td> <td>1130</td> <td>1035</td> <td>1120</td> </tr> <tr> <td></td> <td>1080</td> <td>1100</td> <td>1080</td> <td>1195</td> <td>1100</td> <td>1185</td> </tr> <tr> <td></td> <td>940</td> <td>960</td> <td>940</td> <td>1055</td> <td>960</td> <td>980</td> </tr> <tr> <td></td> <td>1020</td> <td>1040</td> <td>1020</td> <td>1135</td> <td>1040</td> <td>1060</td> </tr> <tr> <td></td> <td>1165</td> <td>1185</td> <td>1165</td> <td>1280</td> <td>1185</td> <td>1205</td> </tr> </tbody> </table>	ARMLESS	A8B / A8S	A9B / A9S	A10	A19	A36	A37		770	790	770	885	790	810		820	840	820	935	840	860		850	870	850	965	870	890		900	920	900	1015	920	940		955	975	955	1070	975	995		1015	1035	1015	1130	1035	1120		1080	1100	1080	1195	1100	1185		940	960	940	1055	960	980		1020	1040	1020	1135	1040	1060		1165	1185	1165	1280	1185	1205	<table border="1"> <thead> <tr> <th>A/COM</th> <th>B</th> <th>C</th> <th>D</th> <th>E</th> <th>F</th> <th>G</th> <th>L3/COL</th> <th>L4</th> <th>L5</th> </tr> </thead> <tbody> <tr><td>685</td><td>735</td><td>765</td><td>815</td><td>870</td><td>930</td><td>995</td><td>855</td><td>935</td><td>1080</td></tr> <tr><td>770</td><td>820</td><td>850</td><td>900</td><td>955</td><td>1015</td><td>1080</td><td>940</td><td>1020</td><td>1165</td></tr> <tr><td>790</td><td>840</td><td>870</td><td>920</td><td>975</td><td>1035</td><td>1100</td><td>960</td><td>1040</td><td>1185</td></tr> <tr><td>770</td><td>820</td><td>850</td><td>900</td><td>955</td><td>1015</td><td>1080</td><td>940</td><td>1020</td><td>1165</td></tr> <tr><td>885</td><td>935</td><td>965</td><td>1015</td><td>1070</td><td>1130</td><td>1195</td><td>1055</td><td>1135</td><td>1280</td></tr> <tr><td>790</td><td>840</td><td>870</td><td>920</td><td>975</td><td>1035</td><td>1100</td><td>960</td><td>1040</td><td>1185</td></tr> <tr><td>810</td><td>860</td><td>890</td><td>940</td><td>995</td><td>1055</td><td>1120</td><td>980</td><td>1060</td><td>1205</td></tr> </tbody> </table>	A/COM	B	C	D	E	F	G	L3/COL	L4	L5	685	735	765	815	870	930	995	855	935	1080	770	820	850	900	955	1015	1080	940	1020	1165	790	840	870	920	975	1035	1100	960	1040	1185	770	820	850	900	955	1015	1080	940	1020	1165	885	935	965	1015	1070	1130	1195	1055	1135	1280	790	840	870	920	975	1035	1100	960	1040	1185	810	860	890	940	995	1055	1120	980	1060	1205	<ul style="list-style-type: none"> <li>• Pneumatic seat height adjustment</li> <li>• Infinite back angle adjust with free float</li> <li>• Ratchet back height lumbar adjustment</li> <li>• Knobless height adjustable 20" diameter footring</li> <li>• Warranted to 300 lbs.</li> </ul>	<p>WIDTH: 25.0</p> <p>DEPTH: 26.0</p> <p>HEIGHT: 48.5-61.0</p> <p>SEAT WIDTH: 20.0</p> <p>SEAT DEPTH: 19.0</p> <p>SEAT HEIGHT: 28.0-38.0</p> <p>BACK WIDTH: 20.0</p> <p>BACK HEIGHT: 19.0-21.5</p> <p>COM: 1.4 YDS</p> <p>COL: 20.0 SQ FT</p> <p>WEIGHT: 42.0 LB</p>	<p><b>A8B/S</b> \$85</p> <p>Height Adjustable Arm A8B-Black A8S-Silver</p> <p><b>A9B/S</b> \$105</p> <p>Height/Width Adjustable Arm A9B-Black A9S-Silver</p> <p><b>A10</b> \$85</p> <p>Soft Touch C-Shaped Arm</p> <p><b>A19</b> \$200</p> <p>Polished Aluminum C-Shape Arm</p> <p><b>A36</b> \$105</p> <p>Height Adjustable Pivot/Slide Arm</p> <p><b>A37</b> \$125</p> <p>Height/Width Adjustable Pivot/Slide Arm</p>	<p><b>C6</b> STD</p> <p>60mm Hoodless Casters</p> <p><b>C6S</b> \$35</p> <p>60mm Hoodless Hard Floor Casters</p> <p><b>C7</b> \$35</p> <p>60mm Hoodless Chrome Accented Casters (Standard with Polished Base)</p>
ARMLESS	A8B / A8S	A9B / A9S	A10	A19	A36	A37																																																																																																																																																															
	770	790	770	885	790	810																																																																																																																																																															
	820	840	820	935	840	860																																																																																																																																																															
	850	870	850	965	870	890																																																																																																																																																															
	900	920	900	1015	920	940																																																																																																																																																															
	955	975	955	1070	975	995																																																																																																																																																															
	1015	1035	1015	1130	1035	1120																																																																																																																																																															
	1080	1100	1080	1195	1100	1185																																																																																																																																																															
	940	960	940	1055	960	980																																																																																																																																																															
	1020	1040	1020	1135	1040	1060																																																																																																																																																															
	1165	1185	1165	1280	1185	1205																																																																																																																																																															
A/COM	B	C	D	E	F	G	L3/COL	L4	L5																																																																																																																																																												
685	735	765	815	870	930	995	855	935	1080																																																																																																																																																												
770	820	850	900	955	1015	1080	940	1020	1165																																																																																																																																																												
790	840	870	920	975	1035	1100	960	1040	1185																																																																																																																																																												
770	820	850	900	955	1015	1080	940	1020	1165																																																																																																																																																												
885	935	965	1015	1070	1130	1195	1055	1135	1280																																																																																																																																																												
790	840	870	920	975	1035	1100	960	1040	1185																																																																																																																																																												
810	860	890	940	995	1055	1120	980	1060	1205																																																																																																																																																												
2368	P1	<b>8" STOOL WITH POSTURE BACK</b> Use for work surfaces up to 36 inches high	<table border="1"> <thead> <tr> <th>ARMLESS</th> <th>A8B / A8S</th> <th>A9B / A9S</th> <th>A10</th> <th>A19</th> <th>A36</th> <th>A37</th> </tr> </thead> <tbody> <tr> <td></td> <td>770</td> <td>790</td> <td>770</td> <td>885</td> <td>790</td> <td>810</td> </tr> <tr> <td></td> <td>820</td> <td>840</td> <td>820</td> <td>935</td> <td>840</td> <td>860</td> </tr> <tr> <td></td> <td>850</td> <td>870</td> <td>850</td> <td>965</td> <td>870</td> <td>890</td> </tr> <tr> <td></td> <td>900</td> <td>920</td> <td>900</td> <td>1015</td> <td>920</td> <td>940</td> </tr> <tr> <td></td> <td>955</td> <td>975</td> <td>955</td> <td>1070</td> <td>975</td> <td>995</td> </tr> <tr> <td></td> <td>1015</td> <td>1035</td> <td>1015</td> <td>1130</td> <td>1035</td> <td>1120</td> </tr> <tr> <td></td> <td>1080</td> <td>1100</td> <td>1080</td> <td>1195</td> <td>1100</td> <td>1185</td> </tr> <tr> <td></td> <td>940</td> <td>960</td> <td>940</td> <td>1055</td> <td>960</td> <td>980</td> </tr> <tr> <td></td> <td>1020</td> <td>1040</td> <td>1020</td> <td>1135</td> <td>1040</td> <td>1060</td> </tr> <tr> <td></td> <td>1165</td> <td>1185</td> <td>1165</td> <td>1280</td> <td>1185</td> <td>1205</td> </tr> </tbody> </table>	ARMLESS	A8B / A8S	A9B / A9S	A10	A19	A36	A37		770	790	770	885	790	810		820	840	820	935	840	860		850	870	850	965	870	890		900	920	900	1015	920	940		955	975	955	1070	975	995		1015	1035	1015	1130	1035	1120		1080	1100	1080	1195	1100	1185		940	960	940	1055	960	980		1020	1040	1020	1135	1040	1060		1165	1185	1165	1280	1185	1205	<table border="1"> <thead> <tr> <th>A/COM</th> <th>B</th> <th>C</th> <th>D</th> <th>E</th> <th>F</th> <th>G</th> <th>L3/COL</th> <th>L4</th> <th>L5</th> </tr> </thead> <tbody> <tr><td>685</td><td>735</td><td>765</td><td>815</td><td>870</td><td>930</td><td>995</td><td>855</td><td>935</td><td>1080</td></tr> <tr><td>770</td><td>820</td><td>850</td><td>900</td><td>955</td><td>1015</td><td>1080</td><td>940</td><td>1020</td><td>1165</td></tr> <tr><td>790</td><td>840</td><td>870</td><td>920</td><td>975</td><td>1035</td><td>1100</td><td>960</td><td>1040</td><td>1185</td></tr> <tr><td>770</td><td>820</td><td>850</td><td>900</td><td>955</td><td>1015</td><td>1080</td><td>940</td><td>1020</td><td>1165</td></tr> <tr><td>885</td><td>935</td><td>965</td><td>1015</td><td>1070</td><td>1130</td><td>1195</td><td>1055</td><td>1135</td><td>1280</td></tr> <tr><td>790</td><td>840</td><td>870</td><td>920</td><td>975</td><td>1035</td><td>1100</td><td>960</td><td>1040</td><td>1185</td></tr> <tr><td>810</td><td>860</td><td>890</td><td>940</td><td>995</td><td>1055</td><td>1120</td><td>980</td><td>1060</td><td>1205</td></tr> </tbody> </table>	A/COM	B	C	D	E	F	G	L3/COL	L4	L5	685	735	765	815	870	930	995	855	935	1080	770	820	850	900	955	1015	1080	940	1020	1165	790	840	870	920	975	1035	1100	960	1040	1185	770	820	850	900	955	1015	1080	940	1020	1165	885	935	965	1015	1070	1130	1195	1055	1135	1280	790	840	870	920	975	1035	1100	960	1040	1185	810	860	890	940	995	1055	1120	980	1060	1205	<ul style="list-style-type: none"> <li>• Pneumatic seat height adjustment</li> <li>• Infinite back angle adjust with free float</li> <li>• Ratchet back height lumbar adjustment</li> <li>• Knobless height adjustable 20" diameter footring</li> <li>• Warranted to 300 lbs.</li> </ul>	<p>WIDTH: 25.0</p> <p>DEPTH: 26.0</p> <p>HEIGHT: 44.5-55.0</p> <p>SEAT WIDTH: 20.0</p> <p>SEAT DEPTH: 19.0</p> <p>SEAT HEIGHT: 24.0-32.0</p> <p>BACK WIDTH: 20.0</p> <p>BACK HEIGHT: 19.0-21.5</p> <p>COM: 1.4 YDS</p> <p>COL: 20.0 SQ FT</p> <p>WEIGHT: 43.0 LB</p>	<p><b>BA9B</b> STD</p> <p>26" High Profile Nylon Base - Black</p> <p><b>BA10B</b> \$100</p> <p>26" High Profile Aluminum Base - Black Powder Coat</p> <p><b>BA10P</b> \$100</p> <p>26" High Profile Aluminum Base - Polished (C7 Chrome Accented Hoodless Casters Standard with Polished Base)</p> <p><b>BA10S</b> \$100</p> <p>26" High Profile Aluminum Base - Silver Powder Coat</p>	<p><b>BN1</b> \$35</p> <p><b>BN2</b> N/C</p> <p>Upholstered Outer Back in Black Ballistic Nylon BN1 - with Grade A ONLY BN2 - with Grade B and Up</p>
ARMLESS	A8B / A8S	A9B / A9S	A10	A19	A36	A37																																																																																																																																																															
	770	790	770	885	790	810																																																																																																																																																															
	820	840	820	935	840	860																																																																																																																																																															
	850	870	850	965	870	890																																																																																																																																																															
	900	920	900	1015	920	940																																																																																																																																																															
	955	975	955	1070	975	995																																																																																																																																																															
	1015	1035	1015	1130	1035	1120																																																																																																																																																															
	1080	1100	1080	1195	1100	1185																																																																																																																																																															
	940	960	940	1055	960	980																																																																																																																																																															
	1020	1040	1020	1135	1040	1060																																																																																																																																																															
	1165	1185	1165	1280	1185	1205																																																																																																																																																															
A/COM	B	C	D	E	F	G	L3/COL	L4	L5																																																																																																																																																												
685	735	765	815	870	930	995	855	935	1080																																																																																																																																																												
770	820	850	900	955	1015	1080	940	1020	1165																																																																																																																																																												
790	840	870	920	975	1035	1100	960	1040	1185																																																																																																																																																												
770	820	850	900	955	1015	1080	940	1020	1165																																																																																																																																																												
885	935	965	1015	1070	1130	1195	1055	1135	1280																																																																																																																																																												
790	840	870	920	975	1035	1100	960	1040	1185																																																																																																																																																												
810	860	890	940	995	1055	1120	980	1060	1205																																																																																																																																																												

# cayman

contemporary, ergonomic and built with attention to detail

## MID-BACK

GSA SIN # 711-18

- Conference and executive seating
- Aluminum base standard matches arm finish
- Warranted to 300 lbs.



### CREATING CAYMAN MODEL NUMBER

MODEL NUMBER CONTROL ARMS GRADE BASE CASTERS PACKAGING OPTIONS

2 8 0 0 - [ ] [ ] - A [ ] [ ] - [ ] [ ] - B A [ ] [ ] [ ] - C [ ] [ ] - [ ] [ ] [ ] - [ ] [ ] [ ]

\* FOR ARMLESS CODE USE A00      \* IF BASE AND CASTER MODEL NUMBERS ARE LEFT BLANK THEN STANDARD OPTION WILL BE ASSUMED      \* GT MODELS DO NOT HAVE A CASTER CODE

### PACKAGING NOTES

CODE	DESCRIPTION	LIST UPCHARGE
AB	ASSEMBLED IN BAG	\$0
PAC	PARTIALLY ASSEMBLED IN CARTON	\$0
BAC	BACK ASSEMBLED IN CARTON	\$40

MODEL	CONTROL	DESCRIPTION	ARM	FABRIC/LEATHER	FEATURES	DIMENSIONS	ARM OPTIONS	CASTER OPTIONS																																
2800	S1	<b>MID-BACK SWIVEL TILT</b>  Use for a variety of general office seating, including private office and conference room seating	A20 A21	<table border="1"> <thead> <tr> <th>A/COM</th> <th>B</th> <th>C</th> <th>D</th> <th>E</th> <th>F</th> <th>G</th> <th>L3/COL</th> <th>L4</th> <th>L5</th> </tr> </thead> <tbody> <tr> <td>705</td> <td>765</td> <td>805</td> <td>865</td> <td>935</td> <td>1010</td> <td>1095</td> <td>860</td> <td>915</td> <td>1205</td> </tr> <tr> <td>705</td> <td>765</td> <td>805</td> <td>865</td> <td>935</td> <td>1010</td> <td>1095</td> <td>860</td> <td>915</td> <td>1205</td> </tr> </tbody> </table>	A/COM	B	C	D	E	F	G	L3/COL	L4	L5	705	765	805	865	935	1010	1095	860	915	1205	705	765	805	865	935	1010	1095	860	915	1205	<ul style="list-style-type: none"> <li>• Pneumatic seat height adjustment</li> <li>• Tilt tension control</li> <li>• Seat and back tilt as a unit</li> <li>• 360-degree swivel</li> <li>• Upright position tilt lock</li> <li>• Warranted to 300 lbs.</li> </ul>	<b>WIDTH:</b> 24.0 <b>DEPTH:</b> 30.0 <b>HEIGHT:</b> 39.0-43.5 <b>SEAT WIDTH:</b> 21.0 <b>SEAT DEPTH:</b> 19.5 <b>SEAT HEIGHT:</b> 16.5-21.0 <b>BACK WIDTH:</b> 22.0 <b>BACK HEIGHT:</b> 22.5 <b>COM:</b> 1.9 YD <b>COL:</b> 25.0 SQ FT <b>WEIGHT:</b> 36.0 LB	<b>A20 STD</b> Black Powder Coated Arm w/ Leather Pad	<b>A21 STD</b> Polished Aluminum Arm w/ Leather Pad	<b>C1 STD</b> 50mm Hooded Casters	
A/COM	B	C	D	E	F	G	L3/COL	L4	L5																															
705	765	805	865	935	1010	1095	860	915	1205																															
705	765	805	865	935	1010	1095	860	915	1205																															
2800	K1	<b>MID-BACK KNEE TILT</b>  Ultimate seating comfort suited for the executive or manager. Allows for a full range of movement with a sharp, simple look	A20 A21	<table border="1"> <thead> <tr> <th>A/COM</th> <th>B</th> <th>C</th> <th>D</th> <th>E</th> <th>F</th> <th>G</th> <th>L3/COL</th> <th>L4</th> <th>L5</th> </tr> </thead> <tbody> <tr> <td>755</td> <td>815</td> <td>855</td> <td>915</td> <td>985</td> <td>1060</td> <td>1145</td> <td>910</td> <td>965</td> <td>1255</td> </tr> <tr> <td>755</td> <td>815</td> <td>855</td> <td>915</td> <td>985</td> <td>1060</td> <td>1145</td> <td>910</td> <td>965</td> <td>1255</td> </tr> </tbody> </table>	A/COM	B	C	D	E	F	G	L3/COL	L4	L5	755	815	855	915	985	1060	1145	910	965	1255	755	815	855	915	985	1060	1145	910	965	1255	<ul style="list-style-type: none"> <li>• Pneumatic seat height adjustment</li> <li>• Tilt tension control</li> <li>• Seat and back tilt as a unit</li> <li>• 5 locking positions</li> <li>• Safety tilt release</li> <li>• Reduced rise of front of seat</li> <li>• Warranted to 300 lbs.</li> </ul>	<b>WIDTH:</b> 24.0 <b>DEPTH:</b> 30.0 <b>HEIGHT:</b> 39-42 <b>SEAT WIDTH:</b> 21.0 <b>SEAT DEPTH:</b> 19.5 <b>SEAT HEIGHT:</b> 16.5-19.5 <b>BACK WIDTH:</b> 22.0 <b>BACK HEIGHT:</b> 22.5 <b>COM:</b> 1.9 YD <b>COL:</b> 25.0 SQ FT <b>WEIGHT:</b> 41.0 LB	<b>BA2B STD</b> 27" Aluminum Base - Black Powder-Coat	<b>BA2P STD</b> 27" Aluminum Base - Polished	<b>C1S \$35</b> 50mm Hooded Hard Floor Casters	<b>C2S \$35</b> 50mm Hooded Self-Locking Hard Floor Casters
A/COM	B	C	D	E	F	G	L3/COL	L4	L5																															
755	815	855	915	985	1060	1145	910	965	1255																															
755	815	855	915	985	1060	1145	910	965	1255																															
2800	GT	<b>GUEST</b>  Well suited for guest seating. Comes standard with non-marking glides	A20 A21	<table border="1"> <thead> <tr> <th>A/COM</th> <th>B</th> <th>C</th> <th>D</th> <th>E</th> <th>F</th> <th>G</th> <th>L3/COL</th> <th>L4</th> <th>L5</th> </tr> </thead> <tbody> <tr> <td>635</td> <td>695</td> <td>735</td> <td>795</td> <td>865</td> <td>940</td> <td>1025</td> <td>790</td> <td>845</td> <td>1135</td> </tr> <tr> <td>635</td> <td>695</td> <td>735</td> <td>795</td> <td>865</td> <td>940</td> <td>1025</td> <td>790</td> <td>845</td> <td>1135</td> </tr> </tbody> </table>	A/COM	B	C	D	E	F	G	L3/COL	L4	L5	635	695	735	795	865	940	1025	790	845	1135	635	695	735	795	865	940	1025	790	845	1135	<ul style="list-style-type: none"> <li>• Cantilever frame design</li> <li>• Non-marring floor glides</li> <li>• Warranted to 275 lbs.</li> </ul>	<b>WIDTH:</b> 24.0 <b>DEPTH:</b> 30.0 <b>HEIGHT:</b> 40.0 <b>SEAT WIDTH:</b> 21.0 <b>SEAT DEPTH:</b> 19.5 <b>SEAT HEIGHT:</b> 18.0 <b>BACK WIDTH:</b> 22.0 <b>BACK HEIGHT:</b> 22.5 <b>COM:</b> 1.9 YD <b>COL:</b> 25.0 SQ FT <b>WEIGHT:</b> 38.0 LB				
A/COM	B	C	D	E	F	G	L3/COL	L4	L5																															
635	695	735	795	865	940	1025	790	845	1135																															
635	695	735	795	865	940	1025	790	845	1135																															

SHIPS FULLY ASSEMBLED EITHER AC OR AB

# cayman

contemporary, ergonomic and built with attention to detail

GSA SIN # 711-18

- Conference and executive seating
- Aluminum base standard matches arm finish
- Warranted to 300 lbs.



## CREATING CAYMAN MODEL NUMBER

MODEL NUMBER CONTROL ARMS GRADE BASE CASTERS PACKAGING OPTIONS

2 8 1 0 - [ ] [ ] - A [ ] [ ] - [ ] [ ] - B A [ ] [ ] [ ] - C [ ] [ ] [ ] - [ ] [ ] [ ] [ ]

\* FOR ARMLESS CODE USE A00      \* IF BASE AND CASTER MODEL NUMBERS ARE LEFT BLANK THEN STANDARD OPTION WILL BE ASSUMED      \* GT MODELS DO NOT HAVE A CASTER CODE

### PACKAGING NOTES

CODE	DESCRIPTION	LIST UPCHARGE
AB	ASSEMBLED IN BAG	\$0
PAC	PARTIALLY ASSEMBLED IN CARTON	\$0
BAC	BACK ASSEMBLED IN CARTON	\$40

## HIGH-BACK

MODEL	CONTROL	DESCRIPTION	ARM	FABRIC/LEATHER	FEATURES	DIMENSIONS	ARM OPTIONS	CASTER OPTIONS																															
2810	S1	<p><b>HIGH-BACK SWIVEL TILT</b></p> <p>Use for a variety of general office seating, including private office and conference room seating</p>	<table border="1"> <thead> <tr> <th>A/COM</th> <th>B</th> <th>C</th> <th>D</th> <th>E</th> <th>F</th> <th>G</th> <th>L3/COL</th> <th>L4</th> <th>L5</th> </tr> </thead> <tbody> <tr> <td>A20</td> <td>755</td> <td>825</td> <td>870</td> <td>940</td> <td>1015</td> <td>1100</td> <td>1195</td> <td>910</td> <td>975</td> <td>1395</td> </tr> <tr> <td>A21</td> <td>755</td> <td>825</td> <td>870</td> <td>940</td> <td>1015</td> <td>1100</td> <td>1195</td> <td>910</td> <td>975</td> <td>1395</td> </tr> </tbody> </table>	A/COM	B	C	D	E	F	G	L3/COL	L4	L5	A20	755	825	870	940	1015	1100	1195	910	975	1395	A21	755	825	870	940	1015	1100	1195	910	975	1395	<ul style="list-style-type: none"> <li>• Pneumatic seat height adjustment</li> <li>• Tilt tension control</li> <li>• Seat and back tilt as a unit</li> <li>• 360-degree swivel</li> <li>• Upright position tilt lock</li> <li>• Warranted to 300 lbs.</li> </ul>	<p><b>WIDTH:</b> 24.0</p> <p><b>DEPTH:</b> 30.0</p> <p><b>HEIGHT:</b> 43.0-47.5</p> <p><b>SEAT WIDTH:</b> 21.0</p> <p><b>SEAT DEPTH:</b> 19.5</p> <p><b>SEAT HEIGHT:</b> 16.5-21.0</p> <p><b>BACK WIDTH:</b> 22.0</p> <p><b>BACK HEIGHT:</b> 26.5</p> <p><b>COM:</b> 2.1 YD</p> <p><b>COL:</b> 42.0 SQ</p> <p><b>WEIGHT:</b> 43.0 LB</p>	<p><b>A20 STD</b> Black Powder Coated Arm w/ Leather Pad</p> <p><b>A21 STD</b> Polished Aluminum Arm w/ Leather Pad</p>	<p><b>C1 STD</b> 50mm Hooded Casters</p> <p><b>C1S \$35</b> 50mm Hooded Hard Floor Casters</p> <p><b>C2S \$35</b> 50mm Hooded Self-Locking Hard Floor Casters</p>
A/COM	B	C	D	E	F	G	L3/COL	L4	L5																														
A20	755	825	870	940	1015	1100	1195	910	975	1395																													
A21	755	825	870	940	1015	1100	1195	910	975	1395																													
2810	K1	<p><b>HIGH-BACK KNEE TILT</b></p> <p>Ultimate seating comfort suited for the executive or manager. Allows for a full range of movement with a sharp, simple look</p>	<table border="1"> <thead> <tr> <th>A/COM</th> <th>B</th> <th>C</th> <th>D</th> <th>E</th> <th>F</th> <th>G</th> <th>L3/COL</th> <th>L4</th> <th>L5</th> </tr> </thead> <tbody> <tr> <td>A20</td> <td>805</td> <td>875</td> <td>920</td> <td>990</td> <td>1065</td> <td>1150</td> <td>1245</td> <td>960</td> <td>1025</td> <td>1445</td> </tr> <tr> <td>A21</td> <td>805</td> <td>875</td> <td>920</td> <td>990</td> <td>1065</td> <td>1150</td> <td>1245</td> <td>960</td> <td>1025</td> <td>1445</td> </tr> </tbody> </table>	A/COM	B	C	D	E	F	G	L3/COL	L4	L5	A20	805	875	920	990	1065	1150	1245	960	1025	1445	A21	805	875	920	990	1065	1150	1245	960	1025	1445	<ul style="list-style-type: none"> <li>• Pneumatic seat height adjustment</li> <li>• Tilt tension control</li> <li>• Seat and back tilt as a unit</li> <li>• 5 locking positions</li> <li>• Safety tilt release</li> <li>• Reduced rise of front of seat</li> <li>• Warranted to 300 lbs.</li> </ul>	<p><b>WIDTH:</b> 24.0</p> <p><b>DEPTH:</b> 30.0</p> <p><b>HEIGHT:</b> 43.0-46.0</p> <p><b>SEAT WIDTH:</b> 21.0</p> <p><b>SEAT DEPTH:</b> 19.5</p> <p><b>SEAT HEIGHT:</b> 16.5-19.5</p> <p><b>BACK WIDTH:</b> 26.5</p> <p><b>BACK HEIGHT:</b> 26.5</p> <p><b>COM:</b> 2.1 YD</p> <p><b>COL:</b> 42.0 SQ FT</p> <p><b>WEIGHT:</b> 48.0 LB</p>	<p><b>BA2B STD</b> 27" Aluminum Base - Black Powder-Coat</p> <p><b>BA2P STD</b> 27" Aluminum Base - Polished</p>	<p><b>C1S \$35</b> 50mm Hooded Hard Floor Casters</p> <p><b>C2S \$35</b> 50mm Hooded Self-Locking Hard Floor Casters</p>
A/COM	B	C	D	E	F	G	L3/COL	L4	L5																														
A20	805	875	920	990	1065	1150	1245	960	1025	1445																													
A21	805	875	920	990	1065	1150	1245	960	1025	1445																													



# core

contemporary lines for your workspace

## UPHOLSTERED BACK

GSA SIN # 711-18

- Task, stool, management and conference seating
- Stylish durable poly outer back
- Ratchet height adjustable back
- Weight balanced synchro, knee tilt or synchro with back angle adj.
- High design hubless casters standard
- Optional seat slider
- Black or gray frame colors
- Molded foam back over mesh suspension
- Warranted to 300 lbs.



### CREATING CORE MODEL NUMBER



### PACKAGING NOTES

CODE	DESCRIPTION	LIST UPCHARGE
AB	ASSEMBLED IN BAG	\$0
PAC	PARTIALLY ASSEMBLED IN CARTON	\$0
BAC	BACK ASSEMBLED IN CARTON	\$40

MODEL	CONTROL	DESCRIPTION	ARM	FABRIC/LEATHER	FEATURES	DIMENSIONS	ARM OPTIONS	CASTERS																																																		
2260	W1	<b>RATCHET BACK WEIGHT BALANCED SYNCHRO</b> Use for a variety of general office seating, including private office and conference room seating	ARMLESS A22 A23 A36	<table border="1"> <thead> <tr> <th>A/COM</th> <th>B</th> <th>C</th> <th>D</th> <th>E</th> <th>F</th> <th>G</th> <th>L3/COL</th> <th>L4</th> <th>L5</th> </tr> </thead> <tbody> <tr><td>495</td><td>530</td><td>550</td><td>585</td><td>620</td><td>660</td><td>705</td><td>595</td><td>795</td><td>845</td></tr> <tr><td>545</td><td>580</td><td>600</td><td>635</td><td>670</td><td>710</td><td>755</td><td>645</td><td>845</td><td>895</td></tr> <tr><td>570</td><td>605</td><td>625</td><td>660</td><td>695</td><td>735</td><td>780</td><td>670</td><td>870</td><td>920</td></tr> <tr><td>600</td><td>635</td><td>655</td><td>690</td><td>725</td><td>765</td><td>810</td><td>700</td><td>900</td><td>950</td></tr> </tbody> </table>	A/COM	B	C	D	E	F	G	L3/COL	L4	L5	495	530	550	585	620	660	705	595	795	845	545	580	600	635	670	710	755	645	845	895	570	605	625	660	695	735	780	670	870	920	600	635	655	690	725	765	810	700	900	950	<ul style="list-style-type: none"> <li>• Pneumatic seat height adjustment</li> <li>• Back and seat tilt in 3:1 ratio</li> <li>• 2 position tilt lock</li> <li>• Ratchet back height lumbar adjustment</li> <li>• Molded foam seat</li> <li>• Molded foam back over mesh suspension</li> <li>• High design hubless casters</li> <li>• Warranted to 300 lbs.</li> </ul>	<p>WIDTH: 27.5 DEPTH: 27.5 HEIGHT: 38.5-45 SEAT WIDTH: 19.5 SEAT DEPTH: 17.0 SEAT HEIGHT: 15.5-20 BACK WIDTH: 18.5 BACK HEIGHT: 23.0 COM: 1.5 YD COL: 8 SQ FT WEIGHT: 43.0 LB</p>	<p><b>A22</b> \$50 Fixed Arm with Soft Pad</p> <p><b>A23</b> \$75 6-Way Height Adjustable Arm w/ Sliding Pad</p>	<p><b>C22B</b> STD Standard 60mm Black Hubless Casters</p>
A/COM	B	C	D	E	F	G	L3/COL	L4	L5																																																	
495	530	550	585	620	660	705	595	795	845																																																	
545	580	600	635	670	710	755	645	845	895																																																	
570	605	625	660	695	735	780	670	870	920																																																	
600	635	655	690	725	765	810	700	900	950																																																	
2260	K2	<b>RATCHET BACK KNEE TILT</b> Ultimate seating comfort suited for the executive or manager. Allows for full range of movement with sharp, simple look	ARMLESS A22 A23 A36	<table border="1"> <thead> <tr> <th>A/COM</th> <th>B</th> <th>C</th> <th>D</th> <th>E</th> <th>F</th> <th>G</th> <th>L3/COL</th> <th>L4</th> <th>L5</th> </tr> </thead> <tbody> <tr><td>525</td><td>560</td><td>580</td><td>615</td><td>650</td><td>690</td><td>735</td><td>625</td><td>825</td><td>875</td></tr> <tr><td>575</td><td>610</td><td>630</td><td>665</td><td>700</td><td>740</td><td>785</td><td>675</td><td>875</td><td>925</td></tr> <tr><td>600</td><td>635</td><td>655</td><td>690</td><td>725</td><td>765</td><td>810</td><td>700</td><td>900</td><td>950</td></tr> <tr><td>630</td><td>665</td><td>685</td><td>720</td><td>755</td><td>795</td><td>840</td><td>730</td><td>930</td><td>980</td></tr> </tbody> </table>	A/COM	B	C	D	E	F	G	L3/COL	L4	L5	525	560	580	615	650	690	735	625	825	875	575	610	630	665	700	740	785	675	875	925	600	635	655	690	725	765	810	700	900	950	630	665	685	720	755	795	840	730	930	980	<ul style="list-style-type: none"> <li>• Pneumatic seat height adjustment</li> <li>• Knee tilt with reduced rise in front of seat</li> <li>• Seat and back tilt as a unit</li> <li>• 3 position tilt lock</li> <li>• Ratchet back height lumbar adjustment</li> <li>• Molded foam seat</li> <li>• Molded foam back over mesh suspension</li> <li>• Hubless casters</li> <li>• Warranted to 300 lbs.</li> </ul>	<p>WIDTH: 27.5 DEPTH: 27.5 HEIGHT: 41-47.5 SEAT WIDTH: 19.5 SEAT DEPTH: 17.0 SEAT HEIGHT: 18.-22.5 BACK WIDTH: 18.5 BACK HEIGHT: 23.0 COM: 1.5 YD COL: 8 SQ FT WEIGHT: 43.0 LB</p>	<p><b>A36</b> \$105 Height Adjustable Pivot/Slide Arm</p>	<p><b>C22G</b> STD Standard 60mm Hubless Gray Casters</p>
A/COM	B	C	D	E	F	G	L3/COL	L4	L5																																																	
525	560	580	615	650	690	735	625	825	875																																																	
575	610	630	665	700	740	785	675	875	925																																																	
600	635	655	690	725	765	810	700	900	950																																																	
630	665	685	720	755	795	840	730	930	980																																																	
2260	Y5	<b>RACHET BACK ENHANCED SYNCHRO WITH BACK ANGLE ADJUSTMENT</b> High function full synchro control with independent back angle adjust. Use for general office, task or management	ARMLESS A22 A23 A36	<table border="1"> <thead> <tr> <th>A/COM</th> <th>B</th> <th>C</th> <th>D</th> <th>E</th> <th>F</th> <th>G</th> <th>L3/COL</th> <th>L4</th> <th>L5</th> </tr> </thead> <tbody> <tr><td>575</td><td>610</td><td>630</td><td>665</td><td>700</td><td>740</td><td>785</td><td>675</td><td>875</td><td>925</td></tr> <tr><td>625</td><td>660</td><td>680</td><td>715</td><td>750</td><td>790</td><td>835</td><td>725</td><td>925</td><td>975</td></tr> <tr><td>650</td><td>685</td><td>705</td><td>740</td><td>775</td><td>815</td><td>860</td><td>750</td><td>950</td><td>1000</td></tr> <tr><td>680</td><td>715</td><td>735</td><td>770</td><td>805</td><td>845</td><td>890</td><td>780</td><td>980</td><td>1030</td></tr> </tbody> </table>	A/COM	B	C	D	E	F	G	L3/COL	L4	L5	575	610	630	665	700	740	785	675	875	925	625	660	680	715	750	790	835	725	925	975	650	685	705	740	775	815	860	750	950	1000	680	715	735	770	805	845	890	780	980	1030	<ul style="list-style-type: none"> <li>• Pneumatic seat height adjustment</li> <li>• 2:1 back to seat ratio</li> <li>• Standard seat slider adds 3" adjustment</li> <li>• 4 locking positions</li> <li>• Ratchet back height lumbar adjustment</li> <li>• Molded foam seat</li> <li>• Molded foam back over mesh suspension</li> <li>• Side tension control</li> <li>• High design hubless casters</li> <li>• Warranted to 300 lbs.</li> </ul>	<p>WIDTH: 27.5 DEPTH: 27.5 HEIGHT: 40-46.5 SEAT WIDTH: 19.5 SEAT DEPTH: 17-19.5 SEAT HEIGHT: 17-21.5 BACK WIDTH: 18.5 BACK HEIGHT: 23.0 COM: 1.5 YD COL: 8 SQ FT WEIGHT: 44.0 LB</p>	<p><b>BA11B</b> STD 27" Mid-Profile Nylon Base - Black</p> <p><b>BA11G</b> STD 27" Mid-Profile Nylon Base - Gray</p>	<p><b>C6</b> \$30 60mm Hoodless Casters</p>
A/COM	B	C	D	E	F	G	L3/COL	L4	L5																																																	
575	610	630	665	700	740	785	675	875	925																																																	
625	660	680	715	750	790	835	725	925	975																																																	
650	685	705	740	775	815	860	750	950	1000																																																	
680	715	735	770	805	845	890	780	980	1030																																																	
2260	GT	<b>GUEST</b> Four leg steel frame side chair	SWA	<table border="1"> <thead> <tr> <th>A/COM</th> <th>B</th> <th>C</th> <th>D</th> <th>E</th> <th>F</th> <th>G</th> <th>L3/COL</th> <th>L4</th> <th>L5</th> </tr> </thead> <tbody> <tr><td>450</td><td>485</td><td>505</td><td>540</td><td>575</td><td>615</td><td>660</td><td>550</td><td>750</td><td>800</td></tr> </tbody> </table>	A/COM	B	C	D	E	F	G	L3/COL	L4	L5	450	485	505	540	575	615	660	550	750	800	<ul style="list-style-type: none"> <li>• 4 leg frame design</li> <li>• Non-marring floor glides</li> <li>• Black or gray accents</li> <li>• Black or silver frame</li> <li>• Warranted to 300 lbs.</li> </ul>	<p>WIDTH: 26.0 DEPTH: 28.0 HEIGHT: 39.0 SEAT WIDTH: 20.0 SEAT DEPTH: 16.5 SEAT HEIGHT: 17.5 BACK WIDTH: 20.0 BACK HEIGHT: 22.0 COM: 1.0 YD COL: 8 SQ FT WEIGHT: 38.0 LB</p>	<p><b>SS</b> \$60 Seat Slider 2.5" Side Paddle Activated</p>	<p><b>C7</b> \$35 60mm Hoodless Chrome Accented Casters</p>																														
A/COM	B	C	D	E	F	G	L3/COL	L4	L5																																																	
450	485	505	540	575	615	660	550	750	800																																																	

SEAT SLIDER (SS) - ADD \$60

SEAT SLIDER (SS) - ADD \$60

SEAT SLIDER (SS) - STANDARD

SHIPS PARTIALLY ASSEMBLED PAC OR AB / SWA - STANDARD WITH ARMS

### PLASTIC COLORS\*

BLACK PBK	LIGHT GRAY PGA
--------------	----------------------

(OUTER BACK & ARMS)

\* A22/A23 matches frame color selected

# core

contemporary lines for your workspace

## STOOL

GSA SIN # 711-18

- Stool seating
- Stylish durable poly outer back
- Ratchet height adjustable back
- Weight balanced synchro control
- High design hubless casters standard
- Black or gray accent colors
- Molded foam back over mesh suspension
- Warranted to 300 lbs.



### CREATING CORE MODEL NUMBER



### PACKAGING NOTES

CODE	DESCRIPTION	LIST UPCHARGE
AB	ASSEMBLED IN BAG	\$0
PAC	PARTIALLY ASSEMBLED IN CARTON	\$0
BAC	BACK ASSEMBLED IN CARTON	\$40

MODEL	CONTROL	DESCRIPTION	ARM	FABRIC/LEATHER	FEATURES	DIMENSIONS	ARM OPTIONS	CASTERS																																																		
2266	W1	<b>10" STOOL RATCHET BACK WEIGHT BALANCED SYNCHRO</b>  Use for work surfaces up to 42 inches	ARMLESS	<table border="1"> <thead> <tr> <th>A/COM</th> <th>B</th> <th>C</th> <th>D</th> <th>E</th> <th>F</th> <th>G</th> <th>L3/COL</th> <th>L4</th> <th>L5</th> </tr> </thead> <tbody> <tr> <td>620</td> <td>655</td> <td>675</td> <td>710</td> <td>745</td> <td>785</td> <td>830</td> <td>720</td> <td>920</td> <td>970</td> </tr> <tr> <td>A22</td> <td>670</td> <td>705</td> <td>725</td> <td>760</td> <td>795</td> <td>835</td> <td>880</td> <td>770</td> <td>1020</td> </tr> <tr> <td>A23</td> <td>695</td> <td>730</td> <td>750</td> <td>785</td> <td>820</td> <td>860</td> <td>905</td> <td>795</td> <td>1045</td> </tr> <tr> <td>A36</td> <td>725</td> <td>760</td> <td>780</td> <td>815</td> <td>850</td> <td>890</td> <td>935</td> <td>825</td> <td>1075</td> </tr> </tbody> </table>	A/COM	B	C	D	E	F	G	L3/COL	L4	L5	620	655	675	710	745	785	830	720	920	970	A22	670	705	725	760	795	835	880	770	1020	A23	695	730	750	785	820	860	905	795	1045	A36	725	760	780	815	850	890	935	825	1075	<ul style="list-style-type: none"> <li>• Pneumatic seat height adjustment</li> <li>• Back and seat tilt in 3:1 ratio</li> <li>• 2 position tilt lock</li> <li>• Ratchet back height lumbar adjustment</li> <li>• Molded foam seat</li> <li>• Molded foam back over mesh suspension</li> <li>• High design hubless casters</li> <li>• Knobless height adjustable 20" diameter footring</li> <li>• Warranted to 300 lbs.</li> </ul>	<b>WIDTH:</b> 27.5 <b>DEPTH:</b> 27.5 <b>HEIGHT:</b> 46-58.5 <b>SEAT WIDTH:</b> 19.5 <b>SEAT DEPTH:</b> 17.0 <b>SEAT HEIGHT:</b> 23-33 <b>BACK WIDTH:</b> 18.5 <b>BACK HEIGHT:</b> 23.0 <b>COM:</b> 1.5 YD <b>COL:</b> 8 SQ FT <b>WEIGHT:</b> 49.0 LB	<b>A22</b> \$50 <b>A23</b> \$75 <b>A36</b> \$105	<b>C22B</b> STD <b>C22G</b> STD <b>C6</b> \$30 <b>C6S</b> \$35 <b>C7</b> \$35
A/COM	B		C	D	E	F	G	L3/COL	L4	L5																																																
620	655	675	710	745	785	830	720	920	970																																																	
A22	670	705	725	760	795	835	880	770	1020																																																	
A23	695	730	750	785	820	860	905	795	1045																																																	
A36	725	760	780	815	850	890	935	825	1075																																																	
2268	W1	<b>8" STOOL RATCHET BACK WEIGHT BALANCED SYNCHRO</b>  Use for work surfaces up to 36 inches	ARMLESS	<table border="1"> <thead> <tr> <th>A/COM</th> <th>B</th> <th>C</th> <th>D</th> <th>E</th> <th>F</th> <th>G</th> <th>L3/COL</th> <th>L4</th> <th>L5</th> </tr> </thead> <tbody> <tr> <td>620</td> <td>655</td> <td>675</td> <td>710</td> <td>745</td> <td>785</td> <td>830</td> <td>720</td> <td>920</td> <td>970</td> </tr> <tr> <td>A22</td> <td>670</td> <td>705</td> <td>725</td> <td>760</td> <td>795</td> <td>835</td> <td>880</td> <td>770</td> <td>1020</td> </tr> <tr> <td>A23</td> <td>695</td> <td>730</td> <td>750</td> <td>785</td> <td>820</td> <td>860</td> <td>905</td> <td>795</td> <td>1045</td> </tr> <tr> <td>A36</td> <td>725</td> <td>760</td> <td>780</td> <td>815</td> <td>850</td> <td>890</td> <td>935</td> <td>825</td> <td>1075</td> </tr> </tbody> </table>	A/COM	B	C	D	E	F	G	L3/COL	L4	L5	620	655	675	710	745	785	830	720	920	970	A22	670	705	725	760	795	835	880	770	1020	A23	695	730	750	785	820	860	905	795	1045	A36	725	760	780	815	850	890	935	825	1075	<ul style="list-style-type: none"> <li>• Pneumatic seat height adjustment</li> <li>• Back and seat tilt in 3:1 ratio</li> <li>• 2 position tilt lock</li> <li>• Ratchet back height lumbar adjustment</li> <li>• Molded foam seat</li> <li>• Molded foam back over mesh suspension</li> <li>• High design hubless casters</li> <li>• Knobless height adjustable 20" diameter footring</li> <li>• Warranted to 300 lbs.</li> </ul>	<b>WIDTH:</b> 27.5 <b>DEPTH:</b> 27.5 <b>HEIGHT:</b> 43-53.5 <b>SEAT WIDTH:</b> 19.5 <b>SEAT DEPTH:</b> 17.0 <b>SEAT HEIGHT:</b> 20-28 <b>BACK WIDTH:</b> 18.5 <b>BACK HEIGHT:</b> 23.0 <b>COM:</b> 1.5 YD <b>COL:</b> 8 SQ FT <b>WEIGHT:</b> 48.0 LB	<b>BA11B</b> STD <b>BA11G</b> \$100 <b>BA12P</b> \$100	<b>C6</b> \$30 <b>C6S</b> \$35 <b>C7</b> \$35
A/COM	B		C	D	E	F	G	L3/COL	L4	L5																																																
620	655	675	710	745	785	830	720	920	970																																																	
A22	670	705	725	760	795	835	880	770	1020																																																	
A23	695	730	750	785	820	860	905	795	1045																																																	
A36	725	760	780	815	850	890	935	825	1075																																																	

### PLASTIC COLORS\*

BLACK PBK	LIGHT GRAY PGA
--------------	----------------------

(OUTER BACK & ARMS)

\* A22/A23 matches frame color selected

# cortina

simple, straightforward ergonomics and functionality

GSA SIN # 711-18

- Task, conference and executive seating
- Aluminum base standard
- Warranted to 300 lbs.
- CAL TB 133 Fire Code approved



## MID-BACK

### CREATING CORTINA MODEL NUMBER

MODEL NUMBER CONTROL ARMS GRADE BASE CASTERS PACKAGING OPTIONS

2 9 0 0 - [ ] [ ] - A [ ] [ ] - [ ] [ ] - B A [ ] [ ] [ ] - C [ ] [ ] - [ ] [ ] [ ] [ ]

\* FOR ARMLESS CODE USE A00 \*IF BASE AND CASTER MODEL NUMBERS ARE LEFT BLANK THEN STANDARD OPTION WILL BE ASSUMED

### PACKAGING NOTES

CODE	DESCRIPTION	LIST UPCHARGE
AB	ASSEMBLED IN BAG	\$0
PAC	PARTIALLY ASSEMBLED IN CARTON	\$0
BAC	BACK ASSEMBLED IN CARTON	\$40

MODEL	CONTROL	DESCRIPTION	ARM	FABRIC/LEATHER	FEATURES	DIMENSIONS	ARM OPTIONS	CASTER OPTIONS																																																																																
2900	S2	<b>MID-BACK SWIVEL TILT</b> Use for a variety of general office seating, including private office and conference room seating	<ul style="list-style-type: none"> <li>ARMLESS</li> <li>A8B / A8S</li> <li>A9B / A9S</li> <li>A16</li> <li>A19</li> <li>A36</li> <li>A37</li> </ul>	<table border="1"> <thead> <tr> <th>A/COM</th> <th>B</th> <th>C</th> <th>D</th> <th>E</th> <th>F</th> <th>G</th> <th>L3/COL</th> <th>L4</th> <th>L5</th> </tr> </thead> <tbody> <tr><td>610</td><td>665</td><td>700</td><td>755</td><td>815</td><td>880</td><td>950</td><td>760</td><td>860</td><td>1000</td></tr> <tr><td>695</td><td>750</td><td>785</td><td>840</td><td>900</td><td>965</td><td>1035</td><td>845</td><td>945</td><td>1085</td></tr> <tr><td>715</td><td>770</td><td>805</td><td>860</td><td>920</td><td>985</td><td>1055</td><td>865</td><td>965</td><td>1105</td></tr> <tr><td>710</td><td>765</td><td>800</td><td>855</td><td>915</td><td>980</td><td>1050</td><td>860</td><td>960</td><td>1100</td></tr> <tr><td>810</td><td>865</td><td>900</td><td>955</td><td>1015</td><td>1080</td><td>1150</td><td>960</td><td>1060</td><td>1200</td></tr> <tr><td>715</td><td>770</td><td>805</td><td>860</td><td>920</td><td>985</td><td>1055</td><td>865</td><td>965</td><td>1105</td></tr> <tr><td>735</td><td>790</td><td>825</td><td>880</td><td>940</td><td>1005</td><td>1075</td><td>885</td><td>985</td><td>1125</td></tr> </tbody> </table>	A/COM	B	C	D	E	F	G	L3/COL	L4	L5	610	665	700	755	815	880	950	760	860	1000	695	750	785	840	900	965	1035	845	945	1085	715	770	805	860	920	985	1055	865	965	1105	710	765	800	855	915	980	1050	860	960	1100	810	865	900	955	1015	1080	1150	960	1060	1200	715	770	805	860	920	985	1055	865	965	1105	735	790	825	880	940	1005	1075	885	985	1125	<ul style="list-style-type: none"> <li>• Pneumatic seat height adjustment</li> <li>• Tilt tension control</li> <li>• Seat and back tilt as a unit</li> <li>• 360-degree swivel</li> <li>• Upright position tilt lock</li> <li>• Warranted to 300 lbs.</li> </ul>	<p>WIDTH: 25.0</p> <p>DEPTH: 26.0</p> <p>HEIGHT: 39.0-43.5</p> <p>SEAT WIDTH: 20.5</p> <p>SEAT DEPTH: 19.0</p> <p>SEAT HEIGHT: 18.0-22.5</p> <p>BACK WIDTH: 18.5</p> <p>BACK HEIGHT: 21.0</p> <p>COM: 1.6 YD</p> <p>COL: 20.0 SQ FT</p> <p>WEIGHT: 44.0 LB</p>	<ul style="list-style-type: none"> <li><b>A8</b> \$85 Height Adjustable Arm A8B-Black A8S-Silver</li> <li><b>A9</b> \$105 Height/Width Adjustable Arm A9B-Black A9S-Silver</li> </ul>	<ul style="list-style-type: none"> <li><b>C7</b> STD 60mm Hoodless Chrome Accented Casters (Standard with Polished Base)</li> </ul>
A/COM	B	C	D	E	F	G	L3/COL	L4	L5																																																																															
610	665	700	755	815	880	950	760	860	1000																																																																															
695	750	785	840	900	965	1035	845	945	1085																																																																															
715	770	805	860	920	985	1055	865	965	1105																																																																															
710	765	800	855	915	980	1050	860	960	1100																																																																															
810	865	900	955	1015	1080	1150	960	1060	1200																																																																															
715	770	805	860	920	985	1055	865	965	1105																																																																															
735	790	825	880	940	1005	1075	885	985	1125																																																																															
2900	Y2	<b>MID-BACK HEAVY DUTY SYNCHRO</b> Use for a variety of general office seating, including private office and conference room seating	<ul style="list-style-type: none"> <li>ARMLESS</li> <li>A8B / A8S</li> <li>A9B / A9S</li> <li>A16</li> <li>A19</li> <li>A36</li> <li>A37</li> </ul>	<table border="1"> <thead> <tr> <th>A/COM</th> <th>B</th> <th>C</th> <th>D</th> <th>E</th> <th>F</th> <th>G</th> <th>L3/COL</th> <th>L4</th> <th>L5</th> </tr> </thead> <tbody> <tr><td>690</td><td>745</td><td>780</td><td>835</td><td>895</td><td>960</td><td>1030</td><td>840</td><td>940</td><td>1080</td></tr> <tr><td>775</td><td>830</td><td>865</td><td>920</td><td>980</td><td>1045</td><td>1115</td><td>925</td><td>1025</td><td>1165</td></tr> <tr><td>795</td><td>850</td><td>885</td><td>940</td><td>1000</td><td>1065</td><td>1135</td><td>945</td><td>1045</td><td>1185</td></tr> <tr><td>790</td><td>845</td><td>880</td><td>935</td><td>995</td><td>1060</td><td>1130</td><td>940</td><td>1040</td><td>1180</td></tr> <tr><td>890</td><td>945</td><td>980</td><td>1035</td><td>1095</td><td>1160</td><td>1230</td><td>1040</td><td>1140</td><td>1280</td></tr> <tr><td>795</td><td>850</td><td>885</td><td>940</td><td>1000</td><td>1065</td><td>1135</td><td>945</td><td>1045</td><td>1185</td></tr> <tr><td>815</td><td>870</td><td>905</td><td>960</td><td>1020</td><td>1085</td><td>1155</td><td>965</td><td>1065</td><td>1205</td></tr> </tbody> </table>	A/COM	B	C	D	E	F	G	L3/COL	L4	L5	690	745	780	835	895	960	1030	840	940	1080	775	830	865	920	980	1045	1115	925	1025	1165	795	850	885	940	1000	1065	1135	945	1045	1185	790	845	880	935	995	1060	1130	940	1040	1180	890	945	980	1035	1095	1160	1230	1040	1140	1280	795	850	885	940	1000	1065	1135	945	1045	1185	815	870	905	960	1020	1085	1155	965	1065	1205	<ul style="list-style-type: none"> <li>• Pneumatic seat height adjustment</li> <li>• Back and seat tilt in 2:1 ratio</li> <li>• 4 locking positions</li> <li>• Safety tilt release</li> <li>• Reduced rise of front of seat</li> <li>• Synchro control</li> <li>• Side tension adjustment</li> <li>• Warranted to 300 lbs.</li> </ul>	<p>WIDTH: 25.0</p> <p>DEPTH: 26.0</p> <p>HEIGHT: 39.0-43.5</p> <p>SEAT WIDTH: 20.5</p> <p>SEAT DEPTH: 19.0</p> <p>SEAT HEIGHT: 18.0-22.5</p> <p>BACK WIDTH: 18.5</p> <p>BACK HEIGHT: 21.0</p> <p>COM: 1.6 YD</p> <p>COL: 20.0 SQ FT</p> <p>WEIGHT: 49.0 LB</p>	<ul style="list-style-type: none"> <li><b>A16</b> \$100 Soft Touch C-Shape Arm</li> <li><b>A19</b> \$200 Polished Aluminum C-Shape Arm with Black Urethane Surface</li> </ul>	<ul style="list-style-type: none"> <li><b>C6S</b> \$35 60mm Hoodless Hard Floor Casters</li> </ul>
A/COM	B	C	D	E	F	G	L3/COL	L4	L5																																																																															
690	745	780	835	895	960	1030	840	940	1080																																																																															
775	830	865	920	980	1045	1115	925	1025	1165																																																																															
795	850	885	940	1000	1065	1135	945	1045	1185																																																																															
790	845	880	935	995	1060	1130	940	1040	1180																																																																															
890	945	980	1035	1095	1160	1230	1040	1140	1280																																																																															
795	850	885	940	1000	1065	1135	945	1045	1185																																																																															
815	870	905	960	1020	1085	1155	965	1065	1205																																																																															
2900	M1	<b>MID-BACK MULTI-FUNCTION</b> Use for a variety of general office seating, including private office and conference room seating	<ul style="list-style-type: none"> <li>ARMLESS</li> <li>A8B / A8S</li> <li>A9B / A9S</li> <li>A16</li> <li>A19</li> <li>A36</li> <li>A37</li> </ul>	<table border="1"> <thead> <tr> <th>A/COM</th> <th>B</th> <th>C</th> <th>D</th> <th>E</th> <th>F</th> <th>G</th> <th>L3/COL</th> <th>L4</th> <th>L5</th> </tr> </thead> <tbody> <tr><td>710</td><td>765</td><td>800</td><td>855</td><td>915</td><td>980</td><td>1050</td><td>860</td><td>960</td><td>1100</td></tr> <tr><td>795</td><td>850</td><td>885</td><td>940</td><td>1000</td><td>1065</td><td>1135</td><td>945</td><td>1045</td><td>1185</td></tr> <tr><td>815</td><td>870</td><td>905</td><td>960</td><td>1020</td><td>1085</td><td>1155</td><td>965</td><td>1065</td><td>1205</td></tr> <tr><td>810</td><td>865</td><td>900</td><td>955</td><td>1015</td><td>1080</td><td>1150</td><td>960</td><td>1060</td><td>1200</td></tr> <tr><td>910</td><td>965</td><td>1000</td><td>1055</td><td>1115</td><td>1180</td><td>1250</td><td>1060</td><td>1160</td><td>1300</td></tr> <tr><td>815</td><td>870</td><td>905</td><td>960</td><td>1020</td><td>1085</td><td>1155</td><td>965</td><td>1065</td><td>1205</td></tr> <tr><td>835</td><td>890</td><td>925</td><td>980</td><td>1040</td><td>1105</td><td>1175</td><td>985</td><td>1085</td><td>1225</td></tr> </tbody> </table>	A/COM	B	C	D	E	F	G	L3/COL	L4	L5	710	765	800	855	915	980	1050	860	960	1100	795	850	885	940	1000	1065	1135	945	1045	1185	815	870	905	960	1020	1085	1155	965	1065	1205	810	865	900	955	1015	1080	1150	960	1060	1200	910	965	1000	1055	1115	1180	1250	1060	1160	1300	815	870	905	960	1020	1085	1155	965	1065	1205	835	890	925	980	1040	1105	1175	985	1085	1225	<ul style="list-style-type: none"> <li>• Pneumatic seat height adjustment</li> <li>• Tilt tension control</li> <li>• Seat and back tilt as a unit</li> <li>• Infinite tilt position lock</li> <li>• Infinite back angle adj. w/ free float</li> <li>• Seat pivots from 0° to 6° forward</li> <li>• Warranted to 300 lbs.</li> </ul>	<p>WIDTH: 25.0</p> <p>DEPTH: 26.0</p> <p>HEIGHT: 39.0-43.5</p> <p>SEAT WIDTH: 20.5</p> <p>SEAT DEPTH: 19.0</p> <p>SEAT HEIGHT: 18.5-23.0</p> <p>BACK WIDTH: 18.5</p> <p>BACK HEIGHT: 21.0</p> <p>COM: 1.6 YD</p> <p>COL: 20.0 SQ FT</p> <p>WEIGHT: 52.0 LB</p>	<ul style="list-style-type: none"> <li><b>BA19P</b> STD 27" Aluminum Base - Polished (C7 Chrome Accented Hoodless Casters Standard with Polished Base)</li> <li><b>BA1B</b> DEDUCT \$50 26" Nylon Base - Black</li> <li><b>BA9B</b> DEDUCT \$50 26" High Profile Nylon Base - Black</li> </ul>	
A/COM	B	C	D	E	F	G	L3/COL	L4	L5																																																																															
710	765	800	855	915	980	1050	860	960	1100																																																																															
795	850	885	940	1000	1065	1135	945	1045	1185																																																																															
815	870	905	960	1020	1085	1155	965	1065	1205																																																																															
810	865	900	955	1015	1080	1150	960	1060	1200																																																																															
910	965	1000	1055	1115	1180	1250	1060	1160	1300																																																																															
815	870	905	960	1020	1085	1155	965	1065	1205																																																																															
835	890	925	980	1040	1105	1175	985	1085	1225																																																																															

# cortina

simple, straightforward ergonomics and functionality

GSA SIN # 711-18

- Task, conference and executive seating
- Aluminum base standard
- Warranted to 300 lbs.
- CAL TB 133 Fire Code approved



## CREATING CORTINA MODEL NUMBER

MODEL NUMBER CONTROL ARMS GRADE BASE CASTERS PACKAGING OPTIONS









2 9 1 0 - [ ] [ ] - A [ ] [ ] - [ ] [ ] - B A [ ] [ ] [ ] - C [ ] [ ] [ ] - [ ] [ ] [ ] [ ]

\* FOR ARMLESS CODE USE A00 \*\* IF BASE AND CASTER MODEL NUMBERS ARE LEFT BLANK THEN STANDARD OPTION WILL BE ASSUMED

### PACKAGING NOTES

CODE	DESCRIPTION	LIST UPCHARGE
AB	ASSEMBLED IN BAG	\$0
BAC	BACK ASSEMBLED IN CARTON	\$0

## HIGH-BACK

MODEL	CONTROL	DESCRIPTION	ARM	FABRIC/LEATHER	FEATURES	DIMENSIONS	ARM OPTIONS	CASTER OPTIONS		
2910	S2	<b>HIGH-BACK SWIVEL TILT</b>  Use for a variety of general office seating, including private office and conference room seating	ARMLESS	A/COM B C D E F G L3/COL L4 L5 660 715 750 805 870 940 1015 830 910 1110	<ul style="list-style-type: none"> <li>• Pneumatic seat height adjustment</li> <li>• Tilt tension control</li> <li>• Seat and back tilt as a unit</li> <li>• 360-degree swivel</li> <li>• Upright position tilt lock</li> <li>• Warranted to 300 lbs.</li> </ul>	<b>WIDTH:</b> 25.0 <b>DEPTH:</b> 25.0 <b>HEIGHT:</b> 47.0-51.5 <b>SEAT WIDTH:</b> 20.5 <b>SEAT DEPTH:</b> 19.0 <b>SEAT HEIGHT:</b> 18.0-22.5 <b>BACK WIDTH:</b> 18.5 <b>BACK HEIGHT:</b> 29.0 <b>COM:</b> 1.7 YD <b>COL:</b> 23.0 SQ FT <b>WEIGHT:</b> 48.0 LB	 <b>A8</b> \$85 Height Adjustable Arm A8B-Black A8S-Silver	 <b>A9</b> \$105 Height/Width Adjustable Arm A9B-Black A9S-Silver		
	A8B / A8S		745 800 835 890 955 1025 1100 915 995 1195							
			A9B / A9S	765 820 855 910 975 1045 1120 935 1015 1215						
			A16	760 815 850 905 970 1040 1115 930 1010 1210						
			A19	860 915 950 1005 1070 1140 1215 1030 1110 1310						
			A36	765 820 855 910 975 1045 1120 935 1015 1215						
			A37	785 840 875 930 995 1065 1140 955 1035 1235						
				SEAT SLIDER (SS) - NOT AVAILABLE						
2910	Y2	<b>HIGH-BACK HEAVY DUTY SYNCHRO</b>  Use for a variety of general office seating, including private office and conference room seating	ARMLESS	A/COM B C D E F G L3/COL L4 L5 740 795 830 885 950 1020 1095 910 990 1190	<ul style="list-style-type: none"> <li>• Pneumatic seat height adjustment</li> <li>• Back and seat tilt in 2:1 ratio</li> <li>• 4 locking positions</li> <li>• Safety tilt release</li> <li>• Reduced rise of front of seat</li> <li>• Synchro control</li> <li>• Side tension adjustment</li> <li>• Warranted to 300 lbs.</li> </ul>	<b>WIDTH:</b> 25.0 <b>DEPTH:</b> 25.0 <b>HEIGHT:</b> 47.0-51.5 <b>SEAT WIDTH:</b> 20.5 <b>SEAT DEPTH:</b> 19.0 <b>SEAT HEIGHT:</b> 18.0-22.5 <b>BACK WIDTH:</b> 18.5 <b>BACK HEIGHT:</b> 29.0 <b>COM:</b> 1.7 YD <b>COL:</b> 34.0 SQ FT <b>WEIGHT:</b> 53.0 LB	 <b>A16</b> \$100 Soft Touch C-Shape Arm	 <b>A19</b> \$200 Polished Aluminum C-Shape Arm with Black Urethane Surface		
			A8B / A8S	825 880 915 970 1035 1105 1180 995 1075 1275						
			A9B / A9S	845 900 935 990 1055 1125 1200 1015 1095 1295						
			A16	840 895 930 985 1050 1120 1195 1010 1090 1290						
			A19	940 995 1030 1085 1150 1220 1295 1110 1190 1390						
			A36	845 900 935 990 1055 1125 1200 1015 1095 1295						
			A37	865 920 955 1010 1075 1145 1220 1035 1115 1315						
				SEAT SLIDER (SS) - NOT AVAILABLE						
2910	M1	<b>HIGH-BACK MULTI-FUNCTION</b>  Use for a variety of general office seating, including private office and conference room seating	ARMLESS	A/COM B C D E F G L3/COL L4 L5 760 815 850 905 970 1040 1115 930 1010 1210	<ul style="list-style-type: none"> <li>• Pneumatic seat height adjustment</li> <li>• Tilt tension control</li> <li>• Seat and back tilt as a unit</li> <li>• Infinite tilt position lock</li> <li>• Infinite back angle adj. w/ free float</li> <li>• Seat pivots from 0° to 6° forward</li> <li>• Warranted to 300 lbs.</li> </ul>	<b>WIDTH:</b> 25.0 <b>DEPTH:</b> 25.0 <b>HEIGHT:</b> 47.0-51.5 <b>SEAT WIDTH:</b> 20.5 <b>SEAT DEPTH:</b> 19.0 <b>SEAT HEIGHT:</b> 18.5-23.0 <b>BACK WIDTH:</b> 18.5 <b>BACK HEIGHT:</b> 29.0 <b>COM:</b> 1.7 YD <b>COL:</b> 23.0 SQ FT <b>WEIGHT:</b> 56.0 LB	 <b>A36</b> \$105 Height Adjustable Pivot/Slide Arm	 <b>A37</b> \$125 Height/Width Adjustable Pivot/Slide Arm		
			A8B / A8S	845 900 935 990 1055 1125 1200 1015 1095 1295						
			A9B / A9S	865 920 955 1010 1075 1145 1220 1035 1115 1315						
			A16	860 915 950 1005 1070 1140 1215 1030 1110 1310						
			A19	960 1015 1050 1105 1170 1240 1315 1130 1210 1410						
			A36	865 920 955 1010 1075 1145 1220 1035 1115 1315						
			A37	885 940 975 1030 1095 1165 1240 1055 1135 1335						
				SEAT SLIDER (SS) - NOT AVAILABLE						
		<b>BASE OPTIONS</b>					 <b>BA19P</b> STD 27" Aluminum Base - Polished (C7 Chrome Accented Hoodless Casters Standard with Polished Base)	 <b>BA1B</b> DEDUCT \$50 26" Nylon Base - Black	 <b>BA9B</b> DEDUCT \$50 26" High Profile Nylon Base - Black	

# cosmo

contemporary style, elegance and comfort

GSA SIN # 711-18

- Task, executive and conference seating
- Back styles include: mesh and upholstered
- All mesh styles available M1, M2, M3
- Aluminum base standard
- Seat slider standard
- Warranted to 300 lbs.
- CAL TB 133 Fire Code approved



## CREATING COSMO MODEL NUMBER

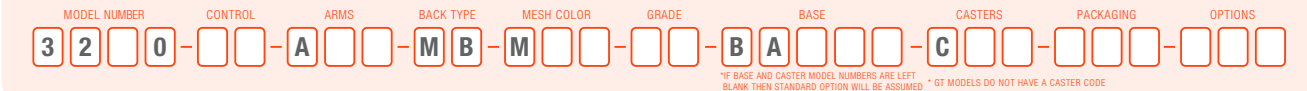

## PACKAGING NOTES

CODE	DESCRIPTION	LIST UPCHARGE
AB	ASSEMBLED IN BAG	\$0
BAC	BACK ASSEMBLED IN CARTON	\$0

## MESH BACK - MB

MODEL	CONTROL	DESCRIPTION	ARM	FABRIC/LEATHER	FEATURES	DIMENSIONS																																																																					
3250	X2	<b>MID-BACK DYNAMIC SYNCHRO</b>  Use for a variety of general office task seating, including private office and conference room seating	MS MS M1 M1 M2/M3 M2/M3	A31 A38 A31 A38 A31 A38	<ul style="list-style-type: none"> <li>• Pneumatic seat height adjustment</li> <li>• Side adjustable tilt tension control</li> <li>• Back and seat tilt in 2.6:1 ratio</li> <li>• 26° tilt of back, 10° seat tilt</li> <li>• 11 locking positions</li> <li>• 2 position forward seat angle adj.</li> <li>• Standard seat slider adds 3" adj.</li> <li>• Warranted to 300 lbs.</li> </ul>	<b>WIDTH:</b> 26.0-28.5 <b>DEPTH:</b> 25.0 <b>HEIGHT:</b> 40.0-45.5 <b>SEAT WIDTH:</b> 20.0 <b>SEAT DEPTH:</b> 17.5-20.0 <b>SEAT HEIGHT:</b> 17.5-22.0 <b>BACK WIDTH:</b> 19.5 <b>BACK HEIGHT:</b> 22.0 <b>COM:</b> 0.8 YDS <b>COL:</b> 10.0 SQ FT <b>WEIGHT:</b> 42.0 LB																																																																					
				<table border="1"> <thead> <tr> <th>A/COM</th> <th>B</th> <th>C</th> <th>D</th> <th>E</th> <th>F</th> <th>G</th> <th>L3/COL</th> <th>L4</th> <th>L5</th> </tr> </thead> <tbody> <tr><td>755</td><td>785</td><td>805</td><td>835</td><td>870</td><td>910</td><td>950</td><td>795</td><td>865</td><td>950</td></tr> <tr><td>765</td><td>795</td><td>815</td><td>845</td><td>880</td><td>920</td><td>960</td><td>805</td><td>875</td><td>960</td></tr> <tr><td>725</td><td>755</td><td>775</td><td>805</td><td>840</td><td>880</td><td>920</td><td>765</td><td>835</td><td>920</td></tr> <tr><td>735</td><td>765</td><td>785</td><td>815</td><td>850</td><td>890</td><td>930</td><td>775</td><td>845</td><td>930</td></tr> <tr><td>755</td><td>785</td><td>805</td><td>835</td><td>870</td><td>910</td><td>950</td><td>795</td><td>865</td><td>950</td></tr> <tr><td>765</td><td>795</td><td>815</td><td>845</td><td>880</td><td>920</td><td>960</td><td>805</td><td>875</td><td>960</td></tr> </tbody> </table>	A/COM	B	C	D	E	F	G	L3/COL	L4	L5	755	785	805	835	870	910	950	795	865	950	765	795	815	845	880	920	960	805	875	960	725	755	775	805	840	880	920	765	835	920	735	765	785	815	850	890	930	775	845	930	755	785	805	835	870	910	950	795	865	950	765	795	815	845	880	920	960	805	875	960	
A/COM	B	C	D	E	F	G	L3/COL	L4	L5																																																																		
755	785	805	835	870	910	950	795	865	950																																																																		
765	795	815	845	880	920	960	805	875	960																																																																		
725	755	775	805	840	880	920	765	835	920																																																																		
735	765	785	815	850	890	930	775	845	930																																																																		
755	785	805	835	870	910	950	795	865	950																																																																		
765	795	815	845	880	920	960	805	875	960																																																																		
				NOTE: AVAILABLE IN M1, M2 AND M3 MESH PATTERNS SEAT SLIDER (SS) - STANDARD																																																																							
3260	X2	<b>HIGH-BACK DYNAMIC SYNCHRO</b>  Use for a variety of general office task seating, including private office and conference room seating	MS MS M1 M1 M2/M3 M2/M3	A31 A38 A31 A38 A31 A38	<ul style="list-style-type: none"> <li>• Pneumatic seat height adjustment</li> <li>• Side adjustable tilt tension control</li> <li>• Back and seat tilt in 2.6:1 ratio</li> <li>• 26° tilt of back, 10° seat tilt</li> <li>• 11 locking positions</li> <li>• 2 position forward seat angle adj.</li> <li>• Standard seat slider adds 3" adj.</li> <li>• Warranted to 300 lbs.</li> </ul>	<b>WIDTH:</b> 26.0-28.5 <b>DEPTH:</b> 25.0 <b>HEIGHT:</b> 47.0-51.5 <b>SEAT WIDTH:</b> 20.0 <b>SEAT DEPTH:</b> 17.5-20.0 <b>SEAT HEIGHT:</b> 17.5-22.0 <b>BACK WIDTH:</b> 19.5 <b>BACK HEIGHT:</b> 29.0 <b>COM:</b> 0.8 YDS <b>COL:</b> 10.0 SQ FT <b>WEIGHT:</b> 44.0 LB																																																																					
				<table border="1"> <thead> <tr> <th>A/COM</th> <th>B</th> <th>C</th> <th>D</th> <th>E</th> <th>F</th> <th>G</th> <th>L3/COL</th> <th>L4</th> <th>L5</th> </tr> </thead> <tbody> <tr><td>855</td><td>885</td><td>905</td><td>935</td><td>970</td><td>1010</td><td>1050</td><td>895</td><td>965</td><td>1050</td></tr> <tr><td>865</td><td>895</td><td>915</td><td>945</td><td>980</td><td>1020</td><td>1060</td><td>905</td><td>975</td><td>1060</td></tr> <tr><td>825</td><td>855</td><td>875</td><td>905</td><td>940</td><td>980</td><td>1020</td><td>865</td><td>935</td><td>1020</td></tr> <tr><td>835</td><td>865</td><td>885</td><td>915</td><td>950</td><td>990</td><td>1030</td><td>875</td><td>945</td><td>1030</td></tr> <tr><td>855</td><td>885</td><td>905</td><td>935</td><td>970</td><td>1010</td><td>1050</td><td>895</td><td>965</td><td>1050</td></tr> <tr><td>865</td><td>895</td><td>915</td><td>945</td><td>980</td><td>1020</td><td>1060</td><td>905</td><td>975</td><td>1060</td></tr> </tbody> </table>	A/COM	B	C	D	E	F	G	L3/COL	L4	L5	855	885	905	935	970	1010	1050	895	965	1050	865	895	915	945	980	1020	1060	905	975	1060	825	855	875	905	940	980	1020	865	935	1020	835	865	885	915	950	990	1030	875	945	1030	855	885	905	935	970	1010	1050	895	965	1050	865	895	915	945	980	1020	1060	905	975	1060	
A/COM	B	C	D	E	F	G	L3/COL	L4	L5																																																																		
855	885	905	935	970	1010	1050	895	965	1050																																																																		
865	895	915	945	980	1020	1060	905	975	1060																																																																		
825	855	875	905	940	980	1020	865	935	1020																																																																		
835	865	885	915	950	990	1030	875	945	1030																																																																		
855	885	905	935	970	1010	1050	895	965	1050																																																																		
865	895	915	945	980	1020	1060	905	975	1060																																																																		
				NOTE: AVAILABLE IN M1, M2 AND M3 MESH PATTERNS SEAT SLIDER (SS) - STANDARD																																																																							
3250	GT	<b>GUEST CHAIR</b>  Well suited for guest seating. Comes standard with non-marring glides	MS M1 M2/M3	A38 A38 A38	<ul style="list-style-type: none"> <li>• Cantilever frame design</li> <li>• Non-marring floor glides</li> <li>• SWA, A38 arm pad only</li> <li>• Warranted to 300 lbs.</li> </ul>	<b>WIDTH:</b> 26.0 <b>DEPTH:</b> 28.0 <b>HEIGHT:</b> 39.0 <b>SEAT WIDTH:</b> 20.0 <b>SEAT DEPTH:</b> 18.0 <b>SEAT HEIGHT:</b> 17.5 <b>BACK WIDTH:</b> 19.5 <b>BACK HEIGHT:</b> 22.0 <b>COM:</b> 0.8 YDS <b>COL:</b> 10.0 SQ FT <b>WEIGHT:</b> 33.0 LB																																																																					
				<table border="1"> <thead> <tr> <th>A/COM</th> <th>B</th> <th>C</th> <th>D</th> <th>E</th> <th>F</th> <th>G</th> <th>L3/COL</th> <th>L4</th> <th>L5</th> </tr> </thead> <tbody> <tr><td>655</td><td>685</td><td>705</td><td>735</td><td>770</td><td>810</td><td>850</td><td>695</td><td>765</td><td>850</td></tr> <tr><td>625</td><td>655</td><td>675</td><td>705</td><td>740</td><td>780</td><td>820</td><td>665</td><td>735</td><td>820</td></tr> <tr><td>655</td><td>685</td><td>705</td><td>735</td><td>770</td><td>810</td><td>850</td><td>695</td><td>765</td><td>850</td></tr> </tbody> </table>	A/COM	B	C	D	E	F	G	L3/COL	L4	L5	655	685	705	735	770	810	850	695	765	850	625	655	675	705	740	780	820	665	735	820	655	685	705	735	770	810	850	695	765	850																															
A/COM	B	C	D	E	F	G	L3/COL	L4	L5																																																																		
655	685	705	735	770	810	850	695	765	850																																																																		
625	655	675	705	740	780	820	665	735	820																																																																		
655	685	705	735	770	810	850	695	765	850																																																																		
				NOTE: AVAILABLE IN M1, M2 AND M3 MESH PATTERNS SHIPS FULLY ASSEMBLED EITHER AC OR AB																																																																							

## ARM OPTIONS

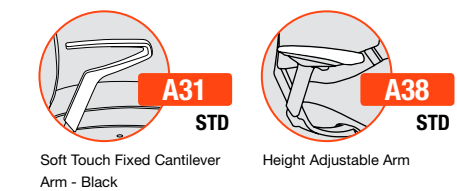

## BASE OPTION



## CASTER OPTIONS



## STRIPE MESH COLORS

BLACK / GRAY MS2	BLACK / GREEN MS4	BLACK / RED MS5	BLACK / BLUE MS6
---------------------	----------------------	--------------------	---------------------

## MESH COLORS\*

BLACK M11	GRAY M12	SILVER M13
GREEN M14	RED M15	BLUE M16

\*Mesh M2/M3/M4 also available

# cosmo

contemporary style, elegance and comfort

GSA SIN # 711-18

- Task, executive and conference seating
- Back styles include: mesh and upholstered
- Aluminum base standard
- Seat slider standard
- Warranted to 300 lbs.



## CREATING COSMO MODEL NUMBER



## PACKAGING NOTES

CODE	DESCRIPTION	LIST UPCHARGE
AB	ASSEMBLED IN BAG	\$0
BAC	BACK ASSEMBLED IN CARTON	\$0

## UPHOLSTERED BACK - UP

MODEL	CONTROL	DESCRIPTION	ARM	FABRIC/LEATHER	FEATURES	DIMENSIONS	ARM OPTIONS																														
3220	X2	<b>MID-BACK DYNAMIC SYNCHRO</b> Use for a variety of general office task seating, including private office and conference room seating	A31	<table border="1"> <thead> <tr> <th>A/COM</th> <th>B</th> <th>C</th> <th>D</th> <th>E</th> <th>F</th> <th>G</th> <th>L3/COL</th> <th>L4</th> <th>L5</th> </tr> </thead> <tbody> <tr> <td>785</td> <td>820</td> <td>845</td> <td>880</td> <td>920</td> <td>960</td> <td>1005</td> <td>825</td> <td>985</td> <td>1285</td> </tr> <tr> <td>A38</td> <td>795</td> <td>830</td> <td>855</td> <td>890</td> <td>930</td> <td>970</td> <td>1015</td> <td>835</td> <td>995</td> </tr> </tbody> </table>	A/COM	B	C	D	E	F	G	L3/COL	L4	L5	785	820	845	880	920	960	1005	825	985	1285	A38	795	830	855	890	930	970	1015	835	995	<ul style="list-style-type: none"> <li>• New! All fabric grades now available</li> <li>• Pneumatic seat height adjustment</li> <li>• Side adjustable tilt tension control</li> <li>• Back and seat tilt in 2.6:1 ratio</li> <li>• 26° tilt of back, 10° seat tilt</li> <li>• 11 locking positions</li> <li>• 2 position forward seat angle adj.</li> <li>• Standard seat slider adds 3" adj.</li> <li>• Standard with heavy duty hard floor casters</li> <li>• Warranted to 300 lbs.</li> </ul>	<b>WIDTH:</b> 26-28.5 <b>DEPTH:</b> 25.0 <b>HEIGHT:</b> 40 - 44.5 <b>SEAT WIDTH:</b> 20.0 <b>SEAT DEPTH:</b> 17.5-20 <b>SEAT HEIGHT:</b> 17.5 - 22 <b>BACK WIDTH:</b> 19.5 <b>BACK HEIGHT:</b> 22.0 <b>COM:</b> 1.2 YD <b>COL:</b> 19 SQ FT <b>WEIGHT:</b> 42 LB	
A/COM	B		C	D	E	F	G	L3/COL	L4	L5																											
785	820	845	880	920	960	1005	825	985	1285																												
A38	795	830	855	890	930	970	1015	835	995																												
3230	X2	<b>HIGH-BACK DYNAMIC SYNCHRO</b> Use for a variety of general office task seating, including private office and conference room seating	A31	<table border="1"> <thead> <tr> <th>A/COM</th> <th>B</th> <th>C</th> <th>D</th> <th>E</th> <th>F</th> <th>G</th> <th>L3/COL</th> <th>L4</th> <th>L5</th> </tr> </thead> <tbody> <tr> <td>885</td> <td>920</td> <td>945</td> <td>980</td> <td>1020</td> <td>1060</td> <td>1105</td> <td>925</td> <td>1085</td> <td>1385</td> </tr> <tr> <td>A38</td> <td>895</td> <td>930</td> <td>955</td> <td>990</td> <td>1030</td> <td>1070</td> <td>935</td> <td>1095</td> <td>1395</td> </tr> </tbody> </table>	A/COM	B	C	D	E	F	G	L3/COL	L4	L5	885	920	945	980	1020	1060	1105	925	1085	1385	A38	895	930	955	990	1030	1070	935	1095	1395	<ul style="list-style-type: none"> <li>• New! All fabric grades now available</li> <li>• Pneumatic seat height adjustment</li> <li>• Side adjustable tilt tension control</li> <li>• Back and seat tilt in 2.6:1 ratio</li> <li>• 26° tilt of back, 10° seat tilt</li> <li>• 11 locking positions</li> <li>• 2 position forward seat angle adj.</li> <li>• Standard seat slider adds 3" adj.</li> <li>• Standard with heavy duty hard floor casters</li> <li>• Warranted to 300 lbs.</li> </ul>	<b>WIDTH:</b> 26-28.5 <b>DEPTH:</b> 25.0 <b>HEIGHT:</b> 47.0 - 51.5 <b>SEAT WIDTH:</b> 20.0 <b>SEAT DEPTH:</b> 17.5-20 <b>SEAT HEIGHT:</b> 17.5 - 22 <b>BACK WIDTH:</b> 19.5 <b>BACK HEIGHT:</b> 29.0 <b>COM:</b> 1.6 YD <b>COL:</b> 22 SQ FT <b>WEIGHT:</b> 44 LB	
A/COM	B		C	D	E	F	G	L3/COL	L4	L5																											
885	920	945	980	1020	1060	1105	925	1085	1385																												
A38	895	930	955	990	1030	1070	935	1095	1395																												
3220	GT	<b>GUEST CHAIR</b> Well suited for guest seating. Comes standard with non-marring glides	A38	<table border="1"> <thead> <tr> <th>A/COM</th> <th>B</th> <th>C</th> <th>D</th> <th>E</th> <th>F</th> <th>G</th> <th>L3/COL</th> <th>L4</th> <th>L5</th> </tr> </thead> <tbody> <tr> <td>685</td> <td>720</td> <td>745</td> <td>780</td> <td>820</td> <td>860</td> <td>905</td> <td>725</td> <td>885</td> <td>1185</td> </tr> </tbody> </table>	A/COM	B	C	D	E	F	G	L3/COL	L4	L5	685	720	745	780	820	860	905	725	885	1185	<ul style="list-style-type: none"> <li>• New! All fabric grades now available</li> <li>• Cantilever frame design</li> <li>• Non-marring floor glides</li> <li>• SWA, A38 arm pad only</li> <li>• Warranted to 300 lbs.</li> </ul>	<b>WIDTH:</b> 26.0 <b>DEPTH:</b> 28.0 <b>HEIGHT:</b> 39.0 <b>SEAT WIDTH:</b> 20.0 <b>SEAT DEPTH:</b> 18.0 <b>SEAT HEIGHT:</b> 17.5 <b>BACK WIDTH:</b> 19.5 <b>BACK HEIGHT:</b> 22.0 <b>COM:</b> 1.2 YD <b>COL:</b> 19 SQ FT <b>WEIGHT:</b> 33 LB											
A/COM	B		C	D	E	F	G	L3/COL	L4	L5																											
685	720	745	780	820	860	905	725	885	1185																												

SHIPS FULLY ASSEMBLED EITHER AC OR AB

# cydia

organic design meets ergonomic excellence

## ALL MESH

GSA SIN # 711-18

- Task, conference, stool, and lounge seating
- Perfect for collaborative, touchdown, meeting and office spaces
- Aligns with how we work, where we work and how we move throughout the day
- Choice of 3 frame colors and 14 mesh colors
- Warranted to 300 lbs.
- CAL TB 133 Fire Code approved



### CREATING CYDIA MODEL NUMBER

MODEL NUMBER	CONTROL	ARMS	PLASTIC COLOR	UPHOLSTERY	MESH COLOR	BASE	CASTER	PACKAGING	OPTIONS
330		A	P	A	M	B	A	C	

\* FOR ARMLESS CODE USE A00      \*\*IF BASE AND CASTER MODEL NUMBERS ARE LEFT BLANK THEN STANDARD OPTION WILL BE ASSUMED

### PACKAGING NOTES

CODE	DESCRIPTION	LIST UPCHARGE
AB	ASSEMBLED IN BAG	\$0
BAC	BACK ASSEMBLED IN CARTON	\$0

MODEL	CONTROL	DESCRIPTION	ARM	MESH	FEATURES	DIMENSIONS	ARM OPTIONS	BASE OPTIONS	CASTER OPTIONS
3300	S3	<b>MID-SCALE SWIVEL TILT</b>  Use for a variety of general office seating, including private office and conference room seating	M1	ARMLESS	615	<ul style="list-style-type: none"> <li>• Pneumatic seat height adjustment</li> <li>• Tilt tension control</li> <li>• Seat and back tilt as a unit</li> <li>• 360-degree swivel</li> <li>• Upright position tilt lock</li> <li>• Warranted to 300 lbs.</li> </ul>	<b>WIDTH:</b> 28.0 <b>DEPTH:</b> 27.5 <b>HEIGHT:</b> 34.0-37.0 <b>SEAT WIDTH:</b> 19.0 <b>SEAT DEPTH:</b> 16.0 <b>SEAT HEIGHT:</b> 16.5-21.0 <b>BACK WIDTH:</b> 18.0 <b>BACK HEIGHT:</b> 19.5 <b>WEIGHT:</b> 23.0 LB	<b>A34</b> \$75 <b>A35</b> \$100	<b>C6</b> STD <b>C6S</b> \$35 <b>C7</b> \$35
			M1	A34	690				
			M1	A35	715				
			M3	ARMLESS	640				
			M3	A34	715				
M3	A35	740							
3300	K3	<b>MID-SCALE KNEE TILT</b>  Ultimate seating comfort suited for the executive or manager. Allows for full range of movement with sharp, simple look	M1	ARMLESS	715	<ul style="list-style-type: none"> <li>• Pneumatic seat height adjustment</li> <li>• Side activated tilt tension control</li> <li>• Seat and back tilt as a unit</li> <li>• 3 locking positions</li> <li>• Forward pitch seat lock</li> <li>• Reduced rise of front of seat</li> <li>• Warranted to 300 lbs.</li> </ul>	<b>WIDTH:</b> 28.0 <b>DEPTH:</b> 27.5 <b>HEIGHT:</b> 36.0-41.0 <b>SEAT WIDTH:</b> 19.0 <b>SEAT DEPTH:</b> 16.0 <b>SEAT HEIGHT:</b> 16.5-21.0 <b>BACK WIDTH:</b> 18.0 <b>BACK HEIGHT:</b> 19.5 <b>WEIGHT:</b> 30.0 LB	<b>BA9B, BA9G, BA9W</b> STD <b>BA10B</b> \$100 <b>BA10P</b> \$100 <b>BA10S</b> \$100	<b>C6S</b> \$35 <b>C7</b> \$35
			M1	A34	790				
			M1	A35	815				
			M3	ARMLESS	740				
			M3	A34	815				
M3	A35	840							
3310	S3	<b>FULL-SCALE SWIVEL TILT</b>  Use for a variety of general office seating, including private office and conference room seating	M1	ARMLESS	665	<ul style="list-style-type: none"> <li>• Pneumatic seat height adjustment</li> <li>• Tilt tension control</li> <li>• Seat and back tilt as a unit</li> <li>• 360-degree swivel</li> <li>• Upright position tilt lock</li> <li>• Warranted to 300 lbs.</li> </ul>	<b>WIDTH:</b> 28.0 <b>DEPTH:</b> 27.5 <b>HEIGHT:</b> 39.5-43.5 <b>SEAT WIDTH:</b> 19.0 <b>SEAT DEPTH:</b> 17.0 <b>SEAT HEIGHT:</b> 18.0-22.5 <b>BACK WIDTH:</b> 18.0 <b>BACK HEIGHT:</b> 23.375 <b>WEIGHT:</b> 26.0 LB	<b>LB</b> \$30 <b>G1</b> \$30	
			M1	A34	740				
			M1	A35	765				
			M3	ARMLESS	700				
			M3	A34	775				
M3	A35	800							
3310	K3	<b>FULL-SCALE KNEE TILT</b>  Ultimate seating comfort suited for the executive or manager. Allows for full range of movement with sharp, simple look	M1	ARMLESS	765	<ul style="list-style-type: none"> <li>• Pneumatic seat height adjustment</li> <li>• Side activated tilt tension control</li> <li>• Seat and back tilt as a unit</li> <li>• 3 locking positions</li> <li>• Forward pitch seat lock</li> <li>• Reduced rise of front of seat</li> <li>• Warranted to 300 lbs.</li> </ul>	<b>WIDTH:</b> 28.0 <b>DEPTH:</b> 27.5 <b>HEIGHT:</b> 41.5-45.5 <b>SEAT WIDTH:</b> 19.0 <b>SEAT DEPTH:</b> 17.0 <b>SEAT HEIGHT:</b> 18.0-22.5 <b>BACK WIDTH:</b> 18.0 <b>BACK HEIGHT:</b> 23.5 <b>WEIGHT:</b> 33.0 LB		
			M1	A34	840				
			M1	A35	865				
			M3	ARMLESS	800				
			M3	A34	875				
M3	A35	900							

### PLASTIC COLORS

BLACK PBK	GRAPHITE GRAY PGG	WHITE PWH

(BACK/SEAT FRAME AND ARMS)

### MESH COLORS

	BLACK M11	GRAY M12	SILVER M13	GREEN M14	RED M15	BLUE M16
M1						
M3	GRAPHITE M31	SLATE M32	SNOW M33	SAGE M34		
M3	CARDINAL M35	ROYAL M36	TANGERINE M37	PLUM M38		

# cydia

organic design meets ergonomic excellence

## ALL MESH - STOOLS

GSA SIN # 711-18

- Task, conference, stool, and lounge seating
- Perfect for collaborative, touchdown, meeting and office spaces
- Aligns with how we work, where we work and how we move throughout the day
- Choice of 3 frame colors and 14 mesh colors
- Warranted to 300 lbs.
- CAL TB 133 Fire Code approved



### CREATING CYDIA MODEL NUMBER



### PACKAGING NOTES

CODE	DESCRIPTION	LIST UPCHARGE
AB	ASSEMBLED IN BAG	\$0
BAC	BACK ASSEMBLED IN CARTON	\$0

MODEL	CONTROL	DESCRIPTION	ARM	MESH										
3306	S3	<b>10" STOOL SWIVEL TILT</b>  Use for work surfaces up to 42 inches high	M1	ARMLESS	M	740								
			M1	A34	815									
			M1	A35	840									
			M3	ARMLESS	765									
			M3	A34	840									
			M3	A35	865									

MODEL	CONTROL	DESCRIPTION	ARM	MESH										
3308	S3	<b>8" STOOL SWIVEL TILT</b>  Use for work surfaces up to 36 inches high	M1	ARMLESS	M	740								
			M1	A34	815									
			M1	A35	840									
			M3	ARMLESS	765									
			M3	A34	840									
			M3	A35	865									

### FEATURES

- Pneumatic seat height adjustment
- Tilt tension control
- Seat and back tilt as a unit
- 360-degree swivel
- Upright position tilt lock
- Knobless height adjustable footring
- Warranted to 300 lbs.

### DIMENSIONS

**WIDTH:** 28.0  
**DEPTH:** 27.5  
**HEIGHT:** 43.5-53.5  
**SEAT WIDTH:** 19.0  
**SEAT DEPTH:** 16.0  
**SEAT HEIGHT:** 26.0-36.0  
**BACK WIDTH:** 18.0  
**BACK HEIGHT:** 19.5  
**WEIGHT:** 41.0 LB

- Pneumatic seat height adjustment
- Tilt tension control
- 360-degree swivel
- Seat and back tilt as a unit
- Upright position tilt lock
- Knobless height adjustable footring
- Warranted to 300 lbs.

**WIDTH:** 28.0  
**DEPTH:** 27.5  
**HEIGHT:** 39.5-47.5  
**SEAT WIDTH:** 19.0  
**SEAT DEPTH:** 16.0  
**SEAT HEIGHT:** 22.0-30.0  
**BACK WIDTH:** 18.0  
**BACK HEIGHT:** 19.5  
**WEIGHT:** 41.0 LB

### ARM OPTIONS



Nylon Loop Arm

**A34**  
\$75



Height Adjustable Arm w/Sliding Pad

**A35**  
\$100

### CASTER OPTIONS

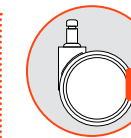

60mm Hoodless Casters

**C6**  
STD

### BASE OPTIONS



26" High Profile Nylon Base  
BA9B - Black  
BA9G - Gray  
BA9W - White

**BA9B**  
**BA9G**  
**BA9W**  
STD

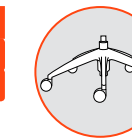

26" High Profile Aluminum Black Powder-Coat

**BA10B**  
\$100

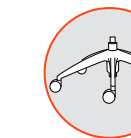

26" High Profile Aluminum Polished

**BA10P**  
\$100

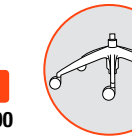

26" High Profile Aluminum Silver Powder-Coat

**BA10S**  
\$100



60mm Hoodless Hard Floor Casters

**C6S**  
\$35



60mm Hoodless Chrome Accented Casters

**C7**  
\$35

### ADDITIONAL OPTIONS

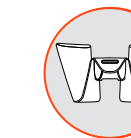

Height Adjustable Lumbar (Factory Installed)

**LB**  
\$30



Stationary Base Glides for 5 Star Base

**G1**  
\$30

### PLASTIC COLORS

BLACK PBK	GRAPHITE GRAY PGG	WHITE PWH
--------------	-------------------------	--------------

(BACK/SEAT FRAME AND ARMS)

### MESH COLORS

	BLACK M11	GRAY M12	SILVER M13	GREEN M14	RED M15	BLUE M16
M1						
M3	GRAPHITE M31	SLATE M32	SNOW M33	SAGE M34		
M3	CARDINAL M35	ROYAL M36	TANGERINE M37	PLUM M38		



# cydia

organic design meets ergonomic excellence

GSA SIN # 711-18

- Multi-purpose guest seating
- Perfect for collaborative, touchdown, meeting and office spaces
- Choice of 3 frame colors and 14 mesh colors
- Warranted to 300 lbs.
- CAL TB 133 Fire Code approved



### CREATING CYDIA MODEL NUMBER

MODEL NUMBER CONTROL PLASTIC COLOR FRAME COLOR UPHOLSTERY MESH COLOR PACKAGING OPTIONS

3 3 1 0 - G T - P - - - - A M - M - - - - -

### PACKAGING NOTES

CODE	DESCRIPTION	LIST UPCHARGE
AB	ASSEMBLED IN BAG	\$0
BAC	BACK ASSEMBLED IN CARTON	\$0

## ALL MESH - GUEST

MODEL	CONTROL	DESCRIPTION	ARM	MESH	FEATURES	DIMENSIONS
3300	GT	<b>MID-SCALE GUEST</b>  Well suited for guest seating	M1 SWA M3 SWA	M 515 540	<ul style="list-style-type: none"> <li>• Non-marring floor glides</li> <li>• Wall saver back legs</li> <li>• Black, silver or white metal frame</li> <li>• Warranted to 300 lbs.</li> </ul>	<b>WIDTH:</b> 23.0 <b>DEPTH:</b> 27.0 <b>HEIGHT:</b> 37.0 <b>SEAT WIDTH:</b> 19.0 <b>SEAT DEPTH:</b> 16.0 <b>SEAT HEIGHT:</b> 19.5 <b>BACK WIDTH:</b> 17.0 <b>BACK HEIGHT:</b> 23.0 <b>WEIGHT:</b> 25.0 LB
<b>SWA - STANDARD WITH ARMS</b>						
3310	GT	<b>FULL-SCALE GUEST</b>  Well suited for guest seating	M1 SWA M3 SWA	M 565 600	<ul style="list-style-type: none"> <li>• Non-marring floor glides</li> <li>• Wall saver back legs</li> <li>• Black, silver or white metal frame</li> <li>• Warranted to 300 lbs.</li> </ul>	<b>WIDTH:</b> 23.0 <b>DEPTH:</b> 27.5 <b>HEIGHT:</b> 37.5 <b>SEAT WIDTH:</b> 19.5 <b>SEAT DEPTH:</b> 17.0 <b>SEAT HEIGHT:</b> 19.5 <b>BACK WIDTH:</b> 17.5 <b>BACK HEIGHT:</b> 23.5 <b>WEIGHT:</b> 27.0 LB
<b>SWA - STANDARD WITH ARMS</b>						

### PLASTIC COLORS

BLACK PBK	GRAPHITE GRAY PGG	WHITE PWH
--------------	-------------------------	--------------

(BACK/SEAT FRAME AND ARMS)

### FRAME COLORS

BLACK BF	SILVER SF	WHITE WF
-------------	--------------	-------------

(FRAME)

### MESH COLORS

	BLACK M11	GRAY M12	SILVER M13	GREEN M14	RED M15	BLUE M16
M1						
M3	GRAPHITE M31	SLATE M32	SNOW M33	SAGE M34		
M3	CARDINAL M35	ROYAL M36	TANGERINE M37	PLUM M38		

# cydia

organic design meets ergonomic excellence

## ALL MESH - LOUNGE & OTTOMAN

GSA SIN # 711-18

- Relaxed angle guest seating with ottoman
- Perfect for collaborative, executive, office and lobby spaces
- Choice of 3 frame colors and 14 mesh colors
- Polished aluminum base
- Self return base mount on both chair and ottoman
- Warranted to 300 lbs.
- CAL TB 133 Fire Code approved



### CREATING CYDIA MODEL NUMBER

MODEL NUMBER	CONTROL	ARMS	PLASTIC COLOR	MESH COLOR	PACKAGING	OPTIONS
331		A	P	M		

\* FOR ARMLESS CODE USE A00

### PACKAGING NOTES

CODE	DESCRIPTION	LIST UPCHARGE
AB	ASSEMBLED IN BAG	\$0
BAC	BACK ASSEMBLED IN CARTON	\$0

MODEL	CONTROL	DESCRIPTION	ARM	MESH	FEATURES	DIMENSIONS	ARM OPTIONS																								
3315	LG	<b>FULL-SCALE LOUNGE</b>  Full scale lounge comfort with cool, breathable all mesh fabric at a reclining angle. Modern design addition to lobby, office or group areas	M1 ARMLESS M1 A34 M3 ARMLESS M3 A34	M 675 750 720 795	<ul style="list-style-type: none"> <li>• Fixed height</li> <li>• Automatic return-to-center swivel</li> <li>• Polished aluminum base</li> <li>• Easy gliding, non-marring feet</li> <li>• Extra-wide scale</li> <li>• Recycled/recyclable cast aluminum base</li> <li>• Warranted to 300 lbs.</li> </ul>	<b>WIDTH:</b> 25.5 <b>DEPTH:</b> 34.0 <b>HEIGHT:</b> 35.5 <b>SEAT WIDTH:</b> 21.5 <b>SEAT DEPTH:</b> 17.0 <b>SEAT HEIGHT:</b> 18.5 <b>BACK WIDTH:</b> 21.5 <b>BACK HEIGHT:</b> 18.5 <b>WEIGHT:</b> 32.0 LB	<p><b>A34</b> \$75</p> <p>Nylon Loop Arm</p>																								
<b>NEW MODEL</b> 3315	R2	<b>FULL-SCALE ROCKING TILT LOUNGE</b>  Full scale lounge comfort with cool, breathable all mesh fabric with rocking tilt comfort. Modern design addition to lobby, office or group areas  Available Q1 2018	M1 ARMLESS M1 A34 M3 ARMLESS M3 A34	M 745 820 790 865	<ul style="list-style-type: none"> <li>• Pneumatic seat height adjustment</li> <li>• R2 motion tilts right, left, front and back</li> <li>• 360-degree swivel</li> <li>• Polished aluminum base</li> <li>• Easy gliding, non-marring feet</li> <li>• Extra-wide scale</li> <li>• Recycled/recyclable cast aluminum base</li> <li>• Warranted to 300 lbs.</li> </ul>	<b>WIDTH:</b> 25.5 <b>DEPTH:</b> 34.0 <b>HEIGHT:</b> 34.0-38.5 <b>SEAT WIDTH:</b> 21.5 <b>SEAT DEPTH:</b> 17.0 <b>SEAT HEIGHT:</b> 16.5-21.0 <b>BACK WIDTH:</b> 21.5 <b>BACK HEIGHT:</b> 18.5 <b>WEIGHT:</b> 33.0 LB	<b>PLASTIC COLORS</b> <table border="1"> <tr> <td>BLACK PBK</td> <td>GRAPHITE GRAY PGG</td> <td>WHITE PWH</td> </tr> </table> <p>(BACK/SEAT FRAME AND ARMS)</p> <b>MESH COLORS</b> <table border="1"> <tr> <td>M1</td> <td>BLACK M11</td> <td>GRAY M12</td> <td>SILVER M13</td> <td>GREEN M14</td> <td>RED M15</td> <td>BLUE M16</td> </tr> <tr> <td>M3</td> <td>GRAPHITE M31</td> <td>SLATE M32</td> <td>SNOW M33</td> <td>SAGE M34</td> <td></td> <td></td> </tr> <tr> <td>M3</td> <td>CARDINAL M35</td> <td>ROYAL M36</td> <td>TANGERINE M37</td> <td>PLUM M38</td> <td></td> <td></td> </tr> </table>	BLACK PBK	GRAPHITE GRAY PGG	WHITE PWH	M1	BLACK M11	GRAY M12	SILVER M13	GREEN M14	RED M15	BLUE M16	M3	GRAPHITE M31	SLATE M32	SNOW M33	SAGE M34			M3	CARDINAL M35	ROYAL M36	TANGERINE M37	PLUM M38		
BLACK PBK	GRAPHITE GRAY PGG	WHITE PWH																													
M1	BLACK M11	GRAY M12	SILVER M13	GREEN M14	RED M15	BLUE M16																									
M3	GRAPHITE M31	SLATE M32	SNOW M33	SAGE M34																											
M3	CARDINAL M35	ROYAL M36	TANGERINE M37	PLUM M38																											
3316	OT	<b>OTTOMAN</b>  Ultimate comfort compliment to lounge chair	M1 M3	M 540 565	<ul style="list-style-type: none"> <li>• Fixed height</li> <li>• Automatic return-to-center swivel</li> <li>• Polished aluminum base</li> <li>• Easy gliding, non-marring feet</li> <li>• Recycled/recyclable cast aluminum base</li> <li>• Warranted to 300 lbs.</li> </ul>	<b>WIDTH:</b> 21.5 <b>DEPTH:</b> 21.5 <b>HEIGHT:</b> 18.0 <b>WEIGHT:</b> 13.0 LB																									

# cydia

organic design meets ergonomic excellence

## FULLY UPHOLSTERED

GSA SIN # 711-18

- Task, conference and stool
- Perfect for collaborative, touchdown, meeting and office spaces
- Aligns with how we work, where we work and how we move throughout the day
- The upholstered option includes woven mesh beneath fabric. Choose between thousands of textile selections or COM
- Warranted to 300 lbs.
- CAL TB 133 Fire Code approved



### CREATING CYDIA MODEL NUMBER

MODEL NUMBER CONTROL ARMS PLASTIC COLOR UPHOLSTERY MESH COLOR GRADE BASE CASTERS PACKAGING OPTIONS

3 3 - - A - P - U - M - - B A - C - - -

\* FOR ARMLESS CODE USE A00 \*\*IF BASE AND CASTER MODEL NUMBERS ARE LEFT BLANK THEN STANDARD OPTION WILL BE ASSUMED

### PACKAGING NOTES

CODE	DESCRIPTION	LIST UPCHARGE
AB	ASSEMBLED IN BAG	\$0
BAC	BACK ASSEMBLED IN CARTON	\$0

MODEL	CONTROL	DESCRIPTION	ARM	FABRIC	A/COM	B	C	D	E	F	G	FEATURES	DIMENSIONS
3300	S3	<b>MID-SCALE SWIVEL TILT</b>  Use for a variety of general office seating, including private office and conference room seating	M1	ARMLESS	765	800	820	855	890	930	975	<ul style="list-style-type: none"> <li>• Pneumatic seat height adjustment</li> <li>• Tilt tension control</li> <li>• Seat and back tilt as a unit</li> <li>• 360-degree swivel</li> <li>• Upright position tilt lock</li> <li>• The upholstered option includes woven mesh beneath fabric. Choose between thousands of textile selections or COM</li> <li>• Warranted to 300 lbs.</li> </ul>	<b>WIDTH:</b> 28.0 <b>DEPTH:</b> 27.5 <b>HEIGHT:</b> 34.0-37.0 <b>SEAT WIDTH:</b> 19.0 <b>SEAT DEPTH:</b> 16.0 <b>SEAT HEIGHT:</b> 16.5-21.0 <b>BACK WIDTH:</b> 18.0 <b>BACK HEIGHT:</b> 19.5 <b>COM:</b> 2.0 YDS <b>COL:</b> 12.0 SQ FT <b>WEIGHT:</b> 36.0 LB
			M1	A34	840	875	895	930	965	1005	1050		
			M1	A35	865	900	920	955	990	1030	1075		
			M3	ARMLESS	790	825	845	880	915	955	1000		
			M3	A34	865	900	920	955	990	1030	1075		
			M3	A35	890	925	945	980	1015	1055	1100		
3300	K3	<b>MID-SCALE KNEE TILT</b>  Ultimate seating comfort suited for the executive or manager. Allows for full range of movement with sharp, simple lock	M1	ARMLESS	865	900	920	955	990	1030	1075	<ul style="list-style-type: none"> <li>• Pneumatic seat height adjustment</li> <li>• Side activated tilt tension control</li> <li>• Seat and back tilt as a unit</li> <li>• 3 locking positions</li> <li>• Forward pitch seat lock</li> <li>• Reduced rise of front of seat</li> <li>• The upholstered option includes woven mesh beneath fabric. Choose between thousands of textile selections or COM</li> <li>• Warranted to 300 lbs.</li> </ul>	<b>WIDTH:</b> 28.0 <b>DEPTH:</b> 27.5 <b>HEIGHT:</b> 36.0-41.0 <b>SEAT WIDTH:</b> 19.0 <b>SEAT DEPTH:</b> 16.0 <b>SEAT HEIGHT:</b> 16.5-21.0 <b>BACK WIDTH:</b> 18.0 <b>BACK HEIGHT:</b> 19.5 <b>COM:</b> 2.0 YDS <b>COL:</b> 12.0 SQ FT <b>WEIGHT:</b> 43.0 LB
			M1	A34	940	975	995	1030	1065	1105	1150		
			M1	A35	965	1000	1020	1055	1090	1130	1175		
			M3	ARMLESS	890	925	945	980	1015	1055	1100		
			M3	A34	965	1000	1020	1055	1090	1130	1175		
			M3	A35	990	1025	1045	1080	1115	1155	1200		
3310	S3	<b>FULL-SCALE SWIVEL TILT</b>  Use for a variety of general office seating, including private office and conference room seating	M1	ARMLESS	815	850	870	905	940	980	1025	<ul style="list-style-type: none"> <li>• Pneumatic seat height adjustment</li> <li>• Tilt tension control</li> <li>• Seat and back tilt as a unit</li> <li>• 360-degree swivel</li> <li>• Upright position tilt lock</li> <li>• The upholstered option includes woven mesh beneath fabric. Choose between thousands of textile selections or COM</li> <li>• Warranted to 300 lbs.</li> </ul>	<b>WIDTH:</b> 28.0 <b>DEPTH:</b> 27.5 <b>HEIGHT:</b> 39.5-43.5 <b>SEAT WIDTH:</b> 19.0 <b>SEAT DEPTH:</b> 17.0 <b>SEAT HEIGHT:</b> 18.0-22.5 <b>BACK WIDTH:</b> 18.0 <b>BACK HEIGHT:</b> 23.5 <b>COM:</b> 2.0 YDS <b>COL:</b> 14.0 SQ FT <b>WEIGHT:</b> 39.0 LB
			M1	A34	890	925	945	980	1015	1055	1100		
			M1	A35	915	950	970	1005	1040	1080	1125		
			M3	ARMLESS	850	885	905	940	975	1015	1060		
			M3	A34	925	960	980	1015	1050	1090	1135		
			M3	A35	950	985	1005	1040	1075	1115	1160		
3310	K3	<b>FULL-SCALE KNEE TILT</b>  Ultimate seating comfort suited for the executive or manager. Allows for full range of movement with sharp, simple lock	M1	ARMLESS	915	950	970	1005	1040	1080	1125	<ul style="list-style-type: none"> <li>• Pneumatic seat height adjustment</li> <li>• Side activated tilt tension control</li> <li>• Seat and back tilt as a unit</li> <li>• 3 locking positions</li> <li>• Forward pitch seat lock</li> <li>• Reduced rise of front of seat</li> <li>• The upholstered option includes woven mesh beneath fabric. Choose between thousands of textile selections or COM</li> <li>• Warranted to 300 lbs.</li> </ul>	<b>WIDTH:</b> 28.0 <b>DEPTH:</b> 27.5 <b>HEIGHT:</b> 41.5-45.5 <b>SEAT WIDTH:</b> 19.0 <b>SEAT DEPTH:</b> 17.0 <b>SEAT HEIGHT:</b> 18.0-22.5 <b>BACK WIDTH:</b> 18.0 <b>BACK HEIGHT:</b> 23.5 <b>COM:</b> 2.0 YDS <b>COL:</b> 14.0 SQ FT <b>WEIGHT:</b> 46.0 LB
			M1	A34	990	1025	1045	1080	1115	1155	1200		
			M1	A35	1015	1050	1050	1050	1050	1050	1050		
			M3	ARMLESS	950	985	1005	1040	1075	1115	1160		
			M3	A34	1025	1060	1080	1115	1150	1190	1235		
			M3	A35	1050	1085	1105	1140	1175	1215	1260		

### CASTER OPTIONS

**A34**  
\$75

**A35**  
\$100

**C6**  
STD

**C6S**  
\$35

**C7**  
\$35

### BASE OPTIONS

**BA9B  
BA9G  
BA9W**  
STD

26" High Profile Nylon Base  
BA9B - Black  
BA9G - Gray  
BA9W - White

**BA10B**  
\$100

26" High Profile Aluminum  
Black Powder-Coat

**BA10P**  
\$100

26" High Profile Aluminum  
Polished

**BA10S**  
\$100

26" High Profile Aluminum  
Silver Powder-Coat

### ADDITIONAL OPTIONS

**LB**  
\$30

**G1**  
\$30

### PLASTIC COLORS

BLACK PBK	GRAPHITE GRAY PGG	WHITE PWH
--------------	-------------------------	--------------

(BACK/SEAT FRAME AND ARMS)

# cydia

organic design meets ergonomic excellence

GSA SIN # 711-18

- Stool, Conference, and Lounge seating
- Choice of 3 plastic colors and 14 mesh colors
- Warranted to 300 lbs.
- CAL TB 133 Fire Code approved



### CREATING CYDIA MODEL NUMBER

MODEL NUMBER CONTROL ARMS PLASTIC COLOR UPHOLSTERY MESH COLOR GRADE BASE CASTERS PACKAGING OPTIONS

3 3 - S 3 - A - P - U P - M - B A - C

\* FOR ARMLESS CODE USE A00 \*\*IF BASE AND CASTER MODEL NUMBERS ARE LEFT BLANK THEN STANDARD OPTION WILL BE ASSUMED

### PACKAGING NOTES

CODE	DESCRIPTION	LIST UPCHARGE
AB	ASSEMBLED IN BAG	\$0
BAC	BACK ASSEMBLED IN CARTON	\$0

## FULLY UPHOLSTERED - STOOL

MODEL	CONTROL	DESCRIPTION	ARM	FABRIC	A/COM	B	C	D	E	F	G
3306	S3	<b>10" STOOL SWIVEL TILT</b> Use for work surfaces up to 42 inches high	M1	ARMLESS	890	925	945	980	1015	1055	1100
			M1	A34	965	1000	1020	1055	1090	1130	1175
			M1	A35	990	1025	1045	1080	1115	1155	1200
			M3	ARMLESS	915	950	970	1005	1040	1080	1125
			M3	A34	990	1025	1045	1080	1115	1155	1200
			M3	A35	1015	1050	1070	1105	1140	1180	1225

MODEL	CONTROL	DESCRIPTION	ARM	FABRIC	A/COM	B	C	D	E	F	G
3308	S3	<b>8" STOOL SWIVEL TILT</b> Use for work surfaces up to 36 inches high	M1	ARMLESS	890	925	945	980	1015	1055	1100
			M1	A34	965	1000	1020	1055	1090	1130	1175
			M1	A35	990	1025	1045	1080	1115	1155	1200
			M3	ARMLESS	915	950	970	1005	1040	1080	1125
			M3	A34	990	1025	1045	1080	1115	1155	1200
			M3	A35	1015	1050	1070	1105	1140	1180	1225

### FEATURES

- Pneumatic seat height adjustment
- Tilt tension control
- Seat and back tilt as a unit
- 360-degree swivel
- Upright position tilt lock
- Knobless height adjustable footring
- The upholstered option includes woven mesh beneath fabric. Choose between thousands of textile selections or COM
- Warranted to 300 lbs.

### DIMENSIONS

**WIDTH:** 28.0  
**DEPTH:** 27.5  
**HEIGHT:** 43.5-53.5  
**SEAT WIDTH:** 19.0  
**SEAT DEPTH:** 16.0  
**SEAT HEIGHT:** 26.0-36.0  
**BACK WIDTH:** 18.0  
**BACK HEIGHT:** 19.5  
**COM:** 2.0 YDS  
**COL:** 12.0 SQ FT  
**WEIGHT:** 42.0 LB

- Pneumatic seat height adjustment
- Tilt tension control
- Seat and back tilt as a unit
- 360-degree swivel
- Upright position tilt lock
- Knobless height adjustable footring
- The upholstered option includes woven mesh beneath fabric. Choose between thousands of textile selections or COM
- Warranted to 300 lbs.

**WIDTH:** 28.0  
**DEPTH:** 27.5  
**HEIGHT:** 39.5-47.5  
**SEAT WIDTH:** 19.0  
**SEAT DEPTH:** 16.0  
**SEAT HEIGHT:** 22.0-30.0  
**BACK WIDTH:** 18.0  
**BACK HEIGHT:** 19.5  
**COM:** 2.0 YDS  
**COL:** 12.0 SQ FT  
**WEIGHT:** 41.0 LB

### ARM OPTIONS



Nylon Loop Arm

**A34**  
\$75



Height Adjustable Arm w/ Sliding Pad

**A35**  
\$100

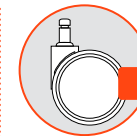

60mm Hoodless Casters

**C6**  
STD

### BASE OPTIONS

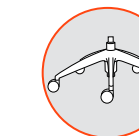

26" High Profile Nylon Base  
BA9B - Black  
BA9G - Gray  
BA9W - White

**BA9B  
BA9G  
BA9W**  
STD

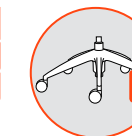

26" High Profile Aluminum Black Powder-Coat

**BA10B**  
\$100

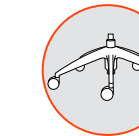

26" High Profile Aluminum Polished

**BA10P**  
\$100



26" High Profile Aluminum Silver Powder-Coat

**BA10S**  
\$100

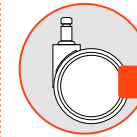

60mm Hoodless Hard Floor Casters

**C6S**  
\$35

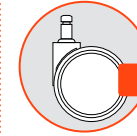

60mm Hoodless Chrome Accented Casters

**C7**  
\$35

### ADDITIONAL OPTIONS

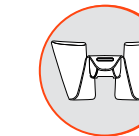

Height Adjustable Lumbar (Factory Installed)

**LB**  
\$30

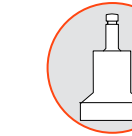

Stationary Base Glides for 5 Star Base

**G1**  
\$30

### PLASTIC COLORS

BLACK PBK	GRAPHITE GRAY PGG	WHITE PWH
--------------	-------------------------	--------------

(BACK/SEAT FRAME AND ARMS)

# cydia

organic design meets ergonomic excellence

## FULLY UPHOLSTERED - GUEST

GSA SIN # 711-18

- Multi-purpose guest seating
- Perfect for collaborative, touchdown, meeting and office spaces
- Choice of 3 frame colors and 14 mesh colors
- The upholstered option includes woven mesh beneath fabric. Choose between thousands of textile selections or COM
- Warranted to 300 lbs.
- CAL TB 133 Fire Code approved



### CREATING CYDIA MODEL NUMBER

MODEL NUMBER CONTROL PLASTIC COLOR FRAME COLOR UPHOLSTERY MESH COLOR GRADE PACKAGING OPTIONS

3 3 - G T - P - - U P - M - - - -

### PACKAGING NOTES

CODE	DESCRIPTION	LIST UPCHARGE
AB	ASSEMBLED IN BAG	\$0
BAC	BACK ASSEMBLED IN CARTON	\$0

MODEL	CONTROL	DESCRIPTION	ARM	FABRIC	FEATURES	DIMENSIONS																				
3300	GT	<b>MID-SCALE GUEST</b>  Well suited for guest seating	M1	SWA	<ul style="list-style-type: none"> <li>• Non-marring floor glides</li> <li>• Wall saver back legs</li> <li>• The upholstered option includes woven mesh beneath fabric. Choose between thousands of textile selections or COM</li> <li>• Warranted to 300 lbs.</li> </ul>	<b>WIDTH:</b> 24.0 <b>DEPTH:</b> 26.5 <b>HEIGHT:</b> 35.0 <b>SEAT WIDTH:</b> 19.0 <b>SEAT DEPTH:</b> 16.0 <b>SEAT HEIGHT:</b> 18.5 <b>BACK WIDTH:</b> 18.0 <b>BACK HEIGHT:</b> 19.5 <b>COM:</b> 2.0 YDS <b>COL:</b> 22.0 SQ FT <b>WEIGHT:</b> 25.0 LB																				
			M3	SWA																						
				<table border="1"> <thead> <tr> <th>A/COM</th> <th>B</th> <th>C</th> <th>D</th> <th>E</th> <th>F</th> <th>G</th> </tr> </thead> <tbody> <tr> <td>665</td> <td>700</td> <td>720</td> <td>755</td> <td>790</td> <td>830</td> <td>875</td> </tr> <tr> <td>690</td> <td>725</td> <td>745</td> <td>780</td> <td>815</td> <td>855</td> <td>900</td> </tr> </tbody> </table>	A/COM	B	C	D	E	F	G	665	700	720	755	790	830	875	690	725	745	780	815	855	900	
A/COM	B	C	D	E	F	G																				
665	700	720	755	790	830	875																				
690	725	745	780	815	855	900																				
				SWA - STANDARD WITH ARMS																						
3310	GT	<b>FULL-SCALE GUEST</b>  Well suited for guest seating	M1	SWA	<ul style="list-style-type: none"> <li>• Non-marring floor glides</li> <li>• Wall saver back legs</li> <li>• The upholstered option includes woven mesh beneath fabric. Choose between thousands of textile selections or COM</li> <li>• Warranted to 300 lbs.</li> </ul>	<b>WIDTH:</b> 24.0 <b>DEPTH:</b> 26.5 <b>HEIGHT:</b> 39.5 <b>SEAT WIDTH:</b> 19.0 <b>SEAT DEPTH:</b> 17.0 <b>SEAT HEIGHT:</b> 18.5 <b>BACK WIDTH:</b> 19.0 <b>BACK HEIGHT:</b> 23.0 <b>COM:</b> 2.0 YDS <b>COL:</b> 22.0 SQ FT <b>WEIGHT:</b> 28.0 LB																				
			M3	SWA																						
				<table border="1"> <thead> <tr> <th>A/COM</th> <th>B</th> <th>C</th> <th>D</th> <th>E</th> <th>F</th> <th>G</th> </tr> </thead> <tbody> <tr> <td>715</td> <td>750</td> <td>770</td> <td>805</td> <td>840</td> <td>880</td> <td>925</td> </tr> <tr> <td>750</td> <td>785</td> <td>805</td> <td>840</td> <td>875</td> <td>915</td> <td>960</td> </tr> </tbody> </table>	A/COM	B	C	D	E	F	G	715	750	770	805	840	880	925	750	785	805	840	875	915	960	
A/COM	B	C	D	E	F	G																				
715	750	770	805	840	880	925																				
750	785	805	840	875	915	960																				
				SWA - STANDARD WITH ARMS - BACK																						

### PLASTIC COLORS

BLACK PBK	GRAPHITE GRAY PGG	WHITE PWH
--------------	-------------------------	--------------

(BACK/SEAT FRAME AND ARMS)

### FRAME COLORS

BLACK BF	SILVER SF	WHITE WF
-------------	--------------	-------------

# diddy

dazzle your conference space

GSA SIN # 711-18

- Classic styling to impact conference space
- Chrome wraparound arms
- Polished high profile base
- Warranted to 300 lbs.
- CAL TB 133 Fire Code approved



## CREATING DIDDY MODEL NUMBER

MODEL NUMBER CONTROL ARMS GRADE CASTERS PACKAGING

2 4 5 0 - - A - - C - - -

\* FOR ARMLESS CODE USE A00

\*\*IF CASTER MODEL NUMBERS ARE LEFT BLANK THEN STANDARD OPTION WILL BE ASSUMED

## PACKAGING NOTES

## UPHOLSTERED BACK

MODEL	CONTROL	DESCRIPTION	ARM	FABRIC/LEATHER	FEATURES	DIMENSIONS	ARM OPTIONS																														
2450	B1	<b>MID-SCALE BASIC</b> Use for a variety of general office seating, including private office and conference room seating	ARMLESS A24	<table border="1"> <thead> <tr> <th>A/COM</th> <th>B</th> <th>C</th> <th>D</th> <th>E</th> <th>F</th> <th>G</th> <th>L3/COL</th> <th>L4</th> <th>L5</th> </tr> </thead> <tbody> <tr> <td>420</td> <td>470</td> <td>500</td> <td>550</td> <td>605</td> <td>665</td> <td>730</td> <td>460</td> <td>560</td> <td>785</td> </tr> <tr> <td>520</td> <td>570</td> <td>600</td> <td>650</td> <td>705</td> <td>765</td> <td>830</td> <td>560</td> <td>660</td> <td>885</td> </tr> </tbody> </table>	A/COM	B	C	D	E	F	G	L3/COL	L4	L5	420	470	500	550	605	665	730	460	560	785	520	570	600	650	705	765	830	560	660	885	<ul style="list-style-type: none"> <li>• Pneumatic seat height adjustment</li> <li>• 360-degree swivel</li> <li>• No seat and back tilt</li> <li>• Warranted to 300 lbs.</li> </ul>	<p>WIDTH: 21.5 DEPTH: 27.5 HEIGHT: 32.0-36.5 SEAT WIDTH: 19.0 SEAT DEPTH: 18.0 SEAT HEIGHT: 17-21.5 BACK WIDTH: 18.0 BACK HEIGHT: 16.5 COM: 1.5 YD COL: 19 SQ FT WEIGHT: 31.0 LBS</p>	<p><b>A24</b> \$100</p> <p>Fixed Chrome Wraparound Arm</p>
A/COM	B	C	D	E	F	G	L3/COL	L4	L5																												
420	470	500	550	605	665	730	460	560	785																												
520	570	600	650	705	765	830	560	660	885																												
2450	S3	<b>MID-SCALE SWIVEL TILT</b> Use for a variety of general office seating, including private office and conference room seating	ARMLESS A24	<table border="1"> <thead> <tr> <th>A/COM</th> <th>B</th> <th>C</th> <th>D</th> <th>E</th> <th>F</th> <th>G</th> <th>L3/COL</th> <th>L4</th> <th>L5</th> </tr> </thead> <tbody> <tr> <td>455</td> <td>505</td> <td>535</td> <td>585</td> <td>640</td> <td>700</td> <td>765</td> <td>495</td> <td>595</td> <td>820</td> </tr> <tr> <td>555</td> <td>605</td> <td>635</td> <td>685</td> <td>740</td> <td>800</td> <td>865</td> <td>595</td> <td>695</td> <td>920</td> </tr> </tbody> </table>	A/COM	B	C	D	E	F	G	L3/COL	L4	L5	455	505	535	585	640	700	765	495	595	820	555	605	635	685	740	800	865	595	695	920	<ul style="list-style-type: none"> <li>• Pneumatic seat height adjustment</li> <li>• Tilt tension control</li> <li>• Seat and back tilt as a unit</li> <li>• 360-degree swivel</li> <li>• Upright position tilt lock</li> <li>• Warranted to 300 lbs.</li> </ul>	<p>WIDTH: 21.5 DEPTH: 27.5 HEIGHT: 32.0-36.5 SEAT WIDTH: 19.0 SEAT DEPTH: 18.0 SEAT HEIGHT: 17-21.5 BACK WIDTH: 18.0 BACK HEIGHT: 16.5 COM: 1.5 YD COL: 19 SQ FT WEIGHT: 32.0 LBS</p>	<p><b>BA10P</b> STD</p> <p>26" High Profile Aluminum Polished (Standard with Polish Base)</p>
A/COM	B	C	D	E	F	G	L3/COL	L4	L5																												
455	505	535	585	640	700	765	495	595	820																												
555	605	635	685	740	800	865	595	695	920																												
2450	GT	<b>MID-SCALE GUEST</b> Diddy guest adds swivel. Modern design addition to lobby, office or group areas	ARMLESS A24	<table border="1"> <thead> <tr> <th>A/COM</th> <th>B</th> <th>C</th> <th>D</th> <th>E</th> <th>F</th> <th>G</th> <th>L3/COL</th> <th>L4</th> <th>L5</th> </tr> </thead> <tbody> <tr> <td>490</td> <td>540</td> <td>570</td> <td>620</td> <td>675</td> <td>735</td> <td>800</td> <td>530</td> <td>630</td> <td>855</td> </tr> <tr> <td>590</td> <td>640</td> <td>670</td> <td>720</td> <td>775</td> <td>835</td> <td>900</td> <td>630</td> <td>730</td> <td>955</td> </tr> </tbody> </table>	A/COM	B	C	D	E	F	G	L3/COL	L4	L5	490	540	570	620	675	735	800	530	630	855	590	640	670	720	775	835	900	630	730	955	<ul style="list-style-type: none"> <li>• Fixed height</li> <li>• Standard with glides</li> <li>• 360-degree swivel</li> <li>• Warranted to 300 lbs.</li> </ul>	<p>WIDTH: 21.5 DEPTH: 27.5 HEIGHT: 33.0 SEAT WIDTH: 19.0 SEAT DEPTH: 18.0 SEAT HEIGHT: 18.0 BACK WIDTH: 18.0 BACK HEIGHT: 16.5 COM: 1.5 YD COL: 19 SQ FT WEIGHT: 30.0 LBS</p>	<p><b>C7</b> STD <b>C6</b> N/C <b>C6S</b> \$35</p> <p>60mm Hoodless Chrome Accented Casters (Standard with Polished Base) 60mm Hoodless Casters 60mm Hoodless Hard Floor Casters</p>
A/COM	B	C	D	E	F	G	L3/COL	L4	L5																												
490	540	570	620	675	735	800	530	630	855																												
590	640	670	720	775	835	900	630	730	955																												
<b>NEW MODEL</b> 2450	R2	<b>MID-SCALE ROCKING TILT GUEST</b> Diddy guest adds rocking tilt. Modern design addition to lobby, office or group areas  Available Q1 2018	ARMLESS A24	<table border="1"> <thead> <tr> <th>A/COM</th> <th>B</th> <th>C</th> <th>D</th> <th>E</th> <th>F</th> <th>G</th> <th>L3/COL</th> <th>L4</th> <th>L5</th> </tr> </thead> <tbody> <tr> <td>525</td> <td>575</td> <td>605</td> <td>655</td> <td>710</td> <td>770</td> <td>835</td> <td>565</td> <td>665</td> <td>890</td> </tr> <tr> <td>625</td> <td>675</td> <td>705</td> <td>755</td> <td>810</td> <td>870</td> <td>935</td> <td>665</td> <td>765</td> <td>990</td> </tr> </tbody> </table>	A/COM	B	C	D	E	F	G	L3/COL	L4	L5	525	575	605	655	710	770	835	565	665	890	625	675	705	755	810	870	935	665	765	990	<ul style="list-style-type: none"> <li>• Pneumatic seat height adjustment</li> <li>• 360-degree swivel</li> <li>• R2 motion tilts right, left, front and back</li> <li>• Standard with Glides</li> <li>• Warranted to 300 lbs.</li> </ul>	<p>WIDTH: 21.5 DEPTH: 27.5 HEIGHT: 32.0-36.5 SEAT WIDTH: 19.0 SEAT DEPTH: 18.0 SEAT HEIGHT: 17-21.5 BACK WIDTH: 18.0 BACK HEIGHT: 16.5 COM: 1.5 YD COL: 19 SQ FT WEIGHT: 32.0 LBS</p>	
A/COM	B	C	D	E	F	G	L3/COL	L4	L5																												
525	575	605	655	710	770	835	565	665	890																												
625	675	705	755	810	870	935	665	765	990																												

# indy

flex back movement yields superior comfort

GSA SIN # 711-19

- High density, multipurpose stacker
- Seat and back styles include: all plastic, upholstered seat w/ plastic back or fully upholstered
- Standard interlocking alignment glides
- Flex back provides 15-degrees of movement
- 11 plastic colors, 2 frame finishes
- Warranted to 300 lbs.



## ALL PLASTIC - AP

### CREATING INDY MODEL NUMBER

MODEL NUMBER	CONTROL	FRAME COLOR	UPHOLSTERY	PLASTIC COLOR	PACKAGING	OPTIONS
1000	GT			AP	P	

### PACKAGING NOTES

CODE	DESCRIPTION	LIST UPCHARGE
AB	ASSEMBLED IN BAG	\$0
AC	ASSEMBLED IN CARTON	\$0

INDY CHAIRS SHIP UP TO 5 PER CARTON

MODEL	CONTROL	DESCRIPTION	FRAME COLOR	PLASTIC	FEATURES	DIMENSIONS
1010	GT	<b>GUEST STACKING</b> Armless sled shape frame with plastic back and plastic seat	BF	P 220	<ul style="list-style-type: none"> <li>• 15-degrees of flex in back</li> <li>• Non-marring floor glides</li> <li>• Stacks 9 high on floor</li> <li>• Stacks 33 high on optional dolly with 80" doorway clearance</li> <li>• Warranted to 300 lbs.</li> </ul>	<b>WIDTH:</b> 20.5 <b>DEPTH:</b> 21.0 <b>HEIGHT:</b> 32.0 <b>SEAT WIDTH:</b> 18.0 <b>SEAT DEPTH:</b> 17.0 <b>SEAT HEIGHT:</b> 18.0 <b>BACK WIDTH:</b> 17.5 <b>BACK HEIGHT:</b> 16.0 <b>COM:</b> N/A <b>WEIGHT:</b> 14.0 LB
			CF	230		

MODEL	CONTROL	DESCRIPTION	FRAME COLOR	PLASTIC	FEATURES	DIMENSIONS
1020	GT	<b>GUEST STACKING</b> Standard with armrests. Sled shape frame with plastic back and plastic seat	BF	P 265	<ul style="list-style-type: none"> <li>• 15-degrees of flex in back</li> <li>• Non-marring floor glides</li> <li>• Stacks 9 high on floor</li> <li>• Stacks 33 high on optional dolly with 80" doorway clearance</li> <li>• Armrests coordinate with plastic shell color</li> <li>• Warranted to 300 lbs.</li> </ul>	<b>WIDTH:</b> 21.5 <b>DEPTH:</b> 21.0 <b>HEIGHT:</b> 32.0 <b>SEAT WIDTH:</b> 18.0 <b>SEAT DEPTH:</b> 18.0 <b>SEAT HEIGHT:</b> 18.0 <b>BACK WIDTH:</b> 17.5 <b>BACK HEIGHT:</b> 16.0 <b>COM:</b> N/A <b>WEIGHT:</b> 15.0 LB
			CF	275		

### ADDITIONAL OPTIONS



**GC5**  
\$20

Ganging Clip - 4 per set  
Armless-to-Armless.  
2" Between Chairs  
When Ganged



**G12**  
\$15

Sled Base Clear Plastic Glide



**G13**  
\$25

Sled Base Clear Plastic Glide with Felt Pad

### ACCESSORIES



**DL4**  
\$250

Stacking Dolly Stacks All Plastic Chairs up to 33 High, Upholstered Chairs up to 20 High

### FRAME COLORS

BLACK BF	CHROME CF
-------------	--------------

(FRAME)

### PLASTIC COLORS

BLACK SWAN P01	CLASSIC BURGUNDY P02	CORAL RED P03	SUNBONNET YELLOW P04	WHITE WHISPER P05	BOULDER GRAY P06
DOVER SKY P07	ESSEX BLUE P08	PALE WATER GREEN P09	CINNABAR ORANGE P10	FEDERAL BLUE P11	

(BACK/SEAT SHELL AND ARMS)

CAUTION: Careless stacking of chairs may scratch and damage frames. Due to the nature of vinyl upholstery, stacking may cause impressions on the seat. 9to5 Seating does not warrant the effects of the stacking on vinyl upholstery.

# indy

flex back movement yields superior comfort

GSA SIN # 711-19

- High density, multipurpose stacker
- Seat and back styles include: all plastic, upholstered seat w/ plastic back or fully upholstered
- Standard interlocking alignment glides
- Flex back provides 15-degrees of movement
- 11 plastic colors, 2 frame finishes
- Warranted to 300 lbs.



## UPHOLSTERED SEAT - US

### CREATING INDY MODEL NUMBER

MODEL NUMBER	CONTROL	FRAME COLOR	UPHOLSTERY	PLASTIC COLOR	GRADE	PACKAGING	OPTIONS
1000	GT		US	P			

### PACKAGING NOTES

CODE	DESCRIPTION	LIST UPCHARGE
AB	ASSEMBLED IN BAG	\$0
AC	ASSEMBLED IN CARTON	\$0

INDY CHAIRS SHIP UP TO 8 PER CARTON

MODEL	CONTROL	DESCRIPTION	FRAME COLOR	FABRIC	FEATURES	DIMENSIONS																					
1010	GT	<b>GUEST STACKING</b> Armless sled shape frame with plastic back and upholstered seat	BF	<table border="1"> <thead> <tr> <th>A/COM</th> <th>B</th> <th>C</th> <th>D</th> <th>E</th> <th>F</th> <th>G</th> </tr> </thead> <tbody> <tr> <td>280</td> <td>305</td> <td>320</td> <td>345</td> <td>370</td> <td>400</td> <td>430</td> </tr> <tr> <td>295</td> <td>320</td> <td>335</td> <td>360</td> <td>385</td> <td>415</td> <td>445</td> </tr> </tbody> </table>	A/COM	B	C	D	E	F	G	280	305	320	345	370	400	430	295	320	335	360	385	415	445	<ul style="list-style-type: none"> <li>• 15-degrees of flex in back</li> <li>• Non-marring floor glides</li> <li>• Stacks 7 high on floor</li> <li>• Stacks 20 high on optional dolly with 80" doorway clearance</li> <li>• Warranted to 300 lbs.</li> </ul>	<b>WIDTH:</b> 20.5 <b>DEPTH:</b> 21.0 <b>HEIGHT:</b> 32.0 <b>SEAT WIDTH:</b> 18.0 <b>SEAT DEPTH:</b> 17.0 <b>SEAT HEIGHT:</b> 18.0 <b>BACK WIDTH:</b> 17.5 <b>BACK HEIGHT:</b> 16.0 <b>COM:</b> 0.7 YDS <b>WEIGHT:</b> 19.0 LB
A/COM	B		C	D	E	F	G																				
280	305	320	345	370	400	430																					
295	320	335	360	385	415	445																					
		CF																									

MODEL	CONTROL	DESCRIPTION	FRAME COLOR	FABRIC	FEATURES	DIMENSIONS																					
1020	GT	<b>GUEST STACKING</b> Standard with armrests. Sled shape frame with plastic back and upholstered seat	BF	<table border="1"> <thead> <tr> <th>A/COM</th> <th>B</th> <th>C</th> <th>D</th> <th>E</th> <th>F</th> <th>G</th> </tr> </thead> <tbody> <tr> <td>325</td> <td>350</td> <td>365</td> <td>390</td> <td>415</td> <td>445</td> <td>475</td> </tr> <tr> <td>340</td> <td>365</td> <td>380</td> <td>405</td> <td>430</td> <td>460</td> <td>490</td> </tr> </tbody> </table>	A/COM	B	C	D	E	F	G	325	350	365	390	415	445	475	340	365	380	405	430	460	490	<ul style="list-style-type: none"> <li>• 15-degrees of flex in back</li> <li>• Non-marring floor glides</li> <li>• Stacks 7 high on floor</li> <li>• Stacks 20 high on optional dolly with 80" doorway clearance</li> <li>• Armrests coordinate with plastic shell color</li> <li>• Warranted to 300 lbs.</li> </ul>	<b>WIDTH:</b> 22.0 <b>DEPTH:</b> 21.5 <b>HEIGHT:</b> 33.0 <b>SEAT WIDTH:</b> 18.0 <b>SEAT DEPTH:</b> 17.5 <b>SEAT HEIGHT:</b> 18.0 <b>BACK WIDTH:</b> 17.0 <b>BACK HEIGHT:</b> 16.0 <b>COM:</b> 0.7 YDS <b>WEIGHT:</b> 20.0 LB
A/COM	B		C	D	E	F	G																				
325	350	365	390	415	445	475																					
340	365	380	405	430	460	490																					
		CF																									

### ADDITIONAL OPTIONS



**GC5**  
\$20

Ganging Clip - 4 per set  
Armless-to-Armless,  
2" Between Chairs  
When Ganged



**G12**  
\$15

Sled Base Clear Plastic Glide



**G13**  
\$25

Sled Base Clear Plastic Glide  
with Felt Pad

### ACCESSORIES



**DL4**  
\$250

Stacking Dolly Stacks All  
Plastic Chairs up to 33 High,  
Upholstered Chairs up to  
20 High

### FRAME COLORS

BLACK BF	CHROME CF
-------------	--------------

(FRAME)

### PLASTIC COLORS

BLACK SWAN P01	CLASSIC BURGUNDY P02	CORAL RED P03	SUNBONNET YELLOW P04	WHITE WHISPER P05	BOULDER GRAY P06
DOVER SKY P07	ESSEX BLUE P08	PALE WATER GREEN P09	CINNABAR ORANGE P10	FEDERAL BLUE P11	

(BACK/SEAT SHELL AND ARMS)

CAUTION: Careless stacking of chairs may scratch and damage frames. Due to the nature of vinyl upholstery, stacking may cause impressions on the seat. 9to5 Seating does not warrant the effects of the stacking on vinyl upholstery.



# indy

flex back movement yields superior comfort

## FULLY UPHOLSTERED - UP

GSA SIN # 711-19

- High density, multipurpose stacker
- Seat and back styles include: all plastic, upholstered seat w/ plastic back or fully upholstered
- Standard interlocking alignment glides
- Flex back provides 15-degrees of movement
- 11 plastic colors, 2 frame finishes
- Warranted to 300 lbs.



### CREATING INDY MODEL NUMBER

MODEL NUMBER	CONTROL	FRAME COLOR	UPHOLSTERY	PLASTIC COLOR	GRADE	PACKAGING	OPTIONS
1000	GT		UP	P			

### PACKAGING NOTES

CODE	DESCRIPTION	LIST UPCHARGE
AB	ASSEMBLED IN BAG	\$0
AC	ASSEMBLED IN CARTON	\$0

INDY CHAIRS SHIP UP TO 6 PER CARTON

MODEL	CONTROL	DESCRIPTION	FRAME COLOR	FABRIC	A/COM	B	C	D	E	F	G	FEATURES	DIMENSIONS
1010	GT	<b>GUEST STACKING</b> Armless sled shape frame with upholstered back and seat	BF CF		330 345	355 370	375 390	400 415	430 445	465 480	500 515	<ul style="list-style-type: none"> <li>• 15-degrees of flex in back</li> <li>• Non-marring floor glides</li> <li>• Stacks 7 high on floor</li> <li>• Stacks 20 high on optional dolly with 80" doorway clearance</li> <li>• Warranted to 300 lbs.</li> </ul>	<b>WIDTH:</b> 20.5 <b>DEPTH:</b> 21.5 <b>HEIGHT:</b> 32.0 <b>SEAT WIDTH:</b> 17.5 <b>SEAT DEPTH:</b> 17.0 <b>SEAT HEIGHT:</b> 18.5 <b>BACK WIDTH:</b> 17.5 <b>BACK HEIGHT:</b> 16.0 <b>COM:</b> 0.8 YDS <b>WEIGHT:</b> 19.0 LB
1020	GT	<b>GUEST STACKING</b> Standard with armrests. Sled shape frame with upholstered back and seat	BF CF		375 390	400 415	420 435	445 460	475 490	510 525	545 560	<ul style="list-style-type: none"> <li>• 15-degrees of flex in back</li> <li>• Non-marring floor glides</li> <li>• Stacks 7 high on floor</li> <li>• Stacks 20 high on optional dolly with 80" doorway clearance</li> <li>• Armrests coordinate with plastic shell color</li> <li>• Warranted to 300 lbs.</li> </ul>	<b>WIDTH:</b> 22.0 <b>DEPTH:</b> 21.5 <b>HEIGHT:</b> 33.0 <b>SEAT WIDTH:</b> 18.0 <b>SEAT DEPTH:</b> 17.5 <b>SEAT HEIGHT:</b> 18.0 <b>BACK WIDTH:</b> 17.5 <b>BACK HEIGHT:</b> 16.0 <b>COM:</b> 0.7 YDS <b>WEIGHT:</b> 20.0 LB

### ADDITIONAL OPTIONS



**GC5**  
\$20

Ganging Clip - 4 per set  
Armless-to-Armless,  
2" Between Chairs  
When Ganged



**G12**  
\$15

Sled Base Clear Plastic Glide



**G13**  
\$25

Sled Base Clear Plastic Glide  
with Felt Pad

### ACCESSORIES



**DL4**  
\$250

Stacking Dolly Stacks All  
Plastic Chairs up to 33 High,  
Upholstered Chairs up to  
20 High

### FRAME COLORS

BLACK BF	CHROME CF
-------------	--------------

(FRAME)

### PLASTIC COLORS

BLACK SWAN P01	CLASSIC BURGUNDY P02	CORAL RED P03	SUNBONNET YELLOW P04	WHITE WHISPER P05	BOULDER GRAY P06
DOVER SKY P07	ESSEX BLUE P08	PALE WATER GREEN P09	CINNABAR ORANGE P10	FEDERAL BLUE P11	

(BACK/SEAT SHELL AND ARMS)

CAUTION: Careless stacking of chairs may scratch and damage frames. Due to the nature of vinyl upholstery, stacking may cause impressions on the seat. 9to5 Seating does not warrant the effects of the stacking on vinyl upholstery.

# kelley

nothing stacks up to kelley

GSA SIN # 711-19

- High density, multipurpose stacker
- Seat and back style include all plastic or upholstered seat
- 11 plastic colors and chrome frame finish
- Bar stool model
- Warranted to 300 lbs.



**ALL PLASTIC - AP**

**CREATING KELLY MODEL NUMBER**

MODEL NUMBER CONTROL FRAME COLOR UPHOLSTERY PLASTIC COLOR GRADE PACKAGING OPTIONS

1 0 - G T - C F - A P - P - - - - -

**PACKAGING NOTES**

CODE	DESCRIPTION	LIST UPCHARGE
AB	ASSEMBLED IN BAG	\$0
AC	ASSEMBLED IN CARTON	\$0

CHAIRS SHIP UP TO 5 AND STOOLS SHIP 2 PER CARTON

MODEL	CONTROL	DESCRIPTION	FABRIC/LEATHER	FEATURES	DIMENSIONS
1060	GT	<b>GUEST STACKING</b> Armless sled shape frame with plastic back and plastic seat	P 170	<ul style="list-style-type: none"> <li>• Stacks 9 high on floor</li> <li>• Stacks 33 high on optional dolly with 80" doorway clearance</li> <li>• Molded-in pull handle</li> <li>• Warranted to 300 lbs.</li> </ul>	<b>WIDTH:</b> 21.0 <b>DEPTH:</b> 21.0 <b>HEIGHT:</b> 31.0 <b>SEAT WIDTH:</b> 18.0 <b>SEAT DEPTH:</b> 16.5 <b>SEAT HEIGHT:</b> 18.0 <b>BACK WIDTH:</b> 18.0 <b>BACK HEIGHT:</b> 14.5 <b>COM:</b> N/A <b>WEIGHT:</b> 15.0 LB
1070	GT	<b>GUEST STACKING</b> Standard with armrests. Sled shape frame with plastic back and plastic seat	P 215	<ul style="list-style-type: none"> <li>• Stacks 9 high on floor</li> <li>• Stacks 33 high on optional dolly with 80" doorway clearance</li> <li>• Armrests coordinate with plastic shell color</li> <li>• Molded-in pull handle</li> <li>• Warranted to 300 lbs.</li> </ul>	<b>WIDTH:</b> 24.0 <b>DEPTH:</b> 21.0 <b>HEIGHT:</b> 31.0 <b>SEAT WIDTH:</b> 18.0 <b>SEAT DEPTH:</b> 16.5 <b>SEAT HEIGHT:</b> 18.0 <b>BACK WIDTH:</b> 18.0 <b>BACK HEIGHT:</b> 14.5 <b>COM:</b> N/A <b>WEIGHT:</b> 17.0 LB
1066	GT	<b>BAR STOOL</b> Armless sled shape frame with plastic back and plastic seat	P 320	<ul style="list-style-type: none"> <li>• Molded-in pull handle</li> <li>• 29" bar stool height</li> <li>• Stacks 4 high on floor</li> <li>• Warranted to 300 lbs.</li> </ul>	<b>WIDTH:</b> 21.0 <b>DEPTH:</b> 21.0 <b>HEIGHT:</b> 42.5 <b>SEAT WIDTH:</b> 18.0 <b>SEAT DEPTH:</b> 16.5 <b>SEAT HEIGHT:</b> 29.0 <b>BACK WIDTH:</b> 18.0 <b>BACK HEIGHT:</b> 14.5 <b>COM:</b> N/A <b>WEIGHT:</b> 21.5 LB
1076	GT	<b>BAR STOOL WITH ARMS</b> Standard with armrests. Sled shape frame with plastic back and plastic seat	P 365	<ul style="list-style-type: none"> <li>• Armrests coordinate with plastic shell color</li> <li>• Molded-in pull handle</li> <li>• 29" bar stool height</li> <li>• Stacks 3 high on floor</li> <li>• Warranted to 300 lbs.</li> </ul>	<b>WIDTH:</b> 24.0 <b>DEPTH:</b> 21.0 <b>HEIGHT:</b> 42.5 <b>SEAT WIDTH:</b> 18.0 <b>SEAT DEPTH:</b> 16.5 <b>SEAT HEIGHT:</b> 29.0 <b>BACK WIDTH:</b> 18.0 <b>BACK HEIGHT:</b> 14.5 <b>COM:</b> N/A <b>WEIGHT:</b> 23.0 LB

**ADDITIONAL OPTIONS**



**GC5**  
\$20

Ganging Clip - 4 per set  
Armless-to-Armless. 2"  
Between Chairs When Ganged



**G16**  
\$15

Sled Base Clear Plastic Glide



**G17**  
\$25

Sled Base Clear Plastic Glide  
with Felt Pad

**ACCESSORIES**



**DL4**  
\$250

Stacking Dolly Stacks All  
Plastic Chairs up to 33 High,  
Upholstered Chairs up to  
20 High

**FRAME COLOR**

CHROME  
CF

(FRAME)

**PLASTIC COLORS**

BLACK SWAN P01	CLASSIC BURGUNDY P02	CORAL RED P03	SUNBONNET YELLOW P04	WHITE WHISPER P05	BOULDER GRAY P06
DOVER SKY P07	ESSEX BLUE P08	PALE WATER GREEN P09	CINNABAR ORANGE P10	FEDERAL BLUE P11	

(BACK/SEAT SHELL AND ARMS)

# kelley

nothing stacks up to kelley

GSA SIN # 711-19

- High density, multipurpose stacker
- Available in All Plastic and Upholstered Seat
- 11 plastic colors and chrome finish
- Bar stool model available
- Warranted to 300 lbs.



## UPHOLSTERED SEAT - US

### CREATING KELLY MODEL NUMBER

MODEL NUMBER CONTROL FRAME COLOR UPHOLSTERY PLASTIC COLOR GRADE PACKAGING OPTIONS

1 0 - G T - C F - U S - P - - - - -

### PACKAGING NOTES

CODE	DESCRIPTION	LIST UPCHARGE
AB	ASSEMBLED IN BAG	\$0
AC	ASSEMBLED IN CARTON	\$0

CHAIRS SHIP UP TO 5 AND STOOLS SHIP 2 PER CARTON

MODEL	CONTROL	DESCRIPTION	FABRIC/LEATHER	FEATURES	DIMENSIONS														
1060	GT	<b>GUEST STACKING</b> Armless sled shape frame with plastic back and upholstered seat	<table border="1"> <thead> <tr> <th>A/COM</th> <th>B</th> <th>C</th> <th>D</th> <th>E</th> <th>F</th> <th>G</th> </tr> </thead> <tbody> <tr> <td>230</td> <td>260</td> <td>280</td> <td>310</td> <td>345</td> <td>380</td> <td>420</td> </tr> </tbody> </table>	A/COM	B	C	D	E	F	G	230	260	280	310	345	380	420	<ul style="list-style-type: none"> <li>• Stacks 7 high on floor</li> <li>• Stacks 20 high on optional dolly with 80" doorway clearance</li> <li>• Molded-in pull handle</li> <li>• Warranted to 300 lbs.</li> </ul>	<b>WIDTH:</b> 21.0 <b>DEPTH:</b> 21.0 <b>HEIGHT:</b> 31.0 <b>SEAT WIDTH:</b> 18.0 <b>SEAT DEPTH:</b> 16.5 <b>SEAT HEIGHT:</b> 18.0 <b>BACK WIDTH:</b> 18.0 <b>BACK HEIGHT:</b> 14.5 <b>COM:</b> 0.9 YD <b>WEIGHT:</b> 15.0 LB
A/COM	B	C	D	E	F	G													
230	260	280	310	345	380	420													
1070	GT	<b>GUEST STACKING</b> Standard with armrests. Sled shape frame with plastic back and upholstered seat	<table border="1"> <thead> <tr> <th>A/COM</th> <th>B</th> <th>C</th> <th>D</th> <th>E</th> <th>F</th> <th>G</th> </tr> </thead> <tbody> <tr> <td>275</td> <td>305</td> <td>325</td> <td>355</td> <td>390</td> <td>425</td> <td>465</td> </tr> </tbody> </table>	A/COM	B	C	D	E	F	G	275	305	325	355	390	425	465	<ul style="list-style-type: none"> <li>• Stacks 7 high on floor</li> <li>• Stacks 20 high on optional dolly with 80" doorway clearance</li> <li>• Armrests coordinate with plastic shell color</li> <li>• Molded-in pull handle</li> <li>• Warranted to 300 lbs.</li> </ul>	<b>WIDTH:</b> 24.0 <b>DEPTH:</b> 21.0 <b>HEIGHT:</b> 31.0 <b>SEAT WIDTH:</b> 18.0 <b>SEAT DEPTH:</b> 16.5 <b>SEAT HEIGHT:</b> 18.0 <b>BACK WIDTH:</b> 18.0 <b>BACK HEIGHT:</b> 14.5 <b>COM:</b> 0.9 YD <b>WEIGHT:</b> 17.0 LB
A/COM	B	C	D	E	F	G													
275	305	325	355	390	425	465													
1066	GT	<b>BAR STOOL</b> Armless sled shape frame with plastic back and upholstered seat	<table border="1"> <thead> <tr> <th>A/COM</th> <th>B</th> <th>C</th> <th>D</th> <th>E</th> <th>F</th> <th>G</th> </tr> </thead> <tbody> <tr> <td>380</td> <td>410</td> <td>430</td> <td>460</td> <td>495</td> <td>530</td> <td>570</td> </tr> </tbody> </table>	A/COM	B	C	D	E	F	G	380	410	430	460	495	530	570	<ul style="list-style-type: none"> <li>• Molded-in pull handle</li> <li>• 29" bar stool height</li> <li>• Stacks 4 high on floor</li> <li>• Warranted to 300 lbs.</li> </ul>	<b>WIDTH:</b> 21.0 <b>DEPTH:</b> 21.0 <b>HEIGHT:</b> 42.5 <b>SEAT WIDTH:</b> 18.0 <b>SEAT DEPTH:</b> 16.5 <b>SEAT HEIGHT:</b> 29.0 <b>BACK WIDTH:</b> 18.0 <b>BACK HEIGHT:</b> 14.5 <b>COM:</b> 0.9 YD <b>WEIGHT:</b> 21.5 LB
A/COM	B	C	D	E	F	G													
380	410	430	460	495	530	570													
1076	GT	<b>BAR STOOL WITH ARMS</b> Standard with armrests. Sled shape frame with plastic back and upholstered seat	<table border="1"> <thead> <tr> <th>A/COM</th> <th>B</th> <th>C</th> <th>D</th> <th>E</th> <th>F</th> <th>G</th> </tr> </thead> <tbody> <tr> <td>425</td> <td>455</td> <td>475</td> <td>505</td> <td>540</td> <td>575</td> <td>615</td> </tr> </tbody> </table>	A/COM	B	C	D	E	F	G	425	455	475	505	540	575	615	<ul style="list-style-type: none"> <li>• Armrests coordinate with plastic shell color</li> <li>• 29" bar stool height</li> <li>• Stacks 4 high on floor</li> <li>• Molded-in pull handle</li> <li>• Warranted to 300 lbs.</li> </ul>	<b>WIDTH:</b> 24.0 <b>DEPTH:</b> 21.0 <b>HEIGHT:</b> 42.5 <b>SEAT WIDTH:</b> 18.0 <b>SEAT DEPTH:</b> 16.5 <b>SEAT HEIGHT:</b> 29.0 <b>BACK WIDTH:</b> 18.0 <b>BACK HEIGHT:</b> 14.5 <b>COM:</b> 0.9 YD <b>WEIGHT:</b> 23.0 LB
A/COM	B	C	D	E	F	G													
425	455	475	505	540	575	615													

### ADDITIONAL OPTIONS



**GC5**  
\$20

Ganging Clip - 4 per set  
Armless-to-Armless, 2"  
Between Chairs When Ganged



**G16**  
\$15

Sled Base Clear Plastic Glide



**G17**  
\$25

Sled Base Clear Plastic Glide  
with Felt Pad

### ACCESSORIES



**DL4**  
\$250

Stacking Dolly Stacks  
Chairs up to 20 High  
Upholstered Seat

### FRAME COLOR

CHROME  
CF  
  
 (FRAME)

### PLASTIC COLORS

BLACK SWAN P01	CLASSIC BURGUNDY P02	CORAL RED P03	SUNBONNET YELLOW P04	WHITE WHISPER P05	BOULDER GRAY P06
DOVER SKY P07	ESSEX BLUE P08	PALE WATER GREEN P09	CINNABAR ORANGE P10	FEDERAL BLUE P11	

(BACK/SEAT SHELL AND ARMS)

# lilly

classic, sophisticated and supremely comfortable

## GSA SIN # 711-16

- Ideal for collaboration, lounge and touchdown workspaces
- Classic, sophisticated design
- Comfortable with roomy back
- Versatile with four base options
- Lightweight for easy mobility
- CAL TB 133 Fire Code approved
- Warranted to 300 lbs.



**NEW FULLY UPHOLSTERED**

### CREATING LILLY MODEL NUMBER

MODEL NUMBER CONTROL FRAME GRADE PACKAGING

9 1 1 - L G - - - -

#### PACKAGING NOTES

CODE	DESCRIPTION	LIST UPCHARGE
AB	ASSEMBLED IN BAG	\$0
BAC	BACK ASSEMBLED IN CARTON	\$0

MODEL	CONTROL	DESCRIPTION	FABRIC/LEATHER	FEATURES	DIMENSIONS																				
9101	LG	<b>LOUNGE CHAIR</b> with 4 legs	<table border="1"> <thead> <tr> <th>A/COM</th> <th>B</th> <th>C</th> <th>D</th> <th>E</th> <th>F</th> <th>G</th> <th>L3/COL</th> <th>L4</th> <th>L5</th> </tr> </thead> <tbody> <tr> <td>1250</td> <td>1325</td> <td>1370</td> <td>1445</td> <td>1525</td> <td>1615</td> <td>1715</td> <td>1340</td> <td>1385</td> <td>1920</td> </tr> </tbody> </table>	A/COM	B	C	D	E	F	G	L3/COL	L4	L5	1250	1325	1370	1445	1525	1615	1715	1340	1385	1920	<ul style="list-style-type: none"> <li>• Lightweight for easy mobility</li> <li>• 4 leg metal base</li> <li>• Silver and black frame colors</li> <li>• Dome guides standard</li> <li>• Warranted to 300 lbs.</li> </ul>	<p><b>WIDTH:</b> 27.0 <b>DEPTH:</b> 29.0 <b>HEIGHT:</b> 33.0 <b>SEAT WIDTH:</b> 22.0 <b>SEAT DEPTH:</b> 23.5 <b>SEAT HEIGHT:</b> 19.0 <b>BACK WIDTH:</b> 17.0 <b>BACK HEIGHT:</b> 23.5 <b>COM:</b> 2.3 YRD <b>COL:</b> 35 SQ FT <b>WEIGHT:</b> 32 LBS</p>
A/COM	B	C	D	E	F	G	L3/COL	L4	L5																
1250	1325	1370	1445	1525	1615	1715	1340	1385	1920																
9111	LG	<b>LOUNGE CHAIR</b> with W legs	<table border="1"> <thead> <tr> <th>A/COM</th> <th>B</th> <th>C</th> <th>D</th> <th>E</th> <th>F</th> <th>G</th> <th>L3/COL</th> <th>L4</th> <th>L5</th> </tr> </thead> <tbody> <tr> <td>1375</td> <td>1450</td> <td>1495</td> <td>1570</td> <td>1650</td> <td>1740</td> <td>1840</td> <td>1465</td> <td>1510</td> <td>2045</td> </tr> </tbody> </table>	A/COM	B	C	D	E	F	G	L3/COL	L4	L5	1375	1450	1495	1570	1650	1740	1840	1465	1510	2045	<ul style="list-style-type: none"> <li>• Lightweight for easy mobility</li> <li>• W leg metal base</li> <li>• Silver and black frame colors</li> <li>• Warranted to 300 lbs.</li> </ul>	<p><b>WIDTH:</b> 27.0 <b>DEPTH:</b> 29.0 <b>HEIGHT:</b> 33.0 <b>SEAT WIDTH:</b> 22.0 <b>SEAT DEPTH:</b> 23.5 <b>SEAT HEIGHT:</b> 19.0 <b>BACK WIDTH:</b> 17.0 <b>BACK HEIGHT:</b> 23.5 <b>COM:</b> 2.3 YRD <b>COL:</b> 35 SQ FT <b>WEIGHT:</b> 29 LBS</p>
A/COM	B	C	D	E	F	G	L3/COL	L4	L5																
1375	1450	1495	1570	1650	1740	1840	1465	1510	2045																
9131	LG	<b>LOUNGE CHAIR</b> with swivel base*	<table border="1"> <thead> <tr> <th>A/COM</th> <th>B</th> <th>C</th> <th>D</th> <th>E</th> <th>F</th> <th>G</th> <th>L3/COL</th> <th>L4</th> <th>L5</th> </tr> </thead> <tbody> <tr> <td>1500</td> <td>1575</td> <td>1620</td> <td>1695</td> <td>1775</td> <td>1865</td> <td>1965</td> <td>1590</td> <td>1635</td> <td>2170</td> </tr> </tbody> </table>	A/COM	B	C	D	E	F	G	L3/COL	L4	L5	1500	1575	1620	1695	1775	1865	1965	1590	1635	2170	<ul style="list-style-type: none"> <li>• Lightweight for easy mobility</li> <li>• Aluminum swivel base</li> <li>• Warranted to 300 lbs.</li> </ul>	<p><b>WIDTH:</b> 27.0 <b>DEPTH:</b> 29.0 <b>HEIGHT:</b> 33.0 <b>SEAT WIDTH:</b> 22.0 <b>SEAT DEPTH:</b> 23.5 <b>SEAT HEIGHT:</b> 19.0 <b>BACK WIDTH:</b> 17.0 <b>BACK HEIGHT:</b> 23.5 <b>COM:</b> 2.3 YRD <b>COL:</b> 35 SQ FT <b>WEIGHT:</b> 34 LBS</p>
A/COM	B	C	D	E	F	G	L3/COL	L4	L5																
1500	1575	1620	1695	1775	1865	1965	1590	1635	2170																
9121	LG	<b>LOUNGE CHAIR</b> with wood legs	<table border="1"> <thead> <tr> <th>A/COM</th> <th>B</th> <th>C</th> <th>D</th> <th>E</th> <th>F</th> <th>G</th> <th>L3/COL</th> <th>L4</th> <th>L5</th> </tr> </thead> <tbody> <tr> <td>1650</td> <td>1725</td> <td>1770</td> <td>1845</td> <td>1925</td> <td>2015</td> <td>2115</td> <td>1740</td> <td>1785</td> <td>2320</td> </tr> </tbody> </table>	A/COM	B	C	D	E	F	G	L3/COL	L4	L5	1650	1725	1770	1845	1925	2015	2115	1740	1785	2320	<ul style="list-style-type: none"> <li>• Lightweight for easy mobility</li> <li>• Wood leg offering of walnut and ash with clear finish</li> <li>• Warranted to 300 lbs.</li> </ul>	<p><b>WIDTH:</b> 27.0 <b>DEPTH:</b> 29.0 <b>HEIGHT:</b> 33.0 <b>SEAT WIDTH:</b> 22.0 <b>SEAT DEPTH:</b> 23.5 <b>SEAT HEIGHT:</b> 19.0 <b>BACK WIDTH:</b> 17.0 <b>BACK HEIGHT:</b> 23.5 <b>COM:</b> 2.3 YRD <b>COL:</b> 35 SQ FT <b>WEIGHT:</b> 27 LBS</p>
A/COM	B	C	D	E	F	G	L3/COL	L4	L5																
1650	1725	1770	1845	1925	2015	2115	1740	1785	2320																

#### BASE COLORS

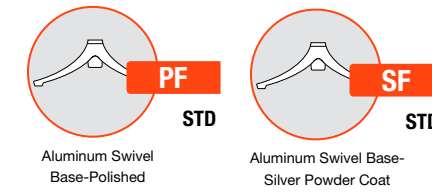

#### ADDITIONAL OPTIONS\*

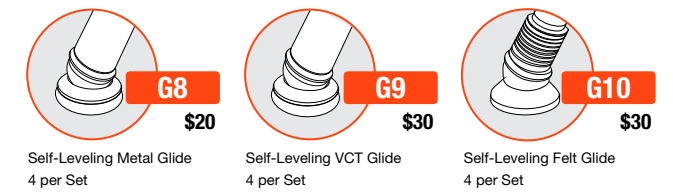

\* GLIDES FOR 9101 ONLY

# link

transitional style with limitless possibilities

GSA SIN # 711-19

- Back styles include: all plastic, upholstered or mesh
- 3" molded foam seat
- 6 powder coat frame colors
- Wall saver legs on model 1410
- Warranted to 300 lbs.
- CAL TB 133 Fire Code approved



## MESH BACK - MB

### CREATING LINK MODEL NUMBER

MODEL NUMBER CONTROL ARMS FRAME COLOR UPHOLSTERY MESH COLOR GRADE CASTERS PACKAGING OPTIONS

1 4 1 - G T - A - - - - M B - M - - - C 1 2 - - - -

\* FOR ARMLESS CODE USE A00 \* ONLY SELECT FOR MODELS 1360/1365 \* ONLY SELECT CASTER CODE FOR MODELS 1315/1365

### PACKAGING NOTES

CODE	DESCRIPTION	LIST UPCHARGE
AB	ASSEMBLED IN BAG	\$0
AC	ASSEMBLED IN CARTON	\$0

LINK MESH BACK SIDE CHAIRS SHIP UP TO 3 PER CARTON

MODEL	CONTROL	DESCRIPTION	ARM	FABRIC/LEATHER	FEATURES	DIMENSIONS	ARM OPTIONS	ACCESSORIES																																								
1410	GT	<b>GUEST SIDE CHAIR</b> Mesh back with upholstered seat	ARMLESS	<table border="1"> <thead> <tr> <th>A/COM</th> <th>B</th> <th>C</th> <th>D</th> <th>E</th> <th>F</th> <th>G</th> <th>L3/COL</th> <th>L4</th> <th>L5</th> </tr> </thead> <tbody> <tr> <td>395</td> <td>430</td> <td>455</td> <td>490</td> <td>530</td> <td>575</td> <td>625</td> <td>485</td> <td>515</td> <td>605</td> </tr> <tr> <td>A15B</td> <td>450</td> <td>485</td> <td>510</td> <td>545</td> <td>585</td> <td>630</td> <td>680</td> <td>540</td> <td>660</td> </tr> <tr> <td>A15G</td> <td>450</td> <td>485</td> <td>510</td> <td>545</td> <td>585</td> <td>630</td> <td>680</td> <td>540</td> <td>660</td> </tr> </tbody> </table>	A/COM	B	C	D	E	F	G	L3/COL	L4	L5	395	430	455	490	530	575	625	485	515	605	A15B	450	485	510	545	585	630	680	540	660	A15G	450	485	510	545	585	630	680	540	660	<ul style="list-style-type: none"> <li>• Non-marring floor glides</li> <li>• 3" molded foam seat</li> <li>• Stacks 4 high on floor</li> <li>• Stacks 4 high on optional dolly</li> <li>• Wall saver legs on model 1410</li> <li>• Warranted to 300 lbs.</li> </ul>	WIDTH: 25.5 DEPTH: 24.0 HEIGHT: 32.0 SEAT WIDTH: 20.0 SEAT DEPTH: 18.0 SEAT HEIGHT: 17.5 BACK WIDTH: 18.0 BACK HEIGHT: 16.0 COM: 1.1 YD COL: 11 SQ FT WEIGHT: 21.0 LB		
A/COM	B		C	D	E	F	G	L3/COL	L4	L5																																						
395	430	455	490	530	575	625	485	515	605																																							
A15B	450	485	510	545	585	630	680	540	660																																							
A15G	450	485	510	545	585	630	680	540	660																																							
1415	GT	<b>GUEST SIDE CHAIR WITH CASTERS</b> Mesh back with upholstered seat	ARMLESS	<table border="1"> <thead> <tr> <th>A/COM</th> <th>B</th> <th>C</th> <th>D</th> <th>E</th> <th>F</th> <th>G</th> <th>L3/COL</th> <th>L4</th> <th>L5</th> </tr> </thead> <tbody> <tr> <td>440</td> <td>475</td> <td>500</td> <td>535</td> <td>575</td> <td>620</td> <td>670</td> <td>530</td> <td>560</td> <td>650</td> </tr> <tr> <td>A15B</td> <td>495</td> <td>530</td> <td>555</td> <td>590</td> <td>630</td> <td>675</td> <td>725</td> <td>585</td> <td>705</td> </tr> <tr> <td>A15G</td> <td>495</td> <td>530</td> <td>555</td> <td>590</td> <td>630</td> <td>675</td> <td>725</td> <td>585</td> <td>705</td> </tr> </tbody> </table>	A/COM	B	C	D	E	F	G	L3/COL	L4	L5	440	475	500	535	575	620	670	530	560	650	A15B	495	530	555	590	630	675	725	585	705	A15G	495	530	555	590	630	675	725	585	705	<ul style="list-style-type: none"> <li>• 50mm hoodless casters</li> <li>• 3" molded foam seat</li> <li>• Stacks 4 high on floor</li> <li>• Stacks 4 high on optional dolly</li> <li>• Warranted to 300 lbs.</li> </ul>	WIDTH: 25.5 DEPTH: 24.0 HEIGHT: 32.0 SEAT WIDTH: 20.0 SEAT DEPTH: 18.0 SEAT HEIGHT: 17.5 BACK WIDTH: 18.0 BACK HEIGHT: 16.0 COM: 1.1 YDS COL: 11.0 SQ FT WEIGHT: 21.0 LB		
A/COM	B		C	D	E	F	G	L3/COL	L4	L5																																						
440	475	500	535	575	620	670	530	560	650																																							
A15B	495	530	555	590	630	675	725	585	705																																							
A15G	495	530	555	590	630	675	725	585	705																																							

CAUTION: Careless stacking of chairs may scratch and damage frames. Due to the nature of vinyl upholstery, stacking may cause impressions on the seat. 9to5 Seating does not warrant the effects of the stacking on vinyl upholstery.

\*Standard lead time applies only to Metallic Brown, Gunmetal, Dover Gray and White frame color options.

Black and Silver frame colors available as Express Ship

# link

transitional style with limitless possibilities

GSA SIN # 711-19

- Back styles include: all plastic, upholstered or mesh back
- 3" molded foam seat
- 6 powder coat frame colors
- Wall saver legs on model 1410
- Warranted to 300 lbs.
- CAL TB 133 Fire Code approved



## PLASTIC BACK - PB

### CREATING LINK MODEL NUMBER

MODEL NUMBER CONTROL ARMS FRAME COLOR UPHOLSTERY GRADE CASTERS PACKAGING OPTIONS

1 4 1 - G T - A - - - - P B - - - - C 1 2 - - - -

\* FOR ARMLESS CODE USE A00 \* ONLY SELECT CASTER CODE FOR MODELS 1315/1365

### PACKAGING NOTES

CODE	DESCRIPTION	LIST UPCHARGE
AB	ASSEMBLED IN BAG	\$0
AC	ASSEMBLED IN CARTON	\$0

LINK MESH BACK SIDE CHAIRS SHIP UP TO 3 PER CARTON

MODEL	CONTROL	DESCRIPTION	ARM	FABRIC/LEATHER	FEATURES	DIMENSIONS	ARM OPTIONS																																										
1410	GT	<b>GUEST</b> Plastic back with upholstered seat	ARMLESS	<table border="1"> <thead> <tr> <th>A/COM</th> <th>B</th> <th>C</th> <th>D</th> <th>E</th> <th>F</th> <th>G</th> <th>L3/COL</th> <th>L4</th> <th>L5</th> </tr> </thead> <tbody> <tr> <td>360</td> <td>395</td> <td>420</td> <td>455</td> <td>495</td> <td>540</td> <td>590</td> <td>450</td> <td>480</td> <td>570</td> </tr> <tr> <td>A15B</td> <td>415</td> <td>450</td> <td>475</td> <td>510</td> <td>550</td> <td>595</td> <td>645</td> <td>505</td> <td>535</td> <td>625</td> </tr> <tr> <td>A15G</td> <td>415</td> <td>450</td> <td>475</td> <td>510</td> <td>550</td> <td>595</td> <td>645</td> <td>505</td> <td>535</td> <td>625</td> </tr> </tbody> </table>	A/COM	B	C	D	E	F	G	L3/COL	L4	L5	360	395	420	455	495	540	590	450	480	570	A15B	415	450	475	510	550	595	645	505	535	625	A15G	415	450	475	510	550	595	645	505	535	625	<ul style="list-style-type: none"> <li>• Non-marring floor glides</li> <li>• 3" molded foam seat</li> <li>• Stacks 4 high on floor</li> <li>• Stacks 4 high on optional dolly</li> <li>• Wall saver legs on model 1410</li> <li>• Warranted to 300 lbs.</li> </ul>	WIDTH: 25.5 DEPTH: 24.0 HEIGHT: 32.0 SEAT WIDTH: 20.0 SEAT DEPTH: 18.0 SEAT HEIGHT: 17.5 BACK WIDTH: 18.0 BACK HEIGHT: 16.0 COM: 1.1 YD COL: 11.0 SQ FT WEIGHT: 21.0 LB	<b>A15B</b> \$55 <b>A15G</b> \$55 <b>C12</b> STD
A/COM	B		C	D	E	F	G	L3/COL	L4	L5																																							
360	395		420	455	495	540	590	450	480	570																																							
A15B	415	450	475	510	550	595	645	505	535	625																																							
A15G	415	450	475	510	550	595	645	505	535	625																																							
1415	GT	<b>GUEST WITH CASTERS</b> Plastic back with upholstered seat	ARMLESS	<table border="1"> <thead> <tr> <th>A/COM</th> <th>B</th> <th>C</th> <th>D</th> <th>E</th> <th>F</th> <th>G</th> <th>L3/COL</th> <th>L4</th> <th>L5</th> </tr> </thead> <tbody> <tr> <td>405</td> <td>440</td> <td>465</td> <td>500</td> <td>540</td> <td>585</td> <td>635</td> <td>495</td> <td>525</td> <td>615</td> </tr> <tr> <td>A15B</td> <td>460</td> <td>495</td> <td>520</td> <td>555</td> <td>595</td> <td>640</td> <td>690</td> <td>550</td> <td>580</td> <td>670</td> </tr> <tr> <td>A15G</td> <td>460</td> <td>495</td> <td>520</td> <td>555</td> <td>595</td> <td>640</td> <td>690</td> <td>550</td> <td>580</td> <td>670</td> </tr> </tbody> </table>	A/COM	B	C	D	E	F	G	L3/COL	L4	L5	405	440	465	500	540	585	635	495	525	615	A15B	460	495	520	555	595	640	690	550	580	670	A15G	460	495	520	555	595	640	690	550	580	670	<ul style="list-style-type: none"> <li>• 50mm hoodless casters</li> <li>• 3" molded foam seat</li> <li>• Stacks 4 high on floor</li> <li>• Stacks 4 high on optional dolly</li> <li>• Warranted to 300 lbs.</li> </ul>	WIDTH: 25.5 DEPTH: 24.0 HEIGHT: 32.0 SEAT WIDTH: 20.0 SEAT DEPTH: 18.0 SEAT HEIGHT: 17.5 BACK WIDTH: 18.0 BACK HEIGHT: 16.0 COM: 1.1 YD COL: 11.0 SQ FT WEIGHT: 21.0 LB	<b>DL1</b> \$250 Stacking Dolly Stacks Chairs 4 High
A/COM	B		C	D	E	F	G	L3/COL	L4	L5																																							
405	440		465	500	540	585	635	495	525	615																																							
A15B	460	495	520	555	595	640	690	550	580	670																																							
A15G	460	495	520	555	595	640	690	550	580	670																																							

CAUTION: Careless stacking of chairs may scratch and damage frames. Due to the nature of vinyl upholstery, stacking may cause impressions on the seat. 9to5 Seating does not warrant the effects of the stacking on vinyl upholstery.

\*Standard lead time applies only to Metallic Brown, Gunmetal, Dover Gray and White frame color options.

Black and Silver frame colors available as Express Ship

# link

transitional style with limitless possibilities

GSA SIN # 711-18

- Back styles include: all plastic, upholstered or mesh back
- 3" molded foam seat
- 6 powder coat frame colors
- Wall saver legs on model 1410
- Warranted to 300 lbs.
- CAL TB 133 Fire Code approved



## UPHOLSTERED BACK - UB

### CREATING LINK MODEL NUMBER

MODEL NUMBER CONTROL ARMS FRAME COLOR UPHOLSTERY GRADE CASTERS PACKAGING OPTIONS

1 4 1 - G T - A - - - - U B - - - - C 1 2 - - - -

\* FOR ARMLESS CODE USE ADD \* ONLY SELECT CASTER CODE FOR MODELS 1315/1365

### PACKAGING NOTES

CODE	DESCRIPTION	LIST UPCHARGE
AB	ASSEMBLED IN BAG	\$0
AC	ASSEMBLED IN CARTON	\$0

LINK MESH BACK SIDE CHAIRS SHIP UP TO 3 PER CARTON

MODEL	CONTROL	DESCRIPTION	ARM	FABRIC/LEATHER	FEATURES	DIMENSIONS	ARM OPTIONS	ACCESSORIES																																										
1410	GT	<b>GUEST</b> Upholstered back with upholstered seat	ARMLESS A15B A15G	<table border="1"> <thead> <tr> <th>A/COM</th> <th>B</th> <th>C</th> <th>D</th> <th>E</th> <th>F</th> <th>G</th> <th>L3/COL</th> <th>L4</th> <th>L5</th> </tr> </thead> <tbody> <tr> <td>395</td> <td>440</td> <td>470</td> <td>515</td> <td>565</td> <td>625</td> <td>690</td> <td>510</td> <td>595</td> <td>730</td> </tr> <tr> <td>450</td> <td>495</td> <td>525</td> <td>570</td> <td>620</td> <td>680</td> <td>745</td> <td>565</td> <td>650</td> <td>785</td> </tr> <tr> <td>450</td> <td>495</td> <td>525</td> <td>570</td> <td>620</td> <td>680</td> <td>745</td> <td>565</td> <td>650</td> <td>785</td> </tr> </tbody> </table>	A/COM	B	C	D	E	F	G	L3/COL	L4	L5	395	440	470	515	565	625	690	510	595	730	450	495	525	570	620	680	745	565	650	785	450	495	525	570	620	680	745	565	650	785	<ul style="list-style-type: none"> <li>• Non-marring floor glides</li> <li>• 3" molded foam seat</li> <li>• Stacks 4 high on floor</li> <li>• Stacks 4 high on optional dolly</li> <li>• Wall saver legs on model 1410</li> <li>• Molded foam back</li> <li>• Warranted to 300 lbs.</li> </ul>	<b>WIDTH:</b> 25.0 <b>DEPTH:</b> 24.0 <b>HEIGHT:</b> 32.0 <b>SEAT WIDTH:</b> 20.0 <b>SEAT DEPTH:</b> 18.0 <b>SEAT HEIGHT:</b> 17.5 <b>BACK WIDTH:</b> 18.0 <b>BACK HEIGHT:</b> 16.0 <b>COM:</b> 1.4 YD <b>COL:</b> 17.0 SQ FT <b>WEIGHT:</b> 23.0 LB	<b>A15B</b> \$55 <b>A15G</b> \$55 <b>C12</b> STD	<b>DL1</b> \$250 Stacking Dolly Stacks Chairs 4 High		
A/COM	B	C	D	E	F	G	L3/COL	L4	L5																																									
395	440	470	515	565	625	690	510	595	730																																									
450	495	525	570	620	680	745	565	650	785																																									
450	495	525	570	620	680	745	565	650	785																																									
1415	GT	<b>GUEST WITH CASTERS</b> Upholstered back with upholstered seat	ARMLESS A15B A15G	<table border="1"> <thead> <tr> <th>A/COM</th> <th>B</th> <th>C</th> <th>D</th> <th>E</th> <th>F</th> <th>G</th> <th>L3/COL</th> <th>L4</th> <th>L5</th> </tr> </thead> <tbody> <tr> <td>440</td> <td>485</td> <td>515</td> <td>560</td> <td>610</td> <td>670</td> <td>735</td> <td>555</td> <td>640</td> <td>775</td> </tr> <tr> <td>495</td> <td>540</td> <td>570</td> <td>615</td> <td>665</td> <td>725</td> <td>790</td> <td>610</td> <td>695</td> <td>830</td> </tr> <tr> <td>495</td> <td>540</td> <td>570</td> <td>615</td> <td>665</td> <td>725</td> <td>790</td> <td>610</td> <td>695</td> <td>830</td> </tr> </tbody> </table>	A/COM	B	C	D	E	F	G	L3/COL	L4	L5	440	485	515	560	610	670	735	555	640	775	495	540	570	615	665	725	790	610	695	830	495	540	570	615	665	725	790	610	695	830	<ul style="list-style-type: none"> <li>• 50mm hoodless casters</li> <li>• 3" molded foam seat</li> <li>• Stacks 4 high on floor</li> <li>• Stacks 4 high on optional dolly</li> <li>• Molded foam back</li> <li>• Warranted to 300 lbs.</li> </ul>	<b>WIDTH:</b> 25.5 <b>DEPTH:</b> 24.0 <b>HEIGHT:</b> 32.0 <b>SEAT WIDTH:</b> 20.0 <b>SEAT DEPTH:</b> 18.0 <b>SEAT HEIGHT:</b> 17.5 <b>BACK WIDTH:</b> 18.0 <b>BACK HEIGHT:</b> 16.0 <b>COM:</b> 1.4 YD <b>COL:</b> 17.0 SQ FT <b>WEIGHT:</b> 23.0 LB	<b>DL1</b> \$250 Stacking Dolly Stacks Chairs 4 High	<table border="1"> <tr> <td>BLACK BF</td> <td>SILVER SF</td> </tr> </table> <p>(FRAME)</p>	BLACK BF	SILVER SF
A/COM	B	C	D	E	F	G	L3/COL	L4	L5																																									
440	485	515	560	610	670	735	555	640	775																																									
495	540	570	615	665	725	790	610	695	830																																									
495	540	570	615	665	725	790	610	695	830																																									
BLACK BF	SILVER SF																																																	

CAUTION: Careless stacking of chairs may scratch and damage frames. Due to the nature of vinyl upholstery, stacking may cause impressions on the seat. 9to5 Seating does not warrant the effects of the stacking on vinyl upholstery.

\*Standard lead time applies only to Metallic Brown, Gunmetal, Dover Gray and White frame color options.

Black and Silver frame colors available as Express Ship

# logic

ergonomics, traditional task styling - an unbeatable value

GSA SIN # 711-18

- Task, stool and conference seating
- Multiple back sizes including low, mid and high
- Ratchet back height adjustment on P1, R1, M1 and Y2 models
- Warranted to 300 lbs.
- CAL TB 133 Fire Code approved



## CREATING LOGIC MODEL NUMBERS

MODEL NUMBER CONTROL ARMS GRADE BASE CASTERS PACKAGING OPTIONS

1 7 2 5 - [ ] [ ] - A [ ] [ ] - [ ] [ ] - B A 1 - C [ ] [ ] - [ ] [ ] - [ ] [ ]

\* FOR ARMLESS CODE USE A00

## PACKAGING NOTES

CODE	DESCRIPTION	LIST UPCHARGE
AB	ASSEMBLED IN BAG	\$0
PAC	PARTIALLY ASSEMBLED IN CARTON	\$0
BAC	BACK ASSEMBLED IN CARTON	\$40

## LOW-BACK FORMERLY PRECEPT

MODEL	CONTROL	DESCRIPTION	ARM	FABRIC/LEATHER	FEATURES	DIMENSIONS	ARM OPTIONS																																																								
1725	B2	<b>LOW-BACK BASIC</b> Our basic control has simple adjustments. Ideal for clerical, casual meetings and general office use  <i>Formerly Precept Series</i>	ARMLESS A1 A4 A5 A6 A7 A16	<table border="1"> <thead> <tr> <th>A/COM</th> <th>B</th> <th>C</th> <th>D</th> <th>E</th> <th>F</th> <th>G</th> </tr> </thead> <tbody> <tr><td>360</td><td>400</td><td>425</td><td>465</td><td>515</td><td>570</td><td>630</td></tr> <tr><td>430</td><td>470</td><td>495</td><td>535</td><td>585</td><td>640</td><td>700</td></tr> <tr><td>435</td><td>475</td><td>500</td><td>540</td><td>590</td><td>645</td><td>705</td></tr> <tr><td>455</td><td>495</td><td>520</td><td>560</td><td>610</td><td>665</td><td>725</td></tr> <tr><td>490</td><td>530</td><td>555</td><td>595</td><td>645</td><td>700</td><td>760</td></tr> <tr><td>510</td><td>550</td><td>575</td><td>615</td><td>665</td><td>720</td><td>780</td></tr> <tr><td>460</td><td>500</td><td>525</td><td>565</td><td>615</td><td>670</td><td>730</td></tr> </tbody> </table>	A/COM	B	C	D	E	F	G	360	400	425	465	515	570	630	430	470	495	535	585	640	700	435	475	500	540	590	645	705	455	495	520	560	610	665	725	490	530	555	595	645	700	760	510	550	575	615	665	720	780	460	500	525	565	615	670	730	<ul style="list-style-type: none"> <li>• Pneumatic seat height adjustment</li> <li>• 360-degree swivel</li> <li>• No seat and back tilt</li> <li>• Adjustable back depth</li> <li>• Warranted to 300 lbs.</li> </ul>	<p>WIDTH: 26.5 DEPTH: 26.5 HEIGHT: 35.0-39.5 SEAT WIDTH: 22.0 SEAT DEPTH: 17.0 SEAT HEIGHT: 17.5-22.0 BACK WIDTH: 19.5 BACK HEIGHT: 18.5 COM: 1.4 YDS WEIGHT: 28.0 LB</p>	<p><b>A1</b> \$70 Soft Touch Loop Arm</p> <p><b>A4</b> \$75 Height Adjustable Arm</p> <p><b>A5</b> \$95 Height/Width Adjustable Arm</p>
A/COM	B	C	D	E	F	G																																																									
360	400	425	465	515	570	630																																																									
430	470	495	535	585	640	700																																																									
435	475	500	540	590	645	705																																																									
455	495	520	560	610	665	725																																																									
490	530	555	595	645	700	760																																																									
510	550	575	615	665	720	780																																																									
460	500	525	565	615	670	730																																																									
1725	S2	<b>LOW-BACK SWIVEL TILT</b> Use for a variety of general office seating, including private office and conference room seating  <i>Formerly Precept Series</i>	ARMLESS A1 A4 A5 A6 A7 A16	<table border="1"> <thead> <tr> <th>A/COM</th> <th>B</th> <th>C</th> <th>D</th> <th>E</th> <th>F</th> <th>G</th> </tr> </thead> <tbody> <tr><td>405</td><td>445</td><td>470</td><td>510</td><td>560</td><td>615</td><td>675</td></tr> <tr><td>475</td><td>515</td><td>540</td><td>580</td><td>630</td><td>685</td><td>745</td></tr> <tr><td>480</td><td>520</td><td>545</td><td>585</td><td>635</td><td>690</td><td>750</td></tr> <tr><td>500</td><td>540</td><td>565</td><td>605</td><td>655</td><td>710</td><td>770</td></tr> <tr><td>535</td><td>575</td><td>600</td><td>640</td><td>690</td><td>745</td><td>805</td></tr> <tr><td>555</td><td>595</td><td>620</td><td>660</td><td>710</td><td>765</td><td>825</td></tr> <tr><td>505</td><td>545</td><td>570</td><td>610</td><td>660</td><td>715</td><td>775</td></tr> </tbody> </table> <p>SEAT SLIDER - ADD \$60</p>	A/COM	B	C	D	E	F	G	405	445	470	510	560	615	675	475	515	540	580	630	685	745	480	520	545	585	635	690	750	500	540	565	605	655	710	770	535	575	600	640	690	745	805	555	595	620	660	710	765	825	505	545	570	610	660	715	775	<ul style="list-style-type: none"> <li>• Pneumatic seat height adjustment</li> <li>• Tilt tension control</li> <li>• Seat and back tilt as a unit</li> <li>• 360-degree swivel</li> <li>• Upright position tilt lock</li> <li>• Adjustable back depth</li> <li>• Warranted to 300 lbs.</li> </ul>	<p>WIDTH: 26.5 DEPTH: 26.5 HEIGHT: 35.0-39.5 SEAT WIDTH: 22.0 SEAT DEPTH: 17.0 SEAT HEIGHT: 17.5-22.0 BACK WIDTH: 19.5 BACK HEIGHT: 18.5 COM: 1.4 YDS WEIGHT: 31.0 LB</p>	<p><b>A6</b> \$130 Height Adjustable Pivot/Slide Arm with Ura-Soft Sliding Arm Pads</p> <p><b>A7</b> \$150 Height/Width Adjustable Pivot/Slide Arm with Ura-Soft Sliding Arm Pads</p> <p><b>A16</b> \$100 Soft Touch C-Shape Arm w/ Upholstered Pad</p>
A/COM	B	C	D	E	F	G																																																									
405	445	470	510	560	615	675																																																									
475	515	540	580	630	685	745																																																									
480	520	545	585	635	690	750																																																									
500	540	565	605	655	710	770																																																									
535	575	600	640	690	745	805																																																									
555	595	620	660	710	765	825																																																									
505	545	570	610	660	715	775																																																									
1725	P1	<b>LOW-BACK POSTURE BACK</b> The articulating back provides proper support for moderate tasking applications  <i>Formerly Precept Series</i>	ARMLESS A1 A4 A5 A6 A7 A16	<table border="1"> <thead> <tr> <th>A/COM</th> <th>B</th> <th>C</th> <th>D</th> <th>E</th> <th>F</th> <th>G</th> </tr> </thead> <tbody> <tr><td>445</td><td>485</td><td>510</td><td>550</td><td>600</td><td>655</td><td>715</td></tr> <tr><td>515</td><td>555</td><td>580</td><td>620</td><td>670</td><td>725</td><td>785</td></tr> <tr><td>520</td><td>560</td><td>585</td><td>625</td><td>675</td><td>730</td><td>790</td></tr> <tr><td>540</td><td>580</td><td>605</td><td>645</td><td>695</td><td>750</td><td>810</td></tr> <tr><td>575</td><td>615</td><td>640</td><td>680</td><td>730</td><td>785</td><td>845</td></tr> <tr><td>595</td><td>635</td><td>660</td><td>700</td><td>750</td><td>805</td><td>865</td></tr> <tr><td>545</td><td>585</td><td>610</td><td>650</td><td>700</td><td>755</td><td>815</td></tr> </tbody> </table> <p>SEAT SLIDER - ADD \$60</p>	A/COM	B	C	D	E	F	G	445	485	510	550	600	655	715	515	555	580	620	670	725	785	520	560	585	625	675	730	790	540	580	605	645	695	750	810	575	615	640	680	730	785	845	595	635	660	700	750	805	865	545	585	610	650	700	755	815	<ul style="list-style-type: none"> <li>• Pneumatic seat height adjustment</li> <li>• Infinite back angle adjust with free float</li> <li>• Ratchet back height lumbar adjustment</li> <li>• Warranted to 300 lbs.</li> </ul>	<p>WIDTH: 26.5 DEPTH: 26.5 HEIGHT: 35.0-42.5 SEAT WIDTH: 22.0 SEAT DEPTH: 17.0 SEAT HEIGHT: 17.5-22.0 BACK WIDTH: 19.5 BACK HEIGHT: 18.5-21.5 COM: 1.4 YDS WEIGHT: 33.0 LB</p>	<p><b>BT</b> \$15 Replace Knob with Bolt (For S2 and B2 Controls Only)</p> <p><b>EF1</b> \$30 1" Extra Foam on Seat</p> <p><b>MF1</b> \$50 1" Visco Elastic Memory Foam on Seat</p>
A/COM	B	C	D	E	F	G																																																									
445	485	510	550	600	655	715																																																									
515	555	580	620	670	725	785																																																									
520	560	585	625	675	730	790																																																									
540	580	605	645	695	750	810																																																									
575	615	640	680	730	785	845																																																									
595	635	660	700	750	805	865																																																									
545	585	610	650	700	755	815																																																									
1725	R1	<b>LOW-BACK ROCKING TILT</b> For managerial and task applications. Similar to a swivel tilt control, with the added comfort of infinite back angle and tilt adjustment  <i>Formerly Precept Series</i>	ARMLESS A1 A4 A5 A6 A7 A16	<table border="1"> <thead> <tr> <th>A/COM</th> <th>B</th> <th>C</th> <th>D</th> <th>E</th> <th>F</th> <th>G</th> </tr> </thead> <tbody> <tr><td>455</td><td>495</td><td>520</td><td>560</td><td>610</td><td>665</td><td>725</td></tr> <tr><td>525</td><td>565</td><td>590</td><td>630</td><td>680</td><td>735</td><td>795</td></tr> <tr><td>530</td><td>570</td><td>595</td><td>635</td><td>685</td><td>740</td><td>800</td></tr> <tr><td>550</td><td>590</td><td>615</td><td>655</td><td>705</td><td>760</td><td>820</td></tr> <tr><td>585</td><td>625</td><td>650</td><td>690</td><td>740</td><td>795</td><td>855</td></tr> <tr><td>605</td><td>645</td><td>670</td><td>710</td><td>760</td><td>815</td><td>875</td></tr> <tr><td>555</td><td>595</td><td>620</td><td>660</td><td>710</td><td>765</td><td>825</td></tr> </tbody> </table> <p>SEAT SLIDER - ADD \$60</p>	A/COM	B	C	D	E	F	G	455	495	520	560	610	665	725	525	565	590	630	680	735	795	530	570	595	635	685	740	800	550	590	615	655	705	760	820	585	625	650	690	740	795	855	605	645	670	710	760	815	875	555	595	620	660	710	765	825	<ul style="list-style-type: none"> <li>• Pneumatic seat height adjustment</li> <li>• Tilt tension control</li> <li>• Seat and back tilt as a unit</li> <li>• Floating seat position tilt lock</li> <li>• Infinite back angle adjust with free float</li> <li>• Ratchet back height lumbar adjustment</li> <li>• Warranted to 300 lbs.</li> </ul>	<p>WIDTH: 26.5 DEPTH: 26.5 HEIGHT: 35.0-42.5 SEAT WIDTH: 22.0 SEAT DEPTH: 17.0 SEAT HEIGHT: 17.5-22.0 BACK WIDTH: 19.5 BACK HEIGHT: 18.5-21.5 COM: 1.4 YDS WEIGHT: 35.0 LB</p>	<p><b>SS</b> \$60 Seat Slider 2.5" Side Paddle Activated</p> <p><b>BN1</b> \$35 <b>BN2</b> \$N/C Upholstered Outer Back in Black Ballistic Nylon BN1 - with Grade A ONLY BN2 - with Grade B and Up</p> <p><b>EP</b> \$60 Edge Protector - a Clear Vinyl Tube Placed Around the Edge of the Back Cushion</p>
A/COM	B	C	D	E	F	G																																																									
455	495	520	560	610	665	725																																																									
525	565	590	630	680	735	795																																																									
530	570	595	635	685	740	800																																																									
550	590	615	655	705	760	820																																																									
585	625	650	690	740	795	855																																																									
605	645	670	710	760	815	875																																																									
555	595	620	660	710	765	825																																																									



# logic

ergonomics, traditional task styling - an unbeatable value

## LOW-BACK FORMERLY PRECEPT

GSA SIN # 711-18

- Task, stool and conference seating
- Multiple back sizes including low, mid and high
- Ratchet back height adjustment on P1, R1, M1 and Y2 models
- Warranted to 300 lbs.
- CAL TB 133 Fire Code approved



### CREATING LOGIC MODEL NUMBERS



### PACKAGING NOTES

CODE	DESCRIPTION	LIST UPCHARGE
AB	ASSEMBLED IN BAG	\$0
PAC	PARTIALLY ASSEMBLED IN CARTON	\$0
BAC	BACK ASSEMBLED IN CARTON	\$40

MODEL	CONTROL	DESCRIPTION	ARM	FABRIC/LEATHER	FEATURES	DIMENSIONS	ARM OPTIONS																																																																																																																
1725	M1	<b>LOW-BACK MULTI-FUNCTION</b> Fully articulating seat and back for the highest level of ergonomic needs. Forward seat pitch adjustment from 0 to 6-degrees  <i>Formerly Precept Series</i>	<table border="1"> <tr><td>ARMLESS</td><td>505</td><td>545</td><td>570</td><td>610</td><td>660</td><td>715</td><td>775</td></tr> <tr><td>A1</td><td>575</td><td>615</td><td>640</td><td>680</td><td>730</td><td>785</td><td>845</td></tr> <tr><td>A4</td><td>580</td><td>620</td><td>645</td><td>685</td><td>735</td><td>790</td><td>850</td></tr> <tr><td>A5</td><td>600</td><td>640</td><td>665</td><td>705</td><td>755</td><td>810</td><td>870</td></tr> <tr><td>A6</td><td>635</td><td>675</td><td>700</td><td>740</td><td>790</td><td>845</td><td>905</td></tr> <tr><td>A7</td><td>655</td><td>695</td><td>720</td><td>760</td><td>810</td><td>865</td><td>925</td></tr> <tr><td>A16</td><td>605</td><td>645</td><td>670</td><td>710</td><td>760</td><td>815</td><td>875</td></tr> </table>	ARMLESS	505	545	570	610	660	715	775	A1	575	615	640	680	730	785	845	A4	580	620	645	685	735	790	850	A5	600	640	665	705	755	810	870	A6	635	675	700	740	790	845	905	A7	655	695	720	760	810	865	925	A16	605	645	670	710	760	815	875	<table border="1"> <tr><td>A/COM</td><td>B</td><td>C</td><td>D</td><td>E</td><td>F</td><td>G</td></tr> <tr><td>505</td><td>545</td><td>570</td><td>610</td><td>660</td><td>715</td><td>775</td></tr> <tr><td>575</td><td>615</td><td>640</td><td>680</td><td>730</td><td>785</td><td>845</td></tr> <tr><td>580</td><td>620</td><td>645</td><td>685</td><td>735</td><td>790</td><td>850</td></tr> <tr><td>600</td><td>640</td><td>665</td><td>705</td><td>755</td><td>810</td><td>870</td></tr> <tr><td>635</td><td>675</td><td>700</td><td>740</td><td>790</td><td>845</td><td>905</td></tr> <tr><td>655</td><td>695</td><td>720</td><td>760</td><td>810</td><td>865</td><td>925</td></tr> <tr><td>605</td><td>645</td><td>670</td><td>710</td><td>760</td><td>815</td><td>875</td></tr> </table>	A/COM	B	C	D	E	F	G	505	545	570	610	660	715	775	575	615	640	680	730	785	845	580	620	645	685	735	790	850	600	640	665	705	755	810	870	635	675	700	740	790	845	905	655	695	720	760	810	865	925	605	645	670	710	760	815	875	<ul style="list-style-type: none"> <li>• Pneumatic seat height adjustment</li> <li>• Tilt tension control</li> <li>• Seat and back tilt as unit</li> <li>• Floating seat position tilt lock</li> <li>• Infinite back angle adj. w/ free float</li> <li>• Seat pivots from 0° to 6° forward</li> <li>• Ratchet back height lumbar adjustment</li> <li>• Warranted to 300 lbs.</li> </ul>	<p><b>WIDTH:</b> 26.5 <b>DEPTH:</b> 26.5 <b>HEIGHT:</b> 35.0-42.5 <b>SEAT WIDTH:</b> 22.0 <b>SEAT DEPTH:</b> 17.0 <b>SEAT HEIGHT:</b> 17.5-22.0 <b>BACK WIDTH:</b> 19.5 <b>BACK HEIGHT:</b> 18.5-21.5 <b>COM:</b> 1.4 YDS <b>WEIGHT:</b> 39.0 LB</p>	<p><b>ARM OPTIONS</b></p> <ul style="list-style-type: none"> <li><b>A1</b> Soft Touch Loop Arm \$70</li> <li><b>A4</b> Height Adjustable Arm \$75</li> <li><b>A5</b> Height/Width Adjustable Arm \$95</li> <li><b>A6</b> Height Adjustable Pivot/Slide Arm with Ura-Soft Sliding Arm Pads \$130</li> <li><b>A7</b> Height/Width Adjustable Pivot/Slide Arm with Ura-Soft Sliding Arm Pads \$150</li> <li><b>A16</b> Soft Touch C-Shape Arm w/ Upholstered Pad \$100</li> </ul>
ARMLESS	505	545	570	610	660	715	775																																																																																																																
A1	575	615	640	680	730	785	845																																																																																																																
A4	580	620	645	685	735	790	850																																																																																																																
A5	600	640	665	705	755	810	870																																																																																																																
A6	635	675	700	740	790	845	905																																																																																																																
A7	655	695	720	760	810	865	925																																																																																																																
A16	605	645	670	710	760	815	875																																																																																																																
A/COM	B	C	D	E	F	G																																																																																																																	
505	545	570	610	660	715	775																																																																																																																	
575	615	640	680	730	785	845																																																																																																																	
580	620	645	685	735	790	850																																																																																																																	
600	640	665	705	755	810	870																																																																																																																	
635	675	700	740	790	845	905																																																																																																																	
655	695	720	760	810	865	925																																																																																																																	
605	645	670	710	760	815	875																																																																																																																	
				SEAT SLIDER (SS) - ADD \$60																																																																																																																			
1725	Y2-SS	<b>LOW-BACK HEAVY DUTY SYNCHRO</b> Use for a variety of general office seating, including private office and conference room seating  <i>Formerly Precept Series</i>	<table border="1"> <tr><td>ARMLESS</td><td>545</td><td>585</td><td>610</td><td>650</td><td>700</td><td>755</td><td>815</td></tr> <tr><td>A1</td><td>615</td><td>655</td><td>680</td><td>720</td><td>770</td><td>825</td><td>885</td></tr> <tr><td>A4</td><td>620</td><td>660</td><td>685</td><td>725</td><td>775</td><td>830</td><td>890</td></tr> <tr><td>A5</td><td>640</td><td>680</td><td>705</td><td>745</td><td>795</td><td>850</td><td>910</td></tr> <tr><td>A6</td><td>675</td><td>715</td><td>740</td><td>780</td><td>830</td><td>885</td><td>945</td></tr> <tr><td>A7</td><td>695</td><td>735</td><td>760</td><td>800</td><td>850</td><td>905</td><td>965</td></tr> <tr><td>A16</td><td>645</td><td>685</td><td>710</td><td>750</td><td>800</td><td>855</td><td>915</td></tr> </table>	ARMLESS	545	585	610	650	700	755	815	A1	615	655	680	720	770	825	885	A4	620	660	685	725	775	830	890	A5	640	680	705	745	795	850	910	A6	675	715	740	780	830	885	945	A7	695	735	760	800	850	905	965	A16	645	685	710	750	800	855	915	<table border="1"> <tr><td>A/COM</td><td>B</td><td>C</td><td>D</td><td>E</td><td>F</td><td>G</td></tr> <tr><td>545</td><td>585</td><td>610</td><td>650</td><td>700</td><td>755</td><td>815</td></tr> <tr><td>615</td><td>655</td><td>680</td><td>720</td><td>770</td><td>825</td><td>885</td></tr> <tr><td>620</td><td>660</td><td>685</td><td>725</td><td>775</td><td>830</td><td>890</td></tr> <tr><td>640</td><td>680</td><td>705</td><td>745</td><td>795</td><td>850</td><td>910</td></tr> <tr><td>675</td><td>715</td><td>740</td><td>780</td><td>830</td><td>885</td><td>945</td></tr> <tr><td>695</td><td>735</td><td>760</td><td>800</td><td>850</td><td>905</td><td>965</td></tr> <tr><td>645</td><td>685</td><td>710</td><td>750</td><td>800</td><td>855</td><td>915</td></tr> </table>	A/COM	B	C	D	E	F	G	545	585	610	650	700	755	815	615	655	680	720	770	825	885	620	660	685	725	775	830	890	640	680	705	745	795	850	910	675	715	740	780	830	885	945	695	735	760	800	850	905	965	645	685	710	750	800	855	915	<ul style="list-style-type: none"> <li>• Pneumatic seat height adjustment</li> <li>• Side tilt tension control</li> <li>• Back and seat tilt in 2:1 ratio</li> <li>• 4 locking positions</li> <li>• Safety tilt release</li> <li>• Ratchet back height lumbar adjustment</li> <li>• SS seat slider standard</li> <li>• Warranted to 300 lbs.</li> </ul>	<p><b>WIDTH:</b> 26.5 <b>DEPTH:</b> 26.5 <b>HEIGHT:</b> 33.5-41.0 <b>SEAT WIDTH:</b> 22.0 <b>SEAT DEPTH:</b> 17.0-19.5 <b>SEAT HEIGHT:</b> 19.0-23.5 <b>BACK WIDTH:</b> 19.5 <b>BACK HEIGHT:</b> 18.5-21.5 <b>COM:</b> 1.4 YDS <b>WEIGHT:</b> 41.0 LB</p>	<p><b>CASTER OPTIONS</b></p> <ul style="list-style-type: none"> <li><b>C1</b> 50mm Hooded Casters STD</li> <li><b>C1S</b> 50mm Hooded Hard Floor Casters \$35</li> <li><b>C2S</b> 50mm Hooded Self-Locking Hard Floor Casters \$35</li> </ul>
ARMLESS	545	585	610	650	700	755	815																																																																																																																
A1	615	655	680	720	770	825	885																																																																																																																
A4	620	660	685	725	775	830	890																																																																																																																
A5	640	680	705	745	795	850	910																																																																																																																
A6	675	715	740	780	830	885	945																																																																																																																
A7	695	735	760	800	850	905	965																																																																																																																
A16	645	685	710	750	800	855	915																																																																																																																
A/COM	B	C	D	E	F	G																																																																																																																	
545	585	610	650	700	755	815																																																																																																																	
615	655	680	720	770	825	885																																																																																																																	
620	660	685	725	775	830	890																																																																																																																	
640	680	705	745	795	850	910																																																																																																																	
675	715	740	780	830	885	945																																																																																																																	
695	735	760	800	850	905	965																																																																																																																	
645	685	710	750	800	855	915																																																																																																																	
				SEAT SLIDER (SS) - STANDARD																																																																																																																			
1725	GT	<b>GUEST</b> Well suited for guest seating  <i>Formerly Precept Series</i>	<table border="1"> <tr><td>ARMLESS</td><td>340</td><td>380</td><td>405</td><td>445</td><td>495</td><td>550</td><td>610</td></tr> <tr><td>A1</td><td>410</td><td>450</td><td>475</td><td>515</td><td>565</td><td>620</td><td>680</td></tr> </table>	ARMLESS	340	380	405	445	495	550	610	A1	410	450	475	515	565	620	680	<table border="1"> <tr><td>A/COM</td><td>B</td><td>C</td><td>D</td><td>E</td><td>F</td><td>G</td></tr> <tr><td>340</td><td>380</td><td>405</td><td>445</td><td>495</td><td>550</td><td>610</td></tr> <tr><td>410</td><td>450</td><td>475</td><td>515</td><td>565</td><td>620</td><td>680</td></tr> </table>	A/COM	B	C	D	E	F	G	340	380	405	445	495	550	610	410	450	475	515	565	620	680	<ul style="list-style-type: none"> <li>• Cantilever base design</li> <li>• Warranted to 300 lbs.</li> <li>• Black powder coat frame</li> </ul>	<p><b>WIDTH:</b> 26.5 <b>DEPTH:</b> 26.5 <b>HEIGHT:</b> 35.5 <b>SEAT WIDTH:</b> 22.0 <b>SEAT DEPTH:</b> 17.0 <b>SEAT HEIGHT:</b> 17.0 <b>BACK WIDTH:</b> 19.5 <b>BACK HEIGHT:</b> 18.5 <b>COM:</b> 1.4 YDS <b>WEIGHT:</b> 38.0 LB</p>	<p><b>ADDITIONAL OPTIONS</b></p> <ul style="list-style-type: none"> <li><b>BT</b> Replace Knob with Bolt (For S2 and B2 Controls Only) \$15</li> <li><b>EF1</b> 1" Extra Foam on Seat \$30</li> <li><b>MF1</b> 1" Visco Elastic Memory Foam on Seat \$50</li> <li><b>SS</b> Seat Slider 2.5" Side Paddle Activated \$60</li> <li><b>BN1</b> Upholstered Outer Back in Black Ballistic Nylon BN1 - with Grade A ONLY \$35</li> <li><b>BN2</b> Upholstered Outer Back in Black Ballistic Nylon BN2 - with Grade B and Up \$N/C</li> <li><b>EP</b> Edge Protector - a Clear Vinyl Tube Placed Around the Edge of the Back Cushion \$60</li> </ul>																																																																											
ARMLESS	340	380	405	445	495	550	610																																																																																																																
A1	410	450	475	515	565	620	680																																																																																																																
A/COM	B	C	D	E	F	G																																																																																																																	
340	380	405	445	495	550	610																																																																																																																	
410	450	475	515	565	620	680																																																																																																																	
				SHIPS PARTIALLY ASSEMBLED PAC OR AB																																																																																																																			

# logic

ergonomics, traditional task styling - an unbeatable value

## STOOL FORMERLY PRECEPT

GSA SIN # 711-18

- Task, stool and conference seating
- Ratchet back height adjustment on P1
- Warranted to 300 lbs.
- CAL TB 133 Fire Code approved



### CREATING LOGIC MODEL NUMBERS



### PACKAGING NOTES

CODE	DESCRIPTION	LIST UPCHARGE
AB	ASSEMBLED IN BAG	\$0
PAC	PARTIALLY ASSEMBLED IN CARTON	\$0
BAC	BACK ASSEMBLED IN CARTON	\$40

MODEL	CONTROL	DESCRIPTION	ARM	FABRIC/LEATHER	FEATURES	DIMENSIONS	ARM OPTIONS																																																								
1726	B2	<b>10" STOOL BASIC</b> Use for work surfaces up to 42 inches high <i>Formerly Precept Series</i>	ARMLESS A1 A4 A5 A6 A7 A16	<table border="1"> <thead> <tr> <th>A/COM</th> <th>B</th> <th>C</th> <th>D</th> <th>E</th> <th>F</th> <th>G</th> </tr> </thead> <tbody> <tr><td>485</td><td>525</td><td>550</td><td>590</td><td>640</td><td>695</td><td>755</td></tr> <tr><td>555</td><td>595</td><td>620</td><td>660</td><td>710</td><td>765</td><td>825</td></tr> <tr><td>560</td><td>600</td><td>625</td><td>665</td><td>715</td><td>770</td><td>830</td></tr> <tr><td>580</td><td>620</td><td>645</td><td>685</td><td>735</td><td>790</td><td>850</td></tr> <tr><td>615</td><td>655</td><td>680</td><td>720</td><td>770</td><td>825</td><td>885</td></tr> <tr><td>635</td><td>675</td><td>700</td><td>740</td><td>790</td><td>845</td><td>905</td></tr> <tr><td>585</td><td>625</td><td>650</td><td>690</td><td>740</td><td>795</td><td>855</td></tr> </tbody> </table>	A/COM	B	C	D	E	F	G	485	525	550	590	640	695	755	555	595	620	660	710	765	825	560	600	625	665	715	770	830	580	620	645	685	735	790	850	615	655	680	720	770	825	885	635	675	700	740	790	845	905	585	625	650	690	740	795	855	<ul style="list-style-type: none"> <li>• Pneumatic seat height adjustment</li> <li>• 360-degree swivel</li> <li>• No seat and back tilt</li> <li>• Adjustable back depth</li> <li>• Height adjustable footring</li> <li>• Warranted to 300 lbs.</li> </ul>	<b>WIDTH:</b> 26.5 <b>DEPTH:</b> 26.5 <b>HEIGHT:</b> 42.5-52.5 <b>SEAT WIDTH:</b> 22.0 <b>SEAT DEPTH:</b> 17.0 <b>SEAT HEIGHT:</b> 25.0-35.0 <b>BACK WIDTH:</b> 19.5 <b>BACK HEIGHT:</b> 18.5 <b>COM:</b> 1.4 YDS <b>WEIGHT:</b> 32.0 LB	<b>A1</b> \$70 <b>A4</b> \$75 <b>A5</b> \$95
A/COM	B	C	D	E	F	G																																																									
485	525	550	590	640	695	755																																																									
555	595	620	660	710	765	825																																																									
560	600	625	665	715	770	830																																																									
580	620	645	685	735	790	850																																																									
615	655	680	720	770	825	885																																																									
635	675	700	740	790	845	905																																																									
585	625	650	690	740	795	855																																																									
1726	P1	<b>10" STOOL POSTURE BACK</b> Use for work surfaces up to 42 inches high <i>Formerly Precept Series</i>	ARMLESS A1 A4 A5 A6 A7 A16	<table border="1"> <thead> <tr> <th>A/COM</th> <th>B</th> <th>C</th> <th>D</th> <th>E</th> <th>F</th> <th>G</th> </tr> </thead> <tbody> <tr><td>570</td><td>610</td><td>635</td><td>675</td><td>725</td><td>780</td><td>840</td></tr> <tr><td>640</td><td>680</td><td>705</td><td>745</td><td>795</td><td>850</td><td>910</td></tr> <tr><td>645</td><td>685</td><td>710</td><td>750</td><td>800</td><td>855</td><td>915</td></tr> <tr><td>665</td><td>705</td><td>730</td><td>770</td><td>820</td><td>875</td><td>935</td></tr> <tr><td>700</td><td>740</td><td>765</td><td>805</td><td>855</td><td>910</td><td>970</td></tr> <tr><td>720</td><td>760</td><td>785</td><td>825</td><td>875</td><td>930</td><td>990</td></tr> <tr><td>670</td><td>710</td><td>735</td><td>775</td><td>825</td><td>880</td><td>940</td></tr> </tbody> </table>	A/COM	B	C	D	E	F	G	570	610	635	675	725	780	840	640	680	705	745	795	850	910	645	685	710	750	800	855	915	665	705	730	770	820	875	935	700	740	765	805	855	910	970	720	760	785	825	875	930	990	670	710	735	775	825	880	940	<ul style="list-style-type: none"> <li>• Pneumatic seat height adjustment</li> <li>• Infinite back angle adjust with free float</li> <li>• Ratchet back height lumbar adjustment</li> <li>• Height adjustable footring</li> <li>• Warranted to 300 lbs.</li> </ul>	<b>WIDTH:</b> 26.5 <b>DEPTH:</b> 26.5 <b>HEIGHT:</b> 42.5-55.5 <b>SEAT WIDTH:</b> 22.0 <b>SEAT DEPTH:</b> 17.0 <b>SEAT HEIGHT:</b> 25.0-35.0 <b>BACK WIDTH:</b> 19.5 <b>BACK HEIGHT:</b> 18.5-21.5 <b>COM:</b> 1.4 YDS <b>WEIGHT:</b> 36.0 LB	<b>A6</b> \$130 <b>A7</b> \$150 <b>A16</b> \$100
A/COM	B	C	D	E	F	G																																																									
570	610	635	675	725	780	840																																																									
640	680	705	745	795	850	910																																																									
645	685	710	750	800	855	915																																																									
665	705	730	770	820	875	935																																																									
700	740	765	805	855	910	970																																																									
720	760	785	825	875	930	990																																																									
670	710	735	775	825	880	940																																																									
1728	B2	<b>8" STOOL BASIC</b> Use for work surfaces up to 36 inches high <i>Formerly Precept Series</i>	ARMLESS A1 A4 A5 A6 A7 A16	<table border="1"> <thead> <tr> <th>A/COM</th> <th>B</th> <th>C</th> <th>D</th> <th>E</th> <th>F</th> <th>G</th> </tr> </thead> <tbody> <tr><td>485</td><td>525</td><td>550</td><td>590</td><td>640</td><td>695</td><td>755</td></tr> <tr><td>555</td><td>595</td><td>620</td><td>660</td><td>710</td><td>765</td><td>825</td></tr> <tr><td>560</td><td>600</td><td>625</td><td>665</td><td>715</td><td>770</td><td>830</td></tr> <tr><td>580</td><td>620</td><td>645</td><td>685</td><td>735</td><td>790</td><td>850</td></tr> <tr><td>615</td><td>655</td><td>680</td><td>720</td><td>770</td><td>825</td><td>885</td></tr> <tr><td>635</td><td>675</td><td>700</td><td>740</td><td>790</td><td>845</td><td>905</td></tr> <tr><td>585</td><td>625</td><td>650</td><td>690</td><td>740</td><td>795</td><td>855</td></tr> </tbody> </table>	A/COM	B	C	D	E	F	G	485	525	550	590	640	695	755	555	595	620	660	710	765	825	560	600	625	665	715	770	830	580	620	645	685	735	790	850	615	655	680	720	770	825	885	635	675	700	740	790	845	905	585	625	650	690	740	795	855	<ul style="list-style-type: none"> <li>• Pneumatic seat height adjustment</li> <li>• 360-degree swivel</li> <li>• No seat and back tilt</li> <li>• Adjustable back depth</li> <li>• Height adjustable footring</li> <li>• Warranted to 300 lbs.</li> </ul>	<b>WIDTH:</b> 26.5 <b>DEPTH:</b> 26.5 <b>HEIGHT:</b> 38.5-46.5 <b>SEAT WIDTH:</b> 22.0 <b>SEAT DEPTH:</b> 17.0 <b>SEAT HEIGHT:</b> 21.0-29.0 <b>BACK WIDTH:</b> 19.5 <b>BACK HEIGHT:</b> 18.5 <b>COM:</b> 1.4 YDS <b>WEIGHT:</b> 31.0 LB	<b>C1</b> STD <b>C1S</b> \$35 <b>C2S</b> \$35
A/COM	B	C	D	E	F	G																																																									
485	525	550	590	640	695	755																																																									
555	595	620	660	710	765	825																																																									
560	600	625	665	715	770	830																																																									
580	620	645	685	735	790	850																																																									
615	655	680	720	770	825	885																																																									
635	675	700	740	790	845	905																																																									
585	625	650	690	740	795	855																																																									
1728	P1	<b>8" STOOL POSTURE BACK</b> Use for work surfaces up to 36 inches high <i>Formerly Precept Series</i>	ARMLESS A1 A4 A5 A6 A7 A16	<table border="1"> <thead> <tr> <th>A/COM</th> <th>B</th> <th>C</th> <th>D</th> <th>E</th> <th>F</th> <th>G</th> </tr> </thead> <tbody> <tr><td>570</td><td>610</td><td>635</td><td>675</td><td>725</td><td>780</td><td>840</td></tr> <tr><td>640</td><td>680</td><td>705</td><td>745</td><td>795</td><td>850</td><td>910</td></tr> <tr><td>645</td><td>685</td><td>710</td><td>750</td><td>800</td><td>855</td><td>915</td></tr> <tr><td>665</td><td>705</td><td>730</td><td>770</td><td>820</td><td>875</td><td>935</td></tr> <tr><td>700</td><td>740</td><td>765</td><td>805</td><td>855</td><td>910</td><td>970</td></tr> <tr><td>720</td><td>760</td><td>785</td><td>825</td><td>875</td><td>930</td><td>990</td></tr> <tr><td>670</td><td>710</td><td>735</td><td>775</td><td>825</td><td>880</td><td>940</td></tr> </tbody> </table>	A/COM	B	C	D	E	F	G	570	610	635	675	725	780	840	640	680	705	745	795	850	910	645	685	710	750	800	855	915	665	705	730	770	820	875	935	700	740	765	805	855	910	970	720	760	785	825	875	930	990	670	710	735	775	825	880	940	<ul style="list-style-type: none"> <li>• Pneumatic seat height adjustment</li> <li>• Infinite back angle adjust with free float</li> <li>• Ratchet back height lumbar adjustment</li> <li>• Height adjustable footring</li> <li>• Warranted to 300 lbs.</li> </ul>	<b>WIDTH:</b> 26.5 <b>DEPTH:</b> 26.5 <b>HEIGHT:</b> 38.5-49.5 <b>SEAT WIDTH:</b> 22.0 <b>SEAT DEPTH:</b> 17.0 <b>SEAT HEIGHT:</b> 21.0-29.0 <b>BACK WIDTH:</b> 19.5 <b>BACK HEIGHT:</b> 18.5-21.5 <b>COM:</b> 1.4 YDS <b>WEIGHT:</b> 35.0 LB	<b>BT</b> \$15 <b>EF1</b> \$30 <b>MF1</b> \$50 <b>SS</b> \$60 <b>BN1</b> \$35 <b>BN2</b> \$N/C <b>EP</b> \$60
A/COM	B	C	D	E	F	G																																																									
570	610	635	675	725	780	840																																																									
640	680	705	745	795	850	910																																																									
645	685	710	750	800	855	915																																																									
665	705	730	770	820	875	935																																																									
700	740	765	805	855	910	970																																																									
720	760	785	825	875	930	990																																																									
670	710	735	775	825	880	940																																																									

# logic

ergonomics, traditional task styling - an unbeatable value

## MID-BACK

GSA SIN # 711-18

- Task, stool, and conference seating
- Multiple back sizes including low, mid and high
- Ratchet back height adjustment on P1, R1, M1 and Y2 models
- Warranted to 300 lbs.
- CAL TB 133 Fire Code approved



### CREATING LOGIC MODEL NUMBER

MODEL NUMBER CONTROL ARMS GRADE BASE CASTERS PACKAGING OPTIONS

1 7 6 0 - [ ] - A [ ] - [ ] - B A 1 - C [ ] - [ ] - [ ] - [ ]

\* FOR ARMLESS CODE USE A00

### PACKAGING NOTES

CODE	DESCRIPTION	LIST UPCHARGE
AB	ASSEMBLED IN BAG	\$0
PAC	PARTIALLY ASSEMBLED IN CARTON	\$0
BAC	BACK ASSEMBLED IN CARTON	\$40

MODEL	CONTROL	DESCRIPTION	ARM	FABRIC/LEATHER	FEATURES	DIMENSIONS	ARM OPTIONS																																																								
1760	S2	<b>MID-BACK SWIVEL TILT</b> Use for a variety of general office seating, including private office and conference room seating	ARMLESS A1 A4 A5 A6 A7 A16	<table border="1"> <thead> <tr> <th>A/COM</th> <th>B</th> <th>C</th> <th>D</th> <th>E</th> <th>F</th> <th>G</th> </tr> </thead> <tbody> <tr><td>470</td><td>520</td><td>555</td><td>605</td><td>665</td><td>730</td><td>800</td></tr> <tr><td>540</td><td>590</td><td>625</td><td>675</td><td>735</td><td>800</td><td>870</td></tr> <tr><td>545</td><td>595</td><td>630</td><td>680</td><td>740</td><td>805</td><td>875</td></tr> <tr><td>565</td><td>615</td><td>650</td><td>700</td><td>760</td><td>825</td><td>895</td></tr> <tr><td>600</td><td>650</td><td>685</td><td>735</td><td>795</td><td>860</td><td>930</td></tr> <tr><td>620</td><td>670</td><td>705</td><td>755</td><td>815</td><td>880</td><td>950</td></tr> <tr><td>570</td><td>620</td><td>655</td><td>705</td><td>765</td><td>830</td><td>900</td></tr> </tbody> </table>	A/COM	B	C	D	E	F	G	470	520	555	605	665	730	800	540	590	625	675	735	800	870	545	595	630	680	740	805	875	565	615	650	700	760	825	895	600	650	685	735	795	860	930	620	670	705	755	815	880	950	570	620	655	705	765	830	900	<ul style="list-style-type: none"> <li>• Pneumatic seat height adjustment</li> <li>• Tilt tension control</li> <li>• Seat and back tilt as a unit</li> <li>• 360-degree swivel</li> <li>• Upright position tilt lock</li> <li>• Adjustable back depth</li> <li>• Warranted to 300 lbs.</li> </ul>	<b>WIDTH:</b> 26.5 <b>DEPTH:</b> 26.0 <b>HEIGHT:</b> 39.0-43.5 <b>SEAT WIDTH:</b> 22.0 <b>SEAT DEPTH:</b> 17.5 <b>SEAT HEIGHT:</b> 17.0-21.5 <b>BACK WIDTH:</b> 20.0 <b>BACK HEIGHT:</b> 20.5-23.5 <b>COM:</b> 1.6 YD <b>WEIGHT:</b> 28.5 LB	<b>A1</b> \$70 Soft Touch Loop Arm <b>A4</b> \$75 Height Adjustable Arm <b>A5</b> \$95 Height/Width Adjustable Arm
A/COM	B	C	D	E	F	G																																																									
470	520	555	605	665	730	800																																																									
540	590	625	675	735	800	870																																																									
545	595	630	680	740	805	875																																																									
565	615	650	700	760	825	895																																																									
600	650	685	735	795	860	930																																																									
620	670	705	755	815	880	950																																																									
570	620	655	705	765	830	900																																																									
1760	R1	<b>MID-BACK ROCKING TILT</b> For managerial and task applications. Similar to a swivel tilt control, with the added comfort of infinite back angle and tilt adjustment	ARMLESS A1 A4 A5 A6 A7 A16	<table border="1"> <thead> <tr> <th>A/COM</th> <th>B</th> <th>C</th> <th>D</th> <th>E</th> <th>F</th> <th>G</th> </tr> </thead> <tbody> <tr><td>520</td><td>570</td><td>605</td><td>655</td><td>715</td><td>780</td><td>850</td></tr> <tr><td>590</td><td>640</td><td>675</td><td>725</td><td>785</td><td>850</td><td>920</td></tr> <tr><td>595</td><td>645</td><td>680</td><td>730</td><td>790</td><td>855</td><td>925</td></tr> <tr><td>615</td><td>665</td><td>700</td><td>750</td><td>810</td><td>875</td><td>945</td></tr> <tr><td>650</td><td>700</td><td>735</td><td>785</td><td>845</td><td>910</td><td>980</td></tr> <tr><td>670</td><td>720</td><td>755</td><td>805</td><td>865</td><td>930</td><td>1000</td></tr> <tr><td>620</td><td>670</td><td>705</td><td>755</td><td>815</td><td>880</td><td>950</td></tr> </tbody> </table>	A/COM	B	C	D	E	F	G	520	570	605	655	715	780	850	590	640	675	725	785	850	920	595	645	680	730	790	855	925	615	665	700	750	810	875	945	650	700	735	785	845	910	980	670	720	755	805	865	930	1000	620	670	705	755	815	880	950	<ul style="list-style-type: none"> <li>• Pneumatic seat height adjustment</li> <li>• Tilt tension control</li> <li>• Seat and back tilt as a unit</li> <li>• Floating seat position tilt lock</li> <li>• Infinite back angle adj. w/ free float</li> <li>• Ratchet back height lumbar adjustment</li> <li>• Warranted to 300 lbs.</li> </ul>	<b>WIDTH:</b> 26.5 <b>DEPTH:</b> 26.0 <b>HEIGHT:</b> 39.0-46.5 <b>SEAT WIDTH:</b> 22.0 <b>SEAT DEPTH:</b> 17.5 <b>SEAT HEIGHT:</b> 16.5-21.0 <b>BACK WIDTH:</b> 20.0 <b>BACK HEIGHT:</b> 20.5-23.5 <b>COM:</b> 1.6 YD <b>WEIGHT:</b> 34.0 LB	<b>A6</b> \$130 Height Adjustable Pivot/Slide Arm with Ura-Soft Sliding Arm Pads <b>A7</b> \$150 Height/Width Adjustable Pivot/Slide Arm with Ura-Soft Sliding Arm Pads <b>A16</b> \$100 Soft Touch C-Shape Arm w/Upholstered Pad
A/COM	B	C	D	E	F	G																																																									
520	570	605	655	715	780	850																																																									
590	640	675	725	785	850	920																																																									
595	645	680	730	790	855	925																																																									
615	665	700	750	810	875	945																																																									
650	700	735	785	845	910	980																																																									
670	720	755	805	865	930	1000																																																									
620	670	705	755	815	880	950																																																									
1760	Y2	<b>MID-BACK HEAVY DUTY SYNCHRO</b> Use for a variety of general office seating, including private office and conference room seating	ARMLESS A1 A4 A5 A6 A7 A16	<table border="1"> <thead> <tr> <th>A/COM</th> <th>B</th> <th>C</th> <th>D</th> <th>E</th> <th>F</th> <th>G</th> </tr> </thead> <tbody> <tr><td>550</td><td>600</td><td>635</td><td>685</td><td>745</td><td>810</td><td>880</td></tr> <tr><td>620</td><td>670</td><td>705</td><td>755</td><td>815</td><td>880</td><td>950</td></tr> <tr><td>625</td><td>675</td><td>710</td><td>760</td><td>820</td><td>885</td><td>955</td></tr> <tr><td>645</td><td>695</td><td>730</td><td>780</td><td>840</td><td>905</td><td>975</td></tr> <tr><td>680</td><td>730</td><td>765</td><td>815</td><td>875</td><td>940</td><td>1010</td></tr> <tr><td>700</td><td>750</td><td>785</td><td>835</td><td>895</td><td>960</td><td>1030</td></tr> <tr><td>650</td><td>700</td><td>735</td><td>785</td><td>845</td><td>910</td><td>980</td></tr> </tbody> </table>	A/COM	B	C	D	E	F	G	550	600	635	685	745	810	880	620	670	705	755	815	880	950	625	675	710	760	820	885	955	645	695	730	780	840	905	975	680	730	765	815	875	940	1010	700	750	785	835	895	960	1030	650	700	735	785	845	910	980	<ul style="list-style-type: none"> <li>• Pneumatic seat height adjustment</li> <li>• Side tilt tension control</li> <li>• Back and seat tilt in 2:1 ratio</li> <li>• 4 locking positions</li> <li>• Safety tilt release</li> <li>• Ratchet back height lumbar adjustment</li> <li>• Warranted to 300 lbs.</li> </ul>	<b>WIDTH:</b> 26.5 <b>DEPTH:</b> 26.0 <b>HEIGHT:</b> 37.5-45.0 <b>SEAT WIDTH:</b> 22.0 <b>SEAT DEPTH:</b> 17.5 <b>SEAT HEIGHT:</b> 18.5-23.0 <b>BACK WIDTH:</b> 20.0 <b>BACK HEIGHT:</b> 19.0-22.0 <b>COM:</b> 1.6 YD <b>WEIGHT:</b> 41.0 LB	<b>C1</b> STD \$15 50mm Hooded Casters <b>C1S</b> \$35 50mm Hooded Hard Floor Casters <b>C2S</b> \$35 50mm Hooded Self-Locking Hard Floor Casters
A/COM	B	C	D	E	F	G																																																									
550	600	635	685	745	810	880																																																									
620	670	705	755	815	880	950																																																									
625	675	710	760	820	885	955																																																									
645	695	730	780	840	905	975																																																									
680	730	765	815	875	940	1010																																																									
700	750	785	835	895	960	1030																																																									
650	700	735	785	845	910	980																																																									
1760	M1	<b>MID-BACK MULTI-FUNCTION</b> Fully articulating seat and back for the highest level of ergonomic needs. Forward seat pitch adjustment from 0 to 6-degrees	ARMLESS A1 A4 A5 A6 A7 A16	<table border="1"> <thead> <tr> <th>A/COM</th> <th>B</th> <th>C</th> <th>D</th> <th>E</th> <th>F</th> <th>G</th> </tr> </thead> <tbody> <tr><td>570</td><td>620</td><td>655</td><td>705</td><td>765</td><td>830</td><td>900</td></tr> <tr><td>640</td><td>690</td><td>725</td><td>775</td><td>835</td><td>900</td><td>970</td></tr> <tr><td>645</td><td>695</td><td>730</td><td>780</td><td>840</td><td>905</td><td>975</td></tr> <tr><td>665</td><td>715</td><td>750</td><td>800</td><td>860</td><td>925</td><td>995</td></tr> <tr><td>700</td><td>750</td><td>785</td><td>835</td><td>895</td><td>960</td><td>1030</td></tr> <tr><td>720</td><td>770</td><td>805</td><td>855</td><td>915</td><td>980</td><td>1050</td></tr> <tr><td>670</td><td>720</td><td>755</td><td>805</td><td>865</td><td>930</td><td>1000</td></tr> </tbody> </table>	A/COM	B	C	D	E	F	G	570	620	655	705	765	830	900	640	690	725	775	835	900	970	645	695	730	780	840	905	975	665	715	750	800	860	925	995	700	750	785	835	895	960	1030	720	770	805	855	915	980	1050	670	720	755	805	865	930	1000	<ul style="list-style-type: none"> <li>• Pneumatic seat height adjustment</li> <li>• Tilt tension control</li> <li>• Seat and back tilt as a unit</li> <li>• Floating seat position tilt lock</li> <li>• Infinite back angle adj. w/ free float</li> <li>• Seat pivots from 0° to 6° forward</li> <li>• Ratchet back height lumbar adjustment</li> <li>• Warranted to 300 lbs.</li> </ul>	<b>WIDTH:</b> 26.5 <b>DEPTH:</b> 26.0 <b>HEIGHT:</b> 39.0-46.5 <b>SEAT WIDTH:</b> 22.0 <b>SEAT DEPTH:</b> 17.5 <b>SEAT HEIGHT:</b> 17.0-21.5 <b>BACK WIDTH:</b> 20.0 <b>BACK HEIGHT:</b> 20.5-23.5 <b>COM:</b> 1.6 YD <b>WEIGHT:</b> 37.5 LB	<b>BT</b> \$15 Replace Knob with Bolt (For S2 and B2 Controls Only) <b>MF1</b> \$50 EF1 \$30 EF1 - 1" Extra Foam on Seat MF1 - 1" Visco Elastic Memory Foam on Seat <b>EP</b> \$60 Edge Protector - a Clear Vinyl Tube Placed Around the Edge of the Back Cushion <b>SS</b> \$60 Seat Slider 2.5" Side Paddle Activated <b>BN1</b> \$35 <b>BN2</b> \$N/C Upholstered Outer Back in Black Ballistic Nylon BN1 - with Grade A ONLY BN2 - with Grade B and Up <b>HD</b> \$125 Heavy Duty Multi-Shift Upgrade 350 lb. Includes BA2 Aluminum Base and C4 60mm Casters; Available with M1 and Y2 Only
A/COM	B	C	D	E	F	G																																																									
570	620	655	705	765	830	900																																																									
640	690	725	775	835	900	970																																																									
645	695	730	780	840	905	975																																																									
665	715	750	800	860	925	995																																																									
700	750	785	835	895	960	1030																																																									
720	770	805	855	915	980	1050																																																									
670	720	755	805	865	930	1000																																																									

# logic

ergonomics, traditional task styling - an unbeatable value

## STOOL

GSA SIN # 711-18

- Task, stool and conference seating
- Ratchet back height adjustment on P1
- Warranted to 300 lbs.
- CAL TB 133 Fire Code approved



### CREATING LOGIC MODEL NUMBER

MODEL NUMBER CONTROL ARMS GRADE BASE CASTERS PACKAGING OPTIONS

1 7 6 - P 1 - A - - - - B A 1 - C - - - - - - -

\* FOR ARMLESS CODE USE A00

### PACKAGING NOTES

CODE	DESCRIPTION	LIST UPCHARGE
AB	ASSEMBLED IN BAG	\$0
PAC	PARTIALLY ASSEMBLED IN CARTON	\$0
BAC	BACK ASSEMBLED IN CARTON	\$40

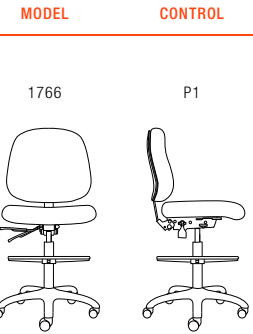

**10" STOOL POSTURE BACK**  
Use for work surfaces up to 42 inches high

ARM	FABRIC/LEATHER	A/COM	B	C	D	E	F	G
ARMLESS		635	685	720	770	830	895	965
A1		705	755	790	840	900	965	1035
A4		710	760	795	845	905	970	1040
A5		730	780	815	865	925	990	1060
A6		765	815	850	900	960	1025	1095
A7		785	835	870	920	980	1045	1115
A16		735	785	820	870	930	995	1065

SEAT SLIDER (SS) - NOT AVAILABLE

- FEATURES**
- Pneumatic seat height adjustment
  - Infinite back angle adjust with free float
  - Ratchet back height lumbar adjustment
  - Height adjustable footring
  - Warranted to 300 lbs.

**DIMENSIONS**

WIDTH: 26.5  
DEPTH: 26.0  
HEIGHT: 46.5-59.5  
SEAT WIDTH: 22.0  
SEAT DEPTH: 17.5  
SEAT HEIGHT: 24.5-34.5  
BACK WIDTH: 20.0  
BACK HEIGHT: 20.5-23.5  
COM: 1.6 YDS  
WEIGHT: 43.5 LB

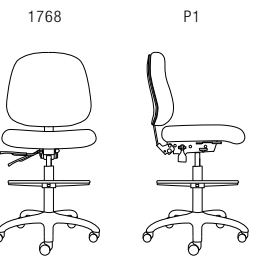
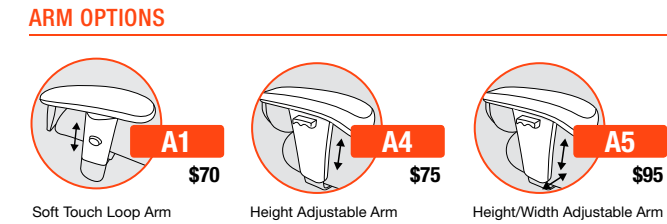

**8" STOOL POSTURE BACK**  
Use for work surfaces up to 36 inches high

ARM	FABRIC/LEATHER	A/COM	B	C	D	E	F	G
ARMLESS		635	685	720	770	830	895	965
A1		705	755	790	840	900	965	1035
A4		710	760	795	845	905	970	1040
A5		730	780	815	865	925	990	1060
A6		765	815	850	900	960	1025	1095
A7		785	835	870	920	980	1045	1115
A16		735	785	820	870	930	995	1065

SEAT SLIDER (SS) - NOT AVAILABLE

- FEATURES**
- Pneumatic seat height adjustment
  - Infinite back angle adjust with free float
  - Ratchet back height lumbar adjustment
  - Height adjustable footring
  - Warranted to 300 lbs.

**DIMENSIONS**

WIDTH: 26.5  
DEPTH: 26.0  
HEIGHT: 43.5-54.5  
SEAT WIDTH: 22.0  
SEAT DEPTH: 17.5  
SEAT HEIGHT: 21.5-29.5  
BACK WIDTH: 20.0  
BACK HEIGHT: 20.5-23.5  
COM: 1.6 YDS  
WEIGHT: 42.5 LB

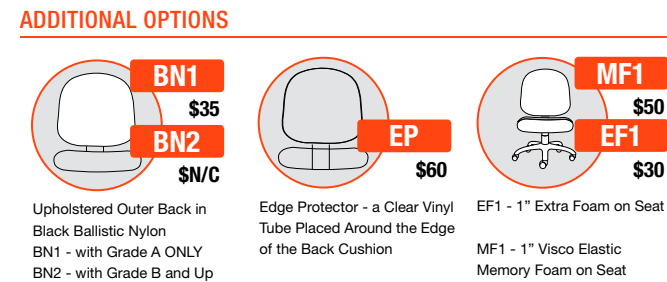
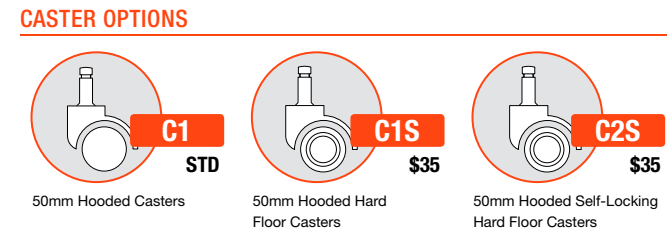

# logic

ergonomics, traditional task styling - an unbeatable value

## HIGH-BACK

GSA SIN # 711-18

- Task, stool and conference seating
- Multiple back sizes including low, mid and high
- Ratchet back height adjustment on R1, M1 and Y2 models
- Warranted to 300 lbs.
- CAL TB 133 Fire Code approved



### CREATING LOGIC MODEL NUMBER

MODEL NUMBER CONTROL ARMS GRADE BASE CASTERS PACKAGING OPTIONS

1 7 8 0 - - A - - - B A 1 - C - - - -

\* FOR ARMLESS CODE USE A00

### PACKAGING NOTES

CODE	DESCRIPTION	LIST UPCHARGE
AB	ASSEMBLED IN BAG	\$0
PAC	PARTIALLY ASSEMBLED IN CARTON	\$0
BAC	BACK ASSEMBLED IN CARTON	\$40

MODEL	CONTROL	DESCRIPTION	ARM	FABRIC/LEATHER	FEATURES	DIMENSIONS	ARM OPTIONS																																																								
1780	S2	<b>HIGH-BACK SWIVEL TILT</b> Use for a variety of general office seating, including private office and conference room seating	ARMLESS A1 A4 A5 A6 A7 A16	<table border="1"> <thead> <tr> <th>A/COM</th> <th>B</th> <th>C</th> <th>D</th> <th>E</th> <th>F</th> <th>G</th> </tr> </thead> <tbody> <tr><td>520</td><td>580</td><td>620</td><td>680</td><td>750</td><td>825</td><td>910</td></tr> <tr><td>590</td><td>650</td><td>690</td><td>750</td><td>820</td><td>895</td><td>980</td></tr> <tr><td>595</td><td>655</td><td>695</td><td>755</td><td>825</td><td>900</td><td>985</td></tr> <tr><td>615</td><td>675</td><td>715</td><td>775</td><td>845</td><td>920</td><td>1005</td></tr> <tr><td>650</td><td>710</td><td>750</td><td>810</td><td>880</td><td>955</td><td>1040</td></tr> <tr><td>670</td><td>730</td><td>770</td><td>830</td><td>900</td><td>975</td><td>1060</td></tr> <tr><td>620</td><td>680</td><td>720</td><td>780</td><td>850</td><td>925</td><td>1010</td></tr> </tbody> </table>	A/COM	B	C	D	E	F	G	520	580	620	680	750	825	910	590	650	690	750	820	895	980	595	655	695	755	825	900	985	615	675	715	775	845	920	1005	650	710	750	810	880	955	1040	670	730	770	830	900	975	1060	620	680	720	780	850	925	1010	<ul style="list-style-type: none"> <li>• Pneumatic seat height adjustment</li> <li>• Tilt tension control</li> <li>• Seat and back tilt as a unit</li> <li>• 360-degree swivel</li> <li>• Upright position tilt lock</li> <li>• Adjustable back depth</li> <li>• Warranted to 300 lbs.</li> </ul>	<p>WIDTH: 26.5 DEPTH: 26.0 HEIGHT: 42.0 SEAT WIDTH: 22.0 SEAT DEPTH: 17.5 SEAT HEIGHT: 17.0-21.5 BACK WIDTH: 20.0 BACK HEIGHT: 24.0 COM: 1.9 YD WEIGHT: 36.0 LB</p>	<p><b>A1</b> \$70 Soft Touch Loop Arm</p> <p><b>A4</b> \$75 Height Adjustable Arm</p> <p><b>A5</b> \$95 Height/Width Adjustable Arm</p>
A/COM	B	C	D	E	F	G																																																									
520	580	620	680	750	825	910																																																									
590	650	690	750	820	895	980																																																									
595	655	695	755	825	900	985																																																									
615	675	715	775	845	920	1005																																																									
650	710	750	810	880	955	1040																																																									
670	730	770	830	900	975	1060																																																									
620	680	720	780	850	925	1010																																																									
1780	R1	<b>HIGH-BACK ROCKING TILT</b> For managerial and task applications. Similar to a swivel tilt control, with the added comfort of infinite back angle and tilt adjustment	ARMLESS A1 A4 A5 A6 A7 A16	<table border="1"> <thead> <tr> <th>A/COM</th> <th>B</th> <th>C</th> <th>D</th> <th>E</th> <th>F</th> <th>G</th> </tr> </thead> <tbody> <tr><td>570</td><td>630</td><td>670</td><td>730</td><td>800</td><td>875</td><td>960</td></tr> <tr><td>640</td><td>700</td><td>740</td><td>800</td><td>870</td><td>945</td><td>1030</td></tr> <tr><td>645</td><td>705</td><td>745</td><td>805</td><td>875</td><td>950</td><td>1035</td></tr> <tr><td>665</td><td>725</td><td>765</td><td>825</td><td>895</td><td>970</td><td>1055</td></tr> <tr><td>700</td><td>760</td><td>800</td><td>860</td><td>930</td><td>1005</td><td>1090</td></tr> <tr><td>720</td><td>780</td><td>820</td><td>880</td><td>950</td><td>1025</td><td>1110</td></tr> <tr><td>670</td><td>730</td><td>770</td><td>830</td><td>900</td><td>975</td><td>1060</td></tr> </tbody> </table>	A/COM	B	C	D	E	F	G	570	630	670	730	800	875	960	640	700	740	800	870	945	1030	645	705	745	805	875	950	1035	665	725	765	825	895	970	1055	700	760	800	860	930	1005	1090	720	780	820	880	950	1025	1110	670	730	770	830	900	975	1060	<ul style="list-style-type: none"> <li>• Pneumatic seat height adjustment</li> <li>• Tilt tension control</li> <li>• Seat and back tilt as a unit</li> <li>• Floating seat position tilt lock</li> <li>• Infinite back angle adjust with free float</li> <li>• Ratchet back height lumbar adjustment</li> <li>• Warranted to 300 lbs.</li> </ul>	<p>WIDTH: 26.5 DEPTH: 26.0 HEIGHT: 42.0-49.5 SEAT WIDTH: 22.0 SEAT DEPTH: 17.5 SEAT HEIGHT: 17.0-21.5 BACK WIDTH: 20.0 BACK HEIGHT: 24.0-27.0 COM: 1.9 YD WEIGHT: 41.0 LB</p>	<p><b>A6</b> \$130 Height Adjustable Pivot/Slide Arm with Ura-Soft Sliding Arm Pads</p> <p><b>A7</b> \$150 Height/Width Adjustable Pivot/Slide Arm with Ura-Soft Sliding Arm Pads</p> <p><b>A16</b> \$100 Soft Touch C-Shape Arm w/Upholstered Pad</p>
A/COM	B	C	D	E	F	G																																																									
570	630	670	730	800	875	960																																																									
640	700	740	800	870	945	1030																																																									
645	705	745	805	875	950	1035																																																									
665	725	765	825	895	970	1055																																																									
700	760	800	860	930	1005	1090																																																									
720	780	820	880	950	1025	1110																																																									
670	730	770	830	900	975	1060																																																									
1780	Y2	<b>HIGH-BACK HEAVY DUTY SYNCHRO</b> Use for a variety of general office seating, including private office and conference room seating	ARMLESS A1 A4 A5 A6 A7 A16	<table border="1"> <thead> <tr> <th>A/COM</th> <th>B</th> <th>C</th> <th>D</th> <th>E</th> <th>F</th> <th>G</th> </tr> </thead> <tbody> <tr><td>600</td><td>660</td><td>700</td><td>760</td><td>830</td><td>905</td><td>990</td></tr> <tr><td>670</td><td>730</td><td>770</td><td>830</td><td>900</td><td>975</td><td>1060</td></tr> <tr><td>675</td><td>735</td><td>775</td><td>835</td><td>905</td><td>980</td><td>1065</td></tr> <tr><td>695</td><td>755</td><td>795</td><td>855</td><td>925</td><td>1000</td><td>1085</td></tr> <tr><td>730</td><td>790</td><td>830</td><td>890</td><td>960</td><td>1035</td><td>1120</td></tr> <tr><td>750</td><td>810</td><td>850</td><td>910</td><td>980</td><td>1055</td><td>1140</td></tr> <tr><td>700</td><td>760</td><td>800</td><td>860</td><td>930</td><td>1005</td><td>1090</td></tr> </tbody> </table>	A/COM	B	C	D	E	F	G	600	660	700	760	830	905	990	670	730	770	830	900	975	1060	675	735	775	835	905	980	1065	695	755	795	855	925	1000	1085	730	790	830	890	960	1035	1120	750	810	850	910	980	1055	1140	700	760	800	860	930	1005	1090	<ul style="list-style-type: none"> <li>• Pneumatic seat height adjustment</li> <li>• Side tilt tension control</li> <li>• Back and seat tilt in 2:1 ratio</li> <li>• 4 locking positions</li> <li>• Safety tilt release</li> <li>• Ratchet back height lumbar adjustment</li> <li>• Warranted to 300 lbs.</li> </ul>	<p>WIDTH: 26.5 DEPTH: 26.0 HEIGHT: 40.5-48.0 SEAT WIDTH: 22.0 SEAT DEPTH: 17.5 SEAT HEIGHT: 17.0-21.5 BACK WIDTH: 20.0 BACK HEIGHT: 22.5-25.5 COM: 1.9 YD WEIGHT: 43.0 LB</p>	<p><b>C1</b> STD 50mm Hooded Casters</p> <p><b>C1S</b> \$35 50mm Hooded Hard Floor Casters</p> <p><b>C2S</b> \$35 50mm Hooded Self-Locking Hard Floor Casters</p>
A/COM	B	C	D	E	F	G																																																									
600	660	700	760	830	905	990																																																									
670	730	770	830	900	975	1060																																																									
675	735	775	835	905	980	1065																																																									
695	755	795	855	925	1000	1085																																																									
730	790	830	890	960	1035	1120																																																									
750	810	850	910	980	1055	1140																																																									
700	760	800	860	930	1005	1090																																																									
1780	M1	<b>HIGH-BACK MULTI-FUNCTION</b> Fully articulating seat and back for the highest level of ergonomic needs. Forward seat pitch adjustment from 0 to 6-degrees	ARMLESS A1 A4 A5 A6 A7 A16	<table border="1"> <thead> <tr> <th>A/COM</th> <th>B</th> <th>C</th> <th>D</th> <th>E</th> <th>F</th> <th>G</th> </tr> </thead> <tbody> <tr><td>620</td><td>680</td><td>720</td><td>780</td><td>850</td><td>925</td><td>1010</td></tr> <tr><td>690</td><td>750</td><td>790</td><td>850</td><td>920</td><td>995</td><td>1080</td></tr> <tr><td>695</td><td>755</td><td>795</td><td>855</td><td>925</td><td>1000</td><td>1085</td></tr> <tr><td>715</td><td>775</td><td>815</td><td>875</td><td>945</td><td>1020</td><td>1105</td></tr> <tr><td>750</td><td>810</td><td>850</td><td>910</td><td>980</td><td>1055</td><td>1140</td></tr> <tr><td>770</td><td>830</td><td>870</td><td>930</td><td>1000</td><td>1075</td><td>1160</td></tr> <tr><td>720</td><td>780</td><td>820</td><td>880</td><td>950</td><td>1025</td><td>1110</td></tr> </tbody> </table>	A/COM	B	C	D	E	F	G	620	680	720	780	850	925	1010	690	750	790	850	920	995	1080	695	755	795	855	925	1000	1085	715	775	815	875	945	1020	1105	750	810	850	910	980	1055	1140	770	830	870	930	1000	1075	1160	720	780	820	880	950	1025	1110	<ul style="list-style-type: none"> <li>• Pneumatic seat height adjustment</li> <li>• Tilt tension control</li> <li>• Seat and back tilt as a unit</li> <li>• Floating seat position tilt lock</li> <li>• Infinite back angle adjust with free float</li> <li>• Seat pivots from 0° to 6° forward</li> <li>• Ratchet back height lumbar adjustment</li> <li>• Warranted to 300 lbs.</li> </ul>	<p>WIDTH: 26.5 DEPTH: 26.0 HEIGHT: 42.0-49.5 SEAT WIDTH: 22.0 SEAT DEPTH: 17.5 SEAT HEIGHT: 17.0-21.5 BACK WIDTH: 20.0 BACK HEIGHT: 24.0-27.0 COM: 1.9 YD WEIGHT: 45.0 LB</p>	<p><b>BT</b> \$15 Replace Knob with Bolt (For S2 and B2 Controls Only)</p> <p><b>MF1</b> \$50 EF1 - 1" Extra Foam on Seat MF1 - 1" Visco Elastic Memory Foam on Seat</p> <p><b>EP</b> \$60 Edge Protector - a Clear Vinyl Tube Placed Around the Edge of the Back Cushion</p> <p><b>SS</b> \$60 Seat Slider 2.5" Side Paddle Activated</p> <p><b>BN1</b> \$35 <b>BN2</b> \$N/C Upholstered Outer Back in Black Ballistic Nylon BN1 - with Grade A ONLY BN2 - with Grade B and Up</p> <p><b>HD</b> \$125 Heavy Duty Multi-Shift Upgrade 350 lb. Includes BA2 Aluminum Base and C4 60mm Casters; Available with M1 and Y2 Configurations Only</p>
A/COM	B	C	D	E	F	G																																																									
620	680	720	780	850	925	1010																																																									
690	750	790	850	920	995	1080																																																									
695	755	795	855	925	1000	1085																																																									
715	775	815	875	945	1020	1105																																																									
750	810	850	910	980	1055	1140																																																									
770	830	870	930	1000	1075	1160																																																									
720	780	820	880	950	1025	1110																																																									

# logic plus

ergonomics, traditional task styling - an unbeatable value

## HIGH-BACK

GSA SIN # 711-18

- Task seating
- Ratchet back height adjustment
- Warranted to 500 lbs.
- Seat slider standard
- Heavy duty 5 star base
- Heavy duty gas lift
- Heavy duty M2 control



### CREATING LOGIC PLUS MODEL NUMBER



### PACKAGING NOTES

CODE	DESCRIPTION	LIST UPCHARGE
AB	ASSEMBLED IN BAG	\$0
PAC	PARTIALLY ASSEMBLED IN CARTON	\$0
BAC	BACK ASSEMBLED IN CARTON	\$40

MODEL	CONTROL	DESCRIPTION	ARM	FABRIC/LEATHER	FEATURES	DIMENSIONS																																			
1790	M2	<b>HIGH-BACK HEAVY DUTY MULTI-FUNCTION</b>  Use for a variety of general office seating, including private office and conference room seating	ARMLESS	<table border="1"> <thead> <tr> <th>A/COM</th> <th>B</th> <th>C</th> <th>D</th> <th>E</th> <th>F</th> <th>G</th> </tr> </thead> <tbody> <tr> <td>825</td> <td>930</td> <td>1000</td> <td>1105</td> <td>1225</td> <td>1360</td> <td>1505</td> </tr> <tr> <td>920</td> <td>1025</td> <td>1095</td> <td>1200</td> <td>1320</td> <td>1455</td> <td>1600</td> </tr> <tr> <td>1025</td> <td>1130</td> <td>1200</td> <td>1305</td> <td>1425</td> <td>1560</td> <td>1705</td> </tr> <tr> <td>950</td> <td>1055</td> <td>1125</td> <td>1230</td> <td>1350</td> <td>1485</td> <td>1630</td> </tr> </tbody> </table>	A/COM	B	C	D	E	F	G	825	930	1000	1105	1225	1360	1505	920	1025	1095	1200	1320	1455	1600	1025	1130	1200	1305	1425	1560	1705	950	1055	1125	1230	1350	1485	1630	<ul style="list-style-type: none"> <li>• Heavy duty pneumatic seat height adjustment</li> <li>• Tilt tension control</li> <li>• Back and seat tilt as unit</li> <li>• Floating seat position tilt lock</li> <li>• Infinite back angle adjust with free float</li> <li>• Seat pivots up to 6-degrees forward w/ adjustable front tilt stop</li> <li>• Built-in seat slider</li> <li>• Ratchet back height lumbar adj.</li> <li>• 26" diameter 5 star base</li> <li>• Warranted to 500 lbs.</li> </ul>	<b>WIDTH:</b> 30.0-33.0 <b>DEPTH:</b> 28.0 <b>HEIGHT:</b> 43.5-52.0 <b>SEAT WIDTH:</b> 25.0 <b>SEAT DEPTH:</b> 17.0-20.0 <b>SEAT HEIGHT:</b> 17.0-22.0 <b>BACK WIDTH:</b> 23.5 <b>BACK HEIGHT:</b> 26.5-30.5 <b>COM:</b> 3.3 YD <b>WEIGHT:</b> 65.0 LB
A/COM	B		C	D	E	F	G																																		
825	930		1000	1105	1225	1360	1505																																		
920	1025		1095	1200	1320	1455	1600																																		
1025	1130	1200	1305	1425	1560	1705																																			
950	1055	1125	1230	1350	1485	1630																																			
	A5																																								
	A90																																								
	A37																																								

SEAT SLIDER (SS) - STANDARD

### ARM OPTIONS



**A5**  
\$95

Height/Width Adjustable Arm



**A90**  
\$200

Height Adjustable Breakaway Arm

### CASTER OPTIONS



**C4**  
STD

60mm Hoodless Casters



**C1S**  
\$35

50mm Hooded Hard Floor Casters



**C2S**  
\$35

50mm Hooded Self-Locking Hard Floor Casters

### BASE OPTIONS



**BA1HD**  
STD

26" Heavy Duty Nylon Base - Black

### ADDITIONAL OPTIONS

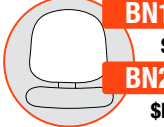

**BN1**  
\$35

Upholstered Outer Back in Black Ballistic Nylon

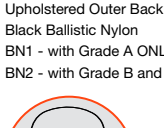

**BN2**  
\$N/C

BN1 - with Grade A ONLY  
BN2 - with Grade B and Up

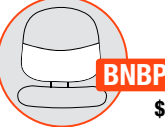

**BNBP1**  
\$90

Ballistic Nylon Applied Over a Portion of the Lower Backrest Surface



**BNBP2**  
\$180

Ballistic Nylon Applied Over a Portion of the Lower Backrest Surface and Full Seat



**EP**  
\$60

Edge Protector - a Clear Vinyl Tube Placed Around the Edge of the Back Cushion

# luna

high design meets supreme ergonomics

NEW MESH BACK

GSA SIN # 711-18 Pending

- Task, stool, conference and collaborative seating
- Sleek contemporary design
- Aluminum accents standard
- Fully ergonomic and stylish design at a budget conscious price
- Seat slider standard
- Height adjustable lumbar available
- Choice of two plastic colors - dove gray and black
- 8 breathable mesh colors
- CAL TB 133 Fire Code approved
- Warranted up to 300 lbs



### CREATING LUNA MODEL NUMBER

MODEL NUMBER CONTROL ARMS PLASTIC COLOR MESH COLOR GRADE BASE CASTERS PACKAGING OPTIONS

3 4 6 - A 4 - P - M - B A - C -

\* FOR ARMLESS CODE USE A00

### PACKAGING NOTES

CODE	DESCRIPTION	LIST UPCHARGE
AB	ASSEMBLED IN BAG	\$0
PAC	PARTIALLY ASSEMBLED IN CARTON	\$0
BAC	BACK ASSEMBLED IN CARTON	\$40

MODEL	CONTROL	DESCRIPTION	ARM	FABRIC/LEATHER	FEATURES	DIMENSIONS																																																		
NEW MODEL 3460	Y1	<b>SIMPLE SYNCHRO</b> Use for a variety of general office task seating, including private office and conference seating	ARMLESS A42B/G A43B/G A45B/G	<table border="1"> <thead> <tr> <th>A/COM</th> <th>B</th> <th>C</th> <th>D</th> <th>E</th> <th>F</th> <th>G</th> <th>L3</th> <th>L4</th> <th>L5</th> </tr> </thead> <tbody> <tr> <td>475</td> <td>505</td> <td>525</td> <td>555</td> <td>590</td> <td>630</td> <td>670</td> <td>515</td> <td>545</td> <td>595</td> </tr> <tr> <td>530</td> <td>560</td> <td>580</td> <td>610</td> <td>645</td> <td>685</td> <td>725</td> <td>570</td> <td>600</td> <td>650</td> </tr> <tr> <td>530</td> <td>560</td> <td>580</td> <td>610</td> <td>645</td> <td>685</td> <td>725</td> <td>570</td> <td>600</td> <td>650</td> </tr> <tr> <td>540</td> <td>570</td> <td>590</td> <td>620</td> <td>655</td> <td>695</td> <td>735</td> <td>580</td> <td>610</td> <td>660</td> </tr> </tbody> </table>	A/COM	B	C	D	E	F	G	L3	L4	L5	475	505	525	555	590	630	670	515	545	595	530	560	580	610	645	685	725	570	600	650	530	560	580	610	645	685	725	570	600	650	540	570	590	620	655	695	735	580	610	660	<ul style="list-style-type: none"> <li>• Pneumatic seat height adjustment</li> <li>• Tilt tension control</li> <li>• Back and seat tilt in 3:1 ratio</li> <li>• Upright position tilt lock</li> <li>• Seat slider standard</li> <li>• Height adjustable lumbar available</li> <li>• Molded foam seat</li> <li>• Warranted to 300 lbs.</li> </ul>	<b>WIDTH:</b> 27.0 <b>DEPTH:</b> 27.0 <b>HEIGHT:</b> 40-44.5 <b>SEAT WIDTH:</b> 20.0 <b>SEAT DEPTH:</b> 16-19 <b>SEAT HEIGHT:</b> 16-20.5 <b>BACK WIDTH:</b> 21.0 <b>BACK HEIGHT:</b> 24.0 <b>COM:</b> 0.8 YD <b>WEIGHT:</b> 41 LBS
A/COM	B	C	D	E	F	G	L3	L4	L5																																															
475	505	525	555	590	630	670	515	545	595																																															
530	560	580	610	645	685	725	570	600	650																																															
530	560	580	610	645	685	725	570	600	650																																															
540	570	590	620	655	695	735	580	610	660																																															
NEW MODEL 3460	Y3	<b>FULL SYNCHRO</b> Use for a variety of general office task seating, including private office and conference seating	ARMLESS A42B/G A43B/G A45B/G	<table border="1"> <thead> <tr> <th>A/COM</th> <th>B</th> <th>C</th> <th>D</th> <th>E</th> <th>F</th> <th>G</th> <th>L3</th> <th>L4</th> <th>L5</th> </tr> </thead> <tbody> <tr> <td>495</td> <td>525</td> <td>545</td> <td>575</td> <td>610</td> <td>650</td> <td>690</td> <td>535</td> <td>565</td> <td>615</td> </tr> <tr> <td>550</td> <td>580</td> <td>600</td> <td>630</td> <td>665</td> <td>705</td> <td>745</td> <td>590</td> <td>620</td> <td>670</td> </tr> <tr> <td>550</td> <td>580</td> <td>600</td> <td>630</td> <td>665</td> <td>705</td> <td>745</td> <td>590</td> <td>620</td> <td>670</td> </tr> <tr> <td>560</td> <td>590</td> <td>610</td> <td>640</td> <td>675</td> <td>715</td> <td>755</td> <td>600</td> <td>630</td> <td>680</td> </tr> </tbody> </table>	A/COM	B	C	D	E	F	G	L3	L4	L5	495	525	545	575	610	650	690	535	565	615	550	580	600	630	665	705	745	590	620	670	550	580	600	630	665	705	745	590	620	670	560	590	610	640	675	715	755	600	630	680	<ul style="list-style-type: none"> <li>• Pneumatic seat height adjustment</li> <li>• Tilt tension control</li> <li>• Back and seat tilt in 2:1 ratio</li> <li>• 3 locking positions</li> <li>• Safety tilt release</li> <li>• Seat slider standard</li> <li>• Height adjustable lumbar available</li> <li>• Molded foam seat</li> <li>• Warranted to 300 lbs.</li> </ul>	<b>WIDTH:</b> 27.0 <b>DEPTH:</b> 27.0 <b>HEIGHT:</b> 40-44.5 <b>SEAT WIDTH:</b> 20.0 <b>SEAT DEPTH:</b> 16-19 <b>SEAT HEIGHT:</b> 16-20.5 <b>BACK WIDTH:</b> 21.0 <b>BACK HEIGHT:</b> 24.0 <b>COM:</b> 0.8 YD <b>WEIGHT:</b> 43 LBS
A/COM	B	C	D	E	F	G	L3	L4	L5																																															
495	525	545	575	610	650	690	535	565	615																																															
550	580	600	630	665	705	745	590	620	670																																															
550	580	600	630	665	705	745	590	620	670																																															
560	590	610	640	675	715	755	600	630	680																																															
NEW MODEL 3460	W1	<b>WEIGHT BALANCED SYNCHRO</b> Use for a variety of general office task seating, including private office and conference seating	ARMLESS A42B/G A43B/G A45B/G	<table border="1"> <thead> <tr> <th>A/COM</th> <th>B</th> <th>C</th> <th>D</th> <th>E</th> <th>F</th> <th>G</th> <th>L3</th> <th>L4</th> <th>L5</th> </tr> </thead> <tbody> <tr> <td>515</td> <td>545</td> <td>565</td> <td>595</td> <td>630</td> <td>670</td> <td>710</td> <td>555</td> <td>585</td> <td>635</td> </tr> <tr> <td>570</td> <td>600</td> <td>620</td> <td>650</td> <td>685</td> <td>725</td> <td>765</td> <td>610</td> <td>640</td> <td>690</td> </tr> <tr> <td>570</td> <td>600</td> <td>620</td> <td>650</td> <td>685</td> <td>725</td> <td>765</td> <td>610</td> <td>640</td> <td>690</td> </tr> <tr> <td>580</td> <td>610</td> <td>630</td> <td>660</td> <td>695</td> <td>735</td> <td>775</td> <td>620</td> <td>650</td> <td>700</td> </tr> </tbody> </table>	A/COM	B	C	D	E	F	G	L3	L4	L5	515	545	565	595	630	670	710	555	585	635	570	600	620	650	685	725	765	610	640	690	570	600	620	650	685	725	765	610	640	690	580	610	630	660	695	735	775	620	650	700	<ul style="list-style-type: none"> <li>• Pneumatic seat height adjustment</li> <li>• Weight balanced synchro</li> <li>• Back and seat tilt in 3:1 ratio</li> <li>• 2 position tilt lock</li> <li>• Seat slider standard</li> <li>• Height adjustable lumbar available</li> <li>• Molded foam seat</li> <li>• Warranted to 300 lbs.</li> </ul>	<b>WIDTH:</b> 27.0 <b>DEPTH:</b> 27.0 <b>HEIGHT:</b> 40-44.5 <b>SEAT WIDTH:</b> 20.0 <b>SEAT DEPTH:</b> 16-19 <b>SEAT HEIGHT:</b> 16-20.5 <b>BACK WIDTH:</b> 21.0 <b>BACK HEIGHT:</b> 24.0 <b>COM:</b> 0.8 YD <b>WEIGHT:</b> 41 LBS
A/COM	B	C	D	E	F	G	L3	L4	L5																																															
515	545	565	595	630	670	710	555	585	635																																															
570	600	620	650	685	725	765	610	640	690																																															
570	600	620	650	685	725	765	610	640	690																																															
580	610	630	660	695	735	775	620	650	700																																															
NEW MODEL 3460	W2	<b>ADVANCED WEIGHT BALANCED SYNCHRO</b> Use for a variety of general office task seating, including private office and conference seating	ARMLESS A42B/G A43B/G A45B/G	<table border="1"> <thead> <tr> <th>A/COM</th> <th>B</th> <th>C</th> <th>D</th> <th>E</th> <th>F</th> <th>G</th> <th>L3</th> <th>L4</th> <th>L5</th> </tr> </thead> <tbody> <tr> <td>535</td> <td>565</td> <td>585</td> <td>615</td> <td>650</td> <td>690</td> <td>730</td> <td>575</td> <td>605</td> <td>655</td> </tr> <tr> <td>590</td> <td>620</td> <td>640</td> <td>670</td> <td>705</td> <td>745</td> <td>785</td> <td>630</td> <td>660</td> <td>710</td> </tr> <tr> <td>590</td> <td>620</td> <td>640</td> <td>670</td> <td>705</td> <td>745</td> <td>785</td> <td>630</td> <td>660</td> <td>710</td> </tr> <tr> <td>600</td> <td>630</td> <td>650</td> <td>680</td> <td>715</td> <td>755</td> <td>795</td> <td>640</td> <td>670</td> <td>720</td> </tr> </tbody> </table>	A/COM	B	C	D	E	F	G	L3	L4	L5	535	565	585	615	650	690	730	575	605	655	590	620	640	670	705	745	785	630	660	710	590	620	640	670	705	745	785	630	660	710	600	630	650	680	715	755	795	640	670	720	<ul style="list-style-type: none"> <li>• Pneumatic seat height adjustment</li> <li>• Weight balance synchro with 2 position body-type adjustment</li> <li>• Back and seat tilt in 3:1 ratio</li> <li>• 4 back recline limit positions</li> <li>• Seat slider standard</li> <li>• Height adjustable lumbar available</li> <li>• Molded foam seat</li> <li>• Warranted to 300 lbs.</li> </ul>	<b>WIDTH:</b> 27.0 <b>DEPTH:</b> 27.0 <b>HEIGHT:</b> 40-44.5 <b>SEAT WIDTH:</b> 20.0 <b>SEAT DEPTH:</b> 16-19 <b>SEAT HEIGHT:</b> 16-20.5 <b>BACK WIDTH:</b> 21.0 <b>BACK HEIGHT:</b> 24.0 <b>COM:</b> 0.8 YD <b>WEIGHT:</b> 40 LBS
A/COM	B	C	D	E	F	G	L3	L4	L5																																															
535	565	585	615	650	690	730	575	605	655																																															
590	620	640	670	705	745	785	630	660	710																																															
590	620	640	670	705	745	785	630	660	710																																															
600	630	650	680	715	755	795	640	670	720																																															

### ARM OPTIONS

**A42B/G**  
\$55

Nylon Loop Arm-Black/Gray

**A43B/G**  
\$55

Fixed Arm-Black/Gray

**A45B/G**  
\$65

4-way Height Adjustable Arm-Black/Gray

### CASTER OPTIONS

**C6**  
STD

60mm Hoodless Casters

**C6S**  
\$35

60mm Hoodless Hard Floor Casters

**C7**  
\$35

60mm Hoodless Chrome Accented Casters

**C22B**  
\$30

60mm Hubless Black Casters

**C22G**  
\$30

60mm Hubless Gray Casters

### BASE OPTIONS

**BA11B**  
STD

27" Mid-Profile Nylon Base - Black

**BA11G**  
STD

27" Mid-Profile Nylon Base - Gray

**BA12P**  
\$100

27" Mid-Profile Aluminum Base - Polished

### ADDITIONAL OPTIONS

**LB**  
\$30

Height Adjustable Lumbar

### MESH COLORS

M2	BLACK M21	GRAY M22	WHITE M23	GREEN M24
M2	RED M25	BLUE M26	ORANGE M27	AQUA M28

M4	LATTE M40	CLOUD M41	LEMON M42	APPLE M43	TANGERINE M4
M4	AQUA M45	CRIMSON M46	ELECTRIC M47	ONYX M48	DOVE M49

### PLASTIC COLORS

DOVE GRAY PDG	BLACK PBK
---------------------	--------------

(BACK FRAME AND SEAT)  
\* A45B/G matches plastic color selected

# luna

high design meets supreme ergonomics

GSA SIN # 711-18 Pending

- Task, stool, conference and collaborative seating
- Sleek contemporary design
- Aluminum accents standard
- Fully ergonomic and stylish design at a budget conscious price
- Seat slider standard
- Height adjustable lumbar available
- Choice of two plastic colors -dove gray and black
- 8 breathable mesh colors
- CAL TB 133 Fire Code approved
- Warranted up to 300 lbs



## CREATING LUNA MODEL NUMBER

MODEL NUMBER CONTROL ARMS PLASTIC COLOR MESH COLOR GRADE BASE CASTERS PACKAGING OPTIONS

3 4 6 - - - A 4 - P - M - - - B A - C - - - -

\* FOR ARMLESS CODE USE A00

## PACKAGING NOTES

CODE	DESCRIPTION	LIST UPCHARGE
AB	ASSEMBLED IN BAG	\$0
PAC	PARTIALLY ASSEMBLED IN CARTON	\$0
BAC	BACK ASSEMBLED IN CARTON	\$40

## NEW MESH BACK STOOL & UPHOLSTERED SEAT

MODEL	CONTROL	DESCRIPTION	ARM	FABRIC/LEATHER	FEATURES	DIMENSIONS	ARM OPTIONS	CASTER OPTIONS																																																																											
<b>NEW MODEL</b> 3466	Y1	<b>10" STOOL SIMPLE SYNCHRO</b> Use for work surfaces up to 42 inches	ARMLESS A42B/G A43B/G A45B/G	<table border="1"> <thead> <tr> <th>A/COM</th> <th>B</th> <th>C</th> <th>D</th> <th>E</th> <th>F</th> <th>G</th> <th>L3</th> <th>L4</th> <th>L5</th> </tr> </thead> <tbody> <tr> <td>600</td> <td>630</td> <td>650</td> <td>680</td> <td>715</td> <td>755</td> <td>795</td> <td>640</td> <td>670</td> <td>720</td> </tr> <tr> <td>655</td> <td>685</td> <td>705</td> <td>735</td> <td>770</td> <td>810</td> <td>850</td> <td>695</td> <td>725</td> <td>775</td> </tr> <tr> <td>655</td> <td>685</td> <td>705</td> <td>735</td> <td>770</td> <td>810</td> <td>850</td> <td>695</td> <td>725</td> <td>775</td> </tr> <tr> <td>665</td> <td>695</td> <td>715</td> <td>745</td> <td>780</td> <td>820</td> <td>860</td> <td>705</td> <td>735</td> <td>785</td> </tr> </tbody> </table>	A/COM	B	C	D	E	F	G	L3	L4	L5	600	630	650	680	715	755	795	640	670	720	655	685	705	735	770	810	850	695	725	775	655	685	705	735	770	810	850	695	725	775	665	695	715	745	780	820	860	705	735	785	<ul style="list-style-type: none"> <li>• Pneumatic seat height adjustment</li> <li>• Tilt tension control</li> <li>• Back and seat tilt in 3:1 ratio</li> <li>• Upright position tilt lock</li> <li>• Seat slider standard</li> <li>• Height adjustable lumbar available</li> <li>• Molded foam seat</li> <li>• Height adj. 20" diameter footing</li> <li>• Warranted to 300 lbs.</li> </ul>	<b>WIDTH:</b> 27.0 <b>DEPTH:</b> 27.0 <b>HEIGHT:</b> 50-60 <b>SEAT WIDTH:</b> 20.0 <b>SEAT DEPTH:</b> 16-19 <b>SEAT HEIGHT:</b> 26.0-36.0 <b>BACK WIDTH:</b> 21.0 <b>BACK HEIGHT:</b> 24.0 <b>COM:</b> 0.8 YD <b>WEIGHT:</b> 47 LB	<b>A42B/G</b> \$55 Nylon Loop Arm-Black/Gray <b>A43B/G</b> \$55 Fixed Arm-Black/Gray <b>A45B/G</b> \$65 4-way Height Adjustable Arm-Black/Gray	<b>C6</b> STD 60mm Hoodless Casters <b>C6S</b> \$35 60mm Hoodless Hard Floor Casters <b>C7</b> \$35 60mm Hoodless Chrome Accented Casters <b>C22B</b> \$30 60mm Black Hubless Casters <b>C22G</b> \$30 60mm Hubless Gray Casters																									
A/COM	B	C	D	E	F	G	L3	L4	L5																																																																										
600	630	650	680	715	755	795	640	670	720																																																																										
655	685	705	735	770	810	850	695	725	775																																																																										
655	685	705	735	770	810	850	695	725	775																																																																										
665	695	715	745	780	820	860	705	735	785																																																																										
<b>NEW MODEL</b> 3468	Y1	<b>8" STOOL SIMPLE SYNCHRO</b> Use for work surfaces up to 36 inches	ARMLESS A42B/G A43B/G A45B/G	<table border="1"> <thead> <tr> <th>A/COM</th> <th>B</th> <th>C</th> <th>D</th> <th>E</th> <th>F</th> <th>G</th> <th>L3</th> <th>L4</th> <th>L5</th> </tr> </thead> <tbody> <tr> <td>600</td> <td>630</td> <td>650</td> <td>680</td> <td>715</td> <td>755</td> <td>795</td> <td>640</td> <td>670</td> <td>720</td> </tr> <tr> <td>655</td> <td>685</td> <td>705</td> <td>735</td> <td>770</td> <td>810</td> <td>850</td> <td>695</td> <td>725</td> <td>775</td> </tr> <tr> <td>655</td> <td>685</td> <td>705</td> <td>735</td> <td>770</td> <td>810</td> <td>850</td> <td>695</td> <td>725</td> <td>775</td> </tr> <tr> <td>665</td> <td>695</td> <td>715</td> <td>745</td> <td>780</td> <td>820</td> <td>860</td> <td>705</td> <td>735</td> <td>785</td> </tr> </tbody> </table>	A/COM	B	C	D	E	F	G	L3	L4	L5	600	630	650	680	715	755	795	640	670	720	655	685	705	735	770	810	850	695	725	775	655	685	705	735	770	810	850	695	725	775	665	695	715	745	780	820	860	705	735	785	<ul style="list-style-type: none"> <li>• Pneumatic seat height adjustment</li> <li>• Tilt tension control</li> <li>• Back and seat tilt in 3:1 ratio</li> <li>• Upright position tilt lock</li> <li>• Seat slider standard</li> <li>• Height adjustable lumbar available</li> <li>• Molded foam seat</li> <li>• Height adj. 20" diameter footing</li> <li>• Warranted to 300 lbs.</li> </ul>	<b>WIDTH:</b> 27.0 <b>DEPTH:</b> 27.0 <b>HEIGHT:</b> 45.0-53.0 <b>SEAT WIDTH:</b> 20.0 <b>SEAT DEPTH:</b> 16-19 <b>SEAT HEIGHT:</b> 22.0-30.0 <b>BACK WIDTH:</b> 21.0 <b>BACK HEIGHT:</b> 24.0 <b>COM:</b> 0.8 YD <b>WEIGHT:</b> 46 LB	<b>BA11B</b> \$100 27" Mid-Profile Nylon Base - Black <b>BA11G</b> \$100 27" Mid-Profile Nylon Base - Gray <b>BA12P</b> \$100 27" Mid-Profile Aluminum Base - Polished	<b>LB</b> \$30 Optional Lumbar	<b>MESH COLORS</b> <table border="1"> <tbody> <tr> <td>M2</td> <td>BLACK M21</td> <td>GRAY M22</td> <td>WHITE M23</td> <td>GREEN M24</td> </tr> <tr> <td>M2</td> <td>RED M25</td> <td>BLUE M26</td> <td>ORANGE M27</td> <td>AQUA M28</td> </tr> </tbody> </table> <table border="1"> <tbody> <tr> <td>M4</td> <td>LATTE M40</td> <td>CLOUD M41</td> <td>LEMON M42</td> <td>APPLE M43</td> <td>TANGERINE M4</td> </tr> <tr> <td>M4</td> <td>AQUA M45</td> <td>CRIMSON M46</td> <td>ELECTRIC M47</td> <td>ONYX M48</td> <td>DOVE M49</td> </tr> </tbody> </table> <b>PLASTIC COLORS</b> <table border="1"> <tbody> <tr> <td>DOVE GRAY PDG</td> <td>BLACK PBK</td> </tr> </tbody> </table> <p>(BACK FRAME AND SEAT) * A45B/G matches plastic color selected</p>	M2	BLACK M21	GRAY M22	WHITE M23	GREEN M24	M2	RED M25	BLUE M26	ORANGE M27	AQUA M28	M4	LATTE M40	CLOUD M41	LEMON M42	APPLE M43	TANGERINE M4	M4	AQUA M45	CRIMSON M46	ELECTRIC M47	ONYX M48	DOVE M49	DOVE GRAY PDG	BLACK PBK
A/COM	B	C	D	E	F	G	L3	L4	L5																																																																										
600	630	650	680	715	755	795	640	670	720																																																																										
655	685	705	735	770	810	850	695	725	775																																																																										
655	685	705	735	770	810	850	695	725	775																																																																										
665	695	715	745	780	820	860	705	735	785																																																																										
M2	BLACK M21	GRAY M22	WHITE M23	GREEN M24																																																																															
M2	RED M25	BLUE M26	ORANGE M27	AQUA M28																																																																															
M4	LATTE M40	CLOUD M41	LEMON M42	APPLE M43	TANGERINE M4																																																																														
M4	AQUA M45	CRIMSON M46	ELECTRIC M47	ONYX M48	DOVE M49																																																																														
DOVE GRAY PDG	BLACK PBK																																																																																		



# mimi

style, flexibility and versatility

**NEW ALL PLASTIC - AP**

## GSA SIN # 711-19

- Stacking chair for ideal training, collaboration meeting spaces
- Modern design with contoured shape that offers comfort
- Subtle flex back movement with pelvic support
- Broad collection including sled and 4 leg models
- Easy to grip edge that doubles as a pull hand
- 12 plastic colors
- Two frame colors that coordinate with arm pads and glides colors
- Warranted to 300 lbs.



## CREATING MIMI MODEL NUMBER

MODEL NUMBER	CONTROL	FRAME COLOR	UPHOLSTERY	PLASTIC COLOR	PACKAGING	OPTIONS
1 0	GT	F	A	P	P	

## PACKAGING NOTES

CODE	DESCRIPTION	LIST UPCHARGE
AB	ASSEMBLED IN BAG	\$0
AC	ASSEMBLED IN CARTON	\$0

SHIPS 3 TO A CARTON

MODEL	CONTROL	DESCRIPTION	ARM	PLASTIC	FEATURES	DIMENSIONS																																
<p><b>NEW MODEL</b></p> <p>1030</p>	GT	<p><b>SLED GUEST STACKING</b></p> <p>Armless sled shape frame with plastic back and seat</p>		<table border="1"> <thead> <tr> <th>P</th> <th>A</th> <th>B</th> <th>C</th> <th>D</th> <th>E</th> <th>F</th> <th>G</th> </tr> </thead> <tbody> <tr> <td>175</td> <td></td> <td></td> <td></td> <td></td> <td></td> <td></td> <td></td> </tr> <tr> <td></td> <td></td> <td></td> <td></td> <td></td> <td></td> <td></td> <td></td> </tr> <tr> <td></td> <td></td> <td></td> <td></td> <td></td> <td></td> <td></td> <td></td> </tr> </tbody> </table>	P	A	B	C	D	E	F	G	175																								<ul style="list-style-type: none"> <li>• Stacks up to 12 on floor</li> <li>• Stacks up to 40 on optional dolly</li> <li>• Subtle flex back movement with pelvic support</li> <li>• 12 plastic colors</li> <li>• Warranted up to 300 lbs.</li> </ul>	<p><b>WIDTH:</b> 21.5</p> <p><b>DEPTH:</b> 23.5</p> <p><b>HEIGHT:</b> 34.0</p> <p><b>SEAT WIDTH:</b> 18.5</p> <p><b>SEAT DEPTH:</b> 16.0</p> <p><b>SEAT HEIGHT:</b> 18.0</p> <p><b>BACK WIDTH:</b> 18.0</p> <p><b>BACK HEIGHT:</b> 18.5</p> <p><b>WEIGHT:</b> 17.0 LB</p>
P	A	B	C	D	E	F	G																															
175																																						
<p><b>NEW MODEL</b></p> <p>1040</p>	GT	<p><b>SLED GUEST STACKING</b></p> <p>Standard with armrests. Sled shape frame with plastic back and seat</p>		<table border="1"> <thead> <tr> <th>P</th> <th>A</th> <th>B</th> <th>C</th> <th>D</th> <th>E</th> <th>F</th> <th>G</th> </tr> </thead> <tbody> <tr> <td>220</td> <td></td> <td></td> <td></td> <td></td> <td></td> <td></td> <td></td> </tr> <tr> <td></td> <td></td> <td></td> <td></td> <td></td> <td></td> <td></td> <td></td> </tr> <tr> <td></td> <td></td> <td></td> <td></td> <td></td> <td></td> <td></td> <td></td> </tr> </tbody> </table>	P	A	B	C	D	E	F	G	220																								<ul style="list-style-type: none"> <li>• Stacks up to 12 on floor</li> <li>• Stacks up to 40 on optional dolly</li> <li>• Subtle flex back movement with pelvic support</li> <li>• 12 plastic colors</li> <li>• All models come in two frame colors that coordinate with arm pads colors</li> <li>• Warranted up to 300 lbs.</li> </ul> <p><i>*Black arm pads with black frame color and gray arm pads with silver frame color</i></p>	<p><b>WIDTH:</b> 26.0</p> <p><b>DEPTH:</b> 23.5</p> <p><b>HEIGHT:</b> 34.0</p> <p><b>SEAT WIDTH:</b> 18.5</p> <p><b>SEAT DEPTH:</b> 15.75</p> <p><b>SEAT HEIGHT:</b> 18.0</p> <p><b>BACK WIDTH:</b> 18.0</p> <p><b>BACK HEIGHT:</b> 18.5</p> <p><b>WEIGHT:</b> 19.0 LB</p>
P	A	B	C	D	E	F	G																															
220																																						

## ADDITIONAL OPTIONS



Stacking Dolly  
Stacks Up to 40 High  
(For Sled Base)

**DL4**  
\$250

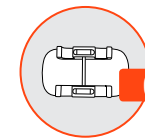

Ganging Clip - 4 per Set  
Armless Only. 2" Between  
Chairs When Ganged (For  
Sled Models)

**GC5**  
\$25

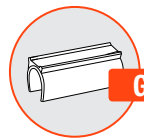

Sled Base Clear  
Plastic Glide

**G16**  
\$15

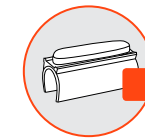

Sled Base Clear Plastic  
Glide with Felt Pad

**G17**  
\$25

## FRAME COLORS

BLACK BF	SILVER SF
-------------	--------------

(FRAME)

## PLASTIC COLORS

BLACK SWAN P01	WHITE WHISPER P05	FEDERAL BLUE P11	CRIMSON RED P12	LEMON YELLOW P13	DOVE GRAY P14
CLOUD GRAY P15	LAGOON BLUE P16	APPLE GREEN P17	TANGERINE ORANGE P18	LATTE P19	AZURE BLUE P20

(BACK AND SEAT)

CAUTION: Careless stacking of chairs may scratch and damage frames. 9to5 Seating does not warrant scratched frames of stacking chairs.

# mimi

style, flexibility and versatility

**NEW ALL PLASTIC - AP**

GSA SIN # 711-19

- Stacking chair for ideal training, collaboration and meeting spaces
- Modern design with contoured shape that offers comfort
- Subtle flex back movement with pelvic support
- Broad collection including sled and 4 leg models
- Easy to grip edge that doubles as a pull handle
- 12 plastic colors
- Two frame colors that coordinate with arm pads and glides colors
- Warranted to 300 lbs.



### CREATING MIMI MODEL NUMBER

MODEL NUMBER CONTROL FRAME COLOR UPHOLSTERY PLASTIC COLOR CASTERS PACKAGING OPTIONS

1 0 - G T - F A P - C - - - -

### PACKAGING NOTES

CODE	DESCRIPTION	LIST UPCHARGE
AB	ASSEMBLED IN BAG	\$0
AC	ASSEMBLED IN CARTON	\$0

SHIPS 3 TO A CARTON

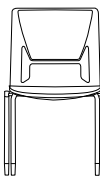
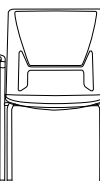
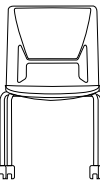
MODEL	CONTROL	DESCRIPTION	ARM	PLASTIC	FEATURES	DIMENSIONS																																																
<p><b>NEW MODEL</b></p> <p>1050</p> 	GT	<p><b>4 LEG GUEST STACKING</b></p> <p>Armless 4 leg frame with plastic back and seat</p>		<table border="1"> <thead> <tr> <th>P</th><th>A</th><th>B</th><th>C</th><th>D</th><th>E</th><th>F</th><th>G</th> </tr> </thead> <tbody> <tr> <td>175</td><td></td><td></td><td></td><td></td><td></td><td></td><td></td> </tr> <tr><td></td><td></td><td></td><td></td><td></td><td></td><td></td><td></td></tr> <tr><td></td><td></td><td></td><td></td><td></td><td></td><td></td><td></td></tr> <tr><td></td><td></td><td></td><td></td><td></td><td></td><td></td><td></td></tr> <tr><td></td><td></td><td></td><td></td><td></td><td></td><td></td><td></td></tr> </tbody> </table>	P	A	B	C	D	E	F	G	175																																								<ul style="list-style-type: none"> <li>• Stacks up to 6 on floor</li> <li>• Stacks up to 12 on optional dolly</li> <li>• Subtle flex back movement with pelvic support</li> <li>• 12 plastic colors</li> <li>• All models come in two frame colors that coordinate with glide colors</li> <li>• Warranted up to 300 lbs.</li> </ul> <p><i>*Black glides with black frame color and gray glides with silver frame color</i></p>	<p><b>WIDTH:</b> 20.5</p> <p><b>DEPTH:</b> 22.0</p> <p><b>HEIGHT:</b> 34.0</p> <p><b>SEAT WIDTH:</b> 18.3</p> <p><b>SEAT DEPTH:</b> 15.5</p> <p><b>SEAT HEIGHT:</b> 17.8</p> <p><b>BACK WIDTH:</b> 18.0</p> <p><b>BACK HEIGHT:</b> 17.0</p> <p><b>WEIGHT:</b> 16.0 LB</p>
P	A	B	C	D	E	F	G																																															
175																																																						
<p><b>NEW MODEL</b></p> <p>1051</p> 	GT	<p><b>4 LEG GUEST STACKING</b></p> <p>Standard with armrests. 4 leg frame with plastic back and seat</p>		<table border="1"> <thead> <tr> <th>P</th><th>A</th><th>C</th><th>C</th><th>D</th><th>E</th><th>F</th><th>G</th> </tr> </thead> <tbody> <tr> <td>220</td><td></td><td></td><td></td><td></td><td></td><td></td><td></td> </tr> <tr><td></td><td></td><td></td><td></td><td></td><td></td><td></td><td></td></tr> <tr><td></td><td></td><td></td><td></td><td></td><td></td><td></td><td></td></tr> <tr><td></td><td></td><td></td><td></td><td></td><td></td><td></td><td></td></tr> <tr><td></td><td></td><td></td><td></td><td></td><td></td><td></td><td></td></tr> </tbody> </table>	P	A	C	C	D	E	F	G	220																																								<ul style="list-style-type: none"> <li>• Stacks up to 6 on floor</li> <li>• Stacks up to 12 on optional dolly</li> <li>• Subtle flex back movement with pelvic support</li> <li>• 12 plastic colors</li> <li>• All models come in two frame colors that coordinate with arms pads and glides colors</li> <li>• Warranted up to 300 lbs.</li> </ul> <p><i>*Black arm pads and glides with black frame color and gray arm pads and glides with silver frame color</i></p>	<p><b>WIDTH:</b> 23.7</p> <p><b>DEPTH:</b> 22.0</p> <p><b>HEIGHT:</b> 34.0</p> <p><b>SEAT WIDTH:</b> 18.3</p> <p><b>SEAT DEPTH:</b> 15.5</p> <p><b>SEAT HEIGHT:</b> 17.8</p> <p><b>BACK WIDTH:</b> 18.0</p> <p><b>BACK HEIGHT:</b> 17.0</p> <p><b>WEIGHT:</b> 17.5 LB</p>
P	A	C	C	D	E	F	G																																															
220																																																						
<p><b>NEW MODEL</b></p> <p>1054</p> 	GT	<p><b>4 LEG GUEST STACKING WITH CASTERS</b></p> <p>Armless 4 leg frame with plastic back and seat</p>		<table border="1"> <thead> <tr> <th>P</th><th>A</th><th>B</th><th>C</th><th>D</th><th>E</th><th>F</th><th>G</th> </tr> </thead> <tbody> <tr> <td>220</td><td></td><td></td><td></td><td></td><td></td><td></td><td></td> </tr> <tr><td></td><td></td><td></td><td></td><td></td><td></td><td></td><td></td></tr> <tr><td></td><td></td><td></td><td></td><td></td><td></td><td></td><td></td></tr> <tr><td></td><td></td><td></td><td></td><td></td><td></td><td></td><td></td></tr> <tr><td></td><td></td><td></td><td></td><td></td><td></td><td></td><td></td></tr> </tbody> </table>	P	A	B	C	D	E	F	G	220																																								<ul style="list-style-type: none"> <li>• Stacks up to 6 on floor</li> <li>• Stacks up to 12 on optional dolly</li> <li>• Subtle flex back movement with pelvic support</li> <li>• 12 plastic colors</li> <li>• Warranted to 300 lbs.</li> </ul>	<p><b>WIDTH:</b> 20.5</p> <p><b>DEPTH:</b> 22.0</p> <p><b>HEIGHT:</b> 34.0</p> <p><b>SEAT WIDTH:</b> 18.3</p> <p><b>SEAT DEPTH:</b> 15.5</p> <p><b>SEAT HEIGHT:</b> 17.8</p> <p><b>BACK WIDTH:</b> 18.0</p> <p><b>BACK HEIGHT:</b> 17.0</p> <p><b>WEIGHT:</b> 16.0 LB</p>
P	A	B	C	D	E	F	G																																															
220																																																						
<p><b>NEW MODEL</b></p> <p>1055</p> 	GT	<p><b>4 LEG GUEST STACKING WITH CASTERS</b></p> <p>Standard with armrests. 4 leg frame with plastic back and seat</p>		<table border="1"> <thead> <tr> <th>P</th><th>A</th><th>B</th><th>C</th><th>D</th><th>E</th><th>F</th><th>G</th> </tr> </thead> <tbody> <tr> <td>265</td><td></td><td></td><td></td><td></td><td></td><td></td><td></td> </tr> <tr><td></td><td></td><td></td><td></td><td></td><td></td><td></td><td></td></tr> <tr><td></td><td></td><td></td><td></td><td></td><td></td><td></td><td></td></tr> <tr><td></td><td></td><td></td><td></td><td></td><td></td><td></td><td></td></tr> <tr><td></td><td></td><td></td><td></td><td></td><td></td><td></td><td></td></tr> </tbody> </table>	P	A	B	C	D	E	F	G	265																																								<ul style="list-style-type: none"> <li>• Stacks up to 6 on floor</li> <li>• Stacks up to 12 on optional dolly</li> <li>• Subtle flex back movement with pelvic support</li> <li>• 12 plastic colors</li> <li>• All models come in two frame finishes that coordinate with arms pads colors</li> <li>• Warranted to 300 lbs.</li> </ul> <p><i>*Black arm pads with black frame color and gray arm pads with silver frame color</i></p>	<p><b>WIDTH:</b> 23.7</p> <p><b>DEPTH:</b> 22.0</p> <p><b>HEIGHT:</b> 34.0</p> <p><b>SEAT WIDTH:</b> 18.3</p> <p><b>SEAT DEPTH:</b> 15.5</p> <p><b>SEAT HEIGHT:</b> 17.8</p> <p><b>BACK WIDTH:</b> 18.0</p> <p><b>BACK HEIGHT:</b> 17.0</p> <p><b>WEIGHT:</b> 17.5 LB</p>
P	A	B	C	D	E	F	G																																															
265																																																						

### ADDITIONAL OPTIONS

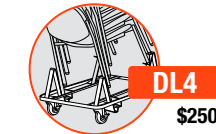

Stacking Dolly  
Stacks Up to 12 High  
(For 4 Leg Models)

**DL4**  
\$250



50mm Hoodless Casters

**C12**  
STD



50mm Hooded Hard Floor Casters

**C5S**  
\$30

### FRAME COLORS

BLACK BF	SILVER SF
-------------	--------------

(FRAME)

### PLASTIC COLORS

BLACK SWAN P01	WHITE WHISPER P05	FEDERAL BLUE P11	CRIMSON RED P12	LEMON YELLOW P13	DOVE GRAY P14
CLOUD GRAY P15	LAGOON BLUE P16	APPLE GREEN P17	TANGERINE ORANGE P18	LATTE P19	AZURE BLUE P20

(BACK AND SEAT)

CAUTION: Careless stacking of chairs may scratch and damage frames. 9to5 Seating does not warrant scratched frames of stacking chairs.

# mimi

style, flexibility and versatility

GSA SIN # 711-19

- Stacking chair for ideal training, collaboration and meeting spaces
- Modern design with contoured shape that offers comfort
- Subtle flex back movement with pelvic support
- Broad collection including sled and 4 leg models
- Easy to grip edge that doubles as a pull handle
- 12 plastic colors
- Two frame colors that coordinate with arm pads and glides colors
- Warranted to 300 lbs.



### CREATING MIMI MODEL NUMBER

MODEL NUMBER CONTROL FRAME COLOR UPHOLSTERY PACKAGING OPTIONS  
 1 0 - G T - F - U S - - -

### PACKAGING NOTES

CODE	DESCRIPTION	LIST UPCHARGE
AB	ASSEMBLED IN BAG	\$0
AC	ASSEMBLED IN CARTON	\$0

SHIPS 3 TO A CARTON

**NEW UPHOLSTERED SEAT - US**

MODEL	CONTROL	DESCRIPTION	ARM	FABRIC/LEATHER	FEATURES	DIMENSIONS														
<p><b>NEW MODEL</b></p> <p>1030</p>	GT	<p><b>SLED GUEST STACKING</b></p> <p>Armless sled shape frame with plastic back and upholstered seat</p>		<table border="1"> <thead> <tr> <th>A/COM</th> <th>B</th> <th>C</th> <th>D</th> <th>E</th> <th>F</th> <th>G</th> </tr> </thead> <tbody> <tr> <td>235</td> <td>260</td> <td>275</td> <td>300</td> <td>325</td> <td>355</td> <td>385</td> </tr> </tbody> </table>	A/COM	B	C	D	E	F	G	235	260	275	300	325	355	385	<ul style="list-style-type: none"> <li>• Stacks up to 12 on floor</li> <li>• Stacks up to 40 on optional dolly</li> <li>• Subtle flex back movement with pelvic support</li> <li>• 12 plastic colors</li> <li>• Warranted up to 300 lbs.</li> </ul>	<p><b>WIDTH:</b> 21.5</p> <p><b>DEPTH:</b> 23.5</p> <p><b>HEIGHT:</b> 34.0</p> <p><b>SEAT WIDTH:</b> 18.5</p> <p><b>SEAT DEPTH:</b> 16.0</p> <p><b>SEAT HEIGHT:</b> 18.0</p> <p><b>BACK WIDTH:</b> 18.0</p> <p><b>BACK HEIGHT:</b> 18.5</p> <p><b>COM:</b> 0.7 YD</p> <p><b>WEIGHT:</b> 19.0 LB</p>
A/COM	B	C	D	E	F	G														
235	260	275	300	325	355	385														
<p><b>NEW MODEL</b></p> <p>1040</p>	GT	<p><b>SLED GUEST STACKING</b></p> <p>Standard with armrests. 4 leg frame with plastic back and seat</p>		<table border="1"> <thead> <tr> <th>A/COM</th> <th>B</th> <th>C</th> <th>D</th> <th>E</th> <th>F</th> <th>G</th> </tr> </thead> <tbody> <tr> <td>280</td> <td>305</td> <td>320</td> <td>345</td> <td>370</td> <td>400</td> <td>430</td> </tr> </tbody> </table>	A/COM	B	C	D	E	F	G	280	305	320	345	370	400	430	<ul style="list-style-type: none"> <li>• Stacks up to 12 on floor</li> <li>• Stacks up to 40 on optional dolly</li> <li>• Subtle flex back movement with pelvic support</li> <li>• 12 plastic colors</li> <li>• All models come in two frame colors that coordinate with arm pads colors</li> <li>• Warranted up to 300 lbs.</li> </ul> <p><i>*Black arm pads with black frame color and gray arm pads with silver frame color</i></p>	<p><b>WIDTH:</b> 26.0</p> <p><b>DEPTH:</b> 23.5</p> <p><b>HEIGHT:</b> 34.0</p> <p><b>SEAT WIDTH:</b> 18.5</p> <p><b>SEAT DEPTH:</b> 15.75</p> <p><b>SEAT HEIGHT:</b> 18.0</p> <p><b>BACK WIDTH:</b> 18.0</p> <p><b>BACK HEIGHT:</b> 18.5</p> <p><b>COM:</b> 0.7 YD</p> <p><b>WEIGHT:</b> 21.0 LB</p>
A/COM	B	C	D	E	F	G														
280	305	320	345	370	400	430														

### ADDITIONAL OPTIONS

**DL4**  
\$250

Stacking Dolly  
Stacks Up to 40 High  
(For Sled Base)

**GC5**  
\$25

Ganging Clip - 4 per Set  
Armless Only. 2" Between  
Chairs When Ganged (For  
Sled Models)

**G16**  
\$15

Sled Base Clear  
Plastic Glide

**G17**  
\$25

Sled Base Clear Plastic  
Glide with Felt Pad

### FRAME COLORS

BLACK BF	SILVER SF
-------------	--------------

(FRAME)

### PLASTIC COLORS

BLACK SWAN P01	WHITE WHISPER P05	FEDERAL BLUE P11	CRIMSON RED P12	LEMON YELLOW P13	DOVE GRAY P14
CLOUD GRAY P15	LAGOON BLUE P16	APPLE GREEN P17	TANGERINE ORANGE P18	LATTE P19	AZURE BLUE P20

(BACK AND SEAT)

CAUTION: Careless stacking of chairs may scratch and damage frames. 9to5 Seating does not warrant scratched frames of stacking chairs.

# mimi

style, flexibility and versatility

GSA SIN # 711-19

- Stacking chair for ideal training, collaboration and meeting spaces
- Modern design with contoured shape that offers comfort
- Subtle flex back movement with pelvic support
- Broad collection including sled and 4 leg models
- Easy to grip edge that doubles as a pull handle
- 12 plastic colors
- Two frame colors that coordinate with arm pads and glides colors
- Warranted to 300 lbs.



### CREATING MIMI MODEL NUMBER

MODEL NUMBER CONTROL FRAME COLOR UPHOLSTERY PLASTIC COLOR CASTERS PACKAGING OPTIONS

1 0 0 0 - G T - F U S - C 0 0 - 0 0 - 0 0

### PACKAGING NOTES

CODE	DESCRIPTION	LIST UPCHARGE
AB	ASSEMBLED IN BAG	\$0
AC	ASSEMBLED IN CARTON	\$0

SHIPS 3 TO A CARTON

## NEW UPHOLSTERED SEAT - US

MODEL	CONTROL	DESCRIPTION	ARM	FABRIC/LEATHER	FEATURES	DIMENSIONS														
<b>NEW MODEL</b> 1050	GT	<b>4 LEG GUEST STACKING</b>  Armless 4 leg frame with plastic back and upholstered seat		<table border="1"> <thead> <tr> <th>A/COM</th> <th>B</th> <th>C</th> <th>D</th> <th>E</th> <th>F</th> <th>G</th> </tr> </thead> <tbody> <tr> <td>235</td> <td>260</td> <td>275</td> <td>300</td> <td>325</td> <td>355</td> <td>385</td> </tr> </tbody> </table>	A/COM	B	C	D	E	F	G	235	260	275	300	325	355	385	<ul style="list-style-type: none"> <li>• Stacks up to 6 on floor</li> <li>• Stacks up to 12 on optional dolly</li> <li>• Subtle flex back movement with pelvic support</li> <li>• 12 plastic colors</li> <li>• All models come in two frame colors that coordinate with glide colors</li> <li>• Warranted up to 300 lbs.</li> </ul> <p><i>*Black glides with black frame color and gray glides with silver frame color</i></p>	<p><b>WIDTH:</b> 20.5 <b>DEPTH:</b> 22.0 <b>HEIGHT:</b> 34.0 <b>SEAT WIDTH:</b> 18.3 <b>SEAT DEPTH:</b> 15.5 <b>SEAT HEIGHT:</b> 17.8 <b>BACK WIDTH:</b> 18.0 <b>BACK HEIGHT:</b> 17.0 <b>COM:</b> 0.7 YD <b>WEIGHT:</b> 18.0 LB</p>
A/COM	B	C	D	E	F	G														
235	260	275	300	325	355	385														
<b>NEW MODEL</b> 1051	GT	<b>4 LEG GUEST STACKING</b>  Standard with armrests. 4 leg frame with plastic back and seat		<table border="1"> <thead> <tr> <th>A/COM</th> <th>B</th> <th>C</th> <th>D</th> <th>E</th> <th>F</th> <th>G</th> </tr> </thead> <tbody> <tr> <td>280</td> <td>305</td> <td>320</td> <td>345</td> <td>370</td> <td>400</td> <td>430</td> </tr> </tbody> </table>	A/COM	B	C	D	E	F	G	280	305	320	345	370	400	430	<ul style="list-style-type: none"> <li>• Stacks up to 6 on floor</li> <li>• Stacks up to 12 on optional dolly</li> <li>• Subtle flex back movement with pelvic support</li> <li>• 12 plastic colors</li> <li>• All models come in two frame colors that coordinate with arms pads and glides colors</li> <li>• Warranted up to 300 lbs.</li> </ul> <p><i>*Black arm pads and glides with black frame color and gray arm pads and glides with silver frame color</i></p>	<p><b>WIDTH:</b> 23.7 <b>DEPTH:</b> 22.0 <b>HEIGHT:</b> 34.0 <b>SEAT WIDTH:</b> 18.3 <b>SEAT DEPTH:</b> 15.5 <b>SEAT HEIGHT:</b> 17.8 <b>BACK WIDTH:</b> 18.0 <b>BACK HEIGHT:</b> 17.0 <b>COM:</b> 0.7 YD <b>WEIGHT:</b> 19.5 LB</p>
A/COM	B	C	D	E	F	G														
280	305	320	345	370	400	430														
<b>NEW MODEL</b> 1054	GT	<b>4 LEG GUEST STACKING WITH CASTERS</b>  Armless 4 leg frame with plastic back and upholstered seat		<table border="1"> <thead> <tr> <th>A/COM</th> <th>B</th> <th>C</th> <th>D</th> <th>E</th> <th>F</th> <th>G</th> </tr> </thead> <tbody> <tr> <td>280</td> <td>305</td> <td>320</td> <td>345</td> <td>370</td> <td>400</td> <td>430</td> </tr> </tbody> </table>	A/COM	B	C	D	E	F	G	280	305	320	345	370	400	430	<ul style="list-style-type: none"> <li>• Stacks up to 6 on floor</li> <li>• Stacks up to 12 on optional dolly</li> <li>• Subtle flex back movement with pelvic support</li> <li>• 12 plastic colors</li> <li>• Warranted up to 300 lbs.</li> </ul>	<p><b>WIDTH:</b> 20.5 <b>DEPTH:</b> 22.0 <b>HEIGHT:</b> 34.0 <b>SEAT WIDTH:</b> 18.3 <b>SEAT DEPTH:</b> 15.5 <b>SEAT HEIGHT:</b> 17.8 <b>BACK WIDTH:</b> 18.0 <b>BACK HEIGHT:</b> 17.0 <b>COM:</b> 0.7 YD <b>WEIGHT:</b> 18.0 LB</p>
A/COM	B	C	D	E	F	G														
280	305	320	345	370	400	430														
<b>NEW MODEL</b> 1055	GT	<b>4 LEG GUEST STACKING WITH CASTERS</b>  Standard with armrests. 4 leg frame with plastic back and seat		<table border="1"> <thead> <tr> <th>A/COM</th> <th>B</th> <th>C</th> <th>D</th> <th>E</th> <th>F</th> <th>G</th> </tr> </thead> <tbody> <tr> <td>325</td> <td>350</td> <td>365</td> <td>390</td> <td>415</td> <td>445</td> <td>475</td> </tr> </tbody> </table>	A/COM	B	C	D	E	F	G	325	350	365	390	415	445	475	<ul style="list-style-type: none"> <li>• Stacks up to 6 on floor</li> <li>• Stacks up to 12 on optional dolly</li> <li>• Subtle flex back movement with pelvic support</li> <li>• 12 plastic colors</li> <li>• All models come in two frame colors that coordinate with arm pads colors</li> <li>• Warranted up to 300 lbs.</li> </ul> <p><i>*Black arm pads with black frame color and gray arm pads with silver frame color</i></p>	<p><b>WIDTH:</b> 23.7 <b>DEPTH:</b> 22.0 <b>HEIGHT:</b> 34.0 <b>SEAT WIDTH:</b> 18.3 <b>SEAT DEPTH:</b> 15.5 <b>SEAT HEIGHT:</b> 17.8 <b>BACK WIDTH:</b> 18.0 <b>BACK HEIGHT:</b> 17.0 <b>COM:</b> 0.7 YD <b>WEIGHT:</b> 19.5 LB</p>
A/COM	B	C	D	E	F	G														
325	350	365	390	415	445	475														

### ACCESSORIES



**DL4**  
Stacking Dolly  
Stacks Up to 12 High  
(For 4 Leg Models)  
**\$250**



**C12 STD**  
50mm Hoodless Casters



**C5S**  
50mm Hooded Hard Floor Casters  
**\$30**

### FRAME COLORS

BLACK BF	SILVER SF
-------------	--------------

(FRAME)

### PLASTIC COLORS

BLACK SWAN P01	WHITE WHISPER P05	FEDERAL BLUE P11	CRIMSON RED P12	LEMON YELLOW P13	DOVE GRAY P14
CLOUD GRAY P15	LAGOON BLUE P16	APPLE GREEN P17	TANGERINE ORANGE P18	LATTE P19	AZURE BLUE P20

(BACK AND SEAT)

CAUTION: Careless stacking of chairs may scratch and damage frames. 9to5 Seating does not warrant scratched frames of stacking chairs.

# neo

the new way to work

GSA SIN # 711-18

- Task, stool, conference and collaborative seating
- Simple, clean design lines
- Adjustable lumbar and seat slider standard
- Pull handle for easy mobility in collaborative spaces
- Choice of two plastic colors-white and graphite gray
- Warranted to 300 lbs.
- CAL TB 133 Fire Code approved



### CREATING NEO MODEL NUMBER



### PACKAGING NOTES

CODE	DESCRIPTION	LIST UPCHARGE
AB	ASSEMBLED IN BAG	\$0
PAC	PARTIALLY ASSEMBLED IN CARTON	\$0
BAC	BACK ASSEMBLED IN CARTON	\$40

## MESH BACK

MODEL	CONTROL	DESCRIPTION	ARM	FABRIC/LEATHER	FEATURES	DIMENSIONS	ARM OPTIONS	CASTER OPTIONS																																								
3160	Y1	<b>SIMPLE SYNCHRO</b> Use for a variety of general office task seating, including private office and conference seating	ARMLESS A46G/W A23G/W	<table border="1"> <thead> <tr> <th>A/COM</th> <th>B</th> <th>C</th> <th>D</th> <th>E</th> <th>F</th> <th>G</th> <th>L3/COL</th> <th>L4</th> <th>L5</th> </tr> </thead> <tbody> <tr> <td>375</td> <td>405</td> <td>425</td> <td>455</td> <td>490</td> <td>530</td> <td>570</td> <td>415</td> <td>455</td> <td>515</td> </tr> <tr> <td>430</td> <td>460</td> <td>480</td> <td>510</td> <td>545</td> <td>585</td> <td>625</td> <td>470</td> <td>510</td> <td>570</td> </tr> <tr> <td>450</td> <td>480</td> <td>500</td> <td>530</td> <td>565</td> <td>605</td> <td>645</td> <td>490</td> <td>530</td> <td>590</td> </tr> </tbody> </table>	A/COM	B	C	D	E	F	G	L3/COL	L4	L5	375	405	425	455	490	530	570	415	455	515	430	460	480	510	545	585	625	470	510	570	450	480	500	530	565	605	645	490	530	590	<ul style="list-style-type: none"> <li>• Pneumatic seat height adjustment</li> <li>• Tilt tension control</li> <li>• Back and seat tilt in 3:1 Ratio</li> <li>• Upright position tilt lock</li> <li>• Seat slider standard</li> <li>• Adjustable lumbar standard</li> <li>• Molded seat foam</li> <li>• Warranted to 300 lbs.</li> </ul>	<p><b>WIDTH:</b> 17.5-22.0 <b>DEPTH:</b> 28.0 <b>HEIGHT:</b> 37.5-42.0 <b>SEAT WIDTH:</b> 20.0 <b>SEAT DEPTH:</b> 17.5-20.0 <b>SEAT HEIGHT:</b> 17.0-21.5 <b>BACK WIDTH:</b> 18.0 <b>BACK HEIGHT:</b> 21.0 <b>COM:</b> 1 YD <b>WEIGHT:</b> 35.0 LB</p>	<p><b>A23G/W</b> \$75 6-Way Height Adjustable Arm w/ Sliding Pad</p> <p><b>A46G/W</b> \$55 Nylon Loop Arm-Gray/White</p>	<p><b>C6</b> STD 60mm Hoodless Casters</p> <p><b>C6S</b> \$35 60mm Hoodless Hard Floor Casters</p> <p><b>C7</b> \$35 60mm Hoodless Chrome Accented Casters</p>
A/COM	B	C	D	E	F	G	L3/COL	L4	L5																																							
375	405	425	455	490	530	570	415	455	515																																							
430	460	480	510	545	585	625	470	510	570																																							
450	480	500	530	565	605	645	490	530	590																																							
3160	Y3	<b>FULL SYNCHRO</b> Use for a variety of general office task seating, including private office and conference seating	ARMLESS A46G/W A23G/W	<table border="1"> <thead> <tr> <th>A/COM</th> <th>B</th> <th>C</th> <th>D</th> <th>E</th> <th>F</th> <th>G</th> <th>L3/COL</th> <th>L4</th> <th>L5</th> </tr> </thead> <tbody> <tr> <td>395</td> <td>425</td> <td>445</td> <td>475</td> <td>510</td> <td>550</td> <td>590</td> <td>435</td> <td>475</td> <td>535</td> </tr> <tr> <td>450</td> <td>480</td> <td>500</td> <td>530</td> <td>565</td> <td>605</td> <td>645</td> <td>525</td> <td>565</td> <td>625</td> </tr> <tr> <td>470</td> <td>500</td> <td>520</td> <td>550</td> <td>585</td> <td>625</td> <td>665</td> <td>565</td> <td>605</td> <td>665</td> </tr> </tbody> </table>	A/COM	B	C	D	E	F	G	L3/COL	L4	L5	395	425	445	475	510	550	590	435	475	535	450	480	500	530	565	605	645	525	565	625	470	500	520	550	585	625	665	565	605	665	<ul style="list-style-type: none"> <li>• Pneumatic seat height adjustment</li> <li>• Tilt tension control</li> <li>• Back and seat tilt in 2:1 Ratio</li> <li>• 3 locking positions</li> <li>• Safety tilt release</li> <li>• Seat slider standard</li> <li>• Adjustable lumbar standard</li> <li>• Molded foam seat</li> <li>• Warranted to 300 lbs.</li> </ul>	<p><b>WIDTH:</b> 17.5-22.0 <b>DEPTH:</b> 28.0 <b>HEIGHT:</b> 37.5-42.0 <b>SEAT WIDTH:</b> 20.0 <b>SEAT DEPTH:</b> 17.5-20.0 <b>SEAT HEIGHT:</b> 17.0-21.5 <b>BACK WIDTH:</b> 18.0 <b>BACK HEIGHT:</b> 21.0 <b>COM:</b> 1 YD <b>WEIGHT:</b> 38.0 LB</p>	<p><b>BA9G</b> STD 26" High-Profile Nylon Base - Gray</p> <p><b>BA9W</b> STD 26" High-Profile Nylon Base - White</p> <p><b>BA10P</b> \$100 26" High-Profile Aluminum Base - Polished</p>	<p><b>C6</b> STD 60mm Hoodless Casters</p> <p><b>C6S</b> \$35 60mm Hoodless Hard Floor Casters</p> <p><b>C7</b> \$35 60mm Hoodless Chrome Accented Casters</p>
A/COM	B	C	D	E	F	G	L3/COL	L4	L5																																							
395	425	445	475	510	550	590	435	475	535																																							
450	480	500	530	565	605	645	525	565	625																																							
470	500	520	550	585	625	665	565	605	665																																							
3160	W1	<b>WEIGHT BALANCED SYNCHRO</b> Use for a variety of general office task seating, including private office and conference seating	ARMLESS A46G/W A23G/W	<table border="1"> <thead> <tr> <th>A/COM</th> <th>B</th> <th>C</th> <th>D</th> <th>E</th> <th>F</th> <th>G</th> <th>L3/COL</th> <th>L4</th> <th>L5</th> </tr> </thead> <tbody> <tr> <td>415</td> <td>445</td> <td>465</td> <td>495</td> <td>530</td> <td>570</td> <td>610</td> <td>455</td> <td>495</td> <td>555</td> </tr> <tr> <td>470</td> <td>500</td> <td>520</td> <td>550</td> <td>585</td> <td>625</td> <td>665</td> <td>580</td> <td>620</td> <td>680</td> </tr> <tr> <td>490</td> <td>520</td> <td>540</td> <td>570</td> <td>605</td> <td>645</td> <td>685</td> <td>640</td> <td>680</td> <td>740</td> </tr> </tbody> </table>	A/COM	B	C	D	E	F	G	L3/COL	L4	L5	415	445	465	495	530	570	610	455	495	555	470	500	520	550	585	625	665	580	620	680	490	520	540	570	605	645	685	640	680	740	<ul style="list-style-type: none"> <li>• Pneumatic seat height adjustment</li> <li>• Tilt tension control</li> <li>• Back and seat tilt in 2:1 Ratio</li> <li>• 3 locking positions</li> <li>• Safety tilt release</li> <li>• Seat slider standard</li> <li>• Adjustable lumbar standard</li> <li>• Molded foam seat</li> <li>• Warranted to 300 lbs.</li> </ul>	<p><b>WIDTH:</b> 17.5-22.0 <b>DEPTH:</b> 28.0 <b>HEIGHT:</b> 37.5-42.0 <b>SEAT WIDTH:</b> 20.0 <b>SEAT DEPTH:</b> 17.5-20.0 <b>SEAT HEIGHT:</b> 17.0-21.5 <b>BACK WIDTH:</b> 18.0 <b>BACK HEIGHT:</b> 21.0 <b>COM:</b> 1 YD <b>WEIGHT:</b> 36.0 LB</p>	<p><b>BA9G</b> STD 26" High-Profile Nylon Base - Gray</p> <p><b>BA9W</b> STD 26" High-Profile Nylon Base - White</p> <p><b>BA10P</b> \$100 26" High-Profile Aluminum Base - Polished</p>	<p><b>C6</b> STD 60mm Hoodless Casters</p> <p><b>C6S</b> \$35 60mm Hoodless Hard Floor Casters</p> <p><b>C7</b> \$35 60mm Hoodless Chrome Accented Casters</p>
A/COM	B	C	D	E	F	G	L3/COL	L4	L5																																							
415	445	465	495	530	570	610	455	495	555																																							
470	500	520	550	585	625	665	580	620	680																																							
490	520	540	570	605	645	685	640	680	740																																							

### PLASTIC AND MESH COLORS

GRAPHITE GRAY PGG	GRAY MESH M32	WHITE PWH	WHITE MESH M33
-------------------------	---------------------	--------------	----------------------

(BACK FRAME AND SEAT) (BACK FRAME AND SEAT)

\* A23G/W matches plastic color selected

# neo

the new way to work

GSA SIN # 711-18

- Task, stool, conference and collaborative seating
- Simple, clean design lines
- Adjustable lumbar and seat slider standard
- Pull handle for easy mobility in collaborative spaces
- Choice of two plastic colors-white and graphite gray
- Warranted to 300 lbs.
- CAL TB 133 Fire Code approved



## MESH BACK STOOLS

### CREATING NEO MODEL NUMBER

MODEL NUMBER CONTROL FRAME COLOR ARM GRADE BASE CASTERS PACKAGING

3 1 6 - - P - - A - - - - B A - - - C - - - -

### PACKAGING NOTES

CODE	DESCRIPTION	LIST UPCHARGE
AB	ASSEMBLED IN BAG	\$0
PAC	PARTIALLY ASSEMBLED IN CARTON	\$0
BAC	BACK ASSEMBLED IN CARTON	\$40

MODEL	CONTROL	DESCRIPTION	ARM	FABRIC/LEATHER	FEATURES	DIMENSIONS	ARM OPTIONS	CASTER OPTIONS																																								
3166	Y1	<b>10" STOOL SIMPLE SYNCHRO</b>  Use for work surfaces up to 42 inches	ARMLESS A46G/W A23G/W	<table border="1"> <thead> <tr> <th>A/COM</th> <th>B</th> <th>C</th> <th>D</th> <th>E</th> <th>F</th> <th>G</th> <th>L3/COL</th> <th>L4</th> <th>L5</th> </tr> </thead> <tbody> <tr> <td>500</td> <td>530</td> <td>550</td> <td>580</td> <td>615</td> <td>655</td> <td>695</td> <td>540</td> <td>580</td> <td>640</td> </tr> <tr> <td>555</td> <td>585</td> <td>605</td> <td>635</td> <td>670</td> <td>710</td> <td>750</td> <td>595</td> <td>635</td> <td>695</td> </tr> <tr> <td>575</td> <td>605</td> <td>625</td> <td>655</td> <td>690</td> <td>730</td> <td>770</td> <td>615</td> <td>655</td> <td>715</td> </tr> </tbody> </table>	A/COM	B	C	D	E	F	G	L3/COL	L4	L5	500	530	550	580	615	655	695	540	580	640	555	585	605	635	670	710	750	595	635	695	575	605	625	655	690	730	770	615	655	715	<ul style="list-style-type: none"> <li>• Pneumatic seat height adjustment</li> <li>• Tilt tension control</li> <li>• Back and seat tilt in 3:1 Ratio</li> <li>• Upright position tilt lock</li> <li>• Seat slider standard</li> <li>• Adjustable lumbar standard</li> <li>• Molded foam seat</li> <li>• Height adj. 20" diameter footring</li> <li>• Warranted to 300 lbs.</li> </ul>	<p><b>WIDTH:</b> 26.0 <b>DEPTH:</b> 26.0 <b>HEIGHT:</b> 47.5-57.5 <b>SEAT WIDTH:</b> 20.0 <b>SEAT DEPTH:</b> 17.5-20.0 <b>SEAT HEIGHT:</b> 27.0-37.0 <b>BACK WIDTH:</b> 18.0 <b>BACK HEIGHT:</b> 21.0 <b>COM:</b> 1 YD <b>WEIGHT:</b> 41.0 LBS</p>	<p><b>A23G/W</b> \$75 6-Way Height Adjustable Arm w/ Sliding Pad</p> <p><b>A46G/W</b> \$55 Nylon Loop Arm-Gray/White</p>	<p><b>C6</b> STD 60mm Hoodless Casters</p> <p><b>C6S</b> \$35 60mm Hoodless Hard Floor Casters</p> <p><b>C7</b> \$35 60mm Hoodless Chrome Accented Casters</p>
A/COM	B	C	D	E	F	G	L3/COL	L4	L5																																							
500	530	550	580	615	655	695	540	580	640																																							
555	585	605	635	670	710	750	595	635	695																																							
575	605	625	655	690	730	770	615	655	715																																							
3168	Y1	<b>8" STOOL SIMPLE SYNCHRO</b>  Use for work surfaces up to 36 inches	ARMLESS A46G/W A23G/W	<table border="1"> <thead> <tr> <th>A/COM</th> <th>B</th> <th>C</th> <th>D</th> <th>E</th> <th>F</th> <th>G</th> <th>L3/COL</th> <th>L4</th> <th>L5</th> </tr> </thead> <tbody> <tr> <td>500</td> <td>530</td> <td>550</td> <td>580</td> <td>615</td> <td>655</td> <td>695</td> <td>540</td> <td>580</td> <td>640</td> </tr> <tr> <td>555</td> <td>585</td> <td>605</td> <td>635</td> <td>670</td> <td>710</td> <td>750</td> <td>595</td> <td>635</td> <td>695</td> </tr> <tr> <td>575</td> <td>605</td> <td>625</td> <td>655</td> <td>690</td> <td>730</td> <td>770</td> <td>615</td> <td>655</td> <td>715</td> </tr> </tbody> </table>	A/COM	B	C	D	E	F	G	L3/COL	L4	L5	500	530	550	580	615	655	695	540	580	640	555	585	605	635	670	710	750	595	635	695	575	605	625	655	690	730	770	615	655	715	<ul style="list-style-type: none"> <li>• Pneumatic seat height adjustment</li> <li>• Tilt tension control</li> <li>• Back and seat tilt in 3:1 Ratio</li> <li>• Upright position tilt lock</li> <li>• Seat slider standard</li> <li>• Adjustable lumbar standard</li> <li>• Molded foam seat</li> <li>• Height adj. 20" diameter footring</li> <li>• Warranted to 300 lbs.</li> </ul>	<p><b>WIDTH:</b> 26.0 <b>DEPTH:</b> 26.0 <b>HEIGHT:</b> 43.5-51.5 <b>SEAT WIDTH:</b> 20.0 <b>SEAT DEPTH:</b> 17.5-20.0 <b>SEAT HEIGHT:</b> 23.0-31.0 <b>BACK WIDTH:</b> 18.0 <b>BACK HEIGHT:</b> 21.0 <b>COM:</b> 1 YD <b>WEIGHT:</b> 40.0 LBS</p>	<p><b>BA9G</b> STD 26" High-Profile Nylon Base - Gray</p> <p><b>BA9W</b> STD 26" High-Profile Nylon Base - White</p> <p><b>BA10P</b> \$100 26" High-Profile Aluminum Base - Polished</p>	<p><b>C6</b> STD 60mm Hoodless Casters</p> <p><b>C6S</b> \$35 60mm Hoodless Hard Floor Casters</p> <p><b>C7</b> \$35 60mm Hoodless Chrome Accented Casters</p>
A/COM	B	C	D	E	F	G	L3/COL	L4	L5																																							
500	530	550	580	615	655	695	540	580	640																																							
555	585	605	635	670	710	750	595	635	695																																							
575	605	625	655	690	730	770	615	655	715																																							

### FRAME AND MESH COLORS\*

GRAPHITE GRAY PGG	GRAY MESH M32	WHITE PWH	WHITE MESH M33
-------------------------	---------------------	--------------	----------------------

(BACK FRAME AND SEAT) (BACK FRAME AND SEAT)

\* A23G/W matches plastic color selected

# shuttle

the ultimate utility chair

## PLASTIC SEAT

GSA SIN # 711-19

- Seat and back styles include: all plastic, upholstered seat w/ plastic back or fully upholstered
- Bariatric, stools and tablet models available
- 11 plastic colors and 6 frame finishes
- All mesh styles available M1, M2, M3, M4
- Wall saver design on model 1210 and 1260
- Warranted to 300 lbs.
- CAL TB 133 Fire Code approved



### CREATING SHUTTLE MODEL NUMBER

MODEL NUMBER CONTROL ARMS FRAME COLOR UPHOLSTERY MESH COLOR PLASTIC COLOR CASTERS PACKAGING OPTIONS

1 2 - G T - A - - - - A P - M - - - - P - - - - C - - - - - - - -

\* FOR ARMLESS CODE USE ADD \* ONLY SELECT CASTER CODE FOR MODEL 1215, 1265

### PACKAGING NOTES

CODE	DESCRIPTION	LIST UPCHARGE
AB	ASSEMBLED IN BAG	\$0
AC	ASSEMBLED IN CARTON	\$0

SHUTTLE SIDE CHAIRS SHIP UP TO 3 PER CARTON (WITH TLF/TRF UP TO 2 PER CARTON)

MODEL	CONTROL	DESCRIPTION	MESH	ARM	PLASTIC	FEATURES	DIMENSIONS	ARM OPTIONS	CASTER OPTIONS	ADDITIONAL OPTIONS	ACCESSORIES
1210	GT	<b>GUEST STACKING</b> Plastic back with plastic seat		ARMLESS A18B A18G TLF/TRF	P 245 290 290 395	<ul style="list-style-type: none"> <li>• Non-marring floor glides</li> <li>• Stacks 4 high on floor</li> <li>• Stacks 10 high on optional dolly</li> <li>• Wall saver back legs</li> <li>• Warranted to 300 lbs.</li> </ul>	<b>ARMLESS</b> <b>W/ ARMS</b> <b>WIDTH:</b> 22.0    25.5 <b>DEPTH:</b> 25.0    25.0 <b>HEIGHT:</b> 33.0    33.0 <b>SEAT WIDTH:</b> 19.5    19.5 <b>SEAT DEPTH:</b> 17.0    17.0 <b>SEAT HEIGHT:</b> 17.0    17.0 <b>BACK WIDTH:</b> 20.0    20.0 <b>BACK HEIGHT:</b> 16.0    16.0 <b>COM:</b> N/A    N/A <b>WEIGHT:</b> 21.0 LB    24.0 LB	<b>A18B</b> <b>A18G</b> <b>\$45</b>	<b>TRF</b> <b>\$150</b>	<b>C5</b> <b>STD</b>	<b>C5S</b> <b>\$30</b>
1215	GT	<b>GUEST STACKING WITH CASTERS</b> Plastic back with plastic seat		ARMLESS A18B A18G	P 290 335 335	<ul style="list-style-type: none"> <li>• 50mm hooded casters</li> <li>• Stacks 4 high on floor</li> <li>• Stacks 10 high on optional dolly</li> <li>• Wall saver back legs</li> <li>• Warranted to 300 lbs.</li> </ul>	<b>WIDTH:</b> 22.0    25.5 <b>DEPTH:</b> 25.0    25.0 <b>HEIGHT:</b> 33.0    33.0 <b>SEAT WIDTH:</b> 19.5    19.5 <b>SEAT DEPTH:</b> 17.0    17.0 <b>SEAT HEIGHT:</b> 17.0    17.0 <b>BACK WIDTH:</b> 20.0    20.0 <b>BACK HEIGHT:</b> 16.0    16.0 <b>COM:</b> N/A    N/A <b>WEIGHT:</b> 21.0 LB    24.0 LB	<b>TLF</b> <b>\$150</b>	<b>C5</b> <b>\$30</b>		
1260	GT	<b>GUEST STACKING</b> Mesh back with plastic seat	M1 M1 M1 M2/M3/M4 M2/M3/M4 M2/M3/M4	ARMLESS A18B A18G ARMLESS A18B A18G	P 310 355 355 340 385 385	<ul style="list-style-type: none"> <li>• All mesh styles available M1, M2, M3, M4</li> <li>• Non-marring floor glides</li> <li>• Stacks 4 high on floor</li> <li>• Stacks 10 high on optional dolly</li> <li>• Wall saver back legs</li> <li>• Warranted to 300 lbs.</li> </ul>	<b>WIDTH:</b> 22.0    25.5 <b>DEPTH:</b> 25.0    25.0 <b>HEIGHT:</b> 33.0    33.0 <b>SEAT WIDTH:</b> 19.5    19.5 <b>SEAT DEPTH:</b> 17.0    17.0 <b>SEAT HEIGHT:</b> 17.0    17.0 <b>BACK WIDTH:</b> 20.0    20.0 <b>BACK HEIGHT:</b> 16.0    16.0 <b>COM:</b> N/A    N/A <b>WEIGHT:</b> 21.0 LB    24.0 LB	<b>G8</b> <b>\$20</b>	<b>G9</b> <b>G10</b> <b>\$30</b>	<b>DL1</b> <b>\$250</b>	<b>GC1</b> <b>\$30</b> <b>GC2</b> <b>\$30</b>
1265	GT	<b>GUEST STACKING WITH CASTERS</b> Mesh back with plastic seat	M1 M1 M1 M2/M3/M4 M2/M3/M4 M2/M3/M4	ARMLESS A18B A18G ARMLESS A18B A18G	P 355 400 400 385 430 430	<ul style="list-style-type: none"> <li>• All mesh styles available M1, M2, M3, M4</li> <li>• 50mm hooded casters</li> <li>• Stacks 4 high on floor</li> <li>• Stacks 10 high on optional dolly</li> <li>• Wall saver back legs</li> <li>• Warranted to 300 lbs.</li> </ul>	<b>WIDTH:</b> 22.0    25.5 <b>DEPTH:</b> 25.0    25.0 <b>HEIGHT:</b> 33.0    33.0 <b>SEAT WIDTH:</b> 19.5    19.5 <b>SEAT DEPTH:</b> 17.0    17.0 <b>SEAT HEIGHT:</b> 17.0    17.0 <b>BACK WIDTH:</b> 20.0    20.0 <b>BACK HEIGHT:</b> 16.0    16.0 <b>COM:</b> N/A    N/A <b>WEIGHT:</b> 21.0 LB    24.0 LB	<b>G8</b> <b>\$20</b>	<b>G9</b> <b>G10</b> <b>\$30</b>	<b>DL1</b> <b>\$250</b>	<b>GC1</b> <b>\$30</b> <b>GC2</b> <b>\$30</b>

NOTE: AVAILABLE IN M1, M2, M3 AND M4 MESH PATTERNS

NOTE: AVAILABLE IN M1, M2, M3 AND M4 MESH PATTERNS

\*Standard lead time applies to Metallic Brown, Gunmetal, Dover Gray and White frame color options. Black and Silver frame colors available in Express Ship

### ARM OPTIONS

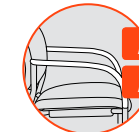

A18B - Soft Touch Arm - Black  
A18G - Soft Touch Arm - Gray

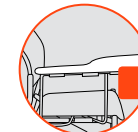

Right Tablet Arm (Available with Black Frame Only)  
Tablet size: 12.5" x 23.25" x .75"

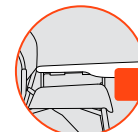

Left Tablet Arm (Available with Black Frame Only)  
Tablet size: 12.5" x 23.25" x .75"



50mm Hooded Casters

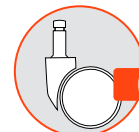

50mm Hooded Hard Floor Casters

### ADDITIONAL OPTIONS



Self-Leveling Metal Glide



G9 - Self-Leveling VCT Glide  
G10 - Self-Leveling Glide with Felt Pad

### FRAME COLORS

BLACK BF	SILVER SF	METALLIC BROWN* MBF
GUNMETAL* GMF	DOVER GRAY* DGF	WHITE* WF

(FRAME)

### MESH COLORS\*

BLACK M11	GRAY M12	SILVER M13
GREEN M14	RED M15	BLUE M16

\*MESH M2/M3/M4 ALSO AVAILABLE

### PLASTIC COLORS

BLACK SWAN P01	CLASSIC BURGUNDY P02	CORAL RED P03	SUNBONNET YELLOW P04
WHITE WHISPER P05	BOULDER GRAY P06	DOVER SKY P07	ESSEX BLUE P08
PALE WATER GREEN P09	CINNABAR ORANGE P10	FEDERAL BLUE P11	

(BACK & SEAT)



Book Rack in Black Only  
Available on All Models  
\*Not Stackable with BRK

# shuttle

the ultimate utility chair

## ALL PLASTIC - AP

GSA SIN # 711-19

- Seat and back styles include: all plastic, upholstered seat w/ plastic back or fully upholstered
- 11 plastic colors and 6 frame finishes
- Wall saver design on model 1210 and 1260
- Three stool seat height options
- Warranted to 300 lbs.
- CAL TB 133 Fire Code approved



### CREATING SHUTTLE MODEL NUMBER

MODEL NUMBER	CONTROL	ARMS	FRAME COLOR	UPHOLSTERY	PLASTIC COLOR	PACKAGING	OPTIONS
1210	ST			AP	P		

\* FOR ARMLESS CODE USE A00

### PACKAGING NOTES

CODE	DESCRIPTION	LIST UPCHARGE
AB	ASSEMBLED IN BAG	\$0
AC	ASSEMBLED IN CARTON	\$0

SHUTTLE STOOLS SHIP UP TO 1 PER CARTON

MODEL	CONTROL	DESCRIPTION	MESH	ARM	PLASTIC	FEATURES	DIMENSIONS																						
1210	ST24	<b>24" COUNTER STOOL</b>  Plastic back and seat. Use for work surfaces up to 34 inches high		ARMLESS A18B A18G	P 375 420 420	<ul style="list-style-type: none"> <li>• Counter height stool</li> <li>• Non-marring floor glides</li> <li>• Foot rest</li> <li>• Warranted to 300 lbs.</li> </ul>	<table border="1"> <thead> <tr> <th>ARMLESS</th> <th>W/ ARMS</th> </tr> </thead> <tbody> <tr><td>WIDTH:</td><td>22.0 25.5</td></tr> <tr><td>DEPTH:</td><td>25.0 25.0</td></tr> <tr><td>HEIGHT:</td><td>39.0 39.0</td></tr> <tr><td>SEAT WIDTH:</td><td>19.5 19.5</td></tr> <tr><td>SEAT DEPTH:</td><td>17.0 17.0</td></tr> <tr><td>SEAT HEIGHT:</td><td>24.0 24.0</td></tr> <tr><td>BACK WIDTH:</td><td>20.0 20.0</td></tr> <tr><td>BACK HEIGHT:</td><td>16.0 16.0</td></tr> <tr><td>COM:</td><td>N/A N/A</td></tr> <tr><td>WEIGHT:</td><td>21.5 LB 24.5 LB</td></tr> </tbody> </table>	ARMLESS	W/ ARMS	WIDTH:	22.0 25.5	DEPTH:	25.0 25.0	HEIGHT:	39.0 39.0	SEAT WIDTH:	19.5 19.5	SEAT DEPTH:	17.0 17.0	SEAT HEIGHT:	24.0 24.0	BACK WIDTH:	20.0 20.0	BACK HEIGHT:	16.0 16.0	COM:	N/A N/A	WEIGHT:	21.5 LB 24.5 LB
ARMLESS	W/ ARMS																												
WIDTH:	22.0 25.5																												
DEPTH:	25.0 25.0																												
HEIGHT:	39.0 39.0																												
SEAT WIDTH:	19.5 19.5																												
SEAT DEPTH:	17.0 17.0																												
SEAT HEIGHT:	24.0 24.0																												
BACK WIDTH:	20.0 20.0																												
BACK HEIGHT:	16.0 16.0																												
COM:	N/A N/A																												
WEIGHT:	21.5 LB 24.5 LB																												
1210	ST27	<b>27" COUNTER STOOL</b>  Plastic back and seat. Use for work surfaces up to 36 inches high		ARMLESS A18B A18G	P 375 420 420	<ul style="list-style-type: none"> <li>• Counter height stool</li> <li>• Non-marring floor glides</li> <li>• Foot rest</li> <li>• Warranted to 300 lbs.</li> </ul>	<table border="1"> <tbody> <tr><td>WIDTH:</td><td>22.0 25.5</td></tr> <tr><td>DEPTH:</td><td>25.0 25.0</td></tr> <tr><td>HEIGHT:</td><td>42.0 42.0</td></tr> <tr><td>SEAT WIDTH:</td><td>19.5 19.5</td></tr> <tr><td>SEAT DEPTH:</td><td>17.0 17.0</td></tr> <tr><td>SEAT HEIGHT:</td><td>27.0 27.0</td></tr> <tr><td>BACK WIDTH:</td><td>20.0 20.0</td></tr> <tr><td>BACK HEIGHT:</td><td>16.0 16.0</td></tr> <tr><td>COM:</td><td>N/A N/A</td></tr> <tr><td>WEIGHT:</td><td>23.5 LB 26.5 LB</td></tr> </tbody> </table>	WIDTH:	22.0 25.5	DEPTH:	25.0 25.0	HEIGHT:	42.0 42.0	SEAT WIDTH:	19.5 19.5	SEAT DEPTH:	17.0 17.0	SEAT HEIGHT:	27.0 27.0	BACK WIDTH:	20.0 20.0	BACK HEIGHT:	16.0 16.0	COM:	N/A N/A	WEIGHT:	23.5 LB 26.5 LB		
WIDTH:	22.0 25.5																												
DEPTH:	25.0 25.0																												
HEIGHT:	42.0 42.0																												
SEAT WIDTH:	19.5 19.5																												
SEAT DEPTH:	17.0 17.0																												
SEAT HEIGHT:	27.0 27.0																												
BACK WIDTH:	20.0 20.0																												
BACK HEIGHT:	16.0 16.0																												
COM:	N/A N/A																												
WEIGHT:	23.5 LB 26.5 LB																												
1210	ST30	<b>30" BAR STOOL</b>  Plastic back and seat. Use for work surfaces up to 42 inches high		ARMLESS A18B A18G	P 395 440 440	<ul style="list-style-type: none"> <li>• Bar height stool</li> <li>• Non-marring floor glides</li> <li>• Foot rest</li> <li>• Warranted to 300 lbs.</li> </ul>	<table border="1"> <tbody> <tr><td>WIDTH:</td><td>22.0 25.5</td></tr> <tr><td>DEPTH:</td><td>25.0 25.0</td></tr> <tr><td>HEIGHT:</td><td>45.0 45.0</td></tr> <tr><td>SEAT WIDTH:</td><td>19.5 19.5</td></tr> <tr><td>SEAT DEPTH:</td><td>17.0 17.0</td></tr> <tr><td>SEAT HEIGHT:</td><td>30.0 30.0</td></tr> <tr><td>BACK WIDTH:</td><td>20.0 20.0</td></tr> <tr><td>BACK HEIGHT:</td><td>16.0 16.0</td></tr> <tr><td>COM:</td><td>N/A N/A</td></tr> <tr><td>WEIGHT:</td><td>24.0 LB 27.0 LB</td></tr> </tbody> </table>	WIDTH:	22.0 25.5	DEPTH:	25.0 25.0	HEIGHT:	45.0 45.0	SEAT WIDTH:	19.5 19.5	SEAT DEPTH:	17.0 17.0	SEAT HEIGHT:	30.0 30.0	BACK WIDTH:	20.0 20.0	BACK HEIGHT:	16.0 16.0	COM:	N/A N/A	WEIGHT:	24.0 LB 27.0 LB		
WIDTH:	22.0 25.5																												
DEPTH:	25.0 25.0																												
HEIGHT:	45.0 45.0																												
SEAT WIDTH:	19.5 19.5																												
SEAT DEPTH:	17.0 17.0																												
SEAT HEIGHT:	30.0 30.0																												
BACK WIDTH:	20.0 20.0																												
BACK HEIGHT:	16.0 16.0																												
COM:	N/A N/A																												
WEIGHT:	24.0 LB 27.0 LB																												

### ARM OPTIONS

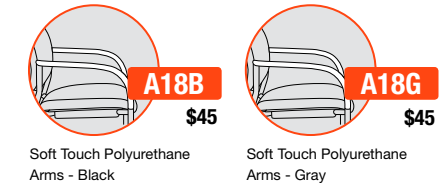

### ADDITIONAL OPTIONS

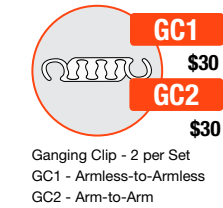

### FRAME COLORS

BLACK BF	SILVER SF	METALLIC BROWN* MBF	GUNMETAL* GMF	DOVER GRAY* DGF	WHITE* WF
-------------	--------------	---------------------------	------------------	-----------------------	--------------

(FRAME)

### PLASTIC COLORS

BLACK SWAN P01	CLASSIC BURGUNDY P02	CORAL RED P03	SUNBONNET YELLOW P04	WHITE WHISPER P05	BOULDER GRAY P06
DOVER SKY P07	ESSEX BLUE P08	PALE WATER GREEN P09	CINNABAR ORANGE P10	FEDERAL BLUE P11	

(BACK & SEAT)

\*Standard lead time applies to Metallic Brown, Gunmetal, Dover Gray and White frame color options. Black and Silver frame colors available in Express Ship



# shuttle

the ultimate utility chair

## MESH BACK - MB

GSA SIN # 711-19

- Seat and back styles include: all plastic, upholstered seat w/ plastic back or fully upholstered
- Bariatric, stools and tablet models available
- 11 plastic colors and 6 frame finishes
- All mesh styles available M1, M2, M3, M4
- Wall saver design on model 1210 and 1260
- Three stool seat height options
- Warranted to 300 lbs.
- CAL TB 133 Fire Code approved



### CREATING SHUTTLE MODEL NUMBER

MODEL NUMBER CONTROL ARMS FRAME COLOR UPHOLSTERY MESH COLOR PLASTIC COLOR PACKAGING OPTIONS

1 2 6 0 - S T - A - - - A P - M - P - - - -

\* FOR ARMLESS CODE USE A00

### PACKAGING NOTES

CODE	DESCRIPTION	LIST UPCHARGE
AB	ASSEMBLED IN BAG	\$0
AC	ASSEMBLED IN CARTON	\$0

MODEL	CONTROL	DESCRIPTION	MESH	ARM	PLASTIC
1260	ST24	<b>24" COUNTER STOOL</b>  Mesh back and plastic seat. Use for work surfaces up to 34 inches high	M1	ARMLESS	P 440
			M1	A18B	485
			M1	A18G	485
			M2/M3/M4	ARMLESS	470
			M2/M3/M4	A18B	515
			M2/M3/M4	A18G	515

NOTE: AVAILABLE IN M1, M2, M3 AND M4 MESH PATTERNS

### FEATURES

- All mesh styles available M1, M2, M3
- Counter height stool
- Non-marring floor glides
- Foot rest
- Warranted to 300 lbs.

### DIMENSIONS

	ARMLESS	W/ ARMS
WIDTH:	22.0	25.5
DEPTH:	25.0	25.0
HEIGHT:	39.0	39.0
SEAT WIDTH:	19.5	19.5
SEAT DEPTH:	17.0	17.0
SEAT HEIGHT:	24.0	24.0
BACK WIDTH:	20.0	20.0
BACK HEIGHT:	16.0	16.0
COM:	N/A	N/A
WEIGHT:	21.5 LB	24.5 LB

### ARM OPTIONS

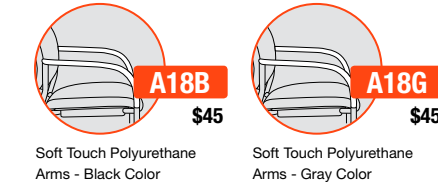

MODEL	CONTROL	DESCRIPTION	MESH	ARM	PLASTIC
1260	ST27	<b>27" COUNTER STOOL</b>  Mesh back and plastic seat. Use for work surfaces up to 36 inches high	M1	ARMLESS	P 440
			M1	A18B	485
			M1	A18G	485
			M2/M3/M4	ARMLESS	470
			M2/M3/M4	A18B	515
			M2/M3/M4	A18G	515

NOTE: AVAILABLE IN M1, M2, M3 AND M4 MESH PATTERNS

- All mesh styles available M1, M2, M3
- Counter height stool
- Non-marring floor glides
- Foot rest
- Warranted to 300 lbs.

WIDTH:	22.0	25.5
DEPTH:	25.0	25.0
HEIGHT:	42.0	42.0
SEAT WIDTH:	19.5	19.5
SEAT DEPTH:	17.0	17.0
SEAT HEIGHT:	27.0	27.0
BACK WIDTH:	20.0	20.0
BACK HEIGHT:	16.0	16.0
COM:	N/A	N/A
WEIGHT:	22.5 LB	25.5 LB

### ADDITIONAL OPTIONS

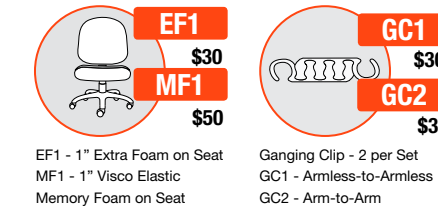

EF1 - 1" Extra Foam on Seat  
MF1 - 1" Visco Elastic Memory Foam on Seat

GC1 - Armless-to-Armless Ganging Clip - 2 per Set  
GC2 - Arm-to-Arm

MODEL	CONTROL	DESCRIPTION	MESH	ARM	PLASTIC
1260	ST30	<b>30" BAR STOOL</b>  Mesh back and plastic seat. Use for work surfaces up to 42 inches high	M1	ARMLESS	P 460
			M1	A18B	505
			M1	A18G	505
			M2/M3/M4	ARMLESS	490
			M2/M3/M4	A18B	535
			M2/M3/M4	A18G	535

NOTE: AVAILABLE IN M1, M2, M3 AND M4 MESH PATTERNS

- All mesh styles available M1, M2, M3
- Bar height stool
- Non-marring floor glides
- Foot rest
- Warranted to 300 lbs.

WIDTH:	22.0	25.5
DEPTH:	25.0	25.0
HEIGHT:	45.0	45.0
SEAT WIDTH:	19.5	19.5
SEAT DEPTH:	17.0	17.0
SEAT HEIGHT:	30.0	30.0
BACK WIDTH:	20.0	20.0
BACK HEIGHT:	16.0	16.0
COM:	N/A	N/A
WEIGHT:	23.5 LB	26.5 LB

### FRAME COLORS

BLACK BF	SILVER SF	METALLIC BROWN* MBF	GUNMETAL* GMF	DOVER GRAY* DGF	WHITE* WF
----------	-----------	---------------------	---------------	-----------------	-----------

(FRAME)

### MESH COLORS\*

BLACK M11	GRAY M12	SILVER M13	GREEN M14	RED M15	BLUE M16
-----------	----------	------------	-----------	---------	----------

\*MESH M2/M3/M4 ALSO AVAILABLE

### PLASTIC COLORS

BLACK SWAN P01	CLASSIC BURGUNDY P02	CORAL RED P03	SUNBONNET YELLOW P04	WHITE WHISPER P05	BOULDER GRAY P06
DOVER SKY P07	ESSEX BLUE P08	PALE WATER GREEN P09	CINNABAR ORANGE P10	FEDERAL BLUE P11	

(BACK & SEAT)

\*Standard lead time applies to Metallic Brown, Gunmetal, Dover Gray and White frame color options. Black and Silver frame colors available in Express Ship

# shuttle

the ultimate utility chair

GSA SIN # 711-19

- Seat and back styles include: all plastic, upholstered seat w/ plastic back or fully upholstered
- 11 plastic colors and 6 frame finishes
- Warranted up to 300 lbs.
- CAL TB 133 Fire Code approved



## PLASTIC SEAT

### CREATING SHUTTLE MODEL NUMBER

MODEL NUMBER CONTROL ARMS FRAME COLOR UPHOLSTERY MESH COLOR PLASTIC COLOR PACKAGING OPTIONS

1 2 - G T - A - A P - M - P - - - -

### PACKAGING NOTES

CODE	DESCRIPTION	LIST UPCHARGE
AB	ASSEMBLED IN BAG	\$0
AC	ASSEMBLED IN CARTON	\$0

SLED BASE CHAIRS SHIP 2 ARMLESS PER CARTON, 1 WITH ARMS

MODEL	CONTROL	DESCRIPTION	MESH	ARM	PLASTIC
-------	---------	-------------	------	-----	---------

MODEL	CONTROL	DESCRIPTION	MESH	ARM	PLASTIC															
					P															
1230	GT	<b>SLED BASE GUEST</b> Plastic back with plastic seat		ARMLESS	345															
				A18B	390															
				A18G	390															

MODEL	CONTROL	DESCRIPTION	MESH	ARM	PLASTIC																
					P																
1280	GT	<b>SLED BASE GUEST</b> Mesh back with plastic seat	M1	ARMLESS	410																
				A18B	435																
				A18G	435																
				M2/M3/M4	ARMLESS	440															
				A18B	465																
				A18G	465																

NOTE: AVAILABLE IN M1, M2, M3 AND M4 MESH PATTERNS

### FEATURES

- Non-marring floor glides
- Warranted to 300 lbs.

### DIMENSIONS

	ARMLESS	W/ ARMS
WIDTH:	22.0	25.5
DEPTH:	25.0	25.0
HEIGHT:	33.0	33.0
SEAT WIDTH:	19.5	19.5
SEAT DEPTH:	17.0	17.0
SEAT HEIGHT:	17.0	17.0
BACK WIDTH:	20.0	20.0
BACK HEIGHT:	16.0	16.0
WEIGHT:	21.0 LB	24.0 LB

### ARM OPTIONS

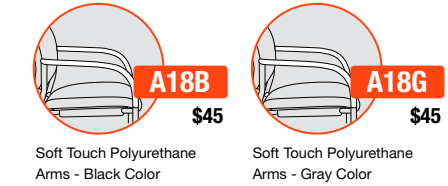

Soft Touch Polyurethane Arms - Black Color

Soft Touch Polyurethane Arms - Gray Color

### ADDITIONAL OPTIONS

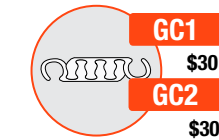

Ganging Clip - 2 per Set  
GC1 - Armless-to-Armless  
GC2 - Arm-to-Arm

### FRAME COLORS

BLACK BF	SILVER SF	METALLIC BROWN* MBF	GUNMETAL* GMF	DOVER GRAY* DGF	WHITE* WF
-------------	--------------	------------------------	------------------	--------------------	--------------

(FRAME)

### MESH COLORS\*

BLACK M11	GRAY M12	SILVER M13	GREEN M14	RED M15	BLUE M16
--------------	-------------	---------------	--------------	------------	-------------

\*MESH M2/M3/M4 ALSO AVAILABLE

### PLASTIC COLORS

BLACK SWAN P01	CLASSIC BURGUNDY P02	CORAL RED P03	SUNBONNET YELLOW P04	WHITE WHISPER P05	BOULDER GRAY P06
DOVER SKY P07	ESSEX BLUE P08	PALE WATER GREEN P09	CINNABAR ORANGE P10	FEDERAL BLUE P11	

(BACK & SEAT)

\*Standard lead time applies to Metallic Brown, Gunmetal, Dover Gray and White frame color options. Black and Silver frame colors available in Express Ship

# shuttle

the ultimate utility chair

## UPHOLSTERED SEAT - US

GSA SIN # 711-19

- Seat and back styles include: all plastic, upholstered seat w/ plastic back or fully upholstered
- Bariatric, stools and tablet models available
- 11 plastic colors and 6 frame finishes
- All mesh styles available M1, M2, M3, M4
- Wall saver design on model 1210 and 1260
- Warranted to 300 lbs.
- CAL TB 133 Fire Code approved



### CREATING SHUTTLE MODEL NUMBER

MODEL NUMBER CONTROL ARMS FRAME COLOR UPHOLSTERY MESH COLOR PLASTIC COLOR GRADE CASTERS PACKAGING OPTIONS

1 2 0 0 - G T - A 0 0 0 - 0 0 0 - U S - M 0 0 - P 0 0 - 0 - C 0 0 - 0 0 - 0 0 0

\* FOR ARMLESS CODE USE A00 \* ONLY SELECT CASTER CODE FOR MODEL 1215

### PACKAGING NOTES

CODE	DESCRIPTION	LIST UPCHARGE
AB	ASSEMBLED IN BAG	\$0
AC	ASSEMBLED IN CARTON	\$0

SHUTTLE SIDE CHAIRS SHIP UP TO 3 PER CARTON (WITH TLF/TRF UP TO 2 PER CARTON)

MODEL	CONTROL	DESCRIPTION	MESH	ARM	FABRIC	DIMENSIONS							FEATURES	DIMENSIONS	ARM OPTIONS	CASTER OPTIONS	ADDITIONAL OPTIONS	ACCESSORIES
						A/COM	B	C	D	E	F	G						
1210	GT	GUEST STACKING Plastic back with upholstered seat		ARMLESS	A/COM	310	335	355	380	410	445	480	<ul style="list-style-type: none"> <li>• Non-marring floor glides</li> <li>• Stacks 4 high on floor</li> <li>• Stacks 10 high on optional dolly</li> <li>• Wall saver back legs</li> <li>• Warranted to 300 lbs.</li> </ul>	<b>ARMLESS</b> WIDTH: 22.0 25.5 DEPTH: 25.0 25.0 HEIGHT: 33.0 33.0 SEAT WIDTH: 19.5 19.5 SEAT DEPTH: 17.0 17.0 SEAT HEIGHT: 17.0 17.0 BACK WIDTH: 20.0 20.0 BACK HEIGHT: 16.0 16.0 COM: 0.8 YDS 0.8 YDS WEIGHT: 19.0 LB 22.0 LB	<b>A18B</b> \$45 Soft Touch Polyurethane Arms - Black Color <b>A18G</b> \$45 Soft Touch Polyurethane Arms - Gray Color <b>TLF</b> \$150 Left Tablet Arm (Available with Black Frame Only) Tablet size: 12.5" x 23.25" x .75" <b>TRF</b> \$150 Right Tablet Arm (Available with Black Frame Only) Tablet size: 12.5" x 23.25" x .75"	<b>C5</b> STD 50mm Hooded Casters <b>C5S</b> \$30 50mm Hooded Hard Floor Casters		
					A18B	355	380	400	425	455	490	525						
					A18G	355	380	400	425	455	490	525						
					TLF/TRF	460	485	505	530	560	595	630						
1215	GT	GUEST STACKING WITH CASTERS Plastic back with upholstered seat		ARMLESS	A/COM	355	380	400	425	455	490	525	<ul style="list-style-type: none"> <li>• 50mm hooded casters</li> <li>• Stacks 4 high on floor</li> <li>• Stacks 10 high on optional dolly</li> <li>• Warranted to 300 lbs.</li> </ul>	WIDTH: 22.0 25.5 DEPTH: 25.0 25.0 HEIGHT: 33.0 33.0 SEAT WIDTH: 19.5 19.5 SEAT DEPTH: 17.0 17.0 SEAT HEIGHT: 17.0 17.0 BACK WIDTH: 20.0 20.0 BACK HEIGHT: 16.0 16.0 COM: 0.8 YDS 0.8 YDS WEIGHT: 19.0 LB 22.0 LB				
					A18B	400	425	445	470	500	535	570						
					A18G	400	425	445	470	500	535	570						
1260	GT	GUEST STACKING Mesh back with upholstered seat	M1	ARMLESS	A/COM	375	400	420	445	475	510	545	<ul style="list-style-type: none"> <li>• All mesh styles available M1, M2, M3, M4</li> <li>• Non-marring floor glides</li> <li>• Stacks 4 high on floor</li> <li>• Stacks 10 high on optional dolly</li> <li>• Wall saver back legs</li> <li>• Warranted to 300 lbs.</li> </ul>	WIDTH: 22.0 25.5 DEPTH: 25.0 25.0 HEIGHT: 33.0 33.0 SEAT WIDTH: 19.5 19.5 SEAT DEPTH: 17.0 17.0 SEAT HEIGHT: 17.0 17.0 BACK WIDTH: 20.0 20.0 BACK HEIGHT: 16.0 16.0 COM: 0.8 YDS 0.8 YDS WEIGHT: 19.0 LB 22.0 LB				
					M1	420	445	465	490	520	555	590						
					M1	420	445	465	490	520	555	590						
					M2/M3/M4	405	430	450	475	505	540	575						
					M2/M3/M4	450	475	495	520	550	585	620						
					M2/M3/M4	450	475	495	520	550	585	620						
NOTE: AVAILABLE IN M1, M2, M3 AND M4 MESH PATTERNS																		
1265	GT	GUEST STACKING WITH CASTERS Mesh back with upholstered seat	M1	ARMLESS	A/COM	420	445	465	490	520	555	590	<ul style="list-style-type: none"> <li>• All mesh styles available M1, M2, M3, M4</li> <li>• 50mm hooded casters</li> <li>• Stacks 4 high on floor</li> <li>• Stacks 10 high on optional dolly</li> <li>• Warranted to 300 lbs.</li> </ul>	WIDTH: 22.0 25.5 DEPTH: 25.0 25.0 HEIGHT: 33.0 33.0 SEAT WIDTH: 19.5 19.5 SEAT DEPTH: 17.0 17.0 SEAT HEIGHT: 17.0 17.0 BACK WIDTH: 20.0 20.0 BACK HEIGHT: 16.0 16.0 COM: 0.8 YDS 0.8 YDS WEIGHT: 19.0 LB 22.0 LB				
					M1	465	490	510	535	565	600	635						
					M1	465	490	510	535	565	600	635						
					M2/M3/M4	450	475	495	520	550	585	620						
					M2/M3/M4	495	520	540	565	595	630	665						
					M2/M3/M4	495	520	540	565	595	630	665						
NOTE: AVAILABLE IN M1, M2, M3 AND M4 MESH PATTERNS																		

CAUTION: Careless stacking of chairs may scratch and damage frames. Due to the nature of vinyl upholstery, stacking may cause impressions on the seat. 9to5 Seating does not warrant the effects of the stacking on vinyl upholstery.

\*Standard lead time applies to Metallic Brown, Gunmetal, Dover Gray and White frame color options. Black and Silver frame colors available in Express Ship

(BACK)

# shuttle

the ultimate utility chair

## UPHOLSTERED SEAT - US

GSA SIN # 711-19

- Seat and back styles include: all plastic, upholstered seat w/ plastic back or fully upholstered
- Bariatric, stools and tablet models available
- 11 plastic colors and 6 frame finishes
- Wall saver design on model 1210 and 1260
- Three stool seat height options
- Warranted to 300 lbs.
- CAL TB 133 Fire Code approved



### CREATING SHUTTLE MODEL NUMBER

MODEL NUMBER CONTROL ARMS FRAME COLOR UPHOLSTERY PLASTIC COLOR GRADE PACKAGING OPTIONS

1 2 1 0 - S T - A - U S - P - - - - -

\* FOR ARMLESS CODE USE A00

### PACKAGING NOTES

CODE	DESCRIPTION	LIST UPCHARGE
AB	ASSEMBLED IN BAG	\$0
AC	ASSEMBLED IN CARTON	\$0

SHUTTLE STOOLS SHIP UP TO 1 PER CARTON

MODEL	CONTROL	DESCRIPTION	MESH	ARM	FABRIC	DIMENSIONS							FEATURES	DIMENSIONS
						A/COM	B	C	D	E	F	G		
1210	ST24	<b>24" COUNTER STOOL</b>  Plastic back with upholstered seat. Use for work surfaces up to 34 inches high		ARMLESS A18B A18G		A/COM 440 485 485	B 465 510 510	C 485 530 530	D 510 555 555	E 540 585 585	F 575 620 620	G 610 655 655	<ul style="list-style-type: none"> <li>• Counter height stool</li> <li>• Non-marring floor glides</li> <li>• Foot rest</li> <li>• Warranted to 300 lbs.</li> </ul>	<b>ARMLESS</b> <b>WIDTH:</b> 22.0 25.5 <b>DEPTH:</b> 25.0 25.0 <b>HEIGHT:</b> 39.0 39.0 <b>SEAT WIDTH:</b> 19.5 19.5 <b>SEAT DEPTH:</b> 17.0 17.0 <b>SEAT HEIGHT:</b> 24.0 14.0 <b>BACK WIDTH:</b> 20.0 20.0 <b>BACK HEIGHT:</b> 16.0 16.0 <b>COM:</b> 0.8 YDS 0.8 YDS <b>WEIGHT:</b> 24.5 LB 27.5 LB
1210	ST27	<b>27" COUNTER STOOL</b>  Plastic back with upholstered seat. Use for work surfaces up to 36 inches high		ARMLESS A18B A18G		A/COM 440 485 485	B 465 510 510	C 485 530 530	D 510 555 555	E 540 585 585	F 575 620 620	G 610 655 655	<ul style="list-style-type: none"> <li>• Counter height stool</li> <li>• Non-marring floor glides</li> <li>• Foot rest</li> <li>• Warranted to 300 lbs.</li> </ul>	<b>WIDTH:</b> 22.0 25.5 <b>DEPTH:</b> 25.0 25.0 <b>HEIGHT:</b> 42.0 42.0 <b>SEAT WIDTH:</b> 19.5 19.5 <b>SEAT DEPTH:</b> 17.0 17.0 <b>SEAT HEIGHT:</b> 27.0 17.0 <b>BACK WIDTH:</b> 20.0 20.0 <b>BACK HEIGHT:</b> 16.0 16.0 <b>COM:</b> 0.8 YDS 0.8 YDS <b>WEIGHT:</b> 25.0 LB 28.0 LB
1210	ST30	<b>30" BAR STOOL</b>  Plastic back with upholstered seat. Use for work surfaces up to 42 inches high		ARMLESS A18B A18G		A/COM 460 505 505	B 485 530 530	C 505 550 550	D 530 575 575	E 560 605 605	F 595 640 640	G 630 675 675	<ul style="list-style-type: none"> <li>• Bar height stool</li> <li>• Non-marring floor glides</li> <li>• Foot rest</li> <li>• Warranted to 300 lbs.</li> </ul>	<b>WIDTH:</b> 22.0 25.5 <b>DEPTH:</b> 25.0 25.0 <b>HEIGHT:</b> 45.0 45.0 <b>SEAT WIDTH:</b> 19.5 19.5 <b>SEAT DEPTH:</b> 17.0 17.0 <b>SEAT HEIGHT:</b> 30.0 30.0 <b>BACK WIDTH:</b> 20.0 20.0 <b>BACK HEIGHT:</b> 16.0 16.0 <b>COM:</b> 0.8 YDS 0.8 YDS <b>WEIGHT:</b> 25.5 LB 28.5 LB

### ARM OPTIONS

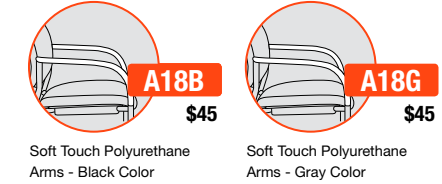

Soft Touch Polyurethane Arms - Black Color

Soft Touch Polyurethane Arms - Gray Color

### ADDITIONAL OPTIONS

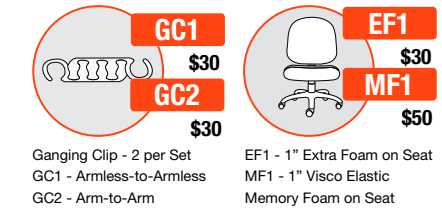

Ganging Clip - 2 per Set  
GC1 - Armless-to-Armless  
GC2 - Arm-to-Arm

EF1 - 1" Extra Foam on Seat  
MF1 - 1" Visco Elastic Memory Foam on Seat

### FRAME COLORS

BLACK BF	SILVER SF	METALLIC BROWN* MBF	GUNMETAL* GMF	DOVER GRAY* DGF	WHITE* WF
-------------	--------------	------------------------	------------------	--------------------	--------------

(FRAME)

### PLASTIC COLORS

BLACK SWAN P01	CLASSIC BURGUNDY P02	CORAL RED P03	SUNBONNET YELLOW P04	WHITE WHISPER P05	BOULDER GRAY P06
DOVER SKY P07	ESSEX BLUE P08	PALE WATER GREEN P09	CINNABAR ORANGE P10	FEDERAL BLUE P11	

(BACK)

CAUTION: Careless stacking of chairs may scratch and damage frames. Due to the nature of vinyl upholstery, stacking may cause impressions on the seat. 9to5 Seating does not warrant the effects of the stacking on vinyl upholstery.

\*Standard lead time applies to Metallic Brown, Gunmetal, Dover Gray and White frame color options. Black and Silver frame colors available in Express Ship

# shuttle

the ultimate utility chair

## UPHOLSTERED SEAT - US

GSA SIN # 711-19

- Seat and back styles include: all plastic, upholstered seat w/ plastic back or fully upholstered
- Bariatric, stools and tablet models available
- 11 plastic colors and 6 frame finishes
- Wall saver design on model 1210 and 1260
- Three stool seat height options
- Warranted to 300 lbs.
- CAL TB 133 Fire Code approved



### CREATING SHUTTLE MODEL NUMBER

MODEL NUMBER CONTROL ARMS FRAME COLOR UPHOLSTERY MESH COLOR PLASTIC COLOR GRADE PACKAGING OPTIONS

1 2 6 0 - S T - A - U S - M - P - - - -

\*FOR ARMLESS CODE USE A00

### PACKAGING NOTES

CODE	DESCRIPTION	LIST UPCHARGE
AB	ASSEMBLED IN BAG	\$0
AC	ASSEMBLED IN CARTON	\$0

SHUTTLE STOOLS SHIP UP TO 1 PER CARTON

MODEL	CONTROL	DESCRIPTION	MESH	ARM	FABRIC	DIMENSIONS							FEATURES	DIMENSIONS
						A/COM	B	C	D	E	F	G		
1260	ST24	<b>24" COUNTER STOOL</b>  Mesh back with plastic seat. Use for work surfaces up to 34 inches high	M1	ARMLESS	505	530	550	575	605	640	675	<ul style="list-style-type: none"> <li>• All mesh styles available M1, M2, M3, M4</li> <li>• Counter height stool</li> <li>• Non-marring floor glides</li> <li>• Foot rest</li> <li>• Warranted to 300 lbs.</li> </ul>	<b>ARMLESS</b> <b>W/ ARMS</b> <b>WIDTH:</b> 22.0    25.5 <b>DEPTH:</b> 25.0    25.0 <b>HEIGHT:</b> 39.0    39.0 <b>SEAT WIDTH:</b> 19.5    19.5 <b>SEAT DEPTH:</b> 17.0    17.0 <b>SEAT HEIGHT:</b> 27.0    17.0 <b>BACK WIDTH:</b> 20.0    20.0 <b>BACK HEIGHT:</b> 16.0    16.0 <b>COM:</b> 0.8 YDS    0.8 YDS <b>WEIGHT:</b> 24.5 LB    27.5 LB	
	M1		A18B	550	575	595	620	650	685	720				
	M1		A18G	550	575	595	620	650	685	720				
	M2/M3/M4		ARMLESS	535	560	580	605	635	670	705				
	M2/M3/M4		A18B	580	605	625	650	680	715	750				
	M2/M3/M4		A18G	580	605	625	650	680	715	750				
<small>NOTE: AVAILABLE IN M1, M2, M3 AND M4 MESH PATTERNS</small>														
1260	ST27	<b>27" COUNTER STOOL</b>  Mesh back with plastic seat. Use for work surfaces up to 36 inches high	M1	ARMLESS	505	530	550	575	605	640	675	<ul style="list-style-type: none"> <li>• All mesh styles available M1, M2, M3, M4</li> <li>• Counter height stool</li> <li>• Non-marring floor glides</li> <li>• Foot rest</li> <li>• Warranted to 300 lbs.</li> </ul>	<b>WIDTH:</b> 22.0    25.5 <b>DEPTH:</b> 25.0    25.0 <b>HEIGHT:</b> 42.0    42.0 <b>SEAT WIDTH:</b> 19.5    19.5 <b>SEAT DEPTH:</b> 17.0    17.0 <b>SEAT HEIGHT:</b> 27.0    17.0 <b>BACK WIDTH:</b> 20.0    20.0 <b>BACK HEIGHT:</b> 16.0    16.0 <b>COM:</b> 0.8 YDS    0.8 YDS <b>WEIGHT:</b> 25.0 LB    28.0 LB	
	M1		A18B	550	575	595	620	650	685	720				
	M1		A18G	550	575	595	620	650	685	720				
	M2/M3/M4		ARMLESS	535	560	580	605	635	670	705				
	M2/M3/M4		A18B	580	605	625	650	680	715	750				
	M2/M3/M4		A18G	580	605	625	650	680	715	750				
<small>NOTE: AVAILABLE IN M1, M2, M3 AND M4 MESH PATTERNS</small>														
1260	ST30	<b>30" BAR STOOL</b>  Mesh back with plastic seat. Use for work surfaces up to 42 inches high	M1	ARMLESS	525	550	570	595	625	660	695	<ul style="list-style-type: none"> <li>• All mesh styles available M1, M2, M3, M4</li> <li>• Bar height stool</li> <li>• Non-marring floor glides</li> <li>• Foot rest</li> <li>• Warranted to 300 lbs.</li> </ul>	<b>WIDTH:</b> 22.0    25.5 <b>DEPTH:</b> 25.0    25.0 <b>HEIGHT:</b> 45.0    45.0 <b>SEAT WIDTH:</b> 19.5    19.5 <b>SEAT DEPTH:</b> 17.0    17.0 <b>SEAT HEIGHT:</b> 30.0    30.0 <b>BACK WIDTH:</b> 20.0    20.0 <b>BACK HEIGHT:</b> 16.0    16.0 <b>COM:</b> 0.8 YDS    0.8 YDS <b>WEIGHT:</b> 25.5 LB    28.5 LB	
	M1		A18B	570	595	615	640	670	705	740				
	M1		A18G	570	595	615	640	670	705	740				
	M2/M3/M4		ARMLESS	555	580	600	625	655	690	725				
	M2/M3/M4		A18B	600	625	645	670	700	735	770				
	M2/M3/M4		A18G	600	625	645	670	700	735	770				
<small>NOTE: AVAILABLE IN M1, M2, M3 AND M4 MESH PATTERNS</small>														

### ARM OPTIONS

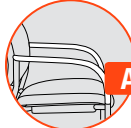

**A18B**  
\$45

Soft Touch Polyurethane Arms - Black Color

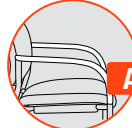

**A18G**  
\$45

Soft Touch Polyurethane Arms - Gray Color

### ADDITIONAL OPTIONS



**EF1**  
\$30

EF1 - 1" Extra Foam on Seat



**MF1**  
\$50

MF1 - 1" Visco Elastic Memory Foam on Seat

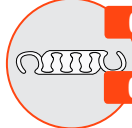

**GC1**  
\$30

Ganging Clip - 2 per Set



**GC2**  
\$30

GC2 - Arm-to-Arm

### FRAME COLORS

BLACK BF	SILVER SF	METALLIC BROWN* MBF	GUNMETAL* GMF	DOVER GRAY* DGF	WHITE* WF
-------------	--------------	------------------------	------------------	--------------------	--------------

(FRAME)

### MESH COLORS\*

BLACK M11	GRAY M12	SILVER M13	GREEN M14	RED M15	BLUE M16
--------------	-------------	---------------	--------------	------------	-------------

\*MESH M2/M3/M4 ALSO AVAILABLE

### PLASTIC COLORS

BLACK SWAN P01	CLASSIC BURGUNDY P02	CORAL RED P03	SUNBONNET YELLOW P04	WHITE WHISPER P05	BOULDER GRAY P06
DOVER SKY P07	ESSEX BLUE P08	PALE WATER GREEN P09	CINNABAR ORANGE P10	FEDERAL BLUE P11	

(BACK)

CAUTION: Careless stacking of chairs may scratch and damage frames. Due to the nature of vinyl upholstery, stacking may cause impressions on the seat. 9to5 Seating does not warrant the effects of the stacking on vinyl upholstery.

\*Standard lead time applies to Metallic Brown, Gunmetal, Dover Gray and White frame color options. Black and Silver frame colors available in Express Ship

# shuttle

the ultimate utility chair

GSA SIN # 711-19

- Seat and back styles include: all plastic, upholstered seat w/ plastic back or fully upholstered
- 11 plastic colors and 6 frame finishes
- All mesh styles available M1, M2, M3, M4
- Warranted to 300 lbs.
- CAL TB 133 Fire Code approved



## UPHOLSTERED SEAT - US

### CREATING SHUTTLE MODEL NUMBER

MODEL NUMBER CONTROL ARMS FRAME COLOR UPHOLSTERY MESH COLOR PLASTIC COLOR GRADE PACKAGING OPTIONS

1 2 - G T - A - U S - M - P - - - -

\* FOR ARMLESS CODE USE ADD

### PACKAGING NOTES

CODE	DESCRIPTION	LIST UPCHARGE
AB	ASSEMBLED IN BAG	\$0
AC	ASSEMBLED IN CARTON	\$0

SLED BASE CHAIRS SHIP 2 ARMLESS PER CARTON, 1 WITH ARMS

MODEL	CONTROL	DESCRIPTION	MESH	ARM	FABRIC
1230	GT	<b>SLED BASE GUEST</b> Plastic back with upholstered seat		A00	A/COM B C D E F G
				A18B	410 435 455 480 510 545 580
				A18G	455 480 500 525 555 590 625
				TLF	560 585 605 630 660 695 730
				TRF	560 585 605 630 660 695 730

MODEL	CONTROL	DESCRIPTION	MESH	ARM	FABRIC
1280	GT	<b>SLED BASE GUEST</b> Mesh back with upholstered seat	M1	ARMLESS	A/COM B C D E F G
			M1	A18B	475 500 520 545 575 610 645
			M1	A18G	520 545 565 590 620 655 690
			M2/M3/M4	ARMLESS	505 530 550 575 605 640 675
			M2/M3/M4	A18B	550 575 595 620 650 685 720
			M2/M3/M4	A18G	550 575 595 620 650 685 720

NOTE: AVAILABLE IN M1, M2, M3 AND M4 MESH PATTERNS

### FEATURES

- Non-marring floor glides
- Warranted to 300 lbs.

### DIMENSIONS

	ARMLESS	W/ ARMS
WIDTH:	22.0	25.5
DEPTH:	25.0	25.0
HEIGHT:	33.0	33.0
SEAT WIDTH:	19.5	19.5
SEAT DEPTH:	17.0	17.0
SEAT HEIGHT:	17.0	17.0
BACK WIDTH:	20.0	20.0
BACK HEIGHT:	16.0	16.0
COM:	0.8 YDS	0.8 YDS
WEIGHT:	21.0 LB	24.0 LB

- All mesh styles available M1, M2, M3, M4
- Non-marring floor glides
- Warranted to 300 lbs.

	ARMLESS	W/ ARMS
WIDTH:	22.0	25.5
DEPTH:	25.0	25.0
HEIGHT:	33.0	33.0
SEAT WIDTH:	19.5	19.5
SEAT DEPTH:	17.0	17.0
SEAT HEIGHT:	17.0	17.0
BACK WIDTH:	20.0	20.0
BACK HEIGHT:	16.0	16.0
COM:	0.8 YDS	0.8 YDS
WEIGHT:	23.0 LB	26.0 LB

### ARM OPTIONS

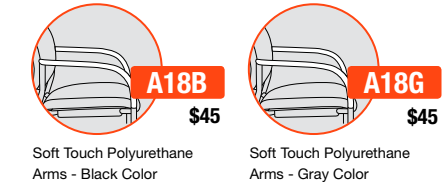

### ADDITIONAL OPTIONS

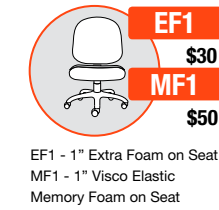

### FRAME COLORS

BLACK BF	SILVER SF	METALLIC BROWN* MBF	GUNMETAL* GMF	DOVER GRAY* DGF	WHITE* WFF
-------------	--------------	------------------------	------------------	--------------------	---------------

(FRAME)

### MESH COLORS\*

BLACK M11	GRAY M12	SILVER M13	GREEN M14	RED M15	BLUE M16
--------------	-------------	---------------	--------------	------------	-------------

\*MESH M2/M3/M4 ALSO AVAILABLE

### PLASTIC COLORS

BLACK SWAN P01	CLASSIC BURGUNDY P02	CORAL RED P03	SUNBONNET YELLOW P04	WHITE WHISPER P05	BOULDER GRAY P06
DOVER SKY P07	ESSEX BLUE P08	PALE WATER GREEN P09	CINNABAR ORANGE P10	FEDERAL BLUE P11	

(BACK)

CAUTION: Careless stacking of chairs may scratch and damage frames. Due to the nature of vinyl upholstery, stacking may cause impressions on the seat. 9to5 Seating does not warrant the effects of the stacking on vinyl upholstery.

\*Standard lead time applies to Metallic Brown, Gunmetal, Dover Gray and White frame color options. Black and Silver frame colors available in Express Ship

# shuttle

the ultimate utility chair

## FULLY UPHOLSTERED - UP

GSA SIN # 711-19

- Seat and back styles include: all plastic, upholstered seat w/ plastic back or fully upholstered
- Bariatric, stools and tablet models available
- 6 powder coat frame finishes
- Wall saver design on model 1210 and 1260
- Warranted to 300 lbs.
- CAL TB 133 Fire Code approved



### CREATING SHUTTLE MODEL NUMBER

MODEL NUMBER	CONTROL	ARMS	FRAME COLOR	UPHOLSTERY	GRADE	CASTERS	PACKAGING	OPTIONS
1 2	GT	A	F	UP				

\* FOR ARMLESS CODE USE A00      \* ONLY SELECT CASTER CODE FOR MODEL 1215

### PACKAGING NOTES

CODE	DESCRIPTION	LIST UPCHARGE
AB	ASSEMBLED IN BAG	\$0
AC	ASSEMBLED IN CARTON	\$0

SHUTTLE SIDE CHAIRS SHIP UP TO 3 PER CARTON (WITH TLF/TRF UP TO 2 PER CARTON)

MODEL	CONTROL	DESCRIPTION	MESH	ARM	FABRIC							FEATURES	DIMENSIONS		ARM OPTIONS	CASTER OPTIONS	ADDITIONAL OPTIONS	ACCESSORIES	
					A/COM	B	C	D	E	F	G		ARMLESS	W/ ARMS					
1210	GT	<b>GUEST STACKING</b>  Fully upholstered back and seat		ARMLESS	335	375	400	440	485	535	590	<ul style="list-style-type: none"> <li>• Non-marring floor glides</li> <li>• Stacks 4 high on floor</li> <li>• Stacks 10 high on optional dolly</li> <li>• Wall saver back legs</li> <li>• Warranted to 300 lbs.</li> </ul>	WIDTH: 22.0 25.5 DEPTH: 25.0 25.0 HEIGHT: 33.0 33.0 SEAT WIDTH: 19.5 19.5 SEAT DEPTH: 17.0 17.0 SEAT HEIGHT: 17.0 17.0 BACK WIDTH: 20.0 20.0 BACK HEIGHT: 16.0 16.0 COM: 1.2 YDS 1.2 YDS WEIGHT: 21.0 LB 24.0 LB	<b>A18B</b> \$45 Soft Touch Polyurethane Arms - Black Color	<b>A18G</b> \$45 Soft Touch Polyurethane Arms - Gray Color	<b>C5</b> STD 50mm Hooded Casters			
			A18B	380	420	445	485	530	580	635									
			A18G	380	420	445	485	530	580	635									
			TLF/TRF	485	525	550	590	635	685	740									
1215	GT	<b>GUEST STACKING WITH CASTERS</b>  Fully upholstered back and seat		ARMLESS	380	420	445	485	530	580	635	<ul style="list-style-type: none"> <li>• 50mm hooded casters</li> <li>• Stacks 4 high on floor</li> <li>• Stacks 10 high on optional dolly</li> <li>• Warranted to 300 lbs.</li> </ul>	WIDTH: 22.0 25.5 DEPTH: 25.0 25.0 HEIGHT: 33.0 33.0 SEAT WIDTH: 19.5 19.5 SEAT DEPTH: 17.0 17.0 SEAT HEIGHT: 17.0 17.0 BACK WIDTH: 20.0 20.0 BACK HEIGHT: 16.0 16.0 COM: 1.2 YDS 1.2 YDS WEIGHT: 21.0 LB 24.0 LB	<b>TLF</b> \$150 Left Tablet Arm (Available with Black Frame Only) Tablet size: 12.5" x 23.25" x .75"	<b>TRF</b> \$150 Right Tablet Arm (Available with Black Frame Only) Tablet size: 12.5" x 23.25" x .75"	<b>C5S</b> \$30 50mm Hooded Hard Floor Casters			
			A18B	425	465	490	530	575	625	680									
			A18G	425	465	490	530	575	625	680									

CAUTION: Careless stacking of chairs may scratch and damage frames. Due to the nature of vinyl upholstery, stacking may cause impressions on the seat. 9to5 Seating does not warrant the effects of the stacking on vinyl upholstery.

\*Standard lead time applies to Metallic Brown, Gunmetal, Dover Gray and White frame color options. Black and Silver frame colors available in Express Ship

### FRAME COLORS

BLACK BF	SILVER SF	METALLIC BROWN* MBF	GUNMETAL* GMF	DOVER GRAY* DGF	WHITE* WF
-------------	--------------	------------------------	------------------	--------------------	--------------

(FRAME)

# shuttle

the ultimate utility chair

## FULLY UPHOLSTERED - UP

GSA SIN # 711-19

- Seat and back styles include: all plastic, upholstered seat w/ plastic back or fully upholstered
- Bariatric, stools and tablet models available
- 11 plastic colors and 6 frame finishes
- Wall saver design on model 1210 and 1260
- Three stool seat height options
- Warranted to 300 lbs.
- CAL TB 133 Fire Code approved



### CREATING SHUTTLE MODEL NUMBER

MODEL NUMBER CONTROL ARMS FRAME COLOR UPHOLSTERY GRADE PACKAGING OPTIONS

1 2 1 0 - S T - A - U P - - - -

\* FOR ARMLESS CODE USE A00

### PACKAGING NOTES

CODE	DESCRIPTION	LIST UPCHARGE
AB	ASSEMBLED IN BAG	\$0
AC	ASSEMBLED IN CARTON	\$0

SHUTTLE STOOLS SHIP UP TO 1 PER CARTON

MODEL	CONTROL	DESCRIPTION	MESH	ARM	FABRIC	FEATURES	DIMENSIONS																											
1210	ST24	<b>24" COUNTER STOOL</b>		ARMLESS		<ul style="list-style-type: none"> <li>• Counter height stool</li> <li>• Non-marring floor glides</li> <li>• Foot rest</li> <li>• Warranted to 300 lbs.</li> </ul>	<p><b>ARMLESS</b>    <b>W/ ARMS</b></p> <p><b>WIDTH:</b> 22.0    25.5</p> <p><b>DEPTH:</b> 25.0    25.0</p> <p><b>HEIGHT:</b> 39.0    39.0</p> <p><b>SEAT WIDTH:</b> 19.5    19.5</p> <p><b>SEAT DEPTH:</b> 17.0    17.0</p> <p><b>SEAT HEIGHT:</b> 24.0    24.0</p> <p><b>BACK WIDTH:</b> 20.0    20.0</p> <p><b>BACK HEIGHT:</b> 16.0    16.0</p> <p><b>COM:</b> 1.2 YDS    1.2 YDS</p> <p><b>WEIGHT:</b> 26.0 LB    29.0 LB</p>																											
		Fully upholstered back and seat. Use for work surfaces up to 34 inches high			<table border="1"> <thead> <tr> <th>A/COM</th> <th>B</th> <th>C</th> <th>D</th> <th>E</th> <th>F</th> <th>G</th> </tr> </thead> <tbody> <tr> <td>465</td> <td>505</td> <td>530</td> <td>570</td> <td>615</td> <td>665</td> <td>720</td> </tr> <tr> <td>A18B</td> <td>510</td> <td>550</td> <td>575</td> <td>615</td> <td>660</td> <td>710</td> </tr> <tr> <td>A18G</td> <td>510</td> <td>550</td> <td>575</td> <td>615</td> <td>660</td> <td>710</td> </tr> </tbody> </table>	A/COM	B	C	D	E	F	G	465	505	530	570	615	665	720	A18B	510	550	575	615	660	710	A18G	510	550	575	615	660	710	
A/COM	B	C	D	E	F	G																												
465	505	530	570	615	665	720																												
A18B	510	550	575	615	660	710																												
A18G	510	550	575	615	660	710																												
1210	ST27	<b>27" COUNTER STOOL</b>		ARMLESS		<ul style="list-style-type: none"> <li>• Counter height stool</li> <li>• Non-marring floor glides</li> <li>• Foot rest</li> <li>• Warranted to 300 lbs.</li> </ul>	<p><b>WIDTH:</b> 22.0    25.5</p> <p><b>DEPTH:</b> 25.0    25.0</p> <p><b>HEIGHT:</b> 42.0    42.0</p> <p><b>SEAT WIDTH:</b> 19.5    19.5</p> <p><b>SEAT DEPTH:</b> 17.0    17.0</p> <p><b>SEAT HEIGHT:</b> 27.0    27.0</p> <p><b>BACK WIDTH:</b> 20.0    20.0</p> <p><b>BACK HEIGHT:</b> 16.0    16.0</p> <p><b>COM:</b> 1.2 YDS    1.2 YDS</p> <p><b>WEIGHT:</b> 26.0 LB    29.0 LB</p>																											
		Fully upholstered back and seat. Use for work surfaces up to 36 inches high			<table border="1"> <thead> <tr> <th>A/COM</th> <th>B</th> <th>C</th> <th>D</th> <th>E</th> <th>F</th> <th>G</th> </tr> </thead> <tbody> <tr> <td>465</td> <td>505</td> <td>530</td> <td>570</td> <td>615</td> <td>665</td> <td>720</td> </tr> <tr> <td>A18B</td> <td>510</td> <td>550</td> <td>575</td> <td>615</td> <td>660</td> <td>710</td> </tr> <tr> <td>A18G</td> <td>510</td> <td>550</td> <td>575</td> <td>615</td> <td>660</td> <td>710</td> </tr> </tbody> </table>	A/COM	B	C	D	E	F	G	465	505	530	570	615	665	720	A18B	510	550	575	615	660	710	A18G	510	550	575	615	660	710	
A/COM	B	C	D	E	F	G																												
465	505	530	570	615	665	720																												
A18B	510	550	575	615	660	710																												
A18G	510	550	575	615	660	710																												
1210	ST30	<b>30" BAR STOOL</b>		ARMLESS		<ul style="list-style-type: none"> <li>• Bar height stool</li> <li>• Non-marring floor glides</li> <li>• Foot rest</li> <li>• Warranted to 300 lbs.</li> </ul>	<p><b>WIDTH:</b> 22.0    25.5</p> <p><b>DEPTH:</b> 25.0    25.0</p> <p><b>HEIGHT:</b> 45.0    45.0</p> <p><b>SEAT WIDTH:</b> 19.5    19.5</p> <p><b>SEAT DEPTH:</b> 17.0    17.0</p> <p><b>SEAT HEIGHT:</b> 30.0    30.0</p> <p><b>BACK WIDTH:</b> 20.0    20.0</p> <p><b>BACK HEIGHT:</b> 16.0    16.0</p> <p><b>COM:</b> 1.2 YDS    1.2 YDS</p> <p><b>WEIGHT:</b> 26.0 LB    29.0 LB</p>																											
		Fully upholstered back and seat. Use for work surfaces up to 42 inches high			<table border="1"> <thead> <tr> <th>A/COM</th> <th>B</th> <th>C</th> <th>D</th> <th>E</th> <th>F</th> <th>G</th> </tr> </thead> <tbody> <tr> <td>485</td> <td>525</td> <td>550</td> <td>590</td> <td>635</td> <td>685</td> <td>740</td> </tr> <tr> <td>A18B</td> <td>530</td> <td>570</td> <td>595</td> <td>635</td> <td>680</td> <td>730</td> </tr> <tr> <td>A18G</td> <td>530</td> <td>570</td> <td>595</td> <td>635</td> <td>680</td> <td>730</td> </tr> </tbody> </table>	A/COM	B	C	D	E	F	G	485	525	550	590	635	685	740	A18B	530	570	595	635	680	730	A18G	530	570	595	635	680	730	
A/COM	B	C	D	E	F	G																												
485	525	550	590	635	685	740																												
A18B	530	570	595	635	680	730																												
A18G	530	570	595	635	680	730																												

### ARM OPTIONS

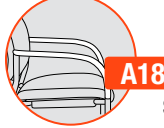

**A18B**  
\$45

Soft Touch Polyurethane  
Arms - Black Color

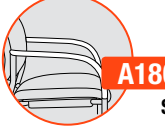

**A18G**  
\$45

Soft Touch Polyurethane  
Arms - Gray Color

### ADDITIONAL OPTIONS



**BN1**  
\$35

**BN2**  
\$0

Black Ballistic Nylon Back  
BN1 w/ Grad A Fabrics  
BN2 w/ Grade B and Up



**EF1**  
\$30

**MF1**  
\$50

EF1 - 1" Extra Foam on Seat  
MF1 - 1" Visco Elastic  
Memory Foam on Seat



**GC1**  
\$30

**GC2**  
\$30

Ganging Clip - 2 per Set  
GC1 - Armless-to-Armless  
GC2 - Arm-to-Arm

### FRAME COLORS

BLACK BF	SILVER SF	METALLIC BROWN* MBF	GUNMETAL* GMF	DOVER GRAY* DGF	WHITE* WF
-------------	--------------	---------------------------	------------------	-----------------------	--------------

(FRAME)

CAUTION: Careless stacking of chairs may scratch and damage frames. Due to the nature of vinyl upholstery, stacking may cause impressions on the seat. 9to5 Seating does not warrant the effects of the stacking on vinyl upholstery.

\*Standard lead time applies to Metallic Brown, Gunmetal, Dover Gray and White frame color options. Black and Silver frame colors available in Express Ship



# shuttle

the ultimate utility chair

GSA SIN # 711-19

- Seat and back styles include: all plastic, upholstered seat w/ plastic back or fully upholstered
- Bariatric, stools and tablet models available
- 6 powder coat frame finishes
- Warranted to 300 lbs.
- CAL TB 133 Fire Code approved



## FULLY UPHOLSTERED - UP

### CREATING SHUTTLE MODEL NUMBER

MODEL NUMBER CONTROL ARMS FRAME COLOR UPHOLSTERY GRADE PACKAGING OPTIONS

1 2 3 0 - G T - A [ ] [ ] [ ] - [ ] [ ] [ ] - U P - [ ] [ ] - [ ] [ ] [ ]

\* FOR ARMLESS CODE USE A00

### PACKAGING NOTES

CODE	DESCRIPTION	LIST UPCHARGE
AB	ASSEMBLED IN BAG	\$0
AC	ASSEMBLED IN CARTON	\$0

SLED BASE CHAIRS SHIP 2 ARMLESS PER CARTON, 1 WITH ARMS

MODEL	CONTROL	DESCRIPTION	MESH	ARM	FABRIC							
					A/COM	B	C	D	E	F	G	
1230	GT	<b>SLED BASE GUEST</b>  Fully upholstered back and seat		A00	435	475	500	540	585	635	690	
			A18B	480	520	545	585	630	680	735		
			A18G	480	520	545	585	630	680	735		
			TLF	585	625	650	690	735	785	840		
			TRF	585	625	650	690	735	785	840		

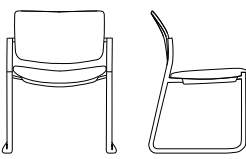

FEATURES	DIMENSIONS																																	
<ul style="list-style-type: none"> <li>• Non-marring floor glides</li> <li>• Warranted to 300 lbs.</li> </ul>	<table border="1"> <thead> <tr> <th></th> <th>ARMLESS</th> <th>W/ ARMS</th> </tr> </thead> <tbody> <tr> <td>WIDTH:</td> <td>22.0</td> <td>25.5</td> </tr> <tr> <td>DEPTH:</td> <td>25.0</td> <td>25.0</td> </tr> <tr> <td>HEIGHT:</td> <td>33.0</td> <td>33.0</td> </tr> <tr> <td>SEAT WIDTH:</td> <td>19.5</td> <td>19.5</td> </tr> <tr> <td>SEAT DEPTH:</td> <td>17.0</td> <td>17.0</td> </tr> <tr> <td>SEAT HEIGHT:</td> <td>19.0</td> <td>19.0</td> </tr> <tr> <td>BACK WIDTH:</td> <td>20.0</td> <td>20.0</td> </tr> <tr> <td>BACK HEIGHT:</td> <td>16.0</td> <td>16.0</td> </tr> <tr> <td>COM:</td> <td>1.2 YDS</td> <td>1.2 YDS</td> </tr> <tr> <td>WEIGHT:</td> <td>24.0 LB</td> <td>27.0 LB</td> </tr> </tbody> </table>		ARMLESS	W/ ARMS	WIDTH:	22.0	25.5	DEPTH:	25.0	25.0	HEIGHT:	33.0	33.0	SEAT WIDTH:	19.5	19.5	SEAT DEPTH:	17.0	17.0	SEAT HEIGHT:	19.0	19.0	BACK WIDTH:	20.0	20.0	BACK HEIGHT:	16.0	16.0	COM:	1.2 YDS	1.2 YDS	WEIGHT:	24.0 LB	27.0 LB
	ARMLESS	W/ ARMS																																
WIDTH:	22.0	25.5																																
DEPTH:	25.0	25.0																																
HEIGHT:	33.0	33.0																																
SEAT WIDTH:	19.5	19.5																																
SEAT DEPTH:	17.0	17.0																																
SEAT HEIGHT:	19.0	19.0																																
BACK WIDTH:	20.0	20.0																																
BACK HEIGHT:	16.0	16.0																																
COM:	1.2 YDS	1.2 YDS																																
WEIGHT:	24.0 LB	27.0 LB																																

### ARM OPTIONS

<p><b>A18B</b> \$45</p> <p>Soft Touch Polyurethane Arms - Black Color</p>	<p><b>A18G</b> \$45</p> <p>Soft Touch Polyurethane Arms - Gray Color</p>
---	--

### ADDITIONAL OPTIONS

<p><b>GC1</b> \$30</p>	<p><b>GC2</b> \$30</p>
----------------------------	----------------------------

Ganging Clip - 2 per Set  
GC1 - Armless-to-Armless  
GC2 - Arm-to-Arm

### FRAME COLORS

BLACK BF	SILVER SF	METALLIC BROWN* MBF	GUNMETAL* GMF	DOVER GRAY* DGF	WHITE* WF
-------------	--------------	------------------------	------------------	--------------------	--------------

(FRAME)

CAUTION: Careless stacking of chairs may scratch and damage frames. Due to the nature of vinyl upholstery, stacking may cause impressions on the seat. 9to5 Seating does not warrant the effects of the stacking on vinyl upholstery.

\*Standard lead time applies to Metallic Brown, Gunmetal, Dover Gray and White frame color options. Black and Silver frame colors available in Express Ship

# shuttle

the ultimate utility chair

GSA SIN # 711-19

- Wall saver legs on Bariatric model
- 6 powder coat frame finishes
- Bariatric warranted to 600 lbs.
- CAL TB 133 Fire Code approved



## BARIATRIC - 30" SEAT RATED FOR 600 LB

### CREATING SHUTTLE MODEL NUMBER

MODEL NUMBER CONTROL ARMS FRAME COLOR UPHOLSTERY GRADE CASTERS PACKAGING OPTIONS

1 2 5 0 - G T - A 1 8 - - - - U P - - - - -

\* ONLY SELECT CASTER CODE FOR MODEL 1215,1265

### PACKAGING NOTES

CODE	DESCRIPTION	LIST UPCHARGE
AB	ASSEMBLED IN BAG	\$0
AC	ASSEMBLED IN CARTON	\$0

MODEL	CONTROL	DESCRIPTION	MESH	ARM	FABRIC
1250	GT	<b>GUEST BARIATRIC</b>		A00	A/COM B C D E F G
		Fully upholstered back and seat. Chair comes standard with arms		A18B	755 825 870 940 1020 1110 1210
				A18G	800 870 915 985 1065 1155 1255

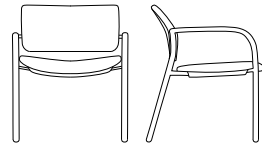

### FEATURES

- Steel reinforced seat and back
- 30" wide seat
- Does not stack
- Warranted to 600 lbs.

### DIMENSIONS

**WIDTH:** 36.5  
**DEPTH:** 25.0  
**HEIGHT:** 33.0  
**SEAT WIDTH:** 31.0  
**SEAT DEPTH:** 17.0  
**SEAT HEIGHT:** 19.0  
**BACK WIDTH:** 30.0  
**BACK HEIGHT:** 16.0  
**COM:** 2.2 YDS  
**WEIGHT:** 32.0 LB

### ARM OPTIONS

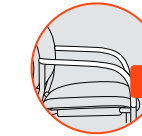

**A18B**  
\$45

Soft Touch Polyurethane Arms - Black Color

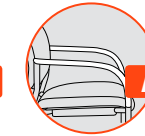

**A18G**  
\$45

Soft Touch Polyurethane Arms - Gray Color

### ADDITIONAL OPTIONS



**G8**  
\$20

Self-Leveling Metal Glide



**G9**  
\$30

Self-Leveling VCT Glide



**G10**  
\$30

Self-Leveling Glide with Felt Pad

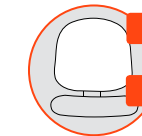

**BN1**  
\$35

Black Ballistic Nylon Back BN1 w/ Grad A Fabrics BN2 w/ Grade B and Up

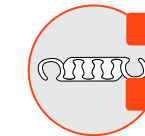

**GC1**  
\$30

Ganging Clip - 2 per Set GC1 - Armless-to-Armless GC2 - Arm-to-Arm

### FRAME COLORS

BLACK BF	SILVER SF	METALLIC BROWN* MBF	GUNMETAL* GMF	DOVER GRAY* DGF	WHITE* WF
-------------	--------------	------------------------	------------------	--------------------	--------------

(FRAME)

\*Standard lead time applies to Metallic Brown, Gunmetal, Dover Gray and White frame color options. Black and Silver frame colors available in Express Ship

# sol

the future at a glance

GSA SIN # 711-18 Pending

- Task, executive and conference seating
- Modern, elegant design with aluminum accents
- Flexible back promotes movement
- Back design allows full range of movement of shoulder and arms
- Ergonomic features including weight balanced synchro, adjustable arms, adjustable lumbar and seat slider
- Warranted to 300 lbs.



### CREATING SOL MODEL NUMBER

MODEL NUMBER	CONTROL	ARMS	PLASTIC COLOR	FRAME COLOR	GRADE	BASE	CASTERS	PACKAGING
3680		A48	PBK			BA36	C	

### PACKAGING NOTES

CODE	DESCRIPTION	LIST UPCHARGE
AB	ASSEMBLED IN BAG	\$0
BAC	BACK ASSEMBLED IN CARTON	\$0

**NEW UPHOLSTERED BACK**

MODEL	CONTROL	DESCRIPTION	ARM	FABRIC							FEATURES	DIMENSIONS			
				A/COM	B	C	D	E	F	G			L3	L4	L5
3680	W2	<b>HIGH-BACK ADVANCED WEIGHT BALANCED SYNCHRO</b>  Use for a variety of general office seating, including private office and conference room seating	A48	895	950	985	1040	1100	1170	1245	1075	1105	1285	<ul style="list-style-type: none"> <li>• Flexible articulating pivoting back rest</li> <li>• Pneumatic seat height adjustment</li> <li>• Tilt tension control</li> <li>• Back and seat tilt in 3:1 ratio</li> <li>• 4 Position back-recline limiting back</li> <li>• Molded foam seat</li> <li>• Height adjustable lumbar standard</li> <li>• Seat slider standard</li> <li>• Warranted to 300 lbs.</li> </ul>	<b>WIDTH:</b> 28.0 <b>DEPTH:</b> 28.0 <b>HEIGHT:</b> 39.5-44 <b>SEAT WIDTH:</b> 19.0 <b>SEAT DEPTH:</b> 16.5-19 <b>SEAT HEIGHT:</b> 16.5-21 <b>BACK WIDTH:</b> 18.5 <b>BACK HEIGHT:</b> 25.0 <b>COM:</b> 2.5 YD <b>WEIGHT:</b> 50.0 LB

### ARM OPTIONS

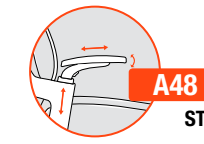

6-Way Height Adjustable Arm w/ Sliding Pad

### BASE OPTIONS



26" Aluminum Base-Polished



26" Aluminum Base-Silver Powder Coat

### CASTER OPTIONS



60mm Hoodless Casters



60mm Hoodless Hard Floor Casters



60mm Hoodless Chrome Accented Casters (Standard with aluminum bases)

### FRAME COLORS

POLISHED PF	SILVER SF
----------------	--------------

### PLASTIC COLORS

BLACK PBK	DOVE GRAY PDG
--------------	------------------

# sophie

ultimate comfort in a complete line of lounge seating

## SOFT SEATING LOUNGE

GSA SIN # 711-16

- Lounge collection includes guest, multi-seating, bariatric, hip chair, bench and table models
- Robust design for the most rigorous high traffic public areas
- Spacious clean-out and wall-saver frame
- Field replaceable parts and arm caps
- 6 powder coat frame colors
- Molded foam
- Steel frame construction for added durability
- CAL TB 133 Fire Code approved



### CREATING SOPHIE MODEL NUMBER

MODEL NUMBER CONTROL ARMS FRAME COLOR GRADE PACKAGING  
**8 1 1** - **G T** - **A 8 0** - - - - **A C**

MODEL	CONTROL	DESCRIPTION	ARM	FABRIC	FEATURES	DIMENSIONS																		
8111	GT	<b>SINGLE SEAT</b> Guest seat with armrest	SWA	<table border="1"> <thead> <tr> <th>A/COM</th> <th>B</th> <th>C</th> <th>D</th> <th>E</th> <th>F</th> <th>G</th> <th>L4</th> <th>L5</th> </tr> </thead> <tbody> <tr> <td>695</td> <td>745</td> <td>775</td> <td>825</td> <td>880</td> <td>940</td> <td>1005</td> <td>985</td> <td>1170</td> </tr> </tbody> </table>	A/COM	B	C	D	E	F	G	L4	L5	695	745	775	825	880	940	1005	985	1170	<ul style="list-style-type: none"> <li>• Spacious clean-out</li> <li>• Wall-saver frame</li> <li>• Field replacement parts and arm caps</li> <li>• 6 powder coat frame finishes</li> <li>• Non-marring adjustable glides</li> <li>• Urethane arm caps-black and gray</li> <li>• Warranted to 350 lbs.</li> </ul>	<p><b>WIDTH:</b> 25.0  <b>DEPTH:</b> 27.5  <b>HEIGHT:</b> 34.0  <b>SEAT WIDTH:</b> 20.0  <b>SEAT DEPTH:</b> 19.0  <b>SEAT HEIGHT:</b> 18.0  <b>BACK WIDTH:</b> 20.0  <b>BACK HEIGHT:</b> 16.0  <b>COM:</b> 1.5 YD  <b>WEIGHT:</b> 56.0 LB</p>
A/COM	B	C	D	E	F	G	L4	L5																
695	745	775	825	880	940	1005	985	1170																
8112	GT	<b>DOUBLE SEAT</b> Lounge seat with outside armrest	SWA	<table border="1"> <thead> <tr> <th>A/COM</th> <th>B</th> <th>C</th> <th>D</th> <th>E</th> <th>F</th> <th>G</th> <th>L4</th> <th>L5</th> </tr> </thead> <tbody> <tr> <td>1095</td> <td>1195</td> <td>1255</td> <td>1355</td> <td>1465</td> <td>1585</td> <td>1715</td> <td>1675</td> <td>2045</td> </tr> </tbody> </table>	A/COM	B	C	D	E	F	G	L4	L5	1095	1195	1255	1355	1465	1585	1715	1675	2045	<ul style="list-style-type: none"> <li>• Spacious clean-out</li> <li>• Wall-saver frame</li> <li>• Field replacement parts and arm caps</li> <li>• 6 powder coat frame finishes</li> <li>• Non-marring adjustable glides</li> <li>• Urethane arm caps-black and gray</li> <li>• Warranted to 525 lbs.</li> </ul>	<p><b>WIDTH:</b> 46.0  <b>DEPTH:</b> 27.5  <b>HEIGHT:</b> 34.0  <b>SEAT WIDTH:</b> 20.5  <b>SEAT DEPTH:</b> 19.0  <b>SEAT HEIGHT:</b> 18.0  <b>BACK WIDTH:</b> 20.0  <b>BACK HEIGHT:</b> 16.0  <b>COM:</b> 3.0 YD  <b>WEIGHT:</b> 87.0 LB</p>
A/COM	B	C	D	E	F	G	L4	L5																
1095	1195	1255	1355	1465	1585	1715	1675	2045																
8113	GT	<b>TRIPLE SEAT</b> Lounge seat with outside armrest	SWA	<table border="1"> <thead> <tr> <th>A/COM</th> <th>B</th> <th>C</th> <th>D</th> <th>E</th> <th>F</th> <th>G</th> <th>L4</th> <th>L5</th> </tr> </thead> <tbody> <tr> <td>1595</td> <td>1745</td> <td>1835</td> <td>1985</td> <td>2150</td> <td>2330</td> <td>2525</td> <td>2465</td> <td>3170</td> </tr> </tbody> </table>	A/COM	B	C	D	E	F	G	L4	L5	1595	1745	1835	1985	2150	2330	2525	2465	3170	<ul style="list-style-type: none"> <li>• Spacious clean-out</li> <li>• Wall-saver frame</li> <li>• Field replacement parts and arm caps</li> <li>• 6 powder coat frame finishes</li> <li>• Non-marring adjustable glides</li> <li>• Urethane arm caps-black and gray</li> <li>• Warranted to 750 lbs.</li> </ul>	<p><b>WIDTH:</b> 66.5  <b>DEPTH:</b> 27.5  <b>HEIGHT:</b> 34.0  <b>SEAT WIDTH:</b> 20.5  <b>SEAT DEPTH:</b> 19.0  <b>SEAT HEIGHT:</b> 18.0  <b>BACK WIDTH:</b> 20.5  <b>BACK HEIGHT:</b> 16.0  <b>COM:</b> 4.5 YD  <b>WEIGHT:</b> 118.0 LB</p>
A/COM	B	C	D	E	F	G	L4	L5																
1595	1745	1835	1985	2150	2330	2525	2465	3170																

### ARM OPTIONS

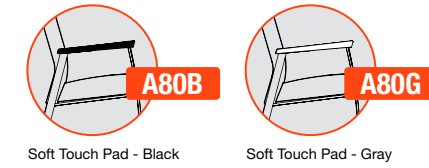

### FRAME COLORS

BLACK BF	SILVER SF	METALLIC BROWN MBF	GUNMETAL GMF	DOVER GRAY DGF	WHITE WF
-------------	--------------	--------------------------	-----------------	----------------------	-------------

(FRAME)

Standard 25 Day Lead Time: Twenty-five (25) business days applies to all Sophie models regardless of quantity. \$120 NET per shipment for Sophie orders of 3 chair model units or less.

# sophie

ultimate comfort in a complete line of lounge seating

## SOFT SEATING LOUNGE

GSA SIN # 711-16

- Lounge collection includes guest, multi-seating, bariatric, hip chair, bench and table models
- Robust design for the most rigorous high traffic public areas
- Spacious clean-out and wall-saver frame
- Field replaceable parts and arm caps
- 6 powder coat frame colors
- Molded foam
- CAL TB 133 Fire Code approved

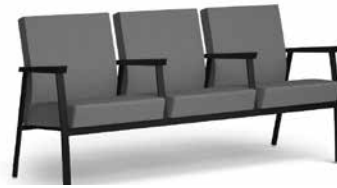

### CREATING SOPHIE MODEL NUMBER

MODEL NUMBER CONTROL ARMS FRAME COLOR GRADE PACKAGING  
**8 1 2** - **G T** - **A 8 0** - - - **A C**

MODEL	CONTROL	DESCRIPTION	ARM	FABRIC	FEATURES	DIMENSIONS														
8122	GT	<b>DOUBLE SEAT</b> Lounge chair with center armrest	SWA	<table border="1"> <thead> <tr> <th>A/COM</th> <th>B</th> <th>C</th> <th>D</th> <th>E</th> <th>F</th> <th>G</th> </tr> </thead> <tbody> <tr> <td>1195</td> <td>1295</td> <td>1355</td> <td>1455</td> <td>1565</td> <td>1685</td> <td>1815</td> </tr> </tbody> </table>	A/COM	B	C	D	E	F	G	1195	1295	1355	1455	1565	1685	1815	<ul style="list-style-type: none"> <li>• Spacious clean-out</li> <li>• Wall-saver frame</li> <li>• Field replacement parts and arm caps</li> <li>• 6 powder coat frame finishes</li> <li>• Non-marring adjustable glides</li> <li>• Urethane arm caps-black and gray</li> <li>• Warranted to 525 lbs.</li> </ul>	<b>WIDTH:</b> 47.5 <b>DEPTH:</b> 27.5 <b>HEIGHT:</b> 34.0 <b>SEAT WIDTH:</b> 20.5 <b>SEAT DEPTH:</b> 19.0 <b>SEAT HEIGHT:</b> 18.0 <b>BACK WIDTH:</b> 20.0 <b>BACK HEIGHT:</b> 16.0 <b>COM:</b> 3.0 YD <b>WEIGHT:</b> 95.0 LB
A/COM	B	C	D	E	F	G														
1195	1295	1355	1455	1565	1685	1815														
8123	GT	<b>TRIPLE SEAT</b> Lounge chair with center armrests	SWA	<table border="1"> <thead> <tr> <th>A/COM</th> <th>B</th> <th>C</th> <th>D</th> <th>E</th> <th>F</th> <th>G</th> </tr> </thead> <tbody> <tr> <td>1795</td> <td>1945</td> <td>2035</td> <td>2185</td> <td>2350</td> <td>2530</td> <td>2725</td> </tr> </tbody> </table>	A/COM	B	C	D	E	F	G	1795	1945	2035	2185	2350	2530	2725	<ul style="list-style-type: none"> <li>• Spacious clean-out</li> <li>• Wall-saver frame</li> <li>• Field replacement parts and arm caps</li> <li>• 6 powder coat frame finishes</li> <li>• Non-marring adjustable glides</li> <li>• Urethane arm caps-black and gray</li> <li>• Warranted to 750 lbs.</li> </ul>	<b>WIDTH:</b> 70.0 <b>DEPTH:</b> 27.5 <b>HEIGHT:</b> 34.0 <b>SEAT WIDTH:</b> 20.5 <b>SEAT DEPTH:</b> 19.0 <b>SEAT HEIGHT:</b> 18.0 <b>BACK WIDTH:</b> 20.0 <b>BACK HEIGHT:</b> 16.0 <b>COM:</b> 4.5 YD <b>WEIGHT:</b> 136.0 LB
A/COM	B	C	D	E	F	G														
1795	1945	2035	2185	2350	2530	2725														

### ARM OPTIONS

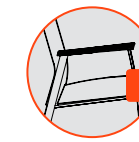

**A80B**

Soft Touch Pad - Black

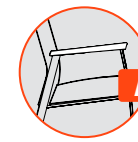

**A80G**

Soft Touch Pad - Gray

### FRAME COLORS

BLACK BF	SILVER SF	METALLIC BROWN MBF	GUNMETAL GMF	DOVER GRAY DGF	WHITE WF
-------------	--------------	--------------------------	-----------------	----------------------	-------------

(FRAME)

Standard 25 Day Lead Time: Twenty-five (25) business days applies to all Sophie models regardless of quantity. \$120 NET per shipment for Sophie orders of 3 chair model units or less.

# sophie

ultimate comfort in a complete line of lounge seating

GSA SIN # 711-16

- Lounge collection includes guest, multi-seating, bariatric, hip chair, bench and table models
- Robust design for the most rigorous high traffic public areas
- Spacious clean-out and wall-saver frame
- Field replaceable parts and arm caps
- 6 powder coat frame colors
- Non-marring adjustable feet
- CAL TB 133 Fire Code approved



## CREATING SOPHIE MODEL NUMBER

MODEL NUMBER CONTROL ARMS FRAME COLOR GRADE PACKAGING  
**8 1 1** - **G T** - **A 8 0** - - - **A C**

## PATIENT SEATING

MODEL	CONTROL	DESCRIPTION	ARM	FABRIC	FEATURES	DIMENSIONS														
8118	GT	<b>HIP CHAIR</b> Hip chair with armrest	SWA	<table border="1"> <thead> <tr> <th>A/COM</th> <th>B</th> <th>C</th> <th>D</th> <th>E</th> <th>F</th> <th>G</th> </tr> </thead> <tbody> <tr> <td>895</td> <td>945</td> <td>975</td> <td>1025</td> <td>1080</td> <td>1140</td> <td>1205</td> </tr> </tbody> </table>	A/COM	B	C	D	E	F	G	895	945	975	1025	1080	1140	1205	<ul style="list-style-type: none"> <li>• Spacious clean-out</li> <li>• Wall-saver frame</li> <li>• Field replacement parts and arm caps</li> <li>• 6 powder coat frame finishes</li> <li>• Non-marring adjustable glides</li> <li>• Urethane arm caps-black and gray</li> <li>• Warranted to 350 lbs.</li> </ul>	<p><b>WIDTH:</b> 25.0  <b>DEPTH:</b> 29.5  <b>HEIGHT:</b> 42.0  <b>SEAT WIDTH:</b> 20.0  <b>SEAT DEPTH:</b> 19.0  <b>SEAT HEIGHT:</b> 26.0  <b>BACK WIDTH:</b> 20.0  <b>BACK HEIGHT:</b> 16.0  <b>COM:</b> 1.5 YD  <b>WEIGHT:</b> 60.0 LB</p>
A/COM	B	C	D	E	F	G														
895	945	975	1025	1080	1140	1205														
8119	GT	<b>BARIATRIC</b> Bariatric guest chair with armrest	SWA	<table border="1"> <thead> <tr> <th>A/COM</th> <th>B</th> <th>C</th> <th>D</th> <th>E</th> <th>F</th> <th>G</th> </tr> </thead> <tbody> <tr> <td>995</td> <td>1075</td> <td>1125</td> <td>1205</td> <td>1295</td> <td>1395</td> <td>1505</td> </tr> </tbody> </table>	A/COM	B	C	D	E	F	G	995	1075	1125	1205	1295	1395	1505	<ul style="list-style-type: none"> <li>• Spacious clean-out</li> <li>• Wall-saver frame</li> <li>• Field replacement parts and arm caps</li> <li>• 6 powder coat frame finishes</li> <li>• Non-marring adjustable glides</li> <li>• Urethane arm caps-black and gray</li> <li>• Warranted to 500 lbs.</li> </ul>	<p><b>WIDTH:</b> 35.0  <b>DEPTH:</b> 27.5  <b>HEIGHT:</b> 34.0  <b>SEAT WIDTH:</b> 30.0  <b>SEAT DEPTH:</b> 19.0  <b>SEAT HEIGHT:</b> 18.0  <b>BACK WIDTH:</b> 30.0  <b>BACK HEIGHT:</b> 16.0  <b>COM:</b> 2.5 YD  <b>WEIGHT:</b> 66.0 LB</p>
A/COM	B	C	D	E	F	G														
995	1075	1125	1205	1295	1395	1505														

## ARM OPTIONS

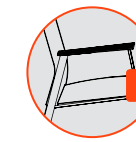

Soft Touch Pad - Black

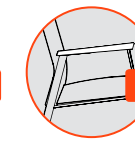

Soft Touch Pad - Gray

## FRAME COLORS

BLACK BF	SILVER SF	METALLIC BROWN MBF	GUNMETAL GMF	DOVER GRAY DGF	WHITE WF
-------------	--------------	--------------------------	-----------------	----------------------	-------------

(FRAME)

Standard 25 Day Lead Time: Twenty-five (25) business days applies to all Sophie models regardless of quantity. \$120 NET per shipment for Sophie orders of 3 chair model units or less.

# sophie

ultimate comfort in a complete line of lounge seating

## SOFT SEATING BENCHES

GSA SIN # 711-16

- Lounge collection includes guest, multi-seating, bariatric, hip chair, bench and table models
- Robust design for the most rigorous high traffic public areas
- Field replaceable parts
- 6 powder coat frame colors
- Non-marring adjustable feet
- CAL TB 133 Fire Code approved



### CREATING SOPHIE MODEL NUMBER

MODEL NUMBER CONTROL FRAME COLOR GRADE PACKAGING  
**8 1 0** - **G T** -  -  - **A C**

MODEL	CONTROL	DESCRIPTION	FABRIC	FEATURES	DIMENSIONS														
8102	GT	<b>DOUBLE SEAT BENCH</b> Bench seating for two	<table border="1"> <thead> <tr> <th>A/COM</th> <th>B</th> <th>C</th> <th>D</th> <th>E</th> <th>F</th> <th>G</th> </tr> </thead> <tbody> <tr> <td>665</td> <td>730</td> <td>770</td> <td>835</td> <td>910</td> <td>990</td> <td>1080</td> </tr> </tbody> </table>	A/COM	B	C	D	E	F	G	665	730	770	835	910	990	1080	<ul style="list-style-type: none"> <li>• Field replaceable parts</li> <li>• 6 powder coat frame finishes</li> <li>• Non-marring adjustable glides</li> <li>• Warranted to 525 lbs.</li> </ul>	<p><b>WIDTH:</b> 45.0  <b>DEPTH:</b> 23.5  <b>HEIGHT:</b> 18.0  <b>SEAT WIDTH:</b> 20.5  <b>SEAT DEPTH:</b> 23.5  <b>SEAT HEIGHT:</b> 18.0  <b>COM:</b> 2.0 YRD  <b>WEIGHT:</b> 44.0 LB</p>
A/COM	B	C	D	E	F	G													
665	730	770	835	910	990	1080													
8103	GT	<b>TRIPLE SEAT BENCH</b> Bench seating for three	<table border="1"> <thead> <tr> <th>A/COM</th> <th>B</th> <th>C</th> <th>D</th> <th>E</th> <th>F</th> <th>G</th> </tr> </thead> <tbody> <tr> <td>1165</td> <td>1265</td> <td>1325</td> <td>1425</td> <td>1535</td> <td>1655</td> <td>1785</td> </tr> </tbody> </table>	A/COM	B	C	D	E	F	G	1165	1265	1325	1425	1535	1655	1785	<ul style="list-style-type: none"> <li>• Field replaceable parts</li> <li>• 6 powder coat frame finishes</li> <li>• Non-marring adjustable glides</li> <li>• Warranted to 750 lbs.</li> </ul>	<p><b>WIDTH:</b> 65.5  <b>DEPTH:</b> 23.5  <b>HEIGHT:</b> 18.0  <b>SEAT WIDTH:</b> 20.5  <b>SEAT DEPTH:</b> 23.5  <b>SEAT HEIGHT:</b> 18.0  <b>COM:</b> 3.0 YD  <b>WEIGHT:</b> 62.0 LB</p>
A/COM	B	C	D	E	F	G													
1165	1265	1325	1425	1535	1655	1785													
8104	GT	<b>DOUBLE SEAT BENCH WITH TABLE TOP</b> Bench seating for two with one table top	<table border="1"> <thead> <tr> <th>A/COM</th> <th>B</th> <th>C</th> <th>D</th> <th>E</th> <th>F</th> <th>G</th> </tr> </thead> <tbody> <tr> <td>1135</td> <td>1200</td> <td>1240</td> <td>1305</td> <td>1380</td> <td>1460</td> <td>1550</td> </tr> </tbody> </table>	A/COM	B	C	D	E	F	G	1135	1200	1240	1305	1380	1460	1550	<ul style="list-style-type: none"> <li>• Field replaceable parts</li> <li>• 6 powder coat frame finishes</li> <li>• Non-marring adjustable glides</li> <li>• 5 surface laminate and edge material colors</li> <li>• Warranted to 525 lbs.</li> </ul>	<p><b>WIDTH:</b> 65.5  <b>DEPTH:</b> 23.5  <b>HEIGHT:</b> 18.0  <b>SEAT WIDTH:</b> 20.0  <b>SEAT DEPTH:</b> 23.5  <b>SEAT HEIGHT:</b> 18.0  <b>COM:</b> 2.0 YD  <b>WEIGHT:</b> 62.0 LB</p>
A/COM	B	C	D	E	F	G													
1135	1200	1240	1305	1380	1460	1550													

### FRAME COLORS

BLACK BF	SILVER SF	METALLIC BROWN MBF	GUNMETAL GMF	DOVER GRAY DGF	WHITE WF
-------------	--------------	--------------------------	-----------------	----------------------	-------------

(FRAME)

### LAMINATE COLORS

BLACK BKL	SLATE GRAY SLG	DESIGNER WHITE DWL	PLATINUM PTL	WALLABY WBL
--------------	-------------------	--------------------------	-----------------	----------------

Standard 25 Day Lead Time: Twenty-five (25) business days applies to all Sophie models regardless of quantity. \$120 NET per shipment for Sophie orders of 3 chair model units or less.

# sophie

ultimate comfort in a complete line of lounge seating

GSA SIN # 711-11

- Tables are like bridges joining chairs and multi-seating models
- Stand-alone and linking tables
- Robust design for the most rigorous high traffic public areas
- Field replacement components
- 6 powder coat frame colors
- 5 surface laminate and edge material colors



## CREATING SOPHIE MODEL NUMBER

MODEL NUMBER	CONTROL	FRAME COLOR	LAMINATE COLOR	PACKAGING	OPTIONS
8 1	T B			K D	

## STAND-ALONE AND LINKING TABLES

MODEL	CONTROL	DESCRIPTION	TABLE	FEATURES	DIMENSIONS	ADDITIONAL OPTIONS						
8170 	TB	<b>RECTANGULAR TABLE</b> 22" x 42" rectangular	395	<ul style="list-style-type: none"> <li>• 2 stand-alone table sizes</li> <li>• 5 surface laminate and edge material colors</li> </ul>	<b>WIDTH:</b> 22.0 <b>DEPTH:</b> 42.0 <b>HEIGHT:</b> 17.0	 <b>8199</b> <b>\$49</b> Large Ganging Bracket						
8190 	TB	<b>24" END TABLE</b> Square	300		<b>WIDTH:</b> 24.0 <b>DEPTH:</b> 24.0 <b>HEIGHT:</b> 17.0							
8191 	TB	<b>24" CONNECTING TABLE</b> End-of-run connecting	295	<ul style="list-style-type: none"> <li>• Connects to guest and multi-seating models</li> <li>• 5 surface laminate and edge material colors</li> </ul>	<b>WIDTH:</b> 24.0 <b>DEPTH:</b> 24.0 <b>HEIGHT:</b> 13.5	<b>FRAME COLORS</b> (FRAME) <table border="1"> <tr> <td>BLACK BF</td> <td>SILVER SF</td> <td>METALLIC BROWN MBF</td> <td>GUNMETAL GMF</td> <td>DOVER GRAY DGF</td> <td>WHITE WF</td> </tr> </table>	BLACK BF	SILVER SF	METALLIC BROWN MBF	GUNMETAL GMF	DOVER GRAY DGF	WHITE WF
BLACK BF	SILVER SF	METALLIC BROWN MBF	GUNMETAL GMF	DOVER GRAY DGF	WHITE WF							
8192 	TB	<b>SUSPENSION TABLE</b> 8" x 18" rectangular	160		<b>WIDTH:</b> 8.0 <b>DEPTH:</b> 18.0 <b>HEIGHT:</b> 13.5	<b>LAMINATE COLORS</b> <table border="1"> <tr> <td>BLACK BKL</td> <td>SLATE GRAY SLG</td> <td>DESIGNER WHITE DWL</td> <td>PLATINUM PTL</td> <td>WALLABY WBL</td> </tr> </table>	BLACK BKL	SLATE GRAY SLG	DESIGNER WHITE DWL	PLATINUM PTL	WALLABY WBL	
BLACK BKL	SLATE GRAY SLG	DESIGNER WHITE DWL	PLATINUM PTL	WALLABY WBL								
8193 	TB	<b>SUSPENSION TABLE</b> Round	350	<ul style="list-style-type: none"> <li>• Connects to guest and multi-seating models</li> <li>• 5 surface laminate and edge material colors</li> </ul>	<b>WIDTH:</b> 27.0 <b>DEPTH:</b> 27.0 <b>HEIGHT:</b> 13.5							
8194 	TB	<b>SUSPENSION TABLE</b> 30-degree angled	165		<b>WIDTH:</b> 11.0 <b>DEPTH:</b> 19.0 <b>HEIGHT:</b> 13.5							
8195 	TB	<b>SUSPENSION TABLE</b> 45-degree angled	175	<ul style="list-style-type: none"> <li>• Connects to guest and multi-seating models</li> <li>• 5 surface laminate and edge material colors</li> </ul>	<b>WIDTH:</b> 16.0 <b>DEPTH:</b> 19.0 <b>HEIGHT:</b> 13.5							
8196 	TB	<b>SUSPENSION TABLE</b> 60-degree angled	200		<b>WIDTH:</b> 21.5 <b>DEPTH:</b> 19.0 <b>HEIGHT:</b> 13.5							

Standard 25 Day Lead Time: Twenty-five (25) business days applies to all Sophie models regardless of quantity. \$120 NET per shipment for Sophie orders of 3 chair model units or less.



# strata

let strata float into your office

## MESH BACK UPHOLSTERED SEAT

GSA SIN # 711-18

- Task, task stool, executive and conference seating
- Aluminum base standard
- Black or silver frame colors
- Warranted to 300 lbs.
- CAL TB 133 Fire Code approved



### CREATING STRATA MODEL NUMBER

MODEL NUMBER CONTROL ARMS\* FRAME COLOR MESH COLOR\*\* BASE CASTERS GRADE PACKAGING OPTIONS

1 5 - Y 2 - A - F - M 0 1 - B A - C

\* FOR ARMLESS CODE USE ADD \*\*ONLY AVAILABLE IN BLACK MESH M01







### FRAME COLORS

CODE	DESCRIPTION
BF	BLACK
SF	SILVER

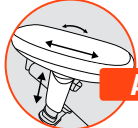
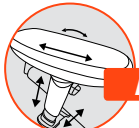
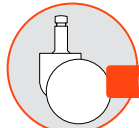
(FRAME)

### PACKAGING NOTES

CODE	DESCRIPTION	LIST UPCHARGE
AB	ASSEMBLED IN BAG	\$0
PAC	PARTIALLY ASSEMBLED IN CARTON	\$0
BAC	BACK ASSEMBLED IN CARTON	\$40

MODEL	CONTROL	DESCRIPTION	ARM	FABRIC/LEATHER											FEATURES	DIMENSIONS	ARM OPTIONS	CASTER OPTIONS	
				T01	A/COM	B	C	D	E	F	G	L3/COL	L4	L5					
1560	Y2	<b>MID-BACK HEAVY DUTY SYNCHRO</b>  Use for a variety of general office seating, including private office and conference room seating	ARMLESS	610	665	695	715	745	780	820	860	790	860	915	<ul style="list-style-type: none"> <li>• Pneumatic seat height adjustment</li> <li>• Side tilt tension control</li> <li>• Back and seat tilt in 2:1 ratio</li> <li>• 4 locking positions</li> <li>• Safety tilt release</li> <li>• Height and depth adjustable lumbar</li> <li>• Warranted to 300 lbs.</li> </ul>	<b>WIDTH:</b> 26.5 <b>DEPTH:</b> 26.5 <b>HEIGHT:</b> 39.5-44.0 <b>SEAT WIDTH:</b> 21.0 <b>SEAT DEPTH:</b> 18.0 <b>SEAT HEIGHT:</b> 17.0-21.5 <b>BACK WIDTH:</b> 21.0 <b>BACK HEIGHT:</b> 22.0 <b>COM:</b> 0.9 YDS <b>COL:</b> 13.0 SQ FT <b>WEIGHT:</b> 50.0 LB	 <b>A6</b> \$130 Height Adjustable Pivot Slide Arm	 <b>A7</b> \$150 Height/Width Adjustable Pivot Slide Arm	 <b>C4</b> STD 60mm Hoodless Casters
			A6	740	795	825	845	875	910	950	990	920	990	1045					
			A7	760	815	845	865	895	930	970	1010	940	1010	1065					
			A8B / A8S	695	750	780	800	830	865	905	945	875	945	1000					
			A9B / A9S	715	770	800	820	850	885	925	965	895	965	1020					
			A10	695	750	780	800	830	865	905	945	875	945	1000					
			A36	715	770	800	820	850	885	925	965	895	965	1020					
A37	735	790	820	840	870	905	945	985	915	985	1040								
				SEAT SLIDER (SS) - ADD \$60															
1580	Y2	<b>HIGH-BACK W/ HEADREST HEAVY DUTY SYNCHRO</b>  Use for a variety of general office seating, including private office and conference room seating	ARMLESS	665	725	755	775	805	840	880	920	850	970	1025	<ul style="list-style-type: none"> <li>• Pneumatic seat height adjustment</li> <li>• Side tilt tension control</li> <li>• Back and seat tilt in 2:1 ratio</li> <li>• 4 locking positions</li> <li>• Safety tilt release</li> <li>• Height and depth adjustable lumbar</li> <li>• 2 way adjustable headrest</li> <li>• Warranted to 300 lbs.</li> </ul>	<b>WIDTH:</b> 26.5 <b>DEPTH:</b> 26.5 <b>HEIGHT:</b> 46.5-51.0 <b>SEAT WIDTH:</b> 21.0 <b>SEAT DEPTH:</b> 18.0 <b>SEAT HEIGHT:</b> 17.0-21.5 <b>BACK WIDTH:</b> 21.0 <b>BACK HEIGHT:</b> 29.0 <b>COM:</b> 0.9 YDS <b>COL:</b> 16.0 SQ FT <b>WEIGHT:</b> 51.0 LB	 <b>A9B A9S</b> \$105 Height/Width Adjustable Arm A9B-Black, A9S-Silver	 <b>A8B A8S</b> \$85 Height Adjustable Arm A8B-Black, A8S-Silver	 <b>C1S C2S</b> \$35 C1S - 50mm Hooded Hard Floor Casters C2S - 50mm Hooded Self-Locking Hard Floor Casters
			A6	795	855	885	905	935	970	1010	1050	980	1100	1155					
			A7	815	875	905	925	955	990	1030	1070	1000	1120	1175					
			A8B / A8S	750	810	840	860	890	925	965	1005	935	1055	1110					
			A9B / A9S	770	830	860	880	910	945	985	1025	955	1075	1130					
			A10	750	810	840	860	890	925	965	1005	935	1055	1110					
			A36	770	830	860	880	910	945	985	1025	955	1075	1130					
A37	790	850	880	900	930	965	1005	1045	975	1095	1150								
				SEAT SLIDER (SS) - ADD \$60															
1566	Y2	<b>10" STOOL HEAVY DUTY SYNCHRO</b>  Use for work surfaces up to 42 inches high	ARMLESS	735	790	820	840	870	905	945	985	910	980	1035	<ul style="list-style-type: none"> <li>• Pneumatic seat height adjustment</li> <li>• Side tilt tension control</li> <li>• Back and seat tilt in 2:1 ratio</li> <li>• 4 locking positions</li> <li>• Safety tilt release</li> <li>• Height and depth adjustable lumbar</li> <li>• Height adj 20" diameter footing</li> <li>• Warranted to 300 lbs.</li> </ul>	<b>WIDTH:</b> 26.5 <b>DEPTH:</b> 26.5 <b>HEIGHT:</b> 49.0-59.0 <b>SEAT WIDTH:</b> 21.0 <b>SEAT DEPTH:</b> 18.0 <b>SEAT HEIGHT:</b> 27.0-37.0 <b>BACK WIDTH:</b> 21.0 <b>BACK HEIGHT:</b> 22.0 <b>COM:</b> 0.9 YDS <b>COL:</b> 13.0 SQ FT <b>WEIGHT:</b> 56.0 LB	 <b>A37</b> \$125 Height/Width Adjustable Pivot/Slide Arm	 <b>BA2B BA2S BA2P</b> \$100 26" Aluminum Base Black Powder Coat    26" Aluminum Base Silver Powder Coat    26" Aluminum Base - Polished	
			A6	865	920	950	970	1000	1035	1075	1115	1040	1110	1165					
			A7	885	940	970	990	1020	1055	1095	1135	1060	1130	1185					
			A8B / A8S	820	875	905	925	955	990	1030	1070	995	1065	1120					
			A9B / A9S	840	895	925	945	975	1010	1050	1090	1015	1085	1140					
			A10	820	875	905	925	955	990	1030	1070	995	1065	1120					
			A36	840	895	925	945	975	1010	1050	1090	1015	1085	1140					
A37	860	915	945	965	995	1030	1070	1110	1035	1105	1160								
				SEAT SLIDER (SS) - NOT AVAILABLE															
1568	Y2	<b>8" STOOL HEAVY DUTY SYNCHRO</b>  Use for work surfaces up to 36 inches high	ARMLESS	735	790	820	840	870	905	945	985	910	980	1035	<ul style="list-style-type: none"> <li>• Pneumatic seat height adjustment</li> <li>• Side tilt tension control</li> <li>• Back and seat tilt in 2:1 ratio</li> <li>• 4 locking positions</li> <li>• Safety tilt release</li> <li>• Height and depth adjustable lumbar</li> <li>• Height adj 20" diameter footing</li> <li>• Warranted to 300 lbs.</li> </ul>	<b>WIDTH:</b> 26.5 <b>DEPTH:</b> 26.5 <b>HEIGHT:</b> 45.0-53.0 <b>SEAT WIDTH:</b> 21.0 <b>SEAT DEPTH:</b> 18.0 <b>SEAT HEIGHT:</b> 23.0-31.0 <b>BACK WIDTH:</b> 21.0 <b>BACK HEIGHT:</b> 22.0 <b>COM:</b> 0.9 YDS <b>COL:</b> 13.0 SQ FT <b>WEIGHT:</b> 55.0 LB	 <b>HD SS</b> \$50 \$60 Heavy Duty Multi-Shift Upgrade 350 lb. (Includes BA2 Aluminum Base and C4 60mm Casters; Available with Y2 Control Only) Seat Slider 2.5" Side Paddle Activated Factory Installed		
			A6	865	920	950	970	1000	1035	1075	1115	1040	1110	1165					
			A7	885	940	970	990	1020	1055	1095	1135	1060	1130	1185					
			A8B / A8S	820	875	905	925	955	990	1030	1070	995	1065	1120					
			A9B / A9S	840	895	925	945	975	1010	1050	1090	1015	1085	1140					
			A10	820	875	905	925	955	990	1030	1070	995	1065	1120					
			A36	840	895	925	945	975	1010	1050	1090	1015	1085	1140					
A37	860	915	945	965	995	1030	1070	1110	1035	1105	1160								
				SEAT SLIDER (SS) - NOT AVAILABLE															

# strata

let strata float into your office

GSA SIN # 711-18

- Multi-purpose guest seating
- Warranted to 300 lbs.
- CAL TB 133 Fire Code approved



## MESH BACK UPHOLSTERED SEAT

### CREATING STRATA MODEL NUMBER

MODEL NUMBER CONTROL ARMS FRAME COLOR MESH COLOR\*\* GRADE PACKAGING  
**1 5 6 0 - G T - S W A - S F - M 0 1 -**

\*\*ONLY AVAILABLE IN BLACK MESH M01

#### FRAME COLORS

CODE	DESCRIPTION
SF	SILVER

(FRAME)

#### PACKAGING NOTES

CODE	DESCRIPTION	LIST UPCHARGE
AB	ASSEMBLED IN BAG	\$0
BAC	BACK ASSEMBLED IN CARTON	\$40

MODEL	CONTROL	DESCRIPTION	ARM	FABRIC/LEATHER											FEATURES	DIMENSIONS	ARM OPTIONS
				T01	A/COM	B	C	D	E	F	G	L3/COL	L4	L5			
1560	GT	<b>GUEST</b> Silver cantilever steel frame side chair	SWA	500	555	585	605	635	670	710	750	680	750	805	<ul style="list-style-type: none"> <li>• Height and depth adjustable lumbar</li> <li>• Black back accents</li> <li>• Cantilever frame</li> <li>• Warranted to 300 lbs.</li> </ul>	<b>WIDTH:</b> 24.0 <b>DEPTH:</b> 24.0 <b>HEIGHT:</b> 39.0 <b>SEAT WIDTH:</b> 21.0 <b>SEAT DEPTH:</b> 18.0 <b>SEAT HEIGHT:</b> 18.0 <b>BACK WIDTH:</b> 21.0 <b>BACK HEIGHT:</b> 22.0 <b>COM:</b> 0.9 YDS <b>COL:</b> 13.0 SQ FT <b>WEIGHT:</b> 28.0 LB	

SHIPS FULLY ASSEMBLED EITHER AC OR AB / SWA - STANDARD WITH ARMS

# strata all mesh

let strata float into your office

## ALL MESH

GSA SIN # 711-18

- Task, conference, executive and stool seating
- Aluminum base standard
- Black or silver frame colors
- Warranted to 300 lbs.



### CREATING STRATA MODEL NUMBER

MODEL NUMBER CONTROL ARMS\* FRAME COLOR MESH COLOR\*\* BASE CASTERS PACKAGING OPTIONS

1 5 - Y 2 - A - F - M 0 1 - B A - C -

\* FOR ARMLESS CODE USE A00 \*\*ONLY AVAILABLE IN BLACK MESH M01

### FRAME COLORS

CODE	DESCRIPTION
BF	BLACK
SF	SILVER

(FRAME)

### PACKAGING NOTES

CODE	DESCRIPTION	LIST UPCHARGE
AB	ASSEMBLED IN BAG	\$0
PAC	PARTIALLY ASSEMBLED IN CARTON	\$0
BAC	BACK ASSEMBLED IN CARTON	\$40

MODEL	CONTROL	DESCRIPTION	ARM	MESH	FEATURES	DIMENSIONS	ARM OPTIONS	CASTER OPTIONS																																
1570	Y2	<b>MID-BACK HEAVY DUTY SYNCHRO</b> Use for a variety of general office seating, including private office and conference room seating	<table border="1"> <tr><td>ARMLESS</td><td>665</td></tr> <tr><td>A6</td><td>795</td></tr> <tr><td>A7</td><td>815</td></tr> <tr><td>A8B / A8S</td><td>750</td></tr> <tr><td>A9B / A9S</td><td>770</td></tr> <tr><td>A10</td><td>750</td></tr> <tr><td>A36</td><td>770</td></tr> <tr><td>A37</td><td>790</td></tr> </table>	ARMLESS	665	A6	795	A7	815	A8B / A8S	750	A9B / A9S	770	A10	750	A36	770	A37	790	<table border="1"> <tr><td>M</td><td>665</td></tr> <tr><td>M</td><td>795</td></tr> <tr><td>M</td><td>815</td></tr> <tr><td>M</td><td>750</td></tr> <tr><td>M</td><td>770</td></tr> <tr><td>M</td><td>750</td></tr> <tr><td>M</td><td>770</td></tr> <tr><td>M</td><td>790</td></tr> </table>	M	665	M	795	M	815	M	750	M	770	M	750	M	770	M	790	<ul style="list-style-type: none"> <li>• Pneumatic seat height adjustment</li> <li>• Side tilt tension control</li> <li>• Back and seat tilt in 2:1 ratio</li> <li>• 4 locking positions</li> <li>• Safety tilt release</li> <li>• Height and depth adjustable lumbar</li> <li>• Warranted to 300 lbs.</li> </ul>	<p><b>WIDTH:</b> 26.5 <b>DEPTH:</b> 26.5 <b>HEIGHT:</b> 39.5-44.0 <b>SEAT WIDTH:</b> 19.0 <b>SEAT DEPTH:</b> 18.0 <b>SEAT HEIGHT:</b> 17.0-21.5 <b>BACK WIDTH:</b> 21.5 <b>BACK HEIGHT:</b> 23.0 <b>WEIGHT:</b> 50.0 LB</p>	<p><b>A6</b> \$130 Height Adjustable Pivot Slide Arm</p> <p><b>A7</b> \$150 Height/Width Adjustable Pivot Slide Arm</p> <p><b>A8B</b> \$85 <b>A8S</b> \$85 Height Adjustable Arm A8B-Black, A8S-Silver</p> <p><b>A9B</b> \$105 <b>A9S</b> \$105 Height/Width Adjustable Arm A9B-Black, A9S-Silver</p> <p><b>A10</b> \$85 Soft Touch C-Shaped Arm</p> <p><b>A36</b> \$105 Height Adjustable Pivot/Slide Arm</p> <p><b>A37</b> \$125 Height/Width Adjustable Pivot/Slide Arm</p>	<p><b>C4</b> STD 60mm Hoodless Casters</p> <p><b>C1S</b> \$35 <b>C2S</b> \$35 C1S - 50mm Hooded Hard Floor Casters C2S - 50mm Hooded Self-Locking Hard Floor Casters</p>
ARMLESS	665																																							
A6	795																																							
A7	815																																							
A8B / A8S	750																																							
A9B / A9S	770																																							
A10	750																																							
A36	770																																							
A37	790																																							
M	665																																							
M	795																																							
M	815																																							
M	750																																							
M	770																																							
M	750																																							
M	770																																							
M	790																																							
				SEAT SLIDER (SS) - ADD \$60 - FACTORY INSTALLED																																				
1590	Y2	<b>HIGH-BACK W/ HEADREST HEAVY DUTY SYNCHRO</b> Use for a variety of general office seating, including private office and conference room seating	<table border="1"> <tr><td>ARMLESS</td><td>720</td></tr> <tr><td>A6</td><td>850</td></tr> <tr><td>A7</td><td>870</td></tr> <tr><td>A8B / A8S</td><td>805</td></tr> <tr><td>A9B / A9S</td><td>825</td></tr> <tr><td>A10</td><td>805</td></tr> <tr><td>A36</td><td>825</td></tr> <tr><td>A37</td><td>845</td></tr> </table>	ARMLESS	720	A6	850	A7	870	A8B / A8S	805	A9B / A9S	825	A10	805	A36	825	A37	845	<table border="1"> <tr><td>M</td><td>720</td></tr> <tr><td>M</td><td>850</td></tr> <tr><td>M</td><td>870</td></tr> <tr><td>M</td><td>805</td></tr> <tr><td>M</td><td>825</td></tr> <tr><td>M</td><td>805</td></tr> <tr><td>M</td><td>825</td></tr> <tr><td>M</td><td>845</td></tr> </table>	M	720	M	850	M	870	M	805	M	825	M	805	M	825	M	845	<ul style="list-style-type: none"> <li>• Pneumatic seat height adjustment</li> <li>• Side tilt tension control</li> <li>• Back and seat tilt in 2:1 ratio</li> <li>• 4 locking positions</li> <li>• Safety tilt release</li> <li>• Height and depth adjustable lumbar</li> <li>• 2 way adjustable headrest</li> <li>• Warranted to 300 lbs.</li> </ul>	<p><b>WIDTH:</b> 26.5 <b>DEPTH:</b> 26.5 <b>HEIGHT:</b> 46.5-51.0 <b>SEAT WIDTH:</b> 19.0 <b>SEAT DEPTH:</b> 18.0 <b>SEAT HEIGHT:</b> 17.0-21.5 <b>BACK WIDTH:</b> 21.5 <b>BACK HEIGHT:</b> 23.0 <b>WEIGHT:</b> 51.0 LB</p>		
ARMLESS	720																																							
A6	850																																							
A7	870																																							
A8B / A8S	805																																							
A9B / A9S	825																																							
A10	805																																							
A36	825																																							
A37	845																																							
M	720																																							
M	850																																							
M	870																																							
M	805																																							
M	825																																							
M	805																																							
M	825																																							
M	845																																							
				SEAT SLIDER (SS) - ADD \$60 - FACTORY INSTALLED																																				
1576	Y2	<b>10" STOOL HEAVY DUTY SYNCHRO</b> Use for work surfaces up to 42 inches high	<table border="1"> <tr><td>ARMLESS</td><td>790</td></tr> <tr><td>A6</td><td>920</td></tr> <tr><td>A7</td><td>940</td></tr> <tr><td>A8B / A8S</td><td>875</td></tr> <tr><td>A9B / A9S</td><td>895</td></tr> <tr><td>A10</td><td>875</td></tr> <tr><td>A36</td><td>895</td></tr> <tr><td>A37</td><td>915</td></tr> </table>	ARMLESS	790	A6	920	A7	940	A8B / A8S	875	A9B / A9S	895	A10	875	A36	895	A37	915	<table border="1"> <tr><td>M</td><td>790</td></tr> <tr><td>M</td><td>920</td></tr> <tr><td>M</td><td>940</td></tr> <tr><td>M</td><td>875</td></tr> <tr><td>M</td><td>895</td></tr> <tr><td>M</td><td>875</td></tr> <tr><td>M</td><td>895</td></tr> <tr><td>M</td><td>915</td></tr> </table>	M	790	M	920	M	940	M	875	M	895	M	875	M	895	M	915	<ul style="list-style-type: none"> <li>• Pneumatic seat height adjustment</li> <li>• Side tilt tension control</li> <li>• Back and seat tilt in 2:1 ratio</li> <li>• 4 locking positions</li> <li>• Safety tilt release</li> <li>• Height and depth adjustable lumbar</li> <li>• Height adj 20" diameter footring</li> <li>• Warranted to 300 lbs.</li> </ul>	<p><b>WIDTH:</b> 26.5 <b>DEPTH:</b> 26.5 <b>HEIGHT:</b> 49.0-59.0 <b>SEAT WIDTH:</b> 19.0 <b>SEAT DEPTH:</b> 18.0 <b>SEAT HEIGHT:</b> 25.0-35.0 <b>BACK WIDTH:</b> 21.5 <b>BACK HEIGHT:</b> 23.0 <b>WEIGHT:</b> 56.0 LB</p>		
ARMLESS	790																																							
A6	920																																							
A7	940																																							
A8B / A8S	875																																							
A9B / A9S	895																																							
A10	875																																							
A36	895																																							
A37	915																																							
M	790																																							
M	920																																							
M	940																																							
M	875																																							
M	895																																							
M	875																																							
M	895																																							
M	915																																							
				SEAT SLIDER (SS) - NOT AVAILABLE																																				
1578	Y2	<b>8" STOOL HEAVY DUTY SYNCHRO</b> Use for work surfaces up to 36 inches high	<table border="1"> <tr><td>ARMLESS</td><td>790</td></tr> <tr><td>A6</td><td>920</td></tr> <tr><td>A7</td><td>940</td></tr> <tr><td>A8B / A8S</td><td>875</td></tr> <tr><td>A9B / A9S</td><td>895</td></tr> <tr><td>A10</td><td>875</td></tr> <tr><td>A36</td><td>895</td></tr> <tr><td>A37</td><td>915</td></tr> </table>	ARMLESS	790	A6	920	A7	940	A8B / A8S	875	A9B / A9S	895	A10	875	A36	895	A37	915	<table border="1"> <tr><td>M</td><td>790</td></tr> <tr><td>M</td><td>920</td></tr> <tr><td>M</td><td>940</td></tr> <tr><td>M</td><td>875</td></tr> <tr><td>M</td><td>895</td></tr> <tr><td>M</td><td>875</td></tr> <tr><td>M</td><td>895</td></tr> <tr><td>M</td><td>915</td></tr> </table>	M	790	M	920	M	940	M	875	M	895	M	875	M	895	M	915	<ul style="list-style-type: none"> <li>• Pneumatic seat height adjustment</li> <li>• Side tilt tension control</li> <li>• Back and seat tilt in 2:1 ratio</li> <li>• 4 locking positions</li> <li>• Safety tilt release</li> <li>• Height and depth adjustable lumbar</li> <li>• Height adj 20" diameter footring</li> <li>• Warranted to 300 lbs.</li> </ul>	<p><b>WIDTH:</b> 26.5 <b>DEPTH:</b> 26.5 <b>HEIGHT:</b> 45.0-53.0 <b>SEAT WIDTH:</b> 20.0 <b>SEAT DEPTH:</b> 17.5 <b>SEAT HEIGHT:</b> 22.0-30.0 <b>BACK WIDTH:</b> 21.5 <b>BACK HEIGHT:</b> 23.0 <b>WEIGHT:</b> 55.0 LB</p>		
ARMLESS	790																																							
A6	920																																							
A7	940																																							
A8B / A8S	875																																							
A9B / A9S	895																																							
A10	875																																							
A36	895																																							
A37	915																																							
M	790																																							
M	920																																							
M	940																																							
M	875																																							
M	895																																							
M	875																																							
M	895																																							
M	915																																							
				SEAT SLIDER (SS) - NOT AVAILABLE																																				

### BASE OPTIONS

<b>BA2B</b> STD 26" Aluminum Base - Black Powder Coat	<b>BA2S</b> STD 26" Aluminum Base - Silver Powder Coat	<b>BA2P</b> \$100 26" Aluminum Base - Polished
--	---	---

### ADDITIONAL OPTIONS

<b>SS</b> \$60 Seat Slider 2.5" Side Paddle Activated Factory Installed
--

# strata LITE

let strata float into your office

GSA SIN # 711-18

- Task, executive, conference and stool seating
- Black nylon base
- Warranted to 300 lbs.
- CAL TB 133 Fire Code approved



## BLACK COLORED ACCENTS AND UPHOLSTERED SEAT

### CREATING STRATA MODEL NUMBER

MODEL NUMBER CONTROL ARMS\* FRAME COLOR MESH COLOR\*\* GRADE BASE CASTERS PACKAGING OPTIONS

1 5 - Y 1 - A - B F - M 0 1 - B A - C -

\* FOR ARMLESS CODE USE A00 \*\*ONLY AVAILABLE IN BLACK MESH M01

### PACKAGING NOTES

CODE	DESCRIPTION	LIST UPCHARGE
AB	ASSEMBLED IN BAG	\$0
PAC	PARTIALLY ASSEMBLED IN CARTON	\$0
BAC	BACK ASSEMBLED IN CARTON	\$40

MODEL	CONTROL	DESCRIPTION	ARM	FABRIC/LEATHER											FEATURES	DIMENSIONS	ARM OPTIONS	CASTER OPTIONS	
				T01	A/COM	B	C	D	E	F	G	L3/COL	L4	L5					
1545	Y1	<b>MID-BACK SIMPLE SYNCHRO</b>  Use for a variety of general office seating, including private office and conference room seating	ARMLESS	495	550	580	600	630	665	705	745	675	745	800	<ul style="list-style-type: none"> <li>• Pneumatic seat height adjustment</li> <li>• Tilt tension control</li> <li>• Back and seat tilt in 3:1 ratio</li> <li>• Upright position tilt lock</li> <li>• Height and depth adjustable lumbar</li> <li>• Warranted to 300 lbs.</li> </ul>	<b>WIDTH:</b> 26.5 <b>DEPTH:</b> 26.5 <b>HEIGHT:</b> 39.5-44.0 <b>SEAT WIDTH:</b> 21.0 <b>SEAT DEPTH:</b> 18.0 <b>SEAT HEIGHT:</b> 17.0-21.5 <b>BACK WIDTH:</b> 21.0 <b>BACK HEIGHT:</b> 22.0 <b>COM:</b> 0.9 YDS <b>COL:</b> 13.0 SQ FT <b>WEIGHT:</b> 46.0 LB	<b>A6</b> \$130 Height Adjustable Pivot Slide Arm	<b>A7</b> \$150 Height/Width Adjustable Pivot Slide Arm	<b>C4</b> STD 60mm Hoodless Casters
			A6	625	680	710	730	760	795	835	875	805	875	930					
			A7	645	700	730	750	780	815	855	895	825	895	950					
			A8B / A8S	580	635	665	685	715	750	790	830	760	830	885					
			A9B / A9S	600	655	685	705	735	770	810	850	780	850	905					
			A10	580	635	665	685	715	750	790	830	760	830	885					
			A36	600	655	685	705	735	770	810	850	780	850	905					
A37	620	675	705	725	755	790	830	870	800	870	925								
				SEAT SLIDER (SS) - ADD \$60															
1555	Y1	<b>HIGH-BACK W/ HEADREST SIMPLE SYNCHRO</b>  Use for a variety of general office seating, including private office and conference room seating	ARMLESS	550	610	640	660	690	725	765	805	735	855	910	<ul style="list-style-type: none"> <li>• Pneumatic seat height adjustment</li> <li>• Tilt tension control</li> <li>• Back and seat tilt in 3:1 ratio</li> <li>• Upright position tilt lock</li> <li>• Height and depth adjustable lumbar</li> <li>• Height and tilt adjustable headrest</li> <li>• Warranted to 300 lbs.</li> </ul>	<b>WIDTH:</b> 26.5 <b>DEPTH:</b> 26.5 <b>HEIGHT:</b> 46.5-51.0 <b>SEAT WIDTH:</b> 21.0 <b>SEAT DEPTH:</b> 18.0 <b>SEAT HEIGHT:</b> 17.0-21.5 <b>BACK WIDTH:</b> 21.0 <b>BACK HEIGHT:</b> 22.0 <b>COM:</b> 0.9 YDS <b>COL:</b> 16.0 SQ FT <b>WEIGHT:</b> 47.0 LB	<b>A8B</b> \$85 <b>A8S</b> \$85 Height Adjustable Arm A8B-Black, A8S-Silver	<b>A9B</b> \$105 <b>A9S</b> \$105 Height/Width Adjustable Arm A9B-Black, A9S-Silver	<b>C1S</b> \$35 <b>C2S</b> \$35 C1S - 50mm Hooded Hard Floor Casters C2S - 50mm Hooded Self-Locking Hard Floor Casters
			A6	680	740	770	790	820	855	895	935	865	985	1040					
			A7	700	760	790	810	840	875	915	955	885	1005	1060					
			A8B / A8S	635	695	725	745	775	810	850	890	820	940	995					
			A9B / A9S	655	715	745	765	795	830	870	910	840	960	1015					
			A10	635	695	725	745	775	810	850	890	820	940	995					
			A36	655	715	745	765	795	830	870	910	840	960	1015					
A37	675	735	765	785	815	850	890	930	860	980	1035								
				SEAT SLIDER (SS) - ADD \$60															
1546	Y1	<b>10" STOOL SIMPLE SYNCHRO TILT</b>  Use for work surfaces up to 42 inches high	ARMLESS	620	675	705	725	755	790	830	870	800	870	925	<ul style="list-style-type: none"> <li>• Pneumatic seat height adjustment</li> <li>• Tilt tension control</li> <li>• Back and seat tilt in 3:1 ratio</li> <li>• Upright position tilt lock</li> <li>• Height and depth adjustable lumbar</li> <li>• Warranted to 300 lbs.</li> </ul>	<b>WIDTH:</b> 26.5 <b>DEPTH:</b> 26.5 <b>HEIGHT:</b> 49.0-59.0 <b>SEAT WIDTH:</b> 21.0 <b>SEAT DEPTH:</b> 18.0 <b>SEAT HEIGHT:</b> 27.0-37.0 <b>BACK WIDTH:</b> 21.0 <b>BACK HEIGHT:</b> 22.0 <b>COM:</b> 0.9 YDS <b>COL:</b> 13.0 SQ FT <b>WEIGHT:</b> 52.0 LB	<b>A37</b> \$125 Height/Width Adjustable Pivot/Slide Arm	<b>BASE OPTIONS</b> <b>BA1B</b> STD 26" Nylon Base - Black <b>BA2B</b> \$100 26" Aluminum Base Black Powder Coat <b>BA2P</b> \$100 26" Aluminum Base Polished	
			A6	750	805	835	855	885	920	960	1000	930	1000	1055					
			A7	770	825	855	875	905	940	980	1020	950	1020	1075					
			A8B / A8S	705	760	790	810	840	875	915	955	885	955	1010					
			A9B / A9S	725	780	810	830	860	895	935	975	905	975	1030					
			A10	705	760	790	810	840	875	915	955	885	955	1010					
			A36	725	780	810	830	860	895	935	975	905	975	1030					
A37	745	800	830	850	880	915	955	995	925	995	1050								
				SEAT SLIDER (SS) - NOT AVAILABLE															
1548	Y1	<b>8" STOOL SIMPLE SYNCHRO TILT</b>  Use for work surfaces up to 36 inches high	ARMLESS	620	675	705	725	755	790	830	870	800	870	925	<ul style="list-style-type: none"> <li>• Pneumatic seat height adjustment</li> <li>• Tilt tension control</li> <li>• Back and seat tilt in 3:1 ratio</li> <li>• Upright position tilt lock</li> <li>• Height and depth adjustable lumbar</li> <li>• Warranted to 300 lbs.</li> </ul>	<b>WIDTH:</b> 26.5 <b>DEPTH:</b> 26.5 <b>HEIGHT:</b> 45.0-53.0 <b>SEAT WIDTH:</b> 21.0 <b>SEAT DEPTH:</b> 18.0 <b>SEAT HEIGHT:</b> 23.0-31.0 <b>BACK WIDTH:</b> 21.0 <b>BACK HEIGHT:</b> 22.0 <b>COM:</b> 0.9 YDS <b>COL:</b> 13.0 SQ FT <b>WEIGHT:</b> 49.5 LB	<b>BA2S</b> \$100 26" Aluminum Base Silver Powder Coat	<b>ADDITIONAL OPTIONS</b> <b>SS</b> \$60 Seat Slider 2.5" Side Paddle Activated factory installed	
			A6	750	805	835	855	885	920	960	1000	930	1000	1055					
			A7	770	825	855	875	905	940	980	1020	950	1020	1075					
			A8B / A8S	705	760	790	810	840	875	915	955	885	955	1010					
			A9B / A9S	725	780	810	830	860	895	935	975	905	975	1030					
			A10	705	760	790	810	840	875	915	955	885	955	1010					
			A36	725	780	810	830	860	895	935	975	905	975	1030					
A37	745	800	830	850	880	915	955	995	925	995	1050								
				SEAT SLIDER (SS) - NOT AVAILABLE															

# strata all mesh

let strata float into your office

GSA SIN # 711-18

- Task, executive, conference and stool seating
- Black nylon base
- Warranted to 300 lbs.



## BLACK COLORED ACCENTS AND ALL MESH

### CREATING STRATA ADDRESS NUMBER MODEL NUMBER

MODEL NUMBER CONTROL ARMS\* FRAME COLOR MESH COLOR\*\* GRADE BASE CASTERS PACKAGING OPTIONS

1 5 - Y 1 - A - B F - M 0 1 - B A - C - - - -

\* FOR ARMLESS CODE USE A00 \*\*ONLY AVAILABLE IN BLACK MESH M01

### PACKAGING NOTES

CODE	DESCRIPTION	LIST UPCHARGE
AB	ASSEMBLED IN BAG	\$0
PAC	PARTIALLY ASSEMBLED IN CARTON	\$0
BAC	BACK ASSEMBLED IN CARTON	\$40

MODEL	CONTROL	DESCRIPTION	ARM	MESH	FEATURES	DIMENSIONS	ARM OPTIONS	CASTER OPTIONS
1535	Y1	<b>MID-BACK SIMPLE SYNCHRO</b> Use for a variety of general office seating, including private office and conference room seating	<ul style="list-style-type: none"> <li>ARMLESS</li> <li>A6</li> <li>A7</li> <li>A8B / A8S</li> <li>A9B / A9S</li> <li>A10</li> <li>A36</li> <li>A37</li> </ul>	<ul style="list-style-type: none"> <li>M</li> <li>550</li> <li>680</li> <li>700</li> <li>635</li> <li>655</li> <li>635</li> <li>655</li> <li>675</li> </ul>	<ul style="list-style-type: none"> <li>• Pneumatic seat height adjustment</li> <li>• Tilt tension control</li> <li>• Back and seat tilt in 3:1 ratio</li> <li>• Upright position tilt lock</li> <li>• Height and depth adjustable lumbar</li> <li>• Warranted to 300 lbs.</li> </ul>	<ul style="list-style-type: none"> <li>WIDTH: 26.5</li> <li>DEPTH: 26.5</li> <li>HEIGHT: 40.0-44.5</li> <li>SEAT WIDTH: 20.0</li> <li>SEAT DEPTH: 17.5</li> <li>SEAT HEIGHT: 17.0-21.5</li> <li>BACK WIDTH: 21.5</li> <li>BACK HEIGHT: 23.0</li> <li>WEIGHT: 47.0 LB</li> </ul>	<ul style="list-style-type: none"> <li><b>A6</b> \$130 Height Adjustable Pivot Slide Arm</li> <li><b>A7</b> \$150 Height/Width Adjustable Pivot Slide Arm</li> <li><b>A8B</b> \$85 Height Adjustable Arm A8B-Black, A8S-Silver</li> <li><b>A9B</b> \$105 Height/Width Adjustable Arm A9B-Black, A9S-Silver</li> <li><b>A10</b> \$85 Soft Touch C-Shaped Arm</li> <li><b>A36</b> \$105 Height Adjustable Pivot/Slide Arm</li> <li><b>A37</b> \$125 Height/Width Adjustable Pivot/Slide Arm</li> </ul>	<ul style="list-style-type: none"> <li><b>C4</b> STD 60mm Hoodless Casters</li> <li><b>C1S</b> \$35 C1S - 50mm Hooded Hard Floor Casters</li> <li><b>C2S</b> \$35 C2S - 50mm Hooded Self-Locking Hard Floor Casters</li> </ul>
				SEAT SLIDER (SS) - ADD \$60 - FACTORY INSTALLED				
1537	Y1	<b>HIGH-BACK W/ HEADREST SIMPLE SYNCHRO</b> Use for a variety of general office seating, including private office and conference room seating	<ul style="list-style-type: none"> <li>ARMLESS</li> <li>A6</li> <li>A7</li> <li>A8B / A8S</li> <li>A9B / A9S</li> <li>A10</li> <li>A36</li> <li>A37</li> </ul>	<ul style="list-style-type: none"> <li>M</li> <li>605</li> <li>735</li> <li>755</li> <li>690</li> <li>710</li> <li>690</li> <li>710</li> <li>730</li> </ul>	<ul style="list-style-type: none"> <li>• Pneumatic seat height adjustment</li> <li>• Tilt tension control</li> <li>• Back and seat tilt in 3:1 ratio</li> <li>• Upright position tilt lock</li> <li>• Height and depth adjustable lumbar</li> <li>• Height and tilt adjustable headrest</li> <li>• Warranted to 300 lbs.</li> </ul>	<ul style="list-style-type: none"> <li>WIDTH: 26.5</li> <li>DEPTH: 26.5</li> <li>HEIGHT: 47.0-51.5</li> <li>SEAT WIDTH: 20.0</li> <li>SEAT DEPTH: 17.5</li> <li>SEAT HEIGHT: 17.0-21.5</li> <li>BACK WIDTH: 21.5</li> <li>BACK HEIGHT: 23.0</li> <li>WEIGHT: 47.0 LB</li> </ul>	<ul style="list-style-type: none"> <li><b>C1S</b> \$35 C1S - 50mm Hooded Hard Floor Casters</li> <li><b>C2S</b> \$35 C2S - 50mm Hooded Self-Locking Hard Floor Casters</li> </ul>	
				SEAT SLIDER (SS) - ADD \$60 - FACTORY INSTALLED				
1536	Y1	<b>10" STOOL SIMPLE SYNCHRO TILT</b> Use for work surfaces up to 42 inches high	<ul style="list-style-type: none"> <li>ARMLESS</li> <li>A6</li> <li>A7</li> <li>A8B / A8S</li> <li>A9B / A9S</li> <li>A10</li> <li>A36</li> <li>A37</li> </ul>	<ul style="list-style-type: none"> <li>M</li> <li>675</li> <li>805</li> <li>825</li> <li>760</li> <li>780</li> <li>760</li> <li>780</li> <li>800</li> </ul>	<ul style="list-style-type: none"> <li>• Pneumatic seat height adjustment</li> <li>• Tilt tension control</li> <li>• Back and seat tilt in 3:1 ratio</li> <li>• Upright position tilt lock</li> <li>• Height and depth adjustable lumbar</li> <li>• Warranted to 300 lbs.</li> </ul>	<ul style="list-style-type: none"> <li>WIDTH: 26.5</li> <li>DEPTH: 26.5</li> <li>HEIGHT: 47.5-57.5</li> <li>SEAT WIDTH: 20.0</li> <li>SEAT DEPTH: 17.5</li> <li>SEAT HEIGHT: 25.0-35.0</li> <li>BACK WIDTH: 21.5</li> <li>BACK HEIGHT: 23.0</li> <li>WEIGHT: 52.2 LB</li> </ul>	<ul style="list-style-type: none"> <li><b>BA1B</b> STD 26" Nylon Base - Black</li> <li><b>BA2B</b> \$100 26" Aluminum Base Black Powder Coat</li> <li><b>BA2S</b> \$100 26" Aluminum Base Silver Powder Coat</li> <li><b>BA2P</b> \$100 26" Aluminum Base - Polished</li> </ul>	<ul style="list-style-type: none"> <li><b>SS</b> \$60 Seat Slider 2.5" Side Paddle Activated factory installed</li> </ul>
				SEAT SLIDER (SS) - NOT AVAILABLE				
1538	Y1	<b>8" STOOL SIMPLE SYNCHRO TILT</b> Use for work surfaces up to 36 inches high	<ul style="list-style-type: none"> <li>ARMLESS</li> <li>A6</li> <li>A7</li> <li>A8B / A8S</li> <li>A9B / A9S</li> <li>A10</li> <li>A36</li> <li>A37</li> </ul>	<ul style="list-style-type: none"> <li>M</li> <li>675</li> <li>805</li> <li>825</li> <li>760</li> <li>780</li> <li>760</li> <li>780</li> <li>800</li> </ul>	<ul style="list-style-type: none"> <li>• Pneumatic seat height adjustment</li> <li>• Tilt tension control</li> <li>• Back and seat tilt in 3:1 ratio</li> <li>• Upright position tilt lock</li> <li>• Height and depth adjustable lumbar</li> <li>• Warranted to 300 lbs.</li> </ul>	<ul style="list-style-type: none"> <li>WIDTH: 26.5</li> <li>DEPTH: 26.5</li> <li>HEIGHT: 44.0-52.0</li> <li>SEAT WIDTH: 20.0</li> <li>SEAT DEPTH: 17.5</li> <li>SEAT HEIGHT: 22.0-30.0</li> <li>BACK WIDTH: 21.5</li> <li>BACK HEIGHT: 23.0</li> <li>WEIGHT: 51.5 LB</li> </ul>	<ul style="list-style-type: none"> <li><b>BA1B</b> STD 26" Nylon Base - Black</li> <li><b>BA2B</b> \$100 26" Aluminum Base Black Powder Coat</li> <li><b>BA2S</b> \$100 26" Aluminum Base Silver Powder Coat</li> <li><b>BA2P</b> \$100 26" Aluminum Base - Polished</li> </ul>	<ul style="list-style-type: none"> <li><b>SS</b> \$60 Seat Slider 2.5" Side Paddle Activated factory installed</li> </ul>
				SEAT SLIDER (SS) - NOT AVAILABLE				

# theory

the facts support theory as the smart choice

## MESH BACK UPHOLSTERED SEAT

GSA SIN # 711-18

- Task, stool and conference seating
- Choice of 14 mesh colors
- Ratchet back adjustment with independent height adjustable lumbar standard
- Multiple synchro controls availavle
- Mesh back and all mesh models available
- Warranted to 300 lbs.



### CREATING THEORY MODEL NUMBER

MODEL NUMBER CONTROL ARMS BACK MESH COLOR GRADE BASE CASTERS PACKAGING OPTIONS

2 1 6 0 - [ ] [ ] - A [ ] [ ] - M [ ] [ ] - [ ] [ ] - B A [ ] [ ] [ ] - C [ ] [ ] [ ] - [ ] [ ] [ ]

\* FOR ARMLESS CODE USE A00 \*\* IF BASE AND CASTER MODEL NUMBERS ARE LEFT BLANK THEN STANDARD OPTION WILL BE ASSUMED

### PACKAGING NOTES

CODE	DESCRIPTION	LIST UPCHARGE
AB	ASSEMBLED IN BAG	\$0
PAC	PARTIALLY ASSEMBLED IN CARTON	\$0
BAC	BACK ASSEMBLED IN CARTON	\$40

MODEL	CONTROL	DESCRIPTION	ARM	FABRIC/LEATHER	DIMENSIONS													FEATURES	DIMENSIONS
					T01	A/COM	B	C	D	E	F	G	L3/COL	L4	L5				
2160	Y1	MID-BACK SIMPLE SYNCHRO	M1	ARMLESS	475	500	530	550	580	615	655	695	625	695	750	<ul style="list-style-type: none"> <li>• Pneumatic seat height adjustment</li> <li>• Tilt tension control</li> <li>• Back and seat tilt in 3:1 ratio</li> <li>• Upright position tilt lock</li> <li>• Height adjustable lumbar</li> <li>• Ratchet back height adjustment</li> <li>• Warranted to 300 lbs.</li> </ul>	WIDTH: 26.5 DEPTH: 26.5 HEIGHT: 40.0-47.0 SEAT WIDTH: 21.0 SEAT DEPTH: 18.0 SEAT HEIGHT: 16.5-21.0 BACK WIDTH: 20.0 BACK HEIGHT: 22.0-25.0 COM: 0.8 YDS COL: 11.0 SQ FT WEIGHT: 42.0 LB		
			M1	A8B	560	585	615	635	665	700	740	780	710	780	835				
			M1	A9B	580	605	635	655	685	720	760	800	730	800	855				
			M1	A10	560	585	615	635	665	700	740	780	710	780	835				
			M1	A36	580	605	635	655	685	720	760	800	730	800	855				
M1	A37	600	625	655	675	705	740	780	820	750	820	875							
					SEAT SLIDER (SS) - ADD \$60														
2160	Y1	MID-BACK SIMPLE SYNCHRO	M3	ARMLESS	500	525	555	575	605	640	680	720	650	720	775	<ul style="list-style-type: none"> <li>• Pneumatic seat height adjustment</li> <li>• Tilt tension control</li> <li>• Back and seat tilt in 3:1 ratio</li> <li>• Upright position tilt lock</li> <li>• Height adjustable lumbar</li> <li>• Ratchet back height adjustment</li> <li>• Warranted to 300 lbs.</li> </ul>	WIDTH: 26.5 DEPTH: 26.5 HEIGHT: 40.0-47.0 SEAT WIDTH: 21.0 SEAT DEPTH: 18.0 SEAT HEIGHT: 16.5-21.0 BACK WIDTH: 20.0 BACK HEIGHT: 22.0-25.0 COM: 0.8 YDS COL: 11.0 SQ FT WEIGHT: 42.0 LB		
			M3	A8B	585	610	640	660	690	725	765	805	735	805	860				
			M3	A9B	605	630	660	680	710	745	785	825	755	825	880				
			M3	A10	585	610	640	660	690	725	765	805	735	805	860				
			M3	A36	605	630	660	680	710	745	785	825	755	825	880				
M3	A37	625	650	680	700	730	765	805	845	775	845	900							
					SEAT SLIDER (SS) - ADD \$60														
2160	Y3	MID-BACK FULL SYNCHRO	M1	ARMLESS	545	570	600	620	650	685	725	765	695	765	820	<ul style="list-style-type: none"> <li>• Pneumatic seat height adjustment</li> <li>• Tilt tension control</li> <li>• Back and seat tilt in 2:1 ratio</li> <li>• 3 locking positions</li> <li>• Safety tilt release</li> <li>• Height adjustable lumbar</li> <li>• Ratchet back height adjustment</li> <li>• Warranted to 300 lbs.</li> </ul>	WIDTH: 26.5 DEPTH: 24.5 HEIGHT: 40.0-47.0 SEAT WIDTH: 21.0 SEAT DEPTH: 18.0 SEAT HEIGHT: 17.5-22.0 BACK WIDTH: 20.0 BACK HEIGHT: 22.0-25.0 COM: 0.8 YDS COL: 11.0 SQ FT WEIGHT: 43.5 LB		
			M1	A8B	630	655	685	705	735	770	810	850	780	850	905				
			M1	A9B	650	675	705	725	755	790	830	870	800	870	925				
			M1	A10	630	655	685	705	735	770	810	850	780	850	905				
			M1	A36	650	675	705	725	755	790	830	870	800	870	925				
M1	A37	670	695	725	745	775	810	850	890	820	890	945							
					SEAT SLIDER (SS) - ADD \$60														
2160	Y3	MID-BACK FULL SYNCHRO	M3	ARMLESS	570	595	625	645	675	710	750	790	720	790	845	<ul style="list-style-type: none"> <li>• Pneumatic seat height adjustment</li> <li>• Tilt tension control</li> <li>• Back and seat tilt in 2:1 ratio</li> <li>• 3 locking positions</li> <li>• Safety tilt release</li> <li>• Height adjustable lumbar</li> <li>• Ratchet back height adjustment</li> <li>• Warranted to 300 lbs.</li> </ul>	WIDTH: 26.5 DEPTH: 26.5 HEIGHT: 40.0-47.0 SEAT WIDTH: 21.0 SEAT DEPTH: 18.0 SEAT HEIGHT: 17.5-22.0 BACK WIDTH: 20.0 BACK HEIGHT: 22.0-25.0 COM: 0.8 YDS COL: 11.0 SQ FT WEIGHT: 43.5 LB		
			M3	A8B	655	680	710	730	760	795	835	875	805	875	930				
			M3	A9B	675	700	730	750	780	815	855	895	825	895	950				
			M3	A10	655	680	710	730	760	795	835	875	805	875	930				
			M3	A36	675	700	730	750	780	815	855	895	825	895	950				
M3	A37	695	720	750	770	800	835	875	915	845	915	970							
					SEAT SLIDER (SS) - ADD \$60														

### ARM OPTIONS

**A10**  
Soft Touch C-Shaped Arm  
\$85

**A8B/A8S**  
Height Adjustable Arm  
A8B-Black, A8S-Silver  
\$85

**A9B/A9S**  
Height/Width Adjustable Arm  
A9B-Black, A9S-Silver  
\$105

**A36**  
Height Adjustable Pivot/Slide Arm  
\$105

**A37**  
Height/Width Adjustable Pivot/Slide Arm  
\$125

### CASTER OPTIONS

**C6**  
60mm Hoodless Casters  
STD

**C6S**  
60mm Hoodless Hard Floor Casters  
\$35

**C7**  
60mm Hoodless Chrome Accented Casters  
\$35

### BASE OPTIONS

**BA9B**  
26" High Profile Nylon Base - Black  
STD

**BA10B**  
26" High Profile Aluminum Base - Black Powder Coat  
\$100

**BA10P**  
26" High Profile Aluminum Base - Polished  
\$100

**BA10S**  
26" High Profile Aluminum Base - Silver Powder Coat  
\$100

### ADDITIONAL OPTIONS

**SS**  
Seat Slider 2.5" Side Paddle Activated  
\$60

### MESH COLORS

BLACK M11	GRAY M12	SILVER M13	GREEN M14	RED M15	BLUE M16
GRAPHITE M31	SLATE M32	SNOW M33	SAGE M34	CARDINAL M35	ROYAL M36
TANGERINE M37	PLUM M38				

# theory

the facts support theory as the smart choice

## MESH BACK UPHOLSTERED SEAT

GSA SIN # 711-18

- Task, stool and conference seating
- Choice of 14 mesh colors
- Ratchet back adjustment with independent height adjustable lumbar standard
- Multiple synchro controls available
- Mesh back and all mesh models available
- Warranted to 300 lbs.



### CREATING THEORY MODEL NUMBER

MODEL NUMBER CONTROL ARMS BACK MESH COLOR GRADE BASE CASTERS PACKAGING OPTIONS

2 1 6 0 - [ ] [ ] - A [ ] [ ] - M [ ] [ ] - [ ] [ ] - B A [ ] [ ] - C [ ] [ ] - [ ] [ ] [ ] - [ ] [ ]

\* FOR ARMLESS CODE USE ADD \*\* IF BASE AND CASTER MODEL NUMBERS ARE LEFT BLANK THEN STANDARD OPTION WILL BE ASSUMED

### PACKAGING NOTES

CODE	DESCRIPTION	LIST UPCHARGE
AB	ASSEMBLED IN BAG	\$0
PAC	PARTIALLY ASSEMBLED IN CARTON	\$0
BAC	BACK ASSEMBLED IN CARTON	\$40

MODEL	CONTROL	DESCRIPTION	ARM	FABRIC/LEATHER	DIMENSIONS										FEATURES	DIMENSIONS					
					T01	A/COM	B	C	D	E	F	G	L3/COL	L4			L5				
2160	Y2	<b>MID-BACK HEAVY DUTY SYNCHRO</b>  Use for a variety of general office seating, including private office and conference room seating	M1	ARMLESS	595	620	650	670	700	735	775	815	745	815	870	<ul style="list-style-type: none"> <li>• Pneumatic seat height adjustment</li> <li>• Side tilt tension control</li> <li>• Back and seat tilt in 2:1 ratio</li> <li>• 4 locking positions</li> <li>• Safety tilt release</li> <li>• Height adjustable lumbar</li> <li>• Ratchet back height adjustment</li> <li>• Warranted to 300 lbs.</li> </ul>	<b>WIDTH:</b> 26.5 <b>DEPTH:</b> 25.0 <b>HEIGHT:</b> 38.5-45.5 <b>SEAT WIDTH:</b> 21.0 <b>SEAT DEPTH:</b> 18.5 <b>SEAT HEIGHT:</b> 17.0-22.0 <b>BACK WIDTH:</b> 20.0 <b>BACK HEIGHT:</b> 21.5-23.5 <b>COM:</b> 0.8 YDS <b>COL:</b> 11.0 SQ FT <b>WEIGHT:</b> 45.5 LB				
			M1	A8B	680	705	735	755	785	820	860	900	830	900	955						
			M1	A9B	700	725	755	775	805	840	880	920	850	920	975						
			M1	A10	680	705	735	755	785	820	860	900	830	900	955						
			M1	A36	700	725	755	775	805	840	880	920	850	920	975						
			M1	A37	720	745	775	795	825	860	900	940	870	940	995						
SEAT SLIDER (SS) - ADD \$60																					
2160	Y2	<b>MID-BACK HEAVY DUTY SYNCHRO</b>  Use for a variety of general office seating, including private office and conference room seating	M3	ARMLESS	620	645	675	695	725	760	800	840	770	840	895	<ul style="list-style-type: none"> <li>• Pneumatic seat height adjustment</li> <li>• Side tilt tension control</li> <li>• Back and seat tilt in 2:1 ratio</li> <li>• 4 locking positions</li> <li>• Safety tilt release</li> <li>• Height adjustable lumbar</li> <li>• Ratchet back height adjustment</li> <li>• Warranted to 300 lbs.</li> </ul>	<b>WIDTH:</b> 26.5 <b>DEPTH:</b> 25.0 <b>HEIGHT:</b> 38.5-45.5 <b>SEAT WIDTH:</b> 21.0 <b>SEAT DEPTH:</b> 18.5 <b>SEAT HEIGHT:</b> 17.0-22.0 <b>BACK WIDTH:</b> 20.0 <b>BACK HEIGHT:</b> 21.5-23.5 <b>COM:</b> 0.8 YDS <b>COL:</b> 11.0 SQ FT <b>WEIGHT:</b> 45.5 LB				
			M3	A8B	705	730	760	780	810	845	885	925	855	925	980						
			M3	A9B	725	750	780	800	830	865	905	945	875	945	1000						
			M3	A10	705	730	760	780	810	845	885	925	855	925	980						
			M3	A36	725	750	780	800	830	865	905	945	875	945	1000						
			M3	A37	745	770	800	820	850	885	925	965	895	965	1020						
SEAT SLIDER (SS) - ADD \$60																					
2160	GT	<b>GUEST MESH BACK UPHOLSTERED SEAT</b>  Black steel cantilever frame	M1	ARMLESS	350	375	405	425	455	490	530	570	500	570	625	<ul style="list-style-type: none"> <li>• Black cantilever frame</li> <li>• Warranted to 300 lbs.</li> </ul>	<b>WIDTH:</b> 24.5 <b>DEPTH:</b> 24.5 <b>HEIGHT:</b> 40.5 <b>SEAT WIDTH:</b> 21.0 <b>SEAT DEPTH:</b> 18.0 <b>SEAT HEIGHT:</b> 21.5 <b>BACK WIDTH:</b> 20 <b>BACK HEIGHT:</b> 22 <b>COM:</b> 0.8 YDS <b>COL:</b> 11.0 SQ FT <b>WEIGHT:</b> 38.0 LB				
			M1	A10	435	460	490	510	540	575	615	655	585	655	710						
			M3	ARMLESS	375	400	430	450	480	515	555	595	525	595	650						
			M3	A10	460	485	515	535	565	600	640	680	610	680	735						
			SHIPS AB OR PAC																		

### ARM OPTIONS

**A10**  
Soft Touch C-Shaped Arm  
\$85

**A8B**  
**A8S**  
Height Adjustable Arm  
A8B-Black, A8S-Silver  
\$85

**A9B**  
**A9S**  
Height/Width Adjustable Arm  
A9B-Black, A9S-Silver  
\$105

**A36**  
Height Adjustable Pivot/Slide Arm  
\$105

**A37**  
Height/Width Adjustable Pivot/Slide Arm  
\$125

### CASTER OPTIONS

**C6**  
60mm Hoodless Casters  
STD

**C6S**  
60mm Hoodless Hard Floor Casters  
\$35

**C7**  
60mm Hoodless Chrome Accented Casters  
\$35

### BASE OPTIONS

**BA9B**  
26" High Profile Nylon Base - Black  
STD

**BA10B**  
26" High Profile Aluminum Base - Black Powder Coat  
\$100

**BA10P**  
26" High Profile Aluminum Base - Polished  
\$100

**BA10S**  
26" High Profile Aluminum Base - Silver Powder Coat  
\$100

### ADDITIONAL OPTIONS

**SS**  
Seat Slider 2.5" Side Paddle Activated  
\$60

**HD**  
Heavy Duty Multi-Shift Upgrade to 350Lbs. (Includes BA10 Aluminum Base and C6 60mm Casters, Y2 Control Only)  
\$125

### MESH COLORS

BLACK M11	GRAY M12	SILVER M13	GREEN M14	RED M15	BLUE M16
GRAPHITE M31	SLATE M32	SNOW M33	SAGE M34	CARDINAL M35	ROYAL M36
TANGERINE M37	PLUM M38				

# theory

the facts support theory as the smart choice

## MESH BACK UPHOLSTERED SEAT

GSA SIN # 711-18

- Task, stool and conference seating
- Choice of 14 mesh colors
- Ratchet back adjustment with independent height adjustable lumbar standard
- Multiple synchro controls available
- Mesh back and all mesh models available
- Warranted to 300 lbs.



### CREATING THEORY MODEL NUMBER

MODEL NUMBER	CONTROL	ARMS	BACK MESH COLOR	GRADE	BASE	CASTERS	PACKAGING	OPTIONS
2180	-Y	-A	-M	-	-BA	-C	-	-

\* FOR ARMLESS CODE USE A00  
\* IF BASE AND CASTER MODEL NUMBERS ARE LEFT BLANK THEN STANDARD OPTION WILL BE ASSUMED

### PACKAGING NOTES

CODE	DESCRIPTION	LIST UPCHARGE
AB	ASSEMBLED IN BAG	\$0
PAC	PARTIALLY ASSEMBLED IN CARTON	\$0
BAC	BACK ASSEMBLED IN CARTON	\$40

MODEL	CONTROL	DESCRIPTION	ARM	FABRIC/LEATHER	DIMENSIONS										FEATURES	DIMENSIONS	ARM OPTIONS	CASTER OPTIONS	ADDITIONAL OPTIONS	
					T01	A/COM	B	C	D	E	F	G	L3/COL	L4						L5
2180	Y1	<b>HIGH-BACK SIMPLE SYNCHRO</b>  Use for a variety of general office seating, including private office and conference room seating	M1	ARMLESS	560	585	615	635	665	700	740	780	710	830	885	<ul style="list-style-type: none"> <li>• Pneumatic seat height adjustment</li> <li>• Tilt tension control</li> <li>• Back and seat tilt in 3:1 ratio</li> <li>• Upright position tilt lock</li> <li>• Height adjustable lumbar</li> <li>• Ratchet back height adjustment</li> <li>• Warranted to 300 lbs.</li> </ul>	<b>WIDTH:</b> 26.5 <b>DEPTH:</b> 25.0 <b>HEIGHT:</b> 40.0-47.0 <b>SEAT WIDTH:</b> 21.0 <b>SEAT DEPTH:</b> 18.0 <b>SEAT HEIGHT:</b> 16.5-21.0 <b>BACK WIDTH:</b> 20.0 <b>BACK HEIGHT:</b> 23.0-25.0 <b>COM:</b> 0.8 YDS <b>COL:</b> 14.0 SQ FT <b>WEIGHT:</b> 42.0 LB	<b>A10</b> \$85	<b>A8B</b> <b>A8S</b> \$85	<b>C6</b> STD
			M1	A8B	645	670	700	720	750	785	825	865	795	915	970					
			M1	A9B	665	690	720	740	770	805	845	885	815	935	990					
			M1	A10	645	670	700	720	750	785	825	865	795	915	970					
			M1	A36	665	690	720	740	770	805	845	885	815	935	990					
			M1	A37	685	710	740	760	790	825	865	905	835	955	1010					
					SEAT SLIDER (SS) - ADD \$60															
2180	Y1	<b>HIGH-BACK SIMPLE SYNCHRO</b>  Use for a variety of general office seating, including private office and conference room seating	M3	ARMLESS	585	610	640	660	690	725	765	805	735	855	910	<ul style="list-style-type: none"> <li>• Pneumatic seat height adjustment</li> <li>• Tilt tension control</li> <li>• Back and seat tilt in 3:1 ratio</li> <li>• Upright position tilt lock</li> <li>• Height adjustable lumbar</li> <li>• Ratchet back height adjustment</li> <li>• Warranted to 300 lbs.</li> </ul>	<b>WIDTH:</b> 26.5 <b>DEPTH:</b> 24.5 <b>HEIGHT:</b> 40.0-47.0 <b>SEAT WIDTH:</b> 21.0 <b>SEAT DEPTH:</b> 18.0 <b>SEAT HEIGHT:</b> 17.5-22.0 <b>BACK WIDTH:</b> 20.0 <b>BACK HEIGHT:</b> 22.0-25.0 <b>COM:</b> 0.8 YDS <b>COL:</b> 14.0 SQ FT <b>WEIGHT:</b> 43.5 LB	<b>A9B</b> <b>A9S</b> \$105	<b>A36</b> \$105	<b>C6S</b> \$35
			M3	A8B	670	695	725	745	775	810	850	890	820	940	995					
			M3	A9B	690	715	745	765	795	830	870	910	840	960	1015					
			M3	A10	670	695	725	745	775	810	850	890	820	940	995					
			M3	A36	690	715	745	765	795	830	870	910	840	960	1015					
			M3	A37	710	735	765	785	815	850	890	930	860	980	1035					
					SEAT SLIDER (SS) - ADD \$60															
2180	Y3	<b>HIGH-BACK FULL SYNCHRO</b>  Use for a variety of general office seating, including private office and conference room seating	M1	ARMLESS	630	655	685	705	735	770	810	850	780	900	955	<ul style="list-style-type: none"> <li>• Pneumatic seat height adjustment</li> <li>• Tilt tension control</li> <li>• Back and seat tilt in 2:1 ratio</li> <li>• 3 locking positions</li> <li>• Safety tilt release</li> <li>• Height adjustable lumbar</li> <li>• Ratchet back height adjustment</li> <li>• Warranted to 300 lbs.</li> </ul>	<b>WIDTH:</b> 26.5 <b>DEPTH:</b> 25.0 <b>HEIGHT:</b> 45.5-54.0 <b>SEAT WIDTH:</b> 21.0 <b>SEAT DEPTH:</b> 18.0 <b>SEAT HEIGHT:</b> 17.0-22.0 <b>BACK WIDTH:</b> 20.0 <b>BACK HEIGHT:</b> 28.5-30.5 <b>COM:</b> 0.8 YDS <b>COL:</b> 14.0 SQ FT <b>WEIGHT:</b> 45.5 LB			
			M1	A8B	715	740	770	790	820	855	895	935	865	985	1040					
			M1	A9B	735	760	790	810	840	875	915	955	885	1005	1060					
			M1	A10	715	740	770	790	820	855	895	935	865	985	1040					
			M1	A36	735	760	790	810	840	875	915	955	885	1005	1060					
			M1	A37	755	780	810	830	860	895	935	975	905	1025	1080					
					SEAT SLIDER (SS) - ADD \$60															
2180	Y3	<b>HIGH-BACK FULL SYNCHRO</b>  Use for a variety of general office seating, including private office and conference room seating	M3	ARMLESS	655	680	710	730	760	795	835	875	805	925	980	<ul style="list-style-type: none"> <li>• Pneumatic seat height adjustment</li> <li>• Tilt tension control</li> <li>• Back and seat tilt in 2:1 ratio</li> <li>• 3 locking positions</li> <li>• Safety tilt release</li> <li>• Height adjustable lumbar</li> <li>• Ratchet back height adjustment</li> <li>• Warranted to 300 lbs.</li> </ul>	<b>WIDTH:</b> 26.5 <b>DEPTH:</b> 25.0 <b>HEIGHT:</b> 45.5-54.0 <b>SEAT WIDTH:</b> 21.0 <b>SEAT DEPTH:</b> 18.0 <b>SEAT HEIGHT:</b> 17.0-22.0 <b>BACK WIDTH:</b> 20.0 <b>BACK HEIGHT:</b> 28.5-30.5 <b>COM:</b> 0.8 YDS <b>COL:</b> 14.0 SQ FT <b>WEIGHT:</b> 45.5 LB			
			M3	A8B	740	765	795	815	845	880	920	960	890	1010	1065					
			M3	A9B	760	785	815	835	865	900	940	980	910	1030	1085					
			M3	A10	740	765	795	815	845	880	920	960	890	1010	1065					
			M3	A36	760	785	815	835	865	900	940	980	910	1030	1085					
			M3	A37	780	805	835	855	885	920	960	1000	930	1050	1105					
					SEAT SLIDER (SS) - ADD \$60															

### MESH COLORS

BLACK M11	GRAY M12	SILVER M13	GREEN M14	RED M15	BLUE M16
GRAPHITE M31	SLATE M32	SNOW M33	SAGE M34	CARDINAL M35	ROYAL M36
TANGERINE M37	PLUM M38				



# theory

the facts support theory as the smart choice

## MESH BACK UPHOLSTERED SEAT

GSA SIN # 711-18

- Task, stool and conference seating
- Choice of 14 mesh colors
- Ratchet back adjustment with independent height adjustable lumbar standard
- Multiple synchro controls available
- Mesh back and all mesh models available
- Warranted to 300 lbs.



### CREATING THEORY MODEL NUMBER

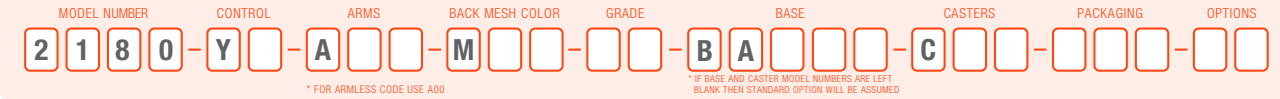

### PACKAGING NOTES

CODE	DESCRIPTION	LIST UPCHARGE
AB	ASSEMBLED IN BAG	\$0
PAC	PARTIALLY ASSEMBLED IN CARTON	\$0
BAC	BACK ASSEMBLED IN CARTON	\$40

MODEL	CONTROL	DESCRIPTION	ARM	FABRIC/LEATHER	DIMENSIONS										
					T01	A/COM	B	C	D	E	F	G	L3/COL	L4	L5
2180	Y2	<b>HIGH-BACK HEAVY DUTY SYNCHRO</b>  Use for a variety of general office seating, including private office and conference room seating	M1	ARMLESS	680	705	735	755	785	820	860	900	830	950	1005
			M1	A8B	765	790	820	840	870	905	945	985	915	1035	1090
			M1	A9B	785	810	840	860	890	925	965	1005	935	1055	1110
			M1	A10	765	790	820	840	870	905	945	985	915	1035	1090
			M1	A36	785	810	840	860	890	925	965	1005	935	1055	1110
M1	A37	805	830	860	880	910	945	985	1025	955	1075	1130			

SEAT SLIDER (SS) - ADD \$60

- ### FEATURES
- Pneumatic seat height adjustment
  - Side tilt tension control
  - Back and seat tilt in 2:1 ratio
  - 4 locking positions
  - Safety tilt release
  - Height adjustable lumbar
  - Ratchet back height adjustment
  - Warranted to 300 lbs.

- ### DIMENSIONS
- WIDTH:** 26.5  
**DEPTH:** 25.0  
**HEIGHT:** 40.0-47.0  
**SEAT WIDTH:** 21.0  
**SEAT DEPTH:** 18.0  
**SEAT HEIGHT:** 16.5-21.0  
**BACK WIDTH:** 20.0  
**BACK HEIGHT:** 23.0-25.0  
**COM:** 0.8 YDS  
**COL:** 14.0 SQ FT  
**WEIGHT:** 42.0 LB

MODEL	CONTROL	DESCRIPTION	ARM	FABRIC/LEATHER	DIMENSIONS										
					T01	A/COM	B	C	D	E	F	G	L3/COL	L4	L5
2180	Y2	<b>HIGH-BACK HEAVY DUTY SYNCHRO</b>  Use for a variety of general office seating, including private office and conference room seating	M3	ARMLESS	705	730	760	780	810	845	885	925	855	975	1030
			M3	A8B	790	815	845	865	895	930	970	1010	940	1060	1115
			M3	A9B	810	835	865	885	915	950	990	1030	960	1080	1135
			M3	A10	790	815	845	865	895	930	970	1010	940	1060	1115
			M3	A36	810	835	865	885	915	950	990	1030	960	1080	1135
M3	A37	830	855	885	905	935	970	1000	1050	980	1100	1155			

SEAT SLIDER (SS) - ADD \$60

- ### FEATURES
- Pneumatic seat height adjustment
  - Side tilt tension control
  - Back and seat tilt in 2:1 ratio
  - 4 locking positions
  - Safety tilt release
  - Height adjustable lumbar
  - Ratchet back height adjustment
  - Warranted to 300 lbs.

- ### DIMENSIONS
- WIDTH:** 26.5  
**DEPTH:** 24.5  
**HEIGHT:** 40.0-47.0  
**SEAT WIDTH:** 21.0  
**SEAT DEPTH:** 18.0  
**SEAT HEIGHT:** 17.5-22.0  
**BACK WIDTH:** 20.0  
**BACK HEIGHT:** 22.0-25.0  
**COM:** 0.8 YDS  
**COL:** 14.0 SQ FT  
**WEIGHT:** 43.5 LB

### ARM OPTIONS



Soft Touch C-Shaped Arm



Height Adjustable Arm  
A8B-Black, A8S-Silver



Height/Width Adjustable Arm  
A9B-Black, A9S-Silver



Height Adjustable  
Pivot/Slide Arm



Height/Width Adjustable  
Pivot/Slide Arm

### CASTER OPTIONS



60mm Hoodless Casters



60mm Hoodless Hard Floor  
Casters



60mm Hoodless Chrome  
Accented Casters

### BASE OPTIONS



26" High Profile Nylon  
Base - Black

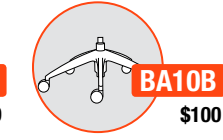

26" High Profile Aluminum  
Base - Black Powder Coat



26" High Profile Aluminum  
Base - Polished

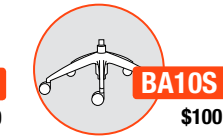

26" High Profile Aluminum  
Base - Silver Powder Coat

### ADDITIONAL OPTIONS



Seat Slider 2.5"  
Side Paddle Activated



Heavy Duty Multi-Shift  
Upgrade to 350Lbs.  
(Includes BA10 Aluminum  
Base and C6 60mm Casters,  
Y2 Control Only)

### MESH COLORS

BLACK M11	GRAY M12	SILVER M13	GREEN M14	RED M15	BLUE M16
GRAPHITE M31	SLATE M32	SNOW M33	SAGE M34	CARDINAL M35	ROYAL M36
TANGERINE M37	PLUM M38				

# theory

the facts support theory as the smart choice

## MESH BACK STOOL UPHOLSTERED SEAT

GSA SIN # 711-18

- Task, stool and conference seating
- Choice of 14 mesh colors
- Ratchet back adjustment with independent height adjustable lumbar standard
- Multiple synchro controls available
- Mesh back and all mesh models available
- Warranted to 300 lbs.



### CREATING THEORY MODEL NUMBER

MODEL NUMBER CONTROL ARMS BACK MESH COLOR GRADE BASE CASTERS PACKAGING OPTIONS

2 1 6 - Y 1 - A - M - B A - C

\* FOR ARMLESS CODE USE A00 \* IF BASE AND CASTER MODEL NUMBERS ARE LEFT BLANK THEN STANDARD OPTION WILL BE ASSUMED

### PACKAGING NOTES

CODE	DESCRIPTION	LIST UPCHARGE
AB	ASSEMBLED IN BAG	\$0
PAC	PARTIALLY ASSEMBLED IN CARTON	\$0
BAC	BACK ASSEMBLED IN CARTON	\$40

MODEL	CONTROL	DESCRIPTION	ARM	FABRIC/LEATHER	DIMENSIONS										FEATURES	DIMENSIONS	ARM OPTIONS	CASTER OPTIONS		
					T01	A/COM	B	C	D	E	F	G	L3/COL	L4					L5	
2166	Y1	10" STOOL SIMPLE SYNCHRO Use for work surfaces up to 42 inches high	M1	ARMLESS	600	625	655	675	705	740	780	820	750	870	925	<ul style="list-style-type: none"> <li>• Pneumatic seat height adjustment</li> <li>• Tilt tension control</li> <li>• Back and seat tilt in 3:1 ratio</li> <li>• Upright position tilt lock</li> <li>• Height adjustable lumbar</li> <li>• Ratchet back height adjustment</li> <li>• Height adjustable 20" diameter footring</li> <li>• Warranted to 300 lbs.</li> </ul>	WIDTH: 26.5 DEPTH: 26.5 HEIGHT: 47.75-60.50 SEAT WIDTH: 21.0 SEAT DEPTH: 18.0 SEAT HEIGHT: 26.5-36.5 BACK WIDTH: 20.3 BACK HEIGHT: 21.0-23.75 COM: 0.9 yd COL: 11.0 sq ft WEIGHT: 48.0			
			M1	A8B	685	710	740	760	790	825	865	905	835	955	1010					
			M1	A9B	705	730	760	780	810	845	885	925	855	975	1030					
			M1	A10	685	710	740	760	790	825	865	905	835	955	1010					
			M1	A36	705	730	760	780	810	845	885	925	855	975	1030					
			M1	A37	725	750	780	800	830	865	905	945	875	995	1050					
					SEAT SLIDER (SS) - NOT AVAILABLE															
2166	Y1	10" STOOL SIMPLE SYNCHRO Use for work surfaces up to 42 inches high	M3	ARMLESS	625	650	680	700	730	765	805	845	775	895	950	<ul style="list-style-type: none"> <li>• Pneumatic seat height adjustment</li> <li>• Tilt tension control</li> <li>• Back and seat tilt in 3:1 ratio</li> <li>• Upright position tilt lock</li> <li>• Height adjustable lumbar</li> <li>• Ratchet back height adjustment</li> <li>• Height adjustable 20" diameter footring</li> <li>• Warranted to 300 lbs.</li> </ul>	WIDTH: 26.5 DEPTH: 26.5 HEIGHT: 47.75-60.50 SEAT WIDTH: 21.0 SEAT DEPTH: 18.0 SEAT HEIGHT: 26.5-36.5 BACK WIDTH: 20.3 BACK HEIGHT: 21.0-23.75 COM: 0.9 yd COL: 11.0 sq ft WEIGHT: 48.0			
			M3	A8B	710	735	765	785	815	850	890	930	860	980	1035					
			M3	A9B	730	755	785	805	835	870	910	950	880	1000	1055					
			M3	A10	710	735	765	785	815	850	890	930	860	980	1035					
			M3	A36	730	755	785	805	835	870	910	950	880	1000	1055					
			M3	A37	750	775	805	825	855	890	930	970	900	1020	1075					
					SEAT SLIDER (SS) - NOT AVAILABLE															
2168	Y1	8" STOOL SIMPLE SYNCHRO Use for work surfaces up to 36 inches high	M1	ARMLESS	600	625	655	675	705	740	780	820	750	870	925	<ul style="list-style-type: none"> <li>• Pneumatic seat height adjustment</li> <li>• Tilt tension control</li> <li>• Back and seat tilt in 3:1 ratio</li> <li>• Upright position tilt lock</li> <li>• Height adjustable lumbar</li> <li>• Ratchet back height adjustment</li> <li>• Height adjustable 20" diameter footring</li> <li>• Warranted to 300 lbs.</li> </ul>	WIDTH: 26.5 DEPTH: 26.5 HEIGHT: 44.75-55.5 SEAT WIDTH: 21.0 SEAT DEPTH: 18.0 SEAT HEIGHT: 24-32 BACK WIDTH: 20.3 BACK HEIGHT: 21.0-23.75 COM: 0.9 yd COL: 11.0 sq ft WEIGHT: 47.0			
			M1	A8B	685	710	740	760	790	825	865	905	835	955	1010					
			M1	A9B	705	730	760	780	810	845	885	925	855	975	1030					
			M1	A10	685	710	740	760	790	825	865	905	835	955	1010					
			M1	A36	705	730	760	780	810	845	885	925	855	975	1030					
			M1	A37	725	750	780	800	830	865	905	945	875	995	1050					
					SEAT SLIDER (SS) - NOT AVAILABLE															
2168	Y1	8" STOOL SIMPLE SYNCHRO Use for work surfaces up to 36 inches high	M3	ARMLESS	625	650	680	700	730	765	805	845	775	895	950	<ul style="list-style-type: none"> <li>• Pneumatic seat height adjustment</li> <li>• Tilt tension control</li> <li>• Back and seat tilt in 3:1 ratio</li> <li>• Upright position tilt lock</li> <li>• Height adjustable lumbar</li> <li>• Ratchet back height adjustment</li> <li>• Height adjustable 20" diameter footring</li> <li>• Warranted to 300 lbs.</li> </ul>	WIDTH: 26.5 DEPTH: 26.5 HEIGHT: 44.75-55.5 SEAT WIDTH: 21.0 SEAT DEPTH: 18.0 SEAT HEIGHT: 24-32 BACK WIDTH: 20.3 BACK HEIGHT: 21.0-23.75 COM: 0.9 yd COL: 11.0 sq ft WEIGHT: 47.0			
			M3	A8B	710	735	765	785	815	850	890	930	860	980	1035					
			M3	A9B	730	755	785	805	835	870	910	950	880	1000	1055					
			M3	A10	710	735	765	785	815	850	890	930	860	980	1035					
			M3	A36	730	755	785	805	835	870	910	950	880	1000	1055					
			M3	A37	750	775	805	825	855	890	930	970	900	1020	1075					
					SEAT SLIDER (SS) - NOT AVAILABLE															

### MESH COLORS

BLACK M11	GRAY M12	SILVER M13	GREEN M14	RED M15	BLUE M16
GRAPHITE M31	SLATE M32	SNOW M33	SAGE M34	CARDINAL M35	ROYAL M36
TANGERINE M37	PLUM M38				

# theory

the facts support theory as the smart choice

## ALL MESH

GSA SIN # 711-18

- Task, stool and conference seating
- Choice of 14 mesh colors
- Ratchet back adjustment with independent height adjustable lumbar standard
- Multiple synchro controls available
- Mesh back and all mesh models available
- Warranted to 300 lbs.



### CREATING THEORY MODEL NUMBER

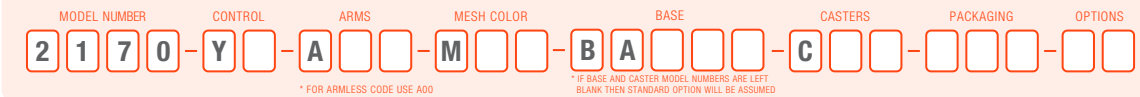

### PACKAGING NOTES

CODE	DESCRIPTION	LIST UPCHARGE
AB	ASSEMBLED IN BAG	\$0
PAC	PARTIALLY ASSEMBLED IN CARTON	\$0
BAC	BACK ASSEMBLED IN CARTON	\$40

MODEL	CONTROL	DESCRIPTION	ARM	MESH	FEATURES	DIMENSIONS	ARM OPTIONS	CASTER OPTIONS	ADDITIONAL OPTIONS
2170	Y1	<b>MID-BACK SIMPLE SYNCHRO</b>  Use for a variety of general office seating, including private office and conference room seating	M1	ARMLESS	M	<ul style="list-style-type: none"> <li>• Pneumatic seat height adjustment</li> <li>• Tilt tension control</li> <li>• Back and seat tilt in 3:1 ratio</li> <li>• Upright position tilt lock</li> <li>• Height adjustable lumbar</li> <li>• Ratchet back height adjustment</li> <li>• Warranted to 300 lbs.</li> </ul>	<b>WIDTH:</b> 26.5 <b>DEPTH:</b> 25.5 <b>HEIGHT:</b> 39.0-46.0 <b>SEAT WIDTH:</b> 20.0 <b>SEAT DEPTH:</b> 18.0 <b>SEAT HEIGHT:</b> 17.5-22.0 <b>BACK WIDTH:</b> 20.0 <b>BACK HEIGHT:</b> 23.0-26.0 <b>COM:</b> N/A <b>COL:</b> N/A <b>WEIGHT:</b> 40.5 LB		
			M1	A8B	455				
			M1	A9B	540				
			M1	A10	560				
			M1	A36	540				
			M1	A37	560				
			SEAT SLIDER (SS) - ADD \$60 - FACTORY INSTALLED						
2170	Y1	<b>MID-BACK SIMPLE SYNCHRO</b>  Use for a variety of general office seating, including private office and conference room seating	M3	ARMLESS	M	<ul style="list-style-type: none"> <li>• Pneumatic seat height adjustment</li> <li>• Tilt tension control</li> <li>• Back and seat tilt in 3:1 ratio</li> <li>• Upright position tilt lock</li> <li>• Height adjustable lumbar</li> <li>• Ratchet back height adjustment</li> <li>• Warranted to 300 lbs.</li> </ul>	<b>WIDTH:</b> 26.5 <b>DEPTH:</b> 26.0 <b>HEIGHT:</b> 38.0-45.0 <b>SEAT WIDTH:</b> 20.0 <b>SEAT DEPTH:</b> 18.0 <b>SEAT HEIGHT:</b> 17.0-21.5 <b>BACK WIDTH:</b> 20.0 <b>BACK HEIGHT:</b> 23.5-26.0 <b>COM:</b> N/A <b>COL:</b> N/A <b>WEIGHT:</b> 43.0 LB		
			M3	A8B	490				
			M3	A9B	575				
			M3	A10	595				
			M3	A36	575				
			M3	A37	595				
			SEAT SLIDER (SS) - ADD \$60 - FACTORY INSTALLED						
2170	Y3	<b>MID-BACK FULL SYNCHRO</b>  Use for a variety of general office seating, including private office and conference room seating	M1	ARMLESS	M	<ul style="list-style-type: none"> <li>• Pneumatic seat height adjustment</li> <li>• Tilt tension control</li> <li>• Back and seat tilt in 2:1 ratio</li> <li>• 3 locking positions</li> <li>• Safety tilt release</li> <li>• Height adjustable lumbar</li> <li>• Ratchet back height adjustment</li> <li>• Warranted to 300 lbs.</li> </ul>	<b>WIDTH:</b> 26.5 <b>DEPTH:</b> 25.5 <b>HEIGHT:</b> 39.0-46.0 <b>SEAT WIDTH:</b> 20.0 <b>SEAT DEPTH:</b> 18.0 <b>SEAT HEIGHT:</b> 17.5-22.0 <b>BACK WIDTH:</b> 20.0 <b>BACK HEIGHT:</b> 23.0-26.0 <b>COM:</b> N/A <b>COL:</b> N/A <b>WEIGHT:</b> 40.5 LB		
			M1	A8B	525				
			M1	A9B	610				
			M1	A10	630				
			M1	A36	610				
			M1	A37	630				
			SEAT SLIDER (SS) - ADD \$60 - FACTORY INSTALLED						
2170	Y3	<b>MID-BACK FULL SYNCHRO</b>  Use for a variety of general office seating, including private office and conference room seating	M3	ARMLESS	M	<ul style="list-style-type: none"> <li>• Pneumatic seat height adjustment</li> <li>• Tilt tension control</li> <li>• Back and seat tilt in 2:1 ratio</li> <li>• 3 locking positions</li> <li>• Safety tilt release</li> <li>• Height adjustable lumbar</li> <li>• Ratchet back height adjustment</li> <li>• Warranted to 300 lbs.</li> </ul>	<b>WIDTH:</b> 26.5 <b>DEPTH:</b> 26.0 <b>HEIGHT:</b> 38.0-45.0 <b>SEAT WIDTH:</b> 20.0 <b>SEAT DEPTH:</b> 18.0 <b>SEAT HEIGHT:</b> 17.0-21.5 <b>BACK WIDTH:</b> 20.0 <b>BACK HEIGHT:</b> 23.5-26.0 <b>COM:</b> N/A <b>COL:</b> N/A <b>WEIGHT:</b> 43.0 LB		
			M3	A8B	560				
			M3	A9B	645				
			M3	A10	665				
			M3	A36	645				
			M3	A37	665				
			SEAT SLIDER (SS) - ADD \$60 - FACTORY INSTALLED						

### MESH COLORS

BLACK M11	GRAY M12	SILVER M13	GREEN M14	RED M15	BLUE M16
GRAPHITE M31	SLATE M32	SNOW M33	SAGE M34	CARDINAL M35	ROYAL M36
TANGERINE M37	PLUM M38				

# theory

the facts support theory as the smart choice

## ALL MESH

GSA SIN # 711-18

- Task, stool and conference seating
- Choice of 14 mesh colors
- Ratchet back adjustment with independent height adjustable lumbar standard
- Multiple synchro controls available
- Mesh back and all mesh models available
- Warranted to 300 lbs.



### CREATING THEORY MODEL NUMBER

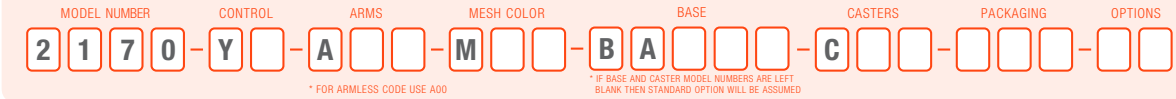

### PACKAGING NOTES

CODE	DESCRIPTION	LIST UPCHARGE
AB	ASSEMBLED IN BAG	\$0
PAC	PARTIALLY ASSEMBLED IN CARTON	\$0
BAC	BACK ASSEMBLED IN CARTON	\$40

MODEL	CONTROL	DESCRIPTION	ARM	MESH		
2170	Y2	<b>MID-BACK HEAVY DUTY SYNCHRO</b>  Use for a variety of general office seating, including private office and conference room seating	M1	ARMLESS	M	575
			M1	A8B	660	
			M1	A9B	680	
			M1	A10	660	
			M1	A36	680	
			M1	A37	700	

SEAT SLIDER (SS) - ADD \$60 - FACTORY INSTALLED

MODEL	CONTROL	DESCRIPTION	ARM	MESH		
2170	Y2	<b>MID-BACK HEAVY DUTY SYNCHRO</b>  Use for a variety of general office seating, including private office and conference room seating	M3	ARMLESS	M	610
			M3	A8B	695	
			M3	A9B	715	
			M3	A10	695	
			M3	A36	715	
			M3	A37	735	

SEAT SLIDER (SS) - ADD \$60 - FACTORY INSTALLED

### FEATURES

- Pneumatic seat height adjustment
- Side tilt tension control
- Back and seat tilt in 2:1 ratio
- 4 locking positions
- Safety tilt release
- Height adjustable lumbar
- Ratchet back height adjustment
- Warranted to 300 lbs.

### DIMENSIONS

**WIDTH:** 26.5  
**DEPTH:** 25.5  
**HEIGHT:** 39.0-46.0  
**SEAT WIDTH:** 20.0  
**SEAT DEPTH:** 18.0  
**SEAT HEIGHT:** 17.5-22.0  
**BACK WIDTH:** 20.0  
**BACK HEIGHT:** 23.0-26.0  
**COM:** N/A  
**COL:** N/A  
**WEIGHT:** 40.5 LB

- Pneumatic seat height adjustment
- Side tilt tension control
- Back and seat tilt in 2:1 ratio
- 4 locking positions
- Safety tilt release
- Height adjustable lumbar
- Ratchet back height adjustment
- Warranted to 300 lbs.

**WIDTH:** 26.5  
**DEPTH:** 26.0  
**HEIGHT:** 38.0-45.0  
**SEAT WIDTH:** 20.0  
**SEAT DEPTH:** 18.0  
**SEAT HEIGHT:** 17.0-21.5  
**BACK WIDTH:** 20.0  
**BACK HEIGHT:** 23.5-26.0  
**COM:** N/A  
**COL:** N/A  
**WEIGHT:** 43.0 LB

### ARM OPTIONS



Soft Touch C-Shaped Arm

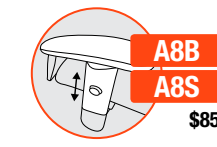

Height Adjustable Arm  
A8B-Black, A8S-Silver

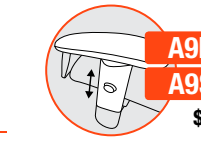

Height/Width Adjustable Arm  
A9B-Black, A9S-Silver



Height Adjustable  
Pivot/Slide Arm



Height/Width Adjustable  
Pivot/Slide Arm

### CASTER OPTIONS



60mm Hoodless Casters



60mm Hoodless Hard Floor  
Casters



60mm Hoodless Chrome  
Accented Casters

### BASE OPTIONS

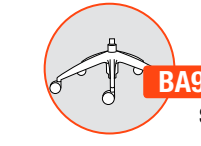

26" High Profile Nylon  
Base - Black



26" High Profile Aluminum  
Base - Black Powder Coat



26" High Profile Aluminum  
Base - Polished



26" High Profile Aluminum  
Base - Silver Powder Coat

### ADDITIONAL OPTIONS



Seat Slider 2.5"  
Side Paddle Activated



Heavy Duty Multi-Shift  
Upgrade to 350Lbs.  
(Includes BA10 Aluminum  
Base and C6 60mm Casters,  
Y2 Control Only)

### MESH COLORS

BLACK M11	GRAY M12	SILVER M13	GREEN M14	RED M15	BLUE M16
GRAPHITE M31	SLATE M32	SNOW M33	SAGE M34	CARDINAL M35	ROYAL M36
TANGERINE M37	PLUM M38				

# theory

the facts support theory as the smart choice

## ALL MESH

GSA SIN # 711-18

- Task, stool and conference seating
- Choice of 14 mesh colors
- Ratchet back adjustment with independent height adjustable lumbar standard
- Multiple synchro controls available
- Mesh back and all mesh models available
- Warranted to 300 lbs.



### CREATING THEORY MODEL NUMBER



### PACKAGING NOTES

CODE	DESCRIPTION	LIST UPCHARGE
AB	ASSEMBLED IN BAG	\$0
PAC	PARTIALLY ASSEMBLED IN CARTON	\$0
BAC	BACK ASSEMBLED IN CARTON	\$40

MODEL	CONTROL	DESCRIPTION	ARM	MESH	FEATURES	DIMENSIONS	ARM OPTIONS	CASTER OPTIONS	ADDITIONAL OPTIONS
2190	Y1	<b>HIGH-BACK SIMPLE SYNCHRO</b>  Use for a variety of general office seating, including private office and conference room seating	M1	ARMLESS	M	<ul style="list-style-type: none"> <li>• Pneumatic seat height adjustment</li> <li>• Tilt tension control</li> <li>• Back and seat tilt in 3:1 ratio</li> <li>• Upright position tilt lock</li> <li>• Height adjustable lumbar</li> <li>• Ratchet back height adjustment</li> <li>• Warranted to 300 lbs.</li> </ul>	<b>WIDTH:</b> 26.5 <b>DEPTH:</b> 25.5 <b>HEIGHT:</b> 44.5-55.0 <b>SEAT WIDTH:</b> 20.0 <b>SEAT DEPTH:</b> 18.0 <b>SEAT HEIGHT:</b> 17.5-21.0 <b>BACK WIDTH:</b> 20.0 <b>BACK HEIGHT:</b> 30.0-35.0 <b>COM:</b> N/A <b>COL:</b> N/A <b>WEIGHT:</b> 42.0 LB	    	  
			M1	A8B	540				
			M1	A9B	625				
			M1	A10	645				
			M1	A36	645				
			M1	A37	665				
			SEAT SLIDER (SS) - ADD \$60 - FACTORY INSTALLED						
2190	Y1	<b>HIGH-BACK SIMPLE SYNCHRO</b>  Use for a variety of general office seating, including private office and conference room seating	M3	ARMLESS	M	<ul style="list-style-type: none"> <li>• Pneumatic seat height adjustment</li> <li>• Tilt tension control</li> <li>• Back and seat tilt in 3:1 ratio</li> <li>• Upright position tilt lock</li> <li>• Height adjustable lumbar</li> <li>• Ratchet back height adjustment</li> <li>• Warranted to 300 lbs.</li> </ul>	<b>WIDTH:</b> 26.5 <b>DEPTH:</b> 25.5 <b>HEIGHT:</b> 44.5-55.0 <b>SEAT WIDTH:</b> 20.0 <b>SEAT DEPTH:</b> 18.0 <b>SEAT HEIGHT:</b> 17.5-21.0 <b>BACK WIDTH:</b> 20.0 <b>BACK HEIGHT:</b> 30.0-35.0 <b>COM:</b> N/A <b>COL:</b> N/A <b>WEIGHT:</b> 42.0 LB	  	  
			M3	A8B	575				
			M3	A9B	660				
			M3	A10	680				
			M3	A36	680				
			M3	A37	700				
			SEAT SLIDER (SS) - ADD \$60 - FACTORY INSTALLED						
2190	Y3	<b>HIGH-BACK FULL SYNCHRO</b>  Use for a variety of general office seating, including private office and conference room seating	M1	ARMLESS	M	<ul style="list-style-type: none"> <li>• Pneumatic seat height adjustment</li> <li>• Tilt tension control</li> <li>• Back and seat tilt in 2:1 ratio</li> <li>• 3 locking positions</li> <li>• Safety tilt release</li> <li>• Height adjustable lumbar</li> <li>• Ratchet back height adjustment</li> <li>• Warranted to 300 lbs.</li> </ul>	<b>WIDTH:</b> 26.5 <b>DEPTH:</b> 26.0 <b>HEIGHT:</b> 45.0-54.0 <b>SEAT WIDTH:</b> 20.0 <b>SEAT DEPTH:</b> 18.0 <b>SEAT HEIGHT:</b> 17.0-21.5 <b>BACK WIDTH:</b> 20.0 <b>BACK HEIGHT:</b> 30.5-35.0 <b>COM:</b> N/A <b>COL:</b> N/A <b>WEIGHT:</b> 44.0 LB	   	
			M1	A8B	610				
			M1	A9B	695				
			M1	A10	715				
			M1	A36	715				
			M1	A37	735				
			SEAT SLIDER (SS) - ADD \$60 - FACTORY INSTALLED						
2190	Y3	<b>HIGH-BACK FULL SYNCHRO</b>  Use for a variety of general office seating, including private office and conference room seating	M3	ARMLESS	M	<ul style="list-style-type: none"> <li>• Pneumatic seat height adjustment</li> <li>• Tilt tension control</li> <li>• Back and seat tilt in 2:1 ratio</li> <li>• 3 locking positions</li> <li>• Safety tilt release</li> <li>• Height adjustable lumbar</li> <li>• Ratchet back height adjustment</li> <li>• Warranted to 300 lbs.</li> </ul>	<b>WIDTH:</b> 26.5 <b>DEPTH:</b> 26.0 <b>HEIGHT:</b> 45.0-54.0 <b>SEAT WIDTH:</b> 20.0 <b>SEAT DEPTH:</b> 18.0 <b>SEAT HEIGHT:</b> 17.0-21.5 <b>BACK WIDTH:</b> 20.0 <b>BACK HEIGHT:</b> 30.5-35.0 <b>COM:</b> N/A <b>COL:</b> N/A <b>WEIGHT:</b> 44.0 LB	   	
			M3	A8B	645				
			M3	A9B	730				
			M3	A10	750				
			M3	A36	750				
			M3	A37	770				
			SEAT SLIDER (SS) - ADD \$60 - FACTORY INSTALLED						

### MESH COLORS

BLACK M11	GRAY M12	SILVER M13	GREEN M14	RED M15	BLUE M16
GRAPHITE M31	SLATE M32	SNOW M33	SAGE M34	CARDINAL M35	ROYAL M36
TANGERINE M37	PLUM M38				

# theory

the facts support theory as the smart choice

## ALL MESH

GSA SIN # 711-18

- Task, stool and conference seating
- Choice of 14 mesh colors
- Ratchet back adjustment with independent height adjustable lumbar standard
- Multiple synchro controls available
- Mesh back and all mesh models available
- Warranted to 300 lbs.



### CREATING THEORY MODEL NUMBER

MODEL NUMBER CONTROL ARMS MESH COLOR BASE CASTERS PACKAGING OPTIONS

2 1 9 0 - Y - A - M - B A - C - - - -

\* FOR ARMLESS CODE USE A00 \* IF BASE AND CASTER MODEL NUMBERS ARE LEFT BLANK THEN STANDARD OPTION WILL BE ASSUMED

### PACKAGING NOTES

CODE	DESCRIPTION	LIST UPCHARGE
AB	ASSEMBLED IN BAG	\$0
PAC	PARTIALLY ASSEMBLED IN CARTON	\$0
BAC	BACK ASSEMBLED IN CARTON	\$40

MODEL	CONTROL	DESCRIPTION	ARM	MESH	FEATURES	DIMENSIONS	
2190	Y2	<b>HIGH-BACK HEAVY DUTY SYNCHRO</b>  Use for a variety of general office seating, including private office and conference room seating	M1	ARMLESS	<ul style="list-style-type: none"> <li>• Pneumatic seat height adjustment</li> <li>• Side tilt tension control</li> <li>• Back and seat tilt in 2:1 ratio</li> <li>• 4 locking positions</li> <li>• Safety tilt release</li> <li>• Height adjustable lumbar</li> <li>• Ratchet back height adjustment</li> <li>• Warranted to 300 lbs.</li> </ul>	<b>WIDTH:</b> 26.5 <b>DEPTH:</b> 25.5 <b>HEIGHT:</b> 44.5-55.0 <b>SEAT WIDTH:</b> 20.0 <b>SEAT DEPTH:</b> 18.0 <b>BACK WIDTH:</b> 20.0 <b>BACK HEIGHT:</b> 30.0-35.0 <b>COM:</b> N/A <b>COL:</b> N/A <b>WEIGHT:</b> 42.0 LB	
			M1	A8B			660
			M1	A9B			745
			M1	A10			765
			M1	A36			745
			M1	A37			765

SEAT SLIDER (SS) - ADD \$60 - FACTORY INSTALLED

MODEL	CONTROL	DESCRIPTION	ARM	MESH	FEATURES	DIMENSIONS	
2190	Y2	<b>HIGH-BACK HEAVY DUTY SYNCHRO</b>  Use for a variety of general office seating, including private office and conference room seating	M3	ARMLESS	<ul style="list-style-type: none"> <li>• Pneumatic seat height adjustment</li> <li>• Side tilt tension control</li> <li>• Back and seat tilt in 2:1 ratio</li> <li>• 4 locking positions</li> <li>• Safety tilt release</li> <li>• Height adjustable lumbar</li> <li>• Ratchet back height adjustment</li> <li>• Warranted to 300 lbs.</li> </ul>	<b>WIDTH:</b> 26.5 <b>DEPTH:</b> 25.5 <b>HEIGHT:</b> 44.5-55.0 <b>SEAT WIDTH:</b> 20.0 <b>SEAT DEPTH:</b> 18.0 <b>BACK WIDTH:</b> 20.0 <b>BACK HEIGHT:</b> 30.0-35.0 <b>COM:</b> N/A <b>COL:</b> N/A <b>WEIGHT:</b> 42.0 LB	
			M3	A8B			695
			M3	A9B			780
			M3	A10			800
			M3	A36			780
			M3	A37			800

SEAT SLIDER (SS) - ADD \$60 - FACTORY INSTALLED

### ARM OPTIONS

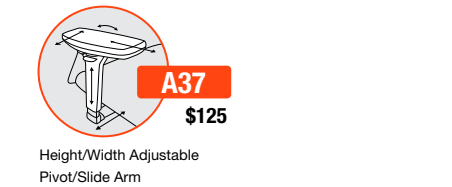

### CASTER OPTIONS

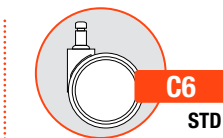

### BASE OPTIONS

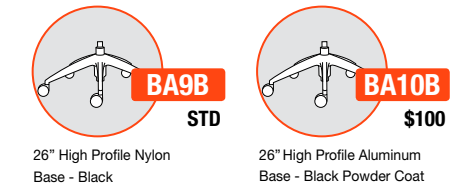

### ADDITIONAL OPTIONS



### MESH COLORS

BLACK M11	GRAY M12	SILVER M13	GREEN M14	RED M15	BLUE M16
GRAPHITE M31	SLATE M32	SNOW M33	SAGE M34	CARDINAL M35	ROYAL M36
TANGERINE M37	PLUM M38				

# theory

the facts support theory as the smart choice

## ALL MESH STOOL

GSA SIN # 711-18

- Task, stool and conference seating
- Choice of 14 mesh colors
- Ratchet back adjustment with independent height adjustable lumbar standard
- Multiple synchro controls available
- Mesh back and all mesh models available
- Warranted to 300 lbs.



### CREATING THEORY MODEL NUMBER

MODEL NUMBER	CONTROL	ARMS	MESH COLOR	BASE	CASTERS	PACKAGING	OPTIONS
217	Y1	A	M	BA	C		

\* FOR ARMLESS CODE USE A00      \* IF BASE AND CASTER MODEL NUMBERS ARE LEFT BLANK THEN STANDARD OPTION WILL BE ASSUMED

### PACKAGING NOTES

CODE	DESCRIPTION	LIST UPCHARGE
AB	ASSEMBLED IN BAG	\$0
PAC	PARTIALLY ASSEMBLED IN CARTON	\$0
BAC	BACK ASSEMBLED IN CARTON	\$40

MODEL	CONTROL	DESCRIPTION	ARM	MESH	FEATURES	DIMENSIONS	
2176	Y1	<b>10" STOOL SIMPLE SYNCHRO</b>  Use for work surfaces up to 42 inches high	M1	ARMLESS	M	<ul style="list-style-type: none"> <li>• Pneumatic seat height adjustment</li> <li>• Tilt tension control</li> <li>• Back and seat tilt in 3:1 ratio</li> <li>• Upright position tilt lock</li> <li>• Height adjustable lumbar</li> <li>• Ratchet back height adjustment</li> <li>• Height adjustable 20" diameter footring</li> <li>• Warranted to 300 lbs.</li> </ul>	<b>WIDTH:</b> 26.5 <b>DEPTH:</b> 26.5 <b>HEIGHT:</b> 47.25-60.5 <b>SEAT WIDTH:</b> 19.5 <b>SEAT DEPTH:</b> 18.0 <b>SEAT HEIGHT:</b> 26.0-36.0 <b>BACK WIDTH:</b> 20.0 <b>BACK HEIGHT:</b> 22.5-25.5 <b>COM:</b> NA <b>COL:</b> NA <b>WEIGHT:</b> 56.0 lbs
			M1	A8B	580		
			M1	A9B	665		
			M1	A10	685		
			M1	A36	665		
			M1	A37	685		
SEAT SLIDER (SS) - NOT AVAILABLE							
2176	Y1	<b>10" STOOL SIMPLE SYNCHRO</b>  Use for work surfaces up to 42 inches high	M3	ARMLESS	M	<ul style="list-style-type: none"> <li>• Pneumatic seat height adjustment</li> <li>• Tilt tension control</li> <li>• Back and seat tilt in 3:1 ratio</li> <li>• Upright position tilt lock</li> <li>• Height adjustable lumbar</li> <li>• Ratchet back height adjustment</li> <li>• Height adjustable 20" diameter footring</li> <li>• Warranted to 300 lbs.</li> </ul>	<b>WIDTH:</b> 26.5 <b>DEPTH:</b> 26.5 <b>HEIGHT:</b> 47.25-60.5 <b>SEAT WIDTH:</b> 19.5 <b>SEAT DEPTH:</b> 18.0 <b>SEAT HEIGHT:</b> 26.0-36.0 <b>BACK WIDTH:</b> 20.0 <b>BACK HEIGHT:</b> 22.5-25.5 <b>COM:</b> NA <b>COL:</b> NA <b>WEIGHT:</b> 56.0 lbs
			M3	A8B	605		
			M3	A9B	690		
			M3	A10	710		
			M3	A36	690		
			M3	A37	710		
SEAT SLIDER (SS) - NOT AVAILABLE							
2178	Y1	<b>8" STOOL SIMPLE SYNCHRO</b>  Use for work surfaces up to 36 inches high	M1	ARMLESS	M	<ul style="list-style-type: none"> <li>• Pneumatic seat height adjustment</li> <li>• Tilt tension control</li> <li>• Back and seat tilt in 3:1 ratio</li> <li>• Upright position tilt lock</li> <li>• Height adjustable lumbar</li> <li>• Ratchet back height adjustment</li> <li>• Height adjustable 20" diameter footring</li> <li>• Warranted to 300 lbs.</li> </ul>	<b>WIDTH:</b> 26.5 <b>DEPTH:</b> 26.5 <b>HEIGHT:</b> 44.25-55.5 <b>SEAT WIDTH:</b> 19.5 <b>SEAT DEPTH:</b> 18.0 <b>SEAT HEIGHT:</b> 23.5-31.5 <b>BACK WIDTH:</b> 20.0 <b>BACK HEIGHT:</b> 22.5-25.5 <b>COM:</b> NA <b>COL:</b> NA <b>WEIGHT:</b> 55.0 lbs
			M1	A8B	580		
			M1	A9B	665		
			M1	A10	685		
			M1	A36	665		
			M1	A37	685		
SEAT SLIDER (SS) - NOT AVAILABLE							
2178	Y1	<b>8" STOOL SIMPLE SYNCHRO</b>  Use for work surfaces up to 36 inches high	M3	ARMLESS	M	<ul style="list-style-type: none"> <li>• Pneumatic seat height adjustment</li> <li>• Tilt tension control</li> <li>• Back and seat tilt in 3:1 ratio</li> <li>• Upright position tilt lock</li> <li>• Height adjustable lumbar</li> <li>• Ratchet back height adjustment</li> <li>• Height adjustable 20" diameter footring</li> <li>• Warranted to 300 lbs.</li> </ul>	<b>WIDTH:</b> 26.5 <b>DEPTH:</b> 26.5 <b>HEIGHT:</b> 44.25-55.5 <b>SEAT WIDTH:</b> 19.5 <b>SEAT DEPTH:</b> 18.0 <b>SEAT HEIGHT:</b> 23.5-31.5 <b>BACK WIDTH:</b> 20.0 <b>BACK HEIGHT:</b> 22.5-25.5 <b>COM:</b> NA <b>COL:</b> NA <b>WEIGHT:</b> 55.0 lbs
			M3	A8B	605		
			M3	A9B	690		
			M3	A10	710		
			M3	A36	690		
			M3	A37	710		
SEAT SLIDER (SS) - NOT AVAILABLE							

### ARM OPTIONS



Soft Touch C-Shaped Arm



Height Adjustable Arm  
A8B-Black, A8S-Silver



Height/Width Adjustable Arm  
A9B-Black, A9S-Silver



Height Adjustable  
Pivot/Slide Arm



Height/Width Adjustable  
Pivot/Slide Arm

### CASTER OPTIONS



60mm Hoodless Casters



60mm Hoodless Hard Floor  
Casters



60mm Hoodless Chrome  
Accented Casters

### BASE OPTIONS



26" High Profile Nylon  
Base - Black



26" High Profile Aluminum  
Base - Black Powder Coat



26" High Profile Aluminum  
Base - Polished



26" High Profile Aluminum  
Base - Silver Powder Coat

### MESH COLORS

BLACK M11	GRAY M12	SILVER M13	GREEN M14	RED M15	BLUE M16
GRAPHITE M31	SLATE M32	SNOW M33	SAGE M34	CARDINAL M35	ROYAL M36
TANGERINE M37	PLUM M38				

# vault

goes beyond the expected

## MESH BACK

GSA SIN # 711-18

- Task, stool, management and conference seating
- Ratchet back height lumbar adjustment
- Choice of 8 back mesh colors
- Seat slider standard on all models
- Warranted to 300 lbs.
- CAL TB 133 Fire Code approved



### CREATING VAULT MODEL NUMBER

MODEL NUMBER	CONTROL	ARMS	BACK MESH COLOR	GRADE	BASE	CASTERS	PACKAGING	OPTIONS
1460		A	M		BA	C		

\* FOR ARMLESS CODE USE A00  
\* IF BASE AND CASTER MODEL NUMBERS ARE LEFT BLANK THEN STANDARD OPTION WILL BE ASSUMED

### PACKAGING NOTES

CODE	DESCRIPTION	LIST UPCHARGE
AB	ASSEMBLED IN BAG	\$0
PAC	PARTIALLY ASSEMBLED IN CARTON	\$0
BAC	BACK ASSEMBLED IN CARTON	\$40

MODEL	CONTROL	DESCRIPTION	ARM	FABRIC/LEATHER											
				T01	A/COM	B	C	D	E	F	G	L3/COL	L4	L5	
1460	Y1	<b>RATCHET BACK SIMPLE SYNCHRO</b>  Use for a variety of general office task seating, including private office and conference room seating	ARMLESS	445	465	495	515	545	580	620	660	660	530	565	655
			A6	575	595	625	645	675	710	750	790	660	695	785	
			A7	595	615	645	665	695	730	770	810	680	715	805	
			A8	530	550	580	600	630	665	705	745	615	650	740	
			A9	550	570	600	620	650	685	725	765	635	670	760	
			A10	530	550	580	600	630	665	705	745	615	650	740	
			A36	550	570	600	620	650	685	725	765	635	670	760	
			A37	570	590	620	640	670	705	745	785	655	690	780	
			A40	555	575	605	625	655	690	730	770	640	675	765	
			A41	575	595	625	645	675	710	750	790	660	695	785	

MODEL	CONTROL	DESCRIPTION	ARM	FABRIC/LEATHER										
				T01	A/COM	B	C	D	E	F	G	L3/COL	L4	L5
1460	Y3	<b>RATCHET BACK FULL SYNCHRO</b>  Use for a variety of general office task seating, including private office and conference room seating	ARMLESS	515	535	565	585	615	650	690	730	600	635	725
			A6	645	665	695	715	745	780	820	860	730	765	855
			A7	665	685	715	735	765	800	840	880	750	785	875
			A8	600	620	650	670	700	735	775	815	685	720	810
			A9	620	640	670	690	720	755	795	835	705	740	830
			A10	600	620	650	670	700	735	775	815	685	720	810
			A36	620	640	670	690	720	755	795	835	705	740	830
			A37	640	660	690	710	740	775	815	855	725	760	850
			A40	625	645	675	695	725	760	800	840	710	745	835
			A41	645	665	695	715	745	780	820	860	730	765	855

MODEL	CONTROL	DESCRIPTION	ARM	FABRIC/LEATHER										
				T01	A/COM	B	C	D	E	F	G	L3/COL	L4	L5
1460	K2	<b>RATCHET BACK ENHANCED KNEE TILT</b>  Ultimate seating comfort suited for the executive or manager. Allows for full range of movement with sharp, simple look	ARMLESS	535	555	585	605	635	670	710	750	620	655	745
			A6	665	685	715	735	765	800	840	880	750	785	875
			A7	685	705	735	755	785	820	860	900	770	805	895
			A8	620	640	670	690	720	755	795	835	705	740	830
			A9	640	660	690	710	740	775	815	855	725	760	850
			A10	620	640	670	690	720	755	795	835	705	740	830
			A36	640	660	690	710	740	775	815	855	725	760	850
			A37	660	680	710	730	760	795	835	875	745	780	870
			A40	645	665	695	715	745	780	820	860	730	765	855
			A41	665	685	715	735	765	800	840	880	750	785	875

### FEATURES

- Pneumatic seat height adjustment
- Tilt tension control
- Back and seat tilt in 3:1 ratio
- Upright position tilt lock
- Seat slider standard
- Ratchet back height lumbar adjustment
- Molded foam seat
- Warranted to 300 lbs.

### DIMENSIONS

WIDTH: 24.5-26.0  
 DEPTH: 25.0  
 HEIGHT: 39.5-46.5  
 SEAT WIDTH: 20.0  
 SEAT DEPTH: 16.0-18.5  
 SEAT HEIGHT: 17.5-22.0  
 BACK WIDTH: 18.5  
 BACK HEIGHT: 23.0-25.5  
 COM: 0.8 yds  
 COL: 11.0 sq ft  
 WEIGHT: 39.0 lb

- Pneumatic seat height adjustment
- Tilt tension control
- Back and seat tilt in 2:1 ratio
- 3 locking positions
- Safety tilt release
- Seat slider standard
- Ratchet back height lumbar adjustment
- Molded foam seat
- Warranted to 300 lbs.

WIDTH: 24.5-26.0  
 DEPTH: 25.0  
 HEIGHT: 39.5-46.5  
 SEAT WIDTH: 20.0  
 SEAT DEPTH: 16.0-18.5  
 SEAT HEIGHT: 17.5-22.0  
 BACK WIDTH: 18.5  
 BACK HEIGHT: 23.0-25.5  
 COM: 0.8 yds  
 COL: 11.0 sq ft  
 WEIGHT: 41.0 lb

- Pneumatic seat height adjustment
- Side activated tilt tension control
- Seat and back tilt as a unit
- 3 locking positions
- Reduced rise of front of seat
- Seat slider standard
- Ratchet back height lumbar adjustment
- Molded foam seat
- Warranted to 300 lbs.







WIDTH: 24.5-26.0  
 DEPTH: 25.0  
 HEIGHT: 40.5-46.0  
 SEAT WIDTH: 20.0  
 SEAT DEPTH: 16.0-18.5  
 SEAT HEIGHT: 18.5-21.5  
 BACK WIDTH: 18.5  
 BACK HEIGHT: 23.0-25.5  
 COM: 0.8 yds  
 COL: 11.0 sq ft  
 WEIGHT: 41.0 lb

### MESH COLORS

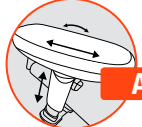
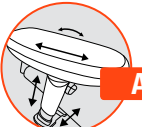
BLACK M21	GRAY M22	WHITE M23	GREEN M24
RED M25	BLUE M26	ORANGE M27	AQUA M28

M4 also available

### ARM OPTIONS

 <p><b>A6</b> \$130</p> <p>Height Adjustable Pivot Slide Arm</p>	 <p><b>A7</b> \$150</p> <p>Height/Width Adjustable Pivot Slide Arm</p>
 <p><b>A8B A8S</b> \$85</p> <p>Height Adjustable Arm A8B-Black, A8S-Silver</p>	 <p><b>A9B A9S</b> \$105</p> <p>Height/Width Adjustable Arm A9B-Black, A9S-Silver</p>
 <p><b>A10</b> \$85</p> <p>Soft Touch C-Shaped Arm</p>	 <p><b>A36</b> \$105</p> <p>Height Adjustable Pivot/Slide Arm</p>
 <p><b>A37</b> \$125</p> <p>Height/Width Adjustable Pivot/Slide Arm</p>	 <p><b>A40</b> \$130</p> <p>Height Adjustable Arm</p>





### CASTERS

 <p><b>C6</b> STD</p> <p>60mm Hoodless Casters</p>
 <p><b>C6S</b> \$35</p> <p>60mm Hoodless Hard Floor Casters</p>
 <p><b>C7</b> \$35</p> <p>60mm Hoodless Chrome Accented Casters</p>

### ADDITIONAL OPTIONS

 <p><b>EF1</b> \$30</p> <p>Extra Foam 1" on Seat (Not Available with Leather)</p>
 <p><b>MF1</b> \$50</p> <p>1" Visco Elastic Memory Foam on Seat (Not Available with Leather)</p>

### BASE OPTIONS

 <p><b>BA9B</b> STD</p> <p>26" High Profile Nylon Base - Black</p>	 <p><b>BA10B</b> \$100</p> <p>26" High Profile Aluminum Base - Black Powder Coat</p>
 <p><b>BA10P</b> \$100</p> <p>26" High Profile Aluminum Base - Polished</p>	 <p><b>BA10S</b> \$100</p> <p>26" High Profile Aluminum Base - Silver Powder Coat</p>



# vault

goes beyond the expected

## MESH BACK

GSA SIN # 711-18

- Task, stool, management and conference seating
- Ratchet back height lumbar adjustment
- Choice of 8 back mesh colors
- Seat slider standard on all models
- Warranted to 300 lbs.
- CAL TB 133 Fire Code approved



### CREATING VAULT MODEL NUMBER

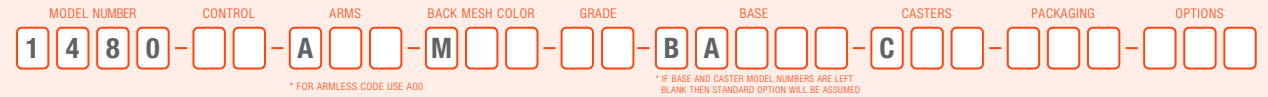

### PACKAGING NOTES

CODE	DESCRIPTION	LIST UPCHARGE
AB	ASSEMBLED IN BAG	\$0
PAC	PARTIALLY ASSEMBLED IN CARTON	\$0
BAC	BACK ASSEMBLED IN CARTON	\$40

MODEL	CONTROL	DESCRIPTION	ARM	FABRIC/LEATHER	DIMENSIONS								FEATURES	DIMENSIONS			
					T01	A/COM	B	C	D	E	F	G			L3/COL	L4	L5
1480	Y1	<b>RATCHET BACK WITH HEADREST SIMPLE SYNCHRO</b>  Use for a variety of general office task seating, including private office and conference room seating	ARMLESS		520	540	570	590	620	655	695	735	605	640	730	<ul style="list-style-type: none"> <li>• Pneumatic seat height adjustment</li> <li>• Tilt tension control</li> <li>• Back and seat tilt in 3:1 ratio</li> <li>• Upright position tilt lock</li> <li>• Seat slider standard</li> <li>• Ratchet back height lumbar adjustment</li> <li>• Molded foam seat</li> <li>• Warranted to 300 lbs.</li> </ul>	<p><b>WIDTH:</b> 24.5-26.0</p> <p><b>DEPTH:</b> 25.0</p> <p><b>HEIGHT:</b> 39.5-46.5</p> <p><b>SEAT WIDTH:</b> 20.0</p> <p><b>SEAT DEPTH:</b> 16.0-18.5</p> <p><b>SEAT HEIGHT:</b> 17.5-22.0</p> <p><b>BACK WIDTH:</b> 18.5</p> <p><b>BACK HEIGHT:</b> 23.0-25.5</p> <p><b>COM:</b> 0.8 yds</p> <p><b>COL:</b> 11.0 sq ft</p> <p><b>WEIGHT:</b> 39.0 lb</p>
			A6	650	670	700	720	750	785	825	865	735	770	860			
			A7	670	690	720	740	770	805	845	885	755	790	880			
			A8	605	625	655	675	705	740	780	820	690	725	815			
			A9	625	645	675	695	725	760	800	840	710	745	835			
			A10	605	625	655	675	705	740	780	820	690	725	815			
			A36	625	645	675	695	725	760	800	840	710	745	835			
			A37	645	665	695	715	745	780	820	860	730	765	855			
			A40	630	650	680	700	730	765	805	845	715	750	840			
			A41	650	670	700	720	750	785	825	865	735	770	860			
1480	Y3	<b>RATCHET BACK WITH HEADREST FULL SYNCHRO</b>  Use for a variety of general office task seating, including private office and conference room seating	ARMLESS		590	610	640	660	690	725	765	805	675	710	800	<ul style="list-style-type: none"> <li>• Pneumatic seat height adjustment</li> <li>• Tilt tension control</li> <li>• Back and seat tilt in 2:1 ratio</li> <li>• 3 locking positions</li> <li>• Safety tilt release</li> <li>• Seat slider standard</li> <li>• Ratchet back height lumbar adjustment</li> <li>• Molded foam seat</li> <li>• Warranted to 300 lbs.</li> </ul>	<p><b>WIDTH:</b> 24.5-26.0</p> <p><b>DEPTH:</b> 25.0</p> <p><b>HEIGHT:</b> 39.5-46.5</p> <p><b>SEAT WIDTH:</b> 20.0</p> <p><b>SEAT DEPTH:</b> 16.0-18.5</p> <p><b>SEAT HEIGHT:</b> 17.5-22.0</p> <p><b>BACK WIDTH:</b> 18.5</p> <p><b>BACK HEIGHT:</b> 23.0-25.5</p> <p><b>COM:</b> 0.8 yds</p> <p><b>COL:</b> 11.0 sq ft</p> <p><b>WEIGHT:</b> 41.0 lb</p>
			A6	720	740	770	790	820	855	895	935	805	840	930			
			A7	740	760	790	810	840	875	915	955	825	860	950			
			A8	675	695	725	745	775	810	850	890	760	795	885			
			A9	695	715	745	765	795	830	870	910	780	815	905			
			A10	675	695	725	745	775	810	850	890	760	795	885			
			A36	695	715	745	765	795	830	870	910	780	815	905			
			A37	715	735	765	785	815	850	890	930	800	835	925			
			A40	700	720	750	770	800	835	875	915	785	820	910			
			A41	720	740	770	790	820	855	895	935	805	840	930			
1480	K2	<b>RATCHET BACK WITH HEADREST ENHANCED KNEE TILT</b>  Ultimate seating comfort suited for the executive or manager. Allows for full range of movement with sharp, simple look	ARMLESS		610	630	660	680	710	745	785	825	695	730	820	<ul style="list-style-type: none"> <li>• Pneumatic seat height adjustment</li> <li>• Side activated tilt tension control</li> <li>• Seat and back tilt as a unit</li> <li>• 3 locking positions</li> <li>• Reduced rise of front of seat</li> <li>• Seat slider standard</li> <li>• Ratchet back height lumbar adjustment</li> <li>• Molded foam seat</li> <li>• Warranted to 300 lbs.</li> </ul>	<p><b>WIDTH:</b> 24.5-26.0</p> <p><b>DEPTH:</b> 25.0</p> <p><b>HEIGHT:</b> 45.0-50.5</p> <p><b>SEAT WIDTH:</b> 20.0</p> <p><b>SEAT DEPTH:</b> 16.0-18.5</p> <p><b>SEAT HEIGHT:</b> 18.5-21.5</p> <p><b>BACK WIDTH:</b> 18.5</p> <p><b>BACK HEIGHT:</b> 23.0-25.5</p> <p><b>COM:</b> 0.8 yds</p> <p><b>COL:</b> 11.0 sq ft</p> <p><b>WEIGHT:</b> 41.0 lb</p>
			A6	740	760	790	810	840	875	915	955	825	860	950			
			A7	760	780	810	830	860	895	935	975	845	880	970			
			A8	695	715	745	765	795	830	870	910	780	815	905			
			A9	715	735	765	785	815	850	890	930	800	835	925			
			A10	695	715	745	765	795	830	870	910	780	815	905			
			A36	715	735	765	785	815	850	890	930	800	835	925			
			A37	735	755	785	805	835	870	910	950	820	855	945			
			A40	720	740	770	790	820	855	895	935	805	840	930			
			A41	740	760	790	810	840	875	915	955	825	860	950			

### MESH COLORS

MODEL NUMBER	CONTROL	ARMS	BACK MESH COLOR	GRADE	BASE	CASTERS	PACKAGING	OPTIONS
1480	Y1	A	M		BA	C		

- Pneumatic seat height adjustment
- Tilt tension control
- Back and seat tilt in 2:1 ratio
- 3 locking positions
- Safety tilt release
- Seat slider standard
- Ratchet back height lumbar adjustment
- Molded foam seat
- Warranted to 300 lbs.

- Pneumatic seat height adjustment
- Side activated tilt tension control
- Seat and back tilt as a unit
- 3 locking positions
- Reduced rise of front of seat
- Seat slider standard
- Ratchet back height lumbar adjustment
- Molded foam seat
- Warranted to 300 lbs.

### MESH COLORS

BLACK M21	GRAY M22	WHITE M23	GREEN M24
RED M25	BLUE M26	ORANGE M27	AQUA M28

M4 also available

### ARM OPTIONS

**A6** \$130  
Height Adjustable Pivot Slide Arm

**A7** \$150  
Height/Width Adjustable Pivot Slide Arm

**A8B** \$85  
Height Adjustable Arm A8B-Black, A8S-Silver

**A8S** \$85

**A9B** \$105  
Height/Width Adjustable Arm A9B-Black, A9S-Silver

**A9S** \$105

**A10** \$85  
Soft Touch C-Shaped Arm

**A36** \$105  
Height Adjustable Pivot/Slide Arm

**A37** \$125  
Height/Width Adjustable Pivot/Slide Arm

**A40** \$130  
Height Adjustable Arm

**A41** \$130  
Height Adjustable Slide Arm

### CASTERS

**C6** STD  
60mm Hoodless Casters

**C6S** \$35  
60mm Hoodless Hard Floor Casters

**C7** \$35  
60mm Hoodless Chrome Accented Casters

### ADDITIONAL OPTIONS

**EF1** \$30  
Extra Foam 1" on Seat (Not Available with Leather)

**MF1** \$50  
1" Visco Elastic Memory Foam on Seat (Not Available with Leather)

### BASE OPTIONS

**BA9B** STD  
26" High Profile Nylon Base - Black

**BA10B** \$100  
26" High Profile Aluminum Base - Black Powder Coat

**BA10P** \$100  
26" High Profile Aluminum Base - Polished

**BA10S** \$100  
26" High Profile Aluminum Base - Silver Powder Coat

# vault

goes beyond the expected

GSA SIN # 711-18

- Task, stool, management and conference seating
- Ratchet back height lumbar adjustment
- Choice of 8 back mesh colors
- Seat slider standard on all models
- Warranted to 300 lbs.
- CAL TB 133 Fire Code approved



## MESH BACK STOOL UPHOLSTERED SEAT

### CREATING VAULT MODEL NUMBER

MODEL NUMBER CONTROL ARMS BACK MESH COLOR GRADE BASE CASTERS PACKAGING OPTIONS

**1** **4** **6**  - **Y** **1** - **A**   - **M**   -    - **B** **A**   - **C**   -    -

\* FOR ARMLESS CODE USE A00      \* IF BASE AND CASTER MODEL NUMBERS ARE LEFT BLANK THEN STANDARD OPTION WILL BE ASSUMED

### PACKAGING NOTES

CODE	DESCRIPTION	LIST UPCHARGE
AB	ASSEMBLED IN BAG	\$0
PAC	PARTIALLY ASSEMBLED IN CARTON	\$0
BAC	BACK ASSEMBLED IN CARTON	\$40

MODEL	CONTROL	DESCRIPTION	ARM	FABRIC/LEATHER	DIMENSIONS										
					T01	A/COM	B	C	D	E	F	G	L3/COL	L4	L5
1466	Y1	10" STOOL SIMPLE SYNCHRO	Use for work surfaces up to 42 inches high	ARMLESS	570	590	620	640	670	705	745	785	655	690	780
				A6	700	720	750	770	800	835	875	915	785	820	910
				A7	720	740	770	790	820	855	895	935	805	840	930
				A8	655	675	705	725	755	790	830	870	740	775	865
				A9	675	695	725	745	775	810	850	890	760	795	885
				A10	655	675	705	725	755	790	830	870	740	775	865
				A36	675	695	725	745	775	810	850	890	760	795	885
				A37	695	715	745	765	795	830	870	910	780	815	905
				A40	680	700	730	750	780	815	855	895	765	800	890
				A41	700	720	750	770	800	835	875	915	785	820	910
1468	Y1	8" STOOL SIMPLE SYNCHRO	Use for work surfaces up to 36 inches high	ARMLESS	570	590	620	640	670	705	745	785	655	690	780
				A6	700	720	750	770	800	835	875	915	785	820	910
				A7	720	740	770	790	820	855	895	935	805	840	930
				A8	655	675	705	725	755	790	830	870	740	775	865
				A9	675	695	725	745	775	810	850	890	760	795	885
				A10	655	675	705	725	755	790	830	870	740	775	865
				A36	675	695	725	745	775	810	850	890	760	795	885
				A37	695	715	745	765	795	830	870	910	780	815	905
				A40	680	700	730	750	780	815	855	895	765	800	890
				A41	700	720	750	770	800	835	875	915	785	820	910

### FEATURES

- Pneumatic seat height adjustment
- Tilt tension control
- Back and seat tilt in 3:1 ratio
- Upright position tilt lock
- Seat slider standard
- Ratchet back height lumbar adjustment
- Molded foam seat
- Height adj. 20" diameter footring
- Warranted to 300 lbs.

### DIMENSIONS

**WIDTH:** 24.5-26.0  
**DEPTH:** 25.0  
**HEIGHT:** 49.0-62.5  
**SEAT WIDTH:** 20.0  
**SEAT DEPTH:** 16.0-18.5  
**SEAT HEIGHT:** 27.0-37.0  
**BACK WIDTH:** 18.5  
**BACK HEIGHT:** 23.0-25.5  
**COM:** 0.8 yds  
**COL:** 11.0 sq ft  
**WEIGHT:** 45.0 lb

- Pneumatic seat height adjustment
- Tilt tension control
- Back and seat tilt in 3:1 ratio
- Upright position tilt lock
- Seat slider standard
- Ratchet back height lumbar adjustment
- Molded foam seat
- Height adj. 20" diameter footring
- Warranted to 300 lbs.

**WIDTH:** 24.5-26.0  
**DEPTH:** 25.0  
**HEIGHT:** 45.0-55.5  
**SEAT WIDTH:** 20.0  
**SEAT DEPTH:** 16.0-18.5  
**SEAT HEIGHT:** 22.0-30.0  
**BACK WIDTH:** 18.5  
**BACK HEIGHT:** 23.0-25.5  
**COM:** 0.8 yds  
**COL:** 11.0 sq ft  
**WEIGHT:** 44.0 lb

### ARM OPTIONS

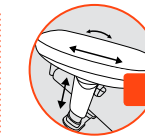

A6 \$130

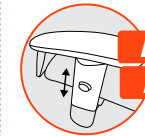

A8B \$85  
A8S \$85

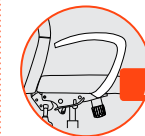

A10 \$85



A37 \$125

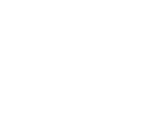

A40 \$130



A41 \$130

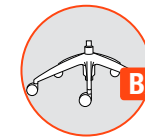

BA9B STD



BA10P \$100

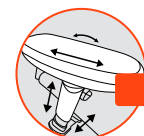

A7 \$150

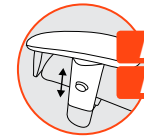

A9B \$105  
A9S \$105



A36 \$105

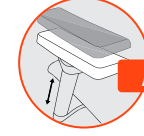

A40 \$130



A41 \$130

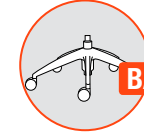

BA10B \$100



BA10S \$100

### CASTERS

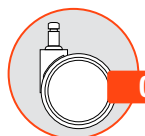

C6 STD

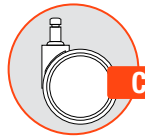

C6S \$35

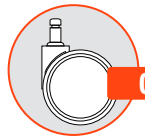

C7 \$35

### ADDITIONAL OPTIONS



EF1 \$30



MF1 \$50

### MESH COLORS

BLACK M21	GRAY M22	WHITE M23	GREEN M24
RED M25	BLUE M26	ORANGE M27	AQUA M28

M4 also available

# vesta

excellence in total ergonomics

GSA SIN # 711-18

- Executive, task, stool and conference seating
- Seat styles include: mesh and upholstered
- Choice of 3 frame colors and 6 mesh colors
- Aluminum base standard
- Warranted to 300 lbs.
- CAL TB 133 Fire Code approved



## CREATING VESTA MODEL NUMBER



### PACKAGING NOTES

CODE	DESCRIPTION	LIST UPCHARGE
AB	ASSEMBLED IN BAG	\$0
BAC	BACK ASSEMBLED IN CARTON	\$0

## ALL MESH

MODEL	CONTROL	DESCRIPTION	ARM	FABRIC	FEATURES	DIMENSIONS	ARM OPTIONS	CASTER OPTIONS
3060	X1	<b>MID-BACK DYNAMIC SYNCHRO</b> Use for a variety of general office seating, including private office and conference room seating	ARMLESS A28 A29 A30	M 995 1095 1095 1120	<ul style="list-style-type: none"> <li>• Pneumatic seat height adjustment</li> <li>• Side adjustable tilt tension control</li> <li>• Back and seat tilt in 2.6:1 ratio</li> <li>• 26° tilt of back, 10° seat tilt</li> <li>• 11 locking positions</li> <li>• 2 position forward seat angle adj.</li> <li>• Standard seat slider adds 2" adj.</li> <li>• Standard with heavy duty casters</li> <li>• Warranted to 300 lbs.</li> </ul>	<b>WIDTH:</b> 25.0 <b>DEPTH:</b> 25.0 <b>HEIGHT:</b> 41.0-45.5 <b>SEAT WIDTH:</b> 19.5 <b>SEAT DEPTH:</b> 17.0-18.5 <b>SEAT HEIGHT:</b> 17.0-21.5 <b>BACK WIDTH:</b> 19.5 <b>BACK HEIGHT:</b> 23.5 <b>COL:</b> 7.5 SQ FT <b>WEIGHT:</b> 54.0 LB	<b>A28</b> \$100 Height Adjustable Arm with 19" Interior Width <b>A29</b> \$100 Height Adjustable Arm with 17.5" Interior Width <b>A30</b> \$125 Height/Width Adjustable Arm w/ Sliding Pad	<b>C8S</b> STD 75mm Hoodless Casters
3080	X1	<b>HIGH-BACK DYNAMIC SYNCHRO</b> Use for a variety of general office seating, including private office and conference room seating	ARMLESS A28 A29 A30	M 1120 1220 1220 1245	<ul style="list-style-type: none"> <li>• Pneumatic seat height adjustment</li> <li>• Side adjustable tilt tension control</li> <li>• Back and seat tilt in 2.6:1 ratio</li> <li>• 26° tilt of back, 10° seat tilt</li> <li>• 11 locking positions</li> <li>• 2 position forward seat angle adj.</li> <li>• Standard seat slider adds 2" adj.</li> <li>• Standard with heavy duty casters</li> <li>• Warranted to 300 lbs.</li> </ul>	<b>WIDTH:</b> 25.0 <b>DEPTH:</b> 25.0 <b>HEIGHT:</b> 50.0-54.5 <b>SEAT WIDTH:</b> 19.5 <b>SEAT DEPTH:</b> 17.0-18.5 <b>SEAT HEIGHT:</b> 17.0-21.5 <b>BACK WIDTH:</b> 19.5 <b>BACK HEIGHT:</b> 23.5 <b>COL:</b> 7.5 SQ FT <b>WEIGHT:</b> 56.0 LB		
3061	X1	<b>10" STOOL DYNAMIC SYNCHRO</b> Use for work surfaces up to 42 inches high	ARMLESS A28 A29 A30	M 1120 1220 1220 1245	<ul style="list-style-type: none"> <li>• Pneumatic seat height adjustment</li> <li>• Side adjustable tilt tension control</li> <li>• Back and seat tilt in 2.6:1 ratio</li> <li>• 26° tilt of back, 10° seat tilt</li> <li>• 11 locking positions</li> <li>• 2 position forward seat angle adj.</li> <li>• Standard seat slider adds 2" adj.</li> <li>• Standard with heavy duty casters</li> <li>• Height adj. 20" diameter footring</li> <li>• Warranted to 300 lbs.</li> </ul>	<b>WIDTH:</b> 25.0 <b>DEPTH:</b> 25.0 <b>HEIGHT:</b> 50.5-60.5 <b>SEAT WIDTH:</b> 19.5 <b>SEAT DEPTH:</b> 17.0-18.5 <b>SEAT HEIGHT:</b> 26.0-36.0 <b>BACK WIDTH:</b> 19.5 <b>BACK HEIGHT:</b> 23.5 <b>COL:</b> 7.5 SQ FT <b>WEIGHT:</b> 60.0 LB		
3063	X1	<b>8" STOOL DYNAMIC SYNCHRO</b> Use for work surfaces up to 36 inches high	ARMLESS A28 A29 A30	M 1120 1220 1220 1245	<ul style="list-style-type: none"> <li>• Pneumatic seat height adjustment</li> <li>• Side adjustable tilt tension control</li> <li>• Back and seat tilt in 2.6:1 ratio</li> <li>• 26° tilt of back, 10° seat tilt</li> <li>• 11 locking positions</li> <li>• 2 position forward seat angle adj.</li> <li>• Standard seat slider adds 2" adj.</li> <li>• Standard with heavy duty casters</li> <li>• Height adj. 20" diameter footring</li> <li>• Warranted to 300 lbs.</li> </ul>	<b>WIDTH:</b> 25.0 <b>DEPTH:</b> 25.0 <b>HEIGHT:</b> 46.5-54.5 <b>SEAT WIDTH:</b> 19.5 <b>SEAT DEPTH:</b> 17.0-18.5 <b>SEAT HEIGHT:</b> 22.0-30.0 <b>BACK WIDTH:</b> 19.5 <b>BACK HEIGHT:</b> 23.5 <b>COL:</b> 7.5 SQ FT <b>WEIGHT:</b> 59.0 LB		

### ARM OPTIONS

### CASTER OPTIONS

### BASE OPTIONS

### FRAME COLORS

### MESH COLORS

BLACK BF	SILVER SF	POLISHED PF
-------------	--------------	----------------

(FRAME)

BLACK M11	GRAY M12	SILVER M13	GREEN M14	RED M15	BLUE M16
--------------	-------------	---------------	--------------	------------	-------------

# vesta

excellence in total ergonomics

GSA SIN # 711-18

- Executive, task, stool and conference seating
- Choice of 3 frame colors and 6 mesh colors
- Aluminum base standard
- Warranted to 300 lbs.
- CAL TB 133 Fire Code approved



## CREATING VESTA MODEL NUMBER

MODEL NUMBER CONTROL ARMS FRAME COLORS MESH COLOR GRADE BASE CASTERS PACKAGING

3 0 - X 1 - A - M - B A 1 0 - C 8 S

\* FOR ARMLESS CODE USE A00 \* CHROME FRAME COLOR (CF) IS NO LONGER AVAILABLE AND HAS BEEN REPLACED WITH POLISHED ALUMINUM (PF)

### PACKAGING NOTES

CODE	DESCRIPTION	LIST UPCHARGE
AB	ASSEMBLED IN BAG	\$0
BAC	BACK ASSEMBLED IN CARTON	\$0

## MESH BACK UPHOLSTERED SEAT

MODEL	CONTROL	DESCRIPTION	ARM	FABRIC/LEATHER	FEATURES	DIMENSIONS	ARM OPTIONS	CASTER OPTIONS																																																		
3065	X1	<b>MID-BACK DYNAMIC SYNCHRO</b> Use for a variety of general office task seating, including private office and conference room seating	ARMLESS A28 A29 A30	<table border="1"> <thead> <tr> <th>A/COM</th> <th>B</th> <th>C</th> <th>D</th> <th>E</th> <th>F</th> <th>G</th> <th>L3/COL</th> <th>L4</th> <th>L5</th> </tr> </thead> <tbody> <tr> <td>1070</td> <td>1105</td> <td>1130</td> <td>1165</td> <td>1205</td> <td>1250</td> <td>1300</td> <td>1115</td> <td>1170</td> <td>1210</td> </tr> <tr> <td>1170</td> <td>1205</td> <td>1230</td> <td>1265</td> <td>1305</td> <td>1350</td> <td>1400</td> <td>1215</td> <td>1270</td> <td>1310</td> </tr> <tr> <td>1170</td> <td>1205</td> <td>1230</td> <td>1265</td> <td>1305</td> <td>1350</td> <td>1400</td> <td>1215</td> <td>1270</td> <td>1310</td> </tr> <tr> <td>1195</td> <td>1230</td> <td>1255</td> <td>1290</td> <td>1330</td> <td>1375</td> <td>1425</td> <td>1240</td> <td>1295</td> <td>1335</td> </tr> </tbody> </table>	A/COM	B	C	D	E	F	G	L3/COL	L4	L5	1070	1105	1130	1165	1205	1250	1300	1115	1170	1210	1170	1205	1230	1265	1305	1350	1400	1215	1270	1310	1170	1205	1230	1265	1305	1350	1400	1215	1270	1310	1195	1230	1255	1290	1330	1375	1425	1240	1295	1335	<ul style="list-style-type: none"> <li>• Pneumatic seat height adjustment</li> <li>• Side adjustable tilt tension control</li> <li>• Back and seat tilt in 2.6:1 ratio</li> <li>• 26° tilt of back, 10° seat tilt</li> <li>• 11 locking positions</li> <li>• 2 position forward seat angle adj.</li> <li>• Standard seat slider adds 2" adj.</li> <li>• Standard with heavy duty casters</li> <li>• Warranted to 300 lbs.</li> </ul>	<p><b>WIDTH:</b> 26.5 <b>DEPTH:</b> 25.0 <b>HEIGHT:</b> 41.0-45.5 <b>SEAT WIDTH:</b> 19.5 <b>SEAT DEPTH:</b> 17.0-18.5 <b>SEAT HEIGHT:</b> 17.0-21.5 <b>BACK WIDTH:</b> 19.5 <b>BACK HEIGHT:</b> 23.5 <b>COM:</b> 1.1 YDS <b>COL:</b> 7.5 SQ FT <b>WEIGHT:</b> 54.0 LB</p>	<p><b>A28</b> \$100 Height Adjustable Arm with 19" Interior Width</p> <p><b>A29</b> \$100 Height Adjustable Arm with 17.5" Interior Width</p> <p><b>A30</b> \$125 Height/Width Adjustable Arm w/ Sliding Pad</p>	<p><b>C8S</b> STD 75mm Hoodless Casters</p>
A/COM	B	C	D	E	F	G	L3/COL	L4	L5																																																	
1070	1105	1130	1165	1205	1250	1300	1115	1170	1210																																																	
1170	1205	1230	1265	1305	1350	1400	1215	1270	1310																																																	
1170	1205	1230	1265	1305	1350	1400	1215	1270	1310																																																	
1195	1230	1255	1290	1330	1375	1425	1240	1295	1335																																																	
3085	X1	<b>HIGH-BACK DYNAMIC SYNCHRO</b> Use for a variety of general office task seating, including private office and conference room seating	ARMLESS A28 A29 A30	<table border="1"> <thead> <tr> <th>A/COM</th> <th>B</th> <th>C</th> <th>D</th> <th>E</th> <th>F</th> <th>G</th> <th>L3/COL</th> <th>L4</th> <th>L5</th> </tr> </thead> <tbody> <tr> <td>1195</td> <td>1230</td> <td>1255</td> <td>1290</td> <td>1330</td> <td>1375</td> <td>1425</td> <td>1240</td> <td>1295</td> <td>1335</td> </tr> <tr> <td>1295</td> <td>1330</td> <td>1355</td> <td>1390</td> <td>1430</td> <td>1475</td> <td>1525</td> <td>1340</td> <td>1395</td> <td>1435</td> </tr> <tr> <td>1295</td> <td>1330</td> <td>1355</td> <td>1390</td> <td>1430</td> <td>1475</td> <td>1525</td> <td>1340</td> <td>1395</td> <td>1435</td> </tr> <tr> <td>1320</td> <td>1355</td> <td>1380</td> <td>1415</td> <td>1455</td> <td>1500</td> <td>1550</td> <td>1365</td> <td>1420</td> <td>1460</td> </tr> </tbody> </table>	A/COM	B	C	D	E	F	G	L3/COL	L4	L5	1195	1230	1255	1290	1330	1375	1425	1240	1295	1335	1295	1330	1355	1390	1430	1475	1525	1340	1395	1435	1295	1330	1355	1390	1430	1475	1525	1340	1395	1435	1320	1355	1380	1415	1455	1500	1550	1365	1420	1460	<ul style="list-style-type: none"> <li>• Pneumatic seat height adjustment</li> <li>• Side adjustable tilt tension control</li> <li>• Back and seat tilt in 2.6:1 ratio</li> <li>• 26° tilt of back, 10° seat tilt</li> <li>• 11 locking positions</li> <li>• 2 position forward seat angle adj.</li> <li>• Standard seat slider adds 2" adj.</li> <li>• Standard with heavy duty casters</li> <li>• 3-way adjustable headrest</li> <li>• Warranted to 300 lbs.</li> </ul>	<p><b>WIDTH:</b> 26.5 <b>DEPTH:</b> 25.0 <b>HEIGHT:</b> 50.0-54.5 <b>SEAT WIDTH:</b> 19.5 <b>SEAT DEPTH:</b> 17.0-18.5 <b>SEAT HEIGHT:</b> 17.0-21.5 <b>BACK WIDTH:</b> 19.5 <b>BACK HEIGHT:</b> 23.5 <b>COM:</b> 1.1 YDS <b>COL:</b> 7.5 SQ FT <b>WEIGHT:</b> 56.0 LB</p>		
A/COM	B	C	D	E	F	G	L3/COL	L4	L5																																																	
1195	1230	1255	1290	1330	1375	1425	1240	1295	1335																																																	
1295	1330	1355	1390	1430	1475	1525	1340	1395	1435																																																	
1295	1330	1355	1390	1430	1475	1525	1340	1395	1435																																																	
1320	1355	1380	1415	1455	1500	1550	1365	1420	1460																																																	
3066	X1	<b>10" STOOL DYNAMIC SYNCHRO</b> Use for work surfaces up to 42 inches high	ARMLESS A28 A29 A30	<table border="1"> <thead> <tr> <th>A/COM</th> <th>B</th> <th>C</th> <th>D</th> <th>E</th> <th>F</th> <th>G</th> <th>L3/COL</th> <th>L4</th> <th>L5</th> </tr> </thead> <tbody> <tr> <td>1195</td> <td>1230</td> <td>1255</td> <td>1290</td> <td>1330</td> <td>1375</td> <td>1425</td> <td>1240</td> <td>1295</td> <td>1335</td> </tr> <tr> <td>1295</td> <td>1330</td> <td>1355</td> <td>1390</td> <td>1430</td> <td>1475</td> <td>1525</td> <td>1340</td> <td>1395</td> <td>1435</td> </tr> <tr> <td>1295</td> <td>1330</td> <td>1355</td> <td>1390</td> <td>1430</td> <td>1475</td> <td>1525</td> <td>1340</td> <td>1395</td> <td>1435</td> </tr> <tr> <td>1320</td> <td>1355</td> <td>1380</td> <td>1415</td> <td>1455</td> <td>1500</td> <td>1550</td> <td>1365</td> <td>1420</td> <td>1460</td> </tr> </tbody> </table>	A/COM	B	C	D	E	F	G	L3/COL	L4	L5	1195	1230	1255	1290	1330	1375	1425	1240	1295	1335	1295	1330	1355	1390	1430	1475	1525	1340	1395	1435	1295	1330	1355	1390	1430	1475	1525	1340	1395	1435	1320	1355	1380	1415	1455	1500	1550	1365	1420	1460	<ul style="list-style-type: none"> <li>• Pneumatic seat height adjustment</li> <li>• Side adjustable tilt tension control</li> <li>• Back and seat tilt in 2.6:1 ratio</li> <li>• 26° tilt of back, 10° seat tilt</li> <li>• 11 locking positions</li> <li>• 2 position forward seat angle adj.</li> <li>• Standard seat slider adds 2" adj.</li> <li>• Standard with heavy duty casters</li> <li>• Height adj. 20" diameter footing</li> <li>• Warranted to 300 lbs.</li> </ul>	<p><b>WIDTH:</b> 26.5 <b>DEPTH:</b> 25.0 <b>HEIGHT:</b> 50.5-60.5 <b>SEAT WIDTH:</b> 19.5 <b>SEAT DEPTH:</b> 17.0-18.5 <b>SEAT HEIGHT:</b> 26.0-36.0 <b>BACK WIDTH:</b> 19.5 <b>BACK HEIGHT:</b> 23.5 <b>COM:</b> 1.1 YDS <b>COL:</b> 7.5 SQ FT <b>WEIGHT:</b> 60.0 LB</p>		
A/COM	B	C	D	E	F	G	L3/COL	L4	L5																																																	
1195	1230	1255	1290	1330	1375	1425	1240	1295	1335																																																	
1295	1330	1355	1390	1430	1475	1525	1340	1395	1435																																																	
1295	1330	1355	1390	1430	1475	1525	1340	1395	1435																																																	
1320	1355	1380	1415	1455	1500	1550	1365	1420	1460																																																	
3068	X1	<b>8" STOOL DYNAMIC SYNCHRO</b> Use for work surfaces up to 36 inches high	ARMLESS A28 A29 A30	<table border="1"> <thead> <tr> <th>A/COM</th> <th>B</th> <th>C</th> <th>D</th> <th>E</th> <th>F</th> <th>G</th> <th>L3/COL</th> <th>L4</th> <th>L5</th> </tr> </thead> <tbody> <tr> <td>1195</td> <td>1230</td> <td>1255</td> <td>1290</td> <td>1330</td> <td>1375</td> <td>1425</td> <td>1240</td> <td>1295</td> <td>1335</td> </tr> <tr> <td>1295</td> <td>1330</td> <td>1355</td> <td>1390</td> <td>1430</td> <td>1475</td> <td>1525</td> <td>1340</td> <td>1395</td> <td>1435</td> </tr> <tr> <td>1295</td> <td>1330</td> <td>1355</td> <td>1390</td> <td>1430</td> <td>1475</td> <td>1525</td> <td>1340</td> <td>1395</td> <td>1435</td> </tr> <tr> <td>1320</td> <td>1355</td> <td>1380</td> <td>1415</td> <td>1455</td> <td>1500</td> <td>1550</td> <td>1365</td> <td>1420</td> <td>1460</td> </tr> </tbody> </table>	A/COM	B	C	D	E	F	G	L3/COL	L4	L5	1195	1230	1255	1290	1330	1375	1425	1240	1295	1335	1295	1330	1355	1390	1430	1475	1525	1340	1395	1435	1295	1330	1355	1390	1430	1475	1525	1340	1395	1435	1320	1355	1380	1415	1455	1500	1550	1365	1420	1460	<ul style="list-style-type: none"> <li>• Pneumatic seat height adjustment</li> <li>• Side adjustable tilt tension control</li> <li>• Back and seat tilt in 2.6:1 ratio</li> <li>• 26° tilt of back, 10° seat tilt</li> <li>• 11 locking positions</li> <li>• 2 position forward seat angle adj.</li> <li>• Standard seat slider adds 2" adj.</li> <li>• Standard with heavy duty casters</li> <li>• Height adj. 20" diameter footing</li> <li>• Warranted to 300 lbs.</li> </ul>	<p><b>WIDTH:</b> 26.5 <b>DEPTH:</b> 25.0 <b>HEIGHT:</b> 46.5-54.5 <b>SEAT WIDTH:</b> 19.5 <b>SEAT DEPTH:</b> 17.0-18.5 <b>SEAT HEIGHT:</b> 22.0-30.0 <b>BACK WIDTH:</b> 19.5 <b>BACK HEIGHT:</b> 23.5 <b>COM:</b> 1.1 YDS <b>COL:</b> 7.5 SQ FT <b>WEIGHT:</b> 59.0 LB</p>		
A/COM	B	C	D	E	F	G	L3/COL	L4	L5																																																	
1195	1230	1255	1290	1330	1375	1425	1240	1295	1335																																																	
1295	1330	1355	1390	1430	1475	1525	1340	1395	1435																																																	
1295	1330	1355	1390	1430	1475	1525	1340	1395	1435																																																	
1320	1355	1380	1415	1455	1500	1550	1365	1420	1460																																																	

# zoom

rapid setup for a crew or a crowd

## MESH BACK

GSA SIN # 711-18

- Multi-purpose seating including nesting, task and task stool models
- Perfect for collaborative, meeting, training and break rooms spaces
- Torsion spring flex back movement with back lock feature
- Choice of two mesh, frame and plastic colors
- Plastic or upholstered seat
- CAL TB 133 Fire Code approved
- Warranted to 300 lbs.



### CREATING ZOOM MODEL NUMBER

MODEL NUMBER CONTROL FRAME COLOR PLASTIC COLOR MESH COLOR UPHOLSTERY GRADE CASTERS PACKAGING

1 1 1 5 - G T - F - P - - - - C - - -

\* FOR ARMLESS CODE USE A00 \* ONLY SELECT CASTER CODE FOR MODEL 1215,1265

### PACKAGING NOTES

CODE	DESCRIPTION	LIST UPCHARGE
AB	ASSEMBLED IN BAG	\$0
AC	ASSEMBLED IN CARTON	\$0

ZOOM NESTING CHAIRS SHIP UP TO 2 PER CARTON

MODEL	CONTROL	DESCRIPTION	FRAME COLOR	PLASTIC	FEATURES	DIMENSIONS
1115	GT	<b>GUEST NESTING</b> Mesh back with plastic seat	SF WF	P 395 395	<ul style="list-style-type: none"> <li>• Flex back movement with back lock feature</li> <li>• Upright lock position with subtle flex back movement</li> <li>• Warranted to 300 lbs.</li> </ul>	<b>WIDTH:</b> 24 <b>DEPTH:</b> 21 <b>HEIGHT:</b> 35 <b>SEAT WIDTH:</b> 17.5 <b>SEAT DEPTH:</b> 15.5 <b>SEAT HEIGHT:</b> 17 <b>BACK WIDTH:</b> 18 <b>BACK HEIGHT:</b> 19 <b>COM:</b> 1 YD <b>WEIGHT:</b> 24 LB

### CASTER OPTIONS

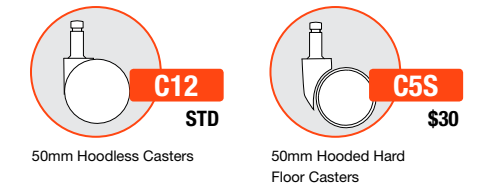

### NESTING FOOTPRINT

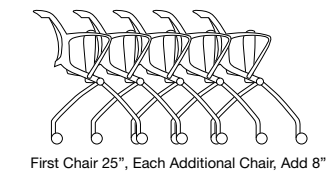

MODEL	CONTROL	DESCRIPTION	FRAME COLOR	PLASTIC	FEATURES	DIMENSIONS
1115	GT	<b>GUEST NESTING</b> Mesh back with upholstered seat	SF WF	A/COM B C D E F G 460 495 515 550 585 625 670 460 495 515 550 585 625 670	<ul style="list-style-type: none"> <li>• Flex back movement with back lock feature</li> <li>• Upright lock position with subtle flex back movement</li> <li>• Molded foam seat</li> <li>• Warranted to 300 lbs.</li> </ul>	<b>WIDTH:</b> 24 <b>DEPTH:</b> 21 <b>HEIGHT:</b> 35 <b>SEAT WIDTH:</b> 17.5 <b>SEAT DEPTH:</b> 15.5 <b>SEAT HEIGHT:</b> 18 <b>BACK WIDTH:</b> 18 <b>BACK HEIGHT:</b> 19 <b>COM:</b> 14 YD <b>WEIGHT:</b> 25 LB

### FRAME COLORS

SILVER SF	WHITE WF
--------------	-------------

(FRAME)

### PLASTIC AND MESH COLORS

GRAPHITE GRAY PGG	MESH SLATE M32
-------------------------	----------------------

(BACK/SEAT SHELL AND ARMS)

WHITE PWH	MESH SNOW M33
--------------	---------------------

(BACK/SEAT SHELL AND ARMS)

CAUTION: Careless stacking of chairs may scratch and damage frames.

# zoom

rapid setup for a crew or a crowd

## ALL PLASTIC - AP

GSA SIN # 711-18

- Multi-purpose seating including nesting, task and task stool models
- Perfect for collaborative, meeting, training and break rooms spaces
- Torsion spring flex back movement with back lock feature
- Choice of two mesh, frame and plastic colors
- Plastic or upholstered seat
- CAL TB 133 Fire Code approved
- Warranted to 300 lbs.



### CREATING ZOOM MODEL NUMBER

MODEL NUMBER CONTROL FRAME COLOR PLASTIC COLOR MESH COLOR BASE CASTERS PACKAGING

1 1 2 - - - F - P - - - B A - C - - -

\* FOR ARMLESS CODE USE A00 \* ONLY SELECT CASTER CODE FOR MODEL 1215,1265

### PACKAGING NOTES

CODE	DESCRIPTION	LIST UPCHARGE
AB	ASSEMBLED IN BAG	\$0
AC	ASSEMBLED IN CARTON	\$0

MODEL	CONTROL	DESCRIPTION	FRAME COLOR	PLASTIC		FEATURES	DIMENSIONS	CASTER OPTIONS	BASE OPTIONS
1125	B2	<b>TASK SEATING BASIC TASK</b> Mesh back with plastic seat	SF WF	A/COM 495 495	B C D E F G	<ul style="list-style-type: none"> <li>• Pneumatic seat height adjustment</li> <li>• No seat and back tilt</li> <li>• Warranted to 300 lbs.</li> </ul>	<b>WIDTH:</b> 26.5 <b>DEPTH:</b> 26.5 <b>HEIGHT:</b> 35 <b>SEAT WIDTH:</b> 17.5 <b>SEAT DEPTH:</b> 16.5 <b>SEAT HEIGHT:</b> 17-22 <b>BACK WIDTH:</b> 18 <b>BACK HEIGHT:</b> 19 <b>COM:</b> 1.0 YD <b>WEIGHT:</b> 24 LB	<b>C6</b> STD 60mm Hoodless Casters <b>C6S</b> \$35 60mm Hoodless Hard Floor Casters	
1126	B2	<b>10" STOOL BASIC TASK</b> Mesh back with plastic seat	SF WF	A/COM 620 620	B C D E F G	<ul style="list-style-type: none"> <li>• Pneumatic seat height adjustment</li> <li>• No seat and back tilt</li> <li>• Height adj. 20" diameter footring</li> <li>• Warranted to 300 lbs.</li> </ul>	<b>WIDTH:</b> 26.5 <b>DEPTH:</b> 26.5 <b>HEIGHT:</b> 35 <b>SEAT WIDTH:</b> 17.5 <b>SEAT DEPTH:</b> 16.5 <b>SEAT HEIGHT:</b> 26-36 <b>BACK WIDTH:</b> 18 <b>BACK HEIGHT:</b> 19 <b>COM:</b> 1.0 YD <b>WEIGHT:</b> 31 LB	<b>BA9G</b> STD 26" High Profile Nylon Base - Gray <b>BA9W</b> STD 26" High Profile Nylon Base - White <b>BA10B</b> \$100 26" High Profile Aluminum Base - Black Powder Coat <b>BA10P</b> \$100 26" High Profile Aluminum Base - Polished <b>BA10S</b> \$100 26" High Profile Aluminum Base - Silver Powder Coat	
1128	B2	<b>8" STOOL BASIC TASK</b> Mesh back with plastic seat	SF WF	A/COM 620 620	B C D E F G	<ul style="list-style-type: none"> <li>• Pneumatic seat height adjustment</li> <li>• No seat and back tilt</li> <li>• Height adj. 20" diameter footring</li> <li>• Warranted to 300 lbs.</li> </ul>	<b>WIDTH:</b> 26.5 <b>DEPTH:</b> 26.5 <b>HEIGHT:</b> 35 <b>SEAT WIDTH:</b> 17.5 <b>SEAT DEPTH:</b> 16.5 <b>SEAT HEIGHT:</b> 21.5-29.5 <b>BACK WIDTH:</b> 18 <b>BACK HEIGHT:</b> 19 <b>COM:</b> 1.0 YD <b>WEIGHT:</b> 30 LB		

### FRAME COLORS

SILVER SF	WHITE WF
--------------	-------------

(FRAME)

### PLASTIC AND MESH COLORS

GRAPHITE GRAY PGG	MESH SLATE M32
-------------------------	----------------------

(BACK/SEAT SHELL AND ARMS)

WHITE PWH	MESH SNOW M33
--------------	---------------------

(BACK/SEAT SHELL AND ARMS)

# zoom

rapid setup for a crew or a crowd

## UPHOLSTERED SEAT - US

GSA SIN # 711-18

- Multi-purpose seating including nesting, task and task stool models
- Perfect for collaborative, meeting, training and break rooms spaces
- Torsion spring flex back movement with back lock feature
- Choice of two mesh, frame and plastic colors
- Plastic or upholstered seat
- CAL TB 133 Fire Code approved
- Warranted to 300 lbs.



### CREATING ZOOM MODEL NUMBER

MODEL NUMBER CONTROL FRAME COLOR PLASTIC COLOR MESH COLOR BASE CASTERS PACKAGING

1 1 2 - - F - P - - B A - - C - - -

### PACKAGING NOTES

CODE	DESCRIPTION	LIST UPCHARGE
AB	ASSEMBLED IN BAG	\$0
AC	ASSEMBLED IN CARTON	\$0

MODEL	CONTROL	DESCRIPTION	FRAME COLOR	PLASTIC	A/COM	B	C	D	E	F	G	FEATURES	DIMENSIONS	CASTER OPTIONS	BASE OPTIONS
1125	B2	<b>TASK SEATING BASIC TASK</b> Mesh back with upholstered seat	SF WF		560 560	595 595	615 615	650 650	685 685	725 725	770 770	<ul style="list-style-type: none"> <li>• Pneumatic seat height adjustment</li> <li>• No seat and back tilt</li> <li>• Molded foam seat</li> <li>• Warranted to 300 lbs.</li> </ul>	<b>WIDTH:</b> 26.5 <b>DEPTH:</b> 26.5 <b>HEIGHT:</b> 35 <b>SEAT WIDTH:</b> 17.5 <b>SEAT DEPTH:</b> 16.5 <b>SEAT HEIGHT:</b> 18-23 <b>BACK WIDTH:</b> 18 <b>BACK HEIGHT:</b> 19 <b>COM:</b> 1.0 YD <b>WEIGHT:</b> 25 LB	<b>C6</b> STD 60mm Hoodless Casters <b>C6S</b> \$35 60mm Hoodless Hard Floor Casters	
1126	B2	<b>10" STOOL BASIC TASK</b> Mesh back with upholstered seat	SF WF		685 685	720 720	740 740	775 775	810 810	850 850	895 895	<ul style="list-style-type: none"> <li>• Pneumatic seat height adjustment</li> <li>• No seat and back tilt</li> <li>• Height adj. 20" diameter footring</li> <li>• Molded foam seat</li> <li>• Warranted to 300 lbs.</li> </ul>	<b>WIDTH:</b> 26.5 <b>DEPTH:</b> 26.5 <b>HEIGHT:</b> 35 <b>SEAT WIDTH:</b> 17.5 <b>SEAT DEPTH:</b> 16.5 <b>SEAT HEIGHT:</b> 27-37 <b>BACK WIDTH:</b> 18 <b>BACK HEIGHT:</b> 19 <b>COM:</b> 1.0 YD <b>WEIGHT:</b> 32 LB	<b>BA9G</b> STD 26" High Profile Nylon Base - Gray <b>BA9W</b> STD 26" High Profile Nylon Base - White <b>BA10B</b> \$100 26" High Profile Aluminum Base - Black Powder Coat <b>BA10P</b> \$100 26" High Profile Aluminum Base - Polished <b>BA10S</b> \$100 26" High Profile Aluminum Base - Silver Powder Coat	
1128	B2	<b>8" STOOL BASIC TASK</b> Mesh back with upholstered seat	SF WF		685 685	720 720	740 740	775 775	810 810	850 850	895 895	<ul style="list-style-type: none"> <li>• Pneumatic seat height adjustment</li> <li>• No seat and back tilt</li> <li>• Height adj. 20" diameter footring</li> <li>• Molded foam seat</li> <li>• Warranted to 300 lbs.</li> </ul>	<b>WIDTH:</b> 26.5 <b>DEPTH:</b> 26.5 <b>HEIGHT:</b> 35 <b>SEAT WIDTH:</b> 17.5 <b>SEAT DEPTH:</b> 16.5 <b>SEAT HEIGHT:</b> 22.5-30.5 <b>BACK WIDTH:</b> 18 <b>BACK HEIGHT:</b> 19 <b>COM:</b> 1.0 YD <b>WEIGHT:</b> 31 LB		

### FRAME COLORS

SILVER SF	WHITE WF
--------------	-------------

(FRAME)

### PLASTIC AND MESH COLORS

GRAPHITE GRAY PGG	MESH SLATE M32
-------------------------	----------------------

(BACK/SEAT SHELL AND ARMS)

WHITE PWH	MESH SNOW M33
--------------	---------------------

(BACK/SEAT SHELL AND ARMS)

SIT IN STYLE. WORK IN COMFORT. GET THE VALUE.

PACKAGING NOTES

CODE	DESCRIPTION	LIST UPCHARGE
	SHIPS IN BOX ONLY	
	SOME ITEMS SHIP PARTIALLY ASSEMBLED	
	**SPLIT CARTON FEE APPLIES	\$25 NET

MODEL	FEATURES	DIMENSIONS	ARM	TEXTILES	MODEL	FEATURES	DIMENSIONS	ARM	TEXTILES
103S \$245	<ul style="list-style-type: none"> <li>Guest chair</li> <li>Black mesh back</li> <li>Black upholstered seat</li> <li>Silver frame</li> <li>Stacks 5 high</li> <li>Warranted to 300 lbs.</li> <li>Ships four per carton</li> </ul>	<b>WIDTH:</b> 18.0 <b>DEPTH:</b> 23.5 <b>HEIGHT:</b> 32.0 <b>SEAT WIDTH:</b> 17.5 <b>SEAT DEPTH:</b> 17.5 <b>SEAT HEIGHT:</b> 18.0 <b>BACK WIDTH:</b> 18.0 <b>BACK HEIGHT:</b> 16.0 <b>WEIGHT:</b> 14.0 LB	A00	<b>BACK</b> BLACK MESH M00 <b>SEAT</b> BLACK 101	203 \$395	<ul style="list-style-type: none"> <li>Y1-Simple synchro</li> <li>2-way height adjustable arms</li> <li>Black mesh back</li> <li>Air grid mesh seat</li> <li>3" thick high resilient</li> <li>Molded foam seat</li> <li>Warranted to 300 lbs.</li> <li>Assembly required</li> </ul>	<b>WIDTH:</b> 25.0 <b>DEPTH:</b> 26.0 <b>HEIGHT:</b> 39.0-43.5 <b>SEAT WIDTH:</b> 20.0 <b>SEAT DEPTH:</b> 17.5 <b>SEAT HEIGHT:</b> 17.0-21.5 <b>BACK WIDTH:</b> 18.0 <b>BACK HEIGHT:</b> 22.0 <b>WEIGHT:</b> 31.0 LB	A203	<b>BACK</b> BLACK MESH M00 <b>SEAT</b> BLACK AIR GRID MESH
103B \$245	<ul style="list-style-type: none"> <li>Guest chair</li> <li>Black mesh back</li> <li>Black upholstered seat</li> <li>Black frame</li> <li>Stacks 5 high</li> <li>Warranted to 300 lbs.</li> <li>Ships four per carton</li> </ul>	<b>WIDTH:</b> 18.0 <b>DEPTH:</b> 23.5 <b>HEIGHT:</b> 32.0 <b>SEAT WIDTH:</b> 17.5 <b>SEAT DEPTH:</b> 17.5 <b>SEAT HEIGHT:</b> 18.0 <b>BACK WIDTH:</b> 18.0 <b>BACK HEIGHT:</b> 16.0 <b>WEIGHT:</b> 14.0 LB	A00	<b>BACK</b> BLACK MESH M00 <b>SEAT</b> BLACK 101	216 \$545	<ul style="list-style-type: none"> <li>Y1-Simple synchro</li> <li>Ratchet back w/ adjustable lumbar</li> <li>8-way adjustable arms</li> <li>Graphite mesh back</li> <li>Air grid mesh seat</li> <li>3" thick high resilient foam seat</li> <li>Warranted to 300 lbs.</li> <li>Assembly required</li> </ul>	<b>WIDTH:</b> 26.5 <b>DEPTH:</b> 26.5 <b>HEIGHT:</b> 39.0-46.0 <b>SEAT WIDTH:</b> 21.0 <b>SEAT DEPTH:</b> 20.0 <b>SEAT HEIGHT:</b> 18.0-22.5 <b>BACK WIDTH:</b> 20.5 <b>BACK HEIGHT:</b> 21.0-24.0 <b>WEIGHT:</b> 44.0 LB	A36	<b>BACK</b> GRAPHITE MESH M31 <b>SEAT</b> BLACK AIR GRID MESH
176 \$495	<ul style="list-style-type: none"> <li>M1-Multi-function</li> <li>4-way adjustable arms</li> <li>Ratchet back</li> <li>3" thick high resilient foam seat</li> <li>Black fabric</li> <li>Warranted to 300 lbs.</li> <li>Partially assembled</li> </ul>	<b>WIDTH:</b> 26.5 <b>DEPTH:</b> 26.0 <b>HEIGHT:</b> 39.0-46.5 <b>SEAT WIDTH:</b> 22.0 <b>SEAT DEPTH:</b> 18.5 <b>SEAT HEIGHT:</b> 17.0-21.5 <b>BACK WIDTH:</b> 20.0 <b>BACK HEIGHT:</b> 20.5-23.5 <b>WEIGHT:</b> 49.0 LB	A5	<b>BACK</b> BLACK 101 <b>SEAT</b> BLACK 101	217 \$645	<ul style="list-style-type: none"> <li>Y3-Full synchro</li> <li>Graphite mesh seat and back</li> <li>Ratchet back w/ adjustable lumbar</li> <li>8-way adjustable arms</li> <li>Polished aluminum base</li> <li>Warranted to 300 lbs.</li> <li>Assembly required</li> </ul>	<b>WIDTH:</b> 26.5 <b>DEPTH:</b> 26.5 <b>HEIGHT:</b> 39.0-46.0 <b>SEAT WIDTH:</b> 19.5 <b>SEAT DEPTH:</b> 18.0 <b>SEAT HEIGHT:</b> 17.5-22.0 <b>BACK WIDTH:</b> 20.5 <b>BACK HEIGHT:</b> 22.5-25.5 <b>WEIGHT:</b> 46.0 LB	A36	<b>BACK</b> GRAPHITE MESH M31 <b>SEAT</b> GRAPHITE MESH M31



# arm guide

## TASKING ARM OPTIONS

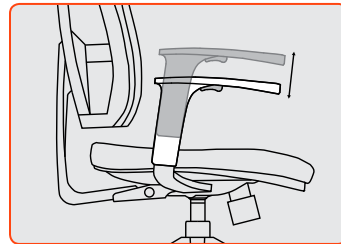

**A2**

**\$80**

### 2-WAY HEIGHT ADJUSTABLE ARM

The A2 arm features height adjustment via a simple trigger mechanism under the arm pad.

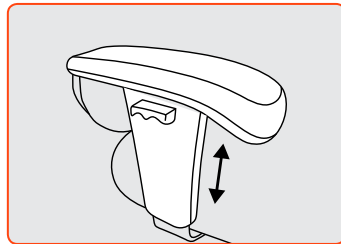

**A4**

**\$75**

### ADJUSTABLE ARM

The A4 arm offers a soft touch polyurethane pad with 3" height adjustment. The arm pad features diamond padded anti-skid surface.

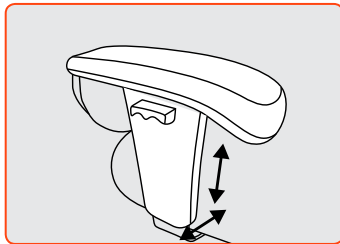

**A5**

**\$95**

### MULTI-ADJUSTABLE ARM

The A5 arm is identical to the A4 arm but offers the added feature of a 4" arm width adjustment [activated via a knob under seat.

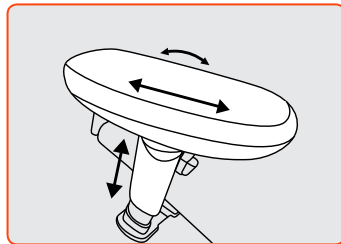

**A6**

**\$130**

### ADJUSTABLE PIVOT/SWIVEL ARM

The A6 arm offers advanced features with Ura-Soft® arm pads. Features locking height adjustment, swivel pad, and adjustable arm pad position (slides forward and back).

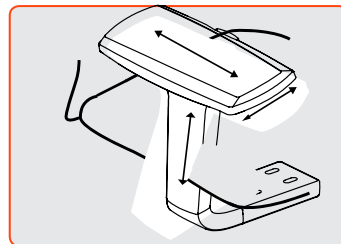

**A23**

**\$75**

### MULTI-ADJUSTABLE ARM

Height adjustable with 4 way sliding arm pad (front to back and side to side)

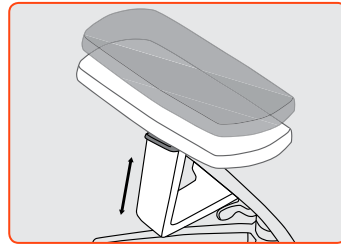

**A28/  
A29**

**\$100**

### HEIGHT ADJUSTABLE ARM

The A28 / A29 is an aluminum height adjustable arm with a fixed arm cap. NOTE: A28 arms offer an additional 3" of interior width.

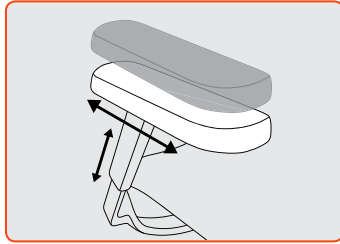

**A30**

**\$125**

### MULTI-ADJUSTABLE ARM

Height adjustable arm with 4-way sliding pad (forward/back and side to side).

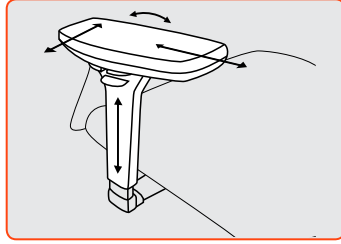

**A36**

**\$105**

### ADJUSTABLE PIVOT/SWIVEL

8-Way Adjustable Arms  
Soft-Touch sliding and pivoting arm pads

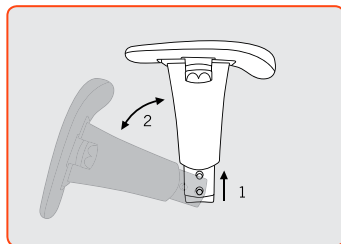

**A90**

**\$200**

### BREAKAWAY ARM

Soft-touch polyurethane pad. 2.5" height adjustable. Use with all task series. Arms rotate back making chair armless. (pair)

## PARTS AND ACCESSORIES DISCOUNT

INDIVIDUAL PARTS & ACCESSORIES WHEN PURCHASED SEPARATE FROM A CHAIR RECEIVE AN EVEN 50% DISCOUNT.

THE 50% ACCESSORY DISCOUNT PROVIDES FOR EXTRA LABOR, PACKAGING MATERIAL AND SHIPPING CHARGES ASSOCIATED WITH SHIPPING A COMPONENT BY ITSELF.

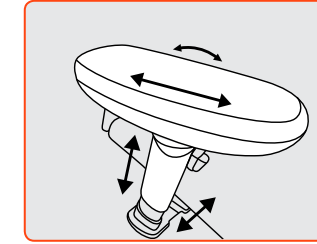

**A7**

**\$150**

### MULTI-ADJUST. PIVOT/SWIVEL ARM

The A7 arm is identical to the A6 arm but offers the added feature of a 4" arm width adjustment activated via a knob under seat.

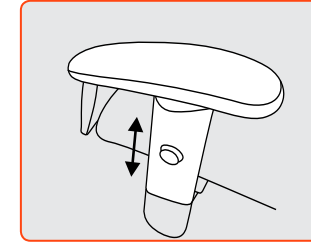

**A8B/S**

**\$85**

### ADJUSTABLE ARM (BLACK/SILVER)

The A8B/S height adjustable arm features push-button height adjustment with a range of 3.5". With matching black/silver powder coated base

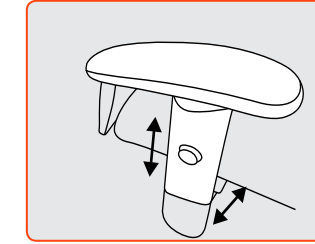

**A9B/S**

**\$105**

### ADJUSTABLE ARM (BLACK/SILVER)

The A9B/S arm is identical to the A8B arm but offers the added feature of 4" arm width adjustment activated via a knob under seat.

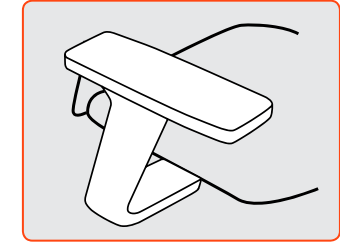

**A22**

**\$50**

### FIXED ARM WITH SOFT PAD

Fixed Arm with Soft Polyurethane Pad

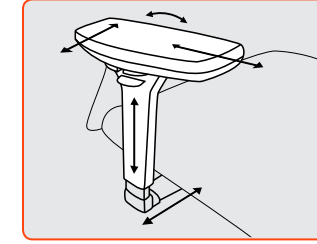

**A37**

**\$125**

### MULTI-ADJUST. PIVOT/SWIVEL

1Height adjustable arm with 4-way sliding pad (forward/back and side to side).

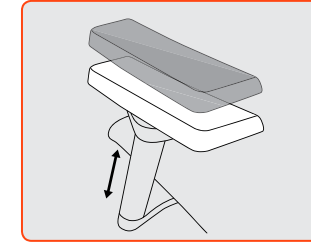

**A40**

**\$110**

### ADJUSTABLE TASKING ARM

2-Way Adjustable Arm, Ratchet Height Adjustment with Fixed Arm Pad

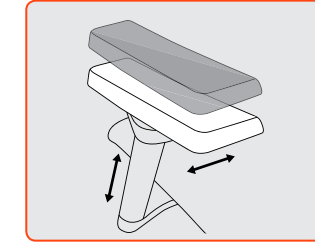

**A41**

**\$130**

### ADJUSTABLE TASKING ARM

6-Way Adjustable Arm Ratchet Height Adjustment with Side and Forward Sliding Arm Pad

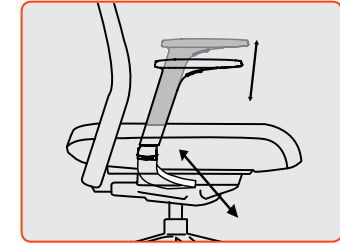

**A45B/G**

**\$65**

### 4-WAY HEIGHT ADJUSTABLE ARM

4-way Height Adjustable Arm-Black/Gray

# arm guide

## FIXED ARM OPTIONS



**A1**

**\$70**

**LOOP ARM**

Soft touch loop arm.

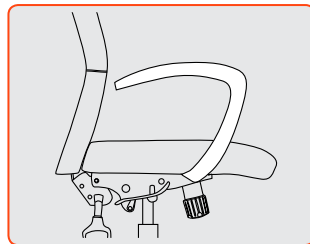

**A10**

**\$85**

**CANTILEVER ARM**

Soft touch cantilever arms provide sleek style and a durable surface. A great look for the office or conference room.

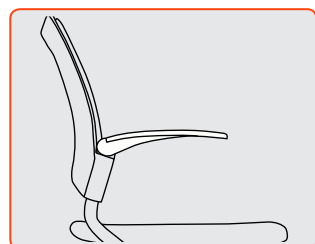

**A12**

**\$45**

**FIXED ARM**

For use on Bella only.



**A14**

**\$80**

**EXTENDED ARM**

Reinforced soft touch extended arm. For use on the Bella only.



**A42**

**\$55**

**NYLON LOOP ARM**

Nylon loop arm Luna only.

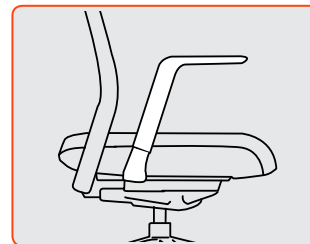

**A43**

**\$55**

**NYLON FIXED ARM**

Nylon fixed arm on Luna only.

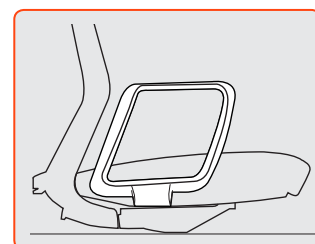

**A46**

**\$45**

**NYLON LOOP ARM**

Nylon Loop Arm-Gray/White on Neo only.

## PARTS AND ACCESSORIES DISCOUNT

INDIVIDUAL PARTS & ACCESSORIES WHEN PURCHASED SEPARATE FROM A CHAIR RECEIVE AN EVEN 50% DISCOUNT.

THE 50% ACCESSORY DISCOUNT PROVIDES FOR EXTRA LABOR, PACKAGING MATERIAL AND SHIPPING CHARGES ASSOCIATED WITH SHIPPING A COMPONENT BY ITSELF.

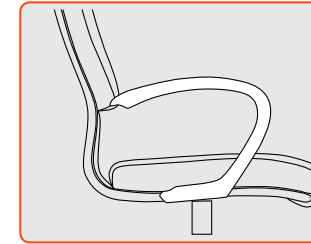

**A16/  
A16P**

**\$100/\$150**

**'C' ARM**

A16 - Soft touch arm / A16P - Soft touch arm with upholstered pad.

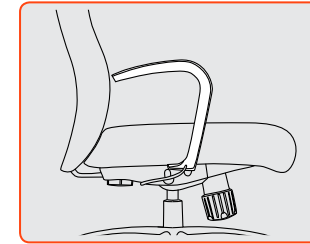

**A19**

**\$200**

**CHROME CANTILEVER ARM**

Fixed C-shaped arm offers a smooth polished aluminum surface with black urethane insert.

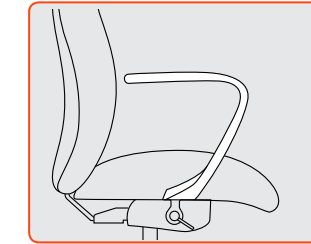

**A27**

**\$180**

**CHROME CANTILEVER ARM**

Fixed C-shaped arm offers a smooth polished aluminum surface with matching upholstered pad.

# caster guide

\*Load Rating in (lbs) per caster/glide

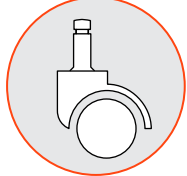
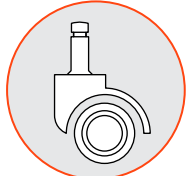
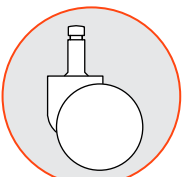
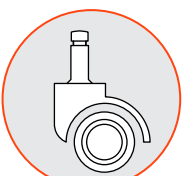
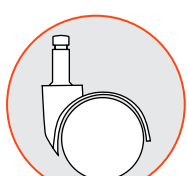
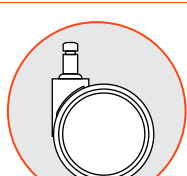
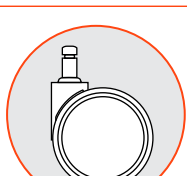
	<b>C1</b> STANDARD CASTERS	\$25 HOODED TWIN WHEEL CASTER WHEEL: 50 MM BARREL: 42 MM LOAD RATING: 110 LBS*	Best for use on carpeted surfaces. Hard nylon wheels are recommended for use on low-to-medium pile carpeting without padding. Dual wheels place more wheel surface on the carpet pile for optimum weight distribution. Wheels move in opposite directions to minimize carpet fiber twisting.
	<b>C1S/C2S</b> HARD FLOOR CASTERS (FIVE STAR BASE)	\$35 HOODED TWIN WHEEL CASTER WHEEL: 50 MM/ BARREL: 42 MM LOAD RATING: 110 LBS*	Designed for use on hardwood floors, tile, chair mats, linoleum and concrete surfaces in an open office/workspace environment. (Lab, healthcare, classroom, and conference room.) Wheels are made from a soft polyurethane material. Set of five used with star bases. C2S -The wheels feature auto-lock; The safety brakes engage when the chair is not in use, this prevents the chair from rolling away when standing up.
	<b>C4</b> HEAVY DUTY CASTER	\$35 HOODED TWIN WHEEL CASTER WHEEL: 60 MM BARREL: 38 MM LOAD RATING: 140 LBS*	Recommended when higher weight capacity is required. Large diameter hard nylon wheels designed for use on low- to medium-pile carpeting with or without padding. Large diameter dual wheels place more wheel surface on the carpet pile for optimum weight distribution. Wheels move in opposite directions to minimize carpet fiber twisting.
	<b>C5</b> STANDARD CASTER (SHUTTLE AND BELLA GUEST CHAIRS)	\$25 HOODED TWIN WHEEL CASTER WHEEL: 50 MM BARREL: 27 MM LOAD RATING: 110 LBS*	Best for use on carpeted surfaces. Hard nylon wheels are recommended for use on low- to medium-pile carpeting without padding. Dual wheels place more wheel surface on the carpet pile for optimum weight distribution. Wheels move in opposite directions to minimize carpet fiber twisting. Set of four used on guest chairs.
	<b>C5S</b> HARD FLOOR CASTER (FOUR LEG GUEST CHAIRS)	\$30 HOODED TWIN WHEEL CASTER WHEEL: 50 MM BARREL: 13 MM LOAD RATING: 110 LBS*	Designed for use on hardwood floors, tile, chair mats, linoleum and concrete surfaces in an open office/workspace environment. (Lab, healthcare, classroom, and conference room.) Wheels are made from a soft polyurethane material. Set of four used on guest chairs.
	<b>C6</b> LARGE DIAMETER CASTER	\$30 TWIN WHEEL CASTER WHEEL: 60 MM BARREL: 25 MM LOAD RATING: 140 LBS*	Recommended for use on carpeted surfaces. Large diameter hard nylon wheels are recommended for use on low to medium pile carpeting with or without padding. 60 mm dual wheels place more wheel surface on the carpet pile for optimum weight distribution and ease of movement. Wheels move in opposite directions to minimize carpet fiber twisting.
	<b>C6S</b> HARD FLOOR LARGE DIAMETER CASTER (FIVE STAR BASE)	\$35 TWIN WHEEL CASTER WHEEL: 60 MM BARREL: 25 MM LOAD RATING: 140 LBS*	Designed for use on hardwood floors, tile, chair mats, linoleum and concrete surfaces in an open office/workspace environment. (Lab, healthcare, classroom, and conference room.) Wheels are made from a soft polyurethane material. Set of five used with star bases.

## PARTS AND ACCESSORIES DISCOUNT

INDIVIDUAL PARTS & ACCESSORIES WHEN PURCHASED SEPARATE FROM A CHAIR RECEIVE AN EVEN 50% DISCOUNT.  
THE 50% ACCESSORY DISCOUNT PROVIDES FOR EXTRA LABOR, PACKAGING MATERIAL AND SHIPPING CHARGES ASSOCIATED WITH SHIPPING A COMPONENT BY ITSELF.

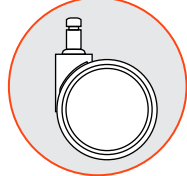
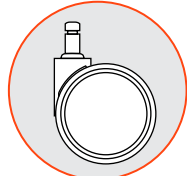
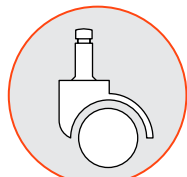
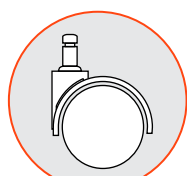
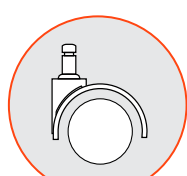
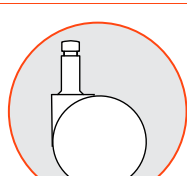
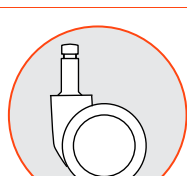
	<b>C7</b> 60MM CHROME ACCENTED HOODLESS CASTERS	\$35 TWIN WHEEL CASTER WHEEL: 60 MM BARREL: 25 MM LOAD RATING: 140 LBS*	Recommended for use on carpeted surfaces. Large diameter hard nylon wheels are recommended for use on low to medium pile carpeting with or without padding. 65mm dual wheels place more wheel surface on the carpet pile for optimum weight distribution and ease of movement. Wheels move in opposite directions to minimize carpet fiber twisting. Standard with A19 base.
	<b>C8S</b> HARD FLOOR LARGE DIAMETER CASTER	\$35 TWIN WHEEL CASTER WHEEL: 75 MM BARREL: 22 MM LOAD RATING: 160 LBS*	Recommended for use on carpeted or hard surfaces. Large diameter soft nylon wheels are recommended for use on low to medium pile carpeting with or without padding. 75mm dual wheels place more wheel surface on floors for optimum weight distribution and ease of movement. Wheels move in opposite directions to minimize carpet fiber twisting.
	<b>C9S</b> COMPRESSION LOCKING HARD FLOOR CASTER	\$50 HOODED TWIN WHEEL CASTER WHEEL: 50 MM BARREL: 42 MM LOAD RATING: 110 LBS*	Designed for use on hardwood floors, tile, chair mats, linoleum and concrete surfaces in an open office/workspace environment. (Lab, healthcare, classroom, and conference room.) The wheels feature compression-lock; The brakes engage when the user is seated in the chair. When seated this prevents the user from rolling away from the work surface.
	<b>C10S</b> SELF-LOCKING HARD FLOOR CASTER	\$50 TWIN WHEEL CASTER WHEEL: 50 MM BARREL: 18 MM LOAD RATING: 110 LBS*	Designed for use on hardwood floors, tile, chair mats, linoleum and concrete surfaces in an open office/workspace environment. (Lab, healthcare, classroom, and conference room.) The wheels feature auto-lock; The safety brakes engage when the chair is not in use, this prevents the chair from rolling away when standing up.
	<b>C11S</b> COMPRESSION LOCKING HARD FLOOR CASTER	\$50 TWIN WHEEL CASTER WHEEL: 50 MM BARREL: 18 MM LOAD RATING: 110 LBS*	Designed for use on hardwood floors, tile, chair mats, linoleum and concrete surfaces in an open office/workspace environment. (Lab, healthcare, classroom, and conference room.) The wheels feature compression-lock; The brakes engage when the user is seated in the chair. When seated this prevents the user from rolling away from the work surface.
	<b>C12</b> STANDARD CASTER (LINK)	\$25 TWIN WHEEL CASTER WHEEL: 50 MM BARREL: RECTANGULAR LOAD RATING: 110 LBS*	Best for use on carpeted surfaces. Hard nylon wheels are recommended for use on low-to-medium pile carpeting without padding. Dual wheels place more wheel surface on the carpet pile for optimum weight distribution. Wheels move in opposite directions to minimize carpet fiber twisting. C12 wheels match the rectangular tubing of the Link chair.
	<b>C22B/G</b> STANDARD 60MM HUBLESS CASTER (CORE)	\$35 TWIN WHEEL CASTER WHEEL: 60 MM BARREL: 25MM LOAD RATING: 110 LBS*	Recommend for use on Carpet or Hard floors. Wheels made of Polyurethane. Available in Black or Gray accents. Stylish hubless design.

# glide guide

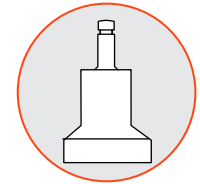

**G1**  
STATIONARY BASE GLIDE

\$30

HIGH BASE GLIDE  
FOR 5 STAR BASE  
LOAD RATING: 110 LBS\*

Glide provide the best stationary support. Use only when a stationary position is desired. The glide height is the same as the caster height. Do not use on hard floor if marring is a concern.

\*Load Rating in (lbs) per caster/glide

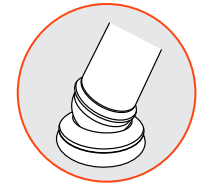

**G8**  
SELF-LEVELING  
METAL GLIDE

\$20

METAL BASE GLIDE  
FOR 4 LEG GUEST CHAIRS  
LOAD RATING: 150 LBS\*

Metal self-leveling base glide are used as an alternate to standard nylon glides. The metal glide offers a 100% increase in weight capacity. The self-leveling articulation allows the glide to flatten against uneven floors for better weight distribution. For use on all surfaces.

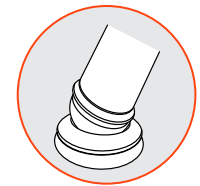

**G9**  
SELF-LEVELING  
VCT GLIDE

\$30

VCT BASE GLIDE  
FOR 4 LEG GUEST CHAIRS  
LOAD RATING: 150 LBS\*

Metal self-leveling base glide with white VCT cap are used as an alternate to standard nylon glides. The VCT glide also offers a 100% increase in weight capacity. The self-leveling articulation allows the glide to flatten against VCT floors for better weight distribution and the white nylon cap protects VCT floors against marring and visible streaking.

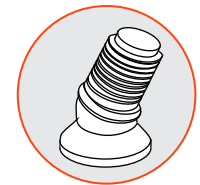

**G10**  
SELF-LEVELING  
PLASTIC GLIDE  
WITH FELT BASE

\$30

FELT BASE ROUND  
PLASTIC GLIDE  
FOR 4 LEG GUEST CHAIRS  
IDEAL FOR WOOD OR  
SOFT COMPOSITE FLOORS  
LOAD RATING: 110 LBS\*

Plastic self-leveling base glide with felt base. Felt base offers additional protection against marring especially on wood or soft composite surfaces

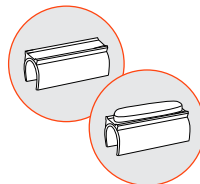

**G12/G13**  
SLED BASE  
CLEAR PLASTIC GLIDE  
(G13 W/ FELT BASE)

\$15/\$25

CLEAR PLASTIC  
RECTANGULAR GLIDE  
(G13 W/ FELT BASE)  
FOR INDY  
SLED BASE  
LOAD RATING: 90 LBS\*

**G12**  
Clear plastic rectangular glide for the Indy sled base. Ideal for use on light-colored floors where streaking may be a concern  
**G13**  
Clear plastic rectangular glide with felt base to provide additional protection on wood or soft composite floors where marring or streaking is a concern

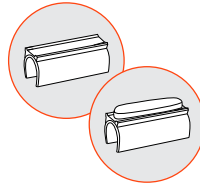

**G16/G17**  
SLED BASE  
CLEAR PLASTIC GLIDE  
(G17 W/ FELT BASE)

\$15/\$25

CLEAR PLASTIC  
RECTANGULAR GLIDE  
(G13 W/ FELT BASE)  
FOR MIMI AND KELLEY  
SLED BASE  
LOAD RATING: 90 LBS\*

**G16**  
Clear plastic rectangular glide for the Mimi and Kelley sled base. Ideal for use on light-colored floors where streaking may be a concern  
**G17**  
Clear plastic rectangular glide with felt base to provide additional protection on wood or soft composite floors where marring or streaking is a concern

# cylinder guide

MODEL	SS	CONTROLS	CYLINDER	STROKE	BASE	CASTER
1125		B2	CYL240	5"	BA9	C12
1126		B2	CYL360	10"	BA9	C12
1128		B2	CYL300	8"	BA9	C12
1325/1375		B2, S3	CYL240	5"	BA9	C6
1326/1376		B2	CYL360	10"	BA9	C6
1328/1378		B2	CYL300	8"	BA9	C6
1336		B2	CYL360	10"	BA9	C6
1338		B2	CYL300	8"	BA9	C6
1425		B2	CYL240	5"	BA1	C1
1425	SS	S2, P1, R1, M1	CYL190	5"	BA1	C1
1425	SS	Y2	CYL160	3"	BA1	C1
1426		B2, P1	CYL360	10"	BA1	C1
1428		B2, P1	CYL300	8"	BA1	C1
1460		Y1, Y3	CYL190	5"	BA9	C6
1460		K2	CYL160	3"	BA9	C6
1466		Y1	CYL360	10"	BA9	C6
1468		Y1	CYL300	8"	BA9	C6
1535/1537		Y1	CYL190	5"	BA1	C4
1535/1537	SS	Y1	CYL190	5"	BA1	C4
1536		Y1	CYL360	10"	BA1	C4
1538		Y1	CYL300	8"	BA1	C4
1545/1555		Y1	CYL190	5"	BA1	C4
1545/1555	SS	Y1	CYL190	5"	BA1	C4
1546		Y1	CYL360	10"	BA1	C4
1548		Y1	CYL300	8"	BA1	C4
1560/1580		Y2	CYL190	5"	BA2S	C4
1560/1580	SS	Y2	CYL160	3"	BA2S	C4
1566		Y2	CYL360	10"	BA2B	C4
1568		Y2	CYL300	8"	BA2B	C4
1570/1590		Y2	CYL190	5"	BA2S	C4
1570/1590	SS	Y2	CYL160	3"	BA2S	C4
1576		Y2	CYL360	10"	BA2B	C4
1578		Y2	CYL300	8"	BA2B	C4
1660		B2	CYL240	5"	BA1	C1
1660		S2, P1, R1, M1	CYL190	5"	BA1	C1
1660	SS	S2, P1, R1, M1	CYL190	5"	BA1	C1
1660	SS-STD	Y2	CYL160	3"	BA1	C1
1666		B2, P1	CYL360	10"	BA1	C1
1668		B2, P1	CYL300	8"	BA1	C1
1725		B2	CYL240	5"	BA1	C1
1725		S2, R1, M1	CYL190	5"	BA1	C1
1725	SS	S2, R1, M1	CYL190	5"	BA1	C1
1726		B2, P1	CYL360	10"	BA1	C1
1728		B2, P1	CYL300	8"	BA1	C1
1760		S2, P1, R1, M1, Y2	CYL190	5"	BA1	C1
1760	SS	S2, P1, R1, M1	CYL190	5"	BA1	C1
1760	SS	Y2	CYL160	3"	BA1	C1
1766		P1	CYL360	10"	BA1	C1
1768		P1	CYL300	8"	BA1	C1
1780		S2, P1, R1, M1, Y2	CYL190	5"	BA1	C1
1780	SS	S2, P1, R1, M1	CYL190	5"	BA1	C1
1780	SS	Y2	CYL160	3"	BA1	C1
1790	SS-STD	M2	CYL197HD	5"	BA1HD	C4

MODEL	SS	CONTROLS	CYLINDER	STROKE	BASE	CASTER
1860		Y1, Y3	CYL190	5"	BA9	C6
1866		Y1	CYL360	10"	BA9	C6
1868		Y1	CYL300	8"	BA9	C6
1880		Y4	CYL160	3"	BA9	C6
2060/2070		Y1, Y3, M1	CYL190	5"	BA9	C6
2066/2076		P1	CYL360	10"	BA9	C6
2068/2078		P1	CYL300	8"	BA9	C6
2160/2180	SS	Y1, Y2, Y3	CYL190	5"	BA9	C6
2170/2190	SS	Y1, Y2, Y3	CYL190	5"	BA9	C6
2166		Y1	CYL360	10"	BA9	C6
2168		Y1	CYL300	8"	BA9	C6
2260	SS	K2, W1, Y5	CYL190	5"	BA11	C22
2266		W1	CYL360	10"	BA11	C22
2268		W1	CYL300	8"	BA11	C22
2360/2380		S2, R1, M1, Y2	CYL190	5"	BA10B	C6
2360/2380	SS	S2, R1, M1	CYL190	5"	BA10B	C6
2360/2380	SS	Y2	CYL160	3"	BA10B	C6
2366		P1	CYL360	10"	BA10B	C6
2368		P1	CYL300	8"	BA10B	C6
2450		B1	CYL240	5"	BA10P	C6
2450GT		R2	CYL190	5"	LG	Glide
2450		S3	CYL200	5"	BA10P	C6
2450GT		B1	CYL240	NA	LG	Glide
2600		S1	CYL190	5"	BA1	C1
2600		K1	CYL160	3"	BA1	C1
2610		S1	CYL190	5"	BA1	C1
2610		K1	CYL160	3"	BA1	C1
2780		W2, Y2	CYL190	5"	BA11B	C6
2780	SS-STD	Y5	CYL190	5"	BA11B	C6
2800		S1	CYL200	5"	BA2B/BA2P	C1
2800		K1	CYL160	3"	BA2B/BA2P	C1
2810		S1	CYL190	5"	BA2B/BA2P	C1
2810		K1	CYL160	3"	BA2B/BA2P	C1
2900/2910		S2, M1, Y2	CYL200	5"	BA19	C7
3060/3065	SS-STD	X1	CYL200	5"	BA10	C8S
3080/3085	SS-STD	X1	CYL200	5"	BA10	C8S
3061/3066	SS-STD	X1	CYL360	10"	BA10	C8S
3063/3068	SS-STD	X1	CYL300	8"	BA10	C8S
3160	SS-STD	W1, Y1, Y3	CYL190	5"	BA9	C6
3166	SS-STD	Y1	CYL360	10"	BA9	C6
3168	SS-STD	Y1	CYL300	8"	BA9	C6
3200/3210	SS-STD	X2	CYL200	5"	BA10P	C6
3220/3230	SS-STD	X2	CYL200	5"	BA10P	C6
3250/3260	SS-STD	X2	CYL200	5"	BA10P	C6
3300/3310		K3, S3	CYL190	5"	BA9	C6
3306		S3	CYL360	10"	BA9	C6
3308		S3	CYL300	8"	BA9	C6
3315		LG		FIXED	LG	Glide
3315		R2	CYL190	5"		Glide
3460	SS-STD	Y1, Y3, W1, W2	CYL190	5"	BA11	C6
3466	SS-STD	Y1	CYL360	10"	BA11	C6
3468	SS-STD	Y1	CYL300	8"	BA11	C6
3680	SS-STD	W2	CYL200	5"	BA36	C6

# accessories

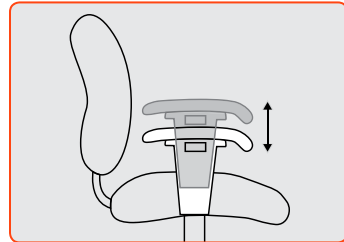

**PA4**

\$20

**SOFT-TOUCH POLYURETHANE PAD ONLY**

Use w/ A4, A5 Arm (ea).

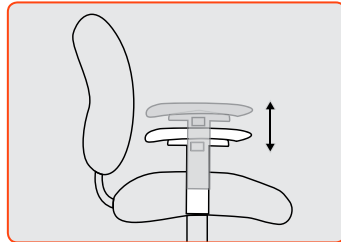

**PA6**

\$30

**URA-SOFT® PAD ONLY**

Use w/ A6, A7 Arm (ea).

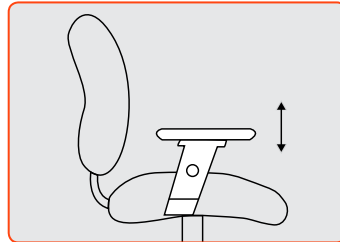

**PA8**

\$25

**SOFT-TOUCH POLYURETHANE PAD ONLY**

Use w/ A8, A9 Arm (ea).

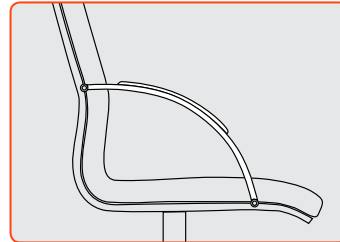

**PA20**

\$25

**LEATHER PAD ONLY**

Use w/ A20, A21 Arm (ea).



**PA22**

\$50

**SOFT-TOUCH POLYURETHANE PAD ONLY**

Use w/ A30 Arm (price per individual pad, specify L or R).



**PA30**

\$50

**SOFT-TOUCH POLYURETHANE PAD ONLY**

Use w/ A30 Arm (price per individual pad, specify L or R).



**PA38**

\$50

**SOFT-TOUCH POLYURETHANE PAD ONLY**

Use w/ A30 Arm (price per individual pad, specify L or R).

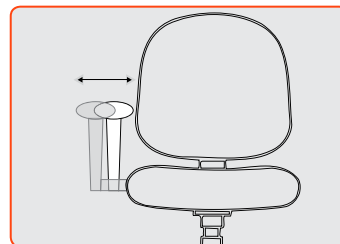

**AW1**

\$25

**4" ARM WIDTH ADJUSTMENT BRACKET**

Use w/ A4, A6, A8 (pair).

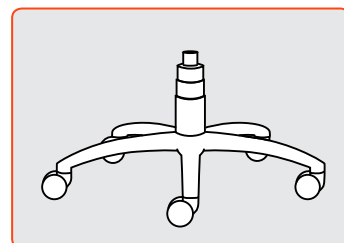

**BA1B**

\$75

**26" NYLON BASE - BLACK**

Use w/ all Task, Management, & Executive Chairs (casters sold separately).

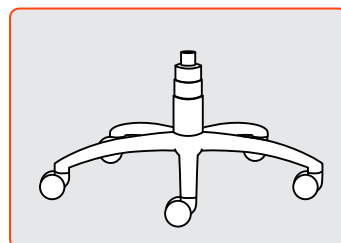

**BA2B,S,P**

\$100

**26" ALUMINUM BASE  
B - BLACK POWDER COATED BASE  
S - SILVER POWDER COATED BASE  
P - POLISHED ALUMINUM BASE**

Use w/ all Task, Management, & Executive Chairs (casters sold separately).

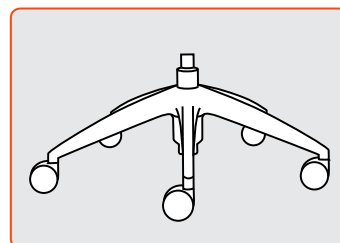

**BA9B,G,W**

\$75

**26" HIGH PROFILE NYLON BASE - BLACK**

26" High Profile Black Nylon Base comes standard w/ C6 65mm Hoodless Casters.

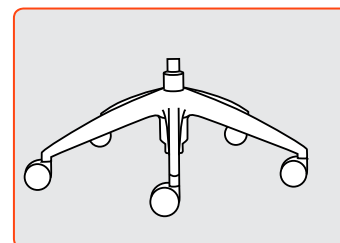

**BA10B,S,P**

\$100

**26" HIGH PROFILE ALUMINUM BASE  
B - BLACK POWDER COATED BASE  
S - SILVER POWDER COATED BASE  
P - POLISHED ALUMINUM BASE**

High Profile Black Powder Coated Aluminum Base (casters sold separately).

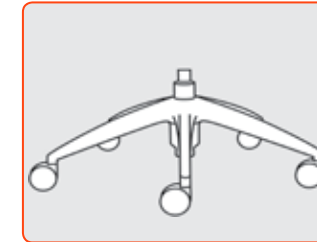

**BA11B,G**

\$75

**27" MID-PROFILE NYLON BASE  
B - BLACK NYLON  
G - GRAY NYLON**

(casters sold separately).

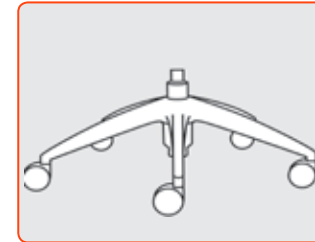

**BA12P**

\$100

**27" MID-PROFILE ALUMINUM BASE**

High Profile Polished Aluminum Base (casters sold separately).

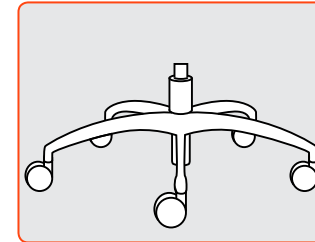

**BA19**

\$125

**27" ALUMINUM BASE - POLISHED**

Use with all Task, Management, & Executive Chairs (includes matching casters with polished aluminum accents).

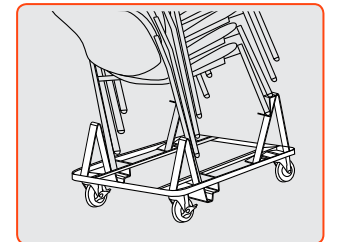

**DL1**

\$250

**STACKING DOLLY**

Use w/ Shuttle, Bella, Link and Mimi four leg models.



**DL4**

\$250

**STACKING DOLLY**

Stacks Indy, Kelly and Mimi all plastic Chairs.

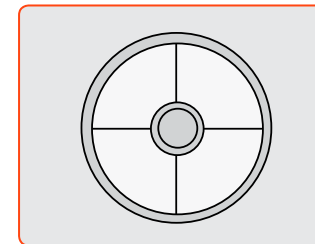

**FR20B**

\$90

**20" BLACK KNOB LESS FOOTRING**

Use with any Stool (standard on Cydia).

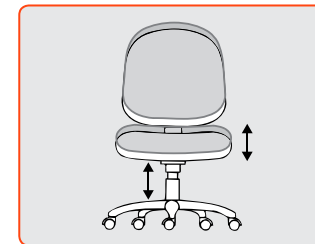

**CYL160**

\$30

**PNEUMATIC CYLINDER 3" LIFT**



**CYL190**

\$30

**PNEUMATIC CYLINDER 5" LIFT**

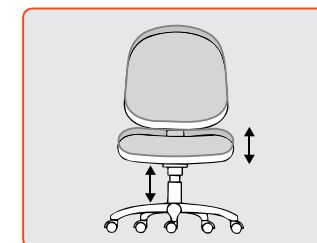

**CYL200C**

\$30

**PNEUMATIC CYLINDER 5" LIFT W/ CHROME FINISH**

Use w/ Cortina, Vesta series or any chrome base.



**CYL200B**

\$30

**PNEUMATIC CYLINDER 5" LIFT W/ BLACK FINISH**

Use w/ Vesta series.

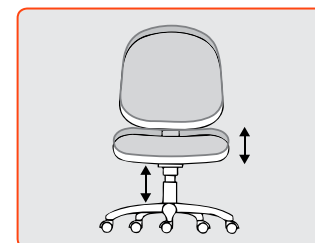

**CYL240**

\$30

**PNEUMATIC CYLINDER 5" LIFT**

## PARTS AND ACCESSORIES DISCOUNT

INDIVIDUAL PARTS & ACCESSORIES WHEN PURCHASED SEPARATE FROM A CHAIR RECEIVE AN EVEN 50% DISCOUNT.

THE 50% ACCESSORY DISCOUNT PROVIDES FOR EXTRA LABOR, PACKAGING MATERIAL AND SHIPPING CHARGES ASSOCIATED WITH SHIPPING A COMPONENT BY ITSELF.

# accessories

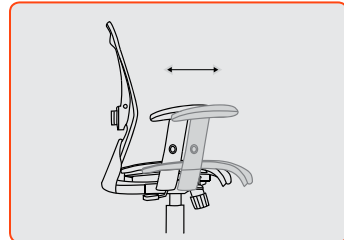

**SS**

\$60

**SEAT SLIDER 2.5" SIDE PADDLE ACTIVATED**

Add to S2, R1, M1, Y2 Controls Only on Select Series'.



**CYL300  
CYL360**

\$45/\$45

**PNEUMATIC CYLINDER 8" LIFT/  
PNEUMATIC CYLINDER 10" LIFT**

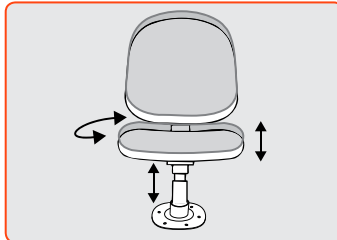

**CYL-ARH**

\$110

**SELF HEIGHT & FORWARD RETURNING  
PNEUMATIC CYLINDER 5" LIFT**

Upon exiting chair the seat returns to standard height & forward position for use with JB1 Jury Base.

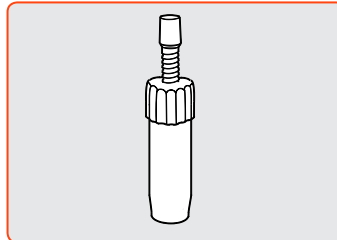

**CYLTHSPD**

\$60

**THREADED SPINDLE CYLINDER**

Replaces standard CYL190 gas lift for applications where the client does not want the chair height to be easily changed; such as conference rooms, cafeterias.  
\*Not compatible with BA9.

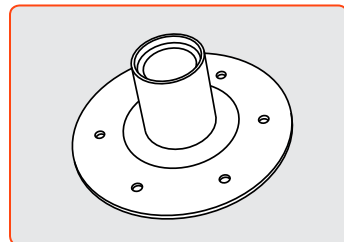

**JB1**

\$300

**STANDARD JURY BASE**

Use w/ all task models  
Consists of round plate which is bolted to floor and receives pneumatic cylinder.

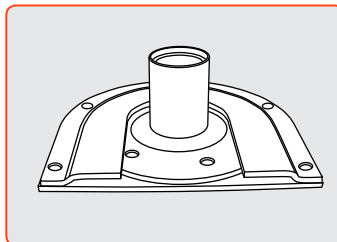

**JB2**

\$675

**QUICK RELEASE JURY BASE**

Use w/ all task models  
Pedestal base with quick release to remove chair and cylinder (includes JB1).

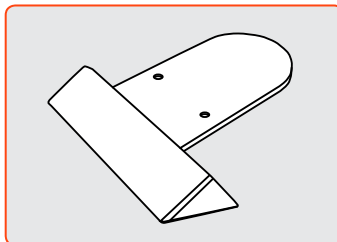

**JB2-PLT**

\$100

**RAMP INSERT FOR JB2 JURY BASE**

Use w/ JB2 Insert when chair & cylinder removed for ADA compliance.

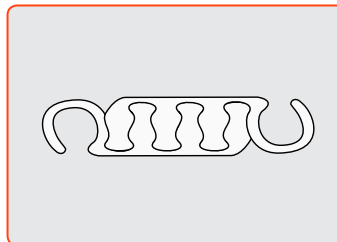

**GC1**

\$30

**GANGING CLIP  
ARMLESS-TO-ARMLESS**

Distance between chairs is 1.25"  
Use w/ Shuttle, Bella (2 per set).

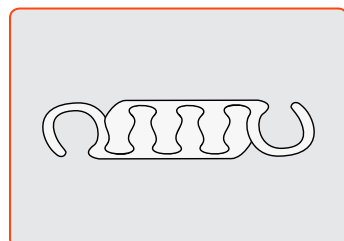

**GC2**

\$30

**GANGING CLIP  
ARM-TO-ARM**

Distance between chairs is 4.25"  
Use w/ Shuttle, Bella (2 per set).

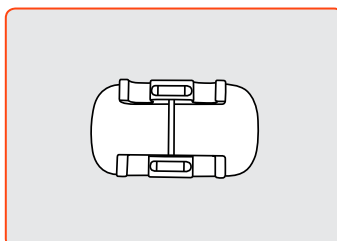

**GC5**

\$20

**GANGING CLIP  
ALL INDY SERIES, KELLEY  
AND MIMI ARMLESS CHAIRS**

Distance between chairs is 2.00"  
Use with all Indy and Kelley armless only.

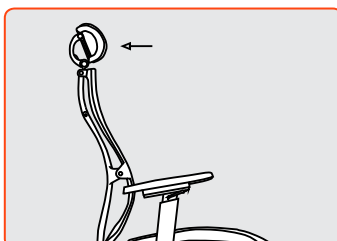

**HR-3080-  
M1X**

\$150

**HEADREST**

Use w/ Vesta series. Pattern "M1" mesh specify: M11-Black, M12 Gray, M13 Silver, M14 Green, M15 Red, M16 Blue.  
Also specify bracket finish:  
PF-Polished, SF-Silver, BF-Black.

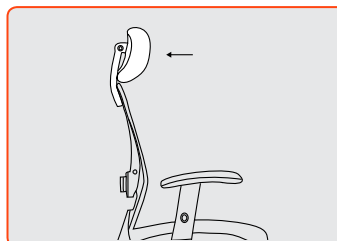

**HR-1580-T01**

\$120

**HEADREST**

Use w/ Strata series.  
T01 black mesh only (other upholstery contact customer service).

## PARTS AND ACCESSORIES DISCOUNT

INDIVIDUAL PARTS & ACCESSORIES WHEN PURCHASED SEPARATE FROM A CHAIR RECEIVE AN EVEN 50% DISCOUNT.

THE 50% ACCESSORY DISCOUNT PROVIDES FOR EXTRA LABOR, PACKAGING MATERIAL AND SHIPPING CHARGES ASSOCIATED WITH SHIPPING A COMPONENT BY ITSELF.

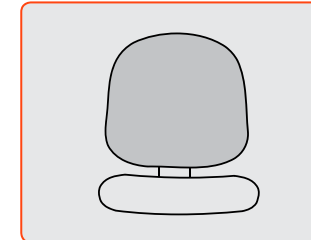

**UB**

\$100

**PLASTIC OUTER BACK COVERED WITH FABRIC**

Use w/ Agent.

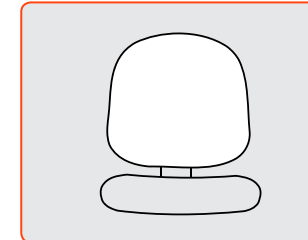

**BN1  
BN2**

\$35/NC

**UPHOLSTERED BACK COVERED WITH BLACK BALLISTIC NYLON**

BN1 - Use with Grade A Fabrics  
BN2 - Use with Grade B & Up Fabrics  
Use w/ Logic, Precept, & Shuttle.

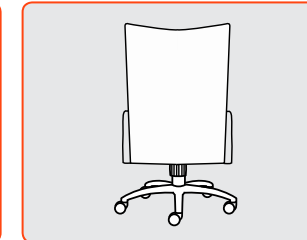

**BNE**

\$150

**UPHOLSTERED BACK COVERED WITH BLACK BALLISTIC NYLON**

Use w/ Axis, Cayman only.

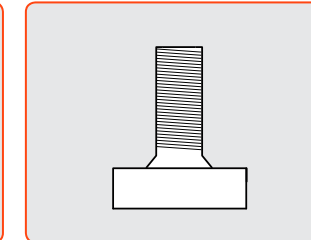

**BT**

\$15

**BOLT**

Replace knob with bolt (for B2 and S2 controls only).

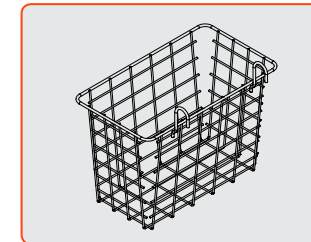

**BSK**

\$60

**BELLA SIDE HANGING BASKET**

Side Hanging Wire Basket for model 1310, 1315, 1360, 1365. Attach to left or right side.

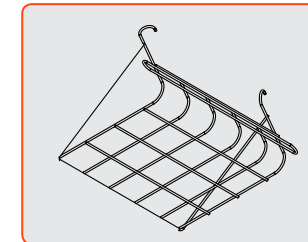

**BRK**

\$70

**SHUTTLE BOOK RACK**

Book Rack in Black Only  
Available on Shuttle.

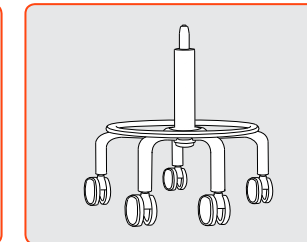

**KIT-FST8**

\$150

**8" GAS LIFT, 20" CHROME FIXED FOOTRING W/ 75MM HARD FLOOR CASTERS**

Durable Classic Fixed Foot ring Base for Lab Stool, Service Counter, Security Guard, and Medical Applications. A Real Workhorse.

## CYLINDER REFERENCE GUIDE

PART #	Stroke	Note
CYL160	3"	Short, reduced range cylinder used to offset added height of SS seat slider or K1 control
CYL190	5"	Standard task cylinder with lower starting height than CYL240. May be substituted for CYL240 when lower starting seat height is required
CYL197	5"	5" Stroke Heavy duty task cylinder
CYL200	5"	Standard task cylinder only used for high profile bases ( BA10, ba19 )
CYL240	5"	Standard task cylinder with higher starting height than CYL190. May be substituted for CYL190 when higher starting seat height is required
CYL300	8"	Stool cylinder with 2" lower starting seat height than stools with CYL360. Typically seat height starts at 19" so chair may be pushed under some desks. Use for workstations up to 36 inches high
CYL360	10"	Stool cylinder with 2" higher starting seat height than stools with CYL300. Generally seat height starts at 21" and chair will not fit under most desks. Use for workstations up to 42 inches high
CYLTHSPD	2.5"	Cylinder with a threaded spindle rather than a gas lift. For applications where client prefers the seat height set and not easily changed, such as a conference room
CYL-ARH	5"	Self height and forward position return. For use with jury base option

# control selection guide

## CONTROL FUNCTION GUIDE

1	INFINITE BACK ANGLE ADJUSTMENT	7	INFINITE POSITION TILT-LOCK
2	SEAT HEIGHT LEVER	8	FORWARD TILT LEVER
3	BACK DEPTH CONTROL KNOB	9	EASY-LIFT RATCHET BACK HEIGHT CONTROL
4	ARTICULATING POSTURE BACK W/ FREE FLOAT	10	BACK MULTI-LOCK W/ SAFETY RELEASE
5	SEAT HEIGHT & TILT LOCK LEVER	11	SEAT SLIDER PADDLE
6	TILT TENSION CONTROL KNOB	12	4 POSITION BACK TRAVEL CONTROL

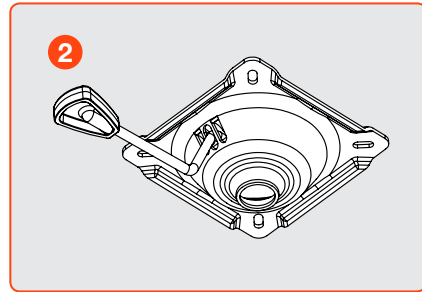

**B1** Basic Task

Our basic control for a one piece seat and back has simple adjustments. Ideal for clerical, casual meeting and general office use.

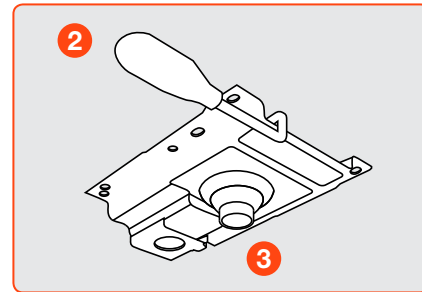

**B2** Basic Task

Our basic control has simple adjustments. Ideal for clerical, casual meeting, and general office use. This control uses a 2.25" cold-rolled steel J-Bar for added strength and back-pull durability.

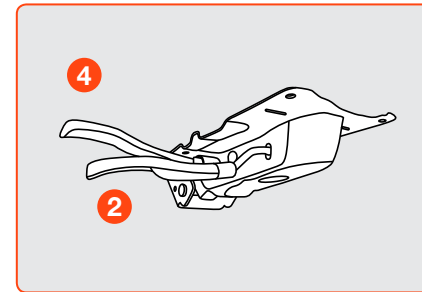

**P1** Posture Back

Ideal for stool applications, the articulating back provides proper support for moderate tasking use.

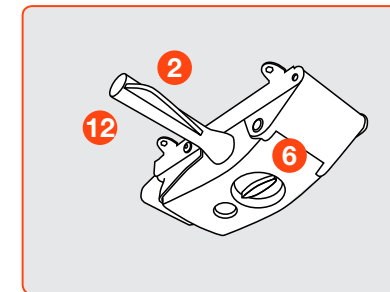

**W2** Advanced Weight Balanced Synchro

Auto-Balance tension adjustment utilizes the weight of the user to balance resistance of back. Sensing can be adjusted to suit individual preference. 3:1 back to seat synchronous movement with 4 position back-travel limiting stop.

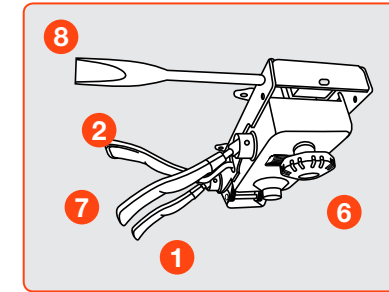

**M1** Multi-Function

For the highest level of ergonomic needs, suited for multi-task functions. Seat pivots from 0 to 6 degrees forward.

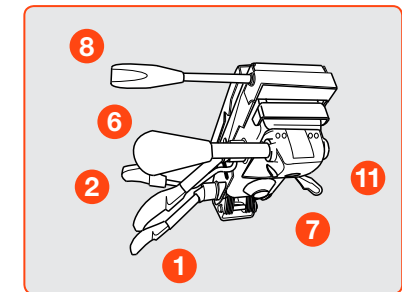

**M2** Heavy Duty Multi-Function

With a weight capacity up to 500 lbs, in addition to multi-task ergonomic functions, its ideal for police departments, 911 emergency, hospitals or whenever a higher weight capacity is needed. A 3.00" wide 5/16" thick cold-rolled steel back support adds strength and back-pull durability.

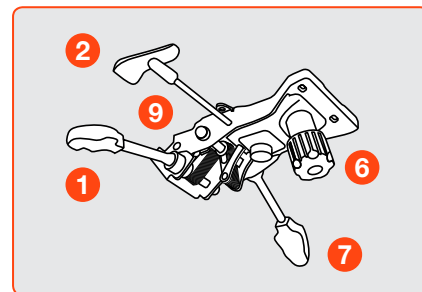

**R1** Rocking Tilt

For managerial and task applications. Similar to a swivel-tilt control with the added comfort of infinite back-angle adjustment and infinite tilt lock. Features 3" cold-rolled steel J-Bar.

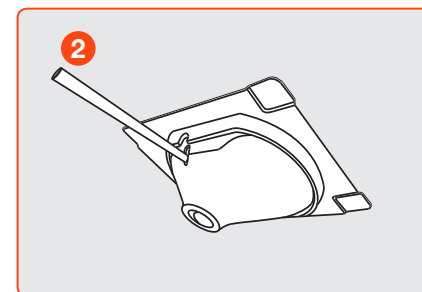

**R2** Rocking Tilt

For lounge, guest and collaboration applications. Rocking motion tilts right, left, front and back. Available on Cydia Lounge and Diddy Guest.

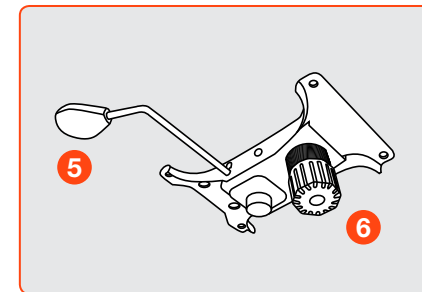

**S1** Swivel - Tilt

Use for a variety of general office seating, including private office and conference room seating. Control locks upright for tasking.

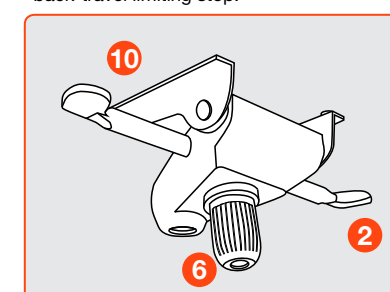

**K1** Knee Tilt

Ultimate seating comfort suited for the executive or manager. Allows for a full range of movement with a reduced rise of front seat edge. 5 position multi-lock with built-in safety return feature.

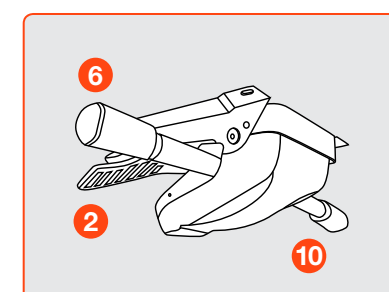

**K2** Advanced Knee Tilt

Ultimate seating comfort for manager, executive or conference seating. Allows for a full range of movement with a reduced rise of front seat edge. 4-position multi lock back. Side tension and back lock.

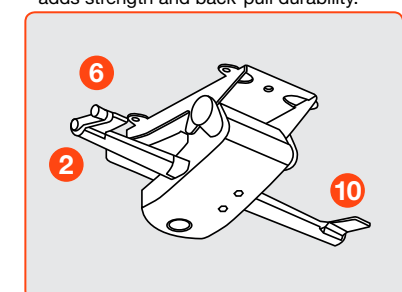

**K3** Knee Tilt (for Cydia only)

Ultimate seating comfort for manager, executive or conference seating. Allows for a full range of movement with a reduced rise of front seat edge. 4-position multi lock back. Side tension and back lock.

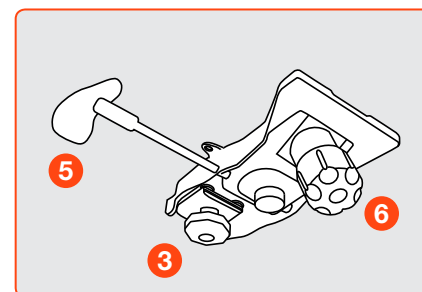

**S2** Swivel - Tilt

Use for a variety of general office seating. Similar function to the S1 however utilising a 2.25" cold-rolled steel J-Bar to connect seat and back. Control locks upright for tasking.

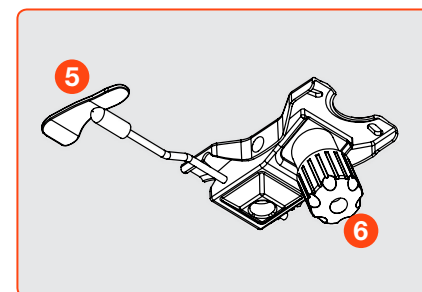

**S3** Swivel - Tilt

Use for a variety of general office seating. Control locks upright for tasking.

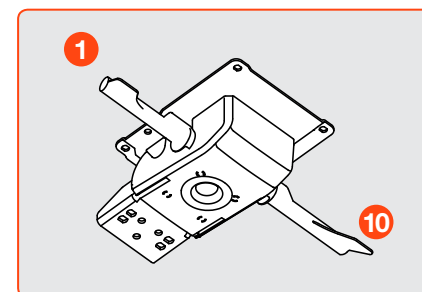

**W1** Weight Balanced Synchro

Auto-Balance tension adjustment utilizes the weight of the user to balance resistance of back. 3:1 back to seat synchronous movement with 2 position back lock.

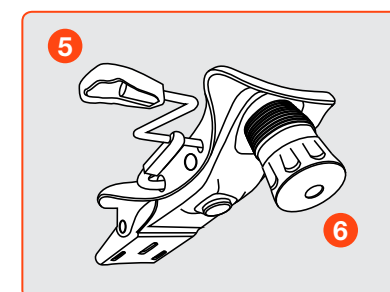

**Y1** Simple Synchro Tilt

Recline with a synchro back and seat movement. Reduced rise of front seat edge. Back may free float or be locked upright. Comparable to swivel tilt control but with asynchronous movement.

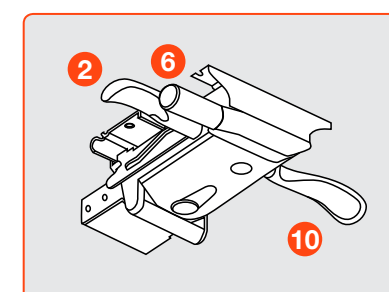

**Y2** Heavy Duty Synchro Tilt

Recline with a synchro back and seat movement featuring a 2:1 back to seat tilt ratio. Reduced rise of front seat edge. 4 position multi-lock with built-in safety return feature and slide tension control.

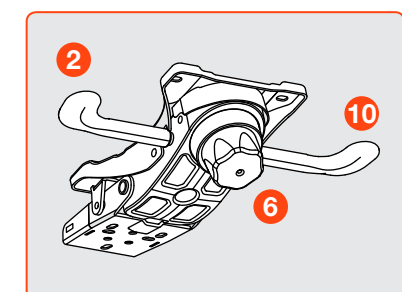

**Y3** Full Synchro Tilt

Recline with a synchro back and seat movement featuring a 2:1 back to seat tilt ratio. Reduced rise of front seat edge. 3 position multi-lock with built-in safety return feature.

# control selection guide

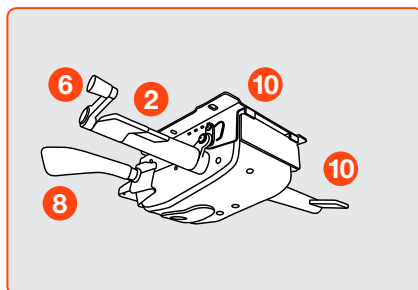

**Y4** Intensive Synchro  
(for Aria HR only)

Recline with a synchro back and seat movement featuring a 2:1 back to seat-tilt ratio. Reduced rise of front seat edge. 4 position multi-lock back position with built-in safety return feature. Integrated seat slider.

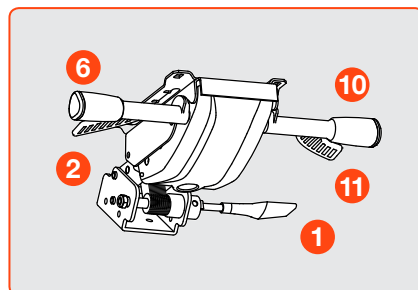

**Y5** Enhanced Synchro with  
back angle adjustment  
(for Core and Acclaim)

Enjoy the ride with this high function full 2:1 synchro control featuring an independent back angle adjustment. 4 position back lock, side tension control and built in seat slider depth adjustment.

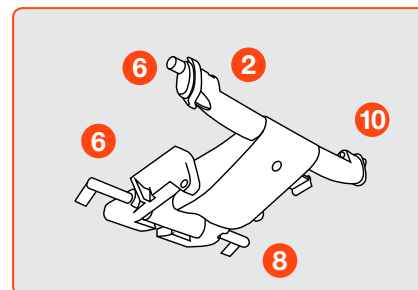

**X1** X1 for Vesta Chairs

Recline with a synchro back and seat movement featuring a 2:1 back to seat tilt ratio. Reduced rise of front seat edge. 11 position multi-lock with built-in safety return feature. Integrated seat slider and forward pitch adjustment.

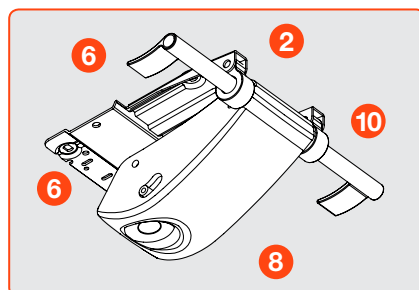

**X2** X2 for Cosmo Chairs

Recline with a synchro back and seat movement featuring a 2:1 back to seat tilt ratio. Reduced rise of front seat edge. 11 position multi-lock with built-in safety return feature. Integrated seat slider and forward pitch adjustment.



# BIFMA Ultimate test for fit (UTFF)

## Ergonomics - The Work Chair

The Business and Institutional Furniture Manufacturer's Association (BIFMA) has developed the following guidelines for UTFF. Parenthetical numbers following each item indicate corresponding subdivisions in the guidelines.

### Seat Height (7.1)

Users should be able to sit with their feet comfortably on the floor or footrest without undue pressure on the underside of the thighs. The thigh-to-torso angle should not be less than 90°.

### Seat Depth (7.2)

Users should be able to sit in the chair without undue pressure against the back of the knees, their back properly supported by the backrest and with adequate buttock and thigh support.

### Seat Width (7.3)

The seat should be wider than the hip breadth of the user with allowance for movement and clothing. The seat width should not limit the ability to use the armrests comfortably.

### Seat Pan Angle (7.4)

This should allow users to support their feet on the floor or footrest. They should not cause the user's torso-to-thigh angle to be less than 90°. Forward seat pan angles should not cause users to shift excessive weight to their feet or experience the sensation of sliding out of the chair.

### Back Support (7.5)

#### Seat Backrest Height (7.5.1)

All backrests should provide adequate support and buttocks clearance. For tasks requiring upper body mobility, the backrest should not interfere with the user's movement. For users who prefer reclining postures or greater upper back support, the back height should provide support for the shoulder blades.

#### Backrest Width (7.5.2)

The width of the backrest should provide adequate support for the curvature of the user's back without causing localized pressure points.

#### Lumbar Support (7.5.3)

The height and shape of the lumbar should coincide with the lumbar curve ("the small") of the user's back. The support should be firm, but not cause localized pressure points.

#### Movements of the Seat Pan and Back Support (7.6)

The user should be able to sit in a position where the torso-to-thigh angle is equal to or greater than 90°. The seat and backrest angles should accommodate the varying postures assumed by the user throughout the day.

### Arm Support (7.7)

#### Armrest Height (7.7.1)

This should allow users to sit in a variety of postures while supporting their forearms and/or elbows in a manner that avoids lifting the shoulders (armrests too high) or leaning to the side to reach the armrest (armrests too low). The armrest height should allow accessibility to, and performance of, tasks.

#### Armrest Length (7.7.2)

The length of the armrest should allow users to sit close enough to the work surface to perform their tasks while maintaining contact with the backrest.

#### Inside Distance Between Armrests (7.7.3)

Armrests should allow users to sit in a variety of postures while supporting their forearms in a manner that avoids lifting the shoulders and/or excessive outward positioning of the elbows. Armrests should allow accessibility to, and performance of, tasks. The inside distance between the armrests should allow the user to enter and exit the chair easily. The hips should comfortably fit between the armrests or supports.

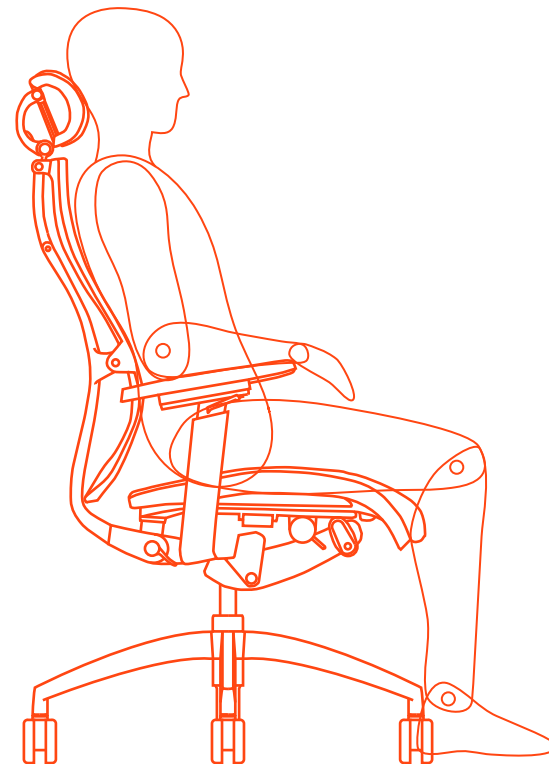

# care and maintenance

- Insure the gas cylinder is inserted into the control firmly. Improper connection may cause wobbling.
- Choose correct casters for different floor surfaces. We suggest choosing hard floor casters for tile or concrete surfaces.
- For drafting stool use, we recommend self-locking casters for hard floors. See Caster Selection Guide for more details.
- Do not stand on footrest
- Do not sit on any part of the chair except the seat; Do not sit on arms or backrest
- To avoid chair collapse do not remove knobs or screws.
- Properly dispose of packing materials. Do not use plastic as head covering. It may cause suffocation.
- If any parts are missing, broken, damaged or worn, do not use the chair until repairs are made using factory-authorized parts.
- Do not attempt to make any alterations to chair.
- Do not use chair on uneven floor surfaces.
- Do not drape coats or sweaters on back of chairs with casters. Hanging fabric may suddenly stop casters from rolling.
- Do not use excessive speed when moving the chair with casters while seated.
- Do not over exert the functions of a chair which are only to be used under normal conditions
- Do not stand on and/or use this chair as a stepladder. Use this product only for seating one person at a time
- Do not use this chair unless all bolts, screws and knobs are firmly secured

### Check the following at 4 month intervals

- All exposed fasteners should be checked and any loose fasteners tightened. Use appropriate tools. Replace any fasteners that appear to be damaged in any way
- The chair mechanism should be checked for any looseness, excessive wear or signs of damage. Immediately remove the chair from service if any damage or failure is found.
- The base and casters should be checked for any signs of excessive wear for failure. Immediately replace any parts that show such wear or failure.

# notes



# notes

