

OXFORD  
LINGUISTICS

Jenneke  
van der Wal

---

A Featural  
Typology  
of Bantu  
Agreement

# A Featural Typology of Bantu Agreement

# RETHINKING COMPARATIVE SYNTAX

## PUBLISHED

*The Syntax of Yes and No*  
Anders Holmberg

*Verb Movement in Romance*  
*A Comparative Study*  
Norma Schifano

*Person, Case, and Agreement*  
*The Morphosyntax of Inverse Agreement and Global Case Splits*  
András Bárány

*Parameter Hierarchies and Universal Grammar*  
Ian Roberts

*Rethinking Verb Second*  
Edited by Rebecca Woods and Sam Wolfe

*A Featural Typology of Bantu Agreement*  
Jenneke van der Wal

## IN PREPARATION

*Case and Agreement Alignment in Romance and Beyond*  
Michelle Sheehan

# A Featural Typology of Bantu Agreement

JENNEKE VAN DER WAL

OXFORD  
UNIVERSITY PRESS

# OXFORD

UNIVERSITY PRESS

Great Clarendon Street, Oxford, OX2 6DP,  
United Kingdom

Oxford University Press is a department of the University of Oxford.  
It furthers the University's objective of excellence in research, scholarship,  
and education by publishing worldwide. Oxford is a registered trade mark of  
Oxford University Press in the UK and in certain other countries

© Jenneke van der Wal 2022

The moral rights of the author have been asserted

Impression: 1

Some rights reserved. No part of this publication may be reproduced, stored in  
a retrieval system, or transmitted, in any form or by any means, for commercial purposes,  
without the prior permission in writing of Oxford University Press, or as expressly  
permitted by law, by licence or under terms agreed with the appropriate  
reprographics rights organization.



This is an open access publication, available online and distributed under the terms of a  
Creative Commons Attribution – Non Commercial – No Derivatives 4.0  
International licence (CC BY-NC-ND 4.0), a copy of which is available at  
<http://creativecommons.org/licenses/by-nc-nd/4.0/>.

Enquiries concerning reproduction outside the scope of this licence  
should be sent to the Rights Department, Oxford University Press, at the address above

Published in the United States of America by Oxford University Press  
198 Madison Avenue, New York, NY 10016, United States of America

British Library Cataloguing in Publication Data  
Data available

Library of Congress Control Number: 2021944570

ISBN 978–0–19–884428–0

DOI: 10.1093/oso/9780198844280.001.0001

Printed and bound by  
CPI Group (UK) Ltd, Croydon, CR0 4YY

Links to third party websites are provided by Oxford in good faith and  
for information only. Oxford disclaims any responsibility for the materials  
contained in any third party website referenced in this work.

*For all African native-speaker linguists – you are brave,  
and you are needed*



# Contents

<i>Preface</i>	x
<i>List of abbreviations and symbols</i>	xiii
1. Introduction: Agreement, variation, and features	1
1.1 About the book	1
1.2 Agree(ment)	2
1.3 Defective goals between agreement and incorporation	7
1.4 Variation in features	9
1.4.1 Emergent features and parameters	9
1.4.2 Licensing/Case	13
1.4.3 Saliency: Animacy and information structure	15
1.5 Bantu languages and their features	17
1.5.1 Bantu basics	18
1.5.2 Bantu word order and agreement – expressing information structure	20
1.5.3 The Bantu challenges and the proposals	23
1.6 Scope of the book	27
2. Object marking defective goals	33
2.1 Bantu verbal morphosyntax	33
2.2 The defective goal approach in Bembe	39
2.3 Doubling	42
2.4 Differential object marking	46
2.4.1 Variation in differential object marking	47
2.4.2 Saliency of [Person]	50
2.4.3 Cut-off points on the hierarchies	56
2.5 Extending the analysis	62
2.5.1 Reanalyzed Person	62
2.5.2 Personal predictions	64
2.5.3 Unagreement	67
2.6 Absence of object marking	69
2.7 Summary	70
3. Object marking in ditransitives	72
3.1 Introduction and overview of the chapter	72
3.2 The structure of ditransitives	74
3.3 Asymmetric object marking	79
3.3.1 Agree with the highest goal	80
3.3.2 Case is independent of agreement	82
3.3.3 Agree with the Theme in an asymmetric language	85



3.4	Symmetric objects and object marking	87
3.4.1	Word order	89
3.4.2	Passive	90
3.4.3	Object marking	90
3.4.4	Reciprocal	91
3.4.5	Extraction	92
3.4.6	Unspecified object deletion	93
3.4.7	Mismatches in symmetry properties	93
3.4.8	Hidden symmetry	96
3.5	Circumventing the locality restriction in symmetry	100
3.5.1	Equidistance	101
3.5.2	Movement of the Theme	103
3.5.3	Relativized probing by v	105
3.5.4	Flexible licensing	108
3.6	Flexible licensing through animacy and topicality	111
3.6.1	Animacy	112
3.6.2	Topicality	115
3.6.3	Case checking and Agree	119
3.6.4	Summary flexible licensing	124
3.7	Partial symmetry	125
3.7.1	Different types of ditransitives: Lexical, applicative, causative	126
3.7.2	Type 1: Fully symmetric	127
3.7.3	Type 2: Only lexical and applicative symmetric	128
3.7.4	Type 3: Only lexical symmetric	130
3.7.5	Type 4: Fully asymmetric	131
3.7.6	Accounting for partial symmetry	132
3.8	Multiple object markers	135
3.9	The phoenix probe	142
3.9.1	Type A: 1+ with 1SG	143
3.9.2	Type B: 1+ with 1SG and animate	144
3.9.3	Phoenix parameter	146
3.9.4	Type C: 1+ with reflexive	147
3.9.5	Type D: 1+ for reflexive and 1SG	149
3.10	Summary and further research	150
4.	Subject marking and inversion	156
4.1	Introduction: Extending flexible licensing	156
4.2	Subject inversion constructions	158
4.2.1	Postverbal subject is <i>in situ</i>	163
4.2.2	Preverbal DP as subject	169
4.2.3	Research questions for subject marking and inversion	173
4.3	Circumventing the locality restriction in inversion	173
4.3.1	Equidistance	174
4.3.2	Movement of the Locative	176

4.3.3	Movement of the external argument	178
4.3.4	Locative originates higher	179
4.3.5	Flexible licensing	181
4.4	Flexible licensing in more detail	188
4.4.1	Flexible licensing in Default Agreement Inversion (DAI)	189
4.4.2	The features and flexibility of v in Kirundi and Kinyarwanda	196
4.4.3	The subject marker in inversion	201
4.4.4	Interim summary and connection to theory	208
4.5	Implicational relation flexibility lower heads (FLUID)	212
4.5.1	Asymmetry: Agreeing Inversion	213
4.5.2	Asymmetry: Only unaccusatives invert	214
4.5.3	Unergatives and valency relations	216
4.5.4	Asymmetry and flexible v	220
4.5.5	Partial symmetry and inversion	221
4.5.6	Symmetric object marking and subject inversion	225
4.5.7	FLUID conclusion	226
4.6	Conclusions and further research	227
5.	Features in agreement and licensing	229
5.1	$\phi$ probes	230
5.1.1	A potential hierarchy for $\phi$ feature parameterization	232
5.1.2	(In)Dependent parameters	237
5.1.3	Nanoparametric variation for $\phi$	240
5.1.4	$\phi$ on Appl and symmetry (the AWSOM)	243
5.1.5	Multiple object markers as additional higher $\phi$ probes	246
5.1.6	Summary	250
5.2	Saliency features	251
5.2.1	[Person] in doubling object marking	251
5.2.2	Symmetry as flexible nominal licensing	252
5.2.3	Interaction between doubling and symmetry (the RANDOM)	253
5.2.4	Only one route of parametric change	256
5.2.5	A hierarchy for flexible licensing	261
5.2.6	Inversion without dedicated features	263
5.3	Looking ahead: What is needed	267
	<i>Appendix: Sources consulted for each language</i>	272
	<i>References</i>	275
	<i>Language Index</i>	301
	<i>General Index</i>	304

# Preface

How people say what they say has always fascinated me. On the one hand there are the strict boundaries of grammar (some sentences are simply ungrammatical), but on the other hand there is plenty of space to choose in which form you structure your message. Structuring your information according to what is given or new turns out to be fundamental in Bantu languages. This is visible in their word order, but also in their subject and object marking, and that is what I investigate in this book: what precise grammatical features determine Bantu subject and object agreement? And what does that show us about human language and its variation?

The seed for this book was planted when Anders Holmberg asked me to co-supervise David Iorio. David applied Ian Roberts' idea of defective goals to the Bantu language Bembe, and showed that the approach worked well for this particular language, but I kept wondering: how could it ever account for the variation across the many Bantu languages? Rather than posing this as a rhetorical question, I decided to see how far I could get in understanding Bantu object marking parameters, and from there the thinking eventually extended to include subject marking and inversion as well. Theresa Biberauer's brilliant 'MMM' model turned out to fit this research wonderfully. It has taken many years to let the ideas brought together in this book ripen and to obtain the data to test the predictions, but along the way I learned a ton, and even discovered new typological generalizations (the RANDOM and the AWSOM).

All the thinking and writing in those years has been made possible through the support of the ReCoS project at the University of Cambridge (European Research Council Advanced Grant 269752) and the BaSIS project at Leiden University (NWO Vidi grant 176-78-001), and both are hereby gratefully acknowledged. I am also grateful to NWO for financially supporting this book as an open access publication.

On the ReCoS project, I was extremely lucky to be surrounded by a great team of syntacticians, whom I want to thank very much for their input in many ways: Ian Roberts, Anders Holmberg, Theresa Biberauer, Michelle Sheehan, Timothy Bazelgette, Alison Biggs, Georg Höhn, András Bány, Sam Wolfe, and Jamie Douglas were all part of ReCoS at some point while I was at Cambridge.

Two of the ReCoSians have played a vital role for this book. Without András there would not have been a book at all – for his comments on many earlier versions as well as his encouragement I am very grateful indeed, and I hope our discussions and conversations may continue, ideally with lots of tea and vegan food! Without Theresa’s comments on a pre-final manuscript, the book would have been in a significantly worse shape, and the same goes for Michael Diercks’ comments – I am grateful for the constructive feedback they have given me. I hasten to say they are not in any way responsible for the contents of the current book, and this also holds for the following list of people whom I wish to thank for helping me in one way or another throughout the research reported here, with apologies for anyone I may have forgotten to mention.

For brainstorming about ideas and data, and constructive comments on parts of the analysis, I thank Lisa Cheng, Denis Creissels, Zuzanna Fuchs, Claire Halpert, Carolyn Harford, David Iorio, Elisabeth Kerr, Zhen Li, Michael Marlo, Lutz Marten, Maarten Mous, Andrew Nevins, Steve Nicolle, Rodrigo Ranero, Patricia Schneider-Zioga, Mattie Wechsler, Hedde Zeijlstra, and Jochen Zeller. I am certain that Thilo Schadeberg thinks there are too many footnotes in this book, but I am grateful for his example as a Bantuist.

For providing data and judgements, I thank all the language experts: Nikki Adams, Allen Asimwe, Olinda Baixane, Eva-Marie Bloom-Ström, Eyamba Bokamba, Koen Bostoen, Jean Chavula, Gloria Cocchi, Thera Crane, Denis Creissels, Thabo Ditsele, Laura Downing, Hannah Gibson, Peter Githinji, Chege Githiora, Rozenn Guérois, Tumaini Kallaghe, Patrick Kanampiu, Jekura Kavari, Heidrun Kröger, Nancy Kula, Chiku Lijongwa, Amani Lusekelo, Innocent Masengo, Konosoang Elisabeta Masupha, Joyce Mbepera, Sam Mchombo, Lioba Moshi, Peter Muriungi, Paul Murrell, Joseph Mwalonya, Judith Nakayiza, Andrew Nalani, Saudah Namyalo, Jean Paul Ngoboka, Nelsa Nhantumbo, Ernest Nshemezimana, Annah Ramtu, Possa Rethabile, Justine Sikuku, Aurélio Simango, Ron Simango, Erika Just, Nobuko Yoneda, Jochen Zeller. Finally, presenting this work at various conferences has also been fruitful, and I thank the audiences at ACAL47, Bantu 6, BLS41, CamCoS5&7, CILV 2014, FAMSV 2015, GLOW41, Frankfurt, IGRA Leipzig, ComSyn Leiden, MIT LingLunch, SLE48, the Oxford Linguistics seminar, and the Dutch Annual Language Day 2016, 2018 for their comments.

I thank Saskia Dunn and the editors at OUP for their help in finding typos and getting the manuscript ready for print.

To all friends and family, who understand how important these puzzles and languages are for my general happiness: thank you for bearing with me, supporting me, and loving me. You visited us abroad, you understood the

absence during Christmas while I was on fieldwork, you celebrated new work opportunities with me, gave me hope in times of bad health, and invited me to play and be creative. To Wilbert, I am eternally grateful for our whole shared life, but especially for choosing to make the Cambridge and Harvard adventures possible and living them together to the fullest. I am truly blessed to have such a strong, encouraging, and flexible home in you. Dankjewel.

Finally, the adage that made me brave enough to keep pushing the research, I owe to Mark C. Baker. At a talk many years ago, he said 'I am bound to be wrong about some or all of this, but at least I will be wrong in an interesting way!'. Whenever I was in doubt as to how much sense it all made, I remembered this phrase. Inspired by his example as a linguist, my hope for this book is that I may be wrong in interesting ways.

Jenneke van der Wal

# List of abbreviations and symbols

Numbers refer to noun classes unless followed by SG or PL, in which case they refer to persons. High tones are indicated by an acute accent; low tones are generally left unmarked but are sometimes marked as a grave accent.

*	ungrammatical example
#	infelicitous example in given context
?	questionable acceptability
%	a subgroup of speakers accepts the sentence
	phonological phrase boundary/prosodic boundary
!	tonal downstep
δ	discourse feature (topic/focus)
φ	phi (person, number, and gender) features
π	general Person feature (can combine with Participant and Speaker)
♠	Person feature
,	comma intonation, prosodic break
A	Changanga determiner (unclear function)
ABS	absolutive
ACC	accusative
ADD.P	additive pronoun
addr	addressee
ADJ	adjectival
AF	antifocus
AI	agreeing inversion
ANTI	anti-agreement
APPL	applicative
ASP	aspect
AUG	augment
auth	author
AUX	auxiliary
AWSOM	Asymmetry Wants Single Object Marking
BEN	benefactive
CAUS	causative
CAUS	causee
CC	complement case
CJ	conjoint
COMP	complementizer
COP	copula
CPR	contrastive pronoun

DAI	default agreement inversion
DAT	dative
dby	day before yesterday
DC	default case
DEM	demonstrative
DET	determiner
DIST	distal
DJ	disjoint
DOC	double object construction
DOM	differential object marking
DUR	durative
EA	external argument
EPP	extra peripheral position (previously extended projection principle)
ERG	ergative
EXPL	expletive
FE	feature economy
FLUID	Flexible Licensing Up Implies Down
FOC	focus
FPAST	far past
FUT	future
FV	final vowel
G	TAM suffix or infix
Gen	gender
HAB	habitual
HAppl	high applicative
IG	input generalization
II	instrument inversion
INF	infinitive
inh	inherent case
int.	intended meaning
INV	inverse
IPFV	imperfective
IRR	irrealis
LAppl	low applicative
LF	logical form
LI	locative inversion
LOC	locative DP
LOC	locative
LT	link tone
MLC	minimal link condition
NARR	narrative
NEG	negation
NFUT	near future
NOM	nominative
NPPR	non-final form of the personal pronominal

N.PST	near past
Num	number
OBJ	object
OBL	oblique
OM	object marker
OPT	optative
Q	(polar) question particle
PASS	passive
PCC	person-case constraint
PERF	perfect
PERS	persistive aspect
PF	perfect final
PF	phonological form
PFV	perfective
PI	patient inversion
PLA	plural addressee
PLUR	plurative
POSS	possessive
PP	past participle
PREP	preposition
PRS	present
PRO	independent pronoun
PROG	progressive
PROX	proximal
PST	past tense
ptcp	participle
R	recipient
RANDOM	Relation between Asymmetry and Non-Doubling Object Marking
REL	relative
REFL	reflexive
RECP	reciprocal
RECPST	recent past
REP	repetitive
RM	relative marker
RS	resultative
SBJV	subjunctive
SF	simple final
SM	subject marker
SQ	sequential
Th	theme
T(NS)	tense
UG	Universal Grammar
YPST	yesterday past





# 1

## Introduction

### Agreement, variation, and features

#### 1.1 About the book

How can there be so many different languages in the world while the ability to use language seems to be fundamentally the same for every human being? This is without doubt one of the core questions of linguistics, and it is this Big Question that is hidden behind the smaller questions in this book. To study the variation and the underlying linguistic system in a scientific way, we ideally want to have a laboratory in which we can just change one parameter and observe the effect. For a natural phenomenon like language, this is of course impossible. However, the Bantu language family comes close to a natural language variation lab: this language family consists of an estimated 555 languages (Hammarström 2019), which are spoken in the area between Cameroon, Kenya, and South Africa. Larry M. Hyman once said ‘If you’ve seen one Bantu language, you’ve seen them all – except they are all different!’ and this is precisely what makes them so fascinating and suitable for comparative research.

In this book I therefore investigate a subset of the Bantu languages with respect to how arguments in the clause are licensed, and how this is reflected in agreement marking on the verb. Precisely because there is microvariation in this area, we can unravel which features are involved in agreement and licensing and pinpoint the featural parameters that give rise to the variation.

The empirical basis covers Bantu object marking, in monotransitives and ditransitives, as well as subject marking and subject inversion constructions. To account for the patterns found, I propose a new analysis that involves Agree and Case licensing, and importantly takes the influence of information structure into account (building on Morimoto 2000; Halpert 2015; and many others). The proposed analysis captures parameters as variation in formal features, and as a result, the featural analysis presented in this book shines

a light on what is needed in the grammar to cover the attested typological variation while taking into account learnability. Specifically, the data and analysis in this book argue against both the Strong Uniformity Hypothesis (Chomsky 2001; Miyagawa 2010, 2017) and the Strong Modularity Hypothesis (Chomsky 2008; Berwick & Chomsky 2011; Fanselow 2006; Fanselow & Lenertová 2011; Horvath 2010). The former claims that all languages share the same set of grammatical features, and the latter that narrow syntax cannot be influenced by information-structural factors. Considering the clear influence of information structure on the syntax of (some) Bantu languages, and considering the amount of variation in sensitivity to these (and other) features, I follow Biberauer (2011, 2017b, 2018ab, 2019) in arguing that a model is to be preferred in which features are not just assumed to be present or absent, but postulated on the basis of their effects on the output.

What is at stake, then, is more than just the analysis of subject or object marking in Bantu languages. But we have to start somewhere, and agreement is a useful starting point for our further discoveries. The questions for the current book, then, are which precise features play a role in agreement phenomena, and how these features can explain crosslinguistic variation. In this chapter, I start by introducing agreement and the notion of Agree (Section 1.2) and then discuss the features of the goal of agreement, specifically the notion of a defective goal (Section 1.3). Section 1.4 presents a new way of thinking about features (Section 1.4.1), as well as Case as a feature responsible for licensing (Section 1.4.2) and information structure (Section 1.4.3). I then introduce the Bantu languages (Section 1.5), and I finish the chapter by briefly touching upon the challenges and scope of the book (Sections 1.5.3 and 1.6).

## 1.2 Agree(ment)

Agreement is an interesting starting point because it shows the person, number, and gender features of arguments away from those arguments, on the verb. This entails that there is some relation between the arguments and the clause in which they appear, and it is worthwhile uncovering what exactly that relation is, and specifically which features are involved. In order to start this investigation, I introduce the Minimalist way of thinking about the relation between arguments and the clause and illustrate with examples from Bantu object marking.

Many languages index a verb's arguments on the verb itself, in the form of some inflectional morphology. In many Bantu languages, both the subject and

the object are indexed on the verb. The prefixes for subject and object marking reflect the person and noun class of the subject and object, indicated in the Bantu tradition by a number (Meinhof & Van Warmelo 1906/1932). In (1) from the Bantu language Makhuwa, the subject is either *nikhúlé* ‘mouse’ in noun class 5 (1a, c) or the plural *makhúlé* ‘mice’ in class 6 (1b), and this determines the shape of the first verbal prefix as *ni-* or *a-* (underlined in (1)). The object is in class 1 *napulú* (1a, b) or class 2 *anaphúlu* (1c), determining the shape of the object marker as *-m-* or *-aa-* (boldfaced in (1)).<sup>1</sup>

Makhuwa (P31)

- (1) a. Ni-khúlé ni-ni-**m**-vár-á                      naphulú.  
       5-mouse    5SM-PRS.CJ-1OM-grab-FV    1a.frog  
       ‘A/the mouse grabs a/the frog.’
- b. Ma-khúlé a-ni-**m**-vár-á                      naphulú.  
       6-mice        6SM-PRS.CJ-1OM-grab-FV    1a.frog  
       ‘(The) mice grab a/the frog.’
- c. Ni-khúlé ni-n-**aa**-vár-á                      anaphúlu.  
       5-mouse    5SM-PRS.CJ-2OM-grab-FV    2a.frog  
       ‘A/the mouse grabs (the) frogs.’

The agreement relation between the arguments and their co-indexing by the verbal morphology has been captured in the generative Minimalist framework by the syntactic operation Agree (Chomsky 2000, 2001). Under Agree, a head and a phrase (or technically, the head of that phrase) share features, typically  $\phi$  features: person, number, and gender. The phrase has values for these features, for example the subject in (1a) *nikhúle* ‘mouse’ is specified as [person: 3], [number: SG], [gender: C].<sup>2</sup> The head, on the other hand, does not inherently have these features, but ‘needs’ them. This is modelled as uninterpretable unvalued features on the head, which probe the structure for valuation; for u $\phi$  features we indicate this as [person: \_], [number: \_], [gender: \_]. The unvalued features are therefore also called the ‘probe’. As soon as the probe encounters a matching goal, namely a DP that can value features of the probe, the two agree, which means that unvalued features on the probe are valued.

This is illustrated for object marking in (3): the probe *v* has unvalued  $\phi$  features, which search in the existing structure (the c-command domain, here the

<sup>1</sup> Where no source is indicated, examples come from personal knowledge or original data collection. See Section 1.5.1 for information on the Guthrie code mentioned for each language.

<sup>2</sup> The Bantu noun classes can be analyzed as gender, forming singular-plural pairs. Where useful, I use Carstens’ (1993) notation, where noun classes 1 and 2 form gender A, class 3/4 form gender B, etc. See also Fuchs and Van der Wal (2022).

VP) for a matching goal. The DP *mtoto* ‘child’ is specified for these features and when the two agree, the goal DP values the features of the probe *v* (3b).

Swahili (G42)

- (2) Wa-zee            wa-na-mw-ona        m-toto.  
 2-old.person    2SM-PRS-1OM-see    1-child  
 ‘The elders see the child.’

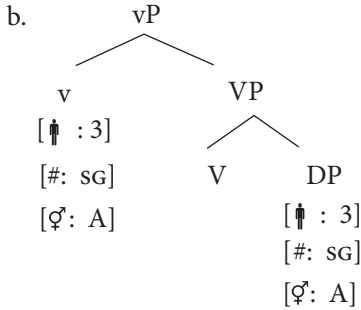
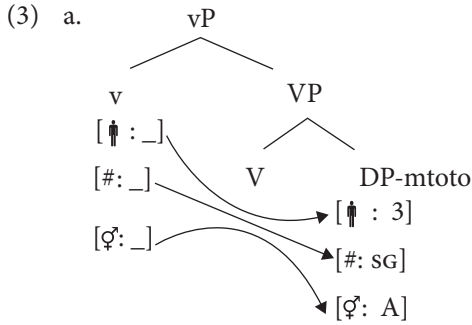

After the syntactic operation Agree, the feature values of the goal are also present on the probe and can be interpreted at the conceptual–intentional interface. The features may then be spelled out, on the DP, on *v*, or on both: on the DP the features spell out as the prefix *m-*, which is bound to the root *-toto*, and on *v* the features spell out as an object marker *-mw-*. See Fuchs and Van der Wal (2022) for an implementation in Distributed Morphology of the spell-out rules involved in noun class prefixes, and see Chapter 2 for the spell-out of object marking. The same operation happens again for subject marking, where T has unvalued  $\phi$ -features, probing the structure to find the subject DP *wazee* ‘elders’ in specvP. The  $\phi$  probe on T agrees with the goal (the subject DP) to value its  $u\phi$  features (plural of gender A), which then spell out as the subject marker *wa-*. If the  $u\phi$  probe has a movement diacritic (or what has been called an EPP feature), then the agreed-with goal will be moved to specTP (typically the preverbal subject – see Chapter 4).

With this standard model, we can thus capture the (morphological) agreement marking on the verb as (the spell-out of) an Agree relation between the heads T and v and the subject and object arguments respectively. However, there is a question whether everything we see as agreement in languages across the world should also be analyzed as underlyingly involving the operation Agree. The Bantu languages have been hotly debated in this respect. If object marking is pure syntactic agreement, it should be possible for both the object marker and the coreferring object DP<sup>3</sup> to be present (in the same domain, as opposed to being dislocated – see Section 1.3). And this is indeed possible for Swahili: a Recipient object that is not dislocated (because it precedes the Theme object) is felicitously object-marked in (4).

Swahili (G42, Riedel 2009: 80)

- (4) A-li-**m**-nunulia                      Juma      ki-tabu.  
 ISM-PST-1OM-buy.APPL    1.Juma    7-book  
 ‘S/he bought a book for Juma.’

In contrast, there are Bantu languages in which object markers are argued to behave more like incorporated pronouns rather than syntactic agreement. In Lugwere, for example, an object marker is only felicitous if the coreferring DP is outside of the vP domain. It is right-dislocated in (5b), as seen by the position with respect to the Theme object, as well as the required pause, indicated by the three dots. Example (6b) shows that an *in situ* object, preceding the adverb that canonically follows arguments, cannot be object-marked.

Lugwere (JE17)

- (5) a. Tw-á-(*\*mu*-)w’                      ómú-lími      één-kuumbi.  
 1PL.SM-T-1OM-give    1-farmer    9-hoe  
 ‘We will give the farmer a hoe.’  
 b. Tw-á-mu-w’                      één-kuumbi...      ómú-lími.  
 1PL.SM-T-1OM-give    9-hoe                      1-farmer  
 ‘We will give him a hoe... the farmer (that is).’
- (6) a. Swáya    y-á-βona      óDéo      máángumáángu.  
 1.Swaya    1SM-T-see    1.Deo    quickly  
 ‘Swaya will see Deo quickly.’  
 b. \*Swáya    y-á-mu-βona      óDéo      máángumáángu.  
 1.Swaya    1SM-T-1OM-see    1.Deo    quickly  
 int. ‘Swaya will see Deo quickly.’

<sup>3</sup> While I refer here to ‘object DP’, this can be any argument introduced below v, fulfilling different semantic functions (Recipient, Benefactive, Locative, Instrument); see discussion in Thwala (2006).

Similar data for Chichewa inspired [Bresnan and Mchombo \(1987\)](#) to propose an incorporation analysis for object marking. Under this analysis, it is the object marker that functions as the argument, and the coreferring DP is adjoined. Specifically, the object is said to originate as a pronoun in argument position, and is incorporated into the verb to appear as a prefix (see also [Jelinek 1984](#); [Baker 2003](#)), as in (7).

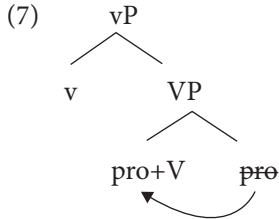

The debate on the status of Bantu object markers as agreement or pronoun incorporation has continued, with studies arguing for the one or the other analysis, for individual languages as well as in general. We find unified approaches, such as [Riedel \(2009\)](#) arguing for an agreement analysis across Bantu, as well as proposals for parametric variation, such as [Henderson \(2006\)](#); [Zeller \(2014\)](#); and [Baker \(2018\)](#) (see for further comparative aspects of Bantu object markers and their status [Morimoto 2002](#); [Beaudoin-Lietz et al. 2004](#); [Thwala 2006](#); [Creissels 2005](#); [Baker 2008a](#); [Riedel 2009](#); [Marten & Kula 2012](#); [Marlo 2013](#)). [Zeller \(2012b\)](#) sums up the situation, pointing out that things may not be as simple as a choice between two analyses:

It is uncontroversial that object markers behave like agreement markers in some Bantu languages, but like pronominal clitics in others. However, most languages lie somewhere between the two opposite ends of the agreement-pronoun continuum, showing ‘mixed’ properties, which perhaps reflect intermediate stages of a grammaticalization process that turns pronominal object markers into agreement morphemes (cf. [Henderson, 2006](#)). [...] Despite the existence of many Bantu languages in which object markers are neither prototypical agreement markers nor prototypical pronouns, the theoretical debate about object marking in Bantu is still characterized by a strict agreement marker versus pronoun-dichotomy. Because of this dichotomy, the strongest arguments for one type of analysis are often provided by those properties of object markers which *cannot* be explained easily by the competing analysis. The problem with this method is that reducing the theoretical analysis to these two possibilities may prevent a better understanding of the true nature of object marking. ([Zeller 2012b](#): 232)

Our aim should thus be to capture the parametric variation found in object marking across Bantu, and furthermore, to do so in a simple and motivated way. This brings us to the defective goals approach of object marking, which forms the basis of the analysis of object marking in this book.

### 1.3 Defective goals between agreement and incorporation

Roberts (2010) proposes an analysis of Romance complement clitics that is ‘hybrid’ between an account as pure agreement and an account as incorporated pronouns. He suggests that an Agree relation between the probing head and the goal phrase is always involved, but that the spell-out as a clitic depends on the structure of the goal.

For pronouns, the structure depends on the type of pronoun. Cardinaletti and Starke (1999) propose a distinction between strong pronouns, weak pronouns, and clitic pronouns. These differ in their structural size: strong pronouns have more structure than weak pronouns, which in turn project an extra layer with respect to the clitic pronoun. With Roberts (2010), I will assume Déchaine and Wiltschko’s (2002) structures of pro-forms, as given in (8). The difference in categorical status of these forms determines ‘their external syntax and their inherent semantics’ (Déchaine & Wiltschko 2002: 410).

Déchaine & Wiltschko (2002: 410)

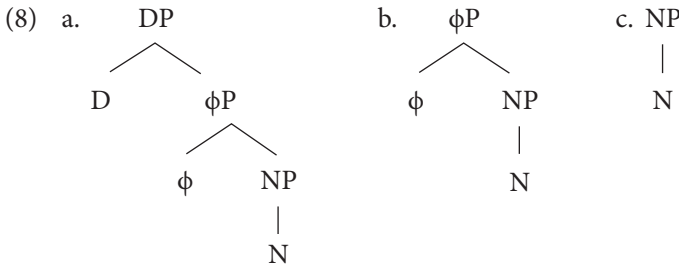

What is relevant in the current discussion is the external syntax of  $\phi$ P pronouns. Considering that these pro-forms only contain  $\phi$  features and no D feature, as soon as a  $\phi$ P values the features on a probe, the probe will contain the same valued features as the goal (and more). Furthermore, the goal does not contain any features that are not present on the probe. The goal in such a case can be said to be ‘defective’ with respect to the probe. Roberts formulates this as follows:

- (9) A goal  $G$  is defective iff  $G$ ’s formal features are a proper subset of those of  $G$ ’s probe  $P$ . (Roberts 2010: 62)



The consequence, as Roberts explains, is that there are two copies of the features: one set of features on the probe and one on the goal. This is reminiscent of the situation after phrasal movement, also resulting in two copies: one lower in the base position and one higher in the position it moved to. What normally happens in such a situation is the deletion of one of the copies ('chain reduction') so that the other copy is linearized and spelled out (see Nunes 2004). It is usually the higher copy that is spelled out. If the same features are present on the probe and the defective goal, and chain reduction takes place, the features will thus be spelled out on the (higher) probe.

This is illustrated in (11), taking the French object clitic *le* for concreteness, as in (10). The  $\phi$  probe on *v* probes the structure, matches with the object  $\phi$ P pronoun and agrees with it. Upon agreement, the  $\phi$  features on *v* are valued as third, singular, and masculine. Since the  $\phi$ P pronoun is a defective goal, the features are spelled out on the probe, *v*, as the clitic *le* 'him'.

French

- (10) Amélie *le* voi-t.  
 Amélie 3SG.M.PRO.ACC see-3SG.PRS  
 'Amélie sees him.'

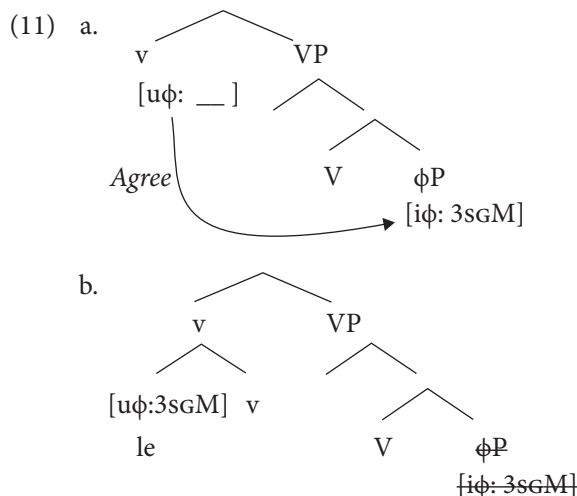

This also means that clitic placement is not due to EPP/movement features, but purely the result of Agree and general rules of copy spell out (plus language-specific rules determining proclisis or enclisis).

With this analysis, we can now understand why (12a, b) are grammatical, but (12c, d) are not. Assuming that in French *v* has a  $\phi$  probe, *v* will agree with the object in all four sentences. The difference is only in the structure of

the goal: If the object is a  $\phi$ P pronoun, as in (12b) and (12d), after Agree, the exact same features are present on *v* and the object (while *v* may have more features, e.g. [+V]). According to chain reduction, the highest copy survives and is spelled out, correctly predicting the appearance of the clitic as  $\phi$  on *v* (as in (12b)) and ruling out the appearance of  $\phi$ P in its base position (i.e. spell out of the lower copy is not possible, as in (12d)). If the object is a DP, on the other hand, the features on the goal do not form a subset of those copied on the probe (with the consequence that the object is not minimal and can hence not ‘incorporate’ into *v*), and hence this non-defective object DP is simply spelled out in its base position, as in (12a). This also shows that there is no EPP feature on *v* that would move the object to its specifier (12c).

French (based on Roberts 2010: 62)

- (12) a. Amélie voit Michel.  
 b. Amélie le voit.  
 c. \*Amélie Michel-voit.  
 d. \*Amélie voit le.

Roberts’ approach not only forms a unified analysis of the two types of object marking systems (agreement vs pronoun incorporation), as is shown in more depth in Chapter 2, but it also forms a conceptually very attractive model for language variation, as explained in Section 1.4.

## 1.4 Variation in features

Locating the variation in formal features, as Roberts does, has very interesting consequences for how we think of parameters (Section 1.4.1) as well as for the features involved (Sections 1.4.2 and 1.4.3).

### 1.4.1 Emergent features and parameters

If we postulate variation to only be in features (of the probe, the goal, or both), then crucially the Agree operation is always the same. This means that we can maintain two base operations in syntax as invariable: Merge and Agree operate in the same manner across all languages. This forms the invariable core of the language faculty.

There is another advantage to positing parametric variation just in the features and not in the syntactic operations: having one point of variation is desirable from the point of view of acquisition. This is a main motivation

behind the ‘Borer–Chomsky Conjecture’, which goes back to [Borer \(1984\)](#) and [Fukui \(1995\)](#), is adopted by [Chomsky \(1995\)](#), and formulated by [Baker \(2008b: 353\)](#) as follows:

(13) Borer–Chomsky Conjecture (BCC):

All parameters of variation are attributable to differences in the features of particular items (e.g., the functional heads) in the lexicon.

We know that items in the lexicon need to be acquired anyway, so adding (parameters of) syntactic features to the list of items that need to be acquired is a straightforward conceptual move (see [Roberts 2019](#) chapter 1 for further conceptual discussion of formal features and the BCC).

A next question is whether these features are part of UG, implying that all acquirers have access to these features and need to make a selection out of them ([Chomsky 2001](#)). This is not the most economical option, since not all languages make use of all features – consider, for example, a dual in number, or evidentiality, which only a subset of languages have as a grammatical(ized) feature. Additionally, while Minimalist analyses have assumed a universally given feature inventory (e.g. [Chomsky 2001](#)), we may wonder whether such a rich set of formal features is the best starting point. Staying in the minimalist spirit: as researchers we want to keep our theory as simple as possible, and only accept extra features in the model if the data requires us to do so.

We may well assume that language acquirers operate in the same way as minimalist researchers, the motto being ‘do not postulate any unnecessary features until the input requires it’. This leads to an emergentist approach to formal features, as proposed and developed by [Biberauer \(2011, 2017b, 2018ab, 2019\)](#), whereby features are only acquired if there is evidence for them in the primary linguistic data (PLD).

One type of data point that may provide the acquirer with evidence for formal features is the doubling of information ([Zeijlstra 2008; Biberauer 2018ab, 2019b](#)), as an instance of a ‘systematic departure from Saussurean arbitrariness, that is, one-to-one form:meaning mapping’ ([Biberauer 2019a](#)). This is what we observe in subject and object agreement: the same features are spelled out in two places (the DP and the verb) but there is only one semantic contribution. Morphological markers of syntactic agreement do not have a particular interpretation, and yet they are obligatory. This doubling of information provides the acquirer with a hint that something else may be present: a formal feature.

The first task for a language acquirer in setting the syntactic parameters for the language they are learning is thus to discover which formal features the language has. As soon as there is evidence for the presence of such a feature, for

example a Number feature, the language acquirer faces a second task: discover on which syntactic heads the feature is present. By this hypothesis, these two tasks are all that is needed for a successful parameter setting for any given language. This can be modelled as an acquisition algorithm, as proposed by [Biberauer and Roberts \(2015ab, 2017\)](#); see also [Bazalgette 2015](#)), guided by two cognitive biases: Feature Economy and Input Generalization:

- (14) Feature Economy (FE)  
Postulate as few formal features as possible to account for the input.
- (15) Input Generalization (IG)  
Maximize already-postulated features.  
([Biberauer 2019a](#): 59, 60; cf. [Biberauer & Roberts 2015b](#): 300; [Roberts & Roussou 2003](#); [Roberts 2007](#))

According to FE, a language acquirer will first assume the absence of all features. Only if the PLD provides evidence for the presence of a (grammaticalized) formal feature ([Zeijlstra 2008](#); [Biberauer 2017b, 2018b, 2019ab](#); [Longobardi 2018](#); cf. [Gianollo, Guardiano, & Longobardi 2008](#)) will a first parameter be set: Is a formal feature F present in the language? As soon as the feature is postulated ('yes'), IG will urge the acquirer to make maximal use of it. This is a second parameter: Is F present on all relevant heads? This will be set as 'yes', until the PLD provides counterevidence and the parameter setting needs further specification. From this point, further parameters establish which features determine the subset of heads on which F is present. We thus derive a 'none-all-some' order of implicational parameters and of parameter acquisition, as represented in (16). Parameters in this system are an emergent property of the grammar; see [Biberauer & Roberts \(2015ab, 2016\)](#); [Biberauer \(2017a, 2018b, 2019ab\)](#); and [Roberts \(2019\)](#) for a full explanation of emergent parameter setting, and further discussion on the three factors in language design.

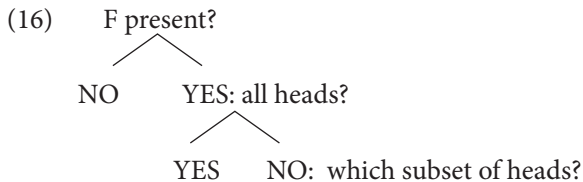

The dependency of parameters in this hierarchy can also be seen as modelling crosslinguistic parametric variation. An example is the hierarchy for word order ([Roberts 2012](#)), assuming that the default is for languages to be head-initial ([Kayne 1994](#)) and that head-finality is triggered by a feature moving the

complement to the specifier of the head containing the feature (Biberauer, Holmberg, & Roberts 2014):

(17) *Word order parameter hierarchy* (Roberts 2012):

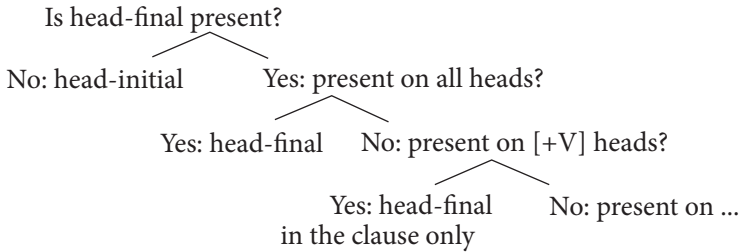

Any subsequent parameters are thus dependent on the setting of parameters higher in the hierarchy, and ultimately all are dependent on the initial parameter concerning the presence of the feature. This means that as soon as the PLD lacks further evidence to motivate another feature, or a different distribution of an existing feature, the algorithm (i.e. the acquirer) halts, and all further theoretical possibilities (i.e. all lower parameters) are not even taken into account. This makes for a much more economical system of parameters than earlier Principles and Parameters models. In earlier systems all parameters were supposed to be set for all languages, leading to an enormous number of possible combinations of parameter settings, that is, possible (but not attested) grammars (see Fodor & Sakas' 2017 overview). In contrast, the proposed parameter hierarchies drastically reduce the number of possible combinations of parameter settings, as shown by Roberts and Holmberg (2010); Sheehan (2014); Biberauer et al. (2014); and Roberts (2019).<sup>4</sup>

In summary, it is attractive to model dependent parameters in hierarchies. The reasons are that, first, the pathway is motivated by general learning biases, and second, such emergent parameters form a much more plausible model of parametric variation, as they reduce the number of possible grammars as well as the cognitive load of language learning. The model does so by, on the one hand, reducing the features to just those that the input requires to be present, and on the other hand stopping the algorithm at the earliest point (i.e. the fewest parameter settings) that the data can be accounted for. The parameter hierarchies crucially are built on formal features as the locus of crosslinguistic variation.

<sup>4</sup> The full impact of such restrictions on the combinations of parameter settings will only be known, however, if we also discover the relations *between* different hierarchies, as Theresa Biberauer rightly points out.

A next question is which formal features are relevant to agreement, and specifically to Bantu subject and object marking. I introduce two types of relevant features: related to nominal licensing (Section 1.4.2), and related to information structure (1.4.3).

### 1.4.2 Licensing/Case

The  $\phi$  features presented above have long been connected to the licensing of nominal expressions. Referring expressions cannot be placed randomly in the sentence but must somehow be licensed by connecting to a head in the clause. If that head is  $v$ , we may say that the phrase is licensed as an object, and when the head is T, the phrase is licensed as the subject. This requirement to connect to the clause can also be captured in features, and has been captured as a [Case] feature (Chomsky 2000; see Bobaljik and Wurmbrand 2008 for an overview of Case Theory and Case in Minimalism). There is an ongoing debate as to whether Bantu languages have Case at all, which I discuss in Chapter 3, Section 3.3.2. I assume that there is a universal requirement that arguments connect to the clause, and I use the traditional term ‘Case’ to refer to that licensing requirement.

Arguments thus have an uninterpretable [uCase] feature, and certain heads such as  $v$  and T have [iCase] to license the arguments in the clause. Since we have said that uninterpretable features probe the structure to find a matching feature, there is no reason to assume that [uCase] features behave differently, as Carstens (2016) convincingly explains. As soon as a [uCase] feature is present in the structure, it probes the structure it is merged to, in search for a matching [iCase] feature on a head. If it finds none, it stays active and keeps probing the structure as it is built up.

As a brief illustration of Carstens’ (2016) minimalistic probing, consider the derivation of a ditransitive construction. V merges with the Theme, which bears [uCase] and [i $\phi$ ]. Since there is no licensing [iCase] on V, the Theme stays active and as soon as the applicative head is merged, which does have an [iCase] feature, the Theme can be licensed, as in (18).

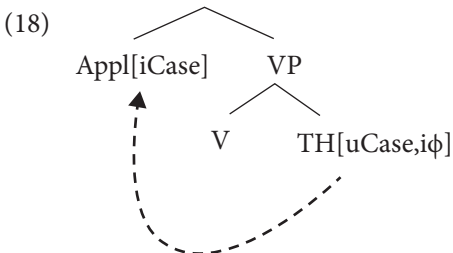

Then the next argument, the Benefactive, is merged, also with [uCase] and [ $\phi$ ]. The structure it is merged to no longer has an available licenser, as Appl is in a relation with the Theme. It therefore keeps probing and is licensed by [iCase] on *v*.

(19)

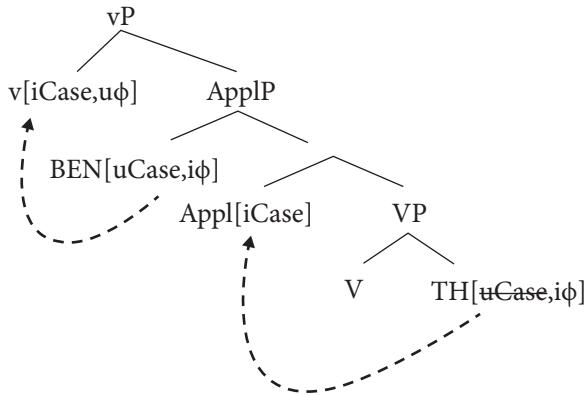

When the Benefactive has initiated a relation with *v*, and since *v* itself also has a probe, *v* can immediately value its  $u\phi$  features by agreeing with the  $i\phi$  features of the Benefactive, as in (20).

(20)

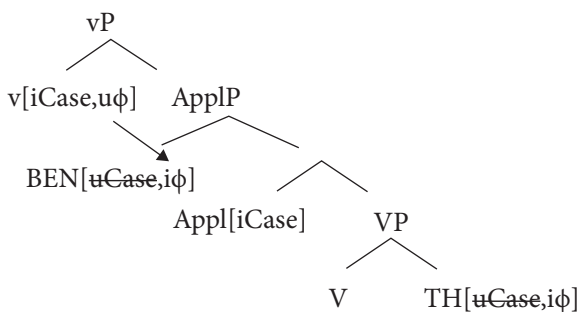

Although Case licensing and  $\phi$  agreement are logically speaking separate operations, we see how they tend to go together: as soon as there is a relation for one feature, the other feature will follow.<sup>5</sup> Case and agreement are therefore closely linked, as has been the assumption for decades. However, for [Chomsky \(2000\)](#), abstract Case was an ‘activity feature’ needed for the  $\phi$  probe to be able to agree with the goal, rather than a probe by itself. [Carstens \(2016\)](#) rectifies this and presents a consistent picture in which probes for  $\phi$  and Case features follow the same rules.

<sup>5</sup> This is reminiscent of [Bjorkman & Zeijlstra’s \(2019\)](#) approach involving checking and Agree, but there are fundamental differences – see Chapter 3, Section 6.4, as well as [Bárány & Van der Wal \(to appear\)](#) for discussion.

With this approach to licensing, it is possible that the Benefactive, is under certain circumstances, not licensed by *v* but by Appl. A typical instance is dative as an inherent case, when Appl assigns dative case to the Benefactive in its specifier (Woolford 2006; Cuervo 2003 for Spanish, among others). This is proposed for Spanish and Italian dative case, for example, where Appl standardly licenses its specifier. In Chapter 3, I propose that there are also languages in which Appl is flexible in licensing either an argument in its complement, or an argument in its specifier: either the Theme or the Benefactive can check its *uCase* feature against Appl's *iCase*, as represented in (21). The argument that is not licensed by Appl still has its [*uCase*] feature, which is then checked by *v*.

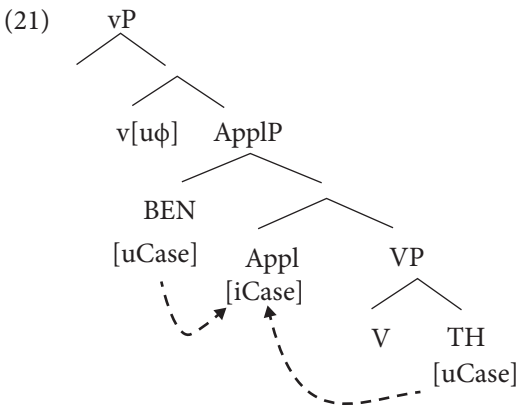

Variation in licensing and agreement can thus be captured in features: we have seen  $\phi$  and Case features, but which of the two arguments Appl licenses in the previous example is ultimately determined by the relative salience of the two arguments, as we shall see in Chapter 3. Can this salience be captured in features too?

### 1.4.3 Salience: Animacy and information structure

Salience can be understood as the inherent salience of the referent, and as discourse salience. The inherent salience relevant here is that related to animacy: humans are higher in salience than animals, which are more salient than inanimates. In Chapter 2, I explain how animacy can be captured as a [Person] feature. Discourse salience can also be captured in features, and it deals with information structure, of which I give a very brief overview here.

Informally speaking, information structure concerns the packaging of information to facilitate the hearer's processing of the information. The same



information may be presented as given, new, or contrasted, depending on the context. For example, ‘We ate pancakes’ is felicitous in different contexts than ‘It’s pancakes that we ate’, even if the propositional content is the same (involving ‘us’ and a pancake-eating event). Since information structure will turn out to be crucial in understanding both word order and verb agreement in Bantu languages, some further terms in information structure are first briefly explained here, before illustrating their relevance for subject and object marking.

Two key factors in information structure are the *information status* of individual referents, and the *function* they take in the clause as topic or focus (Lambrecht 1994). The information status concerns the activation of referents in the mind of the hearer: if you read the word ‘pancakes’ the mental representation of pancakes will ‘light up’ in your mind and become active. Referents may thus be more active or less active, or in other words the mental concepts may be more or less accessible. This accessibility status can be reflected in how they are referred to. For example, an active referent is easily referred to with a pronoun (‘we ate *them*’), whereas this is impossible for a brand-new referent, since in that case the hearer would not understand which referent is being referred to. See Prince (1981, 1992); Chafe (1976, 1987); Givón (1983, 1994); Gundel (1988); Gundel et al. (1993); Ariel (2001), among others, on the activation and accessibility of referents.

When referents are accessed in the mental lexicon, they have a particular activation status, and this may be reflected on the DP referring to that referent in the form of a formal feature. In Chapter 2, I propose that the feature [Person] can be associated with givenness (i.e. a position high on the accessibility scale), and in Chapters 3 and 4 we see how it can alternatively grammaticalize as the feature [Topic]. Both are what can be called ‘salience features’.

With respect to the information-structural function, referents can take up a *topic* or *focus* function. Topic is defined as ‘what the sentence is about’ (Reinhart 1981), or the referent that anchors the rest of the information in a sentence. The referent taking the topic function is typically the most active referent, but it must at least be accessible (i.e. cannot be brand new) to function as a stable anchor for the new information (Lambrecht 1994). The complement of the topic expression is the *comment*, which provides information about the topic. For example, if we have been talking about pancakes, then a next sentence might be ‘they were eaten by the cats’ – here, the topic expression is ‘they’, referring to the topic ‘the pancakes’, and the comment is ‘were eaten by the cats’, which provides information about the pancakes.

When a whole sentence is presented as one chunk of information, without a split between topic and comment, this is called a *thetic* sentence (see the

overview in Sasse 1996, 2006). Such a sentence does not contain a topic *expression*, although it can be said to have a topic *referent*, which is the ‘here and now’ (Gundel 1974; Erteschik-Shir 1997). Thetic sentences typically present a referent (‘Here’s Peter’ or ‘There was a cat on the shed’) or a situation (‘It’s warm today’), or they bring ‘hot news’ (‘The HOUSE is on fire!’) – see Lambrecht (1994); Sasse (1996, 2006); and Garcia (2016).

The *focus* of the clause is that part that provides new or contrastive information; semantically it is the part that triggers a set of *alternatives* (Rooth 1992, 1996). The focus is clearly visible in question–answer pairs: in a wh question, the wh word is itself a set of alternatives asking for which alternative the proposition is true (Hamblin 1973), and the answer to a wh question picks out one of those alternatives (without necessarily excluding the others). Exclusion of some or all of the alternatives results in *exclusive* or *exhaustive* focus, for example with the exhaustive focus particle ‘only’: in the sentence ‘we want only pancakes’, the focus is on ‘pancakes’, which triggers alternatives such as soup, chips, aubergines, etc. The particle ‘only’ then tells us that the predicate is exhaustively true for the focused referent ‘pancakes’ and false for all alternatives. Focus is in this way part of the semantics, but different ‘flavours’ of focus have been proposed that are part of the pragmatics: depending on the context in which a sentence is used, the (exhaustive or non-exhaustive) focus can be seen as replacive, corrective, contrastive, completive, selective, etc. (e.g. Dik 1997; see also Zimmermann 2008 on the semantic/pragmatic types of focus).

This is an extremely brief introduction to the main concepts of information structure (see further overviews in Krifka & Musan 2012; and Féry & Ishihara 2016), and we will see in this book that information structure influences Bantu word order and agreement, concluding that high accessibility, or topic-worthiness, can grammaticalize as a formal feature. This brings us back to the research questions for the current book: which precise formal features play a role in agreement phenomena, and how can these features explain crosslinguistic variation?

## 1.5 Bantu languages and their features

The Bantu languages form an ideal testbed for these research questions, because, as mentioned, they display a lot of variation while still being part of one (relatively uniform) language family. As Henderson (2011: 23) notes:

[. . .] work on African languages has reached the critical mass necessary to make insightful comparative work between African languages possible. I

think this is especially true of the Bantu languages, for perhaps no other language family possesses so many distinct languages that have so much in common syntactically. This makes comparison between these languages potentially very fruitful since it is relatively easy to seek explanation for variation while holding other syntactic factors constant.

Furthermore, because of their overall agglutinative nature, we can easily observe much of the variation in the segmental morphology. Specifically for this book, I concentrate on the following research questions (and see Sections 1.1 and 1.6 for broader and more specific aims):

1. Which features are involved in Bantu subject and object marking?
2. How can variation in those features account for the cross-Bantu variation?

In order to answer those questions, in this section I first present some further background on the Bantu languages (Section 1.5.1) and then discuss the features involved in word order and agreement (Section 1.5.2).

### 1.5.1 Bantu basics

The large amount of variation in Bantu is possible because the family is estimated to consist of more than 500 languages: 542 Narrow Bantu languages according to Ethnologue (online, 26/02/2019); 555 according to Hammarström (2019). These are spread from Cameroon to Kenya to South Africa, as in Map 1.1. The Bantu languages are referred to by their ‘Guthrie code’: Guthrie (1948) devised a classification of the family’s members by dividing them into mostly geographically based zones indicated by a letter, and numbering the languages within each zone and subzone. For example, Ndebele is S44, which gives us the information that it is spoken in the south, and that it is part of the Nguni languages (which are all S40). Throughout the book, the Guthrie code will be mentioned for each example (according to Maho’s 2009 updated Guthrie list).

For such a large language family, the basic typological characteristics are remarkably uniform. The large majority of languages can be said to have SVO basic word order (only Tunen having been argued as SOV; Mous 1997, 2005) with a large degree of flexibility; most languages are tonal, typically with a high versus low opposition; and all languages have a noun class system. That is, nouns are divided into classes (gender/number combinations) that are visible

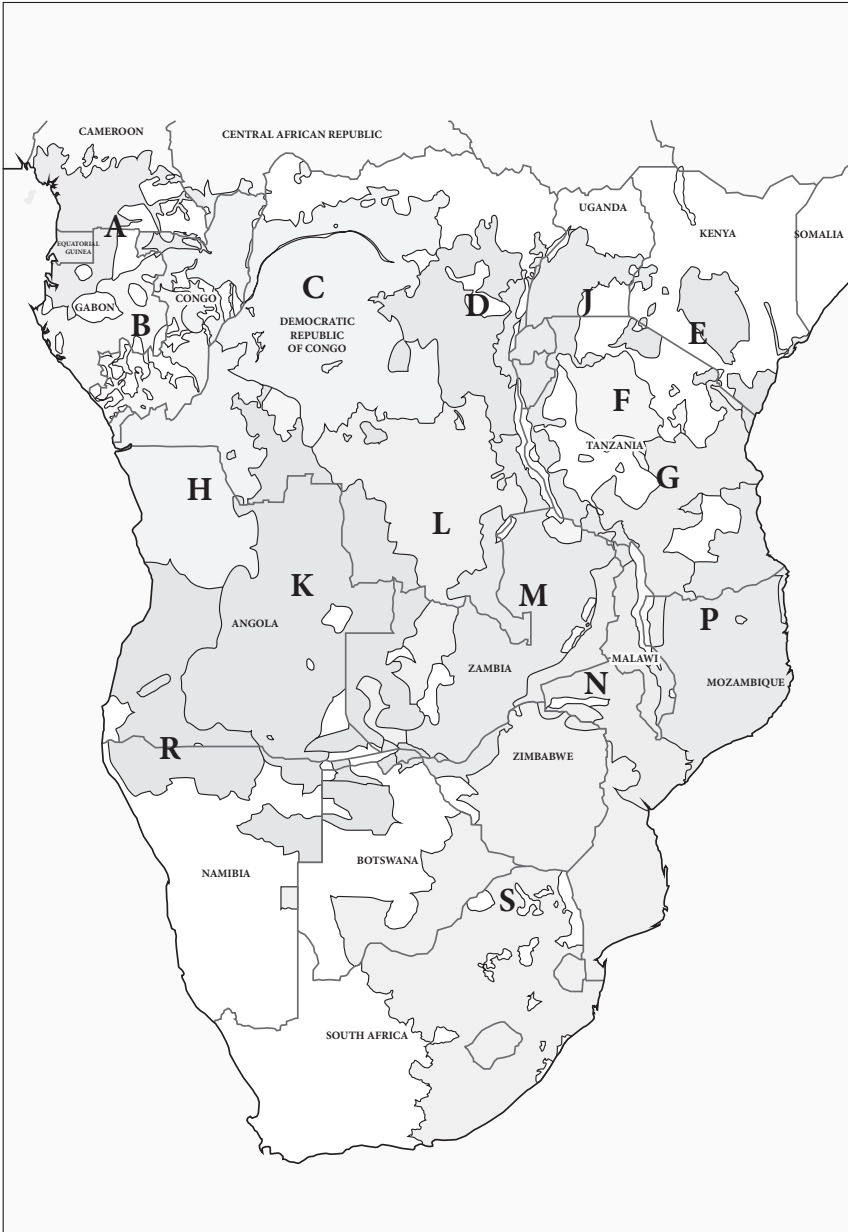

**Map 1.1** The Bantu languages in Guthrie's (1948) groupings, including Maho's (2009) update

in the shape of the (prefix on the) noun, its concord within the DP, and its agreement on the verb. This is illustrated again in the constructed sentence in (22): the noun *abaana* ‘children’ is in class 2 and determines concord on all modifiers as well as subject marking on the verb.

Nyakyusa (M31, [Persohn 2017](#): adapted from p.39, 60)

- (22) A-ba-ana            a-ba-lūmyana    a-ba-tupe    b-angu        ba-bili  
 AUG-2-children    AUG-2-boys     AUG-2-fat    2-POSS.1SG   2-two  
 ba-la                ba-ny-aag-ile.  
 2-DEM.DIST        2SM-1SG.OM-find-PFV  
 ‘These two fat sons of mine have found me.’

The majority of Bantu languages (with the exception of those in the north west) also show an agglutinative morphological structure, with extensive verbal morphology. Inflected verbs always consist of a subject marker, verb stem, and in most languages a final suffix, but may contain additional prefixes for tense/aspect inflection, one or more object prefixes, and derivational suffixes, as illustrated in the two verbs in (23).

Makhuwa (P31)

- (23) Mwi-ńńí-phéél-a        k-uu-túm-ŋh-er-é=ńńí  
 2PL.SM-HAB-want-FV    1SG.SM-2SG.OM-buy-CAUS-APPL-OPT=PLA  
 olávílávi?  
 14.trick  
 ‘Do you want me to sell you a trick?’  
 lit. ‘Do you want I make you buy a trick?’

For further general information about the Bantu languages and Bantu linguistics, I refer to the introduction and first chapters in [Nurse and Philippson’s \(2003\) \*The Bantu Languages\*](#) and its second edition by [Van de Velde et al. \(2019\)](#). Here I continue by discussing word order and agreement in a bit more depth.

### 1.5.2 Bantu word order and agreement – expressing information structure

In a canonical Bantu SVO sentence, the subject and object prefixes on the verb indeed agree with the referents that we think of as fulfilling the grammatical roles of subject and object. However, referents not only have a grammatical role, but also a semantic one, and, as we have seen in [Section 1.4.3](#), they may also take up an information-structural function. The referent *umúnyéeshuûri*

‘student’ in (24a) is thus not only the subject, but also the agent and the topic of the sentence, and it determines the agreement on the verb (*y-* in noun class 1). While there is a crosslinguistic tendency for subject, agent, and topic to map onto each other (Li & Thompson 1976), this need not be the case (as we already know from passives, where the patient is the subject). Sentence (24b) expresses the same proposition as (24a), involving a student and a school-going event, but differs in its information structure: the Locative argument *ishuûri* ‘school’ is the topic here, and the Agent ‘the student’ is in focus. In this locative inversion construction, the agreement on the verb is determined by the preverbal DP, which has the semantic role of ‘Goal’ and the information-structural function of ‘topic’. It also shows subject properties other than triggering agreement (Bresnan & Kanerva 1989; Ngoboka 2016 for Kinyarwanda) – see Chapter 4.

Kinyarwanda (JD61, Kimenyi 1980: 141, 142, adapted)

- (24) a. U-mú-nyéeshuûri y-a-gii-ye kw’ iishuûri.  
 AUG-1-student 1SM-PST-go-PFV to 5.school  
 ‘The student went to school.’
- b. Ishuûri ry-a-gii-yé=ho u-mú-nyéeshuûri.  
 5.school 5SM-PST-go-PFV=LOC AUG-1-student  
 ‘It’s the student who went to school’  
 lit. ‘The school went-to the student.’

The question that subject inversion constructions bring to the fore is whether agreement here is determined by the grammatical roles (that is, by traditional Case) or by topicality. This question is even more pressing for the patient inversion construction, as in (25b), which has been called ‘subject-object reversal’, suggesting a true change of grammatical role.

Kinyarwanda (JD61, Ngoboka 2016: 356)

- (25) a. A-bá-ana nti-ba-nywá i-n-zogá.  
 AUG-2-children NEG-2SM-drink AUG-9-alcohol  
 ‘Children don’t drink alcohol.’
- b. I-n-zogá nti-zi-nywá a-bá-ana.  
 AUG-9-alcohol NEG-9SM-drink AUG-2-children  
 ‘It’s the children who do not drink alcohol.’  
 lit. ‘Alcohol does not drink children.’

Exactly on this question, Morimoto (2006: 164) notes the following on the interaction of grammatical roles, information structure, and inversion constructions:

There are two possible solutions for the agreement pattern. The predominant solution has been to maintain the standard assumption about agreement that it licenses core argument functions such as subjects and (primary) objects. An alternative solution [...] assumes that no grammatical relation change takes place in S-O reversal. Rather, the agreement marker [...] is analyzed as a topic marker licensing the topical object.

The idea that topicality, or more generally information structure, plays an essential role in the grammar of Bantu languages<sup>6</sup> is not just visible in subject marking, but also object marking. Manyika Shona marks a non-agent as ‘given’ (Bax & Diercks 2012). Non-agents are typically part of the new information of a sentence, but when they are already known information, Manyika Shona marks this non-focused status on the verb: (26a) without the object marker is felicitous when the verb, the object, or the VP is in focus (as diagnosed by a contextualizing question), whereas (26b) with the object marker is only felicitous when the object is not included in the focus.

Manyika (S10, Bax & Diercks 2012: 191)

- (26) a. Tendai w-aka-wereng-a bhuku nekukasika.  
 1.Tendai 1F.SM-PST-read-FV 5.book quickly  
 ‘Tendai read the/a book quickly.’
- b. Tendai w-aka-ri-wereng-a bhuku nekukasika.  
 1.Tendai 1F.SM-PST-5OM-read-FV 5.book quickly  
 ‘Tendai read the (particular) book quickly.’  
 ✓ answer to ‘what did Tendai do with the book?’ (V foc)  
 \* answer to ‘what did Tendai do?’ (VP foc)  
 \* answer to ‘what did Tendai read?’ (O foc)

Information structure can thus be seen to play a determining role in both subject and object marking, at least in some Bantu languages. If crosslinguistic variation is located in the formal features (and their distribution), this suggests that agreement involves more than only  $\phi$  features and Case, specifically also features related to information structure. I explore in Chapter 3 how high accessibility, or topic-worthiness, can grammaticalize as a formal feature [Person] to account for differential object marking, or [Topic], determining flexible licensing.

<sup>6</sup> This was already recognized by Byarushengo & Tenenbaum (1976); Trithart (1979); and Wald (1979), to name some earlier sources; and see Downing & Hyman (2015); Güldemann et al. (2015); and Downing & Marten (2019) for overviews.

That information structure can be involved in agreement is not a new insight, and particularly Miyagawa's (2010) proposals concern this very question: how do  $\phi$  features and discourse features ( $\partial$ ) interact and vary across languages? There are three important differences between Miyagawa's approach and the one taken in this book. The first is conceptual: Miyagawa (2010) assumes Strong Uniformity, that is, all languages have the same features ( $\phi$  and  $\partial$ ), and he posits variation in their location (on C or T) as an explanation for crosslinguistic variation. As outlined in Section 1.4.1 and further explored in Chapter 5, I adopt and develop a model in which not all languages have all features, but features are emergent properties that language acquirers posit if the PLD provides enough evidence (Biberauer 2017a, 2018b, 2019ab). Languages may or may not have  $\phi$  features and/or formal features for salience (specifically, [Person] and [Topic]). Furthermore, some of the variation can be captured in dependent parameters that form implicational hierarchies.

A second difference with respect to Miyagawa is the empirical scope: Miyagawa considers subject agreement and complementizers in selected languages from across the world, whereas this book investigates subject and object marking, and does so in 75 Bantu languages. As a result, the family-internal microvariation analyzed in this book is more detailed.

Third, I take into account both sides of the relation between a phrase and a head in the clause:  $\phi$  features as well as Case features. Instead of directly associating salience features only with heads or with a  $\phi$  probe, I suggest that salience features may also affect licensing. Licensing heads that introduce an argument may have a Case feature that is sensitive to the salience of the argument it introduces. Associating salience features with licensing allows for a better understanding of the influence of salience (animacy and topicality) on word order, as well as syntactic processes such as the passive, subject marking, and (symmetric) object marking.

The precise challenges that the Bantu languages pose for a featural account of subject and object marking are outlined in the next section, along with the proposals to account for these phenomena, in a nutshell.

### 1.5.3 The Bantu challenges and the proposals

The first point of variation to account for is the long-standing debate on whether Bantu object markers are incorporated pronouns or grammatical agreement. The proposal is that both can be derived using the same mechanism



of Agree and defective goals introduced in this chapter, and that parametric variation is due to the structure of the DP: if [Person] forms its own projection on top of the DP, object marking will be doubling (= ‘agreement’). If it does not and [Person] is a feature on D, object marking is non-doubling (= ‘pronominal’). The feature [Person] also explains the patterns of differential object marking in Bantu languages, as it is related not just to first and second person, but also to third person for animacy, definiteness, and givenness. This is explained in detail in Chapter 2, capturing the wide range of variation attested in Bantu object marking with respect to doubling vs non-doubling object marking.

Two further points of variation in object marking relate to ditransitives: the symmetry of the two objects, and the number of object markers. A distinction can be made between languages with asymmetric object marking and languages with symmetric object marking. In asymmetric object marking, only the highest object (Benefactive/Recipient) can be object-marked, as illustrated in (27); in symmetric object marking, either object of a ditransitive can be marked, as shown in (28).

Chichewa (N31, [Mchombo 2004](#): 80, 83)

- (27) a. A-lenje a-ku-phík-il-á anyáni zí-tumbûwa.  
 2-hunters 2SM-PRS-cook-APPL-FV 2.baboons 8-pancakes  
 ‘The hunters are cooking pancakes for the baboons.’
- b. A-lenje a-ku-wá-phík-il-á zí-tumbûwa.  
 2-hunters 2SM-PRS-2OM-cook-APPL-FV 8-pancakes  
 ‘The hunters are cooking them (the baboons) some pancakes.’
- c. \*A-lenje a-ku-zí-phík-il-á anyáni.  
 2-hunters 2SM-PRS-8OM-cook-APPL-FV 2.baboons  
 int. ‘The hunters are cooking them (pancakes) for the baboons.’

Zulu (S42, [Adams 2010](#): 11, adapted)

- (28) a. U-mama u-nik-e aba-ntwana in-cwadi.  
 1a-mama 1SM-give-PFV 2-children 9-book  
 ‘Mama gave the children a book.’
- b. U-mama u-ba-nik-e in-cwadi (aba-ntwana).  
 1a-mama 1SM-2OM-give-PFV 9-book 2-children  
 ‘Mama gave them a book (the children).’
- c. U-mama u-yi-nik-e aba-ntwana (in-cwadi).  
 1a-mama 1SM-9OM-give-PFV 2-children 9-book  
 ‘Mama gave the children it (a book).’

This variation too can be captured in features, specifically the features [Person] as related to animacy, and [Topic] as high in accessibility. I propose in Chapter 3 that in symmetric object marking, Case licensing by the applicative head Appl is sensitive to the animacy and topicality of the argument it introduces in its specifier (the Benefactive/Recipient). One way of implementing this is to take Person and Topic as values of Case ([iCase:top]). The featural values of the Benefactive and Theme then determine which object is licensed by Appl, leaving the other object to be licensed and agreed with by *v* in an active clause, or T in a passive. This is illustrated in simplified form in (29) and (30), where the arrows indicate uCase finding a licensing head. This is, in a nutshell, the theory of flexible licensing, still keeping the operation Agree invariable, and taking into account the interaction of Person and Topic with Case licensing and  $\phi$  features.

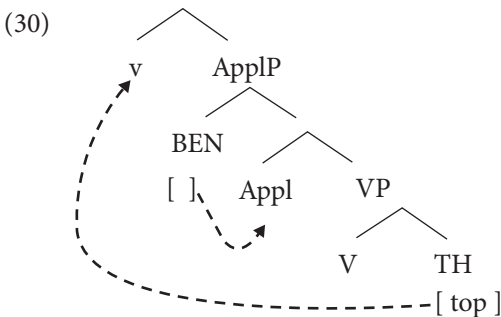
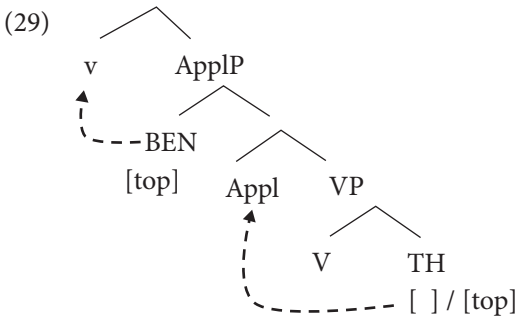

In fact, such flexible licensing may hold for all low functional heads that introduce an argument (high applicative, low applicative, and causative). Strikingly, however, we discover that language-internally, such heads can differ in their setting for this parameter, and moreover that there is an implicational relation: if in a given language higher heads are flexible and allow symmetric object marking, then lower heads must do so too, but not vice versa (Caus

> HAppl > LAppl). This is named the FLUID relation: Flexible Licensing Up Implies Down. Such variation between heads is easily captured in a flexible licensing approach, as the ability to license the specifier is determined for each head, but it is more troublesome in alternative accounts (e.g. relativized probing or equidistance). Flexible licensing thus accounts for the second point of variation, that between asymmetric and symmetric object marking.

A third parameter distinguishes between languages that allow only one object marker (31) and languages allowing more than one (32). This is captured in the parameter determining which heads have  $u\phi$  features: if both Appl and  $v$  do, then the language allows multiple object markers.

Tumbuka (N21, Jean Chavula, personal communication)

- (31) a. Wa-ka-cap-il-a                    **mwaana**    vyakuvwara.  
           2SM-T-wash-APPL-FV    1.child    8.clothes  
           ‘They washed clothes for the child.’  
       b. \*Wa-ka-vi-**mu**-cap-il-a.  
           2SM-T-8OM-1OM-wash-APPL-FV  
           int. ‘They washed them for him.’

Kinyarwanda (JD62, Zeller & Ngoboka 2015: 212)

- (32) a. Yahaaye ingurube ibijuumba.  
           a-a-ha-ye                    **i-n-gurube**    i-bi-juumba  
           1SM-PST-give-ASP    AUG-9-pig    AUG-8-sweet\_potatoes  
           ‘He has given the pig sweet potatoes.’  
       b. Yabiyihaaye.  
           a-a-a-bi-**yi**-ha-ye  
           1SM-PST-DJ-8OM-9OM-give-ASP  
           ‘He has given them to it.’

The presence of  $u\phi$  features on Appl has consequences for symmetry as well, as discussed in Chapter 3, and it forms part of a larger parameter hierarchy proposed in Chapter 5. The implicational relation between  $\phi$  features on T (subject marking),  $v$  (object marking), and Appl (multiple object marking) can fruitfully be modelled in such a parameter hierarchy, but crucially leaving  $u\phi$  on C as a separate parameter, as is shown in Chapter 5.

Apart from these three parameters concerning object marking (doubling, symmetry, number of object markers), I will also show that the flexible licensing approach provides interesting analyses for subject inversion, i.e. constructions in which the logical subject appears in a postverbal position, as

in (33b). Such postverbal ‘subjects’ are never interpreted as the topic, whereas any preverbal constituents, such as a locative, are topical.

Zezeru Shona (S12, [Harford Perez 1983](#): 142)

- (33) a. Mombe dz-áka-vát-á mú-mu-nda  
 10.cattle 10SM-PST-sleep-FV 18-3-field  
 ‘Cattle slept in the field.’
- b. Mu-mu-nda m-áka-vát-á mómbe.  
 18-3-field 18SM-PST-sleep-FV 10.cows  
 ‘In the field there slept cattle.’

The idea proposed and expounded in Chapter 4 is that *v*, as a licenser and an introducer of the external argument, will license the external argument in its specifier when it is non-topical – much like the applicative head licenses the Benefactive in its specifier when that is less topical than the Theme. As a consequence, we can understand (among other things) why non-topical subjects remain *in situ*, and how T can probe past the already-licensed external argument to agree with a locative (or other) topical constituent and move it to a preverbal position. The same mechanism of flexible licensing can thus be seen to apply on Appl as well as *v*.

Importantly, the crosslinguistic variation in all four areas (doubling, symmetry, number of markers, inversion) is accounted for as parameterization in the features of clausal heads and phrases, and not in the syntactic operations. Merge creates structures, Agree takes place when uninterpretable features encounter matching interpretable features (be that in their *c*-command domain or their specifier), and Locality is also kept constant: probe and goal only Agree if no other goals intervene between the two. This is important, as it has been shown time and again that ‘syntactic processes respect fundamental locality principles’ ([Rizzi 2013](#): 169). By keeping the Agree mechanism and Locality the same and investigating subject and object marking across Bantu languages, we can thus discover which precise features are involved in agreement, and which parameter settings can account for the attested variation.

## 1.6 Scope of the book

The approach taken here aims to combine typological findings and formal modelling, in line with [Baker and McCloskey \(2007\)](#); [Polinsky and Kluender \(2007\)](#); and [Baker’s \(2010\)](#) ‘formal typology’ (see also [Holmberg 2017](#)). For

me, the data are always the starting point – from the data, crosslinguistic tendencies and (im)possibilities are deduced, which then can be understood in a formal model of natural language syntax. The model in turn makes predictions that trigger new questions for both theory and data, leading to a further refinement of our understanding of both the unchangeable core and the variation in human language. One of the aims of this book is thus to show how fruitful formal typology can be for linguistic theory as a whole. It does so by bringing to light further crosslinguistic variation, as well as the limits to that variation, and explaining the patterns that are encountered in a systematic way.

Concentrating on subject and object marking, there are many morphosyntactic phenomena that fall outside the scope of the book. I mention three here. A first is DP-internal agreement. Bantu languages show concord within the DP, as already illustrated in (22) and again in (34), where the modifiers vary their prefix depending on the noun class of the head noun, in (34) in class 6.

Makhuwa (P31)

- (34) ma-khule oo-riipa ma-nceene ma-khaani a-le  
 6-mice 6-black 6-many 6-small 6-DEM.DIST  
 ‘those many small black mice’

There is discussion as to whether DP-internal concord and agreement in the clause involve the same mechanism; this question is left for other research, and the reader is referred to [Giusti \(2008\)](#); [Carstens \(2000\)](#); and the overviews in [Norris \(2017ab\)](#) for further information.

However, DP-internal structure is relevant for subject and object marking in a different way: in the proposed analysis, featural variation is located in both the clausal and the non-clausal domain, and I argue that we can only account for the complex variation attested if we take the interaction between these two into account. To mention just one example: there is variation in the presence of a  $\phi$  probe on the clausal head  $v$ , but this accounts only for the split between languages that have or lack object marking. Further variation within the languages that do show object marking is accounted for by the structure of the goal: only if the goal is a  $\phi$ P will the  $\phi$  features on  $v$  be spelled out as an object marker, and only if the goal has a separate  $\phi$  layer will object marking be ‘doubling’ (see further in Chapter 2).

A second phenomenon that is related but not covered here is agreement with conjoined DPs. Given their rich noun class systems, Bantu languages are very instructive in showing which arguments are accessible for agreement. [Mitchley \(2015\)](#) shows for Xhosa the different options of default agreement for animates

(35a) and inanimates (35b) when the verb agrees with a conjunction of two DPs.

Xhosa (S41, [Mitchley 2015](#): 114, 115)

- (35) a. I-polisa            ne-gqwetha    **ba**-ya-sebenza.  
           5-policeman    and.5-lawyer    2SM-PRS.DJ-work  
           ‘The policeman and the lawyer are working.’  
       b. Um-nqathe    ne-qanda    **zi**-se            tafile-ni.  
           3-carrot        and.5-egg    8/10SM-LOC    table-LOC  
           ‘The carrot and the egg are on the table.’

But last conjunct agreement also occurs in Xhosa, as illustrated in (36), where the second DP determines verb agreement, regardless of the featural specification (e.g. animacy).

Xhosa (S41, [Mitchley 2015](#): 117)

- (36) a. Izi-caka        n’        aba-pheki    ba-ya-pheka.  
           8-servants    and    2-cooks        2SM-PRS.DJ-cook  
           ‘The servants and the cooks are cooking.’  
       b. Aba-pheki    n’        ezi-caka        zi-ya-pheka.  
           2-cooks        and    8-servants    8/10SM-PRS.DJ-cook  
           ‘The cooks and the servants are cooking.’

For a minimalist analysis of these patterns I refer to Carstens (2019) who implements [Boskovic’s \(2009\)](#) analysis of conjoined NPs (see also [Marten 2000](#); and [Nevins 2018](#)). Whichever analysis is opted for to account for the default agreement and first or last conjunct agreement, I assume that the Agree system as proposed and discussed in this book will be compatible with it, and hence leave it aside for the rest of the book.

A third theme that does not receive (much) attention in this book is the augment. In various Bantu languages, the noun stem not only has a noun class prefix but also a ‘pre-prefix’ called the augment.

Lusoga (JE16)

- (37) a. a-ká-ghalá    ‘little girl’  
       b. e-cí-kópo    ‘cup’  
       c. o-mú-zí        ‘root’

Nouns can appear with or without the augment, and the circumstances under which the augment can be optionally absent have been linked to negation, indefiniteness, Case, and focus (illustrated in (38)).<sup>7</sup>

<sup>7</sup> The augment is typically obligatorily absent in denominal derivations (locative, compound), vocatives, and nominal predicates.

Luganda (JE15, [Hyman and Katamba 1993](#): 228)

- (38) a. Y-a-gúla            e-bí-tábó.  
           1SM-PAST-buy    AUG-8-books  
           ‘He bought books.’  
       b. Y-a-gúla            \_\_\_-bí-tábó.  
           1SM-PAST-buy    8-books  
           ‘He bought *books*.’

An overall generalization seems to be that augmentless nouns must appear inside the vP when their lack of augment is licensed on the clausal level ([Halpert 2013, 2015](#)), which Halpert takes to be an indication of nominal licensing. This is therefore an important aspect to investigate further in the context of licensing and information structure. However, before taking augments into account in a comparative study like the present one, more detailed description and analysis of individual languages is needed (see for example [Gambarage 2019](#)), and the augment does not form part of the core discussions here. I refer to the overviews on the augment in [Van de Velde \(2019\)](#) and Halpert (to appear) for further information.

A final related phenomenon not covered here is agreement in relative clauses and A-bar extraction. Some Bantu languages show anti-agreement in such cases, as illustrated for Kinande in (39). The normal subject marker for class 1 is *a-*, but if the subject is extracted as in the interrogative clause in (39b), the subject marker must be *u-*.

Kinande ([Schneider-Zioga 2007](#): 404)

- (39) a. Kambale    a-alangira    Marya.  
           1.Kambale    1SM-see    1.Mary  
           ‘Kambale saw Mary.’  
       b. Iyondi    yo    u-alangira    Marya?  
           who    REL    1SM.ANTI-see    1.Mary  
           ‘Who saw Mary?’

As we shall see, the phenomena discussed in this book concern primarily the A and not the A-bar domain, and hence I leave this as a topic for further study.

Having delimited the phenomena and theoretical approach to a featural account of Bantu subject and object marking, the aims of the book are as follows:

1. To provide a detailed description of the variation between Bantu languages in subject and object marking, in monotransitive and ditransitive clauses, along the following descriptive parameters:
  - a. doubling vs non-doubling object marking;

- b. single vs multiple object marking;
  - c. symmetric vs asymmetric object marking;
  - d. subject agreement in subject inversion with the preverbal element, postverbal subject, or default;
  - e. restriction of subject inversion to unaccusative, intransitive, or none.
2. To show correlations between these parameters (the RANDOM, the AWSOM, and the FLUID correlation).
  3. To propose a formal analysis of this variation, locating the parametric variation in the formal features.
  4. To show how information structure can form part of the grammar, specifically in the presence or absence of the features [Person] and [Topic].
  5. To show how formal typology can increase our understanding of the tension between linguistic variation and uniformity.

In order to reach these goals, the rest of the chapters are organized as follows, repeating in part the overview in Section 1.5.3.

Chapter 2 presents the defective goal approach to object clitics in more detail, and adds to the theory in order to capture the variation between object markers as incorporated pronouns or grammatical agreement. The proposal is that both can be derived using the same mechanism of Agree and defective goals, and that parametric variation is due to the structure of the DP: if [Person] forms its own projection on top of the DP, object marking will be doubling (= ‘agreement’), if it does not and [Person] is a feature on D, object marking is non-doubling (= ‘pronominal’). The feature [Person] also explains the patterns of differential object marking in Bantu languages, as it is related not just to first and second person, but also to animacy, definiteness, and givenness.

Chapter 3 extends the approach developed in Chapter 2 from monotransitives to ditransitives. It addresses two parameters regarding object marking: symmetry and number of object markers. The first parameter distinguishes between asymmetric languages in which only the highest object (Benefactive/Recipient) can be object-marked and symmetric languages in which either object of a ditransitive can be marked. This too we can capture in features, specifically the features [Person] and [Topic]. These are active on the applicative head Appl which introduces the Benefactive/Recipient and which licenses one of the objects. [Person] and [Topic] determine flexible licensing by Appl in symmetric object marking. The relative animacy and topicality of the two objects determines which object is licensed by a low functional head (such as Appl), leaving the other object to be licensed and agreed with by *v* in an active



clause, or T in a passive. A striking discovery is that not all low functional heads may have the same setting for this parameter, and moreover that there is an implicational relation: if higher heads (like Caus) are flexible and allow symmetric object marking, then lower heads (HAppl and LAppl) must do so too, but not vice versa. This relation is named ‘Flexible Licensing Up Implies Down (FLUID)’. The third parameter distinguishes between languages that allow only one object marker and languages allowing more. This is captured in the parameter determining which heads have  $u\phi$  features: if both Appl and  $v$  do, then the language allows multiple object markers.

The FLUID triggers the question of whether flexible licensing is also possible on  $v$ , and Chapter 4 shows that this is a fruitful analysis of subject inversion constructions. In languages where  $v$  is sensitive to topicality,  $v$  licenses an argument in its complement when the external argument in its specifier is topical (which it typically is), but  $v$  exceptionally licenses the external argument if this is non-topical. Possible lower arguments can then be agreed with and moved by T, resulting in XVS subject inversion constructions. Flexible licensing by  $v$  does not, however, form part of the FLUID, as it is independent of lower heads Caus, HAppl, and LAppl.

Chapter 5 brings the analyses in the previous chapters together, showing relations between parameter settings. The chapter first discusses the presence of  $\phi$  features on heads in the clause, showing that  $u\phi$  on Appl implies  $u\phi$  on  $v$ , which in turn implies  $u\phi$  on T, but that  $u\phi$  on C is independent of other heads. These dependencies can be captured in a parameter hierarchy that is motivated by general learning biases. The chapter then turns to the salience features [Person] and [Topic], showing the Relation between Asymmetry and Non-Doubling Object Marking (RANDOM). This relation is explained by the fact that both doubling and symmetry are parameters showing salience in the form of [Person] and/or [Topic], be it on the noun itself (doubling, Chapter 2) or in the clause (symmetry on Appl, Chapter 3): Bantu languages always provide evidence for the influence of salience in object marking, in one way or another. A further correlation is the Asymmetry Wants Single Object Marking (AWSOM) correlation, which shows that allowing multiple object markers implies symmetry (with the exception of Sambia). This too can be understood in the featural analysis from the perspective of acquiring emergent features.

The conclusion is that the featural approach taken in the book is not just conceptually more attractive than Strong Uniformity and Strong Modularity, and superior to the classical Principles and Parameters approach, but can really help us to understand the patterns of morphosyntactic variation encountered in a large language family showing much microvariation.

## Object marking defective goals

The aim of this chapter is to apply the defective goal approach to object marking in Bantu languages, and to account for the broad variation found within the language family.<sup>1</sup> A specific point of variation captured in this chapter is whether object marking is ‘doubling’ (where DP and object marker co-occur) or ‘non-doubling’ (where DP and object marker are in complementary distribution). Doubling object marking is always differential object marking, whereby typically the more animate and definite objects are marked, and that fact provides a clue to the analysis developed here. Three parameters will be identified: the first is whether *v* has a  $\phi$  probe at all (yes = object prefix, no = no object prefix), the second is whether Person forms a separate projection (yes = doubling object marking, no = non-doubling object marking), and the third parameter is whether Person associates with animacy, definiteness, and/or givenness. In order to see how the defective goal approach fares in capturing the data, however, I first explain some basics and assumptions of Bantu morphosyntax.

### 2.1 Bantu verbal morphosyntax

Bantu languages typically have agglutinative morphology,<sup>2</sup> which allows for a straightforward characterization of the linear make-up of the verb, and a relatively transparent mapping from the underlying structure. Bantu verbs consist of a root with inflectional prefixes and (mostly optional) derivational suffixes, ordered as in the simplified template in Table 2.1.

To illustrate, in the Swahili sentence in (1), the verb root is *-pik-* ‘cook’, from which the applicative is derived by the suffix *-i-*, introducing the Benefactive ‘children’. Then a passive is derived by the suffix *-w-*, making the Benefactive

**Table 2.1** Slots in the Bantu verb (cf. Meeussen 1967)

NEG/ FOC	subject	NEG	TAM	object	root	APPL, PASS, CAUS, etc.	final suffix	post-final

<sup>1</sup> A large part of this chapter is based on Van der Wal (2015b).

<sup>2</sup> Bantu languages in the north-west tend to be more analytical.

the subject. The verb is inflected for tense/aspect by the prefix *-li-* and for noun class of the subject (class 2 *wa-*).

Swahili (G42)

- (1) Wa-toto wa-li-pik-i-w-a ma-haragwe.  
 2-children 2SM-PST-COOK-APPL-PASS-FV 6-beans  
 ‘The children were cooked beans.’

Example (2) additionally illustrates the pre-initial negative slot *kh(a)-* in Makuwa, the object marker *-N-* (a homorganic nasal) between the tense/aspect marking (*-ni-*) and the verb stem, as well as the post-final slot, which can be filled by clitics such as in this case *=tho*, expressing repetition.

Makuwa (P31)

- (2) Kh-u-ní-ń-tsivela=thó ntékw’ áaw’ óole.  
 NEG-3SM-PRS-1OM-please=REP 3.work 3.POSS.1 3.DEM.DIST  
 ‘He doesn’t like his work anymore.’

While most inflected verbs fill three or more of these slots, only the root and the final suffix (better known as the final vowel) are obligatorily present. This is typically the morphology of the imperative, which shows the neutral suffix *-a*.

Digo (E73, [Nicolle 2013](#): 113)

- (3) Phiy-a!  
 go-FV  
 ‘Go!’

While the final suffix is needed for phonological reasons, i.e. to conform to the open CV syllabic structure of most Bantu languages, it is variable and can contribute meaning. Some conjugations do not take the neutral final vowel *-a*, but require a special inflectional suffix; for example the subjunctive or optative often has *-e*, as in (4a), and many languages have a suffixal reflex of the Proto-Bantu perfective suffix *-ide*, as in (4b) *-ire*.

Digo (E73, [Nicolle 2013](#): 114, 153)

- (4) a. Ni-phiy-e.  
 1SG.SM-go-SBJV  
 ‘Let me go / I should go.’  
 b. Ka-fik-ire.  
 NEG.1SM-arrive-PFV  
 ‘S/he did not arrive / has not arrived.’

This verbal morphology provides clear clues as to its underlying syntax. Following [Myers \(1990\)](#); [Julien \(2002\)](#); [Kinyalolo \(2003\)](#); and [Buell \(2005\)](#), and drawing on the explanation in [Van der Wal \(2009\)](#), I assume that the verb starts out in V and incorporates the derivational and inflectional *suffixes* by

head movement in the lower part of the clause. It then terminates in a position lower than T (unlike Ngonyani 2000; Wasike 2007; Zeller 2013, where the verb head-moves to a higher inflectional position such as Aux or T). The mid-level functional head where the verb lands has been identified as Aspect or Mood (Julien 2002; Kinyalolo 2003; Carstens 2005; Ngonyani & Githinji 2006). The inflectional *prefixes* on the verb represent functional heads spelled out in their base positions. The (derived) verb stem and the prefixes form one word by phonological merger.

To illustrate this derivation and provide evidence for it, consider first the Makhuwa example in (5) and the proposed derivation in (6). The verb stem *-oon-* ‘to see’, head-moves to CausP and incorporates the causative morpheme to its left: *-oon-ih-*. This combined head moves on to ApplP, incorporating a further suffix to its left: *-oon-ih-er-*. The next step adds the passive morpheme to form *-oon-ih-er-iy-* and this complex moves once more to add the final suffix. Since it clearly forms part of the inflection, the final suffix has been posited in an aspectual projection just above vP. Crucially, these are all suffixes, and they surface in reversed order of structural hierarchy.

Makhuwa (P31, Van der Wal 2009: 168–9)

- (5) Nlópwáná o-h-oón-ih-er-íy-á epuluútsá.  
 1.man 1SM-PFV.DJ-see-CAUS-APPL-PASS-FV 9.blouse  
 ‘The man was shown the blouse.’

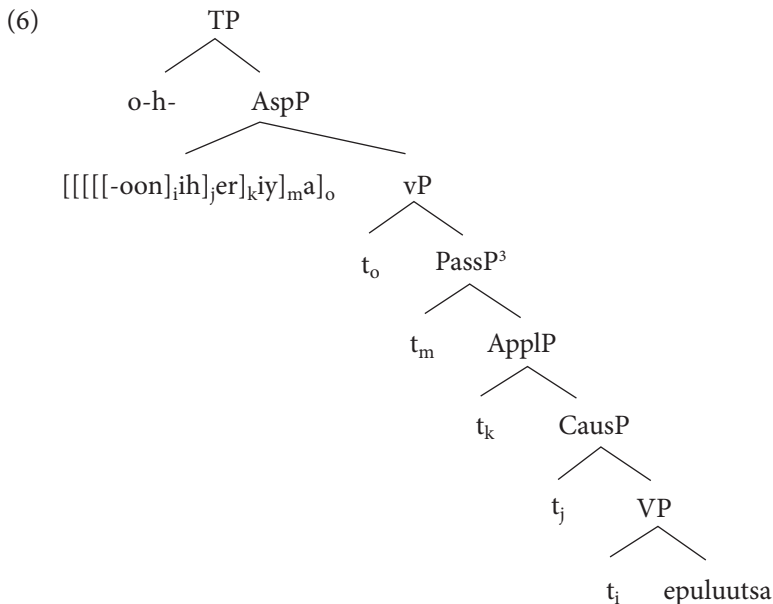

<sup>3</sup> The passive morpheme can also reside in a higher VoiceP (see e.g. Harley 2013); for the current point it does not make a difference.

There is no reason to assume that a moved head will first incorporate morphemes to its right (the extensions and final inflectional suffix) and then to its left (the agreement and TAM markers), in line with left-adjunction of morphology in head movement by [Kayne's \(1994\)](#) Linear Correspondence Axiom. Therefore, the fact that inflectional morphemes surface as prefixes strongly suggests that these are not incorporated into the verb in the same way as the derivational suffixes, and thus that the verb has not head-moved further in the inflectional domain.

Another argument for this analysis is found in the order of the prefixes, which matches the order of the corresponding syntactic heads, as shown in (7) and (8). This contrasts with the order of inflectional morphemes in a language like French, where there is independent evidence that the verb moves to T: the inflectional suffixes appear in the exact reverse order of the Makhuwa inflectional prefixes (9).<sup>4</sup> This is straightforwardly accounted for as a difference in verb movement (to T in French; to Asp in Makhuwa).

Makhuwa (P31, [Van der Wal 2009](#): 169)

- (7) Kha-mw-aa-tsuwéla.  
 NEG-2PL.SM-IPFV-know  
 'You didn't know.'

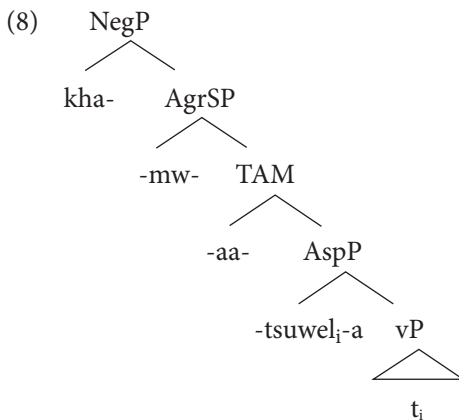

French

- (9) Nous aim-er-i-ons.  
 1PL.PRO love-IRR-PST-1PL  
 'We would love.'

<sup>4</sup> For expository purposes I have indicated the subject marker as AgrSP – I assume in the rest of this book that the subject marker spells out  $\phi$  features on T.

The verbal morphology of Bantu languages thus gives evidence for movement of the verb in the lower part of the clause to a position just outside of vP, with the prefixes spelled out in their individual positions in the inflectional domain.

As seen in the template in Figure 2.1, the object marker sits right between the derived verb stem and the inflectional prefixes. Despite its prefixal appearance, the object marker is different from the other prefixes such as the subject marker. The object marker and the verb stem still behave as one unit, together forming what is known in Bantu studies as the ‘macrostem.’ This is the unit to which tone rules and other phonological rules can apply, for example high tone assignment in Kuria (10): the first inflectional high tone is assigned to the first mora of the macrostem (rather than the stem), which can be the verb itself, or any of three object markers. Marlo (2013) provides an overview of languages that make use of the macrostem as the domain for tonal processes, and further evidence also comes from reduplication of the macrostem, for which see Hyman et al. (2008).

Kuria (JE43, Mwita 2008, via Marlo 2013: 162)<sup>5</sup>

- (10) a. òkò{[βérékèr-á]}  
 15{[call-FV]}  
 ‘to call’ (Mwita 2008: 7)
- b. òkò{mó[βén-èr-á]}  
 15{1OM[sing-APPL-FV]}  
 ‘to sing for him/her’ (Mwita 2008: 53)
- c. òkò{mó-βá[tèm-ér-á]}  
 15{1OM-2OM[beat-APPL-FV]}  
 ‘to beat him for them’ (Mwita 2008: 43)
- d. òyò{ké-βá-mù[rúm-ír-y-a]}  
 15{7OM-2OM-1OM[bite-APPL-CAUS-FV]}  
 ‘to cause them to bite it for him’ (Mwita 2008: 43)

The object markers are thus somehow special within the verbal morphology. This is captured in the analysis proposed in Section 2.2: object markers are the result of spell out of  $\phi$  features on v. These ‘verb-internal’ object markers are the focus of the current chapter and Chapter 3.

There are two closely related phenomena that will not be discussed in any detail in the current work, but that should be mentioned: reflexives and postverbal clitics. The reflexive marker occupies the same linear slot as the object marker in many Bantu languages, as illustrated for Makhwa in (11). As reflexives behave quite differently to object markers, they will not be analyzed

<sup>5</sup> Class 15 contains the infinitive forms of verbs. Consistent with Dahl’s Law (Hyman 2003b, 2019), the consonant is voiced in (10d) when the following consonant is voiceless.

in depth (but see Section 3.9 in Chapter 3; and see [Marlo 2015a](#); [Storoshenko 2009](#); and [Sikuku 2012](#) on reflexives).

Makhuwa (P31)

- (11) a. O-h-aá-thíkíla.  
           2SG.SM-PFV.DJ-2OM-cut  
           ‘You cut them.’  
       b. O-h-íí-thíkíla.  
           2SG.SM-PFV.DJ-REFL-cut  
           ‘You cut yourself.’

Also related are postverbal object markers, which show crosslinguistic variation: either the object pronoun is the sole possibility for pronominal objects, or it occurs in addition to prefixal object marking. The first is generally found more to the north-west of the Bantu area, as illustrated in (12) for Mboshi. These postverbal ‘object markers’ are actually independent pronouns ([Beaudoin-Lietz et al. 2004](#): 183), and I will analyze them accordingly.

Mboshi (C25, Fontenay 1989: 125, via [Beaudoin-Lietz et al. 2004](#): 184)

- (12) a. Wà á-pe bísí mbóngó.  
           he PST2-give us money  
           ‘He gave us money.’  
       b. Pé wa buá.  
           give him it  
           ‘Give him it.’

The second option (enclitics in addition to prefixes) is illustrated in (13) for Kifuliiru, where the recipient object surfaces as the object prefix *-ba-* and the Theme object as the enclitic = *kyo*.

Kifuliiru (JD63, [Van Otterloo 2011](#): 310)

- (13) É dáata u-ba-heerez-é=kyo.  
       o 1a.father 2SG.SM.SBJV-2OM-give-FV=7OM  
       ‘Oh my father, give it to them.’

In many languages such an object enclitic is restricted to the locative classes only, as for example in Lubukusu. Expressing a non-locative object as an enclitic would not be grammatical.

Lubukusu (J30, [Diercks 2011](#): 708)

- (14) a. Bá-sóréerí khé-bá-enja chí-ndemu mu-si-kuuri ...  
           2-boys PROG-2SM-look.for 10-snakes 18-7-field  
           ‘The boys looking for snakes in the field ...’  
       b. ... bá-a-chí-nyóla-mo.  
           2SM-PST-10OM-find-18LOC  
           ‘... they found them (in) there.’

While these object enclitics are obviously interesting, and in some cases relevant to the general discussion about object marking, they will not be discussed in the current work, because the status of these enclitics is not always clear (showing pronominal behaviour, partitive readings, extraction sensitivity, etc.) and because the pre-stem object markers provide enough material to analyze (as agreement) already. For a comparative overview of these enclitics, see [Beaudoin-Lietz et al. \(2004\)](#); and [Marlo \(2013\)](#), and for a theoretical analysis, see [Diercks \(2010\)](#); [Carstens & Diercks \(2013\)](#). With the terms ‘object marking’ or ‘object markers’, then, in the current work I mean the prefix referring to an internal argument, not enclitics or independent pronouns.

## 2.2 The defective goal approach in Bembe

In Chapter 1, the general analysis of clitics as agreement with defective goals was outlined. As mentioned, I assume an Agree relation between a functional head with uninterpretable  $\phi$  features (the probe) and a phrase with matching interpretable  $\phi$  features (the goal). If the features of the goal are a subset of the features on the probe, the shared features of the two are indistinguishable from a movement chain, where only the highest position is normally spelled out. In this configuration the features are spelled out on the probe, resulting in an agreement marker on the verb.

Concretely for object marking, this can be seen as follows. Little *v* has uninterpretable unvalued  $\phi$  features ( $u\phi$ ), which probe down to find an internal argument (object) with interpretable valued  $\phi$  features ( $i\phi$ ). If the object goal is a defective pronoun (a  $\phi$ P), the goal’s nominal features are a subset of the probe’s. Agree is established, and the  $\phi$  features are spelled out on *v* in the form of an object marker.<sup>6</sup>

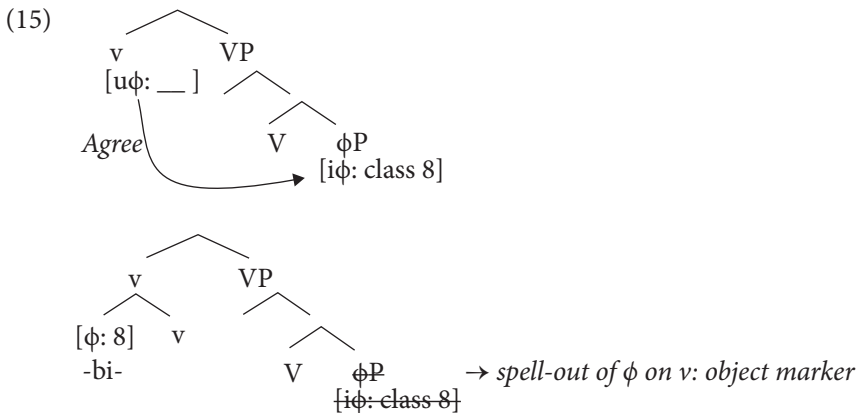

<sup>6</sup> Technically, it is the ‘compiled’ verbal complex head ending up in Asp that carries the  $\phi$  features, and their spelling out as a prefix is due to the impossibility of inserting morphemes into the complex head.



This also implies that if the goal's features are *not* a subset, the features will not be spelled out on the probe. If the goal is a DP, the probe simply agrees with it, but the goal will not be a copy and so the features will not be spelled out on the probe – instead the DP itself is spelled out.

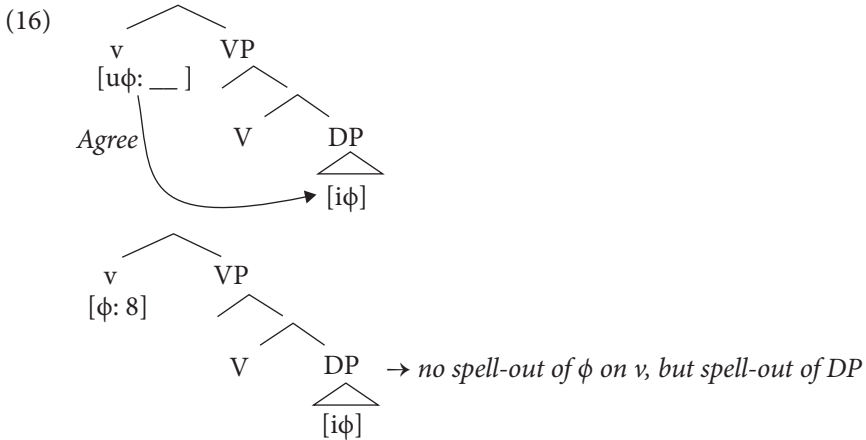

The analysis makes the clear prediction that either the valued probe will be spelled out, resulting in an object marker on the verb, or the goal is spelled out, resulting in the DP object appearing in full. This prediction is true for some languages, such as Bembe, but not others, as presented in Section 2.3.

Iorio (2014) applies Roberts' (2010) proposal and shows that it makes all the right predictions for the Bantu language Bembe. The object marker and the full DP object are indeed in complementary distribution: whenever both are present in the same sentence, the DP can be shown to be dislocated. The  $\phi$ P is thus the true argument and the DP a dislocated adjunct (which is not in the c-command domain and will therefore not be a goal). The same kind of analysis is also proposed for Zulu by Cheng and Downing (2009). I refer to the DP object that is coreferent with the object marked on the verb as the 'coreferent DP'.

Iorio (2014: 210) advances a number of arguments to show that the coreferent object DP is in a dislocated position in Bembe. I repeat three of these here. First, there is an obligatory pause before the DP when it is object-marked on the verb, as shown in (17c), where the comma represents a phonological break.

Bembe (D54, Iorio 2014: 203)

- (17) a. Mwana a-a-(*\*ya-*)yak-a ngyoʔa.  
 1.child 1SM-T-9OM-kill-FV 9.snake  
 'The child has killed a/\*the snake.'

- b. Mwana a-a-\*(**ya-**)yak-a.  
 1.child 1SM-T-9OM-kill-FV  
 ‘The child has killed it.’
- c. Mwana a-a-**ya-**yak-a \*(,) ngyo?a.  
 1.child 1SM-T-9OM-kill-FV 9.snake  
 ‘The child has killed it, the/\*a snake (that is).’

Second, the coreferent DP cannot be indefinite or focused, nor can it be a negative polarity item (18). These are typical properties that *in-situ* arguments can have, but that are banned for topical dislocated DPs (Rizzi 1986; Baker 1996, 2003). The ungrammaticality would thus be expected under a dislocation analysis.

Bembe (D54, Iorio 2014: 205)

- (18) Shi-na-a-\*(**m-**)mon-a mtu.  
 NEG-1SG.SM-T-1OM-see-FV 1.man  
 ‘I have not seen anybody.’

Third, the coreferent DP cannot precede non-object-marked objects and adverbs (19), suggesting that it is not in its base position but adjoined to vP.

Bembe (D54, Iorio 2014: 209)

- (19) a. Ba-\*(**bi-**)koch-ile bilewa elya ekolo.  
 2SM-8OM-buy-PST 8.food 9.DEM.DIST 9.night  
 ‘They bought food yesterday.’
- b. Ba-\*(**bi-**)koch-ile elya ekolo \*(,) bilewa.  
 2SM-8OM-buy-PST 9.DEM.DIST 9.night 8.food  
 ‘They bought it yesterday, the food (that is).’

This shows that object DPs in Bembe are never locally ‘doubled’ by an object marker on the verb. As predicted in the defective goal analysis, whenever there is an object marker, the object argument is a  $\phi$ P pronoun whose features are spelled out on v, and possible co-occurring coreferent DPs are generated as adjuncts (Van der Spuy 1993). The DP adjuncts are taken to be right-adjoined to the vP, as shown for Zulu by Cheng and Downing (2009, 2012).

This analysis of object marking differs from other approaches where the object marker was taken to either be a reflex of an agreement relation between a head AgrOP above vP (for example, Julien 2002; Buell 2005; Riedel 2009), or an incorporated pronoun (for example, Zeller 2006; Bresnan & Mchombo 1987), as also discussed in Chapter 1. Roberts’ (2010) defective goal analysis

of object clitics forms an attractive hybrid approach between the two existing analyses.

Taking Roberts (2010) proposal of Agree with defective Goals as a point of departure, then, and considering the convincing analysis of Bembe object marking, the question is whether the defective goal approach can account for object marking across the Bantu languages. There is a large amount of variation in Bantu object marking (see the overviews in Marlo 2014, 2015b; Beaudoin-Lietz et al. 2004; Riedel 2009; Marten & Kula 2012), two aspects of which are discussed in this chapter. These are the challenges of local object doubling (Section 2.3) and differential object marking (Section 2.4).

### 2.3 Doubling

The neat complementary distribution of object marking and full DPs evidenced in Bembe is not replicated throughout the Bantu family. That is, in many languages object DPs and coreferential object markers can appear in the same domain. This is referred to as ‘local doubling’, since the object DP can be locally ‘doubled’ on the verb. Sambaa is one of the languages that has been argued to have local doubling of the object DP by an object marker (Riedel 2009).

In order to show that object marking in Sambaa is truly local doubling, it must be the case that the DP is in the same domain as the verb+OM, i.e. it is not dislocated as it is in Bembe. Riedel (2009) advances five diagnostics, showing that the doubled DP in Sambaa is not dislocated but *in situ*. First, object marking can be obligatory for some DPs and not others (20),<sup>7</sup> which would be unexpected if the presence of the object marker were determined by the object being a  $\phi$ P.

Sambaa (G23, Riedel 2009: 44, 46)

- (20) a. N-za-**mw**-ona                      Stella.  
           1SG.SM-PFV.DJ-1OM-see    1.Stella  
           ‘I saw Stella.’
- b. \*N-za-ona                             Stella.  
           1SG.SM-PFV.DJ-see    1.Stella  
           int: ‘I saw Stella.’
- c. N-za-(**chi**-)ona                    ki-tezu.  
           1SG.SM-PFV.DJ-7OM-see    7-basket  
           ‘I saw the/a basket.’

<sup>7</sup> Riedel (2009) identifies proper names, kinship terms, titles, and pronouns for first and second person as requiring object marking – it is preferred for humans, and possible for other animates.

Second, the *wh* word *ndayi* ‘who’, which is arguably *in situ*, must be doubled in Sambia, as shown in (21).

Sambia (G23, Riedel 2009: 155)

- (21) a. U-**mw**-ene                      ndayi?  
           2SG.SM-1OM-see.PFV.CJ    who  
           ‘Who did you see?’  
       b. \*U-ene                      ndayi?  
           2SG.SM-see.PFV.CJ    who  
           int: ‘Who did you see?’

Third, doubled DPs can follow a so-called conjoint verb form (as in (21)), which indicates the presence of a following (focused/non-topical) element in the same domain. This diagnostic is not further discussed or illustrated here, but see Riedel (2009); Buell and Riedel (2008) on the conjoint/disjoint alternation in Sambia; and Van der Wal and Hyman (2017) for a general overview of the alternation in Bantu.

Fourth, a pause is not necessary before the doubled DP (22a). This crucially contrasts with dislocated DPs, which are preceded by a pause (22b).

Sambia (G23, Riedel 2009: 66)

- (22) a. N-zà-í-óná                      ng’ombè.  
           1SG.SM-PFV.DJ-9OM-see    9.cow  
           ‘I saw the cow.’  
       b. N-zà-í-óná,                      ng’ombè.  
           1SG.SM-PFV.DJ-9OM-see    9.cow  
           ‘I saw it, the cow.’

Fifth, High Tone Spread applies between the (conjoint) verb and the object, whether the object marker is present or not, which also suggests that there is no phonological phrase boundary. This can also be seen in (22), where the first syllable of the object *ng’ombe* carries a low tone when it is dislocated (as in b), but a high tone when it is *in situ* (as in a).

Sambia thus clearly has doubling object marking, where the DP is the argument while the object marker is present too. This is unexpected under the defective goal analysis of object marking, according to which the object marker can only be spelled out if the goal is defective (a  $\phi$ P, not a DP). In other words, the analysis predicts complementarity of the object marker and the object DP, as in Bembe, rather than doubling as in Sambia. How can we account for the co-occurrence of the object marker and the DP object in the same domain?

Keeping the theory of Agree as it is, there must be something in the goal argument that is defective. The proposal is that the variation between non-doubling and doubling object marking is in the structure of the goal. In the case of doubling object marking we postulate that what the probe agrees with is not the whole DP. Instead, it agrees with an extra layer of  $\phi$  features on the goal (23). This extra layer has been proposed as part of a ‘big DP’ by Uriagereka (1995) and used by Cechetto (1999); Nevins (2011); Roberts (2010); and others, notably for Manyika object marking by Bax and Diercks (2012).<sup>8</sup>

(23) Extra layer of  $\phi$  on DP

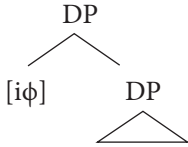

The goal for  $v$ 's probe is now the extra layer of  $\phi$  features, not the whole DP. As these  $\phi$  features are a subset of the features on the probe, they will be spelled out as an object marker, while still leaving the (lower) DP to be spelled out as well, resulting in doubling, as represented in (24).

(24) Agree in doubling:  $v$  agrees with the  $\phi$  layer, which has a subset of  $v$ 's formal features, thus  $\phi$  is spelled out on  $v$  and DP is also spelled out

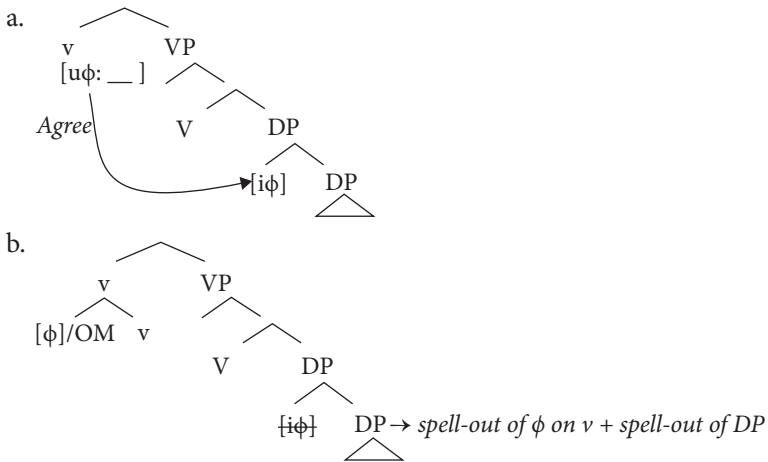

Suggestive evidence for the extra layer of  $\phi$  features is the similarity in morphological shape between the object markers, the independent pronouns, and demonstratives, which seems to hold across Bantu, and was observed as early

<sup>8</sup> In these approaches the extra layer is itself the object (or subject) marker.

Table 2.2 Luganda noun classes (Ashton 1954)

	Noun class prefix	Object Agreement	Independent pronouns	Demonstratives
1	mu-	mu-	ye	ono, oli, oyo
2	a-	ba-	bo	bano, bali, abo
3	mu-	gu-	gwo	guno, guli, ogwo
4	mi-	gi-	gyo	gino, giri, egyo
5	li-	li-	lyo	lino, liri, eryo
6	ma-	ga-	go	gano, gali, ago
7	ki-	ki-	kyo	kino, kiri, ekyo
8	bi-	bi-	byo	bino, biri, ebyo
9	N-	e-	yo	eno, eri, eyo
10	N-	zi-	zo	zino, ziri, ezo
11	lu-	lu-	lwo	luno, luli, olwo
12	ka-	ka-	ko	kano, kali, ako
13	tu-	tu-	twe	tuno, tuli, otwo
14	bu-	bu-	bwo	buno, buli, obwo
15	ku-	ku-	kwo	kuno, kuli, okwo

as 1876 by Endemann for Sotho. Note in Table 2.2 that the shape of the object marker is not necessarily identical or related to the noun class prefix on the noun. This suggests an origin of Bantu object markers as erstwhile preverbal pronouns that were reanalyzed as prefixes and in some cases agreement markers, as Givón (1976) proposes (see Hyman & Duranti 1982; and Bentley 1995 for alternatives, and see Chapter 5). In the current analysis, it shows that the idea of object markers as a spell-out of an extra layer of  $\phi$  features on the object noun is plausible considering the (near-)identity in morphological shape of  $\phi$  features as expressed on independent pronouns and demonstratives.

Assuming a big-DP structure in languages with doubling object marking thus allows us to capture the variation between doubling and non-doubling object marking while keeping the Agree mechanism constant. This is attractive, because it leaves the core syntactic processes uniform (and perhaps universal) and attributes variation to properties of items in the lexicon. If this is on the right track, it already shows us that the variation cannot be located only on the syntactic heads/probes in the clause (concretely, the presence or absence of  $\phi$  features on  $v$ ), but the structure and featural make-up of the nominals/goals needs to be taken into account as well.

In Section 2.4 we need to delve deeper into the featural make-up of the goal, because in doubling languages it is never the case that *all* objects are doubled. As Nevins (2011: 952–3) notes: ‘Crosslinguistic variation in clitic doubling results from conditions on generating big-DP structures. For example, if only

definite or specific Direct Objects undergo clitic doubling, then only definite or specific DPs will be eligible to generate a big-DP structure.’ The challenge is thus to account not just for *how* DP objects can be doubled by an object marker – a question we answered by postulating a big-DP structure – but also *which* objects are doubled and which are not.

## 2.4 Differential object marking

Languages with doubling object marking display diversity as to which objects are marked. In these differential object marking systems, it is usually the animate, definite,<sup>9</sup> and/or given objects that are doubled by an object marker. For example, in Nyaturu, inanimate objects are never object-marked (25a, b) and animate objects are marked when they are definite (25c, e). Since proper names of people are always animate and definite, they are obligatorily marked (25c, d), whereas indefinite nouns remain unmarked (25f).

Nyaturu (F32, [Hualde 1989](#): 182, glosses added)

- (25) a. N-a-*onaa*            *kitabū*.  
           1SG.SM-PST-see 7.book  
           ‘I saw the book.’
- b. \*N-a-*ki*-*onaa*        *kitabū*.  
           1SG.SM-PST-7OM-see 7.book  
           int. ‘I saw the book.’
- c. N-a-*mū*-*onaa*        *Maria*.  
           1SG.SM-PST-1OM-see 1.Maria  
           ‘I saw Maria.’
- d. \*N-a-*onaa*        *Maria*.  
           1SG.SM-PST-see 1.Maria  
           int: ‘I saw Maria.’
- e. N-a-*mū*-*onaa*        *mwalimu*.  
           1SG.SM-PST-1OM-see 1.teacher  
           ‘I saw the teacher.’
- f. N-a-*onaa*        *mwalimu*.  
           1SG.SM-PST-see 1.teacher  
           ‘I saw a teacher.’

<sup>9</sup> There is a longstanding debate over what defines ‘definiteness’ (see the overview in [Abott 2004](#)). Since the latest insights show that, from a crosslinguistic point of view, definiteness should be analyzed as a spectrum between familiarity and uniqueness ([Ahn 2017](#); see also [Schwarz 2013](#)), I will not enter into this debate, and for each piece of data simply take the author’s description and/or translation as an indication of definiteness. Where relevant, the prototypical familiar and/or unique referent can be taken as ‘definite’, and as ‘specific’ if the speaker has a particular referent in mind.

Such differential object doubling triggers both empirical and theoretical questions:

1. Which objects are doubled in the various Bantu languages?
2. How can we account for differential object doubling while keeping the Agree mechanism constant?

In Section 2.4.1 I illustrate the variation attested in Bantu differential object marking, showing that referents high on the scales of animacy, definiteness, and/or givenness are marked. In Section 2.4.2 I propose an analysis making use of the feature [Person] as a marker of salience: only nouns high on the given scales have a [Person] feature, and this feature can form its own (big-DP) projection, allowing spell-out of both  $\phi$  on v and the DP (i.e. doubling).<sup>10</sup>

#### 2.4.1 Variation in differential object marking

The Nyaturu examples show that animacy and definiteness jointly play a role in this language, but the factors influencing object marking are not the same in every Bantu language. While I have not encountered a system in which only animate objects are object-marked,<sup>11</sup> languages have been reported to only be sensitive to definiteness, as illustrated for Chinnima Makonde (26) and Kimatuumbi (27).<sup>12</sup>

Chinnima Makonde (P23, Kraal 2005: 235, glosses added)

- |         |                       |          |                    |
|---------|-----------------------|----------|--------------------|
| (26) a. | Tu-yangata            | vayéeni. | <i>non-doubled</i> |
|         | 1PL.SM-help           | 2.guests |                    |
|         | ‘We help guests.’     |          |                    |
| b.      | Tu-va-yangata         | vayéeni. | <i>doubled</i>     |
|         | 1PL.SM-2OM-help       | 2.guests |                    |
|         | ‘We help the guests.’ |          |                    |

<sup>10</sup> See Morimoto (2002) for an OT account of Bantu differential object marking.

<sup>11</sup> Although object marking in Sambia is generally sensitive to more than just animacy, the question word ‘who’ requires object marking, as in (21), whereas ‘what’ does not. Since a wh question word is neither definite nor given, animacy seems to be the only factor for this particular example.

<sup>12</sup> Note that in these examples the benefactive object is in fact the primary object, as will be seen in Chapter 3 when we look at ditransitives.



Kimatuumbi (P13, [Odden 2003](#): 544, glosses added)

- (27) a. Ni-nolya                      baandu      yiimbe.                      *non-doubled*  
 1SG.SM-sharpen    2.people    knives  
 'I'm sharpening knives for people.'
- b. Ni-**ba**-nolya                      baandu      yiimbe.                      *doubled*  
 1SG.SM-2OM-sharpen    2.people    knives  
 'I'm sharpening knives for the people.'

An additional factor that comes into differential object marking is givenness (distinct from definiteness, although related). [Bax and Diercks \(2012\)](#) show that object marking in Manyika is not sensitive to definiteness or specificity, but triggered by non-focal objects (see also DOM for secondary topics in [Dalrymple & Nikolaeva 2011](#)). They show that object marking is felicitous only for a non-focused object DP: (28a) without the object marker is felicitous when the verb, the object, or the VP is in focus (as diagnosed by a contextualizing question), whereas (28b) with the object marker is only felicitous when the object is not included in the focus.<sup>13</sup>

Manyika (S10, [Bax & Diercks 2012](#))

- (28) a. Tendai    w-aka-werenga      bhuku    nekukasika.    *non-doubled*  
 1.Tendai    1F.SM-PST-read    5.book    quickly  
 'Tendai read the/a book quickly.'
- b. Tendai    w-aka-**ri**-werenga      bhuku    nekukasika.    *doubled*  
 1.Tendai    1F.SM-PST-5OM-read    5.book    quickly  
 'Tendai read the (particular) book quickly.'  
 ✓ answer to 'what did Tendai do with the book?' (V focus)  
 \* answer to 'what did Tendai do?' (VP focus)  
 \* answer to 'what did Tendai read?' (O focus)

Object marking can also be sensitive to a combination of factors, as seen previously for Nyaturu (25). Like Nyaturu, Matengo also shows sensitivity to both animacy and definiteness, but differs slightly in that object marking of animates is obligatory, illustrated by a proper name in (29), whereas inanimates are only object-marked when they are definite or specific (30).

<sup>13</sup> See [Bax and Diercks \(2012: 192\)](#) for arguments that doubling in Manyika cannot be captured in an analysis referring to specificity.

Matengo (N13, [Yoneda 2008](#): 111)

- (29) a. Lujúsi lu-a-mú-lumíti Kinûnda. *doubled*  
 11.bees 11SM-PST-1OM-bite.PFV 1.Kinunda  
 ‘Bees stung Mr Kinunda.’
- b. \*Lujúsi lu-a-lumíti Kinûnda. *non-doubled*  
 11.bees 11SM-PST-bite.PFV 1.Kinunda

([Van der Wal 2015b](#): 89)

- (30) a. Tu-bó-ichi méesa. *non-doubled*  
 1PL.SM-move-PFV 9.table  
 ‘We moved a table.’
- b. Tu-ji-bó-ichi méesa. *doubled*  
 1PL.SM-9OM-move-PFV 9.table  
 ‘We moved the/a specific table.’

Chichewa was claimed to be a non-doubling language by [Bresnan and Mchombo \(1987\)](#); with [Alsina and Mchombo \(1993\)](#); [Marten and Kula \(2012\)](#); as well as [Riedel \(2009\)](#) referring to these findings. However, it has been noted that these data are not uncontroversial: [Bresnan and Mchombo \(1987](#): 751, 764) already marked a doubled example with a question mark rather than an asterisk, suggesting further necessary research on ditransitives (with *in situ* object marking). Although doubling was not at the centre of [Baker’s \(1988\)](#) research, he noted that Chichewa allows optional marking of the applied object. Further, [Henderson \(2006\)](#) and particularly [Downing \(2018\)](#) also show that Chichewa certainly has doubling for human objects.

Chichewa (N13, [Downing 2018](#): 52)

- (31) a. Kodí ámányi a-ná-m-pátsá ndaní ma-lalaanje?  
 Q 2.mother 2SM-T-1OM-give 1.who 6-oranges  
 ‘Who did mother give the oranges to?’
- b. Amáaryi a-ná-m-pátsá nzáawo ma-lalaanje.  
 2.mother 2SM-T-1OM-give 1.her.friend 6-oranges  
 ‘Mother gave her friend the oranges.’

Swahili is typically described as having obligatory object marking for animates and object marking for inanimates when definite (e.g. [Riedel 2009](#)). However, on the basis of corpus research, [Seidl and Dimitriadis \(1997\)](#) show that in Swahili hearer-old referents are significantly more often object-marked than hearer-new referents, and that this factor correlates more strongly with object marking than definiteness. Similarly, [Mursell \(2018\)](#) argues that Swahili object marking is topic agreement (see also [Allan 1983](#); [Wald 1979](#)). Swahili can thus

be thought of as a language in which object marking correlates with animacy and givenness, rather than animacy and definiteness.

The properties that trigger object marking – animacy, definiteness, and givenness – are all high on the various hierarchies associated with ‘prominence/salience’ (Silverstein 1976; Duranti 1979; Aissen 2003; among others):

Aissen (2003: 437)

- (32) a. Animacy Scale  
Human > Animate > Inanimate
- b. Definiteness Hierarchy:  
Proper name > Pronoun > Definite NP > Indefinite specific NP  
> Non-specific NP
- (33) Gundel, Hedberg, & Zacharski’s (1993) Givenness Hierarchy  
in conscience > activated > familiar > uniquely identifiable  
> referential > type identifiable

For the current analysis this implies that object-marked/‘doubled’ objects have one or more properties on the high end of these hierarchies. This means that we now have two properties of doubled objects: they are high in salience, and they have a big-DP structure. These two requirements can be combined, I propose, in the presence of a separate [Person] feature.

#### 2.4.2 Salience of [Person]

Richards (2008, 2015) proposes that animacy and definiteness can be unified and accounted for by a [Person] feature. First and second person are always animate and definite, as represented in (34) and (35), and therefore, according to Richards (2008: 140), ‘only [+animate/+definite] nominals have an indeterminacy for Person, i.e. may be first or second or third person. Only animates and definites, then, require a person specification.’ See also Ormazabal & Romero (2007); Adger & Harbour (2007) for similar ideas.

- (34) Person-animacy

	Animate	Inanimate
1	✓	✗
2	✓	✗
3	✓	✓

## (35) Person-definiteness

	Definite	Indefinite
1	✓	✗
2	✓	✗
3	✓	✓

This means that third person indefinites and inanimates are characterized by the absence of [Person] in the syntax, but third person animates and definites have an (otherwise unspecified) [Person] feature. Thus, if a nominal has [Person], it can be either a first/second person, or it is an animate/definite third person. Richards proposes that languages can vary in the association of [Person] with the hierarchies of animacy, definiteness, or both, as schematically represented in (36).

(36) Person/animacy scale and Person/definiteness scale  
(Richards 2008: 141)

animacy	definiteness	
1 <sup>st</sup> , 2 <sup>nd</sup> person pronoun	1 <sup>st</sup> , 2 <sup>nd</sup> person pronoun 3 <sup>rd</sup> person pronoun	 [+Person]          [-Person]
animate pronoun/noun	definite noun	
inanimate pronoun/noun	specific noun	
	non-specific	

There are two questions that can be asked at this point, the first concerning the difference between animacy and definiteness as an inherent property of referents, and the second concerning how a scalar property can map to a binary feature. The latter is discussed in Section 2.4.3, and the former can be thought of as follows. While animacy is typically an invariable property of referents and their referring nouns, definiteness is not. Nevertheless, the mental representations of referents are at a certain level of activation, familiarity, and uniqueness, depending on the context situation and the preceding co-text. Upon selecting a referent and accessing its referring expression from the mental lexicon, then, this level translates into being marked for [Person] or not.

This also suggests that activation and familiarity that are not grammaticalized into definiteness may play a role, and hence that a third scale can potentially be added that [Person] can associate with: givenness. By definition, first and second person, as speech participants, are present in the discourse situation and therefore count as 'given'. This does not hold for third persons, which can be either given or new. Following the same reasoning as Richards

for animacy and definiteness, a [Person] specification is thus only necessary for given referents.

(37) Person-givenness

	Given	New
1	✓	✗
2	✓	✗
3	✓	✓

It may well be that ‘given’ is simply a substage of ‘definite’ and that they ultimately refer to the same property. If they turn out not to be, then the associated scale for givenness is taken to be (similar to) [Gundel et al.’s \(1993: 275\)](#) Givenness Hierarchy or [Ariel’s \(2001\)](#) Accessibility Hierarchy, which rank elements on the basis of their mental activation or accessibility.

(38) Person/givenness scale

in conscience		[+Person]
activated		
familiar		
uniquely identifiable		
referential		
type identifiable		[-Person]

In summary, the presence of a [Person] feature on a third person noun means that it is high on one or more of the scales of animacy, definiteness, and givenness. And these are exactly the properties of doubled/object-marked objects in the Bantu languages.

The insight that doubled objects have a Person feature can now be combined with the earlier assumption that doubling object marking involves a big DP with an extra layer. If doubled objects have an extra layer in a big-DP structure and they have a Person feature, could it be that the extra layer *is* the Person feature?

This is exactly what [Höhn \(2016, 2017\)](#) proposes independently: [Person] can either be present on D, or form a separate layer in the DP. Höhn uses this analysis to elegantly account for crosslinguistic variation in adnominal pronoun constructions (APCs), illustrated in (39), and the phenomenon known as ‘unagreement’, as in (40). In unagreement, a third person subject (here *oi foitites* ‘the students’) triggers first or second person agreement on the verb.

Greek (Höhn 2016: 560, 546)

- (39) *emeis oi foitites*  
 we DET.NOM.PL students  
 ‘we students’

- (40) *Oi foitites ftiaksate keik.*  
 DET.NOM.PL students made.2PL cake  
 ‘You students made cake.’

There are two types of languages with respect to APCs, Höhn shows. The first requires the presence of an article, as in (39) where both the pronoun *emeis* ‘we’ and the article *oi* must be present. The second is languages that do not allow the article to be present in an APC, as in (41).

- (41) Languages without unagreement (Höhn 2016: 559)
- |            |        |                   |                       |
|------------|--------|-------------------|-----------------------|
| <i>noi</i> | (*gli) | <i>studenti</i>   | [Italian]             |
| <i>nós</i> | (*os)  | <i>estudantes</i> | [European Portuguese] |
| <i>mi</i>  | (*a)   | <i>diákok</i>     | [Hungarian]           |
| we         | DET.PL | students          |                       |

Höhn draws the generalization that languages that require an article in the APC also allow unagreement, as seen in the grammaticality of (40), whereas the second type, which do not allow the article, also do not allow unagreement, as shown in (42).

(Höhn 2016: 547)

- (42) a. \*Gli *studenti lavoriamo molto.* [Italian]  
 DET.PL students work.1PL much  
 int. ‘We students work much.’
- b. \*Os *portugueses bebemos bom café.* [EP]  
 DET.PL Portuguese drink.1PL good coffee  
 int. ‘We Portuguese drink good coffee.’
- c. \*A *diákok megsütöttük a tortát.* [Hungarian]  
 DET students baked.1PL the cake  
 int. ‘We students baked the cake.’

Höhn argues that the two phenomena are related in the following way: the unagreement languages allow [Person] to form a separate layer, as represented in (43), whereas the other languages have no such layer and instead have [Person] on D, as represented in (44). Number forms its own projection, and Gender is a feature of n (see Fuchs & Van der Wal 2022).

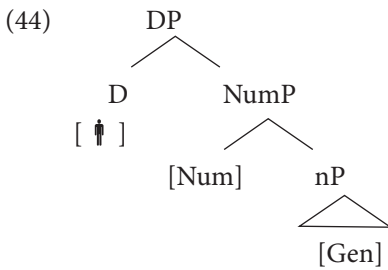
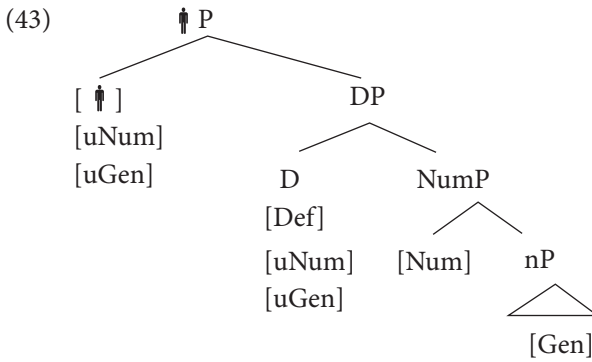

This has as a consequence that: 1. nominals in the unagreement languages have extra space to spell out both the pronoun (on Person) and the article (on D), and 2. they allow agreement with the separate [Person] layer, which may have a first or second person feature, while spelling out the full (third person) DP too, resulting in unagreement. Conversely, if [Person] is not a separate layer, the pronoun cannot be spelled out separately from the article, and agreement is with the whole DP, hence not allowing unagreement.

The properties on the lower heads in the DP are copied on the higher heads, resulting in a complete set of features on the Person head. This is necessary because unagreement has access not just to Person values (author/participant/third person) but also to Number. Höhn (2016, 2017) models this by DP-internal Agree relations, concretely in the form of a [uNumber] probe and a [uGender] probe on the Person head (see Danon 2011 for further discussion); an alternative is Norris' (2014, 2017ab) feature percolation.

In the same way, I proposed (Van der Wal 2015b) that doubled objects also have a separate Person feature. That is, first/second person and third person animate/definite/given nouns have a [Person] feature and hence the structure in (45), whereas third person inanimate/indefinite/non-given nouns do not; they have the structure in (46).

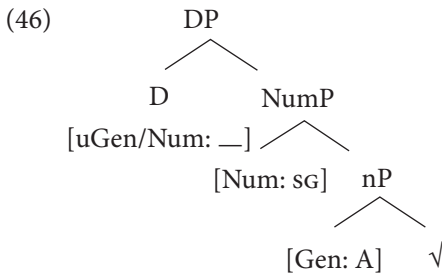
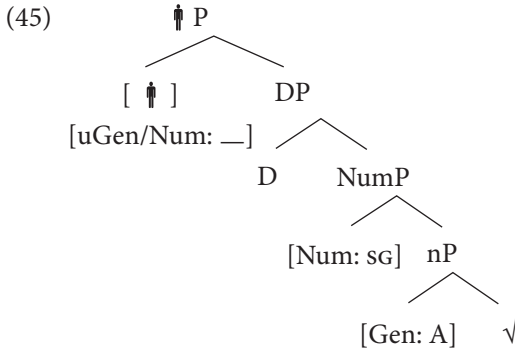

As in unagreement, object marking also spells out complete  $\phi$  features: not only [Person] but also Gender and Number (i.e. noun class, see [Carstens 1991, 1993](#)). This means that all features must be available on the goal, and specifically on the outer layer. Hence there are unvalued [uNumber: \_\_\_] and [uGender: \_\_\_] features on the Person head as well, which are valued in DP-internal agreement with the specification in the DP (on Num and n).

This then works as follows in object marking: the probe on  $v$  finds either an animate/definite/given object with the structure in (45), or an inanimate/indefinite/non-given object with the structure in (46). In the first case,  $v$  agrees with the outer [Person] layer and spells out both the object marker and the DP, whereas in the second case it agrees with the DP and does not spell out the object marker but just the DP.

In summary, I propose that in languages allowing local doubling of a core-ferring object marker and DP, the [Person] feature forms its own projection in the DP. This accounts for differential object marking. Doubling object marking never doubles all objects, but typically only the objects high on one or more of the hierarchies of animacy, definiteness, and givenness. The [Person] feature is shown to associate with precisely these features ([Richards 2008](#),



2015), which brings the variation back to a parameter in this [Person] feature. Combining that insight with the independently proposed parametric variation in the location of [Person] on D or in its separate projection (Höhn 2016, 2017) results in a featural account of differential object marking for the Bantu languages.

### 2.4.3 Cut-off points on the hierarchies

Being animate or being identifiable are not primarily linguistic features, but rather reflects (the cognitive organization of) properties of referents in the outside world. The animacy, definiteness, and givenness hierarchies are thus extra-linguistic, even though languages can and do refer to them, to a greater or lesser extent. This means that as a linguist and also as a language learner, one of the tasks in building a grammar is to figure out whether these hierarchies play a role, and if so, which part of the formal grammar is associated with them. This happens in the same way that language acquisition proceeds in general: establishing form–meaning mappings and deciding what is relevant in the grammar of the language being learnt.

It is thus to be expected that languages can differ in which hierarchies the [Person] feature connects to (as seen in Section 2.4.1), but in mapping a gradient scale to a binary feature, variation is equally expected in which point of the hierarchy they associate [Person] with. That is, languages have different cut-off points. As mentioned, upon selecting a referent and accessing its referring expression from the mental lexicon, the level of activation/definiteness translates into being marked for [Person] or not. But for some languages that level needs to be higher than for others. To illustrate, consider the various languages in which object marking is related to the definiteness hierarchy.

At the most restrictive end of the hierarchy are Chaga and Lubukusu. These are languages in which object marking is not possible for DP objects, but it is for pronouns, obligatorily in Chaga, and strongly preferred in Lubukusu.

Chaga (E62, Moshi 1998: 142)

(47) \*Mangí n-á-lé-m-zríká máná nyáma.  
 1.chief FOC-1SM-PST-1OM-send 1.child 9.meat  
 int. ‘The chief sent the child meat.’

Chaga (E62, [Bresnan & Moshi 1990](#): 151, glosses adapted)

- (48) a. N-á-í-m-lyí-í-à k-èlyá ò.  
 PROG-1SM-PRS-1OM-eat-APPL-FV 7-food 1.PRO  
 ‘He/she is eating food for him/her.’
- b. N-á-í-kì-lyí-í-à m-kà kyò.  
 PROG-1SM-PRS-7OM-eat-APPL-FV 1-wife 7.PRO  
 ‘He/she is eating it for/on the wife.’
- c. N-á-í-kì-m-lyí-m-à òó kyò.  
 PROG-1SM-PRS-7OM-1OM-eat-APPL-FV 1.PRO 7.PRO  
 ‘He/she is eating it for him/her.’

Lubukusu generally does not allow DP objects to be doubled (but see [Sikuku et al. 2018](#)), except for pronouns, which greatly prefer to be doubled.

Lubukusu (JE31c, [Sikuku et al. 2018](#): 360; and Justine Sikuku personal communication.)

- (49) a. N-á-mu-βon-a.  
 1SG.SM-PST-1OM-see-FV  
 ‘I saw him.’
- b. \*N-á-mu-βon-a Weekesa.  
 1SG.SM-PST-1OM-see-FV 1.Wekesa  
 int. ‘I saw Wekesa.’
- c. N-a-mu-βon-a niye.  
 1SG.SM-PST-1OM-see-FV 1.PRO  
 ‘I saw him.’
- d. ??N-a-βon-a niye.  
 1SG.SM-PST-see-FV 1.PRO  
 ‘I saw him.’

That this is truly doubling object marking can be seen in the relative order of object and postverbal adverb in (50): the object marking is present when the independent pronoun is right-dislocated (as indicated by its appearance after the adverb and the intonation break) as in (50b), but also when the object precedes the adverb and is thus in a constituent-internal position (50a). For clarity, in the former case (50b), the object is a  $\phi$ P pronoun, with the independent pronoun as an adjunct, whereas in the latter case (50a), the independent pronoun is *in situ*.

Lubukusu (JE31c, [Sikuku et al. 2018](#): 411)

- (50) a. N-á-xu-βon' eewe lukoolooβa.  
 1SG.SM-PST-2SG.OM-see 2SG.PRO yesterday  
 'I saw you yesterday.'
- b. N-a-xu-βona lúkólóóbá, ewe.  
 1SG.SM-PST-2SG.OM-see yesterday 2SG.PRO  
 'I saw you yesterday.'

One step down the definiteness hierarchy are languages where pronouns and a limited number of DPs need to be object-marked, as is the case in Sambia. Personal pronouns are obligatorily object-marked (51), and so are proper names, being typically definite (52).

Sambia (G23, [Riedel 2009](#): 45)

- (51) a. N-za-ku-ona iwe.  
 1SG.SM-PFV.DJ-2SG.OM-see 2SG.PRO  
 'I saw *you*.'
- b. \*N-za-ona iwe.  
 1SG.SM-PFV.DJ-see 2SG.PRO  
 int. 'I saw you/*you*.'

([Riedel 2009](#): 44)

- (52) a. N-za-mw-ona Stella.  
 1SG.SM-PFV.DJ-1OM-see 1.Stella  
 'I saw Stella.'
- b. \*N-za-ona Stella.  
 1SG.SM-PFV.DJ-see 1.Stella  
 int. 'I saw Stella.'

Other DPs, however, are only optionally object-marked.<sup>14</sup>

([Riedel 2009](#): 46)

- (53) a. N-za-(mw-)ona ng'wana.  
 1SG.SM-PFV.DJ-(1OM-)see 1.child  
 'I saw a/the child.'
- b. N-za-(ji-)ona kui.  
 1SG.SM-PFV.DJ-(5OM-)see 5.dog  
 'I saw a/the dog.'
- c. N-za-(chi-)ona kitezu.  
 1SG.SM-PFV.DJ-(7OM-)see 7.basket  
 'I saw a/the basket.'

<sup>14</sup> [Riedel \(2009\)](#) does not discuss the effect of optional object marking on the interpretation.

Sambaa does not have independent pronouns for third person referents, and demonstratives are used instead. As is usual for pro-drop languages, the presence of a free pro-form carries an emphatic meaning, as also seen previously in (51).<sup>15</sup>

- (54) N-za-(mw-)ona                      uja.  
 1SG.SM-PFV.DJ-(1OM-)see    1.DEM  
 'I saw *him/her*.'

In Nyaturu, obligatory object marking is further extended to include definite animate objects, as shown previously in (25) and repeated in (55). Inanimates cannot be marked (55a, b), proper names must be marked (55c, d), as well as pronouns (56), whereas other third person DPs receive a definite interpretation if they are object-marked (55e, f).

Nyaturu (F32, [Hualde 1989](#): 182, glosses added)

- (55) a. N-a-onaa                      kitabu.  
 1SG.SM-PST-see    7.book  
 'I saw the book.'
- b. \*N-a-ki-onaa                      kitabu.  
 1SG.SM-PST-7OM-see    7.book  
 'I saw the book.'
- c. N-a-mu-onaa                      Maria.  
 1SG.SM-PST-1OM-see    1.Maria  
 'I saw Maria.'
- d. \*N-a-onaa                      Maria.  
 1SG.SM-PST-see    1.Maria  
 int: 'I saw Maria.'
- e. N-a-mu-onaa                      mwalimu.  
 1SG.SM-PST-1OM-see    1.teacher  
 'I saw the teacher.'
- f. N-a-onaa                      mwalimu.  
 1SG.SM-PST-see    1.teacher  
 'I saw a teacher.'

<sup>15</sup> Note that this emphatic effect is independent of the accessible/given status of the first/second person pronoun.

(Hualde 1989: 192, glosses added)

- (56) a. N-a-ku-onaa.  
 1SG.SM-PST-2SG.OM-see  
 'I saw you.'
- b. N-a-ku-onaa                      veve.  
 1SG.SM-PST-2SG.OM-see    2SG.PRO  
 'I saw you.'<sup>16</sup>

Yet another step further down the hierarchy we find Ruwund, which obligatorily object marks proper names (57), definite DPs (58), but also specific DPs (59).

Ruwund (L53, Nash 1992: 565, via Woolford 2001)

- (57) a. \*ku-tàl              Yáav  
 15-visit              1.Yaav  
 int. 'to visit Yaav'
- b. ku-mu-tàl              Yáav  
 15-1OM-visit      1.Yaav  
 'to visit Yaav'

(Nash 1992: 565, via Riedel 2009: 61)

- (58) a. ku-yi-kàt              atùbu  
 15-4OM-like      4.dog  
 'to like the dogs'
- b. ku-kàt              atùbu  
 15-like              4.dog  
 'to like dogs'
- (59) a. ku-kimb              muntu  
 15-look.for      1.person  
 'to look for a/any person'
- b. ku-mu-kimb              muntu  
 15-1OM-look.for    1.person  
 'to look for a/the person' (specific)

All these languages contrast with non-doubling languages like Bembe and Xhosa, where not even strong pronouns can be doubled, unless they are dislocated as in (60b), and (61b) (visible in the disjoint verb form).

<sup>16</sup> I assume this free pronoun also has an emphatic reading, but nothing was indicated in the source example.

Bembe (D54, [Lorio 2014](#): 14)

- (60) a. Na-(*\*m*-)mon-ine      εwé.  
           1SG.SM-1OM-see-PST    1.PRO  
           ‘I saw him.’ or ‘I saw *him*.’  
 b. Ewe,      na-*\**(m-)mon-ine.  
           1.PRO    1SG.SM-1OM-see-PST  
           ‘Him, I saw (him).’

Xhosa (S41, Eva-Marie Bloom-Ström, personal communication)

- (61) a. Ndi-bona      yena      ngoku.  
           1SG.SM-see      1.PRO    now  
           ‘I see her/him now.’  
 b. Ndi-ya-m-bona      yena.  
           1SG.SM-DJ-1OM-see    1.PRO  
           ‘I see her/him.’  
 c. *\**Ndi-m-bona      yena.  
           1SG.SM-1OM-see    1.PRO  
           int. ‘I see her/him.’

For doubling languages, [Riedel \(2009](#): 52) thus comes to the following combined animacy/definiteness hierarchy, and locates languages on the following points in the hierarchy:

- (62) first/second person pronouns > proper names (Sambaa) > definite human common noun (Nyaturu) > specific human common noun (Ruwund) > non-specific human common noun > non-human animate common noun (Swahili) > inanimate common noun

That this is not a complete picture can already be seen in the fact that Ruwund also allows object marking of inanimate definite referents (see (58)). In fact, it may show that it is too simplistic to combine animacy and definiteness into one hierarchy. Nevertheless, in my account of featural variation, the variation along one or more hierarchies would come down to various cut-off points for which referents are associated with a Person feature, as follows.

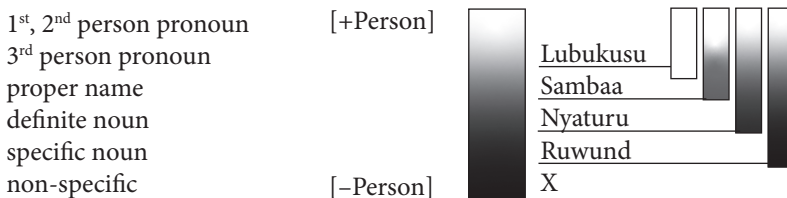

In summary, differential object marking in the Bantu languages can be accounted for by postulating a [Person] feature to be present and to form a separate layer on those object DPs (and only those) that are high on one or more of the hierarchies of animacy, definiteness, and givenness. The mechanism of Agree can then be kept constant, and the nature of the probe (little *v*) can as well. Moreover, bringing the variation back to just two features ( $\phi$  and Person) means that the analysis is in line with the Borer–Chomsky Conjecture (Baker 2008b): all parameters of variation are attributable to differences in the features of heads in the lexicon, and their bundling. Acquiring form–meaning mappings for content words is then quite similar to acquiring form–meaning mappings between a Person feature and a certain range of interpretations on one or more hierarchies. As explained in Chapter 1, this is an attractive view of parametric variation, since items in the lexicon need to be acquired by language learners anyway. This makes the task of setting parameters more straightforward and allows for a rather underspecified Universal Grammar.

## 2.5 Extending the analysis

The analysis so far makes some interesting predictions and brings up questions about other variation. One question is how to account for doubling object marking that is not determined by animacy or definiteness, as will be discussed in Section 2.5.1. I argue that object marking based on noun class is a reanalyzed system, which can still be captured by the Person feature. Making the separate layer of the Person feature responsible for doubling object marking makes two further predictions: first and second person objects will always be marked in a doubling language (as they always have a Person specification), and there is a relation with unagreement: languages that allow doubling (hence have a separate Person layer) are predicted to have object unagreement and languages that are non-doubling do not allow object unagreement. These predictions are discussed in Sections 2.5.2 and 2.5.3, respectively.

### 2.5.1 Reanalyzed Person

There are a small number of languages which restrict third person object marking to nouns in classes 1 and 2 only. Animacy, definiteness, and/or givenness

do not play any role for object marking in these languages whatsoever. A typical language with this system is Makhuwa, where all and only nouns in classes 1/2 (and first, second persons) must be object-marked; no object markers exist for the other classes (Stucky 1985), as illustrated in (63).

Makhuwa (P31, Van der Wal 2009: 84)

- (63) a. Ki-ni-**m̄**-wéha                      Hamísi     / namarokoló     / nancoólo.  
 1SG.SM-PRS.CJ-1OM-look   1.Hamisi   / 1.hare                 / 1.fish.hook  
 'I see Hamisi / the hare / the fish hook'
- b. \*Ki-m-wéhá                      Hamísi     / namarokoló     / nancoólo.  
 1SG.SM-PRS.CJ-look   1.Hamisi   / 1.hare                 / 1.fish.hook
- c. Ki-m-wéhá                      nveló       / mikhorá     / kalapinteéro  
 1SG.SM-PRS.CJ-look   3.broom   / 4.doors     / 5.carpenter  
 / etthepó.  
 / 9.elephant  
 'I see the broom / doors / carpenter / elephant.'
- d. \*Ki-ni-**m̄**-wéha                      nveló       / mikhorá     / kalapinteéro  
 1SG.SM-PRS.CJ-1OM-look   3.broom   / 4.doors     / 5.carpenter  
 / etthepó.  
 / 9.elephant

Many of the languages in Guthrie zone P have this system of object marking, for example Cuwabo (P34, Guérois 2015); Shimakonde (P23, Liphola 2001; Leach 2010); Kimatuumbi (P13, Odden 1984), but Lika (D201) is also reported to have object marking restricted to all and only class 1/2 (De Wit 2015: 409). If such doubling object marking is also the result of a Person feature on the doubled nouns, what does that Person feature associate with? I propose that classes 1/2 in these languages are reanalyzed as having a Person feature.

The Bantu noun classes can be analyzed as Gender (Carstens 1991, 1993; Ferrari-Bridgers 2008; Fuchs & Van der Wal 2022), with several Bantu noun classes forming singular–plural pairs. This is represented in (64), where the genders are labelled A–D.

(64) Bantu noun classes as genders (Carstens 1991)

	Singular	Plural
A	class 1	class 2
B	class 3	class 4
C	class 5	class 6
D	class 7	class 8



In the languages of zone P, I propose that [Person] has become associated with gender A. In Bantu languages in general, first and second person always fall under gender A, and a [Person] feature is hence only needed to distinguish within the 3<sup>rd</sup> person. The result is that a third person with a [Person] feature will belong to gender A. Only when [Person] is not specified/absent does [Gender] kick in to distinguish other third persons, as represented in (65).

(65) First/second person only in gender A, third person also in other genders

	A	B	C	D
1	✓	✗	✗	✗
2	✓	✗	✗	✗
3	✓	✓	✓	✓

The languages in zone P have reanalyzed the presence of a [Person] feature as belonging to gender A. From a diachronic perspective such a reanalysis is plausible, since the reconstructed Bantu gender A typically contained humans, i.e. high on the animacy hierarchy (Denny & Creider 1976; Claudi 1997). Furthermore, it would explain why we only find systems with restrictions to class 1/2 (Marlo 2015b) and not other classes as well: there are no languages where only class 5 and 6, or 9 and 10 can be object-marked, for example.

Just out of interest we may note that a similar restriction is found in Kiyaka (H31), where object-marking prefixes are restricted to first/second person and class 1/2 nouns (66a). Differently from zone P, however, Kiyaka allows other classes to be marked as an enclitic on the verb (66b). The status of the (prefixal and enclitic) object markers as doubling or non-doubling remains uncertain for Kiyaka.

Kiyaka (H31, Kidima 1987: 180, 182, 195, glosses adapted)

- (66) a. Tu-**n̄**-tel-elé                      Maafú.  
           1PL.SM-1OM-call-PST    1.Maafu  
           ‘We called Maafu.’
- b. Baaná            ba-suúmb-ídí=**kyá**            kití.  
           2.children    2SM-buy-REC.PST=7OM    7.chair  
           ‘The children brought the chair.’

## 2.5.2 Personal predictions

We have seen how the [Person] feature distinguishes between animate/inanimate or definite/indefinite third person nouns, and how positing this

feature as a separate projection in the DP accounts for the doubling object marking. But what happens with first and second person objects?

As expected, in non-doubling languages these are only marked on the verb if they are  $\phi$ Ps and hence can be spelled out on *v*. Therefore, the prediction is still that there is a complementary distribution between object markers and strong, independent pronouns in these languages (see (60) and (61) given earlier for third person pronouns). This is borne out in non-doubling languages like Zulu. If the object is a strong pronoun (i.e. a DP (Déchaine & Wiltschko 2002)), there is no subset relation and only the strong pronoun is spelled out, as in (67a). If the object is a weak pronoun (i.e. a  $\phi$ P) the features of the object are spelled out on *v* as an object marker, as in (67b). In the latter case, a strong pronoun can still be added, but only as a dislocated (adjoined) DP. This is shown in (67c), where the form of the verb and the phonological phrasing show that the strong pronoun *mina* is not part of the same phrase: the disjoint, constituent-final form of the verb marked by *-ya-* must be used (Van der Spuy 1993; Buell 2006), and the penultimate lengthening of the verb also indicates a right p-phrase boundary (Cheng & Downing 2009). It is ungrammatical to double the strong pronoun on the verb within the same domain, as attempted in (67d): when the conjoint form is used, object marking the strong pronoun results in ungrammaticality.

Zulu (Zeller 2011 and personal communication)

- (67) a. USipho u-thand-a mi:na.  
 1.Sipho 1SM-like-FV 1SG.PRO  
 ‘Sipho likes me.’
- b. USipho u-ya-ngi-tha:nd-a.  
 1.Sipho 1SM-DJ-1SG.OM-like-FV  
 ‘Sipho likes me.’
- c. USipho u-ya-ngi-tha:nd-a mi:na.  
 1.Sipho 1SM-DJ-1SG.OM-like-FV 1SG.PRO  
 ‘Sipho likes me.’
- d. \*USipho u-ngi-thand-a mi:na.  
 1.Sipho 1SM-1SG.OM-like-FV 1SG.PRO

The predictions are different for doubling languages. Considering that first and second person always have a [Person] feature, in these languages we expect first/second person pronominal objects to always be object-marked on the verb, whether they are weak pronouns or strong pronouns. Weak pronouns have a  $\phi$ P structure and can thus always be spelled out on *v* as an object marker, and strong pronouns have a DP structure with a separate Person layer, which

should always allow for doubling. This seems to be true for most doubling languages, as illustrated in the repeated examples in (68) and (69), although the data are not always available to establish it.

Sambaa (G23, [Riedel 2009](#): 45, see also p.140)

- (68) a. N-za-ku-ona                            iwe.  
           1SG.SM-PFV.DJ-2SG.OM-see  2SG.PRO  
           ‘I saw *you*.’
- b. \*N-za-ona                            iwe.  
           1SG.SM-PFV.DJ-see  2SG.PRO  
           int. ‘I saw you/*you*.’

Nyaturu (F32, [Hualde 1989](#): 192, glosses added)

- (69) a. N-a-ku-onaa.  
           1SG.SM-PST-2SG.OM-see  
           ‘I saw you.’
- b. N-a-ku-onaa                            veve.  
           1SG.SM-PST-2SG.OM-see  2SG.PRO  
           ‘I saw you.’
- c. \*N-a-onaa                            veve.  
           1SG.SM-PST-see  2SG.PRO  
           int. ‘I saw you.’

However, there are two exceptions here. One is noted by [Polak \(1986: 375\)](#) who reports on Bantu languages that lack some first/second person object prefixes (e.g. Nyali, [Harries 1959](#)). This can be seen as a superficial effect in the morphology, a gap in the paradigm. There is thus still an Agree relation between *v* and the object, but the spell-out is a zero morpheme without any overt phonological representation.

A second exception is found in Haya, where a first person strong pronoun is optionally doubled. Examples (70a, b) are expected under the current approach: either the first person object is  $\phi$ P spelled out as an object marker, or it is a big DP resulting in spell-out of both the extra Person layer as an object marker and the DP as a strong pronoun. Considering the position of the object preceding a temporal adverb in this example, [Riedel \(2009\)](#) analyzes Haya object marking as doubling.

Haya (JD22, [Riedel 2009](#): 72)

- (70) a. A-ka-m-bona                            ijo.  
           1SM-PST3-1SG.OM-see  dby  
           ‘He saw me the day before yesterday.’

- b. A-ka-m-bona            inye        ijo.  
 1SM-PST3-1SG.OM-see 1SG.PRO dby  
 ‘He saw *me* the day before yesterday.’

Unexpected under the current analysis is the grammaticality of (70c), where *only* the strong pronoun is present, without the object marker. If Haya has doubling object marking, this means that all (pro)nouns with a Person feature have an extra layer, agreement with which results in the spell-out of  $\phi$  features on the agreeing v head (i.e. object marking). Since a first person has a [Person] feature by definition, we expect an object marker, as in (70b).

- c. A-ka-bona        inye        ijo.  
 1SM-PST3-see 1SG.PRO dby  
 ‘He saw *me* the day before yesterday.’

Although no definitive solution can be given, it should be noted that the status of Haya as a doubling language is debated. Riedel (2009: 52) notes that object marking in Haya is never obligatory, and Byarushengo et al. (1976); Duranti and Byarushengo (1977) clearly analyze Haya as a non-doubling language. Furthermore, adverbs like ‘yesterday’ cannot reliably be used to establish the domain-internal/-external position of the coreferring DP (see Zeller 2012b: 223, 224 for Zulu object marking). Haya thus seems to be in a transition state from non-doubling to doubling (see further Chapter 5; Section 5.2.4).

### 2.5.3 Unagreement

The structural variation postulated as a difference between [Person] as a feature on D or projecting its own head (Höhn 2016, 2017) underlies both doubling object marking and unagreement. The two can thus be combined in the following way to form another prediction: Bantu languages that allow doubling object marking are taken to have a separate [Person] projection. Languages with a separate [Person] projection have been shown to allow unagreement and require the presence of an article in adnominal pronoun constructions (APC). Therefore, it is expected that Bantu languages with doubling object marking also allow unagreement in object marking,<sup>17</sup> and have articles in APCs. The second prediction is very difficult to test, since Bantu

<sup>17</sup> Subject marking is a different story – see Chapter 4 for assumptions about feature spell-out on T.

languages do not have articles.<sup>18,19</sup> The first is more straightforward, although it is still difficult to obtain data that show a clear answer. Preliminary data from Lubukusu and Kinyarwanda look promising, however.<sup>20</sup> As shown before in (49) and (50), Lubukusu doubles pronouns by an object marker, and in object agreement as in (71), the object marker is also present. Note that there is no prosodic boundary between the verb and the object, nor between the pronoun (when present) and the DP (Justine Sikuku, personal communication).

Lubukusu (JE31c, Justine Sikuku, personal communication)

- (71) a. Se-e-mu-subila (enywe) ba-ba-ami ta.  
 NEG-1SG.SM-2PL.OM-trust 2PL.PRO AUG-2-chiefs NEG  
 'I don't trust you chiefs.'
- b. Ba-khu-siima (efwe) ba-keni.  
 2SM-1PL.OM-love 1PL.PRO 2SM-visitor  
 'They love us tourists.'

Kinyarwanda, on the other hand, has non-doubling object marking (72). We thus expect unagreement to be ungrammatical, since objects do not have an extra layer whose features can be spelled out as an object marker. This is indeed borne out, as shown in (73), where the APC can occur as the *in-situ* object without object marker (73a), or if the object marker is present, the object needs to be dislocated (as seen in the use of the disjoint verb form with prefix *-ra-* and the comma intonation, in (73c)). This is likely a vocative use, as Georg Höhn points out.

Kinyarwanda (JD61, Zeller & Ngoboka 2015: 208; and Jean Paul Ngoboka, personal communication)

- (72) a. \*A-ba-gabo ba-gá-kuund-a a-ka-zi.  
 AUG-2-men 2SM-12OM-like-FV AUG-12-work  
 int. 'Men like work.'
- b. A-ba-gabo ba-kuund-a a-ka-zi.  
 AUG-2-men 2SM-like-FV AUG-12-work  
 'Men like work.'

<sup>18</sup> If the augment in a particular language can be shown to spell out (features on) D, then the presence of the augment in APCs could in that language be taken as evidence for a separate Person layer. This remains to be tested.

<sup>19</sup> Georg Höhn points out that Georgian is a language with unagreement and without articles (Höhn 2017: 217–18)

<sup>20</sup> The data reported here come from a small pilot study carried out together with Georg Höhn.

- c. A-ba-gabo ba-gá-kuund-a.  
 AUG-2-men 2SM-12OM-like-FV  
 ‘Men like it (i.e. work).’
- (73) a. N-ubah-a wowe mu-kire.  
 1SG.SM-respect-FV 2SG.PRO 1-rich.man  
 ‘I respect you rich man.’
- b. \*N-ku-ubah-a (wowe) mu-kire.  
 1SG.SM-2SG.OM-respect-FV 2SG.PRO 1-rich.man
- c. N-ra-ku-ubah-a, (wowe) mu-kire.  
 1SG.SM-DJ-2SG.OM-respect-FV 2SG.PRO 1-rich.man  
 ‘I respect you, (you) rich man.’

Further research is needed to confirm the predictions made by Höhn’s (2017) analysis.

## 2.6 Absence of object marking

A final consequence of the proposed analysis is that languages will have object marking as soon as they have a  $u\phi$  probe on  $v$  and a  $\phi P$  pronoun. It turns out that not all Bantu languages have a  $u\phi$  probe on  $v$  – some systematically lack object markers on the verb. Polak (1986: 374) lists the following languages as ‘*langues sans infixes*’, ordered by Guthrie zone:

- A. Bamileke, Bafia, Bankon, Fang, Lundu, Magisa, Benga, Noho, Bujeba
- B. Mbede, Ndumu, Duma
- C. Mbosi, Sogo, Linga
- D. Kare, Enya

To these, we can add at least Basaa (Hyman 2003a); Tunen (Mous 2003); Nyokon (Mous 2014); Eton (Van de Velde 2008), all in zone A. I illustrate the latter two here, showing that an independent pronoun surfaces in the canonical object position (postverbal for Eton, preverbal for Nyokon except focus).

Eton (A71, Van de Velde 2008: 139, 141)

- (74) Èèy vé mâ yó.  
 à-è:j L-vé H mà jǒ  
 1-FUT INF-give LT 1SG.NPPR 7.PRO  
 ‘He will give it to me.’

- (75) Íyðñ àyégłèngàná ñ kúnkúamá, ñágá àbèbgè ñé.  
 H ì-jɔŋ à-H-jégl-əngàná N-kúnkúamá  
 AUG 7-time 1-PI-imitate-G 3-chief  
 ñágá à-bɛb<g>à ñé  
 1.CPR 1-watch<G> 2.PRO  
 ‘While he was imitating the chief, the latter watched him.’

Nyokon (A45, Mous 2014: 77, 81)

- (76) M̃ ándwôm àmò ndá’ ñgé.  
 1SG sheep one give 2SG.OBJ  
 ‘I have given you a sheep.’
- (77) Ké kicá’ànòr pí vó lyès.  
 7.POSS.3SG 7.frog NARR 3SG.OBJ notice  
 ‘His frog notices him.’

As further explored in Chapter 5 (Section 5.1), the distribution of  $\phi$  probes can be seen as a parameter of crosslinguistic variation at various levels, and I take the absence of verbal object markers to reflect the absence of a  $\phi$  probe on *v*.

## 2.7 Summary

In their overview article on Bantu object marking, Marten and Kula (2012: 250) remark that ‘the differences we have observed with respect to obligatory object marking [...] can sometimes be related to animacy or topicality hierarchies. Yet, other systems were related to formal or pragmatic criteria, and so no uniform, all-encompassing generalization could be made.’ With the hybrid formal approach as presented in this chapter, I believe that we can capture the variation found, tying the differential object marking to the presence of a [Person] feature, and its projection in a separate layer. This allows us to locate the source of crosslinguistic variation in the structure of the goal of the Agree relation, which means the Agree mechanism and the probe can be kept constant, and to attribute the variation to a functional feature, which is acquirable.

For a featural typology of Bantu agreement, we have thus identified three parameters. The first is whether a language has a  $\phi$  probe on *v* or not, where some Bantu languages in the north-west have the setting ‘no’ (Eton, Basaa, Tunen, and so on). The setting of this parameter is easily understood in acquisition: if the input contains no object markers, it would be very difficult for the

acquirer to come to the conclusion that *v* has formal  $\phi$  features; on the contrary, the presence of object marking morphology provides direct evidence.<sup>21</sup> I return to the parameterization of  $\phi$  probes at length in Chapter 5. The second parameter is whether the Person feature is in a separate projection or not. Evidence for this parameter setting comes from local doubling. Depending on which objects are doubled, the third parameter can be set as well: the choice of hierarchy that the Person feature is associated with (animacy, definiteness, givenness), and the cut-off point on that hierarchy.

These three parameters thus account for some of the variation in Bantu object marking, specifically the status of the object marker as doubling or non-doubling. However, other parameters are at play when we take into account not just monotransitive predicates, as we have considered so far, but also ditransitive predicates. The two parameters to be considered for object marking in ditransitive predicates are whether either object can be object-marked (symmetry) and the number of object markers allowed. These are discussed and illustrated in Chapter 3.

<sup>21</sup> The independence of Case licensing and  $\phi$  agreement is discussed in Chapter 3.



## Object marking in ditransitives

### 3.1 Introduction and overview of the chapter

Chapter 2 set out the basic mechanism of Agree and explained how parametric variation in the presence of  $\phi$  probes and the structure of the goal can account for the variation between doubling and non-doubling object marking. So far, this only concerned monotransitive predicates, with only one object. But what if there are two objects? The analysis makes clear predictions for object marking in ditransitives too: since object marking involves an Agree relation and Agree is subject to locality, the prediction is that in ditransitives only the higher argument can enter into an Agree relation with little *v*, the locus of object marking. This is borne out in Chichewa, as illustrated in (1): only the Benefactive *anyani* ‘baboons’ can be object-marked (1b), and it is ungrammatical to mark the Theme object (1c). Such a system is called ‘asymmetric object marking.’<sup>1</sup>

Chichewa (N31, [Mchombo 2004](#): 80, 83)

- (1) a. A-lenje    a-ku-phík-il-á                      a-nyaní    zí-tumbûwa.  
       2-hunters 2<sub>SM</sub>-PRS-COOK-APPL-FV 2-baboons 8-pancakes  
       ‘The hunters are cooking pancakes for the baboons.’
- b. A-lenje    a-ku-**wá**-phík-il-á                      zí-tumbûwa.  
       2-hunters 2<sub>SM</sub>-PRS-**2OM**-COOK-APPL-FV 8-pancakes  
       ‘The hunters are cooking them (the baboons) some pancakes.’
- c. \*A-lenje    a-ku-zí-phík-il-á                      a-nyáni.  
       2-hunters 2<sub>SM</sub>-PRS-8OM-COOK-APPL-FV 2-baboons  
       int. ‘The hunters are cooking them (pancakes) for the baboons.’

While this is true for many Bantu languages, there are also languages where either object is available for object marking, as illustrated for Zulu in (2). This is known as ‘symmetric object marking’.

<sup>1</sup> Throughout the chapter, boldface object markers agree with a Benefactive object, and underlining refers to the Theme object.

Zulu (S42, [Adams 2010](#): 11)

- (2) a. U-mama u-nik-e aba-ntwana in-cwadi.  
 1a-mama 1SM-give-PFV 2-children 9-book  
 ‘Mama gave the children a book.’
- b. U-mama u-**ba**-nik-e in-cwadi (aba-ntwana).  
 1a-mama 1SM-2OM-give-PFV 9-book 2-children  
 ‘Mama gave them a book (the children).’
- c. U-mama u-yi-nik-e aba-ntwana (in-cwadi).  
 1a-mama 1SM-9OM-give-PFV 2-children 9-book  
 ‘Mama gave the children it (a book).’

The question is thus how to account for both of these object marking systems in ditransitives, that is, to find the locus of variation. This is not a novel question, far from it: [Baker et al. \(2012: 54\)](#) note that ‘For more than thirty years, symmetrical and asymmetrical object constructions have been a classic topic in the syntax of Bantu languages and beyond’. A landmark publication was [Bresnan and Moshi’s \(1990\)](#) article, which divided Bantu languages into two classes based on the behaviour of objects in ditransitives. Languages are taken to be ‘symmetric’ if both objects of a ditransitive verb behave alike (Zulu), and asymmetric if only one object has prototypical object properties (Chichewa). As we will see, the picture is not that black and white, and it is more appropriate to diagnose *constructions* as symmetric or asymmetric, rather than whole *languages*.

The question addressed in the current chapter is how the approach sketched in Chapter 2 can capture the asymmetric and symmetric behaviour of objects in Benefactive ditransitives, as well as the variation in the number of object markers. In order to extend the analysis to ditransitives, I first introduce the structure of ditransitives in Section 3.2. I then illustrate asymmetric object marking in Section 3.3 and symmetric objects and their diagnostics in Section 3.4. Section 3.5 presents various analyses to account for symmetric object marking while maintaining the principles of Agree and locality. The proposal adopted here is that asymmetry is the basic situation, and symmetry is due to the flexibility of a low applicative head to license either the argument in its complement or that in its specifier. Which argument it licenses is dependent on relative animacy and topicality, as explained in Section 3.6, which derives a number of properties of these constructions. Section 3.7 exposes a new pattern of how languages can be partially symmetric, that is, for some types of ditransitive predicates but not others, and Section 3.8 analyzes multiple object markers as additional  $\phi$  probes on functional heads. Finally,

Section 3.9 suggests an analysis of the ‘1+’ pattern, where languages only allow multiple object markers in restricted situations.

### 3.2 The structure of ditransitives

Ditransitives are predicates that take two internal arguments, here referred to as the Benefactive and the Theme (see the following for discussion of the semantic roles). In English, as in many other languages, ditransitives can surface in two forms, as in (3), where the Benefactive object *Eline* and the Theme object *a teddy bear* can either appear unmarked in the order Benefactive > Theme (3a), or be expressed as the Theme followed by the Benefactive in a prepositional phrase (3b).

- (3) a. Hilde gave Eline a teddy bear.  
 b. Hilde gave a teddy bear to Eline.

For the current analysis I follow [Harley \(1995, 2002\)](#); [Holmberg and Platzack \(1995\)](#); [Pesetsky \(1995\)](#) and assume that these two constructions are derived from distinct underlying structures, as represented in (4). A double object construction (DOC) involves an applicative head that introduces the Benefactive object (or, more generally, the applied object), while the Theme object is introduced by the verb (4a). The so-called prepositional dative construction, on the other hand, introduces the goal argument in a prepositional phrase that is the complement of V, while the Theme is introduced in specVP (4b). See also the overview in [Harley and Miyagawa \(2017\)](#).

- (4) The two base-generated structures for ditransitives

a. DOC

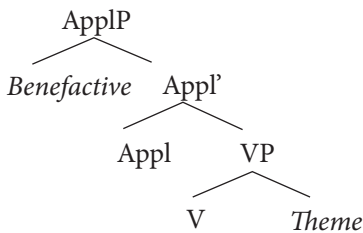

b. Prepositional dative

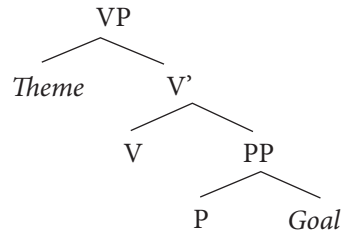

Evidence for the applicative projection in the DOC is easily found in Bantu languages, as they are famous for their extensive verbal morphology (see Chapter 2, Section 2.1). In derived ditransitives, the applicative head is visible as a suffixal morpheme, as shown for Makhuwa in (5) and Swahili in (6).

In Makhuwa, derivation of the monotransitive verb *-ruw-* ‘to stir’ with the applicative morpheme *-el-* allows for the addition of another argument (*anámwáne* ‘children’), which in this example carries the semantic role of Recipient or Benefactive. The same goes for the Swahili applicative *-i-*, which allows for the introduction of *wageni* ‘guests’.

Makhuwa (P31, [Van der Wal 2009](#): 71)

- (5) a. Amíná o-n-rúwá eshimá.  
 1.Amina 1SM-PRS.CJ-stir 9.shima  
 ‘Amina prepares shima.’
- b. Amíná o-n-aá-rúw-él’ éshimá anámwáne.<sup>2</sup>  
 1.Amina 1SM-PRS.CJ-2OM-stir-APPL.FV 9.shima 2.children  
 ‘Amina prepares shima for the children.’

Swahili (G42, [Edelsten et al. 2015](#))

- (6) a. Bibi a-li-pik-a chakula.  
 1.grandma 1SM-PST-cook-FV 7.food  
 ‘Grandmother cooked food.’
- b. Bibi a-li-wa-pik-i-a wageni chakula.  
 1.grandma 1SM-PST-2OM-cook-APPL-FV 2.guests 7.food  
 ‘Grandmother cooked the guests food.’

The proposed structure for these applied ditransitive verbs is thus as follows, with the Theme *eshima* as the complement of the verb, the Benefactive *anamwane* introduced in specApplP, and the external argument in specvP (on the head movement, see Section 2.1 in Chapter 2):

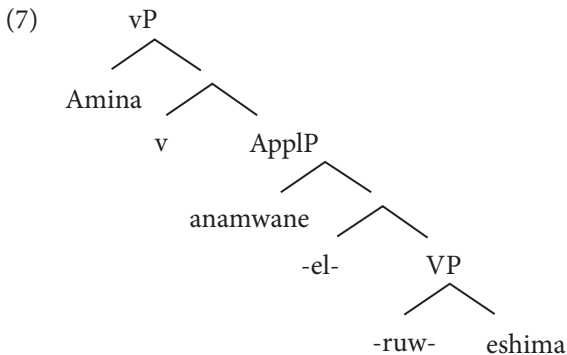

<sup>2</sup> The order of the two objects is determined by information structure in Makhuwa ([Van der Wal 2009](#)).

The prepositional dative construction can also be found, in Makhuwa with the preposition *para* as borrowed from Portuguese (8), and in Swahili with the preposition *kwa* (9).

Makhuwa (P31, Van der Wal 2009: 115)

- (8) Nthíyáná aapey-alé nramá para mwanámwáne óle.  
 1.woman 1SM.cook-PFV.CJ 3.rice for 1.child 1.DEM.DIST  
 ‘The woman cooked rice for that child.’

Swahili (G42, Chiku Lijongwa, personal communication)

- (9) Bibi a-li-pik-a chakula kwa wageni.  
 1.grandma 1SM-PST-cook-FV 7.food for 2.guests  
 ‘Grandmother cooked food for the guests.’

For the current chapter I will focus on the double object construction rather than the prepositional dative and assume that its underlying structure is the one in (7a). Evidence for this structure is found not just in the overt presence of an applicative morpheme and the neutral word order, but also in the relative scope of the two objects. In the given applicative structure, the Benefactive argument is introduced higher than the Theme, and it c-commands the Theme. Therefore the prediction is that a quantified Benefactive object can bind a variable in the Theme, but not vice versa. This is indeed borne out, as shown by Riedel (2009) for Swahili in (10) and (11) and for Sambia in (12). Note that in Swahili the order of the postverbal objects is not entirely rigid, but the scope remains the same: the higher Benefactive object binds the lower Theme object and never the other way around, regardless of linear order.

Swahili (G42, Riedel 2009: 105, from Marantz 1993: 117, translation adapted)

- (10) a. Ni-li-m-som-e-a [kila mwandishi]<sub>i</sub> kitabu ch-ake<sub>i</sub>.  
 1SG.SM-PST-1OM-read-APPL-FV every 1.writer 7.book 7-POSS.1  
 ‘I read for each author their book.’  
 b. Ni-li-m-som-e-a kitabu ch-ake<sub>i</sub> [kila mwandishi]<sub>i</sub>.  
 1SG.SM-PST-1OM-read-APPL-FV 7.book 7-POSS.1 every 1.writer  
 ‘I read for each author their book.’
- (11) a. <sup>0</sup>Ni-li-m-som-e-a [kila kitabu]<sub>i</sub> mwandishi w-ake<sub>k/\*i</sub>.  
 1SG.SM-PST-1OM-read-APPL-FV every 7.book 1.writer 1-POSS.1  
 ‘I read [each book]<sub>i</sub> for his/her<sub>k/\*i</sub> author.’  
 \*‘I read for its author each book.’

- b. %Ni-li-m-som-e-a [mwandishi w-ake]<sub>i</sub> kila kitabu<sub>k/\*i</sub>.  
 1SG.SM-PST-1OM-read-APPL-FV 1.writer 1-POSS.1 every 7.book  
 %‘I read their author each book.’  
 \*‘I read its author each book.’

Sambaa (G23, [Riedel 2009](#): 106)

- (12) a. N-za-m-som-e-a [kia mwandisi]<sub>i</sub> kitabu  
 1SG.SM-PFV.DJ-1OM-read-APPL-FV every 1.writer 7.book  
 ch-akwe<sub>i</sub>.  
 7-POSS.1  
 ‘I read for each author his book.’
- b. N-za-m-som-e-a mwandisi w-akwe<sub>i</sub> [kia  
 1SG.SM-PFV.DJ-1OM-read-APPL-FV 1.writer 1-POSS.1 every  
 kitabu]<sub>k/\*i</sub>.  
 7.book  
 ‘I read for his author every book.’  
 \*‘I read for its author each book.’

A related discussion is whether the structure in (7a) underlies all of the possible applicative constructions. It is well known that Bantu applicatives can introduce arguments that can carry a variety of semantic roles, including Benefactive/Malefactive, Instrumental, Locative, Reason, and Substitutive (see among others [Kimenyi 1980](#); [Baker 1988](#); [Ngonyani 1998](#); [Moshi 1998](#); [Alsina & Mchombo 1993](#); [Ngonyani & Githinji 2006](#); [Marten & Kula 2014](#); and especially [Trithart 1983](#)), as illustrated in (13).

Swahili (G42, [Ngonyani 1998](#): 81, 83)

- (13) a. *Benefactive*  
 Juma a-li-chor-e-a ma-gazeti picha.  
 1.Juma 1SM-PST-draw-APPL-FV 6-paper 10.pictures  
 ‘Juma drew pictures for newspapers.’
- b. *Goal*  
 M-shinana a-li-sukum-i-a kuku ma-jongoo.  
 1-girl 1SM-PST-push-APPL-FV 2.chickens 6-millipedes  
 ‘The girl pushed millipedes towards chickens.’
- c. *Malefactive*  
 Fundi a-li-kat-i-a m-taa u-meme.  
 1.technician 1SM-PST-cut-APPL-FV 3-neighbourhood 11-power  
 ‘The technician cut power to the neighbourhood.’

d. *Instrumental*

??Wa-toto wa-li-vunj-i-a ma-we ch-ungu.  
 2-children 2SM-PST-break-APPL-FV 6-rocks 7-pot  
 'The children broke the pot with rocks.'

e. *Reason*

??Wa-windaji wa-li-wind-i-a pesa ndovu.  
 2-hunters 2SM-PST-hunt-APPL-FV 10.money 9.elephant  
 'The hunters hunted the elephant for money.'

f. *Ingredient*

?M-pishi a-li-und-i-a pilipili nyama.  
 1-cook 1SM-PST-cook-APPL-FV pepper 9.meat  
 'The cook seasoned the meat with pepper.'

g. *Locative*

Wa-teja wa-li-l-i-a ch-akula ofisi-ni.  
 2-customer 2SM-PST-eat-APPL-FV 7-food 9.office-LOC  
 'The customers ate the food in the office.'

A significant conclusion from Ngonyani (1998) is that applied objects in Swahili and Ndendeule fall into three types with respect to their behaviour in four tests (word order, passive, object marking, and reciprocity): the Benefactive, Goal, and Malefactive pattern together; the Instrumental, Motive, and Ingredient applicatives form a second type; and Locatives display yet a different pattern. Importantly, this grouping emerges for applied objects in monotransitive as well as ditransitive predicates, which shows that there is something distinctive in the applied argument itself, or in the applicative head, or both. The difference in the arguments could be the variation between DP and PP status, even if the rest of the structure is the same, as for example proposed by Jeong (2007). Differences in the applicative head could be the position of merger and the ability to license Case, and indeed Buell (2005: 190) concludes that 'with the view that clause structure is largely uniform across languages, it is thus wiser to think of the applicative 'suffix' *-el* in Zulu as a set of homophonous suffixes merged in distinct syntactic positions and possibly having distinct lexical properties'.

Considering the clear separate grouping of the Benefactive type of argument and its implication for variation in the underlying structure, as well as the lack of crosslinguistic data on reason applicatives, and in addition the sometimes unclear status of locatives as DPs or PPs, the current discussion will leave locative, instrument, and reason applicatives for further research and focus on ditransitives with a Recipient or Benefactive object and a Theme object.

There is one more detail to add to the current discussion on the structure of ditransitives, which is the distinction between high and low applicatives. Following Pylkkänen (2008), I take the Recipient in a lexical ditransitive to be introduced by a low applicative head (LApplP), under V (14a). The Benefactive for an applied verb is introduced by a high applicative head (HApplP), between V and v (14b).

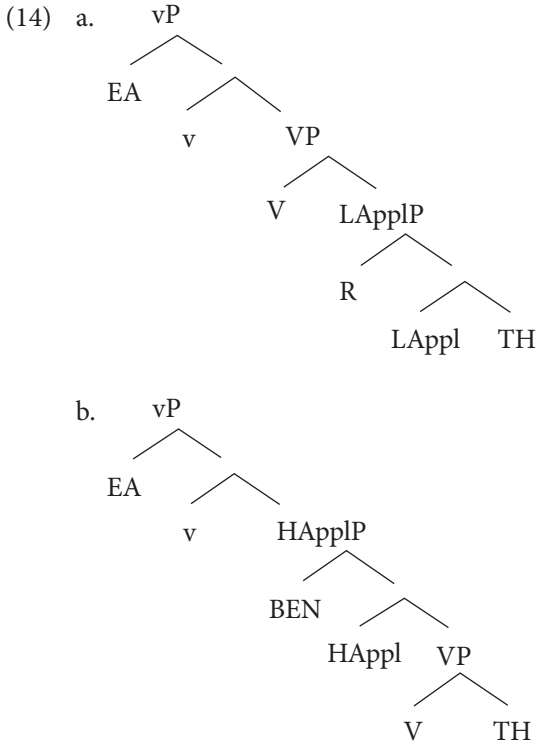

These two structures differ not just syntactically, but they correspond to a semantic difference too, Pylkkänen argues: the low applicative head constructs a transfer-of-possession relation between the two arguments, whereas the high applicative involves a thematic relation between an applied argument and the event described by the verb. This difference will become relevant in Section 3.7 on partial symmetry.

### 3.3 Asymmetric object marking

With the assumptions about the structure of ditransitives in place, I return to the discussion on object marking. In this section, I propose a straightforward



analysis of asymmetric object marking, and explore the theoretical assumptions needed for the analysis, specifically the independence of Case and agreement in Section 3.3.2, and the role of locality (the Minimal Link Condition) in Section 3.3.3. This will then form the background needed to examine symmetric object marking in Section 3.4.

### 3.3.1 Agree with the highest goal

As mentioned, many Bantu languages only allow object marking of the higher of the two objects, that is, the argument introduced by the applicative head. Such asymmetric object marking is illustrated in the following examples for three languages across the Bantu area. In all three languages, object marking is doubling.

For Chimwiini, the object marker is described as ‘used to definitize a NP, and [...] much more common when the NP is human than when it is not’ (Kisseberth & Abasheikh 1977: 191). Regardless of relative definiteness of the two objects, only the higher Benefactive object can be object-marked, as shown in (15a). Object marking the lower Theme object results in ungrammaticality (15b).

Chimwiini (G412, Henderson 2010: 81)

- (15) a. Fatiima Ø-wa-pele waana maanda.  
 1.Fatima 1SM-2OM-give.PST 2.children 9.bread  
 ‘Fatima gave the children bread.’  
 b. \*Fatiima Ø-yi-pele waana maanda.  
 1.Fatima 1SM-9OM-give.PST 2.children 9.bread  
 int. ‘Fatima gave (the) children the bread.’

The same goes for Chingoni, where object marking indicates definiteness.

Chingoni (N12, Ngonyani & Githinji 2006: 37)

- (16) a. M-geni a-m-let-i kuku va-jukulu.  
 1-guest 1SM-1OM-bring-APPL 1.grandfather 2-grandchildren  
 ‘The guest brought grandchildren to the grandfather.’  
 b. \*M-geni a-va-let-i kuku va-jukulu.  
 1-guest 1SM-1OM-bring-APPL 1.grandfather 2-grandchildren  
 int. ‘The guest brought the grandchildren to (the) grandfather.’

In Kiyaka, objects of classes 1 and 2 can be object-marked by a prefix, but when both objects are eligible for object marking, only the higher object can be object-marked and the other object is preceded by an independent pronoun

(17a, b). If the Theme is to be object-marked, the language resorts to the prepositional construction, as in (17c).

Kiyaka (H31, [Kidima 1987](#): 187, glosses adapted)

- (17) a. Tu-**n'**-hitik-idi      yaáwu    baaná      Maafú.  
 1PL.SM-1OM-send-PFV    2.PRO    2.children    1.Maafu  
 'We sent Maafu the children.'
- b. \*Tu-**ba**-hitik-idi      yaáni    Maafú      baaná.  
 1PL.SM-2OM-send-PFV    1.PRO    1.Maafu    2.children  
 int. 'We sent Maafu the children.'
- c. Tu-ba-hitik-idi      baaná      kwa    Maafú.  
 1PL.SM-2OM-send-PFV    2.children    to    1.Maafu  
 'We sent the children to Maafu.'

This pattern of asymmetric object marking can be understood as the  $\phi$  probe on little *v* searching downwards and entering into an Agree relation with the first active argument it encounters, that is, the Benefactive introduced by the applicative head. If the Benefactive argument is a defective goal (a  $\phi$ P or a DP with a separate Person projection, see Chapter 2), the features of the Benefactive argument are spelled out as an object marker on little *v*. The Theme argument, on the other hand, is licensed by Appl. However, since Appl does not have a  $\phi$  probe in these languages, the Agree relation between Appl and the lower Theme argument can never be spelled out as an object marker here (but see Section 3.8 on multiple object markers).

- (18) *v* agrees with the Benefactive (and can object-mark it)

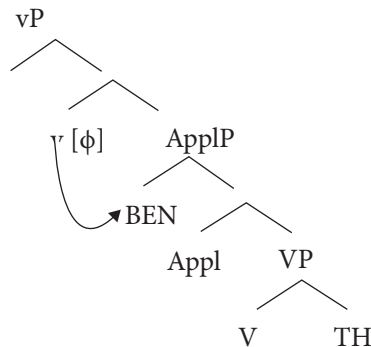

This analysis brings up two issues: Case licensing, and agreement with the Theme in asymmetric languages, considering locality. These are discussed before moving on to the analysis of symmetric object marking.

### 3.3.2 Case is independent of agreement

The proposed analysis entails that  $\phi$  features and Case are independent, or more specifically, that Case can be licensed independently of  $\phi$  agreement. This has been noted for morphologically visible case and agreement, since mismatches occur between the two, for example by [Bhatt \(2005\)](#); [Baker \(2008a, 2012, 2015\)](#); [McFadden \(2004\)](#); [Bobaljik \(2008\)](#); [Bárány \(2017\)](#); [Stegovec \(2020\)](#); among others. [Bárány \(2017\)](#) provides a particularly clear exposition of this, and then argues, following [Legate \(2008\)](#), that agreement should be seen as independent of abstract Case too ([Pesetsky & Torrego 2007](#); [Halpert 2015](#); [Keine 2010](#)). Such a separation of Case licensing and agreement is needed to account for the crosslinguistic variation in ditransitive alignment, and this entails that two separate parameters exist, specifying which heads in a language are  $\phi$  probes, and which heads are Case licensors (see also [Georgala et al. 2008](#); [Georgala 2012](#); [Halpert 2015](#); and [Nie 2020](#)).

For the asymmetric ditransitives, Appl is a Case assigner but does not have a  $\phi$  probe, while *v* checks Case and agrees for  $\phi$  features as well. I return to this in Section 3.8 on multiple object markers, which I argue are generally indicative of a  $\phi$  probe on Appl too.

The analysis proposed in (18) not only assumes that Case licensing and agreement are independent, but, more fundamentally, it presupposes that objects in Bantu need Case licensing. While this was until recently uncontroversial under a standard generative theory of argument licensing (see e.g. the overview on Case in [Bobaljik & Wurmbrand 2008](#)), it has become more disputable upon closer inspection of, in particular, the Bantu languages. One of the important restrictions on syntactic constructions in the Government and Binding (GB) model of syntax was the Case Filter ([Vergnaud 1977, 2008](#); [Chomsky 1981](#)): overt DPs must be Case-licensed, whether this is visible in the morphology or not. The Minimalist framework has inherited some version of the Case Filter, in which nominals have uninterpretable Case features that make a noun active as a goal for Agree and that need to be checked in the course of the derivation.

[Diercks \(2012\)](#) examines this notion of abstract Case for Bantu languages, and reasons that if Case is a feature like any other grammatical feature, then languages can vary as to whether they have this feature. He thus proposes the parameterization of Case, where some languages do, and some do not select [uCase] in their inventories:

- (19) Case Parameter ([Diercks 2012: 254](#)):  
Uninterpretable Case features are/are not present in a language.

His proposal for parameterization is inspired by [Perez's \[Harford\] \(1985\)](#) claim that Case is inoperative in Bantu languages (see also [Carstens 2005, 2011](#)). We know that Bantu languages do not show morphological case, but [Diercks' \(2012: 254\)](#) explicit proposal is that 'Bantu languages do not have uninterpretable Case features in their feature inventories'.

- (20) Case Parameter setting for Bantu ([Diercks 2012: 254](#)):  
Uninterpretable Case features are not present.

While this may be true for some languages, there are three important counter-points to bring to the fore. The first is that some Bantu languages do seem to show the effects of abstract Case, as I have argued for Matengo and Makhuwa ([Van der Wal 2015c](#)). The second is that Bantu languages may not show the influence of abstract Case throughout the grammatical system, but only in part of it. The tests that [Diercks \(2012\)](#) uses to argue against the presence of Case in Bantu languages only concern nominative case: subject marking on the verb, hyperagreement, hyperraising to subject, and subject DPs in non-finite clauses. When it comes to licensing of arguments beyond nominative Case, the data are less clear, as shown in the critical discussion of nine diagnostics in [Sheehan and Van der Wal \(2018\)](#). I discuss this point in a bit more detail here.

Consider the additional diagnostic of licensing the agent DP in a passive clause. If Case did not play any role, the prediction is that DPs can simply appear overtly without explicit Case licensors such as prepositions. This is borne out in Luganda, as in (21b), where the agent in a passive does not need a 'by' phrase but can simply be present.

Luganda (JE15, [Sheehan & Van der Wal 2018: 542](#))

- (21) a. Abaana      ba-a-soma      ekitabo.  
         2.children   2SM-PST-read   7.book  
         'The children read a book.'  
      b. Ekitabo    ky-aa-som-ebw-a      abaana.  
         7.book    7SM-PST-read-PASS-FV   2.children  
         'The book was read (by) the children.'

However, in other Bantu languages agent DPs require a preposition, and interestingly this is true regardless of the behaviour in other Case tests: both Makhuwa ('Case') and Lubukusu ('no Case') need a prepositional Case licensor.

Makhuwa (P31, [Van der Wal 2009: 77](#))

- (22) Íi,    koo-vár-íy-a                                  \*(ni)    khwátte!  
         ii    1SG.SM.PFV.DJ-grab-PASS-FV    by    1.fox  
         'Ii, I am caught by the fox!'

Lubukusu (JE31c, [Diercks 2010](#): 296)

- (23) Ba-sasi      ba-bol-el-w-a                      nende Sammy      mbo  
 2-parents    2SM-say-APPL-PASS-FV    by    1.Sammy      that  
 ba-keni      ba-a-rekukha.  
 2-guests     2SM-PST-leave  
 ‘The parents were told by Sammy that the guests left.’

Assuming that the agent DP is in specvP, this suggests that arguments in the lower part of the clause do need Case licensing.

This is precisely what [Halpert \(2013, 2015\)](#) and [Carstens and Mletshe \(2015\)](#) also propose for Zulu and Xhosa, respectively: even if T may not be associated with Case, there is reason to assume a nominal licensing requirement in the v-domain. Halpert shows that DPs that lack the augment (*muntu* vs *u-muntu*) have a very restricted distribution in Zulu, similar to that of bare NPs in Romance languages.<sup>3</sup> augmentless nominals are licensed under negation, and only within the vP domain, whether in the lower or the higher clause, as illustrated in (24).

Zulu (S42, [Halpert 2012](#))

- (24) a. A-ngi-sho-ngo                                      [ukuthi    ku-fik-e                      muntu].  
       NEG-1SG.SM-say-NEG.PST    that      17SM-arrive-PERF    1.person  
       ‘I didn’t say that anyone came.’  
 b. \*A-ngi-fun-i                                      [ukuthi    muntu    a- pheke                      iqanda].  
       NEG-1SG.SM-want-NEG    that      1.person    1SM.SBJV-cook    5.egg  
 c. A-ngi-fun-i                                      muntu<sub>i</sub>    [ukuthi    t<sub>i</sub> a-pheke                      iqanda].  
       NEG-1SG.SM-want-NEG    1.person    that      1SM.SBJV-cook    5.egg  
       ‘I don’t want anyone to cook an egg.’

To account for the restricted distribution of augmentless nominals in Zulu, Halpert proposes that there is only one case-licensing head in Zulu (the head L, for Licensor), which sits just above vP. Her proposal accounts for the fact that augmentless nominals cannot be licensed outside of vP (the contrast between (24a–b) shows that this is not just because they function as Negative Polarity Items (NPIs)). Any nominal outside of the vP domain must bring its own inherent Case licensing, in the form of an augment, she proposes. Although much further research into nominal licensing is needed, I assume that there is a requirement for nominals in the vP domain to enter into a relation with a functional head, comparable to [Pesetsky’s \(2014\)](#) ‘Vergnaud

<sup>3</sup> [Progovac \(1993\)](#) and [Carstens & Mletshe \(2016\)](#) in fact propose an analysis of augmentless nominals as NPIs.

licensing' and Sheehan and Van der Wal's (2016) 'Extend requirement', and contra approaches in which only certain nominals need Case licensing, see among others Danon (2006); Ormazabal & Romero (2013); Kalin (2019).

This brings us to a third point about Case: even in languages that do not show clear effects of familiar Case licensing, there are restrictions to the placement of nominals, indicating that there must be some system of nominal licensing. Therefore I assume that arguments have a requirement to connect to the clause, formally expressed as a [uCase] feature. The [uCase] feature functions like any other uninterpretable feature in probing for an interpretable counterpart, which is to be found on certain clausal heads. Which clausal heads are involved in licensing, and which other features are associated with these heads may vary across languages. Nominal licensing in this view will play an important role in accounting for symmetric object marking (Section 3.6) and subject inversion constructions (Chapter 4). Before turning to symmetry, however, first we finish the details of asymmetric object marking.

### 3.3.3 Agree with the Theme in an asymmetric language

As mentioned in Chapter 1, the operation Agree is subject to a locality constraint: a probe must agree with the most local goal and cannot skip any potential goals to agree with a lower goal. This is the Intervention Condition on Agree (Chomsky 2000):

- (25) a. Agree requires closest c-command; a probe can only agree with the closest goal in its c-command domain.  
 b. The closest goal is the XP that is c-commanded by the probe and is such that there is no other XP' that c-commands it and is also c-commanded by the same probe.

Applied to the structure in (26), this means that the probe can agree with the closest c-commanded DP1, but not with DP2, since DP1 intervenes.

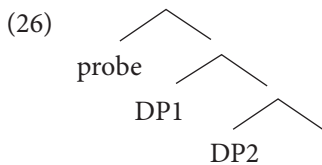

Locality therefore means that the representation of object agreement for asymmetric languages in (18) would not just be one possible analysis, but in fact the *only* possible analysis. The  $\phi$  probe on  $v$  can never enter into an Agree relation

with the Theme, either because the Theme has already had its Case feature checked by Appl and is no longer active when *v* probes (and is hence invisible for Agree – but see Section 5.1.5 in Chapter 5), or because the Benefactive argument will always intervene between *v* and the Theme and skipping it would violate locality.

Agreement with a lower object is thus always ungrammatical in an asymmetric language, and we see that languages need to resort to other constructions in order to object-mark the Theme. As seen in (17c) and again in (27), the Theme object can be marked, but only if this is in fact the only object of the verb, and the Recipient/Benefactive is introduced lower in a PP.

Swahili (G42, Chiku Lijongwa, personal communication)

- (27) Bibi                    a-li-ki-pik-a                    chakula kwa wageni.<sup>4</sup>  
 1.grandma 1SM-PST-7OM-cook-FV 7.food for 2.guests  
 ‘Grandmother cooked the food for the guests.’

A more interesting way to allow agreement with the Theme object in an asymmetric language is when the higher object is absent. In asymmetric Bemba, human objects need to be doubled. While a human Benefactive can be object-marked (pronominalized) in the presence of the Theme (28a), the reverse is not possible (28b). Nevertheless, either object can be marked if the other object is omitted (29).

Bemba (M42, Marten & Kula 2012: 245 and Nancy Kula, personal communication)

- (28) a. N-àlíí-**mù**-péél-à                    amaani.  
 1SG.SM-PST-1OM-give-FV 6.eggs  
 ‘I gave him eggs.’  
 b. \*N-àlíí-**yà**-péél-à                    Chisanga.  
 1SG.SM-PST-6OM-give-FV 1.Chisanga  
 int. ‘I gave it/them to Chisanga.’
- (29) a. N-àlíí-**mù**-péél-à.  
 1SG.SM-PST-1OM-give-FV  
 ‘I gave him (it).’  
 b. N-àlíí-**yà**-péél-à.  
 1SG.SM-PST-6OM-give-FV  
 ‘I gave it (e.g. water).’

That the Benefactive is truly absent can be seen in the unacceptability of the secondary predicate for the Benefactive in (30): if the secondary predicate ‘while singing’ refers to the Benefactive by featuring a class 1 subject marker,

<sup>4</sup> Preferred with stress on *kwa wageni*.

this is ungrammatical (30a) – instead, the secondary predicate can agree with the subject in a first person singular (30b). If the Benefactive were present but received a null spell-out, (30a) would be predicted to be possible too; the fact that it is not argues for the absence of the Benefactive.

Bemba (M42, Nancy Kula, personal communication)

- (30) a. \*N-àlí-yà-péél-à                    a-lee-imb-a.  
 1SG.SM-PST-6OM-give-FV    1SM-PROG-sing-FV  
 int. ‘I gave it/them (to him) when (he was) singing.’
- b. N-àlí-yà-péél-à                    n-dee-imb-a.  
 1SG.SM-PST-6OM-give-FV    1SG.SM-PROG-sing-FV  
 ‘I gave it/them (to him) when (I was) singing.’

Object marking in these cases still marks an Agree relation with the object that is closest to *v*, since the Benefactive does not intervene between *v* and the Theme.

The defective goal analysis presented in Chapter 2 can thus straightforwardly capture asymmetric object marking in ditransitives. This is because it involves an Agree relation and Agree is subject to locality. The  $\phi$  probe on *v* will therefore always agree with the closest goal, which is typically the Recipient/Benefactive object in a double object construction.

Having provided an analysis of asymmetric object marking and its implications, we now turn to the puzzle of symmetric object marking.

### 3.4 Symmetric objects and object marking

Whereas in the languages discussed so far only the higher of two objects can be targeted for object marking, there are famously also Bantu languages in which both objects are available for syntactic operations. This was briefly introduced in Section 3.1, and is illustrated for three further languages in examples (31)–(33), from different parts of the Bantu area. In all of these languages either object can independently be object-marked on the verb.

Kikuyu (E51, Ngonyani & Githinji 2006: 35, 37)

- (31) a. Mũ-geni    a-ra-gũr-ĩ-ire                    ci-ana            mũ-bira.  
 1-guest    1SM-PROG-buy-APPL-PFV    8-children    3-ball  
 ‘The guest bought children a ball.’
- b. Mũ-geni    a-ra-ci-gũr-ĩ-ire                    mũ-bira.  
 1-guest    1SM-PROG-8OM-buy-APPL-PFV    3-ball  
 ‘The guest bought them (children) a ball.’



- c. Mü-geni a-ra-ū-gūr-ī-ire ci-ana.  
 1-guest 1SM-PROG-3OM-buy-APPL-PFV 8-children  
 ‘The guest bought it (ball) for the children.’

Ciluba (L31, [Cocchi 2000](#): 87)

- (32) a. Mukaji u-sumb-il-a muana tshimuna.  
 1.woman 1SM-buy-APPL-FV 1.boy 7.fruit  
 ‘The woman buys the boy fruit.’  
 b. Mukaji u-**mu**-sumb-il-a tshimuna.  
 1.woman 1SM-1OM-buy-APPL-FV 7.fruit  
 ‘The woman buys him fruit.’  
 c. Mukaji u-**tshi**-sumb-il-a muana.  
 1.woman 1SM-7OM-buy-APPL-FV 1.boy  
 ‘The woman buys it for the boy.’

Otjiherero (R30, Jekura Kavari, personal communication)

- (33) a. Omu-kazendu ma pe ova-zandu ovi-kurya.  
 1-woman PRS.1SM give 2-boys 8-food  
 ‘The woman gives the boys food.’  
 b. Omu-kazendu me **ve** pe ovi-kurya.  
 1-woman PRS.1SM 2OM give 8-food  
 ‘The woman gives them food.’  
 c. Omu-kazendu me vi pe ova-zandu.  
 1-woman PRS.1SM 8OM give 2-boys  
 ‘The woman gives it to the children.’

Given the Agree analysis and the predictions of asymmetry, the question is how agreement with the lower object is possible in these languages with symmetric object marking. In order to address that question in Sections 3.5 and 3.6, it will be useful to detail the properties that have previously been used to diagnose symmetry, and to discuss how these properties are not all equally indicative of syntactic symmetric object behaviour.

There are six tests that have been applied to double object constructions in Bantu languages to discover the properties of both objects in relation to each other ([Bresnan & Moshi 1990](#); [Hyman & Duranti 1982](#); [Mchombo & Firmino 1999](#); [Ngonyani & Githinji 2006](#)):

1. word order
2. passive
3. object marking
4. reciprocal
5. extraction
6. unspecified object deletion

These are illustrated for Chichewa (asymmetric) and Chaga (symmetric), as they were in [Bresnan and Moshi \(1990\)](#).

### 3.4.1 Word order

For word order, Chichewa is clearly asymmetric: the Benefactive precedes the Theme.

Chichewa ([Mchombo 2004](#): 80)

- (34) a. A-lenje a-ku-phík-íl-á a-nyaní zí-tumbúwa.  
 2-hunters 2SM-PRS-COOK-APPL-FV 2-baboons 8-pancakes  
 ‘The hunters are cooking pancakes for the baboons.’  
 b. \*A-lenje a-ku-phík-íl-á zí-tumbúwá a-nyani.  
 2-hunters 2SM-PRS-COOK-APPL-FV 8-pancakes 2-baboons  
 int. ‘The hunters are cooking pancakes for the baboons.’

On the other hand, word order of postverbal objects in Chaga is somewhat more flexible. [Moshi \(1998\)](#) shows that word order in Chaga is restricted by animacy and information structure. A flexible order of objects is only possible if the two objects are equal in animacy, as in (35). Otherwise the order Theme > Goal is only allowed under contrastive focus, as shown in the contrast between (36) and (37).

Chaga (E62, [Moshi 1998](#): 149, 150, glosses adapted)

- (35) a. Ndáló n-á-lé-súkúm-í-á lorlíná mawo.  
 1.Ndalo FOC-1SM-PST-push-APPL-FV stool 6.stones  
 ‘Ndalo pushed (to) the stool stones.’  
 b. Ndáló n-á-lé-súkúm-í-á máwó lórlíná.  
 1.Ndalo FOC-1SM-PST-push-APPL-FV 6.stones stool  
 ‘Ndalo pushed (to) the stool stones.’
- (36) a. Ndáló n-á-lé-súkúm-í-á máná máwo.  
 1.Ndalo FOC-1SM-PST-push-APPL-FV 1.child 6.stones  
 ‘Ndalo pushed (to) the child stones.’  
 b. \*Ndáló n-á-lé-súkúm-í-á máwó mána.  
 1.Ndalo FOC-1SM-PST-push-APPL-FV 6.stones 1.child  
 int. ‘Ndalo pushed (to) the stones the child.’
- (37) Mangí n-á-lé-súkúm-í-á máwó máná.  
 1.chief FOC-1SM-PST-push-APPL-FV 6.stones 1.child  
 á-lé-m-sukum-i-a matongá pfo.  
 1SM-PST-1OM-push-APPL-FV 6.stumps NEG  
 ‘The chief pushed *stones* to the child, he did not push (to him) *stumps*.’

## 3.4.2 Passive

A clearer difference between the two languages is found in the passive: in Chichewa only the Benefactive can become the subject of a passive predicate – passivizing the Theme is ungrammatical (38a) – while in Chaga either object is acceptable as the subject of a passive (39).

Chichewa (N31, [Mchombo 2004](#): 82)

- (38) a. \*Maúngu a-ku-phík-íl-idw-á a-nyâni  
 6.pumpkins 6SM-PRS-COOK-APPL-PASS-FV 2-baboons  
 (ndí á-lénje).  
 (by 2-hunters)  
 int. ‘The pumpkins are being cooked for the baboons  
 (by the hunters).’
- b. A-nyaní a-ku-phík-íl-idw-á maúngu  
 2-baboons 6SM-PRS-COOK-APPL-PASS-FV 6.pumpkins  
 (ndí á-lénje).  
 (by 2-hunters)  
 ‘The baboons are being cooked pumpkins (by the hunters).’

Chaga (E62, [Moshi 1998](#): 140, glosses adapted)

- (39) a. Maná n-á-lé-wé-í-o nyáma.  
 1.child FOC-1SM-PST-slice-APPL-PASS 9.meat  
 ‘The child was sliced the meat.’
- b. Nyámá n-í-lé-wé-í-o mána.  
 9.meat FOC-9SM-PST-slice-APPL-PASS 1.child  
 ‘The meat was sliced for the child.’

## 3.4.3 Object marking

The same difference is found for object marking: in Chichewa, only the Benefactive can be object-marked and object marking the Theme in the presence of the Benefactive is always ungrammatical, as was shown in example (1), repeated as (40).

Chichewa (N31, [Mchombo 2004](#): 80, 83)

- (40) a. A-lenje a-ku-phík-íl-á a-nyaní zí-túmbúwa.  
 2-hunters 2SM-PRS-COOK-APPL-FV 2-baboons 8-pancakes  
 ‘The hunters are cooking pancakes for the baboons.’

- b. A-lenje a-ku-wá-phík-il-á zí-túmbúwa.  
 2-hunters 2SM-PRS-2OM-cook-APPL-FV 8-pancakes  
 ‘The hunters are cooking them (the baboons) some pancakes.’
- c. \*A-lenje a-ku-zí-phík-il-á a-nyáni.  
 2-hunters 2SM-PRS-8OM-cook-APPL-FV 2-baboons  
 int. ‘The hunters are cooking them (pancakes) for the baboons.’

In Chaga, on the other hand, either object can be pronominalized as an object marker on the verb (41).

Chaga (E62, Moshi 1998: 142, glosses adapted)

- (41) a. Mangí n-á-lé-zrík-á mchílyí nyáma.  
 1.chief FOC-1SM-PST-send-FV 1.messenger 9.meat  
 ‘The chief sent with the messenger the meat.’
- b. Mangí n-á-lé-m-zrík-á nyáma.  
 1.chief FOC-1SM-PST-1OM-send-FV 9.meat  
 ‘The chief sent him with the meat.’
- c. Mangí n-á-lé-í-zrík-á mchílyi.  
 1.chief FOC-1SM-PST-9OM-send-FV 1.messenger  
 ‘The chief sent it with the messenger.’

### 3.4.4 Reciprocal

When the verb is extended by reciprocal morphology, the languages again differ in which object can be coreferential with the subject: in Chichewa the Benefactive but not the Theme can be interpreted as coreferential with the agent of the action (42), whereas in Chaga either object is available for coreference (43).

Chichewa (N31, Baker 1988: 386)

- (42) Ana a-na-meny-er-an-a zigawenga.  
 2.children 2SM-PRS-hit-APPL-RECP-FV 10.ruffians  
 a. ‘The children<sub>i</sub> are beating the ruffians for each other<sub>i</sub>.’  
 b. \*‘The children are beating each other for the ruffians.’

Chaga (E62, Bresnan & Moshi 1990: 153 and Lioba Moshi, personal communication)

- (43) Wà-chàkà wá-í-w'ágh-ì-à-n-à màngì.  
 2-Chaga 2SM-PRS-kill-APPL-RECP-FV 1.chief  
 a. ‘The Chagas are killing each other for the chief.’  
 b. ‘The Chagas are killing the chief for each other.’

## 3.4.5 Extraction

Bresnan and Moshi (1998) show that Chichewa and Chaga pattern alike in extraction from ditransitives, which is different from the pattern so far observed: in both languages extraction is possible for the Theme, but not the Benefactive.

Chichewa (N31, Baker 1988: 355)

- (44) a. \*Iyi ndi-yo mfumu i-mene ndi-ku-ganiz-a kuti  
 1.PROXDEM COP-1 1.chief 1-REL 1SG.SM-PRS-think-FV COMP  
 Mavuto a-na-umb-ir-a mtsuko.  
 1.Mavuto 1SM-PST-mould-APPL-FV 3.waterpot  
 int. 'This is the chief whom I think Mavuto molded the waterpot for.'
- b. Uwu ndi-wo mtsuko u-mene ndi-ku-ganiz-a kuti  
 3.DEM COP-3 3.waterpot 3-REL 1SG.SM-PRS-think-FV COMP  
 Mavuto a-na-umb-ir-a mfumu.  
 1.Mavuto 1SM-PST-mold-APPL-FV 1.chief  
 'This is the waterpot which I think Mavuto molded for the chief.'

Chaga (E62, Bresnan & Moshi 1990: 159)

- (45) a. \*M-ka a-i-lyi-i-a k-elya nyi-ichu.  
 1-wife 1SM.REL-PRS-eat-APPL-FV 7-food COP-1.DEM  
 int. 'The wife for whom he is eating the food is this one.'
- b. K-èlyá á-í-lyì-í-à m-kà ki-pùsù.  
 7-food 1SM.REL-PRS-eat-APPL-FV 1-wife 7-rotten  
 'The food which he is eating for the wife is rotten.'

Other languages do behave symmetrically for extraction as well, as for example Lubukusu.

Lubukusu (JE31c, Wasike 2007: 52)

- (46) a. Chi-khaafu ni-cho kuuka a-a-elesy-a baa-sooreri  
 10-cows REL-10 1.grandfather 1SM-PST-give-FV 2-boys  
 chi-li e-luuchi.  
 10SM-be at-river  
 'The cows which grandfather gave the boys are at the river.'
- b. Baa-sooreri ni-bo kuuka a-a-elesy-a chi-khaafu  
 2-boys REL-2 1.grandfather 1SM-PST-give-FV 10-cow  
 ba-li e-luuchi.  
 2SM-be at-river  
 'The boys who grandfather gave the cows are at the river.'

The fact that Chichewa and Chaga pattern differently here already shows us that we want to be careful in taking all tests to be diagnostic of the same property (as [Bresnan & Moshi](#) show, in reaction to [Gary & Keenan 1977](#)) – a point I shall return to shortly.

### 3.4.6 Unspecified object deletion

The last diagnostic used by [Bresnan and Moshi \(1990\)](#) is the deletion of an unspecified Theme object. This is possible in Chaga but not Chichewa:

Chichewa (N31, [Alsina & Mchombo 1990](#): 500)

- (47) Msōdzi            a-ku-phík-ír-a            aná            \*(nyêmba).  
 1.fisherman 1SM-PRS-COOK-APPL-FV 2.children 10.beans  
 ‘The fisherman is cooking for the children.’

Chaga (E62, [Bresnan & Moshi 1990](#): 152)

- (48) N-a-i-lyí-í-à            m-kà.  
 FOC-1SM-PRS-eat-APPL-FV 1-wife  
 ‘He/She is eating for/on the wife.’

### 3.4.7 Mismatches in symmetry properties

Although all the mentioned properties elucidate the syntax of ditransitives in Bantu languages, not all are equally useful as diagnostics for symmetry. [Schadeberg \(1995\)](#); [Thwala \(2006\)](#); [Rugemalira \(1993\)](#); [Ngonyani \(1996\)](#); [Marten et al. \(2007\)](#); and [Jerro \(2015\)](#) are rightly critical of these tests, of the all-encompassing nature of symmetry, and even of the notion of (primary) object as a useful concept for Bantu languages at all ([Schadeberg 1995](#)).

A large part of the critique comes from the comparison of different ditransitives within the same language, for example, instruments behaving differently from benefactives and locatives showing yet different properties, as was mentioned in Section 3.2. But even for Benefactive double object constructions, not all properties align to give the same results. This already emerges clearly for the extraction data in Chichewa and Chaga previously mentioned: while for the first four diagnostics Chichewa consistently only allows the Benefactive argument to participate (asymmetry) and Chaga consistently allows both objects (symmetry), neither language allows extraction of the Benefactive (so-called indirective asymmetry; see [Malchukov et al. 2010](#)). Although not much

research has focused on A-bar properties such as extraction, it appears that these are independent from the other properties for symmetry.

A heavily criticized diagnostic is word order, which has been shown to produce deviant results in many languages (Moshi 1998; Marten et al. 2007; Jerro 2015). Furthermore, word order in ditransitives is subject to other conditions than just objecthood, such as information structure and animacy, as was also seen in (37) for Chaga. The mismatch between word order in ditransitives on the one hand, and object marking and passivization on the other is also clearly visible in Luganda and Makhuwa, which I discuss briefly to illustrate the unreliability of word order as a test.

Luganda double objects display symmetric behaviour for the two tests of pronominalization (49) and passivization (50).

Luganda (JE15, Ssekiryango 2006: 67, 72)

- (49) a. Maama a-wa-dde taata ssente.  
 1.mother 1SM-give-PFV 1.father 10.money  
 ‘Mother has given father money.’
- b. Maama a-**mu**-wa-dde ssente.  
 1.mother 1SM-1OM-give-PFV 10.money.  
 ‘Mother has given him money.’
- c. Maama a-zi-wa-dde taata.  
 1.mother 1SM-10OM-give-PFV 1.father  
 ‘Mother has given it father.’
- (50) a. Maama a-were-ddw-a ssente.  
 1.mother 1SM-give-PASS-FV money  
 ‘Mother has been given money.’
- b. Ssente zi-were-ddw-a maama.  
 10.money 10SM-give-PASS-FV 1.mother  
 ‘The money has been given to mother.’

Nevertheless, Luganda shows a strict order of Benefactive > Theme, as is clear from (51) as compared to (49a).

Luganda (JE15, Ssekiryango 2006: 69)

- (51) \*Maama a-wa-dde ssente taata.  
 1.mother 1SM-give-PFV 10.money 1.father  
 int. ‘Mother gave father money.’

The opposite is found in Makhuwa, where postverbal word order is determined primarily by information structure (52), but object marking (53) and passivization (54) are strictly asymmetric.

Makhuwa (P31, Van der Wal 2009: 251)

- (52) a. Nlópwaná o-ni-m-váh-a niphaawá nthiyána.  
 1.man 1SM-PRS.CJ-1-give-FV 5.spoon 1.woman  
 ‘The man gives the/a woman the/a *spoon*.’
- b. Nlópwaná o-m-vah-alé nthiyána nipháawa.  
 1.man 1SM-1OM-give-PFV.CJ 1.woman 5.spoon  
 ‘The man gave the/a *woman* the/a *spoon*.’

(Van der Wal 2009: 86)

- (53) a. O-ń-thól-á naphúlu ule.  
 1SM.PFV.DJ-1OM-search-FV 1.frog 1.DEM.DIST  
 ‘He searched for that frog.’
- b. Mwanámwáne o-n-aá-váh-á **ashipaap’ aáwé**  
 1.child 1SM-PRS.CJ-2OM-give-FV 2.parents 2.POSS.1  
naphúlu.  
 1.frog  
 ‘The child gave the frog to his parents.’
- c. \*Mwanámwáne o-ni-m-váh-a **ashipaap’ aáwé**  
 1.child 1SM-PRS.CJ-1OM-give-FV 2.parents 2.POSS.1  
naphúlu.  
 1.frog

(Van der Wal 2009: 76, 77)

- (54) a. Apílíyú o-nu-m-váh-á mithúpí Shiíla.  
 1.Abelho 1SM-PFV.PERS-1OM-give-FV 4.roosters 1.Shila  
 ‘Abelho gave Shila roosters.’
- b. Shiílá o-núú-váh-íy-á mithúpí (ni Apílíyu).  
 1.Shila 1SM-PFV.PERS-give-PASS-FV 4.roosters (with 1.Abelho)  
 ‘Shila was given roosters (by Abelho).’
- c. \*Mithúpí tsi-núú-váh-íy-á Shiíla.  
 4.roosters 4SM-PFV.PERS-give-PASS-FV 1.Shila  
 int. ‘The roosters were given (to) Shila.’

Word order, being more variable, is thus not as reliable a diagnostic for symmetry as the other tests. Importantly, however, the two tests of passivization and object marking seem to always pattern together. This suggests that whichever object is available for Agree with *v* in the active will be available for agree with *T* in the passive. The independence of word order and the consistent correlation between object marking and passivization in terms of (a)symmetry will form an important ingredient for the syntactic analysis of symmetry.



## 3.4.8 Hidden symmetry

An apparent counterexample to the generalization that passivization and object marking pattern together is Cuwabo (P34, spoken in Mozambique). Guérois (2015) shows how in ditransitives only the Recipient/Benefactive may be object-marked (55), thus appearing as asymmetric. In apparent contrast, both the Theme and the Recipient/Benefactive can become the subject of a passive (56), appearing symmetric. Note that either object in (55) would in principle be object-marked if they were the sole object of a monotransitive verb.

Cuwabo (P34, Guérois 2015: 437)

- (55) a. Múyáná owáavahá naámbédde álêddo.  
 mú-yáná o-hí-á-vah-á naámbédde á-lêddo  
 1-woman 1SM-PFV.DJ-2OM-give-FV 1a.maize 2-guests  
 ‘The woman gave maize to the guests.’
- b. \*Múyáná oómvahá naámbédde álêddo.  
 mú-yáná o-hí-mú-vah-á naámbédde á-lêddo  
 1-woman 1SM-PFV.DJ-1OM-give-FV 1a.maize 2-guests  
 int. ‘The woman gave maize to the guests.’

(Guérois 2015: 442)

- (56) a. Múyáná owáavahá mbúzi akálába.  
 mú-yáná o-hí-á-vah-á mbúzi a-kálába  
 1-woman 1SM-PFV.DJ-2OM-give-FV 9a.goat 2-older  
 ‘The woman gave a goat to the old people.’
- b. Mbúzi eévahíwa akálába na múyanā.  
 mbúzi e-hí-váh-íw-a a-kálába na mú-yanā  
 9a.goat 9SM-PFV.DJ-give-PASS-FV 2-older by 1-woman  
 ‘A goat was given to the old people by the woman.’
- c. Akálába aávahíwa mbúzi na múyanā.  
 a-kálába a-hí-váh-íw-a mbúzi na mú-yanā  
 2-older 2SM-PFV.DJ-give-PASS-FV 9a.goat by 1-woman  
 ‘The old people were given a goat by the woman.’

However, a closer look reveals that Cuwabo object marking is symmetric too, but this is obscured by other properties of Cuwabo object marking. Those properties are, first, the fact that Cuwabo only allows one object marker, and second, that all and only objects in noun classes 1/2, and first and second person are marked. Combined with the knowledge that Recipients and Benefactives are overwhelmingly first/second person or animate in class 1/2,

this means that in practically all contexts a ditransitive verb *has to* object-mark the Benefactive, and that ‘uses up’ all the object-marking capacity, making it impossible for the Theme to be object-marked. In other words, (55b) is not ungrammatical because the Theme is marked, but because the Benefactive is *not* marked.

In this scenario, Cuwabo is predicted to allow object-marking of the Theme when the Benefactive is not in class 1/2. This remains to be tested. However, there is one other circumstance in which the Theme can be object-marked: if the Theme is pronominalized, as in (57). Why object marking of the Theme is only possible in this circumstance is explained in Section 3.6; for now we just note that it is possible to object-mark the Theme in a ditransitive – the hallmark of symmetry in object marking.

Cuwabo (P34, Guérois 2015: 440)

(57) a. Múyáná oómvahá álèddo.

mú-yáná o-hí-mú-vah-á á-lèddo  
1-woman 1SM-PFV.DJ-1OM-give-FV 2-guests  
‘The woman gave it (cl. 1) to the guests.’

b. Múyáná owáávahá álèddo.

mú-yáná o-hí-á-vah-á á-lèddo  
1-woman 1SM-PFV.DJ-2OM-give-FV 2-guests  
interpretation 1: ‘The woman gave them (cl. 2) to the guests.’  
(OM Theme)

interpretation 2: ‘The woman gave to the guests.’ (OM Benefactive)

The same initial mismatch between object marking and passive is found in Makwe (G402), but I have not been able to establish whether the same prediction holds true in this language.

Nyaturu is another language that was thought to be asymmetric. Nyaturu objects need to be marked when they are both animate and definite. It thus usually marks the Benefactive, as in (58) and (59).

Nyaturu (F32, Hualde 1989)

(58) *only BEN is markable: BEN = OM*

N-a-va-et-e-aa **anca** mōhumba.  
1SG.SM-PST-2OM-bring-APPL-FV 2.girls 1.boy  
‘I brought the girls a boy.’ (\*the boy)

(59) *both BEN and Th are markable: BEN = OM*

a. \*N-a-ū-rūgh-I-aa Yohana.  
1SG.SM-PST-1IOM-cook-APPL-FV 1.Yohana

- b. N-a-**mū**-rūgh-I-aa                      **Yohana.**  
 1SG.SM-PST-1OM-COOK-APPL-FV    1.Yohana  
 'I cooked it (the cornmeal) for Yohana.'

However, if the Benefactive is inanimate/indefinite, it suddenly becomes possible to object-mark the Theme:

- (60) *only Th is markable: Th = OM*  
 a. N-a-rūgh-I-aa                      ang'inya      ūghai.  
 1SG.SM-PST-COOK-APPL-FV    2.children    11.cornmeal  
 'I cooked cornmeal for (some) children.'  
 b. N-a-**ū**-rūgh-I-aa                      ang'inya.  
 1SG.SM-PST-11OM-COOK-APPL-FV    2.children  
 'I cooked it for (some) children.'

In this respect Cuwabo and Nyaturu crucially differ from truly asymmetric Makhuwa and Swahili. In Makhuwa, like in Cuwabo, all and only nouns in noun classes 1 and 2, plus first and second persons, are object-marked. When the Benefactive is in noun class 1/2, it needs to be marked on the verb, regardless of the noun class of the Theme, that is, even if the Theme can in principle be marked, as in (62).

Makhuwa (P31)

- (61) *only R is markable: R = OM*  
 a. Ki-ni-**m**-vah-a                      mwanamwane    eliivuru.  
 1SG.SM-PRS.CJ-1OM-give-FV    1.child            9.book  
 'I give a/the child a/the book.'  
 b. \*Ki-m-vah-a                      mwanamwane    eliivuru.  
 1SG.SM-PRS.CJ-give-FV    1.child            9.book  
 int. 'I give a/the child a/the book.'

(Van der Wal 2009: 86)

- (62) *both BEN and Th are markable: BEN = OM*  
 a. O-ń-thól-á                      naphúlú    ule.  
 1SM.PFV.DJ-1OM-search-FV    1.frog          1.DEM.DIST  
 'He searched for that frog.'  
 b. Mwanámwáne o-n-**aá**-váh-á                      **ashipaap'** aáwé  
 1.child            1SM-PRS.CJ-2OM-give-FV    2.parents    2.POSS.1  
naphúlu.  
 1.frog  
 'The child gave the frog to his parents.'

- c. \*Mwanámwáne o-ni-m-váh-a                      **ashipaap'** **aáwé**  
 1.child                      1SM-PRS.CJ-1OM-give-FV 2.parents 2.POSS.1  
naphúlu.  
 1.frog

Nevertheless, when the higher Benefactive object does not need to (and in fact cannot) be object-marked because it is in a class other than 1/2, the Theme still cannot be marked in Makhuwa (63b).

Makhuwa (P31)

(63) *only Th is markable: Th is not OM*

- a. Ki-m-vah-a                      etthepo                      manttúvi.  
 1SG.SM-PRS.CJ-give-FV 10.elephants 1.peanuts  
 'I give the elephants peanuts.'
- b. \*Ki-ni-m-vah-a                      etthepo                      manttúvi.  
 1SG.SM-PRS.CJ-1OM-give-FV 10.elephants 1.peanuts  
 int. 'I give the elephants peanuts.'
- c. \*Manttúvi, ki-ni-m-vah-a                      etthepo.  
 1.peanuts 1SG.SM-PRS-1OM-give-FV 9.elephant  
 int. 'Peanuts, I give them to the elephant.'

For completeness, note that in monotransitives, class 1 'peanuts' does need to be object-marked in Makhuwa:

- (64) a. Ki-ni-m-wéh-a                      manttúví.  
 1SG.SM-PRS.CJ-1OM-see-FV 1.peanuts  
 'I see (the) peanuts.'
- b. \*Ki-m-wéh-á                      manttúví.  
 1SG.SM-PRS.CJ-see-FV 1.peanuts

The same holds for Swahili, according to [Henderson \(2006: 19\)](#), where the animate *mtoto* 'child' (which in a monotransitive requires object marking, see (65)), cannot be object-marked as the Theme in a ditransitive with an inanimate Recipient (66).

Swahili (G42, [Henderson 2006: 19](#))

- (65) a. Bahati a-li-**mw**-ona                      **mtoto.**  
 1.Bahati 1SM-PST-1OM-see 1.child  
 'Bahati saw a/the child.'
- b. \*Bahati a-li-ona                      mtoto.  
 1.Bahati 1SM-PST-see 1.child

- (66) a. Bahati a-li-pa dunia mtoto.  
 1.Bahati 1SM-PST-give 9.world 1.child  
 ‘Bahati gave the world a child.’
- b. \*Bahati a-li-m-pa dunia mtoto.  
 1.Bahati 1SM-PST-1OM-give 9.world 1.child

For further discussion of marking the Theme in asymmetric object marking, see Section 3.3.3.

We thus need to be careful in applying the various diagnostics for symmetry in ditransitives and take into account the universal preference for animate, definite Benefactives, which can obscure the underlying symmetry in object marking.

### 3.5 Circumventing the locality restriction in symmetry

With the data and tests in place, we are now all set to analyze the syntax of symmetric object marking. To repeat, the challenge of symmetric object marking is the following: given universal locality restrictions (e.g. Rizzi’s 1990 *Relativized Minimality*; Chomsky’s 1995 *Minimal Link Condition*), a higher head is not expected to agree with a goal if there are intervening goals. The  $\phi$  probe on  $v$  in (67) cannot agree with the Theme because the Benefactive is a closer goal and therefore intervenes.

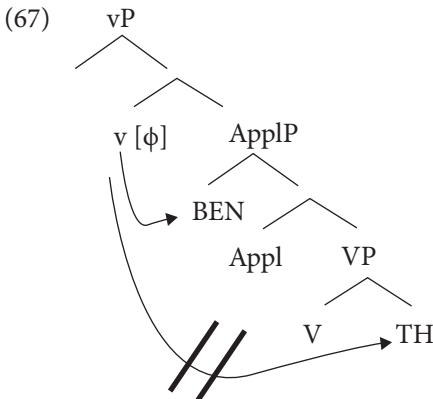

Given this situation, the question in a language with symmetric object marking is how  $v$  can agree with the lower object when the higher object is present.<sup>5</sup> An easy solution would be to parameterize locality conditions and state that in some languages syntactic operations must be local, whereas in others there is no such restriction. This is proposed by Baker and Collins (2006) on the

<sup>5</sup> In these sections I will focus on languages with one probe, i.e. one object marker; see Section 3.8 for multiple object markers.

basis of data from the Bantu language Kinande and the Khoisan language Ju|'hoansi. They state that the Minimal Link Condition can be active or not, varying crosslinguistically. Since locality seems to be a very profound property of human languages (Rizzi 2013), this is a rather daring claim, and moreover seems to be falsified in languages where symmetry is only partial (see Section 3.7). I therefore focus on alternative ways for *v* (or T) to agree with the lower Theme object in the presence of a higher Benefactive object, while keeping with locality principles.

Broadly speaking there are two ways in which the Theme can count as the closest goal for *v* to agree with: either the Theme is in a closer or equally close position to *v* as the Benefactive is, or the Benefactive is somehow invisible for *v*. Each of these strategies has two different ways of implementing:<sup>6</sup> for the former there is equidistance, or movement of the Theme, and for the latter relativized probing, or flexible licensing. I present each of these in turn, pointing out their advantages and drawbacks, and concluding that flexible licensing is the most promising.

### 3.5.1 Equidistance

A first solution to get around the locality problem is to deny that the Benefactive object is actually closer to the *v* probe than the Theme: if both objects are equally close to the probe, then either object can be reached without violating locality. This is Chomsky's (1995, 2000: 122) 'Equidistance Principle':

(68) Equidistance Principle:

Terms of the same Minimal Domain are equidistant to Probes

Minimal Domain:

The Minimal Domain of a head is the set of terms immediately contained in projections of that head

Equidistance has been used to account for symmetry in two ways: first, in structures where two arguments are the specifier and complement of the same head, i.e. the minimal domain circled in (69a); and second, in structures with multiple specifiers, that is, the minimal domain circled in (69b).

<sup>6</sup> There is another option that has been proposed for Bantu instrumental applicatives: Marantz (1993) suggests that the two arguments can be generated in either position. That is, in his analysis either Benefactive or Theme can be generated as the higher object and thus be object-marked and passivized without violating the MLC. For Benefactives, we do not see evidence for two hierarchical orders, so I will not take this analysis into consideration, but see Doggett (2004) for discussion of two underlying DOC structures in other languages.

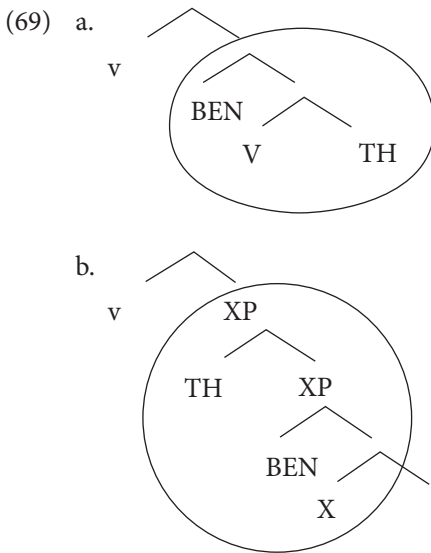

Anagnostopoulou (2003), building on Ura (1996), takes these minimal domains to account for symmetry in a number of languages. She proposes that in symmetric languages, the Theme object can move to the specifier of the applicative head and can therefore be in the same minimal domain as the Benefactive (as in (69b)). From there, both arguments are equidistant to the higher heads  $v$  and  $T$  and hence either argument can be object-shifted or become the subject of a passive verb, respectively. In this proposal, Locality is active, but refers to closest  $c$ -command only *between* minimal domains, not *within* a minimal domain.

A crucial question for this approach is why objects are equidistant in one language but not another. Anagnostopoulou (2003: 157) proposes the following parameter to distinguish symmetric from asymmetric languages, where DO stands for 'direct object' (my Theme):

- (70) The specifier to  $v$ APPL parameter  
Symmetric movement languages license movement of DO to a specifier of  $v$ APPL. In languages with asymmetric movement, movement of DO may not proceed via  $v$ APPL.

In Anagnostopoulou's work this remains a stipulation that, as she says herself, requires further study to see whether it can be reduced to independent properties of the relevant languages. McGinnis (2001) suggests a motivation for the crosslinguistic variation involving differences in the phasehood of applicative heads, as discussed in Section 3.5.2.

Ura (1996) and Anagnostopoulou (2003) explicitly link this movement to specAppl to object shift (cf. Kramer 2014). We would thus expect to see variation in postverbal word order. However, we do not always find evidence for such movement, for example when a language is by and large symmetric but has a very strict word order, as in Luganda: as shown in (49)–(51), Luganda double objects display symmetric behaviour for the two tests of pronominalization and passivization, but nevertheless have a very strict Benefactive > Theme order. Haddican and Holmberg (2012, 2014, 2018) furthermore show that the correlation between object shift and symmetry does not come out in their research on Norwegian and Swedish – the languages that originally supported the correlation – and they find that it is insufficient to rely on *just* locality to account for all the patterns found in Germanic languages.

A further question is how the symmetry could vary from construction to construction within a language, as discussed in Section 3.7. This would suggest that the parameter in (70) holds for some heads but not others – a suboptimal analysis.

### 3.5.2 Movement of the Theme

Even without the Equidistance Principle there could be movement of the Theme that allows it to be available for syntactic operations. That is, if the Theme moves to a position higher than the Benefactive, it will be closer to a higher probing head. In order to account for symmetry, then, we just need to say that the Benefactive will be closest to the probe when the Theme does not move, and whenever the Theme moves, then that will be the closest goal. Furthermore, this assumes that in asymmetric languages the Theme can never move.

This is the gist of McGinnis' (2001) proposal, where the Theme can 'leapfrog' over the Benefactive, as represented in (71).<sup>7</sup> McGinnis (1998ab) distinguishes two types of applicatives, low and high, corresponding to different semantics. The low applicative, situated under V, establishes a semantic relation between the Theme and the applied object, typically a Recipient. The high applicative on the other hand appears between *v* and V and relates the applied object to an event, typically as a Benefactive (see Pylkkänen's 2008 analysis in Section 3.2). McGinnis (2001) proposes that low applicatives cannot function as phases and therefore do not allow movement of the Theme to a second specifier; hence

<sup>7</sup> See Zeller & Ngoboka (2006) for a similar analysis of Asp licensing two objects and projecting two specifiers, though their discussion concerns locative applicatives.



the Theme is always lower than the Benefactive. High applicatives do function as phases and thus provide an escape hatch for unchecked features: the Theme can, in such a construction, move up for Case checking or extraction, ‘leapfrogging’ over the Benefactive and thus becoming available as the closest goal for object marking and passivization. The difference between asymmetric and symmetric languages, according to McGinnis (2001), is thus that asymmetric languages have low applicatives and symmetric languages have high applicatives.

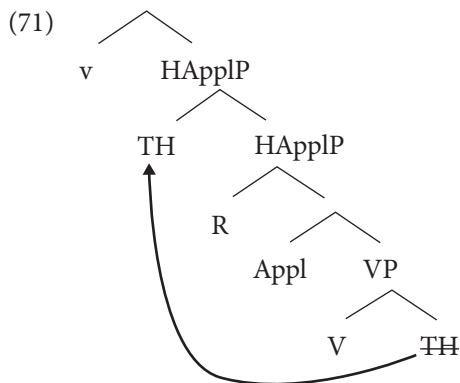

This analysis runs into problems for asymmetric languages, since these have been shown to also have high applicatives, as McGinnis also notes in her 2004 article. If the correlation between semantic interpretation and height of the applicative holds, then a truly Benefactive role should be introduced in a High Applicative, establishing a relation between the applied object as an event, not between the applied object and the Theme object. The data in (72) clearly illustrate the High Applicative semantics for Makhuwa, which is an asymmetric language (as was shown in (53) and (54)).

Makhuwa (P31)

- (72) O-ni-ń-kátth-él-á                      ekuwo      ts-áwé      nháno.  
 2SG.SM-PRS.CJ-1OM-wash-APPL-FV    10.clothes    10-POSS.1    1.lady  
 ‘You wash her clothes for the lady.’

Another problematic aspect of this locality-based approach is that it predicts low applicatives to never be symmetric. Even if LAppl could be a phase, then it would still not allow the Theme to be moved to its specifier, as argued by Jeong (2007). This is because it would involve movement that is too local, the Theme argument merging again with the same head. Abels (2003, 2012) observes that because of antilocality, direct complements of phase heads are frozen: they cannot escape by moving to the specifier of the phase head. For double object constructions, this means that the Theme in a low applicative can never move

higher than the Recipient (unless there is a higher phase head it can move to), and therefore it will never be the first argument found by *v*. However, if lexical ditransitives such as ‘give’ involve a low applicative (as suggested by their semantics), such symmetric low applicative structures do exist, as illustrated in (73). These ‘give’ type predicates are even the most frequently symmetric in comparison with other ditransitive predicates, as further discussed in Section 3.7.

Bembe (D54, [Iorio 2014](#): 101)

- (73) a. Twa-h-ile            batu            bokyo.  
       IPL.SM-give-PST 2.people 14.money  
       ‘We gave people (some) money.’  
       b. Twa-bo-h-ile            batu.  
       IPL.SM-14OM-give-PST 2.people  
       ‘We gave it to people.’  
       c. Twa-**ba**-h-ile            bokyo.  
       IPL.SM-2OM-give-PST 14.money  
       ‘We gave them money.’

As mentioned previously for Anagnostopoulou’s approach, movement of the Theme is predicted to have systematic word order effects, contrary to fact. This is also problematic for ‘raising applicatives’ as proposed by [Georgala et al. \(2008\)](#); [Georgala \(2012\)](#); [Nie \(2020\)](#), whereby a higher Appl phrase functions as a licenser.

I thus conclude that this potential solution to circumvent locality also encounters substantial problems.

### 3.5.3 Relativized probing by *v*

The previous two ways of getting around the locality constraint for *v* to agree with the Theme were based on the position of the Theme with respect to the Benefactive: if it is equally close or closer to *v*, Agree will be with the Theme as this is now the closest goal. Two alternative ways to establish Agree between *v* and the Theme assume that the Theme remains in a lower position than the Benefactive, but that for some reason the probe on *v* cannot ‘see’ the Benefactive argument and that hence there is no intervener. There are two alternatives for why the Benefactive is invisible.

The first alternative assumes that the probe is relativized to certain features that are present on the Theme but not the Benefactive, that is, relativized probing as proposed by [Béjar \(2003\)](#); [Béjar & Rezac \(2009\)](#), and further extended by, for example, [Georgi \(2012, 2013\)](#); [Nevins \(2007, 2011\)](#); [Preminger \(2014\)](#);

Puškar (2017). If a probe is specified for a particular feature, subfeature, or feature value, then only a DP containing the corresponding specification will count as a goal. The probe can thus skip any XP that does not have the specified feature, subfeature, or feature value. For example, if the probe searches specifically for a [+participant] feature, then it can ignore as potential goals all the DPs that do not have that specification. For object marking, the probe *v* could ignore the Benefactive if it does not have the right features and therefore continue its search, finding the Theme which could fully match the probe's feature specifications and enter into an Agree relation.<sup>8</sup> This would thus constitute another way around the locality challenge.

The logic of relativized probing requires an adjusted definition of locality, taking into account the featural specification of the probe and the goals, as argued by Starke (2001).

(74) Featural Relativized Minimality (Rizzi 2013, italics mine):

In the configuration ...X...Z...Y..., a local relation (e.g. movement) cannot hold between X and Y if Z intervenes and Z fully matches the specification of X *in the relevant morphosyntactic features*.

Considering symmetric object behaviour in the Bantu languages, the question is what feature the probe on *v* would be relativized to. Zeller (2015) proposes for object marking in Zulu that this feature is 'antifocus' (AF). In his analysis, a head X above *v*P probes not just for  $\phi$  features but also for an antifocus feature [uAF]. If the Theme is non-focal and hence is specified as [iAF], but the Benefactive is in focus and does not have [iAF], only the Theme forms a goal for the probe, allowing the probe on X to bypass the Benefactive. The same may work for animacy with a specification for [Person], and for a relativized probe on *v*, rather than assuming an additional head X.

A crucial obstacle in this approach, however, is what happens when there is no argument to match the required feature. For example, what if *v* is relativized to search for a topic, but both objects are part of the focus and hence there is no argument with a matching feature? There are four possible outcomes. The first, proposed by Béjar (2003), is that the probe is impoverished after a first search, and then probes a second time. For symmetric object marking, this would mean that the [uAF] feature is present on *v* at first, but

<sup>8</sup> This is crucially different from the approach taken by Nevins (2007) to account for PCC effects. He relativizes the probe on *v* to particular subsets of  $\phi$  features but proposes 1. that *v* agrees with both objects, and 2. a requirement for Matched Values: 'All elements within the domain of relativization must contain the same value' (Nevins 2007: 291). Under this approach the probe does not 'skip' the higher Benefactive but can agree with both Benefactive and Theme if they do not conflict for the relativized feature.

if in a first probe no suitable goal is encountered, [uAF] will vanish and in the second cycle Agree will be possible with arguments not specified for AF (whether this Agree relation spells out would still depend on the structure of the goal, as in Chapter 2). A second outcome is argued for by Preminger (2014), who proposes that upon a failed search, a default value may be inserted at PF and uninterpretable/unvalued features do not need to Agree in order for the derivation to converge. The 'default' inserted in the case of object marking would be consistently phonologically null, which renders the proposed analysis stipulative.<sup>9</sup> A third option is to assume that the relativization of the probe to [AF] (or [Person], [Topic]) is only present when a DP with such a feature is present in the derivation (Zeller 2015; d'Alessandro 2020). This seems a rather ad hoc solution, however, without rigid predictions. A fourth and final outcome is simply that the derivation will crash if the relativized probe does not find its specified goal, either because of a remaining uninterpretable/unvalued feature on *v*, or because one of the arguments is not licensed.

A more articulated version of relativized probing is developed by Deal (2015), who proposes two types of features on the probe: interaction features and satisfaction features. Under this approach, a probe will only halt if it encounters satisfaction features, but until it does so, it will interact with any goal it encounters. She illustrates this for Nez Perce complementizer agreement: C has a  $\phi$  probe, of which [Addr] (second person) is a satisfaction feature. If the subject is a second person, C agrees only with the subject, as the first argument encountered values  $\phi$  and satisfies the [Addr] feature of that probe. If, however, the subject is a first person and the object is a second person, the  $\phi$  probe first interacts with the subject (valuing  $\phi$  features) and then continues to probe for the object because its [Addr] feature is not yet encountered, resulting in complementizer agreement with both the subject and the object. Implementing this for symmetric object marking runs into the same problem as mentioned previously (what if the feature is not present?), but would additionally require adjustment, and furthermore it makes a wrong prediction. The adjustment needed is that the satisfaction feature is not a proper subset of the probe (as Deal explicitly argues) but an additional feature such as Zeller's antifocus or similar (e.g. Topic, or Miyagawa's 2010  $\partial$  feature). The prediction, especially if the satisfaction feature is separate from

<sup>9</sup> Note that in Preminger's (2014) account, the absence of a marker is a diagnostic for clitic doubling, rather than agreement. See Chapter 2, Section 2.3, for discussion on agreement vs pronoun/clitic.

the  $\phi$  probe, is that we would see some effect of the interaction with the higher Benefactive object if satisfaction is only reached upon encountering the lower Theme object. Yet in languages with one object marker we never see any morphological or other traces of the supposed interaction between the  $\phi$  probe on *v* and the higher object it first encounters. Deal's featural analysis therefore does not look promising as an elegant account of symmetric object marking.

A final objection to the relativized probing account of symmetry is the fact that it does not naturally account for the parallel between symmetric object marking and symmetric passivization. The two would necessarily be due to different probes (*v* and *T*, presumably), and it is unclear why a relativized probe on the one would imply a relativized probe on the other in passives.

In summary, while Béjar's or Preminger's solutions to the lack-of-goal objection could be implemented in the model proposed so far (but still face the challenge of the parallel between passive and object marking), in the [next section](#) I will argue for another approach to symmetry: flexible licensing. This allows us to keep probes underspecified, and moreover, flexible licensing takes into account both sides of the relation between arguments and clausal heads: not just  $\phi$  agreement (what heads need), but also nominal licensing (what phrases need) plays a role.

### 3.5.4 Flexible licensing

[Haddican and Holmberg \(2012, 2014, 2018\)](#) propose a different approach to symmetry in double object constructions. In their proposal, which I will adopt and extend in this and the next two sections, the Benefactive can become invisible to the probe on *v* because it is already Case-licensed.<sup>10</sup> Specifically, in symmetric object marking, either argument can be licensed by Appl: the Theme [uCase] probing upwards to Appl, or the Benefactive [uCase] probing downwards, as represented in (75). In all tree representations, dashed arrows represent licensing (Agree for [Case]), and solid arrows represent Agree for  $\phi$  features. The arrows point from the probe to the goal.

<sup>10</sup> This section and Section 3.6 are largely taken from [Van der Wal \(2017\)](#).

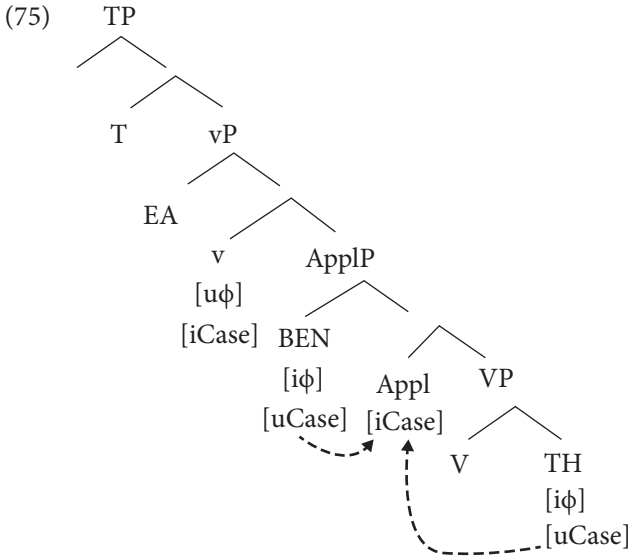

The Case licensing by Appl (and other low functional heads) is thus proposed to be flexible in languages with symmetric object marking. The variation between symmetric and asymmetric languages can then be described as variation in the ability of a functional head to check Case upwards or downwards: inflexible licensing results in asymmetry, whereas flexible licensing allows symmetry. We return to the precise mechanisms shortly, but I first point out the consequences for  $\phi$  agreement.

If the Theme is licensed by Appl, then the Benefactive must be licensed by v. In turn, v agrees with the Benefactive valuing its  $\phi$  features; this is the same as in asymmetric languages, see (18), repeated here as (76).<sup>11</sup>

(76) *v agrees with the Benefactive (and can object-mark it)*

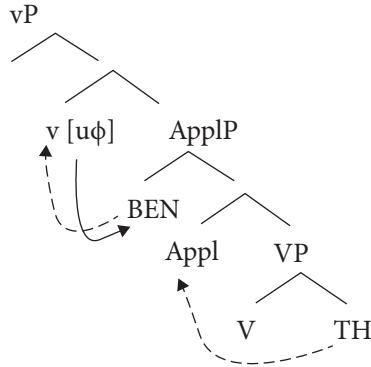

<sup>11</sup> Beyond Bantu, there is another asymmetric language type with a so-called indirective alignment of double objects, where the lower functional head always licenses its specifier. This is different from flexible licensing (see Section 5.2.5).

Now consider the other possibility in a symmetric object-marking language: if the Benefactive is licensed by Appl, then the Theme is free to engage a licensing relation with *v*. The  $\phi$  probe on *v* in turn agrees with the Theme, as represented in (77), either because it is already in a relation with the Theme, or because the Benefactive has become ‘invisible’ to *v* (cf. McGinnis 1998b; Carstens 2016).<sup>12</sup> The Theme’s  $\phi$  features on *v* can then potentially spell out as an object marker.

(77) *v* agrees with the Theme (and can object-mark it)

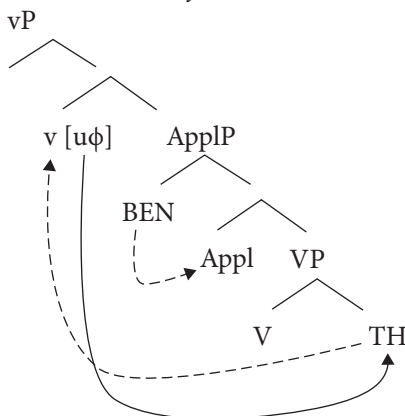

Note that the applicative head here only has a [iCase] feature and no  $u\phi$  features. The presence of the Case feature ensures that the second object is licensed, whereas the absence of  $u\phi$  features on Appl means that the argument agreeing with Appl cannot be object-marked: only the argument agreeing with *v* can spell out as an object marker (whether it does so still depends on whether it is a defective goal). The presence of  $u\phi$  only on *v* also accounts for the fact that there is only one object marker (see Section 3.8 for multiple object markers).

A very obvious question for this flexible licensing approach, which Haddican and Holmberg do not address, is what determines the direction of Case licensing, in other words, what governs whether the Theme or the Benefactive is licensed by the Appl head? In an explanatory analysis this should not be left optional. In the [next section](#), I propose that the relative animacy and topicality of the two arguments are responsible for the flexible direction of licensing.

<sup>12</sup> Assuming that there is no defective intervention clause-internally, a point that has been argued for by Anagnostopoulou (2003) and Bobaljik (2008). See also Bruening (2014) for an argument against defective intervention per se.

### 3.6 Flexible licensing through animacy and topicality

To find a satisfactory answer, the question needs to be reformulated: what prevents the Theme from being licensed by Appl in those sentences where *v* agrees with the Theme? If the Theme has a probing [uCase] feature and Appl is a Case licenser, surely they should Agree at the first possible instance. This indeed happens in asymmetric languages, but not always in symmetric languages. Let us consider the derivation. Building the structure from the bottom up, *V* is merged with the Theme, and conceptually in a next step we would simply want to merge the Benefactive. However, adding an argument requires the presence of another licenser (compare to Kalin 2018). That is, the Appl head can be seen as a ‘side effect’ of merging the Benefactive DP. Considering this tight relation between the Appl head and its specifier, the proposal is that in languages with symmetric object marking, the Case-licensing abilities of the applicative head are determined by the argument it introduces:

(78) Flexible Licensing Parameter (FLiP):

The features and feature values that a head can license [are/are not] restricted to those of the argument introduced in its specifier.

The specific features that are involved here are [Person] and [Topic]. For example, if the Benefactive is topical, Appl can license any argument that is topical or underspecified. If the Benefactive is non-topical, as a consequence Appl is not able to license a topical argument, but it can license a non-topical one. We can now understand, intuitively at least, under which circumstances the Theme cannot be licensed by Appl: when the Benefactive is non-topical (and Appl can hence not license topical arguments) and the Theme is topical, the Theme will not find Appl to be a matching licenser and therefore will not be licensed by it. This leaves the Benefactive to be licensed by Appl, and the Theme to be licensed and agreed with by *v* (possibly spelling out as an object marker).

A more detailed and technical explanation of Case licensing and the FLiP will follow in Section 3.6.3. There, I outline a possible way in which [Person] and [Topic] are integrated into nominal licensing as values of [Case: \_]: objects may be specified for [uCase: top], probing the structure for a head with [iCase: top]. However, it will be useful to first get a better feel for the empirical phenomena. I therefore first illustrate how the derivations proceed for animacy (Section 3.6.1) and then topicality (Section 3.6.2), also explaining the notion of topicality.



## 3.6.1 Animacy

As discussed in Chapter 2, in a featural approach, animacy can be connected to the presence (animates) or absence (inanimates) of a [Person] feature, see also [Adger & Harbour \(2007\)](#); [Bejar & Rezac \(2009\)](#). Under the FLiP, then, if the Benefactive is animate and therefore has a [Person] feature, Appl can license any argument, whether unspecified, as in (79), or carrying a [Person] feature, as in (80). In these examples, there is no problem for the Theme to be licensed by Appl for animacy, but it is the relative topicality of Theme and Benefactive that eventually determines licensing relations, as discussed in Section 3.6.2.

(79) *Benefactive higher in animacy than Theme*

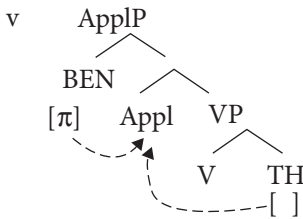

(80) *Benefactive and Theme equally animate*

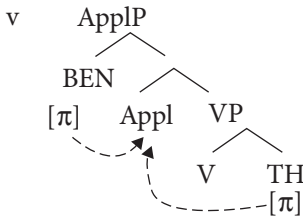

If, on the other hand, the Benefactive lacks a [Person] feature, then Appl can only license an unspecified Theme as in (81). Again, final licensing depends on topicality.

(81) *Benefactive and Theme equally inanimate*

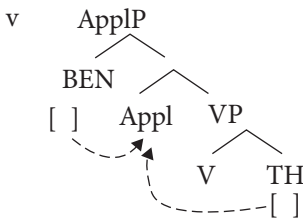

If the Benefactive is lower in animacy than the Theme (i.e. the Benefactive does not have a Person feature, but the Theme does), the animate Theme cannot be

licensed by the underspecified Appl, staying active as a probe. This means that Appl remains as a licenser for the Benefactive, as in (82), leaving the Theme to be licensed by v.

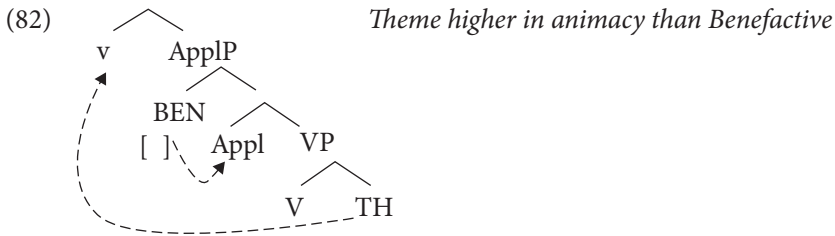

As a result of Appl licensing the Benefactive in its specifier and the Theme being licensed by v, v can only Agree for  $\phi$  features with the more animate Theme (82). This accounts for the restriction found in some symmetric languages of zone S where only the animate Theme can be object-marked if the Benefactive is inanimate, as in Table 3.1 (see also [Hawkinson & Hyman 1974](#) for the influence of animacy and topicality in Shona ditransitives). It remains to be seen whether other symmetric languages also have this animacy restriction (see also Section 3.10).

**Table 3.1** Animacy restriction in symmetric Sotho and Zulu

	<i>Theme</i>	<i>Animate (<math>\pi</math>)</i>	<i>Inanimate (<math>\_</math>)</i>
<i>Benefactive</i>			
<i>Animate (<math>\pi</math>)</i>		either	either
<i>Inanimate (<math>\_</math>)</i>		Theme only	either

[Zeller \(2012b\)](#) shows this pattern for Zulu in the following examples, where the inanimate Reason/Source argument cannot be object-marked (83a), but the animate Theme can be (83b). Further data involving a Benefactive would be necessary for strict comparability.

Zulu (S42, [Zeller 2012b](#): 228)

- (83) a. <sup>??</sup>Ngi-thand-el-a      u-John    ubu-qotho    ba-khe.  
 1SG.SM-like-APPL-FV    1a-John    14-honesty    POSS14-1  
 ‘I like John for his honesty.’
- b. <sup>??</sup>Ngi-thand-el-a      ubu-qotho    ba-khe    u-John.  
 1SG.SM-like-APPL-FV    14-honesty    POSS14-1    1a-John  
 ‘I like John for his honesty.’

- (84) a. \*Ngi-**bu**-thand-el-a                      u-John    **ubu-qotho**    **ba-khe**.  
 1SG.SM-14OM-like-APPL-FV    1a-John    14-honesty    POSS14-1  
 int. 'I like John for it, his honesty.'
- b. Ngi-m-thand-el-a                      ubu-qotho    ba-khe    u-John.  
 1SG.SM-1OM-like-APPL-FV    14-honesty    POSS14-1    1a-John  
 'I like him for his honesty, John.'

Morolong and Hyman (1977) make a case for the influence of animacy in Sesotho as well, where either object can be marked if they are equal in animacy (86) but only the Theme can be marked when the applied object is lower in animacy than the Theme (85c, d).

Sesotho (S33, Morolong & Hyman 1977: 204, glosses added)

- (85) a. Ke            **mó**    phehétsé    lijó.                      *different animacy*  
 1SG.SM    1OM    cooked.APPL    5.food  
 'I cooked food for him/her.'
- b. Ke            lí    phehétsé    ngoaná.  
 1SG.SM    5OM    cooked.APPL    3.child  
 'I cooked it for the child.'
- c. Ke            **ba**    bítselítsé    mokéte.  
 1SG.SM    2OM    called.APPL    3.feast  
 'I called them for the feast.'
- d. \*Ke            o    bítselítsé    baná.  
 1SG.SM    3OM    called.APPL    2.children  
 int. 'I called the children for it.'
- (86) a. Ke            **ó**    phehétsé    lijó.                      *equal in animacy*  
 1SG.SM    3OM    cooked.APPL    5.food  
 'I cooked food for it.'
- b. Ke            lí    phehétsé    mokéte.  
 1SG.SM    5OM    cooked.APPL    3.feast  
 'I cooked it for the feast.'
- c. Ke            **mo**    bítselítsé    baná.  
 1SG.SM    1OM    called.APPL    2.children  
 'I called him/her for the children.'  
 'I called the children for him/her.'
- d. Ke            **ba**    bítselítsé    morena.  
 1SG.SM    2OM    called.APPL    1.chief  
 'I called them for the chief.'  
 'I called the chief for them.'

Animacy in the form of a Person feature thus restricts licensing by Appl when the Theme is more animate than the Benefactive.

### 3.6.2 Topicality

Within the boundaries of this animacy restriction, which object is licensed by Appl, and which is licensed and agreed with by *v* depends on their relative topicality.

The term ‘topicality’ and the feature [Topic] in this book refer primarily to the accessibility status of referents, and to their *potential* for fulfilling the discourse-pragmatic function of (aboutness/familiar/contrastive) topic.<sup>13</sup> Referents, or to be precise the mental representations of referents, have a particular mental activation state. That is, they are typically inactive, they are activated when mentioned in the discourse, and their activation decreases when the discourse shifts to other topics (Prince 1981, 1992; Chafe 1976, 1987). A referent’s accessibility state influences the linguistic form that is chosen to refer to the referent (Gundel et al. 1993; Ariel 1990, 2001), where referents that are at the lower end of the accessibility scale are typically referred to by ‘more coding material’ (Givón 1983: 17), that is, full names, long definite descriptions, etc., whereas more active referents can be referred to by pronouns or remain phonologically null. This is relevant in the current discussion because  $\phi$ P pronouns map onto the ‘active/accessible’ end of the scale, and *v* agreeing with such a pronoun results in a spell out as an object marker.

The same accessibility status is relevant (though not determining) for a referent’s functioning as the topic: the more active a referent is, the more acceptable it is, and the higher its potential is to function as a topic (Lambrecht 1994: 165).

(87) Lambrecht’s (1994) Topic Acceptability Scale

active > accessible > unused > brand-new anchored > brand-new unanchored

Here, by the *function* ‘topic’ I mean the referent that the comment is about (Reinhart 1981), or in other words: the topic provides the anchoring point for the addressee to which the following information should be linked. In order to function as a topic, a referent must at least be identifiable to the addressee, that is, it must have crossed a certain threshold of activation. Above that threshold, and depending on the activation of other referents, the argument referring to

<sup>13</sup> I suppose that ‘antifocus’ [AF] (Zeller 2008, 2015) overlaps to a large extent with this definition and may turn out to be preferable over ‘topic’ [Topic] as the relevant notion and/or feature here.

that referent may be marked as such by a *feature* [Topic]. This does not mean that the referent is necessarily the topic of the clause (although it may well be), or that it is a secondary topic (see Dalrymple & Nikolaeva 2011), but that it is a potential topic that is active enough.

Note that languages differ in how accessibility participates in the grammar: it may be involved in Case licensing, as discussed in this and later sections, and/or it may be associated with [Person] as a separate projection on the DP as seen in Chapter 2 (e.g. in Swahili and Manyika Shona). The two typically do not co-occur in one language, but they may. Interestingly, all Bantu languages seem to have at least one of these options, as extensively discussed in Chapter 5.

If the language has grammaticalized a [Topic] feature influencing flexible licensing, the FLiP states that Appl can only license arguments that are equal or lower in topicality than the argument it introduces.<sup>14</sup> Assuming topicality to be represented as a [Topic] feature, this happens in exactly the same way as for animacy.

For any of the three combinations of animacy in (79)–(81), if the Benefactive is topical, Appl can license any Theme, whether topical or not, and will do so because downward licensing is the default (see Section 3.6.3), as represented in (88). This leaves *v* to agree with the Benefactive. In languages where only *v* has a  $\phi$  probe, object marking will, in that scenario, only be possible with the Benefactive.

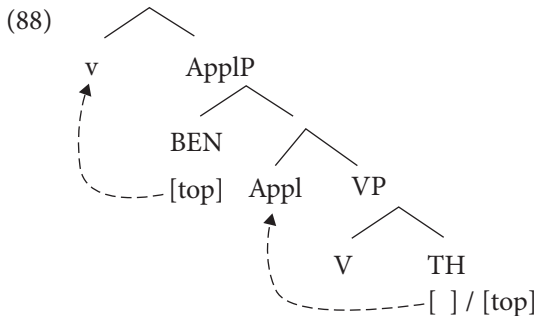

This predicts that when both objects are topical, only the higher will be object-marked. This is in fact borne out in Zulu: when both objects are topical  $\phi$ P pronouns, only the higher can be object-marked. In (89), we know that both coreferring DP objects are in a dislocated position because of the disjoint form of the verb and the accompanying prosodic phrases (not indicated here) (see

<sup>14</sup> See also É.Kiss' (2017) Inverse Topicality Constraint, according to which 'in a construction with two topics, the structural hierarchy of the topics cannot contradict the ranking of their referents in the Animacy/Topicality Hierarchy' (É.Kiss 2017: 373). This approach is different from the proposal here in that it applies not just to objects, and it is proposed as an interface constraint, rather than a derivational choice.



A consequence of this analysis is that it is always the more topical of the two arguments that will be left available for  $\phi$  agreement. In active clauses, the more topical argument agrees with  $v$  and we know that object marking (= agreement with  $v$ ) is crosslinguistically typically with the more topical object (Dalrymple & Nikolaeva 2011), in differential object marking as well as pronominalization (e.g. Adams 2010; Zeller 2014, 2015 for Zulu). In passive clauses, where  $v$  has neither Case nor  $\phi$  features, the more topical argument agrees with  $T$  and is moved to specTP if  $T$  has a movement diacritic ( $\approx$ EPP feature, see also Chapter 4). Passives are known to promote an erstwhile object not only to the syntactic function of subject, but also to the discourse function of topic (Givón 1994: 9). This is especially true for the Bantu languages where the pre-verbal domain favours or is restricted to topical elements (e.g. Morimoto 2006; Henderson 2006; Zeller 2008; Zerbian 2006a; Van der Wal 2009; Yoneda 2011).

Furthermore, 'a symmetric language is predicted, barring additional constraints, to have an alternating passive, as well as an alternating object marker and an alternating reciprocalization' (Alsina 1996: 677). While not all diagnostics for symmetry in ditransitives pattern together, passivization and object marking do so overwhelmingly (as discussed in 3.4.7), which is predicted by the current account (contra Woolford 1993).

We can now return to the apparent asymmetry of Cuwabo and Nyaturu, mentioned in Section 3.4.8. Object marking in these languages at first sight appeared to behave asymmetrically, in requiring the Benefactive object to be object-marked but not the Theme. However, a closer look revealed that the Theme can in fact be object-marked, but only if the Benefactive is inanimate (Nyaturu) or if the Theme is pronominal (Cuwabo). This can now be understood as follows. If both Nyaturu and Cuwabo are symmetric, that means that Appl has flexible licensing, depending on Person and/or Topic. In Nyaturu, if the Benefactive is inanimate, a Theme that is higher in animacy cannot be licensed by Appl and instead the Benefactive in its specifier will be licensed, leaving the Theme to be agreed with and licensed by  $v$  (resulting in object marking). In Cuwabo (and in general), a pronominal Theme is necessarily more topical than a non-pronominal Benefactive. As in Zulu and Sotho, in this scenario Appl can only license the Benefactive in its specifier, and  $v$  agrees with the Theme (resulting in object marking).

The sensitivity of low functional heads to information structure is not a new phenomenon: Creissels (2004); Marten (2003); Voisin (2006); Cann and Mabugu (2007); de Kind and Bostoen (2012); and Marten and Mous (2017, 2018) also show that applicatives are more than simple argument-introducing heads. In various Bantu languages they can be used to indicate some aspect of

information structure (e.g. focus or unexpectedness). To give just one example, [Creissels \(2004\)](#) first shows the familiar function of introducing a Benefactive argument in Tswana (92a), and the function of making a peripheral argument (the locative ‘in the pot’ in (92b)) into a proper argument of the predicate.

Tswana (S31, [Creissels 2004](#): 13, adapted)

- (92) a. Lorato o tlaa ape-el-a bana motogo.  
 1.Lorato 1SM FUT cook-APPL-FV 2.children 3.porridge  
 ‘Lorato will cook the porridge for the children.’  
 b. Lorato o tlaa ape-el-a motogo mo pitse-ng.  
 1.Lorato 1SM FUT cook-APPL-FV 3.porridge PREP 9.pot-LOC  
 ‘Lorato will cook the porridge in the pot.’

Interestingly, Creissels then shows that applicatives in Tswana can also have a non-canonical function as triggering a focus reading of the locative (93).

Tswana (S31, [Creissels 2004](#): 15)

- (93) Lorato o ape-el-a mo jarate-ng.  
 1.Lorato 1SM COOK-APPL-FV PREP 9.yard-LOC  
 ‘Lorato does the cooking *in the yard*.’

This can be taken as independent evidence for the sensitivity of the applicative head to discourse-related properties (although in this case not Topic).<sup>15</sup>

In summary, the FLiP proposes that Appl’s licensing may be dependent on the [Person] and/or [Topic] features of the Benefactive in its specifier. For languages in which this is the case (those with symmetric object marking), this parameter setting can explain why under specific circumstances the Theme cannot be licensed by Appl and instead is licensed and agreed with by v. Such flexible licensing then explains how either object can be object-marked in symmetric languages.

### 3.6.3 Case checking and Agree

Now that the empirical motivation for a flexible licensing in ditransitives has been discussed, we can turn to the question of how flexible licensing works technically. My aim here is to explore a potential direction of how Case licensing and sensitivity to salience (animacy and discourse salience) might function

<sup>15</sup> I leave a formal analysis of non-valency-changing applicatives as in the overview by [Marten & Mous \(2017\)](#) for further research.



(inspired by Good 2011) – it may well be that a different implementation eventually surfaces as optimal.

As discussed in Section 3.3.2, Case licensing is independent of  $\phi$  agreement. Furthermore, I explained that I view Case as a requirement for nominals to enter into a relation with a functional head, and I assume that this requirement is formally present on the nominal in the form of an uninterpretable [uCase] feature, which needs to check against an interpretable [iCase] feature on a head. However, the precise restrictions on this licensing relation may vary from one language to the next: some have just nominative and accusative values of Case, others include dative and genitive, etc., and yet others take ergative and absolutive as values of [Case: \_]. However, it is becoming ever clearer that in the Bantu languages, nominal licensing works differently from European languages (Perez 1985; Diercks 2012; Halpert 2015; Carstens 2005; Carstens & Mletshe 2016; Van der Wal 2015c, 2017; Schneider-Zioga 2019). As we have seen in this chapter and Chapter 2, the features Person and Topic play a significant role in (at least some) Bantu languages. So arguments still need to be licensed syntactically,<sup>16</sup> but instead of a nominative or accusative Case, we may hypothesize that in these languages, [Case] can have the values [Case: top] and/or [Case:  $\pi$ ].<sup>17</sup>

In the languages in which Person and/or Topic are grammaticalized in this way, DPs enter the derivation with an uninterpretable licensing feature [uCase], which is valued if the DP is topical [uCase: top] or animate [uCase:  $\pi$ ]. Being uninterpretable features, they need to be checked and, having a value, they need to be checked by a head that can check that value. Underspecified [uCase: \_] can be licensed by any [iCase] feature. T is present as a licensing head by default, but as mentioned in Section 3.5.4, the Benefactive brings Appl with it as an additional licensing head. Therefore, Appl has the interpretable counterpart [iCase] of the DP's uninterpretable [uCase] in a language that has flexible licensing (a positively set FLiP). In such a language, if the Benefactive has a [uCase: top] feature, for example, the Appl head will carry an

<sup>16</sup> Halpert (2015) argues that Zulu shows evidence for a licensing requirement within the vP, where nouns without the augment (an initial vowel) need to be licensed by a Licensor head, whereas nouns with an augment are intrinsically licensed. I think my proposal is compatible with Halpert's, if augment-less nouns and  $\phi$ Ps need licensing and do not move. A difference is that I assume that v is responsible for licensing and hence do not need a separate Licensor head. Unlike Halpert, however, I have not yet incorporated the conjoint/disjoint alternation into my analysis. Further research should show how the two proposals can be combined. See also Chapter 4, where I explain how an *in situ* external argument can still be licensed by v.

<sup>17</sup> Instead of values of Case, we can also think of [Person] or [Topic] as separate features, or as sub-features of [Case]. Eventually we may want to develop a model in which an information-structural feature itself (like Topic, or Miyagawa's general  $\partial$  for discourse) is responsible for nominal licensing and do away with [uCase]. What features or feature values a language uses depends on what has grammaticalized in the language.

[iCase: top] feature.<sup>18</sup> The result is that Appl can be restricted in its licensing abilities.

As an aside, it may now seem that two aspects are blended in this discussion: on the one hand the grammaticalization of Topic as a value of [uCase], and on the other hand the sensitivity of Appl to the Benefactive's features (the FLiP). The two are of course not independent, as it is necessary for Topic to be connected to uCase for Appl's licensing to be sensitive to it. But theoretically, we can also imagine a language in which Topic is grammaticalized to Case, but Appl is not flexible. This, however, would trigger the question how exactly the acquirer can discover this parameter setting: if not flexibility in object marking, what in the input would lead the acquirer to posit Topic as a formal feature relevant to Case? At this point I pose it as a rhetorical question, but Chapter 5 enters into this question in some detail. For now, I conclude that the variation between symmetric (flexible) and asymmetric (inflexible) object marking is located in a positive or negative setting of the FLiP for the Appl head, asking whether Case licensing is restricted to the features and feature values of the argument it introduces.

To make the suggested implementation of Topic and Person as Case values explicit, I illustrate with two example derivations for flexible licensing, one for a topical Benefactive and non-topical Theme, and one for a non-topical Benefactive and a topical Theme. These will also bring the direction of probing into the picture, which I discuss after the example derivations.

We start by merging the verb and a Theme with interpretable and valued  $\phi$  features [i $\phi$ ], and a simple [uCase] feature (considering that it is not topical but does need to be licensed). The uCase feature, given that it needs checking, probes the structure. Next, the Appl head and Benefactive are merged, the latter with i $\phi$  and [uCase: top], and (therefore) the former with [iCase: top]. The probing uCase on the Theme finds iCase on Appl and is checked; it does not matter for the unspecified uCase whether the iCase has a value or not. The [uCase: top] feature of the Benefactive also probes but will not find an available [iCase] feature in the structure built up so far and hence waits until, at the next step in the derivation, v is merged with [iCase: top] (either by default or possibly because the external argument in a ditransitive is always topical – see further in Chapter 4). The Benefactive's [uCase: top] is now also checked, and at the same time v's u $\phi$  features are checked and valued by the i $\phi$  features of the Benefactive. As the Benefactive is a  $\phi$ P pronoun and hence a defective goal, its features are spelled out on v as an object marker. This can be how (49b) is

<sup>18</sup> A metaphorical way of looking at this is a potluck party: every guest (DP) needs to bring some food (iCase), and guests with food allergies will bring food they are compatible with (iCase: top).

derived, repeated here as (94), and the structure in (88) is then more precisely rendered as (95).

- (94) Maama a-**mu**-wa-dde ssente.  
 1.mother 1SM-1OM-give-PFV 10.money.  
 ‘Mother has given him money.’

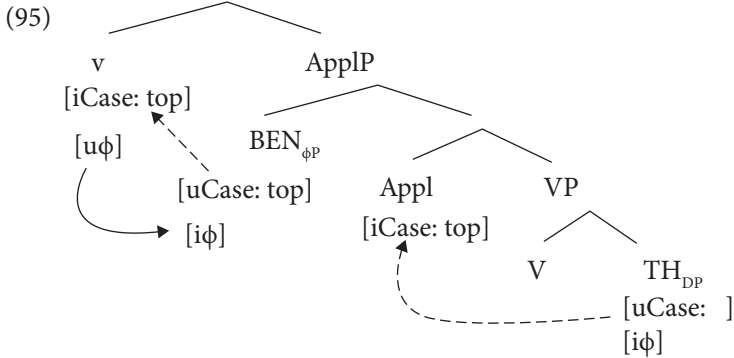

Now we turn to (49c), repeated as (96), with a non-topical Benefactive and a topical Theme. Again, we start by merging V with a Theme, but this time the Theme has [iφ] and [uCase: top]. When Appl and the Benefactive are merged with a simple [uCase] and [iCase], respectively, the probing [uCase: top] feature on the Theme does not find a match. Hence, [uCase] on the Benefactive can now find [iCase] on Appl and be checked. Next, v is merged with [iCase: top], and the – still probing – Theme can now be licensed for Case. The uφ features on v are checked and valued at the same time, resulting in object marking of the Theme (as it is a defective goal). The detailed representation of (91) is given in (97).

- (96) Maama a-**zi**-wa-dde taata.  
 1.mother 1SM-10OM-give-PFV 1.father  
 ‘Mother has given it father.’

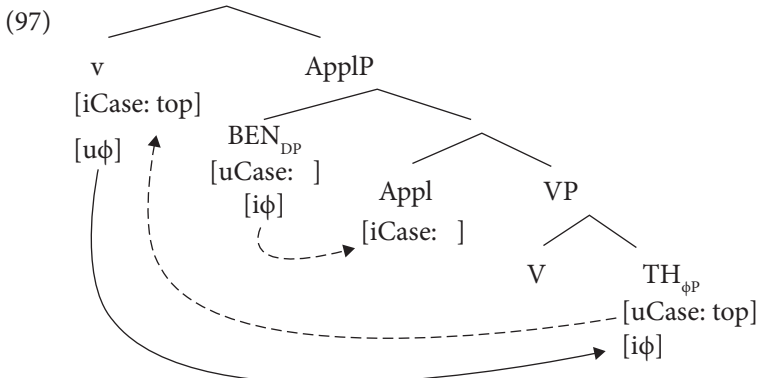

These example derivations bring to the fore two theoretical points: the direction of checking and Agree, and how  $\phi$  and Case tend to cooperate. I discuss both of these theoretical points in a bit more depth. Over the last decade or so, the direction of Agree has been a topic of debate, with Chomsky (2000) taking the view that  $u\phi$  features only probe down and find goals that are activated by virtue of have  $u$ Case features. Baker (2008a), on the other hand, suggests that languages can also Agree upwards, and argues for a ‘Direction of Agreement Parameter’ that specifies for each language whether a head agrees only with a  $c$ -commanding DP or not (see Chapter 4 for further discussion in the context of subject inversion). This ‘Upward Agree’ approach has been further developed by, among others, Hedde Zeijlstra (2008, 2012), also in joint work with Bronwyn Bjorkman (Bjorkman & Zeijlstra 2019). They reason that we should not just be concerned with the direction of agreement for  $u\phi$  features, but uninterpretable features in general. Specifically, they argue that any uninterpretable feature can only be checked by an interpretable feature that  $c$ -commands it:

- (98) *Upward Agree (= feature checking)*  
 $\alpha$  checks an uninterpretable feature on  $\beta$  iff
- a.  $\alpha$  carries a matching interpretable feature;
  - b.  $\alpha$   $c$ -commands  $\beta$ ;
  - c.  $\alpha$  is the closest goal to  $\beta$ . (Bjorkman & Zeijlstra 2019: 535)

The core of their proposal is ‘a distinction between Agree, an operation that checks uninterpretable features, and a separate (and subsequent) operation of valuation’ (Bjorkman & Zeijlstra 2019: 535). Nevertheless, ‘only checked features can be valued, and valuation takes place as soon as possible’ (p. 537). A checking relation does not necessarily have to be between  $u\phi$  and  $i\phi$  but can also be between  $u$ Case and  $i$ Case – after all, this too is an uninterpretable feature that needs checking. As soon as a checking relation for Case exists between a DP and a head, the DP can be moved so that the  $u\phi$  features on the clausal head can Agree upwards with the DP’s  $i\phi$  features. Movement (internal Merge), they claim, is then independent of any movement triggers or EPP features, but simply motivated by the need for upward checking of uninterpretable features.

While their proposal cannot capture the facts in Bantu object marking,<sup>19</sup> I agree with Bjorkman and Zeijlstra that we need to look at the whole set of featural relations. However, the null hypothesis should be that uninterpretable

<sup>19</sup> Bjorkman & Zeijlstra (2019) would require movement of the object to above  $v$  in order to agree for  $\phi$  features, yet we have seen how  $v$  agrees in  $\phi$  features with a DP that is clearly *in situ* (e.g. *wh* words in Sambia or Makhuwa, Section 2.3 in Chapter 2), suggesting that the  $i\phi$  features of the DP have never been in a  $c$ -commanding position. See Bárány & Van der Wal (to appear) for further critical discussion of Bjorkman & Zeijlstra (2019); as well as Carstens & Diercks (2013); and Diercks, Van Koppen, & Putnam (2020) for arguments against upward Agree from downward agreeing ‘how’ in Lubukusu and Lubukusu complementizer agreement, respectively.

features simply agree as soon as possible (see [Pesetsky 1989](#)). That is, upon merger of an uninterpretable feature, it starts probing whatever structure there is ([Epstein 1999](#)): if the already built structure (the c-command domain) contains a suitable goal, agreement happens (downward), and if not, the feature keeps probing (upward). This is precisely what [Carstens \(2016: 37\)](#) argues: ‘valuation is not directional. If a match for uF on head X is available in X’s sister at Merge, valuation happens immediately and instantiates downward Agree. But if no match is available at this point, uF can obtain delayed valuation’. Such ‘delayed valuation’ is typical for Case, as its licenser is often not present in the c-command domain but will be merged later on. uCase can then be checked ‘upward’, but importantly it still happens as soon as possible and within the same phase. In this way, licensing and agreement can be upwards or downwards, depending on when the right match in features is merged. I adopt [Carstens’ \(2016\)](#) non-directional approach to uninterpretable feature checking, which makes for a clean and minimal probing algorithm.

Within this algorithm, while Case checking is logically separate from  $\phi$  agreement, Case and  $\phi$  features must go together whenever they can. That is, if a head has u $\phi$  features and iCase, then u $\phi$  must co-act with iCase, agreeing with the DP whose uCase feature is checked by the head. At this point, I will simply state that as an assumption, but see Section 5.1.5 in Chapter 5 for a learnability argument.

A final point worth mentioning is that nominal licensing being dependent on the relative topicality of the two arguments (the Benefactive and the Theme) may be reminiscent of Dependent Case Theory ([Marantz 1991](#); [Baker 2015](#), among others). In that framework, the morphological form (case) of DPs is determined by their occurrence as the single argument in one domain, or as the higher or lower of two arguments in the same domain, for example a dative form marking the higher of two internal arguments, and the ergative form marking the higher of an external and internal argument. Dependent Case Theory, however, only concerns morphological case and not abstract Case (or, more broadly speaking, nominal licensing). The current exploration, concerning only nominal licensing, can therefore perhaps be seen as a parallel to Dependent Case Theory.

### 3.6.4 Summary flexible licensing

To summarize the proposal, assuming that double object constructions always involve an additional low functional head such as an applicative, the default structure is asymmetric with the Theme lower than the Benefactive argument.

We can account for symmetric behaviour of objects by appealing to flexibility of such a functional head to license either the Theme in its complement, or the Benefactive argument in its specifier. I suggest that this is determined by the relative animacy and/or topicality of the two arguments, rendered as Person and Topic features. Appl is sensitive to the Person and/or Topic features of the argument in its specifier (potentially implementable as values of Case). The argument that is not licensed by Appl, which can be either the Benefactive or the Theme, will be licensed and agreed with by *v*, and will always be the more animate and/or topical one of the two objects (if they differ).

A conceptual benefit of the account sketched here is that symmetry can be captured in syntactic features. This allows us to analyze crosslinguistic variation in terms of functional features, following the Borer–Chomsky conjecture (see Chapter 1): languages differ in whether lower functional heads such as Appl are sensitive to Person (relative animacy) and Topic (relative topicality). The same could be said for the relativized probing approach discussed in Section 3.5.3. However, it is unclear how arguments are licensed and how agreement and licensing go together under relativized probing, as it is focused on  $\phi$  agreement. As also noted previously, whereas object marking symmetry and passive symmetry nicely parallel under the flexible licensing approach, they are independent in relativized probing. Another empirical point where the two approaches differ is in language-internal variation: if *v* probes for a particular feature, the prediction is that it would do so regardless of lower Caus and Appl heads. If, on the other hand, symmetry is due to flexible licensing by such an Appl or Caus head, we expect that not every head in the clausal spine may have this property, which is the topic we turn to now.

### 3.7 Partial symmetry

As already mentioned, the picture is more complicated than variation between completely symmetric and asymmetric languages. Instead, not whole languages but certain *constructions* may exhibit symmetric object behaviour, depending on a number of factors. One superficial factor already mentioned is the matter of mismatches between different diagnostics, as discussed in Section 3.4.7. Other factors include the thematic roles of the two objects (e.g. in Lubukusu instruments introduced by an applicative result in asymmetry whereas benefactives are symmetric, Peterson 2007, via Jerro 2015), and combinations of syntactic operations may also uncover asymmetries (Adams 2010; Zeller 2014; Holmberg, Sheehan, & Van der Wal 2019). A further pattern of partial asymmetry discussed in Van der Wal (2017) concerns different derived

ditransitives. I will present this partial asymmetry here in order to show how the featural approach to symmetry can explain the patterns found. The rest of this section is largely taken from [Van der Wal \(2017\)](#).

### 3.7.1 Different types of ditransitives: Lexical, applicative, causative

Apart from lexical ditransitive predicates such as ‘give’ or ‘teach’, Bantu languages can productively create ditransitive predicates by increasing the valency of verbs with applicative or causative derivations (marked morphologically on the verb), as shown in (99) and (100), respectively.

Makhuwa (P31, [Van der Wal 2009](#): 71)

- (99) a. Amíná o-n-rúw-á eshimá.  
1.Amina 1SM-PRS.CJ-stir-FV 9.shima  
‘Amina prepares shima.’
- b. Amíná o-n-aá-rúw-él’ éshimá anámwáne.  
1.Amina 1SM-PRS.CJ-2OM-stir-APPL.FV 9.shima 2.children  
‘Amina prepares shima for the children.’
- (100) a. Ál’ áthw’ áálá aa-wár-á eshaphéyu.  
2.DEM 2.people 2.DEM 2SM.PFV.DJ-wear-FV 10.hats  
‘These people wear hats.’
- b. O-m-wár-íh-á mwalápw’ ááwé ekúwó.  
1SM.PFV.DJ-1OM-wear-CAUS-FV 1.dog 1.POSS.1 9.cloth  
‘She dressed her dog in a cloth.’

Although the Benefactive (children) and the Causee (dog) fully belong to the argument structure of the verb, just like the Recipient and Theme in a lexical ditransitive such as ‘give’, not all languages treat the two objects in these three types of ditransitives in the same symmetric or asymmetric way. A comparative study I conducted reveals that a) language-internally, causative, applicative and lexical ditransitives can differ with respect to symmetry; and b) crosslinguistically, they are in an implicational relationship: if a language is symmetric for one type of predicate, it is symmetric for the predicate types to its right in (101) as well.

- (101) causative > applicative > lexical ditransitive > (asymmetric)  
type 1 type 2 type 3 type 4

These different types of symmetry patterns are illustrated for object marking in various languages in the following section. Passivization is, in the various

languages, confirmed or expected to follow the same pattern but will not be discussed in depth.

### 3.7.2 Type 1: Fully symmetric

On one end of the continuum are languages that behave symmetrically for all three types of ditransitive constructions. Zulu is one such language: both objects behave symmetrically, whether they belong to a lexical ditransitive verb or a derived applicative or causative. This is illustrated for object marking in (102)–(104) and we observe the same results for passivization. Zulu is thus a language of type 1: symmetric for all types of verbs.

Zulu (S42, Zeller 2011; see also Zeller 2012b)

(102) *lexical ditransitive*

- a. UJohn u-nik-a abantwana imali.  
 1a. John 1SM-give-FV 2.children 9.money  
 ‘John is giving the children money.’
- b. UJohn u-**ba**-nik-a imali (abantwana).  
 1a. John 1SM-2OM-give-FV 9.money 2.children  
 ‘John is giving them money (the children).’
- c. UJohn u-yi-nik-a abantwana (imali).  
 1a. John 1SM-9OM-give-FV 2.children 9.money  
 ‘John is giving it to the children (the money).’

(103) *applicative*

- a. ULanga u-phek-el-a umama inyama.  
 1a. Langa 1SM-cook-APPL-FV 1a.mother 9.meat  
 ‘Langa is cooking meat for mother.’
- b. ULanga u-**m**-phek-el-a inyama (umama).  
 1a. Langa 1SM-1OM-cook-APPL-FV 9.meat 1a.mother  
 ‘Langa is cooking meat for her (mother).’
- c. ULanga u-yi-phek-el-a umama (inyama).  
 1a. Langa 1SM-9OM-cook-APPL-FV 1.mother 9.meat  
 ‘Langa is cooking it for mother (the meat).’

(104) *causative*

- a. ULanga u-phek-is-a umama ukudla.  
 1a. Langa 1SM-cook-CAUS-FV 1a.mother 15.food  
 ‘Langa helps/makes mother cook food.’



- b. ULanga u-**m**-phek-is-a ukudla (umama).  
 1a.Langa 1SM-1OM-cook-CAUS-FV 15.food 1a.mother  
 ‘Langa helps/makes her cook food (mother).’
- c. ULanga u-**ku**-phek-is-a umama (ukudla).  
 1a.Langa 1SM-15OM-cook-CAUS-FV 1a.mother 15.food  
 ‘Langa makes mother cook it (the food).’

The same full symmetry has been found to apply in Kimeru (Hodges 1977); Shona (Mugari 2013; Mathangwane & Osam 2006); Kinyarwanda (Zeller & Ngoboka 2015; Ngoboka 2005); Kiitharaka (Muriungi 2008); and Kikuyu (Peter Githinji, personal communication).

### 3.7.3 Type 2: Only lexical and applicative symmetric

One step further down the cline are languages of type 2, where objects of applicatives and lexical ditransitives behave symmetrically, but objects of causatives do not. In Southern Sotho, either object of lexical ditransitives and applicatives can be object-marked, as in (105) and (106),<sup>20</sup> whereas with a causative only the Causee can be marked, not the Theme (107).

Southern Sotho (S33, Thabo Ditsele, personal communication)

(105) *lexical ditransitive*

- a. Ntate o fa bana lijo.  
 1.father 1SM give 2.children 5.food  
 ‘Father gives the children food.’
- b. Ntate o **ba** fa lijo.  
 1.father 1SM 2OM give 5.food  
 ‘Father gives them food.’
- c. Ntate o li fa bana.  
 1.father 1SM 5OM give 2.children  
 ‘Father gives it to the children.’

(Machobane 1989: 24)

(106) *applicative*

- a. Banana ba-pheh-el-a 'me nama.  
 2.girls 2SM-cook-APPL-FV 1.mother 9.meat  
 ‘The girls are cooking meat for my mother.’

<sup>20</sup> But see the influence of animacy as pointed out for Sesotho by Morolong & Hyman (1977) and comparatively discussed in Hyman & Duranti (1982).

- b. Banana ba-**mo**-p<sub>h</sub>eh-el-a nama.  
2.girls 2SM-1OM-COOK-APPL-FV 9.meat  
'The girls are cooking meat for her.'
- c. Banana ba-e-p<sub>h</sub>eh-el-a 'me.  
2.girls 2SM-9OM-COOK-APPL-FV 1.mother  
'The girls are cooking it for my mother.'

(Machobane 1989: 31)

(107) *causative*

- a. Ntate o-bal-is-a bana buka.  
1.father 1SM-read-CAUS-FV 2.children 9.book  
'My father makes the children read the book.'
- b. Ntate o-**ba**-bal-is-a buka.  
1.father 1SM-2OM-read-CAUS-FV 9.book  
'My father makes them read the book.'
- c. \*Ntate o-e-bal-is-a bana.  
1.father 1SM-9OM-read-CAUS-FV 2.children  
int. 'My father makes the children read it.'

The same pattern is found in Otjiherero:

Otjiherero (R30, Jekura Kavari, personal communication)

(108) *lexical ditransitive*

- a. Omu-kazendu ma pe ova-zandu ovi-kurya.  
1-woman PRS 1SM.give 2-boys 8-food  
'The woman gives the boys food.'
- b. Omu-kazendu me **ve** pe ovi-kurya.  
1-woman PRS.1SM 2OM give 8-food  
'The woman gives them food.'
- c. Omu-kazendu me vi pe ova-zandu.  
1-woman PRS.1SM 8OM give 2-boys  
'The woman gives it to the boys.'

(Marten & Kula 2012: 247)

(109) *applicative*

- a. Má-**vè** tjàng-ér-é òm-bàpírà.  
PRS-2SM 2OM write-APPL-FV 9-letter  
'They are writing them a letter.'
- b. Má-**vá** ì tjàng-ér-é òvà-nàtjé.  
PRS-2SM 9OM write-APPL-FV 2-children  
'They are writing the children it.'

(Jekura Kavari, personal communication)

(110) *causative*

- a. Ma-ve    **ve**    tjang-is-a    om-bapira.  
 PRS-2SM   2OM   write-CAUS-FV   9-letter  
 ‘They make them write a letter.’
- b. \*Ma-ve    i    tjang-is-a    ova-natje.  
 PRS-2SM   9OM   write-CAUS-FV   2-children  
 int. ‘They make the children write it.’

Lubukusu would count as fully symmetric according to Baker et al. (2012), but Jerro (2019) shows that the only causatives that are symmetric are so-called ingestives, which they propose should receive a different treatment and have a different structure. Other causatives do not allow symmetric behaviour. Lubukusu thus appears to be another language with partial symmetry.

### 3.7.4 Type 3: Only lexical symmetric

Type 3 is yet another step down the hierarchy in (101). In Kiluguru, double objects behave symmetrically only for lexical ditransitives (111), but show asymmetries with both applicative and causative predicates (112)–(113).

Kiluguru (G35, Marten & Ramadhani 2001: 266, 269)

(111) *lexical ditransitive*

- a. Chibua    ko-w-eng'-a    iwana    ipfitabu.  
 1.Chibua   1SM-2OM-give-FV   2.children   8.books
- b. Chibua    ko-pf-eng'-a    iwana    ipfitabu.  
 1.Chibua   1SM-8OM-give-FV   2.children   8.books  
 ‘Chibua is giving children books.’

(112) *applicative*<sup>21</sup>

- a. Mayi    ko-w-ambik-il-a    iwana    ipfidyo.  
 1.mother   1SM-2OM-cook-APPL-FV   2.children   7.food  
 ‘Mother is cooking food for the children.’
- b. \*Mayi    ko-pf-ambik-il-a    ipfidyo    iwana.  
 1.mother   1SM-7OM-cook-APPL-FV   7.food   2.children  
 int. ‘Mother is cooking food for the children.’

<sup>21</sup> Marten & Ramadhani (2001: 266) note that ‘both orders of objects are fine, but only the Benefactive object may be object-marked (in general, the object-marked object precedes the unmarked object, and it is the first object which is emphasized. In addition, applicatives without valency change can be used for predicate emphasis)’.

(113) *causative*

- a. Wanzehe wa-**m**w-ambik-its-a Chuma ipfidyo.  
 2.elders 2SM-1OM-cook-CAUS-FV 1.Chuma 8.food  
 ‘The elders made Chuma cook food.’
- b. \*Wanzehe wa-pf-ambik-its-a ipfidyo Chuma.  
 2.elders 2SM-8OM-cook-CAUS-FV 8.food 1.Chuma  
 int. ‘The elders made Chuma cook food.’

## 3.7.5 Type 4: Fully asymmetric

Finally, type 4 languages do not show any symmetric properties in double object constructions: the asymmetric languages. In ditransitives, applicatives, and causatives, only the Recipient/Benefactive/Causee object can be object-marked.

Swahili (G42)

(114) *lexical ditransitive*

- a. A-li-**m**-pa kitabu.  
 1SM-PST-1OM-give 7.book  
 ‘She gave him a book.’
- b. \*A-li-ki-pa Juma.  
 1SM-PST-7OM-give 1.Juma  
 int. ‘She gave it to Juma.’

(115) *applicative*

- a. A-li-**m**-nunul-i-a kitabu.  
 1SM-PST-1OM-buy-APPL-FV 7.book  
 ‘She bought him a book.’
- b. \*A-li-ki-nunul-i-a Juma.  
 1SM-PST-7OM-buy-APPL-FV 1.Juma  
 int. ‘She bought it for Juma.’

(116) *causative*

- a. A-li-**m**-kat-ish-a kamba.  
 1SM-PST-1OM-cut-CAUS-FV 9.rope  
 ‘She made him cut the rope.’
- b. \*A-li-i-kat-ish-a Juma.  
 1SM-PST-9OM-cut-CAUS-FV 1.Juma  
 int. ‘She made Juma cut it.’

## 3.7.6 Accounting for partial symmetry

The languages studied thus illustrate that ‘symmetry’ is not necessarily a property of a whole language, and they also show that (some of) the variation in symmetric object marking is structured. This is summarized in Table 3.2.

**Table 3.2** Cross-Bantu variation in symmetry of double object constructions

	CAUS	APPL	DITRANS	languages
type 1	✓	✓	✓	Zulu, Shona, Kĩtharaka, Kimeru, Kikuyu
type 2	✗	✓	✓	Otjherero, Southern Sotho, Lubukusu
type 3	✗	✗	✓	Kiluguru
type 4	✗	✗	✗	Swahili etc. (asymmetric)

This implicational relation can be described as the FLUID generalization.

- (117) Flexible Licensing Up (the spine) Implies Down (the spine):  
 If a construction involving head H is symmetric, constructions  
 with heads lower than H are also symmetric.

If a head higher up in the same extension has the ability to license flexibly, then all the heads below it need to be flexible licensors as well, but not the other way around: heads c-commanding a flexible-licensing head may have the same property or not. This is much in line with the featural account of the Final-Over-Final Condition (FOFC, [Biberauer, Holmberg, & Roberts 2007](#), 2008ab, 2010; [Biberauer et al. 2014](#); [Schifano 2018](#); [Sheehan et al. 2017](#)), according to which a head-final phrase must dominate a head-initial phrase within the same extended projection, thus restricting the occurrence of disharmonic word orders, such as V-O-aux (‘seen water have’), where a head-final TP dominates a head-initial VP. This restriction is said to be due to the requirement that if a head has a ‘head final’ feature (triggering roll-up movement), then the head selected by that head in the same extended projection must have the same feature ([Biberauer et al. 2014](#)). This, in turn, is motivated by the generalization that roll-up movement must start at the bottom of the extended projection. In short, an extended projection can start with or without a head-final movement trigger; if it starts as head-final, it can at any point stop being head-final (higher heads having no roll-up feature), but if it starts as head-initial, it cannot become head-final (higher heads cannot suddenly acquire the roll-up feature).

The implicational relation of the FLUID is of course very similar to this analysis of the FOFC,<sup>22</sup> even though the motivation may be different.

Assuming that the FLUID as in Table 3.2 is not accidental, the questions are how both the language-internal variation and the implicational relation can be accounted for in the featural analysis proposed in Sections 3.5.4 and 3.6. The former point will be addressed here, and the latter is part of the discussion in Chapter 5.

Following [Pylkkänen \(2008\)](#), and considering the overt applicative and causative morphology in Bantu, I take the Recipient in a lexical ditransitive to be introduced by a low applicative head (LAppl), under V (14a). The Benefactive for an applied verb is introduced by a high applicative head (HAppl), between V and v (14b). For causatives, I assume that the Causee is introduced by a causative head (Caus) between V and v (14c), although one could equally well assume a double little v with Caus in between, forming a bi-eventive structure (see further [Pylkkänen 2008](#) on the different heights of causatives).

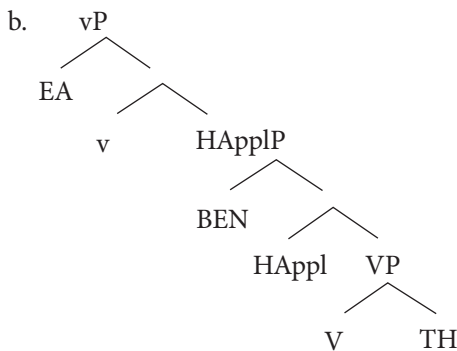
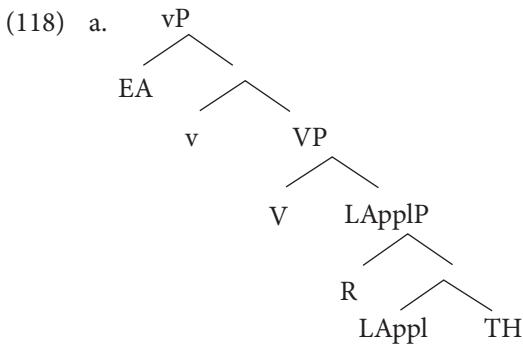

<sup>22</sup> There are other explanations for the FOFC and disharmonic word order, see for example [Sheehan \(2013\)](#).

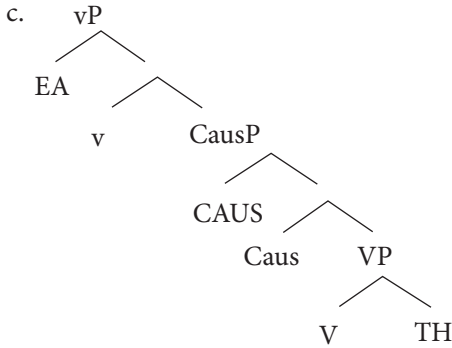

The structured variation in crosslinguistic partial symmetry for different predicate types can, in this analysis, be understood as variation in the parameter setting for flexible licensing for the heads LAppI, HAppI, and Caus. The fact that languages differ in their degree of symmetry is not just *captured* but actually *predicted* by the featural analysis of symmetry: if symmetry is a property of a low functional head, then there is nothing preventing different low functional heads from having different settings. Thus, if the lexical ditransitive, the applicative, and the causative each represent a different functional head introducing the extra argument, they can each allow flexible licensing or not.

To slightly anticipate the discussion of the implicational relation that is to follow in Chapter 5, the implicational relation can be captured as increasing subsets of low functional heads being flexible in licensing their complement or specifier, as in the following parameter hierarchy (where ‘low functional heads’ are any heads within the vP that both license and introduce an argument):

(119) *Parameter hierarchy for the degree of symmetry*

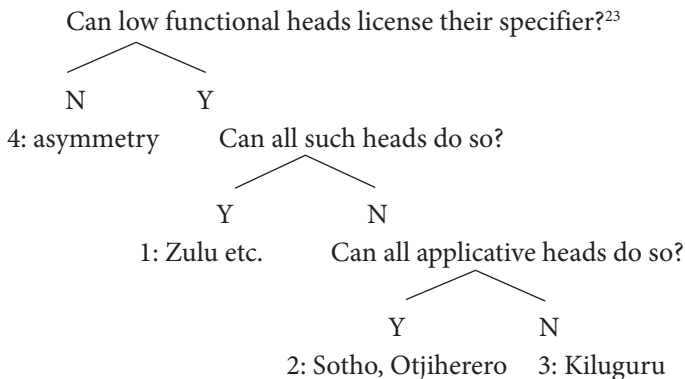

<sup>23</sup>Alternatively, the question can be formulated as more feature-oriented as ‘Is [iCase] dependent on the saliency features of the argument it is introduced with?’ See further in Chapter 5, Section 5.2.5.

The precise feature specification of the heads involved, as well as a conceptual motivation for this parameter hierarchy will be discussed in detail in Chapter 5. What is important for now is to notice that the featural analysis of symmetry as flexible licensing by low functional heads naturally accounts for the attested language-internal variation, since the different ditransitive predicates involve different low functional heads. Note also that the language-internal variation is quite unexpected under the other accounts of symmetry discussed in Section 3.5 (equidistance, movement of the Theme, and relativized probing). For equidistance, there is no reason to expect it to be parameterized for different predicates. As for parameterizing movement of the Theme to different heads, it is unclear what would motivate this movement (apart from variation in phasehood, which is problematic, as discussed in Section 3.5.2). Finally, in relativized probing, the  $\phi$  probe on *v* would presumably remain the same regardless of the type of ditransitive (as it is clearly the lower heads that vary here, *v* remaining responsible for object marking), predicting the same relativized probing in all predicates. In short, all of the alternatives struggle to account for the partial symmetry pattern outlined in this section.

### 3.8 Multiple object markers

Apart from the licensing flexibility of low functional heads, there is another way to be symmetric. This again is expected under an approach where crosslinguistic variation stems from the variation in features on syntactic heads. In this section, I discuss in more detail the distribution of  $\phi$  probes on functional heads in the lower part of the clause (see Chapters 4 and 5 for features on higher heads).

So far, we have seen variation in three object marking parameters: 1. doubling vs non-doubling; 2. which objects are marked (animate, definite, given); 3. symmetry vs asymmetry. A fourth parameter concerns the number of object markers allowed on the verb. Many languages are restricted to only one object marker – whether asymmetric as in (120) or symmetric as in (121).

Tumbuka (N21, Jean Chavula, personal communication)

- (120) a. Wa-ka-cap-il-a            mwaana    vyakuwara.  
           2SM-T-wash-APPL-FV    1.child    8.clothes  
           ‘They washed clothes for the child.’
- b. Wa-ka-**mu**-cap-il-a            vyakuwara.  
           2SM-T-1OM-wash-APPL-FV    8.clothes  
           ‘They washed the clothes for him.’





most straightforward analysis is to postulate these on the functional heads that introduce the ‘extra’ arguments, that is, the applicative and causative heads, as represented in (124).<sup>24</sup>

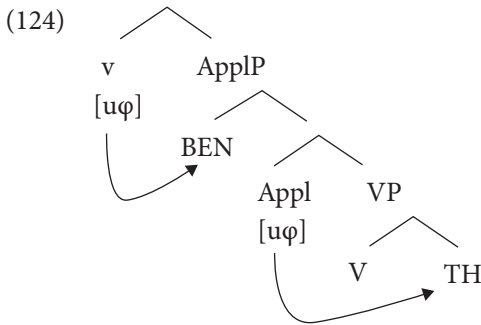

If a language has  $\phi$  features not just on  $v$  but also on Appl, under a default downward probing, the prediction is that Appl agrees with the Theme/lower argument, and that the shared features are spelled out on the probe (Appl) if the features of the goal are a subset of the features of the probe. With the head movement of  $V$  through the lower part of the clause (see Section 2.1 in Chapter 2),  $V$  will pick up the features on Appl and  $v$ , and this results in multiple sets of  $\phi$  features on the derived head, and hence the potential for multiple object markers.<sup>25</sup>

It follows from the presence of lower  $\phi$  probes that the Theme is always accessible to a  $\phi$  probe, independently of the marking of the Recipient/Benefactive/Causee. This is because the Theme is the closest argument for the  $\phi$  probe on Appl. Appl will thus agree with the Theme and may or may not spell out its  $\phi$  features as an object marker, depending on the structure of the goal. And  $v$  will agree with the higher argument, which again has the option of spelling out as an object marker. Either or both objects can thus be object-marked, independently of the other, that is, we have a symmetric object marking pattern with the potential for multiple object markers.

To illustrate how the analysis works, consider the patterns in Luganda. In all sentences in (49), Appl agrees in  $\phi$  features with the Theme *ssente* ‘money’ and  $v$  agrees in  $\phi$  features with the Recipient *taata* ‘father’. Via head movement of the verb these sets of  $\phi$  features end up on the head just above  $v$ . In (125a), the objects are non-defective DPs, and they will simply be spelled out as DPs

<sup>24</sup> I will leave the Kinande linker to one side here, see Schneider-Zioga (2014ab).

<sup>25</sup> Roberts (2010: 75–102) proposes that either the complex  $v$ +clitic can be probed by and incorporated into a higher head (as I propose for Bantu), or that the clitic itself is excorporated and moved to a higher head, as he suggests for Romance clitic climbing.

(no object marker). In (125b, c) only one of the objects is a defective  $\phi$ P goal whose  $\phi$  features will be spelled out on the probe, resulting in the one or the other object marker being present. Finally, in (125d) both objects are defective and therefore spelled out on the probe as object markers.<sup>26</sup>

Luganda (JE15, [Ssekiryango 2006](#): 67, 72)

- (125) a. Maama a-wa-dde **taata** ssente.  
 1.mother 1SM-give-PFV 1.father 10.money  
 ‘Mother has given father money.’
- b. Maama a-**mu**-wa-dde ssente.  
 1.mother 1SM-1OM-give-PFV 10.money.  
 ‘Mother has given him money.’
- c. Maama a-zi-wa-dde **taata**.  
 1.mother 1SM-10OM-give-PFV 1.father  
 ‘Mother has given it to father.’
- d. Maama a-zi-**mu**-wa-dde.  
 1.mother 1SM-10OM-1OM-give-PFV  
 ‘Mother has given it to him.’

A further question that may be asked is what determines the order of object markers when multiple objects are defective. In Luganda, object markers are ordered according to their semantic role (which reflects the structural hierarchy): the Benefactive is always closest to the stem, in mirrored order of the order of postverbal elements (cf. [Baker 1985, 1988](#)), as illustrated in (126).

Luganda (JE15, [Ranero 2015](#): 13)

- (126) a. Omusajja y-a-zi-**ba**-wa.  
 1.man 1SM-PST-10OM-2OM-give  
 ‘The man gave them it.’
- b. \*Omusajja y-a-**ba**-zi-wa.  
 1.man 1SM-PST-2OM-10OM-give  
 int. ‘The man gave them it.’

Neither person, as in (127), nor animacy, as in (128), can change this ordering or make it ambiguous.

<sup>26</sup> The encountered cross-Bantu variation in the precise number of object markers allowed in any particular language ([Polak 1986](#); [Marlo 2015](#)) can potentially be understood as variation in the presence of  $\phi$  features on other lower heads (e.g. a difference between high/low causatives).

Luganda (JE15, Judith Nakayiza & Saudah Namyalo, personal communication)

(127) (Context: my assistant is ill, and Judith is happy for me to work with hers.)

Judith a-mu-nj-aziseemu olwaleero.  
 1.Judith 1SM-1OM-1SG.OM-lend day.of.today  
 ‘Judith lends him/her to me for the day.’ (as said by me)  
 \*‘Judith lends me to him/her for the day.’ (as said by the assistant)

- (128) a. Gavumenti y-a-gul-i-dde tiimu a-ba-zannyi.  
 9.government 9SM-PST-buy-APPL-PFV 9.team AUG-2-player  
 ‘The government bought players for the team.’
- b. Y-a-gi-**ba**-gul-i-dde.  
 9SM-PST-9OM-2OM-buy-APPL-PFV  
 \*‘It bought them for it.’  
 ‘It bought it for them.’ (the team for the players)
- c. Y-a-**ba-gi**-gul-i-dde.  
 9SM-PST-2OM-9OM-buy-APPL-PFV  
 ‘It bought them for it.’ (the players for the team)  
 \*‘It bought it for them.’

In other Bantu languages with multiple object markers, however, the ordering does not necessarily follow the thematic roles but is determined by animacy or is free. To illustrate the animacy-based system, consider Kinyarwanda, where morpheme order is primarily based on person and animacy: when one prefix refers to a human, this needs to be closest to the stem (129). Furthermore, first/second person pronouns take precedence over other referents for the verb-adjacent position (130).<sup>27</sup> As expected, this strict ordering results in ambiguity.

Kinyarwanda (JD62, Zeller & Ngoboka 2015: 211, 212)

- (129) a. Umwáarimú yeeretse Muhiire inká.  
 u-mu-aarimu a-a-eerek-ye Muhiire i-n-ka  
 AUG-1-teacher 1SM-PST-show-ASP 1.Muhire AUG-9-cow  
 ‘The teacher showed Muhire the cow.’

<sup>27</sup> Some form of person restriction for first and second person objects in DOCs is commonly present in Bantu languages, but this extends beyond multiple object markers – see Riedel (2009) for discussion of the strong and weak Person Case Constraint (PCC); see Yokoyama (2016) for a featural account of the PCC and ordering restrictions in Kinyarwanda (also Contini-Morava 1983); and see Section 3.10 for a potential extension of the proposed analysis for the PCC.

- b. Umwáarimú yaayimwéeretse.  
 u-mu-aarimu a-a-a-yi-**mu**-eerek-ye  
 AUG-1-teacher 1SM-PST-DJ-9OM-1OM-show-ASP  
 ‘The teacher showed it to him.’
- c. \*Umwáarimú yaamuyiyéeretse.  
 u-mu-aarimu a-a-a-**mu**-yi-eerek-ye  
 AUG-1-teacher 1SM-PST-DJ-1OM-9OM-show-ASP  
 int. ‘The teacher showed it to him.’

- (130) a. Umwáarimú yaabányeeretse.  
 u-mu-aarimu a-a-a-**ba-n**-eerek-ye  
 AUG-1-teacher 1SM-PST-DJ-2OM-1SG.OM-show-ASP  
 ‘The teacher showed them to me.’ OR  
 ‘The teacher showed me to them.’
- b. \*Umwáarimú yaambéeretse.  
 u-mu-aarimu a-a-a-**n-ba**-eerek-ye  
 AUG-1-teacher 1SM-PST-DJ-1SG.OM-2OM-show-ASP  
 int. ‘The teacher showed them to me/me to them.’

In contrast, there is no strict ordering for multiple object markers referring to non-human referents, as shown in (131), where the authors report that there is no semantic or pragmatic difference between (131b) and (131c). The sets of  $\phi$  features gathered on the verbal head can thus be spelled out in either order.

Kinyarwanda (JD62, Zeller & Ngoboka 2015: 212)

- (131) a. Yahaaye ingurube ibijumba.  
 a-a-ha-ye i-n-gurube i-bi-juumba  
 1SM-PST-give-ASP AUG-9-pig AUG-8-sweet.potatoes  
 ‘He has given the pig sweet potatoes.’
- b. Yabiyíhaaye.  
 a-a-a-bi-**yi**-ha-ye  
 1SM-PST-DJ-8OM-9OM-give-ASP  
 ‘He has given them to it.’
- c. Yayibíhaaye.  
 a-a-a-**yi**-bi-ha-ye  
 1SM-PST-DJ-9OM-8OM-give-ASP  
 ‘He has given them to it.’

Some varieties of Setswana seem to be even less restricted in the order of prefixes, generally allowing either order, as in (132).<sup>28</sup>

Setswana (S31, [Marten & Kula 2012](#): 247)

- (132) a. Ke-**mo**-e-ape-ets-e.  
 1SG.SM-1OM-9OM-COOK-APPL-PFV  
 ‘I cooked it for him/her.’
- b. Ke-e-**mo**-ape-ets-e.  
 1SG.SM-9OM-1OM-COOK-APPL-PFV  
 ‘I cooked it for him/her.’

It seems likely, then, that the sets of  $\phi$  features on the verbal head are spelled out either freely, or according to a morphological template that prioritizes referents higher on the scales of person and animacy, or thematic role ([Duranti 1979](#)). Further research may elucidate the spell-out rules for multiple objects, as well as the interface between syntax and morphology.

The presence of  $\phi$  probes on lower functional heads thus creates another way for constructions to have symmetric object marking. Having two causes for symmetry (multiple  $\phi$  probes and flexible licensing) we may wonder whether the two go together. An important reason to think that they do is in symmetric passivization: languages in which object marking is symmetric also have symmetric passivization. In order for the Theme object of a ditransitive to be agreed with and moved by T, the intervening Benefactive object must be licensed by Appl, and hence this must happen flexibly.

Multiple object marking analyzed as  $\phi$  probes on lower functional heads also predicts that languages with multiple object markers *necessarily* behave symmetrically, since the Theme can always, and independently of the higher argument or probe, be agreed with by the lower probe. This prediction is borne out, as will be shown in Chapter 5 (Section 5.1.4) when discussing the AWSOM correlation. The main point for now is that a fourth parameter in Bantu object marking has received a featural analysis: multiple object markers respond to multiple  $\phi$  probes in the vP-internal part of the clause.

<sup>28</sup> However, [Pretorius et al. \(2012\)](#) suspect that discourse preferences may be of influence here, and [Creissels \(2002\)](#) notes for the variety he describes that the order is determined first by animacy, and in case the arguments are equal in animacy, then semantic role dictates the order of the markers.



- A. first person singular;
- B. 1SG, or both are animate;
- C. a reflexive;
- D. either a reflexive or a 1SG.

These are discussed in turn, resulting in further insights and even more questions.

### 3.9.1 Type A: 1+ with 1SG

Languages of this type include (Marlo 2015a):

Libinza, Luba-Kasai,<sup>29</sup> Lulua, Ndengese, Punu, Suku, Khayo, Kiyaka  
 The restriction in occurrence of a second object marker (namely, in the presence of a 1SG object marker) suggests that the resulting two object markers are not due to independent  $\phi$  probes. Instead, for the 1SG restriction I propose to apply Béjar and Rezac's (2009) Cyclic Agree analysis of an added probe, which they propose to account for agreement with the EA in inverse contexts: if in a first probe *all* the Person features are valued, the probe renews – like a phoenix – and probes again (in Béjar & Rezac's terms, a probe is added).

This requires an 'articulated' probe, where the Person feature actually consists of the features [person [participant [author]]] (Béjar 2003). The different grammatical persons thus have the specifications shown in Table 3.3, following Richards (2008/2015) regarding third person.

**Table 3.3** Feature composition (Béjar 2003)

1st	2nd	3rd animate	3rd inanimate
$\pi$	$\pi$	$\pi$	-
PTCP	PTCP		
AUTH			

This analysis makes two predictions:

1. The phoenix probe renews only when the feature [author] is valued, that is, when the goal is a first person.

<sup>29</sup> According to Cocchi (2000), Ciluba allows multiple object markers, thus this is not a 1+ type language.



2. Since there is only one probe and it is located on *v*, if the Person features probe together at the same time, probe renewal will only occur when the first person is the Benefactive, not when it is the Theme, since the Benefactive is the closest goal to *v*.

For subtype A, both predictions hold true: a second object marker is only allowed when the first object marker refers to a first person singular,<sup>30</sup> and the data so far only show examples of 1SG as Benefactive (though I have not seen evidence for the ungrammaticality of an extra marker with a non-1SG object). For Punu (B34), Fontaney (1980: 73) notes that

*Un seul infixe est admissible dans le syntagme, exception faite de la première personne du singulier [N], qui peut se combiner avec un autre infixe dans l'ordre [CV+N]: jindäsi |ji+N+las+i| 'montre-la-moi' (la maison). Ce PO de la 1ère personne représente nécessairement l'objet indirect (le bénéficiaire).*

(underlining in original)

A single infix [OM] is allowed in the phrase, except for the 1st person singular [N], which can combine with another infix in the order [CV+N]: jindäsi |ji+N+las+i| 'show-it-me' (the house). This 1st person [OM] is necessarily the indirect object (beneficiary).

An alternative analysis is a phonological motivation for this pattern: the homorganic nasal that usually expresses a 1SG object marker would not 'count' for the object marking restriction since it is pronounced as prenasalization on the onset of the verb stem. This account may work for some languages, but as Marlo (2015b) notes, it does not provide a satisfactory explanation for the languages in which the 1SG object marker is a CV syllable such as *-ni-*. See Marlo (2015b) for further discussion.

### 3.9.2 Type B: 1+ with 1SG and animate

Subtype B can also be understood as having a phoenix probe, albeit with a twist. Bemba normally allows only one object marker (134a), but a second is possible in two situations: when the first is a 1SG (134b), and when both object markers refer to animates (134c).

<sup>30</sup> Mongo apparently also allows two object markers when one is first plural (Hulstaert 1965: 329); this is not attested for other languages.

Bemba (M42, [Marten & Kula 2012](#): 245)

- (134) a. \*N-àlí-yà-mù-péél-à. / \*N-àlí-mù-yà-péél-à  
 1SG.SM-PST-6OM-1OM-give-FV  
 int: 'I gave him it (e.g. water).'
- b. À-chí-m-péél-é.  
 1SM-7OM-1SG.OM-give-OPT  
 'S/he should give it to me.'
- c. Mù-kà-bá-mú-ébél-á=kó.  
 2PL.SM-FUT-2OM-1OM-tell-APPL-FV-17.PRO  
 'You will tell them for him.'

Assuming with [Richards \(2008/2015\)](#) that animate third persons have a Person feature and inanimates do not, this suggests as a first hypothesis that in Bemba the phoenix probe is 'easily inflammable' and renews as soon as a goal has a Person feature. However, this would predict (134a) to be grammatical as well, contrary to fact. The new hypothesis is thus that the probe *renews* when all of [Person [participant [author]]] are valued (like type A), and that the probe is *doubled* when just [Person] is valued. This cloned probe crucially keeps the Person valuation, requiring the next goal to have a Person feature too (i.e. be animate).

This second hypothesis makes two predictions:

1. The probe doubles with any goal that has a Person feature, not just first person or third person animate, but also second person;
2. A probe can both double and renew if the added probe also agrees with an animate object, that is, a third object marker is possible in that circumstance.

I do not have data regarding the first prediction, but the second seems true:

Bemba ([Mwansa 2011](#): 19, via [Marten & Kula 2012](#): 246)

- (135) Mú-ká-cí-mù-n-twààl-il-é=<sup>1</sup>kó.  
 2SG.SM-FUT-7OM-1OM-1SG.OM-return-APPL-FV=17  
 'You should return it to him/her for me.'

The derivation for (135) could proceed as follows: one articulated  $\phi$  probe on *v* starts a first search, finds the highest object in class 1, which has a [Person] feature. It agrees, and the probe doubles, keeping the [Person] valuation. This second probe finds the next object, which is a 1SG (i.e. having a [Person] feature), and also [Participant] and [Author]), and the second probe agrees for

all features, and renews completely. This third probe finds and agrees with the Theme object in class 7. As before, the order of the morphemes would have to be determined at spell-out, not in the syntax (see Section 3.8). It remains to be seen whether this derivation also matches the hierarchical structure of the three arguments.

### 3.9.3 Phoenix parameter

The restrictions on the features of the combined object markers show that object marking in these languages is not due to two independent  $\phi$  probes (as is the case in languages with multiple object marking). At the same time these 1+ languages differ from languages that only allow one object marker. The parameter distinguishing languages with one object marker from those of phoenix types A and B at this point needs to simply be stated as a property: is the probe on  $v$  a phoenix probe? This parameter much resembles Béjar and Rezac's (2009) 'property P' ('the ability of the core  $\pi$  probe on  $v$  to add a probe', p. 56), and is similar to Ura's (1996) parameterization of Multiple Agree, that is, it is available in some languages but not others.

This is not a particularly attractive parameter, especially considering the Borer–Chomsky Conjecture (introduced in Chapter 1), since it is unclear at this point whether the parameter can be captured in the presence/absence and distribution of a functional feature. Further research into these types will hopefully shed more light on other features that these languages share, which may provide the crucial breakthrough in the analysis. One suggestion is a parameterization in the timing of probing by separate  $\phi$  features: in single object marking the  $\phi$  features would all probe at once, whereas in 1+ languages [author], [participant], and [ $\pi$ ] (and gender and number) would probe separately (see also Epstein et al. 1998; Müller 2009; Assmann et al. 2015, among others, on the timing of syntactic operations). This requires more dedicated attention than can be given here.

Another consequence of Cyclic Agree as Béjar and Rezac (2009) propose is a second probing action by the same head (and the same features) if there are unvalued features left. This is the case, for example, when an argument values [person] and [participant] but not [author]. Béjar and Rezac (2009) show how this can capture so-called PCC effects in ditransitive constructions, where the Theme cannot be a first person weak pronoun. It remains to be seen whether we find these effects in 1+ languages as well (and see Section 3.10 for

an exploration of the PCC). Here I just continue to consider the other types of 1+ systems.

### 3.9.4 Type C: 1+ with reflexive

Languages of this type include (Marlo 2015a):

Bakweri, Lubukusu, Havu, Kikuyu, Lozi, Kĩitharaka – only Lubukusu is examined here.

Many Bantu languages express reflexivity by a reflexive prefix that is located in the same pre-verb stem position as the object marker. It is therefore usually taken to be an object marker, even if it is invariable:

Shona (S10, Storoshenko 2009: 42)

- (136) a. Mbudzi ya-ka-zvi-pis-a.  
 9.goat 9SM-PST-REFL-burn-FV  
 ‘The goat burnt itself.’
- b. Ka-rume ka-ka-zvi-pis-a.  
 12-man 12SM-PST-REFL-burn-FV  
 ‘The bad man burnt himself.’
- c. Mwana a-ka-zvi-pis-a.  
 1.baby 1SM-PST-REFL-burn-FV  
 ‘The baby burnt themselves.’

In subtype C, two object markers are ungrammatical, unless one is a reflexive:

Lubukusu (JE31c, Marlo 2015b)

- (137) a. \*Wamalwa a-a-mu-ba-siim-isy-a.  
 1.Wamalwa 1SM-PST-1OM-2OM-cook-CAUS-FV  
 int. ‘Wamalwa made him like them.’
- b. \*Wekesa a-a-si-m-b-a.  
 1.Wekesa 1SM-PST-7OM-1SG.OM-give-FV  
 int. ‘Wekesa gave me it.’
- c. Wekesa a-a-mu-i-siim-isy-a.  
 1.Wekesa 1SM-PST-1OM-REFL-like-CAUS-FV  
 ‘Wekesa made him like himself.’

The two predictions made by the phoenix probe analysis are not borne out in this subtype: the first object marker is reflexive, not 1SG, and the reflexive can refer to either the Benefactive or the Theme (see also Storoshenko 2009):

Lubukusu (Justine Sikuku, personal communication)<sup>31</sup>

- (138) Wekesa a-i-ir-ir-a Anna.  
 1.Wekesa 1SM-REFL-kill-APPL-FV 1.Anna  
 i. 'Wekesa killed himself for Anna.'  
 ii. 'Wekesa killed Anna for himself.'

This suggests that the reflexive 1+ phenomenon is not due to a phoenix probe. The fact that languages can have either, none, or both of these restrictions (1SG and reflexive) also suggests that the two phenomena are due to different sources.

In fact, the reflexive in Lubukusu in many respects does not behave as an object marker. Not only does it not 'count' for the restriction to a single object marker that the language otherwise obeys, but in imperatives it also behaves differently from other object markers. In Lubukusu, the imperative takes a final vowel *-a* (139a), unless an object marker is present, in which case the final vowel changes to *-e* (139b, c). Unlike the object markers, the reflexive takes *-a* and not *-e* (139d, e).

Lubukusu (Marlo 2015a: 40)

- (139) a. bek-a 'shave!'  
 b. mu-bek-e 'shave him!'  
 c. m-bek-e 'shave me!'  
 d. i-bek-a 'shave yourself!'  
 e. \*i-bek-e int. 'shave yourself!'

Furthermore, Sikuku (2012) shows that the reflexive can appear in a class 5 nominalization but the object marker cannot:

<sup>31</sup> Muriungi (2008) notes for Kiitharaka that object markers and reflexives hardly ever co-occur, and the examples he provides involve verbs with a lexicalized reflexive such as 'to be proud'. Interestingly, the reflexive can refer to either Benefactive or Theme when the other object is expressed as a DP, as in (i), but the Theme reading of the reflexive is 'murky' when expressed as an object marker, as in (ii).

Kiitharaka (Muriungi 2008: 86, and personal communication)

- i. Mw-arimû n-a-ra-î-tur-î-îr-e tw-ana.  
 1-teacher FOC-1SM-YPST-REFL-cane-APPL-PFV 13-child  
 a. 'The teacher caned the children for himself.'  
 b. 'The teacher caned himself for the children.'
- ii Mw-arimû n-a-ra-ba-î-tur-î-îr-e.  
 1-teacher FOC-1SM-YPST-2OM-REFL-cane-APPL-PFV  
 a. 'The teacher caned them for himself.'  
 b. ?\*'The teacher caned himself for them.'

Lubukusu (Sikuku 2012)

- (140) a. Li-li-i-siim-isy-a                      li-li                      li-lume.  
           5-5-REFL-please-CAUS-FV    5SM-COP    5-difficult  
           ‘Pleasing oneself is difficult.’
- b. Li-(*\*mu*-)siim-isy-a                      li-li                      li-lume.  
           5-1OM-please-CAUS-FV    5SM-COP    5-difficult  
           int. ‘Pleasing him is difficult.’

Sikuku (2012) therefore analyzes the Lubukusu reflexive as incorporating into a voice projection. Similarly for Tswana, Creissels (2002) suggests that the reflexive is a type of middle voice. Following these analyses, I suggest that Lubukusu has a reflexive flavour of little *v*, or a separate Voice head that is spelled out as the reflexive prefix *i-*. If this is true, we expect that any other object marker precedes the reflexive marker, which is true (even for the 1SG homorganic nasal object marker):

Lubukusu (Marlo 2015b: 5)

- (141) Wekesa    a-a-ng-i-siim-isy-a.  
           1.Wekesa    1SM-PST-1SG.OM-REFL-like-CAUS-FV  
           ‘Wekesa made me like myself.’

This type C, allowing an ‘extra’ object marker when a reflexive is present, may thus not be a 1+ system after all, since the reflexive is not an object marker. This in turn suggests that there is a parametric difference in reflexivization, where in some languages the reflexive prefix functions as an object marker, whereas in others it expresses a reflexive flavour of *v*/Voice.<sup>32</sup> This too I leave for further research.

### 3.9.5 Type D: 1+ for reflexive and 1SG

Languages of this type include (Marlo 2015a):

Fuliiru, Kamba, Marachi, Nyala West, Nyaturu, Shi, Wanga.

At present there is not much to say about this type of 1+ language, illustrated in (142) and (143). It seems that these languages combine a phoenix probe for 1SG with a strategy for reflexive that allows object marking (i.e. a combination of types A+C). The two circumstances for more than 1 object marker, 1SG and

<sup>32</sup> Roberts (2010: 120–7) analyzes the Romance *se* reflexive as merging directly to vP, still allowing cliticization to vP as well.

reflexive, are then seen as independent, as discussed in the previous section. However, the status of the reflexive in these languages remains to be tested.

Kifuliiru (JD63, Van Otterloo 2011: 314, 315)<sup>33</sup>

(142) Kiri ná=naa-nî | a-koli ká-m-bit-í-ír-i.  
 even CNJ=ADD.P-1SG 1-be.newly 12.OM-1SG.OM-have-APPL-RS-FV  
 ‘Even *me*, he is now having it (value) to me.’

(143) A-ta-ná-ki-shóból-a ú-kú-mú-yi-lyó-s-á=kwo.  
 1SM-NEG-SQ-PERS-be.able-FV AUG-15-1OM-REFL-leave-CAUS-FV=17  
 ‘And he was not still able to separate himself from him (a second person).’

### 3.10 Summary and further research

In this chapter I have extended the analysis presented in Chapter 2, whereby all object markers involve an Agree relation, to double object constructions. Two parameters were analyzed: the symmetry of object marking, and the number of object markers. Multiple object markers show both core syntactic and post-syntactic (morphophonological) variation: syntactic variation concerns the presence of  $\phi$  probes on only *v* (single OM) or on *v* and lower heads (multiple OM); post-syntactic variation concerns the order of object markers. Multiple probes on neighbouring heads are (featurally) independent of each other in their spell-out. This is different for 1+ object marking, where the specific featural interaction between the two objects suggests that we are dealing with one probe, which has ‘phoenix’ qualities.

Symmetry in object marking follows from the presence of multiple  $\phi$  probes and from a sensitivity to [Person] and [Topic] in licensing by low functional heads. If a head such as Appl or Caus is sensitive to the Person and/or Topic specification of the argument introduced in its specifier (Recipient, Benefactive, Causee), this determines its licensing abilities. A potential implementation proposed here takes Person and Topic as values of Case. As a result, an

<sup>33</sup> Van Otterloo (2011) does not provide an ungrammatical example with two object markers – this remains to be tested. A second object may be pronominalized by an enclitic, as in (i). Such enclitics are not part of the current book but should obviously be incorporated into the proposed analysis in further research.

Kifuliiru (JD63, Van Otterloo 2011: 310)

- (i) É dáata u-ba-heerez-é=kyo.  
 o 1a.father 2SG.SM.SBJV-2OM-give-FV=7OM  
 ‘Oh my father, give it to them.’

animate and/or topical Theme cannot be licensed by Appl if the Benefactive is inanimate and/or non-topical, which results in Appl licensing the argument in its specifier. This leaves the Theme to be licensed by *v* in an active clause or *T* in a passive clause, with the licensing head (*v*, *T*) agreeing for  $\phi$  features too. Flexible licensing as proposed in the FLiP thus accounts for the licensing of both objects as well as the salience-based restrictions (Person, Number) found in symmetric object marking and the parallel between symmetric object marking and passivization.

There are many predictions and further consequences to be explored in applying the proposed analysis to the variation of object marking in Bantu ditransitives. I mention three here, only one of which receives further attention in Chapter 4.

A first extension is to include other ditransitives. Multitransitives are easily constructed in Bantu languages because of the productive causative and applicative derivations. Here I have only taken into consideration double object constructions with a Recipient or Benefactive-like argument, leaving Locatives, Instruments, and other roles to one side. While there are good reasons to distinguish these (see discussion in Section 3.2), the constructions are clearly related, and it would be interesting to explore the proposed analysis here. This is especially true for languages in which some applicatives behave symmetrically while others do not, see Baker (1988); Alsina & Mchombo (1993); Simango (1995); Nakamura (1997); Ngonyani (1998); Ngoboka (2005); Zeller & Ngoboka (2006); Bliss (2010); Jerro (2015); Ngoboka (2017).

A second point is the extension to PCC effects. The flexible licensing approach, which is proposed for [Person] and [Topic], can perhaps be extended to the features responsible for the distinctions between 1<sup>st</sup> and 2<sup>nd</sup> person (see also É.Kiss' 2017 analysis of the PCC as a case of the Inverse Topicality Constraint). If we assume with Béjar (2003) that [Author] is associated with first person and [Participant] with both first and second person, then these features too may need to be part of the licensing head in order to license an argument specified as such. That is, Appl can only license a [Participant] or [Author] feature in its complement if the argument in its specifier has that feature too. Moreover, the head that eventually licenses the first or second person needs to have that feature in a language with flexibility. The feature composition of each person is as in Table 3.3: third person only has a [Person] feature, indicated as [ $\pi$ ], if it is animate (see Chapter 2); first and second person are always animate and are participants in the speech act, therefore they have [ $\pi$  [ptcp]]; and first person also is the author, therefore is composed as [ $\pi$  [ptcp] [auth]]. The predicted possibilities for agreement are then as in Table 3.4, for a symmetric language with only one object marker.





objects, topicality kicks in. When the Theme object is more specified for Person features than the Benefactive, the Theme cannot be licensed by Appl, and as *v* does not have sufficient features (the elicited examples have a third person subject), the Theme cannot be licensed by *v* either, resulting in such configurations being impossible, as predicted.

The majority of the data underlying Table 3.5 are based on scenarios where a man sends a female assistant to work with a female colleague. In example (145), the speaker and the addressee of the utterances can be the colleague, the assistant, or a bystander.

Changana (S53, Simango & Van der Wal database)

- (145) a. Á-ní-rumél-él-é wê:na. 1<sup>st</sup> & 2<sup>nd</sup>  
 1SM-1SG.OM-send-APPL-PFV.CJ 2SG.PRO  
 ‘He sent you to me.’ (colleague to assistant)  
 \*‘He sent me to you.’ (assistant to colleague)
- b. Á-ní-rumél-él-é yê:na. 1<sup>st</sup> & 3<sup>rd</sup>  
 1SM-1SG.OM-send-APPL-PFV.CJ 1.PRO  
 ‘He sent her to me.’ (colleague to bystander)  
 \*‘He sent me to her.’ (assistant to bystander)
- c. Á-kú-rumél-él-é mî:na. 2<sup>nd</sup> & 1<sup>st</sup>  
 1SM-2SG.OM-send-APPL-PFV.CJ 1SG.PRO  
 ‘He sent you to *me*, not others.’  
 \*‘He sent you to me.’ (colleague to assistant)  
 \*‘He sent me to you.’ (assistant to colleague)
- d. Á-kú-rumél-él-é yê:ná. 2<sup>nd</sup> & 3<sup>rd</sup>  
 1SM-2SG.OM-send-APPL-PFV.CJ 1.PRO  
 ‘He sent her to you.’ (bystander to colleague)  
 \*‘He sent you to her.’ (bystander to assistant)  
 (no data on focused interpretation of 2<sup>nd</sup>)
- e. ?Á-mú-rumél-él-é mî:na. 3<sup>rd</sup> & 1<sup>st</sup>  
 1SM-1OM-send-APPL-PFV.CJ 1SG.PRO  
 ‘He sent her to *me* (not someone else).’  
 \*‘He sent her to me.’ (colleague to bystander)  
 \*‘He sent me to her.’ (assistant to bystander)
- f. Á-mú-rumél-él-é wê:ná. 3<sup>rd</sup> & 2<sup>nd</sup>  
 1SM-1OM-send-APPL-PFV.CJ 2SG.PRO  
 ‘He sent her to *you*.’ (she was expecting to work with someone else)  
 \*‘He sent her to you.’ (bystander to colleague)  
 \*‘He sent you to her.’ (bystander to assistant)

A repair strategy used in Changana is a prepositional ditransitive with *ka*, as illustrated in (146).

Changana (S53, Simango & Van der Wal database)

- (146) a. Xjoví:tú á-ní-rumél-é ká wê:na.  
 1.Jovito 1SM-1SG.OM-send-PFV.CJ PREP 2SG.PRO  
 ‘Jovito sent me to you.’
- b. Á-kú-rumél-é ká yê:ná.  
 1SM-2SG.OM-send-PFV.CJ PREP 1.PRO  
 ‘He sent you to her.’

Only one combination was not judged as predicted: an animate Theme with an inanimate Benefactive was found acceptable, as illustrated in (147). The scenario for the examples in (147) is that the animals have built a well, but someone is messing with it overnight and they want to protect the well. This differs from the data and judgements for Zulu and Sesotho in Section 3.6.1, forming a counterexample to the predictions that flexible Person licensing makes: it suggests that *v* can agree with an inanimate Benefactive, requiring that Appl license the animate Theme (but apparently without having the required Person feature activated by its specifier). I have to leave this for further research.

Changana (S53, Simango & Van der Wal database)

- (147) a. Svi-xí-láv-él-á mú-rí:nzi, (a) xí-hlo:vo.  
 8SM-7OM-want-APPL-FV 1-guard A 7-well  
 ‘They (animals, class 8) are looking for a guard for it, the well.’
- b. Svi-mú-láv-él-á xí-hlô:vo, mu-ri:nzi.  
 8SM-1OM-want-APPL-FV 7-well 1-guard  
 ‘They are looking for him for the well, the guard.’

In languages with multiple object markers, the picture is different, judging from the data available so far for Kinyarwanda (from [Kimenyi 1995](#), online; and [Zeller & Ngoboka 2015](#); see also [Yokoyama 2016, 2019](#)), as summarized in Table 3.6. As there are multiple independent licensers and relations, a PCC effect is indeed not expected.

Furthermore, the (weak) PCC also plays a role in asymmetric languages, as [Riedel \(2009\)](#) shows. A combination of first and second person objects is grammatical (148), but if the Benefactive object is third person, then the Theme object cannot be first or second (149). This can potentially be modelled by a sensitivity to [ptcp] only.



## Subject marking and inversion

### 4.1 Introduction: Extending flexible licensing

In Chapter 3, I proposed that symmetric double objects can be understood as a consequence of the licensing flexibility of low functional heads such as Appl. A flexible Appl head can license the Theme in its complement or the Benefactive/Recipient in its specifier, depending on the relative animacy and topicality of the two arguments. This flexible licensing parameter (FLiP) distinguishes between symmetric and asymmetric object marking. It was also illustrated that not all low functional heads need to have this flexible licensing ability; it may for example be the case that applicative verbs have symmetric double objects but causatives have asymmetric object marking. It appeared that there is an implicational relation between these heads for flexible licensing: if one low functional head is flexible, then the functional heads below it need to have that property as well (the Flexible Licensing Up Implies Down (FLUID) generalization).

If it is indeed the case that low functional heads are parameterized for flexible licensing, the question is whether the next functional head up the tree would also allow flexible licensing, in other words, can the parameter be extended to little *v*? We can easily see the parallel between Appl and *v* and their surrounding arguments – compare the two parallel trees in (1a, b).

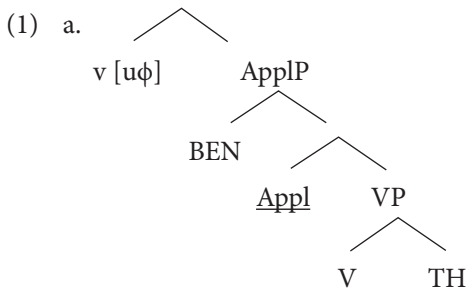

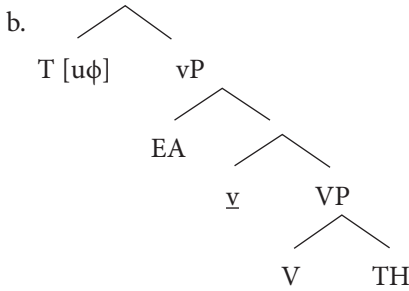

Extending the FLiP to *v* would imply that little *v* in most cases licenses a DP in its complement, but that it licenses the external argument (EA) in its specifier in case the external argument is non-topical and a DP in its complement is topical, as in (2).<sup>1</sup>

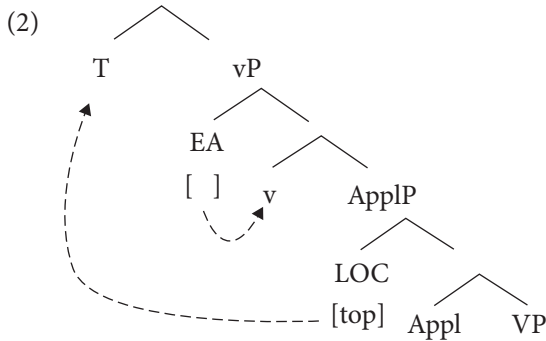

The EA being licensed by *v* means that it will not be moved to specTP and remain *in situ*. Assuming the verb moves to a higher head such as AspP just above vP (see Chapter 2), this results in a postverbal non-topical EA. T agrees with the more topical argument, for example a locative, and moves it to the preverbal position. This is exactly what we find in subject inversion constructions, where the logical subject appears after the verb, as in (3), and is interpreted as non-topical.<sup>2</sup>

Otjijherero (Marten et al. 2007: 278)

- (3) Kò-mù-tí kw-á-pósé òzón-djimá.  
 17-3-tree 17SM-PST-make.noise 10-baboons  
 'In the tree the baboons made noise.'

<sup>1</sup> Licensing of the EA by *v* as an inherent case is also proposed for ergative languages (Levin 1983; Woolford 1997, 2006; Aldridge 2004; Legate 2008; among others). Since the EA in these approaches and languages is standardly licensed by *v* (whereas in this chapter we investigate flexible licensing), I leave the implications for ergativity to one side here (but see Section 5.2.5 in Chapter 5 for some discussion).

<sup>2</sup> I adopt the definition of logical subject from Marten & Van der Wal (2014) as the argument combining last with the predicate to yield a proposition (Cann et al. 2009; Gamut 1991).

The hypothesis that *v* can license flexibly will be further explored in this chapter. In order to discuss the details and predictions of the analysis, I first present the empirical phenomena to be explained in Section 4.2, that is, the various subject inversion constructions encountered across the Bantu languages. A difference with ditransitives is that only topicality seems to play a role in inversion constructions. But similar to ditransitives, the same question of locality arises for the subject inversion constructions, and previous theoretical accounts of subject inversion are hence discussed in Section 4.3. The flexible licensing approach as just sketched comes out as a promising approach and is further explored in Section 4.4. Section 4.5 addresses whether the implicational relation between the lower heads (the FLUID as introduced in Chapter 3) can be extended to little *v*, concluding that it cannot.

The current chapter is thus an exploration to see how far we can get in accounting for Bantu syntactic phenomena while keeping the structure and features as simple as possible, as an extension of the analysis proposed in Chapter 3. It is not meant to account for every possible individual Bantu language (although this would of course be nice) or each little quirk, but the hope is that this approach may inspire experts on various languages to test how the model may work in their language. Or if not, then at least to raise different questions to the ones we asked before. A disclaimer at the beginning of this chapter: in contrast to the previous chapters, the data in the current chapter come from a smaller subset of languages, since the data that are required to check predictions are only available in a few languages, mostly from Eastern and Southern Bantu.

## 4.2 Subject inversion constructions

By most typologists' definition of basic word order, the Bantu languages can be said to have a subject, verb, object (SVO) order. Nevertheless, there is much word order variation, with [Beirth \(2003: 128\)](#) observing that the 'variability of verb-external constituent order is a widespread although insufficiently studied phenomenon of Bantu syntax'. A decade and a half later, many more descriptions and analyses of Bantu word order have become available, and the link with information structure is appearing more and more clearly (see [Downing & Marten 2019](#)). Of interest for the current chapter are constructions where the logical subject appears linearly after the verb in a main clause, as in (3), and this postverbal logical subject is interpreted as non-topical (in athetic 'all new' sentence or as narrow focus). Not all languages have subject inversion constructions (see [Hamlaoui & Makasso 2015](#), for example, on the absence of

postverbal subjects in Basaa). Within the languages that do show subject inversion, however, there is a range of variation in the precise constructions with respect to subject marking and the thematic role of the preverbal element.

To get an overview of the empirical landscape, I illustrate the various types of subject inversion as identified by Marten and Van der Wal (2014). This is important as we will want to answer the question of which of the different constructions can be accounted for by flexible licensing, and which perhaps cannot. As will become clear later in this chapter, there are two factors influencing the choice of analysis. The first is the type of inversion construction; the second factor is the valency of the predicate. The latter is discussed in Section 4.5, the former in this section. There are seven types of inversion that can be categorized into three groups: with a preverbal agreeing argument, with default agreement, and with subject agreement. After presenting the overview of inversion constructions, their syntactic properties are diagnosed in Section 4.2.1, showing that the postverbal logical subject is (in most cases) in a low position, and in Section 4.2.2, showing that the preverbal element functions like a subject in the first group of constructions.

### A. Locative Inversion

In locative inversion (LI), a locative DP precedes the verb and determines subject agreement on the verb. There are two subtypes of locative inversion: formal locative inversion and semantic locative inversion (Buell 2007). In formal locative inversion (FLI), the locative DP is formally marked as locative in a locative noun class, by a nominal prefix in class 16, 17, or 18 (as in (4)), or a suffix *-(i)ni*. In (4b), the subject marker agrees with the Locative *mòngàndá* ‘in the house’ and not with the postverbal logical subject. See Salzmänn (2001, 2011) and Diercks (2017) for overview articles on locative inversion.

Otjiherero (R30, Marten 2006: 98)

- (4) a. Òvǎ-ndù      v-á-hítí      mó-<sup>1</sup>ngándá.  
       2-people      2SM-PST-enter      18-9.house  
       ‘The guests entered the house/home.’
- b. Mò-ngándá      mw-á-hítí      òvǎ-ndù.  
       18-9.house      18SM-PST-enter      2-people  
       ‘Into the house entered (the) people.’

In semantic locative inversion (SLI), the preverbal DP refers to a place, but is not morphologically marked as locative, as illustrated for the class 7 noun ‘school’ in (5).



Zulu (S42, Buell 2007: 110)

- (5) Lesi sikole si-fund-el-a izingane ezikhubazekile.  
 7.this 7.school 7SM-study-APPL-FV 10.children 10.handicapped  
 ‘Handicapped children study at this school.’

The difference between FLI and SLI is due to the status of Locatives in different languages. In some languages these are DPs, whereas in some other languages they have developed to function as PPs, as Marten (2010) argues.<sup>3</sup> Since the preverbal agreeing phrase needs to be a DP, languages with DP Locatives can have FLI whereas languages with PP Locatives may have SLI. This generalization seems to hold broadly, with some exceptions noted by Marten and Van der Wal (2014).

### B. Patient Inversion (a.k.a. Subject–Object Reversal)

The preverbal DP can also be the Theme or Patient, resulting in patient inversion (PI), as illustrated in (6b). The preverbal *inzogá* ‘alcohol’ (and not the postverbal agent) determines the form of the subject marker *zi-* in class 9. It is noted by Nshemezimana (2016) and Nshemezimana and Bostoen (2017) that this construction does not appear much in spontaneous speech in their Kirundi corpus, if at all, but speakers still judge them as grammatical (which is relevant if our aim is to discover the rules of a language’s grammar).

Kinyarwanda (Ngoboka 2016: 356)

- (6) a. A-bá-ana nti-ba-nyw-á i-n-zogá.  
 AUG-2-children NEG-2SM-drink-FV AUG-10-alcohol  
 ‘Children don’t drink alcohol.’  
 b. I-n-zogá nti-zi-nyw-á a-bá-ana.  
 AUG-10-alcohol NEG-10SM-drink-FV AUG-2-children  
 ‘It’s the children who do not drink alcohol.’  
 lit. ‘Alcohol does not drink children.’

### C. Instrument Inversion

The same construction is found where the preverbal DP has the thematic role of Instrument, as in (7), hence called instrument inversion (II).

<sup>3</sup> The status as DP or PP can be seen in their agreement properties, in the separability of the locative prefix/preposition and the noun, in subject raising, etc. See Demuth (1990); Buell (2009); Marten (2010); Creissels (2011); Ngoboka (2017).

Zulu (S42, Zeller 2012a: 134)

- (7) a. U-John            u-dl-a            nge-sipunu.  
           AUG-1a.John 1SM-eat-FV with-7.spoon  
           ‘John is eating with the spoon.’  
       b. I-sipunu        si-dl-a        u-John.  
           AUG-7.spoon 7SM-eat-FV AUG-1a.John  
           ‘John is using the spoon to eat.’  
           lit. ‘The spoon is eating John.’

The Instrument DP in inversion constructions can only refer to a typical instrument, for example, a spoon for eating soup, or a pen for writing letters but not a knife for working (Zeller 2012a: 137).

#### D. Complement Inversion

Even a whole CP complement can precede the verb in subject inversion. It is unclear whether the subject marker, which clearly does not agree with the postverbal logical subject, agrees with the CP or takes a default form (class 8 in (8)).

Kirundi (JD62, Kimenyi 1980: 193)

- (8) [Ko    a-ba-ana            b-a-gii-ye]            by-iibagiw-e  
       COMP AUG-2-children 2SM-PST-leave-PFV 8SM-forget-PFV  
       u-mu-gore.  
       AUG-1-woman  
       ‘It is the woman (not the man) who forgot that children have left.’  
       lit. ‘That the children have left forgot the woman.’

So far, all the types involve a preverbal element (locative, instrument, theme, clause) that determines the subject marker on the verb. We will see that these can be captured by the same underlying structure. There are two further inversion constructions that do not require a preverbal element, and in which subject marking is either default, or agrees with the postverbal logical subject.

#### E. Default Agreement Inversion

In default agreement inversion (DAI), the verb can be clause-initial, or be preceded by an adverb, for example an adjoined Locative. The subject marker takes a default form, usually in class 16 or 17 (originally locative classes).

Northern Sotho (S32, Zerbian 2006b: 362, 366)

- (9) a. Go-eme                            ba-simane.  
           17SM-stand.PFV            2-boys  
           ‘There stood up boys.’

- b. Go ngwala mo-nna le-ngwalo.  
 17SM write 1-man 5-letter  
 'The man is writing the letter.'

### F. Agreeing Inversion

A final subject inversion construction differs from all the others in still requiring the subject marker to agree with the postverbal subject, hence called agreeing inversion (AI). This is illustrated in (10).

Makhuwa (P31, [Van der Wal 2008](#): 328, [2009](#): 197)

- (10) a. A-náá-ttóny-á maátsi.  
 6SM-PRS.DJ-drip-FV 6.water  
 'There is water leaking out.'
- b. Oo-vár-á ephépélé naphúl' úule.  
 1SM.PFV.DJ-grab-FV 9.fly 1.frog 1.DEM.DIST  
 'That frog caught a fly!'

This illustrates the range of variation in these inversion constructions, but [Marten and Van der Wal \(2014: 342\)](#) identify four surface properties that hold for most constructions in most languages:

1. The logical subject follows the verb and cannot be omitted.
2. The postverbal subject is non-topical (but often underspecified for narrow subject focus or use in athetic sentence).
3. Object marking is not possible.
4. Close 'bonding' between verb and postverbal DP is often indicated in phonological phrasing, absence of augment, conjoint verb form, or complement tone pattern.

Notably, animacy seems to play less of a role in inversion constructions. A syntactic analysis of Bantu subject marking and subject inversion should at least account for the properties mentioned, while also identifying plausible parameters for the properties in which inversion constructions differ (notably: variation in subject agreement, restrictions to certain types of predicates, and thematic restrictions on the preverbal element). In order to develop such an account, it is necessary to establish the structural properties that underlie the surface properties, of both the preverbal element and the postverbal logical subject. I first discuss the status of the postverbal logical subject as being *in situ*, and then diagnose the subject status and structural position of the preverbal

element. As before, there is crosslinguistic variation in these properties too, as will be addressed in this section (for example, the postverbal subject in Kirundi and Makhuwa is not *in situ* in the verb phrase). The properties of each inversion construction in each language therefore need to be tested individually, but there are clear generalizations.

#### 4.2.1 Postverbal subject is *in situ*

There is an important difference between on the one hand subject inversion constructions and on the other hand a clause with a right-dislocated subject, even if both have linear VS order. When the subject is right-dislocated, it always shows subject agreement on the verb, there is usually a prosodic break between the verb and the following dislocated subject, and it receives an afterthought interpretation rather than athetic or focused interpretation, as illustrated in (11a). This contrasts with the properties of subject inversion, where the subject marker (in the majority of constructions) does not agree with the postverbal logical subject, the verb and postverbal logical subject form one prosodic phrase, and the logical subject forms the new information, as in (11b). The contrast between (11a) and (11b) clearly shows the subject markers *o-* vs *go-* and the different prosodic phrasing, indicated by the vertical line.

Northern Sotho (S32, Zerbian 2006a: 127, 171, adapted)

- |      |    |                           |          |                           |
|------|----|---------------------------|----------|---------------------------|
| (11) | a. | Ó-a-šó:ma                 | mo:-nna. | <i>right-dislocated S</i> |
|      |    | 1SM-PRS.DJ-work           | 1-man    |                           |
|      |    | 'He is working, the man.' |          |                           |
|      | b. | Go-fihla                  | mo:-nna. | <i>subject inversion</i>  |
|      |    | 17SM-arrive               | 1-man    |                           |
|      |    | 'There arrives a man.'    |          |                           |

Even in a language that has agreeing inversion, such as Makhuwa, right-dislocated subjects can be distinguished from subject inversion by a prosodic break and often the use of demonstratives, as in (12) – compare to (10) previously given.

Makhuwa (P31, Van der Wal 2009: 190)

- |      |                         |                 |
|------|-------------------------|-----------------|
| (12) | Aa-vír-áts-á            | y-eett-ák-a     |
|      | 2SM.PFV.DJ-PASS-PLUR-FV | 2SM-walk-DUR-FV |

mwanámwáne oolé ni mwálápw' aáw' óole.  
 1.child 1.DEM.DIST and 1.dog 1.POSS.1 1.DEM.DIST  
 'They passed walking, that child and that dog of his.'

I will leave right-dislocated subjects to one side in this chapter, and focus on subject inversion constructions. In most of these, the postverbal logical subject can be shown to occupy a position within the verb phrase, that is, *in situ*. This low position is evident in a range of diagnostics.

A first diagnostic already mentioned is prosody: if a language usually phrases elements in the verb phrase together (e.g. verb and object), it is expected to show the same phonological phrasing for verb and following logical subject if it is in a low vP-internal position. To illustrate this, in Northern Sotho the right edge of a phonological phrase is indicated by a lengthening of the penultimate syllable (Zerbian 2006a). Therefore, since only the last word in (11b) shows penultimate lengthening, we can deduce that verb and following logical subject are phrased together.

A second diagnostic is the form of the verb. In a number of southern and eastern Bantu languages some tenses show an alternation between the so-called conjoint and disjoint verb form. In the Nguni languages and Tswana-Sotho, the conjoint form indicates that the verb is not final in its constituent, whereas the disjoint verb form indicates constituent-finality (Van der Spuy 1993; Buell 2006; see also Van der Wal & Hyman 2017). Cheng and Downing (2007) as well as Halpert (2017) identify this constituent as the vP in Zulu. Assuming that the same holds for Northern Sotho, the use of the unmarked conjoint verb form in (11b) thus indicates that the postverbal subject is in the vP, whereas the disjoint form in (11a) is evidence for the dislocated position of the subject.

Other languages, mostly in western Bantu, indicate the closer or looser relation between verb and following element in the tonal form of that following element. These are known as 'tone cases'. In Otjiherero, postverbal objects of verbs inflected in the past tense typically take the 'complement case' (CC), whereas preverbal subjects take the 'default case' (DC). The postverbal logical subject in locative inversion obligatorily shows complement case marking, as seen in the LH tone pattern on the augment and prefix *òvǎ-* in (13a). This shows that the postverbal logical subject occupies a vP-internal position, like the *in situ* object. This can be compared to a right-dislocated subject which must take default case marking: a LL pattern on the augment and prefix *òvǎ-* in

(13b). The opposite tone cases are ungrammatical (Marten 2011; Kavari et al. 2012).

Otjherero (R30, Marten 2011: 801)

- (13) a. P-è-y-á                      òvá-éndà.  
           16SM-PST-come-FV    2CC-visitor  
           ‘Visitors came.’/‘There came visitors.’  
       b. V-è-y-á,                      òvâ-éndà.  
           2SM-PST-come-FV    2DC-visitor  
           ‘They came, the visitors.’

Further evidence for the low position of the postverbal logical subject is found in the indefinite and non-specific interpretation of the logical subject in inversion. As the examples in (14) and (15) show, the postverbal logical subject in Zulu DAI and Matengo AI can clearly have an indefinite interpretation (which is not typical for a subject, and downright impossible for a right-dislocated DP).

Zulu (S42, Zeller 2012a: 139)

- (14) A-ku-hlek-i                      muntu.  
           NEG-17SM-laugh-NEG    1.person  
           ‘No one is laughing.’

Matengo (N13, Yoneda 2011: 761)

- (15) As an answer to ‘What happened?’  
       Ju-hikití                      mû:ndo.  
           1SM-arrive.PF    1.someone  
           ‘Someone has come.’

The Zulu example also shows that the augment can be omitted on the postverbal logical subject, with the form *muntu* rather than *u-muntu*. Halpert (2013, 2015) shows that augmentless nouns can only appear within the vP, so the fact that the postverbal logical subject can remain augmentless forms another diagnostic for its low position.

Furthermore, the logical subject in inversion systematically scopes under negation in Matengo AI (16) and Kinyarwanda PI (17). This again confirms the low position of the postverbal subject.

Matengo (Bárány & Van der Wal to appear)

- (16) a. Míkɔŋgú j-oote ngase ji-á-bwíke.  
 4.trees 4-all NEG.AUX 4SM-PST-fall  
 ‘All trees have not fallen down.’  
 (All trees are still standing) ∀ > Neg
- b. Ngase ji-á-bwiki míkɔŋgú j-oote.  
 NEG.AUX 4SM-PST-fall 4.trees 4-all  
 ‘Not all trees have fallen.’ Neg > ∀  
 (Some trees have fallen and others are still standing)

Kinyarwanda (JD61, Jean Paul Ngoboka, personal communication)

- (17) I-n-zogá nti-zi-nyw-á a-bá-ana b-óose.  
 AUG-10-alcohol NEG-10SM-drink-FV AUG-2-children 2-all  
 ‘Not all children drink alcohol (but some do).’ Neg > ∀  
 \*‘All children do not drink alcohol (none drink).’ ∀ > Neg

Specifically for patient inversion it is relevant to note that, while the interpretation is sometimes represented as a passive, the postverbal logical subject cannot be marked by a preposition (18a), which would normally be the case for a real passive construction (18b). Hence, the postverbal logical subject is not likely a ‘chômeur’ (the suppressed argument in a passive), contrary to what [Kimenyi \(1980\)](#) proposes in his Relational Grammar analysis.

Dzamba (C322, [Bokamba 1976](#): 71, 72, adapted; and personal communication)

- (18) a. *patient inversion*  
 I-mi-nkanda mi-tom-áki oPɔsɔ lɔɔme.  
 AUG-4-letter 4SM-send-IPFV 1.Poso today  
 ‘The letters, Poso sent today.’
- b. *passive*  
 I-mu-nkanda mu-tom-am-áki \*(na) oPɔsɔ.  
 AUG-3-letter 3SM-send-PASS-IPFV by 1.Poso  
 ‘The letter/book was sent by Poso.’

A final diagnostic used by [Carstens and Mletshe \(2015\)](#) shows that the subject has not moved to some in-between position. They show for Xhosa that the postverbal subject follows both the auxiliary (-*phantse* ‘almost’) and the main verb in a complex tense, as in (19b).

Xhosa (S41, [Carstens & Mletshe 2015](#): 204, 205)

- (19) a. U-Thandeka          u-phantse          w-aty-a          i-papa.  
           AUG-1.Thandeka    1SM-almost          1SM-eat-FV    AUG-9.polenta  
           ‘Thandeka almost ate the polenta.’
- b. Ku-phantse          kw-aty-a          u-Thandeka          i-papa.  
           17SM-almost    17SM-eat-FV    AUG-1.Thandeka    AUG-9.polenta  
           ‘It was Thandeka who almost ate the polenta.’
- c. \*Ku-phantse          u-Thandeka          kw-aty-a / w-aty-a  
           17SM-almost          AUG-1.Thandeka    17SM-eat-FV / 1SM-eat-FV  
           i-papa.  
           AUG-9.polenta

These phonological, morphological, semantic, and syntactic diagnostics all indicate that in most inversion constructions in most languages,<sup>4</sup> the postverbal subject remains in a low, vP-internal position, which I assume to be specvP for unergative and transitive predicates, and the complement of V for unaccusatives.

Nevertheless, the postverbal logical subject does not behave like an object, as [Bresnan and Kanerva \(1989\)](#) point out. Unlike canonical object DPs, the postverbal logical subject cannot be object-marked, relativized, or passivized, as will be illustrated in turn.

No object marker referring to the postverbal logical subject is permitted, but crucially object-marking an object is not grammatical either in an inversion construction ([Bresnan & Kanerva 1989](#); [Kimenyi 1980](#); [Marten 2006](#); [Zeller 2012b](#)). This is illustrated for Ndebele DAI in (20a) and (20b), respectively.

Ndebele (S44, [Marten & Van der Wal 2014](#): 325)

- (20) a. Ku-kha          aba-ntwana    ama-nzi.  
           17SM-draw    2-children    6-water  
           ‘There are children drawing water.’
- b. \*Ku-**ba**-kha          (aba-ntwana)    ama-nzi.  
           17SM-2OM-draw    2-children          6-water
- c. \*Ku-**a**-kha          aba-ntwana    (ama-nzi).  
           17SM-6OM-draw    2-children          6-water

[Marten \(2006\)](#) notes that pronominalization does not cause the ungrammaticality of the object marker in Otjiherero locative inversion, as the postverbal logical subject can be expressed as a postverbal pronominal clitic (21).

<sup>4</sup> AI in Makhuwa and Lubukusu forms an exception, where the logical subject is in a structurally higher position, despite its linearly postverbal position; see [Van der Wal \(2012\)](#) and Sections 4.5.1 and 4.5.5.



The same is illustrated for Zulu in (22). With the knowledge on object marking built up in the previous chapters we can thus deduce that this property of subject inversion constructions must be due to the function of little *v*, as will be argued in Section 4.3.5.

Otjiherero (R30, [Marten & Van der Wal 2014](#): 325; cf. [Marten 2006](#): 119)

- (21) a. \*M-on-djuwo mw-a ri hiti.  
 18-9-house 18SM-PST 5OM enter  
 int. 'Into the house entered s/he.'
- b. M-òn-djúwó mw-á hìtí=rò.  
 18-9-house 18SM-PST enter=5PRO  
 'Into the house entered s/he.'

Zulu (S42, [Zeller 2012a](#): 140)

- (22) a. \*I-moto i-m-hamb-ile.  
 AUG-9.car 9SM-1OM-go-PFV.DJ  
 int. 'He travelled by car.'
- b. I-moto i-hamb-e yena.  
 AUG-9.car 9SM-go-PFV.CJ 1.PRO  
 'He travelled by car.'

[Bresnan and Kanerva \(1989\)](#) show for Chichewa that the postverbal logical subject in locative inversion cannot be relativized like an object, and cannot become the subject of a passive verb, as illustrated in (23) and (24), respectively. These properties too show the special status of the postverbal logical subject, which an analysis needs to capture.

Chichewa (N31, [Bresnan & Kanerva 1989](#): 15)

- (23) a. Pa-m-chenga p-a-im-a nkhandwe.  
 16-3-sand 16SM-PRF-stand-FV 9.fox  
 'On the sand is standing the fox.'
- b. \*N`chi-yâni chi-mene pa-m-chenga p-a-im-a?  
 COP7-Q 7-REL 16-3-sand 16RM-PRF-stand-FV  
 lit. 'What is it that on the sand is standing?'
- (24) a. Ku-mu-dzi ku-na-bwer-a a-lendo-wo.  
 17SM-3-village 17SM-RECPST-come-FV 2-visitor-2DEM  
 'To the village came those visitors.'
- b. \*A-lendo-wo a-na-bwer-edw-a ndi ku-mu-dzi.  
 2-visitor-2DEM 2SM-RECPST-come-PASS-FV by 17-3-village  
 lit. 'The visitors were come to by the village.'

Having concluded that the postverbal logical subject is *in situ* in the vP, but does not function as an object, we now turn to the syntactic status and structural position of the preverbal DP.

#### 4.2.2 Preverbal DP as subject

Especially for locative inversion, scholars have shown that the preverbal element (the locative DP) functions as the grammatical subject. The most obvious indication is the fact that the subject marker is determined by preverbal DP in LI, II, and PI. Apart from that, the preverbal Locative has been shown to behave as the subject in four other ways as well. Following [Bresnan and Kanerva's \(1989\)](#) demonstration for Chichewa, [Zeller \(2012, 2013\)](#) shows for Zulu that the preverbal Locative and Instrument display the same subject properties, which I repeat here.

First, the Locative or Instrument can be dropped, resulting in a reading with a pro-form that retains the locative or instrumental reference, as in (25) and (26). The same pronominal interpretation appears when the locative or instrumental DP is right-dislocated, as in (27).

Zulu (S42, [Zeller 2013](#): 1113)

- (25) a. I-Theku            li-yi-i-dolobha            eli-hle.  
           AUG-5.Durban    5SM-COP-AUG-5.city    5.ADJ-pretty  
           'Durban is a pretty city.'  
       b. Li-hlal-a            a-ba-ntu            aba-ningi.  
           5SM-stay-FV    AUG-2-people    2.ADJ-many  
           'Many people live there.'  
           lit. 'It lives many people.'

([Zeller 2012a](#): 137)

- (26) Q U-si-bon-ile            i-sipunu            sa-mi?  
           2SG.SM-7OM-see-PST.DJ    AUG-7.spoon    7.CONN-1SG  
           'Have you seen my spoon?'  
       A Yebo. Si-dla            u-John.  
           yes    7SM-eat-FV    AUG-1a.John  
           'Yes, John is using it to eat.'  
           lit. 'It is eating John.'

([Zeller 2012a](#): 138)

- (27) Namhlanje li-lim-a            a-madoda            i-geja.  
       today            5SM-plough-FV    AUG-6.man    AUG-5.hoe  
       'Today, the men use it to plough the field, the hoe.'  
       lit. 'Today it ploughs the men, the hoe.'

Another typical diagnostic property for subjects is whether a DP can undergo raising. This is well known for Locatives in locative inversion (28), and also holds for Instruments in Zulu, as (29) shows.

Zulu (S42, Zeller 2013: 1113)

- (28) Lezi        zin-dlu        zi-bonakal-a        sengathi        zi-hlal-a  
 10.DEM    10-house    10SM-seem-FV    COMP        10SM-stay-FV  
 a-ba-ntu        aba-dala.  
 AUG-2-person    2.ADJ-old  
 ‘Old people seem to live in these houses.’  
 lit. ‘These houses seem that they live old people.’

(Zeller 2012a: 138)

- (29) I-peni        li-fanel-e        li-bhal-e        a-ba-fundi.  
 AUG-5.pen    5SM-must-FV    5SM-write-SBJV    AUG-2-students  
 ‘The pen must be used by the students to write.’  
 lit. ‘The pen must write the students.’

A last diagnostic is the relativization strategy used for preverbal Locatives and Instruments. If subject relativization takes a different linguistic strategy than relative clause formation with an object or oblique as the head, then relativization of the preverbal DP in subject inversion can inform us about the syntactic role of the preverbal DP. This diagnostic again shows that the preverbal Instrument (30b) is relativized in the same way as a subject (30a); the same holds for the Locative in (31).

Zulu (S42, Zeller 2012a: 137, 138, glosses adapted)

- (30) a. Y-i-siphi                    i-sipunu        esi-hlez-i        e-tafule-ni?  
 COP-AUG-7.which    AUG-7.spoon    7.REL-lie-FV    LOC-5.table-LOC  
 ‘Which spoon is lying on the table?’  
 lit. ‘It is which spoon that lies on the table?’  
 b. Y-i-siphi                    i-sipunu        esi-dla        u-John?  
 COP-AUG-7.which    AUG-7.spoon    7.REL-eat        AUG-1a.John  
 ‘Which spoon is John using to eat?’  
 lit. ‘It is which spoon that eats John?’

(Zeller 2013: 1114, glosses adapted)

- (31) Yi-zi-phi        i-zin-dlu        ezi-hlal-a        a-ba-ntu        aba-dala?  
 COP-10-which    AUG-10-houses    10.REL-stay-FV    AUG-2-people    2.ADJ-old  
 ‘In which houses do the old people live?’  
 lit. ‘It is which houses that stay old people?’

While the evidence for Locatives and Instruments (in Zulu at least) shows that the preverbal element functions as the subject of the clause, this is less straightforward for Theme arguments in patient inversion. Although the preverbal Theme determines subject agreement on the verb, and in spite of the frequently used name ‘subject–object reversal’, the original subject and object in the non-inverted SVO clause do not actually swap their grammatical roles. The partial function change is noted by [Whiteley and Mganga \(1969\)](#); [Bokamba \(1979, 1985\)](#); and [Kimenyi \(1980\)](#); and later [Whaley \(1996\)](#); and [Morimoto \(2000, 2006\)](#). All of these scholars also highlight the topic status of the Theme, and the non-topic or focus status of the postverbal agent. While the influence of topicality on the grammar is crucial (as I will expand on later in this chapter), a remaining question is what the syntactic role and position of the preverbal Theme is. Options are specTP like subjects, or specTopP for left-peripheral topics. The literature does not show convincing syntactic evidence that the Theme does *not* occupy a canonical subject position in specTP. After all, it is perfectly possible to have a topic interpretation and nevertheless be located in a position typical for the subject – or in other words to be a subject (syntactic role) and topic (discourse role) at the same time.

[Ndayiragije \(1999\)](#) argues for Kirundi patient inversion that the Theme occupies specTP and functions like the subject. I discuss some of his arguments here. First, like canonical subjects, the Theme DP can be dropped (32) or right dislocated (33) in facilitating contexts, retaining the inversion interpretation.

Kirundi (JD62, [Ndayiragije 1999](#): 418)

- (32) a. I-bi-tabo            bi-á-somye            Yohani.  
           AUG-8-books    8SM-PST-read.PFV    1.John  
           ‘John (not Peter) has read (the) books.’
- b. Bi-á-somye            Yohani.  
           8SM-PST-read.PFV    1.John  
           ‘John (not Peter) has read them.’

([Ndayiragije 1999](#): 422)

- (33) a. I-gi-tabo            ki-á-somye            a-bá-ana.  
           AUG-7-book    7SM-PST-read.PFV    AUG-2-children  
           ‘Children (not parents) read a book.’
- b. Ki-á-somye            a-bá-ana,            ico            i-gi-tabo.  
           7SM-PST-read.PFV    AUG-2-children    7.DEM    AUG-7-book  
           ‘That book, children (not parents) read it.’

Similarly, the preverbal DP can trigger agreement on multiple verbs (hyper-agreement) in complex tenses, where the inverted Theme (34b) behaves like the uninverted subject (34a), as Ndayiragije (1999) shows. Comparison with the passive shows the same behaviour (34c).

Kirundi (JD62, Ndayiragije 1999: 420)

- (34) a. A-bá-ana           ba-á-riko       ba-soma           i-gi-tabo.  
 AUG-2-children   2SM-PST-be   2SM-read.IPFV   AUG-7-book  
 ‘Children were reading a book.’
- b. I-gi-tabo       ki-á-riko       ki-soma           a-bá-ana.  
 AUG-7-book   7SM-PST-be   7SM-read.IPFV   AUG-2-children  
 ‘Children (not adults) were reading a book.’
- c. I-gi-tabo       ki-á-riko       ki-som-u-a           na a-bá-ana.  
 AUG-7-book   7SM-PST-be   7SM-read-PASS-IPFV by AUG-2-children  
 ‘The book was being read by children.’

The relative scope of logical subject and Theme also indicates that the Theme is in an A-position in patient inversion.<sup>5</sup> The first intuitive interpretation of the SVO order in (35a) is the bound reading, where every author likes his/her own book, but the free reading (someone else’s book) is also available. In the passive construction (35b) and in patient inversion (35c) there is no ambiguity: the possessive pronoun can only be free, not bound. This indicates that the Theme undergoes non-reconstructing A-movement (to specTP), resulting in a structure where the Theme always c-commands the *in-situ* logical subject. If the Theme would undergo A-bar movement, as Henderson (2006, 2011) proposes, it is predicted to reconstruct under the logical subject, resulting in ambiguity. The fact that there is no ambiguity and the preverbal Theme in patient inversion behaves like the passive subject in this respect shows that it is in an A-position, which I take to be specTP.

Kirundi (JD62, Ernest Nshemezimana, personal communication)

- (35) a. [U-mw-anditsi w-éése]<sub>i</sub> a-kund-a       i-gi-tabo       c-íiwé<sub>i/j</sub>.  
 AUG-1-writer   1-every   1SM-like-FV   AUG-7-book   7-POSS.1  
 ‘Every writer<sub>i</sub> likes his<sub>j/i</sub> book.’

<sup>5</sup> Ndayiragije (1999) also applies this weak crossover test, but unfortunately chooses an example with two animate arguments (i), which cannot be inverted for independent reasons.

- i. a. U-mu-nyeshule w-eese<sub>i</sub> a-ra-kunda       u-mw-arimu       w-iwé<sub>i</sub>.  
 AUG-1-student   1-every   1SM-PRS.DJ-like   AUG-1-teacher   1-POSS  
 ‘Every student<sub>i</sub> likes his<sub>i</sub> teacher.’
- b. \*U-mw-arimu w-iwé<sub>i</sub> a-kunda       u-mu-nyeshule w-eese<sub>i</sub>.  
 AUG-1-teacher   1-POSS   1SM-like   AUG-1-student   1-every  
 int. ‘Every student<sub>i</sub> likes his<sub>i</sub> teacher.’

- b. I-gi-tabo      c-íiwé<sub>j/\*i</sub>      gi-kund-w-a      n'      [ú-mw-anditsi  
 AUG-7-book    7-POSS.1    7SM-like-PASS-FV    by    AUG-1-writer  
 w-éése]<sub>i</sub>.  
 1-every  
 'His book<sub>j/\*i</sub> is liked by every writer<sub>i</sub>.'
- c. I-gi-tabo      c-íiwé<sub>j/\*i</sub>      gi-kund-a      [u-mw-anditsi    w-éése]<sub>i</sub>.  
 AUG-7-book    7-POSS.1    7SM-like-FV    AUG-1-writer    1-every  
 'His book<sub>j/\*i</sub> every writer<sub>i</sub> likes.'

#### 4.2.3 Research questions for subject marking and inversion

In summary, there is evidence for: 1. a low *in situ* position of the postverbal logical subject, even if it does not function as an object; and 2. the subject status of the preverbal DP in locative and instrument inversion, and, at least for Kirundi, also in patient inversion. It is important to stress again that these diagnostics need to be applied for each inversion construction in every individual language in order to be able to discover the underlying structure.

The overall picture, then, triggers a number of research questions concerning subject marking and inversion:

1. What determines subject agreement?
2. How is the postverbal logical subject licensed?
3. How can T agree with the Theme/Locative/Instrument if the EA is present too, given the Minimal Link Condition (MLC)?

These questions have received various answers in the literature, as will be discussed in Section 4.3.

### 4.3 Circumventing the locality restriction in inversion

For subject inversion constructions the same locality problem appears as for double object constructions: T agrees with and moves a lower DP (the Locative, Instrument, Theme) across an intervening DP (the external argument). Various analyses exist to get around this problem, proposing either that the Locative/Instrument originates in a position above the EA, or that the Locative/Instrument/Theme has a way to move across the EA before T probes. I discuss each in turn, before outlining how flexible licensing can account for subject inversion if we extend the analysis proposed for ditransitives.

## 4.3.1 Equidistance

For ditransitives in Chapter 3, I discussed the analysis whereby the two internal arguments are equidistant to *v*, thereby denying that there is a locality problem in the first place. The same can be said for subject inversion constructions: if the logical subject is as close to T as an internal DP (Theme, Locative, etc.), then either can be reached as a goal for T without violating locality. I repeat from Chapter 3 Chomsky's (1995, 2000: 122) 'Equidistance Principle':

(36) Equidistance Principle:

Terms of the same Minimal Domain are equidistant to Probes.

Minimal Domain:

The Minimal Domain of a head is the set of terms immediately contained in projections of that head.

There are two heads that could have both DPs in their minimal domain: V and *v*. Ura (1996, 2000) and Collins (1997) analyze Chichewa locative inversion as having the Locative and the logical subject in the minimal domain of V, indicated by the circle in (37). The locative DP is introduced in the specifier of V, and the other DP has the semantic role of Theme – locative inversion in Chichewa is only possible for unaccusative predicates, with the sole argument being a Theme (see further in Section 4.5.2). If Locative and Theme in this structure are seen as equidistant, then either can be a target for T, circumventing the MLC.

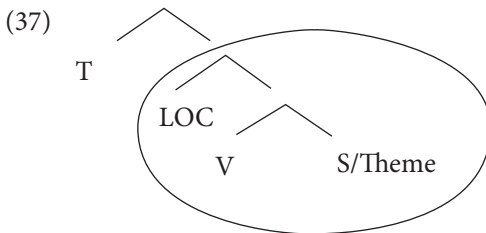

Collins (1997) acknowledges in a footnote that the assumed restriction to unaccusative predicates may not hold across languages, and this is indeed the main problem for the sketched account.<sup>6</sup> This is because the logical subject of unergative and transitive predicates is introduced in specvP as the external argument, resulting in a structure where the Locative and logical subject are no longer in the same minimal domain, whether the Locative is introduced in a lower specifier or as the complement of V:

<sup>6</sup> Another problem is Case licensing of both arguments.

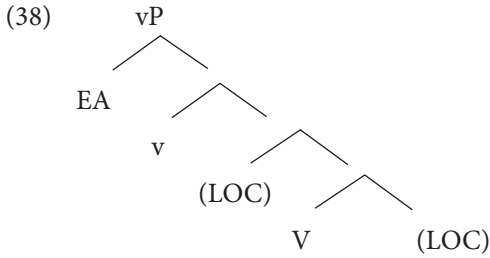

In this configuration the EA and the Locative are no longer equidistant and T moving the Locative over the EA in locative inversion will violate the MLC. Nevertheless, we have seen that locative inversion with unergatives and transitives exists, see example (3), repeated here as (39).

Otjiherero (Marten et al. 2007: 278)

- (39) Kò-mù-tí kw-á-pósé òzón-djimá.  
 17-3-tree 17SM-PST-make.noise 10-baboons  
 ‘In the tree the baboons made noise.’

Another equidistance analysis is proposed by Ura (1996, 2000). Although Ura does not discuss unergative or transitive locative inversion, he does analyze patient inversion (or, in his terms, ‘active/inverse voice alternation’), as in (40).

Dzamba (C322, Henderson 2011: 743)

- (40) a. Omwana a-tom-aki imukanda.  
 1.child 1SM-send-PFV 5.letter  
 ‘The child sent a letter.’  
 b. Imukanda mu-tom-aki omwana.  
 5.letter 5SM-send-PFV 1.child  
 ‘The letter, *the child* sent it.’

The initial structure is the same as in (38), with the Theme as the complement of V (41), posing the locality problem of how T can agree with the Theme when the EA is a closer goal.

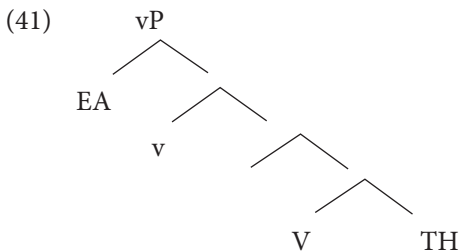



Ura proposes that the external argument and the Theme do end up being equidistant to T, with the Theme moving to a second specifier of v. Both arguments are therefore in the minimal domain of one head (v), being equidistant to a higher probe, and therefore T can attract either of them. When T attracts the EA, the result is SVO order, and when the Theme is attracted we obtain OVS order. Ura proposes that v first attracts the Theme to its specifier, and then projects its external argument, as illustrated in (42).

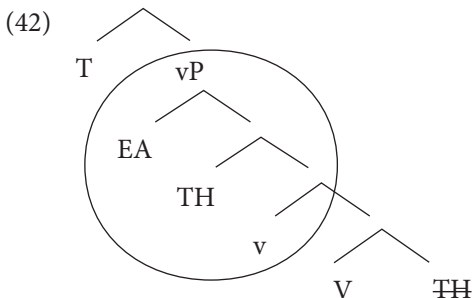

Ura's (1996, 2000) analysis predicts that the Theme *always* moves, because it is attracted by a strong nominal feature, checking the Theme's Case. As Ndayiragije (1999) notes, there is no evidence in Kirundi that the object moves in non-inverted clauses, failing the prediction.

Furthermore, the Case checking relations in the equidistance accounts are not straightforward. Ura proposes that v checks the Theme's Case feature and T does so for the EA.<sup>7</sup> There is, however, no evidence that the EA checks (nominative) Case with T. On the contrary: in locative inversion, where T is also supposed to check nominative Case on the (unaccusative) subject, it is the Locative that displays subject properties, as shown in Section 4.2.2. The Locative is clearly a DP, but Ura and Collins do not account for its Case licensing. In short, apart from the arguments against equidistance in general (see Hiraiwa 2001; Doggett 2004), there are serious flaws in an equidistance account of Bantu subject inversion constructions.

### 4.3.2 Movement of the Locative

Ngoboka (2016) proposes that Kinyarwanda constructions involving locative DPs contain a small clause with the structure of Den Dikken's (2006,

<sup>7</sup> This is possible if – under Ura's multiple feature checking – Case, EPP, and  $\phi$  can operate independently. The Theme checks T's EPP and  $\phi$ , but the EA checks nominative Case.

2007) Linker and Relator projection. The Relator is phonologically null in the non-inverted version, and it links the logical subject DP in its specifier to a locative DP complement. In inversion constructions, the complement of the Relator is a big DP whose top layer is incorporated into Rel (spelled out as a locative enclitic), thereby extending the DP phase and allowing the complement DP to move to a second specifier of RelP, as represented in (44).

Kinyarwanda (JD61, Ngoboka 2016: 223, 224)

- (43) A-ma-tá y-a-guu-ye=mó i-saazi.  
 AUG-6-milk 6SM-PST-fall-PERF=LOC18 AUG-9.fly  
 ‘A fly fell in the milk.’  
 lit. ‘The milk fell in a fly.’

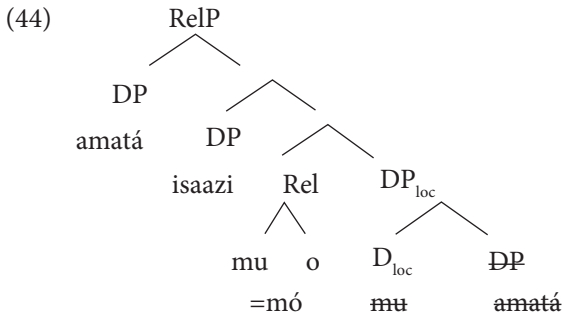

In subject inversion, a movement trigger on v moves the (by now closest) Locative to a second specifier of v, above the EA. In the resulting structure, the Locative is the closest goal for T to agree with and the Locative is moved to a preverbal position. (The EA is subsequently moved to a FocP between vP and TP, as with Ndayiragije 1999 – see in Section 4.3.3).

- (45) (Ngoboka 2016: 357)

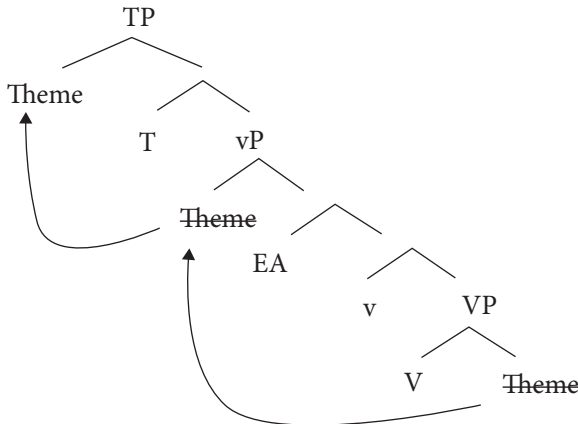

While this analysis correctly accounts for the word order and agreement facts and circumvents locality challenges, it is unclear why the Locative (or Theme, or Instrument) moves up to a second specifier of the Relator or v. Furthermore, the observed interpretational restrictions (postverbal as focus and preverbal as topic) do not play a role in driving the derivation but have to be assumed as independent effects (which is not necessarily problematic, but needs to be considered). Lastly, while the connection between the locative enclitic and locative inversion is inherent in this analysis (rightly so for Kinyarwanda and similar languages), there is no evidence for a Relator in many other Bantu languages, and the analysis can therefore not be straightforwardly extended across the board.

### 4.3.3 Movement of the external argument

Ndayiragije (1999) also recognizes the locality challenge in Kirundi patient inversion and proposes that it is not the Theme but the EA that moves to allow movement without violating locality. Since the postverbal agent in Kirundi receives a focused interpretation, Ndayiragije postulates that it moves to a right-branching specifier of a dedicated Focus projection between vP and TP, as illustrated in (47).

Kirundi (JD62, Ndayiragije 1999: 415)

- (46) I-bi-tabo      bi-á-som-ye      Yohani.  
 AUG-8-books    8SM-PST-read-PERF    I.John  
 ‘John read the books.’

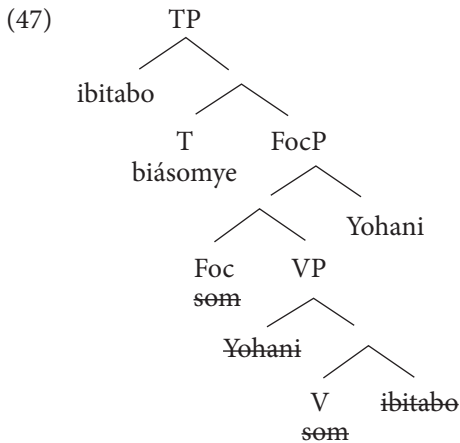

Considering that the Minimal Link Condition concerns hierarchical structure rather than linear structure, the EA is still a closer goal than the Theme in the

proposed structure in (47). In addition, one may wonder what licenses the EA in specFocP (if not some ‘focus Case’, which may turn out to be a valid option, in fact). In order to account for these aspects, Ndayiragije’s (1999) analysis is dependent on another assumption: only functional heads need to check features, not DPs (unlike what I assume in my analysis, and unlike Chomsky’s 2001 model where uCase on DP needs to be valued/deleted). A-bar movement of the EA is driven by the need for the Foc head to check its [focus] feature, and A-movement of the Theme is driven by T’s need to check nominative Case and an EPP feature. Under current assumptions, however, the EA would still constitute an intervener, as Ngoboka (2016: 243) notes. While Kirundi (and Kinyarwanda) patient inversion shows some properties that make it different from other languages and for which we may need a different analysis (see Section 4.4.2), I conclude that this approach is not suitable to account for Bantu inversion constructions in general.

#### 4.3.4 Locative originates higher

Buell (2005) proposes that locative DPs in Zulu originate in a very high projection above the EA – a sort of superhigh applicative – whereas locative PPs originate in an Applicative head under vP, as represented in (48). This ensures that the locative DP is the closest goal to T in Zulu semantic locative inversion (i.e. no violation of locality constraints).

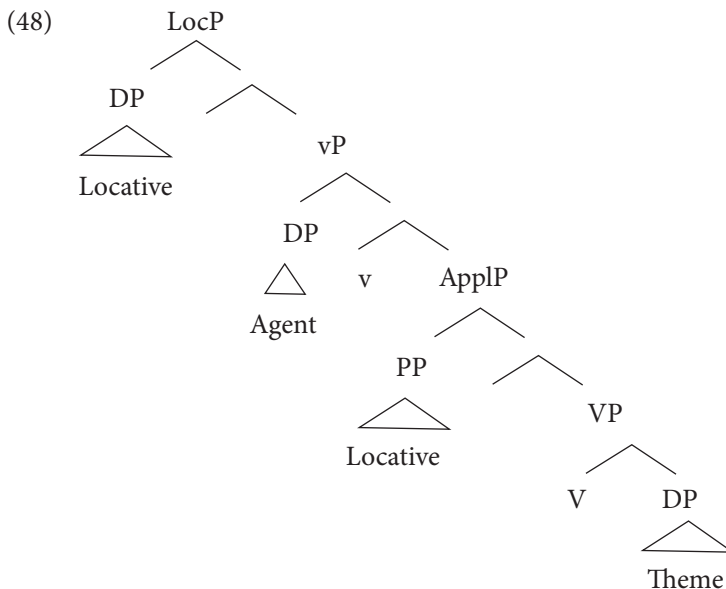

The different height of merger for DP vs PP Locatives is motivated by the difference in formal marking: postverbal Locatives in Zulu need to be marked by a preposition whereas preverbal Locatives in semantic locative inversion cannot be marked by such a preposition but are DPs. This, however, can also be seen as the difference between DPs being introduced by an applicative and PPs being adjuncts. The relation between the information-structural status of the Locative and its height of merger (the superhigh locative DP is necessarily topical) remains mysterious in Buell's analysis, and it is unclear how the postverbal subject is licensed.

A second approach in which the Locative originates higher than the logical subject is proposed by Zeller (2013), who proposes the same analysis for instrument inversion in his (2012) article. Zeller proposes that the structure underlying locative inversion and instrument inversion in Zulu involves non-verbal predication. Specifically, he takes Bowers' (1993) predication projection PrP to establish a semantic and syntactic relation between a verb phrase and a 'holder': the Locative or Instrument. To illustrate this analysis, the example of locative inversion in (49) would have the structure in (50), where the arrows indicate movement.

Zulu (S42, Buell 2007: 108)

- (49) Lezi                   zindlu           zi-hlala           a-ba-ntu           aba-dala.  
 10.DEM.PROX 10.houses 10SM-live AUG-2-people 2.ADJ-old  
 'Old people live in these houses.'

(50) (Zeller 2013: 1123)

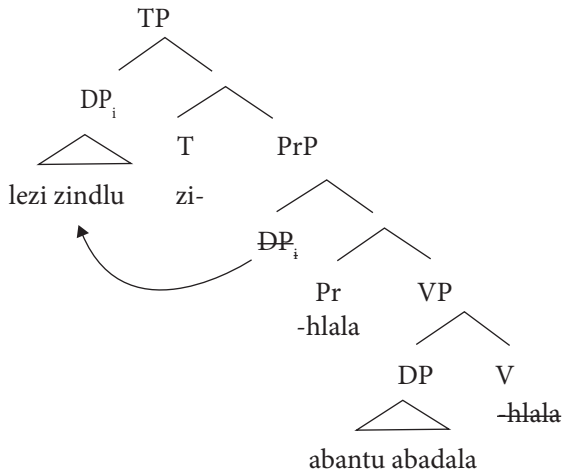

On the semantic side, the structure is interpreted as the event of 'old people living' being a property of 'these houses' (Zeller 2013: 1124), parallel with

non-verbal predication, for example, the adjective ‘successful’ being a property of ‘Gemma’ in ‘Gemma is successful’.

On the syntactic side, the Locative or Instrument DP is closer to T and therefore the EA does not form an intervener, thus circumventing the locality problem. The analysis also accounts for the fact that verbs with different valencies can occur in Zulu inversion constructions, since PrP can take a larger or smaller complement: AdjP for adjectival predicates, VP for unaccusatives and vP for unergatives and transitives. Zeller proposes that PrP is a phase, which traps the EA *in situ*.

It is very unlikely that these accounts can be extended to patient inversion (how can the Theme be a ‘holder’ and an object of the verb at the same time?), default agreement inversion (is there a zero/expletive of which the vP is predicated?), or complement inversion (a whole clause as the individual-type argument of a predicate?). These would require a separate analysis. Considering the commonalities in subject inversion constructions (e.g. topicality of the preverbal element and non-topical or focal interpretation of the postverbal logical subject), a unified account of these inversion constructions would be preferable. An attempt at such an analysis is presented in Section 4.3.5.

### 4.3.5 Flexible licensing

As mentioned in the introduction to this chapter, there is another way to circumvent the locality problem:  $u\phi$  on T can reach past the EA if the EA is already licensed and no longer visible as a goal. This is possible if the EA is licensed upwards by the head that also introduces it: little *v*. But why would *v* license downwards in SV order, and upwards in VS subject inversion? The motivation for licensing the complement or specifier is by hypothesis the same as for flexible licensing of double objects by Appl (see Chapter 3), and depends on the topicality of the arguments involved (in this case not the animacy).

To briefly recap, I proposed in Chapter 3 that low functional heads like Appl can be flexible in licensing a DP in their complement, or a Causee/Benefactive/Recipient DP introduced in their specifier, accounting for symmetric double object behaviour. The head’s licensing abilities in the proposed analysis are determined by the animacy and topicality of the argument introduced in the specifier, as captured in the Flexible Licensing Parameter:

(51) Flexible Licensing Parameter (FLiP):

The features and feature values that a head can license [are/are not] restricted to those of the argument introduced in its specifier.

As a result, the head cannot license an argument that is more topical than the argument in the specifier. I repeat briefly how this works for ditransitives. If the Benefactive is topical, Appl can license any Theme, whether topical or not, and will do so because the Theme's [uCase] feature needs to be checked as soon as possible, as represented in (52). This leaves *v* to agree with the Benefactive. If only *v* has a  $\phi$  probe, object marking will only be possible with the Benefactive.

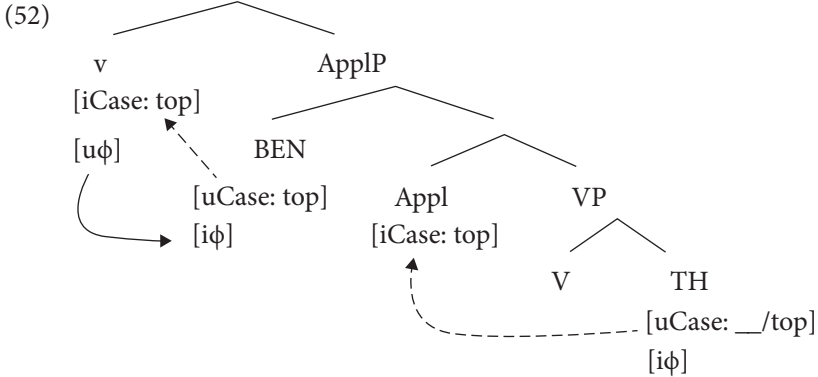

If the Benefactive is non-topical, Appl can still license a non-topical Theme. A topical Theme, however, cannot be licensed in this environment, and instead Appl licenses the Benefactive in its specifier, leaving the Theme for agreement with *v*, as in (53).

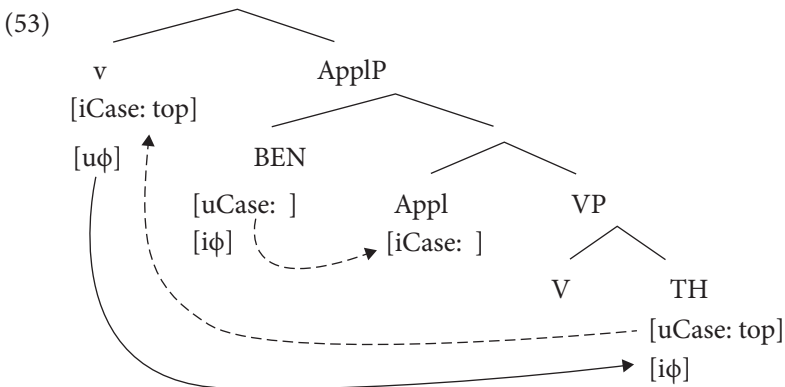

If we postulate that *v*, like Appl, also possesses this flexible licensing property, then the suggestion is that *v*'s licensing abilities are determined by the features of the external argument EA, if there is one (see the following examples for unaccusatives). While for Appl's flexible licensing in ditransitives animacy also played a role, *v*'s flexible licensing seems to be determined only by topicality, as discussed in Section 4.4.2, and I hence only consider topicality in the

remainder of the chapter. As presented in Chapter 3, one way we can think of this is the [iCase] feature on *v* taking the same value as the DP in its specifier, as already indicated in the previous trees.

Flexible licensing by *v* thus entails that an internal argument is licensed by *v* if the EA is topical, but the EA itself will be licensed by *v* if it is less topical than a lower argument. And that is precisely what we find in inversion constructions, as seen in Section 4.2: when the logical subject is in a postverbal position, it is interpreted as non-topical (either presentational in athetic sentence, or with narrow focus on the subject), while the preverbal DP is topical. I will now illustrate the derivation for patient inversion, locative inversion, and instrument inversion, noting how flexible licensing accounts for the licensing and position of both arguments, as well as their interpretation, the agreement with the preverbal element, and the impossibility of object marking. Default agreement inversion is subsequently discussed in Section 4.4.1.

Assuming that Case is a feature that forces arguments to connect to a head (see Section 3.6.3 in Chapter 3), the analysis of patient inversion, as in (46), repeated as (54), will be as follows: *v* introduces as the EA a noun that is non-topical with [uCase]/[iφ],<sup>8</sup> and has in its complement a topical Theme with features [uCase: top]/[iφ]. Since the EA does not have a Topic feature, *v* has a simple feature [iCase]. When the Theme's [uCase] feature probes, it will thus not find *v* to be a suitable licenser. The EA then needs to check its [uCase] feature, finding *v*'s [iCase] in its c-command domain. The Theme continues its probe, is licensed by T,<sup>9</sup> and T's uφ features are valued by the Theme. If T's φ probe has a movement diacritic (written  $\wedge$ ), the Theme moves to specTP, resulting in Theme-V-EA order.<sup>10</sup> Note that T here also needs a topic value for Case licensing – this reflects the generalization that the preverbal domain and subject marking are strongly correlated with topics, as discussed further in Section 4.4.3.

Kirundi (JD62, Ndayiragije 1999)

- (54) Ibitabo bi-á-som-ye Yohani.  
 8.books 8SM-PST-read-PERF I.John  
 'John read the books.'

<sup>8</sup> See also Morimoto's (2006) feature [-ht] standing for 'no element is higher in topicality', which she employs in an LFG framework to account for Kirundi subject inversion.

<sup>9</sup> Under the Phase Impenetrability Condition as formulated by Chomsky (2001), known as PIC2, the lower phase is still accessible for T, until the next phase head (C) is merged.

<sup>10</sup> I thus take a traditional view of agreement and movement (e.g. Carstens 2005 for Bantu), rather than having movement precede Agree (e.g. Baker 2008a; Zeijlstra 2012). More in-depth discussion on subject agreement and movement follows in Section 4.5.2.



(55)

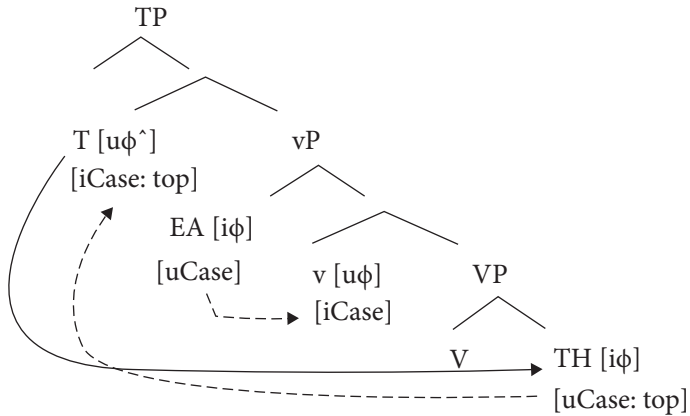

When the EA is topical, on the other hand, *v* has the ability to license topical and non-topical Themes. Therefore, the Theme will be licensed by *v*, and the EA will be licensed by T, followed by  $\phi$  agreement and movement of the subject, resulting in SVO word order.<sup>11</sup>

(56)

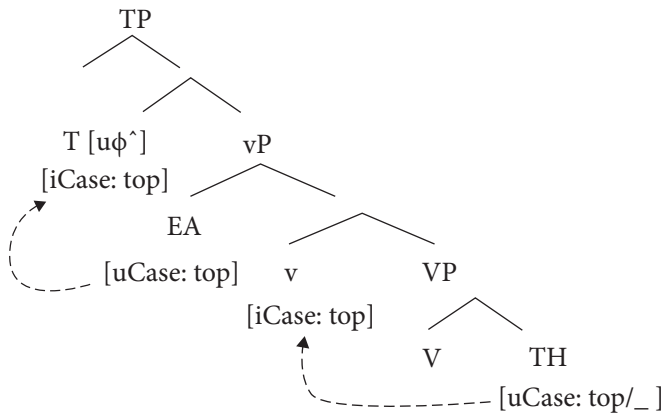

Roughly the same analysis can be given for locative and instrument inversion. For transitive and unergative predicates in inversion, *v* licenses the non-topical EA in its specifier and T licenses, agrees with, and moves the topical locative DP, as sketched in (58) for the example in (57c).

Kĩitharaka (E54, Buell & Muriungi 2008)

- (57) a. Tw-ana      tũ-kũrũ    i-tũ-ceth-ag-(ir)-a      kĩ-eni-ni.  
 13-children    13-old      FOC-13SM-play-HAB-(APPL-)FV    7-field-LOC  
 'Older children play in the field.'

<sup>11</sup> See Section 4.4.2 for an analysis of what happens when both EA and Theme are non-topical in a DAI.

- b. <sup>??</sup>Kî-eni i-gî-ceth-ag-a tw-ana tû-kûrû.  
 7-field FOC-7SM-play-HAB-FV 13-children 13-old  
 int. 'In the field play older children.'
- c. Kî-eni i-gî-ceth-ag-ir-a tw-ana tû-kûrû.  
 7-field FOC-7SM-play-HAB-APPL-FV 13-children 13-old  
 'In the field play older children.'  
 lit. 'The field plays old children.'

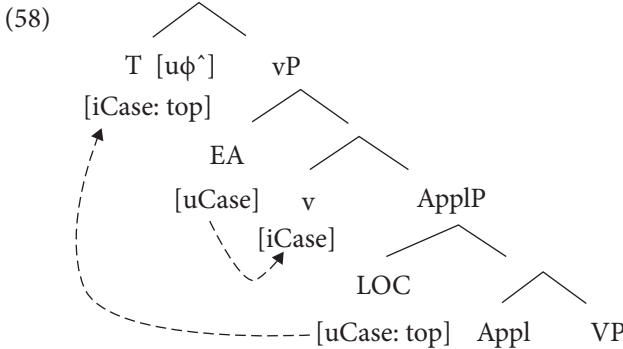

Note that in Kîitharaka (and a number of other languages), unergative predicates require the presence of an applicative in inversion (57b vs c). I assume that the locative DP is introduced in a low or high specAppl, therefore functioning as an argument and participating in licensing relations.

In locative inversion with a transitive predicate, the only change is the addition of a Theme object licensed downward by Appl (60). This is illustrated for Zulu in (59b),<sup>12</sup> where we see direct morphological evidence for the presence of Appl in the form of an applicative suffix.

Zulu (S42, Zeller 2013: 1112)

- (59) a. A-ba-fundi be-be-fund-a i-n-cwadi e-Library  
 AUG-2-students 2SM-AUX-read-FV AUG-9-book LOC-9.library  
 ngo-6.  
 at-6  
 'The students were reading the book in the library at 6 o'clock.'
- b. I-Library i-bi-fund-el-a a-ba-fundi  
 AUG-9.library 9SM-AUX-read-APPL-FV AUG-2-student  
 i-n-cwadi ngo-6.  
 AUG-9-book at-6  
 'The students were reading the book in the library at 6 o'clock.'

<sup>12</sup> Kîitharaka does not allow inversion with transitive predicates, and not all Zulu speakers accept transitive locative inversion, according to Zeller (2013).

(60)

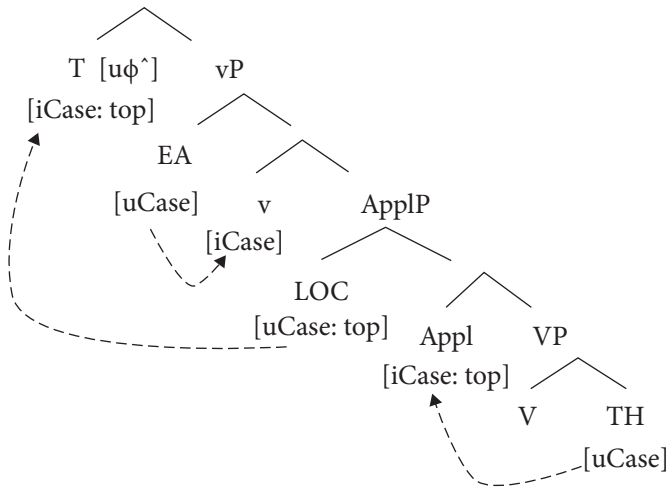

Unaccusative predicates that select a locative DP, such as ‘come’ or ‘arrive’, do not need an applicative extension marked on the verb (61), but since the location is an argument of the predicate, I assume that an Appl head is present in the derivation of locative-selecting predicates, even if it is not spelled out as a separate morpheme.<sup>13</sup> The derivation is as in (62), with the topical locative not able to be licensed by *v* but instead finding *T*.

Ki̱tharaka (E54, Buell & Muriungi 2008)

- (61) a. A-ekûrû ba-ingî i-ba-aj-ag-a kî-rîniki-ni gî-kî.  
 2-women 2-many FOC-2SM-come-HAB-FV 7-clinic-LOC 7-DEM  
 ‘Many women come to this clinic.’
- b. Kî-rîniki gî-kî i-kî-ij-ag-a a-ekûrû ba-ingî.  
 7-clinic 7-DEM FOC-7SM-come-HAB-FV 2-women 2-many  
 ‘To this clinic come very many women.’

<sup>13</sup> Instrument inversion in Zulu does not require the presence of an applicative morpheme. Nevertheless I assume a similar structure to that of locative inversion, where the instrument DP is introduced as an argument. This is partly motivated by the similar behaviour of Zulu locative and instrument inversion (Zeller 2012a, 2013), and partly by the fact that the Instrument DP in inversion constructions can only refer to a typical instrument, e.g. a spoon for eating soup, or a pen for writing letters but not a knife for working (Zeller 2012a: 137).

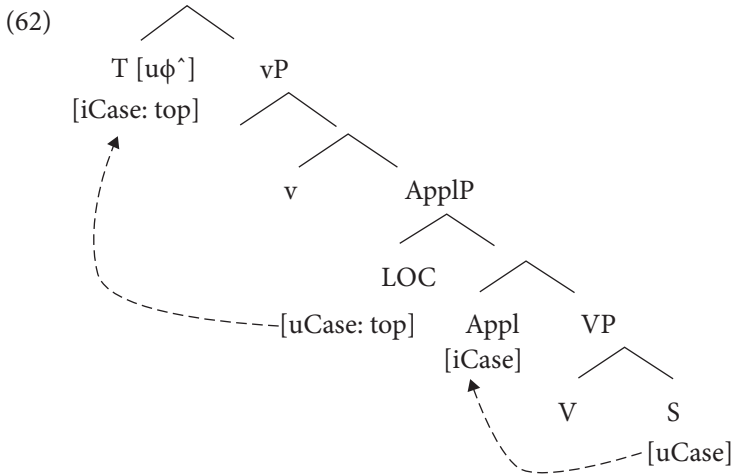

In summary, the possibility of the EA being licensed by *v* naturally captures a number of properties of subject inversion constructions. First, it explains why the subject stays *in situ* (resulting in inversion): there is no Agree relation between EA and T and hence no accompanied (EPP) movement. Second, it also explains why subject inversion only occurs when the subject is non-topical, and third, it accounts for the licensing of the postverbal argument as well, which is not always a point of attention in previous analyses.<sup>14</sup>

Fourth, this analysis accounts for the fact that there is never any object marking in subject inversion constructions – neither for the postverbal EA, nor for any potential objects, as was shown in Section 4.2.1. That is primarily because the postverbal EA is non-topical and therefore not likely to be a defective goal. But even if the EA would be a defective goal, the  $\phi$  features cannot be spelled out as an object marker because the probe on *v* is not the highest of the ‘chain’ of the same set of features, and therefore the EA is spelled out and not the object marker (see Chapter 2 for defective goals and object marking). And obviously, object-marking an object is impossible with *v* licensing the EA, as there is no agreement relation between *v* and any internal argument.

A fifth advantage of this analysis is that it straightforwardly explains why passives of inversion constructions are ungrammatical (as shown for instrument inversion in (63)): passivization requires a passive little *v*, which can therefore not license the EA *in situ*.

<sup>14</sup> Inversion and licensing of augmentless nominals can thus be accounted for without recourse to an additional Licenser head à la Halpert (2015).

Zulu (S42, Zeller 2012a: 141, glosses adapted)

- (63) a. I-sipunu      si-dl-a      u-John      i-sobho.  
           AUG-7.spoon    7SM-eat-FV    AUG-1a.John    AUG-5.soup  
           ‘John is using the spoon to eat soup.’
- b. \*I-sobho      li-dl-iw-a      u-John      y-i-sipunu.  
           AUG-5.soup    5SM-eat-PASS-FV    AUG-1a.John    COP-AUG-7.spoon  
           int. ‘The soup is eaten by John with the spoon.’  
           lit. ‘The soup was eaten John by the spoon.’

In the proposed analysis, the answers to the research questions I posed in Section 4.2.3 are thus as follows:

1. How is the postverbal logical subject licensed? → By little *v* for unergatives and transitives, and by Appl for unaccusatives.
2. What determines subject agreement? → The argument that ends up being licensed by T. Rephrasing this in a  $\phi$ -oriented answer, it is Locality:  $u\phi$  on T agrees with the closest DP that needs licensing.
3. How can T agree with the Theme/Locative/Instrument if the EA is present too, given the Minimal Link Condition? → Because the EA is not in need of licensing anymore, whereas the topical Theme/Locative/Instrument does require licensing. We can rephrase this question from a licensing perspective: What prevents the Theme/Locative/Instrument from licensing by a low head? The answer is that the low head cannot license the Theme/Locative/Instrument’s [uCase: top] feature.

#### 4.4 Flexible licensing in more detail

There are many theoretical details and further questions to be explored for the hypothesis just presented, not all of which can be treated in this chapter. Nevertheless, the positive initial results merit a further exploration of the idea that *v* can license the argument in its specifier. I investigate two questions in some detail here:

- How can flexible licensing account for default agreement inversion (DAI)? (Section 4.4.1)
- Does the implicational relation between low functional heads and flexibility hold? (Section 4.5)

The answers to these questions provide further insights into the flexible licensing approach and the featural specifications as parameterized for individual languages.

#### 4.4.1 Flexible licensing in Default Agreement Inversion (DAI)

So far, we have seen how flexible licensing works when a DP other than the logical subject ends up in a preverbal agreeing position. In DAI, a preverbal element is optional and if one is present, the verb does not agree with it. This is illustrated in (64b), where the preverbal Locative is in class 18, but the default subject marker is class 17. A DAI construction can consist of just the verb and the logical subject (64c).

Setswana (S31, [Creissels 2011](#), adapted)

- (64) a. Basadi ba-opela mo-kereke-ng.  
 2.women 2SM-sing 18-9.church-LOC  
 ‘The women are singing in the church.’
- b. Mo-kereke-ng go-opela basadi.  
 18-9.church-LOC 17SM-sing 2.women  
 ‘In the church there are women singing.’
- c. Go-opela basadi.  
 17SM-sing 2.women  
 ‘There are women singing.’

For DAI, the questions are thus:

- How is the logical subject licensed in inversion with unergative and unaccusative predicates?
- How are two arguments licensed in DAI with transitive predicates?
- How can we understand the appearance of the default subject marker?

I discuss these in turn, starting with unaccusative predicates, then unergatives, then transitives, discussing the licensing abilities of *v* in these constructions. The default subject marker is proposed to simply be a default spell out of the  $\phi$  features on T, further discussed in Section 4.4.3.

In unaccusative and passive DAI, the logical subject must be licensed by *v*, since there is no evidence for licensing by T (no agreement, no movement to preverbal position), nor evidence for another low licensing head such as

Appl.<sup>15</sup> Little *v* in unaccusative predicates does not introduce an argument. As was explained for flexible Appl in Chapter 3, a head's flexible licensing depends on the features of the DP in its specifier. Unaccusative *v* does not have any such features, since an external argument does not exist, and as a result, *v* can only license non-topical DPs in its complement. If the logical subject, which is base-generated as the complement of *V*, is non-topical, then it can be licensed by *v*, resulting in VS order, as in (65).  $\phi$  on *T* spells out as default because there is no other DP to agree with (see also Section 4.4.3 on the subject marker).

Setswana (S31, Demuth & Mmusi 1997: 11)

- (65) a. Gó-fithl-ílé                      rré.  
           17SM-arrive-PFV    1a.father  
           'There arrived father.'
- b. Gó-tlhab-ílwé                      pódi.  
           17SM-slaughter-PFV.PASS    9.goat  
           'There has been slaughtered a goat.'

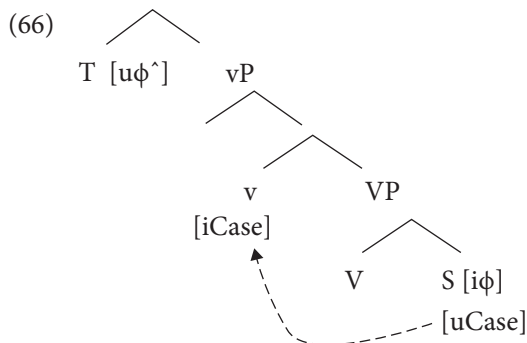

On the other hand, if the logical subject is topical, *v* cannot license it. The argument will then be available for licensing by *T*, subsequently valuing *T*'s  $u\phi$  features and moving to specTP, resulting in SV order (68).<sup>16</sup> As mentioned, *T* has a movement trigger  $\wedge$  associated with the  $\phi$  probe, responsible for moving

<sup>15</sup> This entails that Burzio's Generalization (Burzio 1986) does not hold here (i.e. that unaccusative and passive predicates do not have the ability to license an object, as they do not introduce a thematic role), presumably because nominal licensing based on topicality works differently.

<sup>16</sup> Bringing up an aspect of object marking discussed in Chapter 2, if *v* licenses the logical subject downwards, we may wonder whether the features of the logical subject can also be spelled out on *v* as an object marker. The answer is no, and this is for two reasons. The first is that it is doubtful whether unaccusative *v* possesses  $u\phi$  features at all. But even if it did, and this is the second reason, the logical subject is non-topical and would therefore never be a weak pronoun ( $\phi$ P), so never form a subset of the features on the probe. This is the only possibility to derive an object marker in non-doubling languages. In doubling languages, we can imagine an unaccusative predicate with a definite/animate logical subject, where a subset relation is possible. Whether this occurs in the absence of Appl (which is an alternative licenser for *S*) remains to be seen.

the agreed-with phrase. Topical subjects will thus end up in a preverbal position (SV order). Note that this analysis requires that T has a topic feature to license the topical DP – I come back to this in Section 4.4.3.

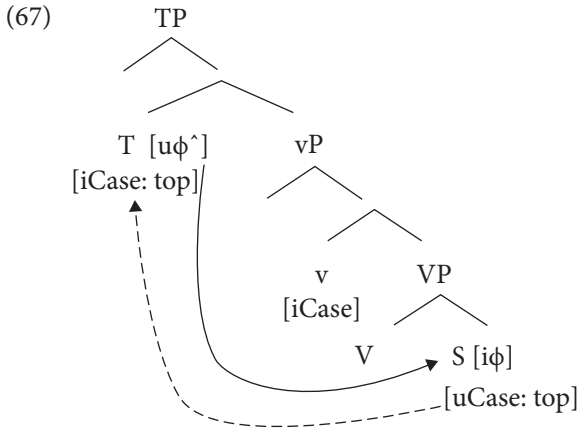

In unergative predicates, *v* does introduce an EA. Under the hypothesis that inversion is the result of the logical subject being licensed in a low position, the question is how the EA in *specvP* is licensed by *v*. Unlike in locative inversion, in DAI there is no second DP that the EA can be compared with for topicality; that is, the EA in (65c) is not relatively less topical than some other DP.

Setswana (S31, Creissels 2011, adapted)

- (65) c. Go-opela basadi.  
 17SM-sing 2.women  
 ‘There are women singing.’

Technically, one could claim that there is a null cognate object that happens to be more topical, making it similar to PI (e.g. ‘song sing women’). However, we would expect such a cognate object to trigger subject marking, which would presumably be different from the default marker, and more importantly, this would not work for passive transitive and unaccusative predicates, since these do not take (overt or covert) other arguments.

Therefore, if the EA is non-topical, I assume that *v* can and will license it upwards, resulting in VS order, with T spelling out as default (and nothing moving to *specTP*). If the EA is topical, we can see that it is licensed and agreed with by T, and moved to *specTP*, resulting in SV order – see (65a). This brings to light an interesting deduction: apparently *v* can only license the non-topical EA. If *v*’s licensing is dependent on the topicality of the EA, we



deduce that [iCase: top] cannot check the topic value of the argument it introduces itself. Looking back to ditransitive licensing in Chapter 3, we see that Appl also only ever licenses an underspecified (non-topical) Benefactive argument in its specifier. What further motivates this restriction is left for further research; here I conclude that flexible licensing cannot license the argument for the value it received from that argument. Therefore, the topical EA of an unergative predicate is not licensed by *v* but by T.

We can take transitivity one step further and explore what happens with word order and inversion for transitive predicates. In a transitive clause, little *v* introduces the EA. Regardless of whether the EA is topical or not, *v* licenses the non-topical object which stays in a postverbal position, as in (68). Note that there is no evidence for an Appl head in simple transitives. If the EA is topical, T will license the EA and agree with it (and move it to specTP), just as in the case of the unergative predicate (69), resulting in SVO order.

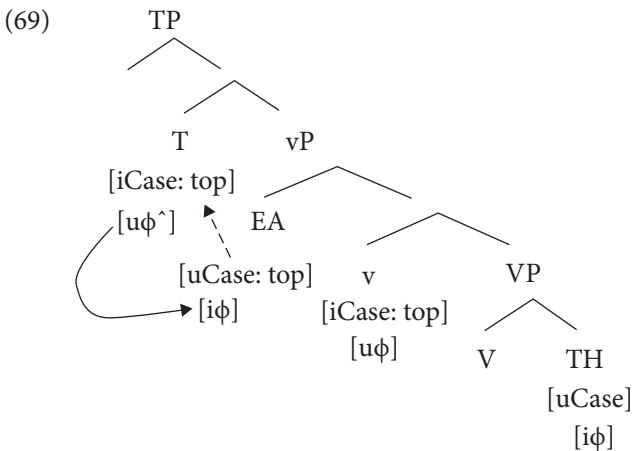
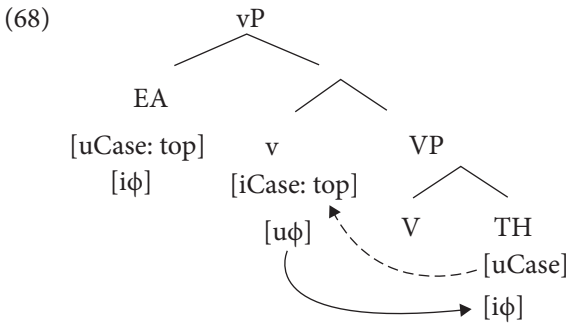

But even if the EA is non-topical, the model predicts that T can and will license it, as the EA has no licensing restrictions. This means that a thetic sentence

(having no topic expression) with a transitive predicate may still appear as SVO word order. This has indeed been reported for Northern Sotho DAI (70) and for Matengo AI (71): the examples show that a non-topical and non-focal (indefinite) subject preferably precedes the verb when an internal argument is present (assuming that the Matengo locative is an internal argument of the verb ‘come’).

Northern Sotho (Zerbian 2006a: 187)

- (70) a. (When reporting that my car was stolen)  
 Ma-hodu a utswitše koloi y-a ka.  
 6-thieves 6SM steal.PST 9.car 9-CONN 1SG.PRO  
 ‘Thieves stole my car.’
- b. (Stage directions)  
 Le-rumo le ja mo-tho, go tuka mo-llo w-a  
 5-spear 5SM eat 1-person 17SM burn 3-fire 3-CONN  
 di-thunya.  
 8-gun  
 ‘A spear kills a person, there is gunfire burning.’

Matengo (N13, Yoneda 2011: 761)

- (71) As an answer to ‘What happened?’
- a. Mundu ju-hikití ku-nyû:mba.  
 1.person 1SM-arrive.PF 17-9.house  
 ‘Someone has come to the house.’
- b. \*Ju-hikití mundu ku-nyû:mba.  
 1SM-arrive.PF 1.person 17-9.house
- c. Ju-hikití mù:ndo.  
 1SM-arrive.PF 1.person  
 ‘Someone has come.’
- d. #Mundu ju-hikí:te.  
 1.person 1SM-arrive.PF

For these languages and constructions, the analysis thus makes the right predictions. Nevertheless, DAI is also allowed in transitives in some languages, resulting in VSO word order, as in (72).

Otjiherero (R30, Marten 2006: 115)

- (72) Pé-rísá òvá-éndá òzò-ngòmbé.  
 16SM.HAB-feed 2-guests 10-cows  
 ‘There feed guests cattle.’

In these VSO constructions, however, the subject cannot receive a mere non-topical reading, but must be interpreted as being in narrow focus. Carstens and Mletshe (2015: 190) notice and analyze this ‘focus asymmetry’ for Xhosa, illustrated in (73): ‘In transitive expletive constructions but not intransitive expletive constructions, the subject must be focused’. This asymmetry is found across southern Bantu languages.

Xhosa (S41, Carstens & Mletshe 2015: 190)

- (73) a. Ku-lil-é                      u-Sindiswa.                      VS  
       17<sub>SM</sub>-cry-PFV.CJ    AUG-1.Sindiswa  
       i. ‘Sindiswa cried.’ (answers ‘What happened?’)  
       ii. ‘It’s Sindiswa who cried.’ (answers ‘Who cried?’)
- b. Ku-theth-a            i-ndoda            ende    i-si-Xhosa.                      VSO  
       17<sub>SM</sub>-speak-FV    AUG-9.man    9.tall    AUG-7-Xhosa  
       ‘It’s the tall man who speaks Xhosa.’ (answers ‘Who speaks Xhosa?’)

The question is how the postverbal EA is licensed in VSO order. It cannot be licensed by T, as T is (in most languages) specified as [topic] and thus incompatible with [focus]. Since *v* licenses the non-topical object, an extra licenser is required for the subject to be present. Carstens and Mletshe suggest that the licensing of the EA is directly linked to its focal status, proposing that raising to the specifier of a low FocusP permits Case licensing. While the details of the analysis are different, I follow Carstens and Mletshe (2015) in assuming that Bantu languages allowing VSO order have an extra licensing head just above *v*P, associated with focus. However, no movement is necessary: the EA can simply be licensed *in situ*. Furthermore, *v* and T have their normal specifications and need not be ‘defective’, as Carstens and Mletshe propose. The reason that licensing works differently in this construction (assuming no defective heads) is that *v* already licenses the object argument (so the EA cannot be licensed by *v* like in intransitive subject inversion),<sup>17</sup> and the focus interpretation of the EA makes that it cannot be licensed by T. Hence, in DAI T spells out as default (see 4.4.3), and the EA must be licensed by the extra head.

For the sake of completeness, I mention one further observation about VSO clauses, which requires further research before a satisfactory analysis can be given. It has been observed that there is a restriction on the animacy of the two arguments in VSO clauses, where the EA must be animate and the Theme inanimate. This is attested in Northern Sotho DAI, where the two arguments

<sup>17</sup> Note that the object still cannot be spelled out as object marker, as it is not a  $\phi$ P in VSO constructions.

cannot both be human (74), but a human EA with an animal or inanimate Theme can grammatically occur in a VSO clause (75).

Northern Sotho (S32, [Zerbian 2006b](#): 367, [2006a](#): 49)

- (74) a. \*Go bona ngaka mo-sadi.  
 17SM see 9.doctor 1-woman  
 int. 'The doctor sees the woman.'  
 b. \*Go betha malome ngwana.  
 17SM beat 1.uncle 1.child  
 int. 'The uncle is beating the child.'

([Zerbian 2006b](#): 366, [2006a](#): 49)

- (75) a. Go ngwala mo-nna le-ngwalo.  
 17SM write 1-man 5-letter  
 'The man is writing the letter.'  
 b. Go hlaba malome kgomo.  
 17SM slaughter 1.uncle 9.cow  
 'The uncle is slaughtering the cow.'

The same pattern is found in Zulu, for which [Buell \(2005\)](#) provides an overview of the restrictions as in (76) and illustrates these in (77).

Zulu subject inversion animacy restrictions ([Buell 2005](#): 181)

- (76) a. S V O<sub>[±human]</sub>  
 b. V S<sub>[±human]</sub>  
 c. V S<sub>[+human]</sub> O<sub>[-human]</sub>  
 d. \*V S<sub>[+human]</sub> O<sub>[+human]</sub>

Zulu (S42, [Buell 2005](#): 179)

- (77) a. Kw-a-bon-a u-Thandi i-ncwadi.  
 17SM-PST-see-FV AUG-1.Thandi AUG-9.book  
 'Thandi saw the book.'  
 b. \*Kw-a-bon-a u-Thandi i-ntombazane.  
 17SM-PST-see-FV AUG-1.Thandi AUG-9.girl  
 int. 'Thandi saw the girl.'

It is unclear to me at this point whether the restriction is a syntactic one (calling for an analysis involving formal features and their interaction), or a pragmatic one, where the syntax can happily derive VSO order with two human arguments, but the interpretation fails – comparable to the Kirundi OVS cases in Section 4.4.2.

4.4.2 The features and flexibility of *v* in Kirundi and Kinyarwanda

I have so far assumed that *v*'s flexibility only involves topicality and not animacy; it is now time to discuss the grounds for this assumption by looking at Kirundi and Kinyarwanda inversion constructions.

Information structure is the main factor for inversion constructions in Kirundi, but there are animacy restrictions in Kirundi PI as well. [Kimenyi \(1980\)](#); [Bukuru \(2003\)](#); and [Morimoto \(2006\)](#) observe that inversion is only possible if the Agent is higher in animacy than the Theme, explaining the contrast between (78) and (79), and in cases of equal animacy, inversion requires a predicate that does not allow for ambiguity: in (80) and (81) both arguments are human, but since doctors cure patients and not vice versa, the inverted interpretation is not at risk, unlike with a predicate such as kissing which can be initiated by either argument. The animacy restrictions are thus somewhat flexible ([Nshemezimana 2016](#)).

Kinyarwanda (JD61, [Kimenyi 1980](#): 141, glosses adapted)

- (78) I-gi-tabo      cyi-ra-som-a      u-mu-huúngu.  
 AUG-7-book    7SM-T-read-FV    AUG-1-boy  
 'The book is being read by the boy.'  
 lit. 'The book is reading the boy.'

([Morimoto 2006](#): 180, glosses adapted)

- (79) a. U-ru-shiinge      ru-ra-joomb-a      u-mw-aana.  
 AUG-11-needle    11SM-T-pierce-FV    AUG-1-child  
 'The needle will pierce the child.'
- b. U-mw-aana      a-joomb-a      u-ru-shiinge.  
 AUG-1-child    1SM-pierce-FV    AUG-11-needle  
 \*'The *needle* will pierce the child.'  
 (?'The child will pierce the needle.')

([Kimenyi 1980](#): 144)

- (80) a. U-mu-gabo      ya-som-ye      u-mu-gore.  
 AUG-1-man      1SM.T-kiss-PFV    AUG-1-woman  
 'The man kissed the woman.'
- b. U-mu-gore      ya-som-ye      u-mu-gabo.  
 AUG-1-woman    1SM.T-kiss-PFV    AUG-1-man  
 'The woman kissed the man.'  
 \*'The *man* kissed the woman.'

(Kimenyi 1988: 384, via Gibson 2008: 6)

- (81) a. U-mu-gaanga a-ra-vuur-a a-ba-rwaayi.  
 AUG-1-doctor 1SM-PRS-cure-FV AUG-2-patients  
 ‘A doctor is curing the patients.’
- b. A-ba-rwaayi ba-ra-vuur-a u-mu-gaanga.  
 AUG-2-patients 2SM-PRS-cure-FV AUG-1-doctor  
 ‘The patients are being cured by the doctor.’

These examples raise the question whether this restriction in animacy combinations is due to syntactic constraints similar to the Person restrictions in Chapter 3. I submit that it is not and that this is a case where the syntax will function okay, but the semantic anomaly overrules acceptability. That is, the inverted OVS clauses can perfectly well be derived syntactically, but the interpretation of the surface NP V NP order as either Agent-V-Theme or Theme-V-Agent depends on the predicate involved and the perceived agency of either argument. When the preverbal DP is more animate or agentive than the postverbal DP, an interpretation as SVO is much more likely.

This implies that the features involved in flexible licensing cannot be the same for Appl and v. Let us briefly return to double objects. In Chapter 3, it was explained that Appl’s licensing abilities are determined first by animacy (in the form of a Person feature) and then by topicality. This accounted for the restriction on object marking in Sotho and Zulu, where either object can be object-marked if the animacy of both objects is equal or if the Benefactive is higher in animacy than the Theme. When the Theme is higher in animacy than the Benefactive, however, v can only agree with the animate Theme, as in (83).

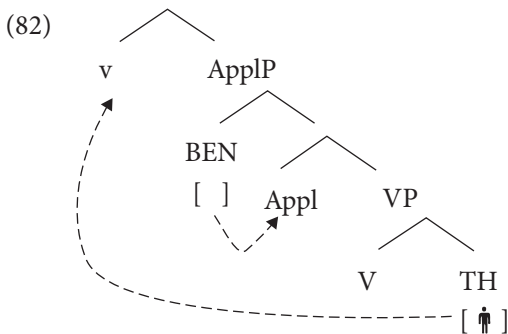

Sesotho (S33, [Morolong & Hyman 1977](#))

- (83) a. Ke        **ba**        bítselítsé        mokéte.  
           1SG.SM    2OM    called.APPL    3.feast  
           ‘I called them for the feast.’
- b. \*Ke        o        bítselítsé        baná.  
           1SG.SM    3OM    called.APPL    2.children  
           int. ‘I called the children for it.’

If the same featural animacy restriction were to hold for little *v*, the SVO sentence in (79a), repeated in (84), would be predicted to not be possible at all: the inanimate subject ‘needle’ would be licensed *in situ* by *v*, and the animate ‘child’ by T, as represented in (85), parallel to (82). Considering that this is not the case, the conclusion is that the licensing abilities of flexible *v* are determined by the topicality of the EA, but not its animacy. At present, I have no further insights to offer as to why this might be the case.<sup>18</sup>

- (84) U-ru-shiinge        ru-ra-joomb-a        u-mw-aana.  
       AUG-11-needle    11SM-T-pierce-FV    AUG-1-child  
       ‘The needle will pierce the child.’

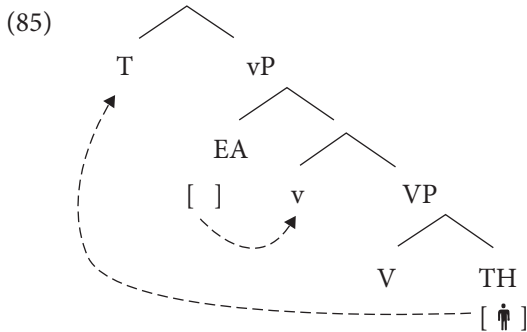

With respect to Kirundi and Kinyarwanda PI, there is another point of potential crosslinguistic variation that I want to briefly touch upon (but will not propose a detailed analysis of), which concerns the status of the postverbal logical subject. The postverbal subject in Kirundi (and Kinyarwanda) differs from other languages in two aspects:

1. it is clause-final, and neither in a position immediately after the verb, nor *in situ* (contra [Ura 1996](#));

<sup>18</sup> Theresa Biberauer suggests that *v*'s sensitivity to discourse-related features (but not animacy) can be related to the idea that the phase edge is reserved to host 'peripheral' features related to information structure and speaker-hearer interaction (see [Belletti 2004](#); [Biberauer 2017b](#)).

2. its referent receives a narrow focus reading, not a mere non-topical interpretation.

I illustrate both properties briefly, and refer to [Ndayiragije \(1999\)](#); [Sabimana \(1986\)](#); and [Nshemezimana \(2016\)](#) for further details. That the postverbal subject is not *in situ* can be deduced from examples like (85) where the EA is forced to follow the infinitival complement. Similar examples concern the order between a postverbal adverb and the logical subject.

Kirundi (JD62, [Ndayiragije 1999](#): 418)

- (86) a. Iyo modoka i-á-emeye [ PRO<sub>i</sub> ku-gura] Yohani<sub>i</sub>.  
 9.DEM 9.car 9SM-PST-accept:PFV 15-buy 1.John  
 ‘John (not Peter) agreed to buy that car.’  
 b. \*Iyo modoka i-á-emeye Yohani<sub>i</sub> [ PRO<sub>i</sub> ku-gura].  
 9.DEM 9.car 9SM-PST-accept:PFV 1.John 15-buy  
 ‘John (not Peter) agreed to buy that car.’

Furthermore, when more than one DP occurs in postverbal position, the last DP is interpreted as the focus, whether in SVOO order (87) or an inverted sentence, like the transitive inversions in Kirundi (88) and Kinyarwanda (89), which result in VOS word order.

Kirundi (JD62, [Sabimana 1986](#): 91)

- (87) a. Mudúga, y-a-hâye a-b-âna i-gi-tabo.  
 Muduga 1SM-FPST-give AUG-2-child AUG-7-book  
 ‘Muduga, he gave the children *a book*.’  
 b. Mudúga, y-a-hâye i-gi-tabo a-b-âna.  
 Muduga 1SM-FPST-give AUG-7-book AUG-2-child  
 ‘Muduga, he gave *the children* a book.’

([Sabimana 1986](#): 67)

- (88) H-aã-ha:-ye a-b-âna i-gi-tabo Mudúga.  
 16SM-FPAST-give-PFV AUG-2-child AUG-7-book Muduga  
 ‘It is Muduga who gave a book to the children.’

Kinyarwanda (JD61, [Ngoboka 2016](#): 332)

- (89) Ha-gur-a i-módoká a-b-íshobo-ye.  
 16SM-buy-FV AUG-10.cars AUG-2-be.wealthy-PFV  
 ‘It is wealthy people who buy cars.’

The narrow focus interpretation is evident in the free translations given, where either a cleft (as consistently used by e.g. [Ndayiragije 1999](#); [Ngoboka 2016](#)) or a following ‘not Y’ suggests identificational or contrastive focus, rather than a





### 4.4.3 The subject marker in inversion

Now that we have identified the (potential) features relevant for flexible *v*, we can turn to the specification of T, addressing the featural specification as topic-licenser, and the spell-out as a subject marker considering the defective goal approach explained in Chapter 2.

We concluded that T must be able to license topical arguments (Locative, Theme, Instrument) in all inversion constructions apart from AI, and therefore we must assume that iCase on T in those cases is specified as topical.<sup>19</sup> In a sense, this is just a formalization of the longstanding insight that the preverbal domain and subject marking in many Bantu languages are restricted to non-focal and topical elements (Bresnan & Kanerva 1989; Whaley 1996; Yoneda 2011; Zerbian 2006a; Baker 2008a; Van der Wal 2009; Nicolle 2015ab; Morimoto 2000, 2006; among others). Such a formalization provides an implementation of the idea that these languages are ‘discourse configurational’, and not just in terms of word order, but also for agreement and for nominal licensing. Note that C, or heads in the CP domain, may also be associated with topicality. Crucially, though, the presence and effects of [Topic] lower than the left periphery are indicative of the (more) fundamental influence that information structure has in the Bantu languages.

A remaining question about T is how the subject marker spells out in various constructions, given the defective goal approach to agreement. If object marking is the spell-out of agreement with a defective goal, as argued in Chapter 2, following Roberts (2010) and Iorio (2014), how can we understand subject marking with a preverbal Locative, or even with a canonical subject? After all, the subject marker is spelled out even in the presence of a preverbal DP. There are two general points I want to make in the answer to this question, after which I discuss the subject marker in DAI. The first point is the difference between dislocated and *in situ* subjects, and the second is the spell-out of features when the goal has moved.

As is familiar from the Romance languages (see Borer 1986; Alexiadou & Anagnostopoulou 1998; Manzini & Savoia 2002; among many others), not all preverbal agreeing DPs live in the same position. Similarly to object markers, subject markers can represent agreement with a DP in an argument position (e.g. specTP, parallel to doubling object marking), or function as a pronoun, with a coreferring DP being in an adjoined/dislocated/A-bar position (parallel to object non-doubling).

<sup>19</sup> Again, this needs to be established on a language-individual basis.

To illustrate the latter, [Iorio \(2014\)](#) argues for Bembe that its subject markers are always pronominal, and that preverbal coreferring DPs are in an A-bar position. Two pieces of evidence are the impossibility of a non-specific indefinite preverbal subject DP, as in (93a), and the necessary wide scope interpretation of the preverbal subject over a quantified object in (94). Non-specific indefinites are known to necessarily occupy sentence-internal positions; (93b) suggests that such a position is only available in a low postverbal position in Bembe.

Bembe (D54, [Iorio 2014: 267](#)) – *No indefinite non-specific subject pre-V*

- (93) a. Mwana a-a-kwel-a.  
 1.child 1SM-T-fall-FV  
 ‘A (certain) child has fallen down.’  
 b. ?wa-a-kwel-a mwana.  
 15EXPL-T-fall-FV 1.child  
 ‘(Some) child has fallen down.’

([Iorio 2014: 267](#)) – *Subject is dislocated in A-bar position, taking wide scope*

- (94) a. O-no mwana a-som-ine bitabo byose ...  
 1-some 1.child 1SM-read-PST 8.book 8.all  
 ‘Some child read every book.’  
 b. ... A-lo-soakelw-a manga. [some > every]  
 1SM-PST-like-FV much  
 ‘He liked them a lot.’  
 c. # ... Ba-lo-soakelw-a manga [\*every > some]  
 2SM-PST-like-FV much  
 ‘They liked them a lot.’

Iorio analyzes Bembe subject marking identically to non-doubling object marking. He proposes that T agrees with a defective  $\phi$ P subject in specvP, whose features spell out on T as the subject marker, the features of the goal being a subset of the features of the probe. This accounts straightforwardly for the data in (93) and (94), but also for the complementary distribution of the subject marker and subject DP in Bembe object relative clauses. If the subject is a  $\phi$ P, as in (95a), the subject marker (*ba-*) is present. If the subject is a DP as in (95b), only the subject DP is spelled out and a subject marker is impossible. The first prefix on the verb (*bi-*) is the relative marker (in C) agreeing with the head of the relative clause.

Bembe (D54, [Iorio 2014](#): 270)

- (95) a. *bilewa bi-ba-a-kol-á* (\**batu*)  
 8.food 8RM-2SM-N.PST-buy-FV 2.person  
 ‘the food that they have bought’
- b. *bilewa bi-(\*ba-)a-kol-á* *batu*  
 8.food 8RM-2SM-N.PST-buy-FV 2.person  
 ‘the food that (some) people have bought’

[Iorio \(2014\)](#) thus argues, following [Henderson \(2011\)](#), that there is no specTP position in Bembe and no *pro* to occupy it (cf. [Baker 2003](#)): DPs are either *in situ* logical subjects (as in relatives, without a subject marker) or base-generated in a peripheral position (with T spelling out the features from the coreferring  $\phi$ P as the subject marker), as represented in (96).

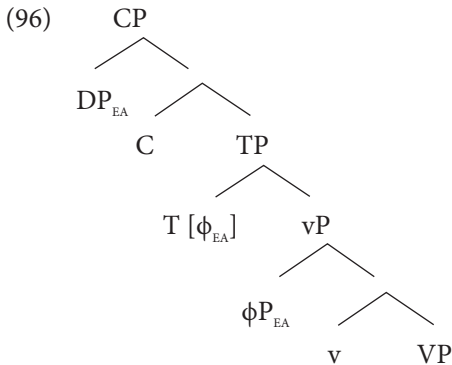

While the defective goal approach works quite straightforwardly for Bembe (and languages with similar subject marking, such as Kinyarwanda), there are also languages where the subject DP can be shown to occupy specTP. In Kĩitharaka, for example, the fact that a preverbal agreeing subject can be a non-specific indefinite in (97) argues against a dislocated status and in favour of an A position in specTP in this language (which could host subjects interpreted as topical or non-topical).

Kĩitharaka (E54, [Muriungi 2008](#): 100)

- (97) *Mu-ntũ noa û-mwe a-ti-ra-gur-a* *î-buku.*  
 1-person NOA 1-one 1SM-NEG-YPST-buy-FV 5-book  
 ‘Nobody bought a book.’ (lit. ‘not even one person’)

Similarly, a preverbal *wh* subject triggering normal subject marking in Bemba (98) also forms evidence for an A-position in specTP, or at least against analyzing the subject marker as a *pro*-form.

Bemba (M42, [Mwansa 2011](#): 52)

- (98) a. Naani a-lee-pyanga mu-ṅanda?  
       who 1<sub>SM</sub>-FUT-sweep 18-house  
       ‘Who is sweeping inside the house?’
- b. Cinshi ci-lee-citika?  
       what 7<sub>SM</sub>-PRS-happen  
       ‘What is happening?’

Given that in these languages, the subject ends up in specTP,<sup>20</sup> it cannot be the case that the subject marker is the spell-out of Agree with a  $\phi$ P pronominal argument (since there is only one subject argument). If the same defective goal analysis were applied here, we would expect the same complementary distribution of the subject marker and the DP as in Bembe, which is clearly not true: the two can co-occur in the same domain. Hence, in languages like Kĩtharaka and Bemba, given that T agrees with the DP subject for  $\phi$  features, and given that the subject is not a defective goal for T (being a DP), the question is how the  $\phi$  features on T still spell out as the subject.

A first idea could be that subjects have an extra (Person) layer, just like objects do in doubling languages, which accounts for doubling of the marker and DP in the same domain (see [Zeller’s 2008](#) analysis of the Zulu subject marker as originating in a big DP structure, based on [Cechetto 1999](#) and [Kayne 1994](#)). However, there is no ‘differential subject marking’ for the same DPs (animate, definite, given), and some of the languages that show evidence for a specTP subject position do not have doubling object marking. Therefore, I conclude that the spell-out of the features on T as subject marker is not due to the structure of the goal (the subject).

There are two alternative solutions. In the first, movement of the goal over the probe triggers spell-out of the features on the probe as well. T in these languages not only has a  $\phi$  probe but also a movement trigger associated with the probe (as represented by  $\wedge$  in (99)). The copy/trace left behind by the moved subject counts as defective, be that because of its status as a copy/trace or because of the presence of the movement trigger which makes the features on T a superset of the DP’s features (although the latter point is debatable, since diacritic features typically function differently than substantial features). As a result, the  $\phi$  features on T will thus also be spelled out.

<sup>20</sup> Non-specific indefinites and interrogatives show that at least some subjects are in specTP. This does not preclude that the language also allows a structure in which the subject is a  $\phi$ P *in situ*, and the potential coreferring DP is adjoined.

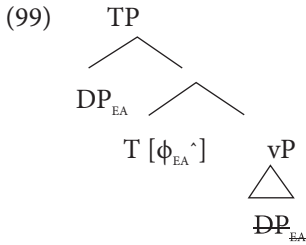

A second solution is found in a morphophonological requirement: the subject marker always has to be spelled out. This requirement is seen to be active in DAI, and in some cases of agreeing inversion, which are discussed in turn. In DAI, we have seen that the subject marker is a default morpheme (class 16 or 17 usually), as exemplified again in (100). I take this to indicate that T's  $u\phi$  features have not found an active goal to agree with – because the non-topical arguments are already licensed in the vP – and then spell out as default.

Tumbuka (N21, Jean Chavula, personal communication)

- (100) Ku-ku-sek-a            wānakazi.  
 17SM-PRS-laugh-FV    2.women  
 ‘There are women laughing.’

That the subject marker in DAI is indeed a default marker is supported by Buell's (2007) observations that the same subject marker, class 17 in Zulu, is used in a range of contexts where it is unclear what T should agree with, or when there are conflicting features. This includes quotative inversion (101), conjunct NP agreement (102), and impersonal expressions (103).

Zulu (S42, Buell 2007: 114)

- (101) ‘Ngi-ya-ku-thand-a.’            **Ku**-sho    u-Sipho.  
 1SG.SM-DJ-2SG.OM-love-FV    17SM-say    AUG-1.Sipho  
 ‘‘I love you,’’ said Sipho.’

(Nyembezi 1990, cited in Buell 2007: 113)

- (102) I-zi-nkuni            n-a-ma-lahle            **ku**-phel-ile.  
 AUG-10-firewood    and-AUG-6-coal    17SM-finish-PERF  
 ‘The firewood and coal is finished.’

(Buell 2007: 113)

- (103) U-phendule            kahle!    **Kw**-a-kuhle            bo!  
 2SG.SM-answer    well            17SM-PST-17.good    really  
 ‘You answered correctly! Great!/Well done!’

Spell-out of the subject marker in the absence of an Agree relation (and hence presumably without valued  $\phi$  features on T) suggests a morphophonological requirement for a verb to have a subject marker (cf. Zeller 2008), and is also in line with Preminger's (2009, 2014) proposal that a  $\phi$  probe that fails to agree spells out as default. Either solution will work.

An alternative analysis of subject marking in DAI is to postulate an expletive *pro*, either merged in specTP or moved from specvP (Richards & Biberauer 2005; Deal 2009), with which T agrees. However, the range of variation in the data in (101)–(103) makes a unified analysis involving an expletive *pro* implausible. An expletive in specvP is also incompatible with unergative and transitive predicates in inversions, as specvP is already occupied by the EA (see further in Section 4.5.2). Furthermore, there is no positive evidence for a (null) expletive in these languages. First, there is no definiteness effect, as would be expected in parallel to the definiteness effect in Romance and Germanic inversion (Leonetti 2008; see the line of argument in Van der Wal 2012 for AI), as shown in (104).

Northern Sotho (S32, Zerbian 2006b: 367)

- (104) a. Go    fihl-ile            malome.  
           17<sub>SM</sub> arrive-PERF 1.uncle  
           ‘The *uncle* arrived.’
- b. Go    hlab-ile            malome kgomo.  
           17<sub>SM</sub> slaughter-PERF 1.uncle 9.cow  
           ‘The *uncle* slaughtered the cow.’

Second, assuming a null loco-temporal argument referring to the ‘here-and-now’, as Pinto (1997) proposes, predicts that inversion constructions cannot co-occur with a temporal or locative expression that does not refer to the ‘here and now’, as is the case in (105b, c). The same is not true for the Sesotho DAI, where a Locative can freely occur in a VS sentence, as in (106). See Van der Wal (2012) for further problematic aspects of this proposal for Bantu inversion constructions.

Italian (Pinto 1997)

- (105) a. Irene è arrivata a casa.  
           Irene arrived at home
- b. \*E' arrivata Irene a casa.  
           arrived Irene (here/at this place) at home
- c. \*A casa è arrivata Irene.  
           at home arrived Irene (here/at this place)

Sesotho (S33, Demuth 1990: 241)

- (106) Hó-lisá bashányána (ma-símó-ng).  
 17SM-herd 2.boys 6-fields-LOC  
 ‘There are boys herding (in the fields).’

Considering the lack of evidence for a preverbal (null) expletive argument, it is more attractive to assume the default spell-out of  $\phi$  on T, and an empty specTP in DAI (see also Carstens & Mletshe 2015 for Xhosa DAI).<sup>21</sup>

The morphophonological requirement (solution 2) can also be seen in some cases of agreeing inversion. As explained in detail in Van der Wal (2012), there are two types of agreeing inversion, exemplified by Makhuwa and Matengo. In Makhuwa, the linearly postverbal subject is actually in a high position, with the rest of the verbal complex moving over it, as represented in (108). We can thus assume that a movement trigger is always present on T in Makhuwa, moving the agreed-with subject to a preverbal position, whether the verbal complex remains where it is (resulting in a preverbal subject), or moves (resulting in a postverbal subject).

Makhuwa (P31, Van der Wal 2008: 328)

- (107) A-náá-ttóny-á maátsi.  
 6SM-PRS.DJ-drip-FV 6.water  
 ‘There is water leaking out.’

(108)

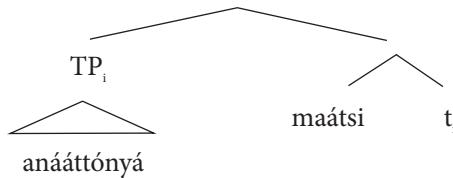

In Matengo, on the other hand, the inverted subject is shown to be *in situ* within the verb phrase (see example (16) in Section 4.2.1). T in Matengo thus agrees with the subject (and licenses it) but does not necessarily move it. Under the morphophonological requirement for a verb to have a subject marker, T spells out the  $\phi$  features that were valued in Agree with the *in situ* subject. The optional movement of the subject results in an interpretational difference: the preverbal subject is topical in Matengo (and Kimatuumbi and Makwe, which

<sup>21</sup> Note that this thus argues against a universal EPP (Extra Peripheral Position (David Pesetsky); cf. Chomsky's 1981 Extended Projection Principle), the parameterization of which is by now uncontroversial (see among others McCloskey 1996; Alexiadou & Anagnostopoulou 1998; Boskovic 2002; Epstein & Seely 2006; Biberauer 2010; Cable 2010).



show the same type of agreeing inversion), whereas the postverbal subject is not. This is further elaborated in Chapter 5.

#### 4.4.4 Interim summary and connection to theory

To summarize the discussion in this section, extending the property of flexible licensing to little *v* provides a plausible analysis of subject marking and (non-agreeing) inversion across Bantu languages. If the subject is non-topical, it will be licensed low in the clause, with T licensing, agreeing with, and moving a topical DP if such is present, and otherwise spelling out as default.

With unaccusative predicates either Appl or *v* licenses the logical subject downwards, as in (110), and T either agrees with a Locative or Instrument (and moves it to a preverbal position) or spells out as default.

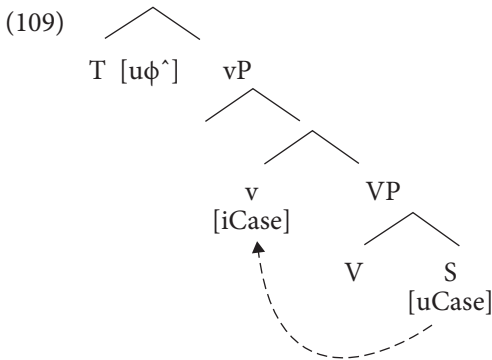

With unergative and transitive predicates, *v* licenses the EA upwards, and T again either finds a topical Locative/Instrument/Theme or spells out as default. VSO order can be analyzed as *v* agreeing with the non-topical Theme, the focused EA being licensed by an extra (focal) licensing head.

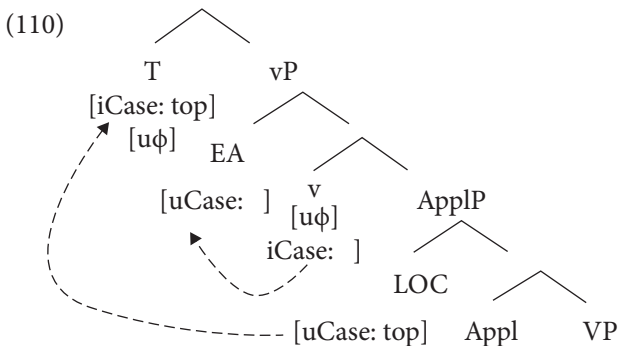

As mentioned, if  $v$  licenses the non-topical EA, T licenses and agrees with a topical DP if such is present and otherwise spells out as default. Because T also has a movement trigger, it moves the (topical) DP it agrees with to its specifier. This specification for T is indeed what Collins (2004) and Carstens (2005) propose to account for the fact that subject agreement and movement are tied together in many Bantu languages (though not the languages with agreeing inversion, as discussed in Section 4.4.3 and Chapter 5). Collins (2004: 116) proposes the Agreement parameter for Bantu languages, which states that a head with a  $\phi$  probe has an EPP feature (movement diacritic) that is satisfied by the goal of the  $\phi$  agree relation. Carstens (2005: 266) formulates the dependency of Agree and Move as the Feature-linking parameter: in Bantu languages, EPP is a subfeature of uninterpretable  $\phi$  features. I adopt Carstens' formulation and take the movement trigger to be a subfeature of  $\phi$  on T (compare to Halpert who views Zulu agreement on T as a side effect of the EPP). Carstens (2005) also proposes that  $\phi$  agreement in Bantu languages is independent of Case, unlike in Indo-European languages. While I take Case to be logically separate from  $\phi$  agreement, the two tend to go together, simply because DPs with an uCase feature often end up agreeing with a head that has a  $\phi$  probe (and see Section 5.1.5 in Chapter 5 for a learnability argument).

Similarly, Baker (2008a) proposes two parameters intended to capture (among other facts) Bantu subject marking. The first is whether agreement is 'downward' (with a  $c$ -commanded element) or 'upward' (with an element  $c$ -commanding the agreeing head). A second parameter then asks whether agreement is linked to Case or not. According to Baker, Bantu languages are set 'yes/no', which means agreement is 'upward' and independent of Case.

- (111) The Direction of Agreement Parameter:  
F agrees with DP/NP only if DP/NP asymmetrically  $c$ -commands F.
- (112) The Case-Dependency of Agreement Parameter:  
F agrees with DP/NP only if F values the Case feature of DP/NP or vice versa.

Assuming that specTP is not filled until a DP moves into it, and assuming that DPs do not randomly move up, we may wonder what in Baker's analysis triggers the movement of the EA (in SV order) or a Locative/Instrument/Theme (in VS order) in the first place, that is, before T can agree upwards with it. Baker suggests this movement to be independently triggered by, for example, topicalization. The same ingredients of upward operations and topicality are

also present in the flexible licensing approach advanced here, but in a quite different way – I explain briefly how.

In the flexible licensing approach, the first features to probe are the uninterpretable Case features on DPs,<sup>22</sup> which ‘drive the DP to connect to a head’ (see Section 3.6.3 in Chapter 3). This connection is restricted by the requirement that a topic feature on the DP must match a topic feature on the head (or, in the implementation sketched in Chapter 3, [uCase: top] must be checked by [iCase: top]). If Case is checked and the head has a  $u\phi$  feature, Agree takes place and the same DP values the  $\phi$  features on the head. Topicality therefore restricts Agree but does not itself probe or move. Furthermore, the upward direction of Agree differs in the following ways between Baker’s approach and mine. First, a flexible licensor only licenses an argument in its specifier, not higher up. Second, it primarily concerns licensing rather than  $\phi$  agreement. Third, it is never the case that all heads in all circumstances agree upwards, as explained in Section 3.6.3. Rather, it’s only (a subset of) the low functional heads, and licensing is *flexible* instead of one-directional. The typical ‘upward’ (spec-head) subject agreement in Bantu, as seen clearly in subject inversion constructions, does *not* arise from an upward Agree parameter for T, but rather from a movement trigger being present on T (as in Carstens 2005; and see also Carstens 2016).

Finally, this approach is reminiscent of global case splits (Silverstein 1976) and direct/inverse systems as found elsewhere in the world. In global case splits, the case marking of one argument is dependent on the features of a second argument, typically the first/second/third person features, but animacy and topicality can also play a role (DeLancey 1981; Rhodes 1994; Bliss 2005; Zúñiga 2014; Bárány 2017; among others). The same holds for direct/inverse marking, where the verbal morphology is determined by the relative features of the external and internal argument. For example, in Nocte (Tibeto-Burman), where the verb is marked by the inverse marker *-h-* when the internal argument is higher on the person hierarchy than the external argument, as in (112b, d). Agreement is always with the argument highest on the hierarchy; in (112) the first person, and the direct/inverse marking indicates the thematic role of each DP.

<sup>22</sup> As explained in more detail in Section 3.6.4 in Chapter 3, I assume with Carstens (2016) that any uninterpretable feature  $uF$  will probe the structure it is merged to (downwards probing), and if no goal is found, it will continue probing when the derivation continues (upwards probing).

Nocte (Tibeto-Burman, DeLancey 1981: 641)

- (113) a. Nga-ma nang hetho-e. 1>2 = direct  
 1SG-ERG 2SG teach-1PL.  
 ‘I will teach you.’
- b. Nang-ma nga hetho-h-ang. 2>1 = inverse  
 2SG-ERG 1SG teach-INV-1  
 ‘You will teach me.’
- c. Nga-ma ate hetho-ang. 1>3 = direct  
 1SG-ERG 3SG teach-1  
 ‘I will teach him.’
- d. Ate-ma nga-nang hetho-h-ang. 3>1 = inverse  
 3SG-ERG 1SG-ACC teach-INV-1  
 ‘He will teach me.’

Crucially, in order to ‘know’ whether the verb takes a direct or inverse form, and in order to establish agreement, both arguments need to be taken into account. The ‘look ahead’ problem that this poses for derivation (the Theme cannot be licensed or agreed with before the EA is introduced) has been dealt with in various ways (see e.g. Müller 2004, 2009; Béjar & Rezac 2009; Keine 2010; Georgi 2013, 2014; Bárány 2017).

If we try and extend flexible licensing on *v* to these direct/inverse systems (just as I tentatively explored the flexible licensing approach for Appl to Person-Case-Constraint effects at the end of Chapter 3), licensing by *v* would, by hypothesis, be sensitive to the individual person features [author], [participant], and [ $\pi$ ]. As with topicality, *v* can only license the Theme in its complement if the EA has the same person features.<sup>23</sup> If the EA has only a subset of the features of the Theme, for example when the Theme has the features [[[author] participant]  $\pi$ ] for first person and the EA has only [ $\pi$ ] for third person, *v* will license the EA and T will agree with the Theme. Verbal agreement will hence always be with the most specified argument – the first person in (113). The inverse marker on the verb can then be seen as the spell-out of *v*’s upward licensing. If Nocte works as just sketched, the morphological case marking is not a reflection of nominal licensing (considering that the argument in ergative case is licensed by T in (113a, c) and by *v* in (113b, d)), but

<sup>23</sup> The flexibility analysis potentially also encounters a look-ahead problem, since the licensing ability of the head is dependent on the features of the argument in its specifier. As explained in Section 3.6.4 in Chapter 3, I see the presence of the Appl head as a ‘side effect’ of merging the Benefactive DP (with its need to be licensed). That is, argument-introducing heads are so closely linked to their arguments, that either the two are introduced together (no timing difference for the purposes of computation), or the head already has the features of the argument when it is merged.

has to be calculated separately, for example as in a theory of Dependent Case.<sup>24</sup> While it is worthwhile exploring flexible licensing for direct/inverse systems, it falls outside the scope of this book, and we return here to consider further implications for Bantu.

#### 4.5 Implicational relation flexibility lower heads (FLUID)

With the flexible licensing analysis of subject marking and subject inversion, we can return to the observation that sparked the analysis in the first place: the implicational relation between lower heads in allowing flexible licensing (a.k.a. the FLUID; see Section 3.7 in Chapter 3).

- (114) Flexible Licensing Up (the spine) Implies Down (the spine):  
If a construction involving head H is symmetric, constructions with heads lower than H are also symmetric.

The pattern in object marking symmetry for ditransitives, applicatives, and causatives observed and analyzed in Chapter 3 can now by hypothesis be extended to subject inversion as flexible licensing of the next functional head up, little *v*, as added in Table 4.1.

A reason to think the FLUID might hold for *v* as well is that the FLUID is reminiscent of the Final-Over-Final Condition (FOFC) which is argued to be due to a restriction on the presence of the movement trigger (Biberauer et al. 2014; see also Sheehan et al. 2017).<sup>25</sup> Specifically, if a head has a movement trigger (making the phrase head-final), then all the heads it dominates in the same extended projection need to also have the movement trigger. Biberauer et al. (2014) argue that the FOFC holds in extended projections, whether verbal

**Table 4.1** Variation in flexible argument licensing in Bantu

v	Caus	HAppl	LAppl	Languages
✓	✓	✓	✓	Zulu, Shona, Kĩitharaka, Kikuyu
	X	✓	✓	Otjiherero, Southern Sotho, Lubukusu
	X	X	✓	Kiluguru
	X	X	X	Makhuwa, Matengo, Chichewa

<sup>24</sup> For languages in which agreement is sensitive to case marking, this split would not work, as pointed out to me by András Bárány.

<sup>25</sup> Roberts (2019: 141) formulates the generalization underlying the Final-Over-Final Condition (FOFC) as the ‘Start At The Bottom Generalization’: heads in a given extended projection can only have a roll-up movement trigger if the root has this feature and all XPs in between do so too. He mentions explicitly that only categorial features (such as +V) can introduce a movement trigger, which can then be ‘inherited’ from head-to-head in an extended projection.

(V-v-T-C) or nominal (N-n-Num-D). If flexible licensing is subject to the same condition, then we would expect *v* to participate in the FLUID as well, since it is part of the same verbal spine as Caus, HAppl, and LAppl.

If the FLUID extends to include *v*, a number of predictions can be made:

(115) Implicational predictions of the FLUID

- I. Languages with subject inversion also have symmetric object marking (if *v* is flexible, then lower heads are flexible).
- II. Languages with (partially) asymmetric object marking do not have subject inversion (if lower heads are not flexible, *v* is not flexible).
- III. Languages with fully symmetric object marking can have or not have subject inversion (if lower heads are flexible, *v* can be flexible or not).

The third prediction is true, as will be shown in Section 4.5.6. The first two predictions as they stand are blatantly false: clearly languages exist with asymmetric object marking and subject inversion. However, the predictions are false in interesting ways: in Section 4.5.1 and Section 4.5.2, I discuss two apparent counterexamples to prediction II that do fit the FLUID, but unfortunately, there are true counterexamples too, as shown in Section 4.5.3 and Section 4.5.4. The partially symmetric languages like Otjherero also turn out to be incompatible with the extension of the FLUID, as shown in Section 4.5.5. These results in turn point to an interesting generalization regarding phases, which is taken up in Chapter 5.

### 4.5.1 Asymmetry: Agreeing Inversion

A first way in which languages with asymmetric object marking can show subject inversion is when T agrees with the postverbal subject. This is the case for agreeing inversion as shown in (10), repeated here as (116).

Makhuwa (P31, Van der Wal 2008: 328, 2009: 197)

- (116) a. A-náá-ttóny-á            maátsi.  
           6SM-PRS.DJ-drip-FV    6.water  
           ‘There is water leaking out.’
- b. Oo-vár-á                    ephepélé    naphúl’    úule.  
           1SM.PFV.DJ-grab-FV    9.fly        1.frog        1.DEM.DIST  
           ‘That frog caught a fly!’

In this case, it is T that licenses (and agrees with) the subject, hence no flexible licensing by v is necessary. This type of inversion in asymmetric languages therefore also fits with the implicational relation in Table 4.1, and AI is only an apparent counterexample.

#### 4.5.2 Asymmetry: Only unaccusatives invert

A second type of counterexample are languages like Chichewa, which shows asymmetric object marking (117), showing that lower heads do not license flexibly, and yet allows locative inversion (118), suggesting that the higher head v does license flexibly.

Chichewa (N31, [Mchombo & Firmino 1999](#): 219)

- (117) a. A-lenje a-ku-wá-phik-ir-á zi-tumbúwa (a-nyani).  
 2-hunters 2SM-PRS-2OM-COOK-APPL-FV 8-pancakes 2-baboons  
 ‘The hunters are cooking (for) them (the baboons) some pancakes.’  
 b. \*A-lenje a-u-zí-phík-ir-á a-nyani (zí-tumbúwa).  
 2-hunters 2SM-PRS-8OM-COOK-APPL-FV 2-baboons 8-pancakes  
 int. ‘The hunters are cooking them (the pancakes) for the baboons.’

([Bresnan & Kanerva 1989](#): 2, 15)

- (118) a. A-lendô-wo a-na-bwér-á ku-mu-dzi.  
 2-visitor-2.DEM 2SM-RECPST-COME-FV 17-3-village  
 ‘Those visitors came to the village.’  
 b. Ku-mu-dzi ku-na-bwér-á a-lendô-wo.  
 17-3-village 17SM-RECPST-COME-FV 2-visitor-2.DEM  
 ‘To the village came those visitors.’  
 c. Pa-m-chenga p-a-im-a nkhandwe.  
 16-3-sand 16SM-PERF-stand-FV 9.fox  
 ‘On the sand is standing the fox.’

Interestingly, locative inversion in Chichewa is restricted to unaccusative and passive predicates ([Bresnan & Kanerva 1989](#); [Bresnan 1994](#); [Ura 1996](#); [Collins 1997](#)), as illustrated in (119) and (120), respectively.

Chichewa ([Bresnan & Kanerva 1989](#): 16)

- (119) M-chi-tsíme mw-a-gw-er-a /\*mw-a-kodz-a mbúzi.  
 18-7-well 18SM-PFV-fall-APPL-FV /18SM-PFV-urinate-FV 9.goat  
 ‘Into the well has fallen/\*urinated a goat.’

(Bresnan &amp; Kanerva 1989: 16, 17)

- (120) a. Mâyi            a-na-péz-á            mw-aná      kú-dâmbo.  
 1a.mother    1SM-RECPST-find-FV    1-child      17-5.swamp  
 ‘The mother found the child in the swamp.’
- b. \*Ku-dâmbo    ku-na-péz-á            mâyi          mw-ána.  
 17-5.swamp    17SM-RECPST-find-FV    1a.mother    1-child  
 int. ‘In the swamp found the mother the child.’
- c. Mw-âna        a-na-péz-édw-á            kú-dâmbo.  
 1-child        1SM-RECPST-find-PASS-FV    17-5.swamp  
 ‘The child was found in the swamp.’
- d. Ku-dâmbo    ku-na-péz-édw-á            mw-ána.  
 17-5.swamp    17SM-RECPST-find-PASS-FV    1-child  
 ‘In the swamp was found the child.’

This means that the only structural configuration in which subject inversion is possible in Chichewa has the logical subject in the low position of the Theme, as the complement of V. The Locative occupies a higher position in the specifier of a HAppl head (visible as the applicative morpheme) or a LAppl head (invisible but present for predicates that select a locative argument, such as motion verbs). In this structure, represented in (121), *v* does not license the subject in its specifier (in unaccusatives at least there is no EA in the first place), and T simply agrees with the closest goal, which is the Locative.<sup>26</sup>

<sup>26</sup> A theoretical scenario in which neither the locative nor the low ‘subject’ is topical takes a different underlying structure, in which the locative is not generated in specAppl, but as an adjunct – compare the difference between i (adjunct) and ii (applicative).

Chichewa (N31, Mchombo 2004: 87)

- i Kalulú    a-ku-phík-á            ma-ûngu    pa    chulu.  
 1a.hare    1SM-PRS-cook-FV    6-pumpkins    16    7.anthill  
 ‘The hare is cooking some pumpkins on the anthill.’
- ii Kalulú    a-ku-phík-il-a            pa    chulu    ma-ûngu.  
 1a.hare    1SM-PRS-cook-APPL-FV    16    7.anthill    6-pumpkins  
 ‘The hare is cooking on the anthill the pumpkins.’



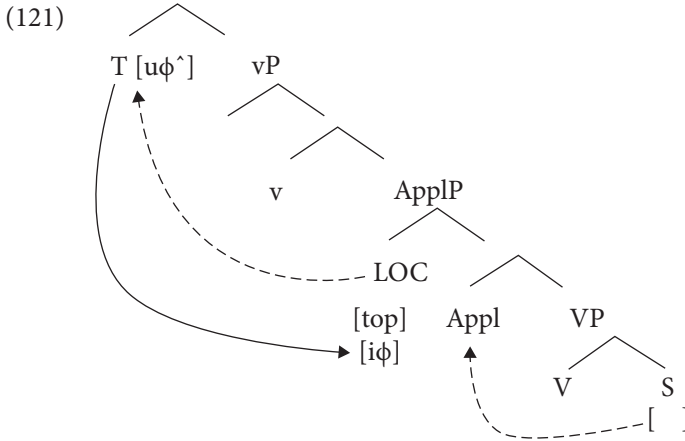

This means that even if Chichewa has locative inversion, this is only allowed in the absence of an intervener between T and the Locative: therefore, we conclude that *v* is not flexible in its licensing. This is in line with the prediction on the basis of the implicational relation between lower functional heads in Table 4.1, and languages like Chichewa are also only apparent counterexamples.

We have thus seen two ways in which languages with asymmetric object marking can still show subject inversion without *v* being flexible in licensing: 1. with agreeing inversion, which does require flexible licensing by *v*; and 2. when only unaccusatives and passives allow inversion, *v* is not flexible and thus irrelevant for the FLUID. We now turn to unergatives, which turn out to form a true counterexample to the FLUID predictions.

### 4.5.3 Unergatives and valency relations

As a corollary we might expect there to be a split for subject inversion between unaccusative on the one hand vs unergative and transitive predicates on the other (rather than a split between transitives and intransitives). The logic is that unaccusatives do not have an intervening EA but unergative and transitive predicates do. This is not exactly what appears from Demuth and Mmusi's (1997: 14) overview of the valency of predicates allowing for subject inversion in four Bantu languages, see Table 4.2. The unexpected combination appears in Sesotho and Setswana, which are here said to allow unergative but not transitive predicates in subject inversion.

**Table 4.2** Variation in predicate types in LI and DAI according to Demuth & Mmusi (1997)

verb type		Chichewa	Chishona	Sesotho	Setswana
unergative	active	*	*	✓	✓
	passive	*	✓	✓	✓
unaccusative	active	✓	✓	✓	✓
	passive	*	✓	✓	✓
transitive	active	*	*	*	*
	passive	✓	✓	✓	✓
ditransitive	active	*	*	*	*
	passive	*	✓	✓	✓

More or less the same picture appears in later versions of this table (e.g. Marten & Van der Wal 2014; Guérois 2014; Marten & Gibson 2016), but as we have seen in (75), Sotho and Setswana *do* allow transitive inversions, so the table needs updating. Another adjustment is that Cuwabo (122) and Bemba (123) do not allow transitives in locative inversion, but LI seems to be fine with unergatives:

Cuwabo (P34, Guérois 2014: 61, 63, 64)

- (122) a. Mmúrúddání muuffya álèddo. (unaccusative)  
 mu-múrúddá=ní mu-Ø-hí-fíy-a álèddo  
 18-3.village=LOC 18SM-PRS-PFV.DJ-arrive-FV 2.guest  
 ‘At the village arrived the guests.’
- b. Mutákwání munóttámaga áyíma. (unergative motion)  
 mu-tákwá=ní mu-Ø-ni-óttámag-a áyíma  
 18-9a.forest=LOC 18SM-PRS-IPFV.DJ-15.run-FV 2.children  
 ‘In the forest are running the children.’
- c. Vatakúlú vanotéya áyíma. (unergative)  
 va-tákúlú va-Ø-ni-otéy-a áyíma  
 16-9a.courtyard 16SM-PRS-IPFV.DJ-15.laugh-FV 2.children  
 ‘At home are laughing the children.’
- d. \*Mucélání mwiimúddoddá ábáabí mwáaná.<sup>27</sup> (transitive)  
 mu-céla=ní mu-Ø-hí-mú-ddodd-á ábáabí mwáaná  
 18-well=LOC 18SM-PRS-PFV.DJ-1OM-grab-FV 2.parents 1.child  
 int. ‘In the well found the parents the child.’

<sup>60</sup> The relative animacy of the arguments does not influence the ungrammaticality of inversion in Cuwabo.

Bemba (M42, [Marten et al. 2007](#): 294)

- (123) a. Kú-mwèsù kwà-lí-ìs-à                      áb-èni. (unergative motion)  
 17-home 17SM-RECPST-come-FV 2-guests  
 ‘Visitors have come to our home.’
- b. Mw-ì-bálá mù-lè-lím-à                      áb-èni. (unergative)  
 18-5-field 18SM-PROG-farm-FV 2-guests  
 ‘Visitors are farming the field.’
- c. \*Kú-ngàndà kú-lé-sòm-à                      Chísángá. (transitive)  
 17-9.home 17SM-PROG-read-FV 1.Chisanga  
 int. ‘Chisanga is reading at home.’

The updated overview thus looks as shown in Table 4.3 (ignoring the passive intransitives).

**Table 4.3** Updated overview of variation in predicate types in LI and DAI (in italics)

			Ciluba	Chichewa/ Kichaga/ Shona/ Bemba	Cuwabo/ Bemba	Otjherero/ Nguni/ Sotho/ Tswana
		Copula ‘be’	✓	✓	✓	✓
no EA	Unaccusative	active	*	✓	✓	✓
	Transitive	passive	*	✓	✓	✓
EA	Unergative	active	*	*	✓	✓
	Transitive	active	*	*	*	✓

The unexpected languages are those where inversion is allowed with unergative predicates (suggesting that the EA can be licensed by *v* – positive FLiP) but not possible with transitive predicates (suggesting that the EA cannot be licensed by *v* – negative FLiP). There are two factors that play a role in explaining the Cuwabo/Bemba type: first, unergatives may behave as unaccusatives in the presence of a locative, and second, languages may or may not be able to license multiple arguments in inversion. I discuss these in turn.

Unergative verbs may behave as unaccusatives in the presence of a Locative, and this is not uncommon crosslinguistically: [Ngoboka \(2016: 353\)](#) refers to observations by [Levin and Rappaport Hovav \(1995\)](#) for English; [Kuno and Takami \(2004: 35–6\)](#); and [Mendikoetxea \(2006: 10\)](#), who claims that the presence of a locative element is a crucial factor in the ‘unaccusativization of the

structure' (Ngoboka 2016: 235). Ngoboka argues, with Zeller (2006b), that the same holds for Kinyarwanda. Similar evidence comes from Dutch, where the distinction between unergatives and unaccusatives is easily traceable via auxiliary selection: unergatives take the auxiliary 'have' (124a) whereas unaccusatives take 'be' (124b). The same verb 'to cycle', which is in principle unergative, behaves as unaccusative when a locative goal is added, selecting 'be' as the auxiliary (124c).

Dutch (own knowledge)

- (124) a. Ik heb/\*ben gefietst.  
 1SG have/am cycle.PP  
 'I have cycled.'
- b. Ik ben/\*heb gevallen.  
 1SG am/have fall.PP  
 'I have fallen.'
- c. Ik ben naar het bos gefietst.  
 1SG am to the forest cycle.PP  
 'I have cycled to the forest.'

If this were true for Cuwabo and Bemba (and other possible languages that show inversion for unergatives but not transitives), then the generalization would hold that predicates split up into those that have an EA (transitives and unergatives) and those that do not have an EA (unaccusatives). This would mean that languages with asymmetric object marking can still show subject inversion with the latter type, but not the former. For both Cuwabo and Bemba this would imply that *v* does not license flexibly, since inversion is only possible with predicates that do not have an EA, regardless of whether lower heads are flexible (as in Cuwabo) or not (as in Bemba).

However, this may explain only part of the unergative inversion examples, as subject inversion in Cuwabo is possible with unergative motion verbs, as well as other unergatives such as 'laugh' (see (122c)). Hence, we have to conclude that there is no neat split between predicates with vs without EA. This in turn leads to another conclusion, and a question. The conclusion is that *v* can license flexibly in languages which allow subject inversion with unergative predicates. The logical next question is what prevents these languages from also grammatically deriving subject inversion with transitive predicates? This is the second factor: I suggest that some but not all languages have an extra licenser for focus, as discussed in Section 4.4.1. If such a licenser is present, the EA can be licensed and VSO clauses are grammatical; if not, the EA cannot be licensed and transitive predicates with a focused subject result in ungrammaticality. This can be related to Alexiadou and Anagnostopoulou's (2001) generalization that only one argument with an unchecked Case feature can remain *v*P-internally,

which is true *unless* the language has an extra licensing head, and perhaps, as is the case here, this licensing is not traditional Case but related to discourse features.

The conclusion here is that languages with asymmetric object marking and subject inversion for true unergative predicates form a counterexample to the extension of the FLUID.

#### 4.5.4 Asymmetry and flexible v

With the data available so far, Yao (P20, [Taji 2014](#)); Kagulu (G12, [Petzell 2008](#)); and Swahili (G42, [Russell 1985](#); [Whiteley 1968](#); [Whiteley & Mganga 1969](#); [Gibson 2008](#); [Rugemalira 1993](#); [Riedel 2009](#)) are also plain counterexamples:<sup>28</sup> they show asymmetric object marking, as in (125), but allow locative (and in some languages other) inversion with predicates that arguably take an EA, as shown in (126).

Swahili (G42, [Riedel 2009](#): 80)

- (125) a. A-li-m-nunulia                      Juma      kitabu.  
           1SM-PST-1OM-buy.APPL    1.Juma    7.book  
           ‘She bought a book for Juma.’  
       b. \*A-li-ki-nunulia                      Juma      (kitabu).  
           1SM-PST-7OM-buy.APPL    1.Juma    7.book  
           int. ‘She bought it/a book for Juma.’

([Whiteley & Mganga 1969](#): 111; via [Gibson 2008](#): 15)

- (126) a. Mgeni    a-li-pik-a                      chakula.  
           1.guest    1SM-PST-cook-FV    7.food  
           ‘The guest cooked food.’  
       b. Chakula    ki-li-pik-a                      mgeni.  
           7.food      7SM-PST-cook-FV    1.guest  
           ‘The guest cooked food.’

In these languages, lower functional heads do not allow flexible licensing (asymmetry), but little v does show flexible licensing (inversion), which does not conform to the FLUID generalization. There are no further properties that reveal an underlyingly different analysis (like the unaccusative/passive restriction), and hence the implicational relation discovered in Chapter 3 cannot be extended to little v. Before speculating about the reasons for this finding, we check the other types of (a)symmetric object marking and subject inversion.

<sup>28</sup> In addition, there are a number of other languages with asymmetric object markers for which the needed inversion data are not available.

## 4.5.5 Partial symmetry and inversion

Languages with partially symmetric object marking, such as Sesotho, Otjiherero, and Lubukusu are also predicted to not show subject inversion with unergative and transitive predicates. These three languages show symmetric object marking in low and high applicatives but crucially not in causatives, and all three show subject inversion constructions.

v	Caus	HAppl	LAppl	Languages
✓	✓	✓	✓	Zulu, Shona, Kĩitharaka, Kikuyu
	✗	✓	✓	Otjiherero, Southern Sotho, Lubukusu
	✗	✗	✓	Kiluguru
	✗	✗	✗	Makhuwa, Matengo, Chichewa

For Lubukusu it is telling that [Diercks \(2010, 2011\)](#) describes two types of inversion: locative inversion and agreeing inversion. Agreeing inversion does not require flexible licensing by v, as shown previously for Makhuwa and Matengo. Interestingly, Diercks indicates for Lubukusu locative inversion that it is only allowed with unaccusative predicates, as shown in (127). That is, Lubukusu has precisely the types of subject inversion that do not require v to license upwards (see Bembe and Chichewa previously illustrated).<sup>29</sup>

Lubukusu (JD31c, [Diercks 2011](#): 703, 716)<sup>30</sup>

- (127) a. Mú-mú-siirú mw-á-kw-á=mó kú-mú-saala.  
 18-3-forest 18SM-PST-fall-FV=18 3-3-tree.  
 ‘In the forest fell a tree.’
- b. \*Mw-i-duka mw-a-chekh-a=mo Moses.  
 18-9-store 18SM-PST-laugh-FV=18 Moses  
 int. ‘In the store laughed Moses.’

Lubukusu thus seems to have flexible licensing for applicatives, but not causative or little v (in line with the FLUID).

Sesotho and Otjiherero are more troublesome for the predictions of the implicational hierarchy. They do not allow symmetric object marking for causatives (hence no flexible Caus), as in (128) and (130). If the FLUID would

<sup>29</sup> [Wasike \(2007: 230\)](#) states that Lubukusu does not allow subject–object reversal, but Justine Sikuku (personal communication) finds it acceptable. I leave this until further clarity on the data is achieved. If Lubukusu allows other types of inversion it patterns with Sesotho and Otjiherero.

<sup>30</sup> Note that inversion in Lubukusu does not show definiteness effects, i.e. this is not the reason for the ungrammaticality of example b.

hold – which we already know is not the case – then these languages would not have a flexible *v* either, in other words, they should not allow subject inversion that requires upwards licensing of the EA. However, both languages clearly show instances of DAI and LI with unergatives and transitives, as in (129) and (131), which in the current model require the EA to be licensed by *v*. These languages deserve a closer look, specifically regarding the height of the Caus head.

Sesotho (S33, [Machobane 1989](#): 31)

- (128) a. Ntate o-bal-is-a bana buka.  
 1.father 1SM-read-CAUS-FV 2.children 9.book  
 ‘My father makes the children read the book.’
- b. Ntate o-**ba**-bal-is-a buka.  
 1.father 1SM-2OM-read-CAUS-FV 9.book  
 ‘My father makes them read the book.’
- c. \*Ntate o-e-bal-is-a bana.  
 1.father 1SM-9OM-read-CAUS-FV 2.children  
 int. ‘My father makes the children read it.’

([Machobane 1995](#): 120)

- (129) Thabe-ng ho-ful-a likhomo.  
 9.mountain-LOC 17SM-graze-FV 10.cattle  
 ‘On the mountain cattle graze.’

Otjiherero (R30, Jekura Kavari, personal communication)

- (130) a. Ma-ve **ve** tjang-is-a om-bapira.  
 PRS-2SM 2OM write-CAUS-FV 9-letter  
 ‘They make them write a letter.’
- b. \*Ma-ve i tjang-is-a ova-natje.  
 PRS-2SM 9OM write-CAUS-FV 2-children  
 ‘They make the children write it.’

([Marten 2006](#): 113)

- (131) Kò-mù-tí kw-á-pósé òzó-ndjímá.  
 17-3-tree 17SM-PST-make.noise 10-baboons  
 ‘In the tree made noise (the) baboons.’

For the FLUID implicational relation, I have so far assumed the clausal heads to be organized hierarchically as follows, following [Pylkkänen \(2008\)](#):

## (132) Clausal spine with verb-selecting causative

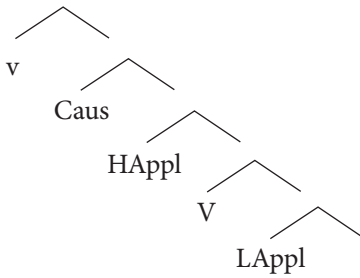

With this structure, Sesotho and Otjiherero form a counterexample to the generalization that all lower heads must be flexible for *v* to be flexible as well. There is one potential analysis under which the two languages are still in line with the implicational hierarchy (spoiler: it does not work). This hypothesizes the causative to be above *v* instead of below it. Pylkkänen (2008) not only distinguishes between two types of applicatives but also three heights of causatives, which take different sizes of complement. The ‘root-selecting’ causative is the lowest merging; this is for example the English zero-derived causative. Next up are ‘verb-selecting’ causatives between *v* and *V*, as represented in (132). The highest causative is ‘phase-selecting’ and merges above *v*P. The question is thus at which height the non-flexible causative in Southern Sotho and Otjiherero is: if it is verb-selecting, then it intervenes between the flexible HAppl and the flexible *v* and forms a counterexample to the implicational relation that higher functional heads can only be flexible if all lower heads are. If, on the other hand, the causative is phase-selecting, it occurs above the *v*P, as in (133), and the implicational relation is the other way around: Caus can only be flexible if *v* is. If this were the structure, the Sesotho and Otjiherero data would be in line with the extended FLUID.

## (133) Clausal spine with phase-selecting causative

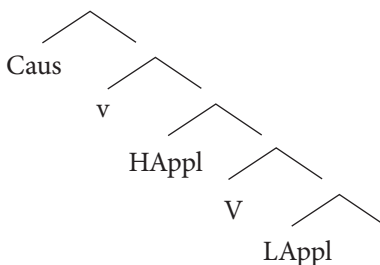



The difference between the verb- and phase-selecting causatives is that only the latter has two agentive arguments: the causer introduced by the causative and the EA in specvP. The agentivity thus provides a basis for distinguishing the two causatives, and Pylkkänen uses the interpretation of agent-oriented adverbs as a diagnostic. If the adverb can modify either argument, as in (134), there are two agents and hence a phase-selecting causative. If on the other hand the agent-oriented adverb can only be interpreted with respect to the subject, we deduce that the causative is verb-selecting, as in (135).

Venda (S20, Pylkkänen 2008: 83)

- (134) Muuhambadzi o-reng-is-a Katonga moḍoro  
 1.salesman 1SM-buy-CAUS-FV 1.Katonga car  
 nga dzangalelo.  
 with enthusiasm  
 ‘The salesman, *eagerly*, *made* Katonga buy the car.’  
 ‘The salesman made Katonga *buy the car eagerly*.’

Bemba (M42, Givón 1976: 345, via Pylkkänen 2008: 115, glosses added)

- (135) Naa-butw-iishy-a umuana ukwiitemenwa.  
 1SG.SM.PST-run-CAUS-FV 1.child willingly  
 ‘I *willingly made* the boy run.’  
 \*‘I made the boy *run willingly*.’

It turns out that both Otjherero and Sesotho use a verb-selecting causative: the interpretation of an agent-oriented adverb is unambiguous and can only refer to the causer, as shown in (136) and (137).

Otjherero (R30, Jekura Kavari, personal communication)

- (136) Omítiri mái tjang-iṣ-á ovanâjté ombapíra  
 1.teacher PRS-1SM write-CAUS-FV 2.children 9.letter  
 wina.  
 intentionally  
 ‘The teacher intentionally caused the children to write a letter.’  
 \*‘The teacher caused the children to intentionally write a letter.’

Sesotho (S33, Possa Rethabile, Konosoang Elisabeta Masupha, personal communication)

- (137) Ntate o-bal-is-a bana buka ka.boomo.  
 1.father 1SM-read-CAUS-FV 2.children book deliberate  
 ‘Father intentionally makes the children read a book.’  
 \*‘Father makes the children intentionally read a book.’

These partially symmetric languages thus allow *v* to be flexible without the next head down (causative) being flexible too. This entails that again we find two

types of languages within the subgroup where applicatives but not causatives are flexible: one without flexible *v* (Lubukusu) and two with flexible *v* (Sesotho, Otjiherero).

The last partially symmetric language is Kiluguru, where causative and applicative verbs do not allow symmetric object marking, but lexical ditransitives do. Furthermore, Kiluguru has patient inversion, locative inversion, and agreeing inversion according to [Mkude \(1974\)](#). This means that LAppl and *v* are flexible but there is no consecutive line of clausal heads showing flexible licensing – again disproving the extension of the FLUID implicational relation. Due to a lack of detailed data I will have to leave a thorough analysis of Kiluguru for further research, but it seems that this is yet another language where the flexibility of *v* is independent of the flexibility on lower heads.

#### 4.5.6 Symmetric object marking and subject inversion

To complete the picture, the third prediction concerning symmetric object marking and subject inversion turns out to hold true: languages with fully symmetric object marking may or may not have subject inversion that involves flexible licensing by *v*. And in fact, we find both types. As seen in this chapter and in [Chapter 3](#), Zulu allows symmetric object marking for ditransitives, applicatives, and causatives, and also shows a number of subject inversion constructions that require the EA to be licensed by *v*. This type of language thus ticks all the boxes, with *v* and all lower functional heads allowing flexible licensing.

While Bembe also shows symmetric object marking (138), it only allows locative inversion and default agreement inversion for unaccusatives (139) and passive transitives (140), like Chichewa. That is, only in structures where the logical subject originates as the Theme complement of *V* and is licensed downwards by another head.

Bembe (D54, [Iorio 2014](#): 237)

- (138) a. Ba-a-kol-el-a                    Iddi    bilewa.  
           2SM-T-buy-APPL-FV    1.Iddi    8.food  
           ‘They have bought Iddi food.’
- b. Ba-a-m-kol-el-a                    bilewa,    (Iddi).  
           2SM-T-1OM-buy-APPL-FV    8.food    1.Iddi  
           ‘They have bought him food (, Iddi that is).’
- c. Ba-a-bi-kol-el-a                    Iddi,    (bilewa).  
           2SM-T-8OM-buy-APPL-FV    1.Iddi    8.food  
           ‘They have bought it for Iddi (, the food that is).’



## 4.6 Conclusions and further research

The flexible licensing approach can account for many aspects of subject inversion across a range of Bantu languages: 1. the postverbal position, non-topical interpretation, and licensing of the logical subject; 2. the preverbal position, topical interpretation, and licensing of a preverbal DP if one is present; 3. the impossibility of object marking in subject inversion constructions; 4. subject marking in both SVO and inverted clauses.

Flexible licensing by *v* parallels flexible licensing in double object constructions: in both structures it is the upwards licensing of a lower head that allows a higher head to license and agree with an argument across a closer argument, obeying locality constraints.

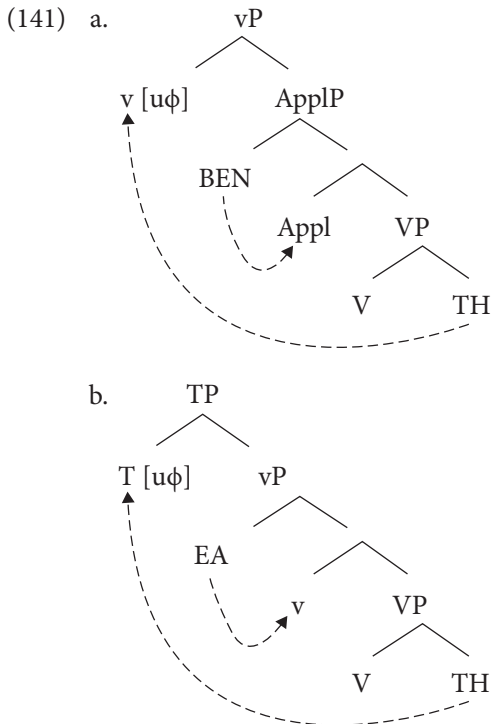

While the flexible licensing approach is thus valuable in itself in understanding Bantu subject inversion, the implicational relation for symmetric object marking (FLUID) that sparked its application to subject inversion turned out not to extend to include *v* as well. Flexible licensing on a causative head still requires flexibility on an applicative, but flexible licensing by *v* appears to be independent of the settings of lower heads.

There are many aspects that have not been addressed in this overview. I merely mention some of these here, and have to leave them for further

research. A first question concerns the restriction on thematic roles: what determines whether a given language shows subject inversion with Locatives only, or with Instruments and Themes as well? Second, there are restrictions on extraction and relativization in combination with subject inversion and passives. Specifically, the postverbal logical subject in PI cannot undergo relativization according to [Morimoto \(2006: 169\)](#), and relativization is asymmetric in double object passives in many of the languages that are otherwise symmetric ([Holmberg et al. 2019](#)). A third question is why ditransitives are hardly ever found in inversion constructions. This may be because in DAI all the licensing possibilities are ‘used up’, but perhaps there is a simple pragmatic reason that it is hard to find a context in which none of the arguments can form the topic. Fourth, the logical subject is also found postverbally in non-subject relative clauses in many Bantu languages. While for example [Henderson \(2006, 2011\)](#) treats these and subject inversion constructions under one analysis, I have not dealt with inversion in relative clauses. Interestingly, [Hamlaoui \(2018\)](#) suggests that the absence of postverbal subjects in the north-western Bantu languages, at least in non-subject relatives, may be related to the lack of object agreement – another interesting link between object marking and inversion. Fifth, I have not paid attention to the fact that in some languages locative inversion requires the presence of a postverbal locative enclitic, something that [Ngoboka \(2016\)](#) does take into account in his analysis of Kinyarwanda locative inversion. There are plenty of other issues related to subject marking and inversion, as well as further predictions, and future research will hopefully shed light on how the flexible licensing approach fares for these.

As already stated at the beginning of this chapter, it is impossible at this stage to account for every detail of every Bantu language. How and to what extent this account can be applied to further individual languages remains an interesting (and promising) challenge for future investigations. Rather, the intention of this chapter has been to propose and explain a different approach to licensing, word order, and agreement, which keeps the syntactic operations minimal and crosslinguistically stable while varying the formal features and their distribution, and furthermore to examine the extent to which such an account can help us understand the nature of syntactic variation. Therefore, with the account of subject and object marking and the crosslinguistic variation in these areas as sketched in Chapters 2–4, more general research questions concerning formal features and parametric variation can be discussed, which is the aim of Chapter 5.

## Features in agreement and licensing

Now that we have a featural analysis of a number of parameters related to object and subject marking, we can return to the research question of which features are involved in agreement and licensing phenomena. The Bantu languages have proven to be an excellent testbed to explore this question and help us find a more uniform approach to crosslinguistic variation.

Keeping the Agree mechanism constant, I have proposed that the crosslinguistic variation described in the previous chapters can be attributed to differences in features, specifically the presence and distribution of  $\phi$  features and Case features and the presence and status of Person and Topic. These features are discussed in the current chapter to appreciate the bigger picture of the parameter settings and their interconnectedness. A partial aim in this chapter is to relate the parameter settings and relations to the none-all-some hierarchies presented in the introduction, as an insightful way of modelling parametric variation.

The chapter first presents, in Section 5.1, the cross-Bantu variation in the presence of  $\phi$  probes on various clausal heads, specifically C, T, v, and Appl, showing that there is an implicational relation in the presence of  $\phi$  features on the various argument-licensing heads (T, v, and Appl), but that the presence of  $\phi$  on C appears to be independent. I also present a typological generalization between the number of object markers and (a)symmetry, called the AWSOM: Asymmetry Wants a Single Object Marker, and discuss why these parameters show a correlation. In Section 5.2, the cross-Bantu variation in salience features is discussed, specifically [Person] and [Topic]. The Relation between Asymmetry and Non-Doubling Object Marking (RANDOM) is presented and subsequently explained as the need for Bantu languages to code salience in the clausal and/or non-clausal domain. This also has repercussions for the diachronic scenario. At the end of this subsection the question is asked whether some part of the variation can be understood without reference to formal salience features (Person and Topic), with a tentative affirmative answer. Finally, Section 5.3 concludes that a model aiming to cover the attested variation

will violate both Strong Uniformity and Strong Modularity. Instead, in a minimalist spirit, an explanatory model needs to postulate only what is needed: formal features are present in the grammar of a given language only when this is warranted by the input.

## 5.1 $\phi$ probes

Subject and object marking are, in the current approach, taken to be a reflection of  $\phi$  features on different functional heads.<sup>1</sup> Subject marking indicates the presence of a  $\phi$  probe on T, object marking is due to  $u\phi$  on little *v*, and multiple object marking indicates  $u\phi$  on lower functional heads like Appl. Additionally, the presence of  $u\phi$  on a higher head like C results in agreeing complementizers or separate relative markers on the verb (Carstens 2003; Henderson 2011; Diercks 2013; among others). In a featural parametric approach, languages thus differ in two respects:

1. whether  $\phi$  probes are present in the language at all, and
2. if they are present, on which heads they occur.

These parameters and their settings can potentially be modelled in a parameter hierarchy for  $\phi$  features, applying the none-all-some motivation for parameter dependencies outlined in Chapter 1.

To briefly recap, parameter setting is hypothesized to be a process guided by cognitive biases such as Feature Economy and Input Generalization.

- (1) Feature Economy (FE)  
Postulate as few formal features as possible to account for the input.
- (2) Input Generalization (IG)  
Maximize already-postulated features.  
(Biberauer 2019b: 59, 60; see also Biberauer & Roberts 2015b: 300; Roberts & Roussou 2003; Roberts 2007)

According to FE, language acquirers will only postulate the presence of a feature if the input (the primary linguistic data) provides evidence for its presence. This entails that parameters are only set, and indeed are only present, if the input provides sufficient evidence, that is, the parameters are emergent (Biberauer & Roberts 2015ab, 2016, 2017; Biberauer 2017a, 2018b, 2019ab; Roberts 2019). Once the presence of a feature is detected, because of IG it is assumed

<sup>1</sup> Sections 5.1 to 5.1.3 are largely taken from Van der Wal (2020a).

to be present on all relevant heads in the language. Should the input indicate that not all heads have this feature, then it needs to be determined which heads do (see [Biberauer 2019ab](#) on the stepwise development). This results in a none-all-some hierarchy of parameters, as in (3).

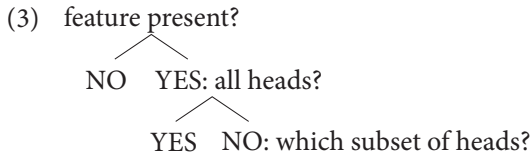

We can think of this hierarchy as ever more specified (i.e. featurally rich) parameters. In ‘size’ terms, [Biberauer & Roberts \(2015ab, 2016, 2017\)](#) propose the following taxonomy of parameters ([Biberauer & Roberts 2012](#); see [Roberts 2019](#): 75–88 for examples):

- (4) Types of parameters  
For a given value  $v_i$  of a parametrically variant feature F:
- Macroparameters: all heads of the relevant type, e.g. all probes, all phase heads, share  $v_i$ ;
  - Mesoparameters: all heads of a given natural class, e.g. [+V] or a core functional category, share  $v_i$ ;
  - Microparameters: a small, lexically definable subclass of functional heads (e.g. modal auxiliaries, subject clitics) share  $v_i$ ;
  - Nanoparameters: one or more individual lexical items is/are specified for  $v_i$ .

[Biberauer \(2018a\)](#) provides the following helpful flowchart of parameter setting:

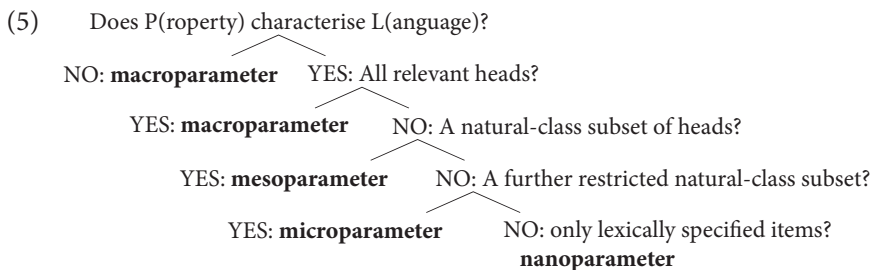

A similar parameter hierarchy for  $\phi$  features and the different sizes of parameter settings will be discussed in the rest of this section; a more detailed discussion of formal features in a minimalistic model follows in [Section 5.3](#).



5.1.1 A potential hierarchy for  $\phi$  feature parameterization

A potential hierarchy for  $\phi$  features is as proposed in (6), following the none-all-some sequence.

- (6) Possible  $u\phi$  feature hierarchy 1  
(to be adjusted, cf. Roberts & Holmberg 2010; Roberts 2012, 2014)

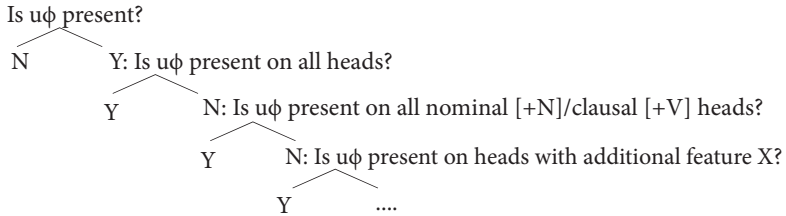

The first parameter asks whether uninterpretable  $\phi$  features are present at all in the language. If the answer is ‘no’, this could describe radical pro-drop languages (Saito 2007; Roberts 2010, 2012, 2014, 2019), which do not show any cross-indexing. Given the lack of input in these languages, this first question will thus not even come up for the language acquirer (sticking to FE). In contrast, verbal inflection in all Bantu languages shows at least some indexing, which means that in the next steps it needs to be established how pervasive this feature is in each language.

By IG, the next parameter sets whether *all* probes have  $u\phi$ . There is a question as to which heads are included in ‘all probes’; concretely, should both the nominal and verbal domain be considered? The acquisition logic of none-all-some requires that the first ‘all’ setting concerns undifferentiated categories (see Drescher 2009; Biberauer 2011; Bazalgette 2015; Biberauer & Roberts 2015ab, 2017 on emergent categories), which means that the whole domain – which is eventually split into nominal and verbal – should at this macro stage be considered. Setting this parameter to ‘yes’ results in agreement not just on C, T, v, and Appl, but also P, D, Num, and Poss.<sup>2</sup> While some Bantu languages may come close to the presence of  $u\phi$  features throughout the language,<sup>3</sup> I do

<sup>2</sup> I do not adopt the feature inheritance approach (Chomsky 2007, 2008; Richards 2007; Miyagawa 2010), whereby T would inherit  $\phi$  features from the phase head C, because in many Bantu languages we can see that the features on C and T clearly differ (see Carstens 2011; also Henderson 2009), and because from an acquisition point of view it does not make sense to postulate a process of inheritance if a consistent one-to-one relation can be deduced between  $\phi$  agreement and T, which can be captured by the presence of  $\phi$  features on T.

<sup>3</sup> There is a question as to whether agreement and concord involve the same operation – see for example Giusti (2008) for discussion claiming that they are not, and Carstens (to appear) for analysis where they are the same. See Norris (2017ab) for an overview.

**Table 5.1** Variation in  $u\phi$  features

SM	OM	multiple OM	agreeing comp	example language
✓	✓	✓	✓	Ciluba
✓	✓	✓		Kinyarwanda
✓	✓			Makhuwa
✓				Basaa

not know of any Bantu language showing  $\phi$  agreement on prepositions,<sup>4</sup> so we move to the next parameter and need to inspect subtypes.

It is important here to distinguish acquisition from typology, in the following way. When describing variation between languages, as I am doing in this section, the existence of certain categories and heads is assumed – hence I mention C, T, v, etc. The acquirer, on the contrary, does *not* have these categories yet at the earlier stages of acquisition; in fact, the process of acquisition is precisely to posit features that distinguish one category from the next, creating categorial splits. See further the difference in views between [Biberauer \(2019b\)](#) and [Roberts \(2019\)](#). Here, I remain agnostic as to whether  $\phi$  features are (partly) responsible for creating categories or are associated with already existing categories and describe the parametric variation between languages referring to categories as if they have already been made distinguishable by other features.

One step further down the hierarchy we ask whether  $u\phi$  is present on a subset of heads, specifically all heads in the nominal or the verbal domain. Since it may be the case that there is a relevant subset in *both* domains, we can see this as a split in a third dimension where parameters are set for the nominal domain [+N] separately from the verbal domain [+V], depending on the input. Focusing on the clausal domain for the current discussion, once the [+V] subset is identified, by IG it is assumed that all heads in the subset, that is, all functional heads in the extended verbal projection, have  $u\phi$ .

In what follows, I consider how each following step in the hierarchy might work and show the crosslinguistic variation in Bantu languages, illustrating from the ones in Table 5.1. By going through this exercise, we learn how the conceptual notions work out in the field of  $\phi$  features, but also discover that  $u\phi$  on C will turn out to not fit the hierarchy, as further discussed in Section 5.1.2.

An example of a language where  $u\phi$  features are generalized to occur on all clausal heads is Ciluba. Ciluba displays multiple object marking (i.e.  $u\phi$

<sup>4</sup> I take the Bantu connective *-a* ‘of’ to not be a true preposition (see [Van de Velde 2013](#)).

on *v* and Appl, in the system as introduced in Chapters 2 and 3), as well as subject marking ( $\phi$  on T), as illustrated in (7). It also shows agreement with a relativized noun on the auxiliary ( $\phi$  on C), separate from subject agreement, as shown in (8).

Ciluba (L31, [Cocchi 2000](#): 87)

- (7) Mukaji **u-tshi-mu**-sumb-il-a.  
 1.woman 1SM-7OM-1OM-buy-APPL-FV.  
 ‘The woman buys it (fruit) for him (the boy).’

([de Kind & Bostoen 2012](#): 104)

- (8) a. maamù **u-di** ba-àna **bà-ambul-il-a** mi-kàndà...  
 1.mother 1RM-be 2-children 2SM-carry-APPL-FV 4-book  
 ‘mother, for whom the children are carrying the books...’  
 b. mi-kàndà **ì-dì** ba-àna **bà-ambul-il-a** maamù...  
 4-book 4RM-be 2-children 2SM-carry-APPL-FV 1.mother  
 ‘the books which the children are carrying for mother...’

In Ciluba, therefore, we conclude that all +V heads (Appl, *v*, T, C) have  $u\phi$  (but as shown in the next section,  $u\phi$  on C turns out to be a separate parameter).

If not all heads in the clause have  $u\phi$ , further parameterization consists of establishing the next relevant subset where  $u\phi$  is present. For the Bantu clausal domain, the next largest subset appears to be the argument-licensing heads: T, *v*, and Appl/Caus. This would, in a featural specification, come down to heads that have Case. In Kinyarwanda, the verb famously displays multiple object marking (9) as well as subject marking, but not complementizer or relative agreement for  $\phi$  features: the relative clause in (10) is formed by a high tone. This means that  $u\phi$  is present on *v* and Appl, as well as T, but not on C. Kinyarwanda thus sets the parameter ‘Is  $u\phi$  present on all argument-licensing heads?’ to ‘yes’. Formulating the parameter as such entails that the Kinyarwanda system does not have  $u\phi$  on C, since otherwise the language would have already set its parameter at the previous question with Ciluba, that is, all clausal heads would have  $u\phi$  (but see the next section for the independence of C).

Kinyarwanda (JD62, [Kimenyi 2002](#): 20, via [Beaudoin-Lietz et al. 2004](#): 183)

- (9) U-mu-goré **a-ra-na-ha-ki-zi-ba-ku-n**-someesheesherereza.  
 AUG-1-woman 1SM-DJ-also-16OM-7OM-10OM-2OM-2SG.OM-  
 1SG.OM-read.CAUS.CAUS.APPL.APPL  
 ‘The woman is also making us read it (book, cl. 7) with them  
 (glasses, cl.10) to you for me there (at the house, cl.16).’

(Zeller & Ngoboka 2014: 11)

- (10) a. U-mu-kózi      a-bar-a      i-bi-tabo.  
           AUG-1-worker    1SM-count-FV    AUG-8-book  
           ‘The worker counts books.’
- b. i-bi-tabo      u-mu-kózi      a-bar-á  
           AUG-8-books    AUG-1-worker    1SM-count-FV  
           ‘the books that the worker counts’

For all languages setting this parameter to ‘no’, a further subset will be found, forming the next parameter. Within the argument-licensing heads, the next question could be whether  $u\phi$  is present on heads in the phase started by *v*. This includes *v* and T, but not Appl as it is in the complement/transfer domain of *v* (and not C because it is part of the next phase up). I refer to this part of the clause as ‘the second phase’. If the setting is ‘yes’, the language has subject marking and only a single object marker, as illustrated for Makhuwa. Makhuwa shows extremely regular subject marking as well as object marking (all and only objects in classes 1 and 2 are marked, Van der Wal 2009), but is restricted to one object marker (11), which means  $\phi$  on T and *v*, but not on Appl.

Makhuwa (P31)

- (11) Xaviéré    o-nú-ń-váh-á      anelá    Lusiána.  
       1.Xavier    1SM-PFV.PERS-1OM-give-FV    1.ring    1.Lusiana  
       ‘Xavier gave Lusiana a ring.’

Makhuwa equally does not show agreement on C: complementizers never agree, and the relative construction in Makhuwa does not have a relative complementizer or special relative agreement, illustrated in (12). Instead, it is best analyzed as a nomino-verbal participial construction which does not have an agreeing C head (Van der Wal 2010).<sup>5</sup>

(Van der Wal 2010: 210)

- (12) a. Ki-m-phéél-á      ekamisá    e-pasar-aly-áaka.  
           1SG.SM-PRS.CJ-want-FV    9.shirt    9-iron-PFV.REL-POSS.1SG  
           ‘I want the shirt that I ironed.’

<sup>5</sup> What seems to be a subject marker or relative marker on the relative verb in Makhuwa (*e-* and *tsi-* in the examples) is a pronominal head (PtcpP) referring to the referent indicated by the head noun, e.g. both refer to a class 9 shirt and therefore both are in class 9. There is no regular subject marking, but the subject can be pronominalized on the verb as a possessive (*-aawe*), showing that the relative clause is not a full clause but lacks higher heads in the extended verbal projection. See Van der Wal (2010) for details.

- b. Ki-m-phéél-á                      ekanetá    tsi-ki-vah-aly-ááwé  
 1SG.SM-PRS.CJ-want-FV    10.pens    10-1SG.OM-give-PFV.REL-POSS.1  
 (Alí).  
 1.Ali  
 'I want the pens that he (Ali) gave me.'

If the parameter setting is 'no' for the presence of  $u\phi$  features in the second phase, then the language only has  $u\phi$  on one head. This turns out to always be the highest in the subset left:  $u\phi$  on T (i.e. only subject marking; see 5.1.2 on the implicational relation for  $u\phi$  on clausal heads). Basaa illustrates this parameter setting: it has a subject marker, which is written separately but is obligatory even in the presence of a full DP subject (13).

Basaa (A43, [Hyman 2003a](#): 277)

- (13) Liwándá jêm lí m    'béná    jé    bíjék    í    'ndáp.  
 friend    my    SM    PRS    do-often    eat    food    in    house  
 'My friend often eats food in the house.'

Objects, however, are not marked on the verb in Basaa, and when the object is pronominalized it simply appears as an independent pronoun following the verb (14b).

([Hyman 2003a](#): 278)

- (14) a. A    bí    nuńúl    lítám.  
          SM    P2    sell        fruit  
          'He sold a fruit.'  
 b. A    bí    nuńúl    jó.  
          'He sold it.'

Finally, relative clauses in Basaa can be marked with a demonstrative (*nu* in (15b) and *hi* in (16b)), but [Jenks et al. \(2017\)](#) argue that this is not a C head.

([Jenks, Makasso, & Hyman 2017](#): 19, 20)

- (15) a. Mut        a        bí        'jé    bíjék.  
          1.person    1SM    P2    eat    8.food  
          'The person ate the food.'  
 b. í-mut                      (nú)        a        bí        'jé    bíjék  
          AUG-1.person    1.REL/DEM    1.SM    P2    eat    8.food  
          'the person that ate the food'
- (16) a. Liwándá lí        bí        'téhé    hínuní.  
          5.friend    5SM    P2    see    19.bird  
          'The friend saw the bird.'

- b. hínuní (hí) liwándá lí bí 'téhε  
 AUG.19.bird 19.REL/DEM 5.friend 5SM P2 see  
 'the bird that the friend saw'

If Jenks et al. (2017) are correct in their analysis of the relative construction, then Basaa can be taken to illustrate a language in which only T has  $u\phi$  features, whereas C, v, and Appl do not.

The parameter hierarchy for Bantu languages discussed so far would thus come out as follows:

- (17) Possible  $u\phi$  feature hierarchy 2 (to be adjusted)

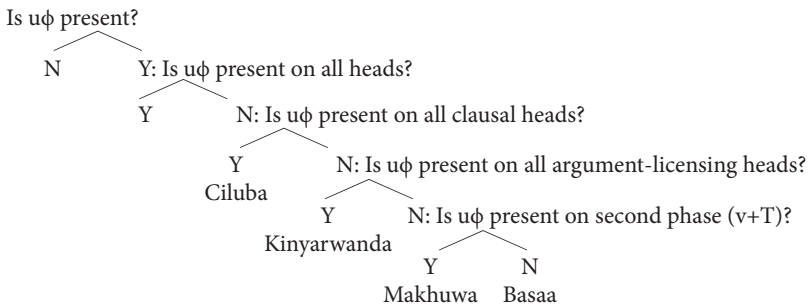

### 5.1.2 (In)Dependent parameters

If this parameter hierarchy represents the typological picture, then it holds an implicational prediction such that if a language has  $u\phi$  on one head in the hierarchy in (18), it will have  $u\phi$  on all the heads to its right (as noted for subject and object agreement by Moravcsik 1974; and see Givón 1976; Bobaljik 2008):

- (18) C > Appl > v > T  
 comp/rel agr > multiple OM > OM > SM

Considering the sequence of heads in the verbal extended projection, it is clear that C is not in the expected position on this implicational hierarchy. And there are more indications that C is not quite in place in this hierarchy. For one thing, the evidence for the absence of  $u\phi$  features on C in Makhuwa and Basaa is very much dependent on the theoretical analysis of relative clauses, which makes the argument for the absence of  $u\phi$  on C in these languages less strong. Moreover, there is clear evidence from other Bantu languages that  $\phi$  agreement on C must be independent of  $u\phi$  on the argument-licensing heads. This is illustrated by Bembe, which shows the typical Bantu subject and object

marking (19b,  $u\phi$  on T and v), but does not allow more than one object marker (19c, no  $u\phi$  on Appl).

Bembe (D54, [Iorio 2014](#): 103)

- (19) a. Twa-h-ile                    batu                    bokyo.  
           1PL.SM-give-PST    2.people    14.money  
           ‘We gave people money.’
- b. Twa-bo-h-ile                    batu.  
           1PL.SM-14OM-give-PST    2.people  
           ‘We gave it to people.’
- c. \*Twa-bo-ba-h-ile                    /    \*Twa-ba-bo-h-ile  
           1PL.SM-14OM-2OM-give-PST    1PL.SM-2OM-14OM-give-PST  
           int. ‘We gave them it.’

Non-subject relative clauses in Bembe can display a relative marker in addition to a pronominal subject marker, as shown in (20) with *ba-twa-* and *bi-ba-*, indicating that T and C both have their own set of  $u\phi$  features.

Bembe (D54, [Iorio 2014](#): 152)

- (20) a. Baana            ba-twa-mon-ilé                    ba-b-ile                    babembe.  
           2.children    2RM-1PL.SM-see-PST    2SM-COP-PST    2.Bembe  
           ‘The children whom we saw were Bembe.’
- b. bilewa    bi-ba-koch-ilé  
           8.food    8RM-2SM-buy-PST  
           ‘the food that they bought’

This suggests that the presence of  $u\phi$  features on C does not form part of the implicational hierarchy that holds between the argument-licensing heads T, v, and Appl, which in turn suggests that  $u\phi$  on C is a parameter that is independent of the parameter hierarchy for  $u\phi$  features. [Biberauer \(2017b\)](#) and references cited therein) also notes how C behaves differently from lower heads, in the domain of word order as well.

However, the implicational hierarchy (Table 5.2) *does* appear to hold for the argument-licensing heads: if a language has  $u\phi$  on Appl (multiple object marking) then it has  $u\phi$  on v (single object marking), and if a language has  $u\phi$  on v (object marking) then it has  $u\phi$  on T (subject marking):

- (21) Appl                    >    v                    >    T  
           multiple OM    >    OM                    >    SM

It is known that case marking on arguments licensed by v can be dependent on case-marking by T ([Marantz 1991](#); [Baker 2015](#)), and it is clear from the data surveyed here that the same holds for head-marking agreement (see [Roberts](#)

**Table 5.2** Implicational relation in  $u\phi$  features

C	T	v	Appl	example language
✓	✓	✓	✓	Ciluba
	✓	✓	✓	Kinyarwanda
	✓	✓		Makhuwa
	✓			Basaa
✓	✓	✓		Bembe

2014 on the same conclusion for Romance; and see, among others, [Bobaljik 2008](#); [Bárány 2017](#) for discussion on implicational relations between heads in the domains of Case and agreement, as well as [Moravcsik 1974](#) for the implication between object and subject agreement). Additionally, based on the data surveyed for the Bantu languages, this implicational relation can be extended to the lower functional heads such as Appl. The fact that these implications hold indicates that argument-licensing heads are a natural class, with a strong relation to  $\phi$  feature agreement.<sup>6</sup>

This suggests a revision of the parameter hierarchy in (6) to a hierarchy that shows the interdependence of argument-licensing heads, keeping C apart. That is, it suggests that crosslinguistic variation in the presence of  $u\phi$  features on C is a parameter that is not actually part of this hierarchy, since hierarchies are only attractive for modelling *dependent* parameters (as argued in [Roberts & Holmberg 2010](#); [Sheehan 2014](#); [Roberts 2019](#)). The separate parameters can

<sup>6</sup> There is a remarkable parallel between the implicational relation in argument-licensing heads bearing  $\phi$  features on the one hand and case marking on the other hand. According to [Smith et al's \(2019\)](#) and [Zoppi's \(2019\)](#) findings, case marking shows the so-called \*ABA pattern: languages do not show suppletion or syncretism of the unmarked case (nominative, absolutive) with inherent cases (dative, oblique), unless the other core case (accusative, ergative) does so too. This observation can be paralleled in agreement, in the following way. For case assignment, assume that the unmarked case is assigned by T (for ergative languages a 'high absolutive', [Aldridge 2004](#)), that ergative and accusative are assigned by v (see for ergative as an inherent case the overview in [Sheehan 2017](#)), and that datives and obliques are assigned lower, by Appl. Then the implicational relation between the morphology of case forms parallels exactly the implicational relation between agreement marking heads, as shown in the following figures. I leave this as a topic for further research.

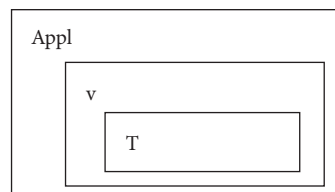
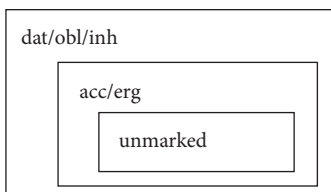



then be modelled as in (22), representing only the dependent parameters in a macro-to-micro hierarchy:

(22) Dependent and independent  $\phi$  feature parameters

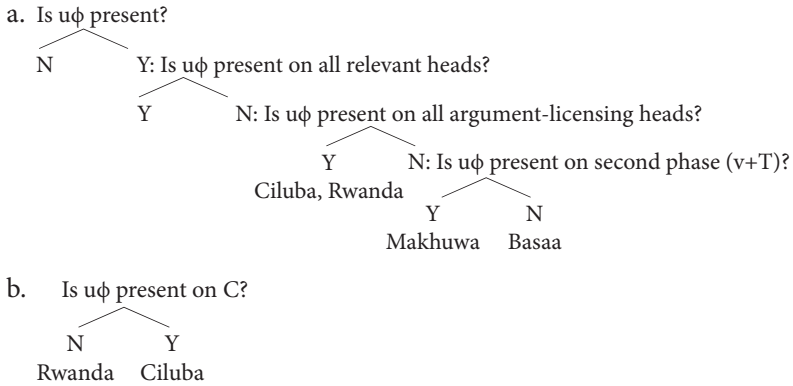

### 5.1.3 Nanoparametric variation for $\phi$

Potential nanoparametric variation can also be attested in the domain of  $\phi$  features, as exemplified by Kiluguru and Kinyakyusa. These languages do display object marking, but only for some predicates. To illustrate with one example: in Kiluguru the verb *-bona* ‘to see’ requires an object marker and cannot be grammatically used without it, as shown for animate and inanimate objects in (23) and (24). The semantically similar verb *-lola* ‘to see/look at’, on the other hand, does not have this requirement and occurs without an object marker (25).

Kiluguru (G35, [Marten & Ramadhani 2001](#): 264–5)

- (23) a. Ni-w-on-a iwana.  
 1SG.SM.TNS-2OM-see-FV 2.children  
 ‘I saw the children.’
- b. \*Ni-on-a iwana.  
 1SG.SM.TNS-see-FV 2.children  
 int. ‘I saw the children.’
- (24) a. Wa-ch-on-a ichtabu.  
 2SM.TNS-7OM-see-FV 7.book  
 ‘They saw the book.’
- b. \*Wa-on-a ichtabu.  
 2SM.TNS-see-FV 7.book  
 int. ‘They saw the book.’

- (25) No-bam-aa                      ku-lola        iwanu.  
 1SG.SM.TNS-want-FV    15-look.at    2.people  
 ‘I want to look at people.’

Marten and Ramadhani (2001) claim that this variation in predicates that do or do not require/allow object marking is not due to transitivity or the choice of object, but individual predicates. Nevertheless, it seems that it can be modelled as variation in *v*'s selection of a predicate taking an argument instead of an adjunct (i.e. microvariation). This would fit the difference between ‘see *X*’ (argument) and ‘look at *X*’ (non-argument). What is particularly suggestive in this case is the fact that the presence of an object marker can influence the interpretation of a predicate in Kiluguru. Marten and Ramadhani illustrate this with the predicate *-pfika*, which is usually interpreted as ‘find, meet’ when used with an object marker (26a), but as ‘arrive’ when there is no object marker (26b).

Kiluguru (G35, Marten & Ramadhani 2001: 265–6)

- (26) a. Wanzehe    wa-pfi-pfika                      ipfitabu.  
           2.elders    2SM.TNS-8OM-find    8.books  
           ‘The elders found books.’  
       b. Wa-pfika    ukaye    kwake.  
           2SM-find    house    POSS  
           ‘They have arrived at / been to his home.’  
       c. <sup>?</sup>Wanzehe    wa-pfika    ipfitabu.  
           2.elders    2SM-find    8.books  
           ‘The elders arrived at the books’  
           int. ‘The elders found books.’

A microparametric account seems less likely for Kinyakyusa, which has similar restrictions on object marking (Lusekelo 2012). Here too, the presence of  $u\phi$  on *v* is not set for *all* *v* heads, and transitive predicates are in one of three groups according to their object marking abilities/possibilities (Lusekelo 2012 and personal communication):

1. impossible (‘cook’, ‘weave’),
2. obligatory (‘see’, ‘love/like’),
3. optional (‘smear’, ‘hold/touch’, ‘take’).

The first type of predicate never shows object marking and thus never projects a *v* with  $u\phi$  features. In the second and third type of predicate  $u\phi$  features must/can be present on *v*. It is unclear however, how type 1 can be distinguished (featurally) from the other two types, or, in other words, how type 1 forms a natural subset. It therefore appears to be an instance of nanoparametric variation: individual predicates have/do not have  $u\phi$  features on *v*.

What underlies the distinction between the second and third type is equally unclear; alternatives suggested by anonymous reviewers of [Van der Wal \(2020a\)](#) include a potential semantic difference for psych vs touch/motion verbs, and a phonological factor where the initial consonant of the verb stem or syllable structure might play a role in requiring object marking. However, at the moment this is only speculative and has to await further research on Kinyakyusa object marking.

Even if the exact size of the parameter setting or the precise features involved are as yet unknown, it is clear that these languages distinguish different predicates, that is, different subtypes of little *v*, when it comes to the distribution of  $u\phi$  features.<sup>7</sup> We thus need a further specification of subsets, arriving at the nano-level where certain predicates have a positive setting for the presence of  $\phi$  features on *v*, indicated as  $v_\alpha$  in the adjusted hierarchy in (27).<sup>8</sup>

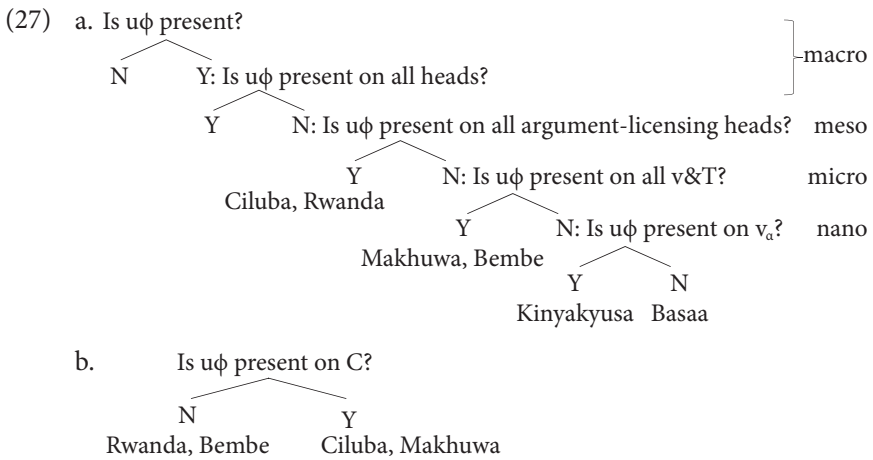

<sup>7</sup> Note that [Sheehan \(2014, 2017\)](#) proposes quite extensive subhierarchies for little *v* with respect to ergative alignment, but starting from a different logic underlying the shape of the parameter hierarchy.

<sup>8</sup> An alternative way of organizing the hierarchy to make the typological implication fall out would be as below (see also [Bárány 2017](#)). Note, though, that this cannot capture the acquisitional path, and hence loses the motivation in the principles of FE and IG.

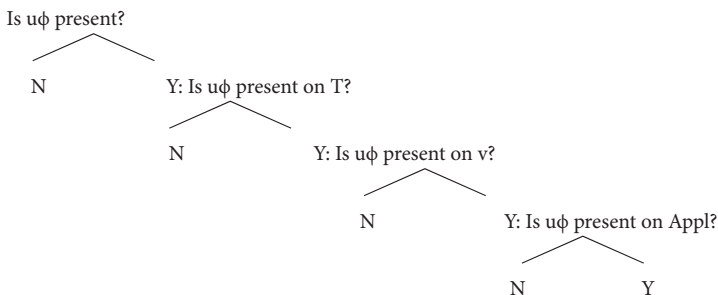

This exploration of the hierarchy for  $u\phi$  parameters has thus brought to light that what is thought to be the same phenomenon in the first instance might actually not be part of the same parameter hierarchy – concretely, the parameter for  $\phi$  features on C is shown to be set independently of the other heads in the clause. The data also reveal an interesting implicational relation for  $\phi$  features on argument-licensing heads, which can be captured in a parameter hierarchy that considers smaller and smaller subsets representing Bantu-internal parametric variation from the meso to the nano level. We may now go beyond this level of explanation and ask why the questions in the hierarchy are as they are. The first parameters are clearly motivated by FE and IG. I will not speculate on possible independent motivations for the lower parameters, but turn the question around: if these are the parameters an acquirer discovers and sets, what does that tell us about the input and about what acquirers pay attention to? One thing we observe is that the hierarchy suggests that the category of licensers is split up step by step, for example, as in [Biberauer's \(2011\)](#) and [Dresher's \(2009\)](#) theory of undifferentiated categories.

Furthermore, there is an interesting parallel here with the parameters setting the FLiP for lower functional heads (Caus, Appl,  $v$ ) discussed in Chapter 4. The implicational relation there (the FLUID) only held for Low Appl, High Appl, and Causative, but turned out to not extend to  $v$ . For  $\phi$  features, the implicational relation holds for Appl,  $v$ , and T, but does not extend to C. In both cases it is the phase head ( $v$  for the FLUID and C for  $u\phi$  features) that does not form part of the hierarchy. This may not be accidental. It suggests that the dependency between heads can apparently be ‘reset’ at phase boundaries. It is therefore not surprising to find that C, being the next phase head up, is also separate from the parameter settings of heads in the lower phase. The question as to why this would be so, and the potential consequences for the Final-Over-Final-Condition ([Sheehan et al. 2017](#)), remains to be investigated more closely, but the observation for both  $v$  (with respect to Topic) and C (with respect to  $\phi$  features) is a new and interesting one, which lends support to phase theory.

#### 5.1.4 $\phi$ on Appl and symmetry (the AWSOM)

In Chapter 3, the presence of a  $\phi$  probe on Appl was proposed to account for multiple object marking. However, it also makes a prediction with respect to symmetry. Since the  $\phi$  probe is merged right above the Theme and no other XP intervenes between the probe and the Theme, the  $\phi$  probe is predicted to always ‘have access to’ the Theme, and to always be able to agree with it. The

$\phi$  bundle on Appl can be spelled out or not, independently of the spell out of the  $\phi$  features on *v* (see Chapter 2 for doubling/non-doubling spell out). As a consequence, object marking must show symmetry if Appl has  $\phi$  features. The prediction is thus that languages with multiple object marking are always symmetric, and this tendency has already been noted in the literature (Henderson 2006: 185; Zeller & Ngoboka 2015: 227). Riedel (2009) describes the correlations as follows:

Across the Bantu family, it has been observed that the languages which allow more than one object marker, such as Haya and Rundi, tend to be symmetric. Baker (2008) suggests that this is a consequence of the properties of syntactic agreement as opposed to object clitics. Bentley (1994) also lumps together agreement, animacy-sensitivity, having only one object marker, and asymmetry as related properties. However, although this may well be a tendency across Bantu, these three properties do not correlate systematically with one another. For example, Sambia is an asymmetric language with multiple object markers. (Riedel 2009: 78)

The question is thus what distribution a larger sample of languages will reveal, and the result of the current survey is summarized in Table 5.3.

**Table 5.3** Interaction between number of object markers and symmetry in Bantu languages

	multiple	single	1+
asymmetric	Sambia	Chichewa, Chimwiini, Chingoni, Cuwabo, Kagulu, Lika, Lunda, Makhuwa, Nsenga, Swahili, Tumbuka, Matengo, Yao	Bemba, Kiyaka, Ruwund
symmetric	Chaga, Ciluba, Dzamba, Ha, Haya, Kinyarwanda, Kirundi, Kuria, Luganda, Lugwere, Luruuli, Mbuun, Runyankore-Rukiga, Oshindonga, Setswana, Totela, Umbundu	Bembe, Changana, Digo, Herero, Gitonga, Kikongo, Kimeru, Kinande, Lozi, Kiluguru, Maragoli, Ndebele, Shona, Sotho, Swati, Totela, Zulu, Xhosa	Kikuyu, Lubukusu, Mongo, Nyaturu, Tharaka, Fuliiru
symmetry unknown		Ekoti, Makwe, Rang, Shimakonde, Nyamwezi	Punu

The prediction is thus largely correct, with the languages under study showing an almost-gap in their parameter settings: there is a systematic correlation



(also to be indicated as ‘R’) – the result is a reversal of the roles, as indicated in the translations of (30) and (31).<sup>9</sup>

Sambaa (own data)

- (30) N-za-**ji**-ghul-iy-á nyumbá.  
 1SG.SM-PST.DJ-5OM-buy-APPL-FV 9.house  
 \*‘I bought it for the house (a/the dog, class 5).’ (\*OM for Th)  
 instead: ‘I bought a house for it (the dog).’ (OM for R)
- (31) (Context: in a different era, plantation owners needed people to work the land.)
- a. Wá-zá-**zi**-ghul-iy-a **khói** z-áwe wátuunghwa.  
 2SM-PST.DJ-10OM-buy-APPL-FV 10.farm 10-POSS.2 2.slaves  
 ‘They bought slaves for their farms.’ (OM for inanimate R)
- b. Wá-zá-wa-ghul-iy-a **khói** z-áwe wátúúnghwa.  
 2SM-PST.DJ-2OM-buy-APPL-FV 10.farm 10-POSS.2 2.slaves  
 ‘They bought farms for the slaves.’ (OM for human R)  
 \*‘They bought slaves for their farms.’ (\*OM for inanimate Th)

Sambaa thus forms a counterexample to the AWSOM correlation in (28), and to the prediction that follows from the account explored in this book. The questions at this point are therefore:

1. How can we account for object marking in Sambaa?
2. Why is this parameter setting for object marking so apparently rare?

A potential analysis for Sambaa, fitting with the current assumptions and providing an answer to both questions, is presented in the next subsection.

### 5.1.5 Multiple object markers as additional higher $\phi$ probes

To restate the exceptional status of Sambaa here: Sambaa allows multiple object markers, but object marking fails to be symmetric (as would be predicted if multiple object marking is due to the presence of a  $\phi$  probe on Appl). The

<sup>9</sup> There appears to be a restriction on the ordering of multiple markers in Sambaa as well, see example below and Section 5.1.5, as well as Section 3.8 in Chapter 3, on prefix ordering.

- i. \*Wa-za-wa-**zi**-ghul-iy-a.  
 2SM-PST.DJ-2OM-10OM-buy-APPL-FV (\*OM order R-Th)
- ii. Wa-za-**zi**-wa-ghul-iy-a.  
 2SM-PST.DJ-10OM-2OM-buy-APPL-FV  
 ‘They bought them (cl. 10, farms) for them (cl. 2, slaves).’ (order Th-R)  
 \*‘They bought them (cl. 2, slaves) for them (cl. 10, farms).’ (\*order R-Th)

hierarchical strictness in Sambaa multiple object marking suggests that the  $u\phi$  features responsible for object marking are located *above* the highest object, with the Minimal Link Condition determining that the highest object be agreed with first. The difference between the featural specification of Sambaa on the one hand, and that of asymmetric object marking in languages with only one object marker on the other hand would thus be the presence of an extra set of  $\phi$  features on  $v$  (cf. Adams 2010). If Sambaa indeed has two  $\phi$  probes on  $v$ , then the first probe finds the closest goal (Benefactive) and agrees with it, after which the second probe finds the lower goal (Theme), forming a second Agree relation for  $\phi$  features. Little  $v$  thus ends up having two sets of valued  $\phi$  features, as in (32), which can be spelled out as object markers.

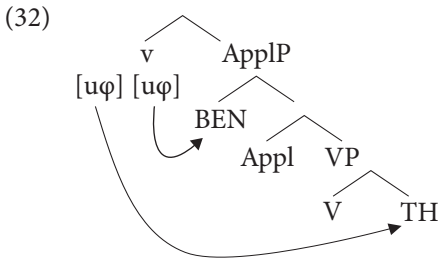

However, remember that the current model assumes that spell-out of the object marker is dependent on the featural make-up of the goal relative to the probe: there is always an Agree relation, but only defective goals will spell out as an object marker (see Chapter 2). This means that the two sets of  $\phi$  features could still be spelled out independently of each other, which is the case in symmetric multiple object marking languages, but not in asymmetric Sambaa. We could potentially repair this by specifying a phonological condition that the second probe can only be spelled out if the first is. This, however, is an ad-hoc solution that should only be adopted as a last resort.

The question thus becomes why the second probe can only reach the Theme if the first probe agrees with a *defective* goal. I propose that this follows from the nature of defective goals: once the first probe has agreed with a defective Recipient (spelling out as an object marker), the relation cannot be distinguished from a chain, and the bottom of a chain (i.e. a trace/copy) is invisible for further agreement (Chomsky 2000, 2001). This allows the second probe to ‘skip’ the invisible higher Benefactive argument and agree with the Theme, as represented in (33).<sup>10</sup>

<sup>10</sup> Remember that the  $\phi$  probes in this analysis are underspecified and therefore do not differ from each other. Probing for different features (combined with a full match requirement) therefore cannot be an explanation here.



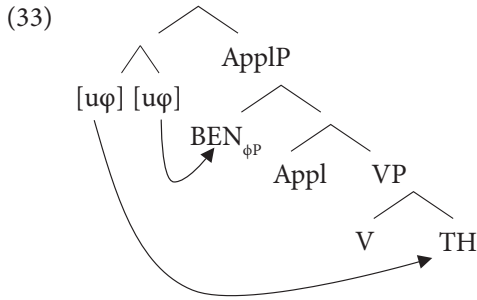

If, on the other hand, the first probe agrees with a non-defective DP Benefactive (which will not be spelled out as an object marker), the DP will still be visible to the second probe. The second probe will thus also agree with the higher Recipient and cannot reach the lower Theme, as in (34). The (double set of the same)  $\phi$  features on *v* will not be spelled out, because the goal is not defective, resulting in no object marking.

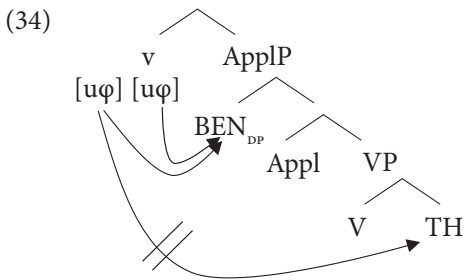

We may now wonder how the Theme is licensed if *v* does not agree with it in (34), and also how the second  $\phi$  probe cannot reach past the Benefactive if that is already licensed by the first probe. The question behind both points is whether the extra  $u\phi$  set is also a Case licenser. I argue that it is not, and that instead Appl is still a licenser. This is the same as in the case of symmetric languages and asymmetric languages with only one object marker. That is, *v* and Appl are always licensers if they introduce an argument (contra Woolford 1995; see discussion in Georgala et al. 2008; Georgala 2012; Nie 2020), and the distribution of  $\phi$  probes is logically independent of this. We have already seen this in the derivation for languages with only one object marker, where Appl licenses an object but only *v* has a  $\phi$  probe.<sup>11</sup> This is represented in (35), where dashed lines indicate licensing and the solid line is  $\phi$  agreement.

<sup>11</sup> Similarly, Bhatt (2005) proposes for Hindi that both T and *v* are Case assigners, but only T has a  $\phi$  probe.

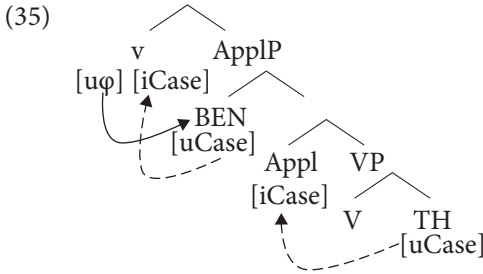

This again highlights the logical separation of nominal licensing (Case) and  $\phi$  agreement, as already discussed in Chapters 3 and 4. If  $\phi$  and Case are logically separate, then we can understand the unique situation of Sambiaa. In all the other combinations of object marking parameters in Table 5.3,  $u\phi$  operates together with *iCase* (further discussed later in this chapter, and see Section 3.6.3 in Chapter 3), and *iCase* can be present by itself, but Sambiaa (asymmetric multiple OM) presents the exceptional situation of a  $u\phi$  probe independent of an *iCase* feature, as shown in Table 5.4.

With this analysis of a second  $\phi$  probe on *v*, the research questions can now be answered: Sambiaa has multiple object marking because it has multiple sets of  $u\phi$  features, and it is asymmetric because the second set of  $u\phi$  features is located not on Appl but on *v*. Case licensing is still taken care of by both *v* and Appl, as in all other languages. This split between Case licensing and  $u\phi$  features is rare, making Sambiaa appear as an exception to the AWSOM correlation.

The rarity of the split between Case and  $\phi$  can potentially be understood from the point of view of acquisition. In order to set parameters and to discover the uninterpretable features in their language, acquirers need a certain amount of clear form–meaning correlations (the ‘Linking Problem’, see Biberauer 2017a, 2019; Biberauer & Roberts 2017; Fasanella & Fortuny 2016; among others). In Bantu languages, morphology in the form of subject and object markers forms a strong clue to deduce the underlying structure and features. The mismatch between the observed  $\phi$  agreement and Case licensing would thus appear to be suboptimal for easy acquisition, explaining the tendency for

**Table 5.4** Featural distribution in 4 types of languages for symmetry and number of object markers

	Multiple	Single
asymmetric	v: Case- $\phi$ $\boxed{+ \phi}$ Appl: Case	v: Case- $\phi$ Appl: Case
symmetric	v: Case- $\phi$ Appl: Case- $\phi$	v: Case- $\phi$ Appl: Case

Case and  $\phi$  agreement to go together. This line of reasoning makes testable predictions for acquisition (on which we have no data whatsoever for Samba), as well as relative diachronic instability (where a comparison between earlier sources such as [Roehl 1911](#) and [Riedel 2009](#) could have given a small amount of time-depth, but Roehl does not provide conclusive data). A study of local microvariation may be worthwhile.

### 5.1.6 Summary

The parameterization of  $\phi$  features as proposed in this section accounts for the crosslinguistic variation in the presence of subject and object marking, as well as complementizer agreement and multiple object marking. Apart from the proposal that  $\phi$  features on Appl are responsible for multiple object marking, the parameterized presence of  $\phi$  probes on clausal heads has received quite a bit of discussion for Bantu languages ([Carstens 2005](#); [Carstens & Diercks 2013](#); [Henderson 2006, 2011](#); [Diercks 2010, 2011](#); [Halpert 2015](#); [Riedel 2009](#); [Zeller 2008](#); among others). What makes the current proposal interesting are four further points.

First, it clearly shows an implicational relation between Case-licensing heads, where  $\phi$  features can only be present on Appl if both *v* and *T* also have  $\phi$  features, and *v* can only have  $\phi$  if *T* does so too. The systematic comparative approach also shows that the presence of  $\phi$  features on *C* is an independent parameter. Second, the distribution of  $\phi$  probes on lower heads predicts the AWSOM correlation as well as the rarity of Samba's exception. This shows again that Case licensing and  $\phi$  agreement are logically independent, even if there is a strong tendency for these two to co-occur. Third, a featural approach is in line with the Borer–Chomsky conjecture, which states that syntactic operations are invariant and that crosslinguistic variation is due to differences in the lexicon (including functional features), which need to be acquired anyway. This means that we can pinpoint more precisely where morphosyntactic variation is located. Fourth, and related to the previous point, the implicational relation between  $\phi$  probes on heads, as well as the co-occurrence of Case and  $\phi$  agreement, can be understood as emerging from acquisitional principles. As mentioned, the tendency for Case and  $\phi$  agreement to go together could be due to the need for clear cues in the input, such as spelled-out morphology, in order to deduce the presence of formal features (see also [Section 5.3](#)). The implicational relation between the presence of  $\phi$  probes on *T*, *v*, and Appl

can be captured in a parameter hierarchy, assuming two learning biases (FE and IG) to guide the path of parameter setting involving ever smaller and more specified subsets of features.

The variation in the presence of  $\phi$  features on functional heads across Bantu languages is thus an important set of parameters, determining much of the characteristic Bantu agreement. A second important aspect that came to the fore in the previous chapters was salience features, specifically Person and Topic. These are discussed in Section 5.2.

## 5.2 Salience features

There are two points in the analysis where salience features (Person and Topic) were invoked in explaining crosslinguistic variation. The first is doubling (and also differential) object marking, as discussed in Chapter 2, and the second is flexible argument licensing for double objects (symmetry, Chapter 3), and for the external argument (subject inversion, Chapter 4). I briefly recap both here, before presenting and analyzing a typological gap in parameter settings.

### 5.2.1 [Person] in doubling object marking

Under Roberts' (2010) defective goal approach, a  $\phi$  probe on a head agrees with the interpretable  $\phi$  features of an argument, sharing the feature values of this argument (standard Agree); if the features of the argument are a subset of those on the probe (a defective goal, typically a  $\phi$ P pronoun), the relation is similar to a movement chain and only the higher set of features will be spelled out, that is, the features on the head. In Bantu languages, features on T will spell out as a subject marker, and features on v (and Appl) as an object marker. Whether an object marker is present thus depends on the goal: if the goal is a defective  $\phi$ P, little v's  $\phi$  features will spell out as an object marker, and if the goal is a DP, little v's  $\phi$  features remain unpronounced and the DP itself is spelled out.

However, in some languages, DPs have an extra layer. This was proposed in Chapter 2 to be a separate Person layer (following Höhn 2017), where Person is associated with animacy, definiteness, and/or givenness, extending Richards' (2008/2015) analysis of Person.

(36) Person feature associated with animacy, definiteness, and/or givenness

	Animate/Definite/Given	Inanimate/Indefinite/New
1	✓	✗
2	✓	✗
3	✓	✓

DPs referring to referents on the high end of the animacy, definiteness, and/or givenness scales have a Person feature. In languages where Person forms a separate layer, as in (37), the probe agrees with this layer, if present. As the features in this layer are a subset of those on the probe, the features on the probe will be spelled out, but the DP itself will be spelled out too. The result is an overt object marker as well as an overt DP, that is, a ‘doubling’ of the argument’s features on the verb.

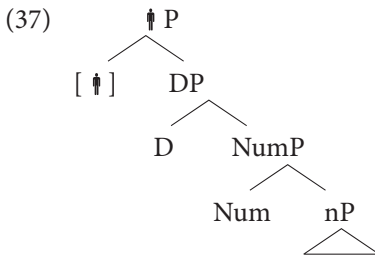

The important point for our typology is the parameter for doubling vs non-doubling: in doubling languages, that is, where the object marker and coreferring object DP can (and sometimes must) appear in the same domain, the salience feature [Person] forms a separate projection. In non-doubling languages, [Person] is located on D, and the object marker and coreferring DP can never occur in the same domain.

Therefore, in a typology for doubling object marking, we can split the Bantu languages as in Table 5.5 (where languages are classified as ‘doubling’ if any DPs are obligatorily doubled, even if not all DPs can be doubled).

### 5.2.2 Symmetry as flexible nominal licensing

I proposed in Chapter 3 that symmetric object marking, where either object in a double object construction can be object-marked, is due to Appl’s flexibility in licensing either an argument in its complement, or the argument it introduces in its specifier. Which argument is licensed by Appl is dependent on the relative salience of these arguments in terms of animacy and topicality.

**Table 5.5** Parameterization of Bantu languages according to the nature of the object marker

non-doubling	doubling	doubling unknown
Bembe, Herero, Swati, Zulu, Sotho, Tharaka, Ikalanga, Kuria, Tswana, Kinyarwanda, Kirundi, Haya (Byarushengo), Luganda, Kinande, Kikuyu, Maragoli, Mongo, Ciluba, Xhosa, Totela, Lugwere, Changana, Dzamba, Mbuun, Kimbundu, Runyankore-Rukiga, Fuli-iru, Luruuli, Oshindonga, Nsong	Makhuwa, Swahili, Kiyaka, Chichewa, Tumbuka, Chimwiini, Bemba, Sam-baa, Ruwund, Kagulu, Yao, Chingoni, Cuwabo, Lozi, Lubukusu, Haya (Riedel), Chaga, Nyaturu, Kiluguru, Ekoti, Manyika, Rangi, Shimakonde, Makwe, Lika, Lucazi, Matengo, Nyamwezi, Mbugwe, Kikamba	Lunda, Nsenga, Ha, Digo, Gitonga, Kimeru, Ndebele, Umbundu

The features associated with animacy and topicality are [Person] and [Topic] respectively. Thus, in asymmetric languages Appl's licensing is independent of [Person] and [Topic] and remains default downwards, whereas in symmetric languages Appl is dependent on the [Person] and [Topic] features of the argument that it introduces in its specifier and is therefore on the one hand more restricted in which arguments it can license, and on the other hand more flexible because not just the c-commanded Theme but also the Benefactive in the specifier can be licensed by Appl. This sensitivity to [Person] and [Topic] needs to be established for each lower functional head (Caus, HAppl, LAppl) as they can vary in this property from language to language and language-internally (see Section 3.7 in Chapter 3). The important point here is that symmetric object marking is the result of a sensitivity of a clausal head to the salience features [Person] and [Topic].

This parameter again splits the Bantu languages into two groups (where languages are classified as symmetric if the Theme can be individually object-marked in a ditransitive construction, even if not all constructions are symmetric), as shown in Table 5.6.

### 5.2.3 Interaction between doubling and symmetry (the RANDOM)

Combining these two parameters (the nature of the object marker and the behaviour in ditransitives), we discover a very interesting gap, as shown in Table 5.7.

**Table 5.6** Parameterization of Bantu languages according to the behaviour in ditransitives

asymmetric	Makhuwa, Swahili, Kiyaka, Chichewa, Tumbuka, Chimwiini, Bemba, Sambaa, Ruwund, Kagulu, Yao, Chingoni, Lunda, Tumbuka, Matengo, Lika, Nsenga
symmetric	Bembe, Herero, Swati, Zulu, Sotho, Tharaka, Shona, Kuria, Tswana, Kinyarwanda, Kirundi, Haya, Luganda, Kinande, Kikuyu, Maragoli, Mongo, Ciluba, Xhosa, Totela, Lozi, Lubukusu, Chaga, Nyaturu, Kiluguru, Ha, Digo, Gitonga, Changana, Ndebele, Kimeru, Lugwere, Dzamba, Runyankore-Rukiga, Kimbundu, Mbuun, Fuliiru, Oshindonga, Umbundu, Cuwabo, Kikongo, Changana, Haya
symm unknown	Ekoti, Rang, Shimakonde, Makwe, Lucazi, Nyamwezi, Digo, Mbugwe, Kikamba, Nsong

**Table 5.7** Interaction between doubling and symmetry in Bantu languages

	non-doubling	doubling	doubling unknown
asymmetric		Makhuwa, Swahili, Kiyaka, Chichewa, Tumbuka, Chimwiini, Bemba, Sambaa, Ruwund, Kagulu, Yao, Chingoni, Matengo, Lika	Lunda, Nsenga
symmetric	Bembe, Herero, Swati, Zulu, Sotho, Tharaka, Shona (Ikalanga), Kuria, Tswana, Kinyarwanda, Kirundi, Haya (Byarushengo), Luganda, Kinande, Kikuyu, Maragoli, Mongo, Ciluba, Xhosa, Totela, Changana, Lugwere, Dzamba, Mbuun, Kimbundu, Runyankore-Rukiga, Fuliiru, Luruuli, Oshindonga	Lozi, Lubukusu, Haya (Riedel), Chaga, Nyaturu, Kiluguru, Shona (Manyika), Cuwabo	Ha, Gitonga, Kimeru, Ndebele, Kikongo, Umbundu
symm unknown	Nsong	Ekoti, Rang, Shimakonde, Makwe, Lucazi, Nyamwezi, Mbugwe, Kikamba	Digo
no OM	Duala, Eton, Basaa, Nen, Nyokon, Nzadi		

This newly discovered typological pattern can be captured as the RAN-DOM:<sup>12</sup>

<sup>12</sup> Riedel (2009: 82) states that 'Chichewa does not have obligatory object marking and does not allow doubling of the object marker with a local object. This shows that there is no predictable correlation

(38) *Relation between Asymmetry and Non-Doubling Object Marking (RANDOM)*

All non-doubling languages allow symmetric object behaviour.

Languages without symmetric object behaviour always allow doubling.

With the featural analysis of doubling and symmetry, we can restate the RANDOM as follows:

## (39) In all languages that do not have a separate Person layer in the DP, Appl is sensitive to Person/Topic.

Languages in which Appl is not sensitive to Person/Topic always have a separate Person layer in the DP.

What in turn emerges from this formulation of the RANDOM is that salience features (Person and Topic) need to be present either on the DP, that is, the non-clausal domain, or on a head, that is, the clausal domain, or both, in any Bantu language. This can be generalized as follows:

## (40) Bantu languages obligatorily mark salience in the clausal and/or non-clausal domain.

Going beyond explanatory adequacy, we may now examine the motivation for the fact that salience plays such an essential role in Bantu object marking. If we look at this again from an acquisition perspective, we see that object markers as used by adult speakers (i.e. in the input for acquirers) are indicators of salience in one way or the other: it is never the case that any and all objects are object-marked, and the task of the acquirer is thus to discover which objects are marked in the language they are acquiring. In other words, they have to deduce where to formally postulate the feature responsible for the object marking pattern in their language. There are two possibilities: if the evidence in the input shows that object marking depends on the salience of the DP object (that is, objects are marked if they are animate, given, definite), then it makes sense to postulate the responsible feature on the DP. As soon as an acquirer has figured this out, their grammar will allow doubling object marking. If on the other hand the evidence shows that object marking depends on the relative salience of two arguments (that is, the Benefactive or Theme are object-marked when topical or animate), then the acquirer can straightforwardly postulate the responsible feature on the pivot, the (Appl) head connecting them, resulting in symmetric object marking.

between asymmetry and [doubling, JW]: As described in Chapter 2, Chichewa behaves as a doubling language, which means that – at least for the languages considered here – there is a relation.



In summary, object marking in Bantu languages is always connected to salience in the form of the features Person and Topic. This results in a necessary acquisition of these formal features in the clausal and/or non-clausal domain, which in turn causes a gap that can be described as the RANDOM.

#### 5.2.4 Only one route of parametric change

The RANDOM not only provides an insight into the obligatory nature of marking salience and therefore the influence of formal features [Person] and [Topic] in the syntax of Bantu languages, but the geographical distribution of the parameter settings that are combined in the RANDOM also reveals a striking pattern. Languages with non-doubling symmetric object marking occur in the north and south of the Bantu-speaking area, whereas languages with doubling asymmetric object marking occupy the central area. The languages with doubling symmetric object marking occur right in between these areas. [Map 5.1](#) shows this distribution.

This distribution holds important information for the diachronic picture. Assuming that Proto Bantu, or at least some common ancestor of most Bantu languages,<sup>13</sup> had object marking ([Meeussen 1967](#)), this was necessarily either doubling or non-doubling, and either symmetric or asymmetric. For both parameters we may thus ask which setting was the original, and which is the innovation.

In theory, either setting can be derived from the other, and for the doubling parameter both developments have been proposed. [Givón \(1976\)](#) claims that languages start with non-doubling object marking, where a pronoun on the verb refers to the same referent as a topical, dislocated noun phrase, as in ‘the man, I saw him’ or ‘I saw him, the man’ (see also [Chapter 2, Section 2.3](#)). Since topics are likely to be animate and definite, the pronoun on the verb can be reinterpreted as an agreement marker, doubling only animate and/or definite referents (41a). [Bentley \(1995\)](#) proposes the opposite order of development, where object marking starts out as a cross-reference of animate objects on the verb. Since such cross-reference is a redundant marking of the same features, she reasons, the object marker is reinterpreted as a pronoun, and the coreferencing free pronoun is now interpreted as emphatic (41b).

<sup>13</sup> See [Gensler \(1994, 1997\)](#) and [Güldemann \(2007\)](#) on preverbal objects in Benue-Congo, and the implications for word order, interpretation, and object marking. See [Güldemann \(2017\)](#) for arguments that the object marker as a morphological marker should not be reconstructed to Proto Bantu, even if Proto Bantu likely had preverbal object pronouns referring to given entities.



**Map 5.1** Distribution of parameter settings for doubling and symmetry.

(41) *Hypotheses for development of Bantu object marking*

- a. Non-doubling -> doubling (Givón 1976)
- b. Doubling -> non-doubling (Bentley 1995)

If we look at the map, the geographical distribution strongly suggests that non-doubling is the older parameter setting and doubling the innovation, because it is unlikely that the non-doubling system developed independently as an

**Table 5.8** Possible and impossible path of diachronic change from non-doubling symmetric to doubling asymmetric object marking

	non-doubling	doubling
asymmetric		Makhuwa, Swahili, Kiyaka, Chichewa, <del>Tumbuka</del> , Chimwiini, Bemba, Samba, Ruwund, Kagulu, Yao, Chingoni, Matengo, Lika
symmetric	Bembe, Herero, Swati, Zulu, Sotho, Tharaka, Shona (Ikalanga), Kuria?, Tswana, Kinyarwanda, Kirundi, Haya (Byarushengo), Luganda, Kisanande, Kikuyu, Maragoli, Mongo, Ciluba, Xhosa, Totela, Changana, Lugwere, Dzamba, Mbuun, Kimbundu, Runyankore-Rukiga, Fuliiru, Luruuli, Oshindonga	Lozi, Lubukusu, Haya (Riedel), Chaga, Nyaturu, Kiluguru, Shona (Manyika), Cuwabo

innovation in both the north and the south (the principle of lateral continuity). This gives credence to [Givón's \(1976\)](#) proposal (see also [Güldemann 2007](#)) and argues against [Bentley's \(1995\)](#).

With the same reasoning, the geographical distribution supports [Wald \(1991, 1994\)](#) in his claim that symmetric object marking is the older parameter setting, since symmetry is found in both the north and the south, with asymmetry emerging as an innovation in the centre (contra [Polak 1986](#)).

Taken together, the patterns of geographical distribution of the two RANDOM parameter settings suggests that languages change from being non-doubling symmetric to doubling asymmetric. Moreover, the gap in the table suggests that this change only takes one route: via doubling symmetric and never via non-doubling asymmetric. This is represented in [Table 5.8](#): across Bantu, object marking changes first from non-doubling to doubling, and then from symmetric to asymmetric.

The geographical distribution shows that these changes happen in two waves that closely follow each other (we can think of [Trudgill's 1994](#) Gravity model or [Labov's 2001](#) Cascade model). The first change is from symmetric non-doubling to symmetric doubling (horizontal in the table) and consists of creating a separate Person layer on the DP. The second change is from symmetric doubling to asymmetric doubling and consists of losing the sensitivity to Person and Topic on Appl. *Why* the changes happen *in that order* can be understood as result of salience being an indispensable property in acquisition, as described in [Section 5.2.3](#): salience must be present in some part of the object-marking system, making it highly unlikely that an acquirer ever arrives

at the top left cell of non-doubling asymmetry. *How* the changes happen is another interesting question, which receives a partial answer if we take a closer look at the languages in the ‘in-between’ category of doubling symmetric languages, that is, languages that have salience in both the clausal and non-clausal domain. I discuss these in some detail.

The fact that languages with this combination of parameter settings are scarce (the bottom right cell in Table 5.8 is less populated than the top right and bottom left) suggests that this is a relatively unstable situation to be in for a language. Indeed, all the languages in this category show in-between steps of development. For example, object marking in Lozi appears as doubling but never obligatory (Fortune 2001 [via Marlo 2015b]; Kashina 2005; Marten et al. 2007). The same non-obligatory nature is described for Haya by Riedel (2009), and it is interesting to note that some 30 years earlier, Duranti and Byarushengo (1977) analyzed Haya as non-doubling. If both analyses of Haya are correct, this is a potential case where we see the switch from non-doubling to doubling happening as we speak. Furthermore, it suggests that languages start doubling as a non-obligatory phenomenon, possibly doubling just those referents that are given. Kidima (1987) describes object marking in Kiyaka as determined by old information and topicality, though it remains unclear whether object marking in Kiyaka is doubling or non-doubling. Manyika allows doubling object marking of given referents (Bax & Diercks 2012), as shown in (42), repeated from Chapter 2: (42a) without the object marker is felicitous when the verb, the object, or the VP is in focus (as diagnosed by a contextualizing question), whereas (42b) with the object marker is only felicitous when the object is not included in the focus.

Manyika (S10, Bax & Diercks 2012)

- (42) a. Tendai w-aka-wereng-a bhuku nekukasika. *non-doubled*  
 1.Tendai 1F.SM-PST-read-FV 5.book quickly  
 ‘Tendai read the/a book quickly.’
- b. Tendai w-aka-ri-wereng-a bhuku nekukasika. *doubled*  
 1.Tendai 1F.SM-PST-5OM-read-FV 5.book quickly  
 ‘Tendai read the (particular) book quickly.’  
 ✓answer to ‘What did Tendai do with the book?’ (V foc)  
 \*answer to ‘What did Tendai do?’ (VP foc)  
 \*answer to ‘What did Tendai read?’ (O foc)

Doubling only given/accessible/non-focal objects may appear to be optional and non-obligatory if one does not spot the subtle differences in information

structure. This can be seen as the first stage of object doubling, before languages may ‘enter’ one of the scales of animacy or definiteness. When they do, they start at the high end of these scales, where for example Lubukusu (Sikuku et al. 2018) and Chaga (Moshi 1998) are now: in both these languages, independent pronouns need to be object-marked, but object-marking is otherwise non-obligatory (see Chapter 2). The addition of Person as a separate layer on the DP thus seems to proceed first from non-obligatorily marking given referents to the high end of the definiteness hierarchy and proceed from there along the hierarchy (as for example Nyaturu, which is also doubling symmetric).

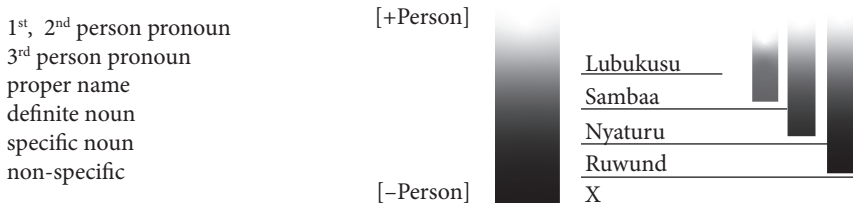

Finally, in Kiluguru, object marking is obligatory for some predicates, showing a restriction in doubling. Kiluguru also shows partial symmetry, because it is described as asymmetric for causatives and applicatives, but symmetric for lexical ditransitives – again evidence for the step-by-step nature of these developments. And similarly for Lubukusu, which is symmetric for lexical ditransitives and applicatives, but not causatives.

This closer look at the ‘in-between’ languages with symmetric doubling object marking reveals that the changes do not happen in one fell swoop but step by step, gaining doubling for some categories before others, and perhaps also losing symmetry gradually.

The sequence of changes can then potentially be understood as follows. When speakers of a symmetric non-doubling language start doubling objects (for whichever reason, perhaps because of contact with a neighbouring doubling language), the objects that are doubled are high in salience (given, definite, animate). These are usually also the highest of two objects, since Benefactives (and related semantic roles) are typically definite and animate. As a result, it will very often be the case that the higher object must be marked. In a language with only one object marker, the object marker will therefore, in the majority of clauses, refer to the highest object, regardless of the relative topicality of the two objects. This in turn means that the Theme will be object-marked increasingly infrequently, and that there are fewer and fewer indications in the language for symmetric object marking, making it difficult for acquirers

to pick up firm evidence from the input for the influence of Person and Topic on lower functional heads. As soon as a large enough number of acquirers miss this crucial input, the change from symmetric to asymmetric for the clausal parameter is a fact. One parameter change (from non-doubling to doubling) can thus naturally lead to another parameter change (from symmetric to asymmetric).<sup>14</sup>

### 5.2.5 A hierarchy for flexible licensing

Returning to the distribution of salience features, we noted in Chapter 3 that there seems to be an implicational hierarchy between lower functional heads with respect to their symmetric object marking (the FLUID). This can potentially also be understood with the none-all-some logic as applied to  $\phi$  features in Section 5.1. As proposed in Van der Wal (2017: 138), the hierarchy for ditransitive alignment could look as in (43). Here, ‘low functional heads’ are any heads within the vP that both license and introduce an argument,  $\partial$  is short for Person and/or Topic (à la Miyagawa 2010), and Case+ $\partial$  refers to the head’s licensing ability coming with the Person and/or Topic feature (value) equal to those of the argument it introduces.

(43) *Parameter hierarchy for (a)symmetry in ditransitive alignment*

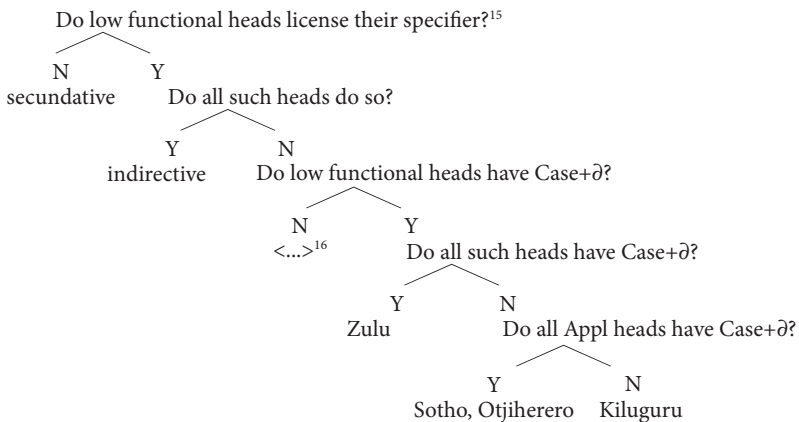

<sup>14</sup> Note that the same logic does not apply to languages with multiple object markers, for which I have no concrete suggestions about their diachronic development.

<sup>15</sup> Note that this formulation does not refer to features as such, and should therefore be adjusted if it is to be compatible with the BCC. The same applies to the hierarchy in (45).

<sup>16</sup> This is a theoretical possibility, representing flexible licensing that is sensitive to other factors.

As concluded in Chapter 4, the flexible licensing by *v* (resulting in subject inversion) is a parameter that is set independently of the lower heads, much like  $\mu\phi$  on C is set separately from the other heads, which *are* connected by an implicational relation. We thus add another parameter, which by itself is rather uninteresting:

- (44) Does *v* have Case+ $\partial$ ?
- 
- ```

graph TD
    A[Does v have Case+∂?] --- B[N]
    A --- C[Y]
    B --- D[Chichewa, Makhuwa]
    C --- E[Zulu, Dzamba]
  
```

It can potentially, however, form part of a larger hierarchy concerning monotransitive alignment (see Sheehan's 2014 parameter hierarchy for alignment, which works slightly differently). Assuming with Aldridge (2004); Legate (2008); and many others (see overview in Sheehan 2017) that ergative alignment reflects *v* licensing the external argument in its specifier, the Bantu subject inversion constructions that are due to flexible licensing by *v* can be seen as a type of split agreement alignment. The hierarchy still follows the same path of setting the dependent parameters, where the second parameter 'Does *v* always license its specifier?' can be read as 'Do all *v* (transitive, intransitive) license their specifier?', if one would want to keep the none-all-some sequence strictly (see also discussion in Roberts 2019, Chapter 6):

- (45) *Parameter hierarchy for monotransitive alignment*

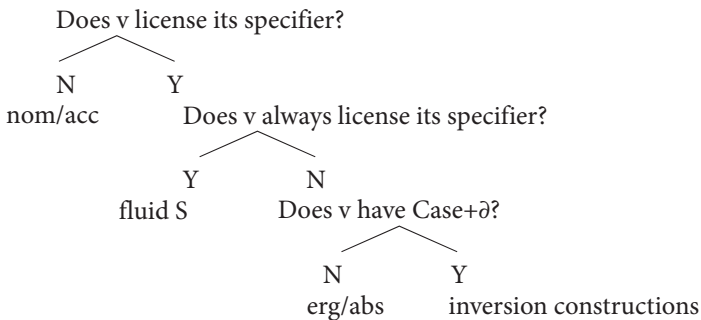

This perspective on flexible licensing as being a type of alignment is not unfamiliar: Ura (2000); Morimoto (2006); and Bostoen and Mundeke (2011) analyzed OVS inversion constructions in Bantu as 'inverse voice', (and see Givón (1994) for an application in a broad sense including information structure). Connecting this to licensing and ergativity in a formal way has not been proposed, though, and it remains to be seen how the implications following from this tentative proposal hold up.

## 5.2.6 Inversion without dedicated features

Continuing to focus on the influence of salience features in subject inversion constructions, I want to present a case study which highlights another point of theoretical importance: not all surface effects are caused by syntactic features. The case study concerns subject inversion in Matengo and Makhuwa, as analyzed in [Van der Wal \(2012\)](#). Both languages display superficially highly similar agreeing inversion: the subject appears in a linearly postverbal position, the subject marker on the verb agrees with the postverbal subject, and the subject is interpreted as non-topical. This is illustrated for Matengo in (46) and Makhuwa in (47).

Matengo (N13, [Yoneda 2011](#): 759)

- (46) CJ Ju-a-lwal-aje mwaná gwa.  
 1SM-PST-suffer-CJ 1.child 1.my  
 ‘My child was sick.’

Makhuwa (P31, [Van der Wal 2009](#): 189)

- (47) DJ Ni-hoó-w-á nláikha.  
 5SM-PFV.DJ-come-FV 5.angel  
 ‘There came an angel.’

As expected, both languages also allow SV order, where the subject marker agrees with the preverbal subject (as in other Bantu languages). One of the questions is thus what triggers the subject DP to move to a preverbal position. At first sight, it appears that movement cannot be due to the association of a movement trigger (EPP feature) with the  $\phi$  features on T (as in [Carstens 2005](#)), given that in languages with agreeing inversion, T always agrees with the subject, whether or not the subject then moves to its specifier. An alternative would be to associate the movement trigger with a [Topic] feature on T, motivated by the interpretation of preverbal subjects (and other DPs) as topical. Under this hypothesis, it follows that non-topical subjects will not be targeted by the movement trigger, thus remaining *in situ* and being spelled out in a postverbal position.

However, upon closer inspection, it appears that the underlying structures are different for the two languages, as argued for in [Van der Wal \(2012\)](#). In Matengo, the postverbal subject is vP-internal (50). This results in VS(O) word order (48), and requires a conjoint verb form, which is associated with the presence of an element in the vP (see [Yoneda 2017](#) for the conjoint/disjoint alternation in Matengo). The sentence is ambiguous between athetic or a



subject-focus interpretation, as illustrated by the different contexts given for (49).

Matengo (N13, Yoneda 2011: 763)

- (48) CJ Ju-a-teleka María wâ:le. VSO  
 1SM-PST-cook/SF 1.Maria 9.rice  
 ‘Maria cooked rice.’  
 CJ ?\*Juateleka wáli Marî:a. VOS

- (49) CJ Ju-híkítí Marî:a.  
 1SM-arrive.PFV 1.Maria  
 ‘Maria has come.’  
 – as an answer to a. ‘What happened?’  
 b. ‘Who has come?’

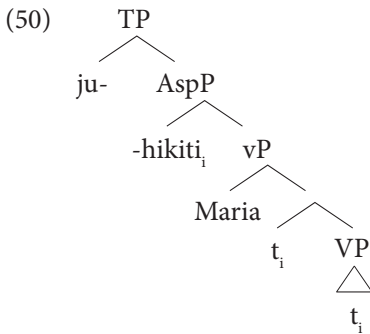

In Makuwa, on the other hand, the subject is raised to specTP (and possibly higher to a separate projection like FinP), followed by remnant movement of the verb and its complement, as shown in the subsequent steps in (53b, c); see also Chapter 4. This results in V(O)S word order (51), the use of the disjoint verb form, and *only* athetic interpretation, but not narrow focus, as shown by the impossibility of modifying the postverbal subject with the focus particle ‘only’ (52).

Makuwa (P31, Van der Wal 2009)

- (51) Oo-vár-á ephepélé naphúl’ úule VOS  
 1SM.PFV.DJ-grab-FV 9.fly 1.frog 1.DEM.DIST  
 ‘That frog caught a fly!’

- (52) a. \*Aa-váh-íy-a ekanétá anámwáne paáhi. VOS  
 2SM.PFV.DJ-give-PASS-FV 10.pens 2.children only  
 int: ‘Only the children were given pens.’

- b. Aa-váh-íy-a                      ekanétá    anámwáne.  
 2SM.PFV.DJ-give-PASS-FV    10.pens    2.children  
 ‘The children were given pens.’

- (53) a. Waa-nú-mwááryá    mweéri.  
 3SM.PST-PERS-shine    3.moon  
 ‘The moon was shining.’

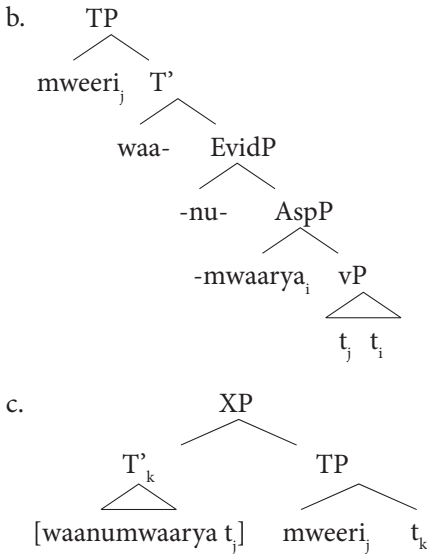

This shows that in Matengo the linearly postverbal subject is *in situ* in a vP-internal position, whereas in Makhuwa the subject always raises to specTP, but is followed by remnant movement of the whole verbal complex to establish the inverted order with a linearly postverbal subject. Superficially similar constructions like agreeing subject inversion may thus not have the same underlying structure (*in situ* vs raised) or the same interpretation (thetic or also narrow focus) – what you see is not what you get.

Associating the movement trigger with a [Topic] feature would make the wrong predictions both for Makhuwa and for Matengo. In Makhuwa, movement of the subject to specTP happens regardless of the interpretation as a topic or not. That is, the movement trigger is present on T (as a subfeature on the  $\phi$  features of T) in Makhuwa anyway: T has  $\phi$  features and a movement trigger, but no [Topic]. In Matengo the association between structural position and interpretation seems stronger: the postverbal subject in specvP is focal or thetic (54b), whereas the preverbal subject is usually interpreted as the topic (54a).

Matengo (N13, Yoneda 2011: 756)

- (54) a. Nkongu gu-hábwí:ke.  
           3.tree      3SM-fall/PF  
           (As a comment on a particular tree) ‘The tree has fallen down.’
- b. Gu-hábwiki níko:ngo.  
           3SM-fall/PF    3.tree  
           (As athetic sentence) ‘A tree has fallen down.’  
           (Answer to ‘What has fallen down?’) ‘A tree has fallen down.’

Associating the movement trigger with a [Topic] feature, however, would predict that all preverbal subjects are topical and that only topical subjects can be moved to specTP. This turns out not to be the case: according to Yoneda (2011), in transitive sentences the subject must be moved if it is not focal. That is, the subject in SVO order is not necessarily topical, but can be said to have an underspecified non-focal interpretation in transitives (55a).

Matengo (N13, Yoneda 2011: 761)

- (55) As an answer to ‘what happened?’
- a. Mundu ju-hikití ku-nyû:mba.  
           1.person 1SM-arrive/PF 17-9.house  
           ‘Someone has come to the house.’
- b. \*Ju-hikití mundu ku-nyû:mba.  
           1SM-arrive/PF 1.person 17-9.house

Given these data, it becomes less attractive to postulate a [Topic] feature on T in Matengo. For the associated movement in Matengo we can alternatively assume an optional movement trigger on T that is not associated with any information-structural feature, but that must – by Interface Economy (Reinhart 2006) – influence the interpretation: only if the movement trigger is present is the subject moved, receiving a topical interpretation in intransitive clauses, but an underspecified non-focus interpretation in transitive clauses. In Matengo, T only has  $\phi$  features, no [Topic], and an optional movement trigger.

On the basis of the data from subject inversion, then, there is no evidence to postulate a formal, grammaticalized [Topic] feature in either language, even if the pragmatic notion of topicality does play a role. That is, the language acquirer does not receive input from subject inversion for the presence of [Topic], and neither do we as language modellers. The Makuwa/Matengo case study hence also highlights a methodological point: in order to see whether features like [Topic] are present in the derivation (i.e. whether they are grammaticalized as syntactic formal features), we need to answer the following questions:

1. Are the superficially similar phenomena (i.e. a certain linguistic strategy with a certain information-structural interpretation) structurally the same?
2. Is there an alternative analysis that makes use of fewer features? (i.e. is it necessary to postulate a feature at all? = feature economy)
3. Is there evidence that the feature is a *formal* feature? (i.e. if a feature is postulated, what is the nature of the feature?)

These are essential preliminaries for a featural account of the crosslinguistic variation found in the morphosyntactic expression of information structure and discourse-configurationality. Given the premise of the Minimalist Framework, the best model is one with 1. as few features as possible, and 2. a good motivation for the presence of the features as formal features. This is the topic of a broader theoretical discussion that I briefly address in Section 5.3 as a way of concluding the book.

### 5.3 Looking ahead: What is needed

The parameter settings for each of the features presented here are obviously not the same for all languages (or else they would not be parameters), but the variation runs deeper: even the features themselves are not taken to be universal (following the work by Biberauer on emergent features). Not every feature is present in every language. If the logic behind the parameter hierarchies holds true, that is, if language acquisition follows a path that is guided by Feature Economy and Input Generalization, then it is expected that not all features are present as formal features in all languages. Some languages will therefore have, for example, evidentiality as a formal feature in the syntax, whereas other languages, while able to express the source of information, do not have it grammaticalized as part of their formal feature inventory.

This point of view naturally follows if we take a serious minimalist approach to syntax (Chomsky 1993, 1995, 2000, 2005). The starting point should be that UG is minimally specified, perhaps consisting of only one operation (Merge), and that the overall model for Language and individual languages should be as simple as possible. As and when further patterns in a given language are encountered that cannot be accounted for with the minimalist model, something has to be added to the model. Studying syntax from a minimalist perspective should not mean that the grammar is fixed at one, two, or any other number of operations and features universally, but that the model we develop to understand the structures in the languages of the world (with all their

commonalities and variation) should be as simple as possible while accounting for the data attested, or indeed, as the name suggests: the model should be minimal. Our theory formation should work in exactly this way, from zero to the minimal necessary, rather than taking as a starting point the presence of a large number of operations and features, potentially discovering that they play no vital role in the grammar of a given language.

This line of thinking goes against the (Strong) Uniformity Hypothesis (Chomsky 2001), as advocated by Miyagawa (2010, 2017).

(56) Strong Uniformity (Miyagawa 2010: 12)

All languages share the same set of grammatical features, and every language overtly manifests these features.

Miyagawa (2010: 12) himself notes that this cannot be right for all features in a language, as evidently there is variation. Nevertheless, in his exploration Miyagawa assumes that all languages have  $\phi$  features and topic/focus features ( $\partial$ ), and that the variation is located in the inheritance from C to T of either, both, or neither feature. Miyagawa thus extends É.Kiss' (1995) and Li and Thompson's (1976) research quest into the nature of discourse configurationality, making an important step forward in comparative syntax by taking seriously the potentially profound influence topic and focus may have on the syntax. Considering the further variation studied in this book, and advancing from Miyagawa's starting point, it is now time to reconsider and ask which features are or are not present in the syntax of a given language.

On the other extreme, the view explored here also goes against the Strong Modularity Hypothesis as advocated by Chomsky (2008); Berwick and Chomsky (2011); Fanselow (2006); Fanselow and Lenertová (2011); Horvath (2010):

(57) Strong Modularity

Narrow syntactic operations cannot be influenced by information-structural factors.

No discourse notion can be encoded by formal features.

The Bantu languages show clear counterevidence to Strong Modularity, since information-structural notions do affect the syntax (see also Aboh 2010). This is the case for subject and object marking, as explored in the previous chapters, but also, for example, for passive formation (Bostoen & Mundeke 2011; Ham-laoui & Makasso 2015; Van der Wal 2015a; among others), and for verbal inflection and transitivity in the conjoint/disjoint alternation (see overview in Van der Wal & Hyman 2017). Again, we need to go beyond this attractive but overly simple view and appreciate how languages vary in whether aspects of information structure are grammaticalized as formal features.

We are thus in search of a model in which not all information-structural effects are due to formal features and in which languages may vary in this respect. There are two important parts in finding such a middle-way alternative: better data; and more insight into the parameter setting process.

The first part, data, insists on a more detailed knowledge of which precise information-structural features affect the syntax in each individual language, on a more detailed level than just ‘topic’ and ‘focus’. We now know that there is more variation than simply the notion of ‘topic’ (Frascarelli & Hinterhölzl 2007; among others), that simple focus differs from exhaustive focus (e.g. for Hungarian É.Kiss 1998; Horvath 2010, among others), that unexpectedness can play a role (e.g. Bianchi et al. 2016; Cruschina 2019), etc. Finding and interpreting these data will take some years and it is not possible yet to take this into account in the current model. In this book, I have thus maintained a broad notion of topicality, givenness, and simple focus (but specifying wherever I can).

The second part of exploring the crosslinguistic variation in the presence of information-structural features in the syntax involves the parameter setting process, as already discussed for the setting of  $\phi$  features. We thus hope to arrive at a model in which only what is needed is postulated in the syntax. A model based on this principle is still minimalistic, but much more realistic than a bare model of syntax that keeps only Merge (cf. Berwick & Chomsky 2011, 2016), that is, it can handle the complexity and variation found in human language.

In such a model, all language acquirers are hypothesized to start from the same underspecified situation, discovering the features of the language they are acquiring along the course of their acquisition. This is the spirit of Biberauer’s (2011, 2017b, 2018ab, 2019ab) neo-emergentist model of grammar. As discussed earlier, Biberauer proposes that language acquirers use the learning biases of Feature Economy and Input Generalization, resulting in a model whereby formal features are only postulated if there is enough evidence in the input. But once a feature is postulated, it will be made full use of. That is, acquirers ‘maximize minimal means’ (MMM). Inspired by Chomsky’s (2005) three factors in language design, Biberauer’s MMM model takes the following ingredients to arrive at the adult grammar.

- (58) Neo-emergentist model (Biberauer 2019a: 49)  
 UG + primary linguistic data (PLD) + Maximize Minimal Means  
 (MMM)= steady state grammar

In Biberauer’s model, UG provides the feature template, which might be thought of as [attribute: value] (e.g. [Person: 1]). The features themselves, however, are detected from the input, where features ‘are postulated if they

can be seen to regulate some form of systematic contrast' (Biberauer 2019a: 58), that is 'children are sensitive to systematic departures from Saussurian arbitrariness (arbitrary form–meaning mappings)' (Biberauer & Roberts 2015a: 8). The *formal nature* of a feature (rather than phonological or semantic), can be detected in at least four ways (Biberauer 2018b, 2019b; cf. Wiltschko 2014), which all need further research.

- a. Morphology without meaning: doubling in agreement and concord (see Zeijlstra 2008; Koenenman & Zeijlstra 2014)
- b. Meaning without morphology: ellipsis, null marking (e.g. of 'singular' or 'nominative')
- c. Multifunctionality of a morpheme depending on its structural position (e.g. Vietnamese modals, Duffield 2013, 2017)
- d. Movement without meaning (abstract movement trigger)

Not only parameters but also formal syntactic features are thus emergent in the grammar (see Roberts 2019: 99, 100 for discussion of Biberauer's proposals). This emergentist approach to morphosyntactic language variation shows compelling evidence suggesting that notions like time, location, or number are not universally part of the core grammar (Ritter & Wiltschko 2009, 2014; Wiltschko 2014). Instead, Wiltschko (2014) suggests broader notions such as 'anchoring an event in the world' as part of our language capacity, rather than 'tense'. I think we can extend this non-universalist approach and would like to suggest that a parallel can hold for information structure, where notions like 'exhaustivity' or 'emphasis' can be shown to grammaticalize in some but not other languages (as is more widely accepted for the notion of evidentiality, for example). This in turn would inspire a different perspective and a firmer grip on the notion of discourse-configurationality (É.Kiss 1995). Moreover, as Bazalgette (2015) has shown, it is possible and attractive to model the acquisition of focus features in this neo-emergentist way.

What the discussion of the Bantu languages in this book has shown is that the input that a Bantu acquirer receives provides the crucial evidence needed to detect not only that there is a salience feature in the first place, but also that this is a *formal* feature, affecting subject and object agreement as well as nominal licensing. What the discussion in this chapter has also provided is the insight that not all effects in information structure are due to formal syntactic features – all speakers need to express information structure, but not all information structure is in the grammar.

This leaves us with a rich research agenda of documenting information structure and syntax in languages around the world, and improving the theory to become a more encompassing model of the human language faculty, truly reflecting universal variation.



## APPENDIX

## Sources consulted for each language

---

|        |                |                                                                                                                                                                                                                                                                                                                                                             |
|--------|----------------|-------------------------------------------------------------------------------------------------------------------------------------------------------------------------------------------------------------------------------------------------------------------------------------------------------------------------------------------------------------|
| A43    | Basaa          | <a href="#">Hyman 2003a</a> ; <a href="#">Hamlaoui &amp; Makasso 2015</a>                                                                                                                                                                                                                                                                                   |
| A44    | Tunen          | <a href="#">Mous 1997, 2003, 2005</a>                                                                                                                                                                                                                                                                                                                       |
| A45    | Nyokon         | <a href="#">Mous 2014</a>                                                                                                                                                                                                                                                                                                                                   |
| A71    | Eton           | <a href="#">Van de Velde 2008</a>                                                                                                                                                                                                                                                                                                                           |
| B34    | Punu           | <a href="#">Bonneau 1956</a> ; <a href="#">Fontaney 1980</a>                                                                                                                                                                                                                                                                                                |
| B85d   | Nsong          | <a href="#">Bostoen &amp; Koni Muluwa 2019</a>                                                                                                                                                                                                                                                                                                              |
| B865   | Nzadi          | <a href="#">Crane et al. 2011</a>                                                                                                                                                                                                                                                                                                                           |
| B87    | Mbuun          | <a href="#">Bostoen &amp; Mundeke 2011, 2012</a>                                                                                                                                                                                                                                                                                                            |
| C322   | Dzamba         | <a href="#">Bokamba 1976</a> ; <a href="#">Eyamba Bokamba p.c.</a>                                                                                                                                                                                                                                                                                          |
| C60    | Mongo          | <a href="#">Hulstaert 1965</a>                                                                                                                                                                                                                                                                                                                              |
| C71    | Tetela         | <a href="#">Jacobs 1964</a>                                                                                                                                                                                                                                                                                                                                 |
| D20    | Liko/Lika      | <a href="#">Augustin 2010</a> ; <a href="#">De Wit 2015</a>                                                                                                                                                                                                                                                                                                 |
| D25    | Kilega         | <a href="#">Botne 2003</a>                                                                                                                                                                                                                                                                                                                                  |
| D54    | Bembe          | <a href="#">Iorio 2014</a>                                                                                                                                                                                                                                                                                                                                  |
| E51    | Kikuyu         | <a href="#">Ngonyani &amp; Githinji 2006</a> ; <a href="#">Bergvall 1987</a> ; <a href="#">Masunaga 1983</a> ;<br><a href="#">Peter Githinji p.c.</a> ; <a href="#">Chege Githiora p.c.</a>                                                                                                                                                                 |
| E53    | Kimeru         | <a href="#">Hodges 1977</a>                                                                                                                                                                                                                                                                                                                                 |
| E54    | Kiitharaka     | <a href="#">Harford 1991</a> ; <a href="#">Muriungi 2005, 2008, 2010</a> ; <a href="#">Buell &amp; Muriungi ms.</a> ; <a href="#">Peter Muriungi p.c.</a>                                                                                                                                                                                                   |
| E55–56 | Kikamba        | <a href="#">Kioko 2000</a>                                                                                                                                                                                                                                                                                                                                  |
| E62    | Kivunjo Chaga  | <a href="#">Marten et al. 2007</a> ; <a href="#">Bresnan &amp; Moshi 1990</a> ; <a href="#">Moshi 1998</a> ; <a href="#">Lioba Moshi p.c.</a>                                                                                                                                                                                                               |
| E73    | Digo           | <a href="#">Nicolle 2013</a> ; <a href="#">Steve Nicolle p.c.</a>                                                                                                                                                                                                                                                                                           |
| F22    | Nyamwezi       | <a href="#">Maganga &amp; Schadeberg 1992</a>                                                                                                                                                                                                                                                                                                               |
| F32    | Nyaturu/Kirimi | <a href="#">Hualde 1989</a> ; <a href="#">Woolford 2000</a> ; <a href="#">Riedel 2009</a> ; <a href="#">Olson 1964</a>                                                                                                                                                                                                                                      |
| F33    | Rangi          | <a href="#">Hawkinson 1976</a> , via <a href="#">Wald 1979</a> ; <a href="#">Gibson 2012</a> ; <a href="#">Hannah Gibson p.c.</a> ; <a href="#">Oliver Stegen p.c.</a>                                                                                                                                                                                      |
| F34    | Mbugwe         | <a href="#">Wilhelmsen 2019</a>                                                                                                                                                                                                                                                                                                                             |
| G12    | Kagulu         | <a href="#">Petzell 2008</a>                                                                                                                                                                                                                                                                                                                                |
| G23    | Sambaa         | <a href="#">Besha 1989</a> ; <a href="#">Riedel 2009</a> ; <a href="#">Buell &amp; Riedel 2008</a> ; <a href="#">Tumaini Kallaghe p.c.</a>                                                                                                                                                                                                                  |
| G35    | Kiluguru       | <a href="#">Marten &amp; Ramadhani 2001</a> ; <a href="#">Mkude 1974</a>                                                                                                                                                                                                                                                                                    |
| G402   | Makwe          | <a href="#">Devos 2008</a>                                                                                                                                                                                                                                                                                                                                  |
| G412   | Chimwiini      | <a href="#">Henderson 2010</a> ; <a href="#">Kisseberth &amp; Abasheikh 1977</a>                                                                                                                                                                                                                                                                            |
| G42    | Swahili        | <a href="#">Riedel 2009</a> ; <a href="#">Murrell 2012</a> ; <a href="#">Ngonyani 1998</a> ; <a href="#">Henderson 2006</a> ;<br><a href="#">Seidl &amp; Dimitriadis 1997</a> ; <a href="#">Whiteley 1972</a> ; <a href="#">Whiteley &amp; Mganga 1969</a> ; <a href="#">Marten 2011</a> ; <a href="#">Gibson 2008</a> ; <a href="#">Joyce Mbepera p.c.</a> |
| G67    | Kinyakyusa     | <a href="#">Lusekelo 2012</a> ; <a href="#">Amani Lusekelo p.c.</a>                                                                                                                                                                                                                                                                                         |
| H16a   | Kikongo        | <a href="#">Bostoen &amp; Mundeke 2011</a> ; <a href="#">Diarra 1990</a>                                                                                                                                                                                                                                                                                    |

---

|         |                   |                                                                                                                                                                                                                                                                   |
|---------|-------------------|-------------------------------------------------------------------------------------------------------------------------------------------------------------------------------------------------------------------------------------------------------------------|
| H21a    | Kimbundu          | Duranti 1979; Quintão 1934, via Rozenn Guérois p.c.                                                                                                                                                                                                               |
| H31     | Kiyaka            | Kidima 1987, 1991                                                                                                                                                                                                                                                 |
| JD42    | Kinande           | Baker 2003; Schneider-Zioga 2014ab; Schneider-Zioga & Mutaka 2015; Baker & Collins 2006; Richards 2009; Patricia Schneider-Zioga p.c.                                                                                                                             |
| JD61    | Kinyarwanda       | Marantz 1984; Ngoboka 2005, 2016; Zeller & Ngoboka 2014; Zeller 2008; Ngoboka & Zeller 2017; Kimenyi 1980, 1988, 1995; Morimoto 2000, 2006; Maxwell 1981; Jean-Paul Ngoboka p.c.                                                                                  |
| JD62    | Kirundi           | Ndayiragije 1999; Sabimana 1986; Nshemezimana 2016; Nshemezimana & Bostoen 2017; Ernest Nshemezimana p.c.                                                                                                                                                         |
| JD63    | Kifuliiru         | Van Otterloo 2011                                                                                                                                                                                                                                                 |
| JD66    | Ha                | Harjula 2004                                                                                                                                                                                                                                                      |
| JE103   | Luruuli           | Erika Just p.c.                                                                                                                                                                                                                                                   |
| JE13/14 | Runyankore-Rukiga | Taylor 1985; Asiiimwe 2014; Asiiimwe & Beermann 2016; Allen Asiiimwe p.c.                                                                                                                                                                                         |
| JE15    | Luganda           | Ranero 2015; Ssekiryango 2006; Judith Nakayiza p.c.; Saudah Namyalo p.c.; Innocent Masengo p.c.                                                                                                                                                                   |
| JE22    | Haya              | Riedel 2009; Hyman 1999; Duranti 1979; Hyman & Duranti 1982                                                                                                                                                                                                       |
| JE31c   | Lubukusu          | Sikuku 2012; Diercks 2011; Wasike 2007; Baker et al. 2012; Sikuku et al. 2018; Justine Sikuku p.c.                                                                                                                                                                |
| JE41    | Maragoli          | Murrell 2012; Paul Murrell p.c.                                                                                                                                                                                                                                   |
| JE43    | Kuria             | Marlo 2015b                                                                                                                                                                                                                                                       |
| K13     | Lucazi            | Fleisch 2000                                                                                                                                                                                                                                                      |
| K20     | Lozi              | Marten et al. 2007; Mwisiya 1977; Kashina 2005; Fortune 2001; Marlo 2015                                                                                                                                                                                          |
| K41     | Totela            | Crane 2011, 2019; Thera Crane p.c.                                                                                                                                                                                                                                |
| L31     | Ciluba            | de Kind & Bostoen 2012; Kuperus & Mpunga wa Ilunga 1990; Cocchi 2000; Gloria Cocchi p.c.                                                                                                                                                                          |
| L40     | Kikaonde          | Wright 2007                                                                                                                                                                                                                                                       |
| L52     | Lunda             | Kawasha 2003                                                                                                                                                                                                                                                      |
| L53     | Ruwund            | Nash 1992; Woolford 2001; Riedel 2009                                                                                                                                                                                                                             |
| M42     | Bemba             | Mwansa 2011; Marten et al. 2007; Kula 2017; Marten & Kula 2012, 2014; Nancy Kula p.c.                                                                                                                                                                             |
| N13     | Matengo           | Yoneda 2008; Nobuko Yoneda p.c.                                                                                                                                                                                                                                   |
| N20     | Tumbuka           | Downing 2006; Chavula 2016; Jean Chavula p.c.; Laura Downing p.c.                                                                                                                                                                                                 |
| N21     | Chingoni          | Ngonyani & Githinji 2006                                                                                                                                                                                                                                          |
| N31     | Chichewa          | Downing 2018; Downing & Pompino-Marshall 2013; Marten et al. 2007; Marten & Kula 2012; Simango 1995; Alsina 1992; Alsina & Mchombo 1990, 1993; Bresnan & Mchombo 1987; Mchombo 2004; Mchombo & Firmino 1999; Baker 1988; Bresnan & Kanerva 1989; Sam Mchombo p.c. |

---

|      |                      |                                                                                                                                                                                                                                                                                                                           |
|------|----------------------|---------------------------------------------------------------------------------------------------------------------------------------------------------------------------------------------------------------------------------------------------------------------------------------------------------------------------|
| N41  | Cinsenga             | <a href="#">Simango 1995, 2006</a> ; Ron Simango p.c.                                                                                                                                                                                                                                                                     |
| P13  | Kimatuumbi           | <a href="#">Odden 1984, 2003</a>                                                                                                                                                                                                                                                                                          |
| P20  | Yao                  | <a href="#">Taji 2014</a>                                                                                                                                                                                                                                                                                                 |
| P23  | Shimakonde (Plateau) | <a href="#">Leach 2010</a>                                                                                                                                                                                                                                                                                                |
| P31  | Makhuwa              | <a href="#">Van der Wal 2009</a> , own database                                                                                                                                                                                                                                                                           |
| P311 | Ekoti                | <a href="#">Schadeberg &amp; Muchanheia 2000</a>                                                                                                                                                                                                                                                                          |
| R11  | Umbundu              | <a href="#">Valente 1964</a> ; <a href="#">Schadeberg 1990</a>                                                                                                                                                                                                                                                            |
| R22  | Oshindonga           | <a href="#">Fivaz 1986</a>                                                                                                                                                                                                                                                                                                |
| R30  | Otjiherero           | <a href="#">Marten et al. 2007</a> ; <a href="#">Marten &amp; Kula 2012</a> ; <a href="#">Marten 2006, 2011</a> ; <a href="#">Möhlig et al. 2002</a> ; <a href="#">Möhlig &amp; Kavari 2008</a> ; <a href="#">Marten &amp; Van der Wal 2014</a> ; <a href="#">Kavari et al. 2012</a> ; <a href="#">Jekura Kavari p.c.</a> |
| S16  | Ikalanga Shona       | <a href="#">Mathangwane &amp; Osam 2006</a> ; <a href="#">Hawkinson &amp; Hyman 1974</a> ; <a href="#">Mugari 2013</a> ; <a href="#">Bliss 2010</a> ; <a href="#">Letsholo 2013</a> ; <a href="#">Harford 1990</a> ; <a href="#">Carolyn Harford p.c.</a>                                                                 |
| S13  | Manyika Shona        | <a href="#">Bax &amp; Diercks 2012</a> ; <a href="#">Mattie Wechsler p.c.</a>                                                                                                                                                                                                                                             |
| S30  | Sotho                | <a href="#">Morolong &amp; Hyman 1977</a> ; <a href="#">Zerbian 2006ab</a> ; <a href="#">Demuth 1990</a> ; <a href="#">Machobane 1989</a> ; <a href="#">Louwrens 1991</a> ; <a href="#">Possa Rethabile &amp; Konosoang Elisabeta Masupha p.c.</a> ; <a href="#">Sabine Zerbian p.c.</a>                                  |
| S31  | Tswana               | <a href="#">Creissels 1996, 2002, 2004, 2005, 2011</a> ; <a href="#">Demuth &amp; Mmusi 1997</a> ; <a href="#">Pretorius et al. 2012</a> ; <a href="#">Cole 1955</a> ; <a href="#">Thabo Ditsele p.c.</a>                                                                                                                 |
| S41  | Xhosa                | <a href="#">Visser 1986</a> ; <a href="#">duPlessis &amp; Visser 1992</a> ; <a href="#">Eva-Marie Bloom-Ström p.c.</a>                                                                                                                                                                                                    |
| S42  | Zulu                 | <a href="#">Adams 2010</a> ; <a href="#">Zeller 2011, 2012, 2013, 2015</a> ; <a href="#">Buell 2005, 2006, 2007</a> ; <a href="#">Halpert 2012, 2015</a>                                                                                                                                                                  |
| S44  | Ndebele              | <a href="#">Khumalo 2007</a>                                                                                                                                                                                                                                                                                              |
| S53  | Changana/Tsonga      | <a href="#">Bonfim Duarte 2011</a> ; <a href="#">duPlessis et al. 1995</a> ; <a href="#">Olinda Baixane p.c.</a>                                                                                                                                                                                                          |
| S62  | Gitonga              | <a href="#">Mchombo &amp; Firmino 1999</a>                                                                                                                                                                                                                                                                                |

---

For some languages, I initially consulted the data sheets created by the project ‘Morphosyntactic variation in Bantu’ at SOAS, hereby gratefully acknowledged.

# References

- Abels, Klaus. 2003. Successive cyclicity, anti-locality, and adposition stranding. PhD dissertation, University of Connecticut.
- Abels, Klaus. 2012. *Phases: An Essay on Cyclicity*. Berlin: de Gruyter.
- Abbott, Barbara. 2004. Definiteness and indefiniteness. In L. R. Horn and G. Ward (eds.), *The Handbook of Pragmatics*, 122–49. Oxford: Blackwell.
- Aboh, Enoch O. 2010. Information structuring begins with the numeration. *Iberia: An International Journal of Theoretical Linguistics* 2: 12–42.
- Adams, Nikki B. 2010. The Zulu ditransitive verb phrase. PhD dissertation, University of Chicago.
- Adger, David and Daniel Harbour. 2007. Syntax and syncretisms of the Person Case Constraint. *Syntax* 10 (1): 2–37.
- Ahn, Dorothy. 2017. Definite and demonstrative descriptions: A micro typology. In Erlewine, Michael Yoshitaka (ed.), *Proceedings of GLOW in Asia XI*, Volume 1: 33–48.
- Aissen, Judith. 2003. Differential object marking: Iconicity vs. economy. *Natural Language & Linguistic Theory* 21: 435–83.
- Aldridge, Edith. 2004. Ergativity and word order in Austronesian languages. PhD dissertation, Cornell University.
- Alexiadou, Artemis and Elena Anagnostopoulou. 1998. Parametrizing AGR: word order, V-movement and EPP-checking. *Natural Language and Linguistic Theory* 16 (3): 491–539.
- Alexiadou, Artemis and Elena Anagnostopoulou. 2001. The subject-in-situ generalization and the role of case in driving computations. *Linguistic Inquiry* 32: 193–232.
- Allan, Keith. 1983. Anaphora, cataphora, and topic focussing: Functions of the object prefix in Swahili. In I. R. Dihoff (ed.), *Current Approaches to African Linguistics*, 323–35. Dordrecht: Foris Publications.
- Alsina, Alex. 1992. On the argument structure of causatives. *Linguistic Inquiry* 23: 517–55.
- Alsina, Alex. 1996. Passive types and the theory of object asymmetries. *Natural Language and Linguistic Theory* 14: 673–723.
- Alsina, Alex and Sam Mchombo. 1990. The syntax of applicatives in Chicheŵa: Problems for a Theta theoretic asymmetry. *Natural Language & Linguistic Theory* 8 (4): 493–506.
- Alsina, Alex and Sam Mchombo. 1993. Object asymmetries and the Chichewa applicative construction. In S. Mchombo (ed.), *Theoretical Aspects of Bantu Grammar*, 17–45. Stanford: CSLI.
- Anagnostopoulou, Elena. 2003. *The Syntax of Ditransitives*. Berlin: Mouton de Gruyter.
- Anagnostopoulou, Elena. 2017. Clitic doubling. In M. Everaert and H. van Riemsdijk (eds.), *The Wiley-Blackwell Companion to Syntax*, Second Edition, 1–56. London: Wiley-Blackwell Publishing.
- Ariel, Mira. 1990. Accessing Noun-Phrase Antecedents. London: Routledge.
- Ariel, Mira. 2001. Accessibility theory: An overview. In T. Sanders, J. Schilperoord, and W. Spooren (eds.), *Text Representation: Linguistic and Psycholinguistic Aspects*, 29–88. Amsterdam: John Benjamins.
- Ashton, Ethel O. 1954. *A Luganda Grammar*. London: Longmans.

- Asiimwe, Allen. 2014. Definiteness in Runyankore-Rukiga. PhD dissertation, Stellenbosch: University of South Africa.
- Asiimwe, Allen and Dorothee Beermann. 2016. Object-marking in Runyankore-Rukiga. Presentation at Bantu 6, Helsinki.
- Assmann, Anke, Doreen Georgi, Fabian Heck, Gereon Müller, and Philipp Weisser. 2015. Ergatives move too early: On an instance of opacity in syntax. *Syntax* 18 (4): 343–87.
- Augustin, MaryAnne. 2010. Selected features of syntax and information structure in Lika (Bantu D.20). MA thesis, Dallas, Texas: Graduate Institute of Applied Linguistics.
- Baker, Mark. 1985. The Mirror Principle and morphosyntactic explanation. *Linguistic Inquiry* 16: 373–415.
- Baker, Mark. 1988. Theta theory and the syntax of applicatives in Chichewa. *Natural Language & Linguistic Theory* 6: 353–89.
- Baker, Mark. 1996. *The Polysynthesis Parameter*. Oxford: Oxford University Press.
- Baker, Mark. 2003. Agreement, dislocation, and partial configurationality. In A. Carnie, H. Harley, and M. Willie (eds.), *Formal Approaches to Function in Grammar*, 107–32. Amsterdam: John Benjamins.
- Baker, Mark. 2008a. *The Syntax of Agreement and Concord*. Cambridge: Cambridge University Press.
- Baker, Mark. 2008b. The macroparameter in a microparametric world. In T. Biberauer (ed.), *The Limits of Syntactic Variation*, 351–73. Amsterdam: John Benjamins.
- Baker, Mark. 2010. Formal Generative Typology. In B. Heine and H. Narrog (eds.), *The Oxford Handbook of Linguistic Analysis*, 285–312. Oxford: Oxford University Press.
- Baker, Mark. 2012. On the relationship of object agreement and accusative case: Evidence from Amharic. *Linguistic Inquiry* 43 (2): 255–74.
- Baker, Mark. 2015. *Case. Its Principles and its Parameters*. Cambridge: Cambridge University Press.
- Baker, Mark. 2018. On the status of object markers in Bantu. In O. Adesola, A. Akinlabi, and O. O. Orié (eds.), *Data-Rich Linguistics: Papers in Honor of Yiwola Awoyale*, 2–40. Newcastle: Cambridge Scholars Publishing.
- Baker, Mark and Chris Collins. 2006. Linkers and the internal structure of vP. *Natural Language & Linguistic Theory* 24: 307–54.
- Baker, Mark and Jim McCloskey. 2007. On the relationship of typology to theoretical syntax. *Linguistic Typology* 11: 285–96.
- Baker, Mark, Ken Safir, and Justine Sikuku. 2012. Sources of (a)symmetry in Bantu double object constructions. In N. Arnett and R. Bennett (eds.), *Proceedings of the 30th West Coast Conference on Formal Linguistics*, 54–64. Cascadia Proceedings Project.
- Bárány, András. 2015. Differential object marking in Hungarian and the morphosyntax of case and agreement. PhD dissertation, University of Cambridge.
- Bárány, András. 2017. *Person, Case, and Agreement. The Morphosyntax of Inverse Agreement and Global Case Splits*. Oxford: Oxford University Press.
- Bárány, András and Jenneke van der Wal. To appear. We don't Agree (only) upwards. *Linguistic Inquiry*.
- Bax, Anna and Michael Diercks. 2012. Information structure constraints on object marking in Manyika. *Southern African Linguistics and Applied Language Studies* 30 (2): 185–202.
- Bazalgette, Timothy. 2015. Algorithmic acquisition of focus parameters. PhD dissertation, University of Cambridge.
- Beard, Thomas. 2003. Syntax. In D. Nurse & G. Philippson (eds.), *The Bantu Languages*, 121–42. London: Routledge.

- Beaudoin-Lietz, Christa, Derek Nurse, and Sarah Rose. 2004. Pronominal object marking in Bantu. In A. Akinlabi and O. Adesola (eds.), *Proceedings of the 4th World Congress of African Linguistics, New Brunswick 2003*, 175–88. Cologne: Rüdiger Köppe.
- Béjar, Susana. 2003. Phi-syntax: A theory of agreement. PhD dissertation, University of Toronto.
- Béjar, Susana and Milan Rezac. 2009. Cyclic agree. *Linguistic Inquiry* 40 (1): 35–73.
- Belletti, Adriana. 2004. Aspects of the low IP area. In L. Rizzi (ed.), *The structure of CP and IP*, 16–51. Oxford: Oxford University Press.
- Bentley, Mayrene E. 1994. The syntactic effects of animacy in Bantu languages. PhD Dissertation, Indiana University.
- Bentley, Mayrene E. 1995. Animacy and pronominal systems in Bantu. Report, available via ERIC.
- Bergvall, Victoria L. 1987. Focus in Kikuyu and universal grammar. Doctoral Dissertation, Cambridge, MA: Harvard University.
- Berwick, Robert and Noam Chomsky. 2011. Biolinguistics: The current state of its evolution and development. In A. M. di Sciullo and C. Boeckx (eds.), *Biolinguistic Investigations*, 19–41. Oxford: Oxford University Press.
- Berwick, Robert and Noam Chomsky. 2016. Why Only Us? Language and Evolution. Cambridge, MA: Massachusetts Institute of Technology (MIT) Press.
- Besha, Ruth M. 1989. *A Study of Tense and Aspect in Shambala*. Berlin: Dietrich Reimer.
- Bhatt, Rajesh. 2005. Long distance agreement in Hindi-Urdu. *Natural Language & Linguistic Theory* 23: 757–807.
- Bianchi, Valentina, Giuliano Bocci, and Silvio Cruschina. 2016. Focus fronting, unexpectedness, and the evaluative dimension. *Semantics and Pragmatics* 9 (3): 1–54.
- Biberauer, Theresa. 2010. Semi pro-drop languages, expletives and expletive pro reconsidered. In T. Biberauer, A. Holmberg, I. Roberts, and M. Sheehan (eds.), *Parametric variation: null subjects in Minimalist Theory*, 153–99. Cambridge: Cambridge University Press.
- Biberauer, Theresa. 2011. In defence of lexico-centric parametric variation: Two 3rd factor-constrained case studies. (Paper presented at Workshop on Formal Grammar and Syntactic Variation: Rethinking Parameters, Madrid).
- Biberauer, Theresa. 2017a. Maximising minimal means: Typological, acquisitional and diachronic perspectives. (Three-day invited Lecture Series at the Center for Research in Syntax, Semantics and Phonology (CRiSSP), Brussels).
- Biberauer, Theresa. 2017b. The Final-over-Final condition and particles. In M. Sheehan, T. Biberauer, I. Roberts, and A. Holmberg (eds.), *The Final-Over-Final Condition: A Syntactic Universal*, 187–296. Cambridge, MA: Massachusetts Institute of Technology (MIT) Press.
- Biberauer, Theresa. 2018a. Pro-drop and emergent parameter hierarchies. In F. Cognola and J. Casalicchio (eds.), *Null Subject in Generative Grammar: A Synchronic and Diachronic Perspective*, 94–140. Oxford: Oxford University Press.
- Biberauer, Theresa. 2018b. Less IS more: Some thoughts on the Tolerance Principle in the context of the Maximise Minimal Means model. *Cambridge Occasional Papers in Linguistics* 11: 131–45.
- Biberauer, Theresa. 2019a. Factors 2 and 3: Towards a principled explanation. In Á. Gallego and D. Ott (eds.), *Catalan Journal of Linguistics* (Special issue: Generative Syntax. Questions, Crossroads, and Challenges): 45–88.
- Biberauer, Theresa. 2019b. Children always go beyond the input: The Maximise Minimal Means perspective. *Theoretical Linguistics* 45 (3–4): 211–24.

- Biberauer, Theresa and Ian Roberts. 2012. The significance of what hasn't happened. Paper presented at DiGS12 (Lisbon).
- Biberauer, Theresa and Ian Roberts. 2015a. Rethinking formal hierarchies: A proposed unification. *Cambridge Occasional Papers in Linguistics* 7: 1–31.
- Biberauer, Theresa and Ian Roberts. 2015b. The clausal hierarchy, features and parameters. In Shlonsky, U. (ed.), *Beyond Functional Sequence: The Cartography of Syntactic Structures*, 295–313. Oxford: Oxford University Press.
- Biberauer, Theresa and Ian Roberts. 2016. Parameter typology from a diachronic perspective: The case of Conditional Inversion. In E. Bidese, F. Cognola, and M. Moroni (eds.), *Theoretical Approaches to Linguistic Variation*, 259–91. Amsterdam: John Benjamins.
- Biberauer, Theresa and Ian Roberts. 2017. Parameter setting. In A. Ledgeway and I. Roberts (eds.), *The Cambridge Handbook of Historical Syntax*, 134–62. Cambridge: Cambridge University Press.
- Biberauer, Theresa, Anders Holmberg, and Ian Roberts. 2007. Disharmonic word order systems and the Final-over-Final Constraint. In A. Bisetto and F. Barbieri (eds.), *Proceedings of the XXXIII Incontro di Grammatica Generativa*, 86–105. Bologna: University of Bologna.
- Biberauer, Theresa, Anders Holmberg, and Ian Roberts. 2008a. Linearising disharmonic word orders: the Final-over-Final Constraint. In K.-A. Kim (ed.), *Perspectives on Linguistics in the 21st Century*, 301–18.
- Biberauer, Theresa, Anders Holmberg, and Ian Roberts. 2008b. Structure and linearization in disharmonic word orders. In C. B. Chang and H. J. Haynie (eds.), *Proceedings of the 26th West Coast Conference on Formal Linguistics*, 96–104. Somerville, MA: Cascadilla Proceedings Project.
- Biberauer, Theresa, Anders Holmberg, and Ian Roberts. 2014. A syntactic universal and its consequences. *Linguistic Inquiry* 45 (2): 169–225.
- Biberauer, Theresa, Anders Holmberg, Ian Roberts, and Michelle Sheehan. 2014. Complexity in comparative syntax: The view from modern parametric theory. In F. J. Newmeyer and L. B. Preston (eds.), *Measuring Grammatical Complexity*, 103–27. Oxford: Oxford University Press.
- Bjorkman, Bronwyn and Hedde Zeijlstra. 2019. Checking Up on ( $\phi$ -)Agree. *Linguistic Inquiry* 50 (3): 527–69.
- Bliss, Heather. 2005. Topic, focus, and point of view in Blackfoot. In J. Alderete et al. (eds.), *Proceedings of the 24th West Coast Conference on Formal Linguistics*, 61–9. Somerville, MA: Cascadilla Proceedings Project.
- Bliss, Heather. 2010. Case asymmetry and information structure in Shona. In H. Bliss, M. Louie, and M. Schellenberg (eds.), *Proceedings of the Northwest Linguistics Conference 2009 (University of British Columbia Working Papers in Linguistics 25)*, 29–40. Vancouver: UBCWPL.
- Bobaljik, Jonathan David. 2008. Where's  $\phi$ ? Agreement as a post-syntactic operation. In D. Harbour, D. Adger, and S. Béjar (eds.), *Phi-Theory: Phi Features Across Interfaces and Modules*, 295–328. Oxford: Oxford University Press.
- Bobaljik, Jonathan David and Susi Wurmbrand. 2008. Case in GB/Minimalism. In A. Malchukov and A. Spencer (eds.), *The Oxford Handbook of Case*, 44–58. Oxford: Oxford University Press.
- Bokamba, Eyamba G. 1976. On the syntax and semantics of wh-questions in Kikongo and Kiswahili. *Studies in the Linguistic Sciences* 6 (2): 65–88.
- Bokamba, Eyamba. 1979. Inversions as grammatical relation changing rules in Bantu languages. *Studies in the Linguistic Sciences* 9: 1–24.

- Bokamba, Eyamba. 1985. Verbal agreement as a noncyclic rule in Bantu. In D. Goyvaerts (ed.), *African linguistics*, 9–54. Amsterdam: John Benjamins.
- Bonfim Duarte, Fábio. 2011. Tense encoding, agreement patterns, definiteness and relativization strategies in Changana. In E. G. Bokamba et al. (eds.), *Selected Proceedings of the 40th Annual Conference on African Linguistics*, 80–94. Somerville, MA: Cascadilla Proceedings Project.
- Bonneau, J. and Fburet, J. B. 1956. *Grammaire Pounoue et Lexique Pounou-Français*.
- Borer, Hagit. 1984. *Parametric Syntax*. Dordrecht: Foris.
- Borer, Hagit. 1986. I-subjects. *Linguistic Inquiry* 17: 375–416.
- Boskovič, Zelko. 2009. Unifying first and last conjunct agreement. *Natural Language and Linguistic Theory* 27: 455–96.
- Bostoen, Koen and Leon Mundeke. 2011. Passiveness and inversion in Mbuun (Bantu B87, DRC). *Studies in Language* 21 (1): 72–111.
- Bostoen, Koen and Leon Mundeke. 2012. Subject marking, object-verb order and focus in Mbuun (Bantu, B87). *Southern African Linguistics and Applied Language Studies* 30 (2): 139–54.
- Bostoen, Koen and Joseph Koni Muluwa. 2019. Nsong (B85d). In M. Van de Velde et al. (eds.), *The Bantu Languages*, Second Edition, 414–48. London: Routledge.
- Botne, Robert. 2003. Lega (Beya dialect) (D25). In D. Nurse & G. Philippson (eds.), *The Bantu Languages*, 422–49. London: Routledge.
- Bowers, John. 1993. The syntax of predication. *Linguistic Inquiry* 24: 591–656.
- Bresnan, Joan. 1994. Locative inversion and Universal Grammar. *Language* 70: 72–131.
- Bresnan, Joan and Jonni M. Kanerva. 1989. Locative Inversion in Chichewa – a case-study of factorization in grammar. *Linguistic Inquiry* 20 (1): 1–50.
- Bresnan, Joan and Sam Mchombo. 1987. Topic, pronoun, and agreement in Chicheŵa. *Language* 63: 741–82.
- Bresnan, Joan and Lioba Moshi. 1990. Object asymmetries in comparative Bantu syntax. *Linguistic Inquiry* 21 (2): 147–85.
- Bruening, Benjamin. 2014. Defects of defective intervention. *Linguistic Inquiry* 45: 707–19.
- Buell, Leston C. 2005. Issues in Zulu morphosyntax. PhD dissertation, University of California Los Angeles.
- Buell, Leston C. 2006. The Zulu conjoint/disjoint verb alternation: Focus or constituency? *ZAS Papers in Linguistics* 43: 9–30.
- Buell, Leston C. 2007. Semantic and formal locatives: Implications for the Bantu locative inversion typology. In N. C. Kula and L. Marten (eds.), *SOAS Working Papers in Linguistics 15: Bantu in Bloomsbury*, 105–20.
- Buell, Leston C. 2009. Evaluating the Immediate Postverbal Position as a Focus Position in Zulu. In M. Matondo et al. (eds.), *Selected Proceedings of the 38th Annual Conference on African Linguistics*, 166–72. Somerville, MA: Cascadilla Proceedings Project.
- Buell, Leston C. and Peter Muriungi. 2008. Locatives and locative inversion in Tharaka. Ms.
- Buell, Leston C. and Kristina Riedel. 2008. The conjoint/disjoint alternation in Sambaa. (Talk given at TiN-dag, Utrecht).
- Bukuru, Denis. 2003. Phrase structure and functional categories in the Kirundi sentence. PhD dissertation, University of Dar es Salaam.
- Burzio, Luigi. 1986. *Italian syntax: A government-binding approach*. Dordrecht: Reidel.
- Byarushengo, Ernest R., Larry M. Hyman, and Sarah Tenenbaum. 1976. Tone, accent and assertion in Haya. In L. M. Hyman (ed.), *Studies in Bantu Tonology*, 183–205. Los Angeles: Department of Linguistics, University of Southern California.



- Byarushengo, Ernest R. and Sarah Tenenbaum. 1976. Agreement and word order: A case for pragmatics in Haya. *Proceedings of the 2nd Annual Meeting of the Berkeley Linguistics Society*: 89–99.
- Cann, Ronnie and Patricia Mabugu. 2007. Constructional polysemy: The applicative construction in chiShona. In M. Rakova, G. Petho, and C. Rakosi (eds.), *The Cognitive Basis of Polysemy*, 221–45. Peter Lang Publishing Group.
- Cardinaletti, Anna and Michal Starke. 1999. The typology of structural deficiency: A case study of the three classes of pronouns. In H. van Riemsdijk (ed.), *Clitics in the Languages of Europe*, 145–233. Berlin: Mouton de Gruyter.
- Carstens, Vicki. 1991. The morphology and syntax of DPs in Kiswahili. PhD dissertation, University of California Los Angeles.
- Carstens, Vicki. 1993. On nominal morphology and DP structure. In S. Mchombo (ed.), *Theoretical Aspects of Bantu Grammar*, 151–80. Stanford: CSLI Publications, Stanford.
- Carstens, Vicki. 2000. Concord in minimalist theory. *Linguistic Inquiry* 31: 319–55.
- Carstens, Vicki. 2003. Rethinking complementizer agreement: Agree with a case-checked goal. *Linguistic Inquiry* 34 (3): 393–412.
- Carstens, Vicki. 2005. Agree and EPP in Bantu. *Natural Language & Linguistic Theory* 23 (2): 219–79.
- Carstens, Vicki. 2011. Hyperactivity and Hyperagreement in Bantu. *Lingua* 121 (5): 721–41.
- Carstens, Vicki. 2016. Delayed valuation: A reanalysis of goal features, ‘upwards’ complementizer and the mechanics of Case. *Syntax* 19 (1): 1–42.
- Carstens, Vicki and Michael Diercks. 2013. Agreeing how? *Linguistic Inquiry* 44: 179–237.
- Carstens, Vicki and Loyiso Mletshe. 2015. Implications of Xhosa expletive constructions. *Linguistic Inquiry* 46 (2): 187–242.
- Carstens, Vicki and Loyiso Mletshe. 2016. N-words in disguise: A negative concord approach to augmentless NPs in Xhosa and Zulu. *Natural Language & Linguistic Theory* 34: 761–804.
- Cechetto, Carlo. 1999. A comparative analysis of left and right dislocation in Romance. *Studia Linguistica* 53: 40–67.
- Chafe, Wallace. 1976. Givenness, contrastiveness, definiteness, subjects, topics and point of view. In C. N. Li and S. Thompson (eds.), *Subject and Topic*, 27–55. New York: Academic Press.
- Chafe, Wallace. 1987. Cognitive Constraints on Information Flow. In R. Tomlin (ed.), *Coherence and Grounding in Discourse*, 21–51. Amsterdam: John Benjamins.
- Chavula, Jean Josephine. 2016. Verbal derivation and valency in Citumbuka. PhD dissertation. Utrecht: Landelijke Onderzoekschool Taalwetenschap (LOT) publications.
- Cheng, Lisa L.-S. and Laura J. Downing. 2007. The prosody and syntax of Zulu relative clauses. *SOAS Working Papers in Linguistics* 15: 51–63.
- Cheng, Lisa L.-S. and Laura J. Downing. 2009. Where’s the topic in Zulu? In H. de Hoop and G. van Bergen (eds.), (Special Issue: Topics Cross-linguistically), *The Linguistic Review* 26: 207–38.
- Cheng, Lisa L.-S. and Laura Downing. 2012. Against FocusP: Arguments from Zulu. In I. Kucerova and A. Neeleman (eds.), *Contrasts and Positions in Information Structure*, 247–66. Cambridge: Cambridge University Press.
- Chomsky, Noam. 1981. *Lectures on Government and Binding*. Dordrecht: Foris.
- Chomsky, Noam. 1993. A Minimalist Program for linguistic theory. In K. Hale and S. J. Kayser (eds.), *The View from Building 20*, 1–52. Cambridge, MA: Massachusetts Institute of Technology (MIT) Press.

- Chomsky, Noam. 1995. *The Minimalist Program*. Cambridge, MA: Massachusetts Institute of Technology (MIT) Press.
- Chomsky, Noam. 2000. Minimalist inquiries: The framework. In R. Martin, D. Michaels, and J. Uriagereka (eds.), *Step by Step: Essays on Minimalist Syntax in Honor of Howard Lasnik*, 89–155. Cambridge, MA: Massachusetts Institute of Technology (MIT) Press.
- Chomsky, Noam. 2001. Derivation by phase. In M. Kenstowicz (ed.), *Kenneth Hale: A Life in Language*, 1–52. Cambridge, MA: Massachusetts Institute of Technology (MIT) Press.
- Chomsky, Noam. 2005. Three factors in Language Design. *Linguistic Inquiry* 36: 1–22.
- Chomsky, Noam. 2007. Approaching UG from below. In U. Sauerland and H.-M. Gärtner (eds.), *Interfaces + Recursion = Language?*, 1–29. Berlin: Mouton de Gruyter.
- Chomsky, Noam. 2008. On phases. In R. Freidin, C. P. Otero, and M. L. Zubizarreta (eds.), *Foundational Issues in Linguistic Theory. Essays in Honor of Jean-Roger Vergnaud*, 133–66. Cambridge, MA: Massachusetts Institute of Technology (MIT) Press.
- Claudi, Ulrike. 1997. Some thoughts on the origin of gender marking. In R. K. Herbert (ed.), *African Linguistics at the Crossroads*, 63–74. Cologne: Rüdiger Köppe.
- Cocchi, Gloria. 2000. Free clitics and bound affixes: Towards a unitary analysis. In B. Gerlach and J. Grijzenhout (eds.), *Clitics in Phonology, Morphology and Syntax*, 85–119. Amsterdam: John Benjamins.
- Cole, D. T. 1955. *An Introduction to Tswana Grammar*. Cape Town: Longman.
- Collins, Chris. 1997. *Local Economy*. Cambridge, MA: Massachusetts Institute of Technology (MIT) Press.
- Collins, Chris. 2004. The agreement parameter. In A. Breitbarth and H. van Riemsdijk (eds.), *Triggers*, 115–36. Mouton de Gruyter, Berlin.
- Contini-Morava, Ellen. 1983. Ranking of participants in Kinyarwanda: The limitation of arbitrariness in language. *Anthropological Linguistics* 25 (4): 425–35.
- Crane, Thera Marie. 2011. Beyond time: Temporal and extra-temporal functions of tense and aspect marking in Totela, a Bantu Language of Zambia. PhD dissertation, University of California.
- Crane, Thera Marie. 2019. Totela. In M. Van de Velde, K. Bostoen, D. Nurse, and G. Philippson (eds.), *The Bantu languages, 2nd edition*, 645–91. London: Routledge.
- Crane, Thera Marie, Larry M. Hyman, and Simon Nsielanga Tukumu. 2011. *A Grammar of Nzadi: A Language of Democratic Republic of Congo*. Berkeley: UC Press.
- Creissels, Denis. 1996. Conjunctive and disjunctive verb forms in Setswana. *South African Journal of African Languages* 16 (4): 109–15.
- Creissels, Denis. 2002. Valence verbale et voix en Tswana. *Bulletin de la Société de linguistique de Paris* XCVII (1): 371–426.
- Creissels, Denis. 2004. Non-canonical applicatives and focalization in Tswana. (Paper presented at Syntax of the World's Languages, Leipzig).
- Creissels, Denis. 2005. A typology of subject and object markers in African languages. In F. K. E. Voeltz, *Studies in African Linguistics*, 43–70. Amsterdam: John Benjamins.
- Creissels, Denis. 2011. Tswana locatives and their status in the inversion construction. *Africana Linguistica* XVII: 33–52.
- Cruschina, Silvio. 2019. Focus fronting in Spanish: Mirative implicature and information structure. *Probus* 29 (1): 119–46.
- Cuervo, María Cristina. 2003. Datives at large. PhD dissertation, Massachusetts Institute of Technology (MIT).
- D'Alessandro, Roberta A. G. 2020. Agreement across the board: Topic agreement in Ripano. In K. Hartmann, J. Mursell, & P. Smith (eds.), *Agree to Agree: Agreement in the Minimalist Programme*. Berlin: Language Science Press.

- Dalrymple, Mary and Irina Nikolaeva. 2011. *Objects and Information Structure*. Cambridge: Cambridge University Press.
- Danon, Gabi. 2006. Caseless nominals and the projection of DP. *Natural Language & Linguistic Theory* 24 (4): 977–1008.
- Danon, Gabi. 2011. Agreement and DP-internal Feature Distribution. *Syntax* 14: 297–317.
- Deal, Amy Rose. 2009. The origin and content of expletives: Evidence from 'selection'. *Syntax* 12 (4): 285–323.
- Deal, Amy Rose. 2015. Interaction and satisfaction in  $\phi$ -agreement. In T. Bui and D. Özyıldız (eds.), *NELS 45: Proceedings of the forty-fifth annual meeting of the North East Linguistic Society*, 1–14.
- Déchaine, Rose-Marie and Martina Wiltschko. 2002. Decomposing pronouns. *Linguistic Inquiry* 33 (3): 409–42.
- de Kind, Jasper and Koen Bostoen. 2012. The applicative in ciLubá grammar and discourse: A semantic goal analysis. *Southern African Linguistics and Applied Language Studies* 30 (1): 101–24.
- DeLancey, Scott. 1981. An interpretation of split ergativity and related patterns. *Language* 57 (3): 626–57.
- Demuth, Katherine. 1990. Locatives, impersonals and expletives in Sesotho. *The Linguistic Review* 7 (3): 233–49.
- Demuth, Katherine and Sheila Mmusi. 1997. Presentational focus and thematic structure in comparative Bantu. *Journal of African Languages & Linguistics* 18: 1–19.
- Den Dikken, Marcel. 2006. *Relators and linkers*. Cambridge, MA: Massachusetts Institute of Technology (MIT) Press.
- Den Dikken, Marcel. 2007. Phase extension contours of a theory of the role of head movement in phrasal extraction. *Theoretical Linguistics* 33 (1): 1–41.
- Denny, J. Peter and Chet Creider. 1976. The semantics of noun classes in Proto-Bantu. *Studies in African Linguistics* 7: 1–30.
- Devos, Maud. 2008. *A Grammar of Makwe*. Munich: LINCOM Europa, Studies in African Linguistics 71.
- De Wit, Gerrit. 2015. *Liko Phonology and Grammar: A Bantu Language of the Democratic Republic of the Congo*. Utrecht: Landelijke Onderzoeksschool Taalwetenschap (LOT).
- Diarra, Boubacar. 1990. *Grammática Kikongo*. UNESCO, Luanda: ILN.
- Diercks, Michael. 2010. Agreement with subjects in Lubukusu. PhD dissertation, Georgetown University.
- Diercks, Michael. 2011. The morphosyntax of Lubukusu locative inversion and the parameterization of Agree. *Lingua* 121 (5): 702–20.
- Diercks, Michael. 2012. Parameterizing case: Evidence from Bantu. *Syntax* 15 (3): 253–86.
- Diercks, Michael. 2013. Indirect agree in Lubukusu complementizer agreement. *Natural Language & Linguistic Theory* 31 (2): 357–407.
- Diercks, Michael. 2017. Locative Inversion. In M. Everaert and H. C. Riemsdijk (eds.), *The Wiley-Blackwell Companion to Syntax*, Second Edition.
- Diercks, Michael, Marjo van Koppen, and Michael Putnam. 2020. Agree probes down: Anaphoric feature valuation and phase reference. In P. W. Smith, J. Mursell, and K. Hartmann (eds.), *Agree to Agree: Agreement in the Minimalist Programme*, 347–89. Berlin: Language Science Press.
- Dik, Simon C. 1997. *The Theory of Functional Grammar, Part 1: The Structure of the Clause*. Kees Hengeveld (ed.). Berlin: Mouton de Gruyter.
- Doggett, Teal Bissell. 2004. All things being unequal: Locality in movement. PhD dissertation, Massachusetts Institute of Technology (MIT).

- Downing, Laura J. 2006. The Prosody and Syntax of Focus in Chitumbuka. In *ZAS Papers in Bantu Grammar and Description* (ZASPiL 43), L. J. Downing, L. Marten, and S. Zerbian (eds.), 55–80. Berlin: ZAS.
- Downing, Laura J. 2018. Differential object marking in Chichewa. In I. A. Seržant and A. Witzlack-Makarevich (eds.), *The Diachronic Typology of Differential Argument Marking*, 41–67. Berlin: Language Science Press.
- Downing, Laura J. and Larry M. Hyman. 2015. Information structure in Bantu. In C. Féry and S. Ishihara. *The Oxford Handbook of Information Structure*. Oxford: Oxford University Press.
- Downing, Laura J. and Lutz Marten. 2019. Clausal morphosyntax and information structure. In M. Van de Velde et al. (eds.), *The Bantu Languages*, Second Edition, 270–307. London: Routledge.
- Downing, Laura J. and Bernd Pompino-Marschall. 2013. The focus prosody of Chichewa and the Stress-Focus constraint: A response to Samek-Lodovici (2005). *Natural Language & Linguistic Theory* 31: 647–81.
- Dresher, Elan. 2009. *The Contrastive Hierarchy in Phonology*. Cambridge: Cambridge University Press.
- Duffield, Nigel. 2013. Minimalism and semantic syntax: interpreting multifunctionality in Vietnamese. Unpublished ms: Konan University.
- Duffield, Nigel. 2017. On what projects in Vietnamese. *Journal of East Asian Linguistics* 26 (4): 351–87.
- du Plessis, Jacobus A. and Marianna W. Visser. 1992. *Xhosa Syntax*. Johannesburg: Afrikaanse Pers-Boekhandel.
- du Plessis, Jacobus A., N. E. Nxumalo, and Mariana Visser. 1995. *Tsonga Syntax*. Stellenbosch: University of Stellenbosch.
- Duranti, Alessandro. 1979. Object clitic pronouns in Bantu and the topicality hierarchy. *Studies in African Linguistics* 10: 31–45.
- Duranti, Alessandro and Ernest R. Byarushengo. 1977. On the notion of 'direct object.' In A. Duranti, E. R. Byarushengo, and L. M. Hyman (eds.), *Haya Grammatical Structure: Phonology, Grammar, Discourse*, 45–71. Los Angeles: Department of Linguistics, University of Southern California.
- Edelsten, Peter, Lutz Marten, and Chiku Lijongwa. 2015. *Information Structure Constraints to Swahili Word Order*. London: SOAS.
- É.Kiss, Katalin (ed.) 1995. *Discourse Configurational Languages*. Oxford: Oxford University Press.
- É.Kiss, Katalin. 1998. Identificational focus versus information focus. *Language* 74: 245–73.
- É.Kiss, Katalin. 2017. The person–case constraint and the inverse agreement constraint are manifestations of the same inverse topicality constraint. *The Linguistic Review* 34 (2): 365–95.
- Endemann, Karl. 1876. *Versuch einer Grammatik des Sotho*. Berlin: W. Hertz.
- Epstein, Samuel D. 1999. Unprincipled syntax and the derivation of syntactic relations. In S. Epstein and N. Hornstein (eds.), *Working Minimalism*, 317–45. Cambridge, MA: Massachusetts Institute of Technology (MIT) Press.
- Epstein, Samuel D., Erich M. Groat, Ruriko Kawashima, and Hisatsugu Kitahara. 1998. *A Derivational Approach to Syntactic Relations*. Oxford: Oxford University Press.
- Erteschik-Shir, Nomi. 1997. *The Dynamics of Focus Structure*. Cambridge: Cambridge University Press.
- Fanselow, Gisbert. 2006. On pure syntax (uncontaminated by information structure). In P. Brandt and E. Fuss (eds.), *Form, Structure, and Grammar*, 137–58. Berlin: Akademie Verlag.

- Fanselow, Gisbert and Denisa Lenertová. 2011. Left peripheral focus: Mismatches between syntax and information structure. *Natural Language & Linguistic Theory* 29: 169–209.
- Fasanella, Adriana and Jordi Fortuny. 2016. Deriving linguistic variation from learnability conditions: The chunking procedure. In L. Eguren, O. Fernández-Soriano, and A. Mendikoetxea (eds.), *Rethinking Parameters*, 105–32. Oxford: Oxford University Press.
- Ferrari-Bridgers, Franca. 2008. A unified syntactic analysis of Italian and Luganda nouns. In C. de Cat and K. Demuth (eds.), *The Bantu-Romance Connection: A Comparative Investigation of Verbal Agreement, DPs, and Information Structure*, 239–58. Amsterdam: John Benjamins.
- Féry, Caroline and Shinichiro Ishihara (eds.). 2016. *The Oxford Handbook of Information Structure*. Oxford: Oxford University Press.
- Fivaz, Derek. 1986. *A Reference Grammar of Oshindonga*. Windhoek: Bureau for Research, University of Namibia.
- Fleisch, Azel. 2000. *Lucazi Grammar: A Morphosemantic Analysis*. Cologne: Rüdiger Köppe.
- Fleisch, Axel. 2005. Agent phrases in Bantu passives. In F. K. E. Voeltz (ed.), *Studies in African Linguistic Typology*, 93–111. Amsterdam: John Benjamins.
- Fodor, Janet and William Sakas. 2017. Learnability. In I. Roberts (ed.), *The Oxford Handbook of Universal Grammar*, 249–69. Oxford: Oxford University Press.
- Fontaney, Louise. 1980. Le verbe. In F. Nsuka-Nkutsi (ed.), *Elements de description du punu*, 51–114. Lyon: CRLS, Université Lumière Lyon 2.
- Fortune, George. 2001. *An Outline of Silozi Grammar*. Lusaka: Bookworld Publishers.
- Frascarelli, Mara and Roland Hinterhölzl. 2007. Types of topics in German and Italian. In S. Winkler and K. Schwabe (eds.), *On Information Structure, Meaning and Form*, 87–116. Amsterdam: John Benjamins.
- Fuchs, Zuzanna and Jenneke van der Wal. 2022. Gender on little n in Bantu. *Linguistic Variation* 22 (1): 267–323.
- Fukui, Naoki. 1995. The Principles-and-Parameters approach: A comparative syntax of English and Japanese. In M. Shibatani and T. Bynon (eds.), *Approaches to Language Typology*, 327–71. Oxford: Oxford University Press.
- Gambarage, Joash J. 2019. Belief-of-existence determiners: Evidence from the syntax and semantics of Nata augments. PhD dissertation, University of British Columbia.
- Garcia, Hugo. 2016. From the unexpected to the unbelievable: Thetics, miratives and exclamatives in conceptual space. PhD dissertation, The University of New Mexico at Albuquerque.
- Gary, Judith and Edward Keenan. 1977. On collapsing grammatical relations in Universal Grammar. In P. Cole and J. M. Sadock (eds.), *Syntax and Semantics 8: Grammatical Relations*, 83–120. New York: Academic Press.
- Georgala, Effi. 2012. Applicatives in their structural and thematic function: A minimalist account of multitransitivity. Ithaca, NY: Cornell University, PhD dissertation.
- Georgala, Effi, Waltraud Paul, and John Whitman. 2008. Expletive and thematic applicatives. *Proceedings of WCCFL* 26: 181–9.
- Georgi, Doreen. 2012. A local derivation of global case splits. In A. Alexiadou, T. Kiss, and G. Müller (eds.), *Local Modelling of Nonlocal Dependencies in Syntax*, 305–36. Berlin: De Gruyter.
- Georgi, Doreen. 2013. A relativized probing approach to person encoding in local scenarios. *Linguistic Variation* 12: 153–210.
- Georgi, Doreen. 2014. Opaque interactions of Merge and Agree: On the nature and order of elementary operations. PhD dissertation, Universität Leipzig.

- Gianollo, Chiara, Cristina Guardiano, and Giuseppe Longobardi. 2008. Three fundamental issues in parametric linguistics. In T. Biberauer (ed.), *The Limits of Syntactic Variation*, 109–142. Amsterdam: John Benjamins.
- Gibson, Hannah. 2008. Half empty or half full: An analysis of subject-object inversion in Swahili. London: SOAS, University of London, MA dissertation.
- Gibson, Hannah. 2012. Auxiliary placement in Rangi: A dynamic syntax perspective. SOAS, University of London.
- Giusti, Giuliana. 2008. Agreement and concord in nominal expressions. In C. De Cat and K. Demuth (eds.), *The Bantu-Romance Connection*, 201–37. Amsterdam: John Benjamins.
- Givón, Talmy. 1976. Topic, pronoun, and grammatical agreement. In C. N. Li (ed.), *Subject and Topic*, 149–88. New York: Academic Press.
- Givón, Talmy (ed.). 1983. *Topic Continuity in Discourse: A Quantitative Cross-Language Study*. Amsterdam: John Benjamins.
- Givón, Talmy. 1994. The pragmatics of de-transitive voice: Functional and typological aspects of inversion. In T. Givón (ed.), *Voice and Inversion*, 3–46. Amsterdam: John Benjamins.
- Good, Jeff. 2011. The lexical status of ‘grammatical’ focus in Bantu languages. (Paper presented at Morphology Day, University at Buffalo).
- Guérois, Rozenn. 2014. Locative inversion in Cuwabo. *ZAS Papers in Linguistics* 57: 49–71.
- Guérois, Rozenn. 2015. A Grammar of Cuwabo (Mozambique, Bantu P34). PhD dissertation, University of Lyon 2.
- Güldemann, Tom. 2007. Preverbal objects and information structure in Benue-Congo. In E. O. Aboh, K. Hartmann, and M. Zimmermann (eds.), *Focus Strategies in African Languages: The Interaction of Focus and Grammar in Niger-Congo and Afro-Asiatic*, 83–111. Berlin: Mouton de Gruyter.
- Güldemann, Tom, Sabine Zerbian, and Malte Zimmermann. 2015. Variation in information structure with special reference to Africa. *Annual Review of Linguistics* 1: 155–78.
- Gundel, Jeanette. 1974. The role of topic and comment in linguistic theory. PhD dissertation, Austin: University of Texas.
- Gundel, Jeanette. 1988. Universals of topic-comment structure. In M. Hammond, E. A. Moravcsik, and J. R. Wirth (eds.), *Studies in Syntactic Typology*, 209–42. Amsterdam: John Benjamins.
- Gundel, Jeanette, Nancy Hedberg, and Ron Zacharsky. 1993. Cognitive status and the form of referring expressions in discourse. *Language* 69: 274–307.
- Guthrie, Malcolm. 1948. *The Classification of the Bantu Languages*. London: Oxford University Press.
- Haddican, William and Anders Holmberg. 2012. Object movement symmetries in British English dialects: Experimental evidence for a mixed case/locality approach. *Journal of Comparative Germanic Linguistics* 15: 189–212.
- Haddican, William and Anders Holmberg. 2014. Four kinds of object asymmetry. In L. Veselovská and M. Janebová (eds.), *Complex Visible Out There. Proceedings of the Olomouc Linguistics Colloquium 2014: Language Use and Linguistic Structure*, 145–62. Olomouc: Palacky University.
- Haddican, William and Anders Holmberg. 2018. Object symmetry effects in Germanic: Evidence for the role of case. *Natural Language & Linguistic Theory* 37 (1): 91–122.
- Halpert, Claire. 2012. Argument Licensing and Agreement in Zulu. PhD dissertation, Massachusetts Institute of Technology (MIT).
- Halpert, Claire. 2013. Structural case and the nature of vP in Zulu. In *Proceedings of NELS42*. Amherst, MA: GLSA.

- Halpert, Claire. 2015. *Argument Licensing and Agreement*. Oxford: Oxford University Press.
- Halpert, Claire. 2017. Prosody/syntax mismatches in the Zulu conjoint/disjoint alternation. In J. van der Wal and L. M. Hyman (eds.), *The conjoint/disjoint alternation in Bantu*, 329–349. Berlin: Mouton de Gruyter.
- Hamblin, Charles L. 1973. Questions in Montague English. *Foundations of Language* 10: 41–53.
- Hamlaoui, Fatima. 2018. Proto Bantu word order. Presentation at BGR2, Ghent.
- Hamlaoui, Fatima and Emmanuel-Moselly Makasso. 2015. Focus marking and the unavailability of inversion structures in the Bantu language Bàsàá (A43). *Lingua* 154: 35–64.
- Hammarström, Harald. 2019. An inventory of Bantu languages. In M. Van de Velde et al. (eds.), *The Bantu Languages*, Second Edition, 17–78. London: Routledge.
- Harford Perez, Carolyn. 1983. Locative pseudo-subjects in Shona. *Journal of African Languages & Linguistics* 5: 131–55.
- Harford, Carolyn. 1990. Locative inversion in Chishona. In John P. Hutchison and Victor Manfredi (eds.), *Current Approaches to African Linguistics*, Vol. 7. Publications in African Languages and Linguistics 11: 137–44. Dordrecht: Foris.
- Harford, Carolyn. 1991. Object asymmetries in Kitharaka. In *Proceedings of the Seventeenth Annual Meeting of the Berkeley Linguistics Society: Special Session on African Language Structures*, 98–105.
- Harjula, Lotta. 2004. *The Ha Language of Tanzania*, Köln: Köppe.
- Harley, Heidi. 1995. Subjects, events and licensing. PhD dissertation, Massachusetts Institute of Technology (MIT).
- Harley, Heidi. 2002. Possession and the double object construction. *Linguistic Variation Yearbook* 2: 29–68.
- Harley, Heidi. 2013. External arguments and the Mirror Principle: On the distinctness of Voice and v. *Lingua* 15: 34–57.
- Harley, Heidi and Shigeru Miyagawa. 2017. Syntax of Ditransitives. In *Oxford Research Encyclopedia of Linguistics*. Oxford: Oxford University Press.
- Harries, Lyndon. 1955. Grammar of Gesogo. *Kongo-Overzee* 11: 420–40.
- Harries, Lyndon. 1959. Nyali, a Bantoid language (Belgian Congo). *Kongo-Overzee* 25: 174–205.
- Hawkinson, Ann. K. 1976. A semantic characterization of verbal agreement and word order in several Bantu languages. MA thesis, University of Dar es Salaam.
- Hawkinson, Annie and Larry M. Hyman. 1974. Hierarchies of natural topic in Shona. *Studies in African Linguistics* 5: 147–70.
- Henderson, Brent M. 2006. The syntax and typology of Bantu relative clauses. PhD dissertation, University of Illinois at Urbana-Champaign.
- Henderson, Brent M. 2009. Anti-agreement and [Person] in Bantu. In M. Matondo, F. McLaughlin, and E. Potsdam (eds.), *Selected Proceedings of the 38th Annual Conference on African Linguistics: Linguistic Theory and African Language Documentation*, 173–81. Somerville, MA: Cascadilla Press.
- Henderson, Brent M. 2010. Chimwiini: Endangered status and syntactic distinctiveness. *The Journal of West African Languages* 37 (1): 75–91.
- Henderson, Brent M. 2011. Agreement, locality, and OVS in Bantu. *Lingua* 121 (5): 742–53.
- Hiraiwa, Ken. 2001. Multiple Agree and the defective intervention constraint in Japanese. *MIT Working Papers in Linguistics* 40: 67–80.
- Hodges, Kathryn S. 1977. Causatives, transitivity and objecthood in Kimeru. In M. Mould and T. J. Hinnebusch (eds.), *Papers from the eighth conference on African linguistics*, 113–25.

- Höhn, Georg. 2016. Unagreement is an illusion. Apparent mismatches and nominal structure. *Natural Language & Linguistic Theory* 34 (2): 543–92.
- Höhn, Georg. 2017. Non-possessive person in the nominal domain. PhD dissertation, University of Cambridge.
- Holmberg, Anders. 2017. Linguistic Typology. In I. Roberts (ed.), *The Oxford Handbook of Universal Grammar*, 355–76. Oxford: Oxford University Press.
- Holmberg, Anders and Crister Platzack. 1995. *The Role of Inflection in Scandinavian Syntax*. Oxford: Oxford University Press.
- Holmberg, Anders, Michelle Sheehan, and Jenneke van der Wal. 2019. Movement from the double object construction is not fully symmetrical. *Linguistic Inquiry* 50 (4): 677–721.
- Horvath, Julia. 2010. 'Discourse features', syntactic displacement and the status of contrast. *Lingua* 120: 1346–69.
- Hualde, José. 1989. Double object constructions in Kirimi. In R. Botne and P. Newman (eds.), *Current Approaches to African Linguistics*, 179–89. Dordrecht: Foris.
- Hulstaert, Gustaaf. 1965. *Grammaire du lomónḡo. Deuxième partie: Morphologie*. Tervuren: Royal Museum for Central Africa.
- Hyman, Larry M. 1999. The interaction between focus and tone in Bantu. In G. Rebuschi and L. Tuller (eds.), *The Grammar of Focus*, 151–78. Amsterdam: John Benjamins.
- Hyman, Larry M. 2003a. Basaa' (A43). In D. Nurse and G. Philippson (eds.), *The Bantu Languages*, 257–82. London: Routledge.
- Hyman, Larry M. 2003b. Segmental phonology. In D. Nurse and G. Philippson (eds.), *The Bantu Languages*, 42–58. London: Routledge.
- Hyman, Larry M. 2019. Segmental phonology. In M. O. Van de Velde, K. Bostoen, D. Nurse, and G. Philippson (eds.), *The Bantu Languages*, Second Edition, 128–49. London: Routledge.
- Hyman, Larry M. and Alessandro Duranti. 1982. On the object relation in Bantu. In P. Hopper and S. Thompson (eds.), *Syntax and Semantics: Studies in Transitivity*, 217–39. New York: Academic Press.
- Hyman, Larry M. and Francis X. Katamba. 1993. The augment in Luganda: Syntax or pragmatics? In Sam Mchombo (ed.), *Theoretical Aspects of Bantu Grammar*, 209–56. Stanford: CLSI.
- Hyman, Larry M., Sharon Inkelas, and Galen Sibanda. 2008. Morphosyntactic correspondence in Bantu reduplication. In K. Hanson & S. Inkelas (eds.), *The nature of the word: Essays in honor of Paul Kiparsky*, 273–310. Cambridge, MA: Massachusetts Institute of Technology (MIT) Press.
- Iorio, David. 2014. Subject and object marking in Bembe. PhD dissertation, Newcastle University.
- Jacobs, J. 1964. *Morphologie van het Tetela*. Gent: Orientalia Gandensia.
- Jelinek, Eloise. 1984. Empty categories, case, and configurationality. *Natural Language & Linguistic Theory* 2: 39–76.
- Jenks, Peter, Emmanuel-Moselly Makasso, and Larry M. Hyman. 2017. Relative clauses in Cameroonian languages: Structure, function and semantism. In G. Atindogbe and R. Grollemund (eds.), *Relative Clauses in Cameroonian Languages*, 17–46. Berlin: De Gruyter.
- Jeong, Youngmi. 2007. *Applicatives: Structure and Interpretation from a Minimalist Perspective*. Amsterdam: John Benjamins.
- Jerro, Kyle. 2015. Revisiting object symmetry in Bantu. In R. Kramer, E. C. Zsiga, and O. T. Boyer (eds.), *Selected Proceedings of the 44th Annual Conference on African Linguistics*, 130–45. Somerville, MA: Cascadilla Proceedings Project.



- Jerro, Kyle. 2019. Ingestive verbs, causatives, and object symmetry in Lubukusu. *Linguistic Inquiry* 50 (1): 219–32.
- Julien, Marit. 2002. *Syntactic heads and word formation*. Oxford: Oxford University Press.
- Kalin, Laura. 2018. Licensing and differential object marking: The view from Neo-Aramaic. *Syntax* 21 (2): 112–59.
- Kalin, Laura. 2019. Nominal licensing is driven by valued (phi-)features. *Nordlyd* 43 (1): 15–29.
- Kashina, Kashina. 2005. *The Silozi Clause*. LINCOM Studies in African Linguistics. Munich: LINCOM Europa.
- Kavari, Jekura, Lutz Marten, and Jenneke van der Wal. 2012. Tone cases in Otjiherero: Head-complement relations, linear order, and information structure. *Africana Linguistica* XVIII: 315–53.
- Kawasha, Boniface K. 2003. Lunda grammar: A morphosyntactic and semantic analysis. Eugene: University of Oregon, PhD dissertation.
- Kayne, Richard. 1994. *The Antisymmetry of Syntax*. Cambridge, MA: Massachusetts Institute of Technology (MIT) Press.
- Keine, Stefan. 2010. *Case and Agreement from Fringe to Core: A Minimalist Approach*. Berlin: De Gruyter.
- Khumalo, Langa. 2007. An analysis of the Ndebele passive construction. PhD dissertation, University of Oslo.
- Kidima, Lukowa. 1987. Object agreement and topicality hierarchies in Kiyaka. *Studies in African Linguistics* 18 (2): 175–209.
- Kidima, Lukowa. 1991. Tone and accent in KiYaka. PhD dissertation, University of California Los Angeles.
- Kimenyi, Alexandre. 1980. *A Relational Grammar of Kinyarwanda*. Berkeley and Los Angeles: University of California Press.
- Kimenyi, Alexandre. 1988. Passives in Kinyarwanda. In M. Shibatani (ed.), *Passive and Voice*, 355–86. Amsterdam/Philadelphia: John Benjamins.
- Kimenyi, Alexandre. 1995. Kinyarwanda applicatives revisited. (Keynote address at the 8th Niger-Congo Syntax–Semantics Workshop, Boston University).
- Kinyalolo, Kasangati K. W. 2003. Limiting the scope of V-movement in Kilega. (Handout of a talk given at Stony Brook, New York).
- Kioko, Angelina N. 2000. On determining the primary object in Bantu. *South African Journal of African Languages* 20 (3): 225–33.
- Kisseberth, Charles and Mohammad Imam Abasheikh. 1977. The object relationship in Chimwini, a Bantu language. In P. Cole and J. M. Sadock (eds.), *Syntax and Semantics: Grammatical Relations*, 179–218. New York: Academic Press.
- Koenenman, Olaf and Hedde Zeijlstra. 2014. The rich agreement hypothesis rehabilitated. *Linguistic Inquiry* 45 (4): 571–615.
- Kraal, Peter. 2005. A grammar of Makonde. PhD dissertation, Leiden University.
- Kramer, Ruth. 2014. Clitic doubling or object agreement: The view from Amharic. *Natural Language & Linguistic Theory* 32: 593–634.
- Krifka, Manfred and Renate Musan. 2012. Information structure: Overview and linguistic issues. In M. Krifka and R. Musan (eds.), *The Expression of Information Structure*, 1–44. Berlin: Mouton de Gruyter.
- Kula, Nancy C. 2017. The conjoint/disjoint alternation and phonological phrasing in Bemba. In J. van der Wal and L. M. Hyman (eds.), *The Conjoint/Disjoint Alternation in Bantu*, 258–94. Berlin: De Gruyter.

- Kuno, Susumu and Ken-ichi Takami. 2004. *Functional constraints in grammar: On the unergative-unaccusative distinction* (Vol. 1). Amsterdam/Philadelphia: John Benjamins Publishing.
- Kuperus, Julianna and A. Mpunga wa Ilunga. 1990. *Locative Markers in Luba*. Tervuren: Royal Museum for Central Africa.
- Labov, William. 2001. *Principles of Linguistic Change. Volume II: Social Factors*. Oxford/Cambridge: Blackwell.
- Lambrecht, Knud. 1994. *Information Structure and Sentence Form*. Cambridge: Cambridge University Press.
- Leach, Benjamin. 2010. *Things Hold Together: Foundations for a Systemic Treatment of Verbal and Nominal Tone in Plateau Shimakonde*. Utrecht: Landelijke Onderzoekschool Taalwetenschap (LOT).
- Legate, Julie-Anne. 2008. Morphological case and abstract case. *Linguistic Inquiry* 39: 55–101.
- Leonetti, Manuel. 2008. Definiteness effects and the role of the coda in existential constructions. In A. Klinge and H. Hoeg-Muller (eds.), *Essays of determination*, 131–62. Amsterdam: John Benjamins.
- Letsholo, Rose. 2013. Object markers in Ikalanga. *Linguistic Discovery* 11 (1): 105–28.
- Levin, Beth. 1983. On the nature of ergativity. PhD thesis, Massachusetts Institute of Technology (MIT) Press.
- Levin, Beth and Malka Rappaport Hovav. 1995. *Unaccusativity: At the syntax-lexical semantics interface*. Cambridge, MA: Massachusetts Institute of Technology (MIT) Press.
- Li, Charles N. and Sandra Thompson. 1976. Subject and topic: A new typology of language. In C. N. Li and S. Thompson (eds.), *Subject and Topic*, 457–90. New York: Academic Press.
- Liphola, Marcelino. 2001. Aspects of the phonology and morphology of Shimakonde. PhD dissertation, Ohio State University.
- Longobardi, Giuseppe. 2018. Principles, parameters, and schemata: A radically underspecified UG. *Linguistic Analysis* 41 (3–4): 517–58.
- Louwrens, Louis J. 1991. *Aspects of Northern Sotho Grammar*. Pretoria: Via Afrika Ltd.
- Lusekelo, Amani. 2012. Inflectional and derivational morphology in optimality theory. PhD dissertation, University of Botswana.
- Machobane, 'Malillo. 1989. Some restrictions of the Sesotho transitivizing morpheme. PhD dissertation, McGill University, Montreal.
- Machobane, 'Malillo. 1995. Sesotho locative constructions. *The Journal of African Languages and Linguistics* 16 (2): 115–36.
- Maganga, Clement and Thilo C. Schadeberg. 1992. *Kinyamwezi Grammar, Text and Vocabulary*. Cologne: Rüdiger Köppe Verlag.
- Maho, Jouni F. 2009. NUGL Online: The online version of the new updated Guthrie list, a referential classification of the Bantu languages.
- Malchukov, Andrej L., Martin Haspelmath, and Bernard Comrie. 2010. Ditransitive constructions: A typological overview. In A. L. Malchukov, M. Haspelmath, and B. Comrie (eds.), *Studies in Ditransitive Constructions: A Comparative Handbook*, 1–64. Berlin: Mouton de Gruyter.
- Manzini, Maria-Rita and Leonardo Savoia. 2002. Parameters of subject inflection in Italian dialects. In P. Svenonius (ed.), *Subjects, expletives, and the EPP*, 157–99. Oxford: Oxford University Press.
- Marantz, Alec. 1984. *On the Nature of Grammatical Relations*. Cambridge, MA: Massachusetts Institute of Technology (MIT) Press.

- Marantz, Alec. 1991. Case and licensing. In G. F. Westphal, B. Ao, and H.-R. Chae (eds.), *Proceedings of the 8th Eastern States Conference on Linguistics* (ECOL), 234–53. Ohio: The Ohio State University, Department of Linguistics.
- Marantz, Alec. 1993. Implications of asymmetries in double object constructions. In S. A. Mchombo (ed.), *Theoretical Aspects of Bantu Grammar*, 113–50. Stanford: CSLI.
- Marlo, Michael R. 2013. Verb tone in Bantu languages: Micro-typological patterns and research methods. *Africana Linguistica* 19: 137–234.
- Marlo, Michael R. 2014. Exceptional patterns of object marking in Bantu. *Studies in African Linguistics* 43 (2): 85–123.
- Marlo, Michael R. 2015a. Exceptional properties of the reflexive in Bantu languages. *Nordic Journal of African Studies* 24: 1–22.
- Marlo, Michael R. 2015b. On the number of object markers in Bantu languages. *Journal of African Languages & Linguistics* 36: 1–65.
- Marten, Lutz. 2000. Agreement with conjoined noun phrases in Swahili. *Afrikanistische Arbeitspapiere* 64: *Swahili Forum VII*: 75–96.
- Marten, Lutz. 2003. The dynamics of Bantu applied verbs: An analysis at the syntax–pragmatics interface. In K. K. Lévikaza (ed.), *Actes du 3e Congrès Mondial de Linguistique Africaine Lomé 2000*, 207–21. Cologne: Rüdiger Köppe Verlag.
- Marten, Lutz. 2006. Locative inversion in Herero: More on morphosyntactic variation in Bantu. In L. Downing, L. Marten, and S. Zerbian (eds.), *Papers in Bantu grammar and description*. *ZASPiL* 43: 97–122.
- Marten, Lutz. 2010. The great siSwati locative shift. In A. Breitbarth, C. Lucas, S. Watts, and D. Willis (eds.), *Continuity and Change in Grammar*, 249–67. Amsterdam: John Benjamins.
- Marten, Lutz. 2011. Information structure and agreement: Subjects and subject markers in Swahili and Herero. *Lingua* 121 (5): 787–804.
- Marten, Lutz and Hannah Gibson. 2016. Structure building and thematic constraints in Bantu inversion constructions. *Journal of Linguistics* 53 (3): 565–607.
- Marten, Lutz and Nancy C. Kula. 2012. Object marking and morphosyntactic variation in Bantu. *South African Journal of African Languages* 30 (2): 237–53.
- Marten, Lutz and Nancy C. Kula. 2014. Benefactive and substitutive applicatives in Bemba. *Journal of African Languages & Linguistics* 23 (1): 1–44.
- Marten, Lutz and Maarten Mous. 2017. Valency and expectation in Bantu applicatives. *Linguistics Vanguard* 3 (1): 1–15.
- Marten, Lutz and Maarten Mous. 2018. Non-valency changing valency-changing derivations. *Frankfurter Afrikanistische Blätter* 26: 89–105.
- Marten, Lutz and Deograsia Ramadhani. 2001. An overview of object marking in Kiluguru. *SOAS Working Papers in Linguistics* 11: 259–75.
- Marten, Lutz and Jenneke van der Wal. 2014. A typology of Bantu inversion constructions. *Linguistic Variation* 14 (2): 318–68.
- Marten, Lutz, Nancy C. Kula, and Nhlanhla Thwala. 2007. Parameters of morpho-syntactic variation in Bantu. *Transactions of the Philological Society* 105 (3): 253–338.
- Masunaga, Kiyoko. 1983. The applied suffix in Kikuyu. In J. Kaye and Koopman (eds.), *Current Approaches to African Linguistics* 2.5: 283–91.
- Mathangwane, Joyce T. and E. Kweku Osam. 2006. Grammatical relations in Ikalanga. *Studies in African Linguistics* 35 (2): 189–208.
- Maxwell, Edith. 1981. Question Strategies and Hierarchies of Grammatical Relations in Kinyarwanda. In *Proceedings of the 7th Annual Meeting of the Berkeley Linguistics Society*, 166–77. Berkeley, California: University of California.

- McFadden, Thomas. 2004. The position of morphological case in the derivation: A study on the syntax–morphology interface. PhD dissertation, University of Pennsylvania.
- McGinnis, Martha. 1998a. Locality and inert Case. In P. Tamanji and K. Musumoto (eds.), *Proceedings of NELS 28*, 267–81. Amherst, MA: GLSA Publications, University of Massachusetts.
- McGinnis, Martha. 1998b. Locality in A-movement. PhD dissertation, University of Toronto.
- McGinnis, Martha. 2001. Variation in the syntax of applicatives. *Linguistics Variation Yearbook* 1: 105–46.
- Mchombo, Sam. 2004. *The Syntax of Chichewa*. Cambridge: Cambridge University Press.
- Mchombo, Sam and Gregório Firmino. 1999. Double object constructions in Chichewa and Gitonga: A Comparative Analysis. *Linguistic Analysis* 29: 214–33.
- Meeussen, A. E. 1967. Bantu grammatical reconstructions. *Annales du Musée Royal de l'Afrique Centrale* 61.
- Meinhof, Carl. 1906. *Grundzüge einer vergleichenden Grammatik der Bantusprachen*. Berlin: Reimer.
- Meinhof, Carl and Nicolaus J. van Warmelo (eds.). 1932. *Introduction to the Phonology of the Bantu Languages*, being the English version of *Grundriss einer Lautlehre der Bantusprachen* by Carl Meinhof, translated, revised, and enlarged in collaboration with the Author and Dr. Alice Werner by N. J. van Warmelo. Dietrich Reimer/Ernst Vohsen, published under the auspices of The International Institute of African Languages and Cultures, The Carnegie Corporation of New York, and The Witwatersrand Council of Education, Johannesburg.
- Mendikoetxea, Amaya. 2006. Unergatives that 'become' unaccusatives in English Locative Inversion Structures: a lexical-syntactic approach. *Points de vue sur l'inversion. Cahiers de Recherche en Grammaire Anglaise de L'Enonciation*, Tome 9, 133–55.
- Mitchley, Hazel. 2015. Agreement and coordination in Xitsonga, Sesotho and isiXhosa: An Optimality Theoretic perspective. MA thesis, Rhodes University.
- Miyagawa, Shigeru. 2010. *Why Agree? Why Move?* Cambridge, MA: Massachusetts Institute of Technology (MIT) Press.
- Miyagawa, Shigeru. 2017. *Agreement Beyond Phi*. Cambridge, MA: Massachusetts Institute of Technology (MIT) Press.
- Mkude, Daniel J. 1974. A study of Kiluguru syntax with special reference to the transformational history of sentences with permuted subject and object. PhD dissertation, SOAS University of London.
- Möhlig, Wilhelm J. G. and Jekura U. Kavari. 2008. *Reference Grammar of Herero (Otjiherero)*. Cologne: Rüdiger Köppe Verlag.
- Möhlig, Wilhelm J. G., Lutz Marten, and Jekura Kavari. 2002. *A Grammatical Sketch of Herero (Otjiherero)*. Cologne: Rüdiger Köppe Verlag.
- Moravcsik, Edith A. 1974. Object-verb agreement. *Working Papers in Language Universals, Stanford University* 15: 25–140.
- Morimoto, Yukiko. 2000. Discourse configurationality in Bantu Morphosyntax. PhD dissertation, Stanford: Stanford University.
- Morimoto, Yukiko. 2002. Prominence mismatches and differential object marking in Bantu. In M. Butt and T. H. King (eds.), *Proceedings of the LFG02 conference*, 292–314. Stanford: CSLI Publications.
- Morimoto, Yukiko. 2006. Agreement properties and word order in comparative Bantu. *ZAS Papers in Linguistics* 43: 161–88.

- Morolong, 'Malillo and Larry M. Hyman. 1977. Animacy, objects and clitics in Sesotho. *Studies in African Linguistics* 8: 199–218.
- Moshi, Lioba. 1998. Word order in multiple object constructions in KiVunjo-Chaga, *Journal of African Languages & Linguistics* 19: 137–52.
- Mous, Maarten. 1997. The position of the object in Tunen. In R.-M. Déchaine and V. Manfredi (eds.), *Object Positions in Benue-Kwa*, 123–37. Den Haag: Holland Academic Graphics.
- Mous, Maarten. 2003. Nen. In D. Nurse and G. Philippson (eds.), *The Bantu Languages*, 283–306. London: Routledge.
- Mous, Maarten. 2005. The innovative character of object-verb word order in Nen (Bantu A44, Cameroon). In K. Bostoen and J. Maniacky (eds.), *Studies in African Comparative Linguistics with Special Focus on Bantu and Mande. Essays in Honour of Y. Bastin and C. Grégoire*, 411–24. Tervuren: RMCA.
- Mous, Maarten. 2014. TAM-Full object-verb order in the Mbam languages of Cameroon. *ZAS Papers in Linguistics* 57: 72–94.
- Mugari, Victor. 2013. Object marking restrictions on Shona causative and applicative constructions. *Southern African Linguistics and Applied Language Studies* 31 (2): 151–60.
- Müller, G. 2004. Phrase impenetrability and wh-intervention. In A. Stepanov, G. Fanselow and R. Vogel (eds.), *Minimality effects in syntax*, 289–325. Berlin: Mouton de Gruyter.
- Müller, Gereon. 2009. Ergativity, accusativity, and the order of Merge and Agree. In K. Grohmann (ed.), *Explorations of Phase Theory: Features and Arguments*, 269–308. Berlin: Mouton de Gruyter.
- Muriungi, Peter. 2005. Wh-questions in Kitharaka. *Studies in African Linguistics* 34: 43–104.
- Muriungi, Peter. 2008. Phrasal movement inside Bantu verbs: Deriving affix scope and order in Kitharaka. PhD dissertation, University of Tromsø.
- Muriungi, Peter. 2010. Accounting for the three readings of the causative morpheme in Kitharaka. *Nordic Journal of African Studies* 19: 181–200.
- Murrell, Paul. 2012. The applicative construction and object symmetry as a parameter of variation in Kiswahili and Maragoli. *Southern African Linguistics and Applied Language Studies* 30 (2): 255–75.
- Mursell, Johannes. 2018. Object marking in Swahili is topic agreement. *Jezikoslovlje* 19 (3): 427–55.
- Mwansa, Joseph M. 2011. The acquisition of object markers by Bemba-speaking children. PhD dissertation, University of Leeds.
- Mwisiya, M. W. 1977. *Introduction to Silozi Grammar*. Lusaka: Kenneth Kaunda Foundation.
- Mwita, Leonard C. 2008. Verbal tone in Kikuria. PhD dissertation, University of California Los Angeles.
- Myers, Scott. 1990. *Tone and the Structure of Words in Shona*. New York: Garland.
- Nakamura, Masanori. 1997. Object extraction in Bantu applicatives: Some implications for Minimalism. *Linguistic Inquiry* 28 (2): 252–80.
- Nash, Jay. 1992. *Aspects of Ruwund Grammar*. University of Illinois Press at Urbana-Champaign.
- Nash, Léa. 2017. Person split and pronominal asymmetries. In A. Lamont and K. Tetzloff (eds.), *NELS 47: Proceedings of the Forty-Seventh Annual Meeting of the North East Linguistic Society*, Vol. 2, 303–14. Amherst: GLSA Publications.
- Ndayiragije, Juvénal. 1999. Checking economy. *Linguistic Inquiry* 30 (3): 399–444.

- Nevins, Andrew. 2007. The representation of third person and its consequences for person-case effects. *Natural Language & Linguistic Theory* 25: 273–313.
- Nevins, Andrew. 2011. Multiple agree with clitics: Person complementarity vs omnivorous number. *Natural Language & Linguistic Theory* 29: 939–71.
- Nevins, Andrew. 2018. Copying and resolution in South Slavic and South Bantu Conjunct Agreement. In R. Petrosino, P. Cerrone, and H. van der Hulst (eds.), *From Sounds to Structures – Beyond the Veil of Maya*, 391–408. Berlin: De Gruyter Mouton.
- Ngoboka, Jean Paul. 2005. A syntactic analysis of Kinyarwanda applicatives. Master's thesis, University of KwaZulu-Natal.
- Ngoboka, Jean Paul. 2016. Locatives in Kinyarwanda. PhD dissertation, University of KwaZulu-Natal.
- Ngoboka, Jean Paul. 2017. Locative markers in Kinyarwanda as determiners. *Nordic Journal of African Studies* 26 (4): 292–317.
- Ngoboka, Jean Paul and Jochen Zeller. 2017. The Conjoint/Disjoint Alternation in Kinyarwanda. In J. van der Wal and L. M. Hyman (eds.), *The Conjoint/Disjoint Alternation in Bantu*, 350–89. Berlin: De Gruyter Mouton.
- Ngonyani, Deo. 1996. The morphosyntax of applicatives. PhD dissertation, University of California Los Angeles.
- Ngonyani, Deo. 1998. Properties of applied objects in Kiswahili and Kindendeule. *Studies in African Linguistics* 27: 67–95.
- Ngonyani, Deo. 2000. The structure of Kindendeule applicatives. In V. Carstens and F. Parkinson (eds.), *Advances in African Linguistics*, 61–76. Trenton, NJ: Africa World Press.
- Ngonyani, Deo and Peter Githinji. 2006. The asymmetric nature of Bantu applicative constructions. *Lingua* 116: 31–63.
- Nicolle, Steve. 2013. *A Grammar of Digo*. Dallas, TX: SIL International.
- Nicolle, Steve. 2015a. Digo narrative discourse. *SIL Language and Culture Documentation and Description* 26.
- Nicolle, Steve. 2015b. A comparative study of eastern Bantu narrative texts. *SIL Electronic Working Papers* 2015–003.
- Nie, Yining. 2020. *Licensing arguments*. PhD dissertation, New York University.
- Norris, Mark. 2014. *A theory of nominal concord*. PhD dissertation, University of California Santa Cruz.
- Norris, Mark. 2017a. Description and analyses of nominal concord (Pt I). *Language and Linguistics Compass* 11.
- Norris, Mark. 2017b. Description and analyses of nominal concord (Pt II). *Language and Linguistics Compass* 11.
- Nshemezimana, Ernest. 2016. Morphosyntaxe et structure informationnelle en Kirundi: Focus et stratégies de focalisation. PhD dissertation, Ghent: Ghent University.
- Nshemezimana, Ernest and Koen Bostoen. 2017. The conjoint/disjoint alternation in Kirundi (JD62): A case for its abolition. In J. van der Wal and L. M. Hyman (eds.), *The Conjoint/Disjoint Alternation in Bantu*, 390–425. Berlin: De Gruyter.
- Nunes, Jairo. 2004. *Linearization of Chains and Sideward Movement*. Cambridge, MA: Massachusetts Institute of Technology (MIT) Press.
- Nurse, Derek and Gérard Philippson. 2003. Introduction. In D. Nurse and G. Philippson (eds.), *The Bantu Languages*, 1–12. London: Routledge.
- Nyembezi, C. L. S. 1990. *Learn More Zulu*. Second Edition. Pietermaritzburg: Shuter and Shooter. (First published 1970.)

- Odden, David. 1984. Formal correlates of focusing in Kimatuumbi. *Studies in African Linguistics* 15 (3): 275–99.
- Odden, David. 2003. Rufiji-Ruvuma (N10, P10–20). In D. Nurse and G. Philippson (eds.), *The Bantu Languages*, 529–45. London: Routledge.
- Olson, Howard S. 1964. *The Phonology and Morphology of Rimi*. Hartford, Connecticut: The Hartford Seminary Foundation.
- Ormazabal, Javier and Juan Romero. 2007. The object agreement constraint. *Natural Language & Linguistic Theory* 25: 315–47.
- Ormazabal, Javier and Juan Romero. 2013. Differential object marking, case and agreement. *Borealis: An International Journal of Hispanic Linguistics* 2: 221–39.
- Perez (Harford), Caroline. 1985. Aspects of complementation in three Bantu languages. PhD dissertation, University of Wisconsin, Madison.
- Persohn, Bastian. 2017. *The Verb in Nyakyusa: A Focus on Tense, Aspect, and Modality* (Contemporary African Linguistics 2). Berlin: Language Science Press.
- Pesetsky, David. 1989. The earliness principle. Paper presented at GLOW in 1989.
- Pesetsky, David. 1995. *Zero Syntax: Experiencers and Cascades*. Cambridge, MA: Massachusetts Institute of Technology (MIT) Press.
- Pesetsky, David. 2014. *Russian Case Morphology and the Syntactic Categories*. Cambridge, MA: Massachusetts Institute of Technology (MIT) Press.
- Pesetsky, David and Esther Torrego. 2007. The syntax of valuation and the interpretability of features. In S. Karimi, V. Samiian, and W. Wilkins (eds.), *Phrasal and Clausal Architecture: Syntactic Derivation and Interpretation*, 262–94. Amsterdam: John Benjamins.
- Peterson, David A. 2007. *Applicative Constructions*. Oxford: Oxford University Press.
- Petzell, Malin. 2008. *The Kagulu Language of Tanzania: Grammar, Text and Vocabulary* (East African Languages and Dialects 19). Cologne: Rüdiger Köppe Verlag.
- Pinto, Manuela. 1997. *Licensing and interpretation of inverted subjects in Italian*. Utrecht: Landelijke Onderzoekschool Taalwetenschap (LOT).
- Polak, Louise. 1986. Les infices ('préfixes objets') du bantou et leur reconstruction. *Africana Linguistica* X: 365–421.
- Polinsky, Maria and Robert Kluender. 2007. Linguistic typology and theory construction: Common challenges ahead. *Linguistic Typology* 11: 273–83.
- Preminger, Omer. 2009. Breaking agreements: Distinguishing agreement and clitic doubling by their failures. *Linguistic Inquiry* 40 (4): 619–66.
- Preminger, Omer. 2014. *Agreement and its Failures*. Cambridge, MA: Massachusetts Institute of Technology (MIT) Press.
- Pretorius, Rigardt, Ansu Berg, and Laurette Pretorius. 2012. Multiple object agreement morphemes in Setswana: a computational approach. *Southern African Linguistics and Applied Language Studies* 30 (2): 203–18.
- Prince, Ellen F. 1981. Toward a taxonomy of given/new information. In P. Cole (ed.), *Radical Pragmatics*, 223–56. New York, NY: Academic Press.
- Prince, Ellen F. 1992. The ZPG letter: Subjects, definiteness, and information status. In S. Thompson and W. Mann (eds.), *Discourse Description: Diverse Analyses of a Fund-Raising Text*, 295–325. Amsterdam: John Benjamins.
- Progovac, Liljana. 1993. Non-augmented NPs in Kinande as Negative Polarity Items. In S. Mchombo (ed.), *Theoretical Aspects of Bantu Grammar 1*: 257–70. California: CSLI Publication.
- Puškar, Zorica. 2017. Hybrid agreement: Modelling variation, hierarchy effects and  $\phi$ -feature mismatches. PhD dissertation, Leipzig University.

- Pylkkänen, Liina. 2008. *Introducing Arguments*. Cambridge, MA: Massachusetts Institute of Technology (MIT) Press.
- Quintão, José Luis. 1934. *Gramática de Kimbundo*. Edições Descobrimento.
- Ranero, Rodrigo. 2015. *The syntax of dislocated objects in Luganda*. MPhil dissertation, University of Cambridge.
- Reinhart, Tanya. 1981. Pragmatics and linguistics: An analysis of sentence topics. *Philosophica* 27: 53–94.
- Reinhart, Tanya. 2006. *Interface Strategies*. Cambridge, MA: Massachusetts Institute of Technology (MIT) Press.
- Rhodes, Richard A. 1994. Agency, inversion, and thematic alignment in Ojibwe. In S. Gahl, A. Dolbey, and C. Johnson (eds.), *Berkeley Linguistics Society* 20: 431–46.
- Richards, Marc. 2008. Defective Agree, case alternations, and the prominence of person. In M. Richards and A. L. Malchukov (eds.), *Scales*, 137–61. Leipzig: University of Leipzig.
- Richards, Marc. 2015. Defective agree, case alternations, and the prominence of Person. In I. Bornkessel-Schlesewsky, A. L. Malchukov, and M. D. Richards (eds.), *Scales and Hierarchies*, 173–96. Berlin: De Gruyter.
- Richards, Marc and Theresa Biberauer. 2005. Explaining Expl. In M. Den Dikken (ed.), *The Function of Function Words and Functional Categories*, 115–54. Amsterdam: John Benjamins.
- Richards, Norvin. 2009. Locality and linearization: The case of Kinande. *Gengo Kenkyu* 136: 75–92.
- Riedel, Kristina. 2009. *The Syntax of Object Marking in Sambia: A Comparative Perspective*. Utrecht: Landelijke Onderzoekschool Taalwetenschap (LOT).
- Ritter, Elizabeth and Martina Wiltschko. 2009. Varieties of INFL: Tense, Location and Person. In J. van Craenenbroeck (ed.), *Alternatives to Cartography*, 153–201. Berlin: Mouton de Gruyter.
- Ritter, Elizabeth and Martina Wiltschko. 2014. The composition of INFL. *Natural Language & Linguistic Theory* 32 (4): 1331–86.
- Rizzi, Luigi. 1986. On chain formation. In H. Borer (ed.), *The Syntax of Pronominal Clitics*, 65–95. Syntax and Semantics 19. New York: Academic Press.
- Rizzi, Luigi. 1990. *Relativized Minimality*. Cambridge, MA: Massachusetts Institute of Technology (MIT) Press.
- Rizzi, Luigi. 2013. Locality. *Lingua* 130: 169–86.
- Roberts, Ian. 2007. *Diachronic Syntax*. Oxford: Oxford University Press.
- Roberts, Ian. 2010. *Agreement and Head Movement: Clitics, Incorporation, and Defective Goals*. Cambridge, MA: The Massachusetts Institute of Technology (MIT) Press.
- Roberts, Ian. 2012. Macroparameters and Minimalism: A programme for comparative research. In C. Galves, S. Cyrino, R. Lopes, F. Sandalo, and J. Avelar (eds.), *Parameter Theory and Linguistic Change*, 320–35. Oxford: Oxford University Press.
- Roberts, Ian. 2014. Subject clitics and macroparameters. In P. Benincà, A. Ledgeway, and N. Vincent (eds.), *Diachrony and Dialects: Grammatical Change in the Dialects of Italy*, 177–201. Oxford: Oxford University Press.
- Roberts, Ian. 2019. *Parameter Hierarchies and Universal Grammar*. Oxford: Oxford University Press.
- Roberts, Ian and Anders Holmberg. 2010. Introduction: Parameters in Minimalist Theory. In T. Biberauer, A. Holmberg, I. Roberts, and M. Sheehan (eds.), *Parametric Variation. Null Subjects in Minimalist Theory*, 1–57. Cambridge: Cambridge University Press.
- Roberts, Ian and Anna Roussou. 2003. *Syntactic Change: A Minimalist Approach to Grammaticalization*. Cambridge: Cambridge University Press.



- Roehl, Karl. 1911. *Versuch einer systematischen Grammatik der Schambalaspache*. Hamburg: Friederichsen.
- Rooth, Mats. 1992. A theory of focus interpretation. *Natural Language Semantics* 1: 75–116.
- Rooth, Mats. 1996. Focus. In S. Leppin (ed.), *The Handbook of Contemporary Semantic Theory*, 271–97. Oxford: Blackwell.
- Rugemalira, Josephat M. 1991. What is a symmetrical language? Multiple object constructions in Bantu. In K. Hubbard (ed.), *Proceedings of the 17th Annual Meeting of the Berkeley Linguistics Society: Papers from the Special Session*, 200–209. Berkeley Linguistics Society.
- Rugemalira, Josephat M. 1993. Bantu multiple ‘object’ constructions. *Linguistic Analysis* 23: 226–52.
- Russell, Joan. 1985. Swahili quasi-passives: The question of context. In D. L. Goyvaerts (ed.), *African linguistics: Essays in memory of M.W.K. Semikenke*, 477–90. Amsterdam: John Benjamins.
- Sabimana, Firmard. 1986. The relational structure of the Kirundi verb. PhD dissertation, Department of Linguistics, Indiana University.
- Saito, Mamoru. 2007. Notes on East Asian argument ellipsis. *Language Research* 43: 203–27.
- Salzmann, Martin. 2001. Theoretical approaches to locative inversion. Zürich: University of Zürich, MA dissertation.
- Salzmann, Martin. 2011. Towards a typology of locative inversion—Bantu, perhaps Chinese and English—but beyond? *Language and Linguistics Compass* 5/4: 169–89.
- Sasse, Hans-Jürgen. 1996. *Theticity*. Arbeitspapiere Cologne: Institut für Sprachwissenschaft der Universität zu Köln.
- Sasse, Hans-Jürgen. 2006. Theticity. In G. Bernini and M. Schwarz (eds.), *Pragmatic Organization of Discourse in the Languages of Europe*, 255–308. Berlin: Mouton de Gruyter.
- Schadeberg, Thilo C. 1990. *A Sketch of Umbundu*. Cologne: Rüdiger Köppe Verlag.
- Schadeberg, Thilo C. 1995. Object diagnostics in Bantu. In E. N. Emenanjo and O.-M. Ndimele (eds.), *Issues in African Languages and Linguistics*, 173–80. Aba: National Institute for Nigerian Languages.
- Schadeberg, Thilo C. and Francisco Ussene Mucanheia. 2000. *Ekoti: The Maka or Swahili language of Angoche*. Cologne: Rüdiger Köppe Verlag.
- Schifano, Norma. 2018. *Verb movement in Romance: a comparative study*. Oxford: Oxford University Press.
- Schneider-Zioga, Patricia. 2007. Anti-agreement, anti-locality, and minimality: The syntax of dislocated subjects. *Natural Language & Linguistic Theory* 25 (2): 403–46.
- Schneider-Zioga, Patricia. 2014a. The linker in Kinande re-examined. In R. Kramer, E. C. Zsiga, and O. T. Boyer (eds.), *Selected Proceedings of the 44th Annual Conference on African Linguistics*, 254–63. Somerville, MA: Cascadilla Proceedings Project.
- Schneider-Zioga, Patricia. 2014b. Linking, predication and symmetry: On the syntax of the linker in Kinande. In T. Borer, H. Fang, A. Garcia-Pardo, P. Guekguezian, B. Hsu, C. O’Hara, I. C. Ouyang, and U. Steindl (eds.), *Proceedings of the 32nd Annual West Coast Conference on Formal Linguistics*, 323–31. Somerville, MA: Cascadilla Press.
- Schneider-Zioga, Patricia. 2019. On the licensing of nominals in Kinande. In P. Akumbu and E. P. Chie (eds.), *Engagement with Africa: Linguistic Essays in Honor of Ngesimo Mutaka*. Cologne: Rüdiger Köppe Verlag.
- Schneider-Zioga, Patricia and Philip N. Mutaka. 2015. Copular clauses in Kinande. *The Journal of West African Languages* 42 (2): 57–78.
- Schwarz, Florian. 2013. Two kinds of definites cross-linguistically. *Language and Linguistics Compass* 7 (10): 534–59.

- Seidl, Amanda and Alexis Dimitriadis. 1997. The discourse function of object marking in Swahili. *CLS 33: The Main Session*, 373–89.
- Sheehan, Michelle. 2013. Explaining the Final-over-Final constraint: Formal and functional approaches. In T. Biberauer and M. Sheehan (eds.), *Theoretical Approaches to Disharmonic Word Order*, 407–44. Oxford: Oxford University Press.
- Sheehan, Michelle. 2014. Towards a parameter hierarchy for alignment. In R. E. Santana-LaBarge (ed.), *Proceedings of WCCFL 31*: 399–408. Somerville, MA: Cascadilla Press.
- Sheehan, Michelle. 2017. Parameterising ergativity: An inherent case approach. In J. Coon, D. Massam, and L. Travis (eds.), *The Oxford Handbook of Ergativity*, 59–85. Oxford: Oxford University Press.
- Sheehan, Michelle, Theresa Biberauer, Anders Holmberg, and Ian Roberts (eds.). 2017. *The Final-Over-Final Condition: A Syntactic Universal*. Cambridge, MA: Massachusetts Institute of Technology (MIT) Press.
- Sheehan, Michelle and Jenneke van der Wal. 2016. Do we need abstract Case? In K.-M. Kim et al. (eds.), *Proceedings of the 33rd WCCFL*, 351–60. Somerville, MA: Cascadilla Proceedings Project.
- Sheehan, Michelle and Jenneke van der Wal. 2018. Evidence for nominal licensing in caseless languages. *Journal of Linguistics* 54: 527–89.
- Sikuku, Justine. 2012. Comparing reflexive and object marking in Lubukusu. Technical report Afranaph, available via [https://afanaphproject.afanaphdatabase.com/images/stories/downloads/technical\\_reports/technicalreport10\\_comparingrf\\_mom.pdf](https://afanaphproject.afanaphdatabase.com/images/stories/downloads/technical_reports/technicalreport10_comparingrf_mom.pdf).
- Sikuku, Justine, Michael Diercks, and Michael Marlo. 2018. Pragmatic effects of clitic doubling: Two kinds of object markers in Lubukusu. *Linguistic Variation* 18 (2): 359–429.
- Silverstein, Michael. 1976. Hierarchy of features and ergativity. In R. M. W. Dixon (ed.), *Grammatical Categories in Australian Languages*, 112–71. Canberra: Australian Institute of Aboriginal Studies.
- Simango, Silvester Ron. 1995. The syntax of Bantu double object constructions. PhD dissertation, University of South Carolina.
- Simango, Silvester Ron. 2006. Verb agreement and the syntax of ciNsenga relative clauses. *Southern African Linguistics and Applied Language Studies*, 24 (3): 277–90.
- Smith, Peter W., Beate Moskal, Ting Xu, Jungmin Kang, and Jonathan David Bobaljik. 2019. Case and number suppletion in pronouns. *Natural Language & Linguistic Theory* 37: 1029–1101.
- Ssekiryango, Jackson. 2006. Observations on double object construction in Luganda. In O. F. Arasanyin and M. A. Pemberton (eds.), *Selected Proceedings of the 36th Annual Conference on African Linguistics*, 66–74. Somerville, MA: Cascadilla Proceedings Project.
- Starke, Michal. 2001. *Move dissolves into Merge: A theory of locality*. PhD dissertation: University of Geneva.
- Stegovec, Adrian. 2020. Taking case out of the person-case-constraint. *Natural Language & Linguistic Theory* 38: 261–311.
- Storoshenko, Dennis Ryan. 2009. Investigating the Shona reflexive *zvi*. In A. Ojo and L. Moshi (eds.), *Selected Proceedings of the 39th Annual Conference on African Linguistics*, 42–55. Somerville, MA: Cascadilla Proceedings Project.
- Stucky, Susan. 1985. *Order in Makua Syntax*. New York: Garland Publishing.
- Taji, Julius. 2014. Grammatical relations in Chiyao. *Journal of the Korean Association of African Studies* 42: 149–77.
- Taylor, Charles. 1985. *Nkore-Kiga*. London: Croom Helm.

- Thwala, Nhlanhla. 2006. Parameters of variation and complement licensing in Bantu. *ZAS Papers in Linguistics* 43: 209–232.
- Trithart, Lee. 1979. Topicality: An alternative to the relational view of Bantu passive. *Studies in African Linguistics* 10 (1): 1–45.
- Trithart, Mary Lee. 1983. The applied suffix and transitivity: A historical study in Bantu. PhD dissertation, University of California Los Angeles.
- Trudgill, Peter. 1994. Language contact and dialect contact in linguistic change. In U. Kotsinas and J. Helgander (eds.), *Dialektkontakt, språkkontakt och språkförändring i Norden. Föredrag från ett forskarsymposium Series: MINS* 40, 13–22. Stockholm: Stockholm University.
- Ura, Hiroyuki. 1996. Multiple feature-checking: A theory of grammatical function splitting. PhD dissertation, Massachusetts Institute of Technology (MIT).
- Ura, Hiroyuki. 2000. *Checking Theory and Grammatical Functions in Universal Grammar*. New York: Oxford University Press.
- Uriagereka, Juan. 1995. Aspects of the syntax of clitic placement in Western Romance. *Linguistic Inquiry* 26: 79–123.
- Valente, P. Jose Francisco. 1964. *Gramatica Umbundu. A Lingua do Centro de Angola*. Lisboa.
- Van de Velde, Mark L. O. 2008. *A Grammar of Eton*. Berlin: Mouton de Gruyter.
- Van de Velde, Mark L. O. 2013. The Bantu connective construction. In A. Carlier and J.-C. Verstraete (eds.), *The Genitive*, 217–52. Amsterdam: John Benjamins.
- Van de Velde, Mark, Koen Bostoen, Derek Nurse, and Gérard Philippson (eds.). 2019. *The Bantu Languages*, Second Edition. London: Routledge.
- Van der Spuy, Andrew. 1993. Dislocated noun phrases in Nguni. *Lingua* 90: 335–55.
- Van der Wal, Jenneke. 2008. Agreement inthetic sentences in Bantu and Romance. In C. De Cat and K. Demuth (eds.), *The Bantu-Romance connection. A comparative investigation of verbal agreement, DPs and information structure*, 323–50. Amsterdam: John Benjamins.
- Van der Wal, Jenneke. 2009. *Word order and Information Structure in Makhuwa-Enahara*. Utrecht: Landelijke Onderzoekschool Taalwetenschap (LOT).
- Van der Wal, Jenneke. 2010. Makhuwa non-subject relatives as participial modifiers. *Journal of African Languages & Linguistics* 31 (2): 205–31.
- Van der Wal, Jenneke. 2012. Subject agreement and the EPP in Bantu Agreeing Inversion. *Cambridge Occasional Papers in Linguistics* 6: 201–36.
- Van der Wal, Jenneke. 2015a. A note on the (non-existing) passive in Matengo. *Linguistique et Langues Africaines* 1: 81–98.
- Van der Wal, Jenneke. 2015b. Bantu object clitics as defective goals. *Revue Roumaine de Linguistique* LX (2–3): 277–96.
- Van der Wal, Jenneke. 2015c. Evidence for abstract Case in Bantu. *Lingua* 165: 109–32.
- Van der Wal, Jenneke. 2017. Flexibility in symmetry: An implicational relation in Bantu double object constructions. In M. Sheehan and L. R. Bailey (eds.), *Order and Structure in Syntax II: Subjecthood and Argument Structure*, 115–52. Berlin: Language Science Press.
- Van der Wal, Jenneke. 2020a. From macroparameters to nanoparameters – a comparative Bantu case study. In A. Bárány, T. Biberauer, J. Douglas, and S. Vikner (eds.), *Syntactic Architecture and its Consequences I: Syntax Inside the Grammar*, 25–60. Berlin: Language Science Press.
- Van der Wal, Jenneke. 2020b. The AWSOM correlation in comparative Bantu object marking. In K. Hartmann, J. Mursell, and P. W. Smith (eds.), *Agree to agree: Agreement in the Minimalist Program*, 199–234. Open Generative Syntax, Language Science Press.

- Van der Wal, Jenneke and Larry Hyman (eds.). 2017. *The Conjoint/Disjoint Alternation in Bantu*. Trends in Linguistics series. Berlin: Mouton de Gruyter.
- Van Otterloo, Roger. 2011. *The Kifuliiru Language, Volume 2: A Descriptive Grammar*. Dallas: SIL International.
- Vergnaud, Jean-Roger. 1977/2008. Letter to Noam Chomsky and Howard Lasnik on 'Filters and control'. In R. Freidin, P. Otero, and M. L. Zubizarreta (eds.), *Foundational issues in linguistic theory: Essays in honor of Jean-Roger Vergnaud*, 3–15. Cambridge, MA: Massachusetts Institute of Technology (MIT) Press.
- Visser, Marianna. 1986. Cliticization and Case theory in Xhosa. *South African Journal of African Languages* 6 (3): 129–37.
- Voisin, Sylvie. 2006. Applicatif et emphase. In D. Lebaud, C. Paulin, and K. Ploog (eds.), *Constructions verbales et production de sens*, 155–70. Besançon: Presses Universitaires de Franche-Comté.
- Wald, Benji. 1979. The development of the Swahili object marker: A study of the interaction of syntax and discourse. *Syntax and Semantics* 12: 505–24.
- Wald, Benji. 1991. Longterm evolution of the syntax of discourse and the Swahili person markers. In J. van Marle (ed.), *Historical Linguistics 1991*, 325–42. Amsterdam: John Benjamins.
- Wald, Benji. 1994. East-Coast Bantu and the evolution of constraints on passivisation. *Sprache und Geschichte in Afrika* 15: 211–315.
- Wasike, Aggrey. 2007. The left periphery, wh-in-situ and A-bar movement in Lubukusu and other Bantu languages. PhD dissertation, Cornell University, Ithaca.
- Whaley, Lindsey. 1996. Kinyarwanda topics and object-subject reversal. *Eastern States Conference on Linguistics (ESCOL)* 12: 354–63.
- Whiteley, Wilfred. 1968. *Some problems of transitivity in Swahili*. London: SOAS.
- Whiteley, Wilfred H. 1972. Case complexes in Swahili. *Studies in African Linguistics* 3: 1–45.
- Whiteley, Wilfred H. and J. D. Mganga. 1969. Focus and entailment: Further problems of Transitivity in Swahili. *African Language Review* 8: 108–25.
- Wilhelmsen, Vera. 2019. Mbugwe F34. In M. Van de Velde et al. (eds.), *The Bantu Languages*, Second Edition, 533–62. London: Routledge.
- Wiltschko, Martina. 2014. *The Universal Structure of Categories. Towards a Formal Typology*. Cambridge: Cambridge University Press.
- Woolford, Ellen. 1993. Symmetric and asymmetric passives. *Natural Language & Linguistic Theory* 11: 679–728.
- Woolford, Ellen. 1995. Why passive can block object marking. In A. Akinlabi (ed.), *Theoretical Approaches to African Linguistics*, 199–215. New Jersey: Africa World Press.
- Woolford, Ellen. 1997. Four-way case systems: Ergative, nominative, objective and accusative. *Natural Language & Linguistic Theory* 15: 181–227.
- Woolford, Ellen. 2000. Agreement in disguise. In V. M. Carstens, and F. Parkinson (eds.), *Advances in African Linguistics*, 103–17. Trenton, NJ: Africa World Press.
- Woolford, Ellen. 2001. Conditions on object agreement in Ruwund (Bantu). In E. Benedicto (ed.), *The Umass volume on indigenous languages*. Amherst, MA: GLSA.
- Woolford, Ellen. 2006. Lexical case, inherent case, and argument structure. *Linguistic Inquiry* 37 (1): 111–30.
- Wright, J. L. 2007. An outline of Kikaonde grammar. Lusaka, Zambia: Gadsden Publishers.
- Yokoyama, Tomohiro. 2016. Structure and features: The ordering of object markers in Kinyarwanda. (Paper presented at Bantu 6, Helsinki.) Handout available at <https://blogs.helsinki.fi/bantu-6/files/2016/09/Bantu6-WS4-Yokoyama-Ordering-OMs-In-Kinyarwanda.pdf>.

- Yokoyama, Tomohiro. 2019. The Person Case Constraint. Unconditional interfaces and faultless derivations. PhD dissertation, University of Toronto.
- Yoneda, Nobuko. 2008. Matengo-go no jouhou-kouzou to gojun. *Gengo-Kenkyu* 133: 107–32.
- Yoneda, Nobuko. 2011. Word order in Matengo (N13): Topicality and informational roles. *Lingua* 121 (5): 754–71.
- Yoneda, Nobuko. 2017. Conjoint/disjoint distinction and focus in Matengo (N13). In J. van der Wal and L. M. Hyman (eds.), *The conjoint/disjoint alternation in Bantu*, 426–52. Berlin: De Gruyter.
- Zeijlstra, Hedde. 2008. On the syntactic flexibility of formal features. In T. Biberauer (ed.), *The Limits of Syntactic Variation*, 143–73. Amsterdam: John Benjamins.
- Zeijlstra, Hedde. 2012. There is only one way to agree. *The Linguistic Review* 29: 491–539.
- Zeller, Jochen. 2006. Raising out of finite CP in Nguni: The case of fanele. *Southern African Linguistics and Applied Language Studies* 24: 255–75.
- Zeller, Jochen. 2008. The subject marker in Bantu as an antifocus marker. *Stellenbosch Papers in Linguistics* 38: 221–54.
- Zeller, Jochen. 2011. Aspects of object marking in Zulu. (Talk given at LSSA conference, Rhodes University, Grahamstown.)
- Zeller, Jochen. 2012a. Instrument inversion in Zulu. In M. R. Marlo et al. (eds.), *Selected Proceedings of the 42nd Annual Conference on African Linguistics*, 134–148. Somerville, MA: Cascadilla Proceedings Project.
- Zeller, Jochen. 2012b. Object marking in isiZulu. *Southern African Linguistics and Applied Language Studies* 30 (2): 219–35.
- Zeller, Jochen. 2013. Locative inversion in Bantu and predication. *Linguistics* 51 (6): 1107–46.
- Zeller, Jochen. 2014. Three types of object marking in Bantu. *Linguistische Berichte* 239: 347–67.
- Zeller, Jochen. 2015. Argument prominence and agreement: Explaining an unexpected object asymmetry in Zulu. *Lingua* 156: 17–39.
- Zeller, Jochen and Jean Paul Ngoboka. 2006. Kinyarwanda locative applicatives and the Minimal Link Condition. *South African Journal of African Languages* 24: 101–24.
- Zeller, Jochen and Jean Paul Ngoboka. 2015. On parametric variation in Bantu, with particular reference to Kinyarwanda. *Transactions of the Philological Society* 113 (2): 206–31.
- Zerbian, Sabine. 2006a. *Expression of information structure in Northern Sotho*. PhD dissertation, Humboldt University.
- Zerbian, Sabine. 2006b. Inversion structure in Northern Sotho. *Southern African Linguistics and Applied Language Studies* 24 (3): 361–76.
- Zimmermann, Malte. 2008. Contrastive focus and emphasis. *Acta Linguistica Hungarica* 55 (3): 47–60.
- Zompi, Stanislaw. 2019. Ergative is not inherent: Evidence from \*ABA in suppletion and syncretism. *Glossa* 4 (1): 73.
- Zúñiga, Fernando. 2014. Inversion, obviation, and animacy in native languages of the Americas: Elements for a cross-linguistic survey. *Anthropological Linguistics* 56 (4): 334–55.

# Language Index

- Bafia 69  
Bakweri 147  
Bamileke 69  
Bankon 69  
Basaa 69–70, 159, 233, 236–7, 239–40, 242, 254, 257  
Bemba 86–7, 136, 144–5, 203–4, 217–19, 224, 244, 253–4, 257–8  
Bembe 39–43, 60–1, 105, 202–4, 218, 221, 225–6, 237–9, 242, 244, 253–4, 257–8  
Benga 69  
Bujeba 69  
Byarushengo 22, 67, 253–4, 258–9
- Chaga 56–7, 89–94, 218, 226, 244, 253–4, 257–8, 260  
Changana 152–4, 244, 253–4, 257–8  
Chichewa 6, 24, 49, 72–3, 89–93, 168–9, 174, 212, 214–18, 221, 225–6, 244, 253–5, 257–8, 262  
Chimwiini 80, 244, 253–4, 257–8  
Chingoni 80, 244, 253–4, 257–8  
Chinnima *See* Makonde  
Chishona *See* Shona  
Ciluba (Kasai) 88, 143, 218, 233–4, 237, 239–40, 242, 244, 253–4, 257, 258  
Cuwabo 63, 96–8, 118, 217–19, 244, 253–4, 257–8
- Digo 34, 244, 253–4  
Duala 254  
Duma 69  
Dutch 219  
Dzamba 166, 175, 244, 253–4, 258, 262
- Ekoti 244, 253–4  
English 74, 218, 223  
Enya 69  
Eton 69–70, 254, 257
- Fang 69  
French 8–9, 36  
Fuliiru *See* Kifuliiru
- Ganda *See* Luganda  
Georgian 68  
Germanic 103, 206  
Gitonga 244, 253–4  
Greek 53, 245
- Ha 244, 253–4  
Havu 147  
Haya 66–7, 244, 253–4, 257–9  
Herero *See* Otjiherero  
Hungarian 53, 269
- Ikalanga *See* Shona  
Indo-European 209  
Italian 15, 53, 206
- Ju|'hoansi 101
- Kagulu 220, 226, 244, 253–4, 257–8  
Kare 69  
Khayo 143  
Khoisan 101  
Kifuliiru 38, 149–50, 244, 254, 258  
Kiïtharaka 128, 132, 147–8, 184–6, 203–4, 212, 221, 226, 244, 253–4, 257–8  
Kikamba 149, 253–4  
Kikongo 244, 254  
Kikuyu 87, 128, 132, 147, 212, 221, 226, 244, 253–4, 257–8  
Kiluguru 130, 132, 134, 212, 221, 225–6, 240–1, 244, 253–4, 257–8, 260–1  
Kimatuumbi 47–8, 63, 207  
Kimbundu 253–4, 257–8  
Kimeru 128, 132, 244, 253–4  
Kinande 30, 101, 137, 244, 253–4, 257–8  
Kinyakyusa 20, 240–2, 257

- Kinyarwanda 21, 26, 68, 128, 136, 139–40, 154–5, 160, 165–6, 176–9, 196, 198–200, 203, 219, 228, 233–4, 237, 239–40, 242, 244, 253–4, 257–8  
 Kirundi 160–1, 163, 171–3, 176, 178–9, 183, 195–6, 198–200, 244, 253–4, 257–8  
 Kiswahili *See Swahili*  
 Kiyaka 64, 80–1, 143, 244, 253–4, 257–9  
 Kuria 37, 244, 253–4, 258  
  
 Libinza 143  
 Lika 63, 244, 253–4, 257–8  
 Linga 69  
 Lomongo *See Mongo*  
 Lozi 147, 244, 253–4, 257–9  
 Luba *See Ciluba (Kasai)*  
 Lubukusu 38, 56–8, 61, 68, 83–4, 92, 123, 125, 130, 132, 147–9, 167, 212, 221, 225–6, 244, 253–4, 257–8, 260  
 Lucazi 253–4  
 Luganda 30, 45, 83, 94, 103, 137–9, 244, 254, 257–8  
 Luguru *See Kiluguru*  
 Lugwere 5, 244, 253–4, 257–8  
 Lulua 143  
 Lunda 244, 253–4  
 Lundu 69  
 Luruuli 244, 253–4, 258  
  
 Magisa 69  
 Makuwa 3, 20, 28, 34–8, 63, 74–6, 83, 94–5, 98–9, 104, 123, 126, 162–3, 167, 207, 212–13, 221, 226, 233, 235, 237, 239–40, 242, 244, 253–4, 257–8, 262–6  
 Makonde 47, 63, 244, 253–4  
     Chinnima 47  
     Shimakonde 63, 244, 253–4  
 Makwe 97, 207, 244, 253–4  
 Manyika *See Shona*  
 Marachi 149  
 Maragoli 244, 253–4, 257–8  
 Matengo 48–9, 83, 165–6, 193, 207, 212, 221, 226, 244, 253–4, 258, 263–6  
 Matuumbi *See Kimatuumbi*  
 Mbede 69  
 Mbosi 69  
 Mbugwe 253–4  
 Mbuun 244, 253–4, 257–8  
 Mongo 144, 244, 253–4, 257–8  
  
 Ndebele 18, 167, 253–4  
 Ndendeule 78  
 Ndumu 69  
 Nez Perce 107  
 Ngoni *See Chingoni*  
 Nguni 18, 164, 218  
 Nocte 210–11  
 Noho 69  
 north-western Bantu 33, 38, 70, 228  
 Norwegian 103  
 Nsenga 244, 253–4  
 Nsong 253–4  
 Nyakyusa *See Kinyakyusa*  
 Nyala West 149  
 Nyali 66  
 Nyamwezi 244, 253–4  
 Nyaturu 46–8, 59, 61, 66, 97–8, 118, 142, 149, 244, 253–4, 257–8, 260  
 Nyokon 69–70, 254  
 Nzadi 254, 257  
  
 Oshindonga 244, 253–4, 257–8  
 Otjiherero 88, 129, 132, 134, 157, 159, 164–5, 167–8, 175, 193, 212–13, 218, 221–6, 244, 253–4, 257–8, 261  
  
 Portuguese 53, 76  
 Proto Bantu 34, 256  
 Punu 143–4, 244  
  
 Rangi 244, 253–4  
 Romance 7, 84, 137, 149, 201, 206, 239  
 Rukiga *See Runyankore-Rukiga*  
 Rundi *See Kirundi*  
 Runyankore-Rukiga 244, 253–4, 257–8  
 Ruuli 257  
 Ruwund 60–1, 244, 253–4, 257–8, 260  
 Rwanda *See Kinyarwanda*  
  
 Sambaa 32, 42–3, 47, 58–9, 61, 66, 76–7, 123, 244–7, 249–50, 254, 257–8, 260  
 Sesotho *See Sotho, Southern Sotho*  
 Setswana 119, 141, 149, 189–91, 216–18, 244, 253–4, 257–8  
 Shi 149  
 Shimakonde *See Makonde*

- Shona 22, 27, 44, 48, 113, 116, 128, 132, 147, 212, 217–18, 221, 226, 244, 253–4, 257–9
- Sogo 69
- Sotho 45, 113, 118, 134, 164, 195, 197, 217–18, 244, 253–4, 258, 261
- Northern Sotho 161, 163–4, 193–5, 206
- Southern Sotho 114, 128, 132, 154, 198, 206–7, 212, 216–17, 221–6
- Suku 143
- Swahili 4–5, 33–4, 49, 61, 74–8, 86, 98–9, 116, 131–2, 155, 220, 226, 244, 253–4, 257–8
- Swati 244, 253–4, 257–8
- Swedish 103
- Tharaka *See* [Kiitharaka](#)
- Totela 244, 253–4, 257–8
- Tshiluba *See* [Ciluba \(Kasai\)](#)
- Tswana *See* [Setswana](#)
- Tumbuka 26, 135, 205, 244, 253–4, 257–8
- Tunen 18, 69–70, 254, 257
- Umbundu 244, 253–4
- Venda 224
- Wanga 149
- Xhosa 28–9, 60–1, 84, 166–7, 194, 200, 207, 244, 253–4, 257–8
- Yao 220, 226, 244, 253–4, 257–8
- Zulu 24, 40–1, 65, 67, 72–3, 78, 84, 106, 113, 116–18, 120, 127, 132, 134, 136, 154, 160–1, 164–5, 168–71, 179–81, 185–6, 188, 195, 197, 200, 204–5, 209, 212, 221, 225–6, 244, 253–4, 257–8, 261–2



# General Index

- accessibility 16–17, 22, 25, 50, 52, 56,  
115–16  
Accessibility Hierarchy 52  
acquisition (of language) 9, 11, 56, 70,  
232–3, 242, 249–50, 255–6, 258, 267,  
269–70  
Agree 1–5, 7–9, 14, 24–5, 27, 29, 31, 39–40,  
42, 44–5, 47, 54, 62, 66, 70, 72–3, 80–2,  
85–8, 95, 105–8, 111, 113, 119, 123–4,  
143, 146, 150, 183, 187, 204, 206–7,  
209–10, 229, 247, 251  
cyclic Agree 143, 146  
multiple Agree 146  
upward Agree 123, 210  
agreement 1–10, 13–18, 20–5, 27–32, 36,  
39–41, 44–5, 47, 49, 52, 54–5, 67–8,  
70–1, 81–2, 85–8, 95, 100–1, 105–6,  
108–11, 115–20, 123–5, 136–7, 141,  
143, 145–6, 151–2, 154, 157, 159–63,  
171–3, 175, 177–8, 182–4, 187–92,  
197, 201–15, 227–9, 232–5, 237–9,  
243–4, 247–52, 256, 262–3, 265, 270  
Case-Dependency of Agreement  
Parameter 209  
complementizer agreement 23, 107,  
123, 230, 234–5, 250  
default agreement 28–9, 159, 161, 181,  
183, 188–9, 225  
Direction of Agreement Parameter 123,  
209  
hyperagreement 83, 172  
 $\phi$  agreement *See*  $\phi$   
relative agreement 234–5  
unagreement 52–5, 62, 67–8  
animacy 15, 23–5, 29, 31, 33, 47–8, 50–2,  
55–6, 61–2, 64, 70–1, 73, 89, 94, 106,  
110–16, 118–19, 125, 128, 138–9, 141,  
156, 162, 181–2, 194–8, 210, 217, 245,  
251–3, 260  
animacy/definiteness hierarchy 61  
animacy scale 50–1, 64  
animacy/topicality hierarchy 116  
animate referent 28, 33, 42, 46–51, 54–6,  
59, 61, 64, 96–7, 99–100, 112–13,  
115, 120, 125, 135–6, 143–5, 151–2,  
154–5, 172, 190, 194, 197–8, 204, 240,  
245, 255–6, 260 (*See also* inanimate  
referent)  
Person/animacy scale *See* Person  
(feature)  
reversed animacy 245  
applicative 13–15, 25–7, 31–3, 73–82,  
86, 100–5, 108–22, 124–34, 137,  
141, 150–7, 179–82, 184–90, 192,  
197–8, 208, 211–12, 215–16, 221,  
223, 225, 227, 229–30, 232, 234–5,  
237–9, 242–4, 246–53, 255, 258,  
260–1  
Appl head 110–11, 120–1, 125, 156, 186,  
192, 211, 255, 261  
high applicative (HAppl) 25–  
6, 32, 79, 103–4, 133–4,  
212–13, 215, 221, 223, 226,  
253  
low applicative (LAppl) 25–6, 32, 73, 79,  
103–5, 133–4, 212–13, 215, 221, 223,  
225–6, 253  
arbitrariness 10, 270  
asymmetry 32, 73, 82, 88, 93, 109, 118,  
125–6, 130–1, 134–5, 194, 213–14,  
220, 229, 244–5, 255, 258–9 (*See also*  
symmetry)  
asymmetric object marking 24, 31,  
72–3, 79–81, 83, 85–7, 100, 156,  
213–14, 216, 219–20, 247–9, 256, 258  
Asymmetry Wants Single Object  
Marking (AWSOM) 31–2, 141, 229,  
243, 245–6, 249–50  
indirective asymmetry 93, 109, 261  
partial asymmetry *See* symmetry

- Relation between Asymmetry and Non-Doubling Object Marking (RANDOM) 31–2, 229, 253–6, 255, 258  
 secundative asymmetry 261  
 augment 29–30, 68, 84, 120, 162, 164–5  
 author (feature) 54, 143, 145–6, 151, 211  
 AWSOM *See* asymmetry
- Benefactive 5, 14–15, 24–5, 27, 31, 33, 47, 72–81, 86–7, 89–94, 96–106, 108–13, 115–22, 124–6, 130–1, 133, 137–8, 141, 144, 147–8, 150–4, 156, 181–2, 192, 197, 211, 245, 247–8, 253, 255, 260  
 big DP 44–7, 50, 52, 66, 177, 204  
 Borer–Chomsky conjecture 10, 62, 125, 146, 250  
 Burzio’s generalization 190
- Cascade model 258  
 categorial splits 233  
 causative 25, 35, 126–31, 133–4, 137–8, 151, 156, 212, 221, 223–5, 227, 243, 260  
 C/case 2, 13–14, 21–2, 25, 29, 80, 82–5, 104, 108–9, 111, 118–25, 139, 150, 164, 176, 179, 209–12, 220, 234, 238–9, 248–50, 261–2 (*See also* licensing)  
 ABA pattern 239  
 absolutive case 120, 239  
 accusative case 120, 239  
 Case assigner 82, 239, 248  
 Case feature 13–15, 23, 82–3, 86, 110, 176, 209–10, 219, 229  
 Case filter 82  
 Case licensing 1, 14, 25, 71, 78, 81–5, 108–11, 116, 119–21, 174, 176, 183, 194, 248–50  
 Case parameter 82–3  
 Case tests 83  
 Case values 121  
 dative case 15, 74, 76, 120, 124, 239  
 default case 164  
 Dependent Case Theory 124  
 ergative case *See* ergativity  
 flexible licensing *See* flexible licensing  
 focus case *See* focus  
 genitive case 120  
 global case splits 210  
 inherent case 15, 84, 157, 239  
 nominative case 83, 120, 176, 179, 239, 270  
 person case constraint *See* person case constraint (PCC)  
 tone cases *See* tone
- c-command domain 3, 27, 40, 85, 124, 183  
 chain reduction 8–9  
 clausal domain 233–4, 255  
 clausal head 27–8, 85, 108, 123, 222, 225, 229, 233–4, 236–7, 250, 253  
 clitic doubling *See* object marking  
 comment 16, 115  
 conjoint/disjoint alternation 43, 60, 65, 68, 120, 162, 164, 263–4, 268  
 contrast *See* focus  
 coreferent DP 40–1
- default agreement *See* agreement  
 default agreement inversion (DAI) *See* inversion construction  
 defective goal 2, 7–8, 24, 31, 33–4, 36, 38–44, 46, 48, 50, 52, 54, 56, 58, 60, 62, 64, 66, 68, 70, 81, 87, 110, 121–2, 136, 187, 201, 203–4, 247, 251  
 defective goal approach 31, 33, 39, 41–2, 201, 203, 251  
 defective pronoun 39  
 definiteness 24, 31, 33, 46–52, 55–6, 58, 61–2, 71, 80, 206, 221, 245, 251–2, 256, 260 (*See also* indefiniteness)  
 definiteness hierarchy 50–1, 56, 58, 61, 260  
 demonstratives 44–5, 59, 163, 236  
 diachronic change 258  
 diagnostics  
 for Case *See* C/case  
 for object symmetry *See* symmetry  
 for subject inversion *See* inversion constructions
- direct/inverse 210–12  
 discourse-configurationality 201, 267–8, 270  
 discourse features 23, 220 (*See also* Topic; Person)  
 discourse role 171  
 discourse salience 15, 119

- dislocation (of argument) 5, 40–3, 60, 65, 68, 116, 163–4, 171, 201–3, 256
- ditransitives 1, 13, 24, 30–1, 47, 49, 71–80, 82, 84, 86–8, 90, 92–4, 96–100, 102, 104–6, 108, 110, 112–14, 116, 118–22, 124, 126–36, 138, 140–2, 144, 146, 148, 150–2, 154, 158, 173–4, 182, 192, 212, 217, 225, 228, 245, 253–4, 260–1 (*See also* valency; causative; applicative)
- emergentist approach *See* neo-emergentist model; maximize minimal means (MMM)
- EPP 4, 8–9, 118, 123, 176, 179, 187, 207, 209, 263 (*See also* movement)  
EPP feature 4, 9, 118, 123, 179, 209, 263
- equidistance 26, 101–3, 135, 174–6  
equidistance principle 101, 103, 174
- ergativity 120, 124, 157, 211, 239, 242, 262  
ergative alignment 242, 262  
ergative case 124, 211
- extended projection 132, 207, 212, 237
- extend requirement 85
- external argument (EA) 27, 32, 75, 79, 109, 120–1, 133–4, 143, 155, 157, 173–9, 181–8, 190–2, 194–5, 198–9, 203, 205–6, 208–11, 215–16, 218–20, 222, 224–5, 227, 251, 262
- feature 1–3, 7–8, 10–18, 23, 25–8, 32, 36–7, 39–41, 44–5, 51–6, 68, 70, 81–3, 85–6, 104–11, 113, 118, 120–5, 132, 134–8, 140–1, 143–4, 146, 151–3, 158, 176, 179, 181–3, 187–91, 196, 198, 200–7, 209–12, 219–20, 229–34, 236–44, 247–50, 253, 255–6, 266–70  
author *See* author (feature)  
emergent features 9, 32, 267  
EPP feature *See* EPP movement  
Feature Economy 11, 230, 267, 269  
feature inventory 10, 83, 267  
feature value 4, 106, 111, 120–1, 181, 251, 261  
formal features 1, 7, 9–13, 17, 22–3, 31, 44, 51, 116, 120–1, 125, 195, 228, 230–1, 250, 256, 263, 266–70  
Gender *See* gender  
interaction & satisfaction features 107–8, 150  
interpretable feature 27, 39, 123, 251  
multiple feature checking 176  
Number *See* Number (feature)  
participant *See* participant (feature)  
Person *See* Person (feature)  
 $\phi$  feature *See*  $\phi$   
topic *See* topic  
uninterpretable feature 3, 13, 27, 39, 82–3, 85, 107, 120, 123–4, 209–10, 232, 249  
unvalued feature 3–4, 39, 55, 107, 146
- Final-Over-Final Condition 132, 212, 243
- final vowel 20, 34–5, 148
- flexible licensing 22, 25–7, 31–2, 101, 108–11, 113, 115–21, 123–5, 132, 134–5, 141, 151, 154–9, 173, 181–3, 188–93, 195, 197, 199–201, 203, 205, 207–14, 216, 219–21, 225–8, 261–2
- Flexible Licensing Parameter (FLiP) 111–12, 116–17, 119–21, 151, 156–7, 181, 218, 243
- Flexible Licensing Up Implies Down (FLUID) 26, 31–2, 132–3, 156, 158, 212–13, 215–17, 219–23, 225–7, 243, 261
- flexible person licensing 154
- FLiP *See* flexible licensing
- FLUID *See* flexible licensing
- focus 16–17, 21–2, 29, 48, 69, 89, 106, 119, 158, 162, 171, 178–9, 183, 194, 199–200, 219, 259, 264–5, 268–70  
antifocus 106–7, 115  
contrastive focus 89, 199  
exclusive focus 17  
exhaustive focus 17, 269  
focus asymmetry 194  
focus features 179, 268, 270  
identificational focus 199  
narrow focus 158, 162, 183, 194, 199–200, 264–5  
non-focus 22, 48, 106, 193, 201, 259, 266  
subject focus 162, 200, 264
- form-meaning mapping 56, 62, 249, 270
- gender  
gender (as noun class) 18, 55, 63–4  
Gender (feature) 2–4, 53, 55, 64, 146
- givenness 16, 24, 31, 33, 47–8, 50–2, 55–6, 62, 71, 251–2, 269

- givenness hierarchy 50, 56  
 givenness scale 52, 252  
 Person/givenness scale *See* Person  
 (feature)  
 goal 2–4, 7–9, 14, 21, 24, 27–8, 31, 33–4,  
 36, 38–46, 48, 50, 52, 54–6, 58, 60,  
 62, 64, 66, 68, 70, 72, 74, 77–8, 80–2,  
 85, 87, 89, 100–1, 103–8, 110, 121–4,  
 136–8, 143–5, 174–5, 177–9, 181, 187,  
 201–5, 209–10, 215, 219, 247–8, 251  
 defective goal *See* defective goal  
 grammatical role 20–1, 171  
 gravity model 258  
 Guthrie, Malcolm 3, 18–19, 69  
 hierarchies 11–12, 23, 26, 32, 35, 50–2,  
 55–6, 58, 60–2, 64, 70–1, 101, 116,  
 130, 134–5, 138, 146, 178, 210, 221–3,  
 226, 229–33, 237–40, 242–3, 245, 247,  
 251, 260–2, 267  
 Accessibility Hierarchy *See* accessibility  
 definiteness hierarchy *See* definiteness  
 givenness hierarchy *See* givenness  
 none-all-some 11, 229–32, 261–2  
 parameter hierarchy 12, 26, 32, 134–5,  
 230–1, 237–9, 242–3, 251, 261–2, 267  
 hyperagreement *See* agreement  
 identifiability *See* accessibility  
 inanimate referent 15, 29, 46, 48–51, 54–5,  
 59, 61, 64, 98–9, 112–13, 118, 143,  
 145, 151–2, 154–5, 194–5, 198, 240,  
 245–6 (*See also* animacy)  
 indefiniteness 29, 41, 46, 50–1, 54–5,  
 64, 98, 165, 193, 202–4 (*See also*  
 definiteness)  
 inflectional domain 36–7  
 information structure 1–2, 13, 15–17,  
 20–3, 30–1, 75, 89, 94, 118–20, 158,  
 180, 196, 198, 200–1, 262, 266–71  
 sensitivity to 2, 39, 48, 118–19, 121, 150,  
 154, 198, 253, 258  
 input generalization (IG) 11, 230, 232–3,  
 242–3, 251, 267, 269  
 instrument inversion (II) *See* inversion  
 construction  
 interface economy 266  
 internal argument 39, 74, 124, 174, 183,  
 187, 193, 210  
 inverse topicality constraint 116, 151  
 inverse voice 175, 262  
 inversion 1, 21, 26–7, 31–2, 85, 123,  
 156–92, 161–5, 167–71, 173–4, 176–7,  
 181, 183, 187, 194–6, 198, 200–2,  
 204–10, 212–22, 224–8, 251, 262–3,  
 265–6  
 inversion construction 27, 156, 158–9,  
 161–3, 165, 167, 171, 173, 179, 181,  
 183–5, 187, 189, 191–2, 195–6, 200–1,  
 205–6, 208, 214, 216–22, 228, 262  
 agreeing inversion (AI) 162–3, 165, 167,  
 193, 201, 205–9, 213–14, 216, 221,  
 225, 263  
 complement inversion 161, 181  
 default agreement inversion (DAI) 161,  
 165, 167, 181, 183–4, 188–9, 191,  
 193–4, 200–1, 205–7, 217–18, 222,  
 225, 228  
 diagnostics (of inversion con-  
 structions) 164–7, 170, 173,  
 224  
 formal locative inversion (FLI) 159–60  
 instrument inversion (II) 160, 169, 173,  
 180, 183–4, 186–7, 194, 213, 215  
 locative inversion (LI) 21, 159, 164,  
 167–70, 174–6, 178–80, 183, 185–6,  
 191, 200, 214, 216–18, 221–2, 225, 228  
 patient inversion (PI) 21, 160, 165–6,  
 169, 171–3, 175, 178–9, 181, 183, 191,  
 196, 198, 200, 221, 225, 228  
 semantic locative inversion  
 (SLI) 159–60, 179–80  
 subject–object reversal *See* patient  
 inversion (PI)  
 lateral continuity (principle of) 258  
 LFG framework 183  
 licensing 1–2, 13–15, 22–3, 25–7, 30–2,  
 71, 81–5, 101, 103, 108–13, 115–21,  
 123–5, 132, 134–5, 141, 150–1,  
 154, 156–9, 173–4, 176, 181–3, 185,  
 187–95, 197–201, 203, 205, 207–14,  
 216, 220–2, 225–30, 232, 234, 236,  
 238, 240, 242, 244, 246, 248–54, 256,  
 258, 260–2, 264, 266, 268, 270 (*See*  
*also* C/case)  
 downward licensing 116, 181  
 flexible licensing *See* flexible licensing

- licensing head 23, 25, 120, 151, 189, 194, 208, 220, 229, 234–5, 237–40, 242–3
- low licensing head *See* applicative
- subject licensing 173, 188–9
- linear correspondence axiom (LCA) 36
- linear order 76
- linker projection 177
- linking problem 249
- locality 27, 72–3, 80–1, 85–7, 100–7, 109, 158, 173–5, 177–9, 181, 183, 185, 187–8, 227
- antilocality 104
- intervention condition 85
- locality restriction 27, 85, 100–1, 103, 105, 107, 109, 173–5, 177, 179, 181, 183, 185, 187, 227
- minimal link condition (MLC) 80, 100–1, 173–5, 178, 188, 247
- relativized minimality 100, 106
- locative 5, 21, 27, 29, 38, 77–8, 93, 103, 119, 151, 157, 159–61, 164, 167–71, 173–81, 183–6, 188–9, 191, 193, 200–1, 206, 208–9, 214–21, 225, 228
- locative inversion *See* inversion construction
- Malefactive *See* applicative
- Maximize Minimal Means (MMM) 10, 269–70
- mental representation 16, 51, 56, 115
- Merge (operation) 9, 27, 111, 123–4, 267, 269
- minimal domain 101–2, 174, 176
- minimalist framework 2–3, 10, 13, 29, 82, 230, 267
- movement 4, 8, 36–7, 101–6, 118, 123, 132, 135, 172, 176, 178–80, 183–4, 187, 189, 194, 204, 207, 209, 263–6, 270
- head movement 35–6, 75, 137
- movement chain 39, 251
- movement trigger 123, 132, 155, 177, 190, 204, 207, 209–10, 212, 263, 265–6, 270
- subject movement 184, 207, 265–6
- verb movement 36–7, 137, 157, 264
- narrow syntax 2, 268
- negation 29, 34, 41, 84, 121, 165, 218
- neo-emergentist model 269–70 (*See also* Maximize Minimal Means (MMM))
- non-clausal domain 28, 229, 255–6, 259
- non-verbal predication 180–1
- noun class 3–4, 18, 21, 28–9, 34, 45, 55, 62–3, 96, 98, 159
- gender (as noun classes) *See* gender
- noun class prefix 4, 29, 45
- null argument 87, 107, 115, 177, 191, 206–7, 245
- Number (feature) 2–3, 11, 53–5, 146, 151, 270
- object 1–10, 13, 16, 18, 20, 22–8, 30–4, 36–76, 78–104, 106–12, 114–28, 130–2, 134–56, 158, 162, 164, 167–71, 173, 176, 181–3, 185, 187, 190–2, 194, 197, 201–2, 204, 212–14, 216, 219–21, 225–30, 233–61, 268, 270
- direct object 46, 102
- double object construction (DOC) 74, 76, 87–8, 93–4, 101, 103–4, 108–9, 124, 130–2, 150–1, 156, 173, 181, 197, 227–8, 251–2
- local object 42, 254
- object shift 102–3
- pronominal object 6, 24, 31, 38–9, 65, 86, 91, 97, 118, 150, 236
- reflexive object 37–8, 136, 143, 147–50
- object marking 1–7, 9, 13, 16, 18, 22–8, 30–4, 36–74, 76, 78–102, 104, 106–28, 130–2, 134–52, 154–6, 162, 167–8, 182–3, 187, 190, 194, 197, 201–2, 204, 212–14, 216, 219–21, 225–30, 233–5, 238, 240–61, 268
- 1+ object marking 74, 125, 142–4, 146–50, 216, 244
- complementary distribution (of object marking) 33, 40, 42, 65
- differential object marking 22, 24, 31, 33, 42, 46–9, 51, 53, 55–7, 59, 61–2, 70, 118, 251
- doubling object marking 33, 43–6, 52, 55, 57, 62–3, 65, 67, 201, 204, 251–2, 255, 259–60
- multiple object marking 26, 31–2, 73–4, 81–2, 100, 110, 135–41, 143, 146, 150, 154, 230, 233–4, 237–8, 243–7, 249–50, 261

- non-doubling object marking 24, 30–3, 44–5, 47–9, 60, 62, 64–5, 67–8, 71–2, 135, 190, 201–2, 229, 244, 252–61
- number of object markers 24, 26, 31, 71, 73, 135, 138, 142, 150, 229, 244, 249
- obligatory object marking 10, 42, 48–9, 59, 67, 70, 254, 259
- partial symmetry 73, 79, 125, 127, 129–35, 213, 221, 224–5, 260
- single object marking 31–2, 124, 136, 146, 148, 150, 229, 235, 238, 244–5, 249
- parameters 1, 9–12, 23, 25–7, 30–3, 56, 62, 70–1, 82–3, 102–3, 111, 119, 121, 123, 134–5, 141–2, 146, 150, 156, 162, 181, 209–10, 229–40, 242–4, 246, 249–53, 256–9, 261–2, 267, 269–70
- macroparameter 231
- mesoparameter 231
- microparameter 231, 241
- nanoparameter 231, 240–1
- parameter hierarchy *See* hierarchy
- parameter setting 11–12, 27, 32, 71, 83, 119, 121, 134, 229–31, 236, 242–4, 246, 251, 256–9, 267, 269
- parametric variation 6–7, 9, 11–12, 24, 31, 56, 62, 72, 228–9, 233, 243
- Principles and Parameters 12, 32
- participant (feature) 54, 106, 143, 145–6, 151, 211
- passive 21, 23, 25, 32–3, 35, 78, 83, 88, 90, 95–7, 102, 108, 118, 125, 151, 166, 168, 172, 187, 189–91, 214, 216–18, 220, 225–6, 228, 268
- passive predicate (inversion) 90, 190, 214
- passive transitive 191, 225
- passivization *See* tests (of double object constructions)
- Patient *See* Theme
- patient inversion *See* inversion construction
- Person (feature) 2, 15–16, 22–5, 31–3, 47, 50–6, 62–4, 67, 70–1, 81, 106–7, 111–12, 115–16, 118–21, 125, 139, 141, 143–6, 150–4, 197, 204, 210–11, 229, 251–3, 255–6, 258, 260–1, 269
- Person/animacy scale 50–1
- Person/definiteness scale 51
- Person/givenness scale 52
- Person projection 54–5, 62, 65–7, 68, 81, 204, 251, 255, 258
- person case constraint (PCC) 106, 139, 146–7, 151–2, 154–5, 211
- phase 102–5, 124, 135, 177, 181, 183, 198, 213, 223–4, 226, 231–2, 235–7, 240, 243
- phase head 104–5, 183, 226, 231–2, 243
- phase impenetrability condition (PIC) 183
- $\phi$  3–4, 7–9, 13–5, 22–3, 25–6, 28, 32–3, 36–7, 39–40, 44–5, 47, 55, 62, 67, 70–3, 81–2, 85, 87, 100, 106–10, 113, 116–8, 120–1, 123–5, 135–8, 140–3, 145–6, 150–1, 176, 182–4, 187–90, 203–7, 209–10, 229–35, 237, 239–51, 261, 263, 265–6, 268–9
- $\phi$  agreement 14, 71, 82, 108–9, 117–8, 120, 124–5, 184, 209–10, 232–3, 237, 248–50
- $\phi$  features 3–4, 7–8, 13, 22–3, 25–6, 28, 32, 36–7, 39, 44–5, 55, 67, 71, 82, 106–10, 113, 118, 121, 123–4, 136–8, 140–1, 146, 151, 187, 189, 204, 206–7, 209–10, 229–34, 239–40, 242–4, 247–8, 250–1, 261, 263, 265–6, 268–9
- $\phi$ P 7–9, 28, 39–43, 57, 65–6, 69, 81, 115–7, 120–2, 138, 190, 194, 202–4, 248, 251
- $\phi$  probe 4, 8, 14, 23, 28, 33, 70–3, 81–2, 85, 87, 100, 107–8, 110, 116, 135–7, 141–3, 145–6, 150, 182–3, 190, 204, 206, 209, 229–31, 233, 235, 237, 239, 241, 243, 245–51
- predication projection (PrP) 180–1
- preposition 74, 76, 81, 83, 154, 160, 166, 180, 233
- prepositional dative 74, 76
- probe 3–4, 7–9, 13–14, 23, 26–8, 33, 39–40, 44–5, 54–5, 62, 69–73, 81–2, 85–7, 100–1, 103, 105–8, 110–11, 113, 116, 121–5, 135–8, 141–50, 155, 173–4, 176, 182–3, 187, 190, 202, 204, 206, 209–10, 229–33, 235, 237, 239, 241, 243, 245–52
- multiple probes 150
- phoenix probe 142–50

- relativized probing 101, 105–8, 125, 135  
(*See also* locality)
- pronoun 5–9, 16, 23, 31, 38–9, 41–2, 44–5,  
50–4, 56–61, 65–9, 80, 107, 115–17,  
121, 139, 146, 172, 190, 201, 236, 251,  
256, 260
- adnominal pronoun constructions  
(APC) 52–3, 67–8
- defective pronoun *See* defective
- pronominalization 94, 103, 118, 167
- pronominal object marker *See*
- pronominal subject marker *See*
- pronoun incorporation 5–7, 9, 23, 31,  
34–6, 41, 120, 137, 149–50, 177
- strong pronoun 7, 60, 65–7
- weak pronoun 7, 65, 146, 190
- raising 83, 105, 160, 170, 194, 264–5  
hyperraising 83
- RANDOM *See* asymmetry
- Reason argument *See* applicative
- Recipient 5, 24–5, 31, 38, 75, 78–9, 86–7,  
96, 99, 103, 105, 126, 131, 133, 137,  
150–2, 156, 181, 245, 247–8
- relational grammar 166
- relative topicality 112, 115, 124–5, 152,  
155, 260
- relativization 106–7, 170, 228
- relativized minimality *See* locality
- relativized probing *See* probe
- Relator projection 177–8
- right dislocation 5, 57, 163–5, 169, 171
- salience 15–16, 23, 32, 47, 50, 119, 134,  
151, 229, 251–3, 255–61, 263, 265, 270  
salience features 16, 23, 32, 229, 251–3,  
255, 257, 259, 261, 263, 265, 270 (*See  
also* Topic; Person)
- semantic role 21, 74–5, 77, 125, 138–9,  
141, 159–60, 174, 190, 210, 228, 260
- Source 113
- speech act participant *See* author;  
participant
- split agreement 210, 262
- strong modularity 2, 32, 230, 268
- strong uniformity 2, 23, 32, 230, 268
- subject 1–5, 10, 13, 16, 18, 20–3, 26–8,  
30–4, 36–7, 44, 52, 67, 72, 83, 85–7,  
90–1, 94, 96, 102, 107, 118, 123,  
153, 155–74, 176–8, 180–4, 186–96,  
198–210, 212–16, 218–22, 224–31,  
234–9, 249–51, 262–6, 268, 270
- pronominal subject marker 1, 4, 20,  
22–3, 26, 30, 36–7, 67, 83, 86, 155–6,  
158–64, 166, 168–70, 172–4, 176, 178,  
180, 182–4, 186, 188–92, 194, 196,  
198, 200–10, 212, 214, 216, 218, 220,  
222, 224, 226–30, 234–6, 238, 251, 263
- subject agreement 23, 31, 159, 162–3,  
171, 173, 183, 188, 209–10, 234, 239
- subject inversion *See* inversion
- subject properties 21, 169, 176
- syllable structure 34, 242
- symmetry 24, 26–7, 31–2, 71, 73, 79, 85,  
88, 93–7, 100–3, 105, 107–9, 118,  
125–35, 141, 150, 212, 221, 229, 243–5,  
249, 251–5, 257–8, 260–1 (*See also  
asymmetry*)
- diagnostic (of symmetry) 42–3, 73,  
93–5, 100, 107, 118, 125
- partial symmetry 125–35
- symmetric double object 156, 181, 260
- symmetric object marking 23–6, 31–2,  
72–3, 80–1, 85, 87–8, 100, 106–11,  
119, 132, 137, 141, 151, 213, 220–1,  
225–7, 252–3, 255–6, 258, 261
- symmetric passivization 108, 141 (*See  
also* passive)
- syntactic function/role 118, 170–1
- teddy bear 74
- tense and aspect 20, 34–5, 164, 270  
complex tense 166–7, 172
- tests (of double object constructions) 67,  
78, 83, 88, 93–5, 100, 103, 158, 172  
extraction 88, 92–3  
object marking 78, 88, 90–1, 94–5, 103  
passivization 78, 88, 90, 94–5, 103  
reciprocity 78, 88, 91  
unspecified object deletion 88, 93  
word order 88–9, 94–5
- thematic role *See* semantic role
- Theme 5, 13–15, 21, 25, 27, 29, 38, 72,  
74–6, 78, 80–1, 85–7, 89–94, 96–106,  
108–19, 121–2, 124–6, 128, 135, 137,  
141, 144, 146–8, 151–4, 156, 160–1,  
166, 171–9, 181–5, 188, 194–7, 201,  
208–9, 211, 215, 225, 228, 243, 245,  
247–8, 253, 255, 260

- theticity 16–17, 158, 162–3, 183, 192, 200, 263–6
- tone 18, 37, 43, 162, 164–5, 234  
   high tone spread 43  
   tone cases 164–5
- topic 22–3, 25, 31–2, 48, 107, 111, 115–16, 118–21, 125, 150–1, 171, 183, 191–2, 194, 200–1, 210, 229, 243, 251, 253, 255–6, 258, 261, 263, 265–6, 268–9
- non-topicality 27, 32, 43, 111, 117, 121–2, 151, 155, 157–8, 162, 171, 181–4, 187, 190–4, 199–200, 203, 205, 208–9, 227, 263
- Topic (feature) 22–3, 25, 31–2, 107, 111, 115–16, 118–21, 125, 150–1, 183, 191–2, 194, 200–1, 210, 229, 243, 251, 253, 255–6, 258, 261, 263, 265–6, 268–9
- topic acceptability scale 115
- topic agreement 49
- topical argument 111, 118, 121, 155, 157, 201
- topicality 21–3, 25, 31–2, 70, 73, 110–13, 115–17, 119, 121, 123–5, 151–3, 155–6, 158, 171, 181–3, 190–1, 196–8, 201, 209–11, 252–3, 259–60, 266, 269
- topic-licenser 201
- topic-worthiness 17, 22
- transitivity 126, 130, 159, 167, 174–5, 181, 184–5, 188–9, 191–4, 199–200, 206, 208, 216–19, 221–2, 225–6, 241, 262, 266, 268
- unaccusative 31, 167, 174, 176, 181–2, 186, 188–91, 208, 214–21, 225–6
- unagreement *See* agreement
- unergative 167, 174–5, 181, 184–5, 188–9, 191–2, 206, 208, 216–22, 226
- Universal Grammar (UG) 10, 62, 267, 269
- upward Agree *See* Agree
- valency *See* transitivity
- variation 1–2, 6–7, 9–13, 15, 17–18, 22–8, 30–3, 38, 42, 44–5, 47, 52, 56, 61–2, 67, 70–3, 78, 82, 102–3, 109, 121, 125, 132–5, 138, 150–1, 155, 158–9, 162–3, 198, 206, 212, 217–18, 226, 228–9, 233, 239–41, 243, 250–1, 267–71
- cross-Bantu variation 18, 132, 138, 229
- language-internal variation 125, 133, 135
- microvariation 1, 23, 32, 241, 250
- vP domain 5, 84
- wh constituent 17, 30, 43, 47, 203
- word order 11–12, 16–18, 20, 23, 76, 78, 88–9, 94–5, 103, 105, 132–3, 155, 158, 178, 184, 192–3, 199, 201, 228, 238, 256, 263–4 (*See also* tests (of double object constructions); inversion)





















