

# A taxonomic and evolutionary review of the South American *Hierochloë* section *Monoecia* (Poaceae: Anthoxanthinae)

IRENE LEMA-SUÁREZ<sup>1</sup>, ELVIRA SAHUQUILLO<sup>1</sup>, GRACIELA ESTÉVEZ<sup>2</sup>,  
JOÃO LOUREIRO<sup>3</sup>, SÍLVIA CASTRO<sup>3</sup> and MANUEL PIMENTEL<sup>1\*</sup>

<sup>1</sup>Centro de Investigacións Científicas Avanzadas (CICA), Facultade de Ciencias, Universidade da Coruña, Campus da Zapateira sn. 15071 A Coruña, Spain

<sup>2</sup>Departamento de Matemáticas, Facultade de Ciencias, Universidade da Coruña, Campus da Zapateira sn. 15071 A Coruña, Spain

<sup>3</sup>Centre for Functional Ecology, Department of Life Sciences, University of Coimbra, Calçada Martim de Freitas, 3000-456 Coimbra, Portugal

Received 7 June 2017; revised 8 November 2017; accepted for publication 17 December 2017

An integrative approach combining morphological, molecular and cytological information was used to assess the taxonomy and biogeography of *Hierochloë* section *Monoecia*. More specifically, we aimed to evaluate (1) if the morphological and molecular data are in concert with the current taxonomy of the group and (2) if speciation in this exclusively South American group could be linked to the formation of the Andes. Our analysis of 31 macro- and micromorphological characters, four plastid and nuclear DNA regions, and nuclear DNA content suggests that the taxonomic status of several of the species in the section is not justified based on either the phylogenetic (apomorphic) or the phenetic species concepts. We propose that only four out of the eight species in the section (*H. pusilla*, *H. juncifolia*, *H. quebrada* and *H. redolens*) should be recognized and the remaining taxa (*H. altissima*, *H. gunkelii*, *H. spicata* and *H. utriculata*) should be reduced to varieties of the widespread *H. redolens*. In addition, we recover a biogeographical scenario for section *Monoecia* including genetic exchange between the southern and the central Andes, recent and incomplete diversification in the southern Andes, and longer isolation history for those species in the section with restricted ecological and/or geographical ranges.

ADDITIONAL KEYWORDS: biogeography – molecular phylogenetic analysis – morphometric analysis – nuclear DNA content – South America – taxonomy.

## INTRODUCTION

All South American *Hierochloë* spp. have monoecious spikelets, which are unique in the genus. This trait has led different authors to recognize their close relationships (Parodi, 1941; De Paula, 1975; Connor & Renvoize, 2009) and to propose their inclusion in section *Monoecia* Connor (Connor, 2012). Here, we use micro- and macromorphological, molecular and karyological data to clarify the taxonomy in the section and to discuss the biogeography and evolution of *Hierochloë* in the southern New World.

Floral structure is key to the taxonomy of the closely related genera *Hierochloë* and *Anthoxanthum* L. (e.g. Connor, 2012; Pimentel *et al.*, 2013), the only two components of subtribe Anthoxanthinae (Poaceae). They have laterally compressed spikelets bearing three florets, the two lower being male or neuter in *Anthoxanthum* and invariably tristaminate in *Hierochloë*, whereas the apical floret is usually bisexual, bistaminate and protogynous in both genera. Schouten & Veldkamp (1985) proposed merging the two genera based on the existence of intermediate forms, the putatively hybrid *Anthoxanthum* section *Ataxia* R.Br (Pimentel *et al.*, 2013). However, Connor (2012) indicated that ‘both genera should be maintained ... because of their distinctive floral

\*Corresponding author. E-mail: [mpimentel@udc.es](mailto:mpimentel@udc.es)

biology and of their separate pathways to individual floral expression'. Andromonoecism (i.e. perfect apical floret and male lower florets) is dominant in boreal New World, Old World and Australasian *Hierochloë* (Weimarck, 1971; Connor, 2008), with only the South American taxa (section *Monoecia*) showing monoecism (i.e. the apical floret is functionally female, whereas the lower florets are male; Parodi, 1941). The number of species comprising section *Monoecia* is difficult to establish because no recent taxonomic review is available (Parodi, 1941, De Paula, 1975). In his study on floral biology, Connor (2012) included seven species in section *Monoecia*: *H. juncifolia* (Hack.) Parodi, *H. quebrada* Connor & Renvoize, *H. utriculata* (Ruiz & Pav.) Kunth, *H. altissima* Steud., *H. redolens* (Vahl) Roem. & Schult., *H. gunckelii* Parodi and *H. pusilla* Hack. All these species apart from the recently described *H. quebrada* from the central Andes of Peru (Connor & Renvoize, 2009) were also recognized by De Paula (1975) and Parodi (1941) in their taxonomic reviews of the genus in Chile and Argentina and South America, respectively. Parodi (1941) included one additional taxon in his study, *H. spicata* Parodi, a species also accepted by De Paula (1975) who described it as endemic to southern Chile. In her review, De Paula (1975) added two more taxa, *H. sorianoi* De Paula and *H. moorei* De Paula, currently considered extreme forms of the widespread *H. redolens* (e.g. Anton & Zuloaga, 2012; but see Villalobos & Finot, 2016).

Taxa in the exclusively South American *Hierochloë* section *Monoecia* grow from Venezuela to Tierra del Fuego (De Paula, 1975; Connor, 2008; Anton & Zuloaga, 2012) and are restricted to temperate to cold environments in the Andes, defined in this paper following Nagy & Grabherr (2009) and Körner, Paulsen & Spehn (2011). An inverse relationship between elevation and latitude common to most  $C_3$  grass groups (Still *et al.*, 2003) can be observed in the distribution of the section. The central Andean *H. quebrada* from Peru is restricted to tropical alpine areas > 4000 m a.s.l. (Connor & Renvoize, 2009), whereas *H. redolens* presents a disjunct distribution, growing in tropical alpine areas from Venezuela to Peru (up to 3850 m a.s.l.) and in moist areas in southern South America (central to southern Chile and Argentina) at lower elevations. Some doubt has been cast on the identity of the plants from both regions (e.g. Parodi, 1941; Connor, 2012). This taxon has also been recorded in New Zealand, Australia and New Guinea, but populations from these areas show fundamental differences in floral constitution and development and should be considered as representing a different species (Zotov, 1973; De Paula, 1975; Connor, 2012). *Hierochloë utriculata*, *H. altissima*, *H. spicata* and *H. gunckelii* show overlapping ranges at different latitudes in

central to southern South America, on one or both sides of the Andes (De Paula, 1975), whereas *H. juncifolia* grows in volcanic or sandy soils in mountains up to 1750 m a.s.l. in central Chile and central-western Argentina, showing a discontinuous distribution. Finally, *H. pusilla* is restricted to moist areas between 100 and 1000 m a.s.l. at high latitudes in Argentina (Santa Cruz and Tierra del Fuego provinces) and Chile (Magallanes Region; De Paula, 1975).

Morphological differentiation in section *Monoecia* is complicated, casting doubts on the taxonomic status of some of its members (Villalobos & Finot, 2016). *Hierochloë juncifolia* and *H. pusilla* are the only species showing a clear-cut differentiation, based on awn insertion in the male floret and leaf shape and on plant size and lack of awned male florets, respectively (De Paula, 1975). For the remaining taxa, artificial limits in inflorescence shape, an otherwise continuous trait, are used to differentiate *H. altissima*, *H. quebrada*, *H. spicata* and *H. utriculata* (spiciform panicles) and *H. gunckelii* and *H. redolens* (lax to somewhat contracted panicles). The use of micromorphological traits for species differentiation is promising (Connor, 2008; Villalobos & Finot, 2016); however, more complete analyses including more individuals and populations are needed to assess their usefulness.

*Hierochloë* (basic chromosome number,  $x = 7$ ) also displays a wide variation in ploidy, with diploids, tetraploids, hexaploids and duodecaploids having been identified (e.g. Weimarck, 1971). Still, to the best of our knowledge, chromosome numbers or genome size estimations are unknown in section *Monoecia*. These cytogenetic characters have proven to be essential in the clarification of taxonomic problems in reticulated groups with high variation in chromosome numbers, a feature common to many sections in Anthoxanthinae (Chumová *et al.*, 2015).

Overlapping morphologies and distribution ranges associated with climatic conditions highlight the need for a reappraisal of the taxonomy of *Hierochloë* section *Monoecia*, a possible model for diversification of  $C_3$  taxa in the Andes due to its distribution encompassing the whole mountain range. Combined analyses using data from different sources have been deemed especially useful in solving taxonomic problems (Ruhfel, Stevens & Davis, 2013; Besse, 2014; Szlachetko *et al.*, 2017). Here, we follow this approach to clarify the taxonomy of the section and to discuss the evolution and biogeography of this group of South American grasses. First, nuclear DNA content values were assessed for the different species in the section using flow cytometry (FCM) (e.g. Doležel, Greillhuber & Suda, 2007). Second, we conducted multivariate analyses of macro- and micromorphological data to assess the boundaries among taxa and the reliability

of the traits traditionally used in the taxonomy of section *Monoecia*. This methodology has been successfully applied to other complex groups of plants (e.g. Repka, 2003; Ospina, Sylvester & Sylvester, 2016), including those in Anthoxanthinae (Pimentel, Estévez & Sahuquillo, 2007; Pimentel, Catalán & Sahuquillo, 2010). Thirdly, we sequenced several commonly used plastid and ribosomal nuclear DNA markers (e.g. Pimentel *et al.*, 2013) to determine whether the taxonomy of the section is in concert with the phylogenetic tree. Given the multi-copy nature of the nuclear regions used, a cloning strategy was devised to detect possible instances of reticulate evolution (Díaz-Pérez *et al.*, 2014; Wan *et al.*, 2014). Molecular data were also analysed in the light of what is known about the evolution and biogeography of Andean plants (reviewed by Luebert & Weigend, 2014).

## MATERIAL AND METHODS

### PLANT MATERIAL

Ninety-six field-collected or herbarium specimens were used in this study (Appendix 1); 94 plants were included in the morphometric analyses and subsets of specimens were considered in the anatomical (66 samples), molecular (39 samples, 31 used for cloning) and FCM (83 samples) analyses. In *Hierochloë* section

*Monoecia*, four to 22 specimens were sampled per species (Appendix 1), with the exception of *H. quebrada* and *H. spicata*, for which only one plant was included due to the difficulty in differentiating them in the field and their poor representation in the analysed herbaria. Sixty-seven of the analysed specimens were directly collected in the field (15 populations, five specimens per population on average; for population details see Appendix 1). In each population we collected specimens in anthesis that were at least 3 m apart to avoid sampling clones. Collected plants were pressed, leaves were taken and preserved in silica gel for DNA extraction and, when available, seeds were stored for cytometry studies. The selection of localities was based on De Paula (1975) and vouchers were deposited in SANT and CONC (Holmgren, Holmgren & Barnett, 1990). For the geographical location of populations see Figure 1. Twenty-nine herbarium specimens were added to the database in order to (1) complete the representation of section *Monoecia* and (2) include samples of two of the three other exclusively American *Anthoxanthum* or *Hierochloë* spp. outside *Monoecia*, i.e. *Anthoxanthum mexicanum* Mez and *Hierochloë occidentalis* Buckley, and populations of *H. redolens* from South-East Asia. All plants used in the study were tentatively identified (or, for herbarium samples, their identity was confirmed) following De Paula (1975). Herbarium specimens were obtained from

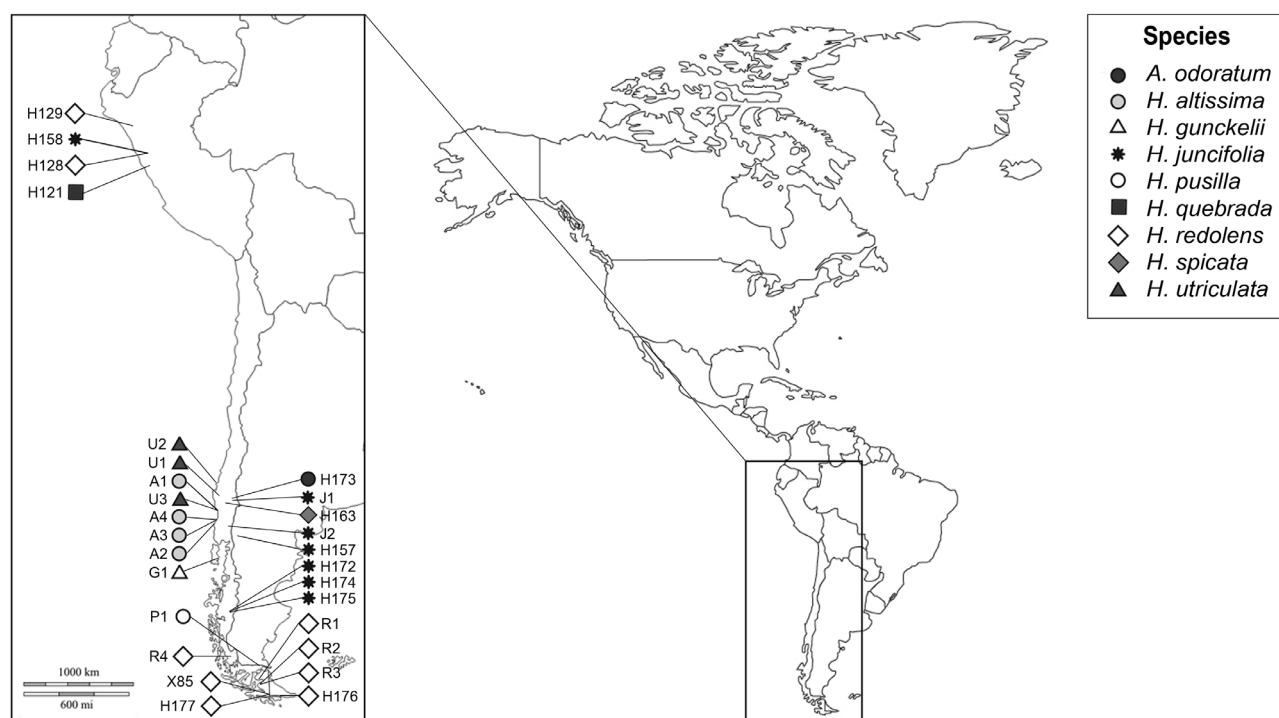

**Figure 1.** Sampled populations of *Hierochloë* section *Monoecia* and *Anthoxanthum odoratum* in South America (population names follow Appendix 1).

CONC, K, M, MA, PH, SANT, UPS and US (Holmgren *et al.*, 1990).

#### GENOME SIZE ESTIMATION BY FLOW CYTOMETRY

Nuclear DNA content was estimated through FCM following Galbraith *et al.* (1983) and Loureiro *et al.* (2007). The obtained values were expressed in picograms (pg) and in mega base pairs (Mbp) using the formula of Doležel *et al.* (2003) (1 pg = 978 Mbp). At least five individuals were assessed per species. A univariate analysis of variance (ANOVA) and a Tukey's test were used to characterize the groups with similar measures of nuclear DNA content (2C values; *sensu* Greilhuber *et al.*, 2005). For a full description of the procedure see Supporting Information Appendix S1.

#### MACRO- AND MICROMORPHOLOGICAL ANALYSES

Fifteen macromorphological (eight quantitative and seven qualitative) and 16 micromorphological (three quantitative and 13 qualitative; 11 from the leaf epidermis and five from the leaf transverse section) characters were measured. The characters were selected because (1) they are commonly used in the taxonomy of Anthoxanthinae and (2) we observed a high variability among the samples included in the analyses. To standardize data collection, leaf and spikelet data were gathered in the second leaf of the plant from the base and the basal spikelet, respectively. Micromorphological data were obtained following Devesa (1992) and Pimentel & Sahuquillo (2003), with minor modifications. All quantitative macromorphological traits and one quantitative micromorphological character (long cells length; LlcL) were logarithmically transformed to limit the influence of allometry on the results (Dufrene, Gathoye & Tyteca, 1991; Almeida-Pinheiro de Carvalho *et al.*, 2004) and quantitative micromorphological data were obtained by calculating the mean value of 12 measurements. Qualitative characters were scored as binary variables (presence/absence). Those qualitative characters that presented more than two states (three macro- and eight micromorphological) were transformed into binary traits. All macro- and micromorphological characters used are listed in Appendix 2.

Each specimen measured was treated as an independent operational taxonomic unit (OTU) for all statistical tests. Macro- and micromorphological databases were built and analysed separately due to the different number of samples, but the same statistical techniques were used. Qualitative and quantitative data were analysed jointly and separately. All statistical analyses were performed using IBM SPSS Statistics for Mac v. 20.0 (IBM Corp., 2011) and

R v. 3.3.2 (R Core Team, 2016a) as implemented in RStudio v. 1.0.136 (RStudio Team, 2016) and Rcmdr v. 2.3-1 (Fox, 2005, 2017; Fox & Bouchet-Valat, 2016). The packages 'RcmdrMisc' (Fox, 2016) and 'foreign' (R Core Team, 2016b) were used to translate our Excel- and SPSS-built databases into an R-readable format. Plots were built using the packages 'lattice' (Sarkar, 2008) and 'rgl' (Adler & Murdoch, 2016). A detailed description of the methods applied can be found in Appendix S2.

#### DNA ISOLATION, AMPLIFICATION, CLONING AND SEQUENCING

DNA from silica-gel dried, field-collected leaves and herbarium samples was extracted using the NORGEN Plant/Fungi DNA isolation kit (Norgen Biotek Corporation, Thorold, Ontario, Canada) and the DNeasy Plant Mini Kit (Qiagen, Hilden, Germany), respectively. We followed the manufacturer's protocols, with modifications in the latter case following Bendiksby (2011).

The selected plastid and nuclear regions were chosen based on results from Pimentel *et al.* (2013) and Tusiime *et al.* (2017). The plastid *trnT-L* and *trnL-F* (including the *trnL* intron plus the *trnL-F* intergenic spacer; Taberlet *et al.*, 1991) regions were amplified and sequenced using primers a and b (*trnT-L* intergenic spacer; Taberlet *et al.*, 1991) and primers c and f. Amplification of the *trnT-L* region followed Galley & Linder (2007), whereas for the *trnL-F* PCR conditions followed Torrecilla *et al.* (2003). Amplification of the ribosomal nuclear ITS (ITS1-5.8S-ITS2) and ETS regions followed Hsiao *et al.* (1995) and Gillespie, Soreng & Jacobs (2009), respectively. Although these regions have produced useful results when comparing closely related taxa (e.g. Consaul, Gillespie & Waterway, 2010; Pimentel *et al.*, 2013), homology issues connected to concerted evolution have been raised (Alvarez & Wendel, 2003). Considering the above, and in view of multiple bands being registered for the ETS of several specimens, this region was cloned in 31 plants belonging to all species in section *Monoecia* plus *A. mexicanum* and South-East Asian *H. redolens* populations (cloning failed for the northern American *H. occidentalis*). Two plants were cloned per population, except for *H. altissima* population A2, *H. pusilla* population P1 and all herbarium samples (Appendix 1), for which only one sample was available. When cloning did not produce enough colonies, one additional plant was added (*H. altissima* population A1 and *H. juncifolia* population J2). Six to 19 clones were sequenced for each plant (Appendix 1). Clones were analysed separately and were only added to the general DNA matrix when direct sequencing of

non-cloned ETS amplicons failed. Cloning and plasmid extractions were performed using the StrataClone PCR cloning kit (Agilent Technologies, Santa Clara, CA, USA) and the QIAprep kit (Qiagen), respectively, following the manufacturers' protocols. An ETS sequence from *Anthoxanthum odoratum* L. was used as an outgroup (Appendix 1).

Non-cloned products were purified using ExoSap-IT PCR cleanup reagent (Affymetrix, Santa Clara, CA, USA), and all products were sequenced using the BigDye Terminator Cycle Sequencing Ready Reaction v3.1 kit (Applied Biosystems, Paisley, UK) on an Applied Biosystems 3710 automated sequencer at the Universidade da Coruña Sequencing Service. Amplification primers were used for all sequencing except for the clones, for which the M13/T7 primer pair was used. Conservative approaches are recommended to reduce the impact of PCR artefacts on the phylogenetic reconstruction based on clones (Popp & Oxelman, 2007). Here, we followed a mixed approach based on Popp & Oxelman (2007) and Díaz-Pérez *et al.* (2014). A maximum parsimony (MP) analysis based only on potentially parsimony-informative characters (see Sequence alignment and phylogenetic analyses below) was run to detect putative chimeric sequences (long terminal branches due to homoplasy; Popp & Oxelman, 2007). These sequences were excluded from all subsequent analyses. Monophyletic groups of clones differing only by autapomorphic substitutions were considered as a single sequence (Popp & Oxelman, 2007). For the remaining clones, the position of which in the parsimony tree was in a polytomy, we followed Díaz-Pérez *et al.* (2014). A *p*-distance matrix was built using MEGA v. 6.0 (Tamura *et al.*, 2013). All sequences with a *p*-distance < 0.01 base substitutions *per site* were collapsed into a single type. Consensus sequences were built using SeaView v. 4 (Gouy, Guindon & Gascuel, 2010).

#### SEQUENCE ALIGNMENT AND PHYLOGENETIC ANALYSIS

The forward and reverse sequences were edited and assembled using CodonCode Aligner v. 4.0 (CodonCode Corp., Dedham, MA, USA). DNA regions were independently aligned using the MUSCLE algorithm (Edgar, 2004) as implemented in SeaView v. 4 (Gouy *et al.*, 2010) and manually adjusted upon the detection of errors. For this study, 539 new sequences were generated: 409 ETS (363 clones), 41 ITS, 48 *trnL-F* and 41 *trnT-L* (Appendix 1). Independent databases were built for each region (plus a fifth database including all clones). Plastid and nuclear sequences from four Eurasian *Hierochloë* spp. were also obtained and added to the different databases to clarify the phylogenetic position of section *Monoecia*

in the genus. Two additional sequences belonging to the closely related but separate *Anthoxanthum* section *Anthoxanthum* were also added and used as outgroups (Appendix 1).

Separate plastid, nuclear and nuclear-clone matrices were built and analysed independently. Sequences missing due to PCR and/or sequencing problems were coded as missing data in the concatenated data sets. Plastid and nuclear datasets were also concatenated and jointly analysed once conflicting samples were removed (see Results). MP or Bayesian inference (BI) analyses were run depending on the data set; MP was used to detect putative chimaeric sequences in the clones database, whereas BI was applied to the inference of phylogenetic relationships in all matrices (plastid, nuclear, combined and clones). MP and Bayesian analyses followed Torrecilla *et al.* (2003) and Pimentel *et al.* (2013), and are described in Supporting Information Appendix S3. Gaps were treated as missing data in all analyses, except in the combined plastid + nuclear tests, for which all gapped positions were excluded.

#### PHYLOGENETIC NETWORKS

Phylogenetic networks were computed to represent groupings in the data and evolutionary distances among taxa simultaneously (López-Pujol *et al.*, 2012). Statistical parsimony analyses as implemented in the software TCS v. 1.21 (Clement *et al.*, 2002) and PopArt v. 1.7 (<http://popart.otago.ac.nz>) were applied to the plastid, nuclear and ETS clone databases. Gaps were ignored and the remaining parameters were set by default. This method was chosen due to its simplicity of representation, because it allows for the detection of haplotypes that are candidates for being products of recombination (Templeton, Crandall & Sing, 1992; Posada & Crandall, 2001) and because it is useful in the definition of species under the phylogenetic species concept (Hart & Sunday, 2007).

## RESULTS

#### GENOME SIZE ESTIMATIONS

Holoploid genome sizes (2C) ranged from 2C = 12.82 pg in *H. pusilla* to 2C = 27.43 pg in *H. altissima* and are listed in Table 1 and Supporting Information Figure S1. The coefficient of variation (CV) of genome size values was < 3% for all populations represented by more than one specimen except for one *H. utriculata* population (U1; CV = 4.77%; for population codes see Appendix 1). *Hierochloë altissima* is the only species showing significant genome size variation across its populations.

**Table 1.** Nuclear DNA content in the South American species of *Hierochloë* section *Monoecia* analysed in this study

Species	Pop.	Genome size (2C, pg)					G*	n. spec.
		Mean	SD	Min.	Max.	CV (%)		
<i>H. altissima</i>	A1	18.58	0.36	18.19	19.08	1.94	G3	5
<i>H. altissima</i>	A2	27.43	0.37	27.02	27.91	1.34	G5	5
<i>H. altissima</i>	A3	27.04	0.40	26.65	27.58	1.48	G5	5
<i>H. altissima</i>	A4	27.30	0.25	27.04	27.55	0.90	G5	5
<i>H. gunkelii</i>	G1	19.43	0.32	19.06	19.84	1.64	G4	5
<i>H. juncifolia</i>	J1	14.75	0.24	14.36	14.98	1.66	G2	5
<i>H. juncifolia</i>	J1	14.09	0.21	13.86	14.38	1.47	G2	5
<i>A. mexicanum</i>	M1	18.89	–	–	–	–		1
<i>A. mexicanum</i>	M2	17.62	–	–	–	–		1
<i>H. occidentalis</i>	O1	21.84	–	–	–	–		1
<i>H. pusilla</i>	P1	12.82	0.21	12.63	13.12	1.61	G1	5
<i>H. quebrada</i>	Q1	18.87	–	–	–	–		1
<i>H. redolens</i>	R1	19.65	0.25	19.37	19.94	1.26	G4	5
<i>H. redolens</i>	R2	19.46	0.42	18.86	19.99	2.17	G4	5
<i>H. redolens</i>	R3	19.84	0.58	18.76	20.42	2.92	G4	6
<i>H. redolens</i>	R4	19.02	0.51	18.34	19.60	2.66	G3	5
<i>H. spicata</i>	S1	13.28	–	–	–	–		1
<i>H. utriculata</i>	U1	18.54	0.88	16.89	19.34	4.77	G3	6
<i>H. utriculata</i>	U2	18.27	0.26	17.90	18.47	1.45	G3	5
<i>H. utriculata</i>	U3	18.46	0.27	18.10	18.84	1.47	G3	5

\*See Discussion in this paper. Pop., population; SD, standard deviation; Min., minimum value; Max., maximum value; CV, coefficient of variation; G, DNA content group; n. spec., number of specimens measured. For population codes see [Appendix 1](#).

According to the ANOVA and Tukey's test conducted, there are five groups based on 2C nuclear DNA content ([Table 1](#); [Fig. S1](#)). Groups G1 (*H. pusilla*, 2C = 12.63–13.12 pg), G2 (*H. juncifolia*, 2C = 13.86–14.98 pg) and G5 (*H. altissima* populations A2, A3 and A4; 2C = 27.04–27.43 pg) are clearly differentiated, whereas groups G3 (*H. altissima* population A1, *H. redolens* population R4 and *H. utriculata*; 2C = 16.89–19.60 pg) and G4 (*H. gunkelii* and *H. redolens* populations R1, R2 and R3; 2C = 18.76–20.42 pg) are partially overlapping. *Anthoxanthum mexicanum*, *H. occidentalis*, *H. quebrada* and *H. spicata* were represented by only one sample and were excluded from the statistical tests.

#### MACROMORPHOLOGICAL ANALYSES: QUANTITATIVE CHARACTERS

Descriptive statistics (not shown) indicate that all characters overlap among most species with plant height (PH) and spikelet length (SL) showing the highest differentiation. Despite this, the ANOVA and Tukey's test revealed significant differentiation among species for all characters. The Kaiser-Meyer-Olkin test analysis performed indicated that our data were adequate for multivariate analyses ([Fig. 2A, B](#)). In the principal components analysis (PCA), the three first principal

components (C1, C2 and C3) accounted for 94.50% of the variability and the characters were grouped as in [Table 2](#). Our accessions clustered into three groups: (1) *H. pusilla*, (2) *H. juncifolia* and (3) the other six species ([Fig. 2B](#)). Vegetative characters differentiated *H. pusilla* from the rest, whereas floral characters were responsible for the differentiation of *H. juncifolia*. A linear discriminant test (LDA) was performed based on the PCA results. Discriminant function 1 (F1) corresponded with the first component (C1; vegetative characters); F2 was composed of the three components of the PCA; and F3 corresponded to C2 and C3 (spikelet length, SL; flower length, FL; and lower glume length, LGL; all floral characters). The three functions are significant according to Wilks's lambda. The plot representing F1 and F3 ([Fig. 2A](#)) reveals a clear separation of *H. pusilla* and *H. juncifolia*, whereas the rest of the species are intermingled. Discriminant functions correctly classified 74.7 % of the specimens, although this percentage was different across species (not shown). The results of hierarchical cluster analysis (not shown) were consistent with the LDA.

#### MACROMORPHOLOGICAL ANALYSES: QUALITATIVE CHARACTERS AND COMBINED ANALYSES

The chi-square test of independence revealed that qualitative characters differed among species. The

**Table 2.** Matrix of rotated components (Varimax rotation) of the PCA performed using macromorphological quantitative data

Characters	Component loadings		
	Component 1	Component 2	Component 3
PH_ln	<b>0.874</b>	0.285	0.357
LL_ln	<b>0.861</b>	0.242	0.399
LW_ln	<b>0.899</b>	0.331	-0.017
IL_ln	<b>0.863</b>	0.322	0.349
SLSB_ln	<b>0.826</b>	0.378	0.300
SL_ln	0.283	0.387	<b>0.860</b>
FL_ln	0.418	<b>0.838</b>	0.250
LGL_ln	0.319	<b>0.754</b>	0.495
% variability	78.65	11.08	4.75

Morphological characters showing highest factor loadings on the first three principal components are in bold type. For character codes, see [Appendix 2](#).

permutational multivariate analysis of variance using the distance matrix test (ADONIS; Supporting Information, [Appendix S2](#)) showed that the most similar species are *H. gunckelii* and *H. utriculata* (94.2% similarity;  $p$ -value = 0.942); all other species showed a higher differentiation (< 30% similarity). The principal coordinate analysis (PCoA; not shown) and the non-metric multidimensional scaling test (NMDS; [Fig. S2A](#)) using the Jaccard index for three axes (stress = 0.07) separate the species into two groups: (1) *H. altissima*, *H. gunckelii*, *H. redolens* and *H. utriculata*; and (2) *A. mexicanum*, *H. juncifolia*, *H. occidentalis* and *H. pusilla*. The hierarchical cluster analysis (not shown) revealed the existence of two clear groupings in the data that did not follow the taxonomy of the section. Increasing the number of groups did not improve species discrimination, highlighting data dispersion. The taxa *H. pusilla*, *H. redolens* and, to a lesser extent, *H. juncifolia* had a less ambiguous adscription into one of the groups.

The NMDS (three axes, stress = 0.09; [Fig. 3A](#)) and the PCoA (not shown) performed with combined data using Gower's similarity coefficient clustered the species into three groups: (1) *H. altissima*, *H. gunckelii*, *H. redolens* and *H. utriculata* (highly overlapped); (2) *A. mexicanum*, *H. juncifolia* and *H. occidentalis* (slightly overlapped); and (3) *H. pusilla* (clearly differentiated). The multiple correspondence analysis (MCA; not shown) yielded the same results as the NMDS.

#### MICROMORPHOLOGICAL ANALYSES: QUANTITATIVE CHARACTERS

Descriptive statistics showed that all variables overlap among species (not shown; for character

names see [Appendix 2](#)). The ANOVA indicates that stomata size (StS) does not differentiate among species ( $p$ -value = 0.176), whereas long cells length (LlL) and number of ribs (NRi) showed significant differences across taxa. Only these variables (LlL and NRi) were included in the discriminant functions obtained in the LDA using the stepwise method. The LDA plot (not shown) indicated that only *H. juncifolia* and *H. pusilla* are clearly different from the rest of the taxa. *Hierochloë juncifolia* shows low values for these two characters, whereas *H. pusilla* has low values for number of ribs (NRi) but intermediate values for long cells length (LlL). The other five species are grouped together, especially *H. altissima*, *H. gunckelii* and *H. occidentalis*, showing higher values for number of ribs (NRi); *H. redolens* and *H. utriculata* presented intermediate values.

#### MICROMORPHOLOGICAL ANALYSES: QUALITATIVE CHARACTERS AND COMBINED ANALYSIS

The chi-square test of independence showed that only two traits, furrow depth (FD) and vascular bundles with sclerenchyma associated only in the margin of the leaf (PBEx) (for character names see [Appendix 2](#)), were not significantly different among taxa. The ADONIS analysis indicated that *A. mexicanum*, *H. occidentalis* and *H. pusilla* showed the highest consistency (100% internal similarity;  $p$ -value = 1.000) followed by *H. redolens* and *H. utriculata* (30.4% similarity;  $p$ -value = 0.304). The NMDS based on the Jaccard index for three axes (stress = 0.1, Supplementary Information [Fig. S2B](#)) separated the species into four groups: (1) *H. altissima*, *H. gunckelii*, *H. pusilla*, *H. redolens* and *H. utriculata*; (2) *H. juncifolia*; (3) *A. mexicanum*; and (4) *H. occidentalis*. The hierarchical cluster analysis (not shown) revealed low differentiating power for micromorphological qualitative data.

Qualitative and quantitative characteristics that did not have discriminating power according to the exploratory tests (StS, FD and PBEx; for character names see [Appendix 2](#)) were excluded from the combined analyses. The PCoA, MCA (not shown) and the NMDS plots performed using Gower's similarity coefficient for three axes (stress = 0.1; [Fig. 3B](#)) gave similar results and showed differentiation among the taxa. Consistent results were obtained in the hierarchical cluster analysis when the number of groups chosen equals the number of taxa. These analyses revealed that hook density (low density, HoF; intermediate density, HoN; high density, HoM), presence and shape of ribs (presence, RS; round-flattened, RSD; round, RSR; quadrangular, RSQ; polygonal, RSP) and leaf section shape (planar, LSP; open, LSO; closed, LSC) were the most differentiating traits.

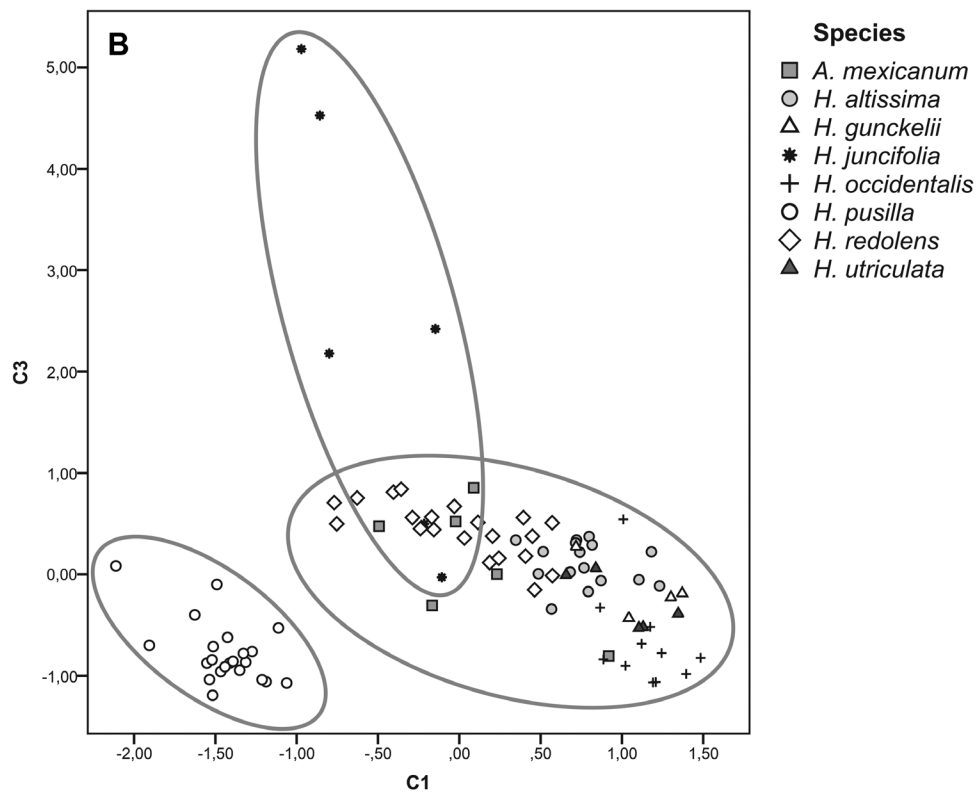
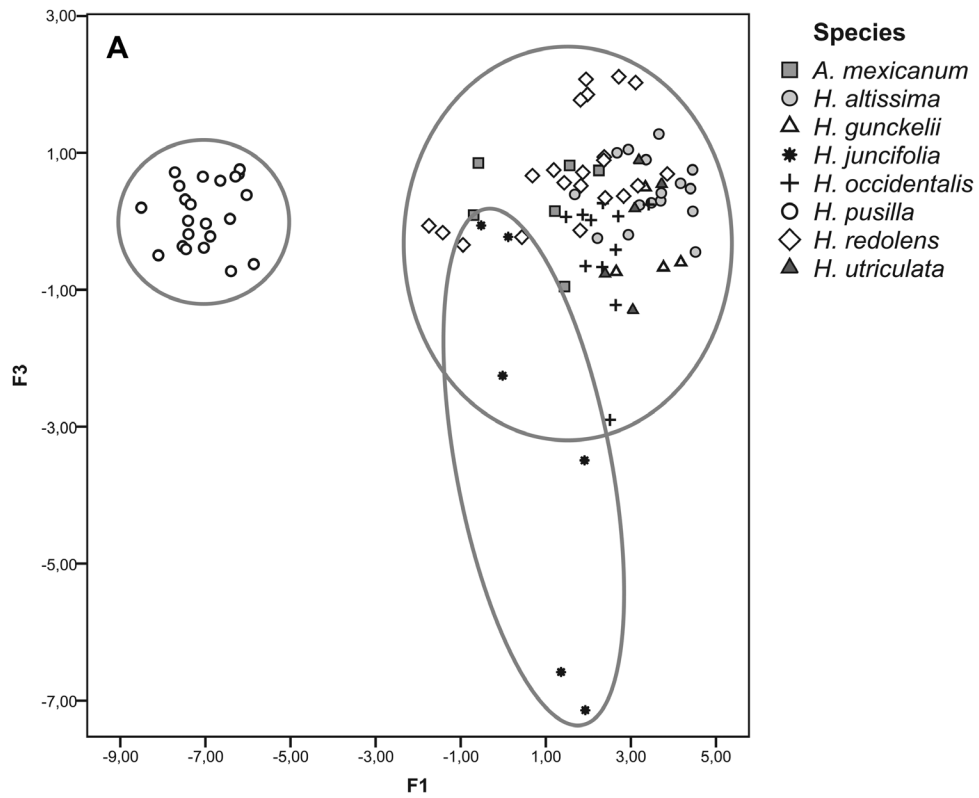



## PHYLOGENETIC RECONSTRUCTION

The independent analyses of the nuclear ribosomal DNA markers produced congruent topologies and the ITS and ETS regions were combined. Tree comparison indicated that the combination of the complete plastid and nuclear data was untenable due to topological conflict (Pirie *et al.*, 2009). A joint plastid + nuclear analysis was conducted after removing the only conflicting sample (*H. quebrada*).

The aligned plastid and nuclear matrices included 48 and 47 terminals, respectively (37 and 36 in section *Monoecia*). They represented 16 species (14 *Hierochloë* + one South American *Anthoxanthum* + one Eurasian *Anthoxanthum*, outgroup) and 1788 (plastid; *trnL-F*, 1–1084; *trnT-L*, 1085–1788) and 1288 (nuclear; ETS, 1–626; ITS, 627–1288) characters. The number of potentially parsimony-informative characters (as estimated using the program PAUP v. 4.10b; Sinauer Associates, Sunderland, MA, USA) was low, in particular 105 (5.9%) and 128 (9.9%) in the plastid and nuclear data, respectively. The Bayesian consensus plastid and nuclear trees are represented in Figures 4 and 5. The topologies were largely congruent (better general resolution in the plastid tree) and only the different position of *H. quebrada* was supported. The results of the concatenated analysis (*H. quebrada* removed from the matrices) are presented in Supporting Information Figure S3. In all trees, *A. mexicanum* is clearly differentiated from *Hierochloë* spp. (regardless of their geographical origin), constituting a highly supported clade. The plastid and concatenated topologies showed a well-supported and monophyletic *Hierochloë* section *Monoecia* as sister to the Eurasian and North American species. The nuclear tree failed to recover this structure, and section *Monoecia* was paraphyletic with *H. quebrada* as sister to all the other *Hierochloë*. A large polytomy including seven independent clades can be observed in the nuclear topology (*H. redolens* from South-East Asia; *H. alpina*; *H. odorata* + *H. hirta* + *H. glabra*; *H. laxal*; *H. pusilla*; *H. occidentalis*; *Hierochloë* section *Monoecia* except *H. quebrada* and *H. pusilla*; Fig. 5). The plastid tree recovered a weakly supported position for the South-East Asian *H. redolens* in the Eurasian + North American clade as the earliest diverging group, whereas the concatenated tree strongly supports *H. occidentalis* as sister to all other *Hierochloë* not in *Monoecia*. With regard to *Hierochloë* section *Monoecia*, *H. pusilla* is well supported as the first diverging group (Figs 4, S3) followed by

*H. quebrada* (not represented in the concatenated tree). The position of *H. juncifolia* is not well resolved in the plastid tree (Fig. 4), but the nuclear and concatenated topologies (Figs 5, S3) clearly place it as sister to all other *Monoecia*, except *H. pusilla* and *H. quebrada*. The phylogenetic resolution of the *H. redolens* species complex, including *H. redolens* (central and southern Andean), *H. altissima*, *H. gunckelii*, *H. utriculata* and *H. spicata* (also *H. juncifolia* in the plastid tree; Fig. 4), is poor (Figs 4, 5, S3). The nuclear and concatenated topologies (Figs 5, S3) recover a well-supported position for an Argentinian *H. redolens* sample (H177, Appendix 1), positioning it as sister to all other specimens in the clade. In the plastid topology (Fig. 4) this position is occupied by a central Andean *H. redolens* (H129, Appendix 1), with low support. No structure could be obtained for *H. altissima*, *H. gunckelii*, *H. spicata* and *H. utriculata*.

The final aligned ETS clone matrix included 33 consensus sequences (see Material and Methods) and 851 characters representing eight South American *Hierochloë* spp. + *A. mexicanum* and *A. odoratum* (outgroup). Consensus sequences were generated for 353 ETS clones. Only *H. quebrada*, *H. pusilla* and *H. redolens* (Indonesia) were represented by one monospecific consensus sequence, including nine, ten and eight clones, respectively. *Hierochloë juncifolia* (78 clones) was represented by 12 consensus sequences, 11 of which were monospecific. *Hierochloë altissima* (80 clones) and *H. utriculata* (57 clones) were represented by six and eight consensus sequences, three and five of which included only one taxon, respectively. South American *H. redolens* (79 clones) and *H. spicata* (12 clones) participated in seven (four monospecific) and two consensus sequences, respectively, and all *H. gunckelii* (20 clones) were included in one non-monospecific consensus sequence (Appendix 1, Supporting Information Fig. S4). The number of clones represented for each consensus sequence was highly variable. Fourteen of them were based on one clone only (six of them belonging to *H. juncifolia*), whereas one consensus sequence accounted for 264 (72.7%) of the clones. This latter sequence represented a high percentage of the clones of all species of *Hierochloë* section *Monoecia*, except *H. juncifolia* and *H. pusilla*. Clones obtained from an individual tended to be represented by the same consensus sequence; monoclonal consensus sequences represent the exceptions to this trend.

The Bayesian consensus tree based on the ETS clone matrix of consensus sequences is represented in Figure

**Figure 2.** Scatterplots of macromorphological quantitative data. (A) Two-dimensional scatterplot of the linear discriminant analysis (LDA), classification functions 1 and 3. (B) Two-dimensional scatterplot of the principal components analysis (PCA), components 1 and 3. The percentage of variability explained by each component and the contributions of single characters are indicated in Table 2.

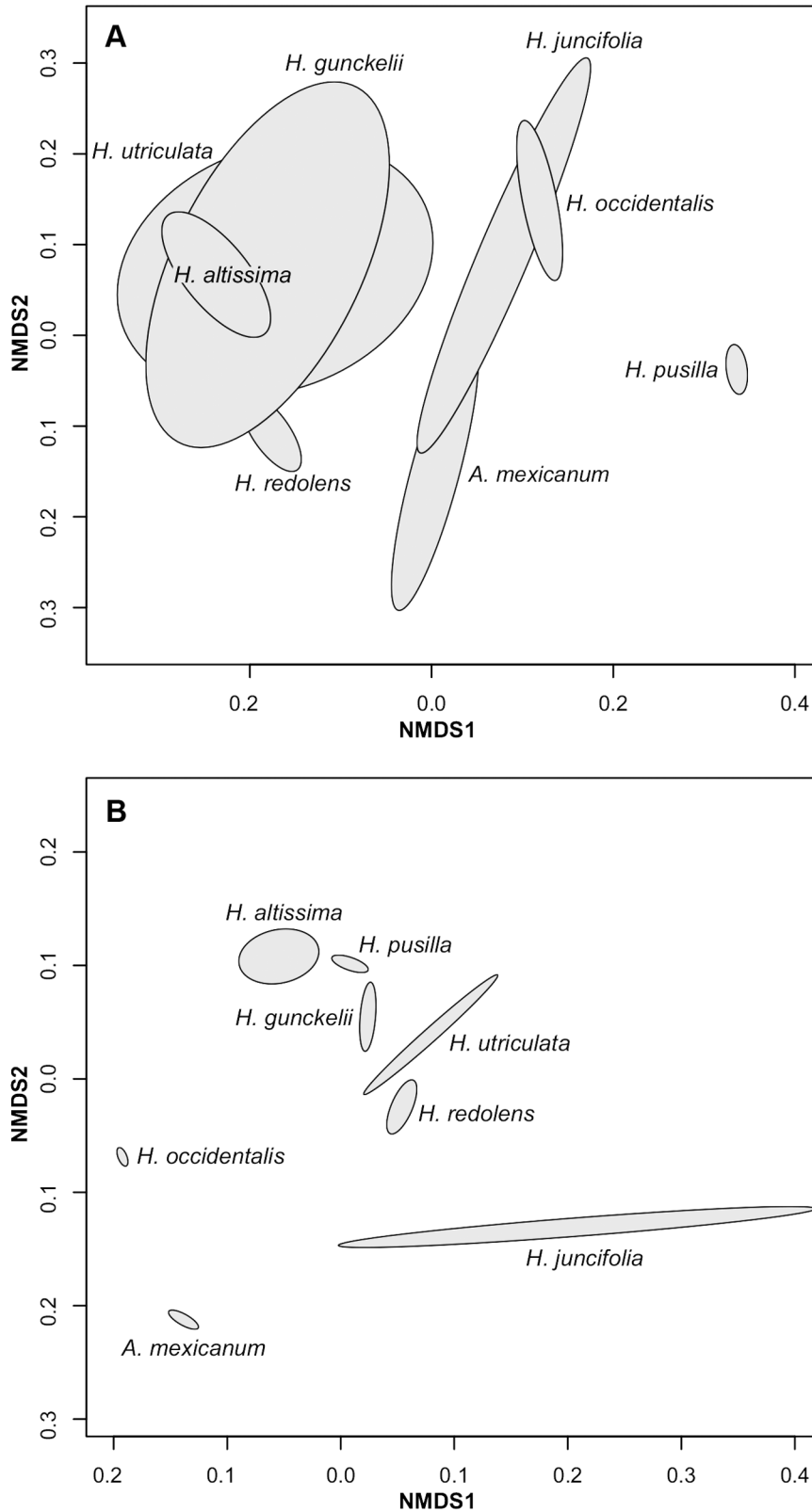

**Figure 3.** Plots of the non-metric multidimensional scaling (NMDS) analysis. (A) Combined macromorphological quantitative and qualitative data. (B) Combined micromorphological quantitative and qualitative data. Data combination was conducted using Gower's similarity coefficient.

S4, and is largely consistent with the phylogenetic tree based on nuclear data (Fig. 5). Resolution in the tree is generally low and only few relationships are strongly supported. *Hierochloë* section *Monoecia* is recovered as monophyletic with respect to *A. mexicanum*, whereas *H. quebrada* is sister to the remaining taxa in the section with strong support. All consensus sequences including clones from specimens of *H. altissima*, *H. utriculata*, *H. juncifolia*, *H. pusilla*, *H. gunckelii*, *H. spicata* and *H. redolens* (all populations) are grouped (low support) in a large polytomy with only three moderately to strongly supported clades: a strongly supported group of two consensus sequences representing two clones of *H. utriculata* and *H. altissima*; a moderately supported clade grouping all but two *H. juncifolia* consensus sequences and one *H. redolens* from the Central Andes; and a third group including three consensus sequences of *H. redolens*, *H. juncifolia* and *H. utriculata* (six clones).

Phylogenetic networks were built to represent ambiguities in the phylogenetic reconstructions. Different explanations lie behind these ambiguities, including hybridization, homoplasy and, in the case of nuclear ribosomal sequences, recombination (Posada & Crandall, 2001). The lack of resolution in the phylogenetic trees for *Hierochloë* section *Monoecia* (Figs 4, 5) renders this approach useful even if it has been traditionally used at an intraspecific level (Clement, Posada & Crandall, 2000). The statistical parsimony networks produced with plastid (Supporting Information Fig. S5) and nuclear sequences (not shown) were largely consistent with the plastid and nuclear Bayesian topologies (Figs 4, 5). Samples of *Hierochloë* section *Monoecia* except *H. juncifolia*, *H. pusilla* and *H. quebrada* are grouped in one haplotype, with these three latter species closely related to it. Eurasian and North American species (+ South-East Asian *H. redolens*) occupy more distant positions in the network. Two missing intermediaries were created (Clement *et al.*, 2000) and one cycle was observed in the plastid network affecting Eurasian, North American, South American and South-East Asian samples (Fig. S5). No cycle is defined in the nuclear network and eight missing intermediaries were inferred. The statistical parsimony network based on clone data (Fig. 6) groups 264 out of 352 clones (75%) in one ribotype. Twenty-four additional ribotypes were defined in the network: *H. juncifolia* (nine), *H. juncifolia* + *H. altissima* (one), *H. altissima* (two), *H. altissima* + *H. redolens* (one), *H. redolens* (six including the South-East Asian populations), *H. utriculata* (four) and *H. quebrada* (one). Two cycles were defined in this network and ten missing intermediaries were inferred.

## DISCUSSION

Integrative approaches offer the best results in exploring biodiversity (e.g. Hörandl, 2007; Schlick-Steiner *et al.*, 2010). Here, we combine macromorphological, micromorphological, molecular and cytological information to assess the taxonomy of *Hierochloë* section *Monoecia*. We conclude that the taxonomic status of several of the species in the section is not justified based on either the phylogenetic (apomorphic) or the phenetic species concepts (for a discussion on the application of different species concepts in plants, see Soltis *et al.*, 2007). In addition, we recovered a scenario of recent and incomplete diversification in the southern Andes for section *Monoecia* and a longer isolation history for those species with restricted ecological and/or geographical ranges.

### INFERENCE OF DNA PLOIDY IN *HIEROCHLOË* SECTION *MONOECIA*

*Hierochloë* displays a wide variation in ploidy, with diploids, tetraploids, hexaploids and duodecaploids being identified (e.g. Weimarck, 1971). As a reference for the tentative translation of our nuclear DNA content values into DNA ploidies we used the measurements performed by Murray, de Lange & Ferguson (2005) in New Zealand *Hierochloë*. These authors found duodecaploids: *H. redolens*, *H. fusca* Zotov and *H. brunonis* Hook (12x; 2n = 84; 2C = 27.55–29.97 pg); hexaploids: *H. equisetata* Zotov (6x; 2n = 42; 2C = 18.10 pg); and tetraploids: *H. novae-zelandiae* Gand (4x; 2n = 28; 2C = 12.54 pg). Considering this, our groups G1 and G2 (2C = 12.82–14.45 pg; Table 1, Fig. S1), including *H. pusilla* and *H. juncifolia*, correspond to DNA tetraploids; groups G3 (*H. altissima* population A1, *H. redolens* population R4 and *H. utriculata*) and G4 (*H. gunckelii* and *H. redolens* populations R1, R2 and R3) are putative DNA hexaploids (2C = 18.27–19.84 pg) and group G5 (*H. altissima* populations A2, A3, A4; 2C = 27.04–27.43 pg) most probably corresponds to DNA duodecaploids (for population codes see Appendix 1 or Fig. 1). *Hierochloë quebrada* and *H. spicata* are probably a DNA hexaploid (2C = 18.87 pg) and a DNA tetraploid (2C = 13.28 pg), respectively, but only one measurement could be attained for these taxa (Table 1).

Genome size variation and the number of chromosomes are not always positively correlated (e.g. Chumová, Mandáková & Trávníček, 2016), and the likelihood of chromosome rearrangements increases with evolutionary distance (Bhutkar *et al.*, 2008). New Zealand taxa of *Hierochloë* do not belong to section *Monoecia* based on morphology; however, recent phylogenetic trees of Anthoxanthinae based on nuclear data (I. Lema-Suárez *et al.*, unpubl. data) indicate that *H. fusca* is nested in the *Monoecia* clade and close to the

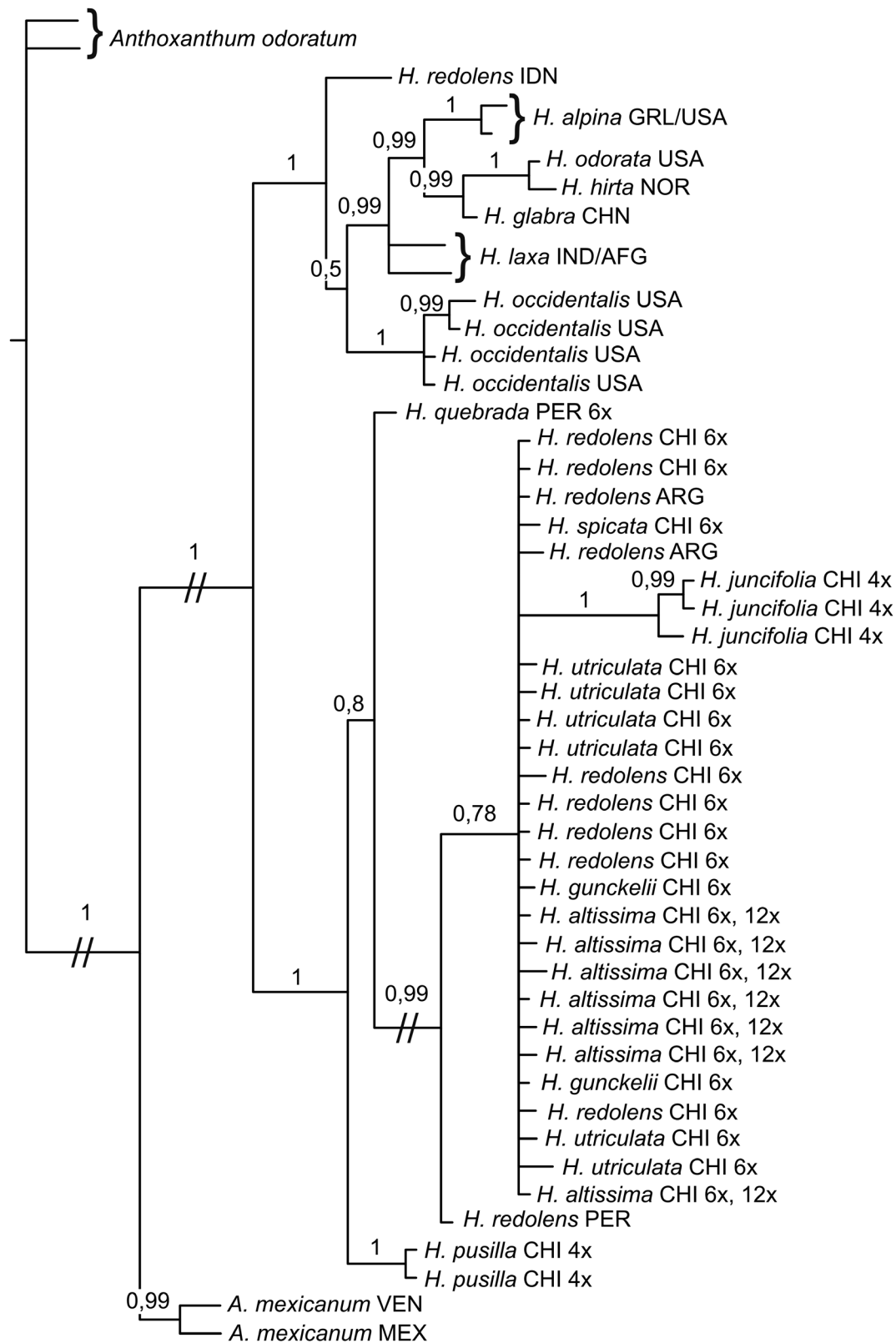

South American *H. redolens* complex. This evolutionary proximity gives consistency to our results; however, the inferred ploidies must be interpreted with caution. B chromosomes have been found in Anthoxanthinae (Chumová *et al.*, 2016), including in some *Hierochloë* Weimarck (1978). However, according to Chumová *et al.* (2015), the contribution of B chromosomes to the total nuclear DNA content is small in different groups of Anthoxanthinae. It is therefore unlikely that they are responsible for the differences in nuclear DNA content observed among and (in some cases) within taxa (Chumová *et al.*, 2015).

#### EVOLUTION AND BIOGEOGRAPHY OF *HIEROCHLOË* SECTION *MONOECIA*

Phylogenetic analyses (e.g. Figs 4, 5, S3) recover a well-defined and monophyletic section *Monoecia* that is clearly separated from other South American groups of Anthoxanthinae. This result is consistent with Connor & Renvoize (2009) who established that spikelet monoecism is a good indicator of evolutionary isolation in the genus. Andromonoecious spikelets are dominant in *Hierochloë* (Connor, 2012) and only one transition to monoecism has been detected. Reversals in this transition have not been reported, although recent phylogenetic results (I. Lema-Suárez *et al.*, unpubl. data) indicate that some andromonoecious taxa are nested in the *Monoecia* clade (e.g. *H. fusca*, a New Zealand endemic).

All analyses recover the split of *A. mexicanum* [*A. davidsei* (Pohl) Veldkamp is not represented in the tree] prior to the divergence of section *Monoecia* and the development of monoecism in *Hierochloë*. Connor & Renvoize (2009) suggested that monoecious *Hierochloë* section *Monoecia* species evolved from non-South American andromonoecious ancestors through the development and fixation of male sterility genes in the apical floret. According to these authors, 'the *Ataxia* system could not give rise to monoecism' and therefore the central to northern South American *Ataxia* spp. *A. mexicanum* and *A. davidsei* can be excluded as ancestors of section *Monoecia* (Connor & Renvoize, 2009). Our molecular phylogenetic trees and networks support this view. Our limited sampling and phylogenies do not allow us to indicate with certainty where these ancestors grew or when the section diverged from the remaining *Hierochloë*, but Nearctic

(and Central American) colonizers are among the main components of the Andean flora since the mid-Miocene (e.g. Simpson, 1983). A Nearctic origin has been detected for other groups of high-elevation Andean grasses such as *Festuca* L. (Inda *et al.*, 2008), and long-distance colonization of high mountain environments by cold-adapted lineages has been observed in different tropical alpine areas of the world (e.g. Gehrke & Linder, 2014; Luebert & Weigend, 2014; Merckx *et al.*, 2015), including in Anthoxanthinae (Tusiime *et al.*, 2017). Our well-supported plastid and concatenated phylogenetic trees (Figs 4, S3) do not seem to support this scenario, as they recover an old divergence for section *Monoecia* and do not show a close association between South American and Nearctic (or Holarctic) *Hierochloë*.

Taxa in section *Monoecia* represent a mixture of well-defined species and other species not yet well differentiated based on morphology or molecular data (e.g. Figs 2, 3A, 4, 5). A clear correlation can be observed between morphological and phylogenetic differentiation and ecological, geographical and/or cytological isolation. The central Andean hexaploid *H. quebrada* and the southern Andean tetraploid *H. pusilla* are the first groups to diverge in section *Monoecia* (Figs 4, 5, S3). Only the plastid phylogenetic tree did not recover a strongly supported position for *H. quebrada* (Fig. 4), and all the analyses based on ETS clones (Figs 6, S4) failed to produce a well-differentiated *H. pusilla*. This latter species, well characterized regarding macromorphological vegetative characters, especially plant size (Fig. 2; e.g. Parodi, 1941), is ecologically restricted to moist meadows in the Patagonian and Tierra del Fuego floristic provinces (De Paula, 1975). Only the hexaploid *H. redolens* grows in similar areas, but both taxa seem to be completely isolated (Figs 4, 5). *Hierochloë pusilla* shows low levels of macro- and micromorphological variation (Fig. 3). This might reflect its small distribution area and the general pattern of low morphological diversity for cold-adapted Antarctic/Arctic species (Grundt *et al.*, 2006), although the number of analysed specimens was too low to draw any final conclusions. The ETS clones obtained from *H. pusilla* were reduced to one, monospecific consensus sequence indicating isolation, but the ETS clones-based network (Fig. 6) and phylogenetic tree (Fig. S4) failed to recover a well-supported position for this taxon. The high level of differentiation observed

**Figure 4.** Majority rule consensus tree inferred from Bayesian analysis (MrBayes) of plastid DNA sequences (*trnT-L* and *trnL-F*). Forty-eight samples representing 17 taxa of *Hierochloë* and *Anthoxanthum* section *Ataxia* and one outgroup (*A. odoratum*) are represented in the tree. The symbol // denotes branches that were shortened to simplify presentation. Posterior probability support values are represented above the branches. For each terminal, the species name is followed by country of origin (IDN, Indonesia; GRL, Greenland; USA, United States of America; NOR, Norway; CHN, China; IND, India; AFG, Afghanistan; PER, Peru; CHI, Chile; ARG, Argentina; VEN, Venezuela; MEX, Mexico).

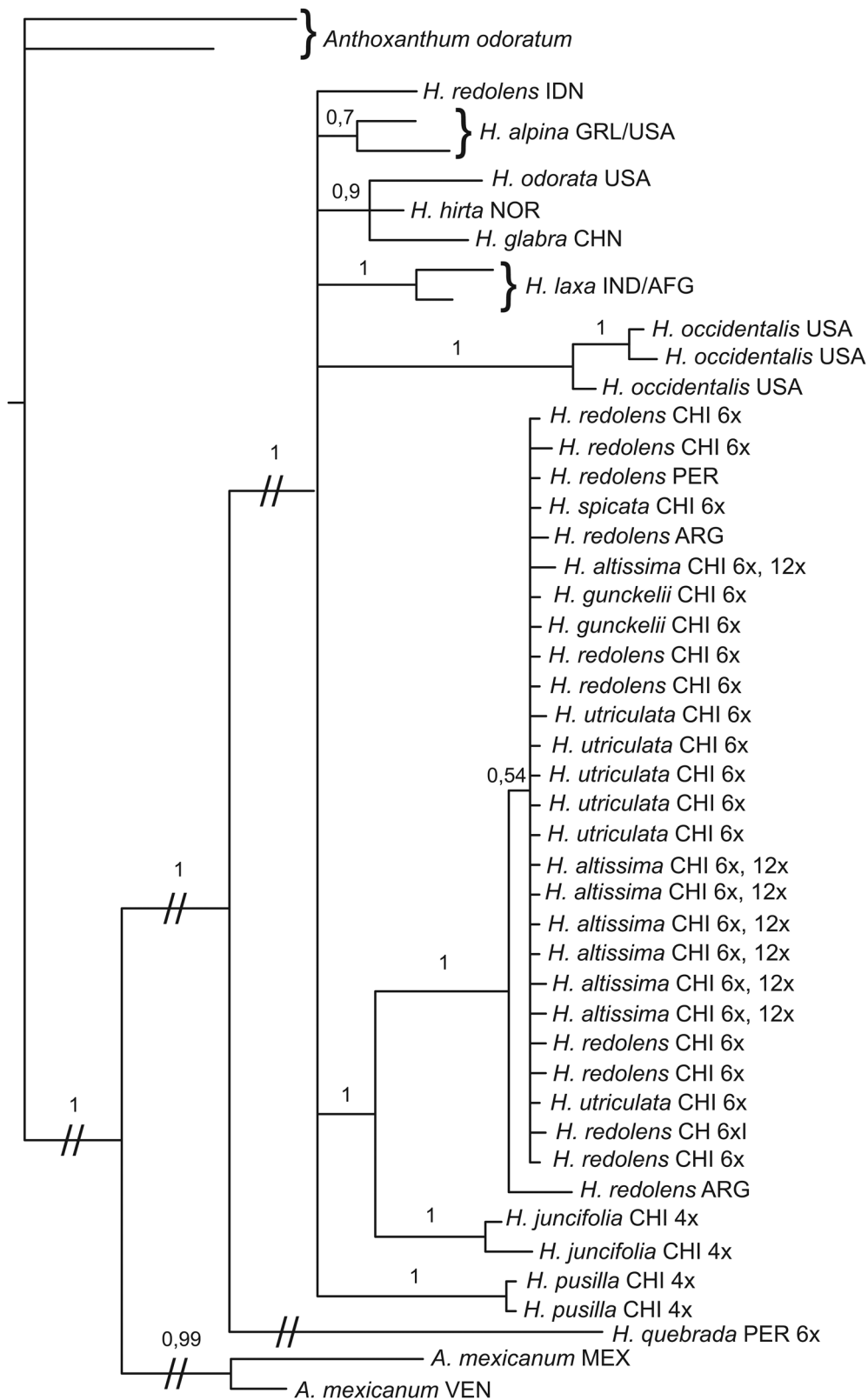

is consistent with an old relative age for *H. pusilla*, a species restricted to the southernmost tip of the Andes (*sensu* Nagy & Grabherr, 2009; Körner *et al.*, 2011). Mountain southern species are generally older than those from the central or northern Andes (Doan, 2003; Luebert & Weigend, 2014) due to earlier uplift (Blisniuk *et al.*, 2005).

The central Andean putative hexaploid *H. quebrada* occupies different positions in the plastid and nuclear trees (Figs 4, 5). Discordance in topologies is common in plants and can be due to different causes, most commonly hybridization and incomplete lineage sorting (Renoult *et al.*, 2009). The frequency of reticulate evolution in *Hierochloë* and in Anthoxanthinae (Pimentel *et al.*, 2010, 2013; Chumová *et al.*, 2017; Tusiime *et al.*, 2017) and the variation of ploidy found in the section suggest hybridization as a likely explanation. Nevertheless, specific tests using more samples should be made to confirm this hypothesis for *H. quebrada*. With regard to the possible parents in a putative reticulation event, a plant from section *Monoecia* is the most likely plastid donor (Fig. 4), whereas the paternal parent must be outside the section. *Hierochloë quebrada* is restricted to high-elevation (4000–4600 m a.s.l.), arid areas on the western slopes of the central Andes (Connor & Renvoize, 2009). Two other species of section *Monoecia* currently grow at lower elevations in the central Andes: the hexaploid *H. redolens* and the tetraploid *H. juncifolia* (Tovar, 1993). The presence of the latter species has been questioned due to the description of *H. quebrada* based on materials identified as *H. juncifolia* (Connor & Renvoize, 2009). An analysis of a specimen of *H. juncifolia* collected in Ancash, Peru (US 2882401, Appendix 1), seems to indicate that *H. juncifolia* does grow in the central Andes. Our network based on ETS clones (Fig. 6) shows a close proximity between *H. juncifolia* and *H. quebrada*, pointing to *H. juncifolia* as the most likely plastid donor. Only two species of Anthoxanthinae outside *Monoecia* grow in the northern to central Andes, namely *A. mexicanum* and *A. davidsei*. The ploidy of these species and their phylogenetic position in Anthoxanthinae remain poorly known, but their lineages are clear candidates to be involved in the putative hybridization. With regard to the age of this reticulation event, the fact that all *H. quebrada* clones cluster in one consensus

sequence points to an old origin and the effect of concerted evolution (Okuyama *et al.*, 2005).

Nuclear and concatenated phylogenetic trees recover the tetraploid *H. juncifolia* as sister to the *H. redolens* complex (Figs 5, S3), whereas its position is not well supported in the plastid topology (Fig. 4). All analyses reveal *H. juncifolia* as a consistent group in section *Monoecia*, and highly distinct based on morphology or molecules (e.g. Figs 3, 4, S3). High variation is also detected in the species. *Hierochloë juncifolia* samples occupy a large morphological space in the NMDS analyses based on the combined macro- or micromorphological data (Fig. 3A, B). A similar pattern is observed in the ETS clone analyses. The phylogenetic tree (Fig. S5) recovered some (poorly supported) structure for the species, which was consistent with the clone-based network (Fig. 6). In addition, the 77 *H. juncifolia* clones were collapsed into 12 mostly monospecific consensus sequences, a number much higher than that obtained for the other species of *Monoecia* with a similar number of specimens sampled (Appendix 1). This scenario of high consistency combined with high interpopulational diversity may be due to the current ecology and distribution of the species. *Hierochloë juncifolia* grows in sandy or volcanic soils up to 1750 m a.s.l. in mountains of the Andean areas of the Argentine provinces of Río Negro, Neuquén and Chubut and in the adjacent regions of Chile (also in the central Andes of Peru, although no Peruvian sample could be used in the molecular analyses). *Hierochloë juncifolia* populations show complete ecological and (to a lesser extent) cytological and geographical isolation from the *H. redolens* complex (De Paula, 1975). They are also isolated from each other, since *H. juncifolia* has a highly discontinuous distribution due to its ecological requirements (De Paula, 1975; Anton & Zuloaga, 2012). This isolation is probably related to the emerging genetic structure in the species.

The *H. redolens* complex, also including *H. altissima*, *H. gunkelii*, *H. spicata* and *H. utriculata*, is the only group in the section that grows from the northern to the southern Andes. The phylogenetic analyses conducted recovered an almost complete lack of resolution for this group (e.g. Figs 4, 5, S3, S5), which might reflect its recent evolutionary origin and lack of reproductive isolation. The main exception to this

**Figure 5.** Majority rule consensus tree inferred from Bayesian analysis (MrBayes) of nuclear DNA sequences (ETS and ITS). Forty-seven samples representing 16 taxa of *Hierochloë* and *Anthoxanthum* section *Ataxia* and one outgroup (*A. odoratum*) are represented in the tree. The symbol // denotes branches that were shortened to simplify presentation. Posterior probability support values are represented above the branches. For each terminal, the species name is followed by country of origin (IDN, Indonesia; GRL, Greenland; USA, United States of America; NOR, Norway; CHN, China; IND, India; AFG, Afghanistan; PER, Peru; CHI, Chile; ARG, Argentina; VEN, Venezuela; MEX, Mexico).

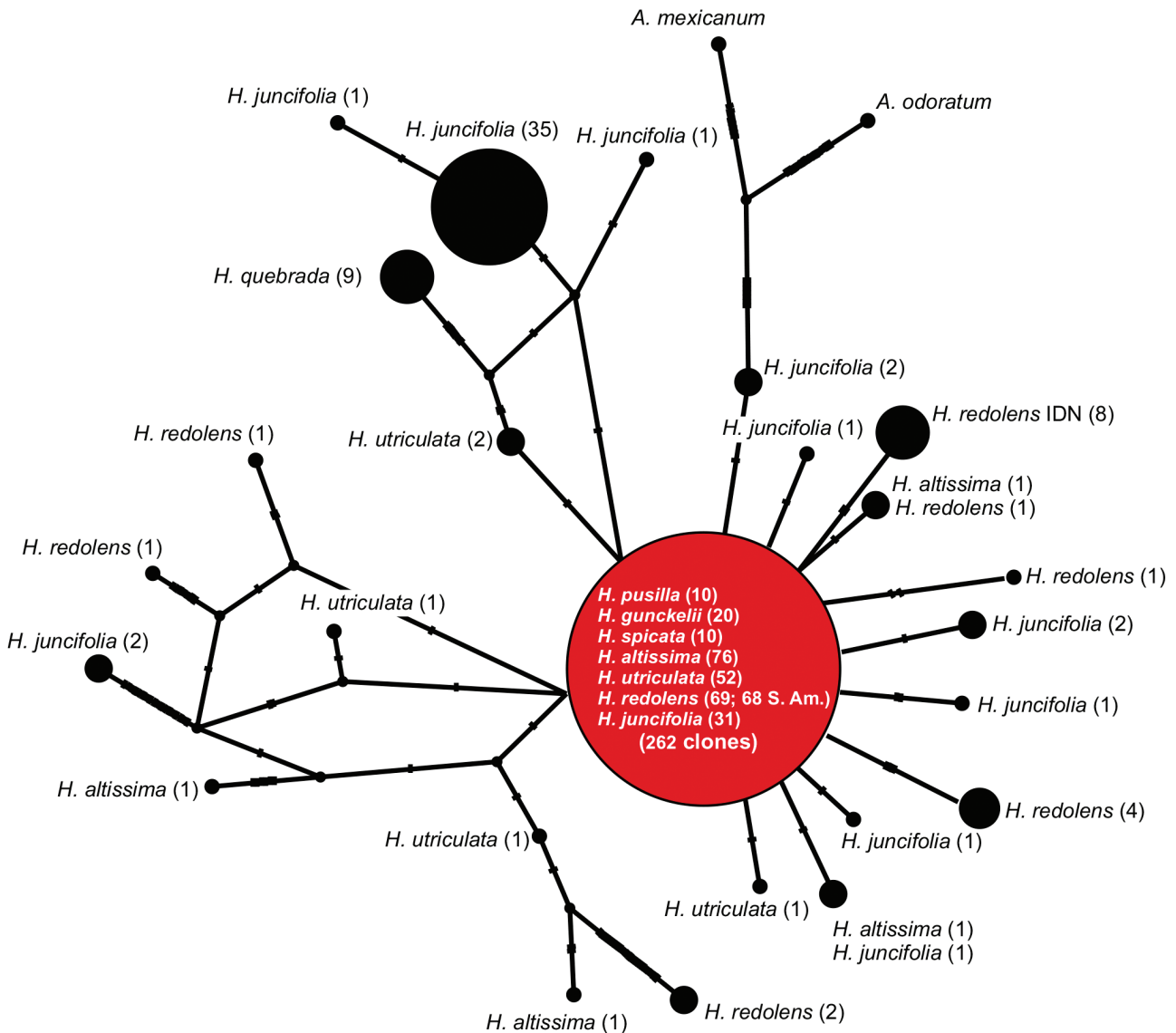

**Figure 6.** Statistical parsimony network based on the consensus sequences obtained from the ETS clones and conducted using the software TCS v. 1.21 and PopArt v. 1.7. S. Am., South America.

pattern is the position of the *H. redolens* accessions from Indonesia, which are clearly differentiated from the South American samples in all molecular analyses. Other authors have highlighted the need for a taxonomic reappraisal of *H. redolens* and have called for the separation of the Asian-Australian and South American andromonoecious populations of this taxon (Zotov, 1973; De Paula, 1975; Connor, 2012). It is important to note that although most of the ETS clones obtained from the Indonesian *H. redolens* sample clustered together in one exclusive consensus sequence, one Indonesian ETS clone clustered with the consensus sequence including most South American *H. redolens* complex clones. More research is needed to assess a

possible relationship between the South-East Asian and the South American populations.

The distribution range of the *H. redolens* complex in South America is clearly disjunct. It grows at low altitudes in temperate to subantarctic areas of Chile and Argentina and at mid- to high altitudes (up to 3850 m a.s.l.; Connor & Renvoize, 2009) in the tropical central and northern Andes. The plastid phylogenetic tree (Fig. 4) shows a well-supported sister relationship between the central and the southern Andean populations that is not recovered in the nuclear or concatenated trees (Figs 5, S3). Analyses based on clones recover a scenario of low differentiation between central and southern Andean populations. All clones



obtained from the Peruvian specimen collapsed in a consensus sequence that also comprised most clones in the southern South American *H. redolens* complex (Figs 6, S4). The biogeographical limit between the central and the southern Andes is the southern limit of the dry puna (Luebert & Pliscoff, 2006), an area of high aridity that acts as a filter to Andean elements, to the north and south (Arroyo *et al.*, 1998). This barrier formed in the Miocene–Pliocene (e.g. Sepulchre *et al.*, 2009; Heibl & Renner, 2012) as a result of Andean uplift together with the combined effect of the Humboldt Current and the Pacific anticyclone (Luebert & Weigend, 2014). It currently precludes the possibility of gene flow between the southern temperate and the northern tropical–alpine *H. redolens*, although whether gene flow was interrupted at the time of the formation of the barrier or afterwards remains to be determined.

The taxa of the *H. redolens* complex in southern South America have distribution and ecological ranges that are partially overlapping on a north–south gradient (De Paula, 1975; Anton & Zuloaga, 2012), and the obtained results must be interpreted in light of this. These groups, except *H. spicata* (tetraploid) and some *H. altissima* populations (duodecaploid), are putative hexaploids (Table 1), but differences in ploidy are not reflected in our phylogenetic analyses (e.g. Figs 4, 5). Differentiation among the species is minimal regardless of the analysis conducted, morphological or otherwise (e.g. Figs 2A, 4, 5, S2A), and only micromorphological data can separate all taxa (Figs 3B, S2B), except *H. spicata*. This species was not included in the analysis, but Villalobos & Finot (2016) indicated that it is not well defined based on leaf anatomy. The use of foliar micromorphological characters in grass taxonomy has been hindered by the effect of environmental parameters on leaf anatomy (Aiken, Darbyshire & Lefkovitch, 1984; Dubé & Moriset, 1996), including in Anthoxanthinae (Pimentel & Sahuquillo, 2008). Given the north–south distribution ranges of the species, new analyses based on additional populations are necessary to assess this point.

Analyses based on ETS clones revealed that (1) almost no structure exists in the data as regards the *H. redolens* complex (Figs 6, S4) and (2) most clones obtained from specimens of the complex collapse into one consensus sequence (80–100% of clones for *H. altissima*, *H. gunckelii*, *H. redolens*, *H. spicata* and *H. utriculata*; Fig. S4). Lack of phylogenetic resolution (Fig. S4) prevents us from making inferences about reticulation and introgression in this group; however, the general lack of differentiation observed, together with the abundance of multispecific consensus sequences (c. 50%) and the similar nuclear DNA estimations (and ploidy) lead us to believe that gene flow does exist in this group.

#### TAXONOMIC ASSESSMENT OF *HIEROCHLOË* SECTION *MONOECIA*

Different species concepts have been applied in plants, especially in groups in which polyploidization is common (e.g. Soltis *et al.*, 2007). Here, we combined the morphologically based phenetic species concept (Sokal & Crovello, 1970) with the DNA-focused apomorphic species concept (Judd *et al.*, 2002). The first approach is practical for taxonomic purposes (e.g. Soltis *et al.*, 2007) and assumes that species are separated by a gap in morphological variation (Sokal & Crovello, 1970), whereas the second reduces subjectivity by recognizing only monophyletic groups that share several apomorphies, morphological or otherwise (Mishler & Theirot, 2000).

Our analyses have shown that the macromorphological traits used by Parodi (1941) and De Paula (1975) to underpin their classification of section *Monoecia* (plant size, inflorescence structure, awn insertion) are not useful for differentiating among the species unambiguously. Based on the two above-mentioned concepts and considering our results, only four species should be recognized in *Hierochloë* section *Monoecia*: *H. juncifolia*, *H. pusilla*, *H. quebrada* and *H. redolens pro parte*. This last name should be restricted to South American specimens following De Paula (1975, but see Zotov, 1973), and it would also include *H. altissima*, *H. gunckelii*, *H. spicata* and *H. utriculata*, as varieties. Given their micromorphological differences, we consider that they should be recognized taxonomically despite their lack of isolation. Although the limits between varieties and subspecies are far from clear-cut (e.g. McNeill *et al.*, 2012), in our view the overlapping ecological and geographical ranges of these taxa would render the varietal rank more appropriate. *Hierochloë sorianoi* and *H. moorei*, not considered in our study, have already been transferred to *H. redolens* by other authors (e.g. Anton & Zuloaga, 2012), but recent results on *H. moorei* (Villalobos & Finot, 2016) call for a reassessment of this species.

#### CONCLUSIONS

Only four out of the eight *Monoecia* species (*H. pusilla*, *H. juncifolia*, *H. quebrada* and *H. redolens*) should be maintained based on morphological and molecular data. The remaining taxa (*H. altissima*, *H. gunckelii*, *H. spicata* and *H. utriculata*) should be reduced to varieties in *H. redolens*. The inclusion of South-East Asian and South American *H. redolens* populations in the same species is untenable according to our data.

Our results support the hypothesis proposed by Connor & Renvoize (2009), who suggested that species of *Hierochloë* section *Monoecia* evolved from non-South

American andromonoecious ancestors, and not from other South American Anthoxanthinae.

Our phylogenetic trees reveal a probable hybrid origin for the central Andean *H. quebrada*, although further studies are needed to confirm this hypothesis. The highly ecologically differentiated *H. pusilla* and *H. juncifolia* were shown to be the oldest species of the group. Extensive gene flow due to ecological, chorological and cytological similarities probably exists in the *H. redolens* complex.

New studies using a greater number of specimens and hypervariable nuclear markers are needed to clarify the structure in the *H. redolens* complex. Conducting chromosome counts in the different species is also necessary to confirm ploidies across the section.

#### ACKNOWLEDGEMENTS

We are grateful to R. Lorenzo, L. Mota and D. Tavares for their help and advice in the laboratory. We thank D. García San León (SANT Herbarium) who arranged and managed loans from different institutions. The curators at CONC, K, M, MA, PH, SANT, UPS and US are thanked for those loans, especially W. Chen, A. P. Clark, R. Duque-Thues, H. J. Esser, A. Freire-Fierro, A. Marticorena, J. Palmer, C. Smith, M. S. Toner, M. Vorontsova and M. Xanthos. J. Amigo and A. Marticorena provided information about the populations from Chile. This work was supported by grants from the Spanish Ministry for Science and Technology (CGL2009-12955-C02-02). G.E. was supported by MINECO grant MTM2014-52876-R and by the Xunta de Galicia (Grupos de Referencia Competitiva ED431C-2016-015 and Centro Singular de Investigación de Galicia ED431G/01), all of them through the ERDF. I.L. was supported by grants from the Universidade da Coruña (Inditex-UDC) and Grupo de Investigación en Biología Evolutiva (GIBE, GRC2014/050).

#### REFERENCES

- Adler D, Murdoch D. 2016.** *rgl: 3D visualization using OpenGL. R package version 0.96.0.* Available at: <https://CRAN.R-project.org/package=rgl> (accessed 27 March 2017).
- Aiken SG, Darbyshire SJ, Lefkovich LP. 1984.** The taxonomic value of using epidermal characteristics in Canadian rough fescue complex (*Festuca altaica*, *F. campestris*, *F. halii*, *F. scabrella*). *Canadian Journal of Botany* **62**: 1864–1870.
- Almeida-Pinheiro de Carvalho MA, Wilcock CC, Marques dos Santos TM, Vale-Lucas IC, Teixeira-Ganança JF, Franco E, Thangadurai D, Muralid-Hara-Rao D, Freitas-Sousa D. 2004.** A review of the genus *Semele* (Ruscaceae) systematics in Madeira. *Botanical Journal of the Linnean Society* **146**: 483–497.
- Alvarez I, Wendel JF. 2003.** Ribosomal ITS sequences and plant phylogenetic inference. *Molecular Phylogenetics and Evolution* **29**: 417–434.
- Anton AM, Zuloaga FO. 2012.** *Flora Argentina–Flora Vascular de la República Argentina. Volume 3 (II). Monocotyledoneae. Poaceae: Pooideae.* Córdoba: Gráficamente Ediciones.
- Arroyo MTK, Castor C, Marticorena C, Cavieres L, Muñoz M, Matthei O, Squeo M, Grosjean M, Rodriguez R. 1998.** The flora of Llullaillaco National Park located in the transitional winter-summer rainfall area of the northern Chilean Andes. *Gayana Botanica* **49**: 47–70.
- Bendiksby M. 2011.** *Molecular phylogeny, taxonomy, and historical biogeography of Lamiaceae subfamily Lamioideae, including surveys of allopolyploid speciation in two Eurasian genera, Galeopsis and Lamium.* PhD Thesis, University of Oslo.
- Besse P, ed. 2014.** *Molecular plant taxonomy – methods and protocols.* New York: Humana Press (Springer).
- Bhutkar A, Schaeffer SW, Russo SM, Xu M, Smith TF, Gelbart WM. 2008.** Chromosomal rearrangement inferred from comparisons of 12 *Drosophila* genomes. *Genetics* **179**: 1657–1680.
- Blisniuk PM, Stern LA, Chamberlain CP, Idleman B, Zeitler PK. 2005.** Climatic and ecologic changes during Miocene surface uplift in the southern Patagonian Andes. *Earth and Planetary Science Letters* **230**: 125–142.
- Chumová Z, Krejčíková J, Mandáková T, Suda J, Trávníček P. 2015.** Evolutionary and taxonomic implications of variation in nuclear genome size: lesson from the grass genus *Anthoxanthum* (Poaceae). *PLoS One* **10**: e0133748.
- Chumová Z, Mandáková T, Trávníček P. 2016.** Are B-chromosomes responsible for the extraordinary genome size variation in selected *Anthoxanthum* annuals? *Plant Systematics and Evolution* **302**: 731–738.
- Chumová Z, Závěská E, Mandáková T, Krak K, Trávníček P. 2017.** The Mediterranean: the cradle of *Anthoxanthum* (Poaceae) diploid diversity. *Annals of Botany* **120**: 285–302.
- Clement M, Posada D, Crandall KA. 2000.** TCS: a computer program to estimate gene genealogies. *Molecular Ecology* **9**: 1657–1659.
- Clement M, Snell Q, Walker P, Posada D, Crandall K. 2002.** TCS: Estimating gene genealogies. *Parallel and Distributed Processing Symposium, International Proceedings* **2**: 184.
- Connor HE. 2008.** Floral biology of Australian species of *Hierochloa* (Gramineae). *Australian Journal of Botany* **50**: 166–176.
- Connor HE, Renvoize SA. 2009.** *Hierochloa quebrada* (Poaceae), a new species from Peru and notes on floral biology in South American species. *Kew Bulletin* **64**: 727–734.
- Connor HE. 2012.** Flowers and floral biology of the holy grasses (*Hierochloa* and *Anthoxanthum*: Aveneae, Gramineae). *Flora* **207**: 323–333.
- Consaul LL, Gillespie LJ, Waterway M. 2010.** Evolution and polyploid origins in North American Arctic *Puccinellia* (Poaceae) based on nuclear ribosomal spacer and chloroplast DNA sequences. *American Journal of Botany* **97**: 324–336.

- De Paula ME. 1975.** Las especies del género *Hierochloë* (Gramineae) de Argentina y Chile. *Darwiniana* **19**: 422–457.
- Devesa JA. 1992.** *Anatomía foliar y palinología de las gramíneas extremeñas*. Badajoz: Universidad de Extremadura.
- Díaz-Pérez A, Sharifi-Tehrani M, Inda LA, Catalán P. 2014.** Polyphyly, gene-duplication and extensive allopolyploidy framed the evolution of the ephemeral *Vulpia* grasses and other fine-leaved Loliinae (Poaceae). *Molecular Phylogenetics and Evolution* **79**: 92–105.
- Doan TM. 2003.** A south to north biogeographic hypothesis for Andean speciation: evidence from the lizard genus *Proctoporus* (Reptilia, Gymnophthalmidae). *Journal of Biogeography* **30**: 361–374.
- Doležel J, Bartoš J, Voglmayr H, Greilhuber J. 2003.** Nuclear DNA content and genome size of trout and human. *Cytometry* **51**: 127–128.
- Doležel J, Greilhuber J, Suda J. 2007.** Estimation of nuclear DNA content in plants using flow cytometry. *Nature Protocols* **2**: 2233–2244.
- Dubé M, Moriset P. 1996.** La plasticité phénotypique des caractères anatomiques foliaires chez le *Festuca rubra* L. (Poaceae). *Canadian Journal of Botany* **74**: 1708–1718.
- Dufrene M, Gathoye JL, Tyteca D. 1991.** Bio-statistical studies on western European *Dactylorhiza* (Orchidaceae) – the *D. maculata* group. *Plant Systematics and Evolution* **175**: 55–72.
- Edgar RC. 2004.** MUSCLE: multiple sequence alignment with high accuracy and high throughput. *Nucleic Acids Research* **32**: 1792–1797.
- Fox J. 2005.** The R Commander: a basic statistics graphical user interface to R. *Journal of Statistical Software* **14**: 1–42.
- Fox J. 2016.** *RcmdrMisc: R Commander miscellaneous functions*. R package version 1.0–5. Available at: <https://CRAN.R-project.org/package=RcmdrMisc> (accessed 27 March 2017).
- Fox J, Bouchet-Valat M. 2016.** *Rcmdr: R Commander*. R package version 2.3–1. Available at: <http://socserv.socsci.mcmaster.ca/jfox/Misc/Rcmdr/> (accessed 27 March 2017).
- Fox J. 2017.** *Using the R Commander: a point-and-click interface for R*. Boca Raton: Chapman and Hall/CRC Press.
- Galbraith DW, Harkins KH, Maddox JM, Ayres NM, Sharma DP, Firoozabady E. 1983.** Rapid flow cytometric analysis of the cell cycle in intact plant tissues. *Science* **220**: 1049–1051.
- Galley CA, Linder HP. 2007.** The phylogeny of the *Pentaschistis* clade (Danthonioideae, Poaceae) based on chloroplast DNA, and the evolution and loss of complex characters. *Evolution* **61**: 864–884.
- Gehrke B, Linder HP. 2014.** Species richness, endemism and species composition in the tropical Afroalpine flora. *Alpine Botany* **124**: 165–177.
- Gillespie LJ, Soreng RJ, Jacobs SWL. 2009.** Phylogenetic relationships of Australian *Poa* (Poaceae: Poinae), including molecular evidence for two new genera, *Saxipoa* and *Sylvipoa*. *Australian Journal of Botany* **22**: 413–436.
- Gouy M, Guindon S, Gascuel O. 2010.** SeaView version 4: a multiplatform graphical user interface for sequence alignment and phylogenetic tree building. *Molecular Biology and Evolution* **27**: 221–224.
- Greilhuber J, Doležel J, Lysák MA, Bennet MD. 2005.** The origin, evolution and proposed stabilization of the terms “genome size” and “C-value” to describe nuclear DNA contents. *Annals of Botany* **95**: 255–260.
- Grundt HH, Kjølnner S, Borgen L, Rieseberg LH, Brochmann C. 2006.** High biological species diversity in the arctic flora. *Proceedings of the National Academy of Sciences USA* **103**: 972–975.
- Hart MW, Sunday J. 2007.** Things fall apart: biological species form unconnected parsimony networks. *Biology Letters* **3**: 509–512.
- Heibl C, Renner SS. 2012.** Distribution model and a dated phylogeny for Chilean *Oxalis* species reveal occupation of new habitats by different lineages, not rapid adaptive radiation. *Systematic Biology* **61**: 823–834.
- Holmgren PK, Holmgren NH, Barnett LC. 1990.** *Index herbariorum. Part I: Herbaria of the World*. New York: New York Botanical Garden.
- Hörandl E. 2007.** Neglecting evolution is bad taxonomy. *Taxon* **56**: 1–5.
- Hsiao C, Chatterton NJ, Asay KH, Jensen KB. 1995.** Molecular phylogeny of the Pooideae (Poaceae) based on nuclear rDNA (ITS) sequences. *Theoretical and Applied Genetics* **90**: 389–398.
- IBM Corp. 2011.** *IBM SPSS Statistics for Mac, Version 20.0*. Armonk: IBM Corp.
- Inda LA, Segarra-Moragues JG, Müller J, Peterson PM, Catalán P. 2008.** Dated historical biogeography of the temperate Loliinae (Poaceae, Pooideae) grasses in the Northern and Southern Hemispheres. *Molecular Phylogenetics and Evolution* **46**: 932–957.
- Judd WS, Campbell CS, Kellogg EA, Stevens PF, Donoghue MJ. 2002.** *Plant systematics: a phylogenetic approach, 2nd edn*. Sunderland: Sinauer Associates.
- Körner C, Paulsen J, Spehn EM. 2011.** A definition of mountains and their bioclimatic belts for global comparisons of biodiversity data. *Alpine Botany* **121**: 73–78.
- López-Pujol J, García Jacas N, Susanna A, Vilatersana R. 2012.** Should we conserve pure species or hybrid species? Delimiting hybridization and introgression in the Iberian endemic *Centaurea podospermifolia*. *Biological Conservation* **152**: 271–279.
- Loureiro J, Rodriguez E, Doležel J, Santos C. 2007.** Two new nuclear isolation buffers for plant DNA flow cytometry—a test with 37 species. *Annals of Botany* **100**: 875–888.
- Luebert F, Pliscoff P. 2006.** *Sinopsis bioclimática y vegetacional de Chile*. Santiago: Editorial Universitaria.
- Luebert F, Weigend M. 2014.** Phylogenetic insights into Andean plant diversification. *Frontiers in Ecology and Evolution* **2**: 27.
- McNeill J, Barrie FR, Buck WR, Demoulin V, Greuter W, Hawksworth DL, Herendeen PS, Knapp S, Marhold K, Prado J, Prud'homme van Reine WF, Smith GF, Wiersema JH, Turland NJ, eds. 2012.** *International Code of Nomenclature for algae, fungi, and plants (Melbourne Code)*. *Regnum Vegetabile* **154**: 1–208.

- Available at: <http://www.iapt-taxon.org/nomen/main.php> (accessed 11 April 2017).
- Merckx VSFT, Hendriks KP, Beentjes KK, Mennes CB, Becking LE, Peijnenburg KTCA, Afendy A, Arumugam N, de Boer H, Biun A, Buang MM, Chen PP, Chung AY, Dow R, Feijen FA, Feijen H, Feijen-van Soest C, Geml J, Geurts R, Gravendeel B, Hovenkamp P, Imbun P, Ipor I, Janssens SB, Jocqué M, Kappes H, Khoo E, Koomen P, Lens F, Majapun RJ, Morgado LN, Neupane S, Nieser N, Pereira JT, Rahman H, Sabran S, Sawang A, Schwallier RM, Shim PS, Smit H, Sol N, Spait M, Stech M, Stokvis F, Sugau JB, Suleiman M, Sumail S, Thomas DC, van Tol J, Tuh FY, Yahya BE, Nais J, Repin R, Lakim M, Schilthuizen M. 2015.** Evolution of endemism in a young tropical mountain. *Nature* **524**: 347–350.
- Mishler BD, Theirot EC. 2000.** The phylogenetic species concept (*sensu* Mishler & Theirot): monophyly, apomorphy, and phylogenetic species concepts. In: Wheeler QD, Meier R, eds. *Species concepts and phylogenetic theory: a debate*. New York: Columbia University Press, 44–54.
- Murray BG, de Lange PJ, Ferguson AR. 2005.** Nuclear DNA variation, chromosome numbers and polyploidy in the endemic and indigenous grass flora of New Zealand. *Annals of Botany* **96**: 1293–1305.
- Nagy L, Grabherr G. 2009.** *The biology of alpine plants*. Oxford: Oxford University Press.
- Okuyama Y, Fujii N, Wakabayashi M, Kawakita A, Ito M, Watanabe M, Murakami N, Kato M. 2005.** Nonuniform concerted evolution and chloroplast capture: heterogeneity of observed introgression patterns in three molecular data partition phylogenies of Asian *Mitella* (Saxifragaceae). *Molecular Biology and Evolution* **22**: 285–296.
- Ospina JC, Sylvester SP, Sylvester MDPV. 2016.** Multivariate analysis and taxonomic delimitation within the *Festuca setifolia* complex (Poaceae) and a new species from the Central Andes. *Systematic Botany* **41**: 727–746.
- Parodi LR. 1941.** Revisión de las gramíneas sudamericana del género *Hierochloe*. *Revista del Museo de La Plata (N.S.)* **3**: 183–212.
- Pimentel M, Sahuquillo E. 2003.** An approach to the study of morphological relationships among the sweet vernal grasses (*Anthoxanthum* L. Poaceae, Pooideae) in the Iberian Peninsula. *Bocconea* **16**: 731–737.
- Pimentel M, Estévez G, Sahuquillo E. 2007.** European sweet vernal grasses (*Anthoxanthum*, Poaceae; Pooideae; Aveneae): a morphometric taxonomical approach. *Systematic Botany* **32**: 43–59.
- Pimentel M, Sahuquillo E. 2008.** Relationships between the close congeners *Anthoxanthum odoratum* and *A. alpinum* (Poaceae: Pooideae) assessed by morphological and molecular methods. *Botanical Journal of the Linnean Society* **156**: 237–252.
- Pimentel M, Catalán P, Sahuquillo E. 2010.** Morphological and molecular taxonomy of the annual diploids *Anthoxanthum aristatum* and *A. ovatum* (Poaceae) in the Iberian Peninsula. Evidence of introgression in natural populations. *Botanical Journal of the Linnean Society* **164**: 53–71.
- Pimentel M, Sahuquillo E, Torrecilla Z, Popp M, Catalan P, Brochmann C. 2013.** Hybridization and long-distance colonization at different time scales: towards resolution of long-term controversies in the sweet vernal grasses (*Anthoxanthum*). *Annals of Botany* **112**: 1015–1030.
- Pirie MD, Humphreys AM, Barker NP, Linder HP. 2009.** Reticulation, data combination, and inferring evolutionary history: an example from Danthonioideae (Poaceae). *Systematic Biology* **58**: 612–628.
- Popp M, Oxelman B. 2007.** Origin and evolution of North America polyploid *Silene* (Caryophyllaceae). *American Journal of Botany* **94**: 330–349.
- Posada D, Crandall KA. 2001.** Intraspecific gene genealogies: trees grafting into networks. *Trends in Ecology and Evolution* **16**: 37–45.
- R Core Team. 2016a.** *R: a language and environment for statistical computing*. Vienna: R Foundation for Statistical Computing. Available at: <http://www.R-project.org/> (accessed 27 March 2017).
- R Core Team. 2016b.** *foreign: read data stored by Minitab, S, SAS, SPSS, Stata, Systat, Weka, dBase, ... R package version 0.8–67*. Available at: <https://CRAN.R-project.org/package=foreign> (accessed 27 March 2017).
- Renoult JP, Kjellberg F, Grout C, Santoni S, Khadari B. 2009.** Cyto-nuclear discordance in the phylogeny of *Ficus* section *Galoglychia* and host shifts in plant-pollinator associations. *BMC Evolutionary Biology* **9**: 248.
- Repka R. 2003.** The *Carex muricata* aggregate in the Czech Republic: multivariate analysis of quantitative morphological characters. *Preslia* **75**: 233–248.
- RStudio Team. 2016.** *RStudio: integrated development for R*. Boston: RStudio, Inc. Available at: <http://www.rstudio.com/> (accessed 27 March 2017).
- Ruhfel BR, Stevens PF, Davis CC. 2013.** Combined morphological and molecular phylogeny of the clusioid clade (Malpighiales) and the placement of the ancient rosid macrofossil *Paleoclusia*. *International Journal of Plant Sciences* **174**: 910–936.
- Sarkar D. 2008.** *lattice: multivariate data visualization with R*. New York: Springer.
- Schlick-Steiner BC, Steiner FM, Seifert B, Stauffer C, Christian E, Crozier RH. 2010.** Integrative taxonomy: a multisource approach to exploring biodiversity. *Annual Review of Entomology* **55**: 421–438.
- Schouten Y, Veldkamp JF. 1985.** A revision of *Anthoxanthum* including *Hierochloe* (Gramineae) in Malesia and Thailand. *Blumea* **30**: 319–351.
- Sepulchre P, Sloan LC, Snyder M, Fiechter J. 2009.** Impacts of Andean uplift on the Humboldt current system: a climate model sensitivity study. *Paleoceanography* **24**: PA4215.
- Simpson BB. 1983.** An historical phytogeography of the high Andean flora. *Revista Chilena de Historia Natural* **56**: 109–122.
- Sokal RR, Crovello T. 1970.** The biological species concept. A critical evaluation. *American Naturalist* **104**: 127–153.
- Soltis DE, Soltis PS, Schemske DW, Hancock JF, Thompson JN, Husband BC, Judd WS. 2007.** Autopolyploidy in angiosperms: have we grossly underestimated the number of species? *Taxon* **56**: 13–30.

- Still CJ, Berry JA, Collatz GJ, DeFries RS. 2003.** Global distribution of C<sub>3</sub> and C<sub>4</sub> vegetation: carbon cycle implications. *Global Biogeochemical Cycles* **17**: 1006.
- Szlachetko DL, Kolanowska M, Naczka A, Górniak M, Dudek M, Rutkowski P, Chiron G. 2017.** Taxonomy of *Cyrtochilum*-alliance (Orchidaceae) in the light of molecular and morphological data. *Botanical Studies* **58**: 8.
- Taberlet P, Gielly G, Pautou G, Bouvet J. 1991.** Universal primers for amplification of three non-coding regions of chloroplast DNA. *Plant Molecular Biology* **17**: 1105–1109.
- Tamura K, Stecher G, Peterson D, Filipowski A, Kumar S. 2013.** MEGA6: molecular evolutionary genetics analysis version 6.0. *Molecular Biology and Evolution* **30**: 2725–2729.
- Templeton AR, Crandall KA, Sing CF. 1992.** A cladistic analysis of phenotypic associations with haplotypes inferred from restriction endonuclease mapping and DNA sequence data. III. Cladogram estimation. *Genetics* **132**: 619–633.
- Torreccilla P, López-Rodríguez JA, Stancik D, Catalán P. 2003.** Systematics of *Festuca* sects. *Eskia* Willk., *Pseudotropis* Kriv., *Amphigenes* (Janka) Tzvel., *Pseudoscariosa* Kriv. and *Scariosae* Hack. based on analysis of morphological characters and DNA sequences. *Plant Systematics and Evolution* **239**: 113–139.
- Tovar O. 1993.** Las gramíneas (Poaceae) del Perú. *Ruizia* **13**: 1–480.
- Tusiime FM, Gizaw A, Wondimu T, Masao CA, Abdi AA, Muwanika W, Travnicek P, Nemomissa S, Popp M, Eilu G, Brochmann C, Pimentel M. 2017.** Sweet vernal grasses (*Anthoxanthum*) colonized African mountains along two fronts in the Late Pliocene, followed by secondary contact, polyploidization and local extinction in the Pleistocene. *Molecular Ecology* **26**: 3513–3532.
- Villalobos N, Finot V. 2016.** *Anatomía foliar y micromorfología de la lemma de Hierochloë (Poaceae: Anthoxanthinae) en Sudamérica Austral*. Concón: XXVII Reunión Anual de la Sociedad de Botánica de Chile.
- Wan D, Sun Y, Zhang X, Bai X, Wang J, Wang A, Milne R. 2014.** Multiple ITS copies reveal extensive hybridization within *Rheum* (Polygonaceae), a genus that has undergone rapid radiation. *PLoS One* **9**: e89769.
- Weimarck G. 1971.** Variation and taxonomy of *Hierochloë* (Gramineae) in the Northern Hemisphere. *Botaniska Notiser* **124**: 129–175.
- Weimarck G. 1978.** Behaviour of B chromosomes in *Hierochloë repens* (Gramineae) during male meiosis. *Hereditas* **88**: 7–11.
- Zotov VD. 1973.** *Hierochloë* R.Br. (Gramineae) in New Zealand. *New Zealand Journal of Botany* **11**: 561–580.

## SUPPORTING INFORMATION

Additional Supporting Information may be found in the online version of this article at the publisher's web-site:

**Figure S1.** Nuclear DNA content (pg/2C) in 82 plants of *Hierochloë* section *Monoecia* estimated using flow cytometric analysis. Specimens sorted according to increasing 2C-values. Putative DNA ploidy levels (see Discussion) were also included. Group G1 corresponds to *H. pusilla* (4x); G2 to *H. juncifolia* (4x); G3 and G4 to *H. altissima* populations A1, *H. redolens*, *H. utriculata* and *H. gunckelii* (all 6x); G5 to *H. altissima* populations A2, A3 and A4 (12x).

**Figure S2.** Plots of the non-metric multidimensional scaling (NMDS) analysis. (A) Qualitative macromorphological data. (B) Qualitative micromorphological data. Data combination was conducted using Gower's similarity coefficient.

**Figure S3.** Majority rule consensus tree inferred from Bayesian analysis (MrBayes) of concatenated nuclear (ETS and ITS) and plastid (*trnT-L* and *trnL-F*) DNA sequences. Forty-eight samples representing 17 taxa of *Hierochloë* and *Anthoxanthum* section *Ataxia* and one outgroup (*Anthoxanthum odoratum*) are represented in the tree. The symbol // denotes branches that were shortened to simplify presentation. Posterior probability support values are represented above the branches. For each terminal, the species name is followed by country of origin (IDN, Indonesia; GRL, Greenland; USA, United States of America; NOR, Norway; CHN, China; IND, India; AFG, Afghanistan; PER, Peru; CHI, Chile; ARG, Argentina; VEN, Venezuela; MEX, Mexico).

**Figure S4.** Majority rule consensus tree inferred from Bayesian analysis (MrBayes) of the consensus sequences obtained from the ETS clone DNA matrix. In total, 353 samples representing 17 taxa of *Hierochloë* and *Anthoxanthum* section *Ataxia* and one outgroup (*Anthoxanthum odoratum*) are represented in the tree. The symbol // denotes branches that were shortened to simplify presentation. Posterior probability support values are represented above the branches. S. Am.; South America. Numbers in parentheses represent the number of clones included in each ribotype (for more information see the Material and Methods).

**Figure S5.** Statistical parsimony network based on plastid data and conducted using the software TCS v. 1.21 and PopArt v. 1.7.

**Appendix S1:** Detailed description of the methodology followed in genome size estimation using flow cytometry.

**Appendix S2:** Detailed description of the statistical analyses applied to morphological data.

**Appendix S3:** Maximum parsimony (MP) and Bayesian analyses conducted on molecular data.

**Appendix 1.** Specimens and populations used in the analyses. Macrom, macromorphological characters; Microm, micromorphological characters; Phylog., phylogenetic tests; FCM, flow cytometry; Prov., province; Co, county; Mt., mountain. IDN, Indonesia; GRL, Greenland; USA, United States of America; NOR, Norway; CHN, China; IND, India; AFG, Afghanistan; PER, Peru; CHI, Chile; ARG, Argentina; VEN, Venezuela; MEX, Mexico. Numbers represent how many specimens were used per population in each analysis.

Species	Country	Location	Date	Code	Herbarium	Macrom	Microm	Phylog			FCM		
								ETS	ITS	<i>trnL-F</i>	<i>trnT-L</i>	CLONES	
<i>A. odoratum</i>	CHI	IX Región de La Araucanía: Conguillio N.P.	2006	H173	CONC 173419	-	-	MF374535	MF374580	MF678684	MF678732	MF688256- MF688264	-
<i>H. alpina</i>	GRL	Kangerlussuaq	2014	X149	-	-	-	MF374536	MF374581	MF678685	MF678733	-	-
<i>H. alpina</i>	USA	AK: Selawik NWR: Waring Mountains	2005	H135	US 3543959	-	-	MF374537	MF374582	MF678686	MF678734	-	-
<i>H. glabra</i>	CHN	Heilongjiang: Harbin	1925	H155	US 3102678	-	-	MF374545	MF374588	MF678694	MF678740	-	-
<i>H. hirta</i>	NOR	Hedmark: Hamar	2007	H43	O 313689	-	-	MF374548	MF374591	MF678697	MF678743	-	-
<i>H. laxa</i>	AFG	Kunar Prov.: Chapa Dara District	1973	H180	M MSB-005986	-	-	MF374551	MF374594	MF678701	MF678747	-	-
<i>H. laxa</i>	IND	Himachal Pradesh State: Lahaul-Spiti District	1930	H117	US 1537029	-	-	MF374552	MF374595	MF678702	MF678748	-	-
<i>H. odorata</i>	USA	AK: Valdez-Cordova C.A.: mile 173 Glenn highway	1959	H127	US 3495920	-	-	MF374556	MF374599	MF678707	MF678753	-	-
<i>A. mexicanum</i>	GTM	Huehuetenango: Sierra de los Cuchumatanes	1960	H109	US 2381698	1	1	-	-	-	-	-	1
<i>A. mexicanum</i>	MEX	Morelos State: Lagunas de Zempoala N.P.	1951	H108	US 2079184	1	1	MF374554	-	MF678683	MF678731	-	-
<i>A. mexicanum</i>	MEX	Chiapas State: San Cristóbal de Las Casas: Las Piedrecitas	1965	H110	US 3007642	1	1	-	-	-	-	-	-
<i>A. mexicanum</i>	VEN	Andean Region: Mérida State: El Rincón	1968	H186	M-0257426	1	-	-	-	-	-	MF688247- MF688255	-
<i>A. mexicanum</i>	VEN	Andean Region: Mérida State: Sierra de Santo Domingo	1977	H103	UPS V-653028	1	1	MF374533	MF374579	MF678682	MF678730	-	-
<i>A. mexicanum</i>	VEN	Andean Region: Mérida State: Sierra Nevada de Mérida: Lake Coromoto	1966	H122	US 2951758	1	1	-	-	-	-	-	1
<i>H. altissima</i>	CHI	IX Región de la Araucanía: Lake Budi	2014	A1	SANT 73530	4	4	MF374538	MF374583	MF678687	MF678735	MF688265- MF688288	5
<i>H. altissima</i>	CHI	XIV Región de Los Ríos: Valdivia: Castro	2014	A2	SANT 73528	4	4	MF374539	MF374584	MF678688	MF678736	MF688299- MF688299	5
<i>H. altissima</i>	CHI	XIV Región de Los Ríos: Valdivia: Niebla	2014	A3	SANT 73527	4	5	MF374540 MF374541 MF374542	MF374585	MF678690 MF678691	MF678737	MF688300- MF688312, MF688314- MF688316	5
<i>H. altissima</i>	CHI	XIV Región de Los Ríos: Valdivia: Niebla	2014	A4	SANT 73529	4	4	MF374543	MF374586	MF678692	MF678738	MF688317- MF688344	5
<i>H. gunckelii</i>	CHI	X Región de los Lagos: Chiloe Island: Compu	2014	G1	SANT 73538	4	4	MF374544	MF374587	MF678693	MF678739	MF688345- MF688364	5
<i>H. juncifolia</i>	ARG	Río Negro: San Carlos de Bariloche	1948	H157	US 2117914	1	1	-	-	-	-	-	-
<i>H. juncifolia</i>	CHI	XI Región Aysén del General Carlos Ibáñez del Campo: Capitán Prat: Cochrane	2007	H172	CONC 172568	-	-	MF374546	MF374589	MF678695	MF678741	MF688365- MF688370	-
<i>H. juncifolia</i>	CHI	XI Región Aysén del General Carlos Ibáñez del Campo: Capitán Prat	2006	H174	CONC 166409	-	-	MF374547	MF374590	MF678696	MF678742	MF688371- MF688379	-

Appendix 1. Continued

Species	Country	Location	Date	Code	Herbarium	Macrom	Microm	Phylog			FCM		
								ETS	ITS	<i>trnL-F</i>		<i>trnT-L</i>	CLONES
<i>H. juncifolia</i>	CHI	XI Región Aysén del General Carlos Ibáñez del Campo: Capitán Prat	2006	H175	CONC 172569	-	-	-	-	-	MF688380-	-	
<i>H. juncifolia</i>	CHI	XI Región de La Araucanía: Curacautín: nearConguillío N.P.	2014	J1	SAANT 73531	4	4	MF374549	MF374592	MF678698	MF678744	MF688387-	5
<i>H. juncifolia</i>	CHI	X Región de Los Lagos: Puyehue N.P.	2014	J2	-	-	-	MF374550	MF374593	MF678700	MF678746	MF688421-	5
<i>H. juncifolia</i>	PER	Ancash Region: Yungay Prov.: Llanganuco Valley	1959	H158	US 2882401	1	1	-	-	-	-	MF688443	-
<i>H. occidentalis</i>	USA	CA: Humboldt Co: Redwood N.P.	1996	H67	K 44813	-	-	MF374553	MF374596	MF678703	MF678749	-	-
<i>H. occidentalis</i>	USA	CA: Marin Co.	1964	H184	M-0257424	1	-	-	-	-	-	-	-
<i>H. occidentalis</i>	USA	CA: Marin Co.	1960	H89	PH 625586	1	-	-	-	-	-	-	-
<i>H. occidentalis</i>	USA	OR: Curry Co.	1928	H90	PH 662901	1	-	MF374554	MF374597	MF678704	MF678750	-	-
<i>H. occidentalis</i>	USA	OR: Coos Co.	1929	H91	PH 684550	1	-	-	-	-	-	-	-
<i>H. occidentalis</i>	USA	CA: Del Norte Co.	1936	H92	PH 756844	1	-	-	-	-	-	-	-
<i>H. occidentalis</i>	USA	CA: Marin Co.	1935	H93	PH 994366	1	-	-	-	MF678705	MF678751	-	-
<i>H. occidentalis</i>	USA	CA: Humboldt Co: around Humboldt Bay	1918	H107	US 1061985	1	1	-	-	-	-	-	-
<i>H. occidentalis</i>	USA	CA: Monterey Co: Big Sur River	1937	H123	US 1649421	1	1	MF374555	MF374598	MF678706	MF678752	-	-
<i>H. occidentalis</i>	USA	CA: Marin Co: Lagunitas Creek	1949	H124	US 2079007	2	2	-	-	-	-	-	1
<i>H. occidentalis</i>	USA	CA: Santa Cruz Co: along Lockhart Gulch Road	1950	H125	US 2976155	1	1	-	-	-	-	-	-
<i>H. occidentalis</i>	USA	CA: MarinCo: Mt. Tamalpais	1925	H126	US 3182072	1	1	-	-	-	-	-	-
<i>H. pusilla</i>	CHI	XII Región de Magallanes y de la Antártida	2014	P1	SAANT 73539	22	4	MF374557	MF374600	MF678708	MF678754	MF688444-	5
<i>H. quebrada</i>	PER	Chilena: near Pali Aike N.P.	1997	H121	US 3423081	1	1	MF374558	MF374601	MF678709	MF678755	MF688453	1
<i>H. quebrada</i>	PER	Ancash Region: Recuay Prov.: Cordillera Blanca	1997	H121	US 3423081	1	1	MF374559	MF374602	MF678710	MF678756	MF688454-	1
<i>H. redolens</i>	ARG	Región de la Patagonia: Tierra del Fuego: Herberton: Moat	2008	H176	-	-	-	MF374560	MF374603	MF678711	MF678757	-	-
<i>H. redolens</i>	ARG	Región de la Patagonia: Tierra del Fuego: Lake Roca	2009	H177	-	-	-	MF374561	MF374604	MF678712	MF678758	-	-
<i>H. redolens</i>	CHI	XII Región de Magallanes y de la Antártida	2014	X85	-	-	-	MF374562	MF374605	MF678713	MF678759	-	-
<i>H. redolens</i>	CHI	XII Región de Magallanes y de la Antártida	2014	R1	SAANT 73533	6	4	MF374563	MF374606	MF678714	MF678760	MF688463-	5
<i>H. redolens</i>	CHI	Chilena: Porvenir: Cape Boquerón	2014	R2	SAANT 73534	4	4	MF374565	MF374607	MF678717	MF678762	MF688481	5
<i>H. redolens</i>	CHI	Chilena: Camerón: Cape Camerón: Inútil Bay	2014	R3	SAANT 73532	4	1	MF374566	MF374608	MF678718	MF678763	MF688492,	5
<i>H. redolens</i>	CHI	XII Región de Magallanes y de la Antártida	2014	R3	SAANT 73532	4	1	MF374567	MF374608	MF678719	MF678764	MF688494-	6
<i>H. redolens</i>	CHI	Chilena: Camerón: Cape Camerón	2014	R3	SAANT 73532	4	1	MF374568	MF374608	MF678720	MF678765	MF688505	6
<i>H. redolens</i>	CHI	Chilena: Camerón: Cape Camerón	2014	R3	SAANT 73532	4	1	MF374568	MF374608	MF678720	MF678765	MF688506-	6

## Appendix 1. Continued

Species	Country	Location	Date	Code	Herbarium	Macrom	Microm	Phylog			FCM		
								ETS	ITS	<i>trnL-F</i>	<i>trnT-L</i>	CLONES	
<i>H. redolens</i>	CHI	XII Región de Magallanes y de la Antártida Chilena: Torres del Paine N.P.: above Lake Grey	2014	R4	SANT 73535	2	2	MF374569	MF374609	MF678766	MF688526– MF688534	5	
<i>H. redolens</i>	IDN	New Guinea: Papua Prov.: Maoke Mountains: Sudirman Range: Lake Habbema	1938	H130	US 1761684	1	1	–	–	–	–	–	–
<i>H. redolens</i>	IDN	New Guinea: Papua Prov.: Maoke Mountains: Sudirman Range: 11 km NE of PuncakTrikorra	1938	H131	US 1761695	1	1	MF374570	MF678721	MF678767	MF688535– MF688543	–	–
<i>H. redolens</i>	PER	Ancash Region: Yungay Prov.: Huascarán N. P., between Lake Llanganuco and Portachuelo	1984	H128	US 3097904	1	1	–	–	–	–	–	–
<i>H. redolens</i>	PER	Cajamarca Region: Cajamarca Province: road from Cajamarca to Bambamarca	1988	H129	US 3480791	1	1	MF374571	MF374610	MF678722	MF678768	MF688544– MF688550	–
<i>H. redolens</i>	PNG	Central Prov.: Wharton Range: Mt. Albert Edward	1974	H119	US 2741741	1	1	–	–	–	–	–	–
<i>H. redolens</i>	PNG	East Sepik Prov.: Mt. Burgers	1977	H120	US 2978618	2	2	–	–	–	–	–	–
<i>H. spicata</i>	CHI	IX Región de La Araucanía: Cautín: Temuco	1923	H163	US 1189418	1	1	MF374572	MF374611	MF678723	MF688551– MF688560	1	–
<i>H. utriculata</i>	CHI	VIII Región del Biobío: Arauco: Lake Lanahue	2014	U1	SANT 73536	3	2	MF374573	MF374612	MF678724	MF678769	MF688561– MF688579	6
<i>H. utriculata</i>	CHI	VIII Región del Biobío: Concepción: Hualpén: Cala Lengua	2014	U2	SANT 73537	2	2	MF374574 MF374575	MF374613 MF374614	MF678725 MF678726	MF678770	MF688580– MF688596	5
<i>H. utriculata</i>	CHI	IX Región de La Araucanía: Lake Budi: Puancho	2014	U3	–	–	–	MF374576 MF374577	MF374615 MF374616	MF678727 MF678728	MF688597– MF688612	5	–
						<b>96</b>	<b>66</b>	<b>46</b>	<b>41</b>	<b>48</b>	<b>41</b>	<b>363</b>	<b>82</b>



## APPENDIX 2

Morphological characters used in this study. Micromorphological characters were selected and described according to [Devesa \(1992\)](#).

**Macromorphological characters. Quantitative:**

**1. Plant height** (mm) (PH). **2. Leaf length** (mm) (LL) measured in the second leaf from the base of the plant. **3. Leaf width** (mm) (LW) measured in the second leaf from the base of the plant. **4. Inflorescence length** (mm) (IL). **5. Spike lower branch length** (mm) (SLBL). The next three characters were measured in the second spikelet from the base of the inflorescence. **6. Spikelet length** (mm) (SL). **7. Flower length** (mm) (FL). **8. Lower glume length** (mm) (LGL). **Qualitative. Binary:** **9. Convolute leaves** (CL): planar (0), convolute (1). **10. Awn in male florets** (AW): absence (0), presence (1). **11. Lower floret** (LF): empty (0), male (1). **12. Intermediate floret** (MF): empty (0), male (1). *Multi-estate:* **12-I. Lower male floret awn inserted in the middle part** (LGAM): yes (1), no (0). **12-II. Lower male floret awn inserted in the upper part** (LGAS): yes (1), no (0). **13-I. Upper male floret awn inserted in the middle part** (UGAM): yes (1), no (0). **13-II. Upper male floret awn inserted in the upper part** (UGAS): yes (1), no (0). **14-I. Apical floret empty** (FE): yes (1), no (0). **14-II. Apical floret hermaphrodite** (FH): yes (1), no (0). **14-III. Apical floret female** (FF): yes (1), no (0). **14-IV. Apical floret with staminodes** (FFE): yes (1), no (0).

**Micromorphological characters. Quantitative:**

**1. Long cells length** ( $\mu\text{m}$ ) (LlCL). **2. Stomata size** ( $\mu\text{m}$ ) (StS). **3. Number of ribs** (NRi). **Qualitative. Binary:** **4. Companion cells type** (CoC): round S5 (0), ax S2 (1). **5. Cilia** (C): absence (0), presence (1). **6. Median vascular bundle sheath type** (MVBt):

single (0), complete (1). **7. Median nerve** (MN): similar to the other nerves (0), bigger (1). **8. Furrows depth** (FD):  $<3/4$  of the total width (0),  $>3/4$  of the total width (1). *Multi-estate:* **9-I. Long cell walls smooth** (I3N): no (0), yes (1). **9-II. Long cell walls moderately undulating** (I3P): no (0), yes (1). **9-III. Long cell deeply undulating** (I3R): yes (1), no (0). **10-I. Bulliform cells** (CB): absence (0), presence (1). **10-II. Bulliform cells very abundant** (CBM): no (0), yes (1). **11-I. Low density of hooks** (HoF): absence (0), presence (1). **11-II. Intermediate density of hooks** (HoN): absence (0), presence (1). **11-III. High density of hooks** (HoM): absence (0), presence (1). **12-I. Stomata in adaxial surface** (StAd): absence (0), presence (1). **12-II. Stomata in abaxial surface** (StAb): absence (0), presence (1). **12-III. Stomata in both surfaces** (StBo): absence (0), presence (1). **13-I. Subepidermal sclerenchyma discontinuous** (SScD): no (0), yes (1). **13-II. Subepidermal sclerenchyma continuous** (SScC): no (0), yes (1). **13-III. Subepidermal sclerenchyma continuous and abundant** (SScCA): no (0), yes (1). **14-I. Vascular bundles without sclerenchyma associated** (PBS): no (0), yes (1). **14-II. Vascular bundles with sclerenchyma associated in the abaxial surface** (PBAb): no (0), yes (1). **14-III. Vascular bundles with sclerenchyma associated only in the margin of the leaves** (PBEx): no (0), yes (1). **15-I. Ribs shape** (RS): presence of ribs (0), absence of ribs (1). **15-II. Ribs round-flattened** (RSD): no (0), yes (1). **15-III. Ribs round** (RSR): no (0), yes (1). **15-IV. Ribs quadrangular** (RSQ): no (0), yes (1). **15-V. Ribs polygonal** (RSP): no (0), yes (1). **16-I. Leaf section planar** (LSP): no (0), yes (1). **16-II. Leaf section open** (LSO): no (0), yes (1). **16-III. Leaf section closed** (LSC): no (0), yes (1).