

## REVIEW ARTICLE

# Emerging facets of prokaryotic glycosylation

Christina Schäffer\* and Paul Messner

Department of NanoBiotechnology, Institute of Biologically Inspired Materials, NanoGlycobiology unit, Universität für Bodenkultur Wien, A-1180 Vienna, Austria

\*Corresponding author: Department of NanoBiotechnology, NanoGlycobiology unit, Universität für Bodenkultur Wien, Muthgasse 11, A-1180 Vienna, Austria. Tel: +0043-1-47654-80203; Fax: +0043-1-4789112; E-mail: [christina.schaeffer@boku.ac.at](mailto:christina.schaeffer@boku.ac.at)

**One sentence summary:** The authors summarise current knowledge of prokaryotic glycobiochemistry, focusing on structures and molecular details of biosynthesis concepts of glycoproteins and secondary cell-wall polymers, including their roles in prokaryotic life and their impact on pathogenicity as well as emerging glycoengineering strategies.

**Editor:** Mecky Pohlschroder

## ABSTRACT

Glycosylation of proteins is one of the most prevalent post-translational modifications occurring in nature, with a wide repertoire of biological implications. Pathways for the main types of this modification, the *N*- and *O*-glycosylation, can be found in all three domains of life—the *Eukarya*, *Bacteria* and *Archaea*—thereby following common principles, which are valid also for lipopolysaccharides, lipooligosaccharides and glycopolymers. Thus, studies on any glycoconjugate can unravel novel facets of the still incompletely understood fundamentals of protein *N*- and *O*-glycosylation. While it is estimated that more than two-thirds of all eukaryotic proteins would be glycosylated, no such estimate is available for prokaryotic glycoproteins, whose understanding is lagging behind, mainly due to the enormous variability of their glycan structures and variations in the underlying glycosylation processes. Combining glycan structural information with bioinformatic, genetic, biochemical and enzymatic data has opened up an avenue for in-depth analyses of glycosylation processes as a basis for glycoengineering endeavours. Here, the common themes of glycosylation are conceptualised for the major classes of prokaryotic (i.e. bacterial and archaeal) glycoconjugates, with a special focus on glycosylated cell-surface proteins. We describe the current knowledge of biosynthesis and importance of these glycoconjugates in selected pathogenic and beneficial microbes.

**Keywords:** glycan biosynthesis; glycoengineering; glycoproteins; prokaryotes; secondary cell-wall polymers; surface (S-) layer

## ABBREVIATIONS

CRISPR: Clustered regularly interspaced short palindromic repeats

HPLC: high performance liquid chromatography

LC-ESI: liquid chromatography- electrospray ionisation

MALDI-TOF: Matrix-assisted laser desorption/

ionization-time-of-flight

NDP: nucleoside diphosphate

NGT: *N*-glycosyl transferase

NMR: nuclear magnetic resonance spectroscopy

OGT: *O*-glycosyl transferase

OST: oligosaccharyl transferase

O-OST: *O*-oligosaccharyl transferase

SDS-PAGE: sodium dodecylsulfate- polyacrylamide gel electrophoresis]

TEM: transmission electron microscopy

## ORGANISMS

*Acidovorax avenae*, *Av. avenae*

*Acinetobacter baumannii*, *Ac. baumannii*

*Actinobacillus pleuropneumoniae*, *A. pleuropneumoniae*

*Aeromonas caviae*, *Ae. caviae*  
*Aeromonas hydrophila*, *Ae. hydrophila*  
*Aggregatibacter actinomycetemcomitans*, *Ag. actinomycetemcomitans*  
*Archaeoglobus fulgidus*, *Ar. fulgidus*  
*Bacillus anthracis*, *Ba. anthracis*  
*Bacillus cereus*, *Ba. cereus*  
*Bacillus subtilis*, *Ba. subtilis*  
*Bacillus thuringiensis*, *Ba. thuringiensis*  
*Bacteroides fragilis*, *Bac. fragilis*  
*Burkholderia cenocepacia*, *B. cenocepacia*  
*Burkholderia cepacia*, *B. cepacia*  
*Burkholderia thailandensis*, *B. thailandensis*  
*Campylobacter coli*, *C. coli*  
*Campylobacter jejuni*, *C. jejuni*  
*Campylobacter lari*, *C. lari*  
*Clostridium botulinum*, *Cl. botulinum*  
*Clostridium difficile*, *Cl. difficile*  
*Corynebacterium glutamicum*, *Co. glutamicum*  
*Francisella tularensis*, *F. tularensis*,  
*Geobacillus stearothermophilus*, *G. stearothermophilus*  
*Haemophilus influenzae*, *Ha. influenzae*  
*Haloarcula hispanica*, *Har. hispanica*  
*Haloarcula japonica*, *Har. japonica*  
*Haloarcula marismortui*, *Har. marismortui*  
*Halobacterium salinarum*, *Hbt. salinarum*  
*Haloferax volcanii*, *Hfx. volcanii*  
*Helicobacter pullorum*, *H. pullorum*  
*Helicobacter pylori*, *H. pylori*  
*Helicobacter canadensis*, *H. canadensis*  
*Helicobacter winghamensis*, *H. winghamensis*  
*Kuenenia stuttgartiensis*, *K. stuttgartiensis*  
*Lactobacillus buchneri*, *La. buchneri*  
*Lactobacillus acidophilus*, *La. acidophilus*  
*Lactobacillus crispatus*, *La. crispatus*  
*Lactobacillus plantarum*, *La. plantarum*  
*Lactobacillus rhamnosus*, *La. rhamnosus*  
*Listeria monocytogenes*, *L. monocytogenes*  
*Methanobrevibacter smithii*, *Meth. smithii*  
*Methanobrevibacter oralis*, *Meth. oralis*  
*Methanococcus maripaludis*, *Me. maripaludis*  
*Methanococcus voltae*, *Me. voltae*  
*Methanosarcina mazei*, *Met. mazei*  
*Methanothermobacter thermoautotrophicus*, *Meth. thermoautotrophicus*  
*Mycobacterium marinum*, *M. marinum*  
*Mycobacterium smegmatis*, *M. smegmatis*  
*Mycobacterium tuberculosis*, *M. tuberculosis*  
*Neisseria gonorrhoeae*, *N. gonorrhoeae*  
*Neisseria meningitidis*, *N. meningitidis*  
*Paenibacillus alvei*, *Pa. alvei*  
*Porphyromonas gingivalis*, *Po. gingivalis*  
*Pseudomonas aeruginosa*, *P. aeruginosa*  
*Pseudomonas syringae*, *P. syringae*  
*Pyrococcus furiosus*, *Py. furiosus*  
*Staphylococcus aureus*, *St. aureus*  
*Streptococcus pneumoniae*, *S. pneumoniae*  
*Sulfolobus acidocaldarius*, *Su. acidocaldarius*  
*Sulfolobus shibatae*, *Su. shibatae*  
*Sulfolobus solfataricus*, *Su. solfataricus*  
*Tannerella forsythia*, *Ta. forsythia*  
*Thermoanaerobacter thermohydrosulfuricus*, *T. thermohydrosulfuricus*

*Thermoanaerobacterium thermosaccharolyticum*, *Th. thermosaccharolyticum*  
*Thermoplasma acidophilum*, *T. acidophilum*

## INTRODUCTION

Glycobiology is one of the rapidly growing fields in the natural sciences with implications to many areas of basic research, biomedicine and biotechnology (for review, see Varki et al. 2015). In fact, glycosylation of proteins is not only the most common but probably also the most important post-translational modification process occurring in nature. It is known to affect the expression, localisation and life time of numerous proteins, which, in turn, might be of relevance for protein function as well as downstream biological events such as the immune behaviour of a cell (Corfield and Berry 2015; Lyons, Milner and Rosenzweig 2015; Valguarnera, Kinsella and Feldman 2016). It is estimated that at least 40% of the human proteome undergoes glycosylation, with glycans comprising as much as up to 90% of the overall molecular mass of certain glycoproteins. It is important to note that glycans are secondary gene products, meaning that instead of being synthesised in a template-driven manner as it is well known from protein biosynthesis, they are built up along an assembly line in which numerous proteins are involved in a sequential order, with the glycosyltransferases being the best-characterised examples. The protein glycosylation mechanism is further characterised by the phenomenon of microheterogeneity, in which variant glycan structures are found at specific attachment sites of a given glycoprotein (Johannessen, Koomey and Børud 2012). Overall, protein glycosylation is an energetically costly cellular process and approximately 2% of the human genome encodes proteins involved in glycosylation events.

While research on glycoproteins of higher organisms has flourished since Neuberger's glycopeptide preparations of ovalbumin in the late 1930s (Neuberger 1938), the question of whether carbohydrates are integral components of prokaryotic proteins had not convincingly approached until studies on the surface (S-) layer glycoproteins of the halophile *Halobacterium salinarum* (Mescher and Strominger 1976) and Gram-positive clostridia (Sleytr and Thorne 1976). However, due the markedly structural differences between the glycans and linkage regions of prokaryotic glycoproteins in comparison to eukaryotic and viral glycoproteins (Gabijs 2015; Varki et al. 2015), it needed a few decades after the first description of a prokaryotic glycoprotein until their existence was fully accepted by the scientific community. Despite much effort has been put on the studies of prokaryotic glycoproteins since then, our understanding of prokaryotic glycoprotein glycan structures is still limited. Thus, any detailed analysis of a bacterial or archeal glycoconjugate can significantly contribute to the advancement of the field (Ristl et al. 2011).

Particularly, the cell surface of prokaryotes (Fig. 1) is rich in glycans where these play fundamental roles in cell physiology (Doyle 2000). As yet relatively unexplored, these modifications have the potential to impact important processes such as microbe–host interactions and immune escape mechanisms. Mostly driven by the discovery of protein glycans in diverse pathogenic microbes (Morrison and Imperiali 2014), there is now an increasing body of evidence of protein glycosylation, both from the domains of *Bacteria* and *Archaea* (here is a selection of most relevant reviews from the past five years: (Børud et al. 2011;

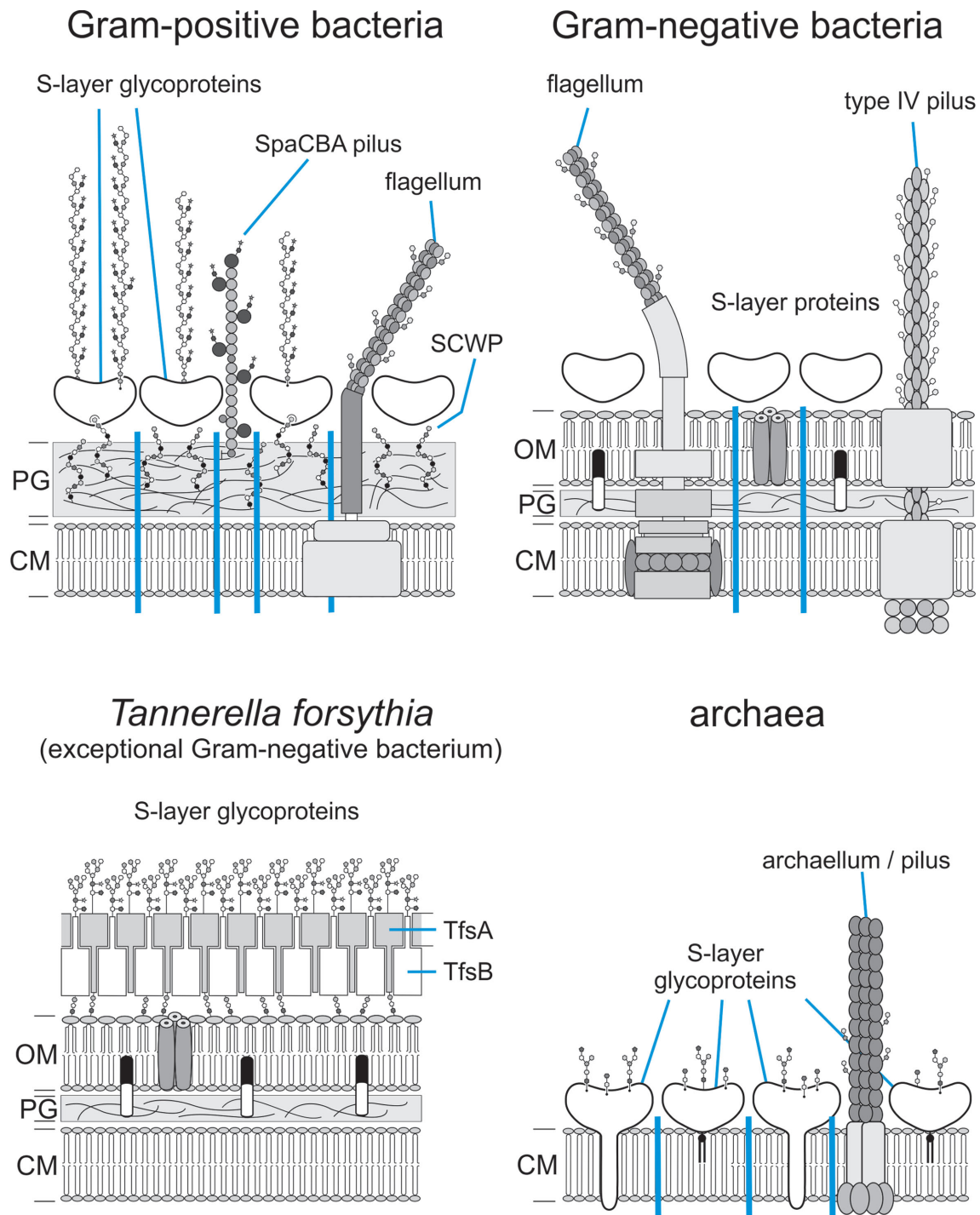

**Figure 1.** Scheme of cell envelopes of prokaryotic organisms, showing representative glycoconjugates (different scenarios of cell envelope architecture are separated by blue perpendicular lines), including S-layer glycoproteins (Messner, Schäffer and Kosma 2013), SCWPs (Messner, Schäffer and Kosma 2013), bacterial flagella (Cullen and Trent 2010; Mukherjee and Kearns 2014) and bacterial pili (Korotkov, Sandkvist and Hol 2012; Reunanen et al. 2012) and archaeella and archaeal pili (Pohlschroder et al. 2011; Korotkov, Sandkvist and Hol 2012). CM, cytoplasmic membrane; PG, peptidoglycan; —, peptidoglycan strand; OM, outer

membrane; , outer membrane lipid A; , bacterial and archaeal membrane phospholipid; , archaeal membrane tetraetherlipid; , different S-layer glycans; SCWP, secondary cell wall polymer. In different archaeal species, S-layer (glyco)protein anchoring to the cell envelope has been suggested either by a protein transmembrane anchor (Lechner and Wieland 1989) or in an archaeosortase-dependent process by a lipid anchor (Abdul Halim et al. 2016). (Extended and modified from Messner, Schäffer and Kosma 2013. With permission from Elsevier).

Table 1. Selected prokaryotic glycosylation systems discussed in this review<sup>a,b</sup>.

Organism	Glycosyltransferase	Linkage	Substrates	Residues modified	Glycan	Reference
<i>Campylobacter jejuni</i>	PglB (GT66)	N	~60 substrates	Asn	Heptasaccharide	Nothhaft and Szymanski (2010)
<i>Helicobacter pullorum</i>	PglB1	N	Peptides obtained from a reaction mixture of <i>C. jejuni</i> membranes	Asn	Pentasaccharide	Jervis et al. (2010)
<i>Haemophilus influenzae</i>	HMW1C and HMW2C (GT41)	N	HMW1/2 adhesins	Asn	Hex and di-Hex (Hex: Glc or Gal)	Kawai et al. (2011)
<i>Actinobacillus pleuropneumoniae</i>	ApNGT	N / O	Autotransporter adhesins (preferred)	Asn, Gln, Ser	Glc and Gal	Naegeli et al. (2014)
<i>Campylobacter jejuni</i> 11168	NC	O	Flagellin FlaA	Ser, Thr	Pse and derivatives	Zampronio et al. (2011)
<i>Campylobacter coli</i> VC167	NC	O	Flagellin	Ser, Thr	Leg and derivatives	Morrison and Imperiali (2014)
<i>Burkholderia cepacia</i> K56-2	bcaI0960, Pgl <sub>Lbc</sub>	O	Relaxed specificity for sugar donor and protein acceptor	Serine	Trisaccharide: HexNAC-HexNAC-Hex	Lithgow et al. (2014)
<i>Aeromonas hydrophila</i> AH-3	OTase-like protein	O	Polar flagella	Ser, Thr	Pse-containing heptasaccharide	Merino et al. (2014)
<i>Clostridium difficile</i> 630	CD0240	O	Flagellin FliC	Ser, Thr	Modified HexNAC residues	Twine et al. (2009)
<i>Paenibacillus alvei</i> CCM 2051 <sup>T</sup>	PAV2c.01630 and PAV2c.01640	O	Flagellin Hag	Ser, Thr	Trisaccharide: Hex-HexNAC-HexNAC	Janesch et al. (2016)
<i>Neisseria meningitidis</i>	PglL	O	Type IV pilin	Ser	Disaccharide: Bac and Gal	Faridmoayer et al. (2007)
<i>Neisseria gonorrhoeae</i>	PglO	O	Pilin PilE	Ser	Trisaccharide: Bac and Gal <sub>2</sub>	Hartley et al. (2011)
<i>Pseudomonas aeruginosa</i> Pa5196	Tfpw (GT-C)	O	Type IVa pilin	Thr, Ser	$\alpha$ 1,5-D-Araf residues	Harvey et al. (2011)
<i>Mycobacterium tuberculosis</i>	Ru1002c	O	Several cell-surface glycoproteins, including protein Apa	Thr	$\alpha$ 1,2-D-mannobioses	Liu et al. (2013)
<i>Staphylococcus aureus</i>	GtfA and GtfB	O	Human platelets incl. serine-rich adhesin for platelets (SraP)	Ser	GlcNAC-containing oligosaccharides	Li et al. (2014)
<i>Bacillus anthracis</i>	BA3668?	O	BclA spore glycoprotein	Ser, Thr	Serum-specific short O-glycans and large oligosaccharides	Maes et al. (2016)
<i>Bacillus subtilis</i> 168	SunS	S	SunA precursor peptide of sublaNCin	Cys	Glc	Wang and van der Donk (2011)
<i>Haloflex volcanii</i>	AgIB	N	Major archaeellin FlgA1	Asn	Pentasaccharide with proximal Glc	Tripepi et al. (2012)
<i>Methanococcus maripaludis</i> S2	AgIB	N	Major archaeellins FlaB1 and FlaB2, and minor archaeellin FlaB3	Asn	Complex tetra- saccharide with proximal GalNAc	Siu et al. (2015)
<i>Methanococcus maripaludis</i> S2	AgIB	N	Major pilin EpdE	Asn	Archaeallin tetra- saccharide + Hex, branching off from GalNAc	Siu et al. (2015)
<i>Haloflex volcanii</i>	AgIB	N	Major adhesion pilins PflA1 and PflA2	Asn	Like archaeallin penta- saccharide	Esquivel et al. (2016)
<i>Thermoplasma acidophilum</i>	AgIB	N	6-C-sulfatocose containing cell-surface glycoproteins	Asn	Okta- and heptasac- charide with proximal $\beta$ -Gal	Vinogradov et al. (2012)

<sup>a</sup> AgIB, archaeal N-oligosaccharyltransferase; Asn, asparagine; ApNGT, A. pleuropneumoniae N-glycosyltransferase; Bac, bacillosamine; BclA, Bacillus collagen-like protein of anthracis; Cys, cysteine; Gal, galactose; Glc, glucose; GalNAc, N-acetylgalactosamine; GlcNAc, N-acetylglucosamine; Gln, glutamine; GT, glycosyltransferase family; Gtf, glycosyltransferase; Hex, hexose; HexNAC, N-acetylhexosamine; HMW, high molecular weight protein; Leg, legionaminic acid; NC, not classified; OTase, oligosaccharyltransferase; Pgl, protein glycosylation; PglB, bacterial N-oligosaccharyltransferase; Pse, pseudaminic acid; SunS, S-glycosyl-transferase; Ser, serine; SraP, serine-rich adhesin for platelets; Thr, threonine.

<sup>b</sup> Glycan structure and composition of bacterial and archaeal S-layer glycoproteins and SCWPs are provided in Figs 2-1 to 2-4, and these systems are described in greater detail in specific chapters of the review.



Giltner, Nguyen and Burrows 2012; Wang et al. 2012; Eichler 2013; Iwashkiw et al. 2013; Messner, Schäffer and Kosma 2013; Meyer and Albers 2013; Nothaft and Szymanski 2013; Jarrell et al. 2014; Tytgat and Lebeer 2014; Kandiba and Eichler 2015; Naegeli and Aebi 2015; Lu, Li and Shao 2015). As more prokaryotic protein glycosylation systems are being identified and characterised, the central question arises as to what governs the biosynthesis and prevalence of particular protein glycans (Table 1). In a recent review Tan, Tang and Exley (2015) discussed different glycoprotein biosynthesis pathways and hypotheses relating to the roles of this post-translational modification in specific host-microbe interactions.

Nowadays it is accepted knowledge that protein N- and O-glycosylation systems are present in both eukaryotes and prokaryotes (for review, see Spiro 2002; Logan 2006; Messner et al. 2010; Jarrell et al. 2014; Varki et al. 2015). While numerous documentations about eukaryotic glycosylation processes predict more than two-thirds of all eukaryotic proteins to be glycosylated (Apweiler, Hermjakob and Sharon 1999), no such estimate is currently available for prokaryotic glycoproteins, whose understanding is lagging behind, mainly due to the enormous variability of glycan structures and underlying glycosylation processes, in several cases accompanied by a lack of tools for genetic manipulation.

The detailed understanding of the impact of glycosylation on structure and function of a protein is often also hampered by the inavailability of well-defined homogeneous glycoproteins/glycopeptides for analysis, because these are mostly difficult to obtain from natural sources in sufficient quantity. To overcome this hurdle, the development of various chemical, enzymatic, chemoenzymatic and bioengineering methods for the synthesis of homogeneous samples is currently a major research goal within the glycobiology research community.

## N-LINKED BACTERIAL GLYCOPROTEINS

In the following, a description of the currently best investigated N-linked bacterial glycosylation systems is given according to organisms, accompanied with glycoengineering approaches based on distinct modules of these systems.

### Protein N-glycosylation in *Campylobacter* strains

As of yet the best-investigated prokaryotic glycoproteins containing N-linked glycans originate from *Campylobacter jejuni*, *C. lari* and other closely related Gram-negative members of the  $\delta$ - $\epsilon$ -subdivision of the *Proteobacteria* family (Szymanski and Wren 2005; Nothaft and Szymanski 2010; Jervis et al. 2012). At the turn of the century, the first general protein glycosylation system was identified in *C. jejuni* (Szymanski et al. 1999). This bacterium is the etiological agent of human bacterial gastroenteritis worldwide; the consumption of contaminated chicken products is thought to be the principal mode of *C. jejuni* transmission to the human population. *Campylobacter jejuni* devotes a large proportion of its small genome (1640 kb) to carbohydrate biosynthesis (Parkhill et al. 2000), yielding an amazing repertoire of glycoconjugates. This includes lipooligosaccharides (LOSs) mimicking human glycolipids, capsular polysaccharides with complex and unusual sugars and about 60 proteins that are post-translationally modified with either N- or O-linked glycans, with the crucial roles of these glycans in the biology and patho-

genesis of *C. jejuni* remaining to be fully deciphered (Alemka et al. 2013; Lu, Li and Shao 2015). It is hypothesised that N-linked glycosylation of surface proteins may enhance *C. jejuni* fitness by protecting bacterial proteins from cleavage by gut proteases (Alemka et al. 2013). The glycome of this important food-borne pathogen turned out to be an excellent toolbox to unravel the fundamentals of prokaryotic glycosylation pathways and their roles in host-microbe interactions and to exploit these pathways for novel diagnostics and therapeutics (Guerry and Szymanski 2008).

Generally, in N-linked protein glycosylation of eukaryotes and prokaryotes, an oligosaccharide is transferred by a membrane-bound oligosaccharyltransferase (N-OST) in a canonical, highly conserved pathway from a lipid donor to asparagines within the sequon N-X(S/T) of polypeptides (Burda and Aebi 1999; Weerapana and Imperiali 2006). N-Glycosylation in *C. jejuni* implies the transfer of the heptasaccharide  $\alpha$ -GalNAc-(1 $\rightarrow$ 4)- $\alpha$ -GalNAc-(1 $\rightarrow$ 4)-[ $\beta$ -Glc-(1 $\rightarrow$ 3)-] $\alpha$ -GalNAc-(1 $\rightarrow$ 4)- $\alpha$ -GalNAc-(1 $\rightarrow$ 4)- $\alpha$ -GalNAc-(1 $\rightarrow$ 3)- $\alpha$ -Bac to proteins, where N,N'-diacetylbacillosamine (Bac, diNacBac) is 2,4-diacetamido-2,4,6-trideoxy-D-Glc (Young et al. 2002). This glycoside is also found at the reducing end of O-linked oligosaccharides in *C. jejuni* as well as in *Neisseria gonorrhoeae*, another Gram-negative pathogen (Morrison and Imperiali 2014). Biosynthesis of diNacBac starts from UDP-GlcNAc involving three conserved enzymes in a sequential order—a dehydratase, an aminotransferase and an acetyltransferase—all of which have been extensively studied in *C. jejuni* (Olivier et al. 2006; Schoenhofen et al. 2006; Vijayakumar et al. 2006). The biosynthesis of the full *C. jejuni* heptasaccharide following the general N-linked protein glycosylation pathway is encoded in the *pgl* glycosylation gene cluster; pathway genes are remarkably conserved among the *Proteobacteria* and do not seem to have the potential for phase variation in *C. jejuni* (Szymanski and Wren 2005). Using chemically synthesised substrates, B. Imperiali's group demonstrated the complete enzymatic set-up involved in the *C. jejuni* N-linked glycosylation process (Weerapana and Imperiali 2006). That study also discovered conceptual differences between prokaryotic and eukaryotic N-glycosylation systems (Larkin and Imperiali 2011). While prokaryotes (i.e. bacteria and archaea) display a certain degree of variability in N-linked glycan structures due to the utilisation of unique monosaccharide building blocks during the assembly process (Larkin and Imperiali 2011; Schwarz and Aebi 2011; Nothaft et al. 2012), nearly all eukaryotes produce the same nascent tetradecasaccharide (Glc<sub>3</sub>Man<sub>9</sub>GlcNAc<sub>2</sub>); heterogeneity is introduced into this glycan structure after it is transferred to the protein through a complex series of glycosyl trimming and addition steps (Burda and Aebi 1999).

Following up fundamental studies of the *C. jejuni* N-linked glycosylation system, a milestone for prokaryotic glycoengineering had been accomplished with the successful transfer of this N-glycosylation system into *Escherichia coli* (Wacker et al. 2002). After this ground-breaking observation, an extensive exploitation of the biotechnological application potential of this N-linked glycosylation pathway ensued (e.g. Dürr et al. 2010; Schwarz et al. 2010; Nothaft et al. 2012; Valderrama-Rincon et al. 2012; Naegeli and Aebi 2015; Ollis, Chai and DeLisa 2015), with the N-OST PglB being a key module thereof. In these various glycoengineering approaches, PglB proved to possess remarkably relaxed substrate specificity.

In 2011, Locher and colleagues published the first X-ray crystal structure of a functional bacterial OST, which was the N-OST from *C. lari*, in complex with an acceptor peptide (Lizak

et al. 2011); partial structures of yeast N-OST subunits have been published earlier (Yan, Wu and Lennarz 2005). The protein N-glycosylation reaction in bacteria and archaea is catalysed by a single protein, namely the N-OST, which is in contrast to most eukaryotes, where a membrane protein complex of nine subunits located in the endoplasmic reticulum performs this task (Yan and Lennarz 2002). This central, catalytic enzyme PglB of *Proteobacteria* resembles the Stt3 subunit of the eukaryotic N-glycosylation machinery, which has homologues in bacteria and archaea (Lizak et al. 2011; Matsumoto et al. 2013). The X-ray structure defined the fold of Stt3 proteins and provided insight into glycosylation sequon recognition and amide nitrogen activation, both of which are prerequisites for the formation of the N-glycosidic linkage. To better understand the mechanism of PglB, quantification of sequon binding and glycosylation turnover *in vitro* using purified enzyme and fluorescently labelled, synthetic peptide substrates was performed (Gerber et al. 2013). This work revealed the impact of active site residues and divalent metal ions for sequon binding, the specificity of the Ser/Thr binding pocket and bacteria-specific requirements of sequon recognition. The quantitative assessment of peptide binding and catalysis provided insight into the natural selection of the N-X-S/T sequon in eukaryotes and the extended sequon D/E-Y-N-X-S/T (Y, X ≠ P) in *Campylobacter* strains (Kowarik et al. 2006) where the eukaryotic primary consensus sequence for N-glycosylation is N-terminally extended for recognition by the bacterial N-OST PglB. Thus, bacterial N-glycosylation site selection is more specific than the eukaryotic counterpart with respect to the polypeptide acceptor sequence. In this context, it is of importance that recently the structure of an ATP-binding cassette (ABC) transporter lipid flippase has been determined at high resolution (Perez et al. 2015). A prominent example of the flipping reaction is the translocation of lipid-linked oligosaccharides (LLOs), which serve as donors in N-linked protein glycosylation. In *C. jejuni*, this process is catalysed by the ABC transporter PglK. Based on crystal structures in distinct process states in combination with a newly devised *in vitro* flipping assay and *in vivo* studies, a mechanism of the PglK-catalysed LLO flipping has been inferred (Perez et al. 2015). The proposed mechanism is distinct from the classical alternating-access model applied to other transporters. Two key differences are the proposed recognition of the polyprenyl tail of the LLOs on the PglK surface by means of the external helix EH in the PglK-LLO interaction, and the requirement of a long, sufficiently wide translocation pathway that contains the pyrophosphate and oligosaccharide moieties during flipping. In contrast, the proposed mechanism for MsbA, the bacterial flippase of the lipid A-core, implicates that the entire lipid A-core may enter the nucleotide-free state of MsbA during the flipping reaction (Ward et al. 2007; Eckford and Sharom 2010). With the recent observations, a more detailed molecular basis for understanding the mechanism of N-linked protein glycosylation in *C. jejuni* is now provided.

In further glycosylation engineering efforts based on this insight, a convergent chemoenzymatic method was developed that permits site-specific enzymatic ligation between an activated glycan oxazoline and a GlcNAc-peptide/protein to yield homogeneous glycopeptide/proteins (Schwarz et al. 2010; Schwarz and Aebi 2011; Wang 2011). The method involves glycosylation pathway engineering and functional transfer of the *C. jejuni* glycosylation machinery (Wacker et al. 2002) into *E. coli* to express a glycoprotein, in which the Asn-linked monosaccharide bacillosamine was changed to the eukaryotic

GlcNAc moiety. Fortunately, PglB<sub>*C. jejuni*</sub> accepted the resulting GlcNAc(GalNAc)<sub>5</sub>-containing glycolipid as substrate to glycosylate the target protein. Then the Asn-linked N-glycan was trimmed by  $\alpha$ -N-acetylgalactosaminidase to give a GlcNAc-tagged glycoprotein. Finally, eukaryotic N-glycans of high-mannose or complex type were introduced by an enzymatic transglycosylation reaction to produce homogeneous eukaryotic glycoproteins (Schwarz et al. 2010). Different high-mannose and complex type N-glycans could be readily transferred to the GlcNAc moiety by ENGases to provide full-size glycopeptides. The usefulness of the chemoenzymatic method was exemplified by the efficient synthesis of a complex glycoform of polypeptide C34, a potent HIV inhibitor derived from HIV-1 gp41. Thus, this approach provides an efficient way for introducing complex N-glycans into polypeptides for the gain of novel protein properties that might be valuable for drug discovery (Lomino et al. 2013).

Recently, a mixed approach combining *in vivo* and *in vitro* steps for the synthesis of glycoproteins containing the Lewis  $\times$  antigen was devised by using glycosyltransferases from different bacteria (Hug et al. 2011). Proteins carrying Lewis antigens have been shown to have an application potential in the treatment of diverse autoimmune diseases. The initiating glycosyltransferase WecA from *E. coli* (Raetz and Whitfield 2002; Ruiz, Kahne and Silhavy 2009) was employed for the addition of the first GlcNAc residue onto the lipid carrier undekaprenyl pyrophosphate (undPP). Glycosyltransferases from the *Haemophilus influenzae* LOS biosynthesis cluster (*lsgc-f*) were introduced into *E. coli* for completion of the precursor glycolipid  $\beta$ -Gal-(1 $\rightarrow$ 4)- $\beta$ -GlcNAc-(1 $\rightarrow$ 3)- $\beta$ -Gal-(1 $\rightarrow$ 3)-GlcNAc-undPP. The glycan was then conjugated in the same *E. coli* cells by the *C. jejuni* N-OST PglB onto the protein acceptor AcrA. Eventually, the addition of the fucose residue in an  $\alpha$ -(1 $\rightarrow$ 3) linkage onto the exterior GlcNAc residue by the *Helicobacter pylori* fucosyltransferase FucT *in vitro* completed the synthesis. As a result, a Lewis  $\times$  containing glycoprotein was synthesised using bacterial enzymes from four different species using *in vivo* and *in vitro* steps (Hug et al. 2011).

'Hijacking' prokaryotic glycosylation systems to exploit them for glyco-biotechnological applications including glycoconjugate vaccine and humanised glycoprotein production is a promising perspective for future developments (Cuccui and Wren 2015). The challenges that remain for these approaches to reach full biotechnological maturity will include new strategies for creation of new glycomaterials including glyconanomaterials, evaluation of their targeting potential and their drug delivery properties, as well as characterisation of the internalisation process of these neo-glycoconjugates (Ramström and Yan 2015). Vaccines against both Gram-negative and Gram-positive organisms have already been developed, and efficacy testing has thus far demonstrated that the vaccines are safe and that robust immune responses are being detected. These are likely to complement and reduce the cost of current technologies, thus opening new avenues for glycan-based application strategies. In conclusion, the molecular understanding of bacterial N-glycosylation systems has opened up new avenues for engineering of bacteria to produce glycoproteins that are tailored for specific purposes, displaying either defined eukaryotic-like (such as therapeutic glycoproteins) or completely novel glycan structures (neo-glycoconjugates). Such approaches might also be exploited for screening purposes for improvement and adaptation of the glycosylation machinery to specific applications (Nothhaft and Szymanski 2013; Çelik et al. 2015; Cuccui and Wren 2015; Naegeli and Aebi 2015; Vorwerk et al. 2015).

## Protein N-glycosylation in *Helicobacter*, *Haemophilus*, *Pseudomonas* and *Actinobacillus* strains

N-Glycosylation of proteins has also been documented in strains of *Helicobacter* (Jervis et al. 2010), *Haemophilus* (St Geme and Yeo 2009) and *Pseudomonas* (Khemiri et al. 2013), however, without detailed structural characterisation of the synthesised glycans (for review, see Tan, Tang and Exley 2015). In the  $\delta$ -proteobacterium *Actinobacillus pleuropneumoniae*, an unusual glycosylation pathway was identified (Naegeli et al. 2014).

Emerging genome sequencing data revealed that *pglB* orthologues are present in a subset of species from the  $\delta$ - and  $\epsilon$ -Proteobacteria, including three *Helicobacter* species—*H. pullorum*, *H. canadensis* and *H. winghamensis*. In contrast to *C. jejuni*, these species contain two unrelated *pglB* genes (*pglB1* and *pglB2*), neither of which is located within a larger genomic protein glycosylation locus. In complementation experiments, the *H. pullorum* PglB1 protein, but not PglB2, could transfer the *C. jejuni* N-linked glycan onto an acceptor protein in *E. coli* (Jervis et al. 2010). Analysis of N-glycosylation in an *in vitro* OST assay revealed that a linear pentasaccharide is synthesised in *H. pullorum* that is processed via PglB1-dependent N-glycosylation. This reaction requires an acidic residue at the -2 position of the N-glycosylation sequon, as for *C. jejuni* (Kowarik et al. 2006). Attempted insertional knockout mutagenesis of the *H. pullorum pglB2* gene was unsuccessful, suggesting that this gene is essential for the organism (Jervis et al. 2010). Up to now, however, no specific function has been assigned to PglB2.

*Haemophilus influenzae* is a pathogen of the respiratory tract that causes a severe burden of disease in children in both developed and developing countries. Six different capsular serotypes have been identified next to unencapsulated (non-typeable) *Ha. influenzae*. Infection by non-typeable *Ha. influenzae* (NTHi) is the most common cause of exacerbations in chronic obstructive pulmonary disease, a major and growing global health problem in ageing populations (Murphy 2006). Up to 80% of NTHi clinical isolates contain genes encoding the related high-molecular-weight adhesins HMW1 and HMW2 (St Geme and Yeo 2009; Lu, Li and Shao 2015). The *Ha. influenzae* HMW1 adhesin is glycosylated by HMW1C, a novel glycosyltransferase in the GT41 family. The HMW1C-like proteins share features of glycogen synthases and OSTs, in part accounting for their dual function as glycosyltransferases that catalyse N-linkages of glucose and galactose residues to HMW1 as well as formation of O-glycosidic bonds between glucose residues on HMW1. It was further shown that HMW1 is glycosylated at multiple asparagines within the well-recognised N-X-S/T (X  $\neq$  P) consensus sequence for N-linked glycans and, in one case, at an N-V-E site (Gross et al. 2008; Kawai et al. 2011). Since the modifying carbohydrates at these sites are glucose or galactose residues (for review, see Tan, Tang and Exley 2015) rather than N-acetylated sugars, this revealed an unusual carbohydrate modification suggesting the involvement of a glycosyltransferase with a novel enzymatic activity capable of transferring hexose moieties to asparagine residues (Gawthorne et al. 2014). As mentioned above, in one case of HMWB glycosylation, the glycosylation sequon was found to be N-V-E, yielding a new type of sequon structure. Thus, it will be interesting to see if the common N-glycosylation machinery can modify this site too (Gross et al. 2008).

In *A. pleuropneumoniae*, protein N-glycosylation was identified to take place in the cytoplasm and to be mediated by a soluble NGT that utilises nucleotide-activated monosaccharides to glycosylate asparagine residues. To characterise this process in detail, the N-glycosylation system of *A. pleuropneumoniae* was func-

tionally transferred into *E. coli* using an approach comparable to that described for the transfer of the *C. jejuni* N-glycosylation machinery into *E. coli* (Wacker et al. 2002). The *A. pleuropneumoniae* NGT is an inverting glycosyltransferase that recognises the N-X-(S/T) consensus sequence, thus exhibiting similar acceptor site specificity as the eukaryotic OST despite the unrelated predicted structural architecture and the apparently different catalytic mechanism. The identification of an enzyme that integrates some of the features of an OST in a cytoplasmic pathway defines a novel class of N-linked protein glycosylation found in pathogenic bacteria (Schwarz et al. 2011). This NGT constitutes a general protein glycosylation system with a preference for autotransporter adhesins as protein substrates *in vivo*, thereby displaying a surprisingly relaxed peptide substrate specificity. Although N-X-(S/T) is the preferred acceptor sequon, glycosylation of alternative sequons was detected, including modification of glutamine and serine residues. The NGT was also able to glycosylate heterologous proteins. Therefore, with *A. pleuropneumoniae* a novel route for engineering of N-glycoproteins in bacteria has been identified (Naegeli et al. 2014).

Prokaryotic N-linked glycans and key OSTs have been mainly studied in  $\epsilon$ -Proteobacteria, including strains from the families *Campylobacteraceae* and *Helicobacteraceae*. Information about the N-linked glycoproteome in  $\gamma$ -Proteobacteria such as in members of the order *Legionellales* or the family *Pseudomonadaceae* is still scarce. In the literature, there are only two reports on N-glycosylated proteins from different pseudomonads, however, without structural characterisation (Bartels et al. 2011; Khemiri et al. 2013). In the latter report, the FliC flagellin glycopolymerism in *Pseudomonas aeruginosa* was investigated after N-glycosidase treatment with  $^{18}\text{O}$  labelling. To detect the possible sites of FliC modification, *de novo* sequencing was performed to discriminate between spontaneous deamidation and N-glycan loss. This approach led to the proposal of three potential N-glycosylated sites on the primary sequence of FliC - Asn26, Asn69 and Asn439—with two of them localised to an N-X-(S/T) consensus sequence (Asn26, Asn439) (Khemiri et al. 2013). Previous analyses of flagellin glycosylation in *Pseudomonas* strains reported only the presence of O-linked glycans (Takeuchi et al. 2007; Miller et al. 2008). A 2D electrophoresis pattern of FliC, however, strongly suggested that the glycosylation of this protein is more complex (Khemiri et al. 2013). It is assumed that FliC is a polymorphous glycoprotein that also exhibits N-glycoforms, probably arising from macro- and microheterogeneity (Morelle et al. 2006).

## O-Linked bacterial glycoproteins

Bacterial O-oligosaccharyl transferases (O-OSTs) constitute a growing family of enzymes that are responsible for protein O-linked glycosylation involving the attachment of glycans to hydroxyl groups of serine, threonine (Power, Seib and Jennings 2006; Aas et al. 2007; Faridmoayer et al. 2007) and tyrosine residues (Zarschler et al. 2010b). On the basis of a sensitive and specific glycan serotyping system, microheterogeneity has been reported for O-linked protein glycosylation systems in different bacteria. Factors underlying microheterogeneity in reconstituted expression systems have been identified and modelled, but those impacting natural systems largely remain enigmatic.

Many proteins from various Gram-negative species, including pathogens such as *C. jejuni* (Szymanski and Wren 2005; Mahdavi et al. 2014), *Burkholderia cenocepacia* (Lithgow et al. 2014), *Acinetobacter baumannii* (Iwashkiw et al. 2012), *H. pylori* (Hopf et al.



2011), mycoplasmas (Jordan et al. 2013), *E. coli* (Benz and Schmidt 2001; Sherlock et al. 2006; Charbonneau et al. 2012), *Bacteroides fragilis* and *Tannerella forsythia* (Posch et al. 2013b), as well as Gram-positive species including different clostridia (Twine et al. 2008; Twine et al. 2009) and *Listeria monocytogenes* (Schirm et al. 2004b) are decorated with O-linked glycans of differing chemical composition (for review, see Tan, Tang and Exley 2015).

In the following, bacterial O-linked glycoproteins are described following the categorisation into flagellins, fimbriae and pili, and 'other glycoproteins'; for the latter, currently only distinct aspects but not an extended picture as for the first two categories is available. The best investigated bacteria of each category are listed and described exemplarily.

## Flagellins

Flagella-mediated motility is a common trait among many bacteria. Bacterial flagella are complex nanostructures in which a 10- to 15- $\mu$ m helical filament extends from the cell surface and is anchored to a rotating basal body spanning the bacterial envelope. The helical filament is composed of repeating subunits known as flagellins (Logan 2006; Erhardt, Namba and Hughes 2010). Flagellin glycosylation has been observed on an increasing number of Gram-negative and Gram-positive bacteria. Many of them are pathogens and despite the enormous differences of the strain-specific glycan structures glycosylation of the flagellar proteins is considered a major virulence factor. Examples of bacteria with glycosylated flagella presented here include *Campylobacter* (Thibault et al. 2001; Verma et al. 2006), *Pseudomonas* (Schirm et al. 2004a) and *Helicobacter* species (Josenhans et al. 2002; Schirm et al. 2003), *B. cepacia* (Lithgow et al. 2014), *Aeromonas* spp. (Parker et al. 2012; Wilhelms et al. 2012), different clostridia (Twine et al. 2008; Twine et al. 2009), *L. monocytogenes* (Schirm et al. 2004b) and *Paenibacillus alvei* (Janesch et al. 2016).

Of particular interest are *C. jejuni* and *C. coli* strains, which possess an O-glycosylation machinery for flagellin glycosylation in addition to the previously described general protein N-glycosylation system (Szymanski and Wren 2005; Guerry et al. 2006; Logan 2006; Guerry and Szymanski 2008). Genes encoding the proteins for the synthesis of the flagellin glycans and the respective protein transferases map adjacent to the flagellin structural genes in one of the most hypervariable regions of the *C. jejuni* chromosome. All flagellin modifications of *C. jejuni* are based on 5,7-diacetamido-3,5,7,9-tetradecoxy-L-glycero-L-mannono-ulosonic acid (pseudaminic acid - Pse, Pse5Ac7Ac) (Thibault et al. 2001), a nine-carbon sugar that is structurally similar to sialic acid (Neu5Ac) (Varki and Varki 2007; Chen and Varki 2010). While the major flagellin modification is Pse, also derivatives thereof occur, including an acetamidino form (Pse5Am7Ac), an acetylated form (Pse5Ac7Ac8OAc), a form substituted with hydroxypropionyl groups (Pse5Pr7Pr) and Pse5Am7Ac to which an N-acetylglutamine residue is attached (Pse5Am7Ac8GlnAc) (Thibault et al. 2001; Schirm et al. 2005). The analysis of flagellin A glycosylation from *C. jejuni* strain NCTC 11168 showed the presence of dimethylglyceric acid derivatives of Pse in addition to Pse5Am7Ac Pse (Hitchen et al. 2010) and the glycosylation sites were assigned to Ser181, Ser207 and Thr464 or Thr465 (Zampronio et al. 2011). The identification of a large number of frequently unstable homopolymeric tracts of G/C residues within genes from chromosomal loci involved in the biosynthesis of capsular polysaccharide, LOS and the flagellin glycoprotein was the most significant finding of the *C. jejuni* NCTC 11168 genome sequencing project (Parkhill et al. 2000). The resultant on/off switching in the translational status of homopolymeric-

tract-containing genes is thought to mediate the structural diversity of the bacterial cell surface. In fact, it was observed that genes from the flagellin glycosylation locus are involved in generating flagellin glycan diversity. An important protein in this context is Cj1295, which is based on the presence of an aminopeptidase-like domain, suggested to cleave the acetamido group on carbon 5 of the basal Pse5Ac7Ac/Pse5Ac7Am sugar, enabling the substitution of the acetamido group with a methylglyceroyl group (Hitchen et al. 2010). Another unusual feature of *C. jejuni* flagellins is the absence of Toll-like receptor 5 (TLR5)-binding sites, which are otherwise highly conserved among bacterial flagellins because of their involvement in subunit interactions in the filament. Flagella from *C. jejuni* and other members of the  $\epsilon$ -Proteobacteria are unusual in that the glycosylation of flagellin is crucial for filament assembly (Guerry 2007), and there is preliminary evidence that the flagellin glycans could contribute to subunit interactions (Guerry and Szymanski 2008). Similarly, surface-exposed glycans mediate autoagglutination and microcolony formation by interactions with other flagellar glycans or other surface structures on adjacent bacteria (Guerry et al. 2006). The flagellin glycans also contribute to virulence of *C. jejuni*; loss of Pse5Am7Ac from the *C. jejuni* 81-176 flagellin resulted in reduced adherence to and invasion of intestinal epithelial cells (Guerry and Szymanski 2008). Pse is also important in gastric pathogens such as *H. pylori*, where it occurs in O-linked flagellin glycosylation that is important to flagellum assembly and motility of *H. pylori* (Hartley et al. 2011; Morrison and Imperiali 2014).

Studies on the *C. coli* VC167 flagellin identified a second nine-carbon sugar, legionaminic acid (5,7-diacetamido-3,5,7,9-tetradecoxy-D-glycero-D-galacto-nonulosonic acid; Leg) and its derivatives (McNally et al. 2007). Leg was first characterised in the lipopolysaccharides (LPS) O antigen of *Legionella pneumophila* (Knirel et al. 1994), where it derived its name from. The Leg biosynthetic pathway is found also in most strains of *C. jejuni*, except for *C. jejuni* 81-176 (Schoenhofen et al. 2009). As an alternative, Leg formation can result from modification of diNacBac through three subsequent enzymatic reactions (Morrison and Imperiali 2014).

Studies on flagellar glycoproteins from other Gram-negative pathogens such as *Pseudomonas* species revealed further insight into O-linked flagellin glycosylation. *Pseudomonas aeruginosa* PAK (serotype O6) produces a single polar flagellum containing an a-type flagellin, which has been shown to be post-translationally modified at two sites with heterogeneous O-linked glycans (Schirm et al. 2004a). To determine the potential role of O antigen biosynthetic genes in the synthesis of these O-glycans, flagellin proteins isolated from PAK wild-type strain and three O antigen biosynthesis mutants were compared. Flagellins from *wbpL* and *wbpP* mutants had a similar size as the wild-type protein (45 kDa), and both were glycosylated. In contrast, flagellin from the *wbpO* mutant had an apparent molecular mass of 42 kDa, indicating an obvious defect in glycosylation. Thus, flagellin glycosylation in *P. aeruginosa* PAK depends on the O antigen biosynthetic enzyme WbpO but not WbpP or WbpL. Kinetic evidence shows that WbpO and WbpP can act in either order in the biosynthesis of UDP-D-GalNAcA; however, there is a strong preference of WbpO to convert UDP-D-GlcNAc into UDP-D-GlcNAcA first, before epimerisation into UDP-D-GalNAcA by WbpP. Since the exact composition of the flagellin glycans is not known, it is not yet possible to propose a pathway for flagellin glycan biosynthesis in *P. aeruginosa* PAK (Miller et al. 2008).

The flagellins from the phytopathogenic bacteria *P. syringae* pv. *glycinea* race 4 and *P. syringae* pv. *tabaci* 6605 are



glycosylated at six serine residues (i.e. Ser143, Ser164, Ser176, Ser183, Ser193 and Ser201) (Takeuchi et al. 2007). The structure of the flagellin glycan at Ser201 from each pathovar consists of a common unique trisaccharide comprising two Rha residues and one modified 4-amino-4,6-dideoxyglucosyl (Qui4N) residue— $\beta$ -D-Quip4N(3-hydroxy-1-oxobutyl)2Me-(1 $\rightarrow$ 3)- $\alpha$ -L-Rhap-(1 $\rightarrow$ 2)- $\alpha$ -L-Rhap—and can be found on each of the six serine residues. Determination of the enantiomeric ratio of the Rha residues showed that the flagellin from *P. syringae* pv. tabaci 6605 consisted solely of L-Rha, whereas the *P. syringae* pv. glycinea race 4 flagellin contained both L-Rha and D-Rha at a molar ratio of about 4:1. Glycosylation of flagellin was shown to be essential for virulence and host specificity of *P. syringae* strains (Takeuchi et al. 2007).

Bacteria of the *B. cepacia* complex are pathogens of humans, plants and animals. *Burkholderia cenocepacia* is one of the most common *B. cepacia* complex species infecting patients with cystic fibrosis and its carriage is associated with poor prognosis (Lithgow et al. 2014). In strain *B. cepacia* K56-2, a general O-linked protein glycosylation system was characterised. The Pgl<sub>BC</sub> O-OST, encoded by the cloned gene *bcal0960*, was shown to be capable of transferring a heptasaccharide from the *C. jejuni* N-glycosylation system to an *N. meningitidis*-derived acceptor protein in an *E. coli* background, indicating that the enzyme has relaxed specificity for both the sugar donor and the protein acceptor. Disruption of *bcal0960* abolished glycosylation and resulted in reduced swimming motility and attenuated virulence of the bacterium towards both plant and insect model organisms (Lithgow et al. 2014). In *B. cepacia* K56-2, Pgl<sub>BC</sub> is responsible for the glycosylation of 23 proteins involved in diverse cellular processes. Mass spectrometric analysis revealed that these proteins are modified with a trisaccharide HexNAc–HexNAc–Hex. This trisaccharide is unrelated to the organism's O antigen, which is a polymer of trisaccharide-repeating unit containing Rha and two N-acetylgalactosamine (GalNAc) residues -  $\rightarrow$ 4)- $\alpha$ -L-Rhap-(1 $\rightarrow$ 3)- $\alpha$ -D-GalpNAc-(1 $\rightarrow$ 3)- $\beta$ -D-GalpNAc-(1 $\rightarrow$  (Ortega et al. 2005). For normal motility of *B. cepacia*, complete O antigen and flagellin glycosylation are required; the flagella also contribute to biofilm production. The key genes of *B. cepacia* flagellin glycosylation were identified, including a predicted glycosyltransferase gene that is linked to the flagellin biosynthesis gene cluster and a putative acetyltransferase gene located within the O antigen LPS cluster. Another gene from the O antigen cluster, *rmlB*, which is required for both flagellin glycan and O antigen biosynthesis, is essential for bacterial viability, uncovering a novel target against *B. cepacia* infections. Using glycosylated and non-glycosylated purified flagellin and a cell reporter system to assess TLR5-mediated responses, it was shown that the presence of the flagellin glycan significantly impaired the inflammatory response of epithelial cells. Based on these data, it is suggested that flagellin glycosylation could provide to *B. cepacia* a strategy to reduce its recognition by the innate immune system (Hanuszkiewicz et al. 2014). *Burkholderia cepacia* K56-2 also causes opportunistic infections in plants and insects, suggesting that virulence depends on the host and its innate susceptibility to infection (Khodai-Kalaki et al. 2015). It was hypothesised that modifications in key bacterial molecules recognised by the innate immune system modulate host responses to *B. cepacia*. Modification of LPS with 4-amino-4-deoxy-L-arabinose (L-Ara4N) and flagellin glycosylation attenuate *B. cepacia* infection in *Arabidopsis thaliana* and *Galleria mellonella* insect larvae. Opportunistic bacteria are a perfect example of microbes whose ability to cause disease is intimately related to the host's ability to recognise and respond to the infection. LPS and flagellin were further investigated for their contri-

bution to infection and eliciting of a host response. It was shown that flagellin glycosylation and LPS modification with L-Ara4N play significant roles in bacterial survival during the early stage of infection but do not alter the sensing of these molecules by the plant innate immune receptors, indicating that these modifications are only critical for the establishment of the infection. Thus, the microbe's sensing by the host and establishment of infection are interrelated but independent events (Khodai-Kalaki et al. 2015; Tavares-Carreón, Patel and Valvano 2015).

Flagellin from the rice-avirulent N1141 strain of the Gram-negative phytopathogenic bacterium *Acidovorax* (formerly *Pseudomonas*) *avenae* induces plant immune responses including H<sub>2</sub>O<sub>2</sub> generation, whereas flagellin from the rice-virulent K1 strain of *Av. avenae* does not induce such a response (Hirai et al. 2011). Structural analyses indicated that the glycan moieties attached to Ser178 or Ser183 in the D2 domain of the K1 flagellin might be involved in flagellin recognition by the plant; plants generally have sensitive systems that detect pathogen-derived molecules to protect against infection (Che et al. 2000). Thus, the glycan moiety attached by the K1 glycosyltransferase disrupts flagellin recognition by rice and causes the induction of immune responses. Elucidating the glycan structure associated with the flagellin in the *Av. avenae* K1 strain will be important to further understand how flagellin is recognised by rice (Hirai et al. 2011).

Glycosylated flagella of several Gram-negative bacteria such as *Aeromonas caviae* (Parker et al. 2012) and *Ae. hydrophila* (Wilhelms et al. 2012; Merino et al. 2014) have been discussed in conjunction with their LPS O antigens (Raetz and Whitfield 2002). Motility in *Ae. caviae* in broth culture is mediated by a single polar flagellum encoded by the *fla* genes (Parker et al. 2012). The two flagellin subunits—FlaA and FlaB—undergo O-glycosylation with six to eight Pse residues linked to serine and threonine residues in the central region of the subunits. The *flm* genetic locus in *Av. caviae* is required for both flagellin glycosylation and LPS O antigen biosynthesis as evidenced by *flm* mutants. However, none of the *flm* genes appeared to encode a candidate glycosyltransferase that might add the Pse moiety to FlaA/B. The motility-associated factors (Maf proteins) were then considered as candidate transferases. Bioinformatic analysis indicated that the genome of *Av. caviae* encodes a single *maf* gene homologue (*maf1*) and that this strain has acquired the minimum gene cluster required for the biosynthesis of Pse5Ac7Ac (Tabei et al. 2009). Phenotypic analysis of a *maf* mutant showed that it is both non-motile and lacks polar flagella. In contrast to *flm* mutants, this mutant revealed no change in the LPS O antigen pattern and retained its ability to swarm. Analysis of *flaA* transcription showed that its transcription was unaltered in the *maf* mutant, while a His-tagged version of the FlaA flagellin protein produced from a plasmid was detected in unglycosylated intracellular form in the *maf* mutant strain. Complementation of the *maf* strain in *trans* partially restored motility and increased levels of glycosylated flagellin to above wild-type levels. These data provided evidence that *maf1* is a pseudaminyl transferase responsible for glycosylation of flagellin and suggest that this event occurs prior to secretion through the flagellar type III secretion system. Based on these data, a glycosylation pathway was proposed for flagellin glycosylation and LPS modification in *Av. caviae* Sch 3N. The pathway to Pse5Ac7Ac is based on similar predicted functions of *Av. caviae* proteins as known for corresponding proteins in *C. jejuni* and *H. pylori* (McNally et al. 2006; Schoenhofen et al. 2006). Following the biosynthesis of Pse5Ac7Ac by the FlmABD and NeuB enzymes, Pse5Ac7Ac is CMP activated through NeuA activity. CMP-Pse5Ac7Ac is then either transferred onto the flagellin by Maf1, which was predicted to be a polar flagellin-specific

glycosyltransferase, or transferred onto a sugar-antigen carrier lipid by Lst (sialyltransferase-like protein) to create an LPS O antigen unit, which is subsequently transported across the cytoplasmic membrane by Lsg (Wzx-like flippase) (Tabei et al. 2009; Parker et al. 2012).

In the related strain *Ae. hydrophila* AH-3 (serotype O34), polar and lateral flagellin proteins were found to be glycosylated with different carbohydrate moieties. The lateral flagellin was modified in O-linkage with a single Pse derivative of 376 Da at three sites, with one site of modification at Ser178, while the polar flagellin was modified with a heterogeneous, more complex O-glycan (Wilhelms et al. 2012). This heptasaccharide is comprised of three N-acetylhexosamines (with variable addition of O-2 phosphate groups and O-2 methyl groups on each), two hexoses and two unknown monosaccharides of 376 and 102 Da in the sequence -376 Da-Hex-Hex-HexNAc-HexNAc-HexNAc-102 Da. A maximum of six heptasaccharide chains was observed by mass spectrometry (MS) analysis of the polar flagellins, one of them linked to Thr161 on FlaB. Compositional analysis of the flagellin glycan indicated the presence of a GalNAc-containing heptasaccharide, whereas the LPS O34 antigen is built from tetrasaccharide repeats comprised of D-mannose, D-GalNAc and 6-deoxytalose (Knirel et al. 2002). In all cases, the 376-Da monosaccharide is the first sugar attached to the polar flagellin. In-frame deletion mutants of the Pse biosynthetic *pseB* and *pseF* orthologues resulted in abolition of polar and lateral flagella formation, obviously due to post-transcriptional regulation of the flagellins. Flagellation could be restored by complementation with wild-type *Ae. hydrophila* *pseB* or *pseF* as well as *C. jejuni* *pseB* and *pseF* (Wilhelms et al. 2012). Mutants unable to produce the WecP (encoding a predicted UDP-HexNAc:polyprenol-P GalNAc-1-P transferase) or Gne (encoding a UDP-N-acetylgalactosamine 4-epimerase) enzymes showed altered motility, their glycosylation pattern differed from that observed for wild-type polar flagellin and both mutants were devoid of the O34-antigen LPS. The effects observed upon WecP deletion suggested the involvement of a lipid carrier in the glycosylation process. With WecX, a gene coding for an enzyme linking a sugar to a lipid carrier was identified in strain AH-3 and, indeed, its deletion completely abolished motility, flagella production (according to TEM evidence) and flagellin glycosylation. This was the first report of a lipid carrier involved in flagella O-glycosylation. Furthermore, by comparing mutants with differing degrees of polar flagellin glycosylation, the importance of glycosylation in *A. hydrophila* flagella formation and motility could be demonstrated (Merino et al. 2014).

Other glycosylated flagellin subunits have been identified on Gram-positive pathogenic clostridia such as *Clostridium botulinum* (Twine et al. 2008), *Cl. difficile* (Twine et al. 2009) and *L. monocytogenes* (Schirm et al. 2004b). In *Cl. botulinum*, bioinformatic genome analysis identified a flagellar glycosylation island containing homologues of Leg biosynthesis genes previously identified in *C. coli* (Doig et al. 1996). Indeed, structural characterisation of the *Cl. botulinum* glycan revealed that it was a novel Leg derivative, 7-acetamido-5-(N-methylglutam-4-yl)-amino-3,5,7,9-tetradeoxy-D-glycero- $\alpha$ -D-galactonulosonic acid ( $\alpha$ Leg5GluNMe7Ac) (Twine et al. 2008). In other strains, di-N-acetylhexuronic acids were identified as glycan constituents.

The composition of the *Cl. difficile* flagellin glycans is quite distinct from those of the related organism *Cl. botulinum*. All *Cl. difficile* flagellins examined were shown to carry a glycan that is attached to serine and threonine residues via a HexNAc residue.

*Clostridium difficile* 630 produces flagellin that is O-glycosylated at up to seven sites with a HexNAc residue to which a methylated aspartic acid is linked via a phosphate bond. In contrast, flagellins from a number of *Cl. difficile* isolates from other outbreaks are decorated with heterogeneous O-linked glycans containing up to five monosaccharide residues with masses of 204 (HexNAc), 146 (deoxyhexose), 160 (methylated deoxyhexose) and 192 (heptose) (Twine et al. 2009).

Post-translational modification of proteins with O-GlcNAc is well known for a number of eukaryotic nuclear and cytoplasmic proteins (Hart et al. 2011) and nowadays emerging also for bacteria, such as *Listeria* species. The addition of GlcNAc to the *Listeria* flagellin would not require a dedicated glycan biosynthetic pathway, since GlcNAc is a common biosynthetic precursor of numerous biochemical pathways (Schirm et al. 2004b). Since in eukaryotic systems an important component of the O-GlcNAc modification system is the O-GlcNAc transferase (Janetzko and Walker 2014), an enzyme of equivalent function would be a prerequisite for O-GlcNAcylation of *L. monocytogenes* flagellin. However, search of the *L. monocytogenes* EGD genome revealed no obvious candidate gene based on homology to known eukaryotic O-GlcNAc transferases, leaving open the question of how GlcNAcylation would be accomplished in this organism.

Recently, flagellin glycosylation was also investigated in the Gram-positive bacterium *Paenibacillus* (formerly *Bacillus*) *alvei* CCM 2051<sup>T</sup> (Altman et al. 1991; Forsgren 2010; Janesch et al. 2016). This organism swarms vigorously on solidified culture medium, with swarming relying on functional flagella as evidenced by abolished biofilm formation of a non-motile *Pa. alvei* mutant defective in the flagellin protein Hag. Investigation of the glycobiology of the polar *Pa. alvei* flagella showed that the purified 30 kDa Hag protein (PAV\_2c01710) is modified with an O-linked trisaccharide comprised of one hexose and two N-acetylhexosamine residues at three glycosylation sites (Janesch et al. 2016). Downstream of the *hag* gene on the bacterial chromosome, two open reading frames (PAV\_2c01630, PAV\_2c01640) encoding putative glycosyltransferases were shown to constitute a flagellin glycosylation island. Mutants defective in these genes exhibited altered migration in SDS-PAGE as well as loss of extracellular flagella production and bacterial motility. Thus, flagellin glycosylation in *Pa. alvei* CCM 2051<sup>T</sup> is pivotal to flagella formation and bacterial motility *in vivo*; flagella glycosylation is a second protein O-glycosylation system in this bacterium, in addition to the well-investigated S-layer tyrosine O-glycosylation pathway (*vide infra*) (Zarschler et al. 2010b).

## Pilins and fimbriae

Examples of glycosylated pili and fimbriae included here come from *Neisseria* spp., *P. aeruginosa*, *Mycobacterium tuberculosis*, *Francisella tularensis* and *Porphyromonas gingivalis*.

Pilin subunits (Logan 2006), mostly of Gram-negative bacteria including important human pathogens, are frequently decorated with O-linked glycans of strain-specific composition (Castric 1995; Stimson et al. 1995; Castric, Cassels and Carlson 2001; Thibault et al. 2001; Schirm et al. 2003, 2004b; Aas et al. 2007; Kus et al. 2008; Børud et al. 2011; Harvey et al. 2011; Lithgow et al. 2014). Different names have been coined for the O-OSTs involved in pilin O-glycosylation, such as PglL in *N. meningitidis* (Faridmoayer et al. 2007; Schulz et al. 2013; Harding et al. 2015), PglO in *N. gonorrhoeae* (Hartley et al. 2011) and PilO in *P. aeruginosa* (Castric 1995; Faridmoayer et al. 2007). Whereas PilO activity is restricted to short oligosaccharides, PglL is able to transfer diverse oligo- and polysaccharides. These O-OSTs are inner membrane

proteins transferring various glycans from a lipid carrier to different protein acceptors, thus exhibiting relaxed specificities. The activity of wild-type Pgl and its mutant derivatives was analysed *in vivo* in engineered *E. coli* cells, and *in vitro* assays. Limited proteolysis experiments of Pgl revealed a conformational change that is triggered upon interaction of the C-terminal region of the enzyme with the LLO substrate; while Gln178 and Tyr405 are required for optimal function, His349 is essential for the enzymatic activity and plays a critical role in the interaction with LLOs (Musumeci et al. 2013, 2014). O-OSTs are in most cases difficult to identify using solely bioinformatic methods because of their sequence similarity with WaaL ligases catalysing the last step in LPS synthesis (Hug and Feldman 2011; Whitfield and Trent 2014). For example, the Wzy\_C signature domain common to O-OSTs is also present in WaaL ligases (Gebhart et al. 2012).

Dependent on the neisserial species, pilin is glycosylated at Ser63 with an oligosaccharide, whose structure can vary upon the availability of glycosyltransferases. In addition, the pilins of *N. meningitidis* are subject to other post-translational modifications including the addition of phosphorylcholine (PC) and phosphoglycerol the pilus of *N. gonorrhoeae* was found to be modified by the addition of PC and phosphoethanolamine (PE) (Musumeci et al. 2014). In this context, PG was determined to play a role in the detachment of the pilus from bacterial aggregates, allowing for colonisation of new sites. The addition of PC and PE is mediated through the activity of the enzymes PptA and PptB, respectively (Warren and Jennings 2003). The residues within pilin to which the unusual PG post-translational modifications are added via PptB were identified as Ser69 in *N. gonorrhoeae* and Ser93 in *N. meningitidis*. The Ser69 has, thus, been found with all three modifications, as this is the site at which PC and PE modifications have previously been identified (Warren and Jennings 2003; Musumeci et al. 2014).

Expression of type IV pili by *N. gonorrhoeae* plays a critical role in mediating adherence to human epithelial cells. Gonococcal pilin is modified with an O-linked glycan with the structure Gal-( $\alpha$ 1 $\rightarrow$ 3)-2,4-diacetimidido-2,4,6-trideoxyhexose (Gal-DATDH) disaccharide (Hegge et al. 2004), which may be present as a di- or monosaccharide because of phase variation of select pilin glycosylation genes. Pilin glycosylation involves multiple pilin glycosylation (*pgl*) genes. For example, PglD contributes to the biosynthesis of the basal DATDH sugar after which PglA adds the (first) hexose to the basal monosaccharide (Jennings et al. 1998). Whereas *pglA* is subject to phase variation (Jennings et al. 1998; Banerjee et al. 2002), *pglD* expression does not appear to be phase variable (Power et al. 2000). Using primary, human, cervical epithelial (i.e. pex) cells, evidence was provided that the pilin glycan mediates productive cervical infection, with the pilin glycan required for gonococcal binding to the I-domain region of complement receptor 3, which is naturally expressed by pex cells (Jennings et al. 2011).

*Pseudomonas aeruginosa* strains Pa7 and Pa5196 glycosylate their type IVa pilins with a rare sugar polymer of  $\alpha$ 1,5-linked D-arabinofuranose (D-Araf) residues, which is identical to that found in the cell walls of *Corynebacterineae*. Bioinformatic analyses pinpointed a cluster of seven *P. aeruginosa* genes, including homologues of the *M. tuberculosis* genes Rv3806c, Rv3790 and Rv3791, required for the synthesis of a polyprenyl-linked D-ribose precursor and its epimerisation to D-Araf. The emergence of multidrug-resistant and extensively drug-resistant strains of *M. tuberculosis*, one of the world's most prevalent human pathogens, underlines an urgent need for new antimicrobials (Manina et al. 2010); this might also translate

to *P. aeruginosa*. Pa5196 mutants lacking the respective orthologues had non-arabinosylated pilins, poor twitching motility, and significantly fewer surface pili than the wild type, even in a retraction-deficient (*pilT*) background. The Pa5196 mutant pilus system did not assemble heterologous non-glycosylated pilins efficiently, demonstrating that this requires post-translationally modified subunits. Thus, type IV pilins provide a rare case of the requirement of PilA O-glycosylation for efficient pilus assembly. A recombinant *P. aeruginosa* PAO1 strain coexpressing the genes for D-Araf biosynthesis, the pilin modification enzyme TfpW and the acceptor PilA(IV) produced arabinosylated pili, confirming that the identified Pa5196 genes are both necessary and sufficient for pilin glycosylation. A *P. aeruginosa* epimerase deletion mutant could be complemented with the corresponding *M. smegmatis* gene, demonstrating conservation between the systems of the *Corynebacterineae* and *Pseudomonadaceae*. This work simultaneously described a novel Gram-negative pathway for the biosynthesis of D-Araf, which in the future may be of therapeutic interest in the context of the emergence of multidrug-resistant strains in *Corynebacterineae* (Harvey et al. 2011).

While in several bacteria glycosylation has been shown to impact protein function with regard to adhesiveness and invasiveness of host cells, questions about glycosylation of proteins in *F. tularensis* and its potential connection to bacterial virulence have not been answered yet. Recently, several putative *F. tularensis* glycoproteins were characterised through the combination of carbohydrate-specific detection and lectin affinity with highly sensitive MS utilising a bottom-up proteomic approach. The pilin protein PilA that was recently found to be glycosylated as well as other novel protein virulence factors were among the identified proteins. Up to 20 putative glycoproteins were detected using fluorescently labelled hydrazide and lectin blotting, while the use of lectin affinity chromatography resulted in the identification of 104 putative *F. tularensis* subsp. *holarctica* glycoproteins (Balonova et al. 2010).

The oral mucosal pathogen *Po. gingivalis* targets the C-type lectin receptor DC-SIGN through its 67-kDa Mfa1 (minor) fimbriae for invasion and persistence within human monocyte-derived dendritic cells (DCs). DCs respond to by inducing an immunosuppressive and Th2-biased CD4<sup>+</sup> T-cell response. Biochemical and molecular analyses of native Mfa1 fimbriae revealed numerous putative O-glycosylation sites and two putative N-glycosylation sites (Zeituni et al. 2010). It was further demonstrated by ProQ Emerald glycan staining that the minor fimbria is glycosylated and that glycosylation is partially removable by treatment with  $\beta$ -(1 $\rightarrow$ 4)-galactosidase, but not by classic N- and O-linked deglycosidases. Monosaccharide analysis by gas chromatography-MS confirmed that the minor fimbria contains the DC-SIGN-targeting carbohydrates Fuc, Man, GlcNAc and GalNAc in a molar ratio of  $\sim$ 2:4:3:1. TEM analysis revealed that the minor fimbria forms fibres of approximately 200 nm in length that could be involved in targeting or cross-linking of DC-SIGN. These findings shed light on molecular mechanisms of invasion and immunosuppression by this unique mucosal pathogen (Zeituni et al. 2010).

### Other bacterial glycoproteins

The number of bacterial species known to perform O-linked protein glycosylation is rapidly increasing. While it is evident that many bacterial pathogens are able to O-glycosylate proteins, the involvement of O-glycosylation in bacterial



pathogenesis remains unknown; it is conceivable that one such effect could be mediated via the involvement of glycoproteins in biofilm formation. Examples from selected Gram-negative and Gram-positive bacteria presented here include *B. thailandensis*, *Vibrio cholerae*, *N. gonorrhoeae*, *Corynebacterium glutamicum*, *Mycobacterium* spp., *Streptococcus* spp., *Staphylococcus aureus*, *Bacillus anthracis*, *Ba. cereus*, *C. difficile*, *Bac. fragilis*, *Pe. gingivalis*, *Aggregatibacter actinomycetemcomitans* and *Lactobacillus* spp.

The hypothetical proteins BTH\_I0650 from *B. thailandensis* E264 and VC0393 from *V. cholerae* N16961 contain the Wzy\_C domain, thus representing putative O-OSTs. In fact, it was demonstrated that both proteins have O-OST activity and therefore they were renamed PglL<sub>Bt</sub> and PglL<sub>Vc</sub>, respectively, in analogy to the *N. meningitidis* counterpart (PglL<sub>Nm</sub>). In *E. coli*, PglL<sub>Bt</sub> and PglL<sub>Vc</sub> display relaxed glycan and protein specificity. Glycosylation efficiency depends on the specific combination of the protein acceptor, glycan and O-OSTs involved. The identification of enzymatically active O-OST in members of the *Vibrio* and *Burkholderia* genera suggests the presence of still unknown O-glycoproteins in these organisms; these might play roles in bacterial physiology or pathogenesis (Gebhart et al. 2012). The discovery of PglL<sub>Vc</sub> and PglL<sub>Bt</sub> increases the repertoire of enzymes available for glycoengineering (*vide supra*, PglB, N-glycosylation), which irrespective of the role played by glycosylation in bacterial physiology and/or pathogenesis, may contribute to the design of novel and improved diagnostics tools and conjugate vaccines against bacterial infections (Gebhart et al. 2012).

By employing state-of-the-art MS techniques, it was demonstrated that *N. gonorrhoeae* expresses a general O-linked protein glycosylation (Pgl) system known to target at least 19 membrane-associated proteins (Anonsen et al. 2012, 2016). No specific target sequon as known from N-glycosylation of both eukaryotic and prokaryotic glycoproteins is apparent (Jarrell et al. 2014; Varki et al. 2015), although glycan attachment sites are most often localised within regions of low-sequence complexity (Anonsen et al. 2012). Moreover, glycan structure variations have been observed in species within the genus *Neisseria*. To elucidate the underlying biosynthesis mechanism, a hypomorphic allele of *pglA* (encoding the PglA galactosyltransferase) was identified in a genetic analysis as a significant contributor to the simultaneous expression of multiple glycoforms. These findings showed that the differences in microheterogeneity could be primarily attributed to the *pglA* allele status and, accordingly, that the corresponding phenotypes resulted from altered *pglA*-associated activity. Moreover, the high-glycoform phenotype was mapped to a single amino acid polymorphism in PglA; the A350G exchange was both necessary and sufficient for this phenotype. Molecular analyses revealed that many *pglA* phase-off variants were associated with disproportionately high levels of the N,N'-diacetylglucosamine-Gal disaccharide glycoform generated by PglA (Johannessen, Kooimey and Børud 2012). Thus, the variability in glycan structure and antigenicity is attributable to differences in the content and expression status of glycan synthesis genes; ultimately, this effect could result in a degree of diversity that may exceed the one currently defined (Børud et al. 2014). Unique protein-associated disaccharide glycoforms were identified that carry N-acetylglucosamine at their non-reducing end. This altered structure was correlated with allelic variants of *pglH* whose product was previously demonstrated to be responsible for the expression of glucose-containing disaccharides. Analogous minimal structural alterations in glycosyltransferases have also been documented in association with LPS and capsular polysaccharide variability (Børud et al. 2011).

*Corynebacterium glutamicum* and *M. tuberculosis* are affiliated to the phylogenetic family of the *Corynebacterineae* (Bou Raad et al. 2010). They possess an atypical cell wall that is composed of a heteropolymer of PG and mycolate-carrying arabinogalactan (AG) cross-linked via trehalose (Tropis et al. 2005) and covalently associated with the outer membrane. Five arabinosyltransferases are involved in the biosynthesis of AG in *Co. glutamicum*. AftB catalyses the transfer of Araf onto the arabinan domain of the AG to form terminal  $\beta$ -(1 $\rightarrow$ 2)-linked Araf residues. It was shown that in  $\Delta$ aftB cells, half of the AG mycolylation sites are missing that may facilitate the detachment of membrane patches. These fragments contain mono- and dimycolate of trehalose and PorA/H, the major porin of *Co. glutamicum*, but lack conventional phospholipids that typify the plasma membrane, suggesting that they are derived from the atypical mycolate outer membrane of the cell envelope wall constituents of mycobacteria.

For *M. tuberculosis*, the causative agent of TB, the cell envelope provides several glycoconjugates such as glycolipids, lipoglycans and polysaccharides (Torrelles and Schlesinger 2010). In fact, *M. tuberculosis* can adapt to the human host by decorating its cell envelope molecules with terminal mannosylated (i.e.  $\alpha$ -Man-(1 $\rightarrow$ 2)-Man) oligosaccharides that resemble the glycoforms of mammalian mannoproteins. These biomolecules engage the mannose receptor (MR) on macrophages during phagocytosis and dictate the intracellular fate of *M. tuberculosis* by regulating the formation of a unique vesicular compartment in which the bacteria survive. The phylogenetic diversity of *M. tuberculosis* strains, together with the genetic diversity observed in human populations including those elements that affect macrophage function, may explain the extraordinary evolutionary host adaptation capability of this pathogen (Torrelles and Schlesinger 2010). Recent studies provide evidence that major mannosylated glycoconjugates on the *M. tuberculosis* cell envelope change as this organism grows *in vitro* on agar plates. Along with these changes, mannan levels on the outer cell surface also increase significantly over time (Yang et al. 2013). Thus, the impact of interrupting O-mannosylation in the human pathogen *M. tuberculosis* and in the non-pathogenic saprophyte *M. smegmatis* by inactivating the respective putative protein mannosyl transferase genes *Msmeg\_5447* and *Rv1002c* was analysed. Unexpectedly, while the *M. smegmatis* phenotype was unaffected by the lack of mannoproteins, the *M. tuberculosis* mutant showed severely impacted growth *in vitro* and *in cellulo* associated with a strong attenuation of its pathogenicity in immunocompromised mice. These data are unique in providing evidence of the biological significance of protein O-mannosylation in mycobacteria (Lommel and Strahl 2009) and demonstrate the crucial contribution of this post-translational protein modification to *M. tuberculosis* virulence in the host (Liu et al. 2013). Specifically, the 45/47-kDa alanine-proline-rich adhesin (Apa), an immunodominant antigen secreted by *M. tuberculosis*, is O-mannosylated at multiple sites. Glycosylation of Apa plays a key role in colonisation and invasion of the host cells by *M. tuberculosis* through interactions of Apa with C-type lectins of the host immune system (Coddeville et al. 2012).

*Mycobacterium marinum*, a fish pathogen, phylogenetically close to *M. tuberculosis*, induces a granulomatous response with features similar to those described for *M. tuberculosis* in humans. O-Mannosylation of *M. marinum* Apa is required for antigenicity but appears to be dispensable for its immunogenicity and protective efficacy in mice. These results have implications for the development of subunit vaccines using tailored glycoproteins against infectious diseases such as

tuberculosis (Nandakumar et al. 2013). Another glycosylated *M. tuberculosis* protein is the secreted glycoprotein Rv1860, which was shown to inhibit DC-mediated Th1 and Th17 polarisation of T cells and abrogate protective immunity conferred by *M. bovis* (Satchidanandam et al. 2014). *Mycobacterium tuberculosis* Rv1860 carries at threonine sites one to three mannose residues linked to each other by  $\alpha$ -(1→2) and  $\alpha$ -(1→3) glycosidic bonds (Dobos et al. 1996). Based on MS characterisation of Con-A binding proteins, *M. tuberculosis* codes for at least 41 glycoproteins (González-Zamorano et al. 2009). Recent reports describe interferon- $\gamma$  secretion by human CD4<sup>+</sup> and CD8<sup>+</sup> T cells in response to recombinant *E. coli*-expressed *M. tuberculosis* Rv1860 protein as well as protection of guinea pigs against a challenge with virulent *M. tuberculosis* following prime-boost immunisation with a DNA vaccine and poxvirus expressing Rv1860.

The serine-rich repeat (SRR) glycoproteins of Gram-positive bacteria constitute a large family of cell-wall proteins among which there are the surface adhesins; the accessory secretion (Sec) system is a specialised transport system for the export of these SRR glycoproteins (Seepersaud et al. 2012). The system contains two homologues of the general Sec pathway (SecA2 and SecY2) and several other essential proteins (Asp1 to Asp5) that share no homology to proteins of known function (Yen et al. 2013). In *Streptococcus gordonii*, Asp2 is a bifunctional protein required for the transport of the SRR adhesin GspB and for its correct glycosylation by modulating GlcNAc deposition onto GspB (Bensing, Gibson and Sullam 2004; Zhou and Wu 2009). According to tertiary structure predictions, the carboxyl terminus of Asp2 resembles the catalytic region of numerous enzymes that function through a Ser-Asp-His catalytic triad. In fact, sequence alignment of known Asp2 homologues identified a highly conserved pentapeptide motif (Gly-X-Ser362-X-Gly) typical of most Ser-Asp-His catalytic triads, where Ser forms the reactive residue. The catalytic domain might be responsible for controlling GspB glycosylation, while surrounding regions might be functionally required for glycoprotein transport (Seepersaud et al. 2012).

In *S. pneumoniae*, the core enzyme GtfA and the coactivator GtfB form an OST complex to O-GlcNAcylate the pneumococcal SRR protein adhesin (PsrP), which is involved in infection and pathogenesis (Lu, Li and Shao 2015). An *in vitro* glycosylation system enabled mapping of the O-linkages to the serine residues within the first SRR of PsrP. These findings suggest that fusion with an add-on domain might be a universal mechanism for diverse OGTs that recognise varying acceptor proteins/peptides (Shi et al. 2014).

*Staphylococcus aureus* has been shown to bind to human platelets through a variety of surface molecules, including an SRR adhesin for platelets (SraP), which is a cell-wall-anchored glycoprotein (Zhou and Wu 2009; Li et al. 2014). SecY2, Asp1, Asp2, Asp3 and SecA2 encoded in the SraP operon are required for the efficient transport of glycosylated SraP from the cytoplasm to the bacterial cell surface (Yen et al. 2013). An SraP mutant strain of *St. aureus* was significantly impaired in its ability to initiate infection compared with the wild type. In fact, it was demonstrated that the predicted OST components GtfA and GtfB transfer GlcNAc-containing oligosaccharides to recombinant SraP. Deletion of either one or both of the OSTs abolished glycosylation of SraP, indicating that both are required for SraP glycosylation in *St. aureus* (Li et al. 2014; Lu, Li and Shao 2015).

The spores of *Ba. anthracis* are notorious for their potential in the development of weapons for mass destruction (Tan and Turnbough 2010). Therefore, over recent years, substantial effort has been directed onto the discovery of novel antigens

from *Ba. anthracis*, including the identification and immunochemical evaluation of glycans that might be used for the specific diagnostic detection of this pathogen. Among the carbohydrate structures found on the surface of vegetative *Ba. anthracis* cells and spores are the cell-wall polysaccharide and multiple copies of an O-linked pentasaccharide that are attached to several sites within the central collagen-like region of BclA (for *Bacillus* collagen-like protein of *anthracis*) (Dong et al. 2008). The structure of this oligosaccharide is 2-O-methyl-4-(3-hydroxy-3-methylbutamido)-4,6-dideoxy- $\beta$ -D-Glcp-(1→3)- $\alpha$ -L-Rhap-(1→3)- $\alpha$ -L-Rhap-(1→2)-L-Rhap-(1→?)-GalNAc (Daubenspeck et al. 2004). The novel terminal sugar 2-O-methyl-4-(3-hydroxy-3-methylbutamido)-4,6-dideoxy-D-glucose was given the trivial name anthrose (Ant). A truncated version of the pentasaccharide, a tetrasaccharide lacking the reducing-end GalNAc residue, was chemically synthesised by several groups and is virtually identical to the material isolated from the *Ba. anthracis* exosporium, validating the originally proposed structure (Adamo, Saksena and Kováč 2005; Saksena, Adamo and Kováč 2006; Adamo 2014). To produce a conjugate model vaccine, the synthetic tetrasaccharide  $\beta$ -Ant-(1→3)- $\alpha$ -L-Rhap-(1→3)- $\alpha$ -L-Rhap-(1→2)-L-Rhap was covalently linked to a protein carrier (Mehta et al. 2006). Immunisation of animals with the vaccine elicited antibodies that bound specifically to *Ba. anthracis* spores (Mehta et al. 2006), providing evidence that the oligosaccharide chains are exposed on the spore surface. Since these sugar moieties are highly specific for the spores of *Ba. anthracis*, they appear to be key biomarkers for the detection of *Ba. anthracis* spores and promising candidates for the development of novel vaccines targeting anthrax spores (Wang et al. 2007). A detailed reinvestigation of spores of the *Ba. cereus* group (*Ba. cereus*, *Ba. anthracis* and *Ba. thuringiensis*) revealed species and domain specificity of BclA glycosylation within the *Ba. cereus* group. The collagen-like regions of both *Ba. cereus* and *Ba. anthracis* are similarly substituted by short O-glycans that bear the species-specific deoxyhexose residues anthrose and the newly observed cereose (abbreviated Cro). Besides a Cro-less trisaccharide the wild-type BclA tetrasaccharide has the structure  $\beta$ -Cro-(1→4)- $\alpha$ -3-OMe-Rha-(1→2)- $\alpha$ -Rha-(1→3)-GalNAc-ol (Maes et al. 2016). Moreover, the C-terminal globular domains of BclA from both species are substituted by polysaccharide-like O-glycans whose structures are also species specific. The presence of such polymers on *Bacillus* spores may have profound impact on spore interaction with biotic and abiotic surfaces.

Recently, evidence was provided that the major spore surface protein BclA of *Cl. difficile* is glycosylated, in addition to several other proteins of this microorganism (Strong et al. 2014). Biochemical characterisation of glycopeptides corresponding to a putative exosporangial glycoprotein (BclA3) showed that these molecules were modified with multiple HexNAc moieties and, in some cases, capped with novel glycans. The glycosyltransferase gene *sgtA* (gene CD3350 in strain 630 and CDR3194 in strain R20291), which is located immediately upstream of and cotranscribed with *bclA3*, was found to be involved in the glycosylation of the spore surface. Reactivity of the spore surface with the anti- $\beta$ -O-GlcNAc antibody was abolished in the 630 and R20291 glycosyltransferase mutants, while complementation with a wild-type copy of the gene restored  $\beta$ -O-GlcNAc reactivity (Strong et al. 2014).

Recently, a protein O-glycosylation system that is unique in that extracytoplasmic proteins are glycosylated at serine or threonine residues within the specific three-amino acid motif D(S/T)(A/I/L/M/T/V) (Fletcher, Coyne and Comstock 2011) was

identified in the Gram-negative intestinal gut symbiont *Bac. fragilis*. In the course of a computational analysis of the bacterial proteome, 1021 *Bac. fragilis* candidate glycoproteins were identified. Among those were species predicted to be localised in the inner membrane, a compartment not previously shown to include glycoproteins. In addition, four glycoproteins involved in cell division and chromosomal segregation were predicted. Up to date, all extracytoplasmic *Bac. fragilis* proteins containing the specific glycosylation motif were found to be glycosylated; it is likely that hundreds of proteins, comprising more than half of the extracytoplasmic proteins of *Bac. fragilis*, are indeed glycosylated. By engineering glycosylation motifs into a naturally unglycosylated protein, it was possible to bring about site-specific glycosylation at the engineered sites, suggesting that this glycosylation system may have applications for glycoengineering (Fletcher, Coyne and Comstock 2011).

*Porphyromonas gingivalis*, which is phylogenetically closely related to *Bac. fragilis*, has been implicated as a major pathogen associated with chronic periodontitis. A proteomic analysis of *Po. gingivalis* ATCC 33277 revealed the presence of four novel glycoproteins, namely PGN0743, PGN0876, PGN1513 and PGN0729 (Kishi et al. 2012); these are predicted to possess a range of biochemical activities, such as chaperone functions based on partial homology with a *cis-trans* isomerase (PGN0743), and diverse subcellular localisations. Two of them (PGN0876, PGN1513) contain tetratricopeptide repeat domains known to mediate protein–protein interactions, and PGN0729 encodes the outer membrane protein 41 precursor, which was previously identified as Pgm6 and is a homologue of the OmpA protein in *E. coli* (Murakami et al. 2002; Dumetz et al. 2007). There is evidence that *Po. gingivalis* possesses a general mechanism for protein glycosylation and that the novel glycoproteins PGN0743 and PGN0876 may play an important role in bacterial growth and colonisation (Kishi et al. 2012).

Another oral bacterium, the human oropharyngeal pathogen *Aggregatibacter* (formerly *Actinobacillus*) *actinomycetemcomitans* that is a Gram-negative, facultative non-motile, rod-shaped oral commensal synthesises multiple adhesins, including the non-fimbrial extracellular matrix protein adhesin A (EmaA) that is required for collagen binding (Tang and Mintz 2010). Two forms of EmaA were identified, which are suggested to be linked to the O-polysaccharide (O-PS) of the bacterium's LPS, maintaining collagen-binding activity (Tang et al. 2007). This association was investigated by generating mutants of a Rha biosynthetic enzyme (RmlC; dTDP-4-dehydrorhamnose 3,5-epimerase), the ABC sugar transport protein (Wzt) and the O antigen ligase (WaaL). All three mutants produced reduced amounts of O-PS, and the EmaA monomers in these mutants displayed a modified glycosylation as was suggested by lectin blots using the fucose-specific *Lens culinaris* agglutinin directed towards the fucose residue present in serotype b O-PS. The  $\Delta rmlC$  mutant expressing modified EmaA protein demonstrated reduced collagen adhesion, supporting a role of the glycoconjugate in collagen binding. These data provided experimental evidence for the dependence of the post-translational modification of EmaA on the LPS biosynthetic machinery in *Ag. actinomycetemcomitans* (Tang and Mintz 2010).

While occurrence, biosynthesis and possible functions of glycoproteins are increasingly documented for pathogens, they are not yet widely described for probiotic bacteria. Knowledge of protein glycosylation in these bacteria is pivotal not only for our understanding of their repertoire of glycan-mediated interactions but also for glycoengineering approaches in food-grade microbes like *Lactobacillus rhamnosus* GG (Lebeer et al. 2012).

The peptidoglycan (PG) hydrolase Msp1 of *La. rhamnosus* is O-glycosylated as evidenced by the identification of a glycopeptide TVETPSSA (amino acids 101–108) bearing hexoses presumably linked to serine residues (Ser106 and Ser107). Obviously, these serine residues of the *La. rhamnosus* enzyme are glycosylated with ConA-reactive sugars; however, they are absent in the homologous enzyme of several *La. casei* strains tested, which also failed to bind ConA. Glycosylation is neither required for enzymatic activity of Msp1 nor for Akt activation capacity in epithelial cells, but appears to be important for enzyme stability and protection against proteases (Lebeer et al. 2012).

Recent analyses of the major autolysin Acm2 from *La. plantarum* strain WCFS1 showed that it undergoes intracellular O-GlcNAcylation (Fredriksen et al. 2012, 2013; Lee et al. 2014). Using biochemical methods, so far 11 *Lactobacillus* glycoproteins were detected exhibiting in total 49 glycosylation sites for HexNAc. Further, based on a comparative genomic approach, six candidate *La. plantarum* WCFS1 genes—*tagE1* to *tagE6*—with significant homology to Gtf1, an enzyme involved in the glycosylation of a fimbria-associated protein (Fap1) in *S. parasanguinis* (Bu et al. 2008), were identified. The candidate genes were targeted by systematic gene deletion, followed by assessment of the consequences on Acm2 glycosylation. sWGA lectin blotting experiments using a panel of eight other *La. plantarum* strains revealed that protein glycosylation is a common feature in *La. plantarum* strains. With the establishment of these enzymes as protein glycosyltransferases, renaming was proposed for TagE5 and TagE6 as GtfA and GtfB, respectively (Lee et al. 2014).

## S-LINKED GLYCOPROTEINS

Recently, a new group of glycoconjugates in the form of ribosomal antimicrobial polypeptides, collectively known as bacteriocins, named glycocins (glycosylated bacteriocins) with cysteine-(S-) linked glycans have been identified (Stepper et al. 2011; Wang and van der Donk 2011).

Among them is glycocin F that is secreted by *Lactobacillus plantarum* KW30; it is modified with an N-acetylhexosamine S-linked to its C-terminal Cys43 residue (Venugopal et al. 2011) in addition to a GlcNAc residue,  $\beta$ -O-linked to Ser18. The latter is essential for bacteriostatic activity of glycocin F in addition to the C-terminus of the peptide being required for its full potency (IC<sub>50</sub> 2 nM) (Stepper et al. 2011).

Genomic context analysis identified diverse putative glycocins in *Firmicutes*. One of these, the reputed lantibiotic sublancin 168 of *Bacillus subtilis* 168 (Paik, Chakicherla and Hansen 1998), was shown to contain a hexose S-linked to Cys22. This residue within the 56-amino acid peptide substrate is selectively modified by a novel S-glycosyltransferase named SunS, which accepts a variety of NDP sugars. It is suggested that SunS recognises an  $\alpha$ -helix N-terminal of the SunA cysteine that is present in a flexible linker for glycosylation (Wang and van der Donk 2011). The solution structure of sublancin 168, a 37-amino-acid peptide produced by *Ba. subtilis* 168, has been solved by NMR spectroscopy; it comprises two  $\alpha$ -helices and a well-defined interhelical loop (Garcia De Gonzalo et al. 2014). The two helices span residues 6–16 and 26–35, and the loop region encompasses residues 17–25. The 9-amino-acid loop region contains a  $\beta$ -S-linked glucose moiety attached to Cys22. Interestingly, sugar attachment is not required for sublancin antimicrobial activity as evidenced upon mutation of Cys22. Considering that the sublancin-producing strain *Ba. subtilis* 168 is susceptible to such mutation also intrinsically, S-glycosylation at Cys22 may



constitute an unusual type of self-resistance and, consequently, stability (Wang and van der Donk 2011).

## PROKARYOTIC SURFACE LAYER (S-LAYER) GLYCOPROTEINS

S-layers are one of the most commonly observed cell-surface structures on different species of nearly every phylogenetic group of prokaryotes. They are formed by self-assembly of monomeric (glyco)proteins into regularly spaced, 2D crystalline arrays with nanometer-scaled periodicity (4–30 nm). Bacteria possess dedicated pathways for the secretion and anchoring of their S-layer to the cell wall, and some Gram-positive species have large S-layer-associated gene families. S-layers have important roles in bacterial growth and survival, and their many functions include the maintenance of cell integrity, enzyme display and, in pathogens and commensals, interaction with the host and its immune system (Sleytr 1978; Sleytr and Messner 1983; Messner and Schäffer 2003; Åvall-Jääskeläinen and Palva 2005; Messner et al. 2010; Hynönen and Palva 2013; Fagan and Fairweather 2014; Sleytr et al. 2014; Gerbino et al. 2015). Current approaches are exploiting the nanopatterned S-layer matrix for the display of biologically relevant molecules (Schuster and Sleytr 2013; Allievi et al. 2014; Baneyx and Matthaëi 2014; Carasi et al. 2014; Turroni et al. 2014; Misra, Basu and Apte 2015; Valero et al. 2015; Zhang et al. 2015).

S-layer protein subunits can undergo glycosylation with glycans of varying complexity (Messner and Sleytr 1991; Messner 1997; Messner and Schäffer 2003; Schäffer and Messner 2004; Messner et al. 2010). Despite the fact that considerable variation exists in the structure and chemistry of prokaryotic cell envelopes, S-layers have apparently coevolved with these diverse structures. In bacteria and archaea, the S-layer lattice assembles on the surface of the rigid wall matrix that is mainly composed of PG or pseudomurein, respectively (Sleytr and Messner 1983). In Gram-positive bacteria, the S-layer has been shown to be attached to PG-bound secondary cell-wall polymers (SCWPs) (Araki and Ito 1989; Mesnage et al. 2000; Sára 2001; Cava et al. 2004; Schäffer and Messner 2005; Pavkov et al. 2008; Messner, Schäffer and Kosma 2013) (*vide infra*); in Gram-negative bacteria, there are indications for attachment of the S-layer to LPS (Awram and Smit 2001); and in most archaea, S-layers are closely attached to or inserted into the plasma membrane (Sumper 1987; Lechner and Wieland 1989; Abdul Halim et al. 2016).

In this section, we give a general overview on the chemical structure and biosynthesis of both bacterial and archaeal S-layer glycoprotein glycans (Fig. 2) and, then, focus particularly on those organisms that have attracted special attention in the past because of scientific, medical or public implications.

### Bacterial S-layer glycoproteins

Since the first description of bacterial S-layer glycoproteins on Gram-positive thermophilic clostridia, now renamed *Thermoanaerobacter thermohydrosulfuricus* (*T. thermohydrosulfuricus*) L111-69 and *Thermoanaerobacterium thermosaccharolyticum* (*Th. thermosaccharolyticum*) D120-70 (Sleytr and Thorne 1976), the number of S-layer glycoprotein-carrying organisms has increased considerably, including Gram-positive isolates such as *Geobacillus* (formerly *Bacillus*) *stearothermophilus* NRS 2004/3a (Steiner et al. 2008), *Anoxybacillus* (formerly *Geobacillus*) *tepidamans* (Kählig et al. 2005), *Aneurinibacillus* (formerly *Bacillus*) *thermoaerophilus* (Kosma et al. 1995b; Pfoestl et al. 2003), different *T.*

*thermoaerophilus* (Altman et al. 1992; Christian et al. 1993; Bock et al. 1994) and *Th. thermosaccharolyticum* strains (Altman et al. 1995), *Paenibacillus alvei* CCM 2051<sup>T</sup> (Altman et al. 1991; Messner et al. 1995) and different *Lactobacillus buchneri* strains (Möschl et al. 1993; Anzengruber et al. 2014b), as well as one Gram-negative bacterium—the oral pathogen *Tannerella forsythia* ATCC 43037 (Posch et al. 2011) (Fig. 2).

The S-layer glycoprotein of *Geobacillus stearothermophilus* NRS 2004/3a was the first bacterial S-layer protein whose glycosylation was studied in detail (Küpcü et al. 1984). The S-layer was isolated by detergent extraction, purified, and after thorough proteolytic digestion the material was purified by gel permeation chromatography. Colorimetric sugar determination revealed Rha as the predominant constituent (55%) of the glycopeptides and traces of Gal (~2%). This material was tritium labelled with N-succinimidyl[2,3-<sup>3</sup>H]propionate and subjected to hydrazinolysis to cleave the glycan off from the labelled glycopeptides (Küpcü et al. 1984). <sup>1</sup>H- and <sup>13</sup>C NMR spectroscopy revealed two types of glycan chains, one of which, a rhamnan with the repeating unit structure →2)-α-L-Rhap-(1→2)-α-L-Rhap-(1→3)-β-L-Rhap-(1→ (Fig. 2) (Christian et al. 1986), was shown to decorate the 93-kDa surface layer protein SgsE of *G. stearothermophilus* NRS 2004/3a at least three distinct sites (Thr590, Thr620 and Ser794; (Fig. 2). The other turned out to be a copurified SCWP present in the bacterial cell envelope (Messner et al. 1987; Schäffer et al. 1999a) (*vide infra*, section 'SCWP'). The elongated rhamnan chains were subsequently shown to additionally comprise a 2-O-methyl modification of the terminal trisaccharide at the non-reducing end and a core saccharide as a linker to the S-layer protein (Schäffer et al. 1999a). Surprisingly, the rhamnosylated S-layer protein of this bacterium reveals a four-banded pattern on SDS-PAGE. According to our current interpretation, the three high-molecular-mass bands originate from either one, two or three glycosylation sites per S-layer protein, whereas the low-molecular-mass band represents non-glycosylated protein (Steiner et al. 2006). Further, microheterogeneity was assigned to the S-layer glycans, with the most prevalent variation between 12 and 18 trisaccharide repeating units accompanied with the possibility of extension of the already-known →3)-α-L-Rhap-(1→3)-α-L-Rhap-(1→ core by one additional Rha residue. The microheterogeneity of elongated sugar chains in *G. stearothermophilus* NRS 2004/3a S-layer glycopeptides, containing up to 51 monosaccharide residues at a single O-attachment site on a 12-amino acid peptide backbone, was investigated by Fourier transform ion cyclotron resonance MS (Bindila et al. 2007).

S-layer glycan biosynthesis in *G. stearothermophilus* NRS 2004/3a is encoded by a polycistronic *slg* (surface layer glycosylation) gene cluster. To get insight into the glycosylation pathway of the S-layer glycoprotein SgsE, the first step was the characterisation of WsaP from this gene cluster as a UDP-Gal:phosphoryl-polyprenol Gal-1-phosphate transferase that primes S-layer glycoprotein glycan biosynthesis in this organism. The enzyme transfers *in vitro* a galactose-1-phosphate from UDP-Gal to endogenous phosphoryl-polyprenol, with the C-terminal half of WsaP comprising the galactosyltransferase function, in analogy to UDP-Gal:phosphoryl-polyprenol Gal-1-phosphate transferase WbaP from *Salmonella enterica* (Steiner et al. 2007). Four assigned glycosyltransferases, named WsaC–WsaF, were investigated by a combined biochemical and NMR approach, starting from synthetic octyl-linked saccharide precursors (Messner et al. 2008). Three of the enzymes are rhamnosyl transferases that are responsible for the transfer of L-Rha from a dTDP-β-L-Rha precursor to the nascent S-layer glycan, catalysing the formation of

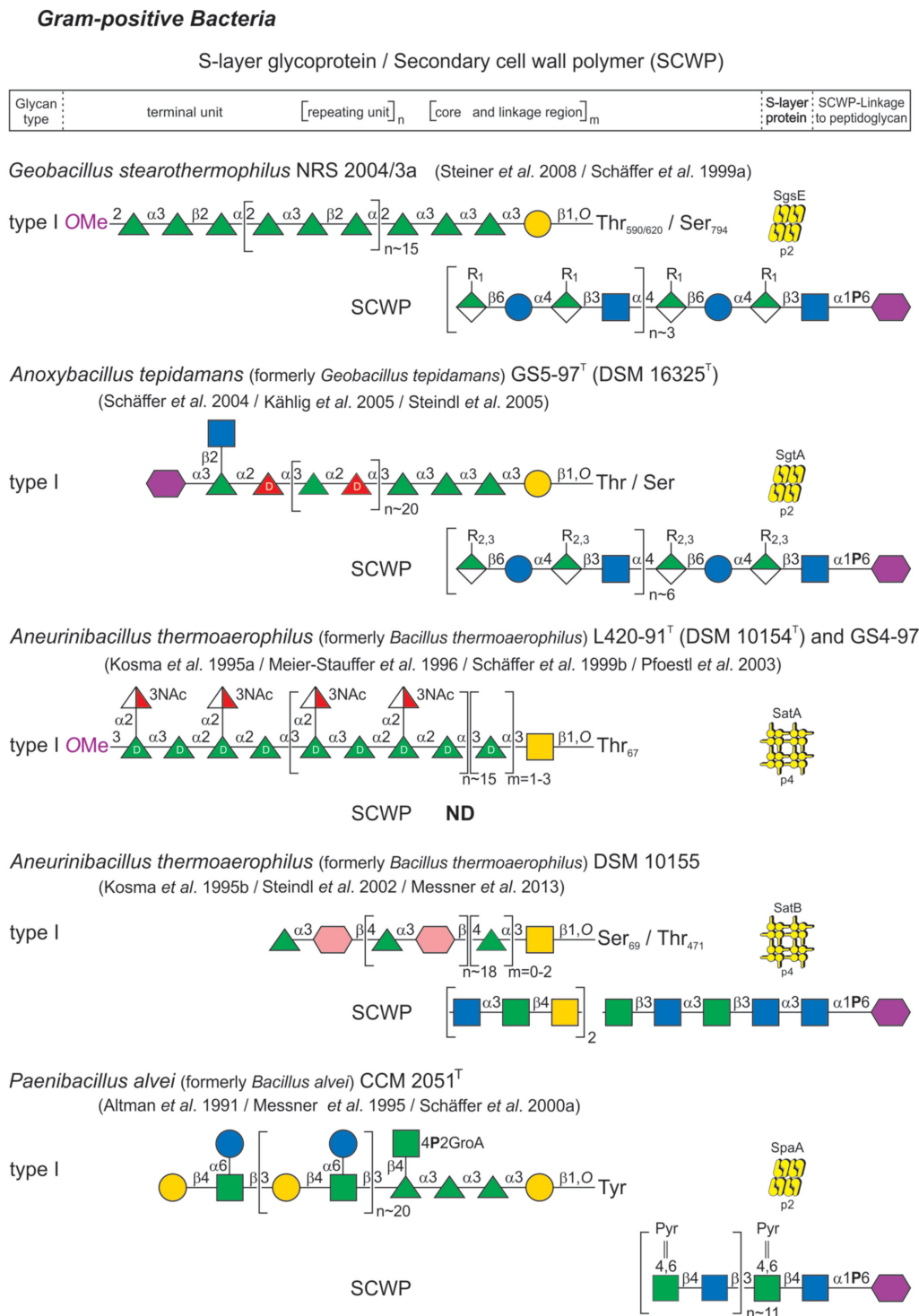

**Figure 2.** Schematic depiction of S-layer glycoprotein glycans from Gram-positive and Gram-negative bacteria and archaea and of SCWPs of Gram-positive bacteria. Ac, CH<sub>3</sub>COO<sup>-</sup>; CONH<sub>2</sub>, amidyl-; -COOMe, methyl ester; Me, CH<sub>3</sub>-; NAc, N-acetyl-; P, phosphate; Pyr, pyruvyl; R<sub>1</sub>, -COOH; R<sub>2</sub>, -CONHAc; R<sub>3</sub>, -CONAc<sub>2</sub>; S, sulfate; Sugar symbols: ○, hexose; ◊, hexuronic acid; ●, glucose; ■, N-acetylglucosamine; ◄, glucuronic acid; ▲, 3-N-acetylquinovosamine; ▲, 2,3-di-N-acetylglucuronic acid; ▲, 6-sulfoquinovose;<sup>2NH</sup>▲, 2-amino-6-sulfo-2,6-dideoxy-quinovose; ●, galactose; ●, galactofuranose; ■, N-acetylgalactosamine; ◄, galacturonic acid; ◄, 3-O-methylgalacturonic acid; ●, mannose; ■, N-acetylmannosamine; ◄, mannosaminuronic acid; ◄, 6-N-amido-Thr mannosaminuronic acid; ▲, L-rhamnose; ▲, D-rhamnose; ▲, L-fucose; ▲, D-fucose; ▲, 3-N-acetylglucosamine; ◄, iduronic acid; ★, ribose; ★, D-glycero-D-manno-heptose; ★, xylose; ★, digitoxose; ★, 5-acetamidino-7-glycerolyl pseudaminic acid; ★, N-acetylmuramic acid. Monosaccharide symbols follow the SNFG (Symbol Nomenclature for Glycans) (Appendix-1B 2015). (Mescher and Strominger 1976; Koval and Jarrell 1987; Lechner and Sumper 1987; Sumper *et al.* 1990; Altman *et al.* 1991, 1992, 1995, 1996; Baumeister and Lembcke 1992; Christian *et al.* 1993; Kärcher *et al.* 1993; Möschl *et al.* 1993; Bock *et al.* 1994; Messner *et al.* 1995; Kosma *et al.* 1995a,b; Meier-Stauffer *et al.* 1996; Schäffer *et al.* 1999a,b, 2000a,b, 2004; Eichler 2000, 2013; Steindl *et al.* 2002, 2005; Pfoestl *et al.* 2003; Kählig *et al.* 2005; Voisin *et al.* 2005; Steiner *et al.* 2008; Veith *et al.* 2009; Peyfoon *et al.* 2010; Posch *et al.* 2011; Messner, Schäffer and Kosma 2013; Palmieri *et al.* 2013; Kandiba and Eichler 2014; Parente *et al.* 2014; Anzengruber *et al.* 2014a; Appendix-1B 2015; Lu *et al.* 2015; Kandiba *et al.* 2016). (Extended and modified from Eichler 2013. With permission from Nature Publishing Group).

## Gram-positive Bacteria

## S-layer glycoprotein / Secondary cell wall polymer (SCWP)

Glycan type	terminal unit	[repeating unit] <sub>n</sub>	[core and linkage region] <sub>m</sub>	S-layer protein
-------------	---------------	-------------------------------	--	-----------------

*Thermoanaerobacterium thermosaccharolyticum* (formerly *Clostridium thermosaccharolyticum*) E207-71  
(Altman et al. 1995 / Altman et al. 1996)

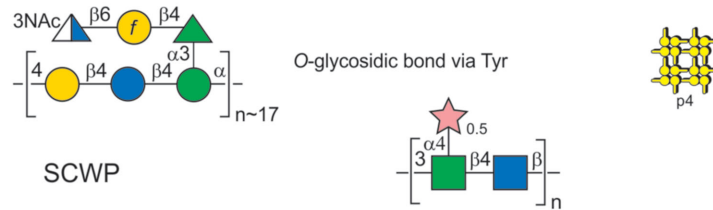

*Thermoanaerobacterium thermosaccharolyticum* D120-70 (Schäffer et al. 2000b)

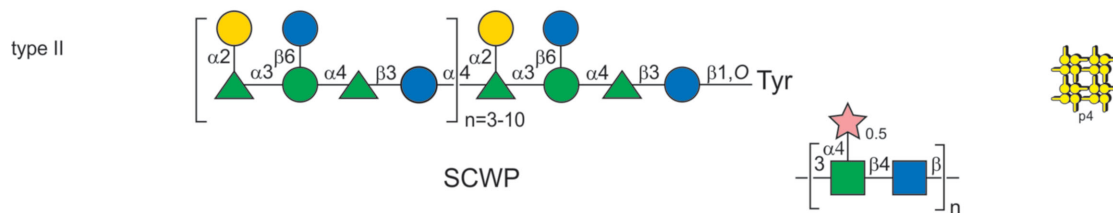

*Thermoanaerobacter thermohydrosulfuricus* L111-69 and L110-69 (DSM 568) (Bock et al. 1994)

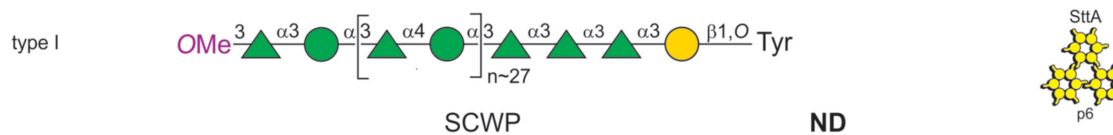

*Thermoanaerobacter thermohydrosulfuricus* L77-66 (DSM 569) and L92-71 (Altman et al. 1992)

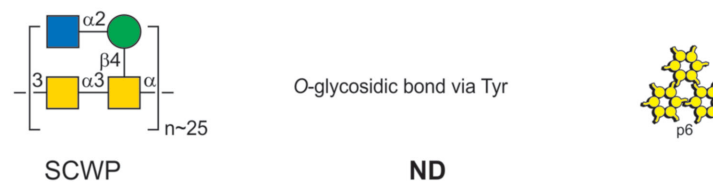

*Thermoanaerobacter thermohydrosulfuricus* S102-70 (Christian et al. 1993)

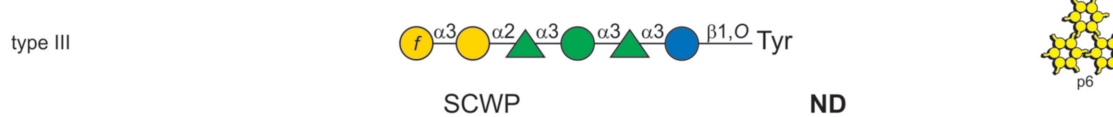

*Lactobacillus buchneri* CD034 and 41021/251 (Anzengruber et al. 2014a / Möschl et al. 1993)

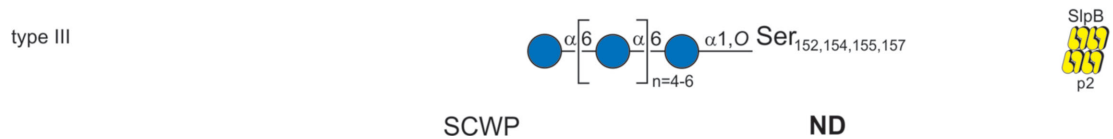
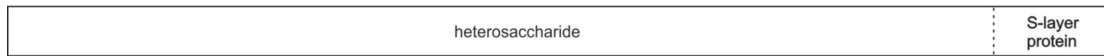

Figure 2 (Continued).



**Gram-negative Bacteria**

S-layer glycoprotein



*Tannerella forsythia* ATCC 43037 (Posch *et al.* 2011)

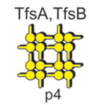
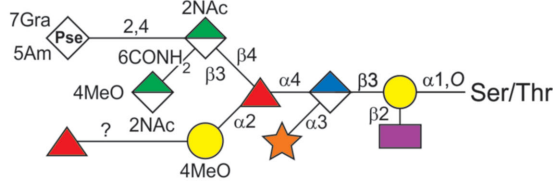

**Archaea**

*Halobacterium salinarum* R<sub>1</sub>M<sub>1</sub>

(Mescher and Strominger 1976 / Lechner und Sumper 1987 / Kandiba and Eichler 2014)

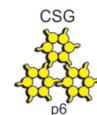
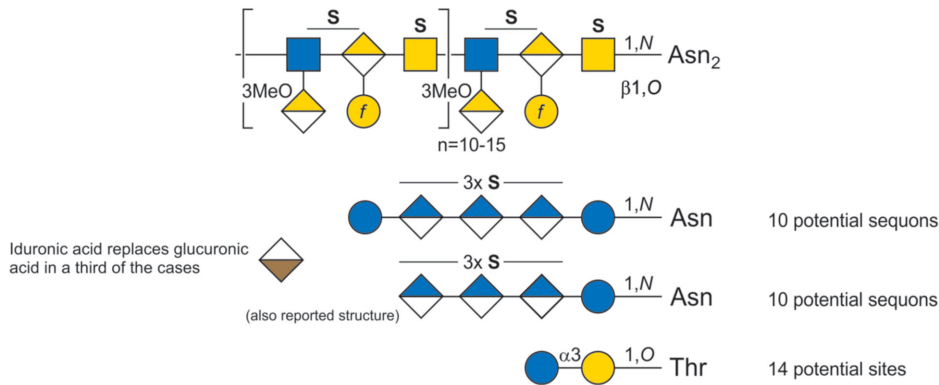

Iduronic acid replaces glucuronic acid in a third of the cases  
(also reported structure)

*Haloferax volcanii* DS2 (Sumper *et al.* 1990 / Eichler 2000 / Eichler 2013 / Kaminski *et al.* 2013 / Kandiba and Eichler 2014 / Parente *et al.* 2014 / Kandiba *et al.* 2016)

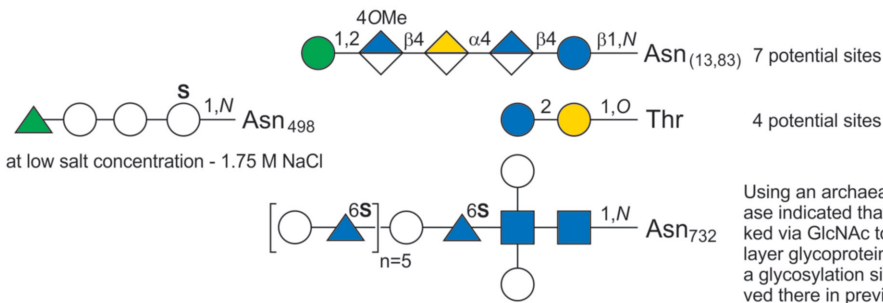

Using an archaeal rhomboid protease indicated that the glycan is linked via GlcNAc to Asn732 of the S-layer glycoprotein of *Hfx. volcanii*; a glycosylation site was not observed there in previous studies

*Haloarcula hispanica* (Lu *et al.* 2015a)

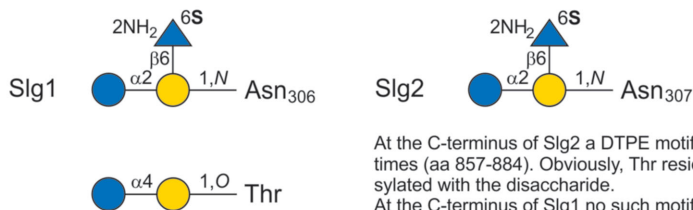

At the C-terminus of Slg2 a DTPE motif was identified, which is repeated six times (aa 857-884). Obviously, Thr residues in the DTPE motifs are O-glycosylated with the disaccharide.  
At the C-terminus of Slg1 no such motifs were found. This region is rich in Asp, Glu, Thr and Pro residues - it is assumed that Thr residues in this region become O-glycosylated with the disaccharide.

Figure 2 (Continued).

## Archaea

## S-layer glycoprotein

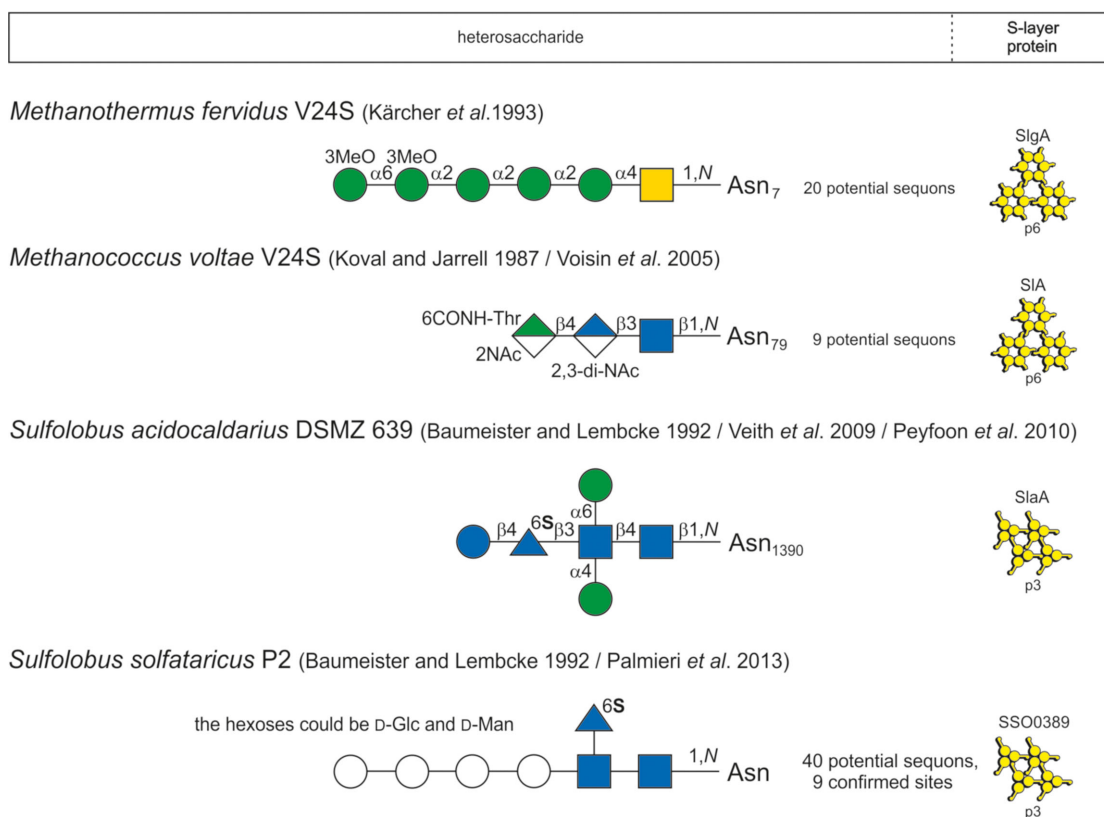

Figure 2 (Continued).

the  $\alpha$ 1,3- (WsaC and WsaD) and  $\beta$ 1,2-linkages (WsaF) (Steiner *et al.* 2010), present in the adaptor saccharide and in the repeating units of the mature S-layer glycan, respectively. These enzymes work in concert with a multifunctional methylrhamsosyl transferase (WsaE). The N-terminal portion of WsaE is responsible for the S-adenosyl methionine-dependent methylation reaction of the terminal  $\alpha$ 1,3-linked L-Rha residue, and the central and C-terminal portions are involved in the transfer of L-Rha from dTDP- $\beta$ -L-Rha to the adaptor saccharide to form the  $\alpha$ 1,2- and  $\alpha$ 1,3-linkages during S-layer glycan chain elongation, with the methylation and the glycosylation reactions occurring independently. Characterisation of these enzymes revealed a molecular basis for S-layer glycan biosynthesis in *G. stearothermophilus* NRS 2004/3a (Steiner *et al.* 2008).

While protein O-glycosylation at serine, threonine or hydroxyproline residues has been studied in detail in prokaryotes (Jarrell *et al.* 2014; Varki *et al.* 2015), only few data are available on O-glycosidic attachment of glycans to the amino acid tyrosine. A bacterial protein tyrosine O-glycosylation system was described for the S-layer glycoproteins of *T. thermohydrosulfuricus* strains S102-70 (Messner *et al.* 1992; Christian *et al.* 1993) and L111-69 (Bock *et al.* 1994; Messner *et al.* 1995), *Th. thermosaccharolyticum* strains D120-70 (Altman *et al.* 1990) and E207-71 (Altman *et al.* 1995), and *Pa. alvei* CCM 2051<sup>T</sup> (Messner *et al.* 1995). The latter is a secondary invader of diseased honeybee colonies infected with *Melissococcus pluton*, the causative agent of European foulbrood (Govan *et al.* 1998). In *Pa. alvei* CCM 2051<sup>T</sup>, a polysaccharide consisting of  $[-\rightarrow 3]-\beta$ -D-Galp-

$(1\rightarrow 4)-[\alpha$ -D-Glcp-( $1\rightarrow 6)]-\beta$ -D-ManpNAC-( $1\rightarrow$ )<sub>n</sub> repeating units is O-glycosidically linked via an adaptor saccharide with the structure  $-\text{[GroA-2}\rightarrow\text{4-OPO}_2\rightarrow\text{4-}\beta$ -D-ManpNAC-( $1\rightarrow 4$ ) $\rightarrow$ 3]- $\alpha$ -L-Rhap-( $1\rightarrow 3$ )- $\alpha$ -L-Rhap-( $1\rightarrow 3$ )- $\alpha$ -L-Rhap-( $1\rightarrow 3$ )- $\beta$ -D-Galp-( $1\rightarrow$ ) to specific tyrosine residues of the S-layer protein SpaA (Figs 2 and 3).

A 24.3-kb *slg* gene cluster comprising 18 open reading frames (ORF) encodes information for the biosynthesis of nucleotide-activated monosaccharides, glycan assembly and export as well as transfer of the completed polysaccharide chain to the S-layer target by a predicted O-OST (Zarschler *et al.* 2010b). To study the glycosylation process in detail, all ORFs of the *slg* gene cluster, except those encoding the nucleotide sugar biosynthesis enzymes and the ABC transporter integral transmembrane proteins (Cuthbertson, Kos and Whitfield 2010) were disrupted by the insertion of the mobile group II intron Ll.LtrB, and S-layer glycoproteins produced in mutant backgrounds were analysed for their glycosylation status by MS. There is evidence that the glycan chain of *Pa. alvei* CCM 2051<sup>T</sup> is synthesised in a process comparable to the ABC transporter-dependent pathway of the LPS O-PS biosynthesis (Cuthbertson, Kos and Whitfield 2010). Furthermore, with the protein WsFb, we have identified a good candidate for an OST involved in the formation of the covalent  $\beta$ -D-Galp $\rightarrow$ Tyr linkage between the glycan chain and the S-layer protein SpaA (Zarschler *et al.* 2010b). As also evidenced for the S-layer Ser/Thr glycosylation system of *G. stearothermophilus* NRS 2004/3a, the components encoded in the *slg* gene cluster work in concert with housekeeping genes such as those required for the

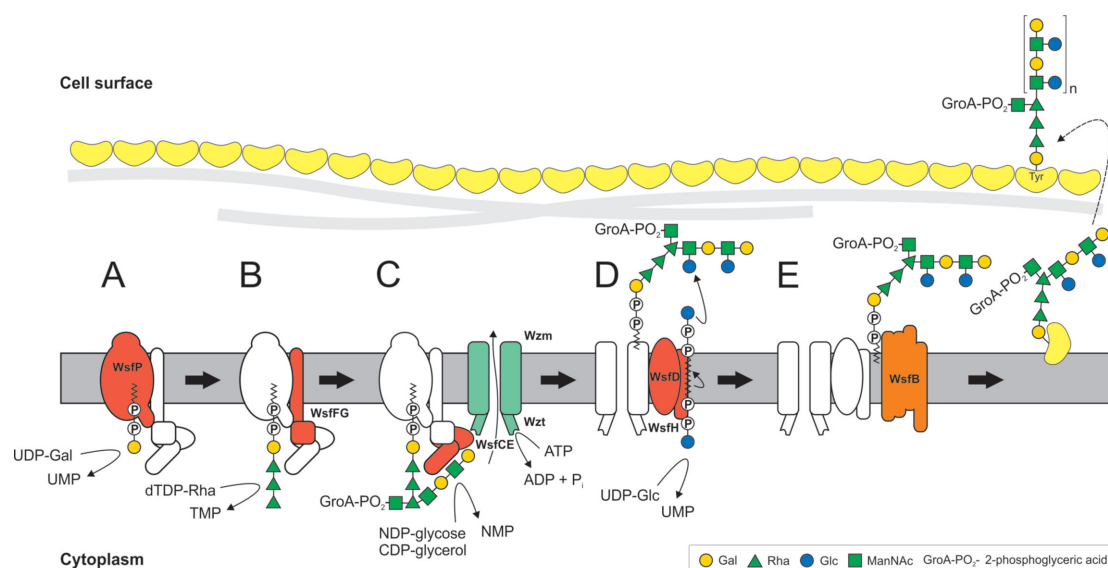

**Figure 3.** Working model of S-layer glycan biosynthesis in *Pa. alvei* CCM 2051<sup>T</sup>. The initial transfer of a Gal residue from UDP- $\alpha$ -D-Gal to a lipid carrier is catalysed by WsfP (A). The adaptor saccharide is formed by the  $\alpha$ 1,3-linkage of an L-Rha residue from dTDP- $\beta$ -L-Rha to the linkage sugar D-Gal possibly performed by WsfG, followed by the transfer of two additional  $\alpha$ 1,3-linked L-Rha residues possibly by the action of WsfF (B). The glycan chain would be elongated by the activity of the aminosugar transferase WsfE and the tripartite transferase WsfC. WsfE may form the  $\beta$ 1,4-linkage of a ManNAc residue from UDP-ManNAc to the third rhamnose residue. WsfC putatively adds a single glycerol phosphate from CDP-glycerol to the ManNAc residue of the adaptor oligosaccharide and may form the  $\beta$ 1,3-linkage of a ManNAc residue to the third rhamnose residue as well as the  $\beta$ 1,4-linkage of a Gal to the ManNAc residues of the repeating units. The glycan chain would be recognised by the carboxy-terminal part of Wzt and exported by the ABC transporter system through the cytoplasmic membrane (C). The transfer of cytoplasmic Glc to the lipid carrier would be carried out by WsfH and, after reorientation, is used at the external face of the cytoplasmic membrane by WsfD for  $\alpha$ 1,6-linkage of the Glc residues to ManNAc residues of the repeating units (D). The final transfer of the completed S-layer glycan to certain tyrosine residues of the S-layer protein is predicted to occur cosecretionally upon catalysis of the O-OST WsfB (E). Eventually, the mature S-layer glycoprotein would be self-assembled at the cell surface (F). Please note that so far only the WsfP protein has been experimentally verified to perform its predicted role. (Adapted from Zarschler et al. 2010b. With permission from Oxford University Press).

production of UDP-Gal, to constitute the full S-layer glycoprotein biosynthesis pathway.

For nanopatterned *in vivo* cell surface codisplay of peptide and glycan epitopes based on the *Pa. alvei* CCM 2051<sup>T</sup> S-layer glycoprotein self-assembly system, a working strategy was developed. The ORF of the S-layer structural gene *spaA* codes for a protein of 983 amino acids, including a signal peptide of 24 amino acids and the glycosylated S-layer protein SpaA has a theoretical molecular mass of  $\sim$ 106 kDa. As demonstrated exemplarily with a hexahistidine tag and enhanced green fluorescent protein (eGFP) translationally fused to the S-layer protein, fused epitopes can be efficiently expressed and successfully displayed via the S-layer glycoprotein matrix on the surface of *Pa. alvei* CCM 2051<sup>T</sup> cells *in vivo* as evidenced by immunoblot analysis, immunofluorescence staining and fluorescence microscopy. In contrast, exclusively non-glycosylated chimeric SpaA proteins were displayed, when the S-layer of the glycosylation-deficient *usfP* mutant was used as matrix (Zarschler et al. 2010a).

SpaA contains three consecutive S-layer homology (SLH) domains at the N-terminus that are involved in non-covalent anchoring of the glycoprotein via a non-classical, pyruvylated SCWP (*vide infra*, see chapter 'SCWP') to the PG layer of the *Pa. alvei* cell wall (Schäffer et al. 2000b). The SLH domains contain the amino acid motif TRAE, known to play a key role in cell-wall binding (May et al. 2006), as well as the TVEE and TRAQ variations thereof. The role of the three predicted binding motifs within the SLH domains was analysed by mutating them into TAAA motifs, either individually, pairwise or all of them (Janesch, Messner and Schäffer 2013). Effects were visualised *in vivo* by homologous expression of chimeras made of the mutated S-layer proteins and eGFP and in an *in vitro* binding assay using His-tagged SpaA vari-

ants and native PG-containing cell-wall sacculi that either contained SCWP or were deprived of it. Experimental data indicated that the TRAE, TVEE and TRAQ motifs are critical for the binding function of SLH domains and two functional motifs are sufficient for cell-wall binding, regardless of the domain location. SLH domains of *Pa. alvei* CCM 2051<sup>T</sup> SpaA recognise both SCWP and PG, but cell-wall anchoring is not necessary for SpaA glycosylation. Additionally, we showed that the SLH domains of SpaA are sufficient for *in vivo* cell-surface display of foreign proteins at the cell surface of *Pa. alvei* (Janesch, Messner and Schäffer 2013).

In contrast to the previously described long-glycan chain S-layer glycoproteins of thermophilic and mesophilic bacilli, short-glycan chain S-layer glycoproteins are also known, for instance, on the Gram-positive GRAS (generally regarded as safe) organism *La. buchneri* CD034 (Anzengruber et al. 2014b), or the Gram-negative periodontal pathogen *Ta. forsythia* ATCC 43037 (Posch et al. 2011).

Based on a previous demonstration of S-layer protein glycosylation in *La. buchneri* strain 41021/251 (Möschl et al. 1993) and because of general advantages of lactic acid bacteria for applied research, protein glycosylation in this species was investigated in more detail recently. The cell surface of *La. buchneri* CD034 is completely covered with an oblique S-layer lattice formed by self-assembly of the abundant S-layer protein SlpB (Anzengruber et al. 2014b). Biochemical and MS analyses revealed that SlpB is O-glycosylated at four serine residues within the sequence Ser152-Ala-Ser154-Ser155-Ala-Ser157 with, on average, seven Glc-( $\alpha$ 1-6) linked residues, each. Subcellular fractionation of strain CD034 indicated a sequential order of SlpB export and glycosylation as evidenced by lack of glycosylation on cytosolic SlpB. Protein glycosylation analysis was extended to strain



*La. buchneri* NRRL B-30929 (Liu et al. 2011) where an analogous glucosylation scenario was detected, with the S-layer glycoprotein SlpN containing an O-glycosylation motif identical to that of SlpB. This led to the proposal of species-wide S-layer protein O-glycosylation in *La. buchneri* strains targeted at the sequence motif Ser-Ala-Ser-Ser-Ala-Ser. Search of the *La. buchneri* genomes for the said glucosylation motif revealed one further ORF, encoding the putative glycosyl-hydrolase LbGH25B and LbGH25N in *La. buchneri* CD034 and NRRL B-30929, respectively; in fact, there are indications of glycosylation comparable to that of the S-layer proteins (Anzengruber et al. 2014b). The glycosyl hydrolase family 25 domain-containing homologues LbGH25B and LbGH25N from *La. buchneri* CD034 and NRRL B-30929, respectively, were characterised in detail. Zymogram analysis confirmed hydrolysing activity on bacterial cell walls for both enzymes. Subsequent reversed-phase HPLC and MALDI-TOF MS analysis of the PG breakdown products from *La. buchneri* strains CD034 and NRRL B-30929 revealed that these enzymes exhibit N-acetylmuramidase activity. Both enzymes were identified as cell-wall-associated proteins due to the binding capability of purified recombinant LbGH25B and LbGH25N to *La. buchneri* cell walls *in vitro*. Moreover, similar secondary structures mainly composed of  $\beta$ -sheets and nearly identical thermal stabilities with  $T_m$  values around 49°C were found for the two N-acetylmuramidases by far-UV circular dichroism spectroscopy. This work provided for the first time a detailed characterisation of a major N-acetylmuramidase from *La. buchneri*; this might have implications for other lactic acid bacteria (Anzengruber et al. 2014a).

Also for the Gram-positive pathogen *Clostridium difficile* that is a major cause of nosocomial diarrhoea (Dingle et al. 2013), there are indications of S-layer protein glycosylation. The cell surface of *Cl. difficile* is covered by an S-layer encoded by the *slpA* gene that localises within the cell-wall protein (*cwp*) gene cluster. For developing safe treatment strategies against *Cl. difficile* infections, it is important to understand the diversity and evolution of *slpA* and nearby genes encoding immunodominant cell-surface antigens (Fagan and Fairweather 2014). The whole-genome sequence was determined for 57 *Cl. difficile* isolates representative of the population structure and different clinical phenotypes. Phylogenetic analyses were performed on their genomic region (>63 kb) spanning the *cwp* cluster, with genetic diversity across the *cwp* cluster peaking within *slpA*, *cwp66* (adhesin) and *secA2* (secretory translocase). These genes form a 10-kb cassette, of which 12 divergent variants were found. Homologous recombination involving this cassette caused it to associate randomly with the genotype. One cassette contains a novel insertion (~24 kb) that resembles an *slg* gene cluster. S-layer switching and immune escape could help explain temporal and geographical variation in *Cl. difficile* epidemiology and may inform genotyping and vaccination strategies (Dingle et al. 2013). Normally, *Cl. difficile* does not possess a glycosylated S-layer (Qazi et al. 2009), but these variant strains contain a distinct S-layer cassette producing S-layer proteins of reduced polypeptide, as well as a gene cluster encoding dTDP-L-Rha biosynthesis (Giraud and Naismith 2000). Whether these strains do indeed have a glycosylated S-layer and what, if any, phenotype that might confer is currently unknown (Dingle et al. 2013).

The periodontopathic pathogen *Ta. forsythia*, a Gram-negative, rod-shaped, strict anaerobic, non-pigmented oral bacterium (Haffajee and Socransky 1994; Tanner and Izard 2006), relies on a unique building plan for its S-layer glycoproteins (Lee et al. 2006). *Tannerella forsythia* is phylogenetically

affiliated to the Bacteroidetes and a member of the so-called red complex of oral bacteria (Holt and Ebersole 2005) that is crucially involved in the onset and progression of a set of inflammatory diseases named periodontitis. Periodontitis is the most common inflammatory disease of the gums worldwide and increasingly linked to systemic inflammation, increased risk of stroke, heart attacks and atherosclerosis (Haffajee et al. 2008; Hajishengallis and Lamont 2012). *Tannerella forsythia* cells are completely covered by a unique square S-layer formed by coassembly of two different glycoproteins in equimolar ratio (Lee et al. 2006; Sekot et al. 2012). The S-layer proteins TfsA and TfsB are both highly O-glycosylated with the equally unique oligosaccharide 4-OMe- $\beta$ -ManpNAcCONH<sub>2</sub>-(1→3)-[Pse5Am7Gra-(2→4)]- $\beta$ -ManpNAcA-(1→4)-[4-OMe- $\alpha$ -Galp-(1→2)]- $\alpha$ -Fucp-(1→4)-[ $\alpha$ -Xylp-(1→3)]- $\beta$ -GlcA-(1→3)-[ $\beta$ -Digp-(1→2)]- $\alpha$ -Galp (Posch et al. 2011) linked to distinct serine and threonine residues within the Bacteroidetes-wide D(S/T)(A/I/L/M/T/V) glycosylation motif (Coyne et al. 2013) (Fig. 2). The structure of the glycan partially imitates that of host glycoproteins (Stafford et al. 2012), having a terminal sialic acid-like residue (nonulosonic acids) and a terminal fucose (Posch et al. 2011; Megson et al. 2015). The glycobiology of this pathogen, including its repertoire of glycosidases, seems to be key to its physiology and, potentially, pathogenicity (Posch et al. 2012; Douglas et al. 2014). In this context, it could be shown that the terminal trisaccharide motif of this glycan comprising the charged sugar residues acts to modulate DC effector functions to suppress T-helper (Th)17 responses (Settem et al. 2013). In contrast to the wild type, infection with a mutant strain lacking the trisaccharide motif induced a robust Th17 response and reduced periodontal bone loss in mice. These findings demonstrate that surface glycosylation of *Ta. forsythia* may act to ensure the bacterium's persistence in the host likely through suppression of Th17 responses. In addition, this data suggest that the bacterium then induces the TLR2—Th2 inflammatory axis that has previously been shown to cause bone destruction. This study provided a biological basis for pathogenesis and opens opportunities in exploiting bacterial glycans as therapeutic targets against periodontitis and a range of other infectious diseases (Settem et al. 2013). Further, *Ta. forsythia* mutants lacking either the S-layer or glycan assembly and maturation genes display phenotypes involving altered human cell attachment to host cells, biofilm formation and disease progression (Sabet et al. 2003; Honma et al. 2007; Sakakibara et al. 2007).

The *Ta. forsythia* S-layer glycoproteins belong to a class of so-called CTD (C-terminal domain containing) proteins, with the CTDs on TfsA and TfsB acting as a signal for their translocation across the outer membrane via a Bacteroidetes type IX secretion system (T9SS) (Glew et al. 2012). The genome sequence of *Ta. forsythia* predicts the presence of the complete set of components for a T9SS in conjunction and a suite of CTD proteins (Tomek et al. 2014). To investigate if T9SS is functional in *Ta. forsythia*, T9SS-deficient mutants were generated by targeting either TF0955 (putative C-terminal signal peptidase) or TF2327 (PorK orthologue), and the mutants were analysed with respect to secretion, assembly and glycosylation of the S-layer proteins as well as proteolytic processing of the CTD. In either mutant, TfsA and TfsB were incapable of translocation as evidenced by the absence of the S-layer on ultrathin-sectioned bacterial cells using TEM. Despite being entrapped within the periplasm, MS analysis revealed that the S-layer proteins were modified with the complete, mature glycan as found on the secreted proteins, indicating that protein translocation and glycosylation are two independent processes in *Ta. forsythia* (Tomek et al. 2014). These

data are supported by an independent investigation by others (Narita et al. 2014). There, *Ta. forsythia* mutants deficient in orthologues of the T9SS-encoding genes *porK*, *porT* and *sov* were constructed. All *porK*, *porT* and *sov* single mutants lacked the S-layer and expressed less-glycosylated versions of the S-layer glycoproteins TfsA and TfsB (Narita et al. 2014).

Besides its glycosylated S-layer, outer membrane vesicles (OMVs) of *Ta. forsythia* enriched in putative glycoproteins were identified as a new addition to the virulence repertoire of *Ta. forsythia* (Friedrich et al. 2015). The organism was grown anaerobically in serum-free medium and biogenesis of OMVs was analysed by TEM and atomic force microscopy revealing OMVs with a mean diameter of ~100 nm, budding off from the outer membrane while retaining the S-layer. A proteomic analysis of OMVs identified 175 proteins. Of these, 14 exhibited a CTD outer membrane translocation signal that directs them to the cell/vesicle surface, 61 and 53 were localised to the outer membrane and periplasm, respectively, 22 were predicted to be extracellular and 39 to originate from the cytoplasm. A total of 80 proteins contained the *Bacteroidales* O-glycosylation motif, 18 of which were confirmed as glycoproteins. The inflammatory response elicited by the OMVs was significantly higher than that caused by whole *Ta. forsythia* cells. This study represents the first characterisation of *Ta. forsythia* OMVs, their proteomic composition and immunogenic potential (Friedrich et al. 2015), and is complemented by a recent study by others (Veith et al. 2015).

Based on the evidence that the two *Bacteroidetes* species *Ta. forsythia* and *Bacteroides fragilis* both employ a general protein O-glycosylation system and share a common glycosylation sequon, the ability of these organisms to glycosylate a protein native to the other organism was demonstrated (Posch et al. 2013b). Using genetic tools previously developed for *Bacteroides* species, two *Bac. fragilis* model glycoproteins were expressed in the fastidious anaerobe *Ta. forsythia* and the attachment of the known *Ta. forsythia* O-glycan to these proteins was demonstrated by LC-ESI tandem MS. Likewise, two predominant *Ta. forsythia* glycoproteins were expressed in *Bac. fragilis* and glycosylation with the *Bac. fragilis* O-glycan was confirmed. Compositional and structural similarities between the *Ta. forsythia* O-glycan and the not yet fully characterised *Bac. fragilis* O-glycan suggest commonalities in their biosynthesis. These data demonstrate the feasibility of exploiting these organisms for the design of novel glycoproteins (Posch et al. 2013b).

Multidrug-resistant strains of the Gram-negative species *Acinetobacter baumannii* are increasingly being isolated in hospitals worldwide. Among the virulence factors identified in this pathogen, there is a general protein O-glycosylation system that appears to be important to biofilm formation and virulence, and a capsular polysaccharide that is essential for resistance to complement killing (Lees-Miller et al. 2013). In fact, the  $[\rightarrow 3)\text{-}[\beta\text{-GlcNAc}\text{-}(1\rightarrow 6)]\text{-}[\alpha\text{-4OAcGlcA}\text{-}(1\rightarrow 4)]\text{-}\alpha\text{-Gal}\text{-}(1\rightarrow 6)\text{-}\beta\text{-Glc}\text{-}(1\rightarrow 3)\text{-}\beta\text{-GalNAc}\text{-}(1\rightarrow )_n$  pentasaccharides that decorate the *Ac. baumannii* glycoproteins are also the building blocks for capsule biosynthesis, with at most two repeat units having been detected on proteins via MS analysis. An O-pentasaccharide biosynthesis gene locus was identified in strain ATCC 17978, with components required for glycan assembly, polymerisation and transport of capsule located within or adjacent to the locus. Mutagenesis of PglC, the initiating glycosyltransferase prevented the synthesis of glycoproteins and capsule, resulting in abnormal biofilm structures and attenuated virulence of *Ac. baumannii* ATCC 17978 in mice. The discovery of a bifurcated pathway for O-glycosylation and capsule synthesis could not only provide insight into the biology of *Ac. bauman-*

*nii* but also identified potential novel candidates for intervention against this emerging pathogen (Lees-Miller et al. 2013). In this context, it should be noted that previous TEM investigations of *Acinetobacter* sp. strain MJT/F5/199A have shown a presumably square S-layer lattice covering the entire cells (Thornley, Glauert and Sleytr 1973). Outer membrane preparations before and after papain digestion suggested the presence of a glycosylated S-layer protein in that strain that might resemble the O-glycosylated *Ac. baumannii* ATCC 17978 protein discussed (Lees-Miller et al. 2013).

Very recently, a glycosylated S-layer was shown to be present also on the anamox bacterium *Kuenenia stuttgartiensis* (van Teeseling et al. 2014). Anammox bacteria perform anaerobic ammonium oxidation and have a unique compartmentalised cell consisting of three membrane-bound compartments (from inside outwards)—the anammoxosome, riboplasm and paryphoplasm (van Teeseling et al. 2014). The cell envelope of anammox bacteria has been proposed to deviate from typical bacterial cell envelopes by lacking both PG and a conventional outer membrane. In the phylum of the *Planctomycetes*, for the first time, an S-layer was described on strain *K. stuttgartiensis*, providing a new addition to the cell plan of anammox bacteria. This S-layer showed hexagonal symmetry and enrichment of the S-layer from bacterial cells led to a 160-kDa candidate protein, Kustd1514, which has no homology to any known protein and is present in glycosylated form. Antibodies were generated against the glycoprotein and used for immunogold localisation. The antiserum localised Kustd1514 to the S-layer and, thus, confirmed it as the S-layer glycoprotein of *K. stuttgartiensis* (van Teeseling et al. 2014).

## Secondary cell-wall polymers

In the course of investigations of Gram-positive bacterial S-layer proteins (both non-glycosylated and glycosylated ones), important aspects of a group of non-classical SCWPs, representing cell-wall polysaccharides of moderate molecular mass, have emerged. The identification of these non-classical SCWPs as mediators for non-covalent attachment of S-layers to carbon 6 of muramic acid of the underlying PG meshwork (Figs 2 and 3) underlines their importance for the cell biology of bacteria. Herein we summarise the current knowledge on structural features, cell-wall attachment and interactions of non-classical SCWPs in S-layer-carrying organisms (Araki and Ito 1989; Sára 2001; Cava et al. 2004; Schäffer and Messner 2005; Ferner-Ortner et al. 2007; Pavkov et al. 2008; Messner et al. 2009).

### Description of non-classical SCWPs

While a considerable body of knowledge has accumulated concerning structural, biochemical and immunological features of teichoic and teichuronic acids (classical SCWPs) present in cell walls of Gram-positive bacteria (Hancock and Baddiley 1985; Archibald, Hancock and Harwood 1993), it should be kept in mind that additional cell-wall polysaccharides are present in these organisms. Driven by our interest in S-layer glycobiology, we initially coincidentally coisolated a fraction of SCWP with S-layer glycoprotein preparations of different bacteria. Improved purification and separation methods eventually led to the clear assignment of this distinct fraction as a separate class of compounds, i.e. SCWPs, which were shown to account for a substantial proportion (7%–15% by weight) of the bacterial PG (Schäffer and Messner 2005). The investigated SCWP-PG complexes were comprised of intact glycan moieties and, usually, of proportions of PG of variable size, arising from random PG degradation

during the preparation procedure (without any acid treatment to prevent undesired removal of acid-labile components) (Messner, Schäffer and Kosma 2013).

Cell-wall polysaccharides of Gram-positive bacteria are generally classified according to their structural characteristics in (i) teichoic acids, (ii) teichuronic acids and (iii) other polysaccharides (neutral or acidic polysaccharides) not classifiable into the two former groups (Araki and Ito 1989). Recent investigations have shown that in S-layer-carrying organisms, teichoic and teichuronic acids as typical representatives of classical SCWPs (Archibald, Hancock and Harwood 1993) are usually not present. Instead, structurally comparable non-classical SCWPs are present. Based on compositional and structural data, we suggested a categorisation of non-classical SCWPs from S-layer-carrying *Bacillaceae* into three groups (group I to III) (Schäffer and Messner 2005). For each of these, representative structures are given below.

**First group.** The structure of the glycan portion of the SCWP-PG complex of *Pa. alvei* CCM 2051<sup>T</sup> was elucidated to be [(Pyr4,6)- $\beta$ -D-ManpNAc-(1 $\rightarrow$ 4)- $\beta$ -D-GlcpNAc-(1 $\rightarrow$ 3)]<sub>n-11</sub>-(Pyr4,6)- $\beta$ -D-ManpNAc-(1 $\rightarrow$ 4)- $\alpha$ -D-GlcpNAc-(1 $\rightarrow$ ) (Fig. 2) (Schäffer et al. 2000b). Each repeating-unit disaccharide of this SCWP is substituted with a 4,6-linked pyruvic acid residue, conferring an overall anionic character to the SCWP. Upon prolonged exposure of the polymer to acidic conditions, as occurs for instance upon solvation in D<sub>2</sub>O during NMR experiments, considerable loss of pyruvate residues can occur. The ManNAc-GlcNAc backbone disaccharide motif corresponds to that frequently observed in certain teichoic acids of other bacilli (Araki and Ito 1989). In the group I non-classical SCWPs, this motif is repeated several times, thus constituting the entire glycan moiety of these SCWPs. Pyruvic acid-containing SCWPs have also been reported for the S-layer-carrying organisms *Lysinibacillus* (formerly *Bacillus*) *sphaericus* CCM 2177 (Ilk et al. 1999) and *Ba. anthracis* (Mesnage et al. 2000).

In contrast to anionic polymers, neutral polysaccharides possessing an identical backbone motif are found in the PG of other *Bacillaceae*. The SCWPs of *Th. thermosaccharolyticum* strains D120-70 (Altman et al. 1990) and E207-71 (Altman et al. 1996) display the commonly encountered  $\rightarrow$ 3)- $\beta$ -D-ManpNAc-(1 $\rightarrow$ 4)- $\beta$ -D-GlcpNAc-(1 $\rightarrow$ 4)- $\beta$ -D-ManpNAc-(1 $\rightarrow$ 3)- $\beta$ -D-GlcpNAc-(1 $\rightarrow$ ) motif (Fig. 2) (Altman et al. 1996), which is extended by ribofuranose side chains on alternating ManNAc residues (Altman et al. 1990; Schäffer C, Kählig H, Christian R & Messner P, unpublished results).

**Second group.** The anionic polymer purified from *G. stearothermophilus* NRS 2004/3a (Messner et al. 1987; Schäffer et al. 1999a) comprises on average six tetrasaccharide repeating units with the structure  $\rightarrow$ 4)- $\beta$ -D-Manp-2,3-diNAcA-(1 $\rightarrow$ 6)- $\alpha$ -D-Glcp-(1 $\rightarrow$ 4)- $\beta$ -D-Manp-2,3-diNAcA-(1 $\rightarrow$ 3)- $\alpha$ -D-GlcpNAc(1 $\rightarrow$ ) (Fig. 2). It constitutes the SCWP of many *G. stearothermophilus* wild-type strains and was the first SCWP of an S-layer carrying organism for which the structure was fully elucidated. It covers a mass range of 4000–6000 and substitutes about 20%–25% of the PG muramyl residues (Messner et al. 1987; Schäffer et al. 1999a). Interestingly, analyses of the SCWP of *Anoxybacillus* (formerly *Geobacillus*) *tepidamans* GS5-97<sup>T</sup> indicated that its backbone structure is reminiscent of that of *G. stearothermophilus* NRS 2004/3a, but with additional modifications of the carboxyl groups by amide formation at the Manp-2,3-diNAcA residues, turning the anionic character of the SCWP into a neutral one. <sup>31</sup>P NMR analysis has demonstrated that the SCWP of *Anoxybacillus tepidamans* GS5-97<sup>T</sup> is linked to muramic acid by a common phosphodiester linkage (Steindl et al. 2005).

**Third group.** In this group, the linkage-region disaccharide (compare with the first group) of teichoic acids is further extended. In addition to linear chains, branched repeating units containing neutral sugars and/or amino sugars have been observed. The charge-neutral SCWP isolated from *Aneurinibacillus thermoaerophilus* DSM 10155 represents a unique bacterial glycan structure containing repeats of the sequence  $\rightarrow$ 3)- $\alpha$ -D-GlcpNAc-(1 $\rightarrow$ 3)- $\beta$ -D-ManpNAc-(1 $\rightarrow$ 4)- $\beta$ -D-GalpNAc-(1 $\rightarrow$ ) (Fig. 2) (Steindl et al. 2002) found in the first biantennary SCWP from the domain *Bacteria*, with the full structure  $\alpha$ -D-GlcpNAc-(1 $\rightarrow$ 3)- $\beta$ -D-ManpNAc-(1 $\rightarrow$ 4)- $\beta$ -D-GalpNAc-(1 $\rightarrow$ 3)- $\alpha$ -D-GlcpNAc-(1 $\rightarrow$ 3)- $\beta$ -D-ManpNAc-(1 $\rightarrow$ 4)- $\beta$ -D-GalpNAc-(1 $\rightarrow$ 3)- $\alpha$ -D-GlcpNAc-(1 $\rightarrow$ 4)-[ $\alpha$ -D-GlcpNAc-(1 $\rightarrow$ 3)- $\beta$ -D-ManpNAc-(1 $\rightarrow$ 4)- $\beta$ -D-GalpNAc-(1 $\rightarrow$ 3)- $\alpha$ -D-GlcpNAc-(1 $\rightarrow$ 3)]- $\beta$ -D-ManpNAc-(1 $\rightarrow$ 3)- $\alpha$ -D-GlcpNAc-(1 $\rightarrow$ 3)- $\beta$ -D-ManpNAc-(1 $\rightarrow$ 3)- $\alpha$ -D-GlcpNAc-(1 $\rightarrow$ 3)- $\alpha$ -D-GlcpNAc-(1 $\rightarrow$ ). The interpretation of the observed NMR data supporting a single branched GalNAc unit need, however, to be treated with caution, since the <sup>13</sup>C NMR chemical shifts of the carbon atoms in the branched residue are very similar to those located in the linear chain.

A branched structure was found in the SCWP from *G. stearothermophilus* PV72/p2, which, however, had undergone treatment with hydrofluoric acid (HF) for cleavage of the linkage to PG. Hence, information on the linkage region as well as the extent of pyruvate substitution and proof for N-deacetylated glycoses is compromised (Petersen et al. 2008). The SCWP contains a pentasaccharide repeating unit of the sequence  $\rightarrow$ 4)-[ $\beta$ -D-GlcpNAc-(1 $\rightarrow$ 3)]<sub>0.3</sub>- $\beta$ -D-ManpNAcA-(1 $\rightarrow$ 4)- $\beta$ -D-GlcpNAc-(1 $\rightarrow$ 6)-[4,6-(S)-Pyr- $\alpha$ -D-ManpNAc-(1 $\rightarrow$ 4)]- $\alpha$ -D-GlcpNAc-(1 $\rightarrow$ ). Similar to the SCWPs of the first group, the (S)-configured pyruvate residues are present on the *D*-ManpNAc residues, albeit not within the linear backbone chain, but extending from the branching 4,6-disubstituted  $\alpha$ -D-GlcpNAc residue.

SCWPs of *Ba. anthracis* and *Ba. cereus* may also be classified into the third group. Non-classical SCWPs of *Ba. anthracis* having approximate molecular masses in the range of 12 000–22 000 mediate binding to the SLH domain of the paracrystalline S-layer proteins Sap and extractable antigen 1 (EA1), respectively (Kern et al. 2010, 2012). The SCWP of several *Ba. anthracis* strains was released from its covalent linkage to PG by treatment with HF, and the resulting purified fractions were analysed by high-field NMR spectroscopy and MS techniques (Choudhury et al. 2006). The repeating unit of the SCWP comprises the backbone sequence  $\rightarrow$ 6)- $\alpha$ -D-GlcpNAc-(1 $\rightarrow$ 4)- $\beta$ -D-ManpNAc-(1 $\rightarrow$ 4)- $\beta$ -D-GlcpNAc-(1 $\rightarrow$ ) with  $\alpha$ -galactopyranosyl side chains linked to O-3 of the  $\alpha$ -D-GlcpNAc and  $\beta$ -D-GlcpNAc units, respectively, and a  $\beta$ -D-Galp residue linked to O-4 of the  $\alpha$ -D-GlcpNAc residue. The trisaccharide backbone forms a consensus motif shared by many *Ba. anthracis* and *Ba. cereus* strains, respectively. Cross-reactive epitopes are present in these SCWPs as well as epitopes being specific of *Ba. anthracis* and *Ba. cereus*, respectively (Choudhury et al. 2006; Loeff et al. 2009). The  $\beta$ -D-galactosyl moiety attached to the non-terminal GlcNAc residue constitutes a unique binding epitope to endolysins from *Ba. anthracis* bacteriophages (Schuch, Nelson and Fischetti 2002; Mo et al. 2012). In contrast, galactosylation is absent in the SCWP of the avirulent strain *Ba. anthracis* CDC 648 (Ba684) (Forsberg et al. 2012). This SCWP is tethered via acid-labile phosphodiester bonds to PG. Additionally, pyruvate substitution has been detected in the HF-treated SCWPs from *Ba. anthracis* Sterne 34F2, 7702 and *Ba. cereus* strain G9241, 03BB87 and 03BB102 (Forsberg et al. 2011). The extent of pyruvate substitution remains ambiguous, since the cleavage of the SCWP from PG with 48%



HF leads to the liberation of the acid-sensitive ketal groups, thus preventing quantification. For the *Ba. anthracis* SCWP CDC 684, the terminal (S)-pyruvate substituent at O-4 and O-6 of the  $\beta$ -D-ManpNAc residue has been identified by NMR spectroscopy (Forsberg et al. 2012). Earlier work identified the UDP-GlcNAc 2-epimerases GneY (BAS5048) and GneZ (BAS5117) that act as catalysts of ManNAc synthesis, as well as a polysaccharide deacetylase (BAS5051), as factors contributing to SCWP synthesis (Lunderberg et al. 2015). It was shown that *tagO* (BAS5050), which encodes a UDP-N-acetylglucosamine:undekaprenyl-P N-acetylglucosaminyl 1-P transferase, the enzyme that initiates the synthesis of murein linkage units, is required for *Ba. anthracis* SCWP synthesis and S-layer assembly. Similar to *gneY-gneZ* mutants, *Ba. anthracis* strains lacking *tagO* cannot maintain cell shape or support vegetative growth. In contrast, mutations in BAS5051 do not affect *Ba. anthracis* cell shape, vegetative growth, SCWP synthesis or S-layer assembly. These data suggest that TagO-mediated murein linkage unit assembly supports SCWP synthesis and attachment to PG via acid-labile phosphodiester bonds. Further, *Ba. anthracis* variants unable to synthesise SCWP trisaccharide repeats cannot sustain cell shape and vegetative growth (Lunderberg et al. 2015). A hallmark of S-layer proteins is their C-terminal crystallisation domain that assembles into a crystalline lattice once these polypeptides are deposited on the bacterial surface via association between their N-terminal SLH domains and the SCWP (Huber et al. 2005). In *Ba. anthracis*, it was shown that *slaQ*, encoding a small cytoplasmic protein conserved among pathogenic bacilli elaborating S-layers, is required for the efficient secretion and assembly of Sap and EA1. S-layer protein precursors cosediment with SlaQ, and SlaQ appears to facilitate Sap assembly. Purified SlaQ polymerises and when mixed with purified Sap promotes the *in vitro* formation of tubular S-layer structures. In the current model, SlaQ in conjunction with S-layer secretion factors SecA2 and SlaP promotes localised secretion and S-layer assembly in *Ba. anthracis* (Nguyen-Mau et al. 2015).

In other *Ba. anthracis* and *Ba. cereus* strains, modifications of the basic SCWP structure such as galactosidation and O-acetylation have been reported (Choudhury et al. 2006; Leoff et al. 2008; Forsberg et al. 2011). In addition, environmental conditions and expression levels may play important roles in dictating which of the SCWPs is actually formed. The induction of SCWPs synthesis under specific culture conditions points to the possibility of other, still unknown SCWPs being induced under different environmental conditions, such as the host internal milieu. Changes in the *Ba. cereus* cell-wall polysaccharide components could be involved in the high adaptability of this bacterium to environmental changes (Candela et al. 2011).

#### General considerations about non-classical SCWP structures

Comparison of the overall composition of non-classical SCWPs analysed so far revealed that the more complex glycans of the second group exhibit the same alternating order of *gluco* and *manno* sugars as glycans from the first group. The glycan chain starts with a GlcNAc residue at the reducing end and ends with Manp-2,3-diNAcA. It is possible that glycan structures of the second group have evolved from the simpler first-group structures by the introduction of residues such as glucose or Manp-2,3-diNAcA through the action of strain-specific enzymes. The same scenario could be imagined for glycans of the third group. However, biosynthesis pathways of greater complexity have to be envisaged and, so far, no experimental evidence is available

to support this notion. The linkages between SCWPs and PG are currently being investigated in more detail.

#### Interactions of SCWPs and S-layers from Bacillaceae

In addition to the general features previously mentioned, novel properties for SCWPs have emerged from research on S-layers (Sleytr 1978; Sleytr et al. 1996). Provision of any kind of selection advantage by the S-layer to a bacterium in its natural environment requires the stable attachment of the S-layer to the bacterial cell surface *in vivo*. During evolution, Gram-positive bacteria have developed various strategies for displaying proteins on their surface. These strategies include predominantly covalent binding of LPXTG-carrying proteins to PG, but a number of non-covalent binding strategies have also been evolutionarily developed (Navarre and Schneewind 1999). Reattachment experiments of isolated S-layer glycoproteins from thermophilic clostridia revealed the non-covalent character of the interaction between the S-layer and PG (Sleytr 1976). For *La. buchneri*, it was shown very early that hydroxyl groups of a neutral cell-wall polysaccharide are responsible for the attachment of the S-layer protein to the cell wall (Masuda and Kawata 1985).

#### Possible cell-wall-targeting mechanisms

Recently, the cell-wall-targeting mechanism of S-layer proteins has been investigated in more detail (Mesnage et al. 2000; Sára 2001; Cava et al. 2004; Pavkov et al. 2008; Janesch, Messner and Schäffer 2013). In general, S-layer proteins have two functional regions—a cell-wall-targeting domain, which in most of the organisms thus far investigated is located at the N-terminus, and a C-terminal self-assembly domain. The presence of a cell-wall-targeting domain in S-layer proteins was substantiated by Fujino, Béguin and Aubert (1993) and Lupas et al. (1994), who identified motifs of approximately 55 amino acids, containing 10–15 conserved residues, which were designated SLH (S-layer homology) domains. These SLH domains, usually composed of one to three modules, are means frequently used for targeting proteins to the cell surface. They are found not only in various S-layer proteins but also in many other cell-surface-associated proteins, such as the cellulosomes (Bayer et al. 2004) or other enzymes (Liu et al. 1996).

In the case of *Ba. anthracis*, the molecular basis of the interaction between SLH domains and SCWP was established by elucidating the binding properties (Mesnage et al. 2000). Both S-layer proteins of *Ba. anthracis* (EA1 and Sap) possess SLH domains that directly attach the S-layer proteins to PG (Mesnage et al. 1997, 1999). While the overall sequence similarity of SLH domains is rather low, the highly conserved four-amino-acid motif TRAE has been found to play a key role for the binding function to SCWP (May et al. 2006; Kern et al. 2011; Janesch, Messner and Schäffer 2013). The crystal structure recently elucidated of one S-layer protein from *Ba. anthracis* shows the SLH domains arranged in 3-fold pseudo-symmetry with the TRAE (or similar) motifs so that they would be accessible to the SCWP (Kern et al. 2011). A different binding mechanism was proposed for the S-layer proteins of *G. stearoerophilus* PV72/p2 (Ries et al. 1997; Sára et al. 1998) and *Pa. alvei* CCM 2051<sup>T</sup> (Janesch, Messner and Schäffer 2013). In these organisms, two different binding domains were identified in the N-terminal region of the S-layer proteins, one for SCWP and another for PG. In *Thermus thermophilus*, a similar binding mechanism was identified between an S-layer outer membrane complex and the cell wall. There is a strong interaction of the SLH domain of the S-layer protein with a pyruvylated component of a highly immunogenic SCWP (Cava et al. 2004).

Originally, the involvement of pyruvate groups in S-layer binding was inferred from observations in *Ba. anthracis* (Mesnage et al. 2000). It was demonstrated that the pyruvate transferase CsaB is involved in the addition of pyruvate to a PG-associated polysaccharide fraction and that this modification is necessary for the binding of the S-layer via SLH domains. Interestingly, the *csaAB* operon was found to be present in several bacterial species (Mesnage et al. 2000). Pyruvate was also identified in the SCWP repeating units of *Lysinibacillus sphaericus* CCM 2177 (Ilk et al. 1999) and *Pa. alvei* CCM 2051<sup>T</sup> (Schäffer et al. 2000b) (*vide supra*), which may be taken as an indication that pyruvate, or more possibly, negative charges of SCWPs, constitute a widespread mechanism for the anchoring of S-layer proteins containing SLH domains to the bacterial cell wall. Besides the anchoring mechanism involving SLH domains, another mechanism that is hypothesised to utilise basic amino acids, present in the cell-wall-targeting region and known for their direct interaction with carbohydrates, may apply for S-layer proteins devoid of SLH domains. In the genus *Geobacillus*, SLH domains have only been identified on the S-layer protein SbsB of *G. stearothermophilus* PV72/p2 (Kuen et al. 1997). All other investigated *G. stearothermophilus* strains possess S-layer proteins devoid of SLH domains (Messner et al. 2010). Interestingly, none of the SCWPs of organisms that possess S-layer proteins lacking SLH domains are modified with pyruvate groups, and some of them even have a net-neutral charge (Schäffer and Messner 2005). These observations support the notion that, in addition to the previously discussed involvement of pyruvate, other mechanisms are involved in the binding of S-layer proteins to the PG (Mesnage et al. 2000; Sára 2001; Cava et al. 2004; Janesch, Messner and Schäffer 2013). The non-conserved character of S-layer-binding mechanisms is supported by the observation that the cell-wall-targeting domain is not necessarily located at the N-terminal region of the S-layer protein. Well-documented examples of C-terminal anchoring domains are the S-layer proteins of *La. acidophilus* ATCC 4356 (Smit et al. 2001) and *La. crispatus* (Antikainen et al. 2002).

The diversity observed among different SCWP structures of *Bacillaceae* follows a general theme that is well known from other bacterial cell-surface structures, such as the serotypes of LPS (Raetz and Whitfield 2002; Whitfield and Trent 2014) and capsular polysaccharides (Sutherland 1999). Presumably, this diversity is responsible for creating microenvironments in which different organisms can survive under unfavourable conditions. Current data indicate that non-classical SCWPs function as mediators for anchoring S-layer (glyco)proteins from *Bacillaceae* to the bacterial cell wall. The complete elucidation of both the structure and biosynthesis of several non-classical SCWPs will contribute to our general understanding of the various mechanisms underlying the tethering of S-layer (glyco)proteins to the cell surface of Gram-positive bacteria.

### Archaeal S-layer glycoproteins

During the past few years, considerable progress has been made in the structural and functional characterisation of carbohydrate-active proteins involved in archaeal S-layer-protein glycosylation. However, only a few new structures of archaeal S-layer glycans have been reported recently (Chaban et al. 2006; Peyfoon et al. 2010; Guan et al. 2012; Kandiba et al. 2016) (Fig. 2); the initial work on S-layer glycosylation of haloarchaea and methanogens is summarised in several excellent publications (Sumper 1987; Lechner and Wieland 1989; Eich-

ler and Adams 2005; Calo, Kaminski and Eichler 2010; Claus and König 2010; Rachel 2010; Jarrell, Jones and Nair 2010; Jarrell et al. 2010; Albers and Meyer 2011; Eichler 2013; Meyer and Albers 2013; Kaminski et al. 2013b; Eichler et al. 2014; Kandiba and Eichler 2014; Kandiba et al. 2016). Typically, the cell envelope architecture in archaea comprises a paracrystalline S-layer situated on top of the cytoplasmic membrane (Sleytr and Messner 1983); in fact, this holds true for the majority of described archaea. Within the Crenarchaea, the S-layer often represents the only cell envelope component, but there are various exceptions from this wall architecture. Besides (glycosylated) S-layers in (hyper)thermophilic Crenarchaea and Euryarchaea as well as in halophilic archaea, there is a great variety of other cell envelope structures such as proteoglycan-like S-layers (halobacteria), glutaminyglycan (natronococci), methanochondroitin (*Methanosarcina*) or double-layered cell envelopes with pseudomurein (*Methanothermus* and *Methanopyrus*) (Klingl 2014).

Concerning halophilic archaea, S-layer glycoproteins from *Halobacterium salinarum*, *Haloferax volcanii*, *Har. marismortui* and *Har. japonica* have been characterised (Lechner and Sumper 1987; Sumper et al. 1990; Wakai et al. 1997; Calo et al. 2011; Kandiba et al. 2016). Recent molecular analyses of the cell-surface glycoprotein of *Hbt. salinarum* (Kandiba and Eichler 2015), which was among the first prokaryotic glycoproteins ever described (Mescher and Strominger 1976), show differences in the annotation of sugars compared with previous reports. The structural description in this review is based on the most recent report (Kandiba and Eichler 2015) revealing the S-layer glycoprotein CSG (Lechner and Sumper 1987) to contain two different types of sulfated N-linked saccharides—hexuronic acid-containing, non-repetitive oligosaccharides with the structure  $(\text{SO}_3^-)_3\text{GlcA}_3\text{-Glc}$ , N-linked to the Asn residues of the protein via Glc (Wieland, Heitzer and Schaefer 1983) (Fig. 2) and a serially repeated hexuronic acid-containing saccharide with the repeating unit structure  $[-(\text{H}_3\text{CO)-GalA-GlcNAc-(SO}_3^-)-(\text{GalF-GalA)-(SO}_3^-)-\text{GalNAc}]_n$  10–15, N-linked to Asn2 of the S-layer protein CSG via the proximal sulfated GalNAc residue (Paul, Lottspeich and Wieland 1986) (Fig. 2). In addition, approximately 20 O-glycosidically linked neutral disaccharides [Glc-(1→2)-Gal] can be found on CSG of *Hbt. salinarum* (Lechner and Wieland 1989) (Fig. 2). The archaeal lipid carrier of the lipid-linked precursors of these saccharides is a C60-dolichol rather than the bacterial C55-undekaprenol; the oligosaccharide is bound to this lipid via dolichol monophosphate (Dol-P). Exceptionally, in a total lipid extract from *Hbt. salinarum*, a tetrasaccharide-charged dolichol was detected in addition to the Dol-P type LLO (Cohen-Rosenzweig et al. 2014). The tetrasaccharide chain was similar but not identical to the N-glycan attached to the Asn-2 position of the *Hbt. salinarum* S-layer glycoprotein reported previously (Zeitler et al. 1998). Thus, it is possible that both the Dol-PP type LLO and Dol-P LLO are oligosaccharide donors in *Hbt. salinarum* (Taguchi, Fujinami and Kohda 2016). Sulfation of the saccharides is completed while they are linked to lipid and does not occur after transfer of the saccharides to protein (Lechner and Wieland 1989).

A recent comparative analysis of archaeal LLOs that serve as oligosaccharide donors for Asn glycosylation confirmed the above-mentioned results and showed that in the investigated Euryarchaeota, including *Pyrococcus furiosus* and *Archaeoglobus fulgidus*, the oligosaccharide donors were of the Dol-P type whereas crenarchaeotal oligosaccharide donor from species such as *Sulfolobus solfataricus* and *Pyrobaculum calidifontis* belong to the Dol-PP type. Further, the *Ar. fulgidus* cells contain two oligosaccharide donors bearing oligosaccharide moieties with different backbone structures, and the *Su. solfataricus* cells

contain two oligosaccharide donors bearing stereochemically different dolichol chains (Taguchi, Fujinami and Kohda 2016).

In an impressive series of research papers, Eichler and coworkers reinvestigated the structure of the S-layer glycan of *Hfx. volcanii* and established the complete biosynthesis pathway for an S-layer pentasaccharide Man-(H<sub>3</sub>CO)-HexA-HexA-HexA-Hex-Asn (Kaminski and Eichler 2010; Kaminski et al. 2010, 2012; Magidovich et al. 2010; Yurist-Doutsch et al. 2010; Cohen-Rosenzweig, Yurist-Doutsch and Eichler 2012; Arbiv et al. 2013; Cohen-Rosenzweig et al. 2014; Kandiba and Eichler 2015). Only recently, this structure of the *Hfx. volcanii* S-layer glycan was reinvestigated and amended to the novel structure—mannose-(1→2)-[methyl-(O→4)-]-β-GlcA-(1→4)-α-GalA-(1→4)-β-GlcA-(1→4)-β-Glc-(1→N)-Asn (Kandiba et al. 2016) (Fig. 2).

The S-layer glycoprotein forms a hexagonal paracrystalline lattice on the haloarchaeal cell envelope and it was previously believed to be anchored to the cell membrane by the intercalation of a transmembrane segment (Sumper 1987; Sumper et al. 1990). However, previous MS analyses of S-layer proteins have failed to identify peptides at the carboxy-terminus of the protein, which was taken as evidence that the transmembrane segment may not be present in the mature protein (Haft, Payne and Selengut 2012). Moreover, at least a portion of the *Hfx. volcanii* S-layer glycoprotein has been found to be lipid modified (Kikuchi, Sagami and Ogura 1999; Konrad and Eichler 2002; Kandiba, Guan and Eichler 2013). Comparison of the C-termini of the S-layer protein from both wild-type and Δ*artA* mutant indeed showed proteolytic processing as evident from the absence of the extreme C-terminal region in the mature wild-type protein. This observation strongly supports the hypothesis that the S-layer glycoprotein is not attached via a C-terminal transmembrane region (which is rather cleaved off), but instead anchored to the lipid bilayer. It is highly likely that ArtA is directly involved in this post-translational processing step (Abdul Halim et al. 2013). Additional experiments revealed a C-terminal tripartite structure of the S-layer glycoprotein, including a highly conserved proline-glycine-phenylalanine (PGF) motif. The S-layer lipid modification requires the PGF motif, is ArtA dependent and underscores the importance of the ArtA-mediated processing and anchoring of the *Hfx. volcanii* S-layer glycoprotein for growth and maintenance of cell morphology (Abdul Halim et al. 2016).

This archaeal anchoring principle of S-layers clearly contrasts that known for bacterial S-layer proteins, where carbohydrate interactions play a pivotal role in anchoring, either via SCWPs as in Gram-positive bacteria (Mesnage et al. 2000; Sára 2001; Schäffer and Messner 2005; Janesch, Messner and Schäffer 2013) or via rough LPS as suggested for Gram-negative bacteria (Awram and Smit 2001; Posch et al. 2013a).

During these studies, it was discovered that the lipid modification resulted in the formation of two distinct populations of S-layer glycoproteins (Kandiba, Guan and Eichler 2013). These observations are consistent with the S-layer glycoprotein being initially synthesised as an integral membrane protein that subsequently undergoes a processing event in which the extracellular portion of the protein is separated from the membrane-spanning domain and transferred to a 'waiting' lipid moiety (Kandiba, Guan and Eichler 2013). In a comparative approach, protein N-glycosylation in *Har. marismortui*, another haloarchaeon, was investigated (Calo, Guan and Eichler 2011). While both *Hfx. volcanii* and *Har. marismortui* decorate their S-layer proteins with the same N-linked pentasaccharide and employ dolichyl phosphate as the lipid glycan carrier, species-specific differences in the two N-glycosylation pathways exist. *Haloar-*

*cula marismortui* first assembles the complete pentasaccharide on dolichyl phosphate and only then transfers the glycan to the target protein. In contrast, *Hfx. volcanii* initially transfers the first four pentasaccharide subunits from a common dolichyl phosphate carrier to the target protein and subsequently delivers the final pentasaccharide from a distinct dolichyl phosphate to the N-linked tetrasaccharide (Calo, Guan and Eichler 2011). Recent studies of *Hfx. volcanii* have identified a gene cluster comprised of the *agl* genes *aglB*, *aglE*, *aglF*, *aglG*, *aglI* and *aglJ* encoding the Agl (archaeal glycosylation) proteins involved in the assembly and attachment of the pentasaccharide to distinct Asn residues of the S-layer protein in this species (Yurist-Doutsch and Eichler 2009). To cope with life in hypersaline environments, halophilic archaeal proteins are enriched in acidic amino acids. Interestingly, deletion of *aglD* resulted in a reduced growth rate in media with high salinities (3.4 or 4.8 M NaCl), whereas under standard growth conditions (1.7 M NaCl), such a change was not observed. A test of the influence of salinity on archaeal growth was performed by comparing the N-glycosylation of *Hfx. volcanii* S-layer glycoprotein from cells grown in high (3.4 M NaCl) and low (1.7 M NaCl) salt, as was the glycan bound to dolichyl phosphate and the lipid upon which the N-linked glycan is assembled. In high salt, Asn13 and Asn83 on the S-layer protein are modified by a pentasaccharide (*vide supra*), while dolichyl phosphate is modified by a tetrasaccharide comprising the first four sugar residues of the S-layer glycan (Kaminski et al. 2013a). When the same targets were considered from cells grown in low salt, substantially less pentasaccharide was detected. Recent efforts have identified Agl5–Agl15 as components of a second *Hfx. volcanii* N-glycosylation pathway responsible for generating the tetrasaccharide Rha–Hex–Hex–(SO<sub>3</sub><sup>-</sup>)Hex–Asn (Fig. 2) attached to the S-layer glycoprotein when growth occurs in 1.7 M but not 3.4 M NaCl-containing medium (Eichler et al. 2013; Kaminski et al. 2013a). The same tetrasaccharide modifies S-layer glycoprotein Asn498 in cells grown in low salt, whereas no glycan decorates this residue in cells grown in the high-salt medium. Thus, in response to changes in environmental salinity, *Hfx. volcanii* not only modulates the N-linked glycans decorating its S-layer glycoprotein but also the sites where this post-translational modification occurs (Guan et al. 2012). This high degree of inherent structural flexibility makes this organism a potent candidate for glycoengineering (Calo, Guan and Eichler 2011).

While genomic analyses point to N-glycosylation as being a common post-translational modification in archaea, to date distinct pathways of archaeal N-glycosylation have only been described for few species (Kandiba and Eichler 2015). With this in mind, the similarities of N-linked glycans decorating glycoproteins in *Hfx. volcanii* and *Hbt. salinarum* directed a series of bioinformatic, genetic and biochemical experiments, which were designed to elucidate the *Hbt. salinarum* pathway responsible for biogenesis of one of the two N-linked oligosaccharides of that species. As in *Hfx. volcanii*, where *agl* genes encode proteins responsible for the assembly and attachment of the pentasaccharide to the Asn residues of the target protein, also the *Hbt. salinarum* genome contains a group of clustered homologous genes. Introduction of these *Hbt. salinarum* genes into *Hfx. volcanii* mutant strains deleted of the homologous sequences restored the lost activity. Moreover, transcription of the *Hbt. salinarum* genes in the native host and *in vitro* biochemical confirmation of the predicted functions of several of these gene products provided further support for the assignments made according to bioinformatic and genetic experiments, enabling that the first description of the N-glycosylation pathway in *Hbt. salinarum* was presented (Kandiba and Eichler 2015).



Among halophilic archaea, it was generally assumed that paracrystalline S-layers are assembled only of a single (glyco)protein species. Recently, however, this assumption changed when in *Har. hispanica* two S-layer glycoproteins, termed Slg1 and Slg2, with a sequence identity of 83%, were identified as constituents of the S-layer (Lu et al. 2015). Based on MS data, the ratio of these glycoproteins was determined to be 1:1. Selective releasing procedures of the decorating glycans from Slg1 and Slg2 allowed discrimination between an N- and an O-linked fraction. In *Har. marismotui*, *Har. japonica*, *Har. californiae* and *Har. sinaiensis*, homologous genes corresponding to Slg1/Slg2 and Hvo\_2072, the S-layer glycoprotein of *Hfx. volcanii*, were found (Wakai et al. 1997; Calo et al. 2011). In *Har. marismotui* and *Har. Japonica*, expression, regulation and function of the homologous genes of Slg1 and Slg2 are still unknown. In the O-linked glycan fraction containing Slg1 and Slg2, an  $\alpha$ -Glc-(1 $\rightarrow$ 4)-Gal disaccharide was released at a relatively mild condition (low temperature and short time) compared with the release procedure for the acidic, N-linked trisaccharide. MALDI-TOF MS analyses of the digested glycopeptides obtained from Slg1 and Slg2 revealed that these disaccharides are linked to Thr residues within the DTPE repeats at the C-terminus of Slg2. In Slg1, although there are no DTPE repeats, the corresponding region at the C-terminus of Slg1 is almost completely composed of Asp, Glu, Thr and Pro residues. The Thr residues within this region are very likely modified by the same Glc-Gal disaccharide. The acidic N-linked trisaccharides are linked either to Asn306 in Slg1 or Asn307 in Slg2 (Lu et al. 2015). Thus, the S-layer proteins of *Hbt. salinarum* as well as *Hfx. volcanii* can be simultaneously modified by at least two kinds of N-linked glycans (Eichler 2013; Jarrell et al. 2014).

In *Har. hispanica*, only one N-linked glycan species was detected, which comprises a novel branched trisaccharide containing 2-amino-6-sulfo-2,6-dideoxy-glucose (sulfoquinovosamine) (Fig. 2). The trisaccharide is linked to the S-layer glycoprotein via galactose (Lu et al. 2015). The sulfoquinovose identified in the N-glycan of *Har. hispanica* is further modified by an amino group at C-2 position. This was the first observation of the naturally occurring form of sulfoquinovosamine, but it was already chemically synthesised, previously (Sacoman and Hollingsworth 2011). As an analogue of glucosamine-6-phosphate, sulfoquinovosamine is an effective inhibitor of the UDP-N-acetylglucosamine synthesis and leads to defects in bacterial or fungal cell-wall biosynthesis. In *Har. hispanica*, the pathway for biosynthesis and the biological function of this rare amino sugar are still unknown.

Apart from this study, sulfated sugars have been identified in N-linked glycans of several archaeons. In *Su. acidocaldarius*, the S-layer glycoprotein is glycosylated at multiple sites with chitobiose-linked N-glycans containing 6-sulfoquinovose (Peyfoon et al. 2010). Similarly, in *Su. solfataricus* P2, 6-sulfoquinovose is present in surface exposed glycoproteins (Palmieri et al. 2013). In *Thermoplasma acidophilum*, the cell-surface glycoproteins are modified with an N-linked glycan containing 6-sulfofucose (Vinogradov et al. 2012).

Recently, in *Hfx. volcanii*, the S-layer glycoprotein was found modified at Asn732 by a chitobiose-linked oligosaccharide containing 6-sulfoquinovose (Parente et al. 2014). The structural characterisation of the novel oligosaccharide related a rhomboid protease with the protein glycosylation process. Deletion of the protease gene altered the common S-layer glycoprotein N-glycan structure at the Asn732 site (Parente et al. 2014). *Haloferax volcanii* is able to grow at salt concentration from 1.7 to 4.8 M NaCl. When growing at high (3.4 M NaCl) and low (1.7 M

NaCl) salinity, *Hfx. volcanii* cells can modify the N-glycans by utilising different N-glycosylation sites on the S-layer glycoprotein (Guan et al. 2012). The reversible changes of protein glycosylation require *Hfx. volcanii* cells to adapt to the fluctuation of the environmental salinity. If compared with *Hfx. volcanii*, *Har. hispanica* needs at least 3.4 M NaCl for decent growth and grows rather poorly at 2.6 M NaCl. Currently, it is not known whether *Har. hispanica* could adopt to changing environmental salinity and synthesise different N-glycans on the S-layer protein (Lu et al. 2015).

The O-glycan decorating both S-layer glycoproteins of *Har. hispanica* is an  $\alpha$ -Glc-(1 $\rightarrow$ 4)-Gal disaccharide. In *Hbt. salinarum* and *Hfx. volcanii*, chemical characterisation established a Glc-(1 $\rightarrow$ 3)-Gal linkage and a Glc-(1 $\rightarrow$ 2)-Gal linkage, respectively (Sumper 1987; Sumper et al. 1990). Although there are differences in sugar linkages, the O-glycan structures seem to be relatively unchanged when compared with the diverse N-glycans found in different haloarchaeal species. The conserved O-glycan structure may indicate a universal function of this Glc-Gal disaccharide in halophilic archaea (Lu et al. 2015).

Recently, by performing for the first time metaproteomics on haloarchaea, genomic variation of S-layer, archaeella [= archaeal flagella; compare with (Jarrell and Albers 2012; Albers and Jarrell 2015); *vide infra*] and other cell-surface proteins was linked to mechanisms of infection evasion (Tschitschko et al. 2015). In Deep Lake, Antarctica, intergenera gene exchange occurs rampantly within the low complexity, haloarchaea-dominated community, strongly balanced by distinctions in niche adaptation that maintain sympatric speciation. CRISPR defence systems were found to be active, with haloarchaea responding to at least eight distinct types of viruses, including those infecting between genera. Although evasion and defence were evident, both hosts and viruses also may benefit from viruses carrying and expressing host genes, thereby potentially enhancing genetic variation and phenotypic differences within populations (Tschitschko et al. 2015).

The cell surface of the hyperthermophile *Methanothermobacter fervidus* is covered by an S-layer glycoprotein with the composition D-3-O-methylmannose, D-Man and D-GalNAc in a molar ratio of 2:3:1, with the first residue partly replaced by 3-O-methylglucose. The heterosaccharide with the proposed structure  $\alpha$ -D-3-MeOManp-(1 $\rightarrow$ 6)- $\alpha$ -D-3-MeOManp-[(1 $\rightarrow$ 2)- $\alpha$ -D-Manp]<sub>3</sub>-(1 $\rightarrow$ 4)-D-GalNAc is linked via GalNAc to asparagines of the peptide moiety (Fig. 2) (Kärcher et al. 1993).

In the course of structural investigations of glycosylated flagellins from methanogenic archaea, Jarrell and coworkers (Koval and Jarrell 1987; Chaban et al. 2009) made the interesting observation that the flagellin and also the glycosylated S-layer protein of *Methanococcus voltae* were decorated with the same complex N-linked glycan  $\beta$ -ManpNAC<sub>6</sub>Thr-(1 $\rightarrow$ 4)- $\beta$ -Glc<sub>3</sub>NAC<sub>3</sub>NAC<sub>1</sub>-(1 $\rightarrow$ 3)- $\beta$ -Glc<sub>1</sub>NAC<sub>1</sub>-(1 $\rightarrow$ N)-Asn (Fig. 2), where one of the constituting glycan components ( $\beta$ -ManNAC<sub>6</sub>) having a carbonyl group at C-6 forms an amide bond with the amino group of a threonine residue. Of note is an extension of the trisaccharide, both on the S-layer glycoprotein and the archaeal glycan, with an additional mass of either 220 or 262 Da, when the glycoproteins were prepared from *Me. voltae* strain PS\* (Fig. 2). Searching the *Me. voltae* genome identified Mv990 and Mv991 as putative glycosyl transferase genes, which are responsible for the mentioned mass addition. Deletions of Mv990 and Mv991 were made, and both resulted in N-glycosylation defects to the archaeal and S-layer proteins (Voisin et al. 2005; Chaban et al. 2009). Using a suite of synthetic and semisynthetic substrates, it was shown that AgIK initiates N-linked protein glycosylation in *Me. voltae* through the formation of

$\alpha$ -linked dolichyl monophosphate GlcNAc, which contrasts the polyprenyl diphosphate intermediates that feature in both eukaryotes and bacteria (Weerapana and Imperiali 2006; Varki et al. 2015). Notably, AglK has high-sequence homology to dolichyl phosphate  $\beta$ -glucosyltransferases including Alg5 in eukaryotes (Burda and Aebi 1999), suggesting a common evolutionary origin. The combined action of the first two enzymes, AglK and AglC, affords an  $\alpha$ -linked dolichyl monophosphate glycan that serves as a competent substrate for the archaeal OST AglB (Larkin and Imperiali 2011).

The *Methanosarcina mazei* sheath or S-layer protein MM1976 is one of the most abundant proteins made by the archaeon (Francoleon et al. 2009; Rohlin et al. 2012). ConA-binding enriched cell lysates for this protein, permitting characterisation of low stoichiometry modifications. Bona fide glycosylated proteins, revealed by their oxonium ions in peptide MS/MS spectra, were identified from ConA-eluate as MM0002, MM0716, MM1364 and S-layer protein MM1976. The OST (MM0647) detected in the ConA pull-down experiment is a product of one of three *aglB* homologues encoded in the *Met. mazei* genome (MM646, MM0647, MM2210) (Magidovich and Eichler 2009). Its detection makes MM0647 a logical candidate for the AglB OST that links glycans to asparagines on the MM1976 S-layer protein and to other N-linked glycoproteins. In addition, it was found that the hypothetical proteins MM0716 and MM1364 are glycosylated. Glycosylation of MM1364 correlates with homology to known *Methanosarcina* S-layer proteins (Francoleon et al. 2009; Rohlin et al. 2012) that also bear glycans. To date, no structural information about glycosylated *Met. mazei* proteins is available (Leon et al. 2015).

Recently, it was shown that the S-layer oligosaccharide of the thermoacidophilic crenarchaeon *Su. acidocaldarius* consists of a tri-branched hexasaccharide  $\{\alpha\text{-Man-(1}\rightarrow\text{6)-}\}\{\alpha\text{-Man-(1}\rightarrow\text{4)-}\}\text{-}[(\text{HO}_3\text{S}\rightarrow\text{6})\text{-}][\beta\text{-Glc-(1}\rightarrow\text{4)-}]\text{-}\beta\text{-Qui-(1}\rightarrow\text{3)-}\beta\text{-GlcNAc-(1}\rightarrow\text{4)-}\beta\text{-GlcNAc-(1}\rightarrow\text{N)-}$  that is N-glycosidically linked via a chitobiose core to several asparagine sites at the S-layer protein (Baumeister and Lembcke 1992; Veith et al. 2009) (Fig. 2). Interestingly, the same glycan structure was already reported on the *Su. acidocaldarius* cytochrome *b* (Zähringer et al. 2000) and on the archaeum (*vide infra*). Sharing of identical glycan structures on both S-layers and archaeella was first reported with the haloarchaeon *Hbt. salinarum* (Wieland, Paul and Sumper 1985).

The N-glycosylation pattern of cell-surface-exposed proteins of *Su. solfataricus* P2 (Baumeister and Lembcke 1992; Veith et al. 2009) was analysed by lectin affinity purification, HPAEC-PAD and multiple MS-based techniques (Palmieri et al. 2013). Detailed analysis of SSO1273, one of the most abundant ABC transporters present in the cell-surface fraction of *Su. solfataricus*, revealed a novel glycan structure composed of a branched sulfated heptasaccharide, Hex<sub>4</sub>(GlcNAc)<sub>2</sub> and sulfoquinovose, where Hex is D-mannose and D-glucose. The same type of N-glycosylation was found and verified on the S-layer glycoprotein (SSO0389) (Fig. 2) and different proteases, having one monosaccharide unit more than the glycan of the S-layer glycoprotein of *Su. acidocaldarius* (Peyfoon et al. 2010). This is one of the most complex archaeal glycan structure known today (Palmieri et al. 2013).

## ARCHAEL SURFACE APPENDAGES

Archaea have evolved fascinating surface structures allowing rapid adaptation to changing environments. Archaeal surface appendages display diverse biological roles such as motility,

adhesion, biofilm formation, exchange of genetic material and species-specific interactions and, in turn, increase fitness of the cells (Ng, Chaban and Jarrell 2006; Lassak, Ghosh and Albers 2012).

## Archaeella

Flagella as motility structures evolved independently in the bacterial and the archaeal kingdom. Since the archaeal archaeum is different from the bacterial flagellum, investigation of structural biochemistry and activities of this motility machinery is of great interest (Ng, Chaban and Jarrell 2006; Jarrell and Albers 2012; Albers and Jarrell 2015). To account for this difference, re-naming of the archaeal flagellum to 'archaeum' was proposed (Jarrell and Albers 2012; Albers and Jarrell 2015). With increased studies conducted on archaea, it has become clear that the archaeum only functionally appears similar to the bacterial flagellum fulfilling the same swimming function, whereas it structurally resembles a bacterial type IV pilus. Important genes for proper function of the archaeella are conserved in the *fla* operons of the different archaea (Eichler 2000; Ghosh and Albers 2011; Jarrell and Albers 2012), with defects in N-glycosylation influencing the function of the archaeum. In *Haloferax volcanii* (Abu-Qarn et al. 2007; Tripepi et al. 2012), *Methanococcus voltae* (Chaban et al. 2006), *Me. maripaludis* (VanDyke et al. 2009) and *Sulfolobus acidocaldarius* (Meyer et al. 2011, 2013), for instance, AglB, the archaeal OST is the central enzyme of the N-glycosylation pathway; its deletion results in non-motile cells, lacking any archaeella filament.

Previously, an archaeum-related gene cluster was identified in *Halobacterium salinarum* (Patenge et al. 2001). For the structural characterisation of halobacterial archaeella originally *Hbt. salinarum* strain R1M1 was used (Trachtenberg, Pinnick and Kessel 2000; Cohen-Krausz and Trachtenberg 2002). However, recent work was performed with strain M175, which, under conditions of relatively low ionic strength (0.8 M versus 5 M) and low pH (~2.5 versus ~6.8), forms polyarchaeal bundles at high yield. The archaeum assembles at the proximal end and is constructed from different glycosylated archaeellins (Cohen-Krausz and Trachtenberg 2002).

Besides the S-layer glycoproteins of the haloarchaea *Hbt. salinarum* (Kandiba and Eichler 2015) and *Hfx. volcanii* (Kandiba et al. 2016), little is known about the glycosylation of other haloarchaeal proteins. Recently, it was demonstrated that the *Hfx. volcanii* archaeellins require archaeal glycosylation (Agl) components involved in S-layer protein glycosylation and that the deletion of any *Hfx. volcanii agl* gene impairs the bacterium's swimming motility to various extents (Tripepi et al. 2012). A comparison of wild-type *Hfx. volcanii* and deletion mutants lacking the oligosaccharyltransferase AglB suggests that when the Agl glycosylation pathway is disrupted, cells lack stable archaeellins, which consist of the major archaeum, FlgA1, and a minor archaeum, FlgA2. MS analyses of FlgA1 confirm that its three predicted N-glycosylation sites Asn70, Asn115 and Asn172 are modified with covalently linked pentasaccharides having the same mass as that modifying the S-layer glycoprotein, namely mannose-(1→2)-[methyl-(O→4)-]- $\beta$ -GlcA-(1→4)- $\alpha$ -GalA-(1→4)- $\beta$ -GlcA-(1→4)- $\beta$ -Glc-(1→N)-Asn (Kandiba et al. 2016) (Fig. 2). Finally, the replacement of any of three predicted N-glycosylated asparagines of FlgA1 renders cells non-motile, providing direct evidence for the first time that the N-glycosylation of archaeellins is critical for motility (Tripepi et al. 2012).

The archaeum of *Me. voltae* is composed of four structural archaeellins FlaA, FlaB1, FlaB2 and FlaB3; they possess

a total of 15 potential N-linked (N-X-(S/T)) sequons with 14 of them carrying glycan modifications. The archaeum glycan structure was shown to be a trisaccharide composed of  $\beta$ -ManpNAc3NAcA6Thr-(1 $\rightarrow$ 4)- $\beta$ -GlcPNAc3NAcA-(1 $\rightarrow$ 3)- $\beta$ -GlcPNAc, linked to Asn residues (Voisin et al. 2005). Further, an extension of the archaeal glycan by an additional mass of 220 or 262 Da is possible when the glycoprotein is prepared from *Me. voltae* strain PS\* (vide supra, characterisation of the respective S-layer glycoprotein) (Chaban et al. 2009). In *Me. maripaludis*, the three archaeellins that comprise the archaeum are modified at multiple sites with the N-linked tetrasaccharide Sug-(1 $\rightarrow$ 4)- $\beta$ -ManNAc3NAcA6Thr-(1 $\rightarrow$ 4)- $\beta$ -GlcNAc3NAcA-(1 $\rightarrow$ 3)- $\beta$ -GalNAc-Asn, with the components GalNAc, a diacetylated glucuronic acid (GlcNAc3NAc) and an acetylated and acetamido-modified mannuronic acid with a threonine substitution in an amid-linkage to carbon 6 of the uronic acid (ManNAc3NAcA6Thr). Further, at the non-reducing end is the novel sugar residue Sug with the structure (5S)-2-acetamido-2,4-dideoxy-5-O-methyl- $\alpha$ -L-erythro-hexos-5-ulo-1,5-pyranose, so far found exclusively in this species. Thus, the *Me. voltae* GlcNAc-linked trisaccharide is extended in *Me. maripaludis* by an additional sugar residue and is attached in a different N-linkage via  $\beta$ -GalNAc to Asn residues. The significance of this linkage to archaeellins via  $\beta$ -GalNAc rather than  $\beta$ -GlcNAc is not known, but this may be a reflection of the specificity of the respective glycosyltransferases from either strain (Kelly et al. 2009). Several studies were devoted to the analysis of protein functions encoded in the archaeellin gene clusters. Successful deletion of genes encoding the three glycosyltransferases and an OST (Stt3p homologue) resulted in archaeellins of decreased molecular masses as evidenced by immunoblotting and TEM, indicating partial or completely absent glycan structures (VanDyke et al. 2009; Ding et al. 2013). In an extension of this work, a series of genes in adjacent operons were shown to encode enzymes that complete the pathway for generation of the subsequent sugars of the N-linked tetrasaccharide that modifies archaeellins of *Me. maripaludis*. Among the genes involved in sugar biosynthesis was the putative acetyltransferase gene *mmp0350*, which appears to attach an acetyl group to the second sugar of the glycan, a diacetylated glucuronic acid (VanDyke et al. 2009; Jarrell, Jones and Nair 2010; Jarrell et al. 2010; Jones et al. 2012). This post-translational modification of archaeellins is necessary for archaeum assembly (Siu et al. 2015). *Methanococcus maripaludis*, the *mmp0350-mmp0353* and *mmp0357* genes are proposed to be functionally equivalent to the *Pseudomonas aeruginosa* *wbpABEDI* genes involved in converting UDP-GlcNAc to UDP-2,3-diacetamido-2,3-dideoxy-D-mannuronic acid, a serotype O5-specific sugar antigen (Westman et al. 2009). Cross-domain complementation of the final step of the *P. aeruginosa* pathway with *mmp0357* supports this hypothesis. This study included a rare example of an archaeal gene functionally replacing a bacterial gene in a complex sugar biosynthesis pathway (Siu et al. 2015). Characterisation of single genes from the cluster *mmp1089-mmp1094* and gene annotation and bioinformatic analyses indicated that MMP1090 is a UDP-glucose 4-epimerase, suggesting that the unique terminal sugar of the archaeellin N-glycan might be synthesised from UDP-Glc or UDP-GlcNAc with an essential early step in synthesis catalysed by MMP1090 (Ding et al. 2016).

Whereas flagella have been intensively studied (Kearns 2010), the knowledge regarding the archaeal counterpart is mostly restricted to Euryarchaeota rather than Crenarchaeal archaea. Therefore, the archaeal assembly system of the Crenarchaeal

model organism *Su. acidocaldarius* was investigated in vivo in greater detail (Lassak et al. 2012). Promoter studies and qRT-PCR analyses of the archaea gene cluster provided evidence that the expression of the *fla* genes was induced by tryptone starvation. Moreover, it was confirmed that a secondary *fla* promoter is present within the *flaB* gene that regulates the transcription of downstream genes *flaX-J*. Markerless in-frame deletions for all *fla* genes encoded in the *fla* gene cluster were constructed. Western blot analysis of the *fla* deletion strains suggested hierarchical protein interactions during archaea assembly. TEM micrographs demonstrated the loss of archaeal assembly coincided with a lack of motility. Thus, all seven *fla* genes are essential for Crenarchaeal archaeum assembly and function.

Recently, the S-layer protein of *Su. acidocaldarius* was shown to be N-linked with a tri-branched hexasaccharide containing a sulfated sugar called sulfoquinovose (Peyfoon et al. 2010). Concerning the frequently observed convergence of sugar biosynthesis pathways, it was interesting to see that the effect of deletion of *agl3*, encoding the UDP-sulfoquinovose, did not only result in an altered N-glycan on SlaA but also on the *Su. acidocaldarius* archaeellin FlaB (Meyer et al. 2011). Thus, it was reasoned that deletion of *agl16*, encoding a glycosyltransferase involved in S-layer N-glycan assembly, might also lead to different migration behaviour of the FlaB protein in SDS-PAGE. MS analyses confirmed that the glycan of the S-layer protein from the *agl16* deletion mutant was a pentasaccharide, which was missing a terminal hexose residue; HPLC analyses of the hydrolysed N-glycan indicated that the missing hexose is a glucose residue. A physiological characterisation of the  $\Delta$ *agl16* deletion mutant revealed a significant effect on the growth at elevated salt concentrations. At 300 mM NaCl, the doubling time of the  $\Delta$ *agl16* mutant was increased 10-fold compared to the background strain. Furthermore, the incomplete glycan structure of the  $\Delta$ *agl16* deletion strain affected the assembly and function of the archaeum, as exemplified by semisolid Gelrite plate analysis, in which the motility is decreased in dependence of the N-glycan size. Indeed, both FlaB proteins from the  $\Delta$ *agl16* and the  $\Delta$ *agl3* deletion strain migrated faster than the wild-type protein, whereas in the complemented strains, the original FlaB wild-type size was restored. As was shown for the S-layer glycoprotein, FlaB in the  $\Delta$ *agl16* strain was smaller compared to FlaB in the wild-type and  $\Delta$ *agl3* strains. This difference is most likely due to the loss of only one sugar residue on the N-glycan in  $\Delta$ *agl16*, whereas in  $\Delta$ *agl3*, the N-glycan is truncated by three sugar residues (Meyer et al. 2011). In *Su. acidocaldarius*, N-glycosylation mutants, which exhibited reduced N-glycan size, lacking one or three-terminal sugar residues, were severely affected in motility (Meyer et al. 2011, 2013). Interestingly, there are also indications of a physical association between the archaeum and the S-layer glycoprotein in *Su. acidocaldarius*. FlaF, localised in the archaeum biosynthesis gene cluster, was shown to specifically bind to the S-layer protein, suggesting that its interaction domain is located in the pseudoperiplasm with its N-terminal helix in the membrane. Thus, FlaF may act as the previously unknown archaeum stator protein that anchors the rotating archaeum (Shahpure et al. 2014) to the archaeal cell envelope (Banerjee et al. 2015). Structural comparison with archaea from *Su. shibatae* B12 and *Hbt. salinarum* revealed high similarity. This suggests a unique and common underlying symmetry for archaeal filaments (Cohen-Krausz and Trachtenberg 2008).

The archaea of the Euryarchaeon *Pyrococcus furiosus* are multifunctional cell appendages used for swimming, adhesion to surfaces and formation of cell-cell connections. Archaea



were purified by shearing from cells followed by CsCl-gradient centrifugation and were found to consist mainly of an approximately 30-kDa glycoprotein as was demonstrated by SDS-PAGE and glycan staining (Näther-Schindler et al. 2014).

### Archaeal pili

In both bacteria and archaea, the biosynthesis of type IV pilus-related structures involves a set of core components (Logan 2006; Makarova, Koonin and Albers 2016). Although *in silico* analyses showed that most sequenced archaeal genomes encode predicted pilins and conserved pilus biosynthesis components, only recent *in vivo* analyses of archaeal pili in genetically tractable crenarchaea and euryarchaea revealed archaea-specific type IV pilus functions and biosynthesis components. In the future, studies in a variety of archaeal species will reveal which type IV pilus-like structures are common in all archaea and which are limited only to certain species within this domain (Pohlschroder et al. 2011; Pohlschroder and Esquivel 2015). These structures do not only comprise the widely distributed archaeella, but also different highly specialised archaeal pili which may possess different assembly mechanisms, structural aspects and physiological roles (Lassak, Ghosh and Albers 2012; Makarova, Koonin and Albers 2016).

At least two different types of pilus structures have been reported in archaea, including those assembled from type IV pilin-like proteins, as seen in several genera including *Hfx. volcanii* (Esquivel et al. 2016), *Methanococcus* and *Sulfolobus*, and others that are not seemingly related to type IV pili, as in *Methanothermobacter thermoautotrophicus* (Jarrell, Jones and Nair 2010).

The oligosaccharyltransferase (AglB)-dependent N-glycosylation of archaeellins is required for archaeella assembly in many archaea (Tripepi et al. 2012). However, whether N-glycosylation is required for the assembly and/or function of the structurally related archaeal type IV pili was unknown so far. In a recent study, type IV pilin N-glycans of *Hfx. volcanii* with diverse roles in pilus biosynthesis, adhesion and microcolony formation have been identified (Esquivel et al. 2016). It was shown that of six adhesion pilins, PilA1 and PilA2, the most abundant pilins in wild-type and  $\Delta$ aglB strains, are modified under planktonic conditions in an AglB-dependent manner by the same pentasaccharide as was detected on *Hfx. volcanii* archaeellins (mannose-(1→2)-[methyl-(O→4)]- $\beta$ -GlcA-(1→4)- $\alpha$ -GalA-(1→4)- $\beta$ -GlcA-(1→4)- $\beta$ -Glc-(1→N)-Asn; Fig. 2) (Kandiba et al. 2016). These data revealed that PilA1–PilA4 are N-glycosylated in an AglB-dependent manner and also showed that these pilins inhibit microcolony formation, which is promoted by PilA5 and PilA6 (Esquivel et al. 2016). Non-glycosylated pilins are not able to inhibit this early step in biofilm formation. Since loss of AglB-dependent glycosylation of the archaeellins also inhibits *Hfx. volcanii* archaeella biosynthesis (Tripepi et al. 2012), low salt conditions might promote biofilm formation by inhibiting archaeella-dependent motility as well as resulting in promotion of microcolony formation, which is dependent on the glycosylation of PilA1–PilA4. This is the first demonstration of a differential effect of glycosylation on pilus assembly and function of paralogous pilins. The growth of wild-type cells in low salt media, a condition that decreases AglB glycosylation, also stimulates microcolony formation and inhibits motility, supporting the hypothesis that N-glycosylation plays an important role in regulating the transition between planktonic to sessile cell states as a response to stress (Esquivel et al. 2016).

A study on *Meth. thermoautotrophicus* fimbriae/pili indicated that the main structural component is a 16-kDa glycoprotein

(Mth60) with no known homologues reported in the databases (Thoma et al. 2008). For the first time in archaea, pili structures were shown to be adhesive surface appendages, and their abundance on the cell surface was greatly enhanced when cells were grown on surfaces rather than in liquid cultures. In this context, it is interesting to note that archaea, like bacteria, predominately exist as biofilms in nature (Thoma et al. 2008).

The type IV pili on the surface of *Me. maripaludis* are much less numerous than archaeella. They are composed of a major structural protein of 17 kDa that is N-glycosylated with the same complex tetrasaccharide as it is present in *Me. maripaludis* archaeella (*vide supra*), but with an additional hexose attached to the GalNAc linking sugar (Siu et al. 2015).

*Sulfolobus acidocaldarius* displays three distinct type IV pili-like structures on its surface: the archaeellum, the UV-induced pili and the adhesive pili (Henche et al. 2012b; Lassak et al. 2012). To investigate the influence of the diverse set of type IV pili-like structures, deletion mutants lacking the cell-surface appendages were constructed and analysed for their behaviour in attachment assays and during biofilm formation. There is evidence that all three cell-surface appendages play a role in the colonisation of surfaces and only the interplay of all three appendages leads to the observed wild-type biofilm phenotype (Henche et al. 2012b). Type IV pilins and archaeellins are N-glycosylated by the archaeal Agl N-glycosylation machinery (Ghosh and Albers 2011). MS analysis of the pilin/archaeellin fraction of *Su. acidocaldarius* identified, among other genes, *aapB* (Saci2319) as the gene encoding the pilin AapB. Harsh treatment of the isolated pili with phenol and detergents like Triton X-100 did not lead to the disassociation of the pilin subunits. This stability might stem from strong hydrophobic interactions of the pilin subunits and also post-translational modification of the aap pilus by glycosylation. As only AapB was identified in the isolated fraction, it is assumed that this protein is the major pilin of the aap filament. Numerous asparagines are present in the pilins that are possible target residues of the N-glycosylation machinery; the isolated fraction was analysed by TEM analysis, SDS-PAGE and glyco-stained using the Pro-Q Emerald 300 Glycoprotein Gel Stain kit (Henche et al. 2012a). Up to now, no defined pilus glycan structure of *Su. acidocaldarius* has been reported.

### Other archaeal glycoproteins

The glycan structure of *Py. furiosus* proteins, as determined by MS, is a single oligosaccharide chain composed of two N-acetylhexosamines, two hexoses, one hexuronic acid and two pentoses. The fragmentation pattern of the heptasaccharide suggests the branched structure HexNAc-(Pentose)-HexA)-(Pentose)-Hex-Hex-HexNAc-Asn (Igura et al. 2008). The *Py. furiosus* linkage unit is probably GalNAc-Asn, as in *Hbt. salinarum* (Paul, Lottspeich and Wieland 1986).

The N-linked glycoprotein of the hyperthermophilic archaeon *Archaeoglobus fulgidus* was investigated by MS and revealed a relatively simple N-glycan structure Hex-Hex-dHex-dHex-Hex-Hex with a Hex-Asn linkage unit (Matsumoto et al. 2012). This is rare because the first monosaccharide moiety of most N-glycans contain an N-acetyl group at carbon 2, except for N-glycans from *Hbt. salinarum*, *Hfx. volcanii* and *Har. marismortui* (Lechner and Wieland 1989; Calo et al. 2011; Kandiba and Eichler 2014).

*Thermoplasma acidophilum* is a thermoacidophilic archaeon that grows optimally at pH 2 and 59°C (Vinogradov et al. 2012). This extremophile is remarkable because of the absence of a cell wall or an S-layer. Treating the cells with Triton X-100 at

pH 3 allowed the extraction of all of the cell-surface glycoproteins while keeping cells intact. The extracted glycoproteins were partially purified and five glycoproteins were identified by N-terminal sequencing and MS after in-gel tryptic digests. The obtained glycopeptides were positive for carbohydrates in a periodic acid-Schiff staining reaction and had a high content of Asn residues, represented in many Asn-X-Ser/Thr sequons. Structure determination by NMR showed that the carbohydrate portion was represented by two glycans in nearly equal amounts, differing by the presence of one terminal mannose residue. The larger glycan chain consists of eight residues, six hexoses, one heptose and one sugar with an unusual residue mass of 226 Da, which was identified as 6-deoxy-6-C-sulfo-D-galactose (6-C-sulfo-D-fucose). MS analyses of peptides obtained after trypsin and chymotrypsin digestion confirmed the principal structures to be those determined by NMR and identified 14 glycopeptides derived from the main glycoprotein, Ta0280, all containing the Asn-X-Ser/Thr sequons. Thus, *T. acidophilum* appears to have a general protein N-glycosylation system that targets a number of cell-surface proteins (Vinogradov et al. 2012).

The haloarchaeal pleomorphic virus HRPV-1 infecting *Halorubrum* sp. strain PV6 and VP4 has a major structural protein that is glycosylated (Kandiba et al. 2012). After  $\beta$ -elimination glycans released from VP4 were analysed by MS and NMR, showing that the major VP4-derived glycan is the pentasaccharide  $\alpha$ -5FmLeg-(2 $\rightarrow$ 4)- $\beta$ -(SO<sub>3</sub> $\rightarrow$ 2)-GlcA-(1 $\rightarrow$ 2)- $\alpha$ -Man-(1 $\rightarrow$ 4)- $\beta$ -GlcA-(1 $\rightarrow$ 4)-Glc, comprising Glc, GlcA, Man, sulfated GlcA and a terminal 5-N-formyl-legionaminic acid residue (Knirel et al. 2003). The importance of this modified nonulosonic acid (NulO) residue for viral infection was demonstrated upon incubation with N-acetylneuraminic acid. Such treatment reduced progeny virus production by half 4 h post infection. The presence of pentasaccharide precursors on two different VP4-derived peptides bearing the N-glycosylation signal NTT was confirmed by MS (Kandiba et al. 2012). The same sites modified by the native host, *Halorubrum* sp. strain PV6, were also recognised by the *Hfx. volcanii* N-glycosylation apparatus, as determined by MS of heterologously expressed VP4. Here, however, the N-linked pentasaccharide was the same as shown to decorate the S-layer glycoprotein in this species. Hence, N-glycosylation of the haloarchaeal viral protein, VP4, is host specific. These results present additional examples of archaeal N-glycosylation diversity and show the ability of archaea to modify heterologously expressed proteins.

Furthermore, *Meth. smithii* was shown to generate a different NulO, namely pseudaminic acid, although it is not known whether this sugar is used in protein glycosylation (Lewis et al. 2009). The genes for archaeal NulO sugar biosynthesis might have arrived from animals (Lewis et al. 2009) and later emerged in archaea by lateral gene transfer, assuming a major role in the evolutionary history (Kandiba and Eichler 2013).

In this context, it is appropriate to raise the question as to how exchange of genetic material between eukaryotes and prokaryotes and, specifically, bacteria and archaea is facilitated. Acquisition of new genetic material through gene transfer has been shown to be an important feature in the evolution of prokaryotes (Doolittle 1999). Changes in the genetic repertoire occurring through gene acquisition and deletion are major events underlying the emergence and evolution of prokaryotic pathogens (Nelson-Sathi et al. 2015). Thus, the appearance of legionaminic acid in haloarchaea-derived glycans (Kandiba et al. 2012) and pseudaminic acid in *Methanobrevibacter* (Lewis et al. 2009) is of considerable interest. Members of the domain *Archaea* have been implicated in the severity of periodontal disease, and

a recent report confirms that archaea are present in endodontic infections (Vickerman et al. 2007). A *Meth. oralis*-like species was detected in one asymptomatic and one symptomatic patient. DNA from root canals of one of these patients showed also the presence of 'red complex bacteria' (Holt and Ebersole 2005). These results confirm the presence of archaea in root canals and provide additional insights into the polymicrobial communities in endodontic infections associated with clinical symptoms (Mansfield et al. 2012; Efenberger et al. 2015). Among this group of 'red complex bacteria' is also *Tannerella forsythia*, whose glycosylated S-layer proteins TfsA and TfsB have been characterised recently (Posch et al. 2011) (vide supra and Fig. 2). Very recent unpublished data also show that *Ta. forsythia* can decorate the S-layer proteins and other cellular proteins, in a strain-dependent manner, either with Pse or Leg (Valentin Friedrich, Bettina Janesch, Markus Windwarder, Matthias Braun, Zoë A. Megson, Evgeny Vinogradov, Ashu Sharma, Friedrich Altmann, Paul Messner, Ian C. Schoenhofen, Christina Schäffer, manuscript in preparation).

## CONCLUDING REMARKS

The field of prokaryotic glycosylation remains challenging due to its inherent complexity. Our current knowledge summarised in this review represents only a small fraction of the prokaryotic glyco world because all available information originates from cultivable microorganisms only. However, laboratory cultivation conditions in shaking flasks or fermenters do not mirror those encountered in native habitats where most free-living organisms are socialised in biofilms.

Prokaryotic glycoconjugates exhibit an enormous diversity, but their biosynthesis is often based on common themes and pathways. This common ground can enhance the study of the still unexplored glycosylation potential of several prokaryotic organisms but needs to be complemented with efficient analytical methods, since sequence information alone does not adequately predict the glycosylation potential. The increasing availability of microbial whole-genome sequences has expanded the list of putative glycan biosynthetic enzymes from different prokaryotes, and advances in analytical methods have facilitated more comprehensive analyses of glycoproteins.

Although capsular and exopolysaccharides, PG, SCWPs and LPS have been studied for years, many aspects of prokaryotic glycosylation still remain unknown. Research concerning the functional importance of prokaryotic glycoconjugates, in particular of N- and O-linked glycoproteins, is still lagging behind the wealth of information on eukaryotic scenarios. Currently, the main focus lies on the elucidation of prokaryotic glycan structures and on delineating their role in virulence, pathogenesis and microbe-host interactions. Combining prokaryotic genetics with proteomic analysis and structural characterisation of glycans will pave the way for further elucidating the functions of these important molecules and their impact on the organism's behaviour.

It can be anticipated that the functional importance is more vibrant than currently appreciated. Further, exploitation of new fields for biotechnological and medical applications of the prokaryotic neo-glycoconjugates must be a prime goal in future.

The current knowledge on prokaryotic glycosylation is probably only the tip of the iceberg. However, it is clearer than ever that further elucidation of the enigmatic world of prokaryotic glycoconjugates is worth pursuing, as this can render

important insights into microbe–host interactions and increase our understanding of prokaryotic life. Without a doubt, the future of prokaryotic glycobiology looks challenging and exciting.

**Conflict of interest.** None declared.

## ACKNOWLEDGEMENTS

Work performed at the Department of NanoBiotechnology, Universität für Bodenkultur Wien, Vienna, Austria, was supported by the Austrian Science Fund FWF, projects P24317-B22, P21954-B22, P27374-B22, P26836-B22, and P24305-B20, to C.S. and P.M.

## REFERENCES

- Aas FE, Vik Å, Vedde J et al. *Neisseria gonorrhoeae* O-linked pilin glycosylation: functional analyses define both the biosynthetic pathway and glycan structure. *Mol Microbiol* 2007;**65**:607–24.
- Abdul Halim MF, Karch KR, Zhou Y et al. Permuting the PGF signature motif blocks both archaeosortase-dependent C-terminal cleavage and prenyl lipid attachment for the *Haloferax volcanii* S-layer glycoprotein. *J Bacteriol* 2016;**198**:808–15.
- Abdul Halim MF, Pfeiffer F, Zou J et al. *Haloferax volcanii* archaeosortase is required for motility, mating, and C-terminal processing of the S-layer glycoprotein. *Mol Microbiol* 2013;**88**:1164–75.
- Abu-Qarn M, Yurist-Doutsch S, Giordano A et al. *Haloferax volcanii* AglB and AglD are involved in N-glycosylation of the S-layer glycoprotein and proper assembly of the surface layer. *J Mol Biol* 2007;**374**:1224–36.
- Adamo R. Glycan surface antigens from *Bacillus anthracis* as vaccine targets: current status and future perspectives. *Expert Rev Vaccines* 2014;**13**:895–907.
- Adamo R, Saksena R, Kováč P. Synthesis of the b anomer of the spacer-equipped tetrasaccharide side chain of the major glycoprotein of the *Bacillus anthracis* exosporium. *Carbohydr Res* 2005;**340**:2579–82.
- Albers S-V, Jarrell KF. The archaeellum: how Archaea swim. *Front Microbiol* 2015;**6**:23.
- Albers S-V, Meyer BH. The archaeal cell envelope. *Nat Rev Microbiol* 2011;**9**:414–26.
- Alemka A, Nothaft H, Zheng J et al. N-glycosylation of *Campylobacter jejuni* surface proteins promotes bacterial fitness. *Infect Immun* 2013;**81**:1674–82.
- Allievi MC, Palomino MM, Prado Acosta M et al. Contribution of S-layer proteins to the mosquitocidal activity of *Lysinibacillus sphaericus*. *PLoS One* 2014;**9**:e111114.
- Altman E, Brisson J-R, Gagné SM et al. Structure of the glycan chain from the surface layer glycoprotein of *Clostridium thermohydrosulfuricum* L77-66. *Biochim Biophys Acta* 1992;**1117**:71–7.
- Altman E, Brisson J-R, Messner P et al. Chemical characterization of the regularly arranged surface layer glycoprotein of *Clostridium thermosaccharolyticum* D120-70. *Eur J Biochem* 1990;**188**:73–82.
- Altman E, Brisson J-R, Messner P et al. Structure of the glycan chain from the surface layer glycoprotein of *Bacillus alvei* CCM 2051. *Biochem Cell Biol* 1991;**69**:72–78.
- Altman E, Schäffer C, Brisson J-R et al. Characterization of the glycan structure of a major glycopeptide from the surface layer glycoprotein of *Clostridium thermosaccharolyticum* E207-71. *Eur J Biochem* 1995;**229**:308–15.
- Altman E, Schäffer C, Brisson J-R et al. Isolation and characterization of an amino sugar-rich glycopeptide from the surface layer glycoprotein of *Thermoanaerobacterium thermosaccharolyticum* E207-71. *Carbohydr Res* 1996;**295**:245–53.
- Anonsen JH, Vik Å, Børud B et al. Characterization of a unique tetrasaccharide and distinct glycoproteome in the O-linked protein glycosylation system of *Neisseria elongata* subsp. *glycolytica*. *J Bacteriol* 2016;**198**:256–67.
- Anonsen JH, Vik Å, Egge-Jacobsen W et al. An extended spectrum of target proteins and modification sites in the general O-linked protein glycosylation system in *Neisseria gonorrhoeae*. *J Proteome Res* 2012;**11**:5781–93.
- Antikainen J, Anton L, Sillanpää J et al. Domains in the S-layer protein CbsA of *Lactobacillus crispatus* involved in adherence to collagens, laminin and lipoteichoic acids and in self-assembly. *Mol Microbiol* 2002;**46**:381–94.
- Anzengruber J, Courtin P, Claes IJJ et al. Biochemical characterization of the major N-acetylmuramidase from *Lactobacillus buchneri*. *Microbiology* 2014a;**160**:1807–19.
- Anzengruber J, Pabst M, Neumann L et al. Protein O-glucosylation in *Lactobacillus buchneri*. *Glycoconj J* 2014b;**31**:117–31.
- Appendix-1B. Essentials of glycobiology [Internet]. 3rd edition. Symbol. Nomenclature for Glycans (SNFG). *Glycobiology* 2015;**25**:1323–24.
- Apweiler R, Hermjakob H, Sharon N. On the frequency of protein glycosylation, as deduced from analysis of the SWISS-PROT database. *Biochim Biophys Acta* 1999;**1473**:4–8.
- Araki Y, Ito E. Linkage units in cell walls of gram-positive bacteria. *Crit Rev Microbiol* 1989;**17**:121–35.
- Arbiv A, Yurist-Doutsch S, Guan Z et al. AglQ is a novel component of the *Haloferax volcanii* N-glycosylation pathway. *PLoS One* 2013;**8**:e81782.
- Archibald AR, Hancock IC, Harwood CR. Cell wall structure, synthesis and turnover. In: Sonenshein A, Hoch JA, Losick R (eds). *Bacillus Subtilis and Other Gram-Positive Bacteria*, Washington DC, USA: ASM Press. 1993, 381–410.
- Åvall-Jääskeläinen S, Palva A. *Lactobacillus* surface layers and their applications. *FEMS Microbiol Rev* 2005;**29**:511–29.
- Awram P, Smit J. Identification of lipopolysaccharide O antigen synthesis genes required for attachment of the S-layer of *Caulobacter crescentus*. *Microbiology* 2001;**147**:1451–60.
- Balonova L, Hernychova L, Mann BF et al. Multimethodological approach to identification of glycoproteins from the proteome of *Francisella tularensis*, an intracellular microorganism. *J Proteome Res* 2010;**9**:1995–2005.
- Banerjee A, Tsai C-L, Chaudhury P et al. FlaF is a b-sandwich protein that anchors the archaeellum in the archaeal cell envelope by binding the S-layer protein. *Structure* 2015;**23**:863–72.
- Banerjee A, Wang R, Supernavage SL et al. Implications of phase variation of a gene (*pgtA*) encoding a pilin galactosyl transferase in gonococcal pathogenesis. *J Exp Med* 2002;**196**:147–62.
- Baneyx F, Matthaei JF. Self-assembled two-dimensional protein arrays in bionanotechnology: from S-layers to designed lattices. *Curr Opin Biotechnol* 2014;**28**:39–45.
- Bartels K-M, Funken H, Knapp A et al. Glycosylation is required for outer membrane localization of the lectin LecB in *Pseudomonas aeruginosa*. *J Bacteriol* 2011;**193**:1107–13.
- Baumeister W, Lembcke G. Structural features of archaeobacterial cell envelopes. *J Bioenerg Biomembr* 1992;**24**:567–75.
- Bayer EA, Belaich J-P, Shoham Y et al. The cellulosomes: multienzyme machines for degradation of plant cell wall polysaccharides. *Annu Rev Microbiol* 2004;**58**:521–54.



- Bensing BA, Gibson BW, Sullam PM. The *Streptococcus gordonii* platelet binding protein GspB undergoes glycosylation independently of export. *J Bacteriol* 2004;**186**:638–45.
- Benz I, Schmidt MA. Glycosylation with heptose residues mediated by the *aah* gene product is essential for adherence of the AIDA-I adhesin. *Mol Microbiol* 2001;**40**:1403–13.
- Bindila L, Steiner K, Schäffer C et al. Sequencing of O-glycopeptides derived from an S-layer glycoprotein of *Geobacillus stearothermophilus* NRS 2004/3a containing up to 51 monosaccharide residues at a single glycosylation site by Fourier transform ion cyclotron resonance infrared multiphoton dissociation mass spectrometry. *Anal Chem* 2007;**79**:3271–9.
- Bock K, Schuster-Kolbe J, Altman E et al. Primary structure of the O-glycosidically linked glycan chain of the crystalline surface layer glycoprotein of *Thermoanaerobacter thermohydrosulfuricus* L111-69. Galactosyl tyrosine as a novel linkage unit. *J Biol Chem* 1994;**269**:7137–44.
- Børud B, Anonsen JH, Viburiene R et al. Extended glycan diversity in a bacterial protein glycosylation system linked to allelic polymorphisms and minimal genetic alterations in a glycosyltransferase gene. *Mol Microbiol* 2014;**94**:688–99.
- Børud B, Viburiene R, Hartley MD et al. Genetic and molecular analyses reveal an evolutionary trajectory for glycan synthesis in a bacterial protein glycosylation system. *P Natl Acad Sci USA* 2011;**108**:9643–8.
- Bou Raad R, Méniche X, de Sousa-d'Auria C et al. A deficiency in arabinogalactan biosynthesis affects *Corynebacterium glutamicum* mycolate outer membrane stability. *J Bacteriol* 2010;**192**:2691–700.
- Bu S, Li Y, Zhou M et al. Interaction between two putative glycosyltransferases is required for glycosylation of a serine-rich streptococcal adhesin. *J Bacteriol* 2008;**190**:1256–66.
- Burda P, Aebi M. The dolichol pathway of N-linked glycosylation. *Biochim Biophys Acta* 1999;**1426**:239–57.
- Calo D, Guan Z, Eichler J. Glyco-engineering in Archaea: differential N-glycosylation of the S-layer glycoprotein in a transformed *Haloferax volcanii* strain. *Microb Biotechnol* 2011;**4**:461–70.
- Calo D, Guan Z, Naparstek S et al. Different routes to the same ending: comparing the N-glycosylation processes of *Haloferax volcanii* and *Haloarcula marismortui*, two halophilic archaea from the Dead Sea. *Mol Microbiol* 2011;**81**:1166–77.
- Calo D, Kaminski L, Eichler J. Protein glycosylation in Archaea: sweet and extreme. *Glycobiology* 2010;**20**:1065–76.
- Candela T, Maes E, Garénaux E et al. Environmental and biofilm-dependent changes in a *Bacillus cereus* secondary cell wall polysaccharide. *J Biol Chem* 2011;**286**:31250–62.
- Carasi P, Ambrosio NM, De Antoni GL et al. Adhesion properties of potentially probiotic *Lactobacillus kefir* to gastrointestinal mucus. *J Dairy Res* 2014;**81**:16–23.
- Castric P. pilO, a gene required for glycosylation of *Pseudomonas aeruginosa* 1244 pilin. *Microbiology* 1995;**141**:1247–54.
- Castric P, Cassels FJ, Carlson RW. Structural characterization of the *Pseudomonas aeruginosa* 1244 pilin glycan. *J Biol Chem* 2001;**276**:26479–85.
- Cava F, de Pedro MA, Schwarz H et al. Binding to pyruvylated compounds as an ancestral mechanism to anchor the outer envelope in primitive bacteria. *Mol Microbiol* 2004;**52**:677–90.
- Çelik E, Ollis AA, Lasanajak Y et al. Glycoarrays with engineered phages displaying structurally diverse oligosaccharides enable high-throughput detection of glycan-protein interactions. *Biotechnol J* 2015;**10**:199–209.
- Chaban B, Logan SM, Kelly JF et al. AglC and AglK are involved in biosynthesis and attachment of diacetylated glucuronic acid to the N-glycan in *Methanococcus voltae*. *J Bacteriol* 2009;**191**:187–95.
- Chaban B, Voisin S, Kelly J et al. Identification of genes involved in the biosynthesis and attachment of *Methanococcus voltae* N-linked glycans: insight into N-linked glycosylation pathways in Archaea. *Mol Microbiol* 2006;**61**:259–68.
- Charbonneau M-È, Côté J-P, Haurat MF et al. A structural motif is the recognition site for a new family of bacterial protein O-glycosyltransferases. *Mol Microbiol* 2012;**83**:894–907.
- Che F-S, Nakajima Y, Tanaka N et al. Flagellin from an incompatible strain of *Pseudomonas avenae* induces a resistance response in cultured rice cells. *J Biol Chem* 2000;**275**:32347–56.
- Chen X, Varki A. Advances in the biology and chemistry of sialic acids. *ACS Chem Biol* 2010;**5**:163–76.
- Choudhury B, Leoff C, Saile E et al. The structure of the major cell wall polysaccharide of *Bacillus anthracis* is species-specific. *J Biol Chem* 2006;**281**:27932–41.
- Christian R, Schulz G, Schuster-Kolbe J et al. Complete structure of the tyrosine-linked saccharide moiety from the surface layer glycoprotein of *Clostridium thermohydrosulfuricum* S102-70. *J Bacteriol* 1993;**175**:1250–56.
- Christian R, Schulz G, Unger FM et al. Structure of a rhamnan from the surface-layer glycoprotein of *Bacillus stearothermophilus* strain NRS 2004/3a. *Carbohydr Res* 1986;**150**:265–72.
- Claus H, König H. Cell envelopes of methanogens. In: König H, Claus H, Varma A (eds). *Prokaryotic Cell Wall Compounds—Structure and Biochemistry*. Berlin: Springer, 2010, 231–51.
- Coddeville B, Wu S-W, Fabre E et al. Identification of the *Mycobacterium marinum* Apa antigen O-mannosylation sites reveals important glycosylation variability with the *M. tuberculosis* Apa homologue. *J Proteomics* 2012;**75**:5695–705.
- Cohen-Krausz S, Trachtenberg S. The structure of the archeobacterial flagellar filament of the extreme halophile *Halobacterium salinarum* R1M1 and its relation to eubacterial flagellar filaments and type IV pili. *J Mol Biol* 2002;**321**:383–95.
- Cohen-Krausz S, Trachtenberg S. The flagellar filament structure of the extreme acidothermophile *Sulfolobus shibatae* B12 suggests that archaeobacterial flagella have a unique and common symmetry and design. *J Mol Biol* 2008;**375**:1113–24.
- Cohen-Rosenzweig C, Guan Z, Shaanan B et al. Substrate promiscuity: AglB, the archaeal oligosaccharyltransferase, can process a variety of lipid-linked glycans. *Appl Environ Microb* 2014;**80**:486–96.
- Cohen-Rosenzweig C, Yurist-Doutsch S, Eichler J. AglS, a novel component of the *Haloferax volcanii* N-glycosylation pathway, is a dolichol phosphate-mannose mannosyltransferase. *J Bacteriol* 2012;**194**:6909–16.
- Corfield AP, Berry M. Glycan variation and evolution in the eukaryotes. *Trends Biochem Sci* 2015;**40**:351–59.
- Coyne MJ, Fletcher CM, Chatzidaki-Livanis M et al. Phylum-wide general protein O-glycosylation system of the Bacteroidetes. *Mol Microbiol* 2013;**88**:772–83.
- Cuccui J, Wren B. Hijacking bacterial glycosylation for the production of glycoconjugates, from vaccines to humanised glycoproteins. *J Pharm Pharmacol* 2015;**67**:338–50.
- Cullen TW, Trent MS. A link between the assembly of flagella and lipooligosaccharide of the Gram-negative bacterium *Campylobacter jejuni*. *P Natl Acad Sci USA* 2010;**107**:5160–5.
- Cuthbertson L, Kos V, Whitfield C. ABC transporters involved in export of cell surface glycoconjugates. *Microbiol Mol Biol R* 2010;**74**:341–62.

- Daubenspeck JM, Zeng H, Chen P et al. Novel oligosaccharide side chains of the collagen-like region of BclA, the major glycoprotein of the *Bacillus anthracis* exosporium. *J Biol Chem* 2004;**279**:30945–53.
- Ding Y, Jones GM, Brimacombe C et al. Identification of a gene involved in the biosynthesis pathway of the terminal sugar of the archaeal N-linked tetrasaccharide in *Methanococcus maripaludis*. *Anton Leeuw* 2016;**109**:131–48.
- Ding Y, Jones GM, Uchida K et al. Identification of genes involved in the biosynthesis of the third and fourth sugars of the *Methanococcus maripaludis* archaeal N-linked tetrasaccharide. *J Bacteriol* 2013;**195**:4094–104.
- Dingle KE, Didelot X, Ansari MA et al. Recombinational switching of the *Clostridium difficile* S-layer and a novel glycosylation gene cluster revealed by large-scale whole-genome sequencing. *J Infect Dis* 2013;**207**:675–86.
- Dobos KM, Khoo K-H, Swiderek KM et al. Definition of the full extent of glycosylation of the 45-kilodalton glycoprotein of *Mycobacterium tuberculosis*. *J Bacteriol* 1996;**178**:2498–506.
- Doig P, Kinsella N, Guerry P et al. Characterization of a post-translational modification of *Campylobacter flagellin*: identification of a sero-specific glycosyl moiety. *Mol Microbiol* 1996;**19**:379–87.
- Dong S, McPherson SA, Tan L et al. Anthrose biosynthetic operon of *Bacillus anthracis*. *J Bacteriol* 2008;**190**:2350–9.
- Doolittle WF. Phylogenetic classification and the universal tree. *Science* 1999;**284**:2124–9.
- Douglas CW, Naylor K, Phansopa C et al. Physiological adaptations of key oral bacteria. *Adv Microb Physiol* 2014;**65**:257–335.
- Doyle RJE. *Glycomicrobiology*. New York: Kluwer Academic/Plenum Publishers, 2000, 549.
- Dürr C, Nothaft H, Lizak C et al. The *Escherichia coli* glycoprotein display system. *Glycobiology* 2010;**20**:1366–72.
- Dumetz F, Lapatra SE, Duchaud E et al. The *Flavobacterium psychrophilum* OmpA, an outer membrane glycoprotein, induces a humoral response in rainbow trout. *J Appl Microbiol* 2007;**103**:1461–70.
- Eckford PD, Sharom FJ. The reconstituted *Escherichia coli* MsbA protein displays lipid flippase activity. *Biochem J* 2010;**429**:195–203.
- Efenberger M, Agier J, Pawłowska E et al. Archaea prevalence in inflamed pulp tissues. *Cent Eur J Immunol* 2015;**40**:194–200.
- Eichler J. Novel glycoproteins of the halophilic archaeon *Haloferax volcanii*. *Arch Microbiol* 2000;**173**:445–8.
- Eichler J. Extreme sweetness: protein glycosylation in archaea. *Nat Rev Microbiol* 2013;**11**:151–6.
- Eichler J, Adams MWW. Posttranslational protein modification in Archaea. *Microbiol Mol Biol R* 2005;**69**:393–425.
- Eichler J, Arbiv A, Cohen-Rosenzweig C et al. N-glycosylation in *Haloferax volcanii*: adjusting the sweetness. *Front Microbiol* 2013;**4**:403.
- Eichler J, Arbiv A, Cohen-Rosenzweig C et al. Staying in shape: the haloarchaeal cell wall. In: Papke RT, Oren A (eds). *Halophiles: Genetics and Genomes*. Norwich, UK: Caister Academic Press, 2014, 129–43.
- Erhardt M, Namba K, Hughes KT. Bacterial nanomachines: the flagellum and type III injectisome. *Cold Spring Harb Perspect Biol* 2010;**2**:a000299.
- Esquivel RN, Schulze S, Xu R et al. Identification of *Haloferax volcanii* pilin N-glycans with diverse roles in pilus biosynthesis, adhesion, and microcolony formation. *J Biol Chem* 2016;**291**:10602–14.
- Fagan RP, Fairweather NF. Biogenesis and functions of bacterial S-layers. *Nat Rev Microbiol* 2014;**12**:211–22.
- Faridmoayer A, Fentabil MA, Mills DC et al. Functional characterization of bacterial oligosaccharyltransferases involved in O-linked protein glycosylation. *J Bacteriol* 2007;**189**:8088–98.
- Ferner-Ortner J, Mader C, Ilk N et al. High-affinity interaction between the S-layer protein SbsC and the secondary cell wall polymer of *Geobacillus stearothermophilus* ATCC 12980 determined by surface plasmon resonance technology. *J Bacteriol* 2007;**189**:7154–8.
- Fletcher CM, Coyne MJ, Comstock LE. Theoretical and experimental characterization of the scope of protein O-glycosylation in *Bacteroides fragilis*. *J Biol Chem* 2011;**286**:3219–26.
- Forsberg LS, Abshire TG, Friedlander A et al. Localization and structural analysis of a conserved pyruvylated epitope in *Bacillus anthracis* secondary cell wall polysaccharides and characterization of the galactose-deficient wall polysaccharide from avirulent *B. anthracis* CDC 684. *Glycobiology* 2012;**22**:1103–17.
- Forsberg LS, Choudhury B, Leoff C et al. Secondary cell wall polysaccharides from *Bacillus cereus* strains G9241, 03BB87 and 03BB102 causing fatal pneumonia share similar glycosyl structures with the polysaccharides from *Bacillus anthracis*. *Glycobiology* 2011;**21**:934–48.
- Forsgren E. European foulbrood in honey bees. *J Invertebr Pathol* 2010;**103** (Suppl 1):S5–9.
- Francoleon DR, Boontheung P, Yang Y et al. S-layer, surface-accessible, and concanavalin A binding proteins of *Methanosarcina acetivorans* and *Methanosarcina mazei*. *J Proteome Res* 2009;**8**:1972–82.
- Fredriksen L, Mathiesen G, Moen A et al. The major autolysin Acm2 from *Lactobacillus plantarum* undergoes cytoplasmic O-glycosylation. *J Bacteriol* 2012;**194**:325–33.
- Fredriksen L, Moen A, Adzhubei AA et al. *Lactobacillus plantarum* WCFS1 O-linked protein glycosylation: an extended spectrum of target proteins and modification sites detected by mass spectrometry. *Glycobiology* 2013;**23**:1439–51.
- Friedrich V, Gruber C, Nimeth I et al. Outer membrane vesicles of *Tannerella forsythia*: biogenesis, composition, and virulence. *Mol Oral Microbiol* 2015;**30**:451–73.
- Fujino T, Béguin P, Aubert JP. Organization of a *Clostridium thermocellum* gene cluster encoding the cellulosomal scaffolding protein CipA and a protein possibly involved in attachment of the cellulosome to the cell surface. *J Bacteriol* 1993;**175**:1891–9.
- Gabius H-J. The magic of the sugar code. *Trends Biochem Sci* 2015;**40**:341.
- Garcia De Gonzalo CV, Zhu L, Oman TJ et al. NMR structure of the S-linked glycopeptide sublancin 168. *ACS Chem Biol* 2014;**9**:796–801.
- Gawthorne JA, Tan NY, Bailey U-M et al. Selection against glycosylation sites in potential target proteins of the general HMWC N-glycosyltransferase in *Haemophilus influenzae*. *Biochem Biophys Res Commun* 2014;**445**:633–8.
- Gebhart C, Ielmini MV, Reiz B et al. Characterization of exogenous bacterial oligosaccharyltransferases in *Escherichia coli* reveals the potential for O-linked protein glycosylation in *Vibrio cholerae* and *Burkholderia thailandensis*. *Glycobiology* 2012;**22**:962–74.
- Gerber S, Lizak C, Michaud G et al. Mechanism of bacterial oligosaccharyltransferase: in vitro quantification of sequon binding and catalysis. *J Biol Chem* 2013;**288**:8849–61.
- Gerbino E, Carasi P, Mobili P et al. Role of S-layer proteins in bacteria. *World J Microbiol Biot* 2015;**31**:1877–87.

- Ghosh A, Albers S-V. Assembly and function of the archaeal flagellum. *Biochem Soc Trans* 2011;**39**:64–9.
- Giltner CL, Nguyen Y, Burrows LL. Type IV pilin proteins: versatile molecular modules. *Microbiol Mol Biol R* 2012;**76**:740–72.
- Giraud M-F, Naismith JH. The rhamnose pathway. *Curr Opin Struct Biol* 2000;**10**:687–96.
- Glew MD, Veith PD, Peng B et al. PG0026 is the C-terminal signal peptidase of a novel secretion system of *Porphyromonas gingivalis*. *J Biol Chem* 2012;**287**:24605–17.
- González-Zamorano M, Mendoza-Hernández G, Xolalpa W et al. *Mycobacterium tuberculosis* glycoproteomics based on ConA-lectin affinity capture of mannosylated proteins. *J Proteome Res* 2009;**8**:721–33.
- Govan VA, Brozel V, Allsopp MH et al. A PCR detection method for rapid identification of *Melicoccoccus pluton* in honeybee larvae. *Appl Environ Microb* 1998;**64**:1983–5.
- Gross J, Grass S, Davis AE et al. The *Haemophilus influenzae* HMW1 adhesin is a glycoprotein with an unusual N-linked carbohydrate modification. *J Biol Chem* 2008;**283**:26010–5.
- Guan Z, Naparstek S, Calo D et al. Protein glycosylation as an adaptive response in Archaea: growth at different salt concentrations leads to alterations in *Haloferax volcanii* S-layer glycoprotein N-glycosylation. *Environ Microbiol* 2012;**14**:743–53.
- Guerry P. *Campylobacter* flagella: not just for motility. *Trends Microbiol* 2007;**15**:456–61.
- Guerry P, Ewing CP, Schirm M et al. Changes in flagellin glycosylation affect *Campylobacter* autoagglutination and virulence. *Mol Microbiol* 2006;**60**:299–311.
- Guerry P, Szymanski CM. *Campylobacter* sugars sticking out. *Trends Microbiol* 2008;**16**:428–35.
- Haffajee AD, Socransky SS. Microbial etiological agents of destructive periodontal diseases. *Periodontol* 2000 1994;**5**:78–111.
- Haffajee AD, Socransky SS, Patel MR et al. Microbial complexes in supragingival plaque. *Oral Microbiol Immunol* 2008;**23**:196–205.
- Haft DH, Payne SH, Selengut JD. Archaeosortases and exosortases are widely distributed systems linking membrane transit with posttranslational modification. *J Bacteriol* 2012;**194**:36–48.
- Hajishengallis G, Lamont RJ. Beyond the red complex and into more complexity: the polymicrobial synergy and dysbiosis (PSD) model of periodontal disease etiology. *Mol Oral Microbiol* 2012;**27**:409–19.
- Hancock IC, Baddiley J. Biosynthesis of the bacterial envelope polymers teichoic acid and teichuronic acid. In: Martonosi AN (ed). *The Enzymes of Biological Membranes*. New York: Plenum Press, 1985, 279–307.
- Hanuszkiewicz A, Pittcock P, Humphries F et al. Identification of the flagellin glycosylation system in *Burkholderia cenocepacia* and the contribution of glycosylated flagellin to evasion of human innate immune responses. *J Biol Chem* 2014;**289**:19231–44.
- Harding CM, Nasr MA, Kinsella RL et al. *Acinetobacter* strains carry two functional oligosaccharyltransferases, one devoted exclusively to type IV pilin, and the other one dedicated to O-glycosylation of multiple proteins. *Mol Microbiol* 2015;**96**:1023–41.
- Hart GW, Slawson C, Ramirez-Correa G et al. Cross talk between O-GlcNAcylation and phosphorylation: roles in signaling, transcription, and chronic disease. *Annu Rev Biochem* 2011;**80**:825–58.
- Hartley MD, Morrison MJ, Aas FE et al. Biochemical characterization of the O-linked glycosylation pathway in *Neisseria gonorrhoeae* responsible for biosynthesis of protein glycans containing N,N'-diacetylglucosamine. *Biochemistry* 2011;**50**:4936–48.
- Harvey H, Kus JV, Tessier L et al. *Pseudomonas aeruginosa* D-arabinofuranose biosynthetic pathway and its role in type IV pilus assembly. *J Biol Chem* 2011;**286**:28128–37.
- Hegge FT, Hitchen PG, Aas FE et al. Unique modifications with phosphocholine and phosphoethanolamine define alternate antigenic forms of *Neisseria gonorrhoeae* type IV pili. *P Natl Acad Sci USA* 2004;**101**:10798–803.
- Henche A-L, Ghosh A, Yu X et al. Structure and function of the adhesive type IV pilus of *Sulfolobus acidocaldarius*. *Environ Microbiol* 2012a;**14**:3188–202.
- Henche AL, Koerdt A, Ghosh A et al. Influence of cell surface structures on crenarchaeal biofilm formation using a thermostable green fluorescent protein. *Environ Microbiol* 2012b;**14**:779–93.
- Hirai H, Takai R, Iwano M et al. Glycosylation regulates specific induction of rice immune responses by *Acidovorax avenae* flagellin. *J Biol Chem* 2011;**286**:25519–30.
- Hitchen P, Brzostek J, Panico M et al. Modification of the *Campylobacter jejuni* flagellin glycan by the product of the Cj1295 homopolymeric-tract-containing gene. *Microbiology* 2010;**156**:1953–62.
- Holt SC, Ebersole JL. *Porphyromonas gingivalis*, *Treponema denticola*, and *Tannerella forsythia*: the 'red complex', a prototype polybacterial pathogenic consortium in periodontitis. *Periodontol* 2000 2005;**38**:72–122.
- Honma K, Inagaki S, Okuda K et al. Role of a *Tannerella forsythia* exopolysaccharide synthesis operon in biofilm development. *Microb Pathog* 2007;**42**:156–66.
- Hopf PS, Ford RS, Zebian N et al. Protein glycosylation in *Helicobacter pylori*: beyond the flagellins? *PLoS One* 2011;**6**:e25722.
- Huber C, Ilk N, Rünzler D et al. The three S-layer-like homology motifs of the S-layer protein SbpA of *Bacillus sphaericus* CCM 2177 are not sufficient for binding to the pyruvylated secondary cell wall polymer. *Mol Microbiol* 2005;**55**:197–205.
- Hug I, Feldman MF. Analogies and homologies in lipopolysaccharide and glycoprotein biosynthesis in bacteria. *Glycobiology* 2011;**21**:138–51.
- Hug I, Zheng B, Reiz B et al. Exploiting bacterial glycosylation machineries for the synthesis of a Lewis antigen-containing glycoprotein. *J Biol Chem* 2011;**286**:37887–94.
- Hynönen U, Palva A. *Lactobacillus* surface layer proteins: structure, function and applications. *Appl Microbiol Biot* 2013;**97**:5225–43.
- Igura M, Maita N, Kamishikiryo J et al. Structure-guided identification of a new catalytic motif of oligosaccharyltransferase. *EMBO J* 2008;**27**:234–43.
- Ilk N, Kosma P, Puchberger M et al. Structural and functional analyses of the secondary cell wall polymer of *Bacillus sphaericus* CCM 2177 that serves as an S-layer-specific anchor. *J Bacteriol* 1999;**181**:7643–6.
- Iwashkiw JA, Seper A, Weber BS et al. Identification of a general O-linked protein glycosylation system in *Acinetobacter baumannii* and its role in virulence and biofilm formation. *PLoS Pathog* 2012;**8**:e1002758.
- Iwashkiw JA, Vozza NF, Kinsella RL et al. Pour some sugar on it: the expanding world of bacterial protein O-linked glycosylation. *Mol Microbiol* 2013;**89**:14–28.



- Janesch B, Messner P, Schäffer C. Are the surface layer homology domains essential for cell surface display and glycosylation of the S-layer protein from *Paenibacillus alvei* CCM 2051<sup>T</sup>? *J Bacteriol* 2013;**195**:565–75.
- Janesch B, Schirmeister F, Maresch D et al. Flagellin glycosylation in *Paenibacillus alvei* CCM 2051<sup>T</sup>. *Glycobiology* 2016;**26**:74–87.
- Janetzko J, Walker S. The making of a sweet modification: structure and function of O-GlcNAc transferase. *J Biol Chem* 2014;**289**:34424–32.
- Jarrell KF, Albers S-V. The archaellum: an old motility structure with a new name. *Trends Microbiol* 2012;**20**:307–12.
- Jarrell KF, Ding Y, Meyer BH et al. N-linked glycosylation in *Archaea*: a structural, functional, and genetic analysis. *Microbiol Mol Biol R* 2014;**78**:304–41.
- Jarrell KF, Jones GM, Kandiba L et al. S-layer glycoproteins and flagellins: reporters of archaeal posttranslational modifications. *Archaea* 2010;**2010**:612948.
- Jarrell KF, Jones GM, Nair DB. Biosynthesis and role of N-linked glycosylation in cell surface structures of *Archaea* with a focus on flagella and S layers. *Int J Microbiol* 2010;**2010**:470138.
- Jennings MP, Jen FE-C, Roddam LF et al. *Neisseria gonorrhoeae* pilin glycan contributes to CR3 activation during challenge of primary cervical epithelial cells. *Cell Microbiol* 2011;**13**:885–96.
- Jennings MP, Virji M, Evans D et al. Identification of a novel gene involved in pilin glycosylation in *Neisseria meningitidis*. *Mol Microbiol* 1998;**29**:975–84.
- Jervis AJ, Butler JA, Lawson AJ et al. Characterization of the structurally diverse N-linked glycans of *Campylobacter* species. *J Bacteriol* 2012;**194**:2355–62.
- Jervis AJ, Langdon R, Hitchen P et al. Characterization of N-linked protein glycosylation in *Helicobacter pullorum*. *J Bacteriol* 2010;**192**:5228–36.
- Johannessen C, Koomey M, Børud B. Hypomorphic glycosyltransferase alleles and recoding at contingency loci influence glycan microheterogeneity in the protein glycosylation system of *Neisseria* species. *J Bacteriol* 2012;**194**:5034–43.
- Jones GM, Wu J, Ding Y et al. Identification of genes involved in the acetamidino group modification of the flagellin N-linked glycan of *Methanococcus maripaludis*. *J Bacteriol* 2012;**194**:2693–702.
- Jordan DS, Daubenspeck JM, Laube AH et al. O-linked protein glycosylation in mycoplasma. *Mol Microbiol* 2013;**90**:1046–53.
- Josenhans C, Vossebein L, Friedrich S et al. The *neuA/flmD* gene cluster of *Helicobacter pylori* is involved in flagellar biosynthesis and flagellin glycosylation. *FEMS Microbiol Lett* 2002;**210**:165–72.
- Kählig H, Kolarich D, Zayni S et al. N-Acetylmuramic acid as capping element of  $\alpha$ -D-fucose-containing S-layer glycoprotein glycans from *Geobacillus tepidamans* GS5-97<sup>T</sup>. *J Biol Chem* 2005;**280**:20292–9.
- Kaminski L, Abu-Qarn M, Guan Z et al. AglJ adds the first sugar of the N-linked pentasaccharide decorating the *Haloflex volcanii* S-layer glycoprotein. *J Bacteriol* 2010;**192**:5572–9.
- Kaminski L, Eichler J. Identification of residues important for the activity of *Haloflex volcanii* AglD, a component of the archaeal N-glycosylation pathway. *Archaea* 2010;**2010**:315108.
- Kaminski L, Guan Z, Abu-Qarn M et al. AglR is required for addition of the final mannose residue of the N-linked glycan decorating the *Haloflex volcanii* S-layer glycoprotein. *Biochim Biophys Acta* 2012;**1820**:1664–70.
- Kaminski L, Guan Z, Yurist-Doutsch S et al. Two distinct N-glycosylation pathways process the *Haloflex volcanii* S-layer glycoprotein upon changes in environmental salinity. *mBio* 2013a;**4**:e00716–13.
- Kaminski L, Naparstek S, Kandiba L et al. Add salt, add sugar: N-glycosylation in *Haloflex volcanii*. *Biochem Soc Trans* 2013b;**41**:432–35.
- Kandiba L, Aitio O, Helin J et al. Diversity in prokaryotic glycosylation: an archaeal-derived N-linked glycan contains legionaminic acid. *Mol Microbiol* 2012;**84**:578–93.
- Kandiba L, Eichler J. Analysis of putative nonulosonic acid biosynthesis pathways in *Archaea* reveals a complex evolutionary history. *FEMS Microbiol Lett* 2013;**345**:110–20.
- Kandiba L, Eichler J. Archaeal S-layer glycoproteins: post-translational modification in the face of extremes. *Front Microbiol* 2014;**5**:661.
- Kandiba L, Eichler J. Deciphering a pathway of *Halobacterium salinarum* N-glycosylation. *Microbiologyopen* 2015;**4**:28–40.
- Kandiba L, Guan Z, Eichler J. Lipid modification gives rise to two distinct *Haloflex volcanii* S-layer glycoprotein populations. *Biochim Biophys Acta* 2013;**1828**:938–43.
- Kandiba L, Lin C-W, Aebi M et al. Structural characterization of the N-linked pentasaccharide decorating glycoproteins of the halophilic archaeon *Haloflex volcanii*. *Glycobiology* 2016;**26**:745–56.
- Kärcher U, Schröder H, Haslinger E et al. Primary structure of the heterosaccharide of the surface glycoprotein of *Methanothermobacter fervidus*. *J Biol Chem* 1993;**268**:26821–6.
- Kawai F, Grass S, Kim Y et al. Structural insights into the glycosyltransferase activity of the *Actinobacillus pleuropneumoniae* HMW1C-like protein. *J Biol Chem* 2011;**286**:38546–57.
- Kearns DB. A field guide to bacterial swarming motility. *Nat Rev Microbiol* 2010;**8**:634–44.
- Kelly J, Logan SM, Jarrell KF et al. A novel N-linked flagellar glycan from *Methanococcus maripaludis*. *Carbohydr Res* 2009;**344**:648–53.
- Kern J, Ryan C, Faull K et al. *Bacillus anthracis* surface-layer proteins assemble by binding to the secondary cell wall polysaccharide in a manner that requires *csaB* and *tagO*. *J Mol Biol* 2010;**401**:757–75.
- Kern J, Wilton R, Zhang R et al. Structure of surface layer homology (SLH) domains from *Bacillus anthracis* surface array protein. *J Biol Chem* 2011;**286**:26042–9.
- Kern VJ, Kern JW, Theriot JA et al. Surface-layer (S-layer) proteins Sap and EA1 govern the binding of the S-layer-associated protein BslO at the cell septa of *Bacillus anthracis*. *J Bacteriol* 2012;**194**:3833–40.
- Khemiri A, Naudin B, Franck X et al. N-glycosidase treatment with <sup>18</sup>O labeling and *de novo* sequencing argues for flagellin FliC glycopolymerism in *Pseudomonas aeruginosa*. *Anal Bioanal Chem* 2013;**405**:9835–42.
- Khodai-Kalaki M, Andrade A, Fathy Mohamed Y et al. *Burkholderia cenocepacia* lipopolysaccharide modification and flagellin glycosylation affect virulence but not innate immune recognition in plants. *MBio* 2015;**6**:e00679.
- Kikuchi A, Sagami H, Ogura K. Evidence for covalent attachment of diphytanylglycerol phosphate to the cell-surface glycoprotein of *Halobacterium halobium*. *J Biol Chem* 1999;**274**:18011–6.
- Kishi M, Hasegawa Y, Nagano K et al. Identification and characterization of novel glycoproteins involved in growth and biofilm formation by *Porphyromonas gingivalis*. *Mol Oral Microbiol* 2012;**27**:458–70.
- Klingl A. S-layer and cytoplasmic membrane—exceptions from the typical archaeal cell wall with a focus on double membranes. *Front Microbiol* 2014;**5**:624.

- Knirel YA, Rietschel ET, Marre R et al. The structure of the O-specific chain of *Legionella pneumophila* serogroup 1 lipopolysaccharide. *Eur J Biochem* 1994;221:239–45.
- Knirel YA, Shashkov AS, Senchenkova SN et al. Structure of the O-polysaccharide of *Aeromonas hydrophila* O:34; a case of random O-acetylation of 6-deoxy-L-talose. *Carbohydr Res* 2002;337:1381–6.
- Knirel YA, Shashkov AS, Tsvetkov YE et al. 5,7-diamino-3,5,7,9-tetraoxonon-2-ulosonic acids in bacterial glycopolymers: chemistry and biochemistry. *Adv Carbohydr Chem Bi* 2003;58:371–417.
- Konrad Z, Eichler J. Lipid modification of proteins in Archaea: attachment of a mevalonic acid-based lipid moiety to the surface-layer glycoprotein of *Haloferax volcanii* follows protein translocation. *Biochem J* 2002;366:959–64.
- Korotkov KV, Sandkvist M, Hol WG. The type II secretion system: biogenesis, molecular architecture and mechanism. *Nat Rev Microbiol* 2012;10:336–51.
- Kosma P, Neuninger C, Christian R et al. Glycan structure of the S-layer glycoprotein of *Bacillus* sp. L420-91. *Glycoconj J* 1995a;12:99–107.
- Kosma P, Wügeditsch T, Christian R et al. Glycan structure of a heptose-containing S-layer glycoprotein of *Bacillus thermoaerophilus*. *Glycobiology* 1995b;5:791–6; Corrigendum: *Glycobiology* (1996) 6: 5.
- Koval SF, Jarrell KF. Ultrastructure and biochemistry of the cell wall of *Methanococcus voltae*. *J Bacteriol* 1987;169:1298–306.
- Kowarik M, Young NM, Numao S et al. Definition of the bacterial N-glycosylation site consensus sequence. *EMBO J* 2006;25:1957–66.
- Kuen B, Koch A, Asenbauer E et al. Molecular characterization of the *Bacillus stearothermophilus* PV72 S-layer gene *sbsB* induced by oxidative stress. *J Bacteriol* 1997;179:1664–70.
- Küpcü Z, März L, Messner P et al. Evidence for the glycoprotein nature of the crystalline cell wall surface layer of *Bacillus stearothermophilus* strain NRS 2004/3a. *FEBS Lett* 1984;173:185–90.
- Kus JV, Kelly J, Tessier L et al. Modification of *Pseudomonas aeruginosa* Pa5196 type IV pilins at multiple sites with D-Araf by a novel GT-C family arabinosyltransferase, TfpW. *J Bacteriol* 2008;190:7464–78.
- Larkin A, Imperiali B. The expanding horizons of asparagine-linked glycosylation. *Biochemistry* 2011;50:4411–26.
- Lassak K, Ghosh A, Albers S-V. Diversity, assembly and regulation of archaeal type IV pili-like and non-type-IV pili-like surface structures. *Res Microbiol* 2012;163:630–44.
- Lassak K, Neiner T, Ghosh A et al. Molecular analysis of the cre-narchaeal flagellum. *Mol Microbiol* 2012;83:110–24.
- Lebeer S, Claes IJJ, Balog CIA et al. The major secreted protein Msp1/p75 is O-glycosylated in *Lactobacillus rhamnosus* GG. *Microb Cell Fact* 2012;11:15.
- Lechner J, Sumper M. The primary structure of a procaryotic glycoprotein. Cloning and sequencing of the cell surface glycoprotein gene of halobacteria. *J Biol Chem* 1987;262:9724–9.
- Lechner J, Wieland F. Structure and biosynthesis of prokaryotic glycoproteins. *Annu Rev Biochem* 1989;58:173–94.
- Lee I-C, van Swam II, Tomita S et al. GtfA and GtfB are both required for protein O-glycosylation in *Lactobacillus plantarum*. *J Bacteriol* 2014;196:1671–82.
- Lee S-W, Sabet M, Um H-S et al. Identification and characterization of the genes encoding a unique surface (S-) layer of *Tannerella forsythia*. *Gene* 2006;371:102–11.
- Lees-Miller RG, Iwashkiw JA, Scott NE et al. A common pathway for O-linked protein-glycosylation and synthesis of capsule in *Acinetobacter baumannii*. *Mol Microbiol* 2013;89:816–30.
- Leoff C, Choudhury B, Saile E et al. Structural elucidation of the nonclassical secondary cell wall polysaccharide from *Bacillus cereus* ATCC 10987. Comparison with the polysaccharides from *Bacillus anthracis* and *B. cereus* type strain ATCC 14579 reveals both unique and common structural features. *J Biol Chem* 2008;283:29812–21.
- Leoff C, Saile E, Rauvolfova J et al. Secondary cell wall polysaccharides of *Bacillus anthracis* are antigens that contain specific epitopes which cross-react with three pathogenic *Bacillus cereus* strains that caused severe disease, and other epitopes common to all the *Bacillus cereus* strains tested. *Glycobiology* 2009;19:665–73.
- Leon DR, Ytterberg AJ, Boontheung P et al. Mining proteomic data to expose protein modifications in *Methanosarcina mazei* strain Gö1. *Front Microbiol* 2015;6:149.
- Lewis AL, Desa N, Hansen EE et al. Innovations in host and microbial sialic acid biosynthesis revealed by phylogenomic prediction of nonulosonic acid structure. *P Natl Acad Sci USA* 2009;106:13552–7.
- Li Y, Huang X, Li J et al. Both GtfA and GtfB are required for SraP glycosylation in *Staphylococcus aureus*. *Curr Microbiol* 2014;69:121–6.
- Lithgow KV, Scott NE, Iwashkiw JA et al. A general protein O-glycosylation system within the *Burkholderia cepacia* complex is involved in motility and virulence. *Mol Microbiol* 2014;92:116–37.
- Liu C-F, Tonini L, Malaga W et al. Bacterial protein-O-mannosylating enzyme is crucial for virulence of *Mycobacterium tuberculosis*. *P Natl Acad Sci USA* 2013;110:6560–5.
- Liu S, Leathers TD, Copeland A et al. Complete genome sequence of *Lactobacillus buchneri* NRRL B-30929, a novel strain from a commercial ethanol plant. *J Bacteriol* 2011;193:4019–20.
- Liu S-Y, Gherardini FC, Matuschek M et al. Cloning, sequencing, and expression of the gene encoding a large S-layer-associated endoxylanase from *Thermoanaerobacterium* sp. strain JW/SL-YS 485 in *Escherichia coli*. *J Bacteriol* 1996;178:1539–47.
- Lizak C, Gerber S, Numao S et al. X-ray structure of a bacterial oligosaccharyltransferase. *Nature* 2011;474:350–5.
- Logan SM. Flagellar glycosylation - a new component of the motility repertoire? *Microbiology* 2006;152:1249–62.
- Lomino JV, Naegeli A, Orwenyo J et al. A two-step enzymatic glycosylation of polypeptides with complex N-glycans. *Bioorg Med Chem* 2013;21:2262–70.
- Lommel M, Strahl S. Protein O-mannosylation: conserved from bacteria to humans. *Glycobiology* 2009;19:816–28.
- Lu H, Lü Y, Ren J et al. Identification of the S-layer glycoproteins and their covalently linked glycans in the halophilic archaeon *Haloarcula hispanica*. *Glycobiology* 2015;25:1150–62.
- Lu Q, Li S, Shao F. Sweet talk: protein glycosylation in bacterial interaction with the host. *Trends Microbiol* 2015;23:630–41.
- Lunderberg JM, Liszewski Zilla M, Missiakas D et al. *Bacillus anthracis* tagO is required for vegetative growth and secondary cell wall polysaccharide synthesis. *J Bacteriol* 2015;197:3511–20.
- Lupas A, Engelhardt H, Peters J et al. Domain structure of the *Acetogenium kivui* surface layer revealed by electron crystallography and sequence analysis. *J Bacteriol* 1994;176:1224–33.
- Lyons JJ, Milner JD, Rosenzweig SD. Glycans instructing immunity: the emerging role of altered glycosylation in clinical immunology. *Front Pediatr* 2015;3: 54.

- Maes E, Krzewinski F, Garenaux E et al. Glycosylation of BclA glycoprotein from *Bacillus cereus* and *Bacillus anthracis* exoprotein is domain-specific. *J Biol Chem* 2016;**291**:9666–77.
- Magidovich H, Eichler J. Glycosyltransferases and oligosaccharyltransferases in Archaea: putative components of the N-glycosylation pathway in the third domain of life. *FEMS Microbiol Lett* 2009;**300**:122–30.
- Magidovich H, Yurist-Doutsch S, Konrad Z et al. AglP is a S-adenosyl-L-methionine-dependent methyltransferase that participates in the N-glycosylation pathway of *Haloferax volcanii*. *Mol Microbiol* 2010;**76**:190–9.
- Mahdavi J, Pirinccioglu N, Oldfield NJ et al. A novel O-linked glycan modulates *Campylobacter jejuni* major outer membrane protein-mediated adhesion to human histo-blood group antigens and chicken colonization. *Open Biol* 2014;**4**:130202.
- Makarova KS, Koonin EV, Albers SV. Diversity and evolution of type IV pili systems in archaea. *Front Microbiol* 2016;**7**:667.
- McNally DJ, Aubry AJ, Hui JP et al. Targeted metabolomics analysis of *Campylobacter coli* VC167 reveals legionaminic acid derivatives as novel flagellar glycans. *J Biol Chem* 2007;**282**:14463–75.
- McNally DJ, Hui JPM, Aubry AJ et al. Functional characterization of the flagellar glycosylation locus in *Campylobacter jejuni* 81-176 using a focused metabolomics approach. *J Biol Chem* 2006;**281**:18489–98.
- Manina G, Pasca MR, Buroni S et al. Decaprenylphosphoryl- $\beta$ -D-ribose 2'-epimerase from *Mycobacterium tuberculosis* is a magic drug target. *Curr Med Chem* 2010;**17**:3099–108.
- Mansfield JM, Campbell JH, Bhandari AR et al. Molecular analysis of 16S rRNA genes identifies potentially periodontal pathogenic bacteria and archaea in the plaque of partially erupted third molars. *J Oral Maxil Surg* 2012;**70**:1507–14, e1–6.
- Masuda K, Kawata T. Reassembly of a regularly arranged protein in the cell wall of *Lactobacillus buchneri* and its reattachment to cell walls: chemical modification studies. *Microbiol Immunol* 1985;**29**:927–38.
- Matsumoto S, Igura M, Nyirenda J et al. Crystal structure of the C-terminal globular domain of oligosaccharyltransferase from *Archaeoglobus fulgidus* at 1.75 Å resolution. *Biochemistry* 2012;**51**:4157–66.
- Matsumoto S, Shimada A, Nyirenda J et al. Crystal structures of an archaeal oligosaccharyltransferase provide insights into the catalytic cycle of N-linked protein glycosylation. *P Natl Acad Sci USA* 2013;**110**:17868–73.
- May A, Pusztahelyi T, Hoffmann N et al. Mutagenesis of conserved charged amino acids in SLH domains of *Thermoanaerobacterium thermosulfurigenes* EM1 affects attachment to cell wall sacculi. *Arch Microbiol* 2006;**185**:263–9.
- Megson ZA, Koerdt A, Schuster H et al. Characterization of an  $\alpha$ -L-fucosidase from the periodontal pathogen *Tannerella forsythia*. *Virulence* 2015;**6**:282–92.
- Mehta AS, Saile E, Zhong W et al. Synthesis and antigenic analysis of the BclA glycoprotein oligosaccharide from the *Bacillus anthracis* exoprotein. *Chemistry* 2006;**12**:9136–49.
- Meier-Stauffer K, Busse H-J, Rainey FA et al. Description of *Bacillus thermoaerophilus* sp. nov., to include sugar beet isolates and *Bacillus brevis* ATCC 12990. *Int J Syst Bacteriol* 1996;**46**:532–41.
- Merino S, Fulton KM, Twine SM et al. *Aeromonas hydrophila* flagella glycosylation: involvement of a lipid carrier. *PLoS One* 2014;**9**:e89630.
- Mescher MF, Strominger JL. Purification and characterization of a prokaryotic glucoprotein from the cell envelope of *Halobacterium salinarum*. *J Biol Chem* 1976;**251**:2005–14.
- Mesnager S, Fontaine T, Mignot T et al. Bacterial SLH domain proteins are non-covalently anchored to the cell surface via a conserved mechanism involving wall polysaccharide pyruvylation. *EMBO J* 2000;**19**:4473–84.
- Mesnager S, Tosi-Couture E, Mock M et al. Molecular characterization of the *Bacillus anthracis* main S-layer component: evidence that it is the major cell-associated antigen. *Mol Microbiol* 1997;**23**:1147–55.
- Mesnager S, Tosi-Couture E, Mock M et al. The S-layer homology domain as a means for anchoring heterologous proteins on the cell surface of *Bacillus anthracis*. *J Appl Microbiol* 1999;**87**:256–60.
- Messner P. Bacterial glycoproteins. *Glycoconjugate J* 1997;**14**:3–11.
- Messner P, Christian R, Kolbe J et al. Analysis of a novel linkage unit of O-linked carbohydrates from the crystalline surface layer glycoprotein of *Clostridium thermohydrosulfuricum* S102-70. *J Bacteriol* 1992;**174**:2236–40.
- Messner P, Christian R, Neuninger C et al. Similarity of 'core' structures in two different glycans of tyrosine-linked eubacterial S-layer glycoproteins. *J Bacteriol* 1995;**177**:2188–93.
- Messner P, Egelseer EM, Sleytr UB et al. Surface layer glycoproteins and 'non-classical' secondary cell wall polymers. In: Moran AP, Brennan PJ, Holst O et al. (eds). *Microbial Glycobiology: Structures, Relevance and Applications*. San Diego, CA: Academic Press-Elsevier, 2009, 109–28.
- Messner P, Schäffer C. Prokaryotic glycoproteins. In: Herz W, Falk H, Kirby GW (eds). *Progress in the Chemistry of Organic Natural Products*. Wien: Springer, 2003, 51–124.
- Messner P, Schäffer C, Kosma P. Bacterial cell-envelope glycoconjugates. *Adv Carbohydr Chem Bi* 2013;**69**:209–72.
- Messner P, Schäffer C, Egelseer E-M et al. Occurrence, structure, chemistry, genetics, morphogenesis, and functions of S-layers. In: König H, Claus H, Varma A (eds). *Prokaryotic Cell Wall Compounds—Structure and Biochemistry*. Berlin: Springer, 2010, 53–109.
- Messner P, Sleytr UB, Christian R et al. Isolation and structure determination of a diacetamidodideoxyuronic acid-containing glycan chain from the S-layer glycoprotein of *Bacillus stearotheophilus* NRS 2004/3a. *Carbohydr Res* 1987;**168**:211–8.
- Messner P, Sleytr UB. Bacterial surface layer glycoproteins. *Glycobiology* 1991;**1**:545–51.
- Messner P, Steiner K, Zarschler K et al. S-layer nanoglycobiology of bacteria. *Carbohydr Res* 2008;**343**:1934–51.
- Meyer BH, Albers S-V. Hot and sweet: protein glycosylation in Crenarchaeota. *Biochem Soc Trans* 2013;**41**:384–92.
- Meyer BH, Peyfoon E, Dietrich C et al. Agl16, a thermophilic glycosyltransferase mediating the last step of N-glycan biosynthesis in the thermoacidophilic crenarchaeon *Sulfolobus acidocaldarius*. *J Bacteriol* 2013;**195**:2177–86.
- Meyer BH, Zolghadr B, Peyfoon E et al. Sulfoquinovose synthase - an important enzyme in the N-glycosylation pathway of *Sulfolobus acidocaldarius*. *Mol Microbiol* 2011;**82**:1150–63.
- Miller WL, Matewish MJ, McNally DJ et al. Flagellin glycosylation in *Pseudomonas aeruginosa* PAK requires the O-antigen biosynthesis enzyme WbpO. *J Biol Chem* 2008;**283**:3507–18.
- Misra CS, Basu B, Apte SK. Surface (S)-layer proteins of *Deinococcus radiodurans* and their utility as vehicles for surface localization of functional proteins. *Biochim Biophys Acta* 2015;**1848**:3181–7.
- Mo K-F, Li X, Li H et al. Endolysins of *Bacillus anthracis* bacteriophages recognize unique carbohydrate epitopes of vegetative cell wall polysaccharides with high affinity and selectivity. *J Am Chem Soc* 2012;**134**:15556–62.



- Morelle W, Canis K, Chirat F et al. The use of mass spectrometry for the proteomic analysis of glycosylation. *Proteomics* 2006;**6**:3993–4015.
- Morrison MJ, Imperiali B. The renaissance of bacillosamine and its derivatives: pathway characterization and implications in pathogenicity. *Biochemistry* 2014;**53**:624–38.
- Möschl A, Schäffer C, Sleytr UB et al. Characterization of the S-layer glycoproteins of two lactobacilli. In: Beveridge TJ, Koval SF (eds). *Advances in Paracrystalline Bacterial Surface Layers*, 1993, New York: Plenum Press, 281–4.
- Mukherjee S, Kearns DB. The structure and regulation of flagella in *Bacillus subtilis*. *Annu Rev Genet* 2014;**48**:319–40.
- Murakami Y, Imai M, Nakamura H et al. Separation of the outer membrane and identification of major outer membrane proteins from *Porphyromonas gingivalis*. *Eur J Oral Sci* 2002;**110**:157–62.
- Murphy TF. The role of bacteria in airway inflammation in exacerbations of chronic obstructive pulmonary disease. *Curr Opin Infect Dis* 2006;**19**:225–30.
- Musumeci MA, Faridmoayer A, Watanabe Y et al. Evaluating the role of conserved amino acids in bacterial O-oligosaccharyltransferases by *in vivo*, *in vitro* and limited proteolysis assays. *Glycobiology* 2014;**24**:39–50.
- Musumeci MA, Hug I, Scott NE et al. *In vitro* activity of *Neisseria meningitidis* PglL O-oligosaccharyltransferase with diverse synthetic lipid donors and a UDP-activated sugar. *J Biol Chem* 2013;**288**:10578–87.
- Naegeli A, Aebi M. Current approaches to engineering N-linked protein glycosylation in Bacteria. *Methods Mol Biol* 2015;**1321**:3–16.
- Naegeli A, Neupert C, Fan Y-Y et al. Molecular analysis of an alternative N-glycosylation machinery by functional transfer from *Actinobacillus pleuropneumoniae* to *Escherichia coli*. *J Biol Chem* 2014;**289**:2170–9.
- Nandakumar S, Kannanganat S, Dobos KM et al. O-mannosylation of the *Mycobacterium tuberculosis* adhesin Apa is crucial for T cell antigenicity during infection but is expendable for protection. *PLoS Pathog* 2013;**9**:e1003705.
- Narita Y, Sato K, Yukitake H et al. Lack of a surface layer in *Tannerella forsythia* mutants deficient in the type IX secretion system. *Microbiology* 2014;**160**:2295–303.
- Näther-Schindler DJ, Schopf S, Bellack A et al. *Pyrococcus furiosus* flagella: biochemical and transcriptional analyses identify the newly detected *flaB0* gene to encode the major flagellin. *Front Microbiol* 2014;**5**:695.
- Navarre WW, Schneewind O. Surface proteins of gram-positive bacteria and mechanisms of their targeting to the cell wall envelope. *Microbiol Mol Biol R* 1999;**63**:174–229.
- Nelson-Sathi S, Sousa FL, Röttger M et al. Origins of major archaeal clades correspond to gene acquisitions from bacteria. *Nature* 2015;**517**:77–80.
- Neuberger A. Carbohydrates in protein: the carbohydrate component of crystalline egg albumin. *Biochem J* 1938;**32**:1435–51.
- Ng SYM, Chaban B, Jarrell KF. Archaeal flagella, bacterial flagella and type IV pili: a comparison of genes and posttranslational modifications. *J Mol Microb Biotech* 2006;**11**:167–91.
- Nguyen-Mau S-M, Oh S-Y, Schneewind DI et al. *Bacillus anthracis* SlaQ promotes S-layer protein assembly. *J Bacteriol* 2015;**197**:3216–27.
- Nothaft H, Scott NE, Vinogradov E et al. Diversity in the protein N-glycosylation pathways within the *Campylobacter* genus. *Mol Cell Proteomics* 2012;**11**:1203–19.
- Nothaft H, Szymanski CM. Bacterial protein N-glycosylation: new perspectives and applications. *J Biol Chem* 2013;**288**:6912–20.
- Nothaft H, Szymanski CM. Protein glycosylation in bacteria: sweeter than ever. *Nat Rev Microbiol* 2010;**8**:765–78.
- Olivier NB, Chen MM, Behr JR et al. *In vitro* biosynthesis of UDP-N,N'-diacetylbacillosamine by enzymes of the *Campylobacter jejuni* general protein glycosylation system. *Biochemistry* 2006;**45**:13659–69.
- Ollis AA, Chai Y, DeLisa MP. GlycoSNAP: a high-throughput screening methodology for engineering designer glycosylation enzymes. *Methods Mol Biol* 2015;**1321**:37–47.
- Ortega X, Hunt TA, Loutet S et al. Reconstitution of O-specific lipopolysaccharide expression in *Burkholderia cenocepacia* strain J2315, which is associated with transmissible infections in patients with cystic fibrosis. *J Bacteriol* 2005;**187**:1324–33.
- Paik SH, Chakicherla A, Hansen JN. Identification and characterization of the structural and transporter genes for, and the chemical and biological properties of, sublancin 168, a novel lantibiotic produced by *Bacillus subtilis* 168. *J Biol Chem* 1998;**273**:23134–42.
- Palmieri G, Balestrieri M, Peter-Katalinić J et al. Surface-exposed glycoproteins of hyperthermophilic *Sulfolobus solfataricus* P2 show a common N-glycosylation profile. *J Proteome Res* 2013;**12**:2779–90.
- Parente J, Casabuono A, Ferrari MC et al. A rhomboid protease gene deletion affects a novel oligosaccharide N-linked to the S-layer glycoprotein of *Haloflex volcanii*. *J Biol Chem* 2014;**289**:11304–17.
- Parker JL, Day-Williams MJ, Tomás JM et al. Identification of a putative glycosyltransferase responsible for the transfer of pseudaminic acid onto the polar flagellin of *Aeromonas caviae* Sch 3N. *MicrobiologyOpen* 2012;**1**:149–60.
- Parkhill J, Wren BW, Mungall K et al. The genome sequence of the food-borne pathogen *Campylobacter jejuni* reveals hyper-variable sequences. *Nature* 2000;**403**:665–8.
- Patenge N, Berendes A, Engelhardt H et al. The *fla* gene cluster is involved in the biogenesis of flagella in *Halobacterium salinarum*. *Mol Microbiol* 2001;**41**:653–63.
- Paul G, Lottspeich F, Wieland F. Asparaginyln-acetylgalactosamine. Linkage unit of halobacterial glycosaminoglycan. *J Biol Chem* 1986;**261**:1020–4.
- Pavkov T, Egelseer EM, Tesarz M et al. The structure and binding behavior of the bacterial cell surface layer protein SbsC. *Structure* 2008;**16**:1226–37.
- Perez C, Gerber S, Boilevin J et al. Structure and mechanism of an active lipid-linked oligosaccharide flippase. *Nature* 2015;**524**:433–8.
- Petersen BO, Sára M, Mader C et al. Structural characterization of the acid-degraded secondary cell wall polymer of *Geobacillus stearothermophilus* PV72/p2. *Carbohydr Res* 2008;**343**:1346–58; Corrigendum: *Carbohydr Res* 373 (2013) 52.
- Peyfoon E, Meyer B, Hitchen PG et al. The S-layer glycoprotein of the crenarchaeote *Sulfolobus acidocaldarius* is glycosylated at multiple sites with chitobiose-linked N-glycans. *Archaea* 2010;**2010**:754101.
- Pfoestl A, Hofinger A, Kosma P et al. Biosynthesis of dTDP-3-acetamido-3,6-dideoxy- $\alpha$ -D-galactose in *Aneurinibacillus thermoaerophilus* L420-91<sup>T</sup>. *J Biol Chem* 2003;**278**:26410–7.
- Pohlschroder M, Esquivel RN. Archaeal type IV pili and their involvement in biofilm formation. *Front Microbiol* 2015;**6**:190.

- Pohlschroder M, Ghosh A, Tripepi M et al. Archaeal type IV pilus-like structures—evolutionarily conserved prokaryotic surface organelles. *Curr Opin Microbiol* 2011;**14**:357–63.
- Posch G, Andrukhov O, Vinogradov E et al. Structure and immunogenicity of the rough-type lipopolysaccharide from the periodontal pathogen *Tannerella forsythia*. *Clin Vaccine Immunol* 2013a;**20**:945–53.
- Posch G, Pabst M, Brecker L et al. Characterization and scope of S-layer protein O-glycosylation in *Tannerella forsythia*. *J Biol Chem* 2011;**286**:38714–24.
- Posch G, Pabst M, Neumann L et al. 'Cross-glycosylation' of proteins in *Bacteroidales* species. *Glycobiology* 2013b;**23**:568–77.
- Posch G, Sekot G, Friedrich V et al. Glycobiology aspects of the periodontal pathogen *Tannerella forsythia*. *Biomolecules* 2012;**2**:467–82.
- Power PM, Roddam LF, Dieckelmann M et al. Genetic characterization of pilin glycosylation in *Neisseria meningitidis*. *Microbiology* 2000;**146**:967–79.
- Power PM, Seib KL, Jennings MP. Pilin glycosylation in *Neisseria meningitidis* occurs by a similar pathway to wzy-dependent O-antigen biosynthesis in *Escherichia coli*. *Biochem Biophys Res Co* 2006;**347**:904–8.
- Qazi O, Hitchen P, Tissot B et al. Mass spectrometric analysis of the S-layer proteins from *Clostridium difficile* demonstrates the absence of glycosylation. *J Mass Spectrom* 2009;**44**:368–74.
- Rachel R. Cell envelopes of crenarchaeota and nanoarchaeota. In: König H, Claus H, Varma A (eds). *Prokaryotic Cell Wall Compounds—Structure and Biochemistry*. Berlin: Springer, 2010, 271–91.
- Raetz CRH, Whitfield C. Lipopolysaccharide endotoxins. *Annu Rev Biochem* 2002;**71**:635–700.
- Ramström O, Yan M. Glyconanomaterials for combating bacterial infections. *Chemistry* 2015;**21**:16310–7.
- Reunanen J, von Ossowski I, Hendrickx AP et al. Characterization of the SpaCBA pilus fibers in the probiotic *Lactobacillus rhamnosus* GG. *Appl Environ Microb* 2012;**78**:2337–44.
- Ries W, Hotzy C, Schocher I et al. Evidence that the N-terminal part of the S-layer protein from *Bacillus stearothermophilus* PV72/p2 recognizes a secondary cell wall polymer. *J Bacteriol* 1997;**179**:3892–8.
- Ristol R, Steiner K, Zarschler K et al. The S-layer glycome—adding to the sugar coat of bacteria. *Int J Microbiol* 2011;**2011**:127870.
- Rohlin L, Leon DR, Kim U et al. Identification of the major expressed S-layer and cell surface-layer-related proteins in the model methanogenic archaea: *Methanosarcina barkeri* Fusaro and *Methanosarcina acetivorans* C2A. *Archaea* 2012;**2012**:873589.
- Ruiz N, Kahne D, Silhavy TJ. Transport of lipopolysaccharide across the cell envelope: the long road of discovery. *Nat Rev Microbiol* 2009;**7**:677–83.
- Sabet M, Lee S-W, Nauman RK et al. The surface (S-) layer is a virulence factor of *Bacteroides forsythus*. *Microbiology* 2003;**149**:3617–27.
- Sacoman JL, Hollingsworth RI. Synthesis and evaluation of an N-acetylglucosamine biosynthesis inhibitor. *Carbohydr Res* 2011;**346**:2294–9.
- Sakakibara J, Nagano K, Murakami Y et al. Loss of adherence ability to human gingival epithelial cells in S-layer protein-deficient mutants of *Tannerella forsythensis*. *Microbiology* 2007;**153**:866–76.
- Saksena R, Adamo R, Kováč P. Synthesis of the tetrasaccharide side chain of the major glycoprotein of the *Bacillus anthracis* exosporium. *Bioorg Med Chem Lett* 2006;**16**:615–7.
- Sára M. Conserved anchoring mechanisms between crystalline cell surface S-layer proteins and secondary cell wall polymers in Gram-positive bacteria? *Trends Microbiol* 2001;**9**:47–49; discussion 49–50.
- Sára M, Dekitsch C, Mayer HF et al. Influence of the secondary cell wall polymer on the reassembly, recrystallization, and stability properties of the S-layer protein from *Bacillus stearothermophilus* PV72/p2. *J Bacteriol* 1998;**180**:4146–53.
- Satchidanandam V, Kumar N, Jumani RS et al. The glycosylated Rv1860 protein of *Mycobacterium tuberculosis* inhibits dendritic cell mediated TH1 and TH17 polarization of T cells and abrogates protective immunity conferred by BCG. *PLoS Pathog* 2014;**10**:e1004176.
- Schäffer C, Dietrich K, Unger B et al. A novel type of carbohydrate-protein linkage region in the tyrosine-bound S-layer glycan of *Thermoanaerobacterium thermosaccharolyticum* D120-70. *Eur J Biochem* 2000a;**267**:5482–92.
- Schäffer C, Franck WL, Scheberl A et al. Classification of isolates from locations in Austria and Yellowstone National Park as *Geobacillus tepidamans* sp. nov. *Int J Syst Evol Micr* 2004;**54**:2361–8.
- Schäffer C, Kählig H, Christian R et al. The diacetamidodideoxyuronic-acid-containing glycan chain of *Bacillus stearothermophilus* NRS 2004/3a represents the secondary cell-wall polymer of wild-type *B. stearothermophilus* strains. *Microbiology* 1999a;**145**:1575–83.
- Schäffer C, Messner P. Surface-layer glycoproteins: an example for the diversity of bacterial glycosylation with promising impacts on nanobiotechnology. *Glycobiology* 2004;**14**:31R–42R.
- Schäffer C, Messner P. The structure of secondary cell wall polymers: how Gram-positive bacteria stick their cell walls together. *Microbiology* 2005;**151**:643–51.
- Schäffer C, Müller N, Christian R et al. Complete glycan structure of the S-layer glycoprotein of *Aneurinibacillus thermoaerophilus* GS4-97. *Glycobiology* 1999b;**9**:407–14.
- Schäffer C, Müller N, Mandal PK et al. A pyrophosphate bridge links the pyruvate-containing secondary cell wall polymer of *Paenibacillus alvei* CCM 2051 to muramic acid. *Glycoconj J* 2000b;**17**:681–90.
- Schirm M, Arora SK, Verma A et al. Structural and genetic characterization of glycosylation of type a flagellin in *Pseudomonas aeruginosa*. *J Bacteriol* 2004a;**186**:2523–31.
- Schirm M, Kalmokoff M, Aubry A et al. Flagellin from *Listeria monocytogenes* is glycosylated with  $\beta$ -O-linked N-acetylglucosamine. *J Bacteriol* 2004b;**186**:6721–27.
- Schirm M, Schoenhofen IC, Logan SM et al. Identification of unusual bacterial glycosylation by tandem mass spectrometry analyses of intact proteins. *Anal Chem* 2005;**77**:7774–82.
- Schirm M, Soo EC, Aubry AJ et al. Structural, genetic and functional characterization of the flagellin glycosylation process in *Helicobacter pylori*. *Mol Microbiol* 2003;**48**:1579–92.
- Schoenhofen IC, McNally DJ, Vinogradov E et al. Functional characterization of dehydratase/aminotransferase pairs from *Helicobacter* and *Campylobacter*: enzymes distinguishing the pseudaminic acid and bacillosamine biosynthetic pathways. *J Biol Chem* 2006;**281**:723–32.
- Schoenhofen IC, Vinogradov E, Whitfield DM et al. The CMP-legionaminic acid pathway in *Campylobacter*: biosynthesis

- involving novel GDP-linked precursors. *Glycobiology* 2009; **19**:715–25.
- Schuch R, Nelson D, Fischetti VA. A bacteriolytic agent that detects and kills *Bacillus anthracis*. *Nature* 2002; **418**:884–9.
- Schulz BL, Jen FEC, Power PM et al. Identification of bacterial protein O-oligosaccharyltransferases and their glycoprotein substrates. *PLoS One* 2013; **8**:e62768.
- Schuster B, Sleytr UB. Nanotechnology with S-layer proteins. *Methods Mol Biol* 2013; **996**:153–75.
- Schwarz F, Aebi M. Mechanisms and principles of N-linked protein glycosylation. *Curr Opin Struct Biol* 2011; **21**:576–82.
- Schwarz F, Fan Y-Y, Schubert M et al. Cytoplasmic N-glycosyltransferase of *Actinobacillus pleuropneumoniae* is an inverting enzyme and recognizes the NX(S/T) consensus sequence. *J Biol Chem* 2011; **286**:35267–74.
- Schwarz F, Huang W, Li C et al. A combined method for producing homogeneous glycoproteins with eukaryotic N-glycosylation. *Nat Chem Biol* 2010; **6**:264–6.
- Seepersaud R, Bensing BA, Yen YT et al. The accessory Sec protein Asp2 modulates GlcNAc deposition onto the serine-rich repeat glycoprotein GspB. *J Bacteriol* 2012; **194**:5564–75.
- Sekot G, Posch G, Oh YJ et al. Analysis of the cell surface layer ultrastructure of the oral pathogen *Tannerella forsythia*. *Arch Microbiol* 2012; **194**:525–39.
- Settem RP, Honma K, Nakajima T et al. A bacterial glycan core linked to surface (S)-layer proteins modulates host immunity through Th17 suppression. *Mucosal Immunol* 2013; **6**:415–26.
- Shahapure R, Driessen RPC, Haurat MF et al. The archaeellum: a rotating type IV pilus. *Mol Microbiol* 2014; **91**:716–23.
- Sherlock O, Dobrindt U, Jensen JB et al. Glycosylation of the self-recognizing *Escherichia coli* Ag43 autotransporter protein. *J Bacteriol* 2006; **188**:1798–807.
- Shi W-W, Jiang Y-L, Zhu F et al. Structure of a novel O-linked N-acetyl-D-glucosamine (O-GlcNAc) transferase, GtfA, reveals insights into the glycosylation of pneumococcal serine-rich repeat adhesins. *J Biol Chem* 2014; **289**:20898–907.
- Siu S, Robotham A, Logan SM et al. Evidence that biosynthesis of the second and third sugars of the archaeellin tetrasaccharide in the archaeon *Methanococcus maripaludis* occurs by the same pathway used by *Pseudomonas aeruginosa* to make a di-N-acetylated sugar. *J Bacteriol* 2015; **197**:1668–80.
- Sleytr UB. Self-assembly of the hexagonally and tetragonally arranged subunits of bacterial surface layers and their reattachment to cell walls. *J Ultrastruct Res* 1976; **55**:360–77.
- Sleytr UB. Regular arrays of macromolecules on bacterial cell walls: structure, chemistry, assembly, and function. *Int Rev Cytol* 1978; **53**:1–62.
- Sleytr UB, Messner P. Crystalline surface layers on bacteria. *Annu Rev Microbiol* 1983; **37**:311–39.
- Sleytr UB, Messner P, Pum D et al. Crystalline surface layers on eubacteria and archaeobacteria. In: Sleytr UB, Messner P, Pum D et al. (eds). *Crystalline Bacterial Cell Surface Proteins*. R.G. Austin, TX: Landes/Academic Press, 1996, 211–25.
- Sleytr UB, Schuster B, Egelseer E-M et al. S-layers: principles and applications. *FEMS Microbiol Rev* 2014; **38**:823–64.
- Sleytr UB, Thorne KJL. Chemical characterization of the regularly arranged surface layers of *Clostridium thermosaccharolyticum* and *Clostridium thermohydrosulfuricum*. *J Bacteriol* 1976; **126**:377–83.
- Smit E, Oling F, Demel R et al. The S-layer protein of *Lactobacillus acidophilus* ATCC 4356: identification and characterisation of domains responsible for S-protein assembly and cell wall binding. *J Mol Biol* 2001; **305**:245–57.
- Spiro RG. Protein glycosylation: nature, distribution, enzymatic formation, and disease implications of glycopeptide bonds. *Glycobiology* 2002; **12**:43R–56R.
- St Geme JW, 3rd, Yeo H-J. A prototype two-partner secretion pathway: the *Haemophilus influenzae* HMW1 and HMW2 adhesin systems. *Trends Microbiol* 2009; **17**:355–60.
- Stafford G, Roy S, Honma K et al. Sialic acid, periodontal pathogens and *Tannerella forsythia*: stick around and enjoy the feast! *Mol Oral Microbiol* 2012; **27**:11–22.
- Steindl C, Schäffer C, Smrečki V et al. The secondary cell wall polymer of *Geobacillus tepidamans* GS5-97<sup>T</sup>: structure of different glycoforms. *Carbohydr Res* 2005; **340**:2290–6.
- Steindl C, Schäffer C, Wugeditsch T et al. The first biantennary bacterial secondary cell wall polymer and its influence on S-layer glycoprotein assembly. *Biochem J* 2002; **368**:483–94.
- Steiner K, Hagelueken G, Messner P et al. Structural basis of substrate binding in WsaF, a rhamnosyltransferase from *Geobacillus stearothermophilus*. *J Mol Biol* 2010; **397**:436–47.
- Steiner K, Novotny R, Patel K et al. Functional characterization of the initiation enzyme of S-layer glycoprotein glycan biosynthesis in *Geobacillus stearothermophilus* NRS 2004/3a. *J Bacteriol* 2007; **189**:2590–8.
- Steiner K, Novotny R, Werz DB et al. Molecular basis of S-layer glycoprotein glycan biosynthesis in *Geobacillus stearothermophilus*. *J Biol Chem* 2008; **283**:21120–33.
- Steiner K, Pohlentz G, Dreisewerd K et al. New insights into the glycosylation of the surface layer protein SgsE from *Geobacillus stearothermophilus* NRS 2004/3a. *J Bacteriol* 2006; **188**:7914–21.
- Stepper J, Shastri S, Loo TS et al. Cysteine S-glycosylation, a new post-translational modification found in glycopeptide bacteriocins. *FEBS Lett* 2011; **585**:645–50.
- Stimson E, Virji M, Makepeace K et al. Meningococcal pilin: a glycoprotein substituted with digalactosyl 2,4-diacetamido-2,4,6-trideoxyhexose. *Mol Microbiol* 1995; **17**:1201–14.
- Strong PC, Fulton KM, Aubry A et al. Identification and characterization of glycoproteins on the spore surface of *Clostridium difficile*. *J Bacteriol* 2014; **196**:2627–37.
- Sumper M. Halobacterial glycoprotein biosynthesis. *Biochim Biophys Acta* 1987; **906**:69–79.
- Sumper M, Berg E, Mengele R et al. Primary structure and glycosylation of the S-layer protein of *Haloferax volcanii*. *J Bacteriol* 1990; **172**:7111–8.
- Sutherland IW. Microbial polysaccharide products. *Biotechnol Genet Eng* 1999; **16**:217–29.
- Szymanski CM, Wren BW. Protein glycosylation in bacterial mucosal pathogens. *Nat Rev Microbiol* 2005; **3**:225–37.
- Szymanski CM, Yao R, Ewing CP et al. Evidence for a system of general protein glycosylation in *Campylobacter jejuni*. *Mol Microbiol* 1999; **32**:1022–30.
- Tabei SMB, Hitchen PG, Day-Williams MJ et al. An *Aeromonas caviae* genomic island is required for both O-antigen lipopolysaccharide biosynthesis and flagellin glycosylation. *J Bacteriol* 2009; **191**:2851–63.
- Taguchi Y, Fujinami D, Kohda D. Comparative analysis of archaeal lipid-linked oligosaccharides that serve as oligosaccharide donors for Asn glycosylation. *J Biol Chem* 2016; **291**:11042–54.
- Takeuchi K, Ono H, Yoshida M et al. Flagellin glycans from two pathovars of *Pseudomonas syringae* contain rhamnose in D and L configurations in different ratios and modified 4-amino-4,6-dideoxyglucose. *J Bacteriol* 2007; **189**:6945–56.
- Tan FYY, Tang CM, Exley RM. Sugar coating: bacterial protein glycosylation and host-microbe interactions. *Trends Biochem Sci* 2015; **40**:342–50.



- Tan L, Turnbough CL, Jr. Sequence motifs and proteolytic cleavage of the collagen-like glycoprotein BclA required for its attachment to the exosporium of *Bacillus anthracis*. *J Bacteriol* 2010;**192**:1259–68.
- Tang G, Mintz KP. Glycosylation of the collagen adhesin EmaA of *Aggregatibacter actinomycetemcomitans* is dependent upon the lipopolysaccharide biosynthetic pathway. *J Bacteriol* 2010;**192**:1395–404.
- Tang G, Ruiz T, Barrantes-Reynolds R et al. Molecular heterogeneity of EmaA, an oligomeric autotransporter adhesin of *Aggregatibacter (Actinobacillus) actinomycetemcomitans*. *Microbiol* 2007;**153**:2447–57.
- Tanner ACR, Izard J. *Tannerella forsythia*, a periodontal pathogen entering the genomic era. *Periodontol* 2000 2006;**42**:88–113.
- Tavares-Carreón F, Patel KB, Valvano MA. *Burkholderia cenocepacia* and *Salmonella enterica* ArnT proteins that transfer 4-amino-4-deoxy-L-arabinose to lipopolysaccharide share membrane topology and functional amino acids. *Sci Rep* 2015; **5**:10773.
- Thibault P, Logan SM, Kelly JF et al. Identification of the carbohydrate moieties and glycosylation motifs in *Campylobacter jejuni* flagellin. *J Biol Chem* 2001;**276**:34862–70.
- Thoma C, Frank M, Rachel R et al. The Mth60 fimbriae of *Methanothermobacter thermoautotrophicus* are functional adhesins. *Environ Microbiol* 2008;**10**:2785–95.
- Thornley MJ, Glauert AM, Sleytr UB. Isolation of outer membranes with an ordered array of surface subunits from *Acinetobacter*. *J Bacteriol* 1973;**114**:1294–308.
- Tomek MB, Neumann L, Nimeth I et al. The S-layer proteins of *Tannerella forsythia* are secreted via a type IX secretion system that is decoupled from protein O-glycosylation. *Mol Oral Microbiol* 2014;**29**:307–20.
- Torrelles JB, Schlesinger LS. Diversity in *Mycobacterium tuberculosis* mannosylated cell wall determinants impacts adaptation to the host. *Tuberculosis (Edinb)* 2010;**90**:84–93.
- Trachtenberg S, Pinnick B, Kessel M. The cell surface glycoprotein layer of the extreme halophile *Halobacterium salinarum* and its relation to *Haloferax volcanii*: cryo-electron tomography of freeze-substituted cells and projection studies of negatively stained envelopes. *J Struct Biol* 2000;**130**:10–26.
- Tripepi M, You J, Temel S et al. N-glycosylation of *Haloferax volcanii* flagellins requires known Agl proteins and is essential for biosynthesis of stable flagella. *J Bacteriol* 2012;**194**:4876–87.
- Tropis M, Meniche X, Wolf A et al. The crucial role of trehalose and structurally related oligosaccharides in the biosynthesis and transfer of mycolic acids in *Corynebacterineae*. *J Biol Chem* 2005;**280**:26573–85.
- Tschitschko B, Williams TJ, Allen MA et al. Antarctic archaea-virus interactions: metaproteome-led analysis of invasion, evasion and adaptation. *ISME J* 2015;**9**:2094–107.
- Turroni F, Ventura M, LF Buttó et al. Molecular dialogue between the human gut microbiota and the host: a *Lactobacillus* and *Bifidobacterium* perspective. *Cell Mol Life Sci* 2014;**71**:183–203.
- Twine SM, Paul CJ, Vinogradov E et al. Flagellar glycosylation in *Clostridium botulinum*. *FEBS J* 2008;**275**:4428–44.
- Twine SM, Reid CW, Aubry A et al. Motility and flagellar glycosylation in *Clostridium difficile*. *J Bacteriol* 2009;**191**:7050–62.
- Tytgat HLP, Lebeer S. The sweet tooth of bacteria: common themes in bacterial glycoconjugates. *Microbiol Mol Biol R* 2014;**78**:372–417.
- Valderrama-Rincon JD, Fisher AC, Merritt JH et al. An engineered eukaryotic protein glycosylation pathway in *Escherichia coli*. *Nat Chem Biol* 2012;**8**:434–6.
- Valero E, Martín M, Gálvez N et al. Nanopatterning of magnetic CrNi Prussian Blue nanoparticles using a bacterial S-layer as a biotemplate. *Inorg Chem* 2015;**54**:6758–62.
- Valguarnera E, Kinsella RL, Feldman MF. Sugar and spice make bacteria not nice: protein glycosylation and its influence in pathogenesis. *J Mol Biol* 2016;**428**:3206–20.
- van Teeseling MCF, de Almeida NM, Klingl A et al. A new addition to the cell plan of anammox bacteria: ‘*Candidatus Kuenenia stuttgartiensis*’ has a protein surface layer as the outermost layer of the cell. *J Bacteriol* 2014;**196**:80–9.
- VanDyke DJ, Wu J, Logan SM et al. Identification of genes involved in the assembly and attachment of a novel flagellin N-linked tetrasaccharide important for motility in the archaeon *Methanococcus maripaludis*. *Mol Microbiol* 2009;**72**:633–44.
- Varki A, Cummings RD, Esko JD et al. *Essentials of Glycobiology*, 3rd edn. Woodbury, NY, USA: Cold Spring Harbor Laboratory Press. 2015, 800.
- Varki NM, Varki A. Diversity in cell surface sialic acid presentations: implications for biology and disease. *Lab Invest* 2007;**87**:851–7.
- Veith A, Klingl A, Zolghadr B et al. *Acidianus*, *Sulfolobus* and *Met-allosphaera* surface layers: structure, composition and gene expression. *Mol Microbiol* 2009;**73**:58–72.
- Veith PD, Chen Y-Y, Chen D et al. *Tannerella forsythia* outer membrane vesicles are enriched with substrates of the type IX secretion system and TonB-dependent receptors. *J Proteome Res* 2015;**14**:5355–66.
- Venugopal H, Edwards PJB, Schwalbe M et al. Structural, dynamic, and chemical characterization of a novel S-glycosylated bacteriocin. *Biochemistry* 2011;**50**:2748–55.
- Verma A, Schirm M, Arora SK et al. Glycosylation of b-type flagellin of *Pseudomonas aeruginosa*: structural and genetic basis. *J Bacteriol* 2006;**188**:4395–403.
- Vickerman MM, Brossard KA, Funk DB et al. Phylogenetic analysis of bacterial and archaeal species in symptomatic and asymptomatic endodontic infections. *J Med Microbiol* 2007;**56**:110–8.
- Vijayakumar S, Merckx-Jacques A, Ratnayake DB et al. Cj1121c, a novel UDP-4-keto-6-deoxy-GlcNAc C-4 aminotransferase essential for protein glycosylation and virulence in *Campylobacter jejuni*. *J Biol Chem* 2006;**281**:27733–43.
- Vinogradov E, Deschatelets L, Lamoureux M et al. Cell surface glycoproteins from *Thermoplasma acidophilum* are modified with an N-linked glycan containing 6-C-sulfufofucose. *Glycobiology* 2012;**22**:1256–67.
- Voisin S, Houliston RS, Kelly J et al. Identification and characterization of the unique N-linked glycan common to the flagellins and S-layer glycoprotein of *Methanococcus voltae*. *J Biol Chem* 2005;**280**:16586–93.
- Vorwerk H, Huber C, Mohr J et al. A transferable plasticity region in *Campylobacter coli* allows isolates of an otherwise non-glycolytic food-borne pathogen to catabolize glucose. *Mol Microbiol* 2015;**98**:809–30.
- Wacker M, Linton D, Hitchen PG et al. N-linked glycosylation in *Campylobacter jejuni* and its functional transfer into *E. coli*. *Science* 2002;**298**:1790–3.
- Wakai H, Nakamura S, Kawasaki H et al. Cloning and sequencing of the gene encoding the cell surface glycoprotein of *Haloarcula japonica* strain TR-1. *Extremophiles* 1997;**1**:29–35.
- Wang D, Carroll GT, Turro NJ et al. Photogenerated glycan arrays identify immunogenic sugar moieties of *Bacillus anthracis* exosporium. *Proteomics* 2007;**7**:180–4.
- Wang H, van der Donk WA. Substrate selectivity of the sublancin S-glycosyltransferase. *J Am Chem Soc* 2011;**133**:16394–7.

- Wang L-X. The amazing transglycosylation activity of endo- $\beta$ -N-acetylglucosaminidases. *Trends Glycosci Glyc* 2011;23:33–52.
- Wang Z-x, Deng R-p, Jiang H-W et al. Global identification of prokaryotic glycoproteins based on an *Escherichia coli* proteome microarray. *PLoS One* 2012;7:e49080.
- Ward A, Reyes CL, Yu J et al. Flexibility in the ABC transporter MsbA: alternating access with a twist. *P Natl Acad Sci USA* 2007;104:19005–10.
- Warren MJ, Jennings MP. Identification and characterization of *pptA*: a gene involved in the phase-variable expression of phosphorylcholine on pili of *Neisseria meningitidis*. *Infect Immun* 2003;71:6892–8.
- Weerapana E, Imperiali B. Asparagine-linked protein glycosylation: from eukaryotic to prokaryotic systems. *Glycobiology* 2006;16:91R–101R.
- Westman EL, McNally DJ, Charchoglyan A et al. Characterization of WbpB, WbpE, and WbpD and reconstitution of a pathway for the biosynthesis of UDP-2,3-diacetamido-2,3-dideoxy-D-mannuronic acid in *Pseudomonas aeruginosa*. *J Biol Chem* 2009;284:11854–62.
- Whitfield C, Trent MS. Biosynthesis and export of bacterial lipopolysaccharides. *Annu Rev Biochem* 2014;83:99–128.
- Wieland F, Heitzer R, Schaefer W. Asparaginyglucose: novel type of carbohydrate linkage. *P Natl Acad Sci USA* 1983;80:5470–4.
- Wieland F, Paul G, Sumper M. Halobacterial flagellins are sulfated glycoproteins. *J Biol Chem* 1985;260:15180–5.
- Wilhelms M, Fulton KM, Twine SM et al. Differential glycosylation of polar and lateral flagellins in *Aeromonas hydrophila* AH-3. *J Biol Chem* 2012;287:27851–62.
- Yan A, Wu E, Lennarz WJ. Studies of yeast oligosaccharyl transferase subunits using the split-ubiquitin system: topological features and *in vivo* interactions. *P Natl Acad Sci USA* 2005;102:7121–6.
- Yan Q, Lennarz WJ. Studies on the function of oligosaccharyl transferase subunits. *Stt3p* is directly involved in the glycosylation process. *J Biol Chem* 2002;277:47692–700.
- Yang L, Sinha T, Carlson TK et al. Changes in the major cell envelope components of *Mycobacterium tuberculosis* during *in vitro* growth. *Glycobiology* 2013;23:926–34.
- Yen YT, Cameron TA, Bensing BA et al. Differential localization of the streptococcal accessory *sec* components and implications for substrate export. *J Bacteriol* 2013;195:682–95.
- Young NM, Brisson J-R, Kelly J et al. Structure of the N-linked glycan present on multiple glycoproteins in the Gram-negative bacterium, *Campylobacter jejuni*. *J Biol Chem* 2002;277:42530–9.
- Yurist-Doutsch S, Eichler J. Manual annotation, transcriptional analysis, and protein expression studies reveal novel genes in the *agl* cluster responsible for N glycosylation in the halophilic archaeon *Haloferax volcanii*. *J Bacteriol* 2009;191:3068–75.
- Yurist-Doutsch S, Magidovich H, Ventura VV et al. N-glycosylation in Archaea: on the coordinated actions of *Haloferax volcanii* AglF and AglM. *Mol Microbiol* 2010;75:1047–58.
- Zähringer U, Moll H, Hettmann T et al. Cytochrome *b*<sub>558/566</sub> from the archaeon *Sulfolobus acidocaldarius* has a unique Asn-linked highly branched hexasaccharide chain containing 6-sulfoquinovose. *Eur J Biochem* 2000;267:4144–9.
- Zampronio CG, Blackwell G, Penn CW et al. Novel glycosylation sites localized in *Campylobacter jejuni* flagellin FlaA by liquid chromatography electron capture dissociation tandem mass spectrometry. *J Proteome Res* 2011;10:1238–45.
- Zarschler K, Janesch B, Kainz B et al. Cell surface display of chimeric glycoproteins via the S-layer of *Paenibacillus alvei*. *Carbohydr Res* 2010a;345:1422–31.
- Zarschler K, Janesch B, Pabst M et al. Protein tyrosine O-glycosylation—a rather unexplored prokaryotic glycosylation system. *Glycobiology* 2010b;20:787–98.
- Zeitler R, Hochmuth E, Deutzmann R et al. Exchange of Ser-4 for Val, Leu or Asn in the sequon Asn-Ala-Ser does not prevent N-glycosylation of the cell surface glycoprotein from *Halobacterium halobium*. *Glycobiology* 1998;8:1157–64.
- Zeituni AE, McCaig W, Scisci E et al. The native 67-kilodalton minor fimbria of *Porphyromonas gingivalis* is a novel glycoprotein with DC-SIGN-targeting motifs. *J Bacteriol* 2010;192:4103–10.
- Zhang W-M, Wang H-F, Gao K et al. *Lactobacillus reuteri* glyceraldehyde-3-phosphate dehydrogenase functions in adhesion to intestinal epithelial cells. *Can J Microbiol* 2015;61:373–80.
- Zhou M, Wu H. Glycosylation and biogenesis of a family of serine-rich bacterial adhesins. *Microbiology* 2009;155:317–27.