



AgEcon SEARCH
RESEARCH IN AGRICULTURAL & APPLIED ECONOMICS

The World's Largest Open Access Agricultural & Applied Economics Digital Library

This document is discoverable and free to researchers across the globe due to the work of AgEcon Search.

Help ensure our sustainability.

Give to AgEcon Search

AgEcon Search

<http://ageconsearch.umn.edu>

aesearch@umn.edu

*Papers downloaded from **AgEcon Search** may be used for non-commercial purposes and personal study only. No other use, including posting to another Internet site, is permitted without permission from the copyright owner (not AgEcon Search), or as allowed under the provisions of Fair Use, U.S. Copyright Act, Title 17 U.S.C.*

RESERVOIR AND CULTURE-BASED FISHERIES: BIOLOGY AND MANAGEMENT

**Proceedings of an International Workshop held in
Bangkok, Thailand from 15–18 February 2000**

Editor: Sena S. De Silva

Australian Centre for International Agricultural Research
Canberra, 2001

The Australian Centre for International Agricultural Research (ACIAR) was established in June 1982 by an Act of the Australian Parliament. Its mandate is to help identify agricultural problems in developing countries and to commission collaborative research between Australian and developing country researchers in fields where Australia has a special research competence.

Where trade names are used this constitutes neither endorsement of nor discrimination against any product by the Centre.

ACIAR PROCEEDINGS

This series of publications includes the full proceedings of research workshops or symposia organised or supported by ACIAR. Numbers in this series are distributed internationally to selected individuals and scientific institutions.

© Australian Centre for International Agricultural Research, GPO Box 1571,
Canberra, ACT 2601
<http://www.aciar.gov.au/publications>

Sena S. De Silva, ed. 2001. Reservoir and culture-based fisheries: biology and management. Proceedings of an International Workshop held in Bangkok, Thailand from 15–18 February 2000. ACIAR Proceedings No. 98. 384pp.

ISBN 0 642 45694 1 (printed)
ISBN 0 642 45695 X (electronic)

Editorial management: P.W. Lynch
Production editing: PK Editorial Services, Brisbane
Typesetting, page layout and illustrations: Sun Photoset Pty Ltd, Brisbane
Printing: Watson Ferguson & Co., Brisbane

CONTENTS

Foreword

- Barney Smith* 5
- Reservoir Fisheries: Broad Strategies for Enhancing Yields
Sena S. De Silva 7
- Fish Resources in Chinese Reservoirs and Their Utilisation
Daoming Huang, Jiashou Liu and Chuanlin Hu 16
- The Impact of Large Reservoirs on Fish Biodiversity and Fisheries in China
Li Sifa 22
- Status of Reservoir Fisheries in Vietnam
Ngo Sy Van and Le Thanh Luu 29
- Status and Potential of Reservoir Fisheries in Dak Lak Province, Vietnam
Phan Dinh Phuc and J.D. Sollows 36
- Inventory of Reservoir Fishery Resources in Thailand
Cherdsak Virapat and Niklas S. Mattson 43
- Changes in Fisheries Yield and Catch Composition at the Nam Ngum Reservoir, Lao PDR
N.S. Mattson, V. Balavong, H. Nilsson, S. Phounsavath and W.D. Hartmann 48
- The Role of Reservoir and Lacustrine Fisheries in Rural Development: Comparative Evidence from Sri Lanka, Thailand and the Philippines
D. Simon, C. de Jesus, P. Boonchuwong and K. Mohottala 56
- Characteristics and Status of the Lake Tegano Fishery
E. Oreihaka 66
- Is Lak Lake Overfished?
Thai Ngoc Chien, J.D. Sollows, Nguyen Quoc An, Phan Dinh Phuc, Nguyen Quoc Nghi and Truong Ha Phuong 71
- An Assessment of the Fisheries of Four Stocked Reservoirs in the Central Highlands of Vietnam
Tran Thanh Viet, Do Tinh Loi, Nguyen Ngoc Vihn, Phan Dinh Phuc, Phan Thuong Huy, Thai Ngoc Chien, Nguyen Quoc An and J.D. Sollows 81
- Effect of Hydrological Regimes on Fish Yields in Reservoirs of Sri Lanka
C. Nissanka and U.S. Amarasinghe 93
- Fluctuations in Water Level in Shallow Irrigation Reservoirs: Implications for Fish Yield Estimates and Fisheries Management
U.S. Amarasinghe, C. Nissanka and Sena S. De Silva 101
- Human Factor: the Fourth Dimension of Reservoir Limnology in the Tropics
E.I.L. Silva and F. Schiemer 111
- Water Quality Study of Some Selected Oxbow Lakes with Special Emphasis on Chlorophyll-*a*
M.R. Hasan, M.A.W. Mondal, M.I. Miah and M.G. Kibria 126
- Role of *Oreochromis* Hybrids in Controlling *Microcystis aeruginosa* Blooms in the Kotmale Reservoir
Swarna Piyasiri and Nishanthi Perera 137
- Growth of Indian Major and Chinese Carps in Oxbow Lakes Based on Length–frequency Distribution Analysis
M.R. Hasan, Nityananda Bala and Hans A.J. Middendorp 149
- Carrying Capacity for Small Pelagic Fish in Three Asian Reservoirs
J. Vijverberg, P.B. Amarasinghe, M.G. Ariyaratna and W.L.T. van Densen 153
- Chenderoh Reservoir, Malaysia: Fish Community and Artisanal Fishery of a Small Mesotrophic Tropical Reservoir
Kong Kah-Wai and Ahyaudin B. Ali 167
- Growth Rates of Transplanted Large Icefish (*Protosalanx hyalocranius*) in Daoguanhe Reservoir, China
Hongjuan Wu and Musheng Xu 179
- Estimation of the New Icefish *Neosalanx taihuensis* Yield in Zhanghe Reservoir, China
Jiashou Liu, Jianhua Peng, Fuhu Yu, Jie Jiang, Xianqin Yao and Yuanhong Yi 183

- Population Dynamics of Potential Fish Species for Exploitation in Presently Underdeveloped Fisheries of Some Perennial Reservoirs in Sri Lanka
M.J.S. Wijeyaratne and W.M.D.S.K. Perera **188**
- Trophic Relationships and Possible Evolution of the Production under Various Fisheries Management Strategies in a Sri Lankan Reservoir
J. Moreau, M.C. Villanueva, U.S. Amarasinghe and F. Schiemer **201**
- Ecosystem Structure and Dynamics—A Management Basis for Asian Reservoirs and Lakes
F. Schiemer, U.S. Amarasinghe, J. Frouzova, B. Sricharoendham and E.I.L. Silva **215**
- Developing Fisheries Enhancement in Small Waterbodies: Lessons from Lao PDR and Northeast Thailand
C. Garaway, K. Lorenzen and B. Chamsingh **227**
- Effectiveness of Stocking in Reservoirs in Vietnam
Nguyen Quoc An **235**
- Investigation of the Fisheries in Farmer-Managed Small Reservoirs in Thainguayen and Yenbai Provinces, Northern Vietnam
Nguyen Hai Son, Bui The Anh and Nguyen T.T. Thuy **246**
- Using Population Models to Assess Culture-based Fisheries: A Brief Review with an Application to the Analysis of Stocking Experiments
K. Lorenzen **257**
- Community-based Freshwater Fish Culture in Sri Lanka
K.B.C. Pushpalatha **266**
- Status of Culture-based Fisheries in Small Reservoirs in India
V.V. Sugunan **274**
- Livestock–Fish Integrated Systems and Their Application
Shenggui Wu, Chuanlin Hu and Youchun Chen **281**
- Fisheries Marketing Systems in Sri Lanka and Their Relevance to Local Reservoir Fishery Development
F.J. Murray, S. Koddithuwakku and D.C. Little **287**
- Socio-economic Status of River Sprat (*Clupeichthys aesarnensis*, Wongratana 1983) Lift-net Fishers in Sirinthorn Reservoir, Thailand
T. Jutagate, Sena S. De Silva and N.S. Mattson **309**
- Fisheries Co-management in Two Large Reservoirs — Problems and Challenges
H. Nilsson, S. Phonsavath, M. Khumsri, W.D. Hartmann **314**
- Some Imperatives for Co-management of the Fishery in Ea Soup Reservoir
Truong Ha Phuong, Nguyen Thi Nhung, Mercedes Logarta, J.D. Sollows, Nguyen Thi Bich and Ho Ngoc Dan **321**
- Cage Culture of Finfish in Australian Lakes and Reservoirs: A Pilot-scale Case Study of Biological, Environmental and Economic Viability
G.J. Gooley, Sena S. De Silva, B.A. Ingram, L.J. McKinnon, F.M. Gavine and W. Dalton **328**
- Cage Rearing of Fry to Fingerling of Carp Species in Large Reservoirs in Northern Vietnam
Bui T. Anh and Nguyen H. Son **347**
- Performance of Cage-reared Fingerlings of Commonly Cultured Fish Species in Response to Different Feeds
M.H.S. Ariyaratne **359**
- Cage Fish Trials in Ea Soup Reservoir, Vietnam
Phan Thuong Huy, Phan Dinh Phuc, Nguyen Ngoc Vinh and J.D. Sollows **367**
- Abstracts of other papers presented**
- The Biology and Fishery of Indigenous Gobies of Mainit Lake, Philippines
A.M. Calicia Jr and N.A. Lopez **375**
- Dam and Fish Diversity: Case Study of the Pak Mun, Thailand
C. Vidthayanon and S. Premcharoen **376**
- Workshop Issues and Recommendations **377**
- Participants **382**

FOREWORD

RESERVOIRS are a major, and for several Asian countries an expanding, water resource which is very diverse both in terms of size and fisheries potential. They range from small water bodies with productive culture-based fisheries to expansive reservoirs with variable and often low fish production. The strategies required to achieve desirable productivity levels from these water bodies are similarly diverse, and importantly, are still evolving as our knowledge of these systems improves. This workshop, jointly sponsored by the Australian Centre for International Agricultural Research (ACIAR) and the Mekong River Commission Fisheries Program, brought together 55 scientists from 16 countries to discuss recent progress and future challenges in the wise use and management of reservoir fisheries resources through culture-based interventions. It is particularly pleasing to note the active participation of scientists from all major ongoing reservoir fisheries projects in Asia variously funded by ACIAR, the Mekong River Commission (MRC), European Union (EU), Danish International Development Agency (DANIDA), as well as several national programs.

Such an international gathering on reservoir fisheries was timely, being the first time in almost a decade that scientists from Asian countries actively involved in this area of research have convened for a dedicated scientific exchange on the topic. This enabled regional and international specialists to share research findings and management experience, to identify gaps in existing knowledge, and from this to establish R&D priorities for the future. This is reflected in the workshop objectives below:

- *To bring together the leading reservoir fishery researchers, planners and managers involved in research on aspects of reservoir fisheries biology and management in Asia and to provide an open forum to present the research findings on reservoir and culture-based fisheries biology and management.*
- *To review the current status of reservoir fisheries in Asia; their importance to the animal protein supply, and current management strategies and approaches.*
- *To provide a forum for an exchange of views on potential improvements to reservoir and culture-based fisheries development and management in Asia.*
- *Attempt to prioritise the research needs in reservoir fisheries biology and management at the regional level.*
- *Based on the above, to explore the possibilities of developing a tangible research strategy for reservoir and culture-based fisheries research in Asia (tropics), at the regional level that could impact on the sustainable utilisation of fishery resources in Asian reservoirs.*
- *To explore the possibilities of maintaining a continued dialogue and exchange of information among researchers, planners and managers involved directly and/or indirectly on reservoir and culture based fisheries in Asia.*

The workshop was opportune in other ways as well. The major findings and recommendations of the workshop were presented to a thematic session on 'Fisheries Enhancement' at the joint NACA-FAO international meeting on 'Aquaculture in the Next Millennium' held in Bangkok (21–25 February 2000). This provided valuable input into these broader deliberations aimed at the development of global policies on aquaculture. As a result, the workshop recommendations are reflected in the major outputs of this meeting—'the Bangkok Declaration and Strategy: Aquaculture beyond 2000'.

The success of meetings such as this depend on the dedicated effort of many individuals. I would particularly like to note the contributions of Prof. Sena de Silva, Dr Niklas Mattson and Dr Wolf Hartman, and the exceptional support provided to the activity by Deakin University.

I hope that the papers presented in these Proceedings will assist scientists, managers and all with an interest in reservoir fisheries in their efforts to improve the productivity of reservoirs in a sustainable and equitable manner.

*B.R. Smith
Research Program Manager
Fisheries*

Reservoir Fisheries: Broad Strategies for Enhancing Yields

Sena S. De Silva*

Abstract

Reservoirs are an important water resource in Asia. Inland fisheries in the world account for about 9% of total fish production, and of these, Asia accounts for nearly 60% of world production. In the light of stabilising marine fish catches, inland fisheries, in particular reservoir fishery potential, need to be exploited. The reservoir resource is diverse and therefore the strategies to be adopted for optimising yields are also different. In small reservoirs, culture-based fisheries have been very effective, particularly in the case of China, with a current production of 1 165 075 Mt (from a total area of 1 567 971 ha), amounting to 743 kg/ha/yr. The reasons for this success are discussed. Fish production in large reservoirs is very variable and there is very little information on stocking, the cost-effectiveness of which has not been demonstrated adequately.

RESERVOIRS and fisheries thereof are not new to Asia. Long before the modern era of dam building and reservoir impounding, in the period after World War II last century, reservoirs were an integral component of certain Asian cultures, dating back 4000 years or more. From a fisheries view point, it is important and relevant to note that the reservoir fishery resources were harnessed and, more importantly, there is documentation, dating back more than 1000 years, to indicate that certain regulatory measures were in place with regard to its exploitation. The greatest expansion in reservoir acreage was witnessed in the post-war period, and the expansion is best exemplified in the case of mainland China, when the reservoir acreage increased to about 2.47×10^6 ha from 1949 (Lu 1986). In spite of concerns of varying lobby groups, often headed by environmentalists, reservoir impoundment, particularly in developing countries, goes on almost unbridled.

Reservoirs are never impounded for fishery development per se. But fisheries are beginning to be recognised as an important secondary user of reservoir water resources. In certain instances, it is reported that the income from the fishery exceeds that from the intended primary function of the reservoir, such as for example in Ubolratana reservoir, Thailand

(Fernando 1980). Indeed, fishery aspects did not and still hardly command a consideration during the planning of reservoir impoundment, perhaps with a few exceptions in the region. Of the latter, the situation in China is the most significant exception, when a hatchery and associated facilities (such as fry and fingerling rearing ponds) were provided for below the dam of almost every medium and large reservoir (De Silva et al. 1991), the reservoir bed was prepared to facilitate harvesting, and associated management aspects put in place. One other aspect witnessed in the recent years is the incorporation of fish ladders as seen in some recently constructed reservoirs in Thailand, such as Sirinthorn, which in all probability satisfies the concerns of environmentalists and conservationists, even though there is a dearth of scientific information showing the efficacy of fish ladders in the tropics.

In the light of increasing human population growth, reservoirs are becoming increasingly important in the current millennium as an important provider of animal protein and employment opportunities, particularly to poorer sectors of the community, which also often happens to be rural. Unlike in the past, reservoir fishery activities are considered a significant avenue for resettling displaced persons, particularly exemplified in the case of Saguling and Jatuhur reservoirs in Indonesia (Costa-Pierce and Soemarwoto 1990).

This paper deals with the reservoir resource of Asia and its fisheries, in relation to the global capture

*School of Ecology and Environment, Deakin University, Warrnambool, Victoria Australia 3280 (Email: sena@deakin.edu.au; Fax: (61) (03) 5563 3462)

fishery and fish as a food resource. It also highlights issues related to increasing fish yield from reservoirs and the potential advantages of a more holistic approach to reservoir fisheries management. An attempt is made to highlight ensuing problems associated with increasing reservoir fish production in the region, and to suggest plausible strategies towards that end.

Reservoir Resource

The extent of the reservoir resource in Asia has been documented previously and was reviewed by De Silva (1996). According to those estimates the reservoir acreage was 5 376 618 ha in Asia and was predicted to reach 16 798 000 ha by 2010 (Costa-Pierce 1991), which is tantamount to a 212% increase in reservoir acreage in approximately 25 years or so. According to Avakyan and Iakoleva (1998) in the post-World War II phase when reservoir impoundment proliferated, the number of reservoirs of capacity exceeding 0.1 km³ grew five-fold worldwide, and their volume 12-fold. More importantly, this increase was most evident in Latin America (40-fold) and in Africa and Asia (100-fold).

The trends in reservoir construction in Asia in comparison to that in the world are shown in Figure 1. The importance of reservoirs in Asia is further exemplified when a comparison is made among all continents in respect of the reservoir acreage and river density index (Figure 2), where it is seen that Asia has the highest percentage of reservoir acreage (exceeding 15 m dam height) and the second-lowest river density index.

The point to be noted, however, is not the absolute extent of the resource but the diverse nature of the resource. For example, as exemplified in the case of Thailand (these Proceedings), the resource varies in size, age, soil type of the basin, the nature of the basin shape and depth, submerged vegetation, etc., the maturity of the system, the catchment characteristics and degree of water exchange, to name a few, all of which either directly or indirectly influence the limnology and natural productivity of reservoirs. In addition, the nature of the indigenous fish fauna of the reservoirs and their potential to sustain the pressures of at least an artisanal fishery, if not a commercial large-scale fishery, vary immensely. Obviously, these factors make it imperative to use different strategies for effective, optimal and sustainable exploitation of the fishery resources of reservoirs.

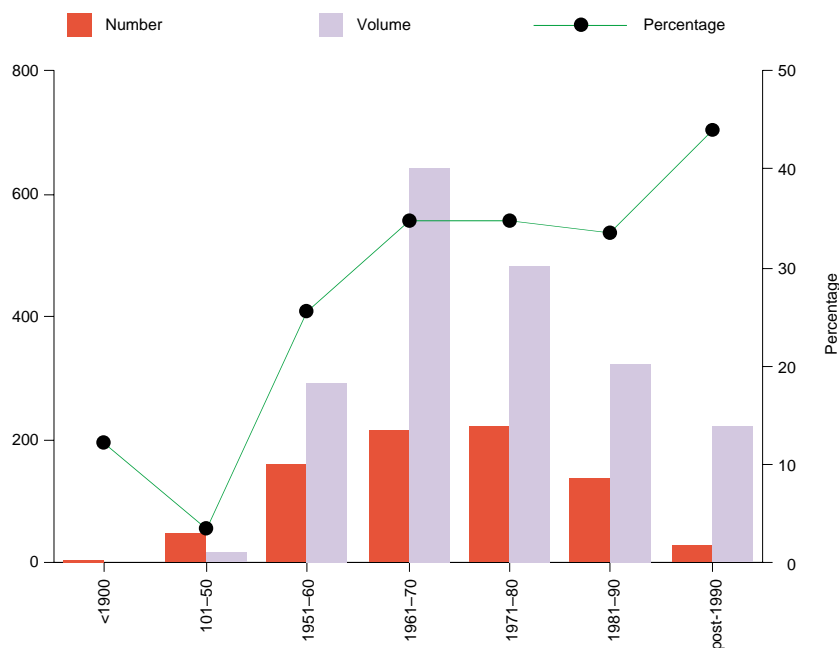

Figure 1. The number and volume of reservoirs impounded in Asia at different times, and the Asian reservoir volume expressed as a percentage of that of the world. The figure indicates only those reservoirs exceeding 0.1 km³ in capacity (using data from Avakyan and Iakovleva 1998).

Fish as a food source

Fish and other aquatic products are an important food source, and in the world as a whole contribute approximately 16% and 12% to the animal protein and total calorie intake per head, respectively (Figure 3). However, in Asia, the dependence on fish as a food source is significantly higher; the region has the highest population concentration in the world, and currently consumes annually about 17.2 kg of fish per head.

The population in the region is expected to reach 4.16 billion by the year 2020. If the current fish consumption rate is to be maintained the region will require 70 million t of fish by 2020, an increase of nearly 26 million t from the present Asian production of 43.96 Mt.

In the light of stable, if not dwindling, marine capture fisheries in the region as well the rest of the world, inland fisheries development and aquaculture become increasingly important in bridging this shortfall.

To most intents and purposes, particularly as most river fisheries have or are declining, with a few exceptions for varying reasons, future developments

in inland fisheries are destined to become synonymous with sustainable developments in reservoir fisheries (Welcomme 1996).

Inland fisheries

In the world, the total number of inland fisheries is relatively small, and has contributed about 7–8.5% to fish supplies over the years (Figure 4). In Asia, the inland fishery currently accounts for about 10.5%, and what is important to note is that it has been increasing over the past decade or so, albeit to a smaller extent (Figure 5).

Similarly, when one considers the inland fishery sector by itself, it is evident that Asia contributes in excess of 50% of world production (Figure 6). The importance of reservoir fisheries as a component of the inland fishery sector in Asia is perhaps seen from a different and a clearer perspective when some of the relevant indices of the different continents are compared (Figure 2); in essence, Asia has the highest relative share of the inland capture fisheries production and reservoirs, but the second-lowest (next to Oceania) river density index. The implication is that,

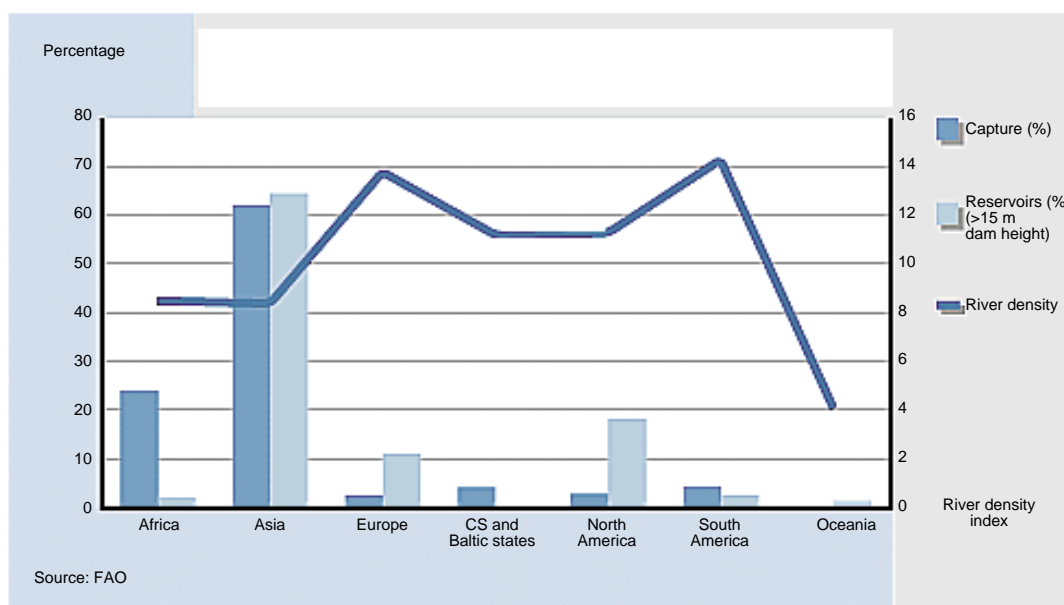

Figure 2. The percentage contribution to world inland capture fishery and the percentage distribution of reservoir acreage (dams exceeding 15 m) and the river density index in different continents (from FAO 1999).

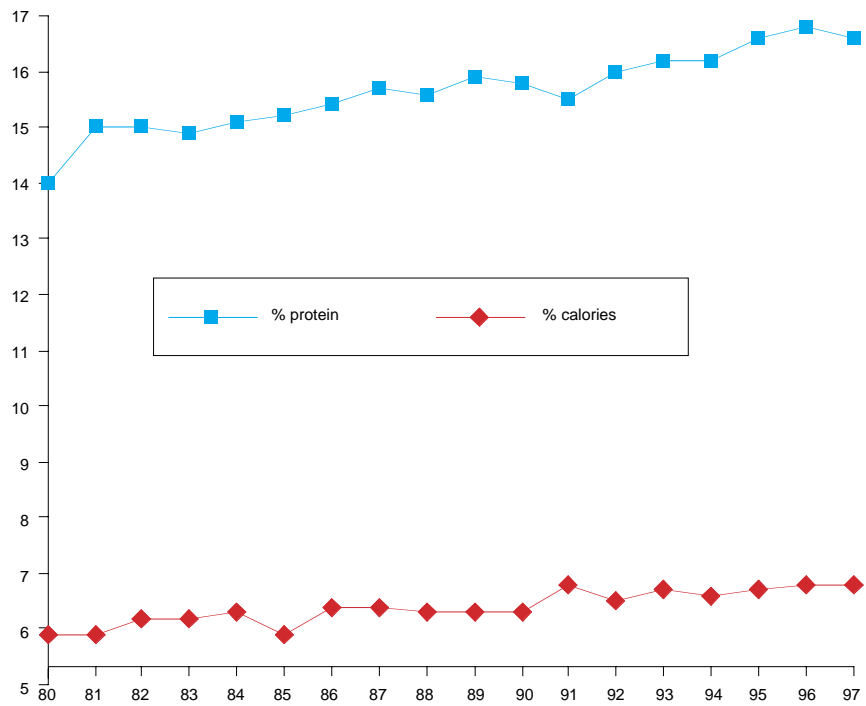

Figure 3. The changes in percentage contribution of aquatic food supplies to per head calorie and animal protein intake.

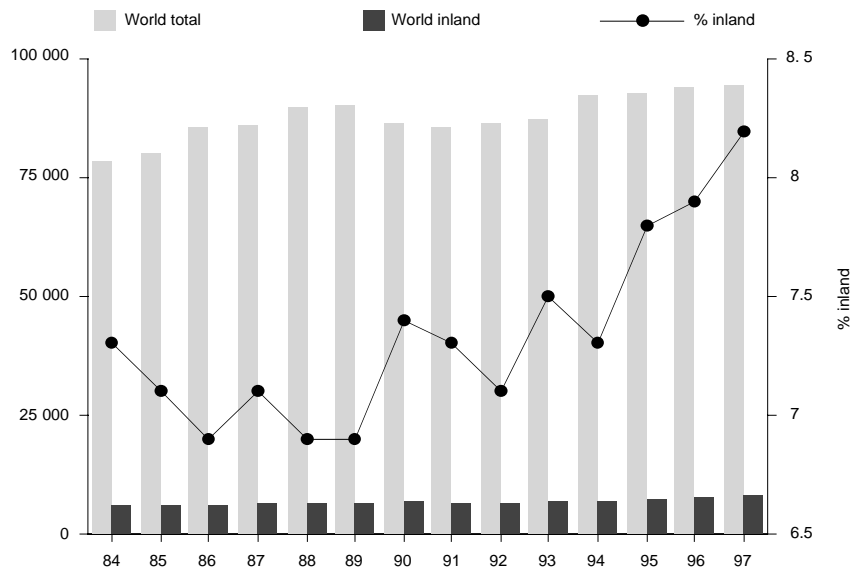

Figure 4. The changes in the total and the inland capture fishery in the world, and the percentage contribution of inland fishery to the world's total (based on data from FAO 1999).

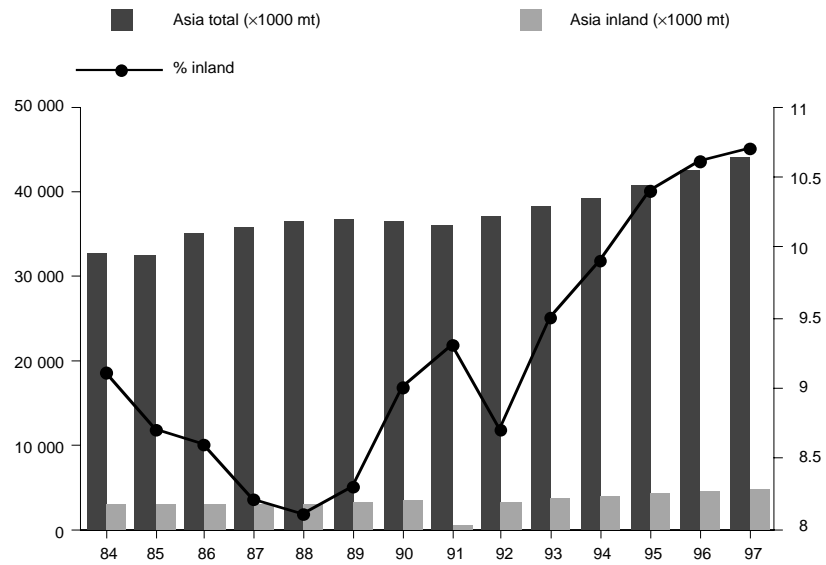

Figure 5. The changes in the total and the inland capture fishery in Asia, and the percentage contribution of inland fishery to the total fish production in Asia (based on data from FAO 1999).

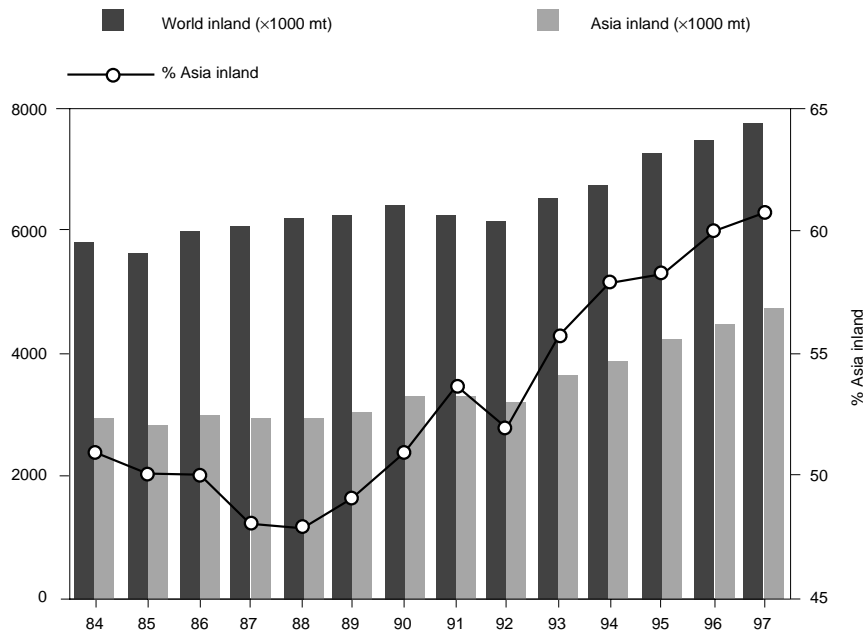

Figure 6. The total world and Asian inland capture fishery ($\times 1000$ Mt) and the percentage contribution of Asian capture fishery to the total (based on data from FAO 1999).

in Asia, reservoirs make a significant contribution to the former.

From a species point of view, two species groups, Cyprinids and tilapias, contribute most to the Asian inland production. Of the cyprinids, the five species caught in largest quantity are common carp, silver carp and Java barb in Asia, freshwater bream in Europe, and silver cyprinid in Africa.

Reservoir Production

Reservoirs are a very diverse resource, and strategies to enhance fish production differ significantly. One main difficulty that confronts fishery scientists is the different classification of reservoirs adopted by different nations.

For example, in India (Srivastava et al. 1985) reservoirs are classified as small (<1000 ha), medium (1000 to 5000 ha) and large (>5000 ha), whereas in China the classification is based on capacity (De Silva et al. 1991) when small, medium and large reservoirs refer to capacities of less than 10×10^6 , $10-100 \times 10^6$ and less than 100×10^6 m³, respectively. In Sri Lanka reservoirs are classified as perennial and non-perennial (= seasonal tanks), and generally the latter rarely exceed 20 ha.

Small reservoirs

Reservoir productivity is very variable (Table 1), significant variations being observed in reservoirs of comparable size and geology even within the same river basin. One obvious difference in fish production is a result of reservoir size and depth, based on which different strategies are adopted to optimise fish production.

Best examples of this are seen in China where in small and medium-size reservoirs fish production is

based on a stock-recapture strategy with Chinese major carps. The resulting yields can be high (Li and Xu 1995), when small reservoirs less than 70 ha are known to yield 750–3000 kg/ha. However, the successful utilisation of small and medium-size reservoirs in China for fish production depends on a number of factors, the foremost being:

- fishery aspects taken into consideration at the planning stage of reservoir construction; e.g., preparation of the reservoir bed;
- incorporation of fry and fingerling production facilities in most reservoirs;
- almost complete eradication of predatory species;
- stocking uniform-sized fingerlings, generally exceeding 12.5 cm;
- species ratio at stocking maintained to enable efficient utilisation of food niches;
- prevention and/or minimisation of escape from the reservoir through the incorporation of barrier nets; and
- efficient harvesting.

In China, reservoir stock and capture fisheries (plus cage culture) are included under aquaculture. Accordingly, reservoir aquaculture production in 1997 was estimated to be 1 165 075 Mt (from a total area of 1 567 971 ha), a yearly average increase of 52.6% from 1979 to 1997 (Song 1999). It is estimated that this activity yields on average 743 kg/ha/yr. In Sri Lanka a comparable strategy was put in place to utilise the seasonal and/or non-perennial reservoirs for a culture-based fishery. Unfortunately, and in spite of encouraging early results (De Silva 1988), the program was not continued due to logistical problems, foremost of these being fingerling availability and marketing. The program is to be revived, and hopefully will augment a much-needed animal protein supply to the rural poor. Sugunan (1995) estimated

Table 1. Range in fish yield (kg/ha/yr) from reservoir capture fisheries in selected Asian countries. Name and size of reservoir, when available, in parenthesis. Where possible a mean yield is also given (modified after De Silva 1996).

Country	Production range (kg/ha/yr)		Mean	Authority
	Minimum	Maximum		
China	85.5 (Heidi 6733 ha)	1460.0 (Zishanchum 64 ha)	214	Jiankung et al. 1992
India*	11.43	49.9	20.1	Sugunan, 1995
Indonesia	15.0 (Jatiluhur 8300 ha)	380.0 (Pascal 450 ha)	—	Hardjmulia and Rabegnatar, 1989
Philippines	16.0 (Pantapangan 84 240 ha)	1508.0 (Magat 4460 ha)	—	Moreau and De Silva, 1988
Sri Lanka	40.0 (Huruluwewa 2 125 ha)	650.0 (Pimburettewa 834 ha)	283	De Silva, 1988
Thailand	7.3 (Srinagarind 2 600 ha)	69.3 (Nam Phung 2165 ha)	23.1	@
Vietnam	6.5 (Thacba 23 400 ha)	248.2 (EaKao 274 ha)	63.3	@

*mean values for large and small reservoirs, respectively.

@ calculated from data from Bernacsek (1997).

that 1 485 557 ha of small reservoirs in India currently yield on average 49.9 kg/ha.yr and suggested that yields could be easily doubled by introducing appropriate management measures. In essence, apart from China, the smaller productive reservoirs in most countries are utilised sub-optimally for fish production, and suitable strategies, perhaps developed regionally, may facilitate such development.

Stock and recapture or culture-based fisheries yield best results with smaller reservoirs, generally less than 50 ha. However, a fishery based on a mixture of stocked and self-recruiting populations is also a possibility, particularly in medium-size reservoirs (100–300 ha), such as Ea Kao Reservoir in Vietnam (Phan and De Silva 2000).

Large reservoirs

As shown in Table 1, reservoir fish productivity differs markedly. However, not all differences can be accounted for by climatic, geographic and/or edaphic differences. This obviously raises the possibility of increasing fish production in large reservoirs through the adoption of appropriate managerial measures.

One major characteristic of Asian reservoirs and fisheries is that the fisheries are basically dependent on colonisation of the reservoirs by riverine indigenous species which do not spawn in lacustrine waters, such as, for example, Indian major carps and Chinese major carps. Of these cyprinid species there is only one documentation, yet to be confirmed, of the spawning of a major carp in the main stream of a reservoir, viz. silver carp, *Hypophthalmichthys molitrix*, in the Gobindsagar in Himachal Pradesh, India (Kumar 1989).

Consequently, the fisheries have developed around suitable exotic species which have established self-recruiting populations, such as in the case of Sri Lanka, and/or regular stocking of appropriate carp species to augment natural recruitment from the rivers. In addition, other indigenous species, particularly carnivorous species such as catfish and ophichthids are known to breed in reservoirs and augment most fisheries.

Also, in a few reservoirs in Asia, particularly in Thailand and Lao PDR, fisheries have developed around pelagic clupeids such as *Clupeichthys aesarnensis* (Thai river sprat). Indigenous fish species, such as for example *Notopterus notopterus*, *Cyclohelichthys armatus*, *Hampala macrolepidota*, and *Mystus nemurus* are known to dominate the fishery in a number of reservoirs in Thailand and Lao PDR. Data available for reservoirs in the Mekong Basin in Thailand suggest that in 15 out of 19 reservoirs the fishery was based on indigenous species, when these accounted for over 80% of the

catch (Bernacsek 1997). However, the situation is somewhat different in Indian reservoirs (Sugunan 1995).

It can be generalised that in Asian reservoir fisheries exploitation is confined to a few species only. This may be a reflection of market demand(s). However, there is an increasing trend to exploit small-sized pelagic fish resources, a resource which can be fairly substantial (De Silva and Sirisena 1989), for other than human consumption, as a feed ingredient (Ariyaratne, these Proceedings).

There have been few cost-benefit analyses of stocking in large reservoirs in Asia (Bhukaswan 1989). In contrast, in small to medium-sized reservoirs the benefits of stocking have been evaluated in China (Li 1988; De Silva et al. 1991) and a number of general principles such as these on stocking efficiency (Li 1988; Lorenzen 1995; Lorenzen and Garaway 1997) developed. In respect of large reservoirs, therefore, much needs to be done. A possible approach is represented schematically in Figure 7. Accordingly, it is suggested that any stocking strategy should be based on the potential yield, predicted through the use of an appropriate empirical model. This information should be linked to the preferred harvest size, and previous experience of stock-recapture data, if available.

In effect, the data available on reservoirs have not been analysed in detail with a view to developing suitable management models. This is a priority area of research into reservoir fisheries in the region.

Role of introduced species

It was mentioned previously that in some instances introduced species, in particular tilapias, have established self-recruiting populations sufficiently large to sustain artisanal fisheries in reservoirs. A case in point is the reservoir fishery of Sri Lanka, almost entirely based on the introduced cichlids *Oreochromis mossambicus* and *O. niloticus* (De Silva 1988). It has been argued that the success of tilapias is a result of the lack of truly lacustrine species in the region (Fernando and Holcik 1982). This in all probability is too simplistic an interpretation. A closer examination of data from Thailand, India and Laos PDR suggests that exotic cichlids, and indeed exotic species, are not the mainstay of fisheries in reservoirs that exceed 10 000 ha or so. The reasons for this may be many; perhaps one important one is the limitation of nesting sites in large reservoirs, which generally tend to have steep banks and limit the area available for nesting. In large reservoirs the landing size of cichlids tends to be much higher. A detailed analysis of data may help to counteract fears of the

potential destructive influence of cichlids on the biodiversity of inland water bodies.

On the other hand, Lorenzen et al. (1998) reported that stocking had no effect on indigenous standing stock in their study of a number of small water bodies with different management regimes.

Cage culture

Cage culture is often mooted as a possible strategy to increase fish production, providing alternative employment to displaced persons and poverty alleviation of rural communities (Costa-Pierce and Soemarwoto 1990). However, it is not always possible to make such activities profitable, the main constraints being a dearth of suitable and low-cost feeds and a suitable market for the produce. Both constraints can be overcome with proper planning, as was the case in Jatiluhur and Saguling, and Batang Ai reservoirs in Indonesia and Malaysia, respectively. There the activity is at almost an industrial level, where large volumes of fish (primarily red tilapia) are produced, and a large proportion destined for export. Similarly in China reservoir cage culture is utilised to produce very high-valued fish such as mandarin fish (*Siniperca chuatsi*), again on almost an industrial scale.

One other important factor is that in large reservoirs small-scale cage-culture developments generally tend to occur upstream, and are undertaken

by artisanal fishers in the hope of supplementing income. Such developments are not always desirable, for a number of reasons. Firstly, the material needed (timber) is always extracted from the catchment, exacerbating and contributing to the problem of catchment damage. Secondly, and more importantly, such activities tend to be located in the sheltered bays or coves upstream, which are often the nursery areas of the indigenous fish, and which become disturbed and indeed unsuitable as nursery areas. Such destruction of nursery areas may have a long-term negative influence on the reservoir ecosystem, and on its biodiversity.

On the other hand, utilisation of large reservoirs to nurture fry to fingerling rearing has not been explored sufficiently. Most nations in Asia produce a large number of fry of major carp species (Chinese and Indian) for use in pond culture and for culture-based fisheries of small-size reservoirs. Due to lack of rearing facilities in most instances fry are stocked and consequently the returns are less than desirable. Cage culture in large reservoirs can therefore be used effectively for fry to fingerling rearing, particularly in nations where there are limited facilities.

Reservoirs in Asia are used for finfish production only, with the exception of China. In China, reservoirs are commonly used for freshwater pearl production without any impediment to fish production. Comparable opportunities in other nations need to be explored.

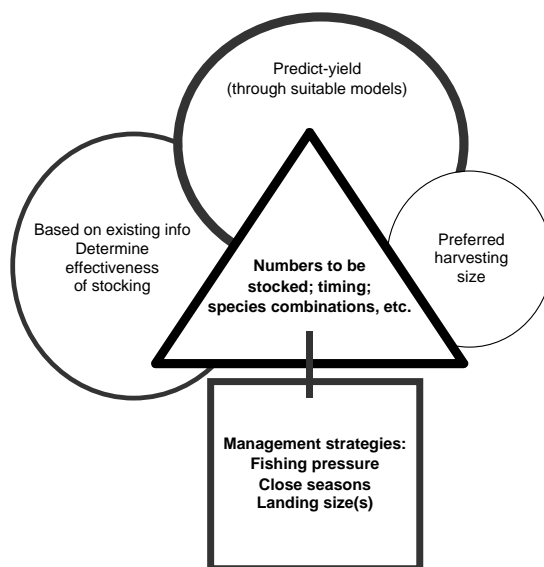

Figure 7. A schematic presentation of the proposed strategy for the development of management strategies for optimising fish yield in large reservoirs.

Conclusion

Asia has a large reservoir resource very diverse in nature. Its inland fishery makes a significant contribution to world fish supply. In view of its diverse nature, strategies to be adopted to optimise fish production are variable. In smaller-size reservoirs a culture-based fishery is most suitable, and practices in China enable production exceeding one million mt. In large reservoirs the economic viability of stocking has not been proven. There is a need to analyse available data for existing fisheries and to develop suitable management strategies to optimise yields.

References

- Avakyan, A.B. and Iakovleva V.B. 1998. Status of global reservoirs: the position in the late twentieth century. *Lakes and Reservoirs: Research and Management*, 3: 45–52.
- Bhukaswan, T. 1989. Use of cyprinids in fisheries management of the larger inland water bodies in Thailand. *FAO Fisheries Report 405 (suppl.)*, 142–150.
- Bernacsek, G.M. 1997. Large farm dam fisheries of the lower Mekong countries: review and assessment. *Database. MKG/R. 97023, Vol. II*, 145 p. Mekong River Commission, Phnom Penh, Cambodia.
- Costa-Pierce, B.A. 1991. Small water bodies for sustainable fisheries production. *NAGA, The ICLARM Quarterly*, 14: 3–5.
- Costa-Pierce, B.A. and Soemarwoto, O. ed. 1990. *Reservoir Fisheries and Aquaculture Development for Resettlement in Indonesia*. ICLARM Technical Report 23, 378 p.
- De Silva, S.S. 1988. Reservoirs of Sri Lanka and Their Fisheries. *FAO Fisheries Technical Paper 298*, 128 p.
- 1996. The Asian inland fishery with special reference to reservoir fisheries: a reappraisal. In: Schiemer, F. and Boland, K.T. ed. *Perspectives in Tropical Limnology*, SPB Academic Publishing, Amsterdam, 321–332.
- De Silva, S.S. and Sirisena, H.K.G. 1989. New fish resources of reservoirs in Sri Lanka 3. Results of commercial-scale trials and yield estimates of a gillnet fishery for minor cyprinids. *Fisheries Research*, 7: 279–287.
- De Silva, S.S., Zhitang, Y. and Lin-Hu, X. 1991. A brief review of the status and practices of the reservoir fishery in mainland China. *Aquaculture and Fisheries Management*, 22: 73–84.
- FAO 1999. *The State of World Fisheries and Aquaculture*. FAO, Rome, Italy, 112 p.
- Fernando, C.H. 1980. Tropical man-made lakes. African fish and cheap protein. *ICLARM Newsletter*, 3: 15–18.
- Fernando, C.H. and Holcik, J. 1982. The nature of fish communities: a factor influencing the fishery potential and yields of tropical lakes and reservoirs. *Hydrobiologia*, 76: 127–140.
- Kumar, K. 1989. Gobindasagar Reservoir: a case study on the use of carp stocking for fisheries enhancement. *FAO Fisheries Report 405 (Suppl.)*, 47–69.
- Li, S. 1988. The principles and strategies of fish culture in Chinese reservoirs. In: De Silva, S.S. ed. *Reservoir Fishery Management and Development in Asia*, International Development Research Centre, Ottawa, Canada, 214–223.
- Li, S. and Xu, X. 1995. *Culture and Capture of Fish in Chinese Reservoirs*. IDRC, Ottawa, Canada, 128 p.
- Lorenzen, K. 1995. Population dynamics and management of culture-based fisheries. *Fisheries Management and Ecology*, 2: 61–73.
- Lorenzen, K. and Garaway, C.J. 1997. How predictable is the outcome of stocking. *FAO Fisheries Technical Paper 374*, 133–152.
- Lorenzen, K., Garaway, C.J., Chamsingh, B. and Warren, T.J. 1998. Effect of access restrictions and stocking in small waterbody fisheries in Laos. *Journal of Fish Biology* 53 (Suppl. A), 345–357.
- Lu, X. 1986. A review on reservoir fisheries in China. *FAO Fisheries Circular 803*, 37 p.
- Moreau, J. and De Silva, S.S. 1991. Predictive Fish Yield Models for Lakes and Reservoirs in the Philippines, Thailand and Sri Lanka. *FAO Fisheries Technical Paper 319*, 42 p.
- Phan, P.D. and De Silva, S.S. 2000. The fishery of Ea Kao Reservoir, Southern Vietnam; a fishery based on a combination of stock and recapture and self-recruiting populations. *Fisheries Management and Ecology*, 7: 251–264.
- Song, Z. 1999. *Rural Aquaculture in China*. RAP Publication 1999/22. RAPA, FAO, Bangkok, 71 p.
- Srivastava, T.K., Srinivasan, K., Seth, G.K., Rao, M.P. and Rao, V.D. 1985. *Inland Fish Marketing in India*. Vol. 4. *Reservoir Fisheries*. Concept Publishing Co., New Delhi, 1184 p.
- Sugunan, V.V. 1995. *Reservoir Fisheries of India*. *FAO Fisheries Technical Paper 345*, 420 p.
- Welcomme, R.L. 1996. Stocking as a technique for enhancement of fisheries. *FAO Aquaculture Newsletter*, 14: 8–14.

Fish Resources in Chinese Reservoirs and Their Utilisation

Daoming Huang, Jiashou Liu and Chuanlin Hu*

Abstract

China has more than 86 000 reservoirs. The diversity of the landscape, water resources and climate in the reservoir catchments provides a variety of habitats for fish, resulting in a diversity of fish species. More than 1020 species of fish have been found in Chinese freshwaters, most of which also occur in reservoirs. However, the lotic species move to the upper reaches of rivers and the migratory species gradually disappear because of the dams. The economically valuable fish in reservoirs are the lacustrine fish and these species prefer slow-flowing waters. About 100 such species are commonly found in reservoirs in China. The species of most economic value in Chinese reservoirs are cyprinids. Typical species include *Hypophthalmichthys molitrix*, *Aristichthys nobilis*, *Cyprinus carpio*, *Carassius auratus*, *Ctenopharyngodon idellus*, *Mylopharyngodon piceus*, *Megalobrama terminalis*, *Cirrhina molitorella*, *Erythroculter mongolicus* and *E. ilishaeformis*. The composition of fish fauna in Chinese reservoirs is complicated and differs in different regions. Almost all reservoirs in China are used for fish enhancement or culture-based fisheries. The 1998 fish yield in Chinese reservoirs was 1 294 000 t, of which more than 60% was silver carp and bighead carp. A series of strategies such as artificial stocking, transplantation, domestication, control of predatory fish, protection of spawning grounds of economically valued species, and extensive, culture-based fisheries in the small and medium-sized reservoirs is adopted to improve yields. About 30 species of fish are stocked or transplanted into reservoirs.

CHINA is a country rich in reservoirs. The cultivable surface area of reservoirs is more than 2×10^6 ha (Liu and He 1992), amounting to 40% of the total cultivable freshwater surface area. Fisheries yield in Chinese reservoirs in 1998 was 1 294 000 tons with a mean yield of 810 kg/ha (FBCMA 1998). Reservoir fisheries are a major component of freshwater fisheries. The diversity of the landscape, water resources and climate in the reservoir catchments provides a variety of living and reproductive habitats for fish, resulting in a diversity of fish species. The rich fish resources provide huge potential for reservoir fisheries development.

Number and distribution of reservoirs

More than 86 000 reservoirs have been constructed with a total storage of 4×10^{11} m³ (Table 1) (Liu and

He 1992). Reservoirs in 29 provinces, autonomous regions and municipalities come directly under the jurisdiction of the Central Government in China, with the exceptions of Shanghai and Tibet. The reservoirs are located between 18°9'N and 35°26'N. Most are distributed in the main seven river systems, including the Changjiang, the Huanghe, the Huaihe, the Hai-luan, the Zhujiang, the Songhuajiang and the Liaohe rivers, amounting to 77% of total storage (Liu and He 1992).

The Changjiang River system has the most reservoirs of the main seven river systems, in which the large and medium-sized reservoirs amount to 36.7%, and the small-sized reservoirs 56.5% of the total number in the same size ranges across mainland China (Table 2). According to the Chinese classification system, a reservoir exceeding 677 ha is ranked as large, 66.7–677 ha as medium-sized, and less than 66.7 ha, small (Wu 1998). There are also some plain reservoirs in Xinjiang and Inner Mongolia. Most reservoirs in China are medium or small, and most large-sized reservoirs have surface areas ranging 10–50 km².

*Institute of Reservoir Fisheries, the Chinese Ministry of Water Resources and the Chinese Academy of Sciences, Zhuo Dao Quan, Wuhan 430079, PR China

Table 1. Data of all sizes of reservoirs in China.

Reservoir size	No.	Storage	
		($\times 10^6 \text{ m}^3$)	(%)
Large	326	2 975.4	72.0
Medium	2 298	605.2	14.7
Small (1)	14 108	365.8	8.9
Small (2)	70 120	184.2	4.4

The origin and succession of fish resources

The fish resources in reservoirs originate from the impounded river. Reservoirs in different districts of China normally maintain their own fish faunal characteristics. For example, the mud carp *Cirrhina molitorella* occurs only in reservoirs of Southern China, *Schizopygopsis* only in reservoirs of the Northwestern Plateau, and *Brachymstax lenok* only in reservoirs of the northeast.

After the impoundment of reservoirs, the flow decreases, the surface area widens, the water column deepens, the transparency increases, nutrients accumulate, and fisheries production potential increases. Especially, some large and medium-sized reservoirs share the characteristics of both lotic and lentic waters. The fish species in these reservoirs are significantly more diverse than in the original rivers. The obvious changes of fish resources are the movement of lotic species upstream. The migratory species gradually disappear because of obstruction from dams. The economically valuable fish are the lacustrine fish, and these species prefer slow-flowing waters.

In the early years of impoundment, many plants and agricultural lands are immersed, and piscivorous fish, except the demersal snakehead, do not exist in great number. Snakehead fish spawn on aquatic plants. Furthermore, lower water levels at this stage interfere with the life of pelagic piscivores, but the air-breathing snakehead is less affected (Liu and

Huang 1998). Economically valuable species grow quickly and their yield increases rapidly at this stage. Later, water levels are raised, nutrients are lost because of the high water exchange rate, and most aquatic plants disappear. Pelagic piscivorous fish gradually develop and become dominant. Predation from piscivorous fish and capture pressure on economically valuable fish are strengthened at this stage. The development of economically valuable fish is prohibited, and the trash fish populations with high rates of reproduction grows quickly to compensate for losses from predation. Since trash fish have a low market value and are hard to capture, their rapid development decreases the production potential of reservoirs.

Piscivorous fish play a very important role in the succession of fish resources. Their succession in reservoirs of the middle and lower reaches of the Changjiang River shows an obvious succession: demersal piscivorous fish (*Channa* and *Silurus*) \rightarrow pelagic *Culter* \rightarrow pelagic *Elopichthys bambusa* \rightarrow *Culter* again after heavy human control of *E. bambusa* (Chen et al. 1978).

In some reservoirs of Northern China, piscivorous niches are vacant. Trash fish dominate in such reservoirs and fish resources are small. Fish assemblage is simple in these reservoirs, and only a few fish species are found in some reservoirs, resulting in low fish yield.

Fish composition is heavily affected by human beings. Since fish culture in Chinese reservoirs is comparatively intensive, natural fish yield amounts to a very small proportion of the total fish yield; in the medium and small-sized reservoirs, it is less than 5% of total yield.

Fish composition and distribution characteristics

China is one of the richest countries in the world in freshwater fish resources; 1020 species of freshwater fish have been recorded. These fish belong to 266 genera, 46 families and 18 orders. Among them, 750

Table 2. Reservoirs in the main seven river systems of China.

River system	No.					Storage	
	Large	Medium	Small (1)	Small (2)	Total	($\times 10^6 \text{ m}^3$)	(%)
Changjiang	101	864	6 700	40 881	48 546	1 186.6	37.3
Huanghe	14	141	848	2 567	3 570	569.5	17.9
Huaihe	36	149	905	4 317	5 407	393.3	12.4
Hai-luan	26	108	343	1 481	1 958	228.3	7.2
Zhujiang	35	327	1 907	7 300	9 569	465.1	14.6
Songhuajiang	17	97	425	942	1481	198.9	6.3
Liaohe	16	67	208	460	751	136.9	4.3

are Cypriniformes, 109 Siluriformes, 70 Perciformes, 39 Salmoniformes, and nine Acipenseriformes. Cypriniformes account for 73.5% of the total. Among them, 530 species are Cyprinidae, 145 Cobitidae and 72 Homalopteridae. Moreover, the main economic fish in Chinese reservoirs are Cyprinidae (Yue 1995).

Reservoirs in China are widely distributed and their characteristics differ from place to place. Most reservoirs in Eastern China are normally plain-typed, and some are valley or river-typed. Their economic characteristics are similar to those of lakes. Reservoirs in Southern China have natural conditions suitable for tropical fish, and in Northern China, suitable for cold-water fish. Reservoirs in Qinghai, Tibet, Inner Mongolia and Xinjiang have ecological characteristics of plateau areas. The ecological diversity in Chinese reservoirs results in a diversity of fish species. In fact, it is very hard to distinguish clearly reservoir fish from river and lake fish. Almost all freshwater fish in China can be found in reservoirs.

Of the cyprinids, about 100 species are of economic value. The four major domestic fish, silver carp *Hypophthalmichthys molitrix*, bighead carp *Aristichthys nobilis*, grass carp *Ctenopharyngodon idellus* and black carp *Mylopharyngodon piceus*, are indigenous to China. Bighead carp and silver carp especially play a very important role in Chinese reservoir fisheries. Their yields amount to more than 60% of the total. The common carp *Cyprinus carpio* and the goldfish *Carassius auratus* have the widest distribution. Their yields amount to about 20% of the total in non-stocked reservoirs. In some reservoirs in Northeastern China, their yield may amount to more than 50% of the total (HFI 1985). *Parabramis*, *Megalobrama*, *Cirrhina* and *Xenocypris* also have a high yield in non-stocked reservoirs. These fish feed mainly on aquatic grasses, periphyton and organic detritus. *Culter*, *Silurus*, *Channa* and *Siniperca* are mild predators and are widely distributed in Chinese reservoirs. They are higher-valued in markets and play an important role in controlling trash fish (Liu and He 1992).

The composition of the fish fauna in Chinese reservoirs is complicated and is different in different regions. Fish species in reservoirs of the East China Plain Region are very rich. Normally, 40–50 fish species can be found in large and medium-sized reservoirs. For example, there are 68 species in Danjiangkou Reservoir (Yuan and Huang 1989). The species mainly comprise river and plain fish. Fish originating from the Tertiary come second. Fish of the Indian plain species also have an important role. Fish of the Sino-Indian Plateau species can also be found in the upstream of reservoirs. The East China Plain Subregion is the most important base of

reservoir fisheries. Almost all reservoirs in China are used for fish enhancement or culture-based fisheries. Main species include silver carp, bighead carp, grass carp, *Parabramis*, *Megalobrama*, *Silurus*, *Siniperca*, *Culter*, *Channa*, *Protosalanx*, *Neosalanx*, and *Elopichthys* (Li 1981; Chen 1990; Liu and He 1992).

South China is also rich in fish species. Normally, 30–40 species can be found in its reservoirs. The region is affected by a warm air flow. It has a long summer and no distinct winter. Its fish composition is close to that of the Oriental region. Proportions of the Indian plain species and Sino-China plateau species obviously increase. Fish originating from the Tertiary and the river and plain species can also be found in this region, which is another important area of reservoir fisheries. There are some endemic species in this region, e.g. mud carp *Cirrhina molitorella*, large-scale silver carp *H. harmandi sauvage*, the ratmouth barbel *Ptychidio jordani*, *Channa asiatica*, some species of Barbinae and introduced tropical tilapias (Li 1981; Lin 1987; Liu and He 1992). For example, the yield of the mud carp amounts to 70% of the total in Songtao Reservoir, Hainan Province.

Reservoirs in North China have about 20 fish species, characterised by cold-water fish, such as the northern plain fish, northern plateau fish and North Pole fish. In reservoirs of the Heilongjiang River (the Amur River) system, there are some river and plain fish and fish originating from the Tertiary. The species peculiar to this region include the minnows *Phoxinus phoxinus*, the silver crussian carp *Carassius gibelio*, the Atlantic salmon *Salmo salar*, the black crussian carp, the roach *Rutilus rutilus*, the sculpin *Cottus gobio* and the pikes *Esocidae* (Li 1981). It has the lowest reservoir number and fish species in the West China Region. The common species are fish of the genera Schizothoracinae, Barbinae and Nemachilinae. Typical species include *Gymnocypris* and *Schizopygopsis* (Liu and He 1992).

Fish Resources Protection and Development

Status of reservoir fisheries in China

China has a long history in freshwater aquaculture. In 1995, the yield of land-based aquatic products amounted to 51.3% of the world's total. Compared with pond and lake fisheries, reservoir fisheries have a later beginning, but a more rapid development and a greater potential. Reservoir fisheries began in the 1950s. With the construction of many reservoirs in the 1960s and 1970s, and the success of the artificial propagation of domestic silver carp, bighead carp, grass carp and black carp, reservoir fisheries developed fast. The application of Joint Capture Methods,

which use driving-nets, bar-nets, gill-nets and stake-nets, has enabled the effective harvesting of pelagic fish (Li and Xu 1995).

Stocking with big-sized fingerlings and the application of protective devices to prevent escape accelerated the development of reservoir fisheries. After 1979, the administrative responsibility was moved to the Chinese Ministry of Water Resources in the Chinese Ministry of Agriculture. More fisheries equipment was built. Technical aid for pond culture and lake culture and the ecological characteristics of reservoirs were considered. Reservoir fisheries developed from extensive culture to semi-intensive and intensive culture.

After the 1990s, with increasing demand for live aquatic products, the development and transplantation of new species were carried out, population structure of cultured species was changed on a large scale, and proportions of high-valued species were increased. Reservoir stocking according to ecological characteristics was more rational, and more attention was paid to sustainable and highly efficient development. During the past 20 years, surface area for reservoir culture has increased by 27.3%, amounting to 1 596 000 ha. Fish yield in reservoirs increased at a mean rate of 14.2%, amounting to 1 294 000 t in 1998 with a yearly increase of 12.7%. The mean fish yield was 810 kg/ha in 1998 (FBCMA 1998) (see Figure 1).

Protection and enhancement

The protection of fish brood stock and its spawning grounds is the precondition of fish resources protection and enhancement. Based on the spawning time, migration path and the spawning sites, closed seasons and areas are determined. If spawning grounds are not suitable, artificial spawning grounds are provided. Protection of fry and fingerlings is also important.

According to the biological characteristics and resource status of fish, the minimum fish size and capture rate are determined, capture tools and capture methods regulated, and lethal capture tools and capture methods prohibited. For endangered and high-valued species, methods of artificial propagation and stocking are adopted.

Reservoir stocking

Reservoir stocking is the most important and most common feature of reservoir fisheries in China, because the main cultured species in Chinese reservoirs are silver carp, bighead and grass carp. These fish cannot reproduce naturally in reservoirs. Even if they can reproduce in reservoirs, their survival rate is very low because reservoirs cannot provide riverine conditions for hatching. In reservoirs of the South China Region, mud carp is commonly stocked. In the

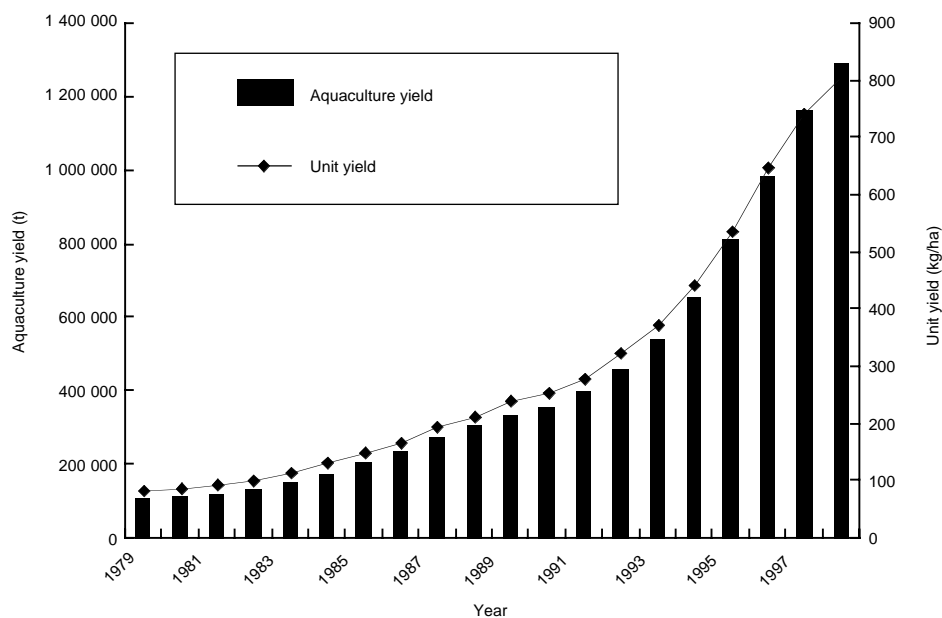

Figure 1. Aquaculture yield and unit yield in Chinese reservoirs (1979–98).

shallow reservoirs of the East China Region, the mandarin fish *Siniperca chuatsi* is also stocked to control trash fish. Most stocked fish in reservoirs use natural feeds which result in high yield and good economic returns. Two types of stocking can be distinguished according to the main species stocked: type of silver carp and bighead carp, and type of common carp and goldfish.

Silver carp and bighead carp: these are the traditional species cultured in China. They are planktivorous, have very high adaptability and their food conversion efficiency is high, showing a rapid growth rate from the southern Hainan Province to the northern Heilongjiang and Xinjiang provinces. In reservoirs with silver carp and bighead carp, their yields normally amount to more than 80% of the total. The stocking efficiency is normally 3–7. In a large-sized reservoir of Northern China, Dahuofang Reservoir, with a surface area of more than 5000 ha, the yield reached 300 kg/ha. In a medium-sized reservoir of Hubei Province, Meichuan Reservoir, the yield is as high as 1000 kg/ha. This type of stocking is also adopted even in some huge reservoirs, for example, Xinanjiang Reservoir, with a surface area of 27 000 ha (Li 1994).

Common carp and goldfish: reservoirs in Northern China are mainly stocked with common carp and goldfish because of the cold weather, as they grow better than silver carp and bighead carp in cold water. Goldfish have been stocked in Wuyi Reservoir, Heilongjiang Province, and the mean yield in that reservoir is 375 kg/ha.

Transplantation and domestication

Transplantation and domestication of fish began in the 1950s in China. The silver carp, bighead carp and grass carp were the first to be transplanted into reservoirs. After the 1960s, the work of transplantation and domestication of fish rapidly developed. Some cold water species were transplanted into reservoirs of Northern China, e.g. the peled *Coregonus peled*, the pike *Leuciscus leuciscus*, the roach *R. rutilus* and the tench *Tinca tinca*. *Xenocypris*, *Megalobrama* and white goldfish were transplanted into reservoirs of Eastern China. The tilapias, mud carp, walking catfish *Clarias batrachus* and the round spadefish *Ephippus orbis* were transplanted into reservoirs of Southern China (Wang 1987).

In the past 10 years, fish transplantation was strengthened with the adjustment of species structure in reservoirs. So far, about 30 species have been introduced into reservoirs. Large-scale fish transplantation not only enriches fish resources, but also contributes to increasing fish yield. Some introduced fish have become the dominant species and the main

contributor to fish yield, showing both good economic efficiency and ecological efficiency. Typical transplanted species include the pond smelt *Hypomesus olidus*, the large icefish *Protosalanx hyalocranius* and the new icefish *Neosalanx taihuensis*.

In the late 1980s, most reservoirs in Northwestern China, Beijing and Northern China were transplanted with pond smelt, resulting in a yearly yield of 3000 t. In the past few years, icefish have been transplanted into reservoirs on a large scale all over China. The icefish yield was about 10 000 t, of which half the yield was from reservoirs. In Shandong Province, 95% of large-sized reservoirs and more than 150 small-sized reservoirs with a total surface area of 73 300 ha were stocked with large icefish eggs. More than 70% of reservoirs so stocked have yielded fish; in reservoirs of Shandong Province, 820 t in 1997. The new icefish was mainly introduced into reservoirs of Southern China, to Dianchi Lake, Yunnan Province. Now the new icefish have been introduced into almost all reservoirs in the province. Its yield was 1000 t in reservoirs of Yunnan Province, about 60 kg/ha (Hu et al. 1998).

Intensive fish culture in reservoirs

Intensive fish culture is carried out in some medium and small-sized reservoirs, in some large and medium-sized reservoirs, and in ponds below reservoir dams. The cultured species differs from place to place, but includes almost all freshwater species cultured in China. It is an important culture method in reservoirs, characterised by heavy investment, high yield and good economic returns.

Intensive culture in medium and small-sized reservoirs and coves

The poly-culture method from the traditional pond culture of China was adopted in some medium and small-sized reservoirs and coves. These water bodies are stocked with artificially reared fingerlings; manure or supplemental feeds are added. In some places, the integrated fish culture method has been adopted including forests, fruit trees and livestock. Yields of this culture method may be as high as 7500 kg/ha (Li 1994).

Cage culture

This culture method began in the 1970s. It was first used for rearing fingerlings of silver carp and bighead carp without feeding. Later, adult fish were also cultured in cages with different species and different culture methods, including about 20 species, e.g. the common carp, tilapias and long-snout catfish *Leiocassis longirostris*, fed with formulated feeds,

and the mandarin fish and southern catfish *Silurus meridionalis* fed with fish. The mean yield of fish culture in cages is 300 kg/m³ (Wang 1989).

Fish culture in flowing water or slowly flowing water below dams

Normally, high-valued species are cultured in flowing water below reservoir dams taking advantage of the good water quality, sufficient dissolved oxygen and different water temperatures at different water levels. These species include the rainbow trout *Salmo gairdneri*, sturgeons, the long-snout catfish and eels. The mean fish yield is about 45 kg/m² (Yang et al. 1993) in flowing water and about 4.5 kg/m² in slowly flowing water (Sheng et al. 1993).

Acknowledgments

We wish to thank Dr S.S. De Silva at Deakin University, Australia, for strictly checking the manuscript and making good suggestions, and we are also grateful to Professor Yue Peiqi at the Institute of Hydrobiology, the Chinese Academy of Sciences, for providing information.

References

- Chen, M. 1990. Fish resources in the Qingtangyang River, Shanghai. Shanghai Science Press (in Chinese).
- Chen, J., Lin, Y. and Wu, Z. 1978 Regulations of succession of predatory fish population in reservoirs of the middle and lower Changjiang Valley, with a discussion of the methods of population control. *Oceanologica et Limnologica Sinica*, 9: 49–58 (in Chinese).
- FBCMA (Fisheries Bureau of the Chinese Ministry of Agriculture) 1979–98. Yearbook of Fisheries in China. Beijing: Agriculture Science (in Chinese).
- HFI (Heilongjiang Fisheries Institute) 1985. Freshwater Fisheries Resources in Heilongjiang Province. Haerbin: Korean Press (in Chinese).
- Hu, C., Chen, W. and Liu, J. 1998. Status of transplantation and enhancement of icefish in China and their development strategies. *Reservoir Fisheries*, 1998(2): 3–7 (in Chinese).
- Li, S. 1981. Studies on Zoogeographical Divisions for Fresh Water Fish in China. Beijing: Science Press (in Chinese).
- Li, S. and Xu, S. 1995. Culture and Capture of Fish in Chinese Reservoirs. Southbound: International Development Research Center.
- Li, Y. 1994. On the status and development strategies of reservoir fisheries in China. *Reservoir Fisheries*, 1994(3): 3–5 (in Chinese).
- Lin, Y. 1987. Assessment of the fisheries productivity reservoirs in Guangdong Province and strategies for increasing fish yield. *Reservoir Fisheries*, 1987(4): 29–33 (in Chinese).
- Liu, J. and He, B. 1992. Cultivation of Freshwater Fish in China (Third edition). Beijing: Science Press (in Chinese).
- Liu, J. and Huang, Y. 1998. Fisheries and fish culture practices in Fuqiaohe Reservoir, China. *Intern. Rev. Hydrobiol.*, 83 (Special): 569–576.
- Sheng, H. et al. 1993. The energy conversion efficiency of fish culture in the slowly flowing water below reservoir dams. *Reservoir Fisheries*, 1993(3): 19–22 (in Chinese).
- Wang, L. 1987. Transplantation and domestication of fish. *Reservoir Fisheries*, 1987(1): 4–5 (in Chinese).
- Wang, L. 1989. Review of reservoir fisheries in China. *Reservoir Fisheries*, 1989(4): 2–7 (in Chinese).
- Wu, J. 1998. Reservoir fisheries in China. *Intern. Rev. Hydrobiol.*, 83 (Special): 611–618.
- Yang, L. et al. 1993. Techniques of rainbow trout culture in Miyun Reservoir. *Reservoir Fisheries*, 1993(2): 48–50 (in Chinese).
- Yuang, F. and Huang, D. 1989. Fish resources and composition in the Danjiangkou Reservoir. *Research Fisheries*, 1989(2): 35–36 (in Chinese).
- Yue, P. 1995. Analysis on the reason that some freshwater fish are endangered. *Lake Science*, 7(3): 271–275 (in Chinese).

The Impact of Large Reservoirs on Fish Biodiversity and Fisheries in China

Li Sifa*

Abstract

The fish biodiversity in large reservoirs is influenced by the hydro-biological changes after impoundment and subsequent fisheries management, particularly stocking, as well as their interaction. The original river fish fauna determine the resulting reservoir fish fauna, but dominant populations usually change from riverine species to lacustrine. Anadromous and/or catadromous migratory species are likely to disappear. Potamodromous migratory species (upstream for spawning, downstream for feeding, or vice versa) are also likely disappear or become much less abundant. The artificial stocking of Chinese carp etc. is a common strategy adopted in reservoir fisheries management and affects the biodiversity significantly. Four large reservoirs are selected as representative of large-size reservoirs in China. The number of fish species in these reservoirs is 40–90. Unlike in smaller reservoirs, where the stocked species dominate, in large reservoirs the population primarily consists of wild, naturally recruited species. Such populations and their diversity are subjected to long-term dynamic processes associated with the aging of the reservoirs and human activity.

RESERVOIRS are constructed for flood control, hydro-electric power, irrigation, and navigation. They are also known as anthropogenic lakes and include impounded basins created in lowlands and flood plains by levees or by digging.

In general, the environmental conditions in reservoirs are intermediate between those of rivers and lakes. These differences are reflected in the morphology, hydrology, physico-chemical and biological characteristics. In large reservoirs, the environment is closer to that of rivers or lakes, whereas in smaller reservoirs, the environment is closer to ponds. This is reflected in fish biodiversity and greatly affects the fisheries utilisation of reservoirs.

This paper discusses fish biodiversity and its impacts on fisheries of large reservoirs in China. In China, reservoir capacity > 10 million m³ or water surface > 6667 ha is classified as huge; > 1 million m³ or water surface 667–6667 ha is considered large.

Four large reservoirs are chosen as representative for this analysis (Table 1; Figure 1).

Formation and development of Ichthyofauna and biomass

The biodiversity of fish in reservoirs is based on the biodiversity of the original rivers, particularly the principal river systems. But after impoundment there are significant changes in fish fauna due to changes of the hydrological regime and biological conditions. Table 2 shows the fish species in the four principal river systems of China. Table 3 shows the fish species in four large reservoirs.

Generally, there are more than 100 fish species in Chinese reservoirs. Each locality has some indigenous species such as the mud carp in Guangdong Province and Guangxi Autonomous Region, *Sinilabeo decorus* in Guangxi, *Hypophthalmichthys harmandi* in Songtao Reservoir (10 000 ha) of Hainan Island, crucian carp, *Pseudogobio vaillanti* and *Gnathopogon chankaensis* in some northeastern reservoirs, *Leuciscus waleckii* in the upstream reservoirs of the Huanghe River and *Anguilla japonica*, *A. marmorata* and *Plecoglossus altivelis* on the coastal reservoirs of Fujian, Zhejiang and other provinces.

*Key Laboratory of Ecology and Physiology in Aquaculture of Ministry of Agriculture, Shanghai Fisheries University, Shanghai, 200090. Email: lisifak@online.sh.cn

Table 1. The physical characteristics of four representative large reservoirs in China.

	Danjiangkou	Xinanjiang	Chanhszhouhu	Hongmen
Year of impoundment	1967	1959	1955	1960
Size (ha)	62 000	53 333	4470	6900
Mean depth (m)	20.0	30.4	10.0	7.3
Original river	Hanshui	Xinanjiang	Longqi	Ganjiang
Principal basin	Yangtze	Qiantangjiang	Yangtze	Yangtze
Fish species	67	83	40	69
Fish species of the original river	75	102	20	n.a.
Fish species of the principal river system	340	220	340	340
Fish yield (kg/ha)	69	90	n.a.	25
Wild fish production (%) total fish production	60	30	40	40

Table 2. Composition of fish species in four principal river systems of China.

Family	Pearl		Yangtze		Qiantangjiang		Liaohe	
	Spp.	(%)	Spp.	(%)	Spp.	(%)	Spp.	(%)
<i>Cyprinidae</i>	167	44.2	141	49.8	79	39.1	59	52.2
<i>Bagridae</i>	23	6.0	19	6.7	12	5.9	4	3.5
<i>Gobiidae</i>	17	4.5	12	4.2	10	5.0	3	2.7
<i>Cobitidae</i>	28	7.4	19	6.7	7	3.5	—	—
<i>Salmonidae</i>	—	—	1	0.4	—	—	—	—
<i>Homalopteridae</i>	22	5.9	15	5.3	—	—	—	—
<i>Salangidae</i>	—	—	5	1.8	3	1.5	—	—
<i>Acipenseridae</i>	—	—	3	1.1	1	0.5	2	1.8
Others	121	32.0	68	24.0	—	—	34	30.1
Total species	378		283		202		113	
Total families	49		37		55		23	

Source: Li Sifa and Xu Senlin, 1995

Table 3. Composition of fish species in four large reservoirs in China.

Family	Danjiangkou		Hongmen		Xinanjiang		Caihe	
	Spp.	(%)	Spp.	(%)	Spp.	(%)	Spp.	(%)
<i>Cyprinidae</i>	43	64.2	40	66.7	56	67.5	22	66.7
<i>Bagridae</i>	9	13.4	5	8.3	4	4.8	1	3
<i>Serranidae</i>	3	4.4	3	5.0	6	7.3	—	—
<i>Cobitidae</i>	3	4.4	2	3.3	5	6.0	4	12
<i>Siluridae</i>	2	2.9	1	1.7	2	2.4	1	3
<i>Gobiidae</i>	1	1.5	1	1.7	2	2.4	—	—
<i>Anguillidae</i>	—	—	1	1.7	2	2.4	—	—
<i>Homalopteridae</i>	1	1.5	1	1.7	1	1.2	—	—
<i>Synbranchidae</i>	1	1.5	1	1.7	1	1.2	1	3
<i>Sisoridae</i>	1	1.5	1	1.7	—	—	—	—
<i>Eleotridae</i>	1	1.5	—	—	—	—	2	6
<i>Channidae</i>	1	1.5	—	—	—	—	1	3
<i>Mastacembelidae</i>	1	1.5	1	1.7	—	—	—	—
<i>Hemiramphidae</i>	—	—	—	—	1	1.2	—	—
<i>Cichlidae</i>	—	—	—	—	1	1.2	—	—
<i>Eleotridae</i>	—	—	—	—	1	1.2	—	—
<i>Channidae</i>	—	—	1	1.7	1	1.2	—	—
<i>Osmeridae</i>	—	—	—	—	—	—	1	3
Total	67		60		83		33	

Caihe Reservoir: capacity 0.64 billion m³, water surface 1667 ha, mean depth 10m.

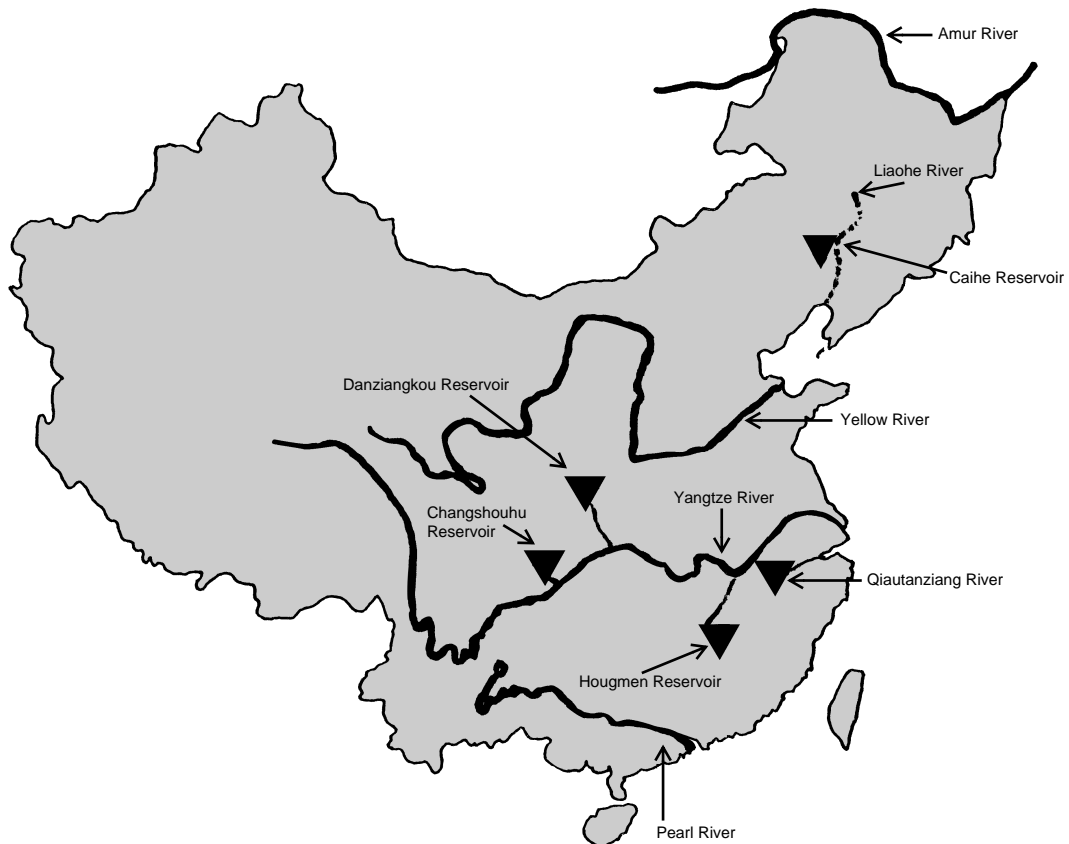

Figure 1. Location of the river systems and reservoirs considered in this study.

Changes in fish diversity after impoundment

The post-impoundment fish diversity of reservoirs changes and remains dynamic. Generally, enlargement of the water surface and artificial stocking make the fish diversity richer.

Riverine fish

As the original rivers disappeared and water flow became almost static in newly impounded reservoirs, riverine fishes such as *Varicorhinus (Onychostoma)* spp. are forced to move upstream and may eventually disappear.

Lacustrine fish

The newly created open water environment provides lacustrine fish with a favourable habitat to live in and spawn as well as an adequate food source, thereby increasing their abundance.

Soon after impoundment, the large number of submerged plants serve as spawning substrate for species such as common carp, crucian carp and *Hemiculter leucisculus*. Due to the large water volume, low initial fish population density, limited interspecific and intraspecific competition and fewer predators, the offspring of these fish usually have a high survival rate; they grow fast and the population increases rapidly. In many reservoirs, this is the major reason why populations formed at the early impoundment stage can be continually harvested for a number of years.

For example, in Shuifeng Reservoir (impounded in 1942), common carp was continuously captured until 1962. After a few years of impoundment, when the submerged plants decayed and the frequent fluctuation in water level causes big changes of draw-down area, a new macrophytes population is not formed or is less developed. Consequently, most

phytophagous fish have difficulty finding suitable spawning grounds and suitable feeding areas for the larvae. Except in the years when rainfall is abundant and water level fluctuations are minimal, spawning takes place readily. However, when dry conditions are present, spawning is not common. This may be the main reason why the populations of common carp and crucian carp increase in the early stages of impoundment but decrease afterwards, and the generations produced in subsequent years are less abundant. However, some fish like *H. leucisculus* and *Pseudolaubuca sinensis* which are not highly specific in their spawning conditions usually sustain a viable fishery.

In the case of common lacustrine predators such as *Erythroculter ilishaeformis*, *E. mongolicus*, *Elopichthys bambusa*, *Parasilurus asotus* (catfish), *Ophicephalus argus* (snakehead), *Siniperca chuatsi* (mandarin fish) and *Esox reicherti* (pike), spawning conditions improve after impoundment, their populations develop and are established rapidly.

Migratory fish

Catadromous species such as eel (*Anguilla japonica*), and anadromous species such as river shad (*Hilsa reevesii*), sturgeon (*Acipenser sinensis*), and *Coilia* spp. cannot in most instances migrate across dams, thus leading to a dramatic decrease in their population numbers and eventual extinction.

For the potamodromous (upstream for spawning, downstream for feeding) species such as silver, bighead and grass carps, they also cannot migrate because of damming. The remainder left in the submerged zone after impoundment will not spawn naturally even though they may reach maturity physiologically. In addition, the flow rate of water is not adequate for hatching and survival of post-larvae. As a result, such species may disappear if no further stocking is done.

Case study I — Changshouhu Reservoir is at Longxi River, a branch of the Yangtze River in Sichuan Province. It was impounded in 1955, with an average water surface of 4470 ha, maximum water depth of 40 m and mean depth of 10 m. The stocking of silver carp and bighead carp began in 1960. The changes in fish composition can be summarised as follows.

After impoundment, the indigenous species such as common carp, crucian carp, *H. leucisculus*, *Ancherythroculter kurematsui*, *Opsariichthys uncirostris bidens* and catfish flourished, particularly *H. leucisculus*. However, the population of *H. leucisculus* decreased remarkably soon after the stocking densities of silver carp and bighead carp were increased. At the same time, riverine species

inhabiting the Longxi River, such as *V. simus*, *Barbodes sinensis*, *Similabeo rendahli* and *Beaufortia leveretti*, gradually moved upstream and their populations declined.

Before damming, in the Longxi River there were four major predatory species, *Opsariichthys bidens*, *Ancherythroculter kurematsui*, catfish and *Mystus* spp. After damming, the *O. bidens* population developed rapidly and became the dominant predator till the later 1950s, to be replaced by *A. kurematsui* in the early 1960s and later by introduced *E. ilishaeformis* in the 1970s. The composition of predatory fishes in Changshouhu Reservoir shows a trend that with the aging of the reservoirs larger predatory species began to replace the smaller species.

After the impoundment of the Changshouhu Reservoir, the number of fish species increased from 20 to 43 in 1982.

Case study II — Foziling Reservoir. If the fish fauna were allowed to develop naturally after impoundment, the small low-value fish with short life cycle and simple spawning conditions would increase in number followed by predatory fish. However, high fish production has never been achieved in reservoirs dominated by small low-value fish and/or predators.

Foziling Reservoir (2670 ha) was impounded in 1954 and artificial stocking initiated in 1956. The reservoir was drained for maintenance purposes from 28 September to 7 October 1965. The fish composition by a complete harvest is shown in Table 4, indicating a natural balance.

Table 4. Observed composition of catch in Foziling Reservoir when drained.

Species	Weight (%)	No. (%)
Filter feeders		
Silver and bighead carp	44.5	5.8
Omnivores and herbivores		
Common carp	21.4	10.1
<i>Xenocypris</i> spp.	11.3	29.0
<i>Parabramis</i> spp. and <i>Megalobrama</i> spp.	10.0	39.5
Grass and black carp	8.5	2.1
Predators		
<i>Elopichthys bambusa</i> *	0.0	0.0

From Li and Xu 1995

Case study III — Danjiangkou Reservoir, stocked lightly with silver and bighead carps for enhancement. Wild fish such as common carp, crucian carp and predators species dominate. Table 5 shows the catch composition of the reservoir.

Table 5. Catch composition of a fishing team of Danjiangkou Reservoir in 1987 (annual yield 27 500 kg).

Species/ species group	(%)
Non-predators	
Common, crucian, silver and bighead carp	50
Predators	
<i>Erythroculter</i> spp.	30
<i>Elopichthys bambusa</i>	10
Marine fish, catfish, etc.	10

From Zhang and Huang 1990

Biology of economically important fish

Based on feeding habits and economic value, fish in the reservoir can be categorised into four groups: (1) non-predatory fish of economic-value; (2) predatory fish; (3) small, high-value fish; and (4) small, low-value fish.

Non-predatory fish of economic-value

This category includes all high-value non-predatory fishes with fast growth and large size. These are the target species for fisheries enhancement, including species such as silver carp, bighead carp, common carp, crucian carp, grass bream, black bream (*Megalobrama terminalis*), grass carp, black carp, mud carp (*Cirrhinus molitorella*), *Xenocypris argentea*, *Plagiognathops microlepis*, *Distoechodon tumirostris*, *Hemibarbus maculatus*, *H. labeo*, *Barbodes (Spinibarbus) sinensis*, *Leuciscus waleckii*, *Squaliobarbus curiculus*, *Sinilabeo decorus*, *Varicorhinus (Onychostoma) spp.*, *tilapia* spp. and *Coregonus* spp.

Silver carp

Silver carp prefers to live on phytoplankton but also ingests a large amount of zooplankton, detritus and bacteria.

Bighead carp

Bighead carp is a zooplankton feeder which also feeds on a certain amount of phytoplankton, detritus and bacteria.

Since the silver and bighead carps have a high food conversion rate and fast growth, utilising both primary and secondary productivity, they are the principal species for stocking.

In most large reservoirs, silver and bighead carps can attain maturity. But, as the hydrology of reservoirs is different from conditions in rivers, they may spawn in some large-sized reservoirs, but would not hatch, or, if they hatch, the fry cannot survive without sufficiently high water flow. Therefore, these two species cannot develop naturally into a large population and require regular stocking.

Common carp

Common carp, an omnivore with a fast growth rate, has a higher resistance to low temperature, alkalinity and low oxygen levels. It is widely distributed in reservoirs of various sizes and types. It is one of the dominant species in reservoirs of China.

Crucian carp

Compared to common carp, crucian carp prefers zooplankton, benthic organisms, algae, tender aquatic grass, detritus, etc. Its natural distribution is very wide and it is one of the dominant species in reservoirs. In north China it contributes over 20–30% to total production.

Grass carp

Grass carp is a herbivore but its population size is limited by the amount of aquatic plants available in most of the reservoirs, which lack suitable reproduction sites.

Grass bream

Grass bream is a medium-sized fish widely distributed in reservoirs. The adults mainly feed on aquatic weeds but also ingest aquatic insect larvae and crustaceans when the source of aquatic weeds is inadequate. It prefers to live in the littoral zone of coves and can spawn in many reservoirs naturally.

Black bream

This species can reach maturity and spawn naturally with its adhesive eggs in reservoirs. It is also one of the economically important species in many reservoirs.

Xenocyprinae

In China, the subfamily Xenocyprinae consists of nine species, of which four species are of economic importance: *X. argentea*, *X. davidi*, *X. microlepis* and *Distoechodon tumirostris*. They feed mainly on detritus and algae. As reservoirs are rich in detritus from runoff and generally the hydrological conditions are suitable for spawning, the Xenocyprinids can develop naturally into dominant populations. For example, *X. davidi* and *X. microlepis* accounted for 26–31% of the total production in Xianghongdian Reservoir (4000 ha) from 1983–85.

Mud carp

Mud carp is one of the dominant species in the reservoirs of Southern China. It feeds mainly on epiphytic algae and detritus. Mud carp spawns naturally in reservoirs and can become a dominant species. For

example, in Nanshan Reservoir (3800 ha) of Guangdong Province, mud carp account for 12% of the total production.

Predatory fish

Most predatory fish grow fast to a large size, produce good quality flesh and are of high economic value. For a long time they were considered dangerous to stocked fish and other wild fish of economic importance. Currently most predatory fish are in high demand and fetch a high price.

Major predatory fish in reservoirs are as follows.

Elopichthys bambusa

This fish begins to prey on other fish at a body length of 1.4 cm and can reach a maximum size of 58 kg. The body length of the fish preyed could be 26–30% of its body length.

Its spawning habit is similar to that of silver-, big-head and grass carp, but it requires simpler spawning conditions and therefore has the ability to increase in large reservoirs.

Erythroculter spp.

This genus includes *E. ilishaeformis*, *E. mongolicus*, and *E. dabryi*. These fish feed on small fish, shrimp, insects, cladocerans and copepods, and are commonly distributed from south to north in China and are the major predators in reservoirs. Maximum body weight can reach 10, 4 and 1 kg, respectively.

Snakehead

This fish is widely distributed in reservoirs because after impoundment, snakeheads originating from submerged ponds soon adapt themselves to the new water body. Using submerged plants as spawning

grounds and numerous small fish as food, the fish is the first to form a large population among predators.

Mandarin fish

Mandarin fish live mainly on small fish and shrimps. The maximum size is 12 kg. It is also widely distributed in reservoirs.

Catfish

Catfish is widely distributed in reservoirs.

Opsariichthys bidens

A small-sized fish with a big mouth gape enabling it to swallow fish nearly half its body length. It prefers small fish and insects. Moreover, it can form large populations in reservoirs because it reproduces quickly, and becomes a predator of fingerlings stocked in the reservoirs.

Esox reicherti

This fish is restricted mainly to Northern China.

The role and control strategy of these fish in reservoirs is controversial. Predatory fish are likely to create great losses in small and middle-size reservoirs where stocking is the principal method to increase fish yield. For example, in Fuqiaohe Reservoir, where intensive stocking started in 1960, and annual production reached 420 kg/ha in 1966. The accidental introduction of *E. bambusa* fry with carp fry, which then propagated naturally, resulted in a reduction of fish production to 24.8 kg/ha in 1975.

In large-sized reservoirs, such as Danjianglou, where light stocking is carried out, the impact of predatory fish on stocked fish has been rather weak (Zhang and Huang 1990, Table 6).

Table 6. Percentage food composition (by weight) of five predatory fish in Danjiangkou Reservoir.

Food fish	Predatory fish				
	<i>E. bambusa</i>	<i>E. mongolicus</i>	<i>E. ilishaeformis</i>	Catfish	Mandarin fish
<i>Hemiculter</i>	74.8	67.9	71.8	36.1	65.6
<i>Gobio</i>	16.3	6.8	7.0	22.5	9.3
<i>Pseudobrama</i>	1.8	3.2	1.1	9.6	5.8
<i>Pseudolaubuca</i>			3.2	1.6	1.4
<i>Erythroculter</i>	6.8	5.1	6.7	2.1	0.7
Crucian carp	1.1			3.8	2.6
<i>Gobidae, Hypseleotris</i>		1.2		1.2	
Prawn	0.7	15.4	10.1	5.8	
Frog				5.9	
Insects				1.9	

Fish production in Xianghongdian Reservoir reached 27 kg/ha only in 1983, of which the predator species *Erythroculter* spp., *E. bambusa* and mandarin fish were 38.25%, 15.02% and 6.91%, respectively.

Small, low-value fish

Most low-value fish compete for food with the economically important fish and some may even predate on the eggs and fry of other species. However, they also serve as forage fish for the predators and play a role in keeping the balance of the aquatic ecosystem.

The main small, low-value fish in reservoirs are *H. leucisculus*, *P. sinensis*, *Toxabramis swinhonis*, *Coilia brachygnathus*, *Saurogobio dabryi*, *P. fulvidraco*, *Rhodeus* spp., *Sarcocheilichthys sinensis*, *Hypseleotris swinhonis*, *Rhinogobius giurinus*, *Pseudorasbora parva*, *Gnathopagon* spp., *Macropodus chinensis* and *Sinibrama macrops*.

Small, high-value fish

The ice fish (*Hemisalanx branchystralis*) and *Hypomesus olidus* are the major small species of high value.

Impacts on fish biodiversity by super reservoir construction

There are 92 freshwater fish species listed in the 'China Red Data Book of Endangered Animals — Fishes'. They cover nine orders, 24 families, 78 genera and 92 species, belonging to the category of Ex (Extinct), Et (Extinct in China), E (Endangered), V (Vulnerable) and R (Rare). Unfortunately, there is no specific study on the relationship between the construction of reservoirs and subsequent fish biodiversity changes. The super reservoirs constructed on the major channels of principal rivers are likely to affect fish biodiversity seriously.

The construction of the Three Gorges 175 m Dam will form a river-like reservoir of 600 km in length and 39.3 billion m³ capacity.

Impacts on the local indigenous fish

In the upper stream above the dam, there are 196 fish species, of which 90 species are indigenous, such as *Coreius guichenoti*, *Rhinogobio cylindricus*, Chinese-ink carp (*Procypris rabaudi*), *Leptobotia*

elongata, *Schizothoras chongi*, *Cetcobitis sinensis* and *Hemimyzon sinensis*. They live in fast-flowing waters. It is estimated that the Three Gorges Dam will reduce 1/5–1/4 habitat areas of indigenous fish. Some are likely to disappear.

Small low-value fish are usually ignored in fisheries management, but are very important in biodiversity issue.

Impacts on Chinese carp spawning

In the 600 km stretch upstream of the dam, there are eight middle-sized spawning grounds of about 20 carp species, mainly silver, bighead, grass and black carp (Yi et al. 1988). After impoundment, these species will probably decline or even disappear.

Impacts on the rare aquatic animals

The negative impact on sturgeons, *Psephurus gladius* and *A. sinensis* needs to be studied. They will not only disappear from upstream (reservoir), but will also be affected by changing habitats downstream of the dam.

References

- Li Sifa 1998. The Fisheries and Aquaculture in the Yangtze River Basin. *Suisanzoshuoku*, 46(3): 354–460.
- Li Sifa and Xu Senlin 1995. Culture and Capture of Fish in Chinese Reservoirs. Southbound, International Development Research Centre, 140 p.
- Yi Belu, Yu Zhitang and Liang Zhishen 1988. Gezhouba Water Control Project and Four Famous Fishes in Yangtze River. Hubei Science and Technology Press, Wuhan China, 112 p.
- Yuan, F.X. and Huang, D.M. 1989. Fisheries resources and composition analysis of the Dangjiangkou Reservoir. *Reservoir Fisheries*, 2: 35–36.
- Yue Peiqi Chen Yiyu, 1998. China Red Data Book of Endangered Animals—Pisces. Science Press, Beijing, 247 p.
- Zhang, J.P. and Huang, X.C. 1990. On the control and utilisation of predator fishes in Dangjiangkou Reservoir. *Reservoir Fisheries*, 2: 27–31.
- Zhang, P.S. and Yang, T.X. 1994. Status, development and utilisation of Chaihe Reservoir. *Reservoir Fisheries*, 2: 22–26.
- Zhou, S.X., Xu, M.X., Zhang, C.R. and Xu, X.H. 1995. Survey report on the Fisheries resources of Hongmen Reservoir. *Reservoir Fisheries*, 3: 28–30.

Status of Reservoir Fisheries in Vietnam

Ngo Sy Van and Le Thanh Luu*

Abstract

The overview describes reservoir systems in Vietnam and their role in industry, agriculture and fishery sectors. It also deals with management issues of water resources and inter-relationships among reservoir users. The paper views development stages of reservoir fisheries before and after reformations in the agriculture sector with a wider perspective of socioeconomic and management aspects. The long-term development strategies of reservoir fisheries for 2000–2010 are also described. Data on fish production, stock-enhancement strategies, management schemes, and policies for different reservoir types are presented with a view to identifying development trends and the constraints thereof. Based on the analysis, and factors influencing the fisheries, the overview also proposes approaches — technological, management and policy — needed to achieve the targeted social, environmental and production objectives of the development strategies.

Reservoir Systems in Vietnam

MOST reservoirs in Vietnam were impounded after 1954 for different purposes such as irrigation, hydro-electricity, flood control and water supply for domestic consumption and industry. There are about 4000 community reservoirs (Hoi 1999) of which 460 are medium or large in size, with a water volume of more than a million m³ (Trong 1994). The reservoirs are usually located in hilly or mountain areas. Most are in the north and central midlands and highlands. Based on size, the reservoirs may be classified as large, which have more than 10 000 ha of water surface, medium, of 1000 ha to 10 000 ha, and small, those of less than 1000 ha. The country has very few large reservoirs; Hoa Binh (19 000 ha), Thac Ba (18 000 ha), and Tri An (32 400 ha), Thac Mo (10 600 ha) and Dau Tieng (18 000 ha). Most are medium (about 460 ha) and small. There is an unaccounted number of reservoirs of less than 1–2 ha constructed under private funding resources. Depending on their function, reservoirs may also be classified for irrigation, hydro-electricity, flood control and industry and drinking uses. However, most are constructed to serve several purposes.

Fishery Resources in Reservoirs

Fish fauna

Fish fauna of any reservoir depends on its geographical location and exploitation and protection of its resources. It is noted that biodiversity of fish fauna in most existing reservoirs in Vietnam is deteriorating.

In the northern mountain regions, 79 species have been recorded in reservoirs; in central Vietnam and the Central Plateau, 53 species (Luu 1994). The recorded number of fish species from reservoirs in both regions is a little higher than from natural lakes (53 and 47 respectively), and probably, some Vietnamese (common carp), Chinese (silver carp, big head carp, grass carp) and Indian carps (rohu, mrigal) have been introduced. Cyprinids are still dominant among species inhabiting the reservoirs in Vietnam.

Recent information (Tuan 1999) on fish fauna of Hoa Binh Reservoir indicate a poor species profile. According to sources, there are only 21 species, while before the reservoir was constructed, 80 species were recorded in the basin and another 28 species found in the springs and creeks. Sources also confirm that many migratory fish species have not been found in this reservoir. Similar situations are known for fish fauna in Thac Ba and Nui Coc reservoirs. Nguyen VH (1994) recorded 96 species in the newly built Thac Ba reservoir. Presently, only 76 species are found (Vu 1999). A recent inventory of the existing species of two reservoirs in the north is given in Table 1.

*Research Institute for Aquaculture No. 1, Dinh Bang, Tu San, Bac Ninh, Vietnam. Email: rial@hn.vnn.vn

Table 1. Species composition of fish fauna of Thac Ba and Nui Coc reservoirs.

No.	Scientific name	N. Coc	T. Ba
A	Salmoniformes		
I	Salangidae		
1	<i>Neosalanx taihuensis</i> Chen, 1956		R
B	Cypriniformes		
II	Cyprinidae		
	Cyprininae		
2	<i>Cyprinus carpio</i> Linnaeus 1758	+	+
3	<i>Cyprinus multitaeniata</i> (Pell et. Chev., 1936)		
4	<i>Carassius auratus</i> (Linnaeus, 1758)	+	+
5	<i>Carassioides cantonensis</i> (Heinke, 1892)	+	+
	Danioinae		
6	<i>Aphyocypris pooni</i> Lin, 1993		+
7	<i>Opasriichthys bidens</i> Giinther, 1873		+
8	<i>Rasbora cephalotaenia steineri</i> N. et. P., 1927		+
	Leuciscinae		
9	<i>Mylopharygodon piceus</i> (Richardson, 1846)	+	V
10	<i>Ctenopharygodon idellus</i> (C. et. V., 1844)	+	+
11	<i>Squaliobarbus curriculus</i> (Rich., 1846)	+	+
12	<i>Ochetobius elongatus</i> (Kner, 1967)	+	+
13	<i>Elopichthys bambusa</i> (Rich., 1844)		+
	Cultrinae		
14	<i>Toxabramis houdemeri</i> Pellegrin, 1932	+	+
15	<i>Pseudolaubuca sinensis</i> Bleeker, 1846		+
16	<i>Hemiculter leucisculus</i> (Basilewsky, 1853)	+	+
17	<i>Culter erythropterus</i> Basilewsky, 1855	+	+
18	<i>Pseudohemiculter dispar</i> (Peters, 1880)	+	+
19	<i>Hainania serrata</i> Koller, 1927		+
20	<i>Megalobrama terminanis</i> (Rich., 1845)		+
21	<i>Megalobrama hofmanni</i> (Here, Myers, 1931)		+
22	<i>Sinibrama merosei</i> Nichoks et. Pope, 1927	+	+
23	<i>Erythroculter recurvirostris</i> (Sauvage, 1884)	+	+
24	<i>E. hypselonotus daovantien</i> Banarescu, 1967	+	+
25	<i>E. illishaefomis</i> (Bleeker, 1871)	+	+
26	<i>Anabarilius hainanensis</i> (N. et. P., 1927)		+
27	<i>Rasborinus linneatus</i> Pellegrin, 1907	+	+
	Xenocyprinae		
28	<i>Xenocypris argentea</i> Giinther, 1868	+	+
29	<i>Xenocypris davidi</i> Bleeker, 1871	+	+
	Hypophthalmichthyinae		
30	<i>Hypophthalmichthys harmandi</i> Sauvage, 1884	+	+
31	<i>Hypophthalmichthys molitrix</i> (C. & V., 1884)	+	+
32	<i>Aristichthys nobilis</i> (Richardson, 1844)	+	+
	Gobioninae		
33	<i>Hemibarbus maculatus</i> Bleeker, 1871		+
34	<i>Hemibarbus labeo</i> Pallas, 1776		+
35	<i>Squalidus argentatus</i> (Sauvage & Dabry, 1874)	+	+
36	<i>Saurogobio dabryi</i> Bleeker, 1871		+
	Acheilognathinae		
37	<i>Acheilognathus tonkinensis</i> Vaillant, 1982	+	+

Table 1. Species composition of fish fauna of Thac Ba and Nui Coc reservoirs. (Continued)

No.	Scientific name	N. Coc	T. Ba
38	<i>Rhodeus spinalis</i> Oshima, 1926		+
	Barbinae		
39	<i>Tor macracanthus</i> (Pellegrin & Chev. 1936)		
40	<i>Spinibarbus denticulatus</i> Oshima, 1920		R
41	<i>Spinibarbus hollandi</i> Oshima, 1919	+	+
42	<i>Puntius ocellatus</i> Yen, 1978		+
43	<i>Capoeta semifasciolatus</i> (Giinther, 1868)	+	+
44	<i>Barbodes sp</i>		+
45	<i>Barbodes gonionotus</i> (Bleeker, 1859)		+
46	<i>Lissochilus elongatus</i> (Pell. & Chev., 1936)		
47	<i>Lissochilus laocaiensis</i> Hao & Hoa, 1969		
48	<i>Lissochilus kremphi</i> Pellegrin & Chev., 1936		+
49	<i>Varicorhinus erthrogenys</i> Hao & Hoa, 1969		+
50	<i>Onychostoma laticeps</i> (Giinther, 1896)	+	+
51	<i>Onychostoma sp₁</i>		+
52	<i>Onychostoma sp₂</i>		+
	Labeoninae		
53	<i>Labeo rohita</i> Giinther, 1868		+
54	<i>Semilabeo obscurus</i> Lin, 1981		R R
55	<i>Sinilabeo tonkinensis</i> (Pell. & Chev., 1936)		R
56	<i>Sinilabeo graffeuilli</i> (Pell. & Chev., 1936)		
57	<i>Sinilabeo lemassoni</i> (Pell. & Chev., 1936)		
58	<i>Cirrhinus molitorrella</i> (C. & V., 1942)	+	V
59	<i>Cirrhinus mriganla</i> (Hamilton, 1820)		+
60	<i>Osteochilus salsburyi</i> Nichs & Pope, 1927	+	+
61	<i>Garra pingi</i> (Tchang, 1929)	+	+
62	<i>Garra orientalis</i> Nichols	+	+
63	<i>Placocheilus gracilis</i> (Pelle. & Chev., 1936)		
	Cobitinae		
64	<i>Nemacheilus pulcher</i> N. & P., 1927		
65	<i>Barbatula fasciolatus</i> (N. & P., 1927)		
66	<i>Cobitis taenia dolychorhynchos</i> Nichols, 1918		+
67	<i>Misgurnus aguillicauda</i> (Cantor, 1842)	+	+
68	<i>Misgurnus mizolepis</i> Giinther, 1888	+	+
C	Siluriformes		
III	Siluridae		
69	<i>Silurus asotus</i> Linnaeus, 1758	+	+
IV	Clariidae		
70	<i>Clarias fuscus</i> (LacPd̃de, 1803)	+	+
71	<i>Clarias lazera</i>	+	+
V	Cranoglanidae		
72	<i>Cranoglanis boaderius</i> (Rich, 1846)	T	+
VI	Bagridae		
73	<i>Pelteobagrus fulvidraco</i> (Richardson, 1846)	+	+
74	<i>Pelteobagrus vachellii</i> (Richardson, 1848)		+
75	<i>Leocassis virgatus</i> (Oshima, 1926)	+	+
76	<i>Mystus guttatus</i> (LacDp̃de, 1803)	T	V
77	<i>Mystus pluriradiatus</i> (Vaillant)	T	V
VII	Sisoridae		
78	<i>Bagarius yarrelli</i> Sykes, 1841		+
79	<i>Glyptothorax hainanensis</i> (N. & P., 1927)		
D	Cyprinodontiformes		
VIII	Cyprinodontidae		
80	<i>Oryzias latipes</i> (Temm. & Schl., 1846)	+	+

Table 1. Species composition of fish fauna of Thac Ba and Nui Coc reservoirs. (Continued)

No.	Scientific name	N. Coc	T. Ba
E	Synbranchiformes		
IX	Flutidae		
81	<i>Monopterus albus</i> (Zuiew, 1793)	+	+
F	Perciformes		
	Anabantoidei		
X	Anabantidae		
82	<i>Anabas testudineus</i> (Bloch, 1792)	+	+
XI	Belontiidae		
83	<i>Macropodus opercularis</i> Linnaeus, 1788	+	+
	Channoidei		
XII	Channidae		
84	<i>Channa asiatica</i> (Linnaeus, 1758)		
85	<i>Channa maculatus</i> (LacDplde, 1802)	+	+
86	<i>Channa striatus</i> Bloch, 1797	+	+
	Peroidei		
XIII	Serranidae		
	Serraninae		
87	<i>Siniperca chuatsi</i> (Basilewsky, 1855)		
88	<i>Coreoperca whiteheadi</i> Boulenger, 1899		
XIV	Cichlidae		
89	<i>Oreochromis mossambicus</i> (Peters, 1880)	+	+
90	<i>Oreochromis niloticus</i> (Linnaeus, 1758)	+	+
	Gobioidei		
XV	Eleotridae		
91	<i>Pereotius chalmersi</i> (N. & P., 1927)	+	+
XVI	Gobiidae		
92	<i>Glossgobio giuris</i> (Hamilton, 1822)	+	+
93	<i>Rhinogobius hadropterus</i> (Jordan & Snyder)	+	+
94	<i>Rhinogobius leavelli</i> (Herre, 1935)	+	+
	Mastacembeloidei		
XVII	Mastacembelidae		
95	<i>Mastacembelus armatus</i> (LacDplde, 1800)	+	+
96	<i>Mastacembelus aculeatus</i> (Basilewsky, 1855)	+	+
97	<i>Mastacembelus sp</i>		+
	Total	56	76

Note: V: Vulnerable; R: Rare; T: Threatened

The survey in the early 1990s also indicated that the size and population structure of the fish species, including stocked species, in the reservoirs have decreased (Nguyen, V.H. 1994; Nguyen, V.L. 1994). A decline in the number and production of economically significant species has been recognised in most reservoirs throughout the country (Nguyen, V.H. 1994; Nguyen, V.L. 1994). Nguyen, V.H. (1994) noted that 70–75% of fish production in reservoirs in the north and central Vietnam was fish of low value.

Fish yields

The fish yields of reservoirs depend on nutrients, biomass, and the quality and quantity of stocked fingerlings. There is a common belief that fish yields

of reservoirs tend to be high in the initial few years after impoundment, and then begin to stabilise at a lower level. Although data on fish yields of the reservoir systems in Vietnam have not been produced, records in some main reservoirs show a downward tendency of fish yield (Table 2).

Nguyen et al. (1995) estimated that the average landing in 1993 in most of the reservoirs studied was 4.5 times lower than that at the beginning. Even in some newly constructed reservoirs such as Tri An, Dau Tieng and Thac Mo, a considerable decrease in yield has been evident for the last few years. It is estimated that the present catch (600 t) in Tri An Reservoir is much lower compared with some years ago. The same situation is seen in Thac Mo, when yield of 404 t in 1995 decreased to 384 t in 1996 and to 145 t in 1997.

An estimation by the Department of Agriculture and Rural Development of Tay Ninh Province shows that present catch (300–500 t) in Dau Tieng Reservoir is less than 20% of the catch in the first year of impoundment. The contribution of stocked species to yields is changing from a low proportion in the few first years of reservoir life to a dominant portion (70–90%) in the 1970s to early 1980s. Breakdown of the restocking program in the late 1980s and early 1990s in most reservoirs has led to a reverse trend, when the yield of indigenous species has increased.

There is great variability in yield from reservoirs (Petr 1985, cited by De Silva 1987). In Vietnam, the lowest yield (11.1 kg/ha) is found in the large-size reservoir (Thac Ba, 19 000 ha); middle yield (Nui Coc, Cam Son, Suoi Hai and Dong Mo 34.8–48.1 kg/ha) is from the medium-size reservoirs (about 2000 ha and 1000 ha) and the highest yield (83.0 kg/ha) is from small-size reservoirs (Eakonia and Nui Mot).

Compared with neighbouring countries (De Silva 1987), the yields of reservoirs in Vietnam are quite low (Table 3). This is mainly caused by poor management, poor stocking strategy (see analysis below) and a low return rate. Compared with China, where return rate in small and medium reservoirs is over 10% (De Silva 1987), in Vietnam the rate is 5.0–10.0% for small, 5.3% for medium and 0.2–4.5% for large reservoirs (Nguyen HV 1994).

Management Practices

Yield management

Enhancement practices

Before the construction of any reservoir of around 1000 ha, the government built a fish hatchery to produce fingerlings for stocking the reservoirs. Even for some small-size reservoirs of 300–400 ha, hatcheries

Table 2. Changes in annual fish production in seven reservoirs (t).

Year	Cam Son 2300 ha	Thac Ba 19 000 ha	Nui Coc 2000 ha	Dong Mo 1100 ha	Suoi Hai 900 ha	Eakonia 260 ha	Nui Mot 600 ha
1972	54	82	—	—	57	—	—
1973	137	202	—	10	60	—	—
1974	255	420	—	45	33	—	—
1975	85	255	—	25	22	—	—
1976	134	290	—	80	70	—	—
1977	206	408	6	96	63	—	—
1978	62	250	47	81	—	—	—
1979	104	350	112	49	—	—	—
1980	60	360	95	40	17	—	15
1981	85	222	118	80	38	—	15
1982	47	136	110	60	43	—	20
1983	20	215	122	40	12	—	—
1984	9	175	100	—	—	—	—
1985	20	171	90	—	—	9	—
1986	36	166	95	—	—	25	—
1987	44	262	97	—	—	27	—
1988	37	250	56	—	—	24	40
1989	24	150	33	—	—	40	50
1990	47	50	12	—	—	17	105
1991	36	55	—	—	—	27	60
1992	7	80	—	—	—	32	65
1993	37	100	—	—	—	—	—

Note: data from Nguyen Huu Nghi.

were built for enhancement purposes as well as for seed supplies for neighbouring fish farmers.

During 1960–85, the central and provincial governments always provided strong support for the hatcheries to produce seed for restocking. The records of fingerling numbers for seven reservoirs are given in Table 4. The size of stocked fingerling range 3–12 cm. The dominant stocked species are silver carp and big head carp, which accounted for 70–80 % of the total stocking number. Common carp and later Indian carps (rohu and mrigal) were also stocked, with approximately 3% and 20–30%, respectively. Stocking density varied depending on the investment capacity of the fishery enterprises.

Table 3. Fish yields and areas of reservoirs in various Southeast Asian countries.

Country	Yield		Area (ha)	
	kg/ha	Total (t)	Min	Max
Bangladesh	46	2 682	58 300	
India	20 (5–100)	200 000	—	—
Indonesia	177 (22–353)	4 768	8300	22 000
P.R. China	150 (75–675)	206 434	75	567
Sri Lanka	283 (84–650)	27 000	650	830
Thailand	47	13 400	1200	41 000
Vietnam	20 (11–97)	26 160	260	19 000

Source: Sena S. De Silva.

There is a clear correlation between yield and the quality and quantity of stocked fingerlings. For example, for 1971–78, an annual stocking rate of 4 292 500 fingerlings of Chinese carps of 8–10 cm in Thac Ba resulted in an annual catch of 350–430 t. For the period 1979–89, annual stocking rate was 2 046 500 fingerlings of 3–4 cm. This resulted in an annual catch of 200–290 t. Since 1990 further reductions in stocking in the reservoir have led to very low yields. Similar situations are known for other reservoirs in Vietnam, such as Nui Coc and Suoi Hai. In the case of Nui Coc, the annual catch for 1978–83 was 100–120 t when about 400 000 fingerlings of 9–12 cm were stocked annually. A dramatic decline in catch in the reservoir has occurred since 1991 due to a considerable reduction in restocking.

Fishing

Before the early 1990s, fishing activity in all reservoirs was carried out by either the fishery cooperatives or government enterprises. All reservoirs either belonged to cooperatives or were enterprises owned by the central or provincial government. The government enterprise caught fish using trammel nets (Chinese style), set-impounding nets and fixed nets in front of the sluices. The common fishing method called joint fishing (Xu 1987) was adopted from China. This method combines the actions of blocking, driving, gill-netting

and filtering pelagic fishes. Its use gives a quite big catch even in those reservoirs having an improper preparation of fishing beds.

Since the middle of the 1990s when a decentralisation policy was adopted in the fishery sector, fishing activities have been given mainly to local enterprise or the private sector. Nguyen et al. (1993) noted eight fishing facilities used in reservoirs. Besides the three net types mentioned above, there are lighting leave-net, push-net, long-line hooks, combination net and trawl net. Some use is made of shrimp traps to catch freshwater shrimp (*Macrobrachium* sp.)

Fish culture

Cage-culture

In some medium and large reservoirs cage-culture is commonly practised. Cages may be constructed of bamboo or wood. Cage size differs depending on species cultured and farmer experience. In northern Vietnam, grass carp is the main species for a small bamboo cage of $2 \times 4 \times 1.5 \text{ m}^3$ to $3 \times 4 \times 2 \text{ m}^3$, while in southern Vietnam, sand goby, snakehead common carp and catfish are the main species. The number of grass carp cages in Thac Ba and Hoa Binh reservoirs is falling (only about 100 cages remain in operation), due to an outbreak of disease. In Tri An Reservoir,

the number of cages has rapidly increased over the last few years. In 1993 there were 185 cages; in 1997, 825, and total fish production from the cages reached 600 t.

Disease and water pollution are seen as potential dangers to cage culture in Tri An Reservoir. Presently, ACIAR is funding a project on nursing carp fingerlings in nylon cages in Thac Ba and Nui Coc reservoirs. Experimental results on nursing fingerlings of common carp, grass carp and rohu illustrate the perspective of new technology of cage culture in sizeable reservoirs.

Cove-culture and other forms of aquaculture

In some reservoirs, households fence coves for nursing and growing-out fish. This practice seems common in many countries, such as China, Israel and Sri Lanka (Beveridge and Phillips 1987). In many reservoirs in Vietnam, households dam coves and farm ponds within the reservoir for fish culture. This aquaculture type is practised in big reservoirs with diverse bottom topology. Although information on the technical parameters and yields is unavailable in Vietnam, it is considered an appropriate technology for those households living around the reservoirs.

In small-size reservoirs, households use them as ponds for extensive or semi-intensive culture purposes. Usually households stock the reservoir and

Table 4. Annual stocking (in million fingerlings) in selected reservoirs for which data are available.

Year	Cam Son 2300 ha	Thac Ba 19 000 ha	Nui Coc 2000 ha	Dong Mo 1100 ha	Suoi Hai 900 ha	Eakonia 260 ha	Nui Mot 600 ha
1972	2.8	4	—	1.53	57	—	—
1973	2.6	6	—	0.68	—	—	—
1974	2.2	3.2	—	1.4	—	—	—
1975	5.8	5.9	—	1.45	—	—	—
1976	12	0.84	—	1	—	—	—
1977	11	5.4	1.44	1.52	—	—	—
1978	12	5	1.88	1.74	—	—	—
1979	1	2.53	1.9	0.24	—	—	—
1980	1.12	6	0.93	0.83	—	—	—
1981	1	—	2.2	—	—	—	—
1982	1.08	—	2.9	—	—	—	—
1983	1	5	2.5	—	—	—	—
1984	0.68	6	2	—	—	0.06	—
1985	0.99	6	1	—	—	0.15	—
1986	0.45	6	0.65	—	—	2	—
1987	0.5	5	0.36	—	—	0.25	—
1988	1	—	0.33	—	—	0.25	—
1989	1.5	4.4	0.36	—	—	0.3	0.7
1990	0.5	—	0.15	—	—	0.3	0.9
1991	0.5	—	—	—	—	0.42	0.6
1992	0.11	—	—	—	—	0.38	1.2
1993	0.005	—	—	—	—	0.38	—

harvest fish using nets, and at the end of the year, when water is not required, the reservoir is emptied for a complete harvest. Such small reservoirs are considered as ponds although these are used for water supply to irrigate small areas of paddies.

Ownership and administrative management of reservoir fisheries

Ownership of reservoir fisheries changes over time and by region. There is a government fishery enterprise in each reservoir of medium and large size, responsible for running the hatchery and producing seed for stocking the reservoir, as well as capturing fish. Distribution of captured fish is the responsibility of the trade enterprise in collaboration with the fishery enterprise. In fact, the enterprise is oriented more to production than management. Central Fishery Department (independently) or later Inland Fisheries Department under the Central Agriculture Committee was made responsible for overall management and planning of these reservoir fishery activities.

In the smaller sized reservoirs owned by cooperatives, the cooperatives were responsible for all activities including restocking and harvesting.

There was no strong link between different stakeholders; for example, irrigation users or industry had no connection with fisheries people.

Since the mid-1990s, the production role of fishery enterprises has either been reduced or completely changed towards resource management. The main reason is that the government was unable to provide funding support to cover production activities, including staff salary and production costs.

Government line management

(i) Provincial fishery enterprise of the reservoir is still responsible for enhancement of fishery production by restocking fingerlings to reservoir and harvesting. This is the old scheme of operation. An example can be seen in Tri An Reservoir, in Dong Nai Province. The advantage of this management pattern is that the enterprise officially owns the fish resources. Production plan is initiated by the enterprise depending on its investment capacity, availability of financial resources and marketing. Its disadvantage is controlling illegal fishing. This is one of the biggest social issues in reservoir fisheries. In fact, during reservoir construction some local inhabitants are displaced. The displaced population often resettles around reservoirs to earn a living. Although government has granted necessary facilities and subsidies to sustain their livelihoods, nevertheless a living is

still needed from fishing. Property-sharing in fishery resources between government ownership and the private sector seems to be in conflict.

- (ii) Enterprise of Water Supply for Agriculture. An example of this can be seen in Ba Khoang Reservoir, Lai Chau Province. A unit under the enterprise is responsible for running all activities relating to fisheries including stocking, capturing and marketing. The conflict situation between the displaced population and enterprise in using fishery resources is a serious issue, while a similar conflict between irrigation and fisheries has disappeared.
- (iii) Reservoir Fishery enterprise in Nui Coc Reservoir, under the provincial Department of Agriculture and Rural Development. The enterprise sells licences to the fishers depending on their fishing facilities. This income pays for staff salaries, running costs, and taxes, and purchasing fingerlings for restocking. This way, the enterprise acts for the benefit of the surrounding population whose lives depend on fishery resources in the reservoir. However, there is still potential conflict between different water users, especially between tourists and fishers and irrigation. Controlling illegal fishing remains an issue.
- (iv) Fishery Centre in Yen Bai province. This is one of the biggest reservoirs in Vietnam. The centre has wide responsibility for aquaculture and fisheries development in the whole Province. Relating to reservoir fisheries, the centre is responsible for: a) restocking (funding from the provincial government); b) navigation registry of fishing boats at a fee; c) overall control of fishing activities; and d) extension services for the aquaculture households. Meantime, commune authorities are authorised to collect fishing fees from fishers living in the commune, depending on their fishing facilities. A part of the income is given to the community and a part to the provincial government in the form of tax. In turn, the provincial government will fund the centre to cover staff salaries, restocking, and other extension activities. This way, the role of the centre is more oriented to management and administration.

Cooperative line management

This management approach is seen in small reservoirs where individual households are unable to invest and the reservoir is owned by a cooperative. A group of members form a small production unit

responsible for running the business, including stocking of fingerlings, harvesting and marketing table-fish. The members of the group work together to decide investment and planning, and to share responsibility and income. Usually under this management system, fish production is much greater compared with medium and large reservoirs, due to higher investment in stocking.

Private sector line management

There are a number of very small reservoirs owned by individual households. In many cases, the households also get a mid-term contract to use the communal reservoir for fish culture. In both, the reservoir is considered as a big pond, and the households culture fish based on their investment capacity and experience.

Policy Constraints

The central government is expected to improve the situation of reservoir fisheries, clearly stated in the 10-year development plan, in which the Ministry of Fisheries expects to get from the reservoirs about 50 000 t fish by the year 2010. However, to date, no clear policies and strategies on reservoir fisheries have been issued. Nor has an action plan been initiated.

Human resources in the field of reservoir fisheries are inadequate. Obviously, reservoir fisheries cover a broad front of environmental, social, biological and technological fields. Certainly there is a challenge for development, but also the issue of human capacity to undertake research and development responsibility remains inadequately addressed.

The last point is the rational structure of reservoir fisheries. There is no doubt that decentralised policies of management are reasonable. But the differences in organisation structure between provinces affect the implementation of appropriate management practices.

Acknowledgment

The authors would like to express sincere thanks to Professor Sena De Silva for his full support and encouragement. They would also like to express great gratitude to the Australian Centre for International Agriculture Research (ACIAR) for its financial support to survey reservoir fisheries and for

participation in this workshop. Lastly, the authors acknowledge the Research Institute for Aquaculture –1 and Scientific Committee for their comments on this paper, as well as Mr Nguyen Van Tu for information on the reservoirs of Southern Vietnam.

References

- Beveridge M. and Phillips M. 1987. Aquaculture in reservoirs. Reservoir Fishery Management and Development in Asia. Proceedings of Workshop. Kathmandu, Nepal 23–28 Nov. 1987, 234–243.
- De Silva, S. 1987. The reservoir fisheries of Asia. Reservoir Fishery Management and Development in Asia. Proceedings of Workshop, Kathmandu, Nepal 23–28 Nov. 1987, 19–28.
- Luu Le Thanh, 1994. Inland fisheries in Vietnam under environmental constraints. Country Report at the sixth session of IPFC Working Party of Experts on Inland Fisheries, Bangkok, Thailand 17–21 Oct. 1994, 185–192.
- Ngo Sy Van, 1999. Status of fish fauna of Thacba Reservoir. Abstract of MSc. thesis, Hanoi, 1999.
- Nguyen Chu Hoi, 1999. Overview environmental situations of rural, mountain and coastal areas in Vietnam. Proceedings of the National Environmental Conference 1998. Ministry of Science Technology and Environment. Hanoi, 1999. 204–210.
- Nguyen Dinh Trong, 1994. Reservoirs in Vietnam: present status and the scientific problems to be considered in the future. Report from the National Workshop on Integrated Management of Reservoirs in Vietnam, Hanoi 5–6 Oct., 1994, 23 p.
- Nguyen Van Hao, 1994. Fishery development in the reservoirs of Vietnam. Report from the National Workshop on Integrated Management of Reservoirs in Vietnam, Hanoi 5–6 Oct. 1994, 20 p.
- 1995. Environmental aspects and aquatic resources in reservoirs of Vietnam. Proceedings of the National Workshop on Environment and Aquaculture Development. Hai Phong, Vietnam, 17–19 May 1994, 42–431.
- Nguyen Van Hao, Pham Xuan Am, and Nguyen Huu Nghi, 1995. Results of survey on reservoir fishery status. Institution Report. 42 p.
- Nguyen Van Lam, 1994. Development trend of fisheries in Thac Ba Reservoir. Report of the Second Workshop on Reservoir Fisheries in Vietnam, 64–70.
- Tuan Vu Van, 1999. Environmental impact assessment of Hoa Binh Reservoir. Proceedings of the National Environmental Conference 1998. Ministry of Science Technology and Environment, Hanoi, 1999, 486–508.
- Xu Senlin, 1987. Fishing techniques in Chinese reservoirs. Reservoir Fishery Management and Development in Asia. Proceedings of Workshop. Kathmandu, Nepal 23–28 Nov. 1987, 169–175.

Status and Potential of Reservoir Fisheries in Dak Lak Province, Vietnam

Phan Dinh Phuc and J.D. Sollows*

Abstract

Dak Lak is the largest of the four provinces in the Central Highlands of Vietnam (19 535 km², and elevation of 515 m). It has a population of 1.75 million in its 17 districts and one city. Dak Lak has an estimated 377 reservoirs (about 6900 ha), constructed mainly for irrigation. Most reservoirs were stocked with fingerlings but only a few have had a good recovery. With good monitoring and annual stocking, fish yields can range 350–700 kg/ha in reservoirs of 10–300 ha. Yields can reach 1000 kg/ha in reservoirs of less than 10 ha. Fish yields from unstocked reservoirs range 30–230 kg/ha. Reservoir fisheries are managed by: a) State agencies; b) State agencies cooperating with other economic units; c) local government (commune, district); and d) individuals or groups. Dak Lak has five hatcheries, which produce 253 million fry annually. Most are shipped south for nursing near Ho Chi Minh City and the Mekong Delta because of a local lack of modern equipment and nursery area. Annually, 22 t of fingerlings (16 million) are produced locally and another 67 t (53 million) are transferred back to Dak Lak for stocking in reservoirs and/or ponds. In Dak Lak, about 4000 t of fish a year are produced, which supplies only 3.3 kg/person. Given an average national fish consumption of 15 kg/yr it is not enough, so the province depends on a large quantity of marine fish. Problems faced by reservoir fisheries in Dak Lak include lack of appropriate management, reliable fingerling supply, and capital for hatcheries and stocking. To develop the potential of reservoir fisheries, a comprehensive fisheries strategy is needed, one which includes the development of reservoir fisheries.

DAK LAK is the largest of the provinces of the Central Highlands of Vietnam. The population of the province grew from about 350 000 in 1975 to about 1.2 million in 1994. Current estimates put it at about 1.5 million. Much of this increase is due to immigration from the north. Soils in most of the province are very fertile, and agriculture is expanding rapidly. Coffee has been a particularly lucrative crop. In 1979, about 18 000 ha were under coffee; an estimate by Dak Lak Department of Agriculture and Rural Development in early 1999 put the area at 175 000 ha.

Fish is the most important, and lowest-cost, source of animal protein for the residents of the Central

Highlands. Good estimates of local production are not available, but the best recent guess is that about 4000 t are harvested annually. This is far too little for local demand, and imports of marine fish make up the bulk of fish marketed in the province.

Expansion of the irrigated area in the province depends largely on irrigation, of which reservoirs are a major source. Reservoir construction is continuing, in response to the growing demand for water for crops. This water area can usually be used secondarily for fisheries.

The project 'Management of Reservoir Fisheries' has worked in Dak Lak since 1996, with an ultimate objective of 'sustained, high yields of fish achieved from reservoirs managed under local community agreement with government'. Work during the initial phase of the project included intensive surveys of six water bodies in the province. This, combined with other information collected, has given some indication of the potential of and constraints to the development of reservoir fisheries in the area.

*Management of Reservoir Fisheries Project, 68 Le Hong Phong Street, Buon Me Thuot City, Vietnam. E-mail: johns@netnam2.org.vn

Reservoir resource

An accurate estimate of the reservoir area in Dak Lak province is not available. The provincial Department of Agriculture and Rural Development estimates the total area under reservoirs at 8500 ha, but that includes a number of stream and river barrages and other water bodies. Scrutiny of data provided by the Irrigation Department (1998) suggests that there are 377 reservoirs in the province with a total area of about 6900 ha. Based on fisheries considerations, the reservoirs can be classified in four size ranges: 0–10 ha, 10.1–50 ha, 50.1–200 ha, and larger than 200 ha. Figure 1 indicates the number of each size range of reservoir.

Reservoirs of less than 10 ha make up 24% of the total area; reservoirs between 10.1 and 50 ha account for 36% of the total. Reservoirs between 50.1 and 200 ha occupy 28% of the area, and the largest reservoirs, larger than 200 ha, cover only 13% of the total reservoir area.

Most reservoirs in Dak Lak province were built for irrigation purposes, and only a few for hydro-electricity. Irrigation reservoirs are managed by an irrigation company, communes, villages, State farms, or army agencies. Reservoir fisheries are not always managed by the same agencies that manage the reservoir's irrigation system. Most reservoirs are stocked and used for fisheries, but to date only some attempts have been cost effective.

Reservoir construction is expected to continue in response to the demands of a rapidly growing population.

Reservoir Fisheries

Types of reservoir fisheries

Our project investigated yields from six water bodies in Dak Lak province. In Ho 31, fish were harvested once a year, and the entire yield was censused. In the other three stocked water bodies (Table 1), commercial catches were landed at predetermined sites, and yield was estimated by census taken on a set number of days per month. In the two unstocked water bodies, where access was more or less open, it was not possible to census yield, since there were many fishers and landing sites. Estimates had to be made on the basis of frame surveys (which censused all gear around the water body), effort surveys (which gave an estimate of the proportion of the gear used on a number of sample days), and catch surveys (which give catch and effort for a small sample of fishers over a set number of sampling days).

Subsistence yields were underestimated by this method, since fish landed for home consumption were not always brought to regular landing sites. Some of these catches were included in the estimates, but total yields are probably underestimated by about 5%.

Based on fish production, reservoir fisheries can be classified into three types: a) those in which self-recruiting fish predominate; b) those in which fish production is mainly dependent on stocked species; and c) those in which both stocked and self-recruited fish are important.

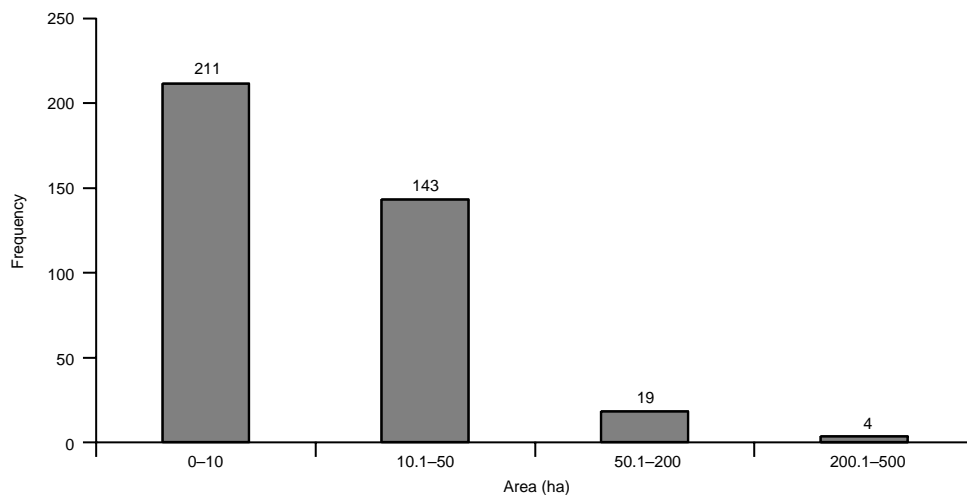

Figure 1. Frequency of reservoirs by area range in Dak Lak.

Table 1 compares fish production from various reservoirs in Dak Lak.

Note that yields from the stocked reservoirs are considerably higher than those from the two unstocked water bodies.

Predominantly self-recruiting

In this case, fish production is based mainly on indigenous and introduced species that can be recruited naturally in the reservoirs. These reservoirs normally are not stocked. Yields often include some escapees from ponds (in the vicinity or reservoirs) and cages, such as silver carp, bighead carp, tilapia, Indian carp, and common carp, but their yield is low to negligible. The fish production of these reservoirs is usually low, about 10–230 kg/ha/yr. Table 1 indicates that the percentages of self-recruiting fish yield in Ea Soup and Lak are 98% and 97% of the totals, respectively.

Predominantly stocked

This type of reservoir is stocked regularly. Fish production is based on stocking because recruitment from natural fish reproduction in the reservoir is negligible, the self-recruiting fish fauna neither abundant nor diverse. Reservoirs of this type are typically fewer than 50 ha in area.

In such reservoirs, fish yields would be negligible in the absence of stocking. In Ea Kar and Ho 31, the yields of stocked fish contribute 98% and 99% to the respective totals (Table 1).

Self-recruiting and stocking combined

Production of both stocked and self-recruiting fish are important in these reservoirs. The reservoirs are stocked annually or frequently. Indigenous species and some exotic self-recruiting species, such as common carp and tilapia, are also represented. In Dak Lak Province, most of the larger reservoirs are of this type, but only in some reservoirs do combined stocked and self-recruiting fish achieve sustained

high production. In some deeper reservoirs, recapture of stocked fish proves difficult; they remain an important part of the fish biomass in the reservoir for many years, even after stocking efforts stop. Table 1 illustrates that Ea Kao (Phan and De Silva 2000) and Yang Re were classified as this type, with respective contributions of stocked fish to total yield of 78% and 87%.

Seed supply

Given the importance of stocking in most reservoirs in the province, seed fish supply is an important issue.

Fry supply

In Dak Lak now, four major hatcheries and a smaller one supply fry for nursing to fingerling size in Dak Lak and export to Ho Chi Minh City and the Mekong delta. Two belong to Dak Lak Aquatic Products Company. Given its elevation, relatively low temperatures and existing facilities, Dak Lak is capable of producing great quantities of fry. However, the number produced depends on the market demand. From 1995 to 1999, the average number of fry produced annually was 253 million.

The main period for producing fry is January to July annually. The major species produced are grass carp, silver carp, bighead carp, common carp and Indian carp.

In recent years, 70–80% of the fry have been shipped south because it is more economical than selling locally or nursing to fingerling size in Dak Lak. These exports have increased recently because of improvements to the road system. Some experienced culturists have pointed out that nursing fry to fingerling size in Dak Lak leads to poorer growth than near Ho Chi Minh City, so the price of the same-sized fingerling produced in Dak Lak is higher than in Ho Chi Minh City.

There are three possible reasons why fingerlings grow more slowly in this area. The temperature is

Table 1. Fish yield from some reservoirs and lakes in Dak Lak province, August 1997–July 1999.

Name	Area (ha)	Stocking history	Yield (kg/ha/yr)	Contribution of stocked fish to total fish yield (%)
Ea Kao	210	Stocked regularly from 1986	734	78
Ea Kar	141	Stocked regularly from 1978	454	98
Yang Re	56	Stocked 1985–87, 1992–1997	566	87
Ho 31	5	Stocked regularly from 1984	1307	99
Ea Soup	240	Unstocked	217	2
Lak*	658	Unstocked	126	3

* Lak is a natural lake, not a reservoir.

low early in the season, local soil conditions allow limited production of natural food, and the area for nursing is limited, due in part to competition from other activities, notably coffee-farming.

Fingerling supply

Fingerlings for aquaculture activities in Dak Lak are supplied from nurseries in Dak Lak and near Ho Chi Minh City.

Nurseries in Dak Lak tend to be near the hatcheries. The total area of nursery ponds in the province is about 39 ha, and supplies about 22 tons of fingerling of 0.8–2 g. Species composition of the supply of fry and fingerlings is somewhat similar, but grass carp account for 70% of the total fingerling supply used in the province. Most are stocked in ponds. Silver carp are a relatively more important proportion of the fry produced.

Sixty to seventy t of fingerlings are imported from Ho Chi Minh City to Dak Lak annually, including simple purchases and exchanges for fry. The major species shipped back are grass carp, silver carp, bighead carp, common carp, Indian carp, *Clarias gareipinnus* and hybrid *Clarias*. The long distance tends to weaken the fish and has carried disease from other places to Dak Lak.

Management considerations

Management of fisheries in the reservoirs

After impoundment, reservoir management can be separated into two components: irrigation and fisheries. In this region, most reservoir fisheries are managed by four kinds of agency: a) State agencies; b) State agencies cooperating with other economic units; c) local government (commune, district); and d) individuals or groups.

The State agencies that monitor reservoir fisheries in Dak Lak include the Fisheries Company, State farms, veterans' associations, and the Army. They stock fingerlings and collect tax from fishers. Nowadays, many reservoirs directly managed by State agencies do not achieve good production and income. So some State agencies cooperate with other agencies, individuals and groups to manage the fisheries. Contracting and subcontracting are common.

The reservoirs which belong to local government are of two kinds:

1. Direct management by local government—the local authority, or its representative such as a cooperative, is in charge of managing the fishery. The concerned organisation is responsible for all expenses, management decisions, and arrangements related to harvesting, sales, and disposal of the catch.

2. Nominal management—in some cases, local authorities are in a position only to make fishery regulations, and may enforce those to a varying degree. Taxation of fish catches may or may not be possible.

Private individuals and groups also often take out contracts of varying duration and values with the agencies originally designated to manage fisheries in a particular reservoir. This is often highly effective economically, but other users of the reservoir risk being marginalised, if safeguards are not in place.

Aquaculture activities in the reservoirs

The main aquaculture activities in the reservoirs of the province consist of stocking and cage-fish culture.

Fingerlings are usually stocked in the reservoirs from April to June, at the beginning of the rainy season. Sometimes reservoirs are stocked later, particularly if the onset of the rains is delayed. The major species stocked include silver carp, bighead carp, grass carp, common carp and Indian carp, of which, silver carp and bighead carp are the most important. Following the data from four reservoirs regularly stocked since 1996, silver carp accounted for about 40–90% of the fingerlings stocked. Their size is very variable, usually about 0.8–2.5 g for silver carp and bighead carp. Stocking densities range 3000–12 500 fingerling per ha. In Dak Lak, most reservoirs were built over 10 years ago, so the natural feed for fish has declined from its initial peak. However, stocking densities are not changed accordingly, so fish growth and the economics of the operations are not thought to be affected.

Cage culture of fish has been practised in Vietnam for many years, but started in Dak Lak Province only in 1993 in Ea Soup reservoir. The number of cages in the reservoir increased rapidly (157 cages) but declined in 1996 due to outbreaks of grass carp disease. Currently, only four cages are being operated. Grass carp is still the main species cultured.

Other attempts have been made in Ea Kao, Ea Knop, and Lak Lake, but none continued (Phillips 1998). In Ea Kao, feeding the grass carp demanded too much labour. In Ea Knop, disease broke out, possibly due to pollution from a nearby sugar mill, and the cost of the cages could not be justified, given modest returns. In Lak, cage fish had disease problems, probably because of poor water circulation.

Given its success rate to date, cage culture seems to have limited potential in the Central Highlands.

Fish exploitation and fish production

Fish exploitation is very important in reservoir fisheries. In Dak Lak Province, the major gear used includes gill-nets, lift-nets, lighted lift-nets, integrated

nets, cast-nets, long-lines, and seines. Traps, fence-nets, rod and lines, and spear are less important. Gill-nets and lift-nets account for most of the yield. Table 2 illustrates catch by gear type of three reservoirs in Dak Lak province.

The relative importance of yields from lift-nets and the integrated net increased and decreased respectively, mainly because of changes in the effort levels of these gears. In Yang Re, no fish were stocked in 1996, so silver and bighead carp were less important in 1997–98 than in the following year. The great increase in the importance of lift-net yields reflects this point.

The integrated net is a very efficient gear which originated in China, but it can be utilised only under certain conditions: a) the area of reservoir must be over 100 ha, b) a large area without submerged trees is necessary, c) it is effective only for silver and bighead carp, and d) the net is very expensive, about VND 25 million per net. As a result, it is not common in Vietnam. In the Central Highlands, only one reservoir in Dak Lak regularly uses the integrated net. Gill-nets and lift-nets are considerably more popular, but the gear could be very helpful in the deeper reservoirs which have been stocked with silver and bighead carp. These species, if stocked in sufficient numbers, make major contributions to the fish production of the reservoir because they are plankton-feeders. Lift-nets, another highly effective gear, cannot be set in deep water, and gill-nets catch those species, but less effectively. Buon Triet Reservoir, Lak District, is a case in point.

Another case is illustrated by the use of dynamo-powered electrofishing in Yang Re Reservoir for three months in 1999. A number of species including grass carp, common carp, snakehead and ca lui (*Osteochilus hasselti*) were four to eight times more vulnerable to that gear than to the other normally used. While dynamo-powered electrofishing itself is not normally a recommended method of exploiting fish, it illustrates that some species, particularly stocked ones, were under-exploited.

Many reservoirs in Dak Lak were built in forested areas. When a dam is built, only some trees are

cleared, so many trees can be submerged after impoundment. This may be beneficial for fish production, but damages and obstructs many gears, and limits the choice of gear to be used (De Silva 1988).

Fish production from the reservoirs of Dak Lak ranges widely, and includes the highest yields per hectare in Vietnam [on comparison with results from Hao et al. 1994, Tuong (unpublished) and Luu (unpublished)].

There are many reasons for these differences, including reservoir size and morphology, nature of fish stocks, type of management, environmental factors, and exploitation techniques.

Large reservoirs tend to have lower production per unit area than smaller ones, since they have a lower perimeter to area ratio. Reservoirs with longer shorelines (many coves and bays) will tend to have higher productivity than those with relatively simple shorelines, for the same reason. Yields from very deep reservoirs tend to be lower than for shallower ones not only because stratification of water can limit surface nutrients, but also because fish harvest is more difficult.

Fish species which feed on plankton and plant material tend to have higher potential productivity than carnivorous fish. Plankton feeders can reach particularly high production because planktonic organisms reproduce very rapidly, so depletion of food rarely occurs.

Prudent management will aim for the highest sustainable yield from the reservoirs, taking into consideration whether or not to stock, the appropriate type and number of gears, the number of fishers who can participate, and the need for seasonal and spatial restrictions to fishing effort.

The productivity of a reservoir depends upon its ecology and that of its catchment area. Siltation and pollution can reduce fish production. Reservoirs and/or catchment areas in rich soils will tend to have higher production, as will reservoirs with larger catchment areas. A diverse fish fauna will tend to have more stable yields than a depauperate one.

The high yields from many reservoirs in Dak Lak may be a reflection both of their size (small to

Table 2. Relative contribution of main gear types to total catch of some reservoirs 1997–99.

Gear	Ea Kao		Yang Re		Ea Kar	
	1997–98	1998–99	1997–98	1998–99	1997–98	1998–99
Lift-nets	46.7	75.9	14.5	67.3	26.3	24.8
Integrated	26.5	5.9				
Gill-nets	15.5	16.3	81.7	28.0	73.7	72.7
Other	11.3	2.0	3.8	3.9	0	2.5

medium), and the rich soil of most. Stocking, predominantly with plankton-feeders, allows this potential to be exploited, in many cases, and the low number of predators leads to relatively high recapture rates, particularly for silver carp.

Marketing

The Central Highlands is the third-poorest region of Vietnam's seven regions so many people have inadequate protein nutrition. In Dak Lak, about 4000 t of fish a year are produced, which supplies only 3.3 kg/person. Given an average national fish consumption of 15 kg/year, it is not enough, so the province depends on a large quantity of marine fish. So, the market for fish produced in Dak Lak is very large, including all the districts in the province and neighbouring landlocked areas.

Yield potential

Based on the surveys of the project, 15 complete years of harvest data are now available for the six water bodies. On the basis of recorded reservoir areas and fish yields, the following regression equation best fits the data:

$$P = -176.84 \ln(A) + 1334.6 \quad (1)$$

where P = Annual fish yield per ha, and
A = Reservoir area in ha.

On the basis of data given earlier, the following table can be constructed.

Table 3. Estimated yield from Dak Lak reservoirs on the basis of reservoir area.

Reservoir size (ha)	Frequency	Total estimated area (ha)	Mean area (ha)	Total annual production potential (t)
<10	211	1656	7.85	1607
10.1–50	143	2484	17.4	2060
50.1–200	19	1932	102	998
200.1–500	4	897	224	339
Total	377	6969	18.5	5004

This implies that about 5000 t of fish could be produced from reservoirs in Dak Lak. Of this, about 40% would come from reservoirs in the 10–50 ha size range, and slightly over 30% of the total from reservoirs under 10 ha. A further 20% of the production could come from reservoirs between 50 and 200 ha, and the largest reservoirs of 200–500 ha would contribute only about 7%.

The 4000 t estimate of fresh water fish production for Dak Lak given earlier may well be an underestimate. A 1997 estimate by Dak Lak Aquatic Products Company suggests that about 70% of that

comes from ponds. On this basis, there is considerable room for increasing fish yields from reservoirs in the province.

Ultimately, yield potential is reservoir-specific, and the projection is valid only if the sample of six reservoirs studied by the project is representative of the potential of all reservoirs in the province.

Other issues

For stocking to be successful, a strong, effective management system is needed. The individual or group that is responsible for stocking must recover the investment, if stocking is to continue. In most cases, therefore, management of stocked reservoirs is highly centralised and distribution of benefits from the fisheries is often highly skewed.

Good management systems are also advisable for unstocked reservoirs, if stocks are to withstand the pressures of a growing population.

Access to the fishery by those dependent on the reservoir is also necessary in order to sustain their livelihoods. Economic and nutritional needs of the reservoir-dependent community need to be balanced against the need to maximise production and economic output. A decentralised management setup, broadly representative of the community dependent on the fishery and given a clear mandate and a well-defined term of sufficient length, could also succeed, and needs to be tested.

Recommendations and Conclusions

Research needs

In reservoir fisheries, environment is crucial to fish production. Limnological parameters can limit fish yields, and pollution and toxic chemicals can lead to fish kills or make fish unsafe for human consumption. Through related studies, managers can assess the natural food situation, as well as hazards, and make decisions regarding fisheries. In Dak Lak, few studies of these aspects have been conducted, except some occasional studies from Fisheries University.

As De Silva and Amarsinghe (1996) point out, empirical models for predicting fish yields in reservoirs could be considered as the first step toward the adoption of a more scientific approach to management. In Vietnam, models for predicting fish yield have never been applied. Therefore, available models should be applied, or appropriate models for predicting fish yield developed.

In Vietnam, surveys of reservoir areas are very difficult, because irrigation departments are interested mainly in the volume of reservoirs; area is rarely measured and data are inconsistent. It will be very convenient if geographical information systems

(GIS) can be utilised to estimate areas of reservoirs and lakes.

The reservoir fisheries in Dak Lak depend on a very limited number of species, most of which are regularly stocked or naturally recruited cyprinids. The biology of some exotic species is well known, but there is little information regarding native species. Further studies are needed on mean size and age at first maturity, fecundity, growth rate, spawning season, and spawning area for specific reservoirs. Such studies should also include gear selectivity with each important species. This knowledge will help managers make appropriate fishery regulations.

As indicated earlier, stocking is popular in Dak Lak reservoirs, but in most cases could be made more effective. Its effectiveness is influenced by many factors, including stocking size, stocking density, quality of fingerlings, nature of existing fish stocks and limnological characteristics. Data are sometimes not available to assess stocking effectiveness because the managers do not always record. In future, longer-term accurate data series are needed from reservoir fisheries to predict appropriate stocking densities and sizes.

The management system of reservoirs, including fisheries and irrigation, is very complicated. Currently in Dak Lak, some reservoirs not only achieve very high fish yield but also get good income from fisheries. But these systems do not share responsibilities for managing the reservoir with, and distribute benefits equitably to, the fishing communities. Addressing this issue will be a major task of the project 'Management of Reservoir Fisheries.'

Expertise in reservoir fisheries is being developed; however, in the long term, Vietnam has very limited resources to sustain such research. Should another fisheries project unrelated to reservoirs appear on the horizon, staff trained in reservoir fisheries may well be assigned to it, should they be the most suitable. This further puts the sustainability of research programs into question.

Conclusion

Irrigation is the main use of reservoirs in Dak Lak. After impoundment, most reservoirs are stocked, but

only some achieve high production and good income.

The potential of reservoir fisheries is high, considering potential area, seed and fingerling supply, and market. Some limitations affecting the fisheries include limited appropriate gear, high stocking densities, low stocking sizes, variable fingerling quality, and management system issues, mainly related to distribution of benefits from the fishery. Stocking can increase fish yield and economic output in many reservoirs.

The need for increased output should be balanced against the needs of the local community.

Most reservoirs were built more than 10 years ago, so the natural feed for fish has declined from its initial peak. Stocking densities should be considered in this light.

References

- De Silva, S.S. 1988. Reservoir bed preparation in relation to fisheries development. In: De Silva, S.S. ed. *Reservoir Fishery Management and Development in Asia*, 121–130 IDRC, Ottawa, Canada.
- De Silva, S.S. and Amarsinghe, U.S. 1996. Reservoir Fisheries in Asia. In: De Silva, S.S. ed. *Perspectives in Asian Fisheries, a Volume to Commemorate the 10th Anniversary of the Asian Fisheries Society*. Asian Fisheries Society, Manila, 497 p.
- Nguyen Van Hao, Nguyen Huu Nghi, Pham Xuan Am. 1994. Ket qua dieu tra hien trang nghe ca ho chua vung khu V-Tay Nguyen. In: *The Second Workshop on Reservoir fisheries in Vietnam*. Ha Bac Province: Ministry of Fisheries, 15–24.
- Nguyen Huu Tuong. Unpublished. Nghe ca ho chua va bien phap bao ve nguon loi thuy san. Lecture notes for training course in fish culture and reservoir fisheries. MRFP, Vietnam.
- Phan, P.D. and De Silva, S.S. 2000. The fishery of the Eal Kao reservoir, Southern Vietnam: a fishery based on a combination of stock and recapture, and self-recruiting populations. *Fisheries Management and Ecology*, 7: 251–264.
- Phillips, M. 1998. *Freshwater Cage Culture Development in the Reservoirs of the Central Highlands of Vietnam*. NACA, Bangkok, 120 p.
- Tran Truong Luu. Unpublished. Nguon loi thuy san trong cac ho chua nuoc Vietnam. Lecture notes for training course in Factors Affecting Fish Production in Reservoirs. MRFP, Vietnam.

Inventory of Reservoir Fishery Resources in Thailand

Cherdsak Virapat¹ and Niklas S. Mattson²

Abstract

Inland capture fisheries show an increasing trend from 1988 to 1995 with a 1995 value of 4601 million baht (about 127 million US dollars). About 872 000 labour households earned their living from both agriculture and inland fisheries. Among these, 47 000 households earned their living on inland fisheries only. More than 80% of the total households that rely on agriculture and/or inland fisheries are living in the Mekong River Basin. A database of physico-chemical parameters, fisheries statistics and fisheries management was assembled for 463 reservoirs with a total area of 5118 km² in 22 provinces in the Mekong River Basin of Thailand, based mainly on published reports. The primary use of these reservoirs can be classified as irrigation (302 reservoirs), domestic water supply (157), electricity generation (5) and fisheries (2). There were only 40 reservoirs where records were kept of fish catches. In 1996, the Thai Department of Fisheries (DOF) collected statistics of 27 799 inland waters in Thailand with surface areas ranging from 0.01 ha to 41 000 ha. The waters were categorised as reservoirs, public waters (communal reservoirs) and village fish ponds with the total numbers of 3241, 18 109 and 6449, respectively. The estimated total annual fish production of these inland waters was about 78 711 t. There were 1872 reservoirs located in the Mekong River Basin with a total surface area of 2120 km² and an estimated total fish catch of 25 428 t. Estimation of fish catch was not carried out for individual reservoirs, and it was not possible to analyse these two sources of data to check reliability of information, etc. It is suggested that DOF should plan to collect and record reservoir fisheries data on an individual water body basis.

INLAND capture fisheries in Thailand usually operate in major rivers and their floodplains, canals, swamps, wetlands, paddy fields, lakes and reservoirs. They are mainly subsistence, with small numbers of commercial fishers. Figure 1 shows the increase of the total inland capture fisheries from reservoirs, swamps, rivers and river flood plains as recorded by the Fisheries Statistics and Information Technology Sub-Division production from 1980 to 1995. It can be noted that production was maintained at about 100 000 t from 1980 to 1988. It then increased from 1989 to reach 200 000 Mt in 1994 and 1995.

Inland capture fisheries are based mainly on indigenous species (80–90%). Introduced species include tilapia and Indian carps (rohu and mrigal), and account for 10–20% of the catches. Fishing fleets include an equal share of motorised boats and unmotorised boats (3–5 m). Main gear types are few and unspecialised. The most common fishing gears are gill-nets, cast-nets, lift-nets, bamboo traps and hooks and lines.

There are about 18 000 commercial fishers who fish in 20 multi-purpose reservoirs. There were about 872 000 labour households of which 47 000 earned their living on inland fishing only, and 825 000 households that earned their living from both agriculture and inland fisheries. More than 80% of these households, i.e. almost 700 000, live in the Mekong River Basin (National Statistical Office 1995). Most catches are for local household consumption.

Due to the large number of reservoirs in Thailand it is necessary to establish an inventory of reservoir fishery resources in an integrated database system.

¹Chief, Small-holder Aquaculture and Fishery Management Research and Development, Fishery Engineering Division, Department of Fisheries, Phaholyothin Road, Chatuchak, Bangkok 10900, Thailand. E-mail: cvirapat@hotmail.com

²Management of Reservoir Fisheries in the Mekong Basin, Mekong River Commission, PO Box 7035, Vientiane, Lao PDR. E-mail: resfish@laonet.net

This paper analyses two major sources of data on reservoir fishery resources in the Mekong River Basin. Finally, some suggestions are given to improve the Thai Department of Fisheries database system of reservoir fishery resources.

Materials and Methods

Reservoir database

The data used in this study are from two sources:

(i) *Virapat et al. (1999)*

Data were compiled from reports of existing and planned dam and reservoir projects in Thailand in the Mekong Basin, available at the various government and provincial departments in Thailand, with the MRC Documentation Centre, and other sources. Data were entered in MS Excel. These include geographic coordinates of the reservoirs, status of project, dam specifications and functions, fisheries, socioeconomic status of the fisheries, former or present management activities (effort management, stocking, cage or pen culture, etc.), uses of the reservoir other than for fisheries, management authorities

responsible for the reservoir and reservoir fisheries management, reservoir morphology and physical and chemical status, and fisheries management issues. The data presented from this study include reservoirs larger than 100 ha. A list of fields for the reservoir database is given in Table 1.

(ii) *Statistics on Thai (not only Mekong Basin) reservoirs, public waters and village fish ponds by Fisheries Economic Division (1996).*

Results

(i) *Virapat et al. (1999)*

Most larger Thai Mekong Basin reservoirs are used for irrigation (299) and domestic water supply (156). There are very few reservoirs used primarily for fisheries (2) and hydro-electric generation (6). Most are state-owned (375), communally owned (82) and parastatals (6). There are no privately owned reservoirs. There were only 40 reservoirs where records were kept of fish catches. The total fish catch of these reservoirs was estimated at 26 794 mt. A total of 67 fish species was registered in 463 reservoirs. Data on physico-chemical parameters were very limited.

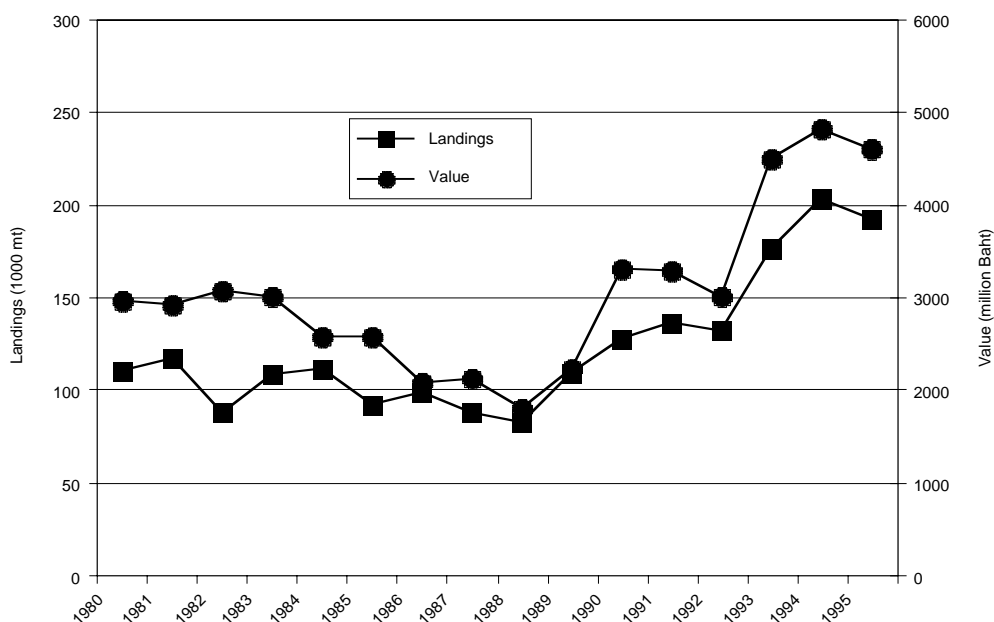

Figure 1. Annual production in quantity and value of inland capture fisheries from reservoirs, swamps, rivers and river floodplains of Thailand, 1980–95 (Fisheries Statistics and Information Technology Sub-Division).

Table 1. List of fields for reservoir database.

No.	Name	Description
1	ID	ID number
2	Name	Name of reservoir
3	Country	Name of country
4	Province	Name of province
5	District	Name of one or more districts associated with the water body
6	Coord North	Geographic coordinates North. Format: dd°mm′ss″ (example: 15°04′30″ N)
7	Coord East	Geographic coordinates East. Format: dd°mm′ss″ E (example: 102°10′45″ E)
8	Map	Scale, number and/or code of the map used
9	Village	Name of the nearest village(s) marked on the map, particularly smaller reservoirs
10	Town	Name, direction and distance to the closest major town (e.g. provincial capital)
11	Basin	Name of river basin (e.g. Mekong)
12	Primary use	The main use of the reservoir, coded as follows: 1 = Domestic water supply 2 = Irrigation 3 = Livestock watering 4 = Municipal water supply 5 = Industry 6 = Fishing 7 = Hydro-electricity generation 8 = Other main use
13	Domestic water supply	Water body used as domestic water supply (including main use, if relevant) (yes/no)
14	Irrigation	Water body used for irrigation (including main use, if relevant) (yes/no)
15	Livestock watering	Water body used for livestock watering (including main use, if relevant) (yes/no)
16	Municipal water supply	Water body used as municipal water supply (including main use, if relevant) (yes/no)
17	Industry	Water body used for industrial purposes (including main use, if relevant) (yes/no)
18	Fishing	Water body used for fishing (including main use, if relevant) (yes/no)
19	Hydro-electric	Water body used for hydropower generation (including main use, if relevant) (yes/no)
20	Owner	Name of (dominant) owner
21	Owner type	Type of owner (if more than one, the dominant owner), coded as follows: 1 = State 2 = Private 3 = Communal 4 = Parastatal 5 = Other
22	Capacity	Hydroelectric capacity, if applicable (MW)
23	Turbine	Turbine type, e.g. Kaplan (relevant for fish mortality when passing turbine during sown-stream migration, and also the level of the intake from the reservoir, which affects downstream water quality, e.g. oxygen concentration)
24	Irrigation Area	Area irrigated by reservoir, if applicable (ha)
25	Year	The year when the reservoir dam was closed, or when a prospective dam or a dam under construction is planned to be closed
26	Height	Dam wall height (m)
27	Length	Dam wall length (m)
28	Crest	The elevation of the dam crest above sea level (m, asl)
29	Out River	Name of the effluent river below the dam
30	Discharge	The average volume of water that flows out of the dam per year (10 ⁶ m ³)
31	NUSL	Normal Upper Storage Level. The elevation above sea level of the water surface when the reservoir is full (m, asl)
32	Area	The area of the reservoir at NUSL (km ²)
33	Vol	The volume of the reservoir at NUSL (m ³)
34	D-down	The mean maximum draw-down of the reservoir (m), i.e. mean of (NUSL-minimum elevation) (m)
35	M-Depth	The mean depth of the reservoir at NUSL (m)
36	Max-Depth	The maximum depth of the reservoir at NUSL (m)
37	Length	The length of the reservoir, measured as the longest straight line (km)
38	Width	The width of the reservoir, measured as the longest straight line perpendicular to the length (km)
39	Shoreline	The length of the shoreline, including shoreline of major islands (km)
40	In rivers	Name(s) of the affluent rivers (flowing into the reservoir)

Table 1. List of fields for reservoir database. (Continued)

41	Catchm	The area of the catchment (km ²)
42	Catchm rain	The average annual rainfall of the catchment (mm)
43	Affl inflow	The volume of water that flows into the reservoir annually (10 ⁶ m ³)
44	Temp-max	The mean maximum water temperature at the surface (°C)
45	Temp-min	The mean minimum water temperature at the surface (°C)
46	Transp	The mean Secchi disk transparency (m)
47	Cond	The mean conductivity of the water (µS/cm ³)
48	TDS	Total dissolved solids (mg/L)
49	MEI C	The Morphoedaphic Index = conductivity/mean depth
50	MEI T	The Morphoedaphic Index = TDS/mean depth
51	Alk	Alkalinity (mg/L)
52	Hard	Hardness (mg CaCO ₃ equiv./L)
53	pH	The pH
54	Na	Sodium (mg/L)
55	K	Potassium (mg/L)
56	Ca	Calcium (mg/L)
57	Mg	Magnesium (mg/L)
58	HCO ₃	Carbonate (mg/L)
59	Cl	Chloride (mg/L)
60	SO ₄	Sulphate (mg/L)
61	P205	Phosphorous (mg/L)
62	No ₃ -N	Nitrate nitrogen (mg/L)
63	Fish taxa	Presence of invertebrate taxa of direct interest for capture fisheries (e.g. <i>Macrobrachium</i>) (yes/no)
64	Fish pass	The presence of a fish pass, e.g. a fish ladder (yes/no)
65	Inv taxa	The mean annual catch over several years, after the reservoir stabilised (t)
66	Catch	The mean annual catch over several years, after the reservoir stabilised (t)
67	Stocked	Indicate whether the reservoir was ever stocked (yes/no)
68	Exotics	Indicate if exotic species (non-indigenous), stocked or otherwise introduced, have established self-maintaining populations in the reservoir (yes/no)
69	F-t fishers	Number of full-time fishers (fishing 16 days or more per month)
70	P-t fishers	Number of part-time fishers (fishing 1–15 days per month)
71	Traps	Number of traps (if present but number not known, set to 1)
72	Seines	Number of seine nets (if present but number not known, set to 1)
73	Gillnets	Number of gill-nets (if present but number not known, set to 1)
74	Long-Lines	Number of long-lines (if present but number not known set to 1)
75	Other gear	List other gear in use
76	Boats w. motor	Give total number of motorised boats or canoes
77	Boats w/o motor	Give total number of non-motorised boats or canoes
78	Manage	Indicate if local communities are involved in Natural Resource Management (e.g. fisheries, forestry or watershed management) (yes/no)
79	C-Policy	Indicate if local communities are involved in policy and/or decision-making (e.g. defining problems, setting long-term objectives, education, research) (yes/no)
80	G-Policy	Indicate if local government is involved in policy and/or decision-making (e.g. defining problems, setting long-term objectives, education, research) (yes/no)
81	C-Data	Indicate if communities are involved in data-gathering and/or analysis (yes/no)
82	G-Data	Indicate if government is involved in data-gathering and/or analysis (yes/no)
83	C-Access	Indicate if communities are involved in regulating access to the fishery (fishing seasons, fishing areas, gears and vessels) (yes/no)
84	G-Access	Indicate if government is involved in regulating access to the fishery (fishing seasons, fishing areas, gears and vessels) (yes/no)
85	C-Harvest	Indicate if communities are involved in regulating the harvest (through quotas) (yes/no)
86	G-Harvest	Indicate if government is involved in regulating the harvest (through quotas) (yes/no)
87	C-Enforce	Indicate if communities are involved in rule enforcement (yes/no)
88	G-Enforce	Indicate if government is involved in rule enforcement (yes/no)
89	C-Habitat	Indicate if communities are involved in habitat/resource protection and/or enhancement (including monitoring, stocking and resource use coordination) (yes/no)
90	G-Habitat	Indicate if government is involved in habitat/resource protection and/or enhancement (including monitoring, stocking and resource use coordination) (yes/no)
91	C-Benefit-max	Indicate if communities are involved in benefit maximisation (supply, quality, product diversification) (yes/no)

Table 1. List of fields for reservoir database. (Continued)

92	G-Benefit-max	Indicate if government is involved in benefit maximisation (supply, quality, product diversification) (yes/no)
93	Comments	Report any other information on the reservoir that may be relevant for fisheries management. [Requires Access: Where possible, please report source(s) of data on the reservoirs. Ideally, each data field should be linked to a reference table, preferably by indexing each entry with a number code].

Table 2. Number, total area and fish production per area and value of inland waters in Thailand in 1996 (Fisheries Economic Division, in press).

Category	Quantity	Area (ha)	Production (kg/ha)	(t)	Value (1000 Baht)
Reservoirs	3 241	432 176	83	35 818	1 043 811
Public Waters	18 109	185 527	199	36 843	1 073 691
Fish Ponds	6 449	22 163	273	6 050	176 311
Total	27 799	639 866	—	78 711	2 293 813

38 Baht = \$1 US.

(ii) *Fisheries Economic Division (1996)*

There were 27 799 waters classified as reservoirs (3241), public waters or communal reservoirs (18 109) and village fish ponds (6449), with a total area of 639 866 ha and a total fish production of 78 710.92 Mt as shown in Table 2. There were 1872 reservoirs located in the Mekong River Basin with a total surface area of 2120 km² and an estimated total fish catch of 25 428 t. There was a total of 43 fish species registered from these reservoirs. The statistical records were reported by 70 Provincial Fisheries Offices and were checked for accuracy by statisticians from the Fisheries Economic Division. About 10% of the data were resampled for verification.

Discussion

Planning of fisheries management should be carried out with good data and information. Most reservoir fisheries data obtained by Virapat et al. (1999) were dispersed and not well-documented in the literature.

Many reports were obsolete and did not provide adequate information on fisheries and limnology necessary for assessment of the situation. Statistical records in 1996 obtained from Department of Fisheries may need to be verified. Data should be recorded so that fisheries resources information on individual water bodies can be retrieved. Data recording should include the database fields listed in Table 1.

Conclusions

It is recognised that fish production from Thai reservoirs and natural fresh waters is an important source of protein and income for rural communities. To date, most emphasis has been on aquaculture, and information on fisheries and the limnology of a large number of Thai reservoirs is not well recorded and documented.

It is important for fisheries scientists and administrators to obtain scientific information for planning reservoir fisheries management. Therefore, we suggest that the Department of Fisheries should extend more effort into data collection and storage in a relational computer database, to enable scientists to analyse the data to provide valid inferences on the status of fish stocks, fisheries and limnology.

References

- Economic Statistics Division (in press). The 1998 Agriculture Census. National Statistical Office, Office of the Prime Minister (Thai language).
- Fisheries Statistics and Information Technology Sub-Division 1981–96. Fisheries Statistics of Thailand 1980–95 (Thai language).
- Fisheries Economic Division (in press). Fisheries Statistics of Thailand 1996 (Thai language).
- National Statistical Office 1995. A Map Showing Districts, Sub-Districts, Municipalities and Baseline Information of Provinces in 1995. Office of the Prime Minister, 340 p. (Thai language).
- Virapat, C., Phimonbutra, U. and Chantarawatid, C. 1999. Fishery and Fisheries Management in Thai Reservoirs: Review and Assessment. Main Report, Management of Reservoir Fisheries in the Mekong Basin, MRC Fisheries Unit, 48 pp.

Changes in Fisheries Yield and Catch Composition at the Nam Ngum Reservoir, Lao PDR

N.S. Mattson, V. Balavong, H. Nilsson, S. Phounsavath and
W.D. Hartmann*

Abstract

THE Nam Ngum hydropower reservoir covers 370 km² at full supply level. It supports a diverse fish fauna of more than 55, mainly indigenous, species. The dominating fishing methods are gill-nets, light fishing (for the small clupeid *Clupeichthys aesarnensis*), and long-lines. In 1982, the annual catch was estimated at 1470 metric tons (mt), of which 3.2% (47 mt) was by light fishing. By 1998, the total estimated landings increased to 6833 mt. The fisheries yield has thus increased from 40 to 185 kg/ha/yr, which is largely explained by an increase in fishing effort. The contribution from light fishing has increased to 28% (1937 mt). The dramatic increase in *C. aesarnensis* catch is assumed to be linked to a high fishing pressure on the large predatory species such as *Hampala macrolepidota*, and ensuing reduction in predation pressure on *C. aesarnensis*. Management options are discussed.

THE Nam Ngum 1 hydropower reservoir is 90 km north of Vientiane, Lao PDR. The dam was constructed in two phases, with the first was completed in 1971. In 1977, following additional construction that raised the dam to its present level (212 m asl), the dam was closed for the second time. At normal upper storage level (NUSL), it covers an area of approximately 370 km² and has a catchment of 8460 km².

The reservoir adjoins Vientiane Province and Saysomboun special zone, and involves five districts. The reservoir is relatively dendritic and deep, with a mean depth of 19 m at NUSL, and a maximum depth of about 60 m. The reservoir basin was not cleared of vegetation prior to the closing of the dam, and submerged trees are assumed to contribute significantly to the primary production of the reservoir by increasing the surface area available for epiphytic periphyton. Thermal stratification is present during a large part of the year, when anoxic conditions prevail in the hypolimnion, below about 10 m depth.

Effectively, Nam Ngum has a large pelagic zone; the area of the reservoir where depth exceeds 10 m is about 275 km² at NUSL. The annual drawdown of the reservoir is up to 16 m. Two water diversion schemes, which increase the amount of water available for hydropower, have been constructed. One of these is part of another hydropower installation on the Nam Leuk River, East of Nam Ngum. There are 30 villages around the reservoir, with a total population of about 16 600. A significant fishery exists, which supplies Vientiane and other markets with fresh and processed fish. The dominating fishing methods in terms of landings are gill-nets and light fishing. The latter catches almost exclusively Pa Keo (*Clupeichthys aesarnensis*) (note that this species was previously misidentified as *C. goniognathus*, pers. comm., M. Kottelat). Gill-net catches are more varied, but are dominated by Pa Sagang (*Puntioplites falcifer*). The reservoir supports a diverse, mainly indigenous, fish fauna. A total of 55 indigenous fish species is known to appear more or less regularly among the catch of fishers. In addition, exotics have been stocked, including Nile tilapia (*Oreochromis niloticus*), grass carp (*Ctenopharyngodon idella*), rohu carp (*Labeo rohita*), and common carp (*Cyprinus carpio*). Of the introduced species, only *O. niloticus* is caught regularly, although in relatively small quantities.

*Management of Reservoir Fisheries in the Mekong Basin, Mekong River Commission, PO Box 7035, Vientiane, Lao PDR. Email: resfish@laonet.net

The area where the Nam Ngum River enters the reservoir, Keng Noi, has been identified as crucial for the recruitment of the mainly riverine fish fauna. At the onset of the wet season, adults of many fish species congregate below Keng Noi, and as the river flow increases with the rains, spawning takes place in Keng Noi and upstream areas. Keng Noi is also an important nursery area for fish fry.

In recent years, fishers have been complaining of declining catches, and one output of the present study is a quantitative and qualitative assessment of the catches. Previous studies of the Nam Ngum Reservoir have been reported by the Mekong Secretariat (1984), and Schouten (1998a) reviewed more recent studies. This paper is based on a report in preparation by Management of Reservoir Fisheries in the Mekong Basin, an MRC Fisheries Program Component.

Materials and Methods

Catch per unit effort surveys

Gill-nets

Ten gill-net fishers were randomly selected in each of the three villages Ban Xai Udom, Ban Phonsavat and Ban Pha Koup. The three villages were selected to represent different areas of the reservoir in terms of fishery catch. Xai Udom is located near the estuary, where the Nam Ngum River enters the reservoir, and is considered the most productive area. Phonsavat has intermediate catches, and Pha Koup, far from the Nam Ngum inlet, is the least productive area. The fishers of each village were first divided into part- and full-time fishers. The proportion of each was determined and used to set the number to be selected from each category. The selected gill-net fishers were asked to meet the project staff in the morning once weekly at the landing site of the village. The catches were enumerated on pre-designed forms, recording numbers and total weight by species, mesh size and effort. The data were subsequently entered into PASGEAR (Kolding 1999), a customised fisheries database, for further analysis. The catch per unit effort (CPUE) data presented in this paper were collected between January and December 1998.

The mesh sizes used by the fishers in the survey were between 30 and 120 mm stretched mesh, and the twine was mono-filament nylon. Note that the CPUE was calculated per net, and not by net-area. All nets sold at the reservoir are 90 m long when mounted at a hanging ratio of 50. The nets are either 30 or 50 meshes deep, and the net area varies between 58 m² for a 25 mm net to 374 m² for a 160 mm net. The most common mesh size, 80 mm, is thus either 187 or 312 m², depending on the number of meshes deep.

Gill-nets are deployed in two different ways. The most common use is the traditional setting at dusk and lifting at dawn. However, an alternative approach is what is called beat-netting, where the nets are set in a circular fashion during daytime, and the fish are chased into the net by beating the water inside the area encircled by the net. Beat-netting was not included in the sampling of gill-net CPUEs, but information on the CPUE was obtained via a questionnaire at the same time as the frame survey (see below).

The CPUE by mesh size was estimated using PASGEAR. For most mesh sizes, the sample was amenable to estimation of mean and confidence intervals using a standard parametric approach. For mesh sizes with few samples and non-normal, asymmetric distributions, the mean CPUE and confidence intervals were estimated using the Bootstrap method on the Pennington estimator (Kolding 1999) (Table 1). The Index of Relative Importance (IRI) (Kolding 1989) was also calculated:

$$\%IRI=100*[(\%W_i+\%N_i)\%F_i]/[\sum((\%W_j+\%N_j)\%F_j)]$$

where %W and %N are the percentage weight and number of each species *i* in the total catch, %F is the percentage of occurrence of each species in the total number of settings (samples), and the denominator is the total of all species *j* (Figure 2). For mesh sizes where the CPUE was unknown (not among samples), it was interpolated from adjacent meshes. Generally, the effort for these meshes was small, and hence this approximation does not seriously affect the catch estimates.

Pa Keo Lamps

Pa Keo are caught at night using paraffin-powered pressure lamps to attract the fish that are subsequently caught using hand lift-nets. Fishing takes place during the dark period, before and after the new (dark) moon. In any given month, fishing may be carried out for about two weeks, and sometimes longer when it is overcast. The catch consists of 99% Pa Keo; the remaining 1% consists mainly of *Pseudambassis notatus* (Pa Capcawn).

CPUE data for Pa Keo light fishing were collected in one village, Ban Sook Pa Keo. During the first period (January 1998), samples were collected every night, but later the sampling interval was increased so that seven samples (each composed of the catches of five fishers) were collected each fishing period until December 1998. Sampling started on the last quarter of the moon and stopped on the first quarter of the moon.

Effort surveys

The effort by the gear types used was estimated from a frame survey carried out in March–April 1999, covering 11 randomly selected villages. Questionnaires were filled out at village unit or 'Noei', level. A brief training session was given before the forms were handed out. The forms were collected after 1–2 weeks, to allow for their completion. Effort was enumerated by number of gear used ≤ 1 , 2–4 and 5–7 days per week, which were multiplied with 1, 3, and 6 for estimation of the weekly effort. The data was pooled by village and mean effort per village calculated, which was used to estimate the effort for rainy (May–September; five months) and dry season (October–April; seven months).

For several gear categories and sizes the reported effort was zero in one or more villages. Therefore, the mean effort per village and gear, E_i , was calculated from villages where gear i was used. It was assumed that the proportion of villages that use the gear was the same in the remaining 19 villages, and the total effort T_i by gear type (excluding Pa Keo lamps) i and, where relevant, gear size, was calculated as

$$T_i = E_i * N_i / N_s * 30$$

where N_i is the number of villages where the effort by gear $i > 0$, and N_s is the total number of sampled villages (including those with effort = 0).

Because the random sample of villages included only three where Pa Keo fishing is practised, a separate effort survey was carried out in the 11 remaining Pa Keo fishing villages (i.e. there was a total of 14 villages which practised Pa Keo fishing). Pa Keo fishers were enumerated in three categories: 1–5, 6–10 and >10 days fishing per month (dpm). For calculation of effort, the fishing nights per month were set to three and eight for the 1–5 and 6–10 dpm categories, respectively. For the >10 dpm category, where most fishers belong, the effort was estimated from the actual number of fishing days reported.

Both surveys also included information on CPUE, as reported by fishers or other key informants. This information was used for verification of the CPUE surveys as well as calculation of the mean CPUE from other gear than gill-nets and Pa Keo lights.

For a complete enumeration of the catches, illegal fishing methods, which include the use of fish poison and dynamite, should have been included. However, for obvious reasons it is very difficult to obtain useful information on these gears.

Total catch estimate

The catch for each gear i , C_i , was calculated as:

$$C_i = CPUE_i * T_i$$

where $CPUE_i$ is the mean catch per effort for gear type i . The total catch for all gear types is the sum of

C_i 's. The variance V_i for the combined catch estimate of each gear i was calculated as:

$$V_i = (V_{CPUE_i} * T_i^2) + (V_{T_i} * CPUE_i^2) - (V_{CPUE_i} * V_{T_i})$$

The variance for the total catch estimates was estimated as the sum of the V_i 's, and subsequently the 95% confidence interval for the total catch estimate was calculated.

Results

Gill-nets

Mean CPUEs by mesh size were mostly less than one kg/net/night, whereas the overall mean CPUE was 0.50 kg/net/night. The relative effort by mesh size among the gill-net fishers that participated in the survey was similar to that of the reservoir as a whole, as estimated by the frame survey, except for the largest mesh sizes (Figure 1). The total annual effort was about 4.3 million net-nights, dominated by the 80 mm mesh size. In general, the difference in CPUE between the dry and rainy season was relatively small, although it tended to be higher (by 20%) in the dry season. The effort per month in the rainy season was slightly higher than in the dry season, whereas the monthly catch was somewhat lower (Table 1).

More than 36 species were caught by the gill-net fishers that participated in the CPUE survey. Considering all mesh sizes, the catch is dominated by *P. falcifer*, which makes up about 37% of the total weight (Figure 2). The second most important species is *Hampala macrolepidota* (Pa Sout), followed by *Notopterus notopterus* (Pa Dtong) and *Amblyrhynchichthys truncatus* (Pa Dta Bo). In the smaller meshes, between 30 and 55 mm, the catch is dominated by *A. truncatus* (27%), followed by *P. falcifer* (15%). In the 70 and 80 mm meshes, the species composition is similar to that of the combined meshes. The largest mesh sizes sampled, from 90 to 120 mm, are dominated by *P. falcifer* (71%).

Other gear

Estimates of catches by gear types other than gill-nets are presented in Table 2. Most of this sub-set of the catch is from Pa Keo fishing, long-lines and beat net fishing, of which the latter is closely related to gill-net catches.

The calculated annual fishing effort for Pa Keo lamps is about 170 000 lamp-nights. Pa Keo fishing takes place on average 13.1 (S.D.: 2.7; N: 29) and 13.3 (4.3; 31) nights per month in the dry and rainy season, respectively. The CPUE from the sampling in Ban Sook Pa Keo was 13.5 (5.6; 310) and 18.9 (8.8; 180) kg/lamp/night in the dry and rainy season,

Table 1. Calculation of total catch (kg) by gill-nets at Nam Ngum Reservoir in 1998. The mesh size is mm stretched mesh. Effort (Ti) is in (net-nights/season) and CPUE is in (kg/net/night). SEM is the standard error of the mean, Ni is the number of villages (of a total of 11) where effort>0, and N is the number of CPUE samples. See text for further explanations.

Mesh size	Effort	N _i	SEM	CPUE	N	SEM	Catch
<i>Dry season</i>							
15	2 727	1		0.49			1 336
20	26 030	2	9 659	0.49			12 755
25	55 862	4	6 241	0.49			27 372
30	187 006	9	7 654	0.49	6	0.03	91 633
35	131 805	8	10 725	0.47			61 948
40	239 645	9	27 239	0.46	78	0.02	110 237
45	130 731	7	11 550	0.95	25	0.29	124 194
50	28 592	3	3 564	0.64	113	0.07	18 299
55	12 395	1		0.30			3 719
60	19 585	1		0.36			7 051
70	465 408	9	32 602	0.38	212	0.01	176 855
80	890 985	11	70 559	0.61	319	0.04	543 501
90	31 402	4	5 804	1.13	22	0.11	35 484
100	76 852	1		0.76			58 407
120	59 168	3	20 080	0.19			11 242
140	2 810	3	810	0.19			534
160	0						
180	0						
200	0						
Subtotal							1 284 567
<i>Rainy season</i>							
15	0						
20	0						
25	23 969	2	1 140	0.31			7 430
30	174 527	10	11 562	0.31	27	0.02	54 103
35	78 771	8	9 848	0.30			23 631
40	141 030	10	10 872	0.30	54	0.01	42 309
45	108 421	9	7 269	0.25	23	0.02	27 105
50	15 506	3	2 882	0.50	32	0.05	7 753
55	8 877	1		0.43			3 817
60	22 252	1		0.43			9 569
70	374 798	9	27 426	0.36	171	0.01	134 927
80	678 993	11	46 983	0.68	259	0.03	461 715
90	31 781	3	5 402	0.72			22 882
100	44 386	1		0.69	5	0.29	30 627
120	59 063	4	14 838	0.19			11 222
140	78 357	4	10 668	0.19			14 888
160	47 405	4	3 181	0.19			9 007
180	15 091	1		0.19			2 867
200	11 422	1		0.19			2 170
Subtotal							866 024
Total							2 150 591

respectively. However, the results of the questionnaire of Pa Keo fishers indicated that the overall CPUE was 9.1 and 14.3 kg lamp/night in the dry and rainy season respectively. The somewhat lower estimates from the latter study may reflect a lower abundance of Pa Keo in other areas of the reservoir, and it was decided to use the lower estimate for the calculation of the catch (Table 2). The total estimated Pa

Keo catch, 1918 metric tons (mt), corresponds to a yield of 52 kg/ha for this species alone.

Estimation of landings and yield

The total estimated annual landings are 6833 mt (Table 3), which gives a yield of 185 kg/ha/yr and landings of 18.7 mt/day.

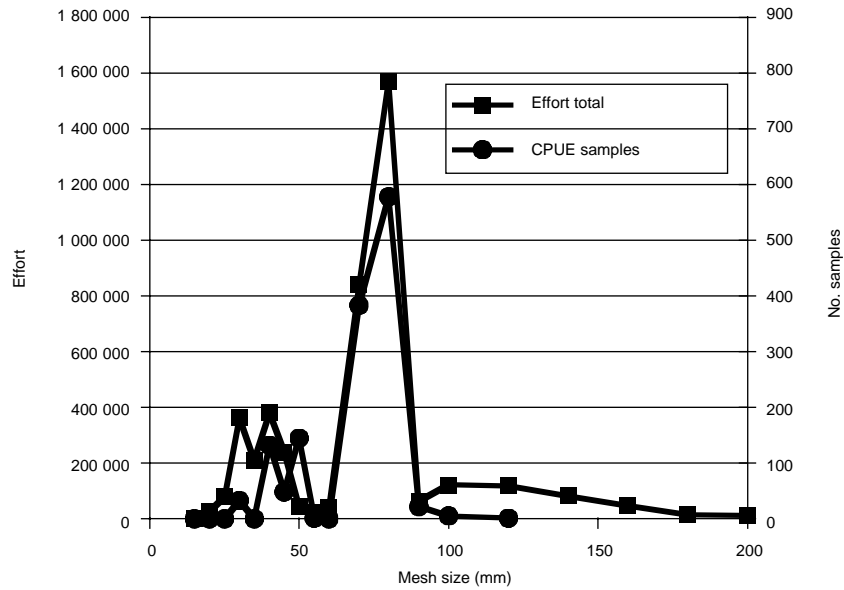

Figure 1. Comparison of the estimate of gill-net effort (net-nights) and the sample size in the gill-net CPUE survey.

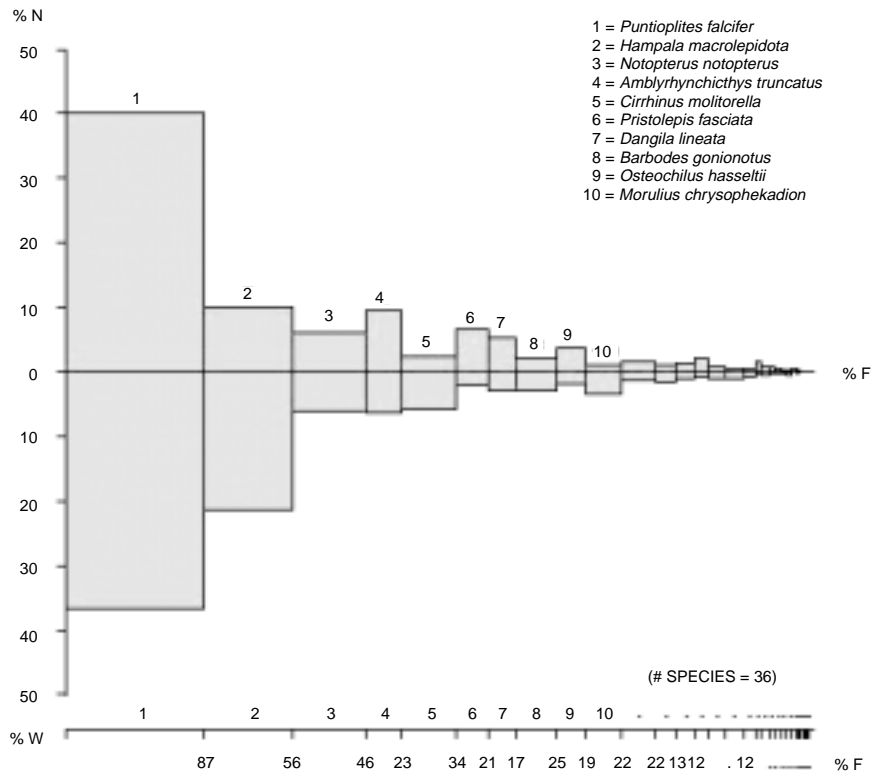

Figure 2. Index of Relative Importance for fish species caught in gill-nets of all sampled mesh sizes (30 to 120 mm stretched mesh; %N: percent by numbers, %W: percent by weight, %F: percent occurrence in samples).

Table 2. Calculation of annual catch (kg) by various gear types at Nam Ngum reservoir. Effort (Ti) is in (gear-days/season) and CPUE is in (kg/gear-day). Ni is the number of villages (of a total of 11) where effort>0, except for longline, where the total is 22 (two samples per village), and Pa Keo lamp where a complete census was carried out in all 14 Pa Keo fishing-villages. SEM. is the standard error of the mean. N is the number of CPUE samples. See text for further explanations.

Gear	Season	Effort	N _i	SEM	CPUE	N	SEM	Catch
Dtoom trap	Dry	530 198	6	80 630	0.43	6	0.10	227 985
	Rainy	213 232	6	19 912	0.67	7	0.14	142 865
Subtotal								370 851
Cast net	Dry	26 444	6	3 593	1.70	10	0.60	44 954
	Rainy	22 135	9	981	3.25	14	1.67	71 937
Subtotal								116 891
Beat net	Dry	134 367	8	8 392	5.05	9	4.37	678 555
	Rainy	60 131	8	4 284	5.66	9	12.81	340 341
Subtotal								1 018 896
Spear gun	Dry	10 246	4	1 311	5.50	4	4.81	56 355
	Rainy	5 624	4	384	8.00	12	10.67	44 989
Subtotal								101 344
Longline *	<= 250	Dry	97 346	11	7 916	9	0.74	194 691
	> 250	Dry	92 718	6	24 933	6	1.05	262 392
	<= 250	Rainy	99 662	13	5 959	10	1.48	278 057
	> 250	Rainy	129 608	10	23 045	5	3.26	401 785
Subtotal								1 136 926
Pa Keo lamp	Dry	96 457	14	509	9.14	29	0.78	881 617
	Rainy	73 887	14	882	14.29	31	1.12	1 055 845
Subtotal								1 937 462
Total								4 682 370

* Number of hooks per longline.

Table 3. Nam Ngum annual catch estimates (metric tons) from 1982 (Mekong Secretariat 1984) and 1998, with percentage contribution to the total given in parenthesis. The range following the total 1998 catch is the 95% confidence interval.

Gear	Catch 1982		Catch 1998	
Beat-net	0	(0.0)	1019	(14.9)
Castnet	31	(2.1)	117	(1.7)
Dtoom trap	74	(5.0)	371	(5.4)
Gill-net	791	(53.7)	2151	(31.5)
Longline	447	(30.3)	1137	(16.6)
Pa Keo light	48	(3.3)	1937	(28.3)
Speargun	*82	(5.6)	101	(1.5)
Total	1473		6833	4283-9383

*, includes harpoon catches.

Discussion

The total catch in 1982 was estimated at 1470 mt (Mekong Secretariat 1984) (no indication of the precision of this estimate is available), and the present estimate of 6833 mt thus point to an increase of more than 460%. Comparing the catch by gear type, the most noticeable change is the dramatic increase (4000%) in Pa Keo light catches, and if the catch composition is considered for Pa Keo only, the increase is even more remarkable, as in 1982 only

49% of the catch consisted of Pa Keo (the second most common species (26%) was *Pristolepis fasciata* (Pa Ka)). The gill-net catches of *H. macrolepidota* have increased from 231 to 458 mt, and the proportion in gill-net catches has decreased from 29% to 21%. *H. macrolepidota* is considered the main predator for Pa Keo, and it appears likely that the increase in Pa Keo catch is linked to a reduction in predation pressure. Generally, the fishing effort and total catch has increased for all the main fishing gears considered here.

The pattern of change in the Nam Ngum fishery from initially being dominated by relatively large-bodied and valuable top-predators to the present situation, where a small-bodied low-value planktivore is expanding, is a commonly observed trend in fisheries, which Pauly et al. (1998) termed 'fishing down food webs'. When a fishery develops the returns increase with fishing effort, then enter a transition phase when the increase in returns stagnate, and finally to declining catches and returns. Pauly et al. (1998) conclude that the latter phase indicates unsustainable exploitation patterns. In the case of Nam Ngum, the increase in fishing effort has led to an increase in yield, but also a shift in species dominance. It seems likely that Nam Ngum is in the transition phase, where individual fishers experience declining catches and returns, although the total catch

is higher than before. A further increase in fishing effort will probably shift the fish stocks even more toward small fast-growing species that feed low in the food chain, such as Pa Keo. Although the catch and its value in 1998 were higher than in 1982 due to a higher fishing effort, further increases in fishing effort are unlikely to bring more profits to individual fishers or the fishery as a whole.

The total number of fishers at Nam Ngum is estimated at 3300, of which about 1500 are full-time fishers (i.e. fishing five days or more per week) (MRF, in prep.). This would indicate that fishers catch on average 2.1 mt/fisher/yr, or if only full-time fishers are considered, 4.6 mt/fisher/yr. Moreau and De Silva (1991) showed by empirical modelling using data from Thai reservoirs, that the expected catches at fishing efforts of 9 and 4 fishers/km are 1.2 and 1.7 mt/fisher/yr, respectively. Generally, the data available for Thai reservoir fisheries are collected from the catch of full-time fishers at main landing sites and via fish traders, and it may be assumed that the catch in most instances is underestimated. The number of full-time fishers in 1982 was 1352 (Mekong Secretariat 1982) and hence their average catch was 1.1 mt/fisher/yr, which is considerably lower than the present estimate.

The apparent gill-net effort in 1982 was one-quarter of the effort in 1998 (not counting the effort by beat-nets). In addition, in 1982, the fishers were using multi-filament gill-nets whereas today practically all nets in use are made from mono-filament twine, which has a higher catchability coefficient, so that the effective effort is even higher. The CPUE in 1982 was on average 0.85 kg/net/night, compared to 0.5 kg/net/night in 1998. This helps explain the reports by fishers that the catches are declining, because each fisher needs to expend a higher effort to catch the same amount of fish. However, this study cannot corroborate the reported decline in the total landings in recent years, and there is no obvious reason that this would be the case. In addition to the increase in gill-net effort, beat-netting contributes 15% of the total catch. The number of motorised boats have increased from 563 in 1982 (Mekong Secretariat 1982) to 1286 in 1998.

A yield of 185 kg/ha/yr for a reservoir of the size of Nam Ngum must be considered as relatively high, and few yields in this range have been reported from reservoirs in the region. Among the Asian lakes and reservoirs listed by Moreau and De Silva (1991), only the Philippine lakes have comparable yields. The relatively long and convoluted shoreline as well as the large catchment means that allochthonous matter may provide considerable amounts of nutrients. It may also be assumed that the surface area of submerged trees further augments the autochthonous

production by providing substratum for epiphytic periphyton. An often-stated reason for low reservoir fish yields is an impoverished fish fauna. This is not the case with Nam Ngum reservoir, where 55 indigenous species are known from the catches. Taki (1974) reported 32 species in Nam Ngum River at the dam site prior to impoundment, and a total of 98 species for several sampling sites on the Nam Ngum River. Thus, the indigenous fish fauna has adapted remarkably well to the reservoir environment. Further evidence of the rich and well-adapted indigenous fish fauna is the failure of attempts to introduce exotics into the reservoir.

According to the official statistics for the Nam Ngum annual fisheries trade, which stem from the monopolist fish trader, the total for 1997 amounted to 774 mt, including both fresh and processed fish trade, and adding an estimated 695 mt in local consumption, Schouten (1998a and 1998b) reasoned the total catch to be 1496 mt. Assuming that the effort and catch estimates in this study are reasonable, the cause for the large discrepancy between the findings of this study and the official statistics may be because of under-reporting due to fear of increased taxes, as well as widespread marketing through unofficial channels. In addition, the local consumption of fish is higher than previously reported, estimated at over 60 kg/person/yr, i.e. about 1000 mt (MRF, in prep.). Another possibility is obviously that the effort survey has produced too high estimates of effort and CPUE. However, CPUE estimates for Pa Keo from the effort survey were lower than those actually measured in the CPUE survey, whereas the effort survey over-estimated gill-net CPUEs. Therefore, there do not seem to be systematic errors in the questionnaire-based effort survey.

Under-reporting of catches from reservoirs and other inland fisheries in Southeast Asia and elsewhere appears to be a general problem that affects the ability to evaluate and manage these fisheries. Important uses of accurate yield estimates from inland waters include quantitative and qualitative prediction of effects of river regulation on fisheries, and setting of appropriate priorities when deciding among alternative resource uses.

There appear to be at least two main options for the management of the Nam Ngum fishery, which will need to be discussed with the Nam Ngum stakeholders in general, and the fishers in particular. An obvious option is to leave the fishery as it is, which may produce the maximum amount of fish protein, but with a sub-optimal value. An alternative is to attempt to enhance the recruitment of larger and more valuable species such as *H. macrolepidota*. This process would probably include the identification and protection of spawning and nursery areas,

and possibly a reduction in the effort of fishing gear that targets immature fish.

As pointed out by Schouten (1998b), a complication for the future management of the Nam Ngum fishery are advanced plans to construct additional dams upstream. The Nam Ngum 2 dam, which is planned virtually directly above Keng Noi, will create major environmental disturbances and changes which will affect the existing Nam Ngum 1 fishery. In particular, many of the important species are riverine, and dependent on the flow of the Nam Ngum River into the reservoir for their recruitment. It is likely that species that are dependent on Keng Noi and Nam Ngum River for their recruitment will decline, e.g. *Puntioplites falcifer* and *Hampala macrolepidota*. *Clupeichthys aesarnensis* is likely to expand further, as well as other species which are not dependent on running water for spawning.

Acknowledgments

Many persons have contributed directly and indirectly to this study, and we would like to mention some of them. Among the Vientiane staff of Management of the Reservoir Fisheries in the Mekong Basin: Saleumphone Chanthavong and Khamla Phommachan. At the Nam Ngum Fishery station, Vankham Keophimphone, Khambao Sihalat, Khankeo Siharath, Khemkham Vanthanouvong, Khantong Chanmany and Bounvou Phantavong. Independent consultant Terry Warren also contributed significantly. Niek van Zalinge provided advice and also set up the gill-net CPUE survey. Management of Reservoir Fisheries in the Mekong Basin is a MRC Fisheries Program Component, funded by Danida. Thanks to Jeppe Kolding and Michael Pennington for assistance with the calculation of the variance of a product.

References

- Kolding, J. 1989. The fish resources of Lake Turkana and their environment. Thesis for Cand. Scient. degree in Fisheries Biology and Final report of KEN 043 Trial Fishery 1986–1987. University of Bergen, 262 p.
- 1999. PASGEAR: A database package for experimental fishery data from passive gears. Dept of Fisheries and Marine Biology, University of Bergen, High Technology Center, N-5020, Bergen, Norway.
- Mekong Secretariat 1984. Development and management of fisheries in Nam Ngum Reservoir, Lao PDR. Interim Committee for Coordination of Investigations of the Lower Mekong Basin, MGK/112.
- 1982. Socio-economic survey of Nam Ngum Fisheries. Interim Committee for Coordination of Investigations of the Lower Mekong Basin, MGK/R.353/INF.
- Moreau, J. and De Silva, S.S. 1991. Predictive Fish Yield Models for Lakes and Reservoirs of the Philippines, Sri Lanka, and Thailand. FAO Fisheries Technical Paper 319, FAO, Rome.
- MRF The Fish and Fishery of Nam Ngum Reservoir. Management of the Reservoir Fisheries in the Mekong Basin. Mekong River Commission, Vientiane. Draft report (in prep.)
- Pauly, D., Christensen, V., Dalsgaard, J., Froese, R. and Torres, F. Jr 1998. Fishing down marine food webs. *Science*, 279: 860–863.
- Schouten, R. 1998a. Fisheries. Nam Ngum Watershed Management. Asian Development Bank, TA-No. 2734–Lao.
- 1998b. Effects of dams on downstream fisheries, case of Nam Ngum Reservoir. Catch and Culture — Mekong Fisheries Network Newsletter, MRC, Phnom Penh, Vol. 4, No. 2, 1–5.
- Taki, Y. 1974. Fishes of the Lao Mekong Basin. United States Agency for International Development Mission to Laos. Agriculture Division.

The Role of Reservoir and Lacustrine Fisheries in Rural Development: Comparative Evidence from Sri Lanka, Thailand and the Philippines

D. Simon¹, C. de Jesus², P. Boonchuwong³ and K. Mohottala⁴

Abstract

The EU-funded FISHSTRAT project is producing an integrated, holistic approach to fisheries development in at least two principal respects. Firstly, it is intentionally multidisciplinary, seeking to integrate limnological, ecological and socio-economic approaches in order to generate more holistic perspectives on, and strategies for, sustainable rural and resource development and management. Secondly, this is a comparative study of five water bodies in Sri Lanka, Thailand and the Philippines, in order to enhance our ability to distinguish local contingency from more generalisable features and processes. This paper offers preliminary insights into the diversity of social and economic conditions prevailing among the littoral communities, the importance of freshwater capture fisheries and aquaculture to them, fishing and marketing strategies, and the potential for socially, economically and environmentally sustainable development of this key resource. Particular attention is devoted to community profiles, fishing strategies and methods, and the relationship between subsistence and commercial fishing.

THIS paper explains a multidisciplinary research project on freshwater fisheries development in Asia, and presents some preliminary results of the socio-economic survey work now approaching completion.

FISHSTRAT is a 42-month research project funded under the European Union's INCO-DC program of scientific collaboration with developing countries. It began on 1 January 1998 and the main research phase is now ending. Arising out of long-standing collaboration among a group of limnologists and fish biologists, this multi-disciplinary project represents an innovative approach to freshwater fisheries development by integrating limnology, fish

biology, ecology and socio-economics within a holistic framework (Amarasinghe et al. in press). In keeping with current donor policies on best practice in development co-operation and partnership, the research team comprises scientists from five European countries (the UK, Austria, Czech Republic, France, the Netherlands) and three in south and Southeast Asia (the Philippines, Sri Lanka and Thailand).

Whereas virtually all published interdisciplinary research has in the past focused on a single water body, or at best has compared several within one country, this project incorporates a second, and quite ambitious, innovative element, namely an international comparative framework. Altogether, five water bodies, comprising four reservoirs (Minneriya, Udawalawe and Victoria in Sri Lanka, and Ubolratana in Thailand's Khon Kaen province) and the natural Lake Taal in Batangas province, on the southern tip of Luzon Island in the Philippines, are being studied. We anticipate that this will provide us with a manageable cross-section of reservoir and lacustrine conditions in different parts of tropical Asia to enable the drawing of distinctions between local specificities and more generic conditions and

¹Centre for Developing Areas Research, Dept. of Geography, Royal Holloway, University of London, Egham, Surrey TW20 0EX, UK

²Philippine Council for Aquatic and Marine Research and Development, Dept. of Science and Technology, Los Baños, Laguna, The Philippines

³Fisheries Economics Division, Dept. of Fisheries, Ministry of Agriculture and Co-operatives, Phaholyothin Rd., Chatuchak, Bangkok 10900, Thailand

⁴Dept. of Economics, Kelaniya University, Kelaniya 11600, Sri Lanka

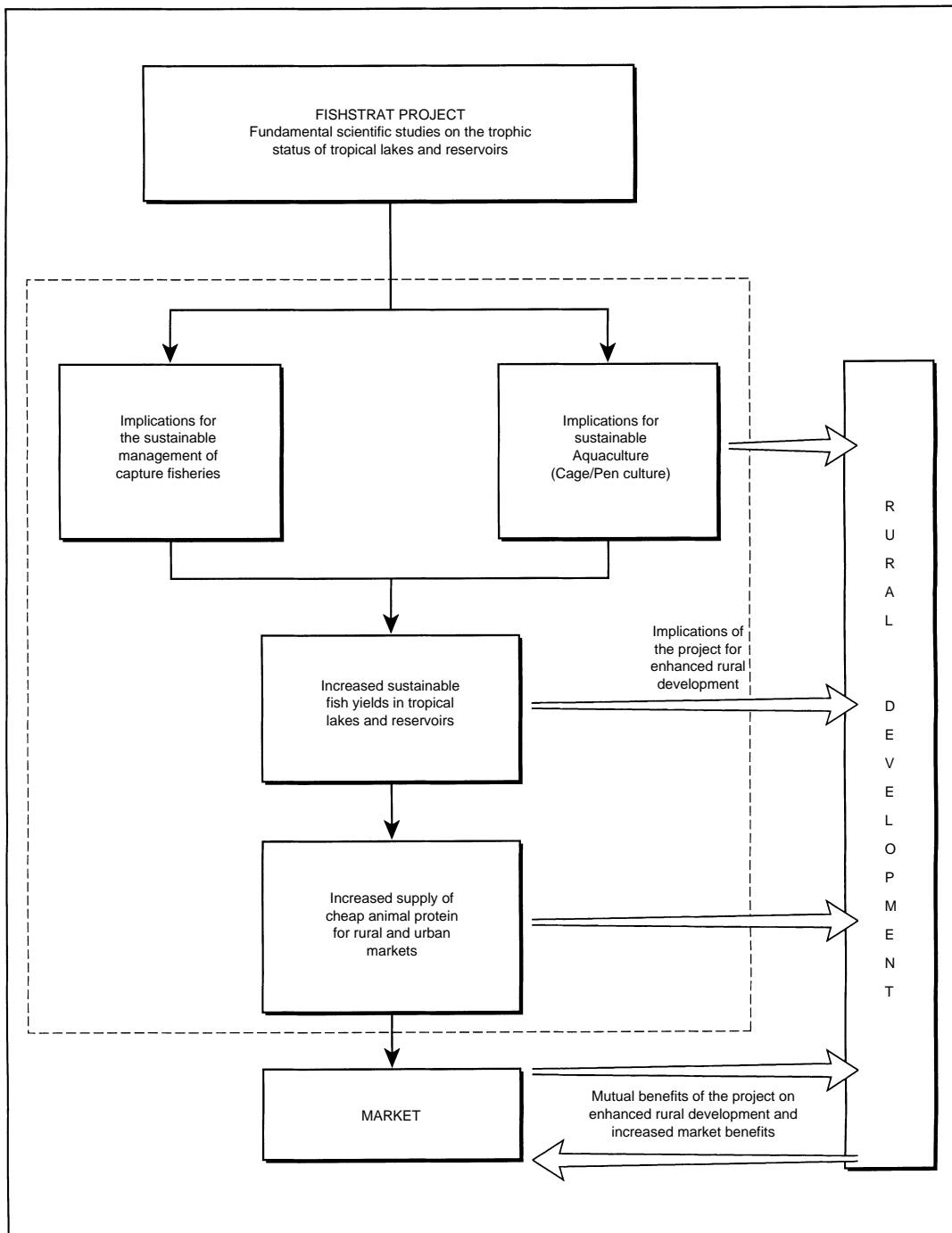

Figure 1. Flow diagram of FISHTRAT Project activities.

processes. Naturally, we are mindful of the dangers of over-simplification or over-generalisation. That is not our intention. Rather, we hope to be able to compare human-environment relations in the context of different water body characteristics and diverse littoral human populations. In particular, we are concerned to establish:

- the extent to which the local fish resources are exploited by the people surrounding these water bodies,
- how important fish and fishing are to them economically and culturally; and
- whether and to what extent there might be scope to increase the yield from capture fisheries and aquaculture on a sustainable basis in order to promote local development in these predominantly rural but rapidly urbanising environments (Figure 1).

Amarasinghe et al. (in press) provide details of the evolution of the project's concept, rationale and organisation

As evidenced by the papers and discussion at this workshop, the distinctions between small and large reservoirs and lakes are becoming increasingly evident in both scientific and management terms. Small water bodies, whether ephemeral or permanent, are often of crucial importance to local communities. They are often heavily utilised but sustainable use and management regimes can frequently be instituted at the very local level of a single village or community under appropriate conditions.

By contrast, all the water bodies considered here are defined as large in terms of surface area (Table 1). As such, they share the following characteristics that are important for purposes of this study:

- They fall within the administrative competence of several littoral local authorities or other statutory bodies.
- Each embraces diverse characteristics in terms of the absence or presence of beaches; shallow or deep littoral zones; the extent of aquatic or submerged terrestrial vegetation; depths and floors; limnological conditions and so forth.
- They experience often pronounced seasonal variations in conditions, due to the changing balance between net inflow and outflow. In the Sri Lankan reservoirs, for example, the seasonal drawdown is 2–2.5 m, which reduces the surface area of Minneriya and Udawalawe by 30–50%. It is now increasingly evident that such water level and volume variations have an important impact upon fish stocks and yields (De Silva 1985; Amarasinghe et al. these Proceedings).
- They contain quite diverse fish fauna, both indigenous and exotic. Not all species are equally or fully exploited for a variety of economic, technological and socio-cultural reasons.
- The nature and extent of both direct human utilisation and the pressures of indirect human impact vary along different parts of the shoreline and hinterland. Such uses include water abstraction, electricity generation, sand winning or quarrying, fishing, leisure and recreation, ablutions, waste disposal and pollution.

In order to take adequate account of these features and their implications, the water bodies in this study are understood not as isolated entities but rather as integral components of wider catchments and social/political economies. This is akin to a systems approach. Accordingly, any strategic sustainable

Table 1. Characteristics of reservoirs in the study.

Name of lake and country	Area (ha)	Mean (and maximum) depth (m)	Comments
Sri Lanka			
Victoria Reservoir	2 270	36.5 (105)	Hydroelectric reservoir in hill country, impounded in 1984
Minneriya Reservoir	2 251	4.0 (11.7)	Ancient irrigation reservoir in low country, impounded in 276AD and restored in 1903
Udawalawe Reservoir	3 362	5.5 (15.3)	Irrigation reservoir in low country, impounded in 1964/68
Thailand			
Ubolratana Reservoir	41 000	5.5 (16.0)	In NE Thailand, impounded in 1965 and has a large pelagic zone. Clupeid fishery
Philippines			
Lake Taal	26 350	65.0 (198)	A natural lake with an active volcano. Clupeid fishery

Note: There is substantial variation in depth in all the water bodies, and a seasonal drawdown of up to 2.5m within the four reservoirs.

development and management approach that is likely to be advocated as an outcome of this project will need to be integrated at the catchment or watershed scale.

One implication of the limnological and biological diversity is that single summary statistics, such as mean depth, surface area and fish yield (kg/ha/yr) are somewhat misleading. As with all average data, they conceal significant internal variation, between littoral and deeper water, between areas of high and low biological productivity, and so forth. Fishing effort and yields are also not uniformly distributed across the water bodies, but are concentrated in particular zones in specific seasons:

- where fishing has the greatest prospect of success;
- where specific species are known to concentrate; and/or
- where particular fishing gear can be utilised.

Ideally, we should be able to disaggregate such statistics by habitat or sub-area. In practice, this is extremely difficult and costly to achieve in large water bodies. We have had to rely largely on fish catches recorded at the various landing sites around the shores, although complemented by experimental fishing in different habitats to ascertain fish stock composition. This check is very important, because it enables distinctions to be made between what people catch and what exists. The two cannot be assumed to be synonymous, especially since we know that certain plentiful species, like the minor cyprinids in Sri Lankan reservoirs, are not exploited to a significant extent.

By the end of this project, we hope to be able to offer explanations for such socio-cultural preferences, and to have examined the potential for enhanced but sustainable fish resource exploitation through utilisation of such species. In Sri Lanka, the capture fishery is based very heavily on the exotic tilapia species (*Oreochromis mossambicus*). In Ubolratana and Lake Taal, this forms the backbone of the aquaculture industry but also constitutes a significant part of the capture fisheries' harvest. However, the tilapia coexist in the relevant habitats with indigenous species, which do not appear to be being displaced (De Silva, these Proceedings).

Two other papers in these Proceedings (Schiemer; Vijverberg et al.) report preliminary limnological and fish biological/ecological findings from FISH-STRAT; this paper focuses on the socio-economic dimensions. Because of the provisional nature of our data, in some cases still based on a sub-sample or incomplete survey, and therefore the inferences being drawn, we have avoided comparisons with published literature at this stage, seeking to elucidate the potential of our approach for the audience at this workshop and the published Proceedings.

Socio-economic characteristics of littoral communities

The communities surrounding the water bodies range in number from a few thousand in Sri Lanka to some 280 000 (or 50 500 households) in the case of Lake Taal. In order to ascertain the extent of utilisation of the water bodies, and the relative importance of fish and fishing in the respective national and socio-economic settings, three related surveys have been undertaken for each water body:

- Baseline socio-economic surveys, incorporating a representative sample of both fishing and non-fishing households in the villages and towns around each water body. This has been the largest survey in each case. However, in view of the very different resident population sizes, different sample sizes and sampling proportions have had to be used.
- Fish marketing surveys, undertaken among traders and merchants who purchase the fishers' catch and then either wholesale or retail it onward. By concentrating on the small number of fish landing sites in the four reservoirs, it has been possible to cover a high proportion of the traders purchasing directly from the fishers. Although the scale of operation on Lake Taal is far greater, even here a modest number of major landing sites is used, enabling high survey coverage.
- Aquaculture surveys, undertaken among fish cage culturists. There is no aquaculture in Victoria and Udawalawe, and only a small experimental venture in Minneriya; similarly, Ubolratana has only a single area of relatively recent cages, although these are of high quality and the aquaculture is being carefully monitored by the feed company that supplies many of the resources. Complete coverage was obtained in our survey. In Lake Taal, the vast scale of aquaculture—over 8000 cages in several distinct areas—has necessitated a sampling strategy. One hundred cage operators were selected proportionately across the 10 coastal municipalities.

Sri Lanka

For logistical reasons, the surveys in Sri Lanka began only in late 1999, a year behind the other two countries. However, since the surveys are smaller, they were due for completion by the end of April 2000. Accordingly, only impressionistic preliminary evidence on the extent of fishing is presented (Table 2). On each reservoir, there are some 250–300 active fishers, although seasonal migrants from the coast are also important in Minneriya. The capture fishery in Sri Lanka is based very largely on tilapia. For reasons related to increased fishing pressure, not

least from unorganised fishers who do not belong to the respective local fishery co-operative society, the use of certain fishing methods like small mesh sizes and water beating, catches have been declining in recent years. Problems of siltation and poor fish reproductive rates are also reported from Minneriya and Victoria, respectively. Nets snagging on submerged vegetation, theft, and also contamination of the water by refuse are regarded as problematic by fishers.

Ubolratana

A total sample of 543 households was drawn from the 101 villages surrounding Ubolratana reservoir; the target had been 550 out of the total of 4621 enumerated. The government statistical base was extremely good, with recent and reliable data available on the population of each village.

The differences in age of the household heads as between fishing and non-fishing households in different parts of the reservoir were not significant (mean 44.9 years; range 42.5–48.3). The same is true of household size (mean 4.5; range 4.3–4.9).

Occupational structure and incomes

Among households that undertake some fishing, this represented the principal occupation in 31% of cases in the area around Lam Choen Main Stream, in 45% of cases around Nam Pong Main Stream, and in 48% around the remainder of the reservoir (Figure 2). In the first area, labouring was marginally more important as the principal occupation, followed by rice field cultivation; in the other two areas, fishing was by far the most widespread main occupation, followed in each case by rice cultivation and then, some

way behind, by labouring. Among non-fishing households, rice cultivation and labouring also represented the most important main occupations. Among fishing and non-fishing households alike, only a handful engaged in each of government service, small business, livestock rearing, cultivating fruit orchards and miscellaneous other jobs.

The most significant preliminary results relate to the distribution of incomes (Table 3). In each of the three areas, non-fishing households earned more than double the income of their fishing counterparts in respect of the main income source; for sub-income 1 non-fishing households also earned somewhat more. However, for sub-incomes 2–4, the picture was varied. In aggregate household income terms, non-fishing households around Lam Choen earned 128% more than fishing households; in the Nam Pong area the figure was over 79%, and elsewhere around the reservoir 57%. The average was 87% more for non-fishing households.

There is a total gender division of labour, with all fishing being done by males and females having almost exclusive responsibility for cleaning and processing of fish at landing sites and elsewhere. Some of these women are the spouses or family members of fishermen or fish traders; however, fish cleaning provides an important source of employment for poor local women of all ages. By contrast, fish trading is not gender-specific although women outnumber men by 3:1. Some fishermen and/or their spouses also trade. Our preliminary work suggests that client-patron relations between traders and 'their' fishermen are widespread. Provision of credit (especially towards the cost of fishing gear) represents the main source of such attachment, in return for a secure outlet for fish catches.

Table 2. Fisheries in the three Sri Lankan reservoirs.

	Udawalawa	Victoria	Minneriya
Total FCS members	264 (200 active)	133 (100 active)	150 (60 active)
Total active fishers	300	250	300 + 90 migrants
Main problems	Depletion of fishery, plant damage to nets	Growth of plants that snag nets, net thieves	Refuse washed into reservoir by rain
Other uses of reservoir	Grazing, recreation, fuel wood collection	HEP generation	Fuel wood collection
Reasons for declining fishery	Use of small mesh nets, water beating system, increasing no. of fishermen and net types, unprotected spillway	Competition from unorganised fishermen (60), use of small mesh nets, poor fish breeding	Use of small mesh nets, sedimentation of watershed, increased catches of small fish for drying

Note: FCS = fishery co-operative society

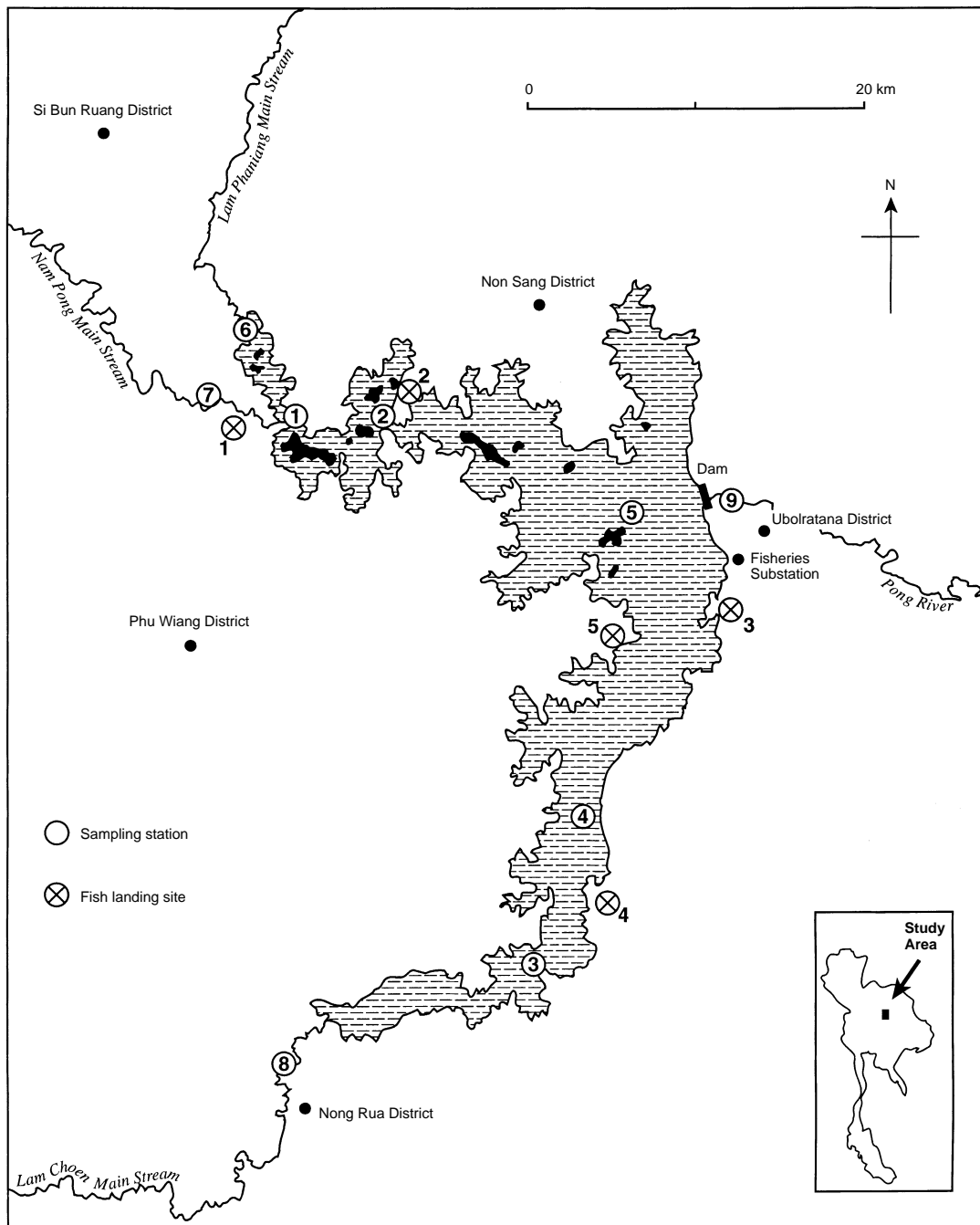

Figure 2. Ubolratana Reservoir, Khon Kaen Province, Thailand.

Table 3. Average annual cash income of household by area in Ubonratana reservoir, Thailand, 1998. (Uni: Bahts/household/year).

Income	Lam Choen Main Stream			Nam Pong Main Stream			Reservoir Area			Total		
	Fishing household	Non-fishing household	Average	Fishing household	Non-fishing household	Average	Fishing household	Non-fishing household	Average	Fishing household	Non-fishing household	Average
Main income	26 794	69 581	8 187	33 858		55 780	29 726	52 057	40 892	90 378	199 341	144 859
Sub-income 1	9 633	11 245	10 439	12 834	14 839	13 837	12 080	12 231	12 155	34 547	38 315	36 431
Sub-income 2	3 371	2 814	3 093	4 093	3 261	3 677	2 725	71	1 398	10 189	6 147	8 168
Sub-income 3	4 273	17 238	10 756	8 547	10 696	9 621	3 210	10 415	6 813	16 031	38 349	27 190
Sub-income 4	44 072	100 878	72 475	59 333	106 499	82 916	47 741	74 775	61 258	51 146	282 152	216 649
Total	88 143	201 756	144 950	118 665	212 998	165 832	95 482	149 550	122 516	302 291	564 304	433 297

Source: survey

Although further analysis of the data must still be completed, it appears that there might be a social equity argument for focusing attention on income enhancement for fishing households, which are generally poorer than non-fishing households. Nevertheless, there is also significant socio-economic differentiation among fishing households; they do not represent a homogeneous group. For example, 70% of fishing households possessed a boat powered by an outboard motor (although they did not necessarily own it outright); 13% an unpowered boat, and 17% no boat. The range of gross daily incomes reported by fishermen interviewed on the reservoir during 1999 was Bt70–2000. A moot point at this stage is whether any such equity promotion strategy would most appropriately aim at increasing incomes from fishing or non-fishing livelihoods, or a combination of the two.

We also found evidence of the responsiveness of some people to changing economic conditions. In February 1999, a group of 14 migrant fisher families from Lam Pae reservoir some 100 km east of Ubolratana was living in temporary shelters along the reservoir shore at Landing Site 2 (Ban Talad). In previous years, they had migrated to Bangkok as construction workers during the dry season, but on account of the paucity of such jobs since the onset of the Asian economic crisis and their consequent inability to find work in 1998, they had decided to experiment with dry season fishing at Ubolratana. They had transported their boats by road and were using cast-net and trap fishing methods. Although their daily incomes from fishing were lower than those of local fishermen using similar gear in the same locality, something they attributed to their lack of familiarity with local conditions, they expressed provisional satisfaction with their decision and expected to return in 2000. We found no evidence of tension between them and local fisher folk. They were also supplementing their incomes by making rattan fish traps for sale locally.

Lake Taal

This lake illustrates particularly well the complex interactions between a water body and its catchment. Because the lake lies in a large extinct volcanic caldera, the porous rocks and steep slopes act as ready conduits for rainfall runoff and waste water from the rapidly expanding industrial, residential and recreational developments. Tourism is concentrated particularly along the northern and western shores and along the steep northern caldera ridge at Tagaytay City. There is little piped sewerage system in the area, so a substantial proportion of waste products will contaminate aquifers and/or reach the lake. To date, however, Taal has enjoyed cleaner

water than many other Philippine lakes. The active volcano island in the middle of the lake is inhabited illegally by several hundred predominantly poor people, who practise subsistence agriculture and operate tourist boats and provide mule rides up the steep slope to the volcano crater lip. Localised environmental degradation, including along the mule path, is evident.

Finally, the 12 km Pansipit River provides the only outlet to the sea. This represents an important fish migratory route for spawning and immature growth stages of many marine and lacustrine species. However, illegal trapping and penning along the river is reportedly having a significant effect on fish stock recruitment and yields, although it is difficult to quantify. Efforts to demolish illegal structures, and cages on the lake, have been intensified since 1998 but reconstruction follows rapidly. Two recent fisheries modernisation and conservation measures have great relevance to the exploitation of Lake Taal:

- The Agriculture and Fisheries Modernisation Act of 1997 (Republic Act 8435), and the regulations pursuant to it. It defines a *micro-enterprise* as having assets (other than land) valued at less than P1.5 million, and *small farmers and fisher folk* as 'natural persons dependent on small-scale subsistence farming and fishing activities as their primary source of income'. These definitions embrace most capture fishing activities on the lake, since the ubiquitous pumpboats are cheaper than that. Even the smaller aquaculturists would qualify as micro-enterprises and therefore be able to benefit from the available support provisions. A different section of the Act addresses watershed conservation.
- The Philippine Fisheries Code of 1998 (Republic Act 8550), which provides for the development, management and conservation of fisheries and aquatic resources and seeks to integrate existing legislation to that end. It seeks to promote rational and sustainable development of the resources in line with principles of integrated coastal area management, protect the rights of fisher folk, especially local communities and municipal fisher folk (i.e. small-scale local fishers registered with their municipality). Its provisions are in tune with current international best practice on sustainable development, such as local agenda 21. By the end of this project, we anticipate being able to assess the extent to which the measures are being implemented on Lake Taal.

Occupational structure

Given the size of the local population, the baseline and fishing surveys here have been far larger than in

the other countries. Preliminary analysis has to date been undertaken only of a sub-sample of the households interviewed in the baseline survey by the end of 1999. This sub-sample comprises 230 households, including 100 fish-cage operators, 100 capture fishermen and 30 non-fishing households (De Jesus and De Jesus n.d.). Seventy five per cent of fish-cage operators and 83% of capture fishermen reported no secondary income source for their household, indicating a far higher reliance on fish than at Ubolratana reservoir. However, it is not yet clear whether this reflects higher incomes and hence better living standards, or a paucity of alternatives. By contrast, only 14% of non-fishing households had no secondary income source. The list of secondary activities was long, with no more than 6% of each household type undertaking any individual activity.

Analysis of the daily incomes of the 100 capture fishermen indicates that 76% earned less than 200 Pesos, and only 24% above that; the mean was P182. The 17 fishermen who declared a secondary income source obtained an average of P150 from that activity (range P100–233); in other words, these people were reliant on a secondary source that was almost as important as their fishing. There is substantial diversity of experience, nature of activity, fishing effort and investment among both the capture fishers and aquaculturists. For the latter group, cage size, stocking density and number of cages represent the effort and investment. Significantly, too, their profitability (net income) varied widely by municipality (the reasons for which are not yet clear) and both within and between the categories of scale of operation (i.e. number of cages per operator, and stocking density). No clear relationship emerges (Tables 4 and 5). Again, the reasons for this remain to be explained.

Table 4. Relationship between average net income per cage and number of cages attended to, 100 fish-cage operator respondents, Taal Lake, Philippines, 1999.

Number of respondent reporting	Number of cages	Net income (P)
23	1	12 441
39	2	9 513
18	3	4 997
4	4	19 718
7	5	10 403
4	6	15 463
2	10	62 219
1	16	1 919
1	20	3 480
1	25	2 154
Average	9	14 231

Table 5. Relationship between average net income per cage and stocking rate per cage, 100 fish-cage operator respondents, Taal Lake, Philippines, 1999.

Number of respondent reporting	Number of cages	Net income (P)
1	less than 5 000	2 154
8	5 000 to 9 999	9 286
30	10 000 to 14 999	12 853
11	15 000 to 19 999	2 927
14	20 000 to 24 999	86
14	25 000 to 29 999	17 828
9	30 000 to 34 999	5 249
6	35 000 to 39 999	1 030
3	40 000 to 44 999	16 427
4	45 000 and above	16 025
Average	19 625	8 621

As in Ubolratana, there is a total gender division of labour in capture fisheries, although there are a number of female aquaculturists and traders.

Conclusions

This paper has explained the context and outlined the nature of the challenges in undertaking a comparative socio-economic analysis of five diverse water bodies in three tropical Asian countries. Preliminary data and qualitative findings have been summarised and a number of pertinent issues have been raised. Analysis of the full data sets will take place in two stages: first by water body and country, and then comparatively across all five water bodies.

Already at this early juncture, several interesting points are emerging. Capture fishing is an exclusively male preserve, whereas fish processing is predominantly a female activity. Trading is mixed, although overwhelmingly male in Sri Lanka and the Philippines, but female-dominated in Thailand. It appears that fishing households are not entirely representative of their communities as a whole, in socio-economic terms, having lower mean incomes and social status. Aquaculturists, by virtue of the nature of investment and management skills required, have above-average incomes. However, at least in Thailand and the Philippines, fishing households are by no means homogeneous, and the importance of the relatively small number of larger and wealthier commercial fishermen is considerable. Conversely, a substantial proportion of capture fishermen operate at a subsistence or even sub-subsistence level, generally combining fishing with one or more other activities, most commonly rice cultivation and wage labour. More detailed analysis of the complete datasets should enable us to compare income status and livelihood

strategies with fishing effort, types and quantity of fishing gear, fish species exploited, in order to compile a more nuanced and disaggregated picture of capture fishing in each water body. Where applicable, the equivalent will be done for aquaculture.

This work has both academic and practical management implications, especially when related to fish ecology and stock assessment data. It would make little sense to recommend poor (or any other) fisher folk to change gear or adopt new fishing practices with the intention of increasing their catch per unit effort and total catch, if the favoured species are already being exploited close to or beyond their maximum sustainable yield.

Conversely, the exploitation of un- or under-exploited species may hold significant potential under certain conditions. On the other hand, it may be that the most appropriate strategies under other conditions would be to promote income and livelihood security through diversification, i.e. combining fishing and non-fishing activities in and around the water body concerned, or through collective action by fishermen (e.g. by forming a co-operative). Equally, the needs of both men and women in fishing households need to be considered, taking into account existing gendered roles and the potential for livelihood enhancement through greater value-added fishing and fish processing and marketing activities by the household as a whole. In addition, the compatibility of fishing with other uses, and the impact of pollution and eutrophication on fishing, need to be considered.

It is through such efforts that we aim to demonstrate that the integration of socio-economic, limnological and biological perspectives holds the greatest promise for promoting sustainable and participatory

management of tropical freshwater fish, an important renewable natural resource in all the countries covered by this study.

References

- Amarasinghe, U.S., Duncan, A., Moreau, J., Schiemer, F., Simon, D. and Vijverberg, J. (in press). Promotion of sustainable capture fisheries and aquaculture in Asian reservoirs and lakes. *Hydrobiologia*, special issue.
- Amarasinghe, U.S., Nissanka, C. and De Silva, S.S. Fluctuations in water level in shallow, irrigation reservoirs: implications on field yield estimates and fisheries management. Paper presented at the Workshop on Reservoir Fisheries Biology and Management, Bangkok, Thailand, 14–18 February.
- De Jesus, C.C. and De Jesus, M.T.R. (n.d.). Philippine FISHSTRAT Socio-economic component: some preliminary findings and implications for developing sustainable management strategies for Taal Lake. Los Baños: PCAMRD.
- De Silva, S.S. 1985. Observations on the abundance of the exotic cichlid *Oreochromis Mossambicus* (Peters) in relation to fluctuations in the water level in a man-made lake in Sri Lanka. *Aquaculture and Fisheries Management*, 16: 265–272.
- De Silva, S.S. Asian reservoir fisheries: broad strategies for enhancing yields. Paper presented at the Workshop on Reservoir Fisheries Biology and Management, Bangkok, Thailand, 14–18 February.
- Schiemer, F. Ecosystem structure and dynamics as management basis for Asian reservoirs and lakes. Paper presented at the Workshop on Reservoir Fisheries Biology and Management, Bangkok, Thailand, 14–18 February.
- Vijverberg, J., Amarasinghe, B. and Ariyaratna, M.G. Biology and ecology of small pelagic fish species in Southeast Asian lakes and reservoirs. Paper presented at the Workshop on Reservoir Fisheries Biology and Management, Bangkok, Thailand, 14–18 February.

Characteristics and Status of the Lake Tegano Fishery

E. Oreihaka*

Abstract

Where accessibility to sea is restricted, access to marine fisheries resources becomes limited. Rennell Island, on which Lake Tegano is situated, is an uplifted coral atoll surrounded by limestone cliffs of up to 150 m, such that the presence of inhabitable sites along the sea coast is limited. Much of the population, therefore, lives inland, making it difficult to engage in sea-fishing activities. Mozambique tilapia (*Oreochromis mossambicus*, Cichlidae) introduced into the lake in the 1950s has grown to become the most important source of protein food for the four village communities of 600 people that live along the lake shore. Realising the importance of tilapia, the Rennell and Bellona Provincial Government seeks the possibility of introducing a new tilapia species, Nile tilapia (*O. niloticus*, Cichlidae) to the lake. With current tilapia already providing a sufficient source of protein, coupled with the island's recent inclusion under the World Heritage listing as a conservation site, caution must be taken in any further developments. Information on the fishery, water quality parameters and the physical environment of Lake Tegano were collected to describe the characteristics and status of the lake fishery.

LAKE TEGANO, reportedly the largest uplifted coral atoll in the world, Rennell Island, Solomon Islands (Figure 1), is believed to be the largest brackish water lake in the insular Pacific, covering an area of about 15 500 ha (Leary 1994). Located at the eastern end of the island at 11°46' S and 160°27' E (Figure 2), its brackish water is continually being replenished by fresh water through underground springs. There is believed to be a one-kilometre underground channel that connects the sea with the lake. It is estimated that the lake rarely exceeds 40 m in depth. Shielding the shores of the lake and its 200 islands is a mixture of mangroves and untouched lowland forests. The aquatic fauna of the lake has been well studied and summarised by Wolff (1970). Some 77 species were recorded from the lake including species endemic to the lake. The lake also supports a large number of waterbirds and waterfowl.

Mozambique tilapia were introduced into Lake Tegano in the late 1950s and have now grown to become the most important source of protein, with minor supplementaries from freshwater eels (*Anguilla obscura*, Anguillidae) and prawns (*Macrobrachium*

spp.) Most catches were for subsistence use, but occasional selling does occur when there is a surplus. With the completion of the road linking the lake to the rest of the island, including the main seaport and airstrip, trade in fish has potential.

In 1986, however, there were reported incidents of tilapia dying in large numbers in the lake. There were also concerns about the abundance and size of tilapia, which were believed to be declining. These concerns stirred the province to consider farming tilapia in and around the lake, which led to the consideration of alternative species that could be introduced. In suggesting Nile tilapia as an alternative species, the Fisheries Division opted to undertake an impact study before any introduction.

This paper, based on preliminary work undertaken by the Fisheries Division, Department of Agriculture and Fisheries, summarises the characteristics and status of the Lake Tegano Fishery, as a lead-up to developing a more comprehensive project proposal for a proposed 'Introduction Impact Study'.

Materials and Method

The data and information used were collected from four surveys undertaken on the lake by the Research Section of the Fisheries Division, Department of Agriculture and Fisheries.

*Fisheries Division, Department of Agriculture and Fisheries, Ministry of Lands, Agriculture and Fisheries, Honiara, Solomon Islands

Survey 1

Questionnaire

Survey 1 followed a request to investigate a report that tilapia were dying in large numbers and were declining in size and abundance. A questionnaire survey designed to collect general information on tilapia abundance, size, its fishery (fishing methods, how often and where fished, etc.) and its physical environment was undertaken during Survey 1. Five individuals from each village were interviewed. Additional information on the general lake appearance was collected through a tour around the lake using a 30 hp outboard motor canoe.

Surveys 2 and 3

Water sampling

The two surveys were conducted two weeks apart, the first as a preliminary and the second as a 'check'. Measurements of salinity, turbidity, pH and temperature were taken at 0 m, 3 m and 5 m depths using a salinometer, Secchi disc, a pH meter and a thermometer, respectively, at selected sites around the lake. Measurements at the depths of 3 m and 5 m were collected by skin-diving, due to the non-availability of appropriate equipment.

Survey 4

(a) Length frequency

Fork length of fish caught using different fishing techniques (gill-net 10, 7.5, 6.5, 3.0 cm meshes, diving (speargun) and handline, were collected using a measuring tape fastened to a board. This was done at different locations within the lake including heavily and lightly fished areas.

(b) Questionnaire

A general questionnaire survey on the status of the lake fishery, almost a replicate of Survey 1, was undertaken at each of the four lake villages. Three individuals from each village were each asked their perception of the lake fishery situation.

Results

Survey 1

Fishing methods

All fishers use either dive-fishing or gill-netting. Other fishing methods such as hand-line, drop-line, spear fishing, traps and traditional poison were either uncommon or had never been used.

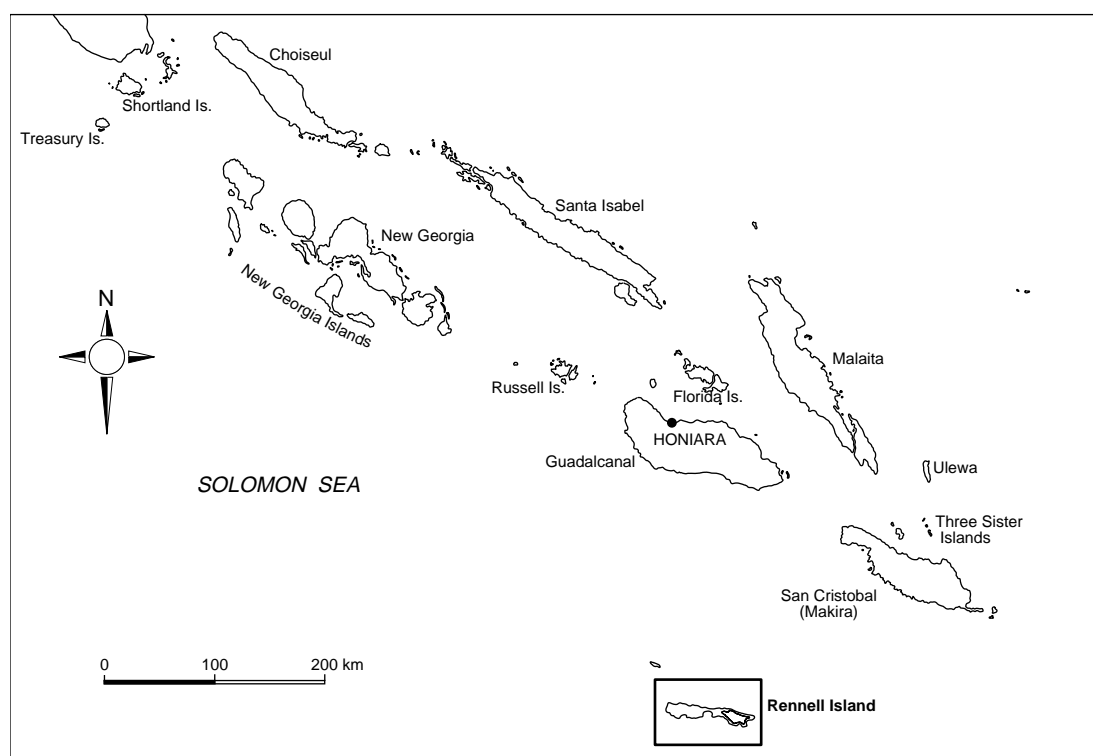

Figure 1. Map of Solomon Islands showing Rennell Island.

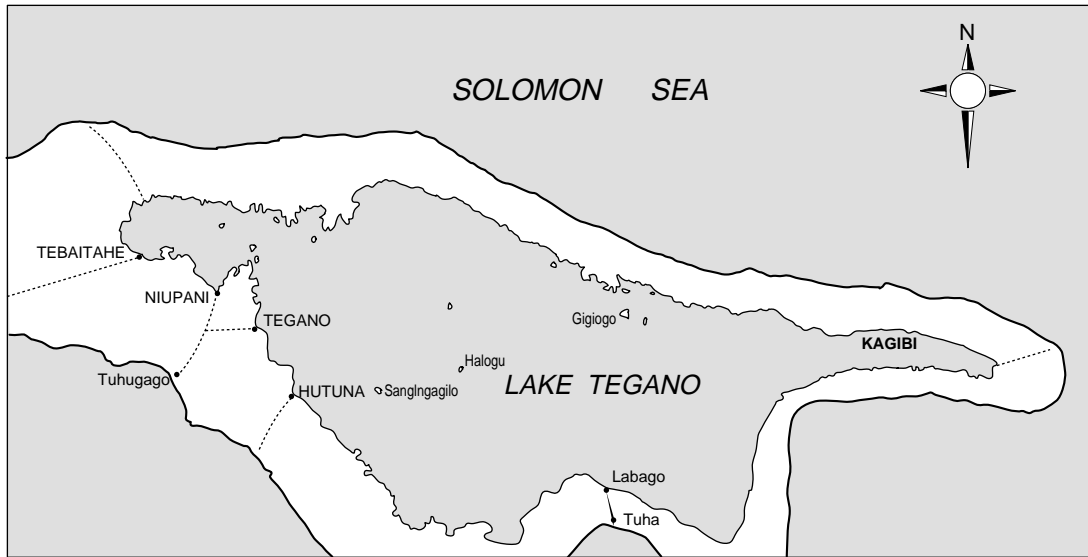

Figure 2. Lake Tegano, Rennell Island.

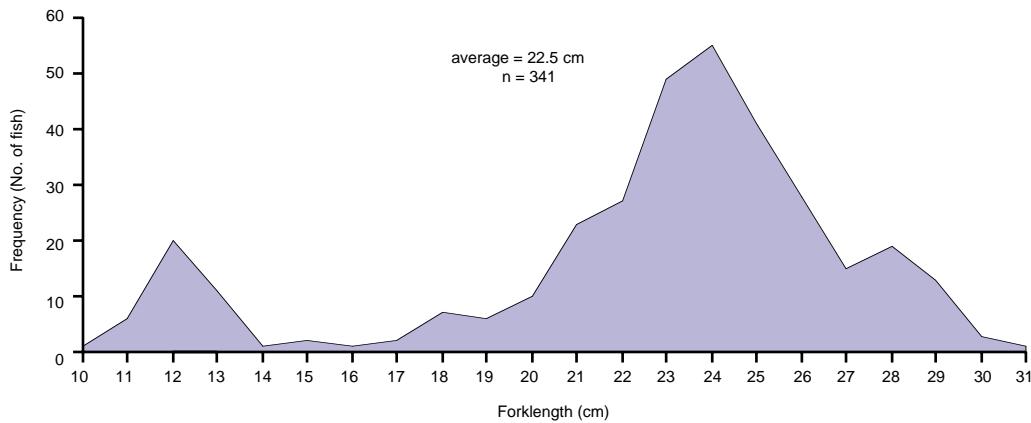

Figure 3. Length frequency distribution of tilapia, *Oreochromis mossambicus*, in Lake Tegano.

Fishing grounds

All of the respondents fish in the shallow western areas of the lake, along the edge and between islets. Fishing at the eastern end of the lake is uncommon because of its distance from the villages. Nobody fishes in the deep part of the lake.

Fishing trips

All of the respondents go fishing either daily or every two to four days a week. The length of a

fishing trip depends on the type of fishing method used. Fishers spend from one to five hours dive-fishing, while net fishing normally takes 6–12 hours.

Catch rate

All respondents reported a fluctuating catch. Their catch depends also on the fishing method used. Dive-fishing gives a low catch, while gill-netting yields higher catches. The best catch for one fisherman interviewed was about 300 fish using a gill-net. The majority of fishers, however, have expressed fears

that fishing effort has increased a great deal in past years.

Stock and size

Seventy-seven per cent of fishers believed that the tilapia stock abundance was declining. Thirteen per cent thought it was increasing. Ten per cent said there was no change in the stock abundance. Ninety-seven per cent claimed the average size of tilapia to be decreasing, while only three per cent believed there was no size change.

Problems

People interviewed perceived the following as contributing factors to the problem:

- (a) overfishing resulting from the use of too many gill-nets with small mesh sizes;
- (b) increased predation by birds, notably the great cormorant;
- (c) pollution related to human activities, including increased use of outboard motor canoes;
- (d) lack of food as a result of competition. Tilapia is a fast breeder and as the population within the lake increases, is competing for the same food resources;

Surveys 2 and 3

The two surveys found the water to be fresher than saline, with an average salinity of 5.5 ppt. The western end of the lake is found to be colder with a water temperature of 22.9°C, and the rest ranging from 29.1° to 31.3°C. Likewise, the pH reading for the western end recorded the lowest of 7.9, while other parts ranged 8.4 to 8.6, more alkaline. This is normal due to the nature of the substrata of the lake and island (Lam 1996) (unpubl.). An average clarity of 6.9 m was measured for the lake.

Survey 4

(a) Length frequency

The length frequency of 341 tilapia were measured and the distribution is presented in Figure 3. The average length is 22.5 cm.

(b) Questionnaire

Fishing methods

Eighty-three per cent of the respondents use dive-fishing and 17% use nets. Hand-lining is sometimes used but very occasionally.

Fishing grounds

All respondents use the western shallow lake edges and between islands to fish.

Fishing trips

Fifty-seven per cent of the respondents go out fishing daily, 33% go four to six times a week, and 10% one to three times a week. The length of fishing trips depends largely on the type of fishing method used. Fishers normally spend between one to three hours dive-fishing, while net fishing normally takes 6–12 hours, normally overnight.

Catch rate

Ninety-two per cent of respondents reported a fluctuating catch, which depends also on the fishing method used. Dive-fishing gives a low catch, from 20–30 fish per hour, while nets yield higher catches. The majority of fishers, however, have expressed fears that fishing effort has increased a great deal during recent years.

Stock and size

Seventy per cent of the respondents observed the stock abundance to have increased since Survey 1, while 13% thought it was decreasing. All except one respondent thought size had improved a bit since Survey 1.

Problems

Above 90% of the respondents claimed overfishing, particularly the increasing use of gill-net, to be the most serious contributing factor to stock and size decline of tilapia in the lake. Water birds and water fowls also contribute to stock decline. The increased use of outboard motor canoe contributes to pollution.

Management measures

There are currently no management measures in place for Lake Tegano in regards to fishing. Although fishing is of open access to all lake communities, commonsense is encouraged to play an important part.

Support for introduction of alternative species

Although with some caution, all respondents support the idea of introducing an alternative species into the lake. This does not necessarily have to be tilapia.

Trade and market

Fishing for sale is very rare and infrequent. None of the respondents fish primarily for sale except for community fundraising events. Only surplus fish are normally sold.

Discussion

Lake Tegano is undoubtedly of high national and international importance, being the largest brackish-water lake in the insular Pacific, as well as harbouring an endemic flora and fauna. Its importance is further reflected by the Solomon Islands Cabinet's commissioning in 1989 an investigation into the proposed designation of Rennell Island as a World Heritage site. Introduced species do not always end up the way intended, and any new introduction to the lake must therefore be carefully assessed. Leary (1993), although he appreciates food-associated benefits of tilapia, saw its introduction as a disturbance and threat to the lake. Introduction of new species would undoubtedly increase such fears, not only for the lake itself but also for the present tilapia, already providing a sufficient protein source.

The Lake Tegano Fishery could be best described as wholly subsistence despite the availability of avenues for development, especially trading with people in other parts of Rennell Island. Because much of the fishing activity is concentrated in only the western end of the lake, it is unlikely that fishing will deplete the tilapia resource.

With the price of marine fish in Honiara high (SI\$10–12/kg), there are possibilities that tilapia could be marketed in Honiara at a much lower price. This could be further enhanced if farming is encouraged around the lake shores.

Because the lake is an enclosed system, the increasing use of the outboard motor canoe in the lake could affect the lake in the long run. Careless resort development on the lake shores would also pose a threat to the lake system. Birds too are increasing in number. These birds occupy two of the lake's eastern islands, and fly in flocks preying on tilapia.

Mozambique tilapia, although receiving a declining welcome from the people, still provides a sufficient source of protein for communities. One of the main reasons the lake communities want an alternative species is more marketable fish, as Mozambique tilapia is regarded as a low-grade fish. Fishers prefer a much larger species than tilapia. This perhaps is one of the reasons why there are currently no management measures in place and fishing is on an open-access basis. Ramohia and Oreihaka (1995) (unpubl.) concluded that anoxic conditions at the bottom of the lake could have been stirred up during cyclones, resulting in mass death and retarded growth of fish. They further suspected that the perceived decreasing size and abundance of fish could

be due to the increasing use of gill-nets, and a result of growth and over fishing. The results of Survey 4 regarding stock and size have indicated a recovering abundance and size, and could well mean that the anoxic conditions have now been reduced and the use of nets decreased due to the associated costs.

Conclusion

The current tilapia species in Lake Tegano is already providing a major protein source for the communities around the lake. Despite the great potential that may be available for aquaculture development in and around the lake, much is yet to be done to fully understand the lake ecosystem. The impacts of introducing a new species to the lake must be investigated, as from experience elsewhere, introductions in the hope that they will be beneficial have not always ended up as intended. In this respect, another option is to look at the feasibility of exploring alternative resources already available in the lake, such as eels and prawns.

Acknowledgments

I would like to thank my colleagues, Michelle Lam for carrying out Surveys 2 and 3, Peter Ramohia for assisting in Survey 1 and Obed Awaohu in Survey 4, for their enthusiasm. The Australian Centre for International Agricultural Research and the Coastal Aquaculture Centre of the International Centre for Living Aquatic Resources Management funded and collaborated in Survey 4. The Provincial Fisheries Officer of Rennell and Bellona Province, Job Togaga, has been very supportive. To you all I owe much gratitude.

References

- Leary, T. 1994. Country Report: Solomon Islands. In: Scott, D.A. ed. A Directory of Wetlands in Oceania, International Waterfowl and Wetlands Research Bureau, UK, 331–361.
- Kile, M.L. 1996. Water sampling survey of Lake Tegano, Rennell Island, Rennell and Bellona Province, Fisheries Division (unpubl.).
- Ramohia, P.C. and Oreihaka, E. 1995. A brief investigation into the Tilapia (*Oreochromis mossambicus*) Fishery and associated problems in Lake Tegano, Rennell Island, Rennell and Bellona Province. Fisheries Division (unpubl.).
- Wolff, T. 1970. The Natural History of Rennell Island, Danish Scientific Press, Copenhagen, 7 vols.

Is Lak Lake Overfished?

**Thai Ngoc Chien, J.D. Sollows, Nguyen Quoc An, Phan Dinh Phuc,
Nguyen Quoc Nghi and Truong Ha Phuong**

Abstract

Fish yields from Lak Lake increased by 2.3% between August 1997 and July 1999, and landed value by 14.1%. However, the status of the Lak fishery is highly species-specific, amounting to an estimated annual yield of 126–130 kg/ha. Over two years of surveys, the study has identified 40 fish species from catches in the lake. Fourteen major species accounted for an estimated 89.2% of the total yield over the two years. Six major gears account for most of the catch from Lak: fence-nets, gill-nets, long-lines, lift-nets, shrimp traps, and electrofishing gear. Data on the effects of electrofishing have not been possible to collect, as electrofishing is now banned. Gill-nets and fence-nets accounted for a total of 84% of the entire recorded yield, and probably put excessive pressure on some species. While overall yield and landed value from the lake have not declined, species diversity and the abundance of native fish species appear to be reduced. Restrictions on increases in fence- and gill-netting, especially the use of small mesh sizes, appear advisable. Electrofishing, which is highly non-selective, should be discouraged, and efforts made to encourage the cooperation of the fishing community in adopting measures to assure yield sustainability.

LAK LAKE has a reported area of 658 ha, the largest standing natural water body of Dak Lak Province, Vietnam. There is roughly 1 m difference between normal high and low water levels. Lak is shallow, with maximum depth of about 3 m at times of high water. Long-time fishers report that the lake is becoming increasingly shallow, and deforestation and landslides add to natural siltation. These phenomena represent the greatest threat to the lake and its fishery.

The stream draining the lake flows about 3 km through flat country to the Krong Ana River, the main tributary of Srepok. Every year or two, at times of high flood, the Krong Ana flows back into Lak. At such times, the catchment area of the lake increases from 108 km² to 3370 km². This backflow adds to the sediment load of the lake, but in the short term positively affects fish production. Flooded land liberates nutrients, and gives fish increased area for growth and reproduction.

The study has identified 40 fish species from Lak Lake as of November, 1999. The high species

diversity can be explained by several factors: it is a natural lake, with fauna already adapted to lacustrine conditions; an abundant growth of macrophytes provides refuges, substrates, and feed to different species; occasional back-flooding by the Krong Ana River also recharges some components of the lake's fauna.

The original human inhabitants of the area belong to the M'ngong ethnic group, who have fished the lake with a variety of traps, spears, long-lines, scoop nets, and since the 1950s, gill-nets. With increasing immigration through the 1980s, the use of gill-nets and lift-nets increased substantially. Seining commenced in the early 1990s, and from 1994, when the district police took over licensing, up to 15 small-mesh seines were permitted to operate. In early 1997, when the Board for the Preservation of History, Culture and Environment of Lak took over management, seining was banned.

Fishers noticed an increase in the abundance of shrimp from the mid-1990s, possibly because of the decline in predatory species. Fence-nets were introduced in 1994, and have become very popular. Shrimp traps, a more selective gear, were introduced in 1995; they are less common than fence-nets and remain important.

Management of Reservoir Fisheries, 69 Le Hong Phong, Ban Me Thuat, Vietnam. Email johns@netnam2.org.vn

Gill-nets and fence-nets are the main gears used in Lak. Lift-nets, long-lines and shrimp trap fishing also contribute significantly to yields from the lake. Pond culture activities are also common in the vicinity of the lake.

Methods

The biological surveys began in January 1997. A frame survey was conducted from May to July 1997, to census fishing gear available around the lake. Six days a month, the fishing effort by the five major gears is estimated. Another six days a month is devoted to collecting catch and effort statistics for each of the gear types: six days are devoted to each of gill-nets, fence-nets, and long-lines. Catch surveys for lift-nets and shrimp traps are conducted on the same days. The catch survey for each gear type is evenly distributed through the month, as is the effort survey. On a given catch-sampling day, detailed data on a sample of five catches per gear type are collected, including fishing effort, and catch by species, number, weight, and value. Each of the five activities (effort survey, and catch survey by gear type) follows a five-day cycle through the month.

A second frame survey was conducted in June 1999.

Gear effort units

Effort units corresponding to each gear were stipulated:

- Gill-net: 100 m²/hr.
- Lift net: 100 m²/hr.
- Long line: 100 hooks/hr.
- Shrimp trap: 100 traps/day.
- Fence net: 4 traps/day.

Effort survey

To know the fishing effort on the lake, we sampled five fishers per gear type, randomly chosen on each of six days of the month. Surveys were conducted on the dates: 3, 8, 13, 18, 23 and 28. Activity coefficient for each gear type (A) was computed thus:

$$H = \frac{\sum_{s=1}^{30} (Uf)_s}{\sum_{s=1}^{30} (Ut)_s} \quad (1)$$

where s = number of fishers,
 Uf = units fished by fishers, and
 Ut = total units owned by fishers.

Average time in a catch day

Average time in a catch day for each gear type was computed thus:

$$T = \frac{\sum ts}{\sum s} \quad (2)$$

where ts = time fished by gear samples, and
 $\sum s$ = total number of gear sampled, normally 30.

Catch survey

For each gear type we collected 30 monthly samples. Catch per unit effort (CPUE) was calculated thus:

$$CPUE \text{ (kg)} = \frac{\sum_{s=1}^{30} Y_s}{\sum_{s=1}^{30} E_s} \quad (3)$$

where s = sample number,
 Y_s = yield for sample s , and
 E_s = effort for sample s .

Estimated production (EP)

EP = TF*H*T*Days in a month * CPUE
 where: TF is total frame for each gear.

Results and Discussion

Major gear types used in Lak include gill-nets, lift-nets, long-lines, fence-nets, and shrimp traps. Electrofishing is widely used and illegal, and data collection on this gear type is not possible. Our yield estimates from Lak are, therefore, probably lower than actual yields.

A second frame survey in June 1999 found a larger number of gill-nets, fence-nets, and long-lines than indicated by the first survey. Hence, yields from Lak for the first half of 1999 are further underestimated.

Estimated production by gear

Fish yield for two periods is presented in Figure 1 (August 1997 to July 1998, and August 1998 to July 1999). Fence-nets and gill-nets caught just over 84% of the yield in Lak, each accounting for similar proportions of the total.

Table 1 shows that estimated production for the first period totalled 83 118 kg, valued at 559 842 157 VND. Total estimated production for the second period was 85 311 kg, valued at 638 846 243 VND. Over two years (August 1997 to July 1999), annual yields were estimated at 126 kg/ha and 130 kg/ha.

Table 1. Production trends for two 12-month periods.

	Parameters	Year (Aug–July)	Yield/value	% of total	Changes (%)
Total production (kg)	Production (kg)	1997–98	83 118	100	+2.3
		1998–99	85 311	100	
	Values (VND)	1997–98	559 842 157	100	+14.0
		1998–99	638 846 243	100	
Stocked fish	Production (kg)	1997–98	947.2	1.14	+393.0
		1998–99	4 672	5.48	
	Values (VND)	1997–98	9 513 800	1.70	+323.0
		1998–99	40 212 000	6.29	
Introduced fish (self-recruiting)	Production (kg)	1997–98	14 387.07	17.31	+7.7
		1998–99	15 501.20	18.17	
	Values (VND)	1997–98	95 669 733.33	17.09	+36.0
		1998–99	130 536 900	20.43	
Shrimp	Production (kg)	1997–98	18 746	22.55	+36.0
		1998–99	25 510	29.90	
	Values (VND)	1997–98	179 352 367	32.04	+46.0
		1998–99	261 406 733	40.92	
Native fish	Production (kg)	1997–98	49 037.39	59.00	–19.0
		1998–99	39 627.55	46.45	
	Value (VND)	1997–98	275 306 256.67	49.18	–25.0
		1998–99	206 690 610.00	32.35	

Note: 1USD = 13 000 VND on average.

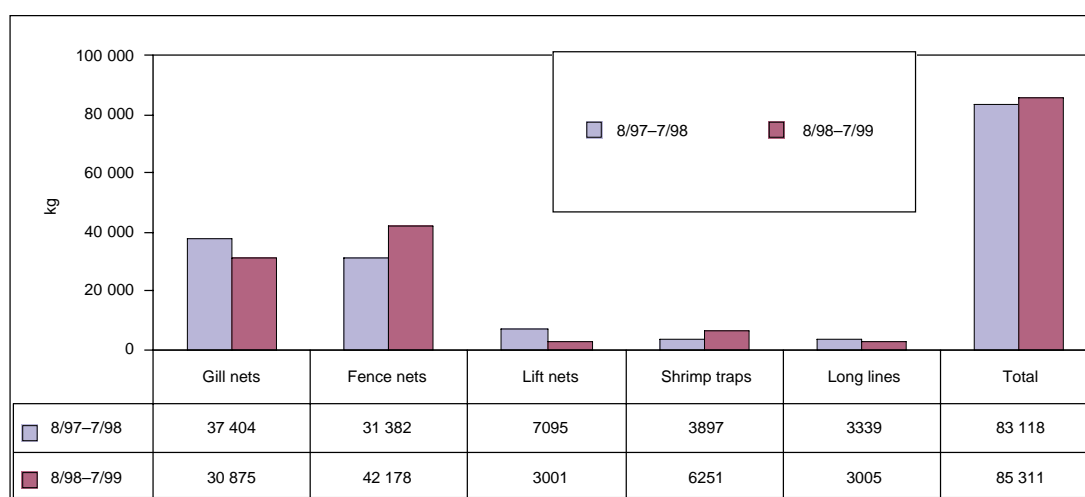

Figure 1. Estimated production by gear over two periods, August 1997–September 1999.

Estimated yields increased by 2.3% between the two periods, and estimated landed value by 14.1%. A small portion of this increase, beginning in July 1999, is thought to be due to the application of the results of a new frame survey. However, it is strongly suspected that any increases are due mainly to the heavy flooding of November 1998.

The performances of various species differ greatly. Yields of all commonly cultured species around the lake (which includes the stocked and introduced species) were higher for the later period: the November 1998 flooding allowed cultured species to escape from ponds around the lake. Annual catch per unit effort (CPUE) for these species increased by 35.8% between the two years under consideration (Figure 2).

Yield of shrimp, which has a high price, rose 36.0% from 18 746 kg to 25 509 kg. Yields of native species dropped by about 19.0%, from 49 036 kg to 39 628 kg. Many lift-nets were damaged by the flood of November 1998. Some fishers were discouraged from using shrimp traps by their high price, short lifetime and high labour demand.

The changes in CPUE suggest that economic pressure may discourage further increases in fishing effort by gill-nets and long-lines (Table 2). The major species which showed decline in abundance were all native: *Osteochilus hasselti*, *Notopterus notopterus*, *O. schlegelii*, *Hampala macrolepidota*, *Rasbora* sp., *Ompok bimaculatus* and *Mystus nemurus* (Table 3). Examination of CPUE trends and catch-effort relationship for the gears to which these species are most vulnerable sheds more light on the situation. It would be desirable to have a longer time-series of data on which to base the following discussion.

Nevertheless, the data suggest some management directions.

Table 2. Fishing effort and CPUE trends for the two periods.

Gears	Change in effort (%)	Change in CPUE (%)
Fence-nets	+27.8	+5.2
Gill-nets	+19.0	-30.6
Shrimp traps	-0.9	+61.9
Long-lines	+52.0	-40.8
Lift-nets	-63.6	+16.3

Featherback (*Notopterus notopterus*)

Annual estimated yields of featherback declined about 6.4% from 8239 kg to 7708 kg over the report period. Nevertheless, it ranked second in landed volume during the second year considered here. While the species has been reported from all major gears except shrimp traps, 52.1% of the yield is reported from gill-nets, 35.6% from long-lines, and 10.5% from fence-nets. Hence the effects of all these gears require some consideration.

Catch per unit effort trends (Figure 3) indicate a similar phenomenon: overall CPUE for gill-nets and fence-nets dropped by 16.4% and 33%, respectively, between the two gears, that for long-lines dropped by 41%. Mean harvested weight over the period for long-lines, gill-nets, and fence-nets were 65 g, 52 g and 47g, respectively. Harvested sizes appear to be declining slowly, at least for long-lines.

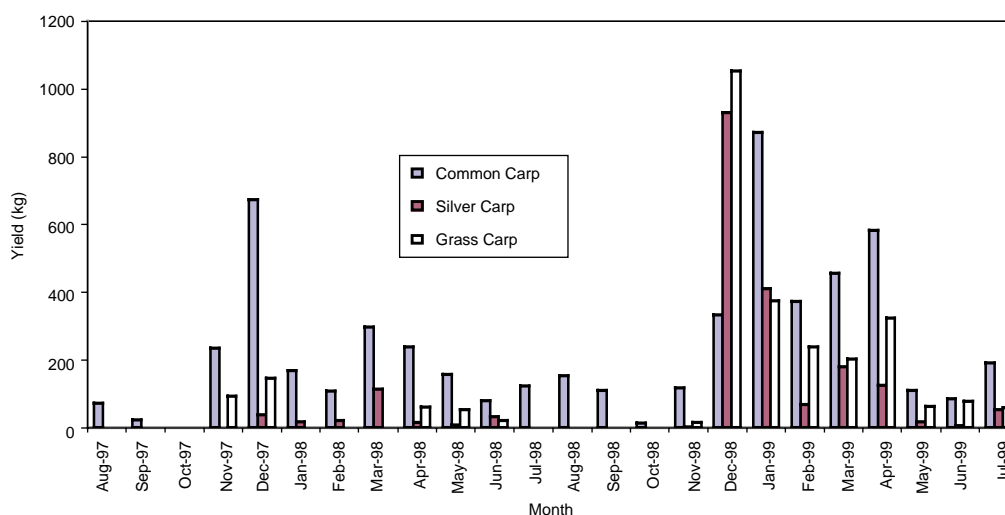

Figure 2. Yields of commonly cultured fish species in Lak, August 1997–July 1999.

Table 3. CPUE trends by major species for the two periods.

Species	Gear	CPUE 97-98	CPUE 98-99	Changes (%)	Trends
Shrimp	Fence net	0.7136	0.7445	+4.3	+
	Shrimp trap	0.4563	0.7406	+62.3	-
<i>Osteochilus hasselti</i> ¹	Gill-net	0.0156	0.0070	-55.0	-
<i>Notopterus notopterus</i>	Gill-net	0.0065	0.0054	-16.4	-
	Long line	0.0458	0.0270	-41.0	-
<i>Toxabramis houdemeri</i>	Lift-net	0.2058	0.2499	+21.4	+
	Fence net	0.1296	0.1140	-12.0	-
<i>Oreochromis</i> sp.	Gill-net	0.0072	0.0088	+22.3	+
<i>Osteochilus schlegelii</i> ²	Fence net	0.2765	0.1566	-43.4	-
<i>Rasbora</i> sp.	Fence net	0.2704	0.1494	-44.8	-
<i>Puntius brevis</i> ²	Fence net	0.1017	0.1995	+96.0	++
	Gill-net	0.00236	0.00153	-35.3	-
<i>Cyprinus carpio</i>	Gill-net	0.0032	0.0044	+35.8	+
<i>Hampala macrolepidota</i>	Gill-net	0.0063	0.0011	-82.6	--
<i>Mystus nemurus</i>	Gill-net	0.0013	0.0009	-32.0	-
	Fence net	0.0214	0.0127	-40.5	-
<i>Ompok bimaculatus</i>	Lift-net	0.0178	0.0320	+79.6	+
	Gill-net	0.0025	0.0010	-62.7	--
<i>Trichogaster trichopterus</i>	Fence net	0.0276	0.0828	+200.5	++

¹Data from Oct. 1997 to Sept. 1998.

²Data for two 12-month periods from Jan. 1998 to Nov. 1999.

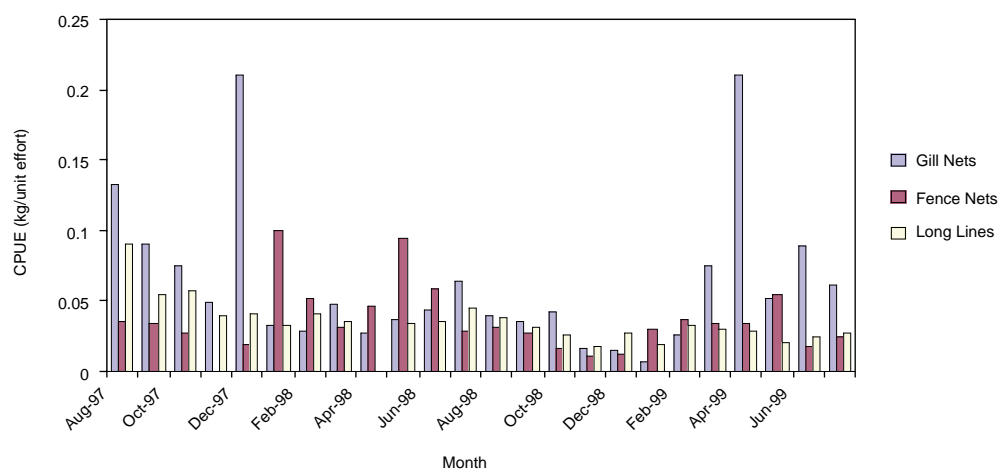

Figure 3. Catch per unit effort for featherback from three gears operating in Lak, August 1997–July 1999.

The curve for gill-nets (see Figure 4) suggests that the fishing effort for this species in 1998–99 was about 10% higher than the optimum. A similar curve for long-lines suggests that the 1998–99 effort was about 30% above the optimum.

However, it must be noted that gill-nets catch a larger proportion of the yield, and both gill-nets and fence-nets tend to catch smaller fish than do long-lines. Hence, the drop in yields with higher long-line effort is due in part to increased fishing by the other two gears, which tend to catch smaller fish.

Ca Me Lui (*Osteochilus hasselti*)

Annual yields of *O. hasselti* dropped from 10 491 kg to 6296 kg, or by about 40% from October 1997 (when this species was first distinguished from other similar species) to September 1999. Gill-nets accounted for about 92.6% of the total catch of *O. hasselti*, and fence-nets only 6%.

The stock appears to be declining in abundance (Figure 5). Overall catch per effort for gill-nets (which accounts for most of the catch) dropped by 55%, from 0.01558 kg to 0.0070 kg × (100 m²/hr). CPUE for fence-nets over the same period increased about 20% from 0.01757 kg/4 trap-days to 0.02113 kg/4 trap-days.

The mean landing weight from gill-nets and fence-nets was 34 g and 11 g, respectively. Fence-nets are catching smaller fish in increasing quantities. If this trend continues, recruitment may be affected.

The curves for this species (Figure 6) suggest that the fishing effort by gill-nets for *O. hasselti* is about 70% above the optimum. Fence-nets, however, remove an appreciable number of fish before they can be caught by gill-nets.

The situation for *O. schlegeli* is similar. Yields are decreasing and fence-nets, which account for most of the yield, catch considerably smaller fish than gill-nets.

Ca Ngua (*Hampala macrolepidota*)

Yields of this species suffered an extremely sharp decline of 79.3% over the reporting period. The yield for the first 12 months was estimated at 4213 kg; that for the last period, only 873 kg. Gill-nets caught 97.1% of the total yield, with lift-nets and fence-nets accounting for the remainder.

Figure 7 represents a drop in annual CPUE of 82.6% for gill-nets over the two years. All signs point to a very rapid decline in abundance.

Mean harvested weights were 63 g for gill-nets, 31 g for lift-nets and 9 g for fence-nets. Fence-nets were very effective at catching smaller fish, particularly during the first five months of 1998. It is possible that this contributed to reduced recruitment by removing fish before they could reproduce.

Mean harvested size of the species from gill-nets appears to be increasing appreciably, with little evidence of recruitment. Whether from over fishing

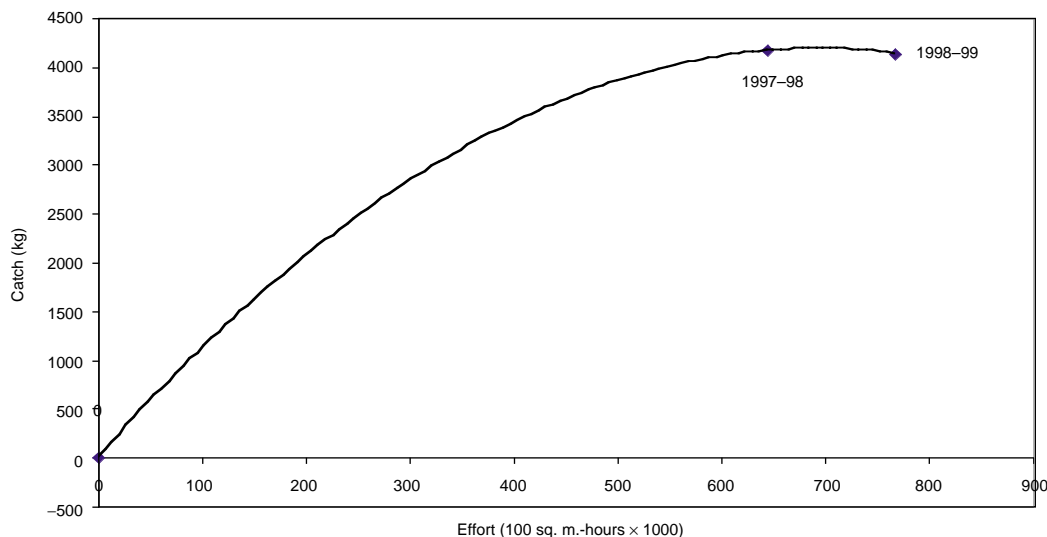

Figure 4. Catch vs. effort for *Notopterus notopterus*, using gill-nets in Lak over two years, August 1997–July 1998.

or other causes, recruitment of this species into the fishery has effectively collapsed.

The catch versus effort curve for the species suggests that the fishing efforts by gill-nets for *H. macrolepidota* is about twice what it should be (Figure 8). Lift-nets, and more especially fence-nets are also removing stock before it can be caught by gill-nets, and possibly before the fish can reproduce.

Ca Dau (*Toxabramis houdemeri*)

The yield of this small pelagic dropped by 31.3%, from 7237 kg to 4972 kg over the reporting period. Lift-nets caught 54.7% of the yield, and the remainder was caught by fence-nets.

Trends in catch per effort for Ca Dau indicate an increase of 21.4% for lift-nets between the two years, but a drop of 12% for fence-nets (Figure 9). In spite

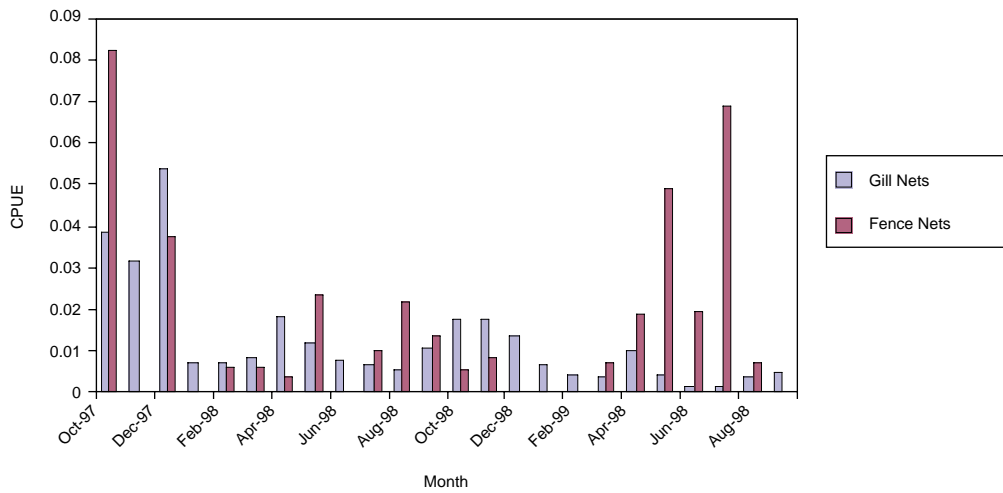

Figure 5. Catch per unit effort for *Osteochilus hasselti* from two gears, operating in Lak, October 1997–September 1999.

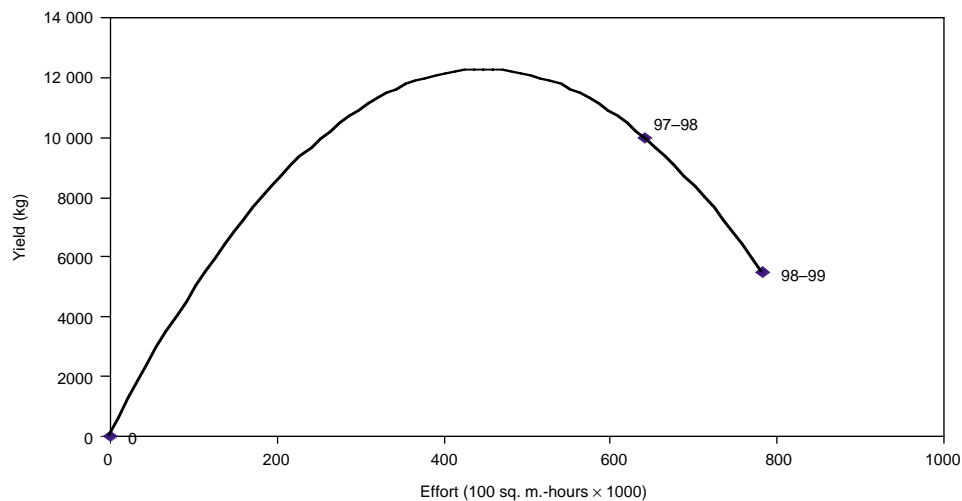

Figure 6. Catch vs. effort for *Osteochilus hasselti* using gill-nets in Lak over two years, October 1997–September 1999.

of the drop in annual yield over the reporting period, the species appears to have made a considerable recovery, beginning in March 1999. This may be due in part to the November floods and consequent reduced effort by lift-nets, many of which were damaged by the floods.

Ca Sac (*Trichogaster trichopterus*)

Yields of Ca Sac increased 251% from 616 kg to 2162 kg between the two years under study. Fence-

nets accounted for 96.3% of the catch, the remainder caught by gill-nets.

Catch per unit effort increased by 200% between the two years under consideration (Figure 10). The species seems to be enjoying a major increase in abundance. It should be noted that there was a prolonged drought from November 1997 to May 1998. The late November 1998 flooding may have had a role in maintaining the high levels of abundance, as these fish invaded flooded rice fields around the lake and were caught there, as well.

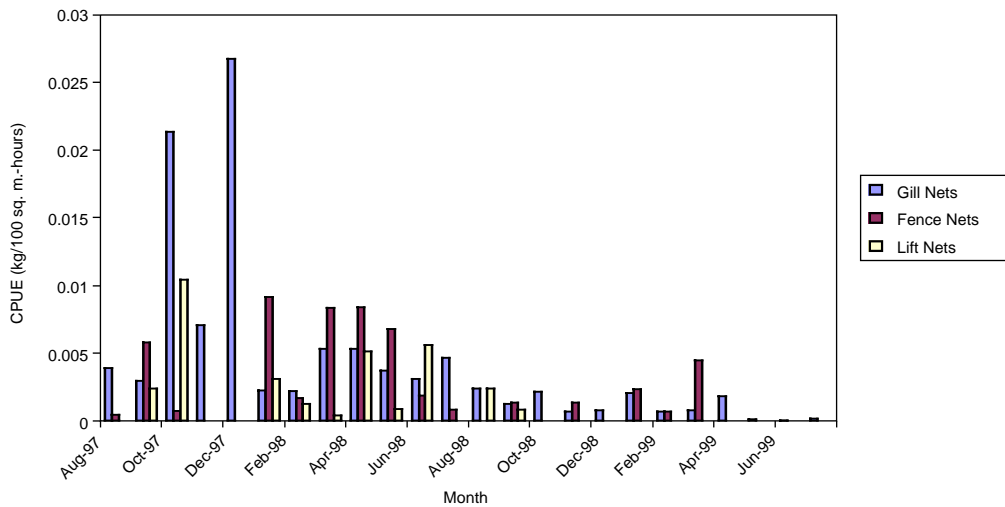

Figure 7. Catch per unit for *Hampala macrolepidota* using three gears in Lak, August 1997–July 1999.

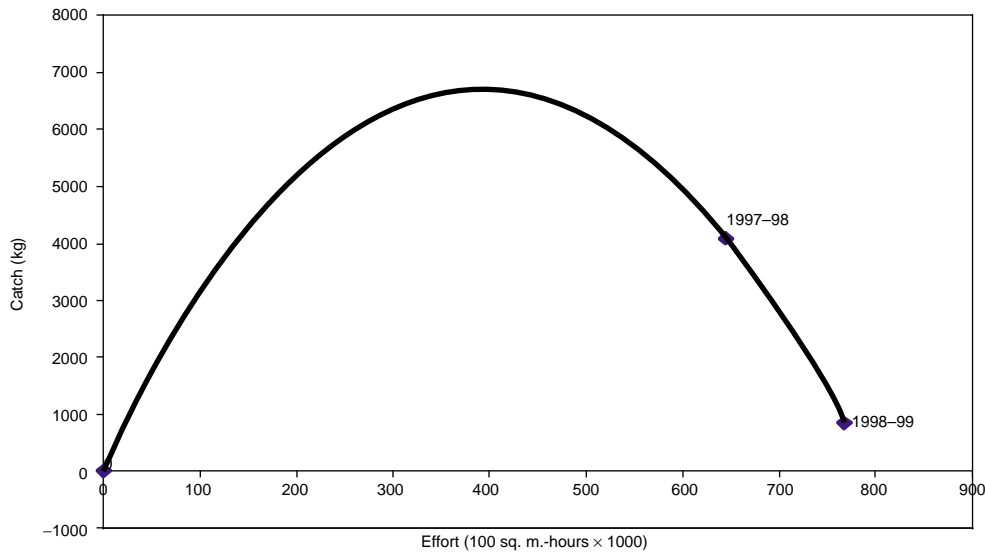

Figure 8. Catch vs. effort for *Hampala macrolepidota* using gill-nets in Lak over two years, August 1997–July 1998.

Conclusion

While year-to-year changes in the faunal composition of a water body are normal, the factors affecting these changes in Lak deserve consideration. Siltation and fluctuations in water quality will give some species competitive advantages. Apparent increases in the abundance of *Oreochromis* sp. and *Trichogaster trichopterus* are cases in point. Heavy fishing effort has undoubtedly also played a role. The reduction in abundance of some predators may enhance the abundance of their prey. Fishers suggest that this may help

explain the apparent increase in the abundance of shrimp.

In general, current fishing effort, especially by fence-nets and gill-nets, may be adversely affecting yields of *Osteochilus hasselti*, *O. schlegeli*, *Hampala macrolepidota* and *Notopterus notopterus*.

The Lak fishery is affected by external factors as well as fishing activities. Notable among these is siltation, which threatens the existence of the lake. Human activities such as deforestation and erosion in the catchment area have caused the lake to become shallower.

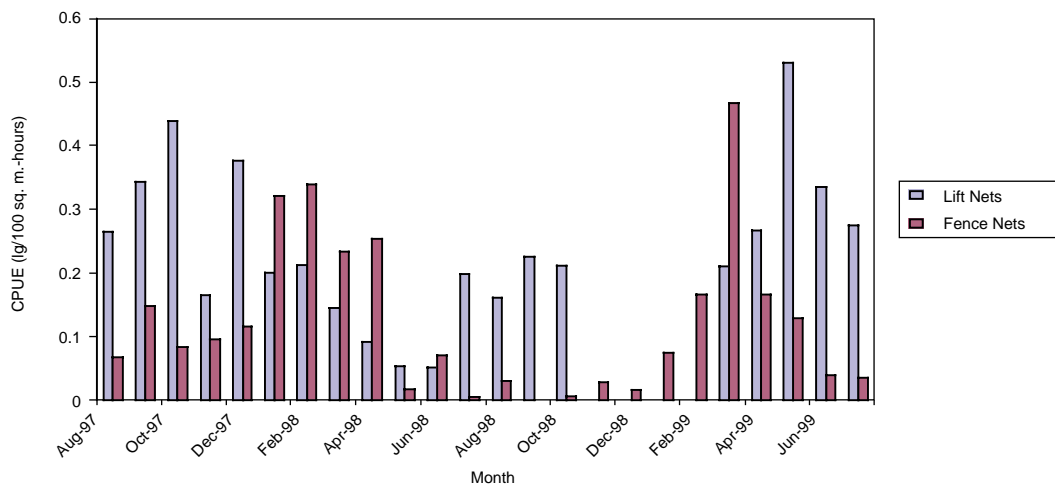

Figure 9. Catch per unit effort for Ca Dau from two gears in Lak, August 1997–July 1999.

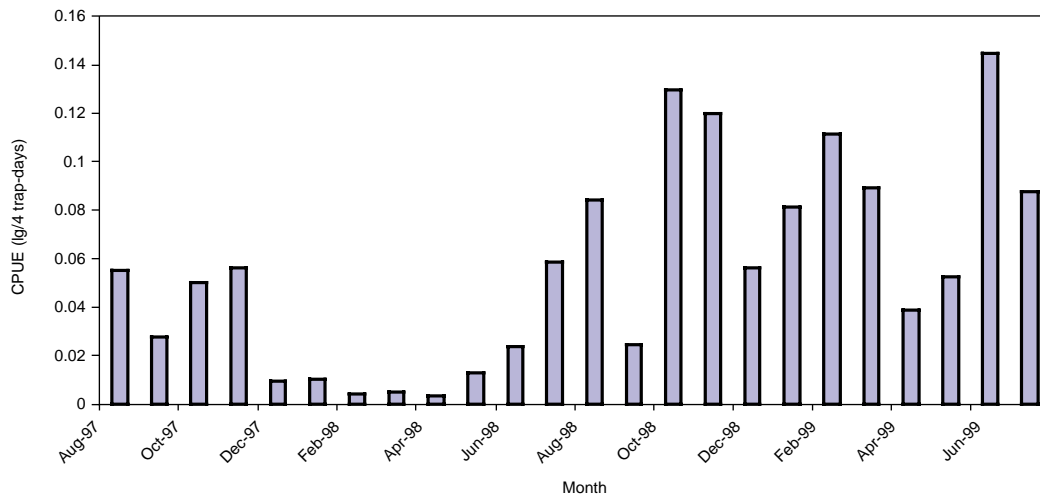

Figure 10. Catch per unit effort for Ca Sac, using fence-nets in Lak, August 1997–July 1999.

The role of water regimes is also important factor in determining the abundance of various species. The abundance of a number of species after the flooding of late November 1998, and some species were sparse during the long drought between November 1997 and May 1998. Fishers have also suggested that the appearance of *Trichopsis vittatus* in August 1998 was due to the beginning of the rainy season and the accompanying floods. Although flooding shortens the life of the lake by importing silt, it appears to have a highly beneficial effect on fish production.

The fishing gears considered here do not represent a complete list. Yield estimates do not take into account the effect of electrofishing. There are battery- and dynamo-operated electrofishing apparatuses in some locations. Among the gears under study here, the effort by gill-nets and fence-nets appears to exceed the optimum, based on data for a number of major species.

Of the major species considered here, the CPUE for five species has decreased: *O. hasselti*, *O. schlegeli*, *N. notopterus*, *Rasbora* spp. and *H. macrolepidota*. The decline in *H. macrolepidota* is particularly sharp.

Fishing efforts of gill-nets, fence-nets and long-lines increased by 19%, 27.8% and 52.0%, respectively. These increases, particularly in gill-nets and fence-nets, could well have adversely affected some native fish species.

The apparent 1999 increases in the abundance of *T. houdemeri* followed the destruction of some lift-nets by the November 1998 flood. This suggests that the earlier fishing effort was excessive. The CPUE for shrimp, *Oreochromis* sp., *Cyprinus carpio* and *T. trichopterus* increased. However, the increase in the case of *C. carpio* may have been due in part to escapes from ponds in the vicinity of the lake after flooding in November 1998. Increases in abundance of some species may be due to declining populations of predatory species or changes in limnological conditions that give them a competitive advantage.

The economic output from the lake is increasing, in spite of the declining yields of many native fish species. This is due mainly to the increase in shrimp yields, which made up 22.6% of the total yield in 1997–98 and 32% of the value. These shares increased the following year to 29.9% of the total yield and 40.9% of the value.

Is Lak over fished? This is the wrong question. Production over the reporting period was stable. There have been changes in the fauna of the lake. While other environmental factors may be responsible, the high fishing effort by some gears has probably contributed to the decline of some species. Native fish species, in general, are decreasing, and the potential loss in biodiversity is of concern.

Recommendations

1. The ban on electrofishing, particularly dynamo-powered electrofishing, should be enforced. It is indiscriminate in damage to stock.
2. Protection of breeding stocks is advisable. Breeding areas should be closed to efficient fishing gears (gill-nets, fence-nets, and lift-nets) in the breeding season. Similarly, small mesh gear should not be deployed in known nursery areas, in order to give as many juvenile fish as possible the chance to reach sexual maturity.
3. Fishing effort by fence-nets and gill-nets, especially small-mesh gill-nets, should not be increased, and reductions in both gears are desirable. Fishers who rely on these gears should be encouraged to consider alternate sources of supplementary income.
4. Shrimp can probably withstand more fishing pressure. A modest expansion in the shrimp trap fishery should do no harm, since that gear is highly selective.
5. Stocked herbivorous fish may help control the dense macrophytes in the lake, but since flooding is relatively frequent, and the fishery is relatively unregulated, losses of stocked fish would certainly limit returns.
6. The shallowness of the lake and wide fluctuation in water quality make the viability of cage-fish culture very doubtful. Pens may work in a few areas, but are very expensive, and can interfere with access to the lake and with breeding and nursing wild fish.
7. Siltation and erosion must be mitigated in order to extend the life of the lake.
8. To conserve fish resources, fishery regulations must be established and enforced. That would reduce the extreme fishing pressure that is partially responsible for changes in species abundance. To achieve any success in adopting these restraints, training for fishers and their involvement in the development and enforcement of regulations are necessary.
9. Steps needed to assure the sustainable exploitation of the Lak fishery may go beyond the fisheries sector. The catchment area must be maintained, and poor fishers and other users of catchment area resources should be able to choose between current practices and more sustainable ones.

An Assessment of the Fisheries of Four Stocked Reservoirs in the Central Highlands of Vietnam

**Tran Thanh Viet, Do Tinh Loi, Nguyen Ngoc Vinh, Phan Dinh Phuc,
Phan Thuong Huy, Thai Ngoc Chien, Nguyen Quoc An and
J.D. Sollows***

Abstract

Stocking and capture results are considered for four reservoirs ranging in area from 5.37 to 210 ha in Dak Lak Province, in the Central Highlands of Vietnam. In all reservoirs, the fish yield is dominated by regularly stocked species, which make up 71.9–99.8% of the total yield over the eight reservoir harvesting years considered. Stocking proved highly cost-effective in most cases. Returns for silver carp were particularly high. Preliminary recommendations with respect to stocking density and size are given, to the extent possible. Every reservoir is unique, and the most appropriate recommendations are therefore reservoir-specific. In general, smaller reservoirs have higher carrying capacity per hectare than larger ones, but other factors also affect the recommendations. The importance and composition of self-recruiting species are cases in point. The uniqueness of each reservoir was brought out by a study of catch versus effort, which indicated that caution is needed in making broad recommendations. The apparent optimal effort suggested by data combined from three reservoirs could be inapplicable in particular water bodies. Further data from continued surveys are needed to generate robust recommendations with regard to stocking and appropriate effort levels for particular reservoirs.

THE Central Highlands of Vietnam have rich soil and two seasons, rainy and dry, annually. The highland region has about 500 reservoirs, most built after 1975, ranging in acreage from one to 6400 ha (MoF 1995).

The indigenous freshwater fish fauna consist of about 150 species (similar to Mekong and Red River fish fauna) and include mainly riverine and marsh-dwelling forms. A report of the Ministry of Fisheries (1995) identified 47 species in reservoirs, but the actual number is greater. The inland reservoir fisheries of the Central Highlands have developed relatively recently and depend largely on exotic species. Seven species have been introduced into the reservoirs, including silver carp, bighead carp, grass carp, common carp, tilapia, rohu and mrigal. The establishment and the success of the exotic species have been considered a major reason for the development of inland fishery in the Central Highlands. But

fish yields and catch composition from different water bodies are quite different, depending on various factors including geological history, catchment, water resource management, exploitation and stocking density.

The project for management of reservoir fisheries has been conducting studies in six water bodies in Dak Lak Province in the Central Highlands. Field activities began in 1996, and all were covered by mid-1997. Physical data on the water bodies are shown in Table 1.

The figures are based on data from Dak Lak Water Resource Scheme and SWAP in Dak Lak Province. All water bodies have similar geographical and climate regimes. Ea Kao, Yang Re, Ea Kar and Ho 31 are regularly stocked. Stocking data for the reservoirs are given in Table 2.

Fingerlings for these reservoirs were supplied from hatcheries in Dak Lak and Ho Chi Minh City (about 400 km away). Managers of reservoirs have to choose species and density for stocking reservoirs, considering the cost of fingerlings, fish availability and recapture rate.

*Management of Reservoir Fisheries, 68 Le Hong Phong, Ban Me Thuot, Vietnam. Email: johns@netnam2.org.vn

Table 1. Physical data on the water bodies.

Water bodies	Start const.	End const.	Area (ha)	Volume (million m ³)	Catchment area (km ²)	Draw-down (m)
Ea Kao	1976	1986	210	10.00	104	5.00
Ea Kar	1977	1984	141	7.40	27	8.00
Yang Re	1982	1984	56	5.40	17	6.53
Ho 31		1980	5.37	0.31	<15	
Ea Soup	1978	1980	240	7.50	350	2.60
Lak Lake	Natural lake		658	13.00	108	About 1

Table 2. Stocking data.

Reservoir	Year	Species	No.	No./ha	Average weight (g)
Ea Kao	1996	Bighead	596 773	2 842	0.40
		Silver carp	361 977	1724	0.55
		Grass carp	150	1	2.67
		Rohu	7 880	38	0.67
	1997	Silver carp	509 006	2 424	0.56
		Rohu	62 346	297	0.88
	1998	Silver carp	258 731	1 232	0.55
		Bighead	100 444	478	0.50
		Common carp	201 806	961	0.50
		Grass carp	141	1	2.00
		Rohu	96 329	459	0.60
		Mrigal	21 519	102	0.70
	Ea Kar	1996	Bighead	84 000	596
Silver carp			615 650	4 366	0.36
Rohu			3 700	26	0.30
Common carp			153 000	1 085	0.42
1997		Silver carp	18 888	134	0.94
		Rohu	253 464	1 798	0.54
1998		Grass carp	517	4	1.99
		Common carp	280 398	1 989	0.64
		Common carp	499 641	3 544	0.46
		Rohu	109 690	778	2.50
Yang Re	1997	Silver carp	207 002	1 468	0.76
		Grass carp	7 569	54	2.30
		Silver carp	179 000	3 196	1.48
		Grass carp	46 300	827	1.94
	1998	Indian carp	136 800	2 443	1.14
		Silver carp	77 717	1 388	0.92
		Bighead	21 697	387	5.16
		Mrigal	22 006	393	2.50
Ho 31	1997	Rohu	1 200	21	6.67
		Tilapia	226	4	3.27
		Common carp	49	1	2.86
		Silver barb	24	0	5.42
		Bighead	282	49	2.74
		Rohu	45 748	8 026	0.33
	1998	Common carp	4 061	712	1.70
		Tilapia	36	6	3.33
		Common carp	5 000	877	0.33
		Silver carp	25 000	4 386	0.33
Mrigal	36 000	6 316	0.40		

This paper considers the effectiveness of stocking in these four water bodies and makes some preliminary recommendations on stocking rate and sizes. Some comments on methodologies for assessing appropriate levels of fishing effort are also offered.

Materials and Methods

At the time of stocking, biologists were present to take samples of each species. Three samples of about 100 g each were collected from each stocked hapa. Each sample was weighed and counted, and the individual lengths and weights of all fish in the sample recorded. Total weight of fish in each hapa was recorded from the sellers and reservoir fisheries management. Prices were also recorded.

Catch assessment, based on catch and effort data by species, gear types, and month, was the main approach used in assessing the fisheries in the various water bodies. Each water body was visited by a team of biologists, according to a monthly routine summarised in Table 3.

Initially, it was hoped that production by species and gear type could be estimated by census: the catch would be calculated on a selected number of days, and the average daily catch by species and gear type applied to the entire month.

It was not possible to count the catch in Ea Soup and Lak, since the fisheries there are less controlled. Therefore, a stratified sampling scheme was needed to estimate production. A frame survey was conducted to census the gear around each water body. Six days a month, an effort survey was carried out to determine the total fishing effort for each gear type for a randomly selected sample of fishers in predetermined parts of the water body. The results of this effort survey were then applied to the entire water body for the entire month to estimate the fishing effort for the month. This tends to accommodate active days, since the fishing effort on non-active days would be counted as zero. Finally, catch surveys were conducted six days a month for each

gear type. Data were collected on fishing effort, as well as catch by species and number. Average catch per unit effort for each species was then multiplied by the fishing effort for each gear in order to estimate the yield for the species, for a particular gear in a particular month.

The fishery in Ho 31 is managed somewhat like a pond. Virtually all the fish are harvested when water level is at its minimum, normally in April and May. The fish are caught over about a week, as the level is lowered to the minimum possible. At this time, project biologists census the catch throughout the catching period. Stocking follows, usually within a month, once water levels have risen acceptably.

Data are entered into the computer and analysed through EXCEL and ACCESS programs.

Results and Discussion

Fish yields from stocked and unstocked water bodies

It is instructive to compare yields of stocked and self-recruited fish from the six water bodies for set periods. Here, comparisons are made for all water bodies for two periods, August 1997–July 1998, and August 1998–July 1999 (Table 4).

The reader's attention is first drawn to the difference in total yield per hectare between the four stocked and two unstocked reservoirs (Ea Soup and Lak). The lowest observed yield from a stocked reservoir was 322 kg/ha (Ea Kar; August 1998–July 1999). The highest yield from an unstocked water body was 252 kg/ha from Ea Soup (August 1998–July 1999).

This by itself suggests that stocking has the potential to increase considerably fish yields in the Central Highlands. Wild (self-recruiting) fish yields tend to be higher in the unstocked water bodies, although there is overlap between figures for Lak (unstocked) and Ea Kao (stocked). The unstocked water bodies have a considerably greater number of fish species.

Table 3. Sampling schedule in project water bodies.

Water body	Visits/month	Data collected since	Day/visit	Supplemental data	Production estimate method
Ea Kao	1	July 1996	6	Fishing team daily records	Census
Ea Kar	2	January 1997	2	Extensionist records 15 days/month	Census
Yang Re	2	April 1997	1	Data collector daily records	Census
Ho 31	Variable	April 1997	Variable	None	Census
Ea Soup	2	June 1997	3	Data collector daily records	Stratified sampling
Lak	3	January 1997	3	Data collector daily records	Stratified sampling

A total of 33 species in Lak and 53 in Ea Soup have so far figured in the catches. The actual number of species is somewhat higher, since others have appeared in negligible quantities. In Ea Kao, Ea Kar, and Yang Re, the number of species recorded from the catches is 19, 12 and 15, respectively.

The relatively low number of self-recruiting species in the stocked reservoirs may suggest a negative effect of stocking on some indigenous species. However, the two unstocked water bodies have other features which favour a large diversity of species. Both lie relatively close to major rivers, which should carry a greater diversity of species than streams higher in the catchment area. Both unstocked water bodies have low draw-downs, and consequently, abundant macrophyte cover, which gives shelter, substrate, and food for a greater variety of fish species. Large catchment areas may also encourage higher productivity and allow spawning by more species. Hence the difference in species diversity between these stocked and unstocked water bodies does not prove a negative effect of stocking on wild fish species.

Cost-effectiveness of stocking, and performance of individual species

Species performance on a reservoir-by-reservoir basis is summarised in Table 5.

Returns on the cost of stocking were, in general, high. In particular, silver carp had a high recapture rate and high potential productivity per hectare, both of which led to a high return on investment (despite a relatively low price). This, along with high availability, helps explain their dominance among the stocked reservoir species.

Relationships between a number of stocking and production parameters were considered in order to get

estimates of carrying capacity and, ultimately, appropriate stocking rates and sizes for various species.

In many cases, there were insufficient data to allow any indication of relationships between various parameters. Variation among reservoirs often tends to confound relationships. The conclusions given here should be considered preliminary and approximate, of use as general guidelines, particularly for inexperienced managers. Since every reservoir is unique, these schemes should be fine-tuned to the circumstances of each reservoir.

In the following section, attempts are made to estimate appropriate stocked size and carrying capacity according to reservoir size, for each species stocked. This assumes that the fish have reached their maximum possible size under the actual densities in each reservoir, and considers cases where mean harvested size is relatively low, suggesting competition.

Silver carp

In this and other cases, carrying capacity is estimated multiplying the number recovered per hectare by the mean harvested weight.

Carrying capacity per hectare, not surprisingly, decreases with increasing reservoir area.

On this basis, a 5-ha reservoir should have a carrying capacity of about 1800 kg/ha, a 50-ha reservoir 700–800 kg/ha, and a 150–200-ha reservoir about 400 kg/ha. The largest mean caught size recorded was somewhat over 600 g. Silver carp larger than 700–800 g tend to have roughly a 20% higher price than smaller fish. A desirable average size of 800 g leads to carrying capacities of 2250 harvestable fish/ha in a 5-ha reservoir, about 1000/ha in a 50-ha reservoir, and about 500/ha in a 150–200-ha reservoir.

Table 4. Fish yields from stocked and unstocked water bodies (*=total yield).

Water body	Area (ha)	No. fish species in catches	Period							
			August 1997–July 1998				August 1998–July 1999			
			kg/ha*		Self-recruited*	kg/ha		Self-recruited*		
			kg/ha	%		kg/ha	%			
Ea Kao	210	19	734	604	82.3	130	442	318	71.9	124
Ea Kar	141	12	454	453	100	0	322	308	95.7	14
Yang Re	56	15	566	502	88.7	65	584	501	85.8	83
Ho 31	5.37	8	1 307	1 301	99.5	6.13	971	949	97.7	22
Ea Soup	240	53	217	6	2.8	211	252	4	1.6	248
Lak	658	33	126	1	0.8	125	130	7	5.4	123

Notes: 'Stocked' species do not include common carp and tilapia, except in Ea Kar and Ho 31, where regular stocking with common carp is necessary to maintain stock.

While the data are too sparse to indicate a relationship, stocking at a size above 0.5 g appears strongly advisable. More data are needed to indicate whether or not an optimal stocked weight exists. It appears that fingerlings should be at least 0.5 g in weight, with a 1 g weight preferable.

Recovery rate for silver carp appeared to be more a function of stocked size than reservoir area, with fish between 0.5 and 1.2 g achieving recoveries of 35–45%. Given a 40% recovery rate for fish of this size range, stocking rates of 5500/ha appear advisable for small (5-ha) reservoirs, 2500/ha for 50-ha reservoirs, and 1250/ha for 150–200-ha.

Higher stocking rates would apply for smaller fish and lower rates for larger fingerlings. The data are not sufficient to give precise estimates here.

Bighead carp

Data for bighead carp do not give a clear picture, except in the case of Ea Kao. Densities were usually so low that carrying capacity was not reached. In Ea Kao, a yield of 172 kg/ha was calculated at a low mean harvested weight of 466 g. This yield can be

taken as a rough estimate of carrying capacity, and is about 40% that suggested for silver carp (400 kg/ha) in similar-sized reservoirs.

Bighead is a plankton feeder, like silver carp. Assuming similar carrying-capacity dynamics and catchability, then, we can estimate that the carrying capacity for bighead is about 40% that of silver carp, or about 700 kg/ha for a 5-ha reservoir, 300 kg/ha in a 50-ha reservoir, and 160 kg/ha in a 200-ha reservoir. Desirable minimum harvested weight is about 1 kg, so these numbers apply to the number of fish, as well.

Table 6. Estimates of silver carp carrying capacity by reservoir area.

Reservoir area (ha)	No. recovered/ha	Mean caught weight (g)	Est. carrying capacity (kg/ha)
5.27	4 913	362	1780
56	1 085	586	635
141	472	674	318
210	667	566	378
210	1 066	383	408

Table 5. Parameters of stocking effectiveness by species and reservoirs (* = total yield).

Species	Reservoir	Period	Recaptured (%)	Recaptures (per ha)	Mean caught weight (g)	Stocking efficiency	Yield* (per ha)	Net benefit ha (1000 VND)	Benefit: cost
Silver carp	Ho 31	4/97–6/98	44.00	4913	362	?	1780	5111	4.57
		5–6/99	12.30	572	1065	392.16	609	2155	7.71
	Yang Re	12/97–5/99	34.60	1085	586	170	635	2735	10.90
	Ea Kar	11/97–6/99	10.50	472	674	186	318	1587	9.84
	Ea Kao	6/97–5/98	38.70	667	566	401	378	1646	30.45
Bighead carp	Ho 31	6/98–4/99	44.00	1066	383	300	408	1751	20.15
		5–6/98	2.48	1.30	800	7.24	1.04	–3	–0.42
	Yang Re	12/97–12/98	20.70	12.4	2713	313	33.5	180	37.5
		1–8/99	22.10	85.5	1139	48.8	97.5	482	8.86
	Ea Kar	7/97–8/98	0.61	3.64	687	8.80	2.5	–16	–0.54
Common Carp	Ea Kao	9/97–12/98	12.90	367.9	466	200	172	687	8.04
		Ho 31	4/97–6/98	2.46	110	501	?	55.3	35
	Ea Kar	10/97–7/98	7.31	145	455	52.3	66.2	607	5.02
Indian carp	Yang Re	8/98–7/99	2.88	102	406	25.3	41.4	275	1.53
		12/97–3/99	11.60	283	593	60.5	168	1484	7.59
	Ea Kar	1/98–2/99	27.00	485	325	164	158	1303	11.1
Rohu	Ho 31	4/97–6/98	5.67	483	633	107	306	1270	1.24
		2–12/98	8.84	26.3	446	44.9	11.7	83	8.01
Mrigal	Ho 31	5–6/99	12.20	819	372	114	305	1730	4.30
Grass carp	Yang Re	12/97–8/99	2.04	16.9	1318	13.9	22.2	134	2.02
		Ea Kar	9/97–10/98	26.50	0.97	461	61.2	0.447	4
		11/98–8/99	15.70	8.44	410	28.1	3.46	26	8.14

Notes: Stocking efficiency = captured weight/stocked weight.

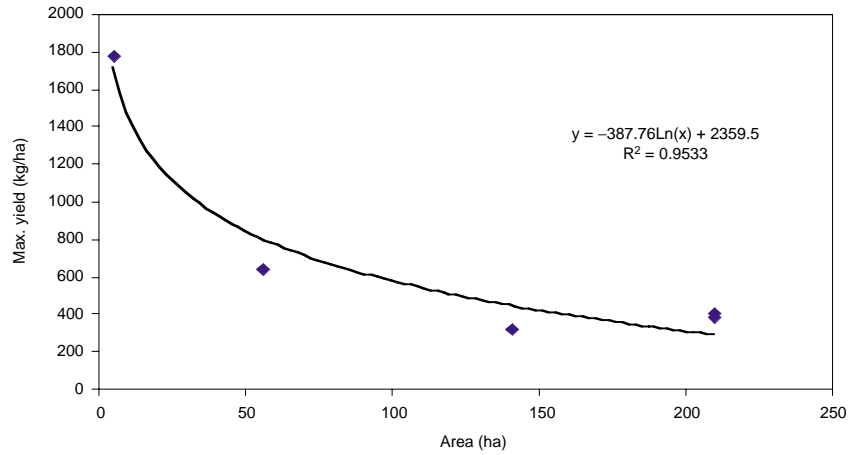

Figure 1. Estimated carrying capacity of silver carp to reservoir area.

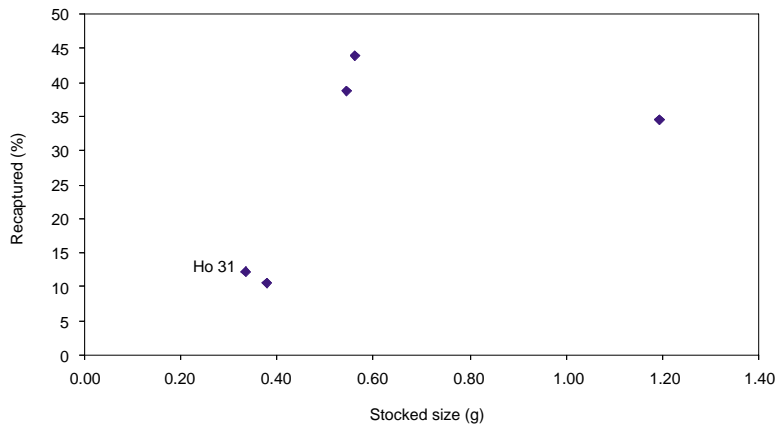

Figure 2. Recovery rate to mean stocked weight, silver carp.

Factors other than stocked size can limit recovery, so the maximum tendencies are of the greatest interest, here. While more data are needed for confirmation, the suggestion from this plot is that stocking a size of much smaller than one gram is likely to lead to low recoveries. In light of the high scatter of points in these plots, considerably more data are needed before strong conclusions can be drawn regarding optimal stocking sizes for bighead.

Stocking fish of about 2 g appears to give about 20% recovery, more often than not. Assuming 20% recovery, possible stocking rates would be 3500/ha for a 5-ha reservoir, 1500/ha in a 50-ha reservoir, and 800/ha in a 100-ha reservoir. Rates should be higher if smaller fish are stocked.

It must be emphasised that more data are desirable in order to confirm the carrying-capacity dynamics of bighead. These recommendations are highly tentative.

Indian major carp

Table 7. Estimates of Indian carp carrying-capacity by reservoir area.

Reservoir area (ha)	No. recovered/ha	Mean caught weight (g)	Carrying capacity (kg/ha)	Major species
5.37	483	633	306	Rohu
5.37	819	372	305	Mrigal
56	283	593	168	Mrigal
141	485	325	158	Both

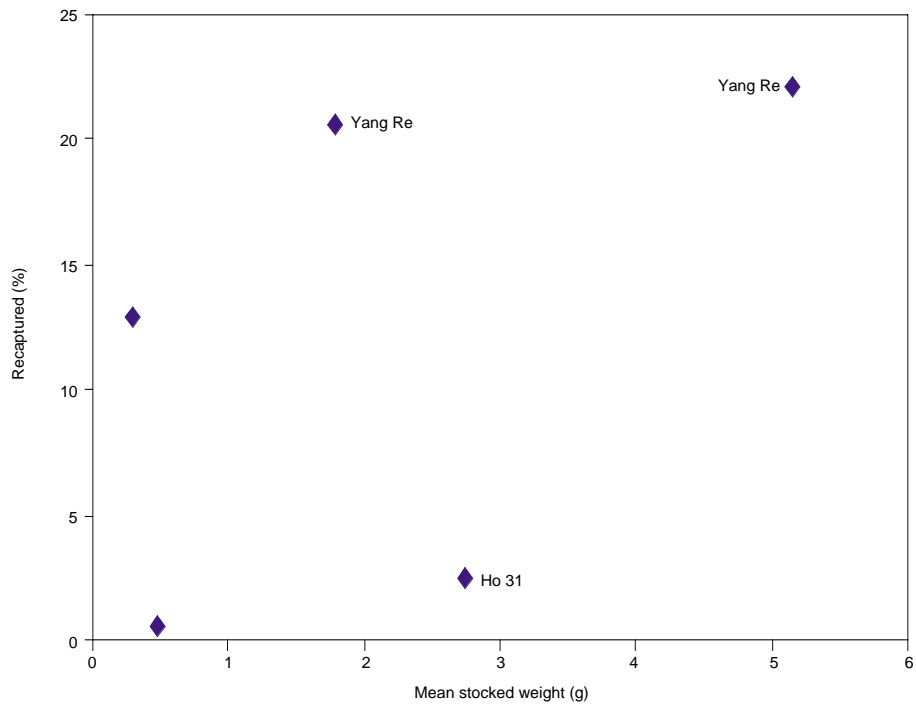

Figure 3. Recovery rates to mean stocked weights, bighead.

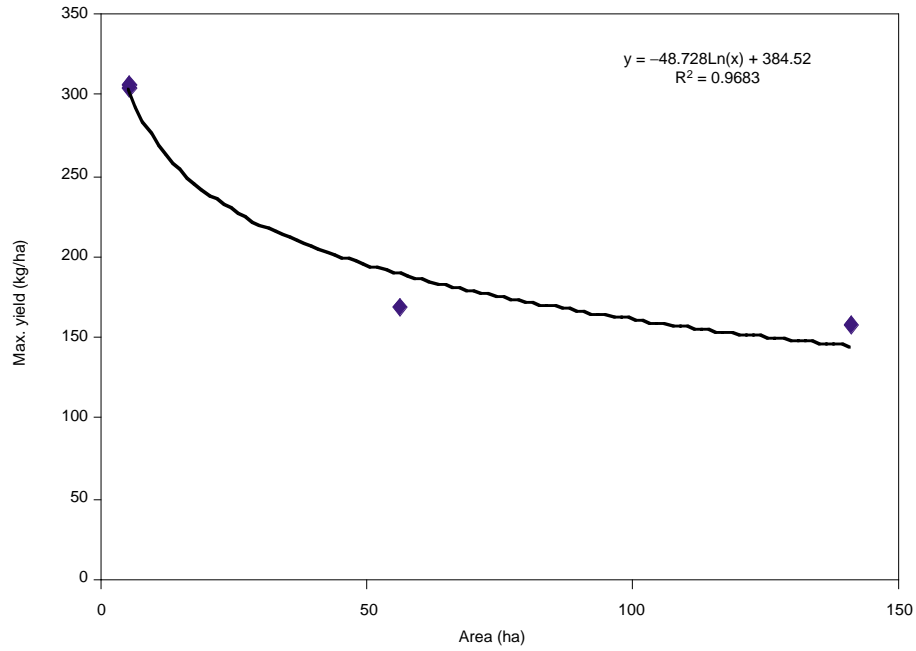

Figure 4. Estimated carrying capacity of Indian carp to reservoir area.

The paucity of available data makes this plot not very helpful. The smallest mean harvested weight was about 325 g (Table 7). If this is taken to represent carrying-capacity of the reservoir in question, then 150–200 ha reservoirs can be taken to have a carrying capacity of about 150 kg/ha. Fish caught in Yang Re averaged considerably larger (593 g) and a carrying capacity of 200 kg/ha for 50-ha reservoirs is a reasonable first guess, on that basis. A capacity of 300 kg/ha appears to apply in 5-ha reservoirs like Ho 31, at least for mrigal. That for rohu may be slightly higher. If a mean caught size of 500 g is preferred, then the number of fish recovered should not exceed 300/ha for larger reservoirs, 400/ha for 50-ha reservoirs, and 500/ha for 5-ha reservoirs.

The data indicated no relationship between recovery rate and stocked size. Given an average observed recovery rate of about 15%, a stocking rate of 2000/ha for larger reservoirs seems advised, assuming a stocking size in the 0.5–1 g range. Stocking rates of up to 4000/ha should be workable in smaller reservoirs.

Two factors confound these analyses.

It would be desirable to partition this stocking rate between rohu and mrigal, but there are insufficient data to allow it and the two species are sometimes not distinguished at stocking. This stocking rate should be considered applicable to a combination of both species, with an advisable rate for either species alone at half to three-quarters this level.

The presence of common carp also appears to affect the carrying capacity of the reservoir for

Indian carp, especially mrigal. When common carp and mrigal are both present in high densities, growth of both species tends to suffer. Common carp tends to have a higher price and is usually self-recruiting. Hence, if it is an important species in the reservoir, mrigal should be stocked only incidentally.

The presence of substantial numbers of tilapia or indigenous species could similarly affect appropriate stocking levels for Indian major carp.

Common carp

Common carp were stocked in only two of the reservoirs under study, Ho 31 and Ea Kar. In Ea Kar, natural recruitment is also strongly suspected of contributing to production. Very low water levels in early 1998 might have had adverse effects on recruitment of the Ea Kar 1988–99 cohort. Competition with Indian major carp, especially mrigal, probably also has an effect on growth and production of that species. Rohu dominated the Indian carp catch in the first year under consideration, for both reservoirs. In the second year, mrigal were predominant. Hence, the reduced growth and production of common carp observed in the second year in both reservoirs are probably due in part to competition with mrigal.

Recoveries of common carp tended to be low, but so were stocking sizes. Stocking sizes of at least one gram should be tested.

Grass carp

This species is sporadically stocked, typically at very low densities. The three larger reservoirs have very

Table 8. Catch by gear type.

Gear type	Ea Kao				Ea Kar				Yang Re			
	Period 4/97–3/98	(%)	Period 4/98–3/99	(%)	Period 4/97–3/98	(%)	Period 4/98–3/99	(%)	Period 4/97–3/98	(%)	Period 4/98–3/99	(%)
Bottom covered	248	0.16	1 807	1.49								
Integrated	39 948	26.53	7 090	5.85								
Trap catch	56	0.04	0	0					22	0.25	47	0.10
Cast net	838	0.56	0	0								
Lighted net	0	0	295	0.24	12	0.03	1 389	2.55				
Long-line	0	0	172	0.14					215	2.49		
Rod and line	25	0.02	0	0					38	0.44		
Trammel net	131	0.09	0	0							1 527	3.28
Seine net	15 615	10.37	3 358	2.77							223	0.48
Fence-net	54	0.04	0	0								
Gill-net	23 288	15.47	16 457	13.58	34 503	73.67	39 607	72.66	7 050	81.68	13 389	28.77
Lift-net	70 374	46.74	91 962	75.91	12 322	26.31	13 514	24.79	1 252	14.50	31 351	67.37
Electrofishing									55	0.64		
Total	150 577	100.00	121 140	100.00	46 837	100.00	54 510	100.00	8 632	100.00	46 536	100.00

limited macrophyte growth, probably the result of high draw-down, so carrying capacity for this species was very limited.

Different gear types vary in terms of versatility and species selectivity, so gear types differ from reservoir to reservoir. For instance, Ea Kao reservoir is more diverse in terms of species and fishers and has a clear bottom, so the number of gear types used is 12. Ea Kar, with few species and fishers, has only three gear types (Table 8).

Ho 31 is seined when water level is at its annual minimum. No other gear is used.

Gill-nets and lift-nets are important gear in all three reservoirs. Table 9 indicates their relative contributions to the three fisheries.

Gill-nets tend to catch a great variety of species, while lift-nets are most effective on pelagic schooling fish (Table 10).

Fish production by lift-net in different periods depends on fishing effort by this and other gear, the number of fish stocked, and the weather. In the three reservoirs, silver carp accounted for 71% to 86% of the lift-net yield. Catch composition is, in general, more uniform than for gill-nets.

The fit between catch and effort for lift-nets (Table 11) strongly suggests that an effort level of about 380 000 m²hr/ha/yr tends to achieve optimal yield in these reservoirs (Figure 5). However, the case of Ea Kar shows that this relationship cannot be applied well to individual reservoirs.

In Ea Kar, an optimal effort of about 16 000 m²hr/ha/yr is suggested, considerably lower than the general case.

When fishing effort increased, effort cost also increased and the effort needed for maximum economic yield appeared to be about 80% of the effort level needed for maximum 'sustainable' yield (it should be noted that since the lift-net fishery depends almost entirely on stocked species, the question of maximum sustainable yield is not particularly relevant). However, the results of this exercise will be more applicable separately for individual reservoirs.

Similar exercises with gill-nets led to similar conclusions. When gill-net catch and effort data were combined for three reservoirs, an optimal effort level of about 400 000 m²hr/ha/yr was suggested. However, the situation with common carp in Ea Kao again showed that this level can not be safely applied to individual reservoirs.

Common carp is the most important self-recruited species in Ea Kao. Gill-nets caught just under 80% of the total yield, and common carp made up about 41% of the total gill-net yield. While the number of points is too low to give a firm indication of optimal fishing effort, catch vs effort data suggest an optimal effort level of about 30 000 m²hr/ha/yr, or much lower than the general case.

An exercise comparing maximum sustainable yield to maximum economic yield for gill-nets suggests that the effort level needed to achieve maximum

Table 9. Yield percentages caught by gill-nets and lift-nets in three reservoirs.

	Ea Kao		Yang Re		Ea Kar	
	1997-98	1998-99	1997-98	1998-99	1997-98	1998-99
Gill-nets	15.5	16.3	81.7	28.0	73.7	72.7
Lift-nets	46.7	75.9	14.5	77.3	26.3	24.8
Other	27.8	10.5	3.8	3.9	0.0	2.5

Table 10. Catch, effort and catch per unit effort by lift-net.

Lift-net	Yang Re		Ea Kar		Ea Kao	
	4/97-3/98	4/98-3/99	4/97-3/98	4/98-3/99	4/97-3/98	4/98-3/99
Catch (kg)	1251.95	31 350.9	12 322	13 514	70 373.5	91 961.6
Effort ⁽²⁾	0.0029	0.27473	0.01619	0.02719	0.24286	0.36524
CPUE	0.43142	0.11412	0.7611	0.49694	0.28977	0.25179

Effort⁽²⁾ = 100m²/hr

Table 11. Effort and catch value for lift-nets.

	Yang Re		Ea Kar		Ea Kao	
Eff val/ha (VND)	15 693.43	1 485 836	34 776	58 414	350 258	526 754
Catch val/ha (VND)	126 861.58	3 177 078	495 937	543 913	1 901 761	2 485 151
(Catch val–effort val)/ha	111 168.15	1 691 242	461 162	485 499	1 551 503	1 958 397

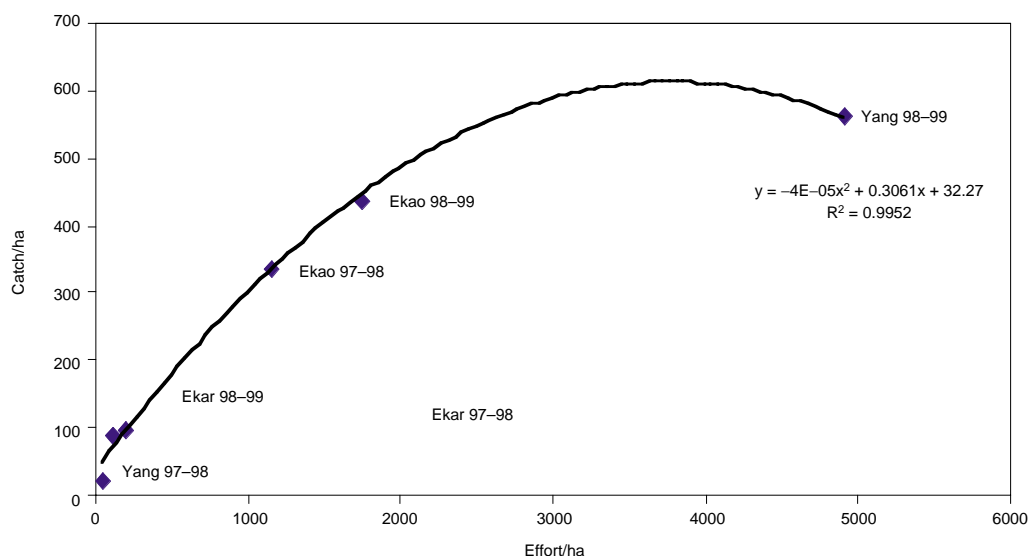

Figure 5. Catch versus effort tendencies by lift-net.

economic yield is about 60% of that needed for maximum sustainable yield. The fit of the data to the response curves was, however, very poor (Figure 6). These data are best analysed on a reservoir-specific basis, and are not yet sufficient to allow such an exercise.

Conclusions

The data given in Tables 4 and 5 give compelling arguments for stocking in most Central Highlands reservoirs. (1) In the absence of stocking, yield would be low to negligible in most cases. (2) Stocking is cost-effective, especially for silver carp.

Stocking may be debatable in water bodies with higher yields and diverse, self-recruiting stocks. Such species cost nothing to stock, and are a dependable source of fish, should stocking prove impossible. A diverse stock also tends to be a stable one, in terms of production. The extent to which stocking

can complement these species still deserves investigation. Species which cannot reproduce in the reservoirs should pose few or no long-term risks to existing stocks.

Table 12 summarises our preliminary stocking recommendations.

Table 12. Preliminary stocking recommendations.

Reservoir size	150–200 ha	50 ha	5 ha	Stocking size (g)
Species	No./ha			
Silver carp	1250	2500	4500	0.5–1
Bighead	800	1500	3500	1–2
Indian carp*	2000	2000	4000	?
Common carp	1000 ?	1000 ?	1000 ?	≥ 1
Grass carp	Depends	Depends	Depends	≥ 1

*Mrigal should not be stocked at high densities if common carp are present.

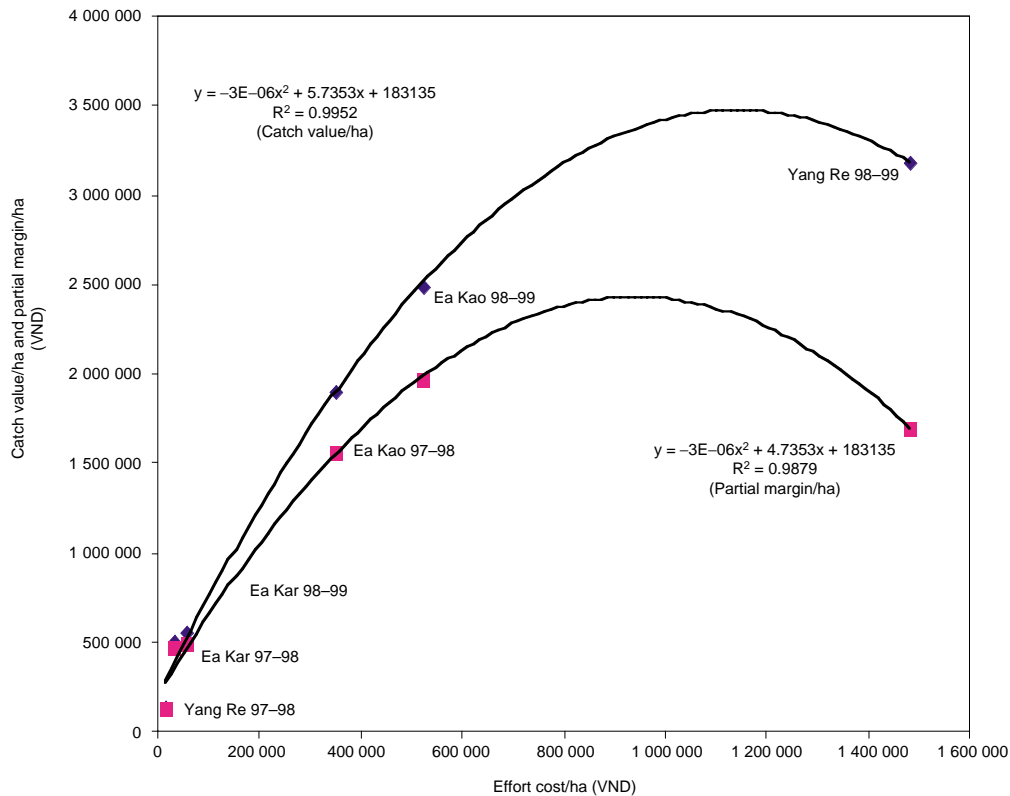

Figure 6. Catch value and partial margins to effort cost, lift-nets, all reservoirs, April 1997–March 1999.

These are first approximations, based on the combined data of four reservoirs, all with depauperate native fish populations. In contrast to the other three reservoirs, Ho 31 is not fished continuously. Hence, its biological ‘carrying capacity’, relative to the other three reservoirs, could be higher than indicated here. When these recommendations are applied to individual reservoirs, the most notable exceptions occur in the case of Indian carp. When common carp, and possibly tilapia and indigenous species, are present in large numbers, the stocking levels suggested here are too high, and can be reduced by half to three-quarters, as a first approximation. Otherwise, appropriate stocking levels tend to vary inversely with fingerling size. Finally, many other uncontrollable factors such as fingerling availability dictate what managers can stock.

Regarding stocking size, the data are still too scanty to indicate optimal stocking sizes clearly. In the case of silver carp, a size of 0.5–1.0 g appears desirable, and for bighead, 1.0–2.0 g. Data for Indian

carp give no indications of desirable stocking size. Realistically, large fingerlings tend to be in shorter supply than smaller ones, and this may limit a manager’s options. However, efforts should be made to stock fingerlings of a size around 1 g or larger. Silver carp, however, have been successfully stocked in the 0.5–1 g range.

These stocking sizes may appear very low, but are based on data from reservoirs with very few predatory species. Many authorities will find the sizes too low. The four reservoirs considered here are relatively small with few predators and perhaps for these reasons, stocking success has been achieved with the small sizes reported. Optimal effort levels by various gears will be reservoir-specific. Differences in gear use and species composition make it impossible to develop general recommendations. Data must be collected over a longer period to develop more solid reservoir-specific advice.

The surveys at these reservoirs should be continued, for a number of reasons. As indicated by the

catch vs effort data, a longer period will allow for enhanced understanding of the dynamics of the various fish stocks in this sample of reservoirs, the effects of the fisheries on these stocks, and what lessons can be applied more broadly to other reservoirs in the region. Stocking is expected to continue to be an important means of enhancing reservoir fish yields in the area, and more robust data are needed to

make appropriate recommendations. Continuous assessment of the extent to which indigenous and stocked species can coexist is also highly desirable.

Reference

Ministry of Fisheries 1995. Hội Nghị Nghệ Cá Hồ Chua Lân Thủ Hai, Hanoi. MoF, 79 p.

Effect of Hydrological Regimes on Fish Yields in Reservoirs of Sri Lanka

C. Nissanka* and U.S. Amarasinghe*

Abstract

The need for empirical models for predicting fish yields in lakes and reservoirs, both in tropical and temperate regions, has long been recognised because investigation of the fisheries of individual water bodies for management purposes is prohibitive. In a previous study, morphological and edaphic factors, including extents of catchment areas in reservoirs of Sri Lanka, were found to influence fish yields. Hydraulic retention time is reported to be another factor influencing fish yields in tropical reservoirs. This paper attempts to investigate the effect of hydrological regimes on fish yields in irrigation reservoirs of Sri Lanka. Daily catch and effort data were collected from 10 shallow irrigation reservoirs from December 1997 to September 1999. Nitrate, phosphate and chlorophyll-*a* content in each reservoir were determined once in two months. Hypsographic curves (i.e. area-water depth relationships) and monthly mean data on reservoir capacity, water level, reservoir area and total outflow volume were obtained from the Department of Irrigation. Flushing rate (outflow/reservoir capacity) had little influence on water nutrients, chlorophyll-*a* and fish yields in reservoirs. As irrigation authorities control the hydrological regimes of these reservoirs, strong co-ordination between fisheries and irrigation authorities is useful for augmenting fish yields in the reservoirs of Sri Lanka.

FISH production in reservoirs is affected by abiotic factors such as physico-chemical parameters and hydrology. But their importance relative to biotic interactions is not fully understood. However, scientists have attempted to relate fish yields in lakes and reservoirs to different biotic and abiotic factors. One of the earliest empirical approaches (Rawson 1952) demonstrated that it was possible to estimate fish yield from the reservoir mean depth. Several indices such as morpho-edaphic index (Ryder 1965; Henderson and Welcomme 1974), primary productivity and phytoplankton standing crop (Oglesby 1977) are found to be powerful yield predictors both in temperate and tropical lakes and reservoirs.

Hydraulic retention time is reported to be another factor influencing fish yield in tropical reservoirs (Marshall 1984). In irrigation reservoirs of Sri Lanka, management of water output for cultivation of two crops of rice per year in the dry zone

(<190 cm of rainfall per year) of the country is superimposed upon the climatic patterns. Therefore, highly variable retention times and water level fluctuations characterise almost all irrigation reservoirs in the dry zone of Sri Lanka.

Fishing effort is a major determinant of fish yields in reservoirs (Bayley 1988). Sri Lanka is no exception (De Silva 1985; De Silva et al. 1991). Alternatively, physico-chemical and biological parameters were also shown to influence fish yields in Sri Lankan reservoirs (Moreau and De Silva 1991). In a previous study, morphological and edaphic factors, including extent of catchment areas in reservoirs of Sri Lanka were also found to influence fish yields (Nissanka et al. 2000). Furthermore, it can be expected that flushing rates and the extent of draw-down area in reservoirs, which are brought about by demand for irrigation water in the command areas, might have negative and positive effects, respectively on nutrient status and fish yields. This paper attempts to investigate the effect of hydrological regimes on fish yields in irrigation reservoirs of Sri Lanka.

*Department of Zoology, University of Kelaniya, Kelaniya 11600, Sri Lanka

Materials and Methods

The study was carried out in 10 shallow irrigational reservoirs of Sri Lanka from December 1997 to September 1999. The fishery data were collected by field assistants for at least 20 days in the month for that period, and included the number of crafts operating per day and the total catch by weight, landed by each craft. Locations of the 10 reservoirs investigated and details of the sampling procedure are given by Amarasinghe et al. (these Proceedings). Hypsographic curves (i.e. relationships of reservoir area to water level) and monthly mean data of reservoir water level, capacity, reservoir area and total outflow volume of individual reservoirs were obtained from the Department of Irrigation for the study period.

Usually, the area at full supply level (FSL) is used for calculating fish yield (Y in kg/ha/yr) in reservoirs. In this study, both the reservoir area at FSL (A_{FSL}) and the actual reservoir area as determined from the hypsographic curves (A_{MEAN}) were used to calculate Y in reservoirs (for details see Amarasinghe et al. these Proceedings).

Nitrate, phosphate, alkalinity, and electrical conductivity in each reservoir were determined once in two months. The chlorophyll- a content (Chl- a) was also determined at the same time intervals.

Morpho-edaphic indices were derived as MEI_c (= conductivity/mean depth) and MEI_a (= alkalinity/mean depth). In Sri Lanka, it has already been found that MEI_c , MEI_a and Chl- a are positively correlated to catchment area (Nissanka et al. 2000), indicating that allochthonous input of nutrients is important to govern the trophic status of reservoirs. In the present study, other factors influencing trophic status were explored. For this purpose, annual flushing rates of individual reservoirs were estimated as the ratio of total annual outflow (in million cubic metres or MCM) to mean reservoir capacity (in MC). Draw-down area of each reservoir was estimated as the difference between reservoir area at FSL and the reservoir area at minimum water level during the study period, the latter determined from the hypsographic curves. The draw-down area was then expressed as a percentage of the reservoir area at FSL (%DDA).

Flushing rates (FR) and %DDA of individual reservoirs were related to nutrients (NO_3 and PO_4), MEI_a , MEI_c and Chl- a . These two parameters were also related to Y . Here both estimates of Y in each reservoir, which were based on reservoir area at FSL (A_{FSL}) and the mean reservoir area (A_{MEAN}), were used to relate to FR. As Y is found to be related to reservoir area (A) according to a negative exponential curve (Amarasinghe et al., these Proceedings), a

multiple regression analysis was attempted to relate A (in ha) and the independent variable(s) which is/are significantly related to Y .

Results

Reservoir area and capacity at FSL, FSL of reservoirs, mean annual reservoir area and capacity, water level at FSL, DDA, %DDA, total annual outflow, flushing rates and fish yields estimated on the basis of FSL and mean monthly reservoir area are given in Table 1. The scatter plots of various indices of trophic status of reservoirs (total phosphorus, dissolved phosphorus, MEI_a , MEI_c and Chl- a) against FR are shown in Figure 1. The scatter plots of the same indices against %DDA are shown in Figure 2. None of these relationships are significant ($P > 0.05$).

The scatter plots of fish yields in individual reservoirs against total annual flushing rates are shown in Figures 3a and 3b for yield estimated based on reservoir area at FSL and those based on mean monthly reservoir area, respectively. These relationships are also not significant at 5% levels. However log-log relationships were evident between fish yields (Y) estimated by both methods and %DDA which are described by the following equations (Figures 4a and 4b).

For Y estimates based on area at FSL:

$$\ln Y = 0.1638 + 1.1132 \ln (\%DDA) \quad (r = 0.858; P < 0.01).$$

For Y estimates based on mean monthly area:

$$\ln Y = -0.9412 + 1.4732 \ln (\%DDA) \quad (r = 0.846; P < 0.01).$$

The $\ln (\%DDA)$ and A are multiply correlated to $\ln Y$ according to the following equations. In these multiple regression analyses, however, data from Chandrikawewa were not used because of low fish yields perhaps due to different limnological conditions (Amarasinghe et al. these Proceedings).

For estimates based on area at FSL:

$$\ln Y = 1.598 + 0.875 \ln (\%DDA) - 0.00023 A \quad (r = 0.82; P < 0.02).$$

For those based on mean monthly area:

$$\ln Y = -1.215 + 1.688 \ln (\%DDA) - 0.00047 A \quad (r = 0.94; P < 0.001).$$

Discussion

It is obvious that water release from multipurpose reservoirs causes loss of nutrients from the reservoir ecosystems. It has been reported that the hydraulic retention time, which is equal to the reciprocal of flushing rate, has a positive affect on fish yields in reservoirs (Marshall 1984). However, in small shallow reservoirs this may not necessarily be true

because allochthonous input of nutrients into the reservoir is more pronounced when compared to nutrient loss with outflow. As Moreau and De Silva (1991) mentioned, reservoir beds themselves in shallow irrigation reservoirs in Sri Lanka may release nutrients, which might compensate for nutrient losses to an extent. The non-significant relationships between flushing rate and various indices of nutrient status in reservoirs (Figure 1), and %DDA and the same indices (Figure 2) are indications of the presence of another set of predictor variables for trophic status, which needs to be identified.

Fish yield is also not related to flushing rate. It is unlikely that flushing rate, which has no effect on nutrient status, can have a significant effect on a higher trophic level. On the other hand, in spite of the non-significant relationships between %DDA and indices of nutrient status (Figure 2), fish yields are positively influenced by %DDA according to a log-log relationship. Draw-down area might therefore be contributing to the reservoir productivity in a way that is less related to the energy flow in the ecosystem through the pathway based on phytoplankton. In reservoirs, detrital pathways are more dominant than grazing pathways with regard to

energy flow (Wetzel 1983). However this aspect has not been adequately addressed in trophic studies in reservoirs. Studies by McLachlan (1971, 1981) of the biological consequences of fluctuations in water level indicate the importance of draw-down area for reservoir productivity.

Possible reasons for the positive relationship between fish yield and %DDA are numerous. Increased food supply for young fish in the form of benthic and epiphytic algae due to inundation of peripheral areas might bring about enhanced growth of fish. Duncan and Kubecka (1995), who have termed the draw-down areas of reservoirs as land-water ecotones, have indicated that there is a positive affect of draw-down areas of reservoirs on fish populations due to the increased food supply for young fish. As the fisheries of the reservoirs studied are mainly dependent on the exotic cichlids *Oreochromis mossambicus* and *O. niloticus*, which construct nests in shallow peripheral areas, extent of draw-down area perhaps reflects the extent of nest-site availability, as shown by De Silva and Sirisena (1988). Draw-down area may therefore play a significant role in recruitment of cichlids to the fishery. Amarasinghe and Upasena (1985) have shown that

Table 1. Reservoir area (ha) and capacity (million cubic metres or MCM) at full supply level (FSL) and monthly means, water level at FSL, draw-down area (DDA) and DDA as percentage of reservoir area at FSL (%DDA), flushing rate (= annual outflow/mean reservoir capacity) and fish yields in 10 Sri Lankan reservoirs. I = yield estimates based on FSL; II = yield estimates based on mean monthly reservoir area (for details see Amarasinghe et. al., these Proceedings).

Reservoir	Reservoir area (ha)		Reservoir capacity (MCM)		Water level (m) at FSL	DDA (ha)	%DDA	Total annual outflow (MCM)	Flushing rate	Yield (kg/ha/yr)	
	At FSL	Monthly mean	At FSL	Monthly mean						I	II
Badagiriya	486	229.4 ±28.16	11.44	5.64 ±0.83	4.28	456.4	95.83	19.703	3.493	229.6	579.6
Chandrikawewa	439	407.2 ±4.18	28.78	24.42 ±0.45	8.3	76.1	17.09	27.139	1.111	25.7	27.9
Kaudulla	2713	1880.2 ±132.72	127.92	75.71 ±7.79	9.14	2127.8	78.43	150.953	1.994	183.5	285.9
Mahawilachchiya	972	741.1 ±14.7	39.58	23.97 ±1.39	6.71	610.2	62.83	41.360	1.725	214.3	262.0
Minneriya	2551	1824.9 ±125.2	135.3	77.54 ±2.94	11.67	1670.6	65.5	324.713	4.188	92.9	128.4
Muthukandiyā	386	280.3 ±42.59	30.17	16.70 ±4.69	11.28	202.0	51.92	24.176	1.448	157.8	240.6
Nachchaduwa	1785	1399.1 ±91.96	57.07	33.32 ±7.19	7.62	1417.6	79.47	89.707	2.692	115.8	193.2
Nuwarawewa	1199	863.2 ±106.66	44.34	26.59 ±10.37	7.01	817.9	68.37	36.693	1.380	126.7	185.5
Parakrama Samudra	2662	2229.3 ±42.62	142.24	10.37 ±101.68	7.62	1274.0	47.86	343.093	3.374	69.4	66.7
Udawalawe	3415	2852.8 ±4.69	267.53	212.95 ±6.92	15.24	15.24	76.69	46.840	0.220	98.9	123.8

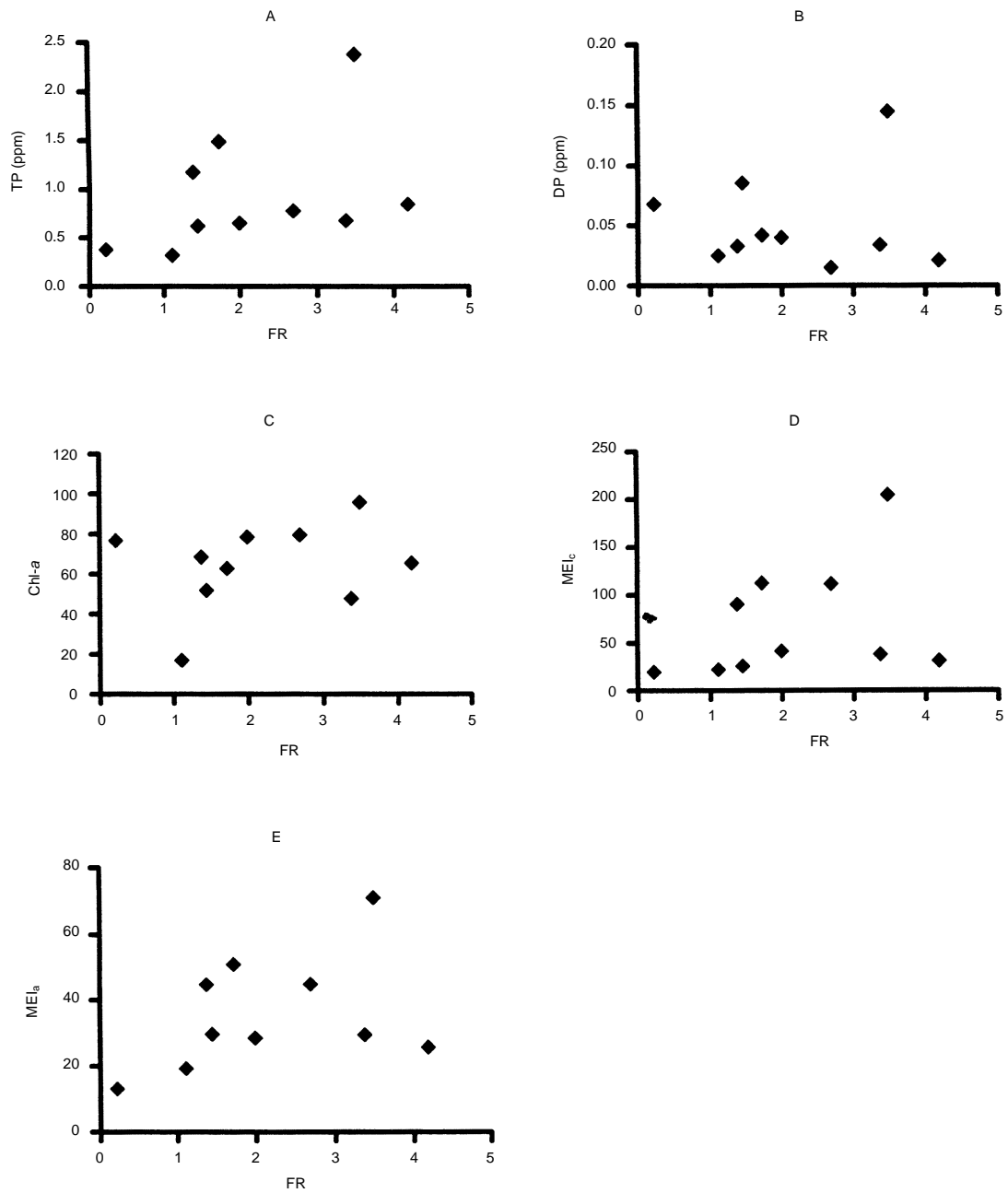

Figure 1 (a–e). The scatter plots of various indices of trophic status of reservoirs against flushing rate (FR). TP – total phosphorus; DP – dissolved phosphorus; Chl-*a* – chlorophyll-*a* content; MEI_c – morphoedaphic index based on conductivity (=conductivity/mean depth); MEI_a – morphoedaphic index based on alkalinity (=alkalinity/mean depth).

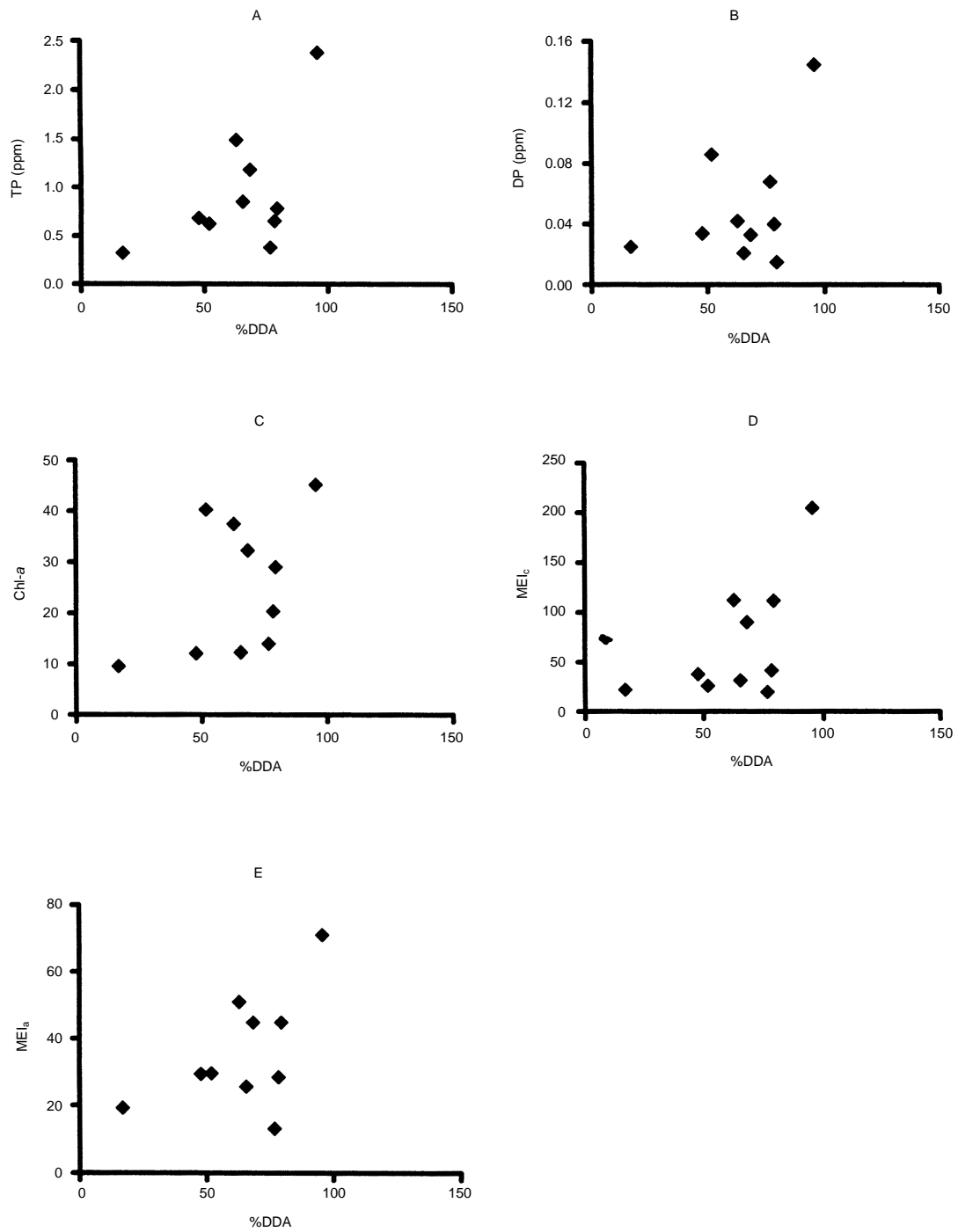

Figure 2 (a-e). The scatter plots of various indices of trophic status of reservoirs against %DDA. TP – total phosphorus; DP – dissolved phosphorus; Chl-*a* – Chlorophyll-*a* content; MEI_c – morphoedaphic index based on conductivity (= conductivity/mean depth); MEI_a – morphoedaphic index based on alkalinity (= alkalinity/mean depth).

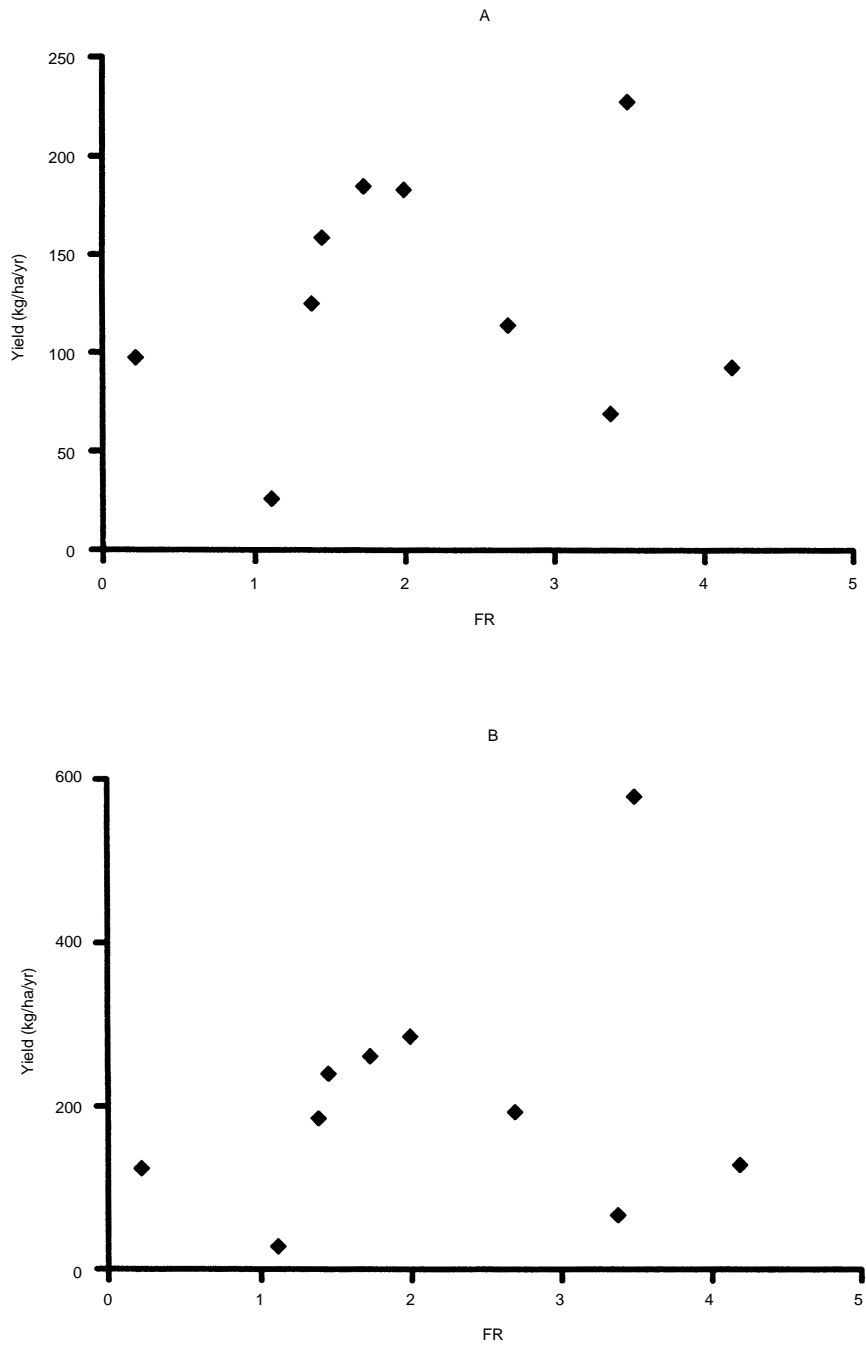

Figure 3 (a, b). The scatter plots of fish yield against flushing rates (FR) in 10 Sri Lankan reservoirs. Fish yields estimated for reservoir area at full supply level (FSL); fish yields estimated for mean monthly reservoir area.

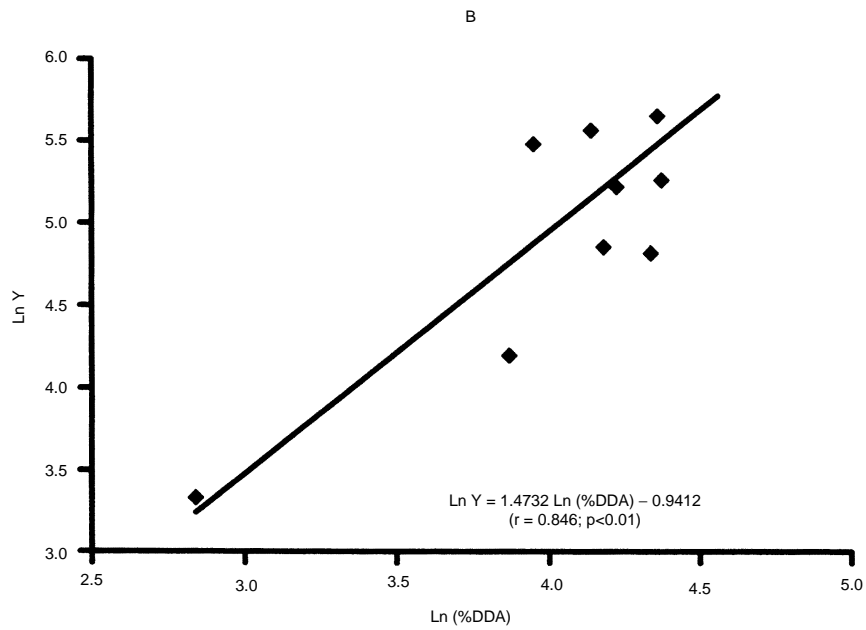
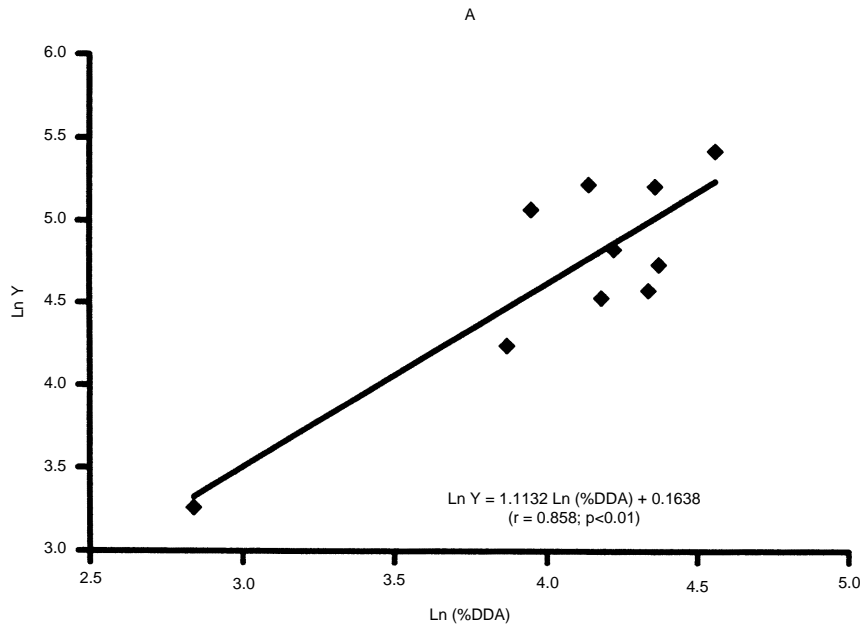

Figure 4(a, b). The relationships between Ln fish yield (Ln Y) and Ln (%DDA) in 10 Sri Lankan reservoirs. Fish yields estimated for reservoir area at full supply level (FSL); fish yields estimated for mean monthly reservoir area.

morphometry of a Sri Lankan reservoir is an important factor influencing recruitment to the cichlid fishery.

As evident from the multiple regression relationship between $\ln Y$, $\ln (\%DDA)$ and reservoir area, yield is negatively influenced by reservoir area. This may perhaps substantiate the opinion put forward by Moreau and De Silva (1991) that, due to their shallowness, reservoir beds in Sri Lankan reservoirs serve as a major source of nutrient release. Naturally in larger reservoirs the dilution effect is more pronounced than in small reservoirs, which justifies the reason for the negative influence of reservoir area on fish yield.

In Sri Lankan irrigation reservoirs, irrigation authorities, depending on the requirements in the command area, solely control water regimes. Fisheries aspects are rarely or never considered during water regime management. However, the present study indicates that the extent of draw-down area and mean reservoir area, both of which are dependent on the bathymetry of reservoirs, have positive and negative effects respectively on fish yields. As such, it appears that through strong coordination between fisheries and irrigation authorities, fish yields could be augmented in shallow, irrigation reservoirs.

Acknowledgments

This study was carried out as part of research project 9440, funded by the Australian Centre for International Agricultural Research.

References

- Amarasinghe, U.S. and Upasena, T. 1985. Morphometry of a man-made lake in Sri Lanka: a factor influencing recruitment to cichlid fishery. *Journal of the National Aquatic Resources Agency (Sri Lanka)*, 32: 121–129.
- Bayley, P.B. 1988. Accounting for effort when comparing tropical fisheries in lakes, river-floodplains and lagoons. *Limnology and Oceanography*, 33: 963–972.
- De Silva, S.S. 1985. Observations on the abundance of the exotic cichlid *Sarotherodon mossambicus* (Peters) in relation to fluctuations in the water-level in a man-made lake in Sri Lanka. *Aquaculture and Fisheries Management*, 16: 265–272.
- De Silva, S.S. and Sirisena, H.G.K. 1988. Observations on the nesting habits of *Oreochromis mossambicus* (Peters) (Pisces: Cichlidae) in Sri Lankan reservoirs. *Journal of Fish Biology*, 33(5): 689–696.
- De Silva, S.S., Moreau, J., Amarasinghe, U.S., Chookajorn, T. and Guerrero, R.D. 1991. A comparative assessment of the fisheries in lacustrine inland waters in three Asian countries based on catch and effort data. *Fisheries Research*, 11: 177–189.
- Duncan, A. and Kubecka, J. 1995. Land/water ecotone effects in reservoirs on the fish fauna. *Hydrobiologia*, 303: 11–30.
- Henderson, H.F. and Welcomme, R.L. 1974. The Relationship of Yield to Morphoedaphic Index and Numbers of Fishermen in African Inland Waters. CIFA Occasional Paper 1, 19 p.
- Marshall, B.E. 1984. Small Pelagic Fishes and Fisheries in African Inland Waters. CIFA Technical Paper 14, 25 p.
- McLachlan, A.J. 1971. The rate of nutrient release from grass and dung following immersion in lake water. *Hydrobiologia*, 37: 521–530.
- 1981. Biological consequences of fluctuations in lake level. CIFA Technical Paper 8: 225–231.
- Moreau, J. and De Silva, S.S. 1991. Predictive Fish Yield Models for Lakes and Reservoirs of the Philippines, Sri Lanka and Thailand. FAO Fisheries Technical Paper 319, 42 p.
- Nissanka, C., Amarasinghe, U.S. and De Silva, S.S. 2000. Yield Predictive Models for the Sri Lankan Reservoir Fishery. *Fisheries Management and Ecology* 7: 425–436.
- Oglesby, R.T. 1977. Relationship of fish yield to lake phytoplankton standing crop, production and morphoedaphic factors. *Journal of Fisheries Research Board of Canada*, 34: 2271–2279.
- Rawson, D.S. 1952. Mean depth and fish production in large lakes. *Ecology*, 33: 513–521.
- Ryder, R.A. 1965. A method for estimating the potential fish production of north-temperate lakes. *Transactions of American Fisheries Society*, 94: 214–218.
- Wetzel, R.G. 1983. *Limnology* (2nd edn). Philadelphia: Saunders College Publishing, 767 p.

Fluctuations in Water Level in Shallow Irrigation Reservoirs: Implications for Fish Yield Estimates and Fisheries Management

U.S. Amarasinghe¹, C. Nissanka* and Sena S. De Silva²

Abstract

Due to fluctuations in water level, reservoir surface area changes considerably. Despite this effect, fish yields (Y) and fishing intensities (FI) in these reservoirs are often estimated for the reservoir area at full supply level (FSL). This paper compares the estimate of optimal fishing strategies according to this conventional method with those based on Y and FI calculated for actual mean monthly reservoir area. Catch and effort data, collected at least for 20 days a month from 10 individual reservoirs in Sri Lanka, were analysed to estimate mean annual fish yields (kg/ha/yr) and total FI (boat-days/ha/yr). Reservoir areas at FSL were used to estimate these values. Using the hypsographic curves and mean monthly water levels in individual reservoirs, actual mean reservoir area in each month in each reservoir was determined. Annual fish yields (kg/ha/yr) and total FI (boat-days/ha/yr) in individual reservoirs were then estimated, based on these actual reservoir areas. In both estimates, Y was linearly related to FI, indicating that the fish stocks were perhaps exploited at suboptimal levels. The results appear to indicate that the conventional method of using reservoir area at FSL to estimate Y and FI in multi-purpose reservoirs, instead of actual reservoir area, may have serious implications for fisheries management. An alternative method for estimating fish yields and FI is suggested for reservoirs with heavy draw-down.

MULTIPLE uses of tropical reservoirs such as irrigation, generation of hydroelectricity and drinking water supply bring about heavy draw-down of reservoir water levels. As such, overall applicability of most stock assessment methodologies evolved around the steady-state assumptions is somewhat questionable (Pauly 1984). Nevertheless, these standing water bodies are biologically productive (Oglesby 1985; De Silva 1988; Sugunan 1993; Welcomme and Bartley 1998).

Sri Lanka is a country with one of the highest densities of reservoirs in the tropical world (De Silva 1988). From the point of view of fisheries management in Sri Lanka, there has been a significant milestone when during the mid-1950s, introduction of the exotic cichlid species *Oreochromis mossambicus*

(Peters) was solely responsible for the development of inland fisheries in the country. Various attempts have been made to define management strategies for reservoir fisheries. These include the development of empirical yield predictive models (Wijeyaratne and Amarasinghe 1987; Moreau and De Silva 1991), application of stock assessment methodologies (Amarasinghe 1996), and introduction of fisheries co-management strategies (Amarasinghe and De Silva 1999). However, fish yield estimates in Sri Lankan perennial reservoirs are always based on reservoir area at full supply level (FSL). Due to heavy draw-down, reservoir water level is below FSL during most months of the year. Fish yields estimated as kg/ha/yr are thus bound to be underestimated when based on reservoir area at FSL. Furthermore, in Sri Lankan reservoirs, the state fisheries authorities allocate fishing craft on the basis of the reservoir area at FSL (Jayasekara 1989). These estimates based on reservoir area at FSL might have a significant impact on the derivation of fisheries management strategies. In this study, the effect of

¹Department of Zoology, University of Kelaniya, Kelaniya 11600, Sri Lanka

²School of Ecology and Environment, Deakin University, Warrnambool, PO Box 423, Victoria 3280, Australia

draw-down on the defining of fisheries management strategies is investigated in Sri Lankan irrigation reservoirs, based on catch and effort data.

Materials and Methods

This study forms a part of a detailed investigation of the management of reservoir fisheries of Sri Lanka. Locations of 10 reservoirs investigated together with the river basins within which they are situated are given in Figure 1. In all reservoirs, fishing craft and characteristics of fishing gear are more or less identical. Fishing craft are non-mechanised fibreglass outrigger canoes in each reservoir and two fishers work in each craft. Major gear is gill-net and the total length of gill-nets in each craft remains constant because each craft can carry a limited amount of nets. Gill-nets are exposed from dusk to dawn.

In individual reservoirs, field assistants were employed to collect catch and effort data. Field assistants visited landing sites at least 20 days a month to collect data. Total catch landed by individual boats and the total number of boats operated in each reservoir were recorded. Total number of fishing days in each month was also noted through interviews with fishers. Sampling of fishing craft was done for at least 56% of the fishing days during the study period from December 1997 to September 1999 and in most reservoirs (especially with few craft) the majority of craft were examined to collect data (Table 1).

Hypsographic curve (i.e. relationship of area to water depth of reservoir), daily water levels during the study period and information on reservoir area at

FSL were obtained from the Department of Irrigation. Using the data on mean monthly water level in each reservoir, mean monthly reservoir area was determined from the hypsographic curves.

Annual fish yield and fishing intensity (FI) in individual reservoirs were determined for two scenarios. First, the mean monthly total fish production was extrapolated in order to determine the fish yield expressed as kg/ha/yr for the reservoir area at FSL. Similarly, annual FI (in boat-days/ha/yr) was determined in each reservoir based on reservoir area at FSL. Secondly, monthly total fish production and fishing effort were divided by the mean monthly reservoir area, which were then extrapolated to obtain estimates of annual fish yields (Y) and FI.

The relationship between Y and FI was determined through a linear regression technique. For this purpose, estimates of Y and FI based on reservoir areas at FSL (A_{FSL}) and mean monthly reservoir areas (A_{MEAN}) were treated separately. Also Y values estimated for A_{FSL} and A_{MEAN} were related to A_{FSL} and A_{MEAN} , respectively.

As can be expected, Y is zero when FI is zero, in order to determine the average catch per unit effort (C/f in kg per boat-day), regression through origin (Zar 1984) was performed to relate Y and FI for the estimates based on A_{FSL} and A_{MEAN} .

Results

Hypsographic curves of the 10 reservoirs studied are shown in Figure 2. Some morphometric characteristics of the 10 reservoirs investigated, annual fish yields (Y) and FI calculated on the basis of reservoir

Table 1. Sampling periods, number of fishing days, number of sampling days, number of boats operated and observed in 10 reservoirs of Sri Lanka.

Reservoirs	Sampling period Dec. 1997– Sep. 1999 (months)	No. fishing days		No. sampling days		No. boats operated during sampling period	No. boats observed during sampling period	
		During sampling period	Per year (average)	Total	%		Total	%
Badagiriya	11	324	353	277	85	2 995	2 256	75.3
Chandrikawewa	22	618	353	454	73	3 743	2 594	69.3
Kaudulla	17	508	359	340	66	37 973	4 281	11.3
Mahawilachchiya	21	593	356	434	73	23 720	7 468	31.5
Minneriya	12	406	348	322	79	17 715	4 508	25.4
Muthukandiya	20	595	357	553	93	8 196	7 789	95.0
Nachchaduwa	19	540	360	347	64	23 044	5 310	23.0
Nuwarawewa	21	618	353	402	65	24 685	2 757	11.2
Parakrama Samudra	10	295	354	197	67	11 457	1 620	14.1
Udawalawe	12	323	352	180	56	7 213	1 828	25.3

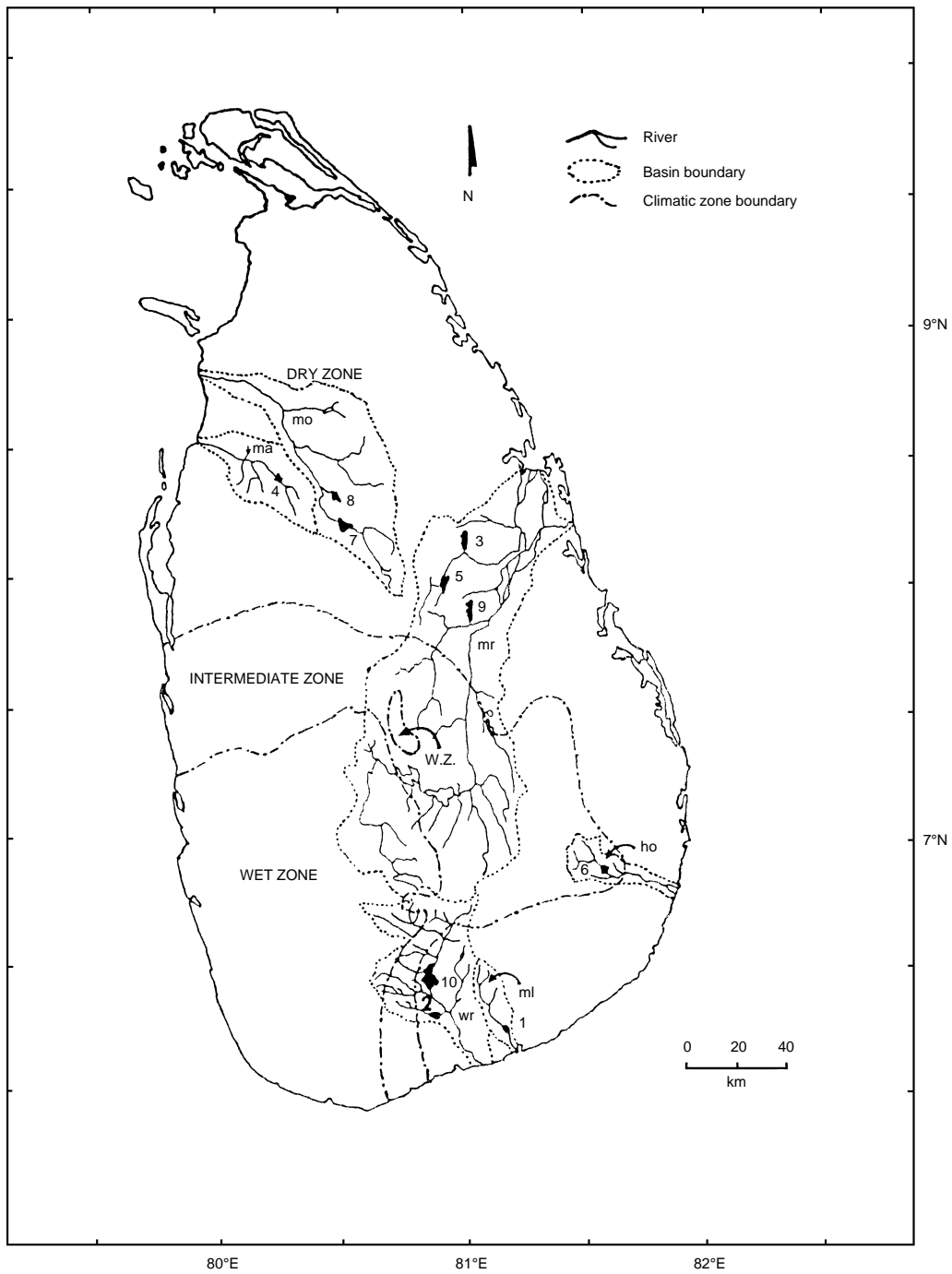

Figure 1. Map of Sri Lanka indicating the locations of 10 reservoirs studied and their respective river basins. River basins (ma = Moderagam Aru; mo = Malwathu Oya; mr = Mahaweli River; ho = Heda Oya; ml = Malala River; wr = Walawe River); reservoirs (1. Badagiriya; 2. Chandrikawewa; 3. Kaudulla; 4. Mahawilachchiya; 5. Minneriya; 6. Muthukandiya; 7. Nachchaduwa; 8. Nuwarawewa; 9. Parakrama Samudra; 10. Udawalawe).

area at FSL (A_{FSL}) and those estimated for mean monthly reservoir area, as determined from hypso-graphic curves (A_{MEAN}), are given in Table 2. Also given in Table 2 are mean annual reservoir areas of individual reservoirs.

It can be seen that, the mean surface area of all 10 reservoirs studied was about 78% of the extent at FSL. However, mean annual fish yield of these reservoirs estimated for A_{FSL} (131.5 kg/ha) is 62.8% of the value estimated for A_{MEAN} (209.4 kg/ha/yr). Also FI estimated for A_{FSL} (8.67 boat-days ha/yr) was 65.8% of FI value estimated for A_{MEAN} (13.17 boat-days ha/yr). From these estimates, it is evident that fish yields and FI are underestimated to a greater degree than the proportion of A_{FSL} to A_{MEAN} .

The relationships between Y (kg/ha/yr) and FI (boat-days ha/yr), calculated for A_{FSL} and A_{MEAN} , are shown in Figures 3A and 3B respectively, and are described by the following equations.

For A_{FSL} :

$$Y = 10.475 FI + 25.46 \quad (r = 0.786; p < 0.02).$$

For A_{MEAN} :

$$Y = 11.835 FI + 24.19 \quad (r = 0.849; p < 0.01).$$

In this analysis, Badagiriya Reservoir represented an outlier. A negative log-linear negative relationship was evident between Y and reservoir area (A). The relationships between Y (kg/ha/yr) and A (ha), calculated for reservoir area at FSL and for mean reservoir area, are shown in Figures 4A and 4B, respectively. The relationships are:

$$\ln Y = -0.0002A_1 + 5.2937 \quad (r = -0.66; p < 0.05)$$

for the yield estimates based on reservoir area at FSL (A_1), and

$$\ln Y = -0.0005A_2 + 5.9468 \quad (r = -0.72; p < 0.05)$$

for Y estimates based on A_{MEAN} (A_2 = mean annual reservoir area). In this analysis too, Chandrikawewa represented an outlier, which was not used in the regression.

The relationships between Y and FI, as determined from the linear regression through origin (Zar 1984) are $Y = 12.9 FI$ ($t = 10.71$; $P < 0.0001$) for the estimates based on A_{FSL} and $Y = 13.4 FI$ ($t = 11.38$; $P < 0.0001$) for the estimates based on A_{MEAN} . Accordingly, mean C/f of the reservoirs is estimated to be 13.4 kg per boat-day for the relationship based on A_{MEAN} , and 12.9 kg per boat-day for the relationship based on A_{FSL} .

Discussion

It has been reported that fluctuations in water level in tropical reservoirs have important influences on nutrient dynamics through nutrient release from grass and dung in the submerged peripheral areas (McLachlan 1971). Duncan and Kubecka (1995)

have shown that the extents of draw-down areas of tropical and temperate reservoirs have positive influences on fish fauna feeding in littoral areas. Beam (1983) and De Silva (1985) have reported long-term positive influences of annual water level fluctuations on the trends of fish populations. In Sri Lankan reservoirs, the dominant fish species in reservoirs is *Oreochromis mossambicus*. Fluctuations in the water-level in reservoirs of Sri Lanka therefore have a positive effect on fish yields through enhancement of nest site availability in peripheral areas of reservoirs (De Silva and Sirisena 1988). The present study indicates that in addition to these long-term effects on limnology and fisheries, fluctuations in the water level in reservoirs have some implications for fish yield estimates and fisheries management.

Fish yield and FI estimates based on A_{FSL} are underestimated by 62.8% and 65.8%, respectively when compared to the estimates based on A_{MEAN} (Table 2). Fish yields are often used to compare productivity of reservoirs (Oglesby 1985). These yield estimates are generally based on reservoir area at FSL which are bound to be underestimations. This is because it is very unlikely that reservoir water level remains at FSL for most of the year, especially in multipurpose reservoirs such as irrigation and hydro-electric reservoirs. As evident from the present study, due to the different magnitudes of the fluctuations in the water level of reservoirs, which are governed by the bathymetry of individual reservoirs, the degree of underestimation of fish yield and FI based on the reservoir area at FSL is, on average, much greater than the ratio of reservoir area at FSL to mean annual reservoir area.

The positive linear relationship between fish yield and FI (Figure 3) perhaps indicates that the fisheries in reservoirs are exploited at suboptimal levels. In Badagiriya Reservoir, which represented an outlier data point, fish yield was exceptionally high. This was perhaps due to the reason that the fish stocks were heavily exploited when the water level receded considerably after August 1998. Furthermore, in this reservoir, ratio of catchment area to reservoir capacity is shown to be relatively high, which has a positive influence on fish yield (Nissanka et al., 2000).

Reservoir area is a major determinant in defining the optimal fishing strategies in lakes and reservoirs. In African reservoirs, further increase of FI is allowed if the density of fishers is less than 1.5/km² (Bernacsek and Lopes 1984). Henderson and Welcomme (1974) have used FI expressed as number of fishers/km² as the criterion to determine whether the fisheries of African lakes and reservoirs were actively exploited, or not.

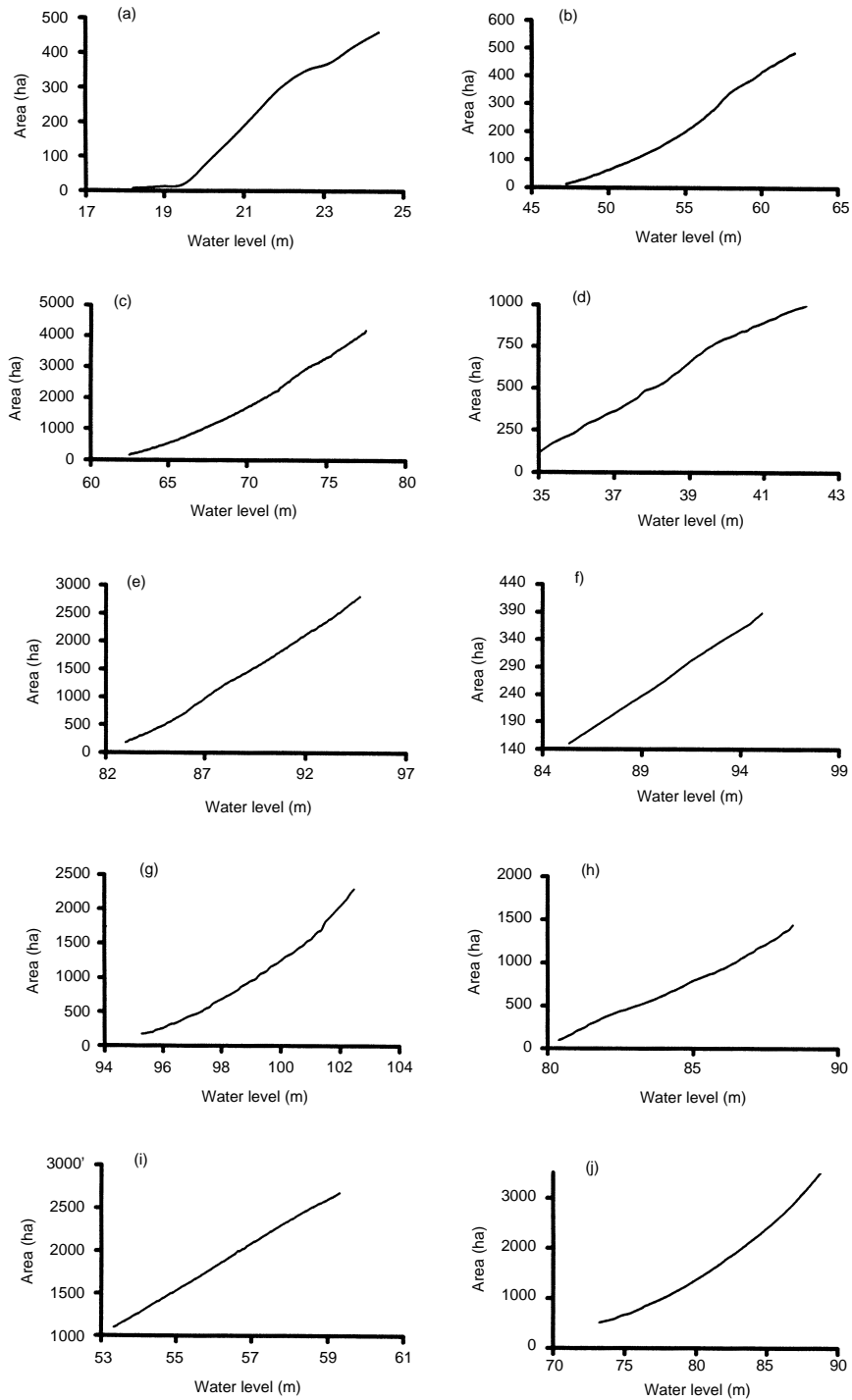

Figure 2. Hypsographic curves of 10 reservoirs studied. Here reservoir water levels are in m above mean sea level.

Table 2. Mean reservoir area, mean water levels, annual fish yields and fishing intensities in 10 reservoirs. I — estimated for area at FSL; II — estimated for mean monthly reservoir areas. Some morphometric characteristics of the 10 reservoirs are also given.

Reservoir	Catchment area (km ²)	Area at FSL (ha)	FLS (above mean sea level) (m)	Water level (m)		Mean depth (m)	Mean reservoir area \pm SE (ha)	Fish yield (kg/ha/yr)		Fishing intensity (boat-days/ha/yr)	
				At FSL	Mean \pm SE			I	II	I	II
Badagiriya	350.00	486	24.1	4.28	2.57 \pm 0.31	2.28	299.4 \pm 28.16	229.8	579.6	8.13	22.18
Chandrikawewa	166.00	439	61.1	8.30	7.73 \pm 1.11	6.51	407.2 \pm 4.18	25.7	27.9	4.98	5.36
Kaudulla	82.00	2 713	73.2	9.14	6.49 \pm 0.45	4.72	1 880.2 \pm 132.72	183.5	285.9	9.88	14.84
Mahawilachchiya	367.00	972	41.8	6.17	4.76 \pm 0.51	4.76	741.1 \pm 14.70	214.3	262.0	14.65	20.31
Minneriya	240.00	2 551	93.7	11.67	8.75 \pm 0.26	5.29	1 824.9 \pm 125.20	92.9	128.4	6.93	9.38
Muthukandiya	25.40	386	95.1	11.28	7.24 \pm 0.25	3.55	280.3 \pm 42.59	157.8	240.6	12.74	18.91
Nachchaduwa	611.00	1 785	101.7	7.62	5.87 \pm 0.35	3.23	1 399.1 \pm 91.96	115.8	193.2	8.61	14.03
Nuwarawewa	84.17	1 199	87.4	7.01	5.17 \pm 0.39	3.72	863.2 \pm 106.66	126.7	185.5	12.25	17.43
Parakrama Samudra	71.68	2 662	59.1	7.62	6.09 \pm 0.32	5.29	2 229.3 \pm 42.62	69.4	66.7	5.74	5.92
Udawalawe	1 162.00	3 415	88.4	15.24	13.32 \pm 0.46	7.84	2 852.8 \pm 4.69	98.9	123.8	2.82	3.36
Total		16 391					12 777.5	1 314.8	2 093.7	86.73	131.72
Average								131.5	209.4	8.67	13.17

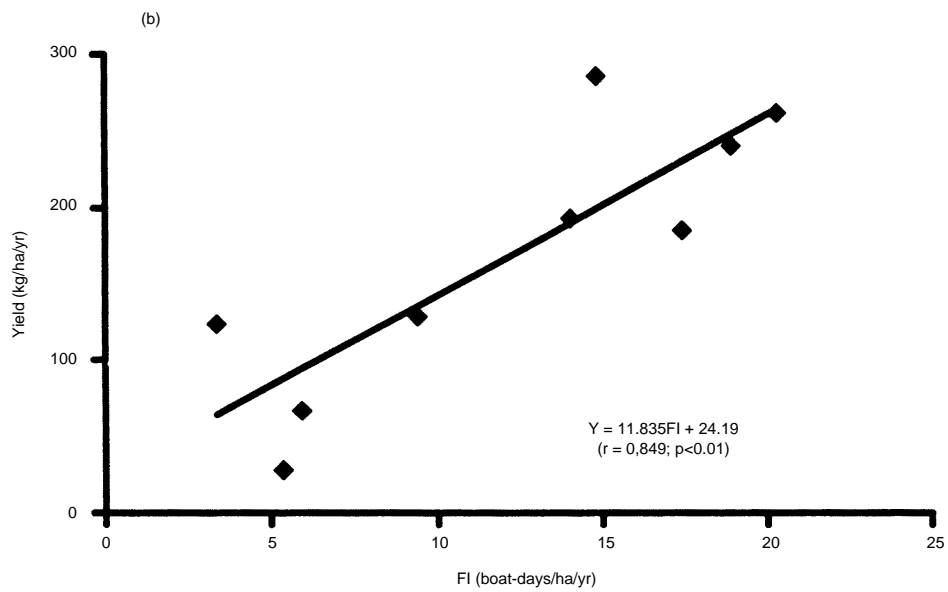
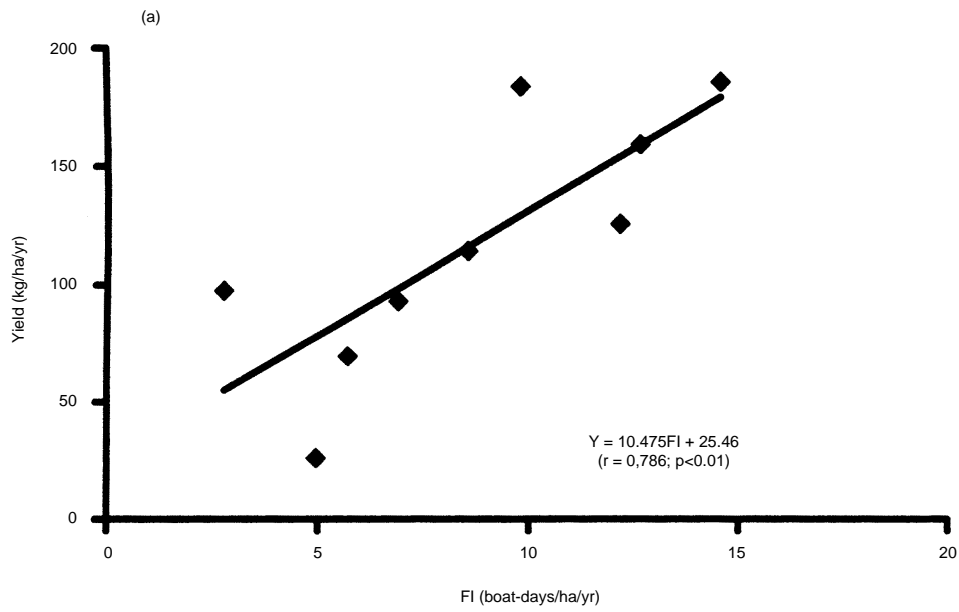

Figure 3. The relationships between fish yield (Y) and fishing intensity (FI) calculated for (a) reservoir area at full supply level (FSL) and (b) mean monthly reservoir area in nine Sri Lankan reservoirs. Data from Badagiriya Reservoir were not used in the regression analysis because it represented an outlier. For details see text.

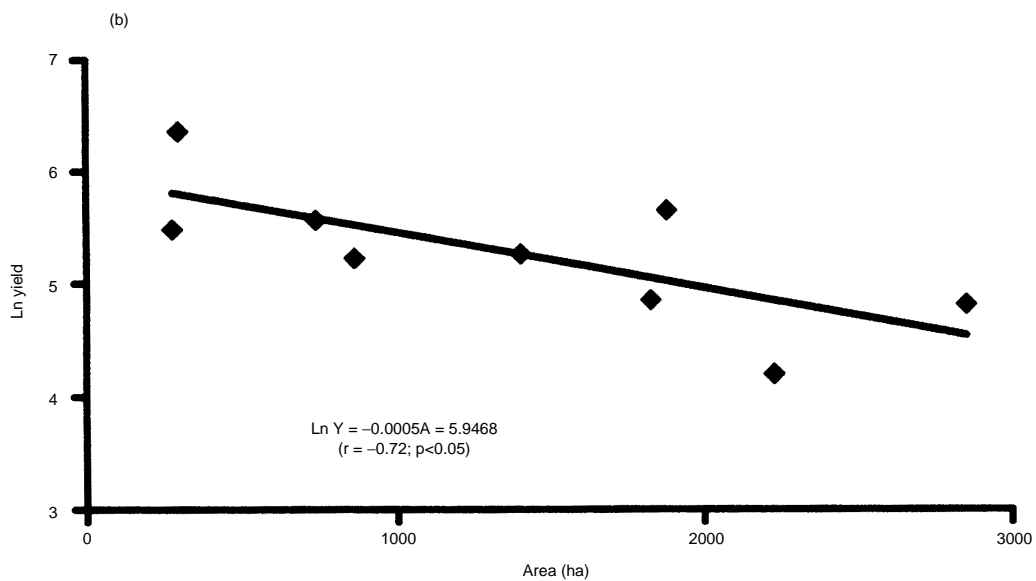
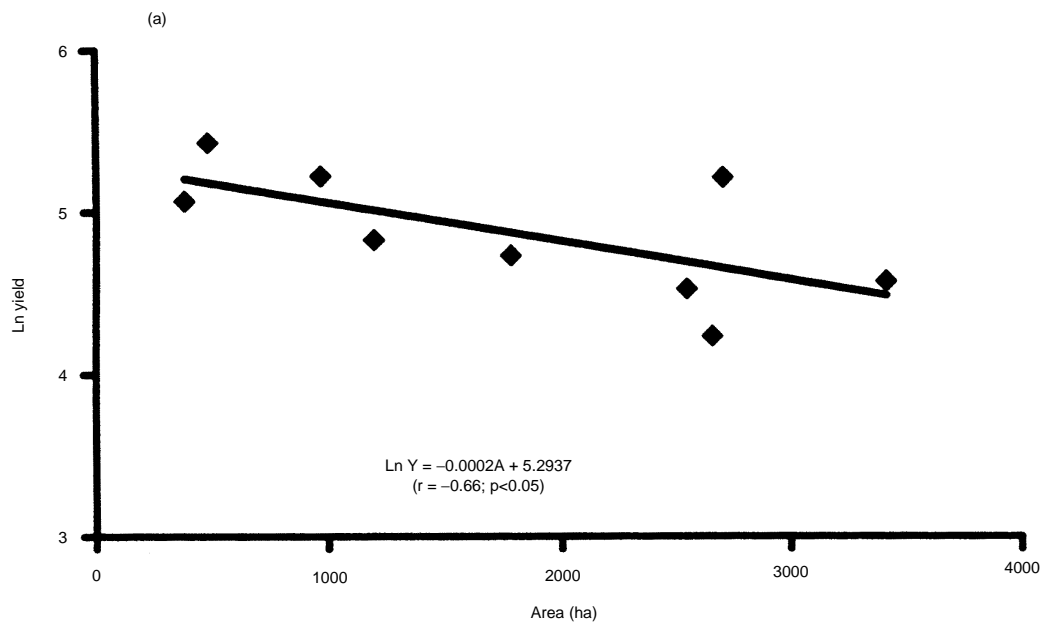

Figure 4. The relationships between Ln fish yield (Ln Yield) and reservoir area (A) calculated for (a) reservoir area at full supply level (FSL) and (b) mean monthly reservoir area in nine Sri Lankan reservoirs. Data from Chandrikawewa were not used in the regression analysis because it represented an outlier. For details see text.

In Sri Lanka too, the number of craft to be operated in reservoirs is determined by the government fisheries authorities depending on the reservoir area at FSL (Jayasekara 1989). However, as shown by Amarasinghe and Pitcher (1986) and Amarasinghe and De Silva (1992), as in many artisanal fisheries, in Sri Lankan reservoirs, fishers tend to increase the efficiency of fishing methods. Nevertheless, when the fishing effort (number of crafts) is allocated to a particular reservoir depending on the reservoir area at FSL, the efficiency of FI might be much greater than the expected level of FI. Therefore, there is a potential danger the FI may exceed the optimal level in reservoirs of Sri Lanka, especially due to the reason that that most reservoir fisheries are exploited at optimal or suboptimal levels (Amarasinghe 1996).

The present study also indicates that there is a negative exponential relationship between fish yield and reservoir area. The outlier data point (Chandrikawewa) may perhaps be due to more pronounced influence of limnological characteristics on fish yield than FI. The relationship between yield and reservoir area, as evident from the present study, indicates that the use of information on reservoir area to allocate fishing effort is not the only reasonable criterion.

Annual fish yields of individual reservoirs estimated on the basis of the reservoir area at FSL and using mean monthly reservoir area are equally related to FI estimates based on the two scenarios, and also to the extent of reservoir. As the estimates based on the actual mean reservoir area are realistic, the relationship between fish yield and FI, based on the reservoir area at FSL (Figure 3B), can be used to determine the number of craft to be allocated in indi-

vidual reservoirs. According to this analysis, FI needed to achieve a catch per unit effort of about 13.4 kg per boat-day (i.e. gradient of the yield and FI relationship, as determined from regression through origin) can be employed in a given reservoir. Here, FI should be calculated for the mean reservoir area. The optimal FI calculated using the relationship between Y and FI based on A_{FSL} and A_{MEAN} is given in Table 3. From the estimates of optimal FI based on A_{FSL} , the effective FI was also calculated on the basis of mean reservoir area of individual reservoirs. The average optimal fishing effort (boats/day), calculated on the basis of the relationships between Y and FI for A_{FSL} and A_{MEAN} , indicate that when A_{FSL} is used for the analysis the optimal effort is overestimated in Minneriya and Parakrama Samudra, and underestimated in Kaudulla, Nachchaduwa and Nuwarawewa. The problem might be aggravated in reservoirs with large surface area with heavy draw-down, such as hydroelectric reservoirs.

Furthermore, when the optimal fishing effort is compared with the existing fishing effort (Table 3), it is evident that in Kudulla, Minneriya, Nachchaduwa and Udawalawe, fishing effort can be increased beyond existing levels. In Chandrikawewa, Nuwarawewa and Parakrama Samudra, existing fishing effort exceeds the optimal level, which may lead to overexploitation of fish stocks. Fishing effort is shown to be a major determinant of fish yield in tropical lakes and reservoirs (Bayley 1988) and the present study is a useful extension for the management of fisheries of reservoirs in the tropics especially when they are multiple-use water bodies which cause heavy draw-down of water levels.

Table 3. Optimal fishing intensities estimated for reservoir area at FSL (Opt FIFSL) and for the mean reservoir area (Opt FI_{MEAN}), effective FI when Opt FI_{FSL} is imposed in reservoir, fishing effort (boats/day) corresponding to Opt FI_{FSL} and Opt FI_{MEAN} and present fishing effort in individual reservoirs. Note: Values for Badagiriya reservoir are not shown here because it represents an outlier in the relationship between Y and FI.

Reservoir	Opt FI _{FSL} (boat-days/ ha/yr)	Effective FI (boat-days/ ha/yr)	Effective effort (boats/day)	Opt FI _{MEAN} (Boat-days/ ha/yr)	Optimal effort (boats/day)	Present effort (boats/day)
Chandrikawewa	2.02	2.18	2.5	2.09	2.4	6.0
Kaudulla	14.22	20.52	107.5	21.33	111.7	74.8
Mahawilachchiya	14.36	18.83	39.2	19.55	40.7	40.0
Minneriya	7.20	10.06	52.8	9.58	50.2	43.6
Muthukandiya	13.33	16.98	13.3	17.96	14.1	13.8
Nachchaduwa	8.83	11.27	43.8	14.42	5.0	42.7
Nuwarawewa	9.70	13.47	32.9	13.85	35.9	39.9
Parakrama Samudra	5.38	6.42	40.4	4.98	31.4	38.8
Udawalawe	7.55	9.04	73.3	9.24	74.9	22.3

Column 2: (Column 1 × A_{FSL})/Mean reservoir area.

Column 3: (Column 2 × Mean reservoir area)/No. of fishing days per year.

Column 5: (Column 4 × Mean reservoir area)/No. of fishing days per year.

Column 6: Estimated from data from Table 1.

Acknowledgment

This study was carried out as part of a research project funded by the Australian Centre for International Agricultural Research (ACIAR Project No. 9440).

References

- Amarasinghe, U.S. 1996. Stock assessment in Sri Lankan reservoir fisheries: a review. In: Cowx, I.G. ed. Stock Assessment in Inland Fisheries, Fishing News Books, Blackwell Science Ltd, Oxford, 345–356.
- Amarasinghe, U.S. and De Silva, S.S. 1992. Empirical approaches for evaluating the efficiencies of different fishing methods in tropical shallow reservoirs: a Sri Lankan case study. In: De Silva, S.S. ed. Reservoir Fisheries of Asia, International Development Research Centre, Ottawa, Canada, 217–227.
- 1999. The Sri Lankan reservoir fishery: a case for introduction of a co-management strategy. *Fisheries Management and Ecology*, 6: 387–399.
- Amarasinghe, U.S. and Pitcher, T.J. 1986. Assessment of fishing effort in Parakrama Samudra, an ancient man-made lake in Sri Lanka. *Fisheries Research*, 4: 271–282.
- Bayley, P.B. 1988. Accounting for effort when comparing tropical fisheries in lakes, river-floodplains and lagoons. *Limnology and Oceanography*, 33: 963–972.
- Beam, J.H. 1983. The effect of annual water level management on population trends of white crappie in Elk City Reservoir, Kansas. *North American Journal of Fisheries Management*, 3(1): 34–40.
- Bernacsek, G.M. and Lopes, S. 1984. Cahora Bassa (Mozambique). In: Kapetsky, J.M. and Petr, T. ed. Status of African Reservoir Fisheries, CIFA Technical Paper No. 10, FAO, Rome, 21–42.
- De Silva, S.S. 1985. Observations on the abundance of the exotic cichlid *Sarotherodon mossambicus* (Peters) in relation to fluctuations in the water-level in a man-made lake in Sri Lanka. *Aquaculture and Fisheries Management*, 16: 265–272.
- 1988. Reservoirs of Sri Lanka and Their Fisheries. FAO Fisheries Technical Paper No. 298, 128 p.
- De Silva, S.S. and Sirisena, H.K.G. 1988. Observations on the nesting habits of *Oreochromis mossambicus* (Peters) (Pisces: Cichlidae) in Sri Lankan reservoirs. *Journal of Fish Biology*, 33(5): 689–696.
- Duncan, A. and Kubecka, J. 1995. Land/water ecotone effects in reservoirs on the fish fauna. *Hydrobiologia*, 303:11–30.
- Henderson, H.F. and Welcomme, R.L. 1974. The Relationship of Yield to Morphoedaphic Index and Numbers of Fishermen in African Inland Waters. CIFA Occasional Paper No. 1, FAO, Rome, 19 p.
- Jayasekara, A.M. 1989. The status of freshwater capture fisheries in Sri Lanka. In: Indo-Pacific Fishery Commission papers contributed to Workshop on the Use of Cyprinids in the Fisheries Management of Larger Inland Water Bodies of the Indo-Pacific, Kathmandu, Nepal, 8–10 September 1988, and country reports presented at the Fourth Session of the Indo-Pacific Fishery Commission Working Party of Experts on Inland Fisheries, Kathmandu, Nepal, 8–14 September 1988, Petr, T. ed. FAO Fisheries Report, No. 405 Supplement. FAO, Rome, 169–179.
- McLachlan, A.J. 1971. The rate of nutrient release from grass and dung following immersion in lake water. *Hydrobiologia*, 37: 521–530.
- Moreau, J. and De Silva, S.S. 1991. Predictive Fish Yield Models for Lakes and Reservoirs of the Philippines, Sri Lanka and Thailand. FAO Fisheries Technical Paper No. 319, 42 p.
- Nissanka, C., Amarasinghe, U.S. and De Silva, S.S. Yield predictive models for the Sri Lankan reservoir fishery. *Fisheries Management and Ecology*, 7: 425–436.
- Oglesby, R.T. 1985. Management of lacustrine fisheries in the tropics. *Fisheries*, 10: 16–19.
- Pauly, D. 1984. Recent developments in the methodology available for the assessment of exploited fish stocks in reservoirs. In: Kapetsky, J.M. and Petr, T. ed. Status of African Reservoir Fisheries, CIFA Technical Paper No. 10, FAO, Rome, 321–326.
- Sugunan, V.V. 1993. Reservoir Fisheries of India. FAO Fisheries Technical Paper No. 345, 423 p.
- Welcomme, R.L. and Bartley, D.M. 1998. Current approaches to the enhancement of fisheries. *Fisheries Management and Ecology*, 5: 351–382.
- Wijeyaratne, M.J.S. and Amarasinghe, U.S. 1987. Estimation of maximum sustainable fish yield and stocking densities of fingerlings in freshwater lakes and reservoirs. *Archiv für Hydrobiologie*, 28: 305–308.
- Zar, J.H. 1984. *Biostatistical Analysis*, 2nd edn. Prentice-Hall, Englewood Cliffs, New Jersey, 718 p.

Human Factor: the Fourth Dimension of Reservoir Limnology in the Tropics

E.I.L. Silva¹ and F. Schiemer²

Abstract

Hydro-geochemistry, morphometry and geographic position are the three fundamental determinants of limnological processes and dynamics of lake ecosystems. Reservoirs, man-made inland water bodies constructed for a variety of human benefits, have resulted in manifold environmental impacts changing the ecosystem continuum at different levels. Trophic characteristics such as nutrients, abundance and species dominance of planktonic algae and chlorophyll-*a* were examined at 32 reservoirs (e.g. irrigation, hydropower) in eight river basins in Sri Lanka. Similar parameters were examined monthly in a man-made aesthetic water body (Kandy Lake) for two years. The primary objective of this comparative cross-section and time series study at the Kandy Lake was to determine the impact of human manipulation of water budget on trophic characteristics of reservoir ecosystems. The abundance and species dominance of planktonic algae varied from reservoir to reservoir. *Aulacoseira granulata* was the dominant phytoplankton in a majority of reservoirs while *Microcystis aeruginosa* was the most important cyanobacterium in hypertrophic reservoirs. Trophic status changed from mesotrophic to hypertrophic but the majority of reservoirs were eutrophic. *M. granulata* and *Pediastrum simplex* were oscillating in the Kandy Lake. Although nitrate-nitrogen concentration was relatively low in remote irrigation reservoirs, phosphorus plays a significant role with respect to hyper-eutrophication of the Kandy Lake. The concentration of major nutrients (i.e. nitrate and total phosphorus) did not show a statistically significant correlation with chlorophyll-*a* content. The abundance and species dominance of planktonic algae varied from reservoir to reservoir. *A. granulata* was the dominant phytoplankton in a majority of reservoirs while *M. aeruginosa* was the most important cyanobacterium in hypertrophic reservoirs. Trophic status changed from mesotrophic to hypertrophic but the majority of reservoirs were eutrophic. The comparison of the age of reservoirs with respective chlorophyll-*a* content revealed that the trophic evolution is essentially not a time-dependent phenomenon. An outbreak of *M. aeruginosa* bloom occurred in the Kandy Lake in 1999 for the first time with the onset of the southwest monsoon as a result of the changes in the hydraulic balance during the dry period. Therefore, the role of man in the water balance of the reservoirs must be considered as an important issue in sustainable management of tropical reservoir ecosystems.

HUMANITY has tinkered with inland waters for thousands of years. Dams are among the biggest and most spectacular structures ever built by mankind. The earliest dam that history records was built in Egypt about 4500 years ago. The off-cited rationales for building dams for creating reservoirs, impoundment, barrages etc., throughout the world are mainly

for human benefit (e.g. irrigation, hydropower generation, flood control, storage, drinking water supply, recreation and transport). Contribution of these man-made inland water bodies to societal uplifting and improving the quality of life is unprecedented. It is more predominant in developing nations blessed with few material resources and altered dramatically by devastating natural hazards such as floods. The use of these artificial inland water bodies for fisheries and aquaculture development, especially in developing countries, is one of the gratifying aspects of reservoir building. Sri Lanka used to obtain about 20% of its national fish production until the recent

¹Institute of Fundamental Studies, Hantana Road, Kandy, Sri Lanka. Fax: 94-8-232131, email: sil@ifs.ac.lk

²Department of Limnology, Institute of Zoology, University of Vienna, Althanstrabe 14, A-1090, Wien, Austria

past exclusively from man-made inland water bodies (De Silva 1988; De Silva and Amarasinghe 1996). Nevertheless, manifold impacts resulting from reservoir building have changed the ecosystem continuum at various levels even in the tropics (Baxter 1977; Davies 1980; Obeng 1981; Rudd et al. 1993).

These intermittent lotic-lentic ecosystems are more riverine when they are built by arresting head-water streams or fast-flowing rivers. A lacustrine nature is predominant when reservoirs are built in the lowlands inundating shallow basins channelling diverted water. Limnology of these man-made water bodies is also primarily determined by three fundamental determinants, namely: hydro-geochemistry of the drainage basin, landscape of the inundated area and the geographical position of the water body. Therefore, it is assumed that ecological processes and dynamics of these reservoirs are more or less similar to those of natural lakes in the tropics, as described by several authors (Ganf and Viner 1973; Ashton 1985; Talling 1966, 1969, 1986, 1990, 1992; Talling and Lemoalle 1998; Lewis 1973, 1974, 1978, 1996; Kalff 1983, 1991; Kalff and Brumelis 1993; Kalff and Watson 1986; Melack 1979, 1996). However, many of the differences between reservoirs and lakes are less obvious. Indeed, reservoirs are limnologically quite different from natural lakes, with respect to their larger shoreline, basin shape, shorter retention time and impulsive draw-down (Pielou 1998).

Tropical reservoirs are poorly studied compared to the present density of man-made water bodies throughout the tropics (Melack 1996; Talling and Lemoalle 1998). Fernando (1980) pointed out two major reasons for the poor knowledge of Asian limnology: the low density of natural lakes in the region and poor development of inland fisheries till quite recently, but lack of expertise seems to be a major factor. Besides, the available information has little deviation from conventional limnological studies (Sreenivasan 1965, 1974; Coche 1974; Tundisi et al. 1978; Kannan and Job 1980; Latif 1984). The limnological study of Parakrama Samudra (Sri Lanka), an ancient man-made lake in the tropics (Schiemer 1983) highlighted the role of operation activities in limnological processes. Consequently, various aspects of reservoir limnology in the tropics have been studied (Silva and Davies 1986, 1987; Silva 1991; Piyasiri 1995; Branco and Senna 1994, 1996; Boland 1996; Boland and Griffiths 1996; Hart 1996; Townsend 1996; Townsend et al. 1996). Limnological studies of reservoirs are also becoming an increasingly important issue since inland waters globally are being subjected not only to galloping eutrophication and pollution but also there is evidence of catastrophic collapse of reservoir ecosystems. Nevertheless, the knowledge of one of the

important human activities, manipulation of hydraulic balance on limnological processes and dynamics of tropical reservoirs is poorly understood. The trophic discrepancies of different reservoirs in Sri Lanka are first compared in this paper and the impact of the man-influenced changes in hydraulic balance or trophic characteristics of reservoir ecosystems is then highlighted.

Materials and Methods

Study site

Sri Lanka (6° – 10° N; 80° – 82° E) has no natural lakes. The permanent standing water bodies are essentially man-made. Three distinct forms of perennial water bodies are in the country (i.e. ancient irrigation tanks which are restored, tanks and reservoirs built during the recent past, and newly built hydropower, irrigation and storage reservoirs under the River Development Projects. In addition to the major inland water bodies, there are thousands of medium-scale perennial and seasonal tanks in the lowland drainage basins. Today, these man-made water bodies with their canals and channel systems have formed a somewhat sophisticated and complicated hydrological network in the country. Limnologically, these reservoirs differ fundamentally in their basin and catchment morphology, depth, flow-through regime and nutrient status, underwater light regime and consequently, their biological productivity (Duncan et al. 1993). The V-shape mountain basins of the upland reservoirs have small areas of littoral zone and a greatly reduced extent of bottom sediment compared to those shallow irrigation reservoirs in the lowland dry zone (Duncan et al. 1993).

The present study was carried out at 29 irrigation reservoirs in the north central lowland, three hydropower reservoirs and a man-made aesthetic water body (Kandy Lake) in the central highlands (Figure 1). The reservoirs under study are in eight river basins between 10 m and 600 m above mean sea level within a wider geoclimatic range (Figure 1 and Table 1). Of the eight rivers, only the Mahaweli, the longest and the largest in the country, has a perennial flow. The Mahaweli River has been diverted to feed the downstream reservoirs in seasonal river basins for irrigation purposes. Three hydropower reservoirs and the Kandy Lake are located in the Central Highland. Table 1 also shows basic physical features (i.e. altitude, catchment area, mean and maximum depths and surface area) with respective ages (number of years since their construction or restoration to year 2000) and some limnological characteristics. The Kandy Lake (19.17 ha), an aesthetic water body in the hill capital (Kandy), 510 m altitude, is about

200 years old. The capacity of the lake is 0.384 MCM and the mean and the maximum depths are 6.5 m and 12.6 m respectively. The lake is elongated in shape with a fetch of 1.16 km, which lies along the SW-NE direction. The lake is fed only by its own catchment which is urbanised and densely populated, with poor sewerage capacity.

Sampling commenced in mid-January 1997 and was completed before the end of February of the same year, during high water level in the case of 29 irrigation reservoirs and three hydropower reservoirs. Kandy Lake was sampled for two consecutive years (September 1996–August 1998) and during May–December 1999. Phytoplankton samples were collected with a Wisconsin Plankton Net (55 µm mesh size) from the centre of each water body and immediately fixed in 5% formalin. Electrical conductivity (Jenway Conductivity Meter, Model 4070) and pH (Horiba pH Meter, Model H-7LD) of water samples were analysed in situ. Water samples were

also collected from each water body and analysed for total and dissolved phosphorus, ammonia, total nitrogen and nitrate-nitrogen (APHA 1987) and chlorophyll-*a* content (Marker et al. 1980) in the laboratory. In the case of Kandy Lake, vertical oxygen profiles (Modified Winkler Technique), the composition and density of phytoplankton, chlorophyll-*a* and P and N nutrients were determined monthly.

Results and Discussion

Nutrients and enrichment

Table 2 shows the concentration of N and P nutrients, pH, chlorophyll-*a* contents and phytoplankton counts of 32 reservoirs. The concentrations of ammonia and nitrate-nitrogen (NO₃-N) are extremely low in a majority of these reservoirs. NO₃-N concentrations were less than 100 µg/L in 22 reservoirs. The dissolved phosphorus concentration

Table 1. Morphometric and some limnological characteristics of 32 reservoirs with their ages (Alt., altitude; CA, catchment area; D, depth; EC, electrical conductivity, temperature)

Reservoir	River basin	Age (yrs)	Alt. (m)	CA (km ²)	A (ha)	Dx (m)	Dmax (m)	EC uS
Maduruoya	Maduru a	14	96	453	6280	9.5	26	100
Pibu'thewa	Mahaweli	35	97	154	1213	2	6	170
Victoria	Mahaweli	12	438	31	2270	31	98	90
Randenigala	Mahaweli	11	232	31	1350	37	80	80
Rantambe	Mahaweli	11	205		400			150
Loggaloya	Mahaweli		112	250		5		80
Hepolaoya	Mahaweli		117	70	868	3	12	75
Mapakada	Mahaweli	44	105	8	186	4	8	90
Dambarawa	Mahaweli	44	102	7	344	5	6	125
Sorabora	Mahaweli	121	104	62	445	3	7	130
Ulhitiya	Mahaweli	14	97	28	2270	5	6	80
Rathkida	Mahaweli	14	102					70
Dalukkana	Mahaweli		97					125
P'samudra	Mahaweli	45	59	72	2266	5	7	200
Giritale	Mahaweli	92	94	24	308	7	12	125
Minneriya	Mahaweli	94	96	24	2550	5	12	135
Kaudulla	Mahaweli	39	65	81	1765	5	9	135
Nalanda	Mahaweli	40	457	124	304	5	21	100
Bowatenna	Mahaweli	21	414		607	8	23	90
Kantale	Kantalae	128	40	199	2023	7	13	145
Huruluwewa	Yan Oya	44		199	1619	4	8	250
Tissawewa	Malwathu	108	93	5	182	2	5	180
N'wewa	Malwathu	107	91	79	1199	4	7	290
Nachiduwa	Malwathu	91	107	610	1785	3	8	610
M'kandrawa	Malwathu	39	102	326	1376	3	6	280
MahaVillachi	Modaragam	39	89	367	972	4	11	560
Kandalama	Kala Oya	40		98	688	4	9	140
Kalawewa	Kala Oya	110	130	837	2590	4	9	180
Balaluwewa	Kala Oya	110	130					300
Rajangana	Kala Oya	46		1611	1619	6	11	350
Thabbowa	Mi Oya	72	13	389	607	2	5	620
Vettukulum	Mi Oya		10					3750

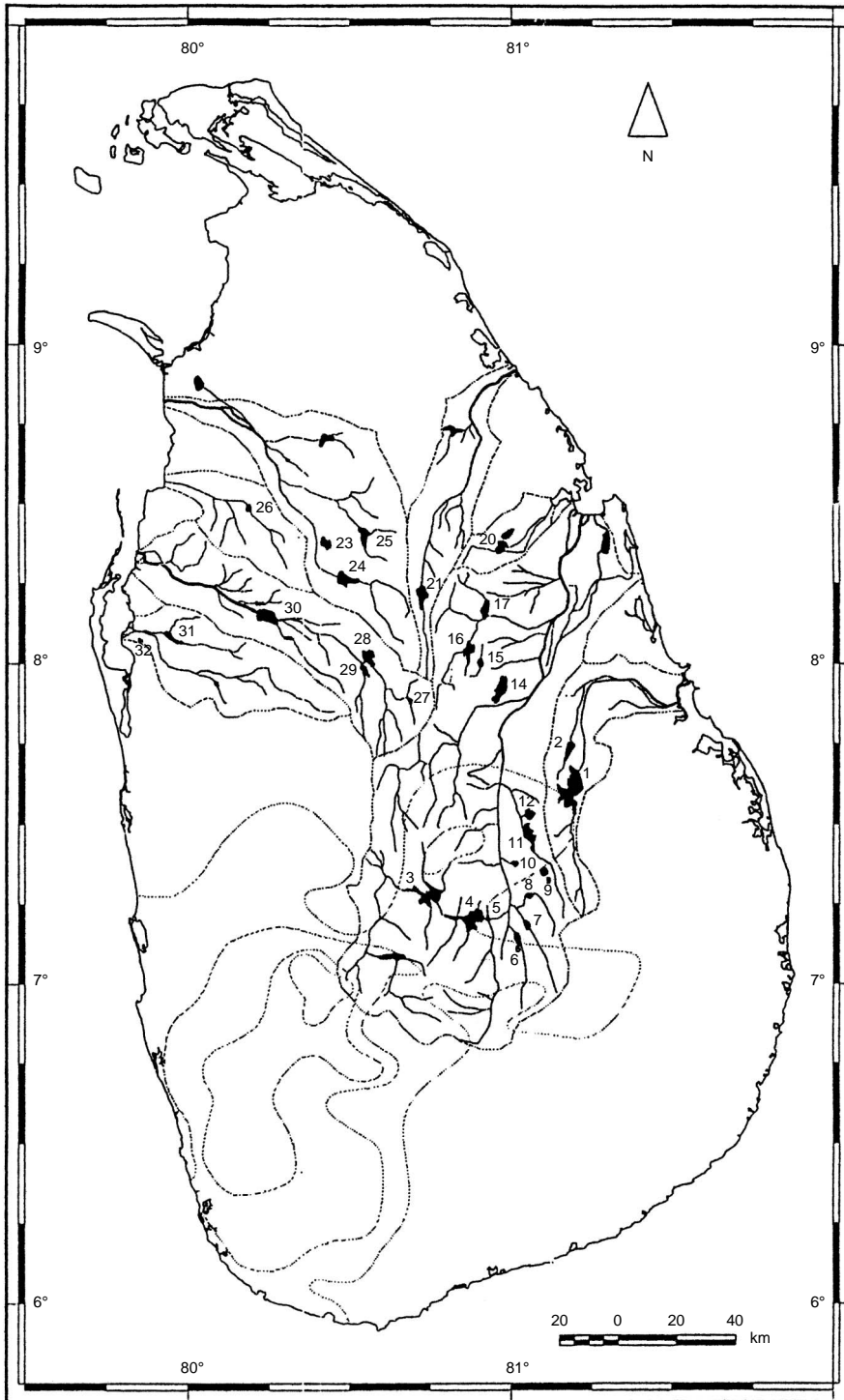

Figure 1. Map of Sri Lanka showing study sites in eight river basins.

ranged 3–40 µg/L but it was less than 10 µg/L in 25 reservoirs and 3–5 µg/L in 13 reservoirs (Table 2). The concentration of total phosphorus was less than 50 µg/L in 27 reservoirs and the lowest was 8 µg/L in the Ulhitiya reservoir. Figure 2 is the scatter diagrams of nutrients and chlorophyll-*a*. No significant relationships were found for chlorophyll-*a* content versus NO₃-N and D-P or T-P. Dillon and Riggler (1980) found statistically significant positive correlation for log chlorophyll-*a* content and log phosphorus for temperate lakes. Values for Parakrama Samudra (Sri Lanka) were close to the Dillon-Riggler line during the period of no flushing in 1982. However, they were well below in 1979, due to high flushing of algal biomass and in 1980, due to loss of algal biomass through combination of herbivorous fish grazing and flushing, even though the T-P levels had increased (Duncan et al. 1993).

The long-term variations of N and P nutrients in surface and bottom waters of the Kandy Lake are

shown in Table 3. NH₄-N and NO₃-N concentrations of the Kandy Lake in both surface and bottom waters were extremely high compared to those irrigation and hydropower reservoirs. However, changes in NH₄-N and NO₃-N did not show a marked seasonal pattern. The concentrations of NH₄-N and NO₃-N were always higher in the bottom waters compared to the surface water in the Kandy Lake. The NH₄-N concentration in the surface water ranged 12–774 µg/L and it was between 421 µg/L and 2711 µg/L for the bottom waters. In contrast, NO₃-N concentration in the bottom water were relatively low compared to the surface water. The highest concentration of NO₃-N in the surface water ranged between 37 µg/L and 1277 µg/L and it ranged between non-detectable level (ND) to 353 µg/L in bottom waters. The concentrations of D-P ranged between ND and 22 µg/L in the surface water and the range was between ND and 19 µg/L in the bottom water. The concentrations of T-P were high

Table 2. Occurrence of major groups of phytoplankton and their counts (per 100 mL) in 32 reservoirs.

Reservoir	Rank 1	Family	Rank 2	Rank 3	Rank 4	Counts
Maduruoya	Micr	Cyanophyceae	Anab	Aucl	Anabena	3571
Pibu'thewa	Micr	Cyanophyceae	Anab	Melo	Anab	3400
Victoria	Stra	Zygenemaphyceae	Aulc	Pedi	Cosm	261
Randenigala	Aulc	Diatomophyceae	Pedi	Stra	Micr	222
Rantambe	Stra	Diatomophyceae	Anab	Cymb	Aulc	232
Loggaloya	Peri	Diophyceae	Stra	Cymb	Navi	432
Hepolaoya	Peri	Diophyceae	Stra	Micr	Pedi	330
Mapakada	Aulc	Diatomophyceae	Pedi	Cymb	Stra	1056
Dambarawa	Aulc	Diatomophyceae	Micr	Pedi	Peri	1490
Sorabora	Micr	Cyanophyceae	Melo	Anab	Pedi	472
Ulhitiya	Aulc	Diatomophyceae	Pedi	Cymb	Anab	748
Rathkida	Cymb	Diatomophyceae	Aulc	Stra	Pedi	1002
Dalukkana	Aulc	Diatomophyceae	Anab	Cymb	Pedi	308
P'samudra	Aulc	Diatomophyceae	Pedi	Anab	Micr	412
Giritale	Micr	Cyanophyceae	Aulc	Anab	Pedi	3871
Minneriya	Micro	Cyanophyceae	Aulc	Pedi	Anab	651
Kaudulla	Aulc	Diatomophyceae	Moug	Pedi	Peri	543
Nalanda	Micr	Cyanophyceae	Aulc	Pedi	Peri	1080
Bowatenna	Aulc	Diatomophyceae	Pedi	Micr	Stra	990
Kantale	Micr	Cyanophyceae	Aulc	Pedi	Anab	3321
Huruluwewa	Aulc	Diatomophyceae	Micr	Pedi	Anab	494
Tissawewa	Aulc	Diatomophyceae	Anab	Micr	Pedi	232
N'wewa	Anab	Cyanophyceae	Aulc	Pedi	Micr	194
Nachiduwa	Aulc	Diatomophyceae	Micr	Anab	Pedi	674
M'kandrawa	Aulc	Diatomophyceae	Micr	Pedi	Anab	2004
Maha Villachi	Anab	Cyanophyceae	Aulc	Pedi	Micr	260
Kandalama	Aulc	Diatomophyceae	Pedi	Micr	Anab	1936
Kalawewa	Aulc	Diatomophyceae	Pedi	Micr	Anab	2474
Balaluwewa	Aulc	Diatomophyceae	Anab	Micr	Pedi	948
Rajangana	Anab	Diatomophyceae	Micr	Aulc	Pedi	2510
Thabbowa	Aulc	Diatomophyceae	Pedi	Anab	Peri	1464
Vettukulum	Scen	Zygenemaphyceae	Aulc	Pedi	Micr	882

Anab, *Anabeaonopsis* sp.; Anbb, *Anabeana* sp.; Aulc, *Aulacoseira granulata*; Cos, *Cosmarium*; Cymb, *Cymbella* sp.; Micr, *Microsystis aeruginosa*; Navi, *Navicula* sp.; Pedi, *Pediastrum* sim; Peri, *Peridinium*; Scen, *Scenedesmus* sp.; Stra, *Staurastrum* sp.

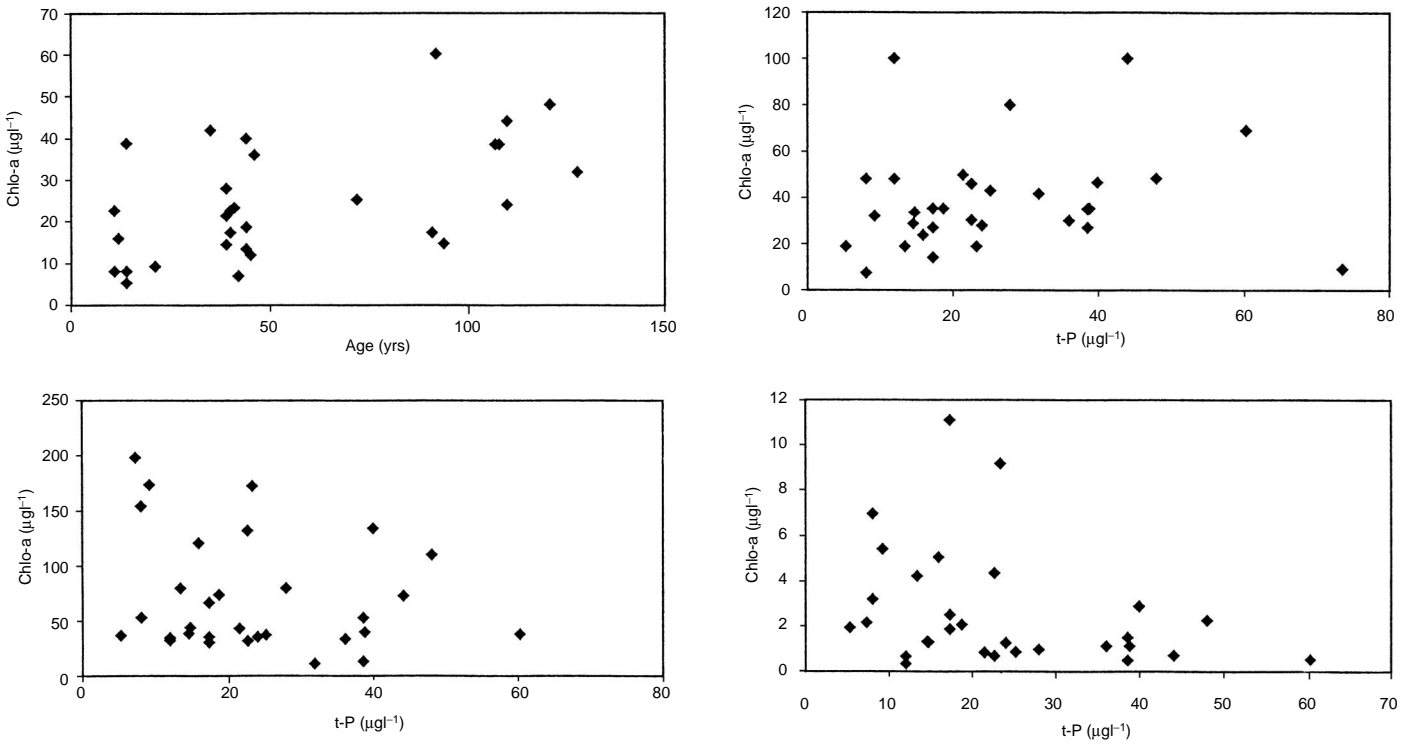

Figure 2. Scatter diagrams of total phosphorus vs chlorophyll-*a* (Chl-*a*), dissolved phosphorus vs Chl-*a*, NO_3^- -N vs Chl-*a* and age vs Chl-*a*.

in the bottom waters (36–431 µg/L) compared to the surface water (14–131 µg/L).

These two sets of nutrient data demonstrate the status of some species of N and P nutrients in Sri Lankan inland water bodies' water and the effect of human activities on enrichment. Tropical water appears to have a lower ratio of dissolved inorganic nitrogen to soluble reactive phosphorus than waters in temperate regions (Viner 1975; Wood et al. 1984; Talling 1992) which is primarily true of East African lakes. However, low nitrate levels are reflected in the low calcium levels in many Southeast Asian waters. Nitrate enrichment may come from volcanic soils as in Java, erosion of farmlands, other altered land use and faecal pollution. Faecal pollution in crowded rural areas is more important in Southeast Asia. Enrichment by sewerage and urban run-off in the tropics is apparent (Osborne 1991). It has been clearly demonstrated the P limitation in the Parakrama Samudra (Schiemer 1983), Kandy Lake and other irrigation reservoirs rich in nitrate with non-nitrogen-fixing cyanobacteria are excellent examples of faecal pollution. But the accepted phenomenon is that the abundance of nitrogen-fixers is high in tropical waters, and element ratio and biomass are often suggestive of nitrogen deficiency (Viner 1977; Mukankomeje et al. 1993). This is not to say that phosphorus limitation is impossible in the tropics (Kalf 1983; Bootsma and Hecky 1993). In the case of irrigation and hydropower reservoirs with high flushing rate, the internal nutrient loading that does occur is lost downstream by the very high flow-through rates at which they are operated for their hydroelectric function and demand for the command areas during the major preparation periods for cultivation. Presently, although both external and internal nutrient loading are low in hydropower reservoirs compared to lowland irrigation reservoirs, these water bodies are much more susceptible to enrichment and subsequent hyper-eutrophication and pollution because of the water depth and long-term thermal stratification (Coche 1974; Townsend et al. 1996).

Phytoplankton density and dominance

Diatoms (Family: Bacillariophyceae) were the dominant phytoplankton in 19 reservoirs of the 32 reservoirs studied (Table 3). *A. granulata* was the dominant diatom except in the Rathkinda Reservoir where a *Cymbell* sp. was found dominant. When *A. granulata* was dominant, *P. simplex* (Family: Chlorophyceae) was the second-dominant species in most of the reservoirs except in a few cases. Blue-green algae, the Cyanobacteria (Family: Cyanophyceae) were found as the dominant species in nine

reservoirs. *M. aeruginosa* was the dominant cyanobacterium in six of the nine reservoirs whereas the other three reservoirs were dominated by an *Anabaenopsis* species. However, there was no particular pattern of co-existence of other phytoplankton species either with *M. aeruginosa* or *Anabaenopsis* sp. The colony densities of *M. aeruginosa* were extremely high in four irrigation reservoirs (i.e. Giritale, Pimburettewa, Maduru Oya and Kantale) that could be considered as blooms. It is interesting to note that a *Peridinium* sp. (Family: Dinophyceae) was dominant in two adjoining reservoirs (Loggal Oya and Hepola Oya) in the Mahaweli River basin. Further, the genus *Staurastrum* (Family: Zygnemaphyceae) was dominant in the Victoria Reservoir while *A. granulata* was dominant in the Randenigala Reservoir which is in the immediate downstream of Victoria reservoir. In addition to four major dominant phytoplankton genera shown in Table 3, many other species belong to nano- and pico-plankton categories that have been reported in previous studies (West and West 1902; Apstein 1907, 1910; Fritsch 1907; Lemmermann 1907; Crow 1923a, b; Holsinger 1955; Foged 1976; Abeywickrema 1979; Rott 1983; Rott and Lanzverger 1994) were also found in small numbers in almost all reservoirs.

Phytoplankton communities in tropical lakes and reservoirs represent summer communities of temperate lakes with a large number of tropical taxa including pantropical and regional endemic elements (Vyvermann 1996). However, there is little information on the distribution, composition and succession of tropical phytoplankton communities and their diversity in relation to environmental gradients in tropical lakes and reservoirs (Lewis 1978; Biswas 1978; Henry et al. 1984; Ramberg 1987; Mukankomeje et al. 1993; Branco and Senna 1994, 1996). Lewis (1996) suggested a progressive decline in phytoplankton diversity towards the tropics. In contrast, extremely high diversity of phytoplankton was shown for floodplain lakes in Papua New Guinea (Vyvermann 1996). Phytoplankton communities in very large lakes are mainly dominated by non-motile species (Lewis 1978; Carney et al. 1987). Species sequences have been reported during the early development of man-made lakes (van der Heide 1973; Biswas 1978; Branco and Senna 1996). Perhaps similar situations could have occurred in newly built hydropower reservoirs in the Mahaweli River basin in Sri Lanka. However, the species composition and diversity of phytoplankton were not similar even between two adjoining reservoirs in the Mahaweli River basin (Silva and Wijeyaratne 1999), indicating that although these reservoirs showed similarity in basic limnological characteristics in the

case of either irrigation or hydropower reservoirs, their microhabitat structure and micro-environment gradients may be different.

Figure 3 shows the phytoplankton succession in the Kandy Lake for two consecutive years. *A. granulata* was oscillating with *P. simplex* throughout the period with several other phytoplankton species commonly found in Sri Lankan inland waters. *A. granulata* was dominant during the rainy season while the density of *P. simplex* was higher during the dry weather. Although *M. aeruginosa* was present throughout the two-year period in small numbers it showed a progressive increase over time (Figure 3). Oscillation of two species of phytoplankton in the Kandy Lake may be attributed to the rainfall pattern. Silica loading during the rainy season may promote the growth of *A. granulata*. However, validity of this hypothesis is questionable, since other diatom species (e.g. *Navicula*, *Cymbella*) present in the lake did not show a marked rainfall-bound seasonal change.

Phytoplankton minimum can be characteristic during washout and raised turbidity in the wet

monsoon season (Alvarez-Cobelas and Jacobsen 1992; Khondker and Parveen 1993). The Kenyan Lake Naivasha showed greater seasonal change in phytoplankton (Kalff and Watson 1986) influenced by variable resuspension of sediment with nutrient exchange induced by the wind regime (Kalff and Brumelis 1993). Changes in density and species composition also occur in tropical lakes and reservoirs with long-term enrichment (Henry et al. 1984; Ramberg 1987; Osborne 1991; Hecky 1993), although few are well-documented (Talling and Lemolle 1998). The progressive increase of *M. aeruginosa* in the Kandy Lake, which is in an urban centre with relatively poor sewerage treatment facilities, may be attributed to long-term enrichment.

Further, internal loading in shallow water bodies is higher than that of in deeper ones. It is assumed that accumulation of organic sediment with progressive changes in the watershed over the past 200 years is substantially high in the Kandy Lake, which has no low level flow-through.

Table 3. pH, N and P nutrients and chlorophyll-a contents (in ug/L) of 30 reservoirs.

Reservoir	pH	NO ₃ -N	d-P	t-P	t-N	t-N:t-P	Chl-a
Maduruoya	7.65	34	3.4	35.1	40	1.1	39
Pibu'thewa	8.06	24.8	3.5	48.1	33	0.7	42
Victoria	7.7	106.9	9.5	23.8	121	5.1	16
Randenigala	7.17	120.3	9.2	30.3	132	4.4	23
Rantambe	7.3	145	7.8	48.1	154	3.2	8
Loggaloya	7.67	188.2	8.9	35	198	5.6	7
Dambarawa	8.44	32.4	5.1	35.2	74	2.1	19
Sorabora	7.9	99.4	3.8	48.2	110	2.3	48
Ulhitiya	7.57	44.5	7.5	7.6	53	7.0	8
Rathkida	7.6	26.5	7.8	18.9	37	2.0	5
Dalukkana	7.8	25.7	4.4	14.1	35	2.5	17
P'samudra	8	26.5	4.1	100	35	0.3	12
Giritale	8.04	26.5	4.5	69.2	38	0.6	60
Minneriya	7.53	35.3	4.8	33.5	44	1.3	15
Kaudulla	7.54	28.2	4.8	28.7	39	1.3	15
Nalanda	7.9	281	11	27	102	3.8	17
Bowatenna	8.19	100	13.6	32	173	5.4	9
Kantale	7.14		4.1	41.6	11	0.3	32
Huruluwewa	7.9	108.6	5.5	46.5	134	2.9	40
Tissawewa	8.22	47	6.1	35	53	1.5	39
N'wewa	8.2		6.5	27.1	14	0.5	39
Nachiduwa	7.9	40.8	7.2	35.2	67	1.9	17
M'kandrawa	8.2	28.6	13.3	49.8	43	0.9	21
MahaVillachi	8.54	32	40	80	80	1.0	28
Kandalama	8.08	17	7.8	46	32	0.7	23
Kalawewa	8.73	27	4.5	28	36	1.3	24
Balaluwewa	8.18	32	13.6	100	73	0.7	44
Rajangana	8.42	22	4.8	30	34	1.1	36
Thabbowa	8.68	24	5.1	43	37	0.9	25
Vettukulum	9.6	30	7.8	183	86	0.5	27

d-P, dissolved phosphorus; t-P, total phosphorus; Chl-a, chlorophyll; t-N, total nitrogen.

Succession of Microcystis

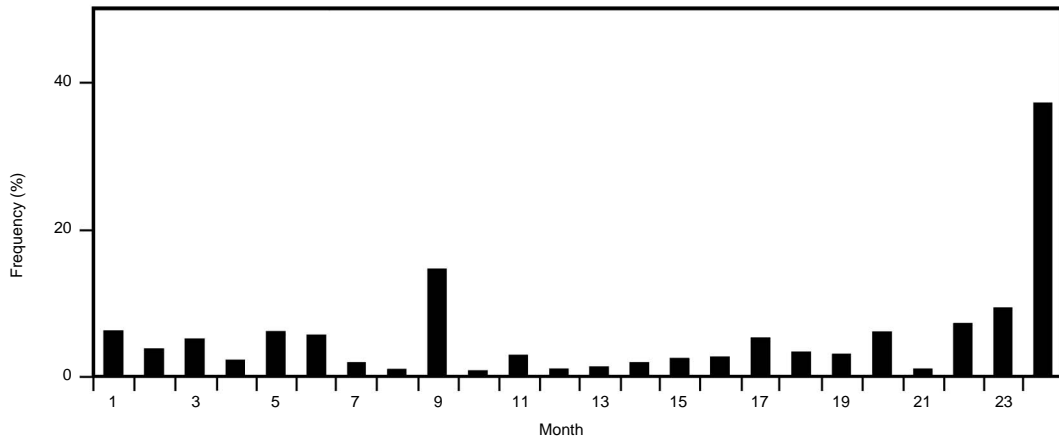

Figure 3. Occurrence of *Microcystis aeruginosa* in the Kandy Lake during the study period.

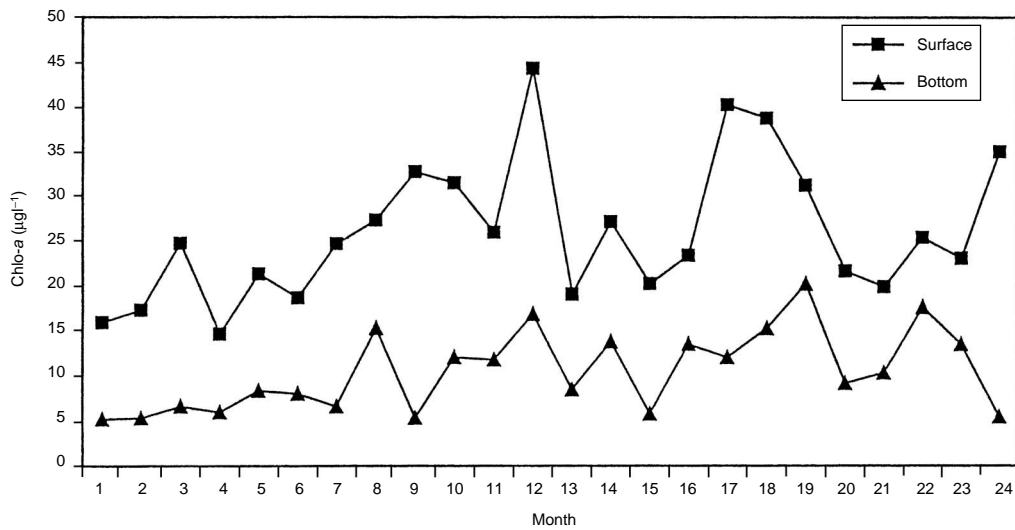

Figure 4. Surface and bottom chlorophyll-a contents in the Kandy Lake during the study period.

Trophic evolution and ecosystem collapse

Chlorophyll-*a* content, an index of phytoplankton biomass, 5–60 µg/L among the 32 reservoirs and was between 10 and 40µg/L in 26 reservoirs (Table 3). Therefore 80% of these reservoirs can be categorised as eutrophic according to the Dillon and Rigler (1980) classification. Only the Hepola Oya and Rathkinda reservoirs fall into the mesotrophic category with respect to chlorophyll-*a* content. However, blooms of *M. aeruginosa* occurred in four reservoirs (Maduru Oya, Giritale, Pimburettewa and Kantale).

Phytoplankton counts of those reservoirs were above 3000 per 100 mL (Table 3). Although there was a positive correlation between log-chlorophyll-*a* content and log-age of the reservoir it was not statistically significant (log Age = 0.441, log Chl-*a* + 0.6607; $r^2 = 0.2948$). This may be attributed to high chlorophyll content occurring in recently built terminal reservoirs (e.g. Maduru Oya). In 1991, a dense thick bloom of *M. aeruginosa* covered the entire Kotmale Reservoir, the uppermost hydropower reservoir in the Mahaweli, during the dry spell of 1991, before the

reservoir reached its 10 years since commission (Piyasiri 1995). This bloom disappeared gradually with the increasing water levels during the northeast monsoonal rain. In contrast, a scum of *Anabena aphanizomenoids* was scattered in the northern basin of the Parakrama Samudra during the high water level in 1993 and it disappeared with the release of surface water to the command (pers. comm. Dr Wolfgang Dittus). The occurrence of temporary cyanobacteria blooms, especially *M. aeruginosa*, is not uncommon in Sri Lankan reservoirs (Silva and Wijeyaratne 1999). Therefore, it is evident that eutrophication and ecosystem collapse in the tropics are not necessarily age-dependent phenomena. They can occur suddenly when hydraulic balance stimulated by man is optimal and is matched with certain limnological factors (e.g. high nutrients and alkalinity) and such prevailing climatic factors as wind and irradiance.

On the other hand, all four water bodies which had cyanobacteria (*M. aeruginosa*) blooms were terminal reservoirs. Silva (1991) showed nutrient enrichment and subsequent hyper-eutrophication in terminal reservoirs resulting from high allochthonous input and reduced flushing rate. The lowland irrigation reservoirs are maintained at high water levels and have high flow-through rates from November to April. The unique feature when water level is high is that there is no turbulent mixing due to windless conditions especially during November and early December, and moderate turbulence mixing from late December to February resulting from the northeast monsoon and stable hydraulic balance. As a result, the external nutrient loading becomes predominant and highly convective forces mediate sediment erosion, but the magnitude of the erosion is comparatively less. The deeper light penetration with euphotic depths of more than 5 m ensures higher turnover rates of algal biomass, but this is subject to both dilution and some loss through relatively high and balanced flushing rates (Duncan et al. 1993). The apparent predominance of phosphorus in man-induced eutrophication of temperate lakes is not necessarily matched in the tropics where natural N:P concentration is often higher (Schiemer 1983).

Therefore, hyper-eutrophication or formation of algal bloom in these reservoirs may occur toward the end of February. The decreasing water level may be attributed to sudden draw-down resulting from release of water to meet the irrigation demand of the command areas. The irrigation demand in the command areas varying from reservoir to reservoir is the principal determinant of water balance of the reservoir ecosystem controlled by man. Similarly power demand determines the retention time of the hydro-power reservoirs.

Figure 3 and Table 4 show the changes of chlorophyll-*a* in the Kandy Lake of 24 months (September 1996–August 1998). The chlorophyll-*a* content in both surface and bottom waters fluctuated within an eutrophic range during this period. The lowest chlorophyll-*a* content was 15 µg/L in December 1996 (rainy season) and the highest was 44 µg/L in August 1997 (dry season). Chlorophyll-*a* in the bottom waters (12 m deep) also fluctuated in the same manner but in lower concentrations. It was shown that there was an oscillation of *A. granulata* and *P. simplex* with progressive increase of *M. aeruginosa* in the Kandy Lake during this period. The oscillation of a diatom and a green algae is an indication of trophic stability, while the progressive increase of *M. aeruginosa* could be considered trophic evolution. Kandy Lake is one of the oldest water bodies in Sri Lanka with continuous water for about 200 years, but an outbreak of an algal bloom had not been reported until May 1999. There is marked stratification with a notable microthermocline in Kandy Lake. De-oxygenation of deeper layers was not seasonal as it was in many tropical reservoirs (Talling and Lemolle 1998), but continual (van der Heide 1978; Matsumara-Tundisi et al. 1991), often with an accumulation of ammonia and H₂S near the bottom.

Table 4. Nutrient concentration (µg/L) of the Kandy Lake over two years.

Month	DP		TP		NO ₃ -N		NH ₃ -N	
	Surf.	Bott.	Surf.	Bott.	Surf.	Bott.	Surf.	Bott.
Sep 96	4	2	23	143	37	78	172	453
Oct 96	1	1	56	66	166	60	170	219
Nov 96	14	0	39	352	681	105	24	1055
Dec 96	22	5	54	349	559	968	490	840
Jan 97	5	4	14	34	156	246	168	300
Feb 97	0	5	28	36	816	306	32.2	450
Mar 97	9	10	51	109	389	53	62	1478
Apr 97	0	0	47	178	271	64	15	2083
May 97	0	2	43	36	84	153	77	2711
Jun 97	5	9	137	431	39	11	12	1682
Jul 97	3	1	72	160	43	3	321	2231
Aug 97	1	3	42	101	538	43	229	1469
Sep 97	5	2	49	82	245	267	392	443
Oct 97	5	4	79	130	340	103	125	1693
Nov 97	7	0	28	156	1277	0	293	2492
Dec 97	0	0	58	212	230	80	774	961
Jan 98	3	3	43	156	334	280	316	421
Feb 98	0	0	50	198	191	353	50	501
Mar 98	0	1	41	37	126	6	67	1449
Apr 98	11	10	38	48	89	2	113	1733
May 98	9	19	25	126	33	6	501	1832
Jun 98	0	1	30	88	78	153	568	569
Jul 98	10	1	52	80	94	200	497	557
Aug 98	5	11	40	72	376	93	176	727

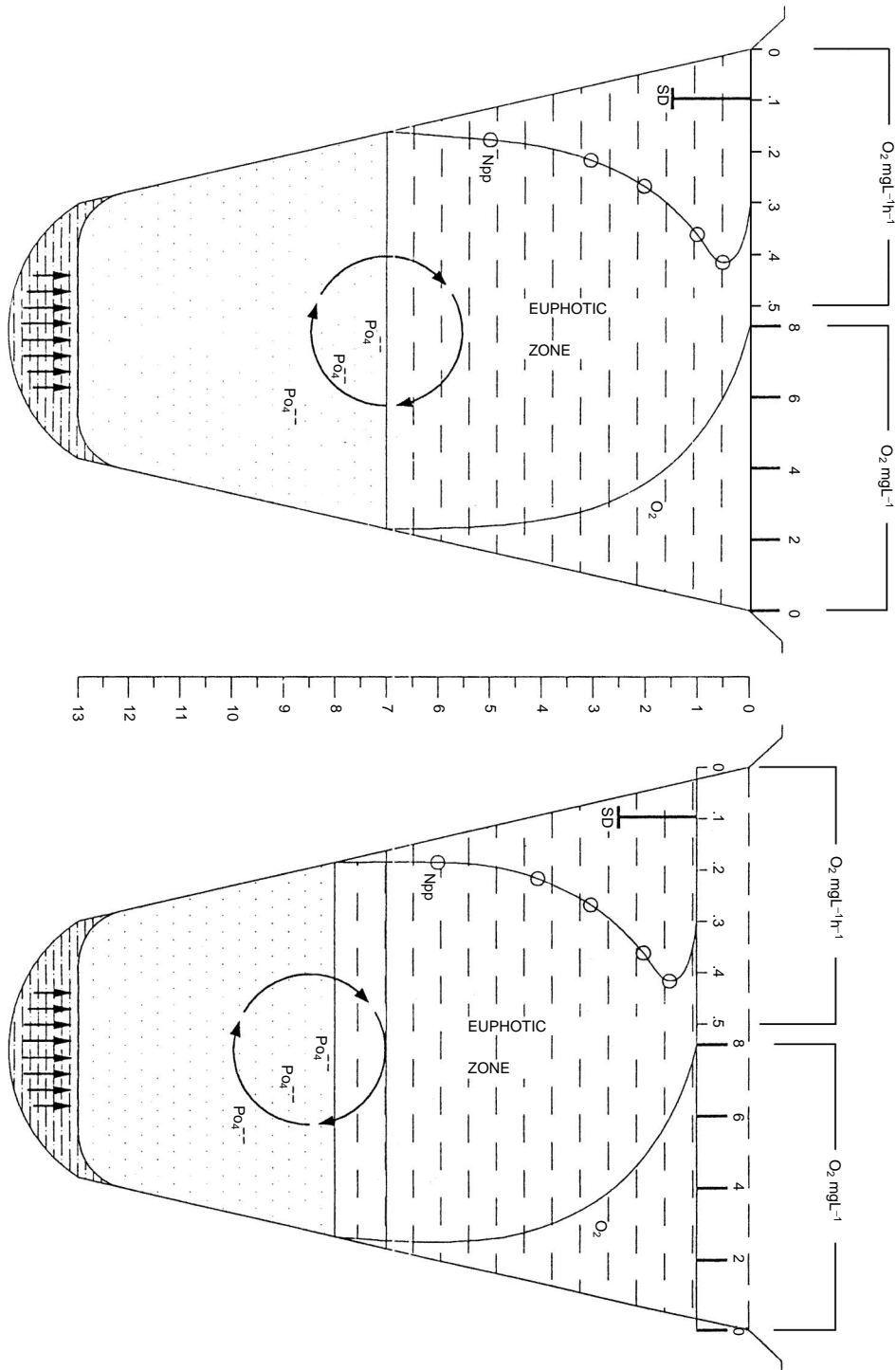

Figure 5. Schematic diagram of vertical depth profile of Kandy Lake showing the changes in euphotic depth with the draw-down before and after the outbreak of *Microcystis* bloom.

The chlorophyll content in Kandy Lake increased up to 80 µg/L in May 1999 following a drop of water level about 1 m to construct a low-level sluice gate, and *M. aeruginosa* out-competed *A. granulata* and *P. simplex* which had been dominant since 1996. This outbreak of cyanobacteria (*M. aeruginosa*) occurred in the Kandy Lake during the dry spell in 1999, an excellent example to demonstrate trophic evolution and ecosystem collapse taking place due to human activities in the watershed as well as in the water body, respectively. The bloom-forming cyanobacteria drifted toward the northeast corner of the lake with the onset of the southwest monsoonal wind (May–Sept) which blows along the fetch of the lake. The dead scum of the cyanobacteria blooms was removed manually while increasing the water level to full supply level. Subsequently, the density of the *M. aeruginosa* colonies decreased with increasing water level and reversing of the wind direction from southwest to northeast. Figure 5 is a schematic diagram to demonstrate the ecosystem collapse of the Kandy Lake due to sudden draw-down matched with prevailing environmental conditions (e.g. wind, irradiance) and the eco-physiological behaviour of *M. aeruginosa*. When the water level dropped in April 1999, the euphotic depth and bottom-dwelling cyanobacteria dropped, reaching the lower layers rich in soluble reactive phosphate due to anoxic conditions in the bottom. This water body is rich in nitrates and the outbreak of non-nitrogen-fixing cyanobacteria suggests phosphorus limitation. On the other hand, availability of chlorophyll-*a* in the entire water column was indicative of rotation of phytoplankton with the convective currents. The reserve potential of tropical phytoplankton to uptake additional nutrients is very high in an absolute sense, and the response of the water body to hyper-eutrophication of tropical latitude may therefore be stronger than it is for temperate areas, and the mix layer is more dynamic in a tropical setting than in a temperate area (Lewis 1996). The diel cycle of temperature/density stratification can have large effects on the vertical distribution of blue-green algae (cyanobacteria) with varying positive or negative buoyancy. Day-to-day variation of wind speed was positively related through turbulence and re-suspension to the abundance of diatom *Aulacoseira italika* in a shallow Brazilian reservoir (de Lima et al. 1983). Phytoplankton is inherently susceptible to both the radiation/temperature and water balance complexes of environmental factors. Its own reaction upon the physical and specially the chemical environment can also be profound, and often cyclical biotic interactions that include grazing and can include further temporal changes.

Conclusion

Heterogeneity of trophic characteristics between and among inter- and intra-basin tropical reservoirs is apparent. The generally accepted phenomenon is that a majority of tropical water bodies are eutrophic due to enrichment by external and internal loading and hyper-eutrophication or the occurrence of algal blooms is also not uncommon.

Eutrophication and subsequent hyper-eutrophication do not necessarily centre on long-term nutrient loading and enrichment. It is associated with thermal stratification and wind-driven convective forces and internal loading to a greater extent. Therefore, sewerage and fertiliser leaching from the watershed are also not the only indicators of hyper-eutrophication in the tropical inland water bodies. Human activities associated with hydraulic balance (draw-down), and introduction of exotics vs over-fishing are directly or indirectly linked with the impulsive emergence of algal blooms in eutrophic tropical reservoirs when reservoir ecosystems and local climate are favourable to growth and the sustenance of bloom-forming phytoplankton.

The role of bio-turbation and grazing pressure on impulsive emergence of algal blooms in cichlid-dominant tropical reservoirs needs more study. More attention should be paid to eutrophic and hyper-eutrophic waters in the tropics, since more than half of the bloom-forming cyanobacterium strains are toxic, and organic compounds found in eutrophic waters form some carcinogenic compounds during the process of chlorinating.

Acknowledgments

We wish to thank the Director, IFS for facilities provided. We also greatly appreciate the assistance of Mr N. Athukorale and Mr S. Wijeyamohan in the field sampling and laboratory analysis. Ms I. Tumpela helped during the examination of phytoplankton and preparation of the manuscript. Ms S. Nathanael read the manuscript in draft.

References

- Abeywickrema, B.A. 1979. The genera of the freshwater algae of Sri Lanka. Part 1 — UNSECO Man and the Biosphere National Committee for Sri Lanka, Special Publication 6. National Science Council Sri Lanka, Colombo, 103 p.
- Alvarez-Cobelas, M. and Jacobsen, B. 1992. Hypertrophic phytoplankton: An overview. Freshwater Biological Association. Freshwater Forum, 2: 184–199.

- APHA. 1987. Standard Methods; Water and Wastewater, 17th Edition, American Public Health Association.
- Apstein, C. 1907. Das Plankton in Colombo-See auf Ceylon. Zoologische Jahrbuecher Abteilung Fuer Systematik, Oekologie und Geographie der Tiere, 25: 201–244.
- 1910. Das Plankton des Gregory-Sees auf Ceylon. Zoologische Jahrbuecher Abteilung fur Systematik, Oekologie und Geographie der Tiere, 29: 661–679.
- Ashton, P.J. 1985. Nitrogen transformations and the nitrogen budget of a hypertrophic impoundment (Hartbeespoort Dam, South Africa). Journal of Limnological Society, South Africa, 11: 32–42.
- Baxter, R.M. 1977. Environmental effects of dams and impoundment. Annual Review of Ecology and Systematics, 8: 253–83.
- Biswas, S. 1978. Observations on phytoplankton and primary productivity in Volta. Lake. Ghana. Verhandlungen. Internationale Vereinigung Limnologie, 20: 1672–1676.
- Boland, K.T. 1996. Some effects on water quality of rapid draw-down in a small, tropical reservoir, Manton River Reservoir, Northern Territory, Australia. In: Schiemer, F. and Boland, K.T. ed. Perspectives in Tropical Limnology, SPB Academic Publishing, Amsterdam, 77–88.
- Boland, K.T. and Griffiths, D.J. 1996. Water column stability as a major determinant of shifts in phytoplankton dominance: evidence from two tropical lakes in northern Australia. In: Schiemer, F. and Boland, K.T. ed. Perspectives in Tropical Limnology, SPB Academic Publishing, Amsterdam, 89–99.
- Bootsma, H.A. and Hecky, R.E. 1993. Conservation of the African Great Lakes: a limnological perspective. Conservation Biology, 7: 1–13.
- Branco, C.W.C. and Senna, P.A.C. 1994. Factors influencing the development of *Cylindrospermopsis raciborskii* and *Microcystis aeruginosa* in the Paranoa Reservoir, Brasilia, Brazil. Archive für Hydrobiologie Supplement, 105 (Algological Studies) 75: 85–96.
- 1996. Phytoplankton composition, community structure and seasonal changes in a tropical reservoir (Paranoa Reservoir, Brazil). Archive für Hydrobiologie Supplement 114, 69–84.
- Carney, H.J., Richerson, P.J. and Eloranta, P. 1987. Lake Titicaca (Peru/Bolivia) Phytoplankton: species composition and structural composition with other tropical and temperate lakes. Archive für Hydrobiologie, 110: 365–85.
- Coche, A.G. 1974. Limnological study of a tropical reservoir, Part 1. In: Balon, E.K. and Coche, A.G. ed. Lake Kariba, Manmade Tropical Ecosystem in Central Africa, Monographie Biologicae 24. The Hague: Junk, 1–248.
- Crow, W.B. 1923a. The taxonomy and variation of the genus *Microcystis* in Ceylon. New Phytologist, 21: 59–68
- 1923b. Freshwater plankton algae from Ceylon. Journal of Botany, London, 61: 110–114, 138–145, 164–171.
- Davies, B.R. 1980. Stream regulation in Africa: a review. In: Ward, J.W. and Stanford, J.A. ed. The Ecology of Regulated Streams. New York: Plenum, 113–142.
- De Lima, W.C., Marins, M. deA. and Tundisi, J.G. 1983. Influence of wind on the standing stock of *Melosira indica* (Ehr.) Kutz. Revta. Bras. Biologia, 43: 317–20.
- De Silva, S.S. 1988. The reservoir fishery in Asia, In: De Silva, S.S. ed. Reservoir Fishery Management and Development in Asia. Proceedings of a Workshop held in Kathmandu, Nepal. 23–28 November 1987, Ottawa, Canada, International Development Research Center 19–28.
- De Silva, S.S. and Amarasinghe, U.S. 1996. Reservoir Fisheries in Asia. Perspective. In: De Silva, S.S. ed. Asian Fisheries. A volume to commemorate the 110th anniversary of the Asian Fisheries Society. Asian Fisheries Society Manila, 189–216.
- Dillon, P. and Rigler, R.H. 1980. A test of a simple nutrient model prediction, the phosphorus concentration in lake water. Journal of Fisheries Research Board, Canada, 31:, 1771–1778.
- Duncan, A., Gunatilaka, A. and Sciemer, F. 1993. Limnological aspects of landscape management in Sri Lanka. In: Erledele, W., Preu, C., Ishwaran, N. and Madduma Bandara, C.M. ed. Proceedings of the International and Interdisciplinary Symposium on Ecology and Landscape Management in Sri Lanka, Margraf Scientific Books, Weikensheim, 381–395.
- Fernando, C.H. 1980. Reservoirs and lakes of Southeast Asia (oriental region). In: Taub, F.B. ed. Ecosystems of the World. 23. Lakes and Reservoirs. Amsterdam: Elsevier, 411–446.
- Foged, N. 1976. Freshwater diatoms in Sri Lanka (Ceylon). Bibliothera Phycology, 23: 1–100.
- Fritsch, F.E. 1907. A general consideration of the sub-aerial and freshwater algal flora of Ceylon. A contribution to the study of tropical algal ecology. Part 1 — Sub-aerial algae and algae of the inland fresh-waters. Proceedings of the Royal Society of London. Series B. 79: 197–254.
- Ganf, G.G. and Viner, A.B. 1973. Ecological stability in a shallow equatorial lake (Lake George, Uganda). Proceedings of the Royal Society (B) 184: 321–46.
- Hart, R.C. 1996. Comparative ecology of plankton in cascading warm-water reservoirs: aspects of relevance to tropical limnology. In: Schiemer, F. and Boland, K.T. ed. Perspectives in Tropical Limnology, SPB Academic Publishing, Amsterdam, 113–130.
- Hecky, R.E. 1993. The eutrophication of Lake Victoria. Verhandlungen Internationale. Vereinigung Limnologie, 25: 39–48.
- Henry, R., Tundisi, J.G. and Curi, P.R. 1984. Effects of phosphorus and nitrogen enrichment on the phytoplankton in a tropical reservoir (Lobo Reservoir, Brazil), Hydrobiologia, 118: 177–185.
- Holsinger, E.C.T. 1955. The plankton algae of three Ceylon lakes, Hydrobiologia, 7: 8–24.
- Kalff, J. 1983. Phosphorus limitation in some tropical African lakes. Hydrobiologia, 100: 102–112.
- 1991. The utility of latitude and other environmental factors as predictors of nutrients, biomass and production in lakes worldwide: Problems and alternatives. Verhandlungen Internationale, Vereinigung Limnologie, 24: 1235–1239.
- Kalff, J. and Brumelis, D. 1993. Nutrient loading, wind speed and phytoplankton in a tropical African lake. Verhandlungen Internationale, Vereinigung Limnologie, 25: 860.
- Kalff, J. and Watson, S. 1986. Phytoplankton and its dynamics in two tropical lakes: a tropical and temperate zone comparison. Hydrobiologia, 138: 161–176.

- Kannan, V. and Job, S.V. 1980. Diurnal, seasonal and vertical study of primary production in Sathiar Reservoir. *Hydrobiologia*, 70: 103–117.
- Khondker, M. and Parveen, L. 1993. Daily rate of primary productivity in hypertrophic Dhamondi Lake. In: Tilzer, M.M. and Khondker, M. ed. *Hypertrophic and Polluted Freshwater Ecosystems: ecological bases for water resources management*. Bangladesh Department of Botany, University of Dhaka, 181–191.
- Latif, A.F.A. 1984. Lake Nasser — the new man-made lake in Egypt (with reference to Lake Nubia). In: Taub, F.B. ed. *Ecosystems of the World*. 23. Lakes and Reservoirs, Elsevier, Amsterdam, 411–446.
- Lemmermann, E. 1907. Protrophyten-plannton von Ceylon. *Zoologische Jahrbuecher Abteilung Fuer Systematik, Oekologie und Geographie der Tiere*, 25: 263–268.
- Lewis, W.M. 1973. The thermal regime of Lake Lanao (Philippines) and its theoretical implications for tropical lakes. *Limnology and Oceanography*, 18: 2000–2017.
- 1974. Primary production in the plankton community of a tropical lake. *Ecological Monograph* 44, 377–409.
- 1978. Dynamics and succession of the phytoplankton in a tropical lake; Lake Lanao, Philippines, *Journal of Ecology*, 66: 849–880.
- 1996. Tropical lakes: how latitude makes a difference. In: Schiemer, F. and Boland, K.T. ed. *Perspective in Tropical Limnology*, SPB Academic Publishing, Amsterdam, 43–64.
- Marker, A.F.H., Crowther, C.A. and Gunn, R.J.M. 1980. Methanol and acetone as solvent for estimating chlorophyll-*a* and phaeopigments by spectrophotometry. *Archive für Hydrobiologie (Supplement)* 14, 52–69.
- Matsumura-Tundisi, T., Tundisi, J.G., Saggio, A., Oliveira Neto, A.L. and Espindola, E.G. 1991. Limnology of Samuel Reservoir (Brazil, Rondonia) in the filling phase. *Verhandlungen Internationale, Vereinigung Limnologie*, 24: 1482–1488
- Melack, J.M. 1979. Temporal variability of phytoplankton in tropical lakes. *Oecologica*, 44: 1–7.
- 1996. Recent developments in tropical limnology. *Verhandlungen Internationale, Vereinigung Limnologie*, 26: 211–217.
- Mukankomeje, R.R., Plisnier, P.D., Descy, J.P. and Massault, L. 1993. Lake Muzah, Rwanda: Limnological features and phytoplankton production. *Hydrobiologia*, 257: 107–120.
- Obeng, L.E. 1981. Man's impact on tropical rivers. In: Lock, M.A. and Williams, D.D. ed. *Perspective in Running Water Ecology*, New York: Plenum, 265–288.
- Osborne, P.L. 1991. Seasonality in nutrients and phytoplankton production in two shallow lakes: Waigani lake, Papua New Guinea, and Barton Broad, Norfolk, England. *Internationale Revue der Gesamten Hydrobiologie*, 76: 105–112.
- Pielou, 1998. *Freshwater University Chicago Press*, 275 p.
- Piyasiri, S. 1995. Eutrophication and bluegreen algal problem in Kotmale Reservoir in Sri Lanka. In: Thomas, K.H. and Golthenboth, F. ed. *Tropical Limnology*, Satya Wacana Christian University, Indonesia. Volume 2. 161–169.
- Ramberg, L. 1987. Phytoplankton succession in the Sanyati Basin, Lake Kariba. *Hydrobiologia*, 153: 193–202.
- Rott, E. 1983. A contribution to the phytoplankton species composition of Parakrama Samudra. In: Schiemer, F. ed. *Limnology of Parakrama Samudra — a case study of an ancient manmade lake in Sri Lanka*. The Hague Junk, 209–226.
- Rott, E. and Lenzenweger, R. 1994. Some rare and interesting plankton algae from Sri Lanka. *Biologia, Bratislava*, 49/4, 497–500.
- Rudd, J.M.W. Harris, R., Kelly, C.A. and Hecky, K.E. 1993. Are hydroelectric reservoirs significant sources of greenhouse gases? *AMBIO*, 22: 46–48.
- Schiemer, F. ed. 1983. *Limnology of Parakrama Samudra, Sri Lanka: A case study of an ancient man-made lake in the tropics*. The Hague Junk.
- Silva, E.I.L. 1991. Limnology and fish yields of newly built standing water bodies in the Mahaweli River Basin, Sri Lanka. *Verhandlungen Internationale Vereinigung Limnologie*, 24: 1425–1429.
- Silva, E.I.L. and Davies, R.W. 1986. Primary productivity and related parameters in three different types of inland waters in Sri Lanka. *Hydrobiologia*, 137: 239–349.
- 1987. The seasonality of monsoonal primary productivity in Sri Lanka. *Hydrobiologia*, 150: 165–175.
- Silva, E.I.L. and Wijeyaratne, M.J.S. 1999. The occurrence of cyanobacteria in the Reservoirs of the Mahaweli River Basin in Sri Lanka. *Sri Lanka Journal of Aquatic Science*, 4: 51–60.
- Sreenivasan, A. 1965. Limnology of tropical impoundments. 111. Limnology and productivity of Amarawathy Reservoir (Madras State), India. *Hydrobiologia*, 26: 510–516.
- 1974. Limnological features of a tropical impoundment. Bhavanisagar Reservoir (Tamil Nadu), India. *Internationale Revue der Gesamten Hydrobiologie*, 59: 327–342.
- Talling, J.F. 1966. The annual cycle of stratification and phytoplankton growth in Lake Victoria (East Africa). *Internationale Revue der Gesamten Hydrobiologie*, 51: 545–621.
- 1969. The incidence of vertical mixing, and some biological and chemical consequences, in tropical African lakes. *Verhandlungen Internationale, Vereinigung Limnologie*, 17: 998–1012.
- 1986. The seasonality of phytoplankton in African lakes. *Hydrobiologia*, 138: 139–160.
- 1990. Diel and seasonal energy transfer, storage and stratification in African reservoirs and lakes. *Archive fur Hydrobiologie. Beih. Ergebn. Limnologie*, 33: 651–660.
- 1992. Environmental regulation in African shallow lakes and wetlands. *Rev. Hydrobiol. Trop.*, 25: 229–256.
- Talling, J.F. and Lemolle, J. 1998. *Ecological Dynamics of Tropical Inland Waters*. Cambridge University Press. 441 p.
- Townsend, S.A. 1996. Metalimnetic and hypolimnetic deoxygenation in an Australian tropical reservoir of low trophic status. In: Schiemer, F. and Boland, K.T. ed. *Perspective in Tropical Limnology*, SPB Academic Publishing, Amsterdam, 151–160.
- Townsend, S.A., Luong-Van, J.T. and Boland, K.T. 1996. Retention time as a primary determination of colour and light attenuation in two tropical Australian reservoirs. *Freshwater Biology*, 36: 57–69.

- Tundisi, J.G., Gentil, J.G. and Dirickson, M.C. 1978. Seasonal cycle of primary production of nanno and microphytoplankton in a shallow tropical reservoir. Review in Brazilian Botany, 1: 35–9.
- Van der Heide, J. 1973. Plankton development during the first years of inundation of the Van Blomestein (Brokopondo) Reservoir in Suriname, Verhandlungen Internationale Vereinigung Limnologie, 24: 1171–1173.
- Viner, A.B. 1975. The supply of minerals to tropical rivers and lakes (Uganda). In: Hasler, A.D. ed. Coupling of Land and Water Systems, New York: Springer, 227–261.
- 1977. Relationships of nitrogen and phosphorus to a tropical phytoplankton population. Hydrobiologia, 52: 185–196.
- Vyvermann, W. 1996. The Indo-Malaysian North-Australian Phycogeographical Region Revised. In: Kristiansen, J. ed.. Developments in Hydrobiology, 118. Biogeography of Freshwater Algae, 107–120.
- West, W. and West, G.S. 1902. A contribution to the freshwater algae of Ceylon — Trans Linnen Society 2nd Series Botany 6, 123–215.
- Wood, R.B. Baxter, R.M. and Prosser, M.V. 1984. Seasonal and cooperative thermal stratification in some tropical crater lakes, Ethiopia. Freshwater Biology, 14: 551–573.

Water Quality Study of Some Selected Oxbow Lakes with Special Emphasis on Chlorophyll-*a*

M.R. Hasan¹, M.A.W. Mondal², M.I. Miah and M.G. Kibria²

Abstract

A study of some selected water quality parameters with special emphasis on chlorophyll-*a* was carried out to estimate productivity in six Oxbow lakes in southwestern Bangladesh from September 1996 to June 1997. The water quality parameters studied were temperature, conductivity (π), total dissolved solids (TDS), Secchi depth and chlorophyll-*a*. Sampling was carried out either once in a month or every fortnight. Water samples were collected from two locations and three depths from each lake. The Oxbow lakes selected were Bahadurpur, Benipur, Bukbhara, Marufdia, Nasti and Porapara. Chlorophyll-*a* values showed significant ($P < 0.05$) negative correlation with Secchi depth in all six lakes. The relationships of chlorophyll-*a* with conductivity and TDS were significant only at Nasti and Bukbhara lakes. There were significant ($P < 0.05$) positive correlations between Secchi depth and conductivity and TDS in Nasti, Benipur and Bahadurpur, while the relationship between Secchi depth and conductivity and TDS in Bukbhara was significantly negative. The prediction of fish yield based on chlorophyll-*a*, Secchi depth and morpho-edaphic index is discussed.

Oxbow lakes (local name: *baors*) are semi-closed water bodies, which occupy the dead channels of the rivers in the moribund delta of the Ganges. Oxbow lakes are believed to have resulted from the change of river courses leaving cut-off Oxbow bends as violated bodies of matter. They apparently look like lakes or reservoirs, but differ from them in having connections with the parent river through channels at least in the monsoonal season. In the dry season, most of the Oxbow lakes become converted to fully closed water bodies. The physico-chemical characteristics of water, nutrient loading, and the quantum and abundance of aquatic macrophytes in the Oxbow lakes also change seasonally. There are approximately 600 Oxbow lakes in southwestern Bangladesh with an estimated combined water area of 5488 ha (Hasan 1990).

The fisheries management in the Oxbow lakes is neither strictly comparable to those in the truly open

water environment of the rivers and natural depressions where the fishery is a 'capture fishery', nor to those in the completely controlled closed water system of ponds or lakes. Fish culture in Oxbow lakes is a practice by which open water fisheries are converted by screening the inlets and outlets into culture-based fisheries. This practice is akin to 'pen culture', where fish are raised in an enclosure. This culture-based fishery as practised in Bangladesh essentially includes fingerling stocking, fish harvesting and regular weeding. The fisheries management of Oxbow lakes can be summarised as stock management, species management, fishing effort management, and organisational or infrastructural support. Six species of Indian major carps (rohu, *Labeo rohita*, catla, *Catla catla* and mrigal, *Cirrhinus mrigala*) and Chinese carps (silver carp, *Hypophthalmichthys molitrix*, grass carp, *Ctenopharyngodon idella*, and common carp, *Cyprinus carpio*) are regularly stocked and harvested. Black carp, *Mylopharyngodon piceus*, and mirror carp are also occasionally stocked in some of the Oxbow lakes.

The Government of Bangladesh (GoB), with financial support from World Bank, embarked on a 7-year pilot project in six Oxbow lakes (total area 1059 ha) in 1978 under Oxbow Lakes Development

¹Corresponding author: c/- Department of Aquaculture, Bangladesh Agricultural University, Mymensingh 2202, Bangladesh. Fax: +88-091-55810; E-mail: mrhasan@citechco.net

²Department of Aquaculture, Bangladesh Agricultural University, Mymensingh 2202, Bangladesh

Project (OLP-I). These six lakes in southwestern Bangladesh were brought under culture-based fisheries management and are presently managed under direct supervision of the Department of Fisheries (DoF) of GoB. In 1991, the second phase of Oxbow Lakes Project (Oxbow Lakes Small Scale Fishermen Project, OLP-II) was initiated by GoB with funding from International Fund for Agricultural Development (IFAD) and with technical assistance from Danish International Development Agency (Danida). A further 22 lakes (total area 1143 ha) in five districts of southwestern Bangladesh were brought under culture-based fisheries management through OLP-II (Hasan and Middendorp 1998).

The Oxbow Lakes Project conducted biological studies in 20 Oxbow lakes 1994–1997. As a result of this study, a yield prediction model was developed to predict fish yield based on the relationship between Secchi depth (water transparency) and stocking density (Hasan and Middendorp 1998; Hasan et al. 1999). However, Secchi depth is an indirect indicator of productivity and may not be always acceptable as a measure of primary productivity. In many instances, it has been reported that turbidity in water may give lower water visibility, hence providing inaccurate estimation of primary productivity. The chlorophyll-*a* is a green pigment-bearing agent, which is directly related to photosynthesis and therefore provides an accurate measure of primary productivity.

The objective of this study was to verify the reliability of Secchi depth data as a measure of productivity by establishing their relationship with some selected water quality parameters with special emphasis on chlorophyll-*a*.

Materials and Methods

Study area and period

The research study was conducted in six selected Oxbow lakes under Oxbow Lakes Project (OLP-II). The selected lakes were Nasti, Porapara, Benipur, Marufdia, Bukbhara and Bahadurpur (Table 1). They are in three districts (Jessore, Chuadanga and Jhenaidah) of southwestern Bangladesh. The study was carried out from September 1996 to June 1997.

Sampling procedure and collection of water samples

Water quality parameters studied were temperature, conductivity (π), total dissolved solids (TDS), Secchi depth and chlorophyll-*a*. Sampling was carried out either once a month or every fortnight. However, due to some logistic difficulties, sampling could not be done during March and April 1997. Water samples were collected from two fixed sites marked by a bamboo pole (middle and near the inlet) and three depths (surface, middle and bottom) from each lake. Water samples were collected between 0900 and 1030 hrs and water quality parameters were subsequently analysed. Water samples from the middle and bottom were collected by Kameron-type water sampler. Surface water samples were collected directly using a plastic bottle.

Data collection

The water area referred to in this text is the measured water area (standard water area, SWA) (ha) of each Oxbow lake under water on 31 December 1994 based on a field survey conducted in early 1995

Table 1. Mean and range (within parentheses) of different water quality parameters of six Oxbow lakes.

Oxbow lakes	Area (ha)	Depth (cm)	Temperature ($^{\circ}$ C)	Conductivity ($\mu\Omega$ /cm)	TDS (mg/L)	Secchi depth (cm)	Chlorophyll- <i>a</i> (μ g/L)	MEI
Nasti	54	220 (120–291)	28.6 (21.7–35.2)	253 (200–286)	127 (100–142)	52 (25–88)	35.9 (2.6–86.3)	64.6 (46.3–98.4)
Porapara	88	190 (97–268)	28.8 (21.7–36.5)	243 (220–267)	123 (110–138)	58 (14–113)	39.7 (12.1–95.5)	68.9 (41.0–85.7)
Benipur	45	209 (137–301)	27.7 (22.4–32.8)	336 (266–402)	167 (133–201)	69 (43–85)	37.0 (18.4–76.2)	89.0 (59.4–103.8)
Marufdia	25	221 (180–263)	28.4 (21.1–33.9)	340 (220–410)	170 (110–206)	74 (63–105)	30.3 (12.8–42.0)	77.9 (58.2–95.4)
Bukbhara	138	287 (168–417)	28.1 (20.7–33.5)	301 (249–356)	155 (124–182)	74 (44–104)	22.3 (10.2–46.2)	66.5 (31.6–102.9)
Bahadurpur	110	297 (156–383)	28.1 (22.1–34.6)	225 (172–260)	113 (86–130)	204 (143–279)	7.7 (2.6–15.8)	38.9 (33.1–47.9)

(Oxbow Lakes Project II 1995). Water depth fluctuation data were collected from Baor Biological Studies Annual Report (July 1996–June 1997) (Oxbow Lakes Project II 1997).

Water transparency (Secchi depth) was measured at each sampling site to the nearest cm by lowering a Secchi disk to the point of disappearance. Water temperature ($^{\circ}\text{C}$), conductivity ($\mu\text{mhos/cm}$) and total dissolved solids (mg/L) were measured in situ from the collected water samples by a combined temperature/conductivity/TDS meter (Ciba-Corning) for each site and depth.

Water samples for chlorophyll-*a* analysis were filtered using a membrane filter (Millipore micro-filter, 47 mm diam; 45 μm) and the filtrates were frozen until analysed. The phytoplankton pigments in the filtrate were extracted in acetone and the concentration of chlorophyll-*a* was determined spectrophotometrically at 665 nm and 750 nm. The concentration was calculated from the following equation after Vollenweider (1969):

$$\text{Chlorophyll-}a \text{ } (\mu\text{g/L}) = 11.9 (A_{665} - A_{750}) \text{ V/L} \times 1000/\text{S}$$

where A_{665} = the absorbance at 665 nm,
 A_{750} = the absorbance at 750 nm,
 L = the length of light path in the spectrophotometer in cm, and
 S = volume (mL) of water sample filtered,
 V = volume of extract (iL).

Morpho-edaphic index was calculated using the following formula after Ryder (1965):

$$\text{MEI} = \text{TDS}/\text{Z}$$

where MEI = morpho-edaphic index,
TDS = total dissolved solids (mg/L), and
Z = mean water depth (m).

Statistical analysis

Data collected from two sites and three depths of each lake were subsequently averaged and were subjected to statistical analysis. Correlation and regression analyses were done to establish relationships between different water quality parameters collected from each Oxbow lake. All analyses were carried out by Microsoft Excel 2000 on a microcomputer.

Results

Mean and range values of different water quality parameters of six Oxbow lakes during the period September 1996 to June 1997 are presented in Table 1. Data of water area and water depth fluctuations of each lake are also given.

Each Oxbow lake was sampled 12 times in eight months. Firstly, we have attempted to establish relationships between Secchi depth, chlorophyll-*a* concentration, conductivity, total dissolved solids

(TDS), temperature and morpho-edaphic index (MEI) of each lake. Correlation matrix between five water quality parameters is presented in Tables 2–7. Chlorophyll-*a* concentration was negatively correlated ($P < 0.05$) with Secchi depth in all six lakes. Although there appears to be a significant relationship between conductivity/TDS and Secchi depth in four Oxbow lakes, the relationship was not clear enough to derive any definite conclusion. Significant ($P < 0.01/0.05$) positive correlation was recorded at Nasti ($P < 0.01$), Benipur ($P < 0.01$) and Bahadurpur ($P < 0.05$) lakes, while the relationship was negative in the case of Bukbhara. Similarly, chlorophyll-*a* concentration was negatively ($P < 0.01$) correlated with conductivity/TDS at Nasti, while the relationship was positive at Bukbhara Lake. However, when the relationships between MEI and chlorophyll-*a* and Secchi depth were examined, definite trends in relationship were recorded, although the relationship was not significant in all lakes (Tables 2–7). Significant ($P < 0.001$) positive relationship between MEI and chlorophyll-*a* was recorded in two lakes (Nasti and Bukbhara) and significant ($P < 0.001$) negative relationship between MEI and Secchi depth was recorded in four lakes (Nasti, Porapara, Bukbhara and Benipur).

Further, chlorophyll-*a* concentration and Secchi depth measured during the total sampling period (varying between 285 and 290 days) for each Oxbow lake were plotted graphically in Figures 1–4 to visualise their seasonal trends and the relationships. In general, in all Oxbow lakes, chlorophyll-*a* concentration was lowest during January–February and the concentration started increasing towards the end of the sampling period (May–June), with the rise in water temperature. In the case of Secchi depth, a general reverse trend was recorded in all lakes.

Since chlorophyll-*a* concentration and Secchi depth were found to be significantly correlated in all six lakes (r values varied 0.587 to 0.798), the regression equation between these two parameters was calculated for all six lakes (Table 8). The values of a and b were significant ($P < 0.05$) in all lakes.

Further, chlorophyll-*a*, Secchi depth, temperature, conductivity, TDS and MEI values of all lakes were pooled, and a correlation matrix between these variables established (Table 9); ($P < 0.000$) negative correlation existed between chlorophyll-*a* and Secchi depth, and no significant positive or negative correlation was observed between conductivity/TDS and chlorophyll-*a*/Secchi depth. In contrast to conductivity/TDS values, MEI values showed significant ($P < 0.000$) relationships with chlorophyll-*a*/Secchi depth. The relationship between MEI and chlorophyll-*a* was positive, while that between MEI and Secchi depth was negative.

Table 2. Correlation matrix between different water quality parameters and MEI of Nasti Lake.

	Chlorophyll- <i>a</i> (µg/L)	Secchi depth (cm)	Temperature (°C)	Conductivity (µΩ/cm)	TDS (mg/L)
Secchi depth (cm)	-0.798**				
Temperature (°C)	0.405	-0.181			
Conductivity (µΩ/cm)	-0.982**	0.850**	-0.414		
TDS (mg/L)	-0.988**	0.847**	-0.419	0.997**	
Morpho-edaphic index (MEI)	0.786**	-0.811**	0.371	-0.768**	-0.801**

P < 0.05 = ±0.576 at degrees of freedom of 10; P < 0.01 = ±0.708 at degrees of freedom of 10.

Table 3. Correlation matrix between different water quality parameters and MEI of Porapara Lake.

	Chlorophyll- <i>a</i> (µg/L)	Secchi depth (cm)	Temperature (°C)	Conductivity (µΩ/cm)	TDS (mg/L)
Secchi depth (cm)	-0.729**				
Temperature (°C)	0.295	-0.367			
Conductivity (µΩ/cm)	-0.203	0.176	-0.647*		
TDS (mg/L)	-0.336	0.357	-0.683*	0.898**	
Morpho-edaphic index (MEI)	0.547	-0.743**	-0.223	0.356	0.162

P < 0.05 = ±0.576 at degrees of freedom of 10; P < 0.01 = ±0.708 at degrees of freedom of 10.

Table 4. Correlation matrix between different water quality parameters and MEI of Benipur Lake.

	Chlorophyll- <i>a</i> (µg/L)	Secchi depth (cm)	Temperature (°C)	Conductivity (µΩ/cm)	TDS (mg/L)
Secchi depth (cm)	-0.715**				
Temperature (°C)	0.268	-0.677*			
Conductivity (µΩ/cm)	-0.446	0.896**	-0.754**		
TDS (mg/L)	-0.428	0.891**	-0.747**	0.999**	
Morpho-edaphic index (MEI)	-0.009	0.039	-0.540	0.168	0.167

P < 0.05 = ±0.576 at degrees of freedom of 10; P < 0.01 = ±0.708 at degrees of freedom of 10.

Table 5. Correlation matrix between different water quality parameters and MEI of Marufdia Lake.

	Chlorophyll- <i>a</i> (µg/L)	Secchi depth (cm)	Temperature (°C)	Conductivity (µΩ/cm)	TDS (mg/L)
Secchi depth (cm)	-0.576*				
Temperature (°C)	-0.275	0.440			
Conductivity (µΩ/cm)	0.333	0.190	-0.612*		
TDS (mg/L)	-0.325	0.178	-0.617*	0.999**	
Morpho-edaphic index (MEI)	-0.149	-0.139	-0.763**	0.881**	0.896**

P < 0.05 = ±0.576 at degrees of freedom of 10; P < 0.01 = ±0.708 at degrees of freedom of 10.

Table 6. Correlation matrix between different water quality parameters and MEI of Bukbhara Lake.

	Chlorophyll- <i>a</i> (µg/L)	Secchi depth (cm)	Temperature (°C)	Conductivity (µΩ/cm)	TDS (mg/L)
Secchi depth (cm)	-0.890**				
Temperature (°C)	0.674*	-0.473			
Conductivity (µΩ/cm)	0.774**	-0.867**	0.328		
TDS (mg/L)	0.654*	-0.806**	0.437	0.862**	
Morpho-edaphic index (MEI)	0.876**	-0.982**	0.516	0.881**	0.888**

P < 0.05 = ±0.576 at degrees of freedom of 10; P < 0.01 = ±0.708 at degrees of freedom of 10.

Table 7. Correlation matrix between different water quality parameters and MEI of Bahadurpur Lake.

	Chlorophyll- <i>a</i> (µg/L)	Secchi depth (cm)	Temperature (°C)	Conductivity (µΩ/cm)	TDS (mg/L)
Secchi depth (cm)	-0.587*				
Temperature (°C)	0.501	-0.638*			
Conductivity (µΩ/cm)	-0.207	0.654*	-0.532		
TDS (mg/L)	-0.217	0.670*	-0.531	0.999**	
Morpho-edaphic index (MEI)	0.244	-0.709**	0.430	-0.900**	-0.910**

P < 0.05 = ±0.576 at degrees of freedom of 10; P < 0.01 = ±0.708 at degrees of freedom of 10.

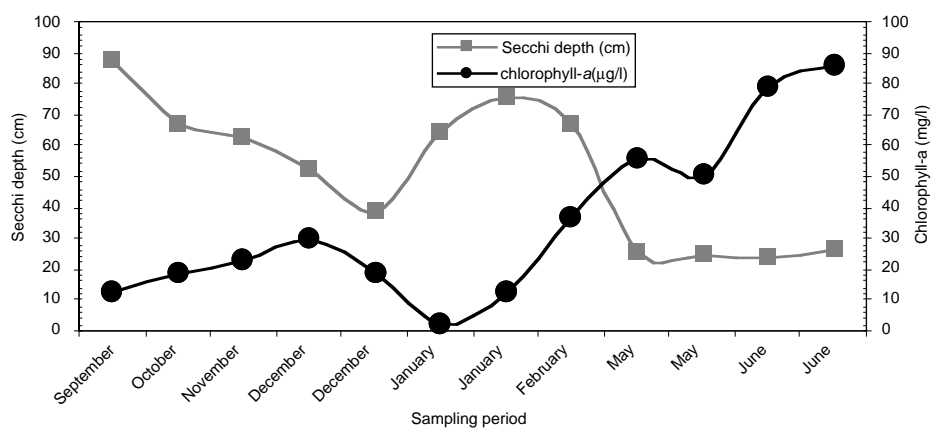

Figure 1. Seasonal fluctuation of chlorophyll-*a* and Secchi depth in Nasti Lake.

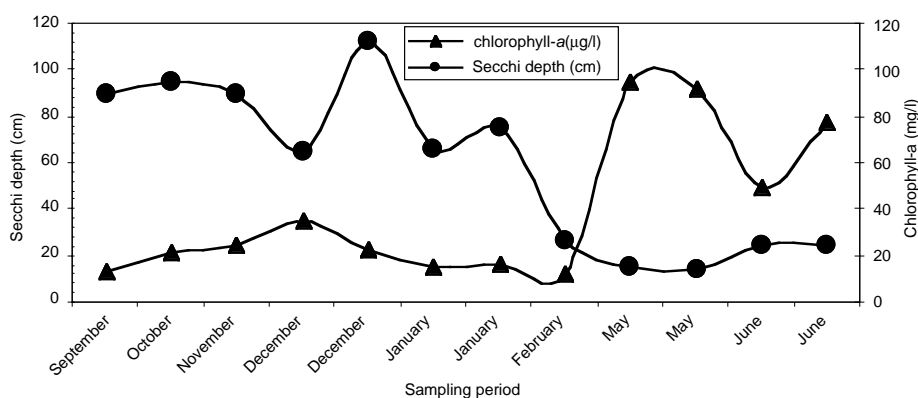

Figure 2. Seasonal fluctuation of chlorophyll-*a* and Secchi depth in Porapara Lake.

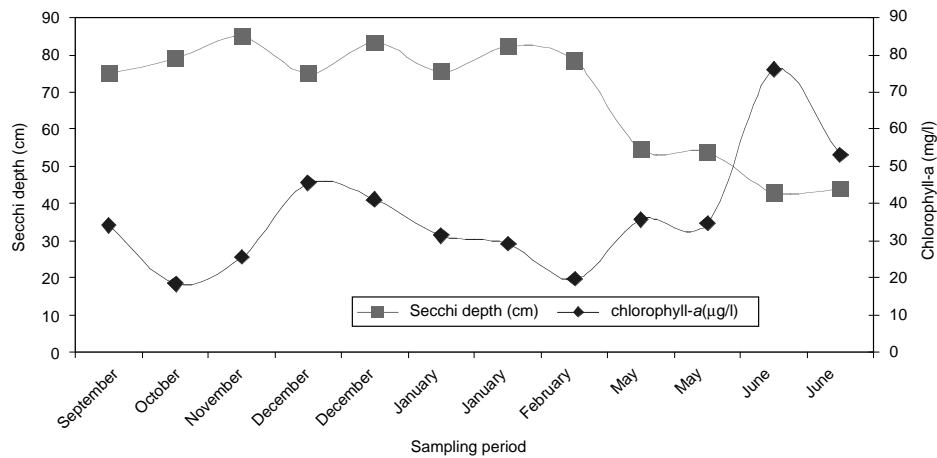

Figure 3. Seasonal fluctuation of chlorophyll-*a* and Secchi depth in Benipur Lake.

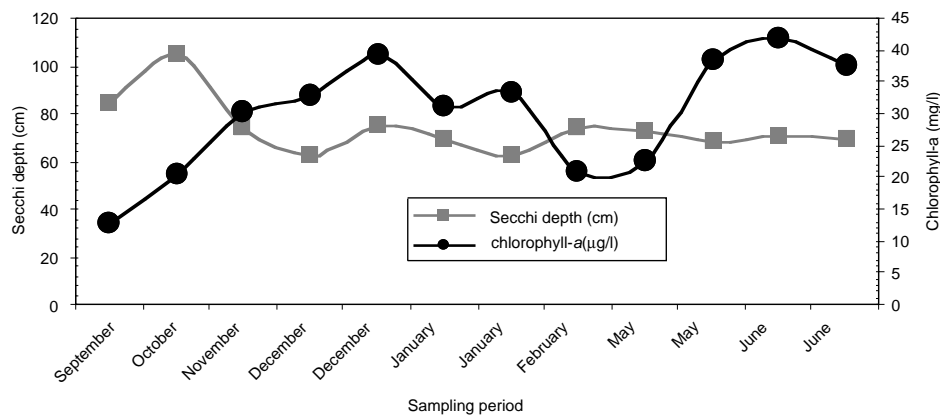

Figure 4. Seasonal fluctuation of chlorophyll-*a* and Secchi depth in Marufdia Lake.

Table 8. Regression equation between chlorophyll-*a* concentration and Secchi depth in different Oxbow lakes.

Oxbow lakes	Regression equation	r	P	N
Nasti	$Y = 75.52 - 0.67X$	-0.798	0.01	12
Porapara	$Y = 90.96 - 0.82X$	-0.729	0.01	12
Benipur	$Y = 95.19 - 0.70X$	-0.715	0.01	12
Marufdia	$Y = 96.01 - 0.71X$	-0.576	0.05	12
Bukbhara	$Y = 111.21 - 1.65X$	-0.890	0.01	12
Bahadurpur	$Y = 265.48 - 7.92X$	-0.587	0.05	12

Y = Secchi depth (cm); X = chlorophyll-*a* concentration (µg/L).

Using the pooled data of all lakes, regression equations between chlorophyll-*a*, Secchi depth and MEI were established (Figures 4, 5 and 6):

$$Y = 140.72 - 1.76X \quad (r = 0.634; P = 0.000; n = 72) \quad (1)$$

where Y = Secchi depth and X = Chlorophyll-*a*.

$$Y = 204.8 - 1.72X \quad (r = 0.654; P = 0.000; n = 72) \quad (2)$$

where Y = Secchi depth and X = MEI.

$$Y = -8.41 + 0.55X \quad (r = 0.582; P = 0.000; n = 72) \quad (3)$$

where Y = Chlorophyll-*a* and X = MEI.

Table 9. Correlation matrix between different water quality parameters of pooled data of all lakes.

	Chlorophyll- <i>a</i> (µg/L)	Secchi depth (cm)	Temperature (°C)	Conductivity (µΩ/cm)	TDS (mg/L)
Secchi depth (cm)	-0.634***				
Temperature (°C)	0.262*	-0.199			
Conductivity (µΩ/cm)	-0.010	-0.202	-0.326**		
TDS (mg/L)	-0.023	-0.206	-0.311**	0.988***	
Morpho-edaphic index (MEI)	0.582***	-0.654***	0.003	0.539***	0.534***

P < 0.05 = ±0.232 at degrees of freedom of 70; P < 0.01 = ±0.302 at degrees of freedom of 70; P < 0.001 = ±0.380 at degrees of freedom of 70.

Discussion

Fish culture is undertaken in different ways in different ecosystems. As opposed to open inland waters, the habitats in Oxbow lakes are semi-closed ecosystems providing scope for augmenting fish production through stocking. In Oxbow lake culture-based fisheries, no extra energy input is used apart from stocking. Therefore, natural productivity can play an important role in fish production. It is therefore essential to have a clear understanding of the biological basis of the system and its productivity, to use its full capability. Since stocking is a major intervention in the natural ecosystem of Oxbow lakes, sustainability of their ecological balance must be ensured by proper stocking of carp according to ecological conditions.

Yield predictive modeling is a basic tool for the effective development and management of culture-based fisheries. The most notable findings of Oxbow lakes fishery are the development of a yield prediction model based on the relationship between stocking density and Secchi depth of water (Hasan and Middendorp 1998; Hasan et al. 1999). In the above findings, Secchi depth was found to be negatively correlated with fish yield when two seasons (1994–1996) mean fish yield and Secchi depth data of 19 Oxbow lakes were analysed. A multivariate regression model was then developed to predict fish yield based on the relationship between Secchi depth and stocking density. However, Secchi depth approximates a rather complex limnological relationship and the yield prediction model was developed on the assumption that Secchi depth is a relatively reliable indicator of the productivity due to the generally very low turbidity in Oxbow lakes (Hasan and Middendorp 1998; Bala and Hasan 1999).

The present study attempts to establish the relationship between Secchi depth and other water quality parameters, particularly chlorophyll-*a* concentration. An inverse significant relationship

between chlorophyll-*a* concentration and Secchi depth was observed in all Oxbow lakes. When the minimum Secchi depth was observed the highest chlorophyll-*a* value was recorded in all Oxbow lakes and vice versa.

The Secchi disc visibility provides an estimate of water transparency that is closely related to plankton abundance, the amount of sandy clay, detritus and organic matter suspended in the water, and the quantity of dissolved elements in the water (Almazan and Boyd 1978; Li and Xu 1995). Secchi depth as a general indicator of chlorophyll-*a* concentration has been reported to be negatively related to chlorophyll-*a* concentration (Hepher 1962; Barica 1975). Anuta (1995) reported that fish production was correlated with mean chlorophyll-*a* concentration (P<0.01) and abundance of zooplankton. Secchi depth reading has therefore often been used as an indicator of primary productivity in ponds and small reservoirs. Since measurements of phytoplankton productivity or plankton abundance may be used as indices of potential fish production in ponds, Secchi depth reading has often been used as a guide for pond fertilisation. However, Secchi disc visibility may not always be acceptable as an index of fish production, as some regions are less turbid than others.

There have been many reports dealing with the relationships between conductivity, nitrate-nitrogen, phosphate-phosphorus and fish yield (Ryder 1965, 1982; Ghosh 1992). Conductivity (π) and total dissolved solids (TDS) have been advocated as a reliable parameter to study productivity and to predict fish yield. Rawson (1951) showed that total mineral content, conductivity and TDS were deemed important parameters for estimating the productivity of the lakes. Northcote and Larkin (1958) found fish production to be proportional to TDS. Rawson (1951) showed that TDS is an important parameter in estimating the productivity of lakes; high fish yield was due to high values of TDS.

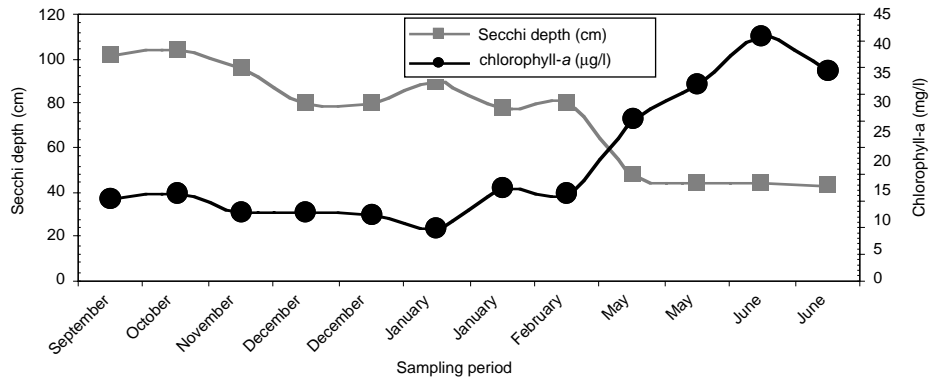

Figure 5. Seasonal fluctuation of chlorophyll-a and Secchi depth in Bukbhara Lake.

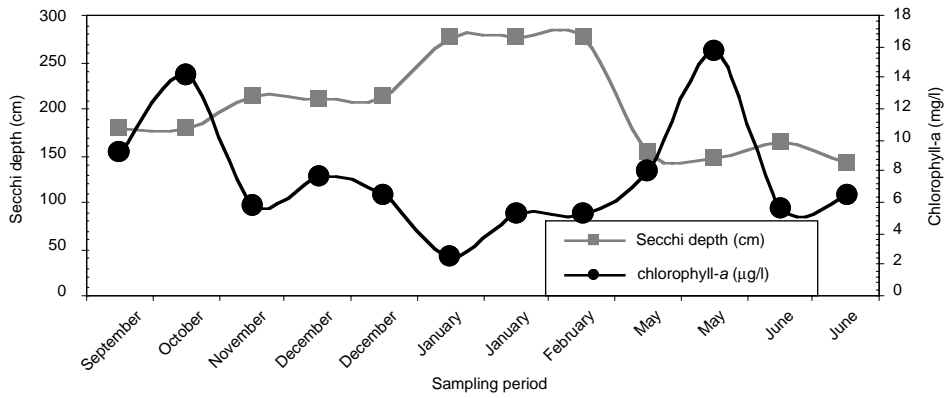

Figure 6. Seasonal fluctuation of chlorophyll-a and Secchi depth in Bahadurpur Lake.

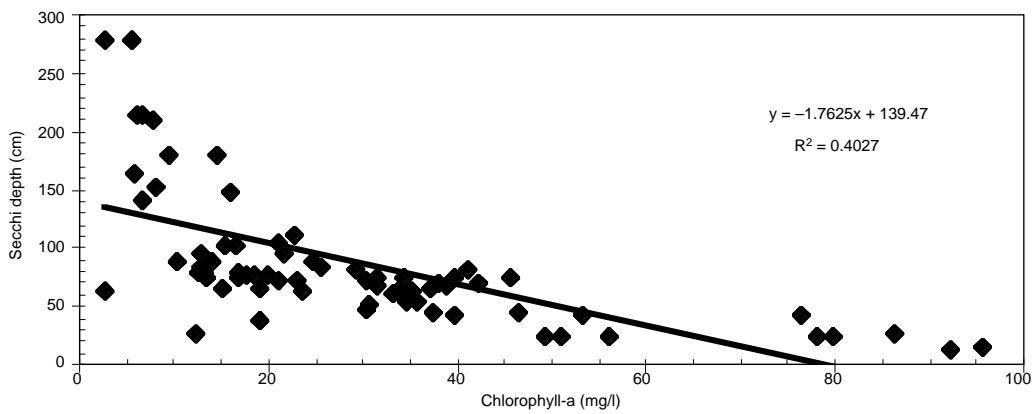

Figure 7. Relationship between Secchi depth and chlorophyll-a using pooled data of all lakes.

The conductivity of water varies due to some major ions and salinity. Specific conductance for freshwater often ranges between <25 and $500 \mu\Omega/\text{cm}$ and the conductivity is generally a good and rapid measure of the total dissolved solids. The total dissolved solid content in mg/L can generally be approximated by multiplying the specific conductance by an empirical factor varying from about 0.55 to 0.90. Ryder (1965) observed in a study in North American lakes and reservoirs that conductivity is directly proportional to TDS. Ryder and Henderson (1975) further established relationship between TDS and conductivity. The established relationship was $\text{TDS} = 0.88\pi$. In water, total dissolved solids are composed mainly of carbonates, bicarbonates, chlorides, phosphates and nitrates of Ca, Mg, Na, K and organic matters. Therefore, the linear correlation

between \leq and TDS varies with water bodies and these two factors must be measured separately to determine the ratio between them before conductivity can be used to estimate TDS. The TDS varies due to the quantity of different salts and organic matters. In Oxbow lakes, TDS was always found to be proportional to conductivity, TDS being 0.50π .

Although conductivity/TDS values for all six Oxbow lakes were apparently high enough (π 225–340 $\mu\Omega/\text{cm}$; TDS 113–170 mg/L) to support productivity, these parameters cannot probably be used, as it is to predict productivity in Oxbow lakes. In our present study, relationships between chlorophyll/Secchi depth and conductivity/TDS were not clear enough to derive any definite conclusion (Tables 2–6). When pooled data of all six Oxbow lakes were analysed, no significant relationship was

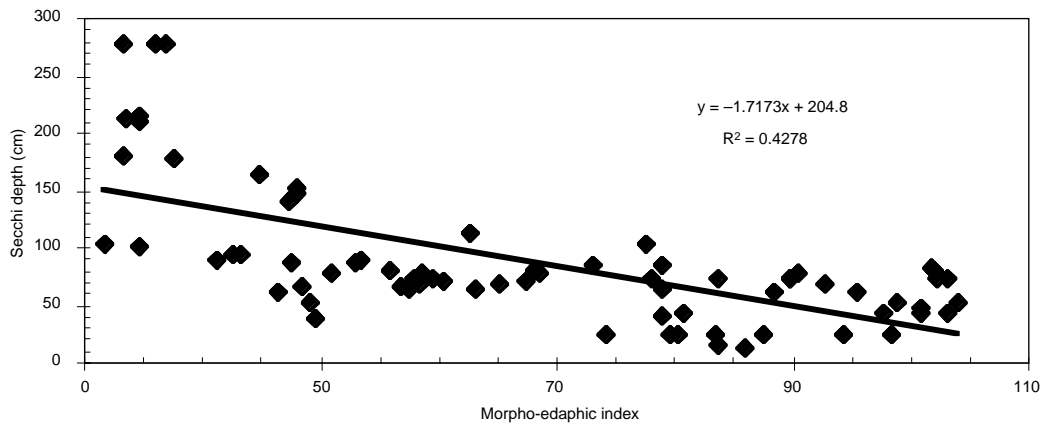

Figure 8. Relationship between Secchi depth and morpho-edaphic index using pooled data of all lakes.

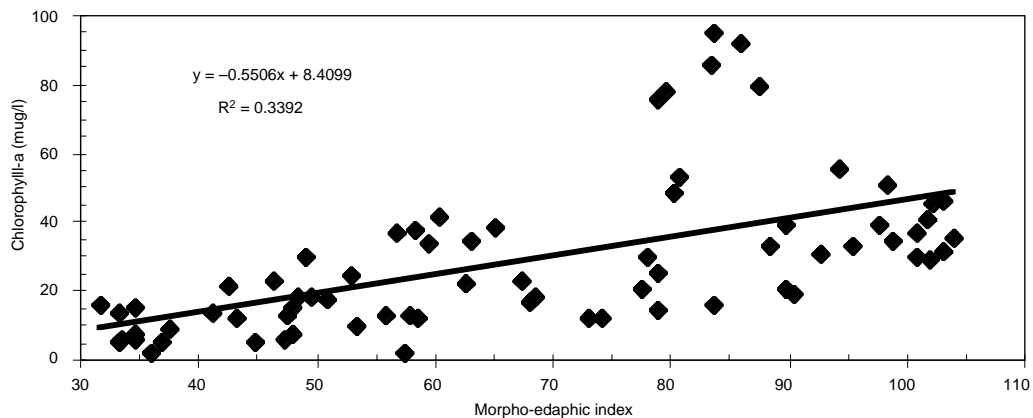

Figure 9. Relationship between chlorophyll-*a* and morpho-edaphic index using pooled data of all lakes.

recorded between these parameters. However, MEI appeared to have a clear relationship with both chlorophyll-*a* concentration and Secchi depth (Equations 2 and 3; Figs 8–9). Chlorophyll-*a* was positively correlated with MEI and Secchi depth negatively correlated with MEI.

Morpho-edaphic index has been used as the universally accepted predictive model of fish yield for deep lakes and reservoirs in temperate regions (Rawson, 1951; Ryder 1965, 1982; Hanson and Leggette 1982). Ryder and Henderson (1975) formulated a general relationship between fish productivity (Y_p) in kg/ha and MEI is: $Y_p = K \sqrt{\text{MEI}}$, where biological parameter K is a variable that must be empirically measured. Jenkins (1982) reported that fish productivity in American reservoirs was highly correlated with MEI.

In contrast to temperate waters, no universally accepted single indicator has been advocated for prediction of productivity in tropical and subtropical waters. Welcomme and Bartley (1997) observed that several indicators are used to measure potential productivity of a water body and can range from the morpho-edaphic index to specialised indices based on benthos or zooplankton densities, while Li (1988) used food biomass as an indicator to establish productivity and carrying capacity in Chinese reservoirs. No significant relationship between fish yields and MEI was established in Chinese reservoirs (Li and Xu 1995) or in Indian reservoirs (Sreenivasan 1992; Hartmann and Aravindakshan 1995). Downing et al. (1990) noted that fish production in tropical and subtropical freshwater lakes and reservoirs is not correlated with MEI but closely correlated with primary productivity. In contrast, Sreenivasan and Thayaparan (1983) predicted that the annual fish yield was higher due to higher conductivity and morpho-edaphic index in Randenigala Lake in Sri Lanka.

Our study observes that both MEI and Secchi depth are significantly correlated with chlorophyll-*a* concentration. Although chlorophyll-*a* concentration will probably be a better indicator of fish yield in tropical lakes/reservoirs, and in the absence of chlorophyll-*a* data, Secchi depth may be a practical potential tool for fisheries management.

To our knowledge, yield prediction model of Oxbow lake fishery (Hasan and Middendorp 1998; Hasan et al. 1999) is the first management model that has dealt with the prediction of fish yield by using a simple management tool such as Secchi depth and stocking density. The results of the present study clearly reinforce the biological significance of Secchi data in the prediction of fish yield in Oxbow lakes and possibly in other culture-based fishery.

Acknowledgments

The research work was carried out in six selected Oxbow lakes under Oxbow Lakes Small Scale Fishermen Project (OLP II) and formed a part of MS research program of the senior author under the Department of Aquaculture, Bangladesh Agricultural University, Mymensingh, Bangladesh. Danida Technical Assistance, OLP II is gratefully acknowledged for funding the research work and the Project Implementation Unit (PIU, DoF) is acknowledged for providing necessary facilities and kindly permitting work in the Oxbow lakes.

References

- Almazan, G. and Boyd, C.E. 1978. An evaluation of Secchi disk visibility for estimating plankton density in fish ponds. *Hydrobiologia*, 65: 601–608.
- Anuta, J.D. 1995. Effect of chicken manure application on water quality and production of *Tilapia guineensis* in freshwater concrete tanks. *Journal of Aquaculture in the Tropics*, 10: 167–176.
- Bala, N. and Hasan, M.R. *in press*. Seasonal fluctuation of different physical parameters of Oxbow lakes in south-western Bangladesh. In: Middendorp, H.A.J., Thompson, P. and Pomeroy, R.S. ed. Sustainable Inland Fisheries Management in Bangladesh. A national workshop, Dhaka, Bangladesh 22–24 March 1997. ICLARM Conference Proceedings.
- Barica, J. 1975. Summer kill risk in prairie ponds and possibilities of its prediction. *Journal of Fisheries Research Board of Canada*, 32: 1283–1288.
- Downing, J.A., Plante, C. and Lalonde, S. 1990. Fish production correlated with primary productivity, not the morphoedaphic index. *Canadian Journal of Fisheries and Aquatic Science*, 47: 1929–1936.
- Ghosh, A. 1992. Rice-fish farming development in India: past, present and future. In: DeLa Cruz, C.R., Lightfoot, C., Costa-Pierce, B.A., Carangal, V.R. and Bimbao, M.B. ed. Rice-fish Research and Development in Asia. ICLARM Conference Proceedings No. 24, 27–43.
- Hanson, J.M. and Leggette. 1982. Empirical prediction of fish biomass and yield. *Canadian Journal of Fisheries and Aquatic Science*, 39: 257–263.
- Hartmann, W.D. and Aravindakshan, N. 1995. Strategy and Plans for Management of Reservoir Fisheries in Kerala, India. Indo-German Reservoir Fisheries Development Project, Department of Fisheries, Vikas Bhavan, Trivandrum 695 001, India. 123 p. Unpublished.
- Hasan, M.R. 1990. Aquaculture in Bangladesh. In: Joseph, M.M. ed. Aquaculture in Asia. Mangalore, Asian Fisheries Society Indian Branch, 105–139.
- Hasan, M.R. and Middendorp, H.A.J. 1998. Optimising stocking density of carp fingerlings through modelling of the carp yield in relation to average water transparency in enhanced fisheries in semi-closed water in western Bangladesh. In: Petr, T. ed. Inland Fishery Enhancements. FAO/DFID international expert consultation, Dhaka, Bangladesh 7–11 April 1997. FAO Fisheries Technical Paper No. 374, 133–140.

- Hasan, M.R., Bala, N. and Middendorp, A.J. 1999. Secchi disc as a tool to determine stocking density and predict fish yield in culture-based fisheries. In: Middendorp, H.A.J., Thompson, P. and Pomeroy, R.S. ed. Sustainable Inland Fisheries Management in Bangladesh. A national workshop, Dhaka, Bangladesh 22–24 March 1997. ICLARM Conference Proceedings 58, Manila, Philippines, 144–140.
- Hepher, B. 1962. Primary production in fish ponds and its application to fertilisation experiments. *Limnology and Oceanography*, 7: 131–135.
- Jenkins, R.M. 1982. The morpho-edaphic index and reservoir fish production. *Transaction of American Fisheries Society*, 111: 133–140.
- Li, S. 1988. The principles and strategies of fish culture in Chinese reservoirs. In: De Silva, S.S. ed. Reservoir Fishery Management and Development in Asia. A regional workshop, Kathmandu, Nepal 23–28 November 1987. IDRC Proceedings, 214–223.
- Li, S. and Xu, S. 1995. Culture and Capture of Fish in Chinese Reservoirs. Penang, Southbound and Ottawa, International Development Research Centre, 128 p.
- Northcote, T.G. and Larkin, P.A. 1958. Indices of productivity in British Columbia lakes. *Journal of Fisheries Research Board of Canada*, 13: 515–540.
- Oxbow Lakes Project II. 1995. Baor Survey: water area and water volume of OLP II baors at various water levels. Jessore, Bangladesh, PIU/BRAC/DTA, 142 p. Unpublished.
- 1997. Baor Biological Studies Annual Report (July 1996–June 1997), Volume I, Studies and Research Report No. 27, Jessore, Bangladesh, PIU/BRAC/DTA, 67 p. Unpublished.
- Rawson, D.S. 1951. The total mineral content of lake water. *Ecology*, 32: 660–672.
- Ryder, R.A. 1965. A method for estimating the potential fish production of north-temperate lakes. *Transaction of American Fisheries Society*, 94: 214–218.
- 1982. The morpho-edaphic index — use, abuse and fundamental concepts. *Transaction of American Fisheries Society*, 111: 154–164.
- Ryder, R.A. and Henderson, H.F. 1975. Estimations of potential fish yield for the Nasser reservoir, Arab Republic of Egypt. *Journal of Fisheries Research Board of Canada*, 32: 3127–3151.
- Sreenivasan, A. 1992. Limnology and fishery of some south Indian reservoirs. In: De Silva, S.S. ed. Reservoir Fisheries of Asia. Second Asian Reservoir Fisheries Workshop, Beijing, China, 15–19 October 1990. IDRC Proceedings, 23–37.
- Sreenivasan, A. and Thayaparan, K. 1983. Fisheries development in the Mahaweli River systems. *Journal of Inland Fisheries*, 2: 34–39.
- Vollenweider, R.A. 1969. A Manual on Methods for Measuring Primary Production in Aquatic Environments. IBP Handbook No. 12, F.A. Davis Co.
- Welcomme, R.L. and Bartley, D.M. 1997. An evaluation of present techniques for the enhancement of fisheries. In: Petr, T. ed. Inland Fishery Enhancements. FAO/DFID international expert consultation, Dhaka, Bangladesh 7–11 April 1997. FAO Fisheries Technical Paper No. 374, 1–36.

Role of *Oreochromis* Hybrids in Controlling *Microcystis aeruginosa* Blooms in the Kotmale Reservoir

Swarna Piyasiri¹ and Nishanthi Perera²

Abstract

Kotmale Reservoir (surface area 6.5 km², maximum depth 90 m, mean depth 26.8 m, volume 174 mcm, maximum length 6.8 km, maximum width 1.41 km and hydrology catchment area 550 km²) is highly sensitive to eutrophication and blooming. In the latter part of 1990, the reservoir was covered with a thick bloom of *Microcystis aeruginosa*, causing severe environmental problems. The objective of the present study was to evaluate whether *M. aeruginosa* blooms can be controlled by using *Oreochromis* hybrids. Previous investigations indicated that top-down control of eutrophication by the use of filter-feeding fish has good potential in tropical countries. The study dealt with feeding habits of fish, digestibility of food items, diurnal feeding rhythms, change of pH during the passage of food in the gut, and the feeding rates. The reservoir fish population was dominated by hybrids of *Oreochromis niloticus* and *O. mossambicus*, which contributed more than 80% of the total commercial fish catch. As pure *O. niloticus* or *O. mossambicus* are not available in the reservoir, the fish types present are considered to be *Oreochromis* hybrids. From gut content analysis, it was found that the fish is an opportunistic feeder. It has a central position in the food web of the reservoir. The fry feed mainly on larger zooplankton such as *Ceriodaphnia* species, while the adults prefer detritus and sedimented diatoms in most months. However, when suspended plankton like *Peridinium cinctum* or *M. aeruginosa* increase during low water levels, the fish switch from diatoms to these forms. The intensive feeding hours of the fish occurred between 1200 and 1800 hrs, and most fish consumed over 3% of their body weight during that time. Stomach pH values of the fish dropped below 2, especially during 1800–0000 hrs. High amounts of digested plankton in the stomach during this period indicated that low pH levels help in digesting the plankton, even though most stomachs were empty during the 0600 hr catch, but the hindgut contained food, thoroughly digested. *Oreochromis* hybrids filter the plankton, converting them directly into fish flesh, which can be readily harvested out from the water body. This short phytoplankton–herbivorous food chain is one of the most productive ways to get rid of excess nutrients.

KOTMALE Reservoir is the uppermost impoundment of the interconnected Mahaweli Reservoir chain of Sri Lanka. It was impounded in 1985, for the main purpose of hydroelectric power generation. Limnological data of the water body have been gathered since 1987, and the findings indicated that the reservoir is sensitive to eutrophication. In 1991, a thick *Microcystis aeruginosa* bloom covered the reservoir and further investigations have shown that the

Kotmale Oya carries large quantities of nutrients to the reservoir via surface runoff of the upper Kotmale catchment (Anon. 1994; Chandrananda 1995; Piyasiri, 1991, 1992, 1995).

Improvements in the water quality are usually attempted by reducing external nutrient loading to the lake. However, reduction of nutrient input via the catchment of Kotmale Reservoir is not an immediately available option for eutrophication control (Lammens 1990; Carvalho 1994).

Manipulation of excessive plankton growth with the use of fish has been studied recently in response to eutrophication. The 'classical' approach in this method is the reduction of phytoplankton abundance via an increase in zooplankton grazing pressure,

¹Dept of Zoology, University of Sri Jayewardenapura, Nugegoda, Sri Lanka

²Planning Division, Ministry of Forestry and Environment, Sri Lanka

resulting from the control of planktivorous fish population (Starling and Rocha 1990; Opuzynski and Shireman 1993).

Unlike temperate countries, it is impossible to control huge algal blooms using zooplankton in tropical reservoirs, as the size and number of zooplankton are much smaller compared to the phytoplankton (Fernando 1994). Therefore, as stated by Chrisman and Beaves (1990), if biomanipulation is to be successful in the tropics, emphasis should be shifted from zooplankton to the role played by filter-feeding phytophagous fish.

The present investigation commenced in 1994 with the objective of finding possibilities to control the bloom with *Oreochromis* hybrids during intensive bloom.

Materials and Methods

Food habits and selectivity

Fish samples were collected between April 1994 and April 1996 using gill, cast and mosquito nets once a month, and for this purpose, fishers were employed. The catches from gill and cast net were anaesthetised, using ethyl-4-aminobenzoate, and identified. Morphological features such as total length, standard length, body width and weight were determined in more than 25 fish each time.

The fish collected were then dissected for gut content analysis. The gut contents were preserved in 5% formalin and stored in plastic containers. In the laboratory, they were diluted with a known volume of water. Then observations under the microscope were conducted and the types of food consumed by the fish determined. If the fish had eaten plankton, the type, number and size were recorded, and for the determination of selectivity, electivity index (Ivel 1961) was used.

$$D = r - p/r + p - 2rp$$

where D is the electivity index and *p* and *r* are the relative abundance of plankton in fish gut and the reservoir. *P* (the percentage composition of individual plankton component) was determined by using number and point methods of Hynes (1950); *r* was calculated by using data obtained by monthly plankton sampling done parallel with fish sampling.

Digestibility of *Microcystis* and other plankton

Microscopic analysis of culture

Modified Chu media with excess nitrates and phosphates (Chu 1942) were prepared in a sterilised form and stored in plastic bottles. Fish were dissected in the field and 1 g of stomach, mid-gut and hind-gut contents introduced to this media. After two days, a

known volume of the sample was observed under the microscope to find the growth status of *Microcystis* and other planktonic forms. Then the remainder of the sample was kept aside for about a week and observed again under the microscope.

pH method

According to Moriarty (1973), when the stomach pH of pure *O. niloticus* is below 2, the possibility of *Microcystis* digestion is very much higher. The pH of the stomach was measured using integrated Johnson (1–14) and Watman (1–4) pH papers.

Feeding intensity

Diurnal feeding habits of Oreochromis hybrids

Fish were caught at six-hourly intervals using horizontally placed gill-nets. These nets were set for 24 hours, and every six hours were checked for fish and the fish caught removed. During the two final diurnal investigations (December 1995 and April 1996), as fishing was prohibited in the reservoir, the fish were caught every six hours by drawing the nets around the shallow areas of the reservoir and by beating the water around the net.

Immediately after capture, the fish were anaesthetised using ammonium benzoate powder. The fish were then dissected, the stomach and intestines of the fish separated and the stomach with its contents then weighed to the nearest 0.01 g (Mettler 2000 g mx). Then the empty stomach was weighed, after its contents were washed out. The difference in weight between the full and empty stomach gives the wet weight of the stomach contents (Getachew 1989).

Daily food consumption and the feeding periodicity of the fish were estimated using the following parameters.

Point method, which is a visual estimation of stomach fullness, was estimated using the classification given by Ball (1961). According to that method 0–10 points were given to a stomach according to its fullness. The number of points per stomach (fullness index) was determined for each sample taken at 6-hourly intervals.

Percentage (%) empty stomachs of the fish were calculated using the following formula:

% Empty stomachs =

$$\frac{\text{No. of stomachs without food}}{\text{Total number of fish in the sample}} \times 100$$

Percentage (%) stomach fullness (W) was calculated using the following formula used in Getachew (1989):

W = wet weight of the stomach contents/body weight of the fish × 100.

The wet weight of the stomach contents was averaged for each six-hourly sample of fish from each size class (10–15, 15–20, and 20–25 cm). These values were then plotted against time of the day using a different plot for each size group of fish.

Estimation of the rate of bloom consumption by *Oreochromis* hybrids at the Beira Lake

For determination of feeding rates of *Oreochromis* hybrids, experiments were carried out in Beira Lake, which is permanently covered with a cyanobacterial bloom. To calculate the amount of algae eaten within a 24-hour period by the *Oreochromis* hybrids, the amount of algae accumulated in the stomach was determined by collecting fish samples within 2-hourly intervals, from 0730 to 1730 hrs. No night sampling was done as it was shown by previous experiments that the intense feeding hours of the fish were 1200 to 1800 hrs.

Results

Species composition

During the study period, nine species of fish were encountered. They could be categorised into two

groups, according to origin. They are the riverine species, which have colonised the reservoir from the original river (*Puntius sarana*, *Tor khudree*, *Danio malabaricus*, *Heteropneustes fossilis*, *Gara ceylonensis* and *Rasbora daniconius*) and exotics or the introduced species (hybrids of *Oreochromis niloticus*, *O. mossambicus* and *Cyprinus carpio*).

Figure 1 gives the percentage composition of gill-net and cast-net fishery of the reservoir and it reveals that *Oreochromis* hybrids form the dominant component with 80% (100–71.2%) of the fishery. The *Oreochromis* hybrids were made up of two types: hybrids with more *Oreochromis niloticus*-like features (over 70%) and those with more *O. mossambicus* features. The differentiation of these two types from external appearance alone was difficult. Therefore, the two *Oreochromis* types were considered as *Oreochromis* hybrids throughout the study.

The size class distribution of the hybrids in the commercial fish catch indicated that the size class 16–20 cm was dominant.

Food habits

The *Oreochromis* hybrids exhibited a great diversity of feeding habits as indicated in Table 1. It is an opportunistic feeder.

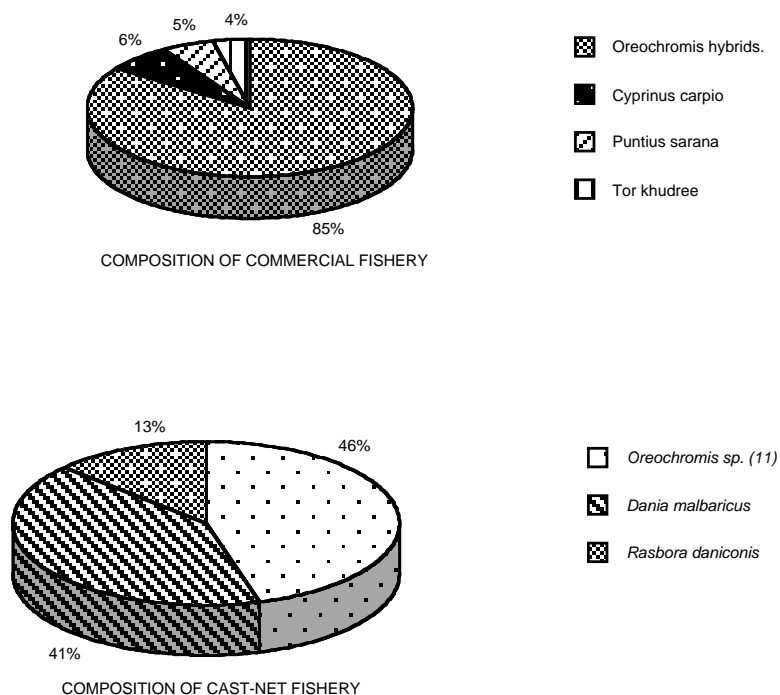

Figure 1. Percentage composition of gill-net and cast-net fishery of the reservoir.

Figure 2 illustrates food items in the fry belonging to two size classes. The *Oreochromis* fry mainly depend on zooplankton and feed on cladoceran species such as *Ceriodaphnia*, *Chydorus*, and *Alona* (Table 1).

The adults were prominent phytoplankton feeders. In fact they were able to utilise both sedimented

(*Navicula*, *Frustulia*, and *Pinularia*) as well as the suspended phytoplankton types (*Staurastrum*, *Microcystis*, and *Peridinium cinctum*). The positive selection of these two phytoplankton types differs with the season (Figure 3). Adult *Oreochromis* hybrids also consumed macrophyte and detritus in large portions, especially in dry months when the reservoir water level was low.

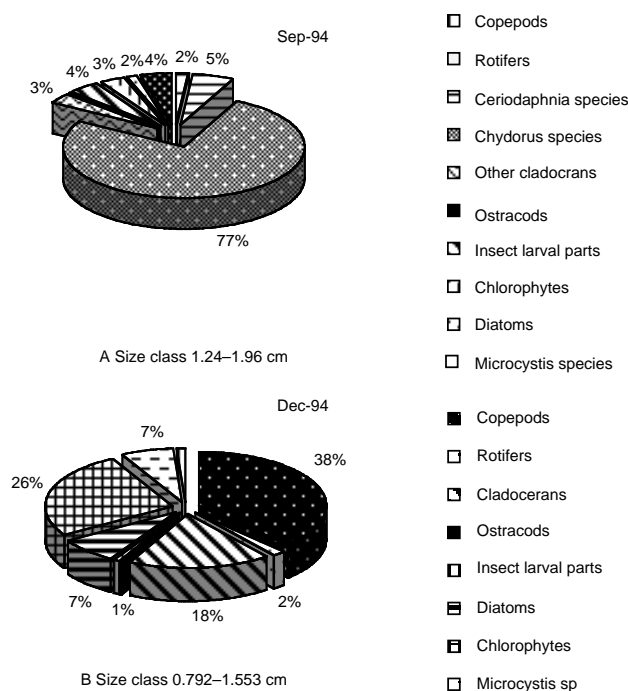

Figure 2. Major food items of *Oreochromis* fry (two size classes).

Table 1. Feeding habits of different size classes of *Oreochromis* hybrids.

Type	Gut contents	The most abundant food type
Size class I 1.5–0.8 cm (mosquito net fishery)	Cladoceran species like <i>Chydorus</i> , <i>Ceriodaphnia</i> , <i>Alona</i> and <i>Macrothrix</i> , Ostracods, <i>Cypris</i> species. Insect parts and copepod parts, small amount of rotifers and phytoplankton like diatoms, desmids, filamentous algae and <i>Microcystis</i> .	<ul style="list-style-type: none"> • Cladocerans like <i>Ceriodaphnia</i> species • Ostracods like <i>Cypris</i> species • Copepod parts
Size class II 10–5 cm (cast-net fishery)	Diatoms like <i>Navicula</i> , <i>Frustulia</i> , and large amounts of sand particles. Detritus, desmids, small amounts of <i>Microcystis</i> and other cyanobacteria, plant fragments.	<ul style="list-style-type: none"> • Diatoms, sand particles • Detritus
Size class III 28–12cm (gill-net fishery)	Macrophyte fragments, detritus, mud particles, insect parts, cyanobacteria, Chlorophytes, diatoms, <i>Peridinium cinctum</i> and small amounts of Cladocerans, Ostracods, Rotifers and Copepods.	<ul style="list-style-type: none"> • Large amount of mud particles and diatoms like <i>Navicula</i>, <i>Frustulia</i> and <i>Pinnularia</i> species • <i>Microcystis</i> species and desmids • <i>Peridinium cinctum</i> and desmids • Macrophyte fragments

Selection of phytoplankton

According to the electivity index (Table 2), a considerable difference was found between the number of phytoplankton in the reservoir water and the stomach contents of the *Oreochromis* hybrids. Several species (e.g. diatoms such as *Navicula*, *Frustulia*, and *Pinnularia*) which were not recorded in the water samples were however, observed in abundance in the stomach contents. These diatoms are sedimented and it may be that the fish browse the

substrate and ingest these. This was further proven by the presence of large amounts of mud with the diatoms in the gut contents. These gut contents also had a small amount of cyanobacterial species such as *Merismopedia*, *Lyngbia*, and *Oscillatoria*. These three phytoplankton were rarely encountered in the reservoir water. During the sampling period, the amount of *Microcystis* in the food contents could be considered as negligible. *Staurastrum* and filamentous diatom *Melosira* was also encountered in low amounts (Figure 3 and Table 2).

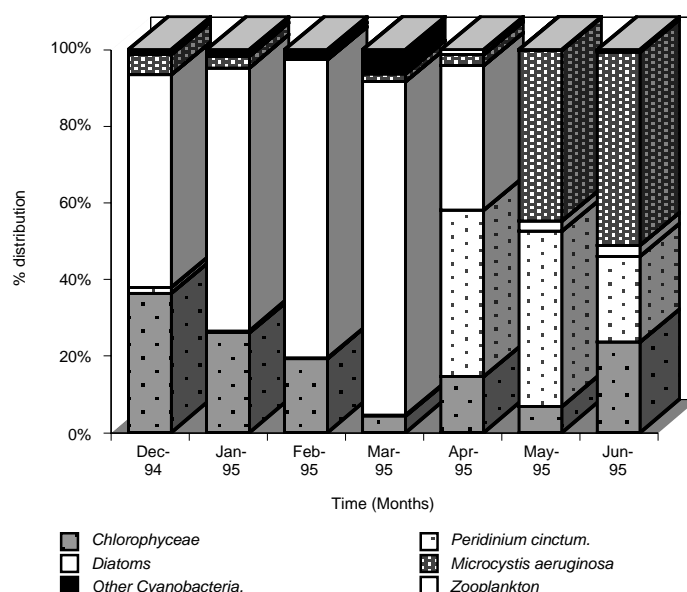

Figure 3. Monthly percentage distribution of major plankton groups in stomach contents of *Oreochromis* hybrid.

Table 2. Seasonal variation in electivity index for different food items in *Oreochromis* hybrids (according to Ivelve index method).

Food item	D 94	J 95	F	M	A	M	J
1. Cyanobacteria							
<i>Microcystis aeruginosa</i>	-0.30	-0.73	-0.63	-0.95	-0.90	-0.02	+0.05
Other cyanophytes	+0.99	1.0	+0.19	1.0	+0.98	+0.53	+0.71
2. Chlorophytes							
<i>Staurastrum</i> species	-0.83	-0.81	-0.95	-0.92	-0.71	-0.64	-0.78
Others	-0.53	-0.61	-0.93	-0.94	-0.53	-0.27	+0.79
3. Diatoms	+0.63	+0.53	+0.99	+0.52	+0.99	-0.55	+0.07
4. <i>Peridinium cinctum</i>	-0.76	-0.59	-0.96	0.58	+0.24	+0.99	+0.94
No. of stomachs examined	09	08	15	13	10	08	12

$$\frac{D = r - p}{r + p - 2rp}$$

D = Electivity index
p = relative abundance of the algae in the gut contents
r = relative abundance of the algae in the environment

During June 1995, most of the fish positively selected *Microcystis* which was very abundant in the reservoir. In the morning (0700 to 1000 hrs), when the bloom drifts toward the edges of the reservoir due to wind action, fish were observed swimming in large numbers near the dam feeding on the *Microcystis*. Fish were in large groups near the dam, 20–70 individuals, and they cleared a considerable area (about 3 m²) of *Microcystis* bloom within a few minutes. With *Microcystis*, large amounts of *Cosmarium* and *Botryococcus* were also positively selected. During this month, the slight positive selection of diatoms was due to the presence of *Melosira* and centric diatoms.

The fish showed a positive selection of the dinoflagellate *Peridinium cinctum* from March to June 1995 (Table 2). When *P. cinctum* was one of the major phytoplankton components of the reservoir, it was again observed in February and March 1996.

Although *Staurastrum* was the most abundant phytoplankton in the reservoir, fish always showed a negative selection to it.

Digestibility of food items

Inspection of the stomach contents of adult *Oreochromis* hybrids under the microscope revealed that some algal and zooplankton species were alive. The zooplankton *Cypris* species and the rotifer, *Lecane* species, were frequently mobile. Numerous protozoans and nematodes were also observed alive.

Of the phytoplankton, diatoms (*Frustulia* and *Navicula*), *Peridinium cinctum* and *Lyngbia* showed

varying degrees of mobility. *Microcystis* colonies, *Staurastrum* species and *Melosira* species were also observed in live condition.

The amount of fully digested phytoplankton was very much larger in the fish rectum in comparison to the stomach. This was especially observed in the *P. cinctum*, which was always without cell contents in the rectum. In the rectum, almost all the diatoms and most of the desmids contained no cytoplasm. The filamentous algal forms like *Melosira* and *Anabaena* were fragmented in parts not longer than 2–5 cells.

Diurnal feeding pattern of *Oreochromis* hybrids

Feeding intensity

Point method and empty stomach percentage

Figure 4 illustrates the variation in feeding intensity over the 24-hour period. The hybrids showed high degrees of fullness of stomach (points per fish) 1200–1800 hrs. During the 6 a.m. catch, the highest degree of empty stomachs was observed, indicating that the fish feed intensively during 1200–1800 hrs.

Wet stomach weight of the fish

The wet weight of the fish was significantly correlated to stomach fullness ($r^2=0.68$, $p<0.001$). According to Figure 5, more than 65% of fish had percentage stomach fullness values (W) 0–2 at 2400–0600 hrs while during 1200–1800 hrs most stomachs had values over 2 points. It further confirms the above results.

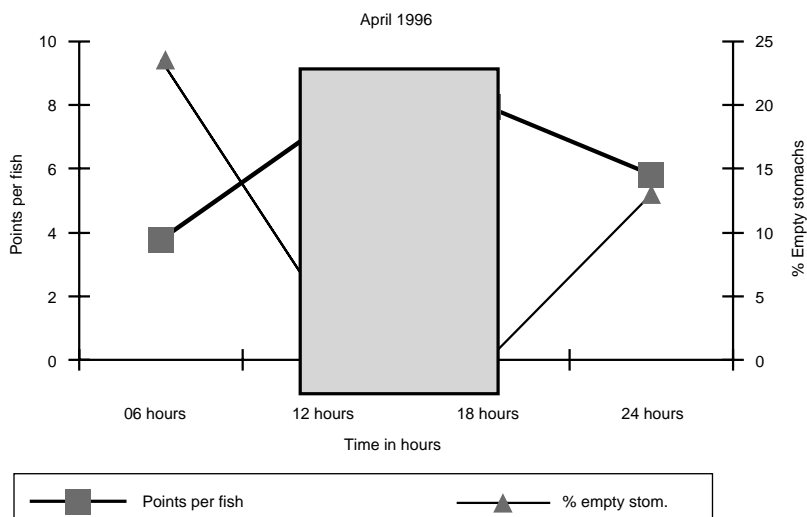

Figure 4. The daily variation in stomach fullness (point per fish) and the percentage of empty stomachs of *Oreochromis* hybrids.

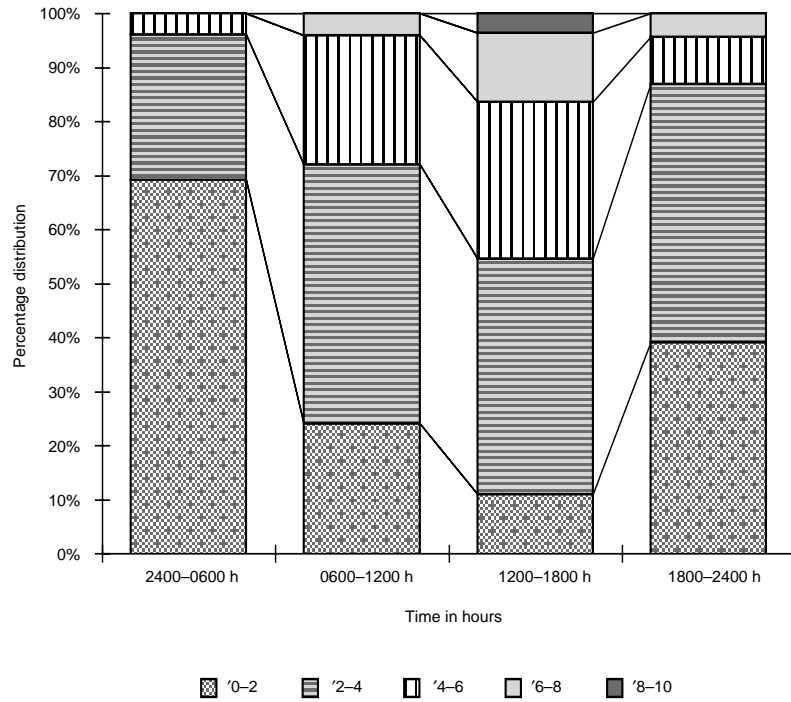

Figure 5. Percentage distribution of stomach fullness (W) of *Oreochromis hybrid* (15-20 cm) with time.

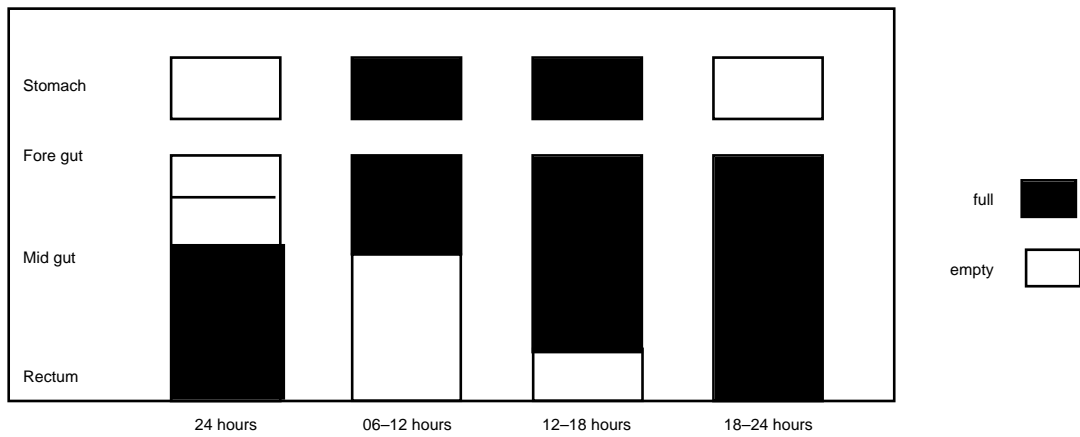

Figure 6. Diagrammatic representation of fullness of the gut of *Oreochromis hybrids* at different hours of the day (modified from Akintunde, 1992).

Figure 6 gives a generalised view of the degree of fullness of the different parts of the alimentary canal of the fish with time. This also confirms that the fish mainly feed between 1200 and 1800 hrs.

pH and food

Stomach pH values of the fish ranged 1–7 and when the stomach was empty, the pH was always 7. But the pH of the other parts of the alimentary canal was always 7–9, irrespective of the presence or absence of food.

As shown in Figure 7, the largest number of stomachs showing pH values below 2 were observed in catches at 1800 hrs and 0000 hrs. There was no

clearcut relationship between the amount of food present in the stomach and the pH value (Figure 8).

Feeding rates of *Oreochromis* hybrids at the Beira Lake

As Figure 9 indicates, from 0730 to 0930 hrs, most fish had empty stomachs. Around 1330 hrs catch, the highest feeding intensity was shown in all the three size classes of fish.

When fish belonging to the size class 15–20 cm were considered, a steady increase in the stomach fullness from 0930–1330 hrs was observed, and afterwards the food intake decreased. Around 13.30 hrs, the mean wet weight of the stomach contents

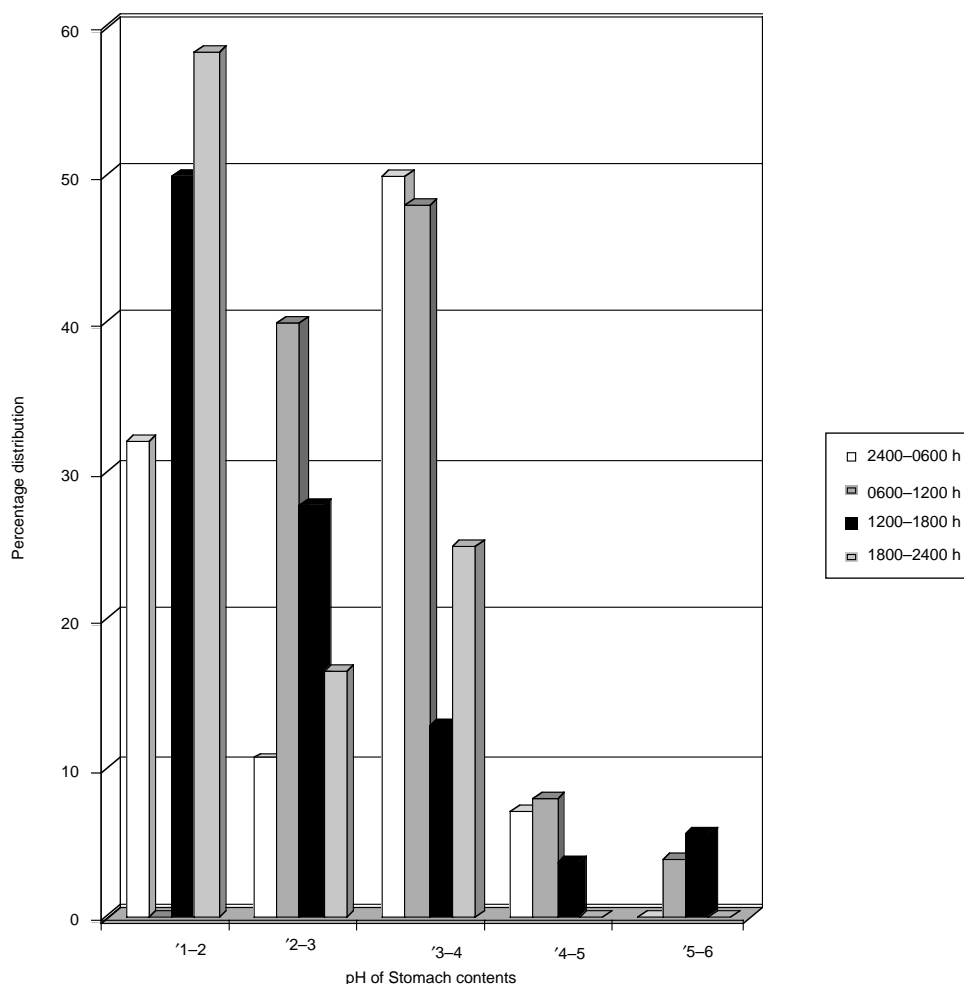

Figure 7. pH variation of the stomach contents of *Oreochromis* hybrids with time.

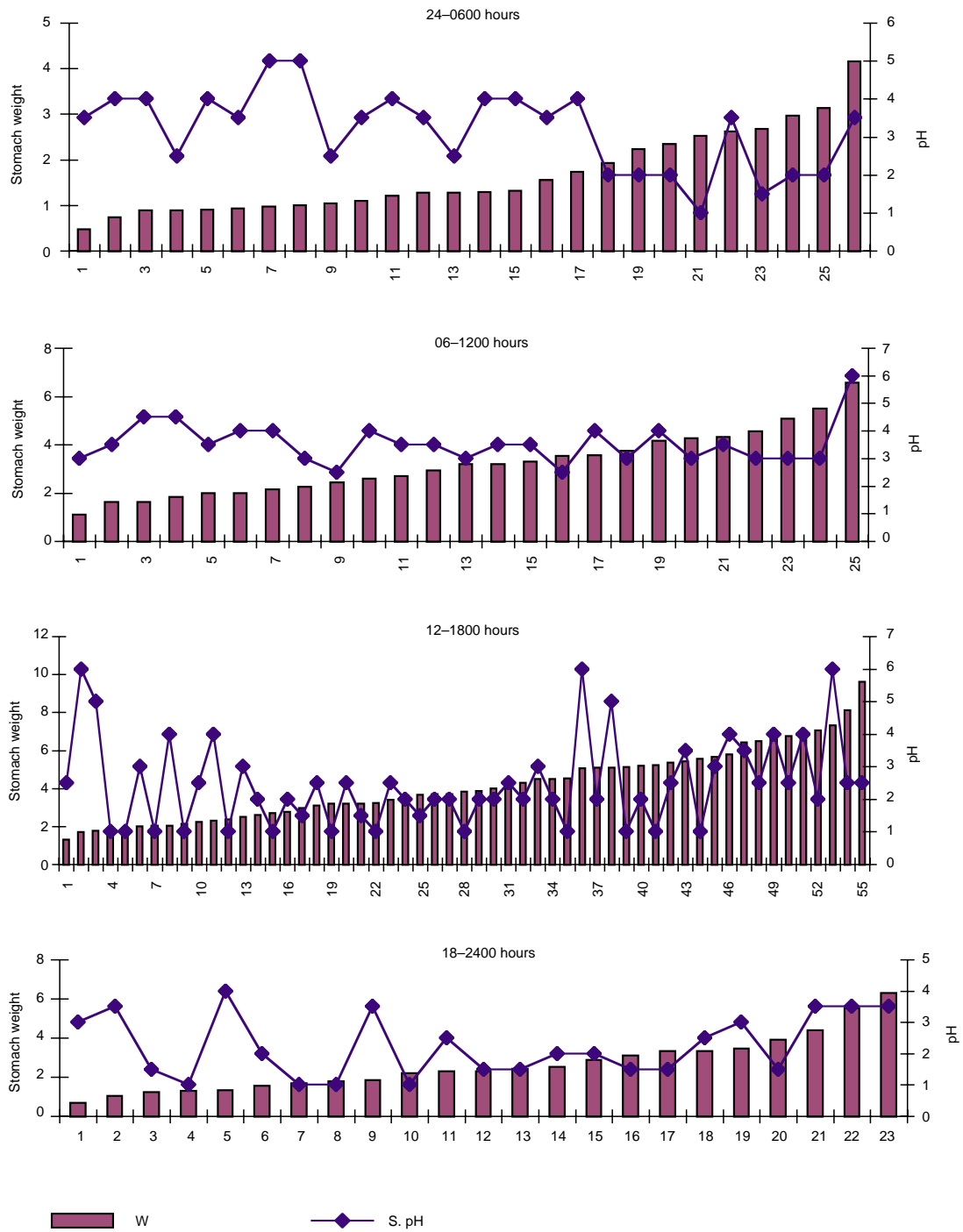

Figure 8. The variation of stomach pH and stomach fullness (w) with time.

was 5.17 g or the fish had eaten 2.495 g of food per 100 g of body weight from the commencement of feeding. However, during this period, some food is passed into the intestine, which was not taken into account. Hence, the actual amount of food taken in would be around 570 mg.

Discussion

Shift in abundance and composition of phytoplankton and zooplankton following a manipulation of the fish population has been observed in several whole-lake food-web experiments (Benndrof 1990).

The classical approach in biomanipulation of eutrophic lakes mainly focuses on the removal or restructuring of planktivorous fish populations to

effect changes in the zooplankton from a community dominated by small-bodied to one dominated by large-bodied cladocerans, particularly of the genus *Daphnia*. Intense grazing by the large-bodied zooplankton can then lead to large-scale reduction in phytoplankton biomass and consequent increases in water clarity, and this was experimentally proven for many temperate lakes (Starling 1993; Carvalho 1994).

The temperate zone limnology is not immediately applicable to tropical countries such as Sri Lanka, because the nature of the biota and characteristic pathways and biological processes differ to a large extent (Schiemer 1995). According to Fernando (1994), the major difference between fish and zooplankton in tropical and temperate lakes is the predominance of rotifera and herbivorous fish in

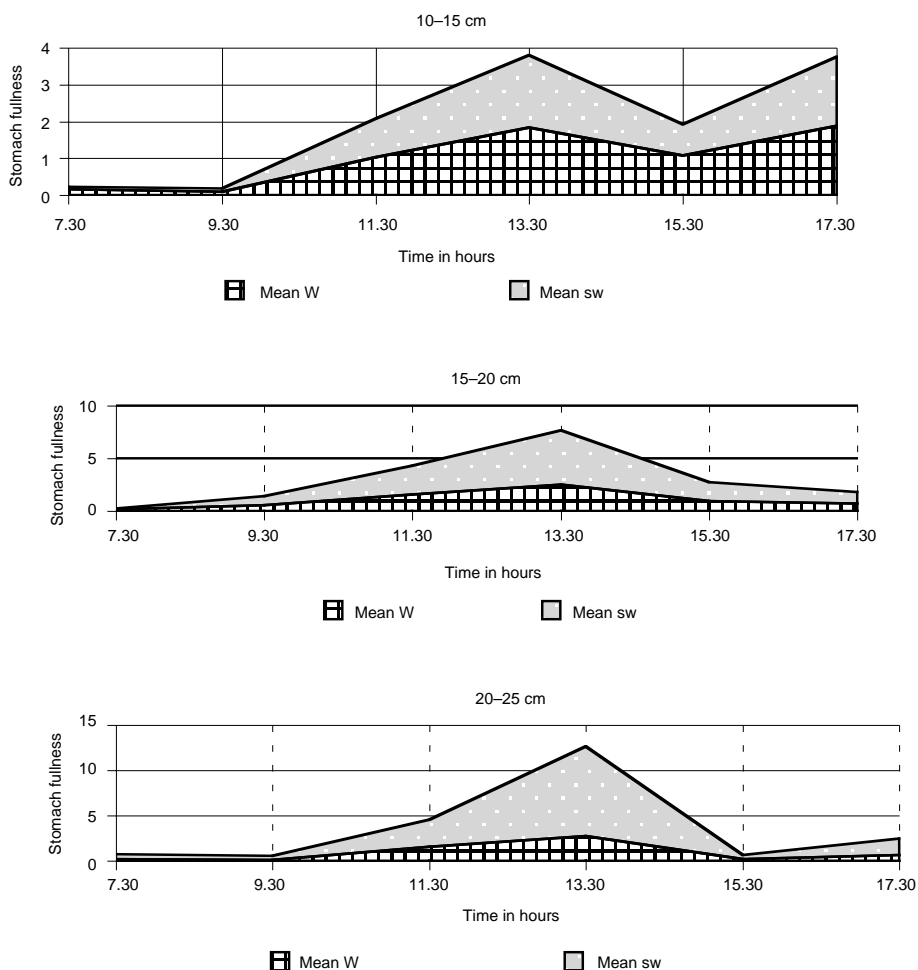

Figure 9. The variation of stomach fullness of *Oreochromis* hybrids with time (three different size classes).

tropical lakes versus crustacea and non-herbivorous fish in temperate lakes. The relative biomass of zooplankton/phytoplankton is low in the tropics and therefore, unlike in temperate lakes, zooplankton does not control phytoplankton biomass in the tropics.

In the Kotmale Reservoir, the zooplankton community was dominated by small-bodied forms such as nauplii larvae of the copepods and rotifers, and formed less than 1% of the total plankton population (Chandrananda 1995; Perera and Piyasiri 1998). The fish population was dominated by *Oreochromis* hybrids, an opportunistic feeder.

The larvae and early juvenile tilapias feed especially on small crustaceans such as *Ceriodaphnia cornuta* and *Chydorus* species and, as recorded by Bowen (1976) and Moriarty (1973), the transition from an invertebrate diet to the typical adult diet (herbivorous and detritivores) was usually abrupt.

Blue-green and green algae, diatoms, macrophytes and amorphous detritus are all common constituents of adult tilapia diets (Bowen 1982; De Silva et al. 1984). In the Kotmale Reservoir, tilapias obtain their food from diverse substrata such as the lake bottom (sedimented diatoms and detritus), from suspension (especially the green algae and *M. aeruginosa*), and macrophytes.

Diel feeding rhythms in tilapias appear to vary according to environmental conditions, but most studies have shown that intense feeding activity is almost entirely restricted to daytime (Moriarty and Moriarty 1973; Akentunde 1982; Getachew 1989). As observed by Getachew (1989), in the *Oreochromis* hybrids of the Kotmale Reservoir, the proportion of empty stomachs was highest 2400–0600 hrs.

It is now well-established that *Sarotherodon* and *Oreochromis* species lyse the cell walls of algae and bacteria by copious acid secretion in the stomach, thereby making the contents of algae vulnerable to digestive enzymes (Moriarty 1973; Bowen 1976; Lobel 1981). As reported by Akintunde (1982), food in the stomach of *Oreochromis* hybrids acts as a stimulus for the secretion of acid, and the lowest pH values in the stomach were observed at 1800–2400 hrs. Also, stomach pH values below 2 were recorded during 1200–2400 hrs, which helps to lyse the plankton cell walls. Observation of the cultured gut contents under the microscope revealed the digestibility of the plankton. According to Moriarty and Moriarty (1973), 70% of the ingested *M. aeruginosa* was digested by *O. niloticus*.

Assessments of consumption of algae by tilapia have been obtained using two approaches: gut content analysis of fish from field populations (Moriarty and Moriarty 1973; Hofer and Schiemer 1983; De Silva et al. 1984; Maitipe and De Silva 1985; Getachew

1989) and direct quantification of algal ingestion by fish in the laboratory (Demster et al. 1993; Keshavanth et al. 1994; Demster et al. 1995).

Getachew (1989) has recorded a feeding rate of 6 mg/g fish body weight/day for *O. niloticus* feeding on *Botryococcus* spp. and *Oscillatoria* spp. in Lake Awasa. During the present study 24.95 mg/g fish body weight (wet weight) was observed during intense feeding hours for *Oreochromis* hybrids (size class 15–20 cm) in the Beira Lake and fed on cyanobacterial *Spirulina* sp. and *M. aeruginosa*. The higher value can be due to the fact that the amount of water ingested with food was not taken into account and only the data of the intense feeding hours (1330 hrs catch) were considered.

According to Van Rijin and Schilo (1989), some fish ponds of Israel which were heavily stocked with tilapia showed shifts from cyanobacterial dominance to the dominance of chlorophyta and/or Chrysophyta. They assumed that the heavy grazing on the phytoplankton exerted by tilapia caused a decrease in overall phytoplankton and nitrogen assimilation, and thus the amount of inorganic nitrogen concentration in the water column increased. These conditions were unfavourable for cyanobacteria. As recorded in Miura (1990), reduction of *Microcystis* as a result of increased grazing pressure by the *Oreochromis* hybrids enhances the green algal biomass of the reservoir, resulting in an increasing food supply through a food chain that connects the green algae to other fish via the zooplankton.

Conclusion

Oreochromis hybrids which feed upon *Microcystis* filter out the plankton, converting the plankton directly into fish flesh, which can be readily harvested from the water body. This short phytoplankton-herbivorous food chain is one of the most productive ways to get rid of the excess nutrients or the top-down control of the bloom. As reservoir fishery depends on stocking and retrieving fish, for the top-down control of *Microcystis* bloom to be efficient, a more scientific control of reservoir fishery is a must.

References

- Akintunde, E.A. 1982. Feeding rhythm in relation to changing patterns of pH in the gut of *Sarotherodon gilaeus* (Artemis) of Lake Kaingi, Nigeria. *Hydrobiologia*, 97: 179–184.
- Anon. 1994. Upper Kotmale Hydropower Project. EIA Report, Vol. 1 (main report) Ceylon Electricity Board, Ministry of Power and Energy, Sri Lanka, 10–120.

- Ball, J.N. 1961. On the food of the brown trout of Llyn Tegid. Proceedings of the Zoological Society of London, 134: 1–41.
- Benndorf, J. 1990. Conditions for effective biomanipulation; conclusions derived from whole-lake experiments in Europe. *Hydrobiologia*, 200/201.
- Bowen, S.H. 1976. Mechanism for digestion and growth-quantitative considerations. In: Pullin, R.S.V. and McConnell, R.M. ed. *Biology and Culture of Tilapias*, International Center for Living Aquatic Resources Management, Philippines, 141–156.
- 1982. Feeding, digestion and growth-quantitative considerations. In: Pullin, R.S.V. and McConnell, R.M. ed. *The Biology and Culture of Tilapias*. Published by ICLARM Manila, 141–156.
- Carvalho, L. 1994. Top-down control of phytoplankton in a shallow hypertrophic lake, Little Mere (England). *Hydrobiologia*, 275/276, 53–63.
- Chandrananda, W.P.N. 1995. Limnology of the Kotmale Reservoir and fish plankton interactions. PhD dissertation, University of Sri Jayewardenapura, Sri Lanka, 12–122.
- Chrisman, T.L. and Beaves, J.R. 1990. Applicability of planktonic biomanipulation for managing eutrophication in subtropics. *Hydrobiologia*, 200/201, 177–185.
- Chu, S.P. 1942. The influence of the material composition of the medium on the growth of planktonic algae 1. Methods and culture media. *Journal of Ecology*, 30: 284–325.
- Demster, P.W., Beveridge, M.C.M. and Baird, D.J. 1993. Herbivory in the tilapia *Oreochromis niloticus*; a comparison of feeding rates on phytoplankton and periphyton. *Journal of Fish Biology*, 43: 385–392.
- Demster, P.W., Baird, D.J. and Beveridge, M.C.M. 1995. Can fish survive by filter-feeding on microparticles? Energy balance in tilapia grazing on algal suspensions. *Journal of Fish Biology*, 47: 7–17.
- De Silva, S.S., Perera, M.K. and Maitipe, P. 1984. The composition, nutritional status and digestibility of the diets of *Sarotherodon mossambicus* from nine man-made lakes in Sri Lanka. *Environmental Biology of Fishes*, 11: 205–219.
- Fernando, C.H. 1994. Zooplankton, fish and fisheries in tropical freshwaters. In: Dumount, H.I., Green, J. and Masundire, H. ed. *Studies on the ecology of tropical zooplankton*. *Hydrobiologia*, 272: 105–123.
- Getachew, T. 1989. Stomach pH, feeding rhythms and ingestion rate in *Oreochromis niloticus* L (Pisces; Cichlidae) in Lake Awasa, Ethiopia. *Hydrobiologia*, 174: 38–43.
- Hofer, R. and Schiemer, F. 1983. Feeding ecology, assimilation efficiencies and energetics of two herbivorous fish: *Sarotherodon (Tilapia) mossambicus* (Peters) and *Puntius filamentosus* (Cuv. et al.) In: Schiemer, F. ed. *Limnology of Parakrama Samudra*, Sri Lanka, The Hague, Dr W. Junk, 155–164.
- Hynes, H.B.N. 1950. The food of fresh water Stickleback (*Gasterosteus aculeatus* and *Pygosteus pungitias*) with a review of methods used in studies of the food of fishes. *Journal of Animal Ecology*, 19: 35–38.
- Ivlev, V.S. 1961. *Experimental Ecology of the Feeding Fishes*. New Heaven, Yale University Press, 302 p.
- Keshavanth, P., Beveridge, M.C.M., Baird, D.J., Lawton, N.A. and Codd, G.A. 1994. The functional grazing response of a phytoplanktivorous fish *Oreochromis niloticus* to mixtures of toxic and non-toxic strains of the cyanobacterium *Microcystis aeruginosa*. *Journal of Fish Biology*, 45: 123–129.
- Lammens, Eddy H.R.R. 1990. Relations of biotic and abiotic interactions to eutrophication in Tjeukemeer, the Netherlands. *Hydrobiologia*, 200/201: 29–37.
- Lobel, P.S. 1981. Trophic biology of herbivorous reef fish: alimentary pH and digestive capabilities. *Journal of Fish Biology*, 19: 365–397.
- Maitipe, P. and De Silva, S.S. 1985. Switches between zoophagy, phytophagy and detritivory of *Sarotherodendron mossambicus* (Peters) populations in 12 man-made Sri Lankan lakes. *Journal of Fish Biology*, 26: 49–61.
- Miura, T. 1990. The effects of planktivorous fish on the plankton community in a eutrophic lake. *Hydrobiologia*, 200/201: 567–579.
- Moirarty, D.J.W. 1973. The physiology of digestion of blue-green algae in the cichlid fish *Tilapia nilotica*. *Journal of Zoology*, London, 171: 25–39.
- Moriarty, C.M. and Moriarty, D.J.W. 1973. Quantitative estimation of the daily ingestion of phytoplankton by *Tilapia nilotica* and *Haplochromis nigripinnis* in Lake George, Uganda. *Journal of Zoology London*, 171: 15–23.
- Opuszynski, K. and Shireman, J.V. 1993. Food habits, feeding behaviour, and impact of tropical bighead carp, *Hapophthalmichthys nobilis*, in experimental pond. *Journal of Fish Biology*, 42: 517–530.
- Perera, N. and Piyasiri, S. 1998. Community dynamics of plankton in the Kotmale Reservoir. Research Sessions of the Faculty of Graduate Studies, University of Sri Jayewardenapura, Sri Lanka, 133–153.
- Piyasiri, S. 1991. Limnology project at Mahaweli reservoirs. Some physical properties of Kotmale, Victoria and Randenigala reservoirs. *Vidyodaya Journal of Science*, Vol. 3, No. 1, 45–61.
- 1992. Limnology project at Mahaweli Reservoirs. Some physical properties of Kotmale, Victoria and Randenigala reservoirs. *Vidyodaya Journal of Science*, Vol. 4, No. 1, 155–166.
- 1995. Eutrophication and blue-green algal problem in Kotmale Reservoir in Sri Lanka. In: Timotius, K.H. and Golthenboth, F. ed. *Tropical Limnology 2*, Satya Wacanan Christian University, Indonesia, 161–169.
- Schiemer, F. 1995. Bottom-up vs. top-down control in tropical reservoir management. In: Timotius, K.H. and Golthenboth, F. ed. *Tropical Limnology 1*, Satya Wacanan Christian University, Indonesia, 57–67.
- Rijin, Jaap and Shilo, M. 1989. Environmental factors in fish culture systems. In: Shilo, M. and Sarig, S. ed. *Fish Culture in Warm Water Systems*. CRC Press, USA, 164–174.
- Starling, F.L. and Rocha, R.M. 1990. Experimental study of the impacts of planktivorous fishes on plankton community and eutrophication of a tropical Brazilian reservoir. *Hydrobiologia*, 200/201: 581–591.
- Starling, F.L., deReso Monteiro 1993. Control of eutrophication by silver carp (*Hapophthalmichthys nilotica*) in the tropical Paranao Reservoir (Brazilia, Brazil): Mesocom experiment. *Hydrobiologia*, 257: 143–152.

Growth of Indian Major and Chinese Carps in Oxbow Lakes Based on Length–frequency Distribution Analysis

M.R. Hasan¹, Nityananda Bala² and Hans A.J. Middendorp²

Abstract

Six species of major carp (Indian rohu, catla, and mrigal, Chinese silver carp, grass carp and common carp) are regularly stocked and harvested in oxbow lakes in southwestern Bangladesh under culture-based fisheries management. Age and growth rates were calculated by using length–frequency distribution analysis and length–weight relationships were established for these carp species from six selected oxbow lakes during the period February 1995 to June 1996. Five age groups (0+ to IV) were identified, although not all age groups were found from all oxbow lakes for all species. Mean growth for six different species was calculated by combining the data for all the oxbow lakes. Age groups ranging 0+ to III years were harvested for all six species. Age group IV was found for common carp and rohu only. In oxbow lakes, Chinese carps appear to have grown better than Indian major carps in the first and second years. In the third year, grass carp grew better than the other two Chinese carps and among major carps, catla grew better than rohu and mrigal. In the third year, growth of rohu was comparable to that of silver carp. However, in the context of overall age group, growth of Chinese carps was better than local carp. Correlation coefficient between length and weight for all carp species for all six lakes was highly significant ($P = 0.000$). The slope of the regression equations for most of the species in all six lakes was above 3.

THE PRINCIPLES of culture-based fisheries in oxbow lakes (local name *baors*) are: (1) large-size fingerling stocking; (2) staggered harvesting; and (3) regular weeding of water hyacinth. Three Indian major carps (rohu, *Labeo rohita*, catla, *Catla catla* and mrigal, *Cirrhinus mrigala*) and three Chinese carps (silver carp, *Hypophthalmichthys molitrix*, grass carps, *Ctenopharyngodon idella* and common carp, *Cyprinus carpio*) are regularly stocked and harvested after a specific period. Growth of stocked fish plays an important role in the culture system in the oxbow lake. The objective of this study is a better understanding of the age, growth and conditions of stocked fish in oxbow lakes so that an appropriate harvesting strategy can be developed for better management.

Materials and Methods

Study area

The paper reports the growth studies of six carps carried out by length–frequency distribution analysis in six selected oxbow lakes under Oxbow Lakes Project II (OLP II). The selected oxbow lakes were Nasti, Porapara, Benipur, Marufdia, Bukbhara and Bahadurpur. They are in three districts (Jessore, Chaudanga and Jhenaidah) of southwestern Bangladesh. Selection was based on their location and physico-biological characters.

Sampling procedure and data collection

Data collection took place from February to April 1995, November–December 1995 and March–June 1996. Data were collected during the fishing season (November–June). Data collection period was not the same for all lakes because the harvesting period during the fishing season was not the same for all lakes. Both marketable and undersized fish were taken randomly from the catch. The total length (cm) and body weight (g) data of three Indian major carps,

¹c/- Department of Aquaculture, Bangladesh Agricultural University, Mymensingh 2202, Bangladesh. Fax: +88-091-55810; email: mrhasan@citechco.net

²Patuakhali Barguna Aquaculture Extension Project, Patuakhali, Bangladesh

rohu, catla, and mrigal and three Chinese carps, silver carp, grass carp, and common carp, were collected at least once every month from each of the six lakes.

Total length was measured on a measuring board to the nearest mm and individual fish were weighed in a polyethylene bag using a spring balance of 1 kg (fraction 5 g) and 5 kg (fraction 100 g). Data were collected from the fish harvested both by purse seine (local name *kotchali*) and brush park (local name *komar*). A total of 14 432 fish was measured from the six oxbow lakes during the period (Table 1).

Data analysis

Length–frequency distribution

The monthly sample of each of the six fish species was grouped in 5 cm class intervals, starting from 10 cm to 80 cm for each lake depending on availability of the data. Age groups were determined from the length–frequency graph by finding the location of the mode for each monthly data. The modal length was estimated from mode of the modal class. Modal length of each age-group for different months was averaged (Table 2). Mean weight of each length class for each species was estimated from the length–

weight relationship established for each species for each lake from the total fish samples collected from February 1995 to June 1996. Log–log transformation was used to establish length–weight relationship. The overall average length and weight of each age group for each six species were calculated by combining data of all six lakes.

Length–weight relationship

A total of 14 432 fish of six species in six oxbow lakes was taken to determine the length–weight relationship. Length–weight relationship was calculated by the regression of the logarithm of length on the logarithm of weight by the method of least squares for the total study period from February 1995 June 1996 for all six species for all six lakes (Table 3).

The analysis was done after LeCren (1951):

$$\log W = \log a + b \log TL$$

where W = weight, a = intercept, and b = slope of regression line of weight on length.

All analyses were done on a microcomputer using MS Excel 7.0.

Table 1. Total number of sampled fish measured during the study period February 1995–June 1996 in all six oxbow lakes under study.

Oxbow lakes	Rohu	Catla	Mrigal	Silver carp	Grass carp	Common carp	Total
Bahadurpur	424	49	144	111	119	146	993
Benipur	334	282	64	104	111	2	897
Marufdia	234	83	193	389	95	184	1178
Bukbhara	66	16	114	43	30	41	310
Nasti	2071	1247	1784	1904	1059	1385	9450
Porapara	237	175	349	513	69	261	1604
Total	3366	1852	2648	2064	1483	2019	14 432

Table 2. Growth of three Indian major and three Chinese carps (combined data of six oxbow lakes). Note that mean weight is calculated from log–log transformation.

Fish Species	Age group (years)									
	0+		I		II		III		IV	
	Length (cm)	Weight (g)	Length (cm)	Weight (g)	Length (cm)	Weight (g)	Length (cm)	Weight (g)	Length (cm)	Weight (g)
Rohu	28.0	232	39.5	734	47.0	1300	56.9	2587	63.8	3525
Catla	29.5	355	38.4	803	50.5	1955	62.9	3709	—	—
Mrigal	30.4	274	38.7	594	48.6	1200	58.9	2188	—	—
Silver carp	32.2	337	48.2	1190	59.6	2319	64.1	2774	—	—
Grass carp	36.5	643	46.9	1253	59.7	2483	69.5	3706	—	—
Common carp	32.4	612	39.3	1196	52.0	2957	55.4	3623	67.5	5328

Results and Discussion

Age and growth

The average length and weight of different age groups of six species are presented in Table 2. Five distinct modes representing five age groups (0+ to IV) were identified from six oxbow lakes. Age groups ranging 0+ to III were harvested for all six species, while age group IV was found for rohu and common carp only. While plotting the growth data, length and weight at stocking were used as initial or zero age. Mean length of rohu, mrigal, catla and grass carp increased more or less in a linear fashion with time, although growth was fastest during the

first year (Table 2). Growth of silver carp and common carp clearly levelled off during the second year, plateauing in the third year. Most of the fish are effectively fished out from oxbow lakes within 2–3 year of stocking and very few fish of age groups III and IV remain in the lakes (Oxbow Lakes Project II, 1996). Therefore, growth data beyond age group III collected from oxbow lakes may not be reliable and will not have any major importance for lake management practices.

In oxbow lakes, Chinese carps appear to grow better than Indian major carps in the first and second years. In the third year, grass carp grew better than the other two Chinese carps, and amongst major carps catla grew better than rohu and mrigal. Growth

Table 3. Length–weight relationship ($\text{Log}W = a + b\text{Log}TL$) of three Indian major and three Chinese carp from six oxbow lakes during the study period of February 1995–June 1996.

Oxbow lakes	Fish species	Number of samples (<i>n</i>)	Correlation coefficient (<i>r</i>)	Intercept (<i>a</i>)	Slope (<i>b</i>)
Bahadurpur	Rohu	424	0.98	–2.285	3.227
	Catla	49	0.92	–2.189	3.312
	Mrigal	144	0.99	–2.445	3.269
	Silver carp	111	0.99	–2.573	3.355
	Grass carp	119	0.98	–2.268	3.205
	Common carp	146	0.95	–1.774	3.059
Benipur	Rohu	334	0.97	–2.461	3.361
	Catla	282	0.97	–2.407	3.362
	Mrigal	64	0.97	–3.219	3.785
	Silver carp	104	0.96	–2.593	3.365
	Grass carp	111	0.98	–1.717	2.891
Marufdia	Rohu	234	0.97	–1.701	2.862
	Catla	83	0.99	–2.266	3.256
	Mrigal	193	0.96	–2.372	3.160
	Silver carp	389	0.99	–1.807	3.232
	Grass carp	95	0.99	–2.059	2.934
	Common carp	184	0.96	–2.204	3.191
Bukbhara	Rohu	66	0.99	–3.162	3.167
	Catla	16	0.99	–1.099	3.838
	Mrigal	114	0.89	–2.564	2.434
	Silver carp	43	0.95	–1.554	3.369
	Grass carp	30	0.96	–1.335	2.774
	Common carp	41	0.96	–1.977	2.770
Nasti	Rohu	2071	0.98	–2.039	3.030
	Catla	1247	0.97	–2.209	3.117
	Mrigal	1784	0.97	–2.209	3.131
	Silver carp	1904	0.96	–1.921	2.969
	Grass carp	1059	0.93	–1.484	2.737
	Common carp	1385	0.95	–1.730	2.983
Porapara	Rohu	237	0.99	–2.301	3.237
	Catla	175	0.99	–2.182	3.198
	Mrigal	349	0.99	–2.264	3.181
	Silver carp	513	0.95	–1.646	2.801
	Grass carp	69	0.96	–1.345	2.656
	Common carp	261	0.95	–2.226	3.323

TL = total length; w = body weight

of rohu was comparable to that of silver carp in its third year. However, in the context of overall age group, growth of Chinese carps is better than local carp. Of two filter feeders, growth of silver carp was better than catla in age groups I and II; catla, however, performed better in age group III.

It is generally assumed that the modal length represents the probable age group (Balan 1967; Goeden 1978). In this study, a total of 14 432 individuals of six species was measured representing four empirical age groups in catla, mrigal, silver carp and grass carp and five age groups in rohu and common carp. It is generally agreed that modal value gives a more accurate result of probable age group than that of mid-values (Ibrahim 1962; Rao 1967). In this study, modal lengths were considered for identification of probable age group. Nevertheless, determination of growth based on modal length frequently leads to slight over-estimation, which has to be taken into account. However, the growth in terms of weight was estimated by taking the weight from the log-transformed length-weight relationship rather than taking corresponding weight of the calculated modal length.

Length-weight relationship

Length-weight relationships of six major and exotic carps of six selected oxbow lakes were calculated from length and weight data collected over February 1995 to June 1996 (Table 3). Correlation coefficient between length and weight for all fish species for all lakes was highly significant ($P = 0.000$) except for common carp in Benipur Lake. Relationship in this case could not be established due to inadequate samples ($n = 2$). Indian major and Chinese carp species showed isometric growth when their 'b' values ranged 2.860 to 3.099 (Hardjamulia et al. 1988). Carp species giving $b > 3$ values less or more than these values appeared to have allometric growth. With the exception of common carp in Bahadurpur Lake, grass carp in Marufdia Lake, and rohu and silver carp in Nasti Lake, all the species showed allometric growth in oxbow lakes. This indicates that fish growth is not uniform in oxbow lakes, but probably varies with season depending on the availability of food.

It is known to all that a b value greater than 3 indicates the robustness of fish, and less than 3 indicates leanness. Although growth is in general allometric, b values of most of the species are above 3, indicating that the fish harvested from lakes are healthy, but growth is allometric.

Conclusions

- (a) Chinese carps grow better than Indian major carps in semi-enclosed water bodies such as

oxbow lakes. Growth of all three Chinese carps was similar in the first year, but in the second and third years, common carp grew best followed by grass carp and silver carp. Among Indian major carps, catla performed better than rohu and mrigal in all three age groups, and the growth of rohu and mrigal was similar.

- (b) In oxbow lakes, growth rates of stocked carp for the first 2–3 years should be used only, as most of the fish are effectively fished out within this period.
- (c) Length-weight relationship of six carp species showed that fish harvested from the oxbow lakes are generally healthy.

Acknowledgments

The Oxbow Lakes Small Scale Fishermen Project II (1991–97) was executed jointly by the Department of Fisheries, the Bangladesh Rural Advance Committee (BRAC) and Danida Technical Assistance (DTA). The Oxbow Lakes Project II was funded through a loan to the Government of Bangladesh from the International Fund for Agricultural Development (IFAD) and through a grant from the Danish International Development Agency (Danida).

References

- Balan, V. 1967. Biology of the silver belly, *Leiognathus bindus* (Val.) of the Culicut coast. Indian Journal of Fisheries, 10: 118–134.
- Goeden, G. 1978. A Monograph of the Coral Trout. Research Bulletin of Fisheries Service, Queensland, No. 1, 42 p.
- Hardjamulia, A. and Suwignyo, P. 1988. The present status of the reservoir fishery in Indonesia. In: De Silva, S.S. ed. Reservoir Fishery Management and Development in Asia. A regional workshop, Kathmandu, Nepal 23–28 November 1987. IDRC Proceedings, 8–13.
- Ibrahim, K.H. 1962. Observation of the fishery and biology of the freshwater prawn, *Macrobrachium malcomsonii* Milne Edwards of River Godavari. Indian Journal of Fisheries 9, 433–467.
- LeCren, E.D. 1951. The length-weight relationship and seasonal cycle in gonad weight and condition in the perch. Journal of Animal Ecology, 20: 219.
- Oxbow Lakes Project II. 1996. Summary Report on Growth and Gear Efficiency Studies of Indian Major and Chinese Carp by Length-Frequency Distribution Analysis in Six Selected Oxbow Lakes. Jessore, Bangladesh, PIU/BRAC/DTA, 244 p (unpublished).
- Rao, R. M. 1967. Studies on the biology of *Macrobrachium rosenbergii* (De Man) of Hoogly Estuary with notes on its fishery. Proceedings of National Institute of Science India, 33B, 242–279.

Carrying Capacity for Small Pelagic Fish in Three Asian Reservoirs

J. Vijverberg¹, P.B. Amarasinghe², M.G. Ariyaratna² and W.L.T. van Densen³

Abstract

On the basis of information from the literature and our own observations, the carrying capacity for small pelagics in Southeast Asian reservoirs was reviewed, and their selective feeding behaviour compared with information from NW Europe. Most information is based on limnological and fishery research carried out in reservoirs in Sri Lanka, Thailand and The Netherlands. There are no large differences in the performances of small pelagics in Southeast Asia and N. Europe, with the exception that small pelagic seston feeders are lacking in Europe. In both regions, most of the zooplanktivorous small pelagics are immigrants from the sea or are of marine origin. Although not much data are available on zooplankton production and the production of small pelagics in Southeast Asian reservoirs, the productions seem higher than previously suggested. In Sri Lanka, *Amblypharyngodon melettinus*, a small pelagic cyprinid feeding on seston, often dominates the fish fauna and is able to realise a very high biological production of 3240 kg fresh weight/ha/year (Tissawewa). The biological production of the zooplanktivorous small pelagics (90–360 kg fresh weight/ha/year) and their yield (50 kg fresh weight/ha/year of *Clupeichthys aesarnensis*) is much lower than those of the seston feeders, but not much lower than could be expected on the basis of the realised primary and secondary production levels. As a group, clupeids are the most successful zooplanktivores, but in Sri Lanka *Rasbora daniconius*, a small cyprinid of riverine origin, is as successful.

IN THE temperate region, zooplanktivorous fish generally dominate the pelagic zones of lakes and reservoirs and play an important role in the food chain. It is generally assumed that most reservoirs in Southeast Asia support only very limited numbers of pelagic zooplanktivores. Most reservoirs are purported to have a riverine fish fauna that inhabits the littoral zone, leaving a large pelagic zone mainly unoccupied (Fernando and Holcik 1982; Sarnita 1987; Fernando 1994).

The reason for this is not clear. It may be the result of the small-bodied zooplankton species dominating

the zooplankton community in tropical lacustrine environments. Because they represent a small particle size, it is possible that they cannot be handled efficiently by the fish inhabiting the reservoirs and result in a poor food conversion efficiency. If this is true, zooplankton production in these reservoirs is not effectively used, and there may be a vacant niche for a pelagic zooplanktivorous fish. Another possible explanation is the nature of the fish communities in Southeast Asia, where most water bodies are man-made and natural lakes are almost absent.

Most of these reservoirs have a riverine faunal composition which generally inhabits the littoral zone, and which may be poorly adapted to feeding on zooplankton. Also, in this case, zooplankton production may be inefficiently utilised. It is also possible that the quantity of the zooplankton production itself is limiting zooplanktivorous fish abundance. It is not unlikely that, because of high respiration rates as the result of high water temperatures, net zooplankton

¹Netherlands Institute of Ecology, Centre for Limnology, PO Box 1299, 3600 BG Maarssen, The Netherlands; E-mail: vijverberg@cl.nioo.knaw.nl

²Department of Fisheries, Ruhuna University, Matara, Sri Lanka

³Fish Culture and Fisheries Group, Wageningen Agricultural University, PO Box 338, 6700 AH Wageningen, The Netherlands

production in the tropics is relatively low (Lehman 1988). This would mean that in the tropics, in contrast with the temperate region, the carrying capacity for zooplanktivorous fish would be relatively low.

In this paper, we address the following questions: 1) Is it true that in most Southeast Asian reservoirs small pelagics are of minor importance? 2) If so, what may be the reason for this? Is the production of the zooplankton relatively low, and is the low food availability limiting the abundance of the small pelagics? 3) Is the zooplankton production in the pelagic zone largely unutilised by predators, and is there a vacant niche available for zooplanktivorous fish? We attempt to answer the questions by comparing the production of small pelagics with the quantity and quality of the resource base (zooplankton) and by studying its feeding efficiency on small and large food organisms.

Material and Methods

The present review is not exhaustive and is mainly based on information from three countries, Sri Lanka, Thailand and The Netherlands (NW Europe). For Southeast Asia, it is based mainly on three sources: 1) results from the Austrian–Sri Lankan ecosystem study in Parakrama Samudra from 1979 to 1982; 2) the results from The Netherlands–Sri Lankan team which carried out a limnological, fish community and fisheries study in Tissawewa from 1989 to 1992; and 3) the ongoing project ‘Strategies for partitioning the productivity of Asian reservoirs and lakes between capture fisheries and aquaculture for social benefit and local market without negative environmental impact’ (FISHSTRAT 1998–2001). FISHSTRAT is a project financed by the European Union in which researchers of three countries (Thailand, Sri Lanka, Philippines) work together. For comparison, information is presented from The Netherlands, where the Netherlands Institute of Ecology and Centre for Limnology studied aquatic food webs for many years (Vijverberg et al. 1993). For the physical characteristics of the reservoirs studied, see Table 1.

Selective feeding of small zooplanktivorous pelagics was studied in four Sri Lankan and one Thai reservoir and results compared with the feeding behaviour of a small pelagic from NW Europe (The Netherlands). The observations of *Ehirava fluviatilis* (Clupeidae) in Parakrama Samudra (Sri Lanka) were carried out previously by Duncan (1999). Observations of the other four tropical reservoirs were carried out within the framework of the FISHSTRAT project. Fish for gut content analysis were generally caught at dusk, when the feeding activity of the fish is often at a maximum. Fish were caught with monofilament gill-nets with mesh of 4, 5, 8 and 10 mm. Exposure time was two hours. The size range (total length) of fish used for the gut analysis was: *Clupeichthys aesarnensis* (Clupeidae), 3.0–3.9 cm (mean 3.6 cm), *Hemiramphus gaimardi* (Hemiramphidae), 9.8–11.7 cm (mean: 11.1), *Osmerus eperlanus* (Osmeridae), 2.1–5.9 (mean: 3.5) and *Rasbora daniconius* (Cyprinidae), 6.1–8.7 cm (mean: 7.8). Body size and species composition of zooplankton in guts of the zooplanktivorous fish species were compared with those in the environment. Zooplankton in the water column was quantitatively sampled with a Patalas (Schindler) sampler of 3 L and a net attached of 100 µm mesh. The selective feeding on size and species by zooplanktivorous fish on microcrustacean zooplankton was studied by comparing zooplankton in the environment with that in the fish guts. To study size selection, food organisms were divided into three size classes, defined for all fish species–reservoir–sampling time combinations separately. The range of the smallest to the largest food organism was found from the gut analysis. This range was divided into three equal parts: small, medium and large. The electivity index E according to Ivlev (1961) was used:

$$E = (r_i - p_i)/(r_i + p_i) \quad (\text{Eqn 1})$$

where r_i is the relative abundance (%) of a specific food item in the gut or stomach and p_i the relative abundance of the same food item in the environment. Values range from +1 (strong positive selection) via zero (no selection) to –1 (strong negative selection or avoidance).

Table 1. Physical characteristics of the waterbodies studied.

Waterbody	Country	Surface area (km ²)	Mean depth (m)	Max. depth (m)	Impounded	Trophic state	
Minneriya	MI	Sri Lanka	22.5	5.3	11.7	276 AD	Eutrophic
Parakrama Samudra	PS	Sri Lanka	11.7	2.8	4.0	386 AD	Eutrophic
Tissawewa	TW	Sri Lanka	2.0	1.2	3.5	35 AD	Eutrophic
Tjeukemeer	TJ	Netherlands	21	1.5	2.5	Ca. 1600	Hypertrophic
Ubolratana	UR	Thailand	401	5.50	15.0	1965	Eutrophic
Udawalawe	UD	Sri Lanka	33.6	7.8	15.3	1968	Meso/Eutrophic
Victoria	VI	Sri Lanka	22.7	10.5	30.5	1984	Meso/Eutrophic

Results and Discussion

Pelagics

The annual production per unit biomass (annual P/B) gives useful information about the productivity of a fish population. The higher the P/B, the higher the fishery mortality will be able to sustain. The P to B ratios of the pelagic fish species are largely affected by their size (L_{\max} , maximum length), but also to a lesser degree by water temperature (Figure 1). The P/B of the tropical *Oreochromis mossambicus* is relatively high for its size. However, within the group of small pelagics ($L_{\max} < 20$ cm) the P/B is high, and differences corrected for size effect are relatively small. The herbivorous/detritivorous small pelagic *Amblypharyngodon melettinus* (Cyprinidae) from Sri Lanka compares well with the group of zooplanktivorous small pelagics. A strong negative correlation between P/B and species size was earlier demonstrated by Pauly and Christensen (1993) for 58 groups of organisms.

Herbivorous/detritivorous fish are lacking in the temperate region, but successful in Southeast Asia where both the small pelagic *A. melettinus* and the larger pelagic *O. mossambicus*, introduced from

Africa in the 1950s, reach high production levels (Pet et al. 1996) (Figure 2, Table 2). The latter species is also important for the fisheries. The temperate region has several large pelagics, some feeding facultatively and some obligatorily on zooplankton. The houting (*Coregonus lavaretus*) is the largest obligatory feeder on zooplankton. It belongs to the Coregonidae, a family that shares traits with both the Clupidae and the Salmonidae. Related species are also abundant in large North American lakes. In Southeast Asia, large pelagic zooplanktivores are completely lacking (Figure 2, Table 2).

Small pelagics

When we compare the number of small ($L_{\max} < 20$ cm) obligatory zooplanktivorous fish species in Southeast Asia with those in NW Europe, we find five species in Asia and three in NW Europe. In Europe, two species belong to the Percidae and one to the Osmeridae, a group closely related to the Salmonidae. In Southeast Asia, three species belong to the Clupeidae, one to the Cyprinidae and one to the Hemiramphidae (Table 2). Thus, the number of small pelagics in the tropics is certainly not smaller than in the temperate region.

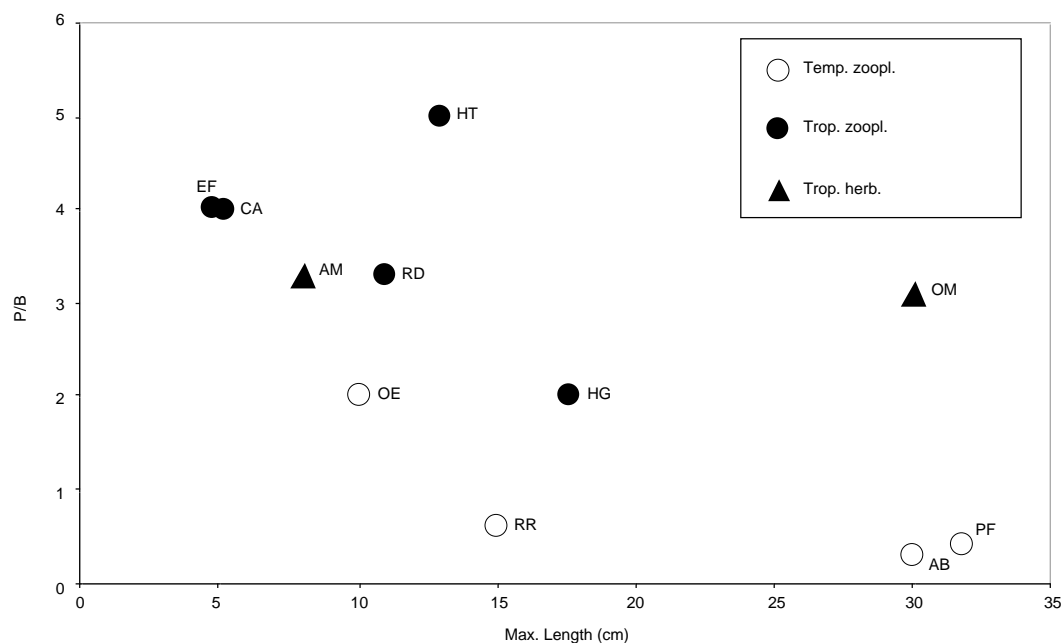

Figure 1. Maximum length and annual P/B ratios of herbivorous and zooplanktivorous pelagic fish species in temperate (open symbols) and tropical (closed symbols) waterbodies. For explanation of abbreviations used for species names see Table 2. Sources for L_{\max} and P/B ratios: AB, Buijse et al. 1993; AM, Pet et al. 1996; CA, Chookajorn et al. 1994; EF, Duncan 1999; HG, Pet et al. 1996; HT, Duncan 1999 and J. Moreau pers. comm.; OE, Buijse et al. 1993; OM, Pet et al. 1996; PF, Reyes-Marchant et al., 1993; RD, Pet et al. 1996; RR, Buijse et al. 1993.

Table 2. Summary of pelagic fish species in lakes and reservoirs from Europe and S Asia (taxonomic position, geographical distribution, habitat of origin, food habits, abundance in region of distribution, and role in food webs).

Scientific name	Abbreviation	Common name	Family	Region/country	Origin?	Food	Common in region of distribution?	Keystone species?
<i>Alburnus alburnus</i>	AA	Bleak	<i>Cyprinidae</i>	NW Europe	Riverine	Z	Yes	No
<i>Abramis brama</i>	AB	Common bream	<i>Cyprinidae</i>	NW Europe	Lake	Z*	Yes	Yes
<i>Amblypharyngodon melettinus</i>	AM	Silver carplet	<i>Cyprinidae</i>	SW Asia	Riverine	H/D	Yes	Yes
<i>Blicca bjoerkna</i>	BB	Silver bream	<i>Cyprinidae</i>	NW Europe	Lake	Z*	Yes	No
<i>Clupeichthys aesarnensis</i>	CA	Thai river sprat	<i>Clupeidae</i>	Thailand	Marine	Z*	No	Yes
<i>Coregonus lavaretus</i>	CL	Houting	<i>Coregonidae</i>	W, N and E Europe	Lake	Z	Yes	No
<i>Ehirava fluviatilis</i>	EF	Malabar sprat	<i>Clupeidae</i>	Sri Lanka, SW India	Marine	Z	No	Yes
<i>Gasterosteus aculeatus</i>	GA	Three-spined stickle-back	<i>Percidae</i>	NW Europe	Marine	Z	Yes	Sometimes
<i>Hemiramphus gaimardi</i>	HG	Halfbeak	<i>Hemi-ramphidae</i>	Sri Lanka, India	Marine	Z	Yes	No
<i>Harengula tawilis</i>	HT	Tawilis	<i>Clupeidae</i>	Philippines	Marine	Z	No	Yes
<i>Osmerus eperlanus</i>	OE	Smelt	<i>Osmeridae</i>	W, N and E Europe	Marine	Z	Yes	Yes
<i>Oreochromis mossambicus</i>	OM	Tilapia	<i>Cichlidae</i>	Tropical region	Lake	H/D	Yes	Yes
<i>Perca fluviatilis</i>	PF	Perch	<i>Percidae</i>	Europe, N Asia	Lake	Z*	Yes	Yes
<i>Pungitius pungitius</i>	PP	Ten-spined stickle-back	<i>Percidae</i>	W Europe	Marine	Z	Yes	Sometimes
<i>Rasbora daniconius</i>	RD	Striped rasbora	<i>Cyprinidae</i>	SW Asia	Riverine	Z	Yes	No
<i>Rutilus rutilus</i>	RR	Roach	<i>Cyprinidae</i>	NW Europe	Lake	Z*	Yes	Sometimes

Abbreviations used: Z = obligate zooplanktivorous, Z* = facultative zooplanktivorous, H/D = herbivorous/detritivorous.

In regard to life histories and migration behaviour, the species from Southeast Asia and NW Europe have much in common (Table 3). They are either recent (in historical times) invaders from marine habitats (*E. fluviatilis*, *H. gaimardi*, *O. eperlanus*) or are immigrants on an evolutionary timescale and live permanently in freshwater (*C. aesarnensis*, *Harengula tawilis*, *Pungitius pungitius*). Whereas the temperate *Gasterosteus aculeatus* shows a very flexible behaviour, most adult individuals live in coastal marine habitats, but migrate for spawning to freshwaters. The juveniles born in the freshwaters stay a year and then migrate back to the sea. However, there are also sub-populations that permanently remain in the sea, or the opposite, which never leave their freshwater habitats.

Production of a species is a measure of the success of a species in a particular ecosystem. We review the absolute and relative production (i.e. species production relative to the total fish production). *A. melettinus* has by far the highest production and also the highest relative production (Table 4). The production levels of the zooplanktivorous small pelagics are 3–11% of this value. The most successful zooplanktivores are *E. fluviatilis* and *R. daniconius*. The status of *C. aesarnensis* is uncertain, because so far we

have no biological production estimates for this species, but only yield estimates. A relative yield of 15–65% (relative to the total fish yield) in three large Thai reservoirs (EGAT 1991) suggests, however, that it may be as successful as the other two species. There is also a successful fishery on *H. tawilis* in Lake Taal (yield = 440 kg/ha/yr, relative yield 79%) (Baluyut 1999). The halfbeak *H. gaimardi* is clearly the least successful of the species reviewed. Although the realised production of the temperate *O. eperlanus* is approximately only one-third that of the most successful tropical species *A. melettinus*, its contribution to the total fish production is similar.

Carrying capacity for small pelagics

The basis of fish production is primary production. In two of the Southeast Asian reservoirs, primary production was twice as high as in the temperate Tjeukemeer. In the third Asian reservoir, Ubolratana, primary production was similar to that of Tjeukemeer. This is unexpected, since Ubolratana and Tissawewa show similar levels of algal biomass (Table 5). Potential zooplankton production was estimated on the basis of food chain efficiency from net phytoplankton production to zooplankton production of 15% (Brylinsky 1980). Only in two of the four

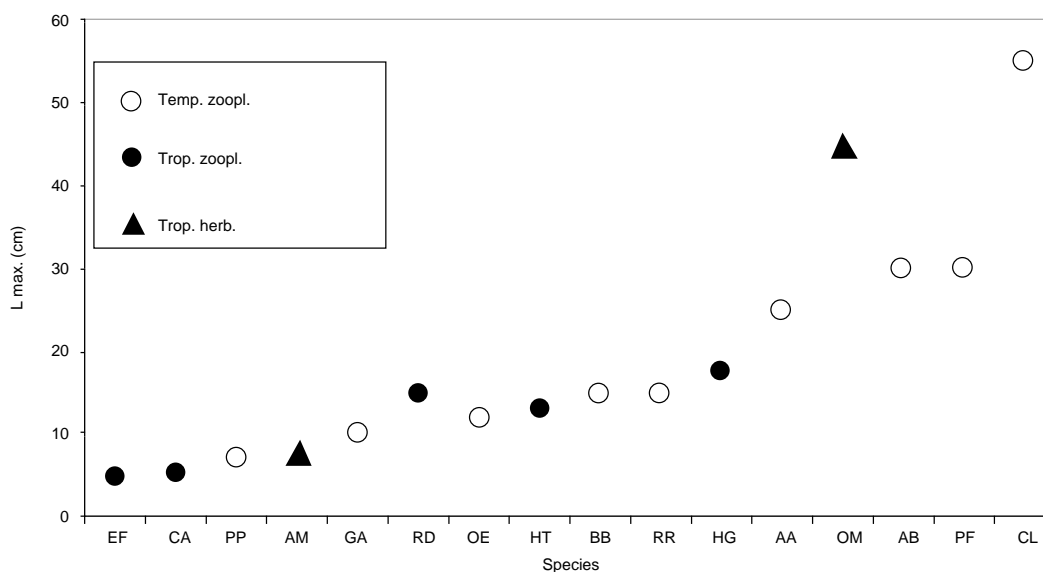

Figure 2. Maximum length of herbivorous and zooplanktivorous pelagic fish species in temperate (open symbols) and tropical (closed symbols) waterbodies. For explanation of abbreviations used for species names see Table 2. Authority for maximum fish length of Sri Lankan species: Pethiyagoda 1991; for other Southeast Asian species see Table 2 and for European species De Nie 1996 and Vijverberg and Van Densen, personal observations. For facultative European zooplanktivores, the maximum length given is the largest length fish still generally feeding on zooplankton.

Table 3. Habitats occupied and migration patterns observed by small pelagics of marine origin. Sri Lankan fish species according to Pethiyagoda (1991), European species according to De Nie (1996), *Clupeichthys* according to Bhukaswan (1985), *Harengulus* according to Aypa et al. (1999). For abbreviations see Table 2.

Habitat/migration pattern	CA	EF	GA	HG	HT	OE	PP
Invader from sea		+		+		+	
Annual migration from sea/spawning in fresh water			+				
Annual migration from fresh water/spawning in brackish water							
Obligate freshwater species/standing populations in rivers	+						+
Obligate freshwater species/standing populations in lakes	+		+		+		+
Facultative freshwater species/standing populations in lakes/landlocked populations		+	+	+		+	

Table 4. Absolute and relative production of small pelagic species in one NW European and three Southeast Asian reservoirs. (Key to water body, see Table 1.)

Species	Reservoir	Species annual production (kg frwt/ha/yr)	Total fish annual production (kg frwt/ha/year)	Species annual production (%)	Authority
<i>A. melettinus</i>	TW	3240	5400	60	Pet et al. 1996
<i>C. aesarnensis</i>	UR	53*	379*	14*	Costa Pierce and Soemarwoto 1990
<i>E. fluviatilis</i>	PS	360			Newrkla and Duncan 1984
					J. Moreau pers. comm.
<i>H. gaimardi</i>	TW	92	5400	1.7	Pet et al. 1996
<i>O. eperlanus</i>	TJ	125	220	57	Vijverberg et al. 1990
<i>R. daniconius</i>	TW	360	5400	6.7	Pet et al. 1996

* = For *Clupeichthys aesarnensis* in Ubolratana, the yield and the yield as percentage of the total fish yield is given. In all other cases, production represents net biological production.

cases was it possible to compare the estimated value with the measured value. In the case of Tissawewa, the measured value was only 13% of the potential value. The main reason for this is that in this very shallow reservoir (mean depth = 1.2 m), most primary production (about 75%) was utilised by benthic invertebrates and not by zooplankton as is generally the case in deeper lakes (Piet et al. 1999). In this reservoir, the seston-feeding fish consumed only a small part of the primary production (5%) and therefore had not much effect on the biomass transfer between algae and zooplanktivorous fish. In the temperate Tjeukemeer, the measured and estimated values for zooplankton production were similar.

The zooplanktivorous fish production was estimated by assuming a conversion of 25% (Brett and Groves 1979). It was estimated in four cases, twice from the measured zooplankton production and twice from the estimated zooplankton production (Table 5). The estimated zooplanktivorous fish production varied from 375 to 1650 kg frwt/ha. The lowest estimated was for Tissawewa. This low value was due to the relative low zooplankton production, which is at least partially caused by the high feeding rate of the benthic invertebrates, but may also be caused by an

underestimation of the zooplankton production value itself. This value was based upon growth in laboratory cultures in which natural pond seston was used as food. Most probably, the dominant green alga in this water represented poor food quality for at least some of the dominant species (e.g. *Diaphanosoma* spp., *Phyllodiaptomus annae*) (Amarasinghe et al. 1997b). The realised zooplankton production relative to the potential value (22%) seems a bit low in Parakrama Samudra, but is similar to the value observed for Tjeukemeer. Furthermore, this value is somewhat underestimated because the measured value is based only on *E. fluviatilis* (F. Schiemer, pers. comm.).

Feeding behaviour of zooplanktivorous small pelagics

All small zooplanktivorous small pelagics are particulate feeders and select their prey items visually. In tropical Southeast Asia, the zooplankton community is dominated by small species. The largest species, *D. lumholzi*, although widely distributed in the tropical region, is rarely found in high densities (Fernando et al. 1987). In Figure 3a, maximum

Table 5. Food chain efficiency and carrying capacity for zooplanktivorous pelagic fish in one NW European and three Southeast Asian reservoirs.

Reservoir	Mean Chlorophyll (mg m ³)	GPP (kg frwt/ha/year)	NPP (kg frwt/ha/year)	P _{Est.} Zoopl. (kg frwt/ha/year)	P _{Meas.} zoopl. (kg frwt/ha/year)	P _{Est.} zoopl. fish (kg frwt/ha/year)	P _{Meas.} zoopl. fish (kg frwt/ha/year)	Authority
PS	40	146 000	87 600	13 100		3 280	360 (11%)	Schiemer and Duncan 1988 Newrkla and Duncan 1984
TJ	125	70 000	42 000	6 300	4 660 (74%)	1 170	180 (15.5%)	Gons 1983 Vijverberg et al. 1990
TW	19	130 000	78 000	11 700	1 500 (13%)	380	452 (120%)	Amarasinghe 1998 Amarasinghe et al. 1997a Pet et al. 1996
UR	20	73 000	43 800	6 600		1 650	53* (3%)	Costa-Pierce and Soemarwoto 1990 Eugen Rott pers. comm. Jaiyen et al. 1980

Measured (yield) of zooplanktivorous fish in Parakrama Samudra based upon *E. fluviatilis* and in Ubolratana based upon *C. aesarnensis* only. Abbreviations used: GPP = Gross Primary Production, NPP = Net Primary Production, P_{Est.} = Estimated production, P_{Meas.} = measured production. Net primary production was calculated from gross production by assuming net production to be 60% of gross production (Westlake 1980). Zooplankton production was estimated by assuming a food chain efficiency of 15% (Brylinsky 1980). Zooplanktivorous fish production was estimated by assuming a conversion of 25% (Brett and Grover 1979).

* = For Ubolratana Reservoir the yield of the zooplanktivorous fish is given instead of the measured biological production. In parenthesis the percentage value of measured relative to estimated value. In calculations the following conversions were used: 1 g dry wt = 0.5 g carbon, for primary production 0.364 mg O₂ = 1 mg C, for zooplankton 1 g dry wt = 10 g fresh wt, for algae and fish 1 g dry wt = 5 g fresh wt = 1 g dry wt for zooplankton (Winberg et al. 1971).

lengths are given for the common zooplankton species, based on culture results and only rarely observed under field conditions. Southeast Asian zooplankton is generally smaller than 1.0 mm, larger individuals present only in low densities. In contrast, in the temperate region, *Daphnia galeata* or other closely related *Daphnia* spp. from *D. longispina* group are both larger than 1.0 mm and abundant. In the temperate region, very large zooplankton (*Leptodora*) or opossum shrimps (*Neomysis*) are often present in low densities, but are lacking in the tropics (Figure 3b). To some extent, this is compensated in the tropics by surface-floating adult insects (mainly chironomids), *Chaoborus* larvae (phantom midge), and chironomid larvae and pupae. All these organisms are mainly available during the night. Chironomid larvae and pupae and *Chaoborus* larvae are often present in the water column during the night, whereas they inhabit the bottom substrates during the day. *Chaoborus*, like *Leptodora*, is transparent and may be difficult to see for the zooplanktivores during the day.

Compared to the food conditions in the temperate region, particle size of available food organisms in the environment is generally small for small pelagic zooplanktivores in Southeast Asia (Figure 4). There are, however, exceptions. *C. aesarnensis* in Ubolratana in a station near the dam during the night has access to adult flying insects floating on the surface (Ca-2), and in a station during the day near the inlet of the Lam Choen Tributary *D. lumholzi* is abundant in the water column (Ca-3). *E. fluviatilis* in Parakrama Samudra is experiencing exceptional food conditions too. In this reservoir, microcrustacean zooplankton were totally lacking and only small rotifers were available as food (Figures 4 and 5). With the exception of *E. fluviatilis*, all fish species showed a positive size-selective feeding behaviour, although in most cases selectivity was weak and mean particle size in the diet was only slightly larger than in the environment (Figures 4 and 5). Only under conditions where large (*Daphnia*) or very large (adult insects) food items are available a strong positive size-selective feeding behaviour is observed (Figures 4, 5 and 6). The tropical species behave in this respect the same as do the temperate *O. eperlanus*.

Selection of food species was mainly the effect of size selection, large and very large items highly sought (Figure 7). In the tropics, species of intermediate size (e.g. *Diaphanosoma*, *Moina*) are also often positively selected; smaller food organisms (e.g. *Bosminopsis*, *Ceriodaphnia*) are either weakly positively selected or avoided. The very small copepod nauplii is always strongly avoided. The avoidance of the relatively large calanoid copepods shows that besides size also prey behaviour affects

selectivity of predation. Calanoid copepods show a strong swimming speed and will swim against water currents. Cyclopod copepods are next, and cladocerans show the lowest swimming speed. The fish catches prey by sucking it in one by one, and therefore calanoid copepods, followed by cyclopod copepods, have the best chance of escaping predation (Drenner and McComas 1984). In the temperate region, *O. eperlanus* shows a very clear pattern, a high positive selection for the large cladocerans (*D. galeata*, *Leptodora*), no selection for cyclopod copepods, and strong avoidance of small-bodied cladocerans.

General Discussion and Conclusions

The zooplanktivorous fish were generally feeding size-selectively. The degree of selectivity depended on the availability of large and very large organisms in the water column or on the water surface. All small pelagic species seem to be adapted to the available size distribution of food organisms. If larger food items were available, a strong positive selection on the larger food items took place. If larger food organisms were lacking, size-selective predation was generally weak. Usually, the large (1.0–1.5 mm) and very large (> 4 mm) food organisms seem to be missing in the tropics and therefore a weak positive selection of the slightly larger food organisms (0.5–0.7) seems to be the rule.

Strong selection for somewhat larger food items (0.7–1.0) which are scarce and only a little bit larger than the more abundant food particles was not observed. At first glance, this seems to be in contrast with the temperate region where usually large (*D. galeata*) and very large (*Leptodora*, *Neomysis*) food organisms are available, resulting in strong positive selection for larger food items and a strong avoidance of small-bodied cladocerans. The observed feeding behaviour of both tropical and temperate small pelagics is, however, in agreement with the optimal foraging theory (Bence and Murdoch 1986). This theory predicts that it is only worthwhile to select for somewhat larger food items if they are present in substantial densities (e.g. *Daphnia*). Selection of larger particles only a little larger but scarce (e.g. the largest *Diaphanosoma*) is energetically not a good strategy because the increased profits per particle eaten will not compensate for increased search time. Selection of much larger particles (e.g. *Leptodora*, insects) is still a good strategy at much lower prey densities because the profitability per eaten particle is much larger than for common much smaller particles.

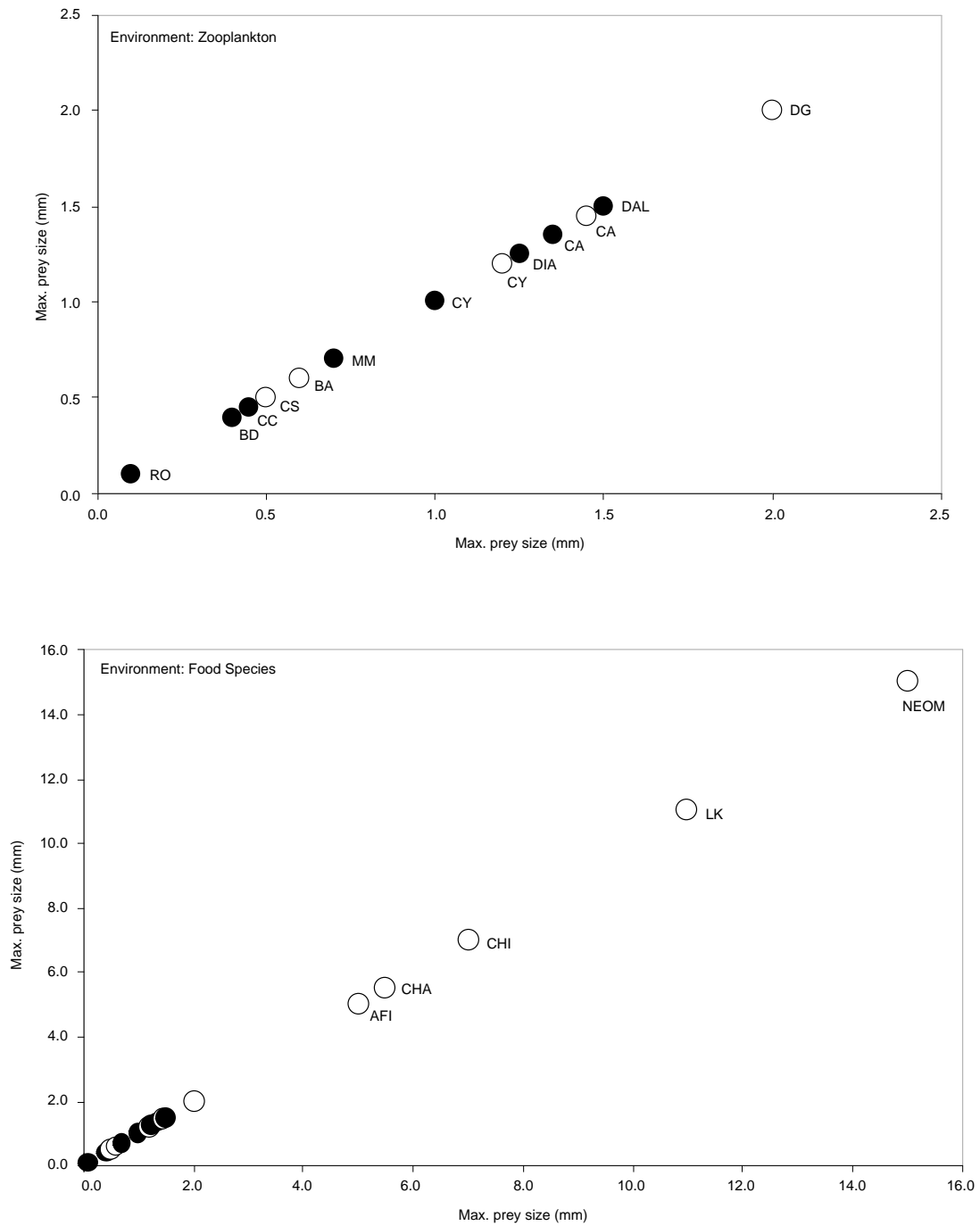

Figure 3. Maximum prey size (mm) of food species (taxa) available in the environment for small zooplanktivorous pelagics in Southeast Asian (closed symbols) and North European (open symbols) reservoirs. Upper panel herbivorous zooplankton, lower panel herbivorous zooplankton with macrofauna and predatory cladoceran (LK). For explanation of abbreviations used for names of food organisms see Figure 5.

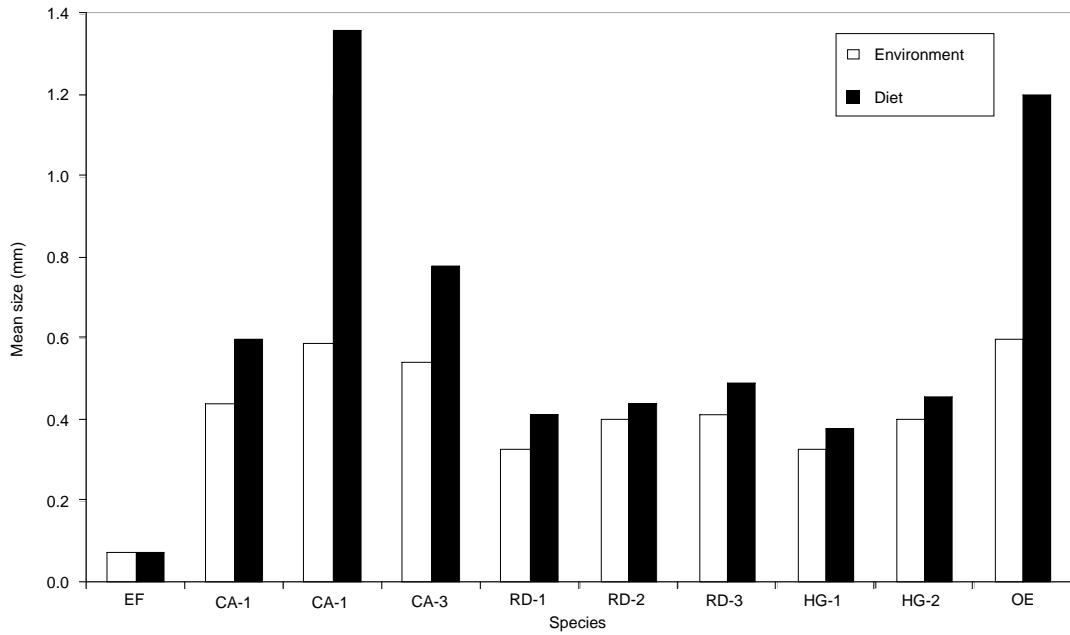

Figure 4. Mean size of food items in the environment and in the diet of four species of Southeast Asian and one species of North European (*O. eperlanus*) small pelagics in reservoirs. For explanation of abbreviations used for species names see Table 2. *Clupeichthys* (CA) was caught at different places and periods of the day: Ca-1, near the dam during dusk, Ca-2, near dam during the night, Ca-3 during the day near the inlet of the Phrom River. Data on *Ehirava fluviatilis* (EF) from Duncan (1999).

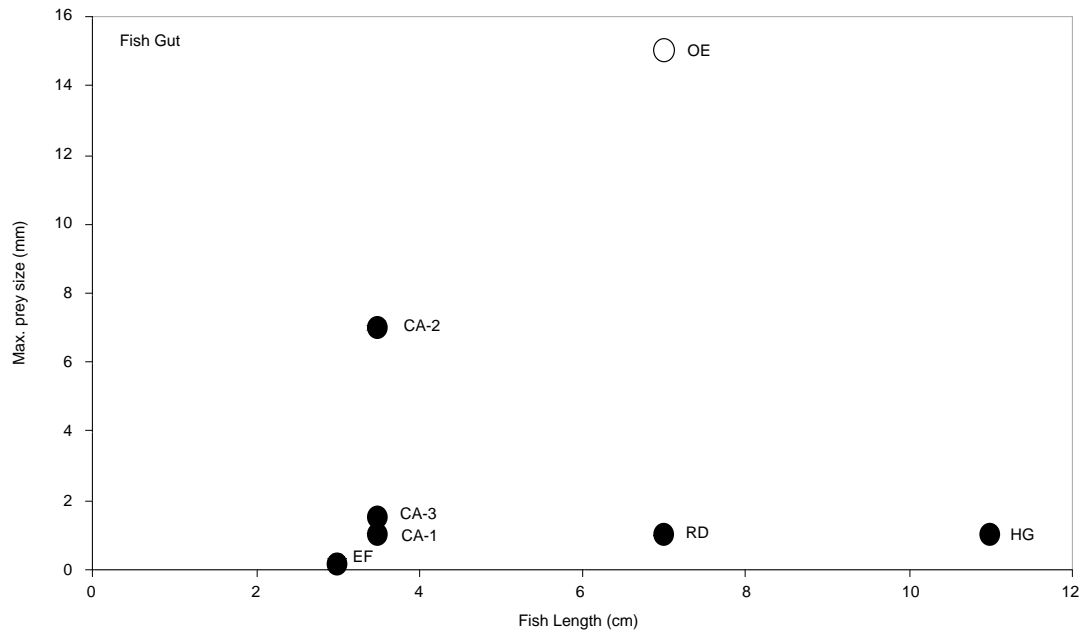

Figure 5. Maximum prey size (mm) of food items in the guts of four species of Southeast Asian (closed symbols) and one species of North European (open symbols) zooplanktivorous small pelagics relative to their length. For explanation of abbreviations used for species names, see Table 2.

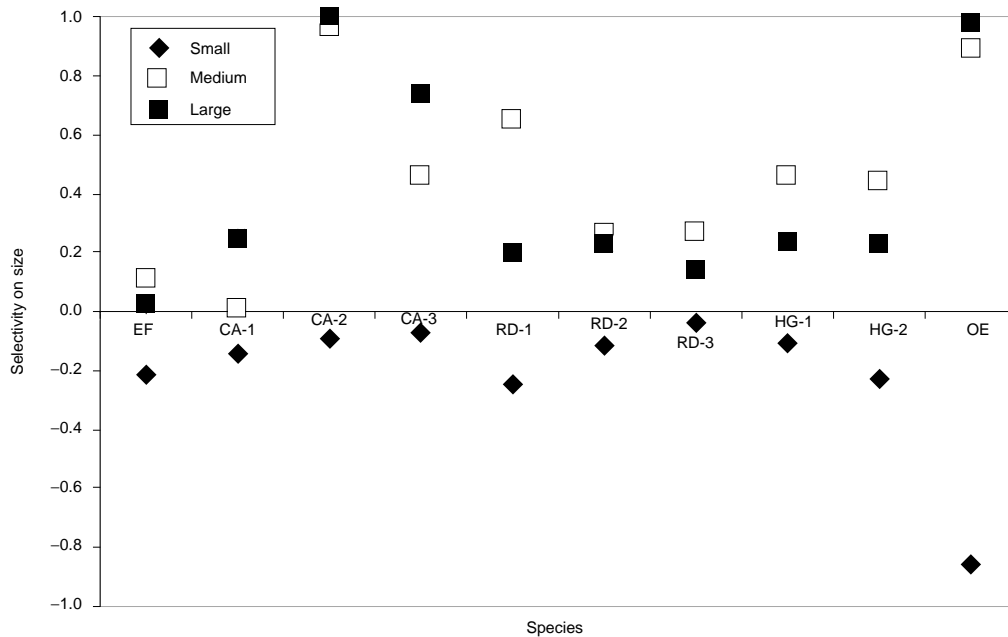

Figure 6. Size-selective feeding of four species of Southeast Asian and one species of North European small pelagics on three size classes of food particles in three Sri Lankan and one Thai reservoir. Selection index according to Ivlev (1961: equation 1). Abbreviations used, size: S = small, M = medium, L = large. For explanation of abbreviations used for species names, see Table 2 and legend Figure 3. Data on *Ehirava fluviatilis* (EF) from Duncan (1999).

Therefore, under the same food conditions tropical and temperate small planktivores show the same selective feeding behaviour.

Small-bodied clupeids were most often the successful zooplanktivores in Southeast Asian water bodies. They showed an amazing flexibility in feeding behaviour, feeding exclusively on small rotifers if larger food items were not available (*E. fluviatilis* in Parakrama Samudra), strongly selecting *Daphnia* when available (*C. aesarnensis* in Ubolratana near inlet of the Lam Choen Tributary), switching from an 100% cyclopoid copepod diet during the day-time to an 80% (biomass) diet of floating insects (*C. aesarnensis* in Ubolratana near the dam). Such an opportunistic feeding behaviour of *C. aesarnensis* in Ubolratana Reservoir was previously reported by Sirimongkonthaworn and Fernando (1994). It was therefore expected that clupeids would be always more successful than cyprinids from riverine origin. However, this was not the case. *R. daniconius* in an Sri Lankan lowland reservoir realised the same high level of production than the clupeid *E. fluviatilis* in an other Sri Lankan lowland reservoir with a similar level of primary production. Catch statistics from the 12 largest reservoirs in Thailand show that in only three of these reservoirs

C. aesarnensis yields are substantially contributing to the total fish catch, i.e. Sirindhorn (65%), Sirikit (30%), Ubolratana (15% of total catch) (EGAT 1991). It is possible that selective overexploitation of the large predatory fish, resulting in a decreasing predation mortality for *C. aesarnensis*, is the cause of its abundance in these three reservoirs (Boonsong Sricharoendham pers. comm.). Mattson et al. (these Proceedings) suggested the same cause to explain the dramatic increase of *C. aesarnensis* catch in the Nam Ngum Reservoir in Lao PDR.

Studies of primary and secondary zooplankton production showed that Southeast Asian reservoirs are able to support significant populations of zooplanktivorous small pelagics (90–360 kg/ha/population/yr). A much larger production is not possible, at least not in shallow reservoirs, where a substantial part of the primary production is channelled into benthic invertebrate production.

Primary production in the tropics is higher than in the temperate region, mainly because of more light, resulting in a higher production per unit of chlorophyll (Lemoalle et al. 1981). Because of the generally higher primary production in the tropical region as compared with the temperate region, the realised zooplanktivorous fish production in Southeast Asian

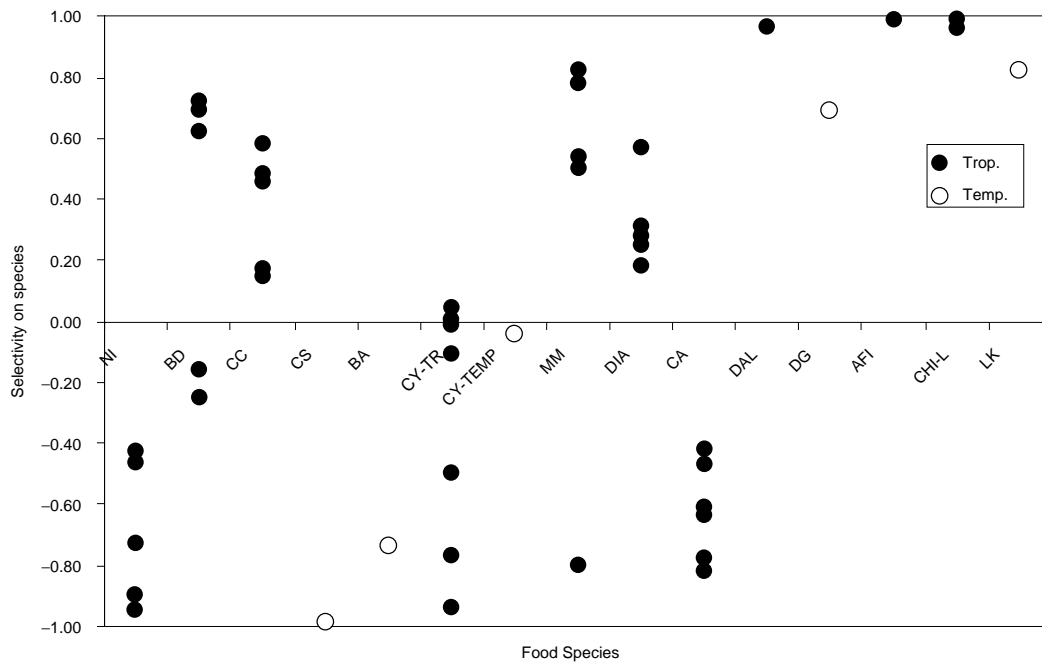

Figure 7. Selective feeding of three species of Southeast Asian (closed symbols) and one N. European (open symbols) small pelagics on species (taxa) of microcrustacean zooplankton (copepods, cladocerans) and macrofauna in three Sri Lankan and one Thai reservoir. Selection index according to Ivlev (1961). This figure is based on the same data set as is Figure 3, except that the observations on *E. fluviatilis* are omitted. One data point represents one fish species per habitat or time of the day per reservoir. For explanation of abbreviations used for fish species names, see Table 2 and legend Figure 3. Abbreviations used for names of food organisms: AFI = Adult flying insects, BA = *Bosmina* spp., BD = *Bosminopsis dietersi*, CA = calanoid copepods, CC = *Ceriodaphnia cornuta*, CHA = Chaoborus larvae, CHI = Chironomid larvae, CS = *Chydorus sphaericus*, CY-TEMP = temperate cyclopoid copepods, CY-TR = tropical cyclopoid copepods, DG = *Daphnia galeata*, DAL = *Daphnia lunholzi*, DIA = *Diaphanosoma* spp., LK = *Leptodora kindtii*, MM = *Moina micrura*, NEOM = *Neomysis*, NI = copepod nauplii.

water bodies (360–450 kg/ha/yr) is somewhat higher than in the temperate zone (180 kg/ha/yr). However, if we take the lower primary production into account and calculate the zooplanktivorous fish production per unit of primary production, production values for tropical and temperate zooplanktivorous fish are very similar. Therefore, when comparing zooplanktivorous fish production in the Southeast Asian region with those in the temperate region in reservoirs of similar trophicity (based on chlorophyll concentration, see Amarasinghe et al. 1997a), zooplanktivorous fish production in the tropics is higher than in the temperate zone.

Our observations of the substantial production of small indigenous fish in the pelagic zone of Southeast Asian reservoirs and lakes is not in agreement with earlier studies by Fernando and Holcik (1982), Sarnita (1987) and Fernando (1994). These authors state that the pelagic zone of Southeast Asian water bodies is mainly unoccupied and that its contribution

to fish production and fisheries yield is generally negligible. This statement is probably not true (also see De Silva and Sirisena 1987, 1989; Sirisena and De Silva 1989). At least in the reservoirs we studied, pelagic fish are common and often realise a high production. This is especially true of the indigenous small pelagics.

In Sri Lanka, *A. melettinus*, a seston feeder, is very successful in many reservoirs, realising more than half of the total fish production in Tissawewa. Small indigenous zooplanktivores were often abundant too, both in Sri Lanka and Thailand. This notion is, however, based on a low number of well studied reservoirs. Furthermore, one reservoir (Ubolratana) and one lake (Lake Taal) were chosen for this study because it was known that they supported large populations of small pelagics. Therefore, the sample size is small and the selection of the study reservoirs to some extent biased. This makes it questionable as

to what extent the information can be generalised for other areas within the Southeast Asian region.

Our findings, however, are in strong contrast with the statement by Fernando and Holcik (1982), Sarnita (1987) and Fernando (1994). Consequently, that statement should be regarded as a hypothesis which needs to be tested, not a proven fact.

As a result of the research carried out within the current FISHSTRAT project, during the next three years more information will become available on primary production, zooplankton production and the production and feeding behaviour of small pelagics. A comparison of food webs in reservoirs with a high production of small pelagics with food webs in reservoirs with a much lower production of small pelagics may provide insight into factors regulating the success of small pelagic fishes in Southeast Asian tropical reservoirs.

Acknowledgments

This research was carried out within the frame work of the project 'Strategies for partitioning the productivity of Asian reservoirs and lakes between capture fisheries and aquaculture for social benefit and local market without negative environmental impact (FISHSTRAT)' which is financed by the European Committee DG12-CDPE (INCO-DC contract No ERBIC18-CT97-0190). We thank our FISHSTRAT colleagues, especially, Nan Duncan (Royal Holloway Inst., University of London), Upali Amarasinghe (Dept of Zoology, University of Kelaniya), Fritz Schiemer (Dept. of Limnology, University of Vienna), and Boonsong Sricharoendham (National Inland Fisheries Institute of Thailand, NIFI) for stimulating discussions and interest. We are thankful to Suchart Inghamjitr (NIFI), Montarop. Kakkaw (NIFI), Deeka Ratanachamnong (NIFI), Tanaporn Chittapalpong (NIFI), Jacques Moreau (Inst. Nat. Polytechnique de Toulouse, ENSAT), James O. Villaneuva (Aquaculture Division, Bureau of Fisheries and Aquatic Resources, Philippines) and Eugen Rott (Dept. Hydrobotany, Univ. Innsbruck) for unpublished results. The research in Sri Lanka by Bandu Amarasinghe and Mr. M.G. Ariyaratne on the feeding behaviour of the zooplanktivorous small pelagics was supported by the Vijverhof Fonds and the Beijerinck-Poppingfonds. We acknowledge Guus Postema for help with the graphics.

References

- Amarasinghe, P.B. 1998. The population dynamics and production of microcrustacean zooplankton in three SE Sri Lankan reservoirs. PhD thesis, Ruhuna University, Sri Lanka.
- Amarasinghe, P.B., Vijverberg, J. and Boersma, M. 1997a. Production biology of copepods and cladocerans in three south-east Sri Lankan low-land reservoirs and its comparison to other tropical freshwater bodies. *Hydrobiologia*, 350: 145–162.
- Amarasinghe, P.B., Boersma, M. and Vijverberg, J. 1997b. The effect of temperature, and food quantity and quality on the growth and development rates in laboratory-cultured copepods and cladocerans from a Sri Lankan reservoir. *Hydrobiologia*, 350: 131–144.
- Ayap, S.M., Galicia, A.M. and Lapasaran, E.S. 1999. The reproduction biology and life cycle of freshwater pelagic sardine *Harengula (Sardinella) tawilis* (Clupeidae) in the volcanic Lake Taal, Philippines. In: van Densen, W.L.T. and Morris, M.J. ed. Fish and Fisheries of Lakes and Reservoirs in Southeast Asia and Africa. Westbury Publishing, Otley, 245–258.
- Baluyut, E.A., 1999. Introduction and fish stocking in lakes and reservoirs in Southeast Asia: a review. In: van Densen, W.L.T. and Morris, M.J. ed. Fish and Fisheries of Lakes and Reservoirs in Southeast Asia and Africa, 117–141. Westbury Publishing, Otley.
- Bence, J.R. and Murdoch, W.W. 1986. Prey size selection by the mosquito fish: relation to optimal foraging. *Ecology*, 67: 324–336.
- Bhukaswan, T. 1985. The Nam Pong Basin (Thailand). In: Petr, T. ed. Inland fisheries in multiple-purpose river basin planning and development in tropical Asian countries. Three case studies. FAO Fisheries, Technical Paper 265. FAO, Rome, 55–90.
- Brett, J.R. and Groves, T.D.D. 1979. Physiological energetics. In: Hoar, W.S., Randall, D.J. and Brett, J.R. ed. Fish Physiology, Vol. 8, Academic Press, New York, 279–352.
- Brylinsky, M. 1980. Estimating the productivity of lakes and reservoirs. In: Le Cren, E.D. and Low-McConnel R.H. ed. The Functioning of Freshwater Ecosystems, IBP 22. Cambridge University Press, Cambridge, UK, 393–410.
- Buijse, A.D., van Eerden, M.R., Dekker, W. and van Densen, W.L.T. 1993. Elements of a trophic model for IJsselmeer (The Netherlands), a shallow eutrophic lake. ICLARM Conference Proceedings, 26: 90–94.
- Chookajorn, T., Leenanond, Y., Moreau, J. and Sricharoendham, B. 1994. Evolution of trophic relationships in Ubolratana Reservoir (Thailand) as described using a multispecies trophic model. *Asian Fisheries Science*, 7: 201–213.
- Costa-Pierce, B.A. and Soemarwoto, O. 1990. Biotechnical feasibility studies on the importation of *Clupeichthys aesarnensis* Wongratana, 1983 from Northeastern Thailand to the Saguling Reservoir, West Java, Indonesia. In: Costa-Pierce, B.A. and Soemarwoto, O. ed. Reservoir Fisheries and Aquaculture Development for Resettlement in Indonesia, ICLARM Tech. Rep. 23: 329–363.
- De Nie, H.W. 1996. Freshwater fishes from The Netherlands. Media Publishing International, Wageningen. 128 p (in Dutch).
- De Silva, S.S. and Sirisena, H.K. 1987. New Fish resources of reservoirs in Sri Lanka: feasibility of introduction of a subsidiary sill-net fishery for minor cyprinids. *Fisheries Research*, 6: 17–34.

- De Silva, S.S. and Sirisena, H.K. 1989. New fish resources of reservoirs in Sri Lanka III: results of commercial-scale trials and yield estimates of a gill-net fishery for minor cyprinids. *Fisheries Research*, 7: 279–287.
- Drenner, R.W. and McComas, S.R. 1984. The role of zooplankton escape ability and fish size selectivity in the selective feeding and impact of planktivorous fish. In: Taub, F.B. ed. *Lakes and Reservoirs. Ecosystems of the world*. Elsevier Amsterdam, 587–593.
- Duncan, A. 1999. Pelagic fish and fisheries in Asian and African lakes and reservoirs. In: van Densen, W.L.T. and Morris, M.J. ed. *Fish and Fisheries of Lakes and Reservoirs in Southeast Asia and Africa*. Westbury Publishing, Otley, UK, 347–382.
- EGAT, 1991. Fisheries statistical report of EGAT reservoirs, for fiscal year 1990 (in Thai). Chemical and Analysis Department, Electricity Generating Authority of Thailand, 26 p.
- Fernando, C.H. 1994. Zooplankton, fish and fisheries in tropical fresh waters. *Hydrobiologia*, 272: 105–123.
- Fernando, C.H. and Holcik, J. 1982. The nature of fish: a factor influencing the fishery potential and yields of tropical lakes and reservoirs. *Hydrobiologia*, 97: 127–140.
- Fernando, C.H., Paggi, J.C. and Rajapaksa, R. 1987. *Daphnia* in tropical lowlands. *Memorie della Istitute Idrobiologia*, 45: 107–141.
- Gons, H.J. 1983. The carbon cycle in three Dutch lakes. In: Parma, S., van Emden, H.M. and Castelein, J. ed. *Ecology of Lakes and Small Water Bodies*. Biologische Raad Reeks. PUDOC, Wageningen (in Dutch), 85–119.
- Ivlev, V.S. 1961. *Experimental ecology of the feeding of fishes*. Yale University Press, New Haven. 302 p.
- Jaiyen, K., Sihapitukgiat, P. and Leelapatra, W. 1980. Plankton. Nam Pong Environmental Management Research Project. Working Document No. 13. Mekong Secretariat.
- Lehman, J.T. 1988. Ecological principles affecting community structure and secondary production by zooplankton in marine and freshwater environments. *Limnology and Oceanography*, 33: 931–945.
- Lemoalle, J., Adeniji, A., Compere, P. Ganf, G.G. and Talling, J.F. 1981. Phytoplankton. In: Symoens, J.J., Burgis, M.J. and Gaudet, J.J. ed. *The ecology and utilisation of African inland waters*. United Nations Environmental Program. UNEP Reports and Proceeding Series 1. Nairobi, Kenya, 37–50.
- Newrkla, P. and Duncan, A. 1984. The biology and density of *Ehirava fluviatilis* (clupeoid) in Parakrama Samudra, Sri Lanka. *Verhandlungen internationale Vereinigung fur Limnologie*, 22: 1572–1578.
- Pauly, D. and Christensen, V. 1993. Graphical representation of steady-state trophic ecosystem models. *ICLARM Conference Proceedings*, 26: 20–28.
- Pet, J.S., Gevers, G.J.M., van Densen, W.L.T. and Vijverberg, J. 1996. Management options for a more complete utilisation of the biological fish production in Sri Lankan reservoirs. *Ecology of Freshwater Fish*, 5: 1–14.
- Pethiyagoda, R. 1991. *Freshwater fish of Sri Lanka*. Wildlife Heritage Trust of Sri Lanka, 362 p.
- Piet, G.J., Vijverberg, J. and van Densen, W.L.T. 1999. Food web structure of a Sri Lankan reservoir. In: van Densen, W.L.T. and Morris, M.J. ed. *Fish and Fisheries of Lakes and Reservoirs in Southeast Asia and Africa*. Westbury Publishing, Otley, UK, 187–205.
- Reyes-Marchant, P., Jamet, J.L., Lair, N., Taleb, H. and Palomares, M.L.D. 1993. A preliminary ecosystem model for a eutrophic lake (Lake Aydat, France). *ICLARM Conference Proceedings*, 26: 95–102.
- Sarnita, A.S. 1987. Introduction and stocking of fish in lakes and reservoirs in Southeast Asian countries, with special reference to Indonesia. *FAO Fish. Rep.*, No. 371, 193–198.
- Schiemer, F. and Duncan, A. 1988. The significance of the ecosystem approach for reservoir management. In: De Silva S.S. ed. *Reservoir Fishery Management and Development in Asia*, IDRC, Ottawa, Canada, 183–194.
- Sirimongkonhaworn, R. and Fernando, C.H. 1994. Biology of *Clupeichthys aesarnensis* (Clupeidae) in Ubolratana Reservoir, Thailand, with special reference to food and feeding habits. *Internationale Revue gesellschaft fur Hydrobiologie*, 79: 95–112.
- Srisena, H.K. and De Silva, S.S. 1989. New fish resources of reservoirs in Sri Lanka II: Further studies on a fill-net fishery for minor cyprinids. *Fisheries Research*, 7: 19–28.
- Vijverberg, J., Boersma, M., van Densen, W.L.T., Hoogenboezem, W., Lammens, E.H.R.R. and Mooij, W.M. 1990. Seasonal variation in interactions between piscivorous fish, planktivorous fish and zooplankton in a shallow eutrophic lake. *Hydrobiologia*, 207: 279–286.
- Vijverberg, J., Gulati, R.D. and Mooij W.M. 1993. Food-web studies in shallow eutrophic lakes by the Netherlands Institute of Ecology. Main results, knowledge gaps and new perspectives. *Netherlands Journal of Aquatic Ecology*, 27: 35–49.
- Westlake, D.F. 1980. Primary production. In: Le Cren, E.D. and Low-McConnel, R.H. ed. *The Functioning of Freshwater Ecosystems*, IBP 22. Cambridge University Press, Cambridge, UK, 141–246.
- Winberg, G.G. and collaborators, 1971. *Symbols, Units and Conversion Factors in Studies of Freshwater Productivity*. IBP Central Office London, 23 p.

Chenderoh Reservoir, Malaysia: Fish Community and Artisanal Fishery of a Small Mesotrophic Tropical Reservoir

Kong Kah-Wai and Ahyaudin B. Ali*

Abstract

A study on the fish community and the status of the fishery of Chenderoh Reservoir was carried out using experimental fishing and creel survey. A total of 27 fish species from 8 families was noted during the study. Experimental fishing with gill nets indicated the domination of small-sized and non-economic species such as *Cyclocheilichthys apogon*, *Osteochilus hasselti*, *Chela anomalura*, and *Barbodes schwanenfeldii*. Although valuable species such as *Puntioplites bulu*, *Thynnichthys thynnoides*, *Chitala lopis*, *Oxyeleotris marmoratus*, and *Mystus nemurus* are present, their catches are not commercially significant. The estimated production was 6.67 kg/ha/year with an annual landing of 13.74 tonnes. The drop in the yield could be due to both the decline in fish stock or to reduced fishing effort.

CHENDEROH RESERVOIR, located on the Perak River, Peninsular Malaysia (5°01' 40°56' N and 100°55' 101°00' E), is the oldest reservoir in Malaysia, being commissioned for hydroelectric generation in 1930 (Dahlen 1993). Three newer reservoirs, namely the Kenering (1984), Bersia (1993) and Temenggor (1974), are located upstream, thus modifying the flow and water level regime of the Chenderoh Reservoir (Dahlen 1993). The morphometric and limnological characteristics of the mesotrophic 67-year-old reservoir have been described in detail by Ali (1996). Fish communities in the reservoir are subjected to varying degrees of environmental manipulation and degradation, such as water level management and fluctuation, riparian land development and home-steading (Ali 1995, 1996). Thus, a change in fish species composition has occurred following the conversion from a lotic to a lentic ecosystem, water level regulation and anthropogenic effects due to development pressure along the reservoir shoreline (Yap 1992a; Ali 1996).

Following impoundment, the artisanal fishery that once thrived in the original lotic ecosystem evolved to adapt to the newly created reservoir fishery. In

Malaysia, this type of artisanal fishery that also involves variations of aquaculture, such as floating cage culture and littoral corral culture, is very important to the economy and well-being of the local communities (Yap 1992a; Costa-Pierce 1992; Ali and Lee 1996). Therefore, management for sustainable exploitation is very important (Khoo et al. 1987; Yap 1988).

Studies by Ali and Lee (1995) showed that in the Chenderoh Reservoir artisanal fishery is important to the local population in providing both protein and supplementary income. The fishery is multi-species and multi-gear in nature with the dominant gear being multi-filament gill nets with stretched-mesh of 5.7, 10.2 and 11.4 cm (Ali and Lee 1995). At the time of that study, there was no official fishery regulation, and community-based management of the fishery was practised by the local people themselves (Ali and Lee 1995; Ali 1996). Subsequently, inland fishery rules and regulations enacted by the Perak State Government in the late 1980s and was implemented State wide in order to protect the fishery (Zakariah and Ali 1996).

The objective of the study was to characterise the present status of the Chenderoh Reservoir fishery. The reservoir has been and is being studied extensively as part of the monitoring program on the development and fate of artisanal inland tropical

*School of Biological Sciences, Universiti Sains Malaysia, 11800 Minden, Penang, Malaysia

fisheries (Lee and Ali 1989; Ali and Lee 1995; Ali 1996; Ali and Kadir 1996; Zakariah and Ali 1996). Therefore, this study compares the current status of Chenderoh Reservoir fishery to previous studies within the context of conservation and management of small-scale, multi-gear and multi-species artisanal fisheries.

Materials and Methods

The equatorial location of Chenderoh Reservoir precludes the occurrence of distinct temperature, photo-period or rainfall cycles, thus allowing for fish to spawn all year round (Hails and Abdullah 1982). Since seasonality is absent and to reduce costs, sampling was carried out from July 1994 to January 1995. Two sampling sites located about 2 km on the opposite sides of the Perak River were selected (Figure 1). These sites are the main fishing grounds for the local population. Each site is essentially an embayment and has riparian homestead and thus received varying amount of anthropogenic effluents (Ali 1996). Part of Site B (i.e. B2) was studied intensively about five years before with respect to its artisanal fishery (Ali and Lee 1995).

During the study, the sampling techniques used followed closely the practice of the local fishers and were also used in previous studies (Ali and Lee 1995). Experimental fishing was conducted using panels of gill nets 208 m long and 3 to 5 m deep and a stretch-mesh of 2.5, 5.1, 7.6, and 10.2 cm respectively. The nets were fished (soak time) day and night at a ratio of 12:12. Nets were set at 1800 h and checked the next day at 0600 h for the night catch with a second check conducted subsequently on the next 1800 h and noted as the day catch. Fishing interval and gear used is the same to that of the local fishery and thus each day or night catch is considered as a unit of fishing effort and the CPUE is expressed as kg/fisher/day. All fish caught were separated based on mesh sizes, and weighed (g), and measured (standard and total length in cm), respectively. For each species caught, five specimen were

preserved in 10% formalin to be further identified in the laboratory using standard taxonomic keys available (Inger and Chin, 1962; Mohsin and Ambak 1992; Ng et al. 1992). Creel surveys and Rapid Rural Appraisal (Khon Kaen University 1987) were conducted at the two main fish landing sites, i.e. Tebok Kelantan and Cangkat Duku Village (Figure 1). Species caught and biomass landed were recorded. The number of active fishers and middlemen involved in the fishery was noted.

Fish community analysis involved the use of Shannon-Wiener Diversity (Poole 1974), evenness (Poole 1975) and dominant indices (Zar 1984). Non-parametric statistics of Mann-Whitney U-test and Wilcoxon test were used to compare between samples because of their independence of normal distribution (Zar 1984) and small sample sizes obtained (Fowler and Cohen 1990). Water quality parameters of pH and temperature (Orion Research SA250), conductivity (Hanna 18333), dissolved oxygen (YSI 58), and Secchi Disk visibility were measured before 1200 h during sampling and means of three readings were obtained.

Results

Generally, there were no differences in water quality parameters between the two sites (Table 1). Mean surface temperature at Site A and B were 27.4 ± 0.4 and $28.1 \pm 0.6^\circ\text{C}$, respectively. The mean pH and dissolved oxygen were 6.44 ± 0.19 and 6.66 ± 0.58 , and 5.01 ± 0.50 and 5.05 ± 0.69 mg/L for sites A and B, respectively. The conductivity for the two sites were 38.15 ± 10.53 and 40.00 ± 10.00 uS/cm whereas the Secchi Disk visibility readings were within the mesotrophic range of 0.8 ± 0.4 and 1.1 ± 0.2 m, respectively.

Forty two species from 13 families were observed (Table 2) in contrast to 63 species observed seven years earlier (Lee 1989; Ali 1996). Only 27 species from 8 families, however, were caught in experimental fishing. A total of 18 species were sampled in site A in contrast to site B which yielded 21 species

Table 1. Water quality parameters at the two study sites of Chenderoh Reservoir, Perak, Malaysia.

Sites	Temperature (°C)	pH	Conductivity (uS/cm)	D.O. (mg/L)	Secchi Disk (m)
A	± 0.4 (26.8 – 27.9)	± 0.19 (6.81 – 6.14)	± 10.53 (24.20 – 54.70)	± 0.50 (3.91 – 6.72)	± 0.4 (0.6 – 1.7)
B	± 0.6 (27.2 – 29.4)	± 0.58 (5.98 – 6.85)	± 10.00 (27.00 – 66.20)	± 0.69 (3.91 – 6.20)	± 0.2 (0.6 – 1.7)

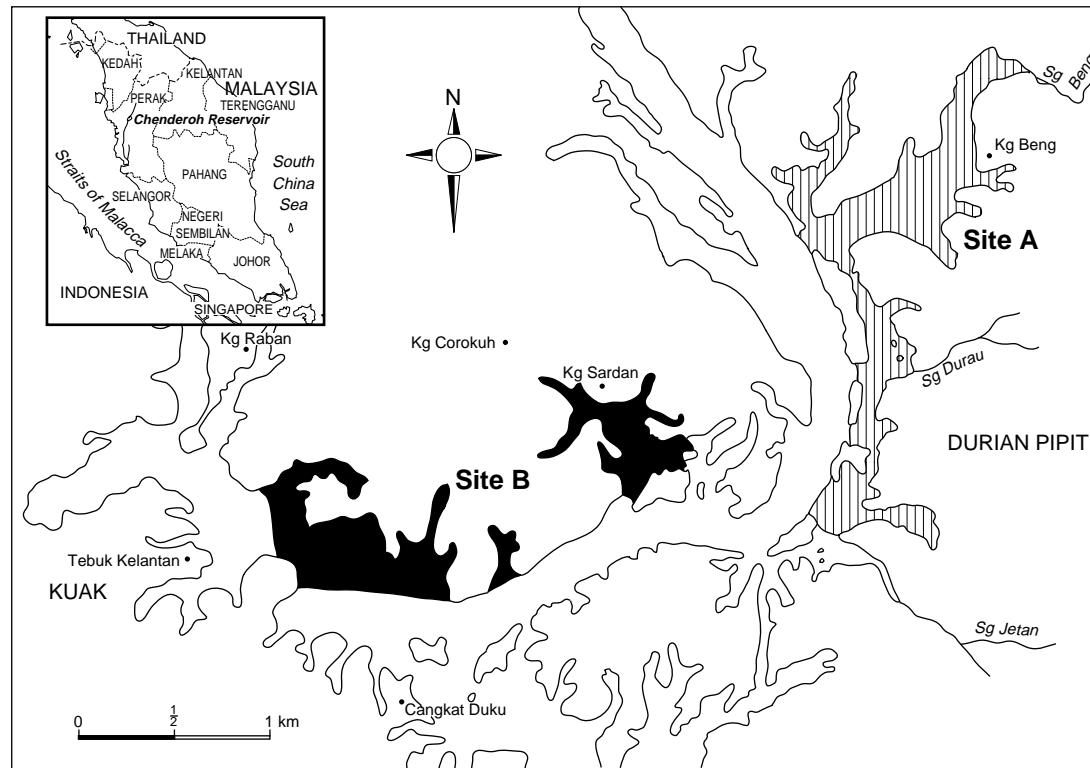

Figure 1. Map of Chenderoh Reservoir showing location of the study sites.

and the family Cyprinidae (50%) has the most number of species (Figure 2). The Shannon-Wiener diversity index showed very little difference between the two sampling sites. The diversity index for site A was 3.3192 whereas for site B it was 3.2057. The evenness indices for the two sites were also fairly close, with site A having an index of 0.7960 and site B 0.7289.

Table 2. List of species observed in the Chenderoh Reservoir during the study.

Species	Present
Cyprinidae	
<i>Oxygaster anomalura</i> (<i>Chela anomalura</i>)	+
<i>Cyclocheilichthys apogon</i>	+
<i>Cyclocheilichthys heteronema</i>	+
<i>Cyclocheilichthys</i> spp.	+
<i>Hampala macrolepidota</i>	+
<i>Labiobarbus lineatus</i>	+
<i>Osteochilus hasselti</i>	+
<i>Osteochilus melanopleurus</i>	+
<i>Osteochilus vittatus</i>	+
<i>Puntioplites bulu</i>	+
<i>Puntius daruphani</i>	+
<i>Barbodes gonionotus</i>	+
<i>Barbodes schwanenfeldii</i>	+
<i>Rasbora cf sumatrana</i>	+
<i>Thynnichthys thynnoides</i>	+
<i>Aristichthys nobilis</i>	+
<i>Ctenopharyngodon idellus</i>	+
<i>Hypophthalmichthys molitrix</i>	+
<i>Labiobarbus sumatrana</i>	+
<i>Leptobarbus hoeveni</i>	+
<i>Puntius partipentazona</i>	+
Belontiidae	
<i>Betta pugnax</i>	+
<i>Trichogaster pectoralis</i>	+
<i>Osphronemus goramy</i>	+
Helostomidae	
<i>Helostoma temminckii</i>	+
Mastacembelidae	
<i>Mastacembelus armatus</i>	+
Pristolepidae	
<i>Pristolepis fasciatus</i>	+
Pangasiidae	
<i>Pangasius micronemus</i>	+
<i>Pangasius sutchi</i>	+
Tetraodontidae	
<i>Tetraodon leiuurus</i>	+

'r' species (Ali 1996) such as *Barbodes schwanenfeldii* (24%), *Cyclocheilichthys apogon* (22%), *Osteochilus hasselti* (14%), and *Rasbora sumatrana* (12%) were the most common. In the 5.1 and 7.6 cm mesh, however, the commercially important 'K' species of *Puntioplites bulu* and *Thynnichthys thynnoides* were dominant (Figure 3). The species *P. bulu* remained dominant in the largest mesh net (10.2 cm) followed by other 'K' species of *Osphronemus goramy* and *Osteochilus melanopleurus*. In terms of catch per set, 69% of the fish caught could be considered as 'mixed fish' which are small in size with little commercial value and consisting of species such as *Barbodes schwanenfeldii*, *Osteochilus hasselti*, *Chela anomalura*, *Cyclocheilichthys apogon*, *Pristolepis fasciatus* and *Labiobarbus* sp. (Figure 4). The length frequency histograms for six most numerous species are shown in Figure 5. Although presently there are no changes in length structures of non-commercial species of *Cyclocheilichthys apogon*, *Rasbora sumatrana*, and *Oxygaster (Chela) anomalura*, when compared to previous studies of Ali and Lee (1995), there is a reduction in size of the commercially important *Puntius bulu*.

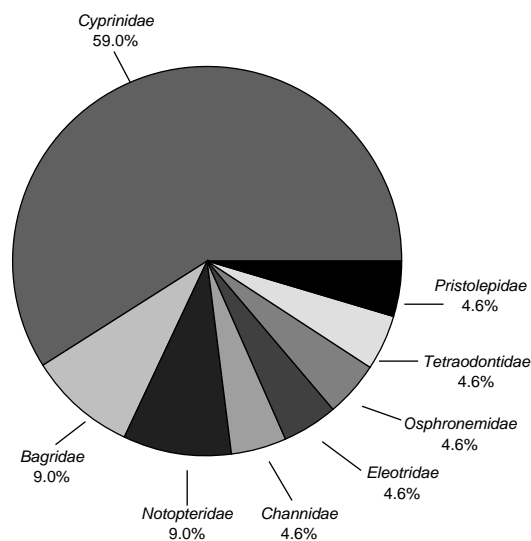

Figure 2. The percentage composition of the major fish families caught.

A total of 1247 individual fish with a biomass of 55.5 kg was caught with gill nets during experimental fishing (Figure 3). Eighty percent of those caught were sampled with the 2.5 cm mesh nets and

The number of full time fishers has declined to 15 from the high of 60 in early 1980s (Ajan 1983) and 30 in mid-2980s (Ali and Lee 1995). Results of the RRA indicated that most remaining fishers are in their late forties and fifties. The major portion of the

Table 3. Number and percentages (in parentheses)¹ of fish caught and percentages of empty catches during experimental fishing with different mesh-size gill nets at Chenderoh Reservoir, Malaysia.

	2.5 cm mesh	5.2 cm mesh	7.6 cm mesh	10.2 cm mesh	Total fish caught
Mixed catch	802 (81/93)	55 (29/ 6)	5 (13/ 1)	0 (0/ 0)	862 (100)
Commercial catch	194 (19/50)	135 (71/35)	34 (87/ 9)	22 (100/ 6)	385 (100)
Total fish caught	996 (80)	190 (15)	39 (3)	22 (2)	1247
Empty catch	(11)	(16)	(30)	(43)	

¹ (column %/row %)

Table 4. Number and percentages (in parentheses)¹ of different species of fish caught during experimental fishing with different mesh-size gill nets at Chenderoh Reservoir, Malaysia.

Species	2.5 cm mesh	5.1 cm mesh	7.6 cm mesh	10.2 cm mesh	Total fish caught
<i>Barbodes gonionotus</i>	–	–	–	1 (5/100)	1
<i>Barbodes schwanenfeldii</i>	236 (24/93)	17 (9/7)	1 (3/t)	–	254
<i>Channa micropeltis</i>	4 (t/100)	–	–	–	4
<i>Chela anomalura</i>	113 (11/100)	–	–	–	113
<i>Chitala lopis</i>	–	–	–	2 (9/100)	2
<i>Cyclocheilichthys apogon</i>	216 (2/100)	–	–	–	216
<i>Cyclocheilichthys heteronema</i>	44 (4/100)	–	–	–	44
<i>Hampala macrolepidota</i>	20 (2/71)	7 (4/25)	1 (3/4)	–	28
<i>Labiobarbus lineatus</i>	27 (3/77)	7 (4/20)	1 (3/3)	–	35
<i>Mystus negriceps</i>	18 (2/100)	–	–	–	18
<i>Mystus nemurus</i>	1 (t/50)	–	–	1 (5/50)	2
<i>Notopterus notopterus</i>	–	2 (1/100)	–	–	2
<i>Oshphronemus goramy</i>	2 (t/40)	–	–	3 (14/60)	5
<i>Osteochilus hasseltii</i>	139 (14/83)	27(14/16)	1 (3/t)	–	167
<i>Osteochilus melanopleurus</i>	–	1 (t/11)	2 (5/22)	6 (27/67)	9
<i>Osteochilus vittatus</i>	6 t/100)	–	–	–	6
<i>Oxyeleotris marmoratus</i>	7 (t/54)	6 (3/46)	–	–	13
<i>Pristolepis fasciatus</i>	4 (t/50)	2 (1/25)	2 (5/25)	–	8
<i>Puntiplites bulu</i>	36 (4/23)	87 (46/57)	22 (56/14)	9 (41/6)	154
<i>Rasbora sumatrana</i>	121 (12/100)	–	–	–	121
<i>Tetraodon leiurus</i>	1 (t/100)	–	–	–	1
<i>Thynnichthys thynnoides</i>	1 (t/2)	34 (18/77)	9 (23/21)	–	44
Total	996	190	39	22	1247

¹ (column %/row %)

t – < 1%

Table 5. Comparison in yearly production and catch per ha between the present studies and previous studies on Chenderoh Reservoir, Malaysia.

Studies	No. of active fishers	Yearly production (tonnes/yr)	Catch per ha (kg/ha/yr)
1983 (Ajan 1983)	60	166.62	66.60
1989 (Ali and Lee 1995)	30	25.71	10.28
1995 (This study)	15	13.85	6.76

commercial landings consisted of mixed fish (33.4%) (Figure 6). Among the commercial species the highest catch was for *P. bulu* (14.1%), *Mystus* sp. (10.0%), *T. Thynnoides* (8.8%) and the snakeheads (5.7%). The average daily CPUE of both commercial and experimental catches is strongly related (Figure 7). The values for both catches range between 1.2 to 3.6 and 1.7 to 2.9, respectively; however, both these values are lower but more stable than the highly fluctuating values obtained in 1988/1989 studies (Ali and Lee 1995).

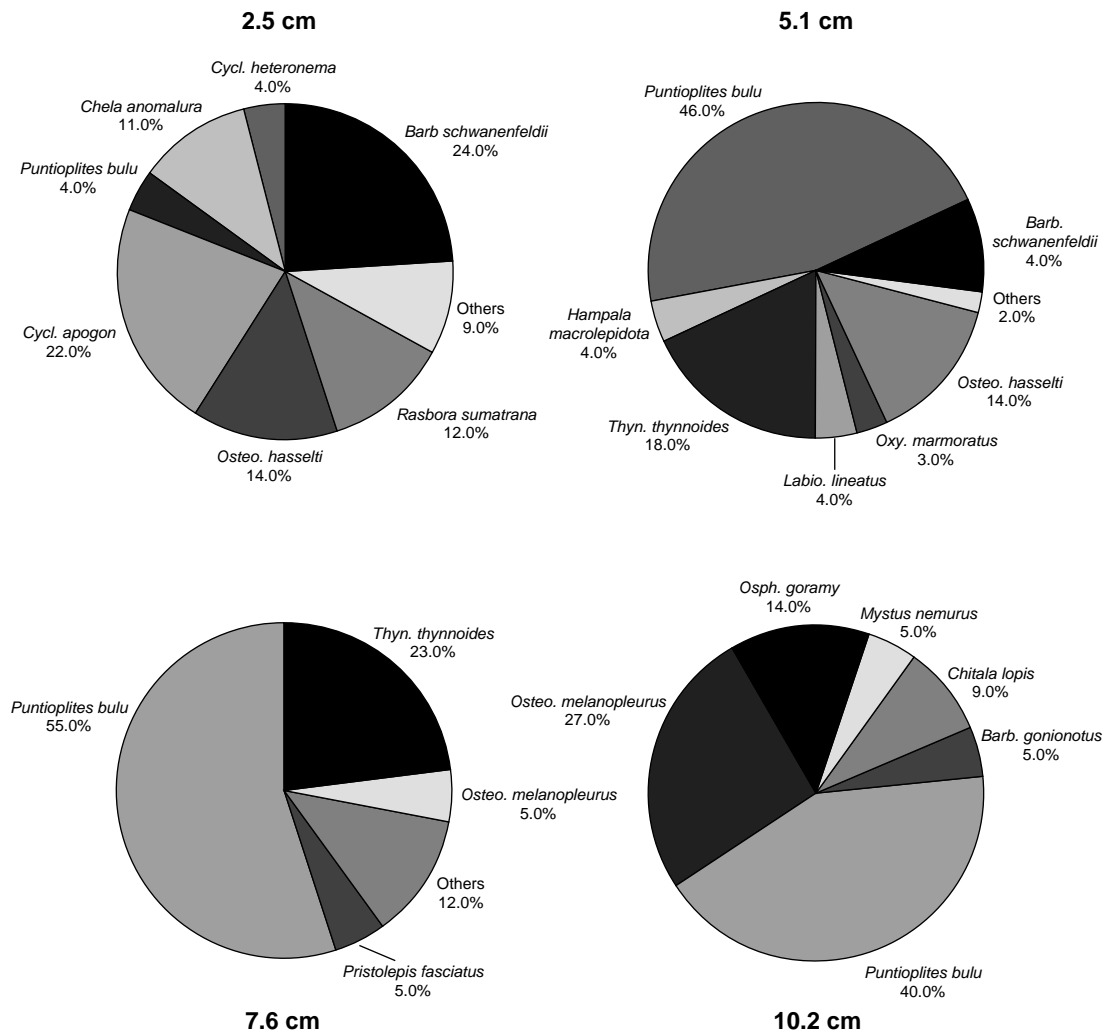

Figure 3. The percentage composition of abundance of different fish species caught in gill nets of different mesh sizes during experimental fishing.

Discussion

Although Chenderoh Reservoir can still be classified as early mesotrophic, there exist a clear trend towards the reservoir becoming eutrophic due to increasing human settlement especially around the embayment areas (Ali 1996). Larger reservoirs such as the Kenyir tend to be oligotrophic (Secchi Disk, 2.55 to 5.35 cm) with low productivity (Yusoff et al. 1995). Because of shallowness, there was less temperature variation in Chenderoh as compared to Kenyir which ranged from 20.8 to 32.0°C (Yusoff et

al. 1995). Chenderoh Reservoir also has narrower pH values and higher D.O. concentrations when compared to Kenyir which exhibited a range of values between 5.96 to 7.90 mg/L and 0.00 to 8.75 mg/L, respectively (Yusoff et al. 1995). The permanent temperature stratification which created an anoxic bottom layer associated with larger and deeper tropical reservoirs such the Temenggor (Zakaria-Ismail and Sabariah 1995) and Kenyir (Yusoff et al. 1995) does not occur at Chenderoh Reservoir due to its shallowness and short retention time (Ali 1996).

Figure 4. Percentage of abundance of different fish species caught by experimental fishing and the composition of mixed and commercially valuable catches obtained.

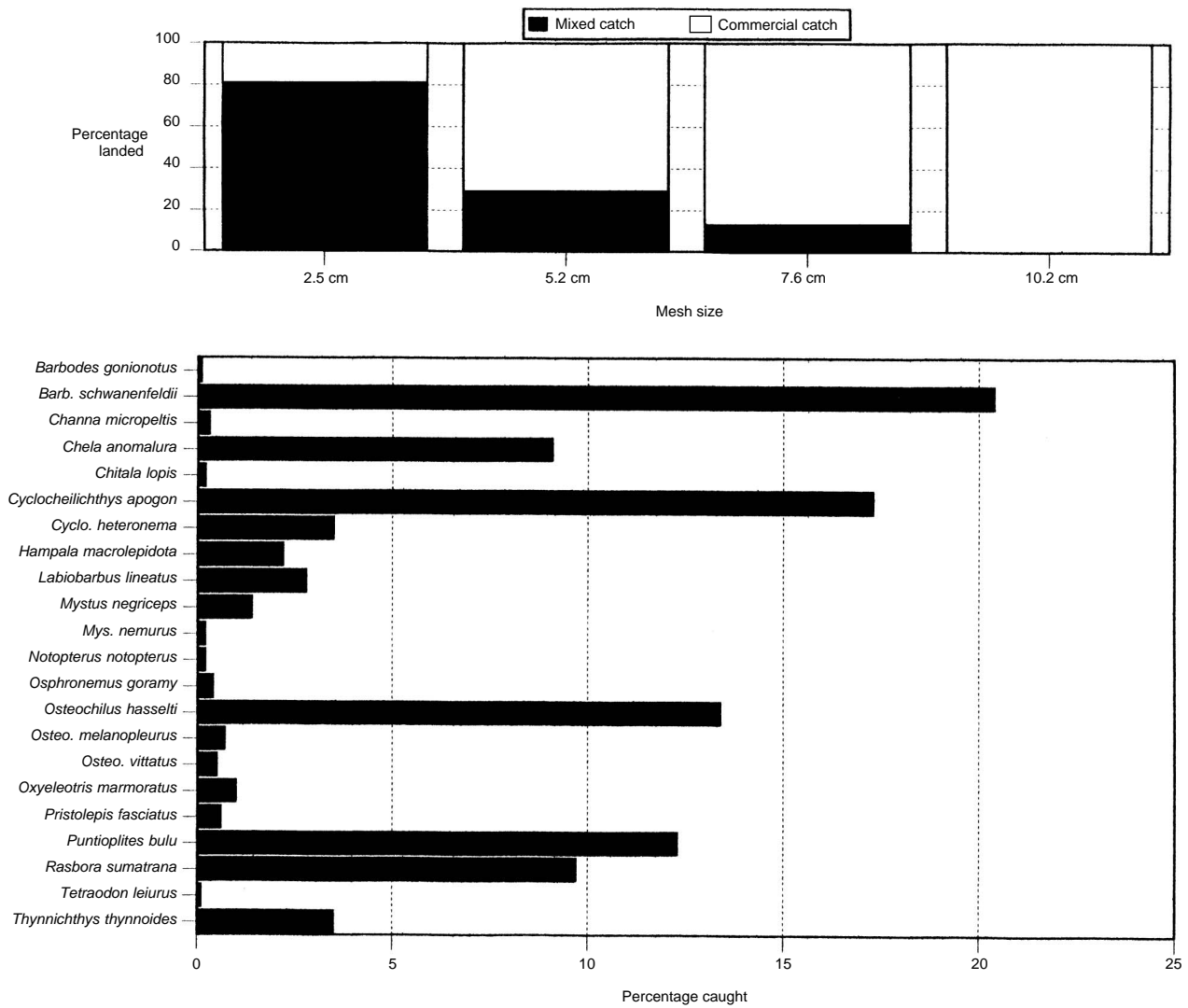
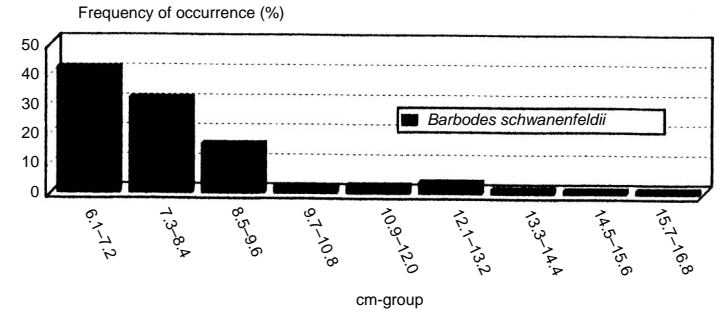
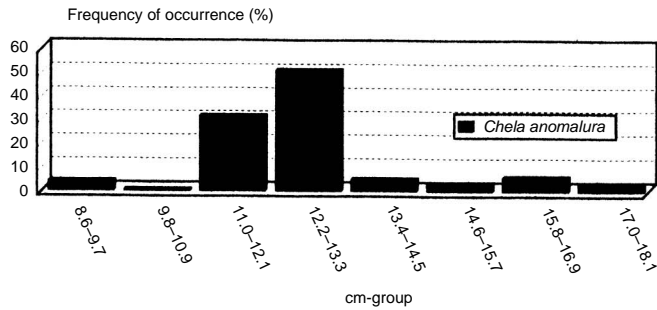
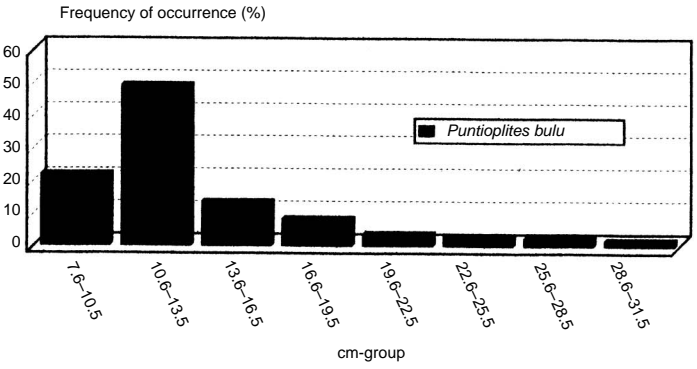
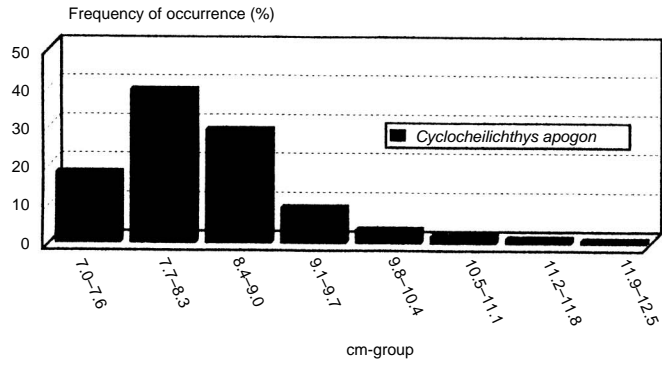
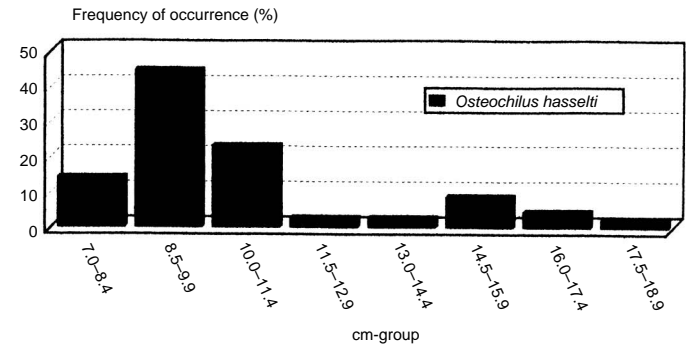
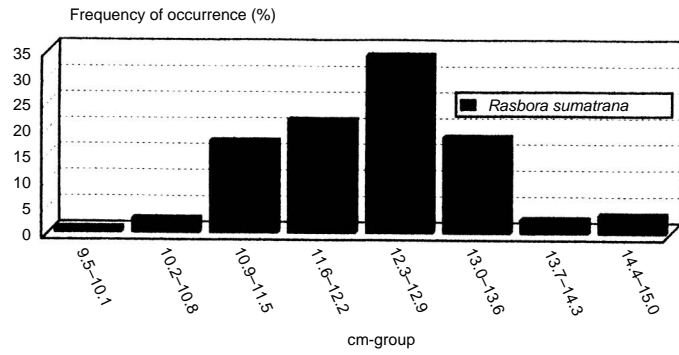

Figure 5. Length-frequency histogram of selected fish species obtained by experimental fishing.



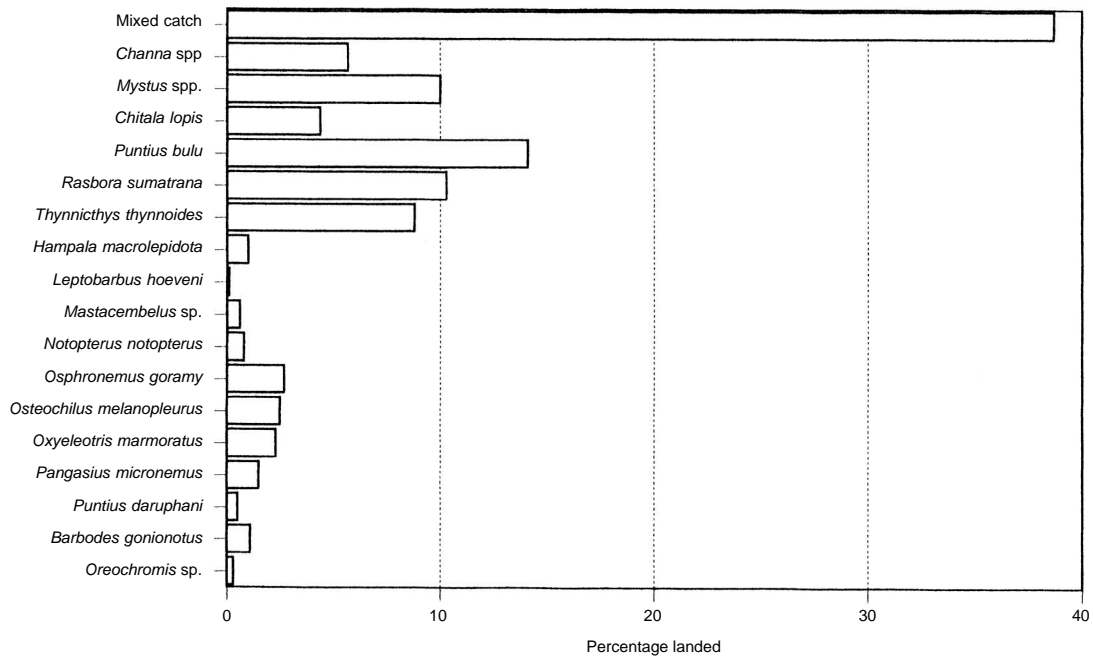

Figure 6. Percentage composition of biomass of different fish species landed by fishers during the study.

On the other hand, the highly irregular shoreline with numerous embayments tend to trap nutrients such as orthophosphate (0.02 to 0.775 mg/L) and nitrate (0.944 to 3.982 mg/L), resulting in fairly high total chlorophyll concentrations (1.7 to 154.03 µg/L) (Ali 1996).

The species diversity for Chenderoh Reservoir, as is indicated by the Shanon-Wiener index, is almost the same as that of the Tasik Merah Reservoir (3.32/3.21 vs 3.12) (Yap 1982). However, when compared to previous studies, the declining trend in species diversity in Chenderoh Reservoir was noted. A total of 63 species was observed in 1988/1989 studies (Lee 1989) as compared to only 42 species presently. Overfishing and anthropogenically related environmental perturbations most probably account for the decline (Ali 1996; Zakariah and Ali 1996).

In previous studies, Ali and Lee (1995) found that the mainstream section of the reservoir is the most productive with respect to fish catch. Subsequently, this and other studies (Ali 1996) showed that embayments have become more productive due to shallowness and a more extensive littoral zone, slow flowing water and higher cultural eutrophication by the surrounding human settlements. In fact, almost 70 to 80% of the embayments in the reservoir are affected by human-related activities such as homesteading,

rubber plantations and fruit orchards. Ground verification of the 1981 map (Director of Mapping Malaysia 1981) has indicated changes to the margin and littoral zone of the reservoir due to shoreline sedimentation and growth of littoral aquatic macrophytes such as *Hydrilla verticillata*, *Ceratophyllum demersum*, *Nymphae* sp., *Phragmites australis* and *Pandanus* sp.

The dominance of cyprinids in tropical reservoirs has been observed in Sri Lankan reservoirs, where the family formed over 50% of the species presence (Amarasinghe 1992). Elsewhere in Malaysia, the same observation was also made in Subang (42%), Bukit Merah (29%) (Yap 1992a), Temenggor (57%) (Zakaria-Ismail and Lim 1995), and Kenyir Reservoir (57%) (Yusoff et al. 1995). As noted by Ali (1996), most of these cyprinids were primarily 'r' strategists consisting of *Barbodes schwanenfeldii*, *Cyclocheilichthys apogon*, *Osteochilus hasselti*, *Rasbora sumatrana* and *Oxygaster (Chela) anomalura* (Table 2). These species were caught essentially in the embayments with *O. anomalura* and *R. sumatrana* being more commonly found feeding on the surface of the littoral zone of the reservoir. Yap (1992a) and Zakariah and Ali (1996) noted that these river cyprinids have been able to adapt from

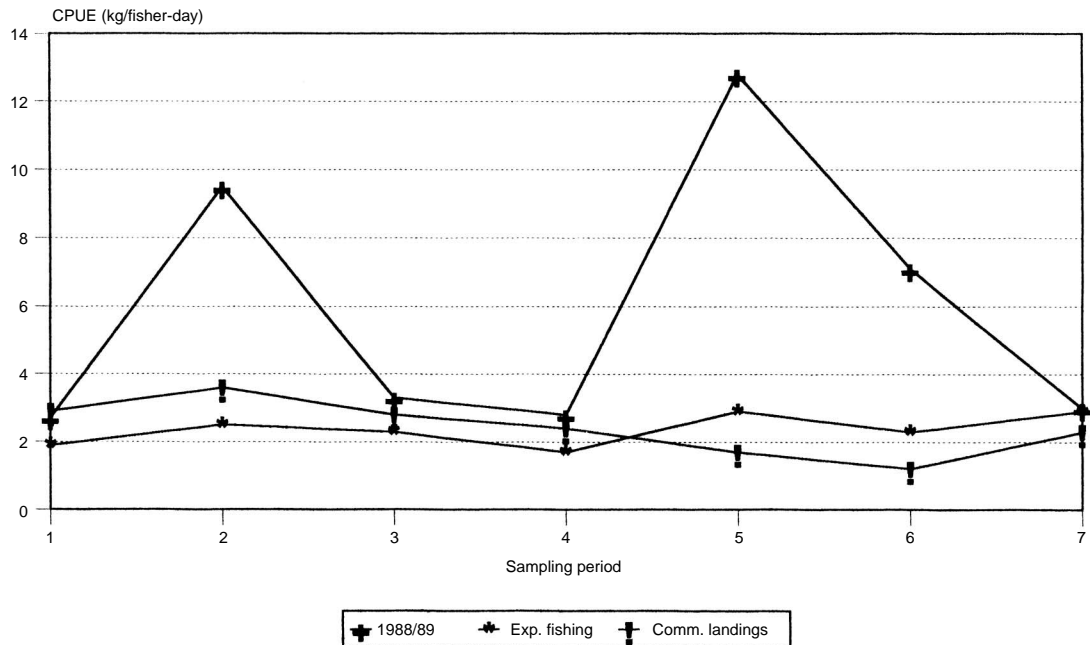

Figure 7. Comparison of catch-per-unit of effort (CPUE) between experimental fishing and commercial landings of the present study with the 1988/1989 study. (modified from Ali and Lee 1996).

the original palustrine condition of the riverine ecosystem to the lacustrine ecosystem.

In comparing the species list to previous studies, we noted the rarity of *Barbodes gonionotus* and *Oreochromis* sp. both in our samplings and in the fishery. These two species have been stocked and restocked at various times reaching up to 14 to 27% of the total hatchery production by the Fishery Department into various rivers and reservoirs including Chenderoh Reservoir (Yap 1992a; 1992b). The species are also being cultured in floating cages and littoral corrals of the reservoir, but the low number of the species in the catch probably reflects the inability of these two species to adapt to the reservoir.

In the Kenyir Reservoir, Yusoff et al. (1995) found that *Barbodes schwanenfeldii* (biomass 24.3 to 54.1%) and the predator *Hampala macrolepidota* (biomass 15.2 to 42.6%) were the most dominant species in their experimental gill nets. The most striking observation in the fish population of the Chenderoh Reservoir is the lack of dominant predatory species such as *Channa* spp., *Hampala macrolepidota* and *Chitala lopis*. The predator-prey relationship for the reservoir is only 2.7 as compared

to the value of 32.2 for Kenyir Reservoir (Yusoff et al. 1995). This poor representation of predatory species probably accounts for the dominant of several 'r' prey species in the population (Figure 3).

With the reduction in landings especially for *T. thynnoides* (8.8% of total commercial landings as compared to 19.4% in 1988/1989 (Ali and Lee 1995), other previously unimportant species of *Osteochilus hasselti* and *Barbodes schwanenfeldii* began to be caught and utilised by the local fishers especially as 'pekasam' or fermented fish which fetches good market values and thus their length structure began to decline to between 7 to 10 and 8 to 9 cm as compared to 5 to 25 and 5 to 15 cm, respectively in the mid-1980s (Ali and Lee 1995).

Unlike in the mid-1980s, the current landing reduction could not be attributed to poor catch but probably to lower fishing effort rather than low productivity. The yearly production and catch per ha for 1983, 1989 and the current studies are 166.62, 25.71 and 13.85 t/year, and 66.60, 10.28 and 6.76 kg/ha/year, respectively (Ajan 1983; Ali and Lee 1995). Studies on reservoir fisheries in Malaysia indicated that shallow reservoirs tend to be more productive

than the larger deeper reservoirs. Subang Reservoir and Bukit Merah Reservoir produced 90 and 37 kg of fish/ha/year (Yap and Furtado 1983; Yap 1983) whereas in the larger and deeper Kenyir Reservoir estimates ranged from 2.0 to 20.0 kg/ha (DoF, 1994; Yusoff et al. 1995). Thus, Chenderoh Reservoir, being shallower like the Subang and Bukit Merah Reservoir, has the potential to produce at least 60 kg/ha of fish if properly managed.

The state of Perak where Chenderoh Reservoir is located is one of the few states in Peninsula Malaysia which has enacted Inland Fishery Regulations controlling the types of gears to be used in the fishery (Ismail 1992). The enactment has controlled the use of destructive fishing techniques such as poisoning, electro-fishing and small mesh gill nets. With the reduction in fishing effort and proper management strategies, we expect the reservoir to recover its fish production. Considering the appropriate limnological and morphometric conditions of the reservoir (Ali 1996), we feel that the reservoir could be made as productive as in the early 1980s. Increased fish production has been obtained through introductions and restockings in other Asian reservoirs (Amarasinghe 1992; Hardjamulia and Wardoyo 1992; Pawaputanon 1992). In fact, inland fisheries of Sri Lanka only developed as recently as 1952 with the successful introduction of *O. mossambicus* (Amarasinghe 1992). However, the caveat to any exotic species introduction is the negative impacts it would have on environment and native fish species and whether the species is acceptable to the local populace (Ali 1998). Other factors negatively affecting reservoir fisheries should also be tackled in order to improve fish production. These factors, such as increased fishing pressure, open access and unregulated fisheries, and biologically incompatible reservoir water level management, are commonly associated with reservoir fisheries in the Indo-Pacific region (Petr 1995). Others such as sustainable riparian land use, protection of riversbanks and littoral zones, and management of watershed area are also important in conserving the biodiversity and production of the fishery.

Acknowledgments

This study was funded by the Malaysian Government R&D-IRPA grant. We thank Md. Yaakob Md. Yusof, Abdullah Nayan, Meor Ahmad Fauzi and Wan Abdul Aziz for their help during the study. We also thank Tok Lang and her family and the kind people of Chenderoh Reservoir for their help and hospitality.

References

- Ajan, J.K. 1983. Assessment of Tasik Chenderoh fishery based on gill-net. B.Sc. Honors Dissertation, Universiti Sains Malaysia, Penang, Malaysia, 69 p.
- Ali, A.B. 1998. Impact of fish introduction on indigenous fish populations and fisheries in Malaysia. In: Cowx, I.G. ed. Stocking and Introduction of Fish. Fishing News Book, UK, 274–286.
- Ali, A.B. 1996. Chenderoh Reservoir, Malaysia: The conservation and wise use of fish biodiversity in a small flow-through tropical reservoir. *Lakes and Reservoirs: Research and Management*, 2, 17–30.
- Ali, A.B. and Kadir, B-K. A. 1996. The reproductive biology of the cyprinid, *Thynnichthys thynnoides* (Bleeker) in the Chenderoh Reservoir – a small tropical reservoir in Malaysia. *Hydrobiologia*, 318: 139–151.
- Ali, A.B. and Lee, K.Y. 1995. Chenderoh Reservoir, Malaysia: a characterisation of a small-scale, multi-gear and multi-species artisanal fishery in the tropics. *Fishery Research*, 23: 267–281.
- Amarasinghe, U.S. 1992. Recent trends in the inland fishery of Sri Lanka. In: Baluyut, E.A. ed. Indo-Pacific Fishery Commission, FAO Fishery Report No. 458 Supplement, FIRI/R458, Rome, 84–105.
- Costa-Pierce, B.A. 1992. Multiple regression analysis of plankton and water-quality relationships as affected by sewage inputs and cage aquaculture in a eutrophic, tropical reservoir. In: De Silva, S.S. ed. Reservoir Fishery in Asia. International Development Research Center (IDRC), Canada, 38–48.
- Dahlen, B.F. 1993. Hydropower in Malaysia. Tenaga Nasional Berhad (TNB), Malaysia, 184 p.
- Department of Fishery (DoF) 1994. Notes on Tasik Kenyir, State Department of Fishery, Kuala Terengganu, Terengganu, Malaysia, 24 p.
- Fowler, J. and Cohen, L. 1990. Practical statistics for field biology. Open University Press, UK, 227 p.
- Hails, A.J. and Abdullah, Z. 1982. Reproductive biology of the tropical fish *Trichogaster pectoralis* (Regan). *Journal of Fish Biology*, 21: 157–170.
- Hardjamulia, A. and Wardoyo, S.E. 1992. The role of tilapia in capture and culture-based fisheries in Indonesia. In: Baluyut, E.A. ed. Indo-Pacific Fishery Commission, FAO Fishery Report No. 458 Supplement, FIRI/R458, Rome, 162–174.
- Inger, R.F. and Chin, P.K. 1962. The freshwater fishes of North Borneo, Fieldiana: Zoology, 45: Chicago, 268p.
- Ismail, A.K. 1992. Utilisation of freshwater fishes for aquaculture, recreational and capture fishery in Malaysia. In: Proceedings of a Workshop on Conservation and Management of Freshwater Fish and Their Habitat in Peninsula Malaysia. The Institute of Advance Studies, University of Malaya, Asian Wetland Bureau Collaborative Program, Kuala Lumpur, Malaysia, 7–15.
- Khon Kaen University 1987. Proceedings of the 1985 International Conference on Rapid Rural Appraisal, Khon Kaen, Thailand: Rural Systems Research and Farming System Research Project, 357 p.
- Khoo, K.H., Leong, T.S., Soon, F.L., Tan, E.S.P. and Wong, S.Y. 1987. Riverine fisheries in Malaysia. *Arch. Hydrobiol. Beiheningen*, 28: 261–268.

- Lee, K.Y. 1989. A preliminary study on fish population of Chenderoh Reservoir, Perak. B.Sc Honors Dissertation, Universiti Sains Malaysia, Penang, Malaysia, 109 p.
- Lee, K.Y. and Ali, A.B. 1989. The status of reservoir fishery in Tasik Chenderoh, Perak: A case study. Proceedings of the 12th Annual Seminar of Malaysian Society of Marine Sciences, 12: 231–239.
- Mohsin, A.K.M. and Ambak, M.A. 1992. Freshwater fishes of Peninsula Malaysia. Dewan Bahasa and Pustaka (DBP), Kuala Lumpur, Malaysia, 284 p.
- Ng., P.K.L., Tay, J.B., Lim, K.K.P. and Yand, C.M. 1992. The conservation of fish and other aquatic fauna of the North Selangor peat swamp forest and adjacent areas. Asian Wetland Bureau (AWB), Institute of Advance Studies, University of Malaya, Kuala Lumpur, 90 p.
- Pawaputanon, O. 1992. Inland capture fishery in Thailand. In: Baluyut, E.A. ed. Indo-Pacific Fishery Commission, FAO Fishery Report No. 458 Supplement, FIRI/R458, Rome, 106–111.
- Petr, T. 1995. The present status of and constraints to inland fishery development in Southeast Asia. In: Petr, T. and Morris, M. ed. Indo-Pacific Fishery Commission, FAO Report No. 512 Supplement, FIRI/R512 Suppl., Rome, 5–29.
- Poole, R.W. 1974. An Introduction to Quantitative Ecology. McGraw-Hill Book Co., NY, 350 p.
- Poule, E.C. 1975. Ecological Diversity. Wiley Interscience Publ., London, 380 p.
- Yap, S.Y. 1982. Fish resources of Bukit Merah Reservoir. Ph.D. Thesis, University Malaya, Kuala Lumpur, Malaysia, 400 p.
- Yap, S.Y. 1988. Water quality criteria for the protection of aquatic life and its uses in tropical Asian reservoirs. In: De Silva, S.S. ed. Reservoir Fishery Management and Development in Asia. Proceedings of a Workshop held in Kathmandu, Nepal, 23–28 November, 1987, 74–86.
- Yap, S.W. 1983. A holistic and ecosystemic approach to multi-species reservoir fisheries in tropical Asia. International Center for Living Aquatic Resources Management (ICLARM) Newsletter 6, 10–11.
- Yap, S.W. 1992a. Inland capture fishery in Malaysia. In: Baluyut, E.A. ed. Indo-Pacific Fishery Commission, FAO Fishery Report No. 458 Supplement, FIRI/R458, Rome, 25–46.
- Yap, S.W. 1992b. The present status and expansion potential of tilapia capture and culture-based fisheries in Malaysia. In: Baluyut, E.A. ed. Indo-Pacific Fishery Commission, FAO Fishery Report No. 458 Supplement, FIRI/R458, Rome, 175–191.
- Yap, S.W. and Furtado J.I. 1983. The fishery potential of Subang Reservoir, Malaysia. International Journal of Ecology and Sciences, 2: 57–66.
- Yusoff, F.M., Zaidi, M.Z. and Ambak, M.A. 1995. Fishery and environmental management of Lake Kenyir, Malaysia. In: Petr, T. and Morris, M. eds. Indo-Pacific Fishery Commission, FAO Report No. 512 Supplement, FIRI/R512 Suppl., Rome, 112–128.
- Zakariah, Z.M. and Ali, A.B. 1996. Fishery management in Chenderoh Reservoir, Perak River, Malaysia. In: Zainal Abidin, A.H. and Zubaid, A. ed. Conservation and Faunal Biodiversity in Malaysia, Universiti Kebangsaan Malaysia, Bangi, Selangor, D.E.. 102–112.
- Zakaria-Ismail and Lim, K.K.P. 1995. The fish fauna of Tasik Temenggor and its tributaries south of Banding, Hulu Perak, Malaysia. Malayan Nature Journal, 48: 319–332
- Zakaria-Ismail and Sabariah, B. 1995. Lake and river water quality as determinants of fish abundance at Temenggor, Hulu Perak, Malaysia. Malayan Nature Journal, 48: 333–345.
- Zar, J.H. 1984. Biostatistical Analysis. Prentice Hall, NJ, 859 p.

Growth Rates of Transplanted Large Icefish (*Protosalanx hyalocranius*) in Daoguanhe Reservoir, China

Hongjuan Wu¹ and Musheng Xu²

Abstract

Protosalanx hyalocranius was first transplanted in January 1995 into Daoguanhe Reservoir (400 ha), Hubei Province. Breeding populations of *P. hyalocranius* were established two years after transplantation, and currently the species contributes about 12 kg/ha/yr to the fishery yield of the reservoir. Information on growth and other related indices on *P. hyalocranius* in Daoguanhe Reservoir were estimated and presented. This paper describes in detail the growth characters of transplanted *P. hyalocranius*, when four stages in growth can be recognised, and the results are compared with those from other reservoirs in China. It is concluded that *P. hyalocranius* influences the ecology of the reservoir and also results in increased production in the waters of Hubei Province.

LARGE ice fish (*Protosalanx hyalocranius*), Salmioninae, Salangidae can be found in the littoral of East Sea, Huang Sea and the waters of Changjiang River, middle-down reach of Huai River. Recently, it has become regarded as a valuable fish and has been successfully transplanted to many reservoirs in China because of its fast growth, short life-cycle and high nutritional value and economic importance. The aim of this study was to explore whether large ice fish could grow in reservoirs in central China.

Daoguanhe Reservoir (DGH) lies south of Dabie Mountain, east of Wuhan, with $1.09 \times 10^9 \text{m}^3$ of total storage, a catchment area of 108.84 km², an average depth of 18.5 m, and 4000 ha surface area.

Materials and Methods

The materials were large ice fish caught in DGH Reservoir by lamp, trawl-net or gill-net, and preserved in 8–10% formalin. The body length (L) and the body weight (W) were measured monthly. The body length composition, the growth index and body condition were calculated using standard formulae.

¹Institute of Reservoir Fisheries, Ministry of Water Resources and CAS, PR China, 430079

²Wuhan Water Conservancy Bureau, PR China, 430015

Results

Growth in body length

Three hundred and thirty-six specimens were collected and measured from April 1995 to January 1996 (Table 1). The growth rate was different at various phases. The fastest growth period was at 3–4 months of age (from May to July) with an average monthly increase of 27.6 mm. There was only 10–20 mm increase in other months. There were two peak values of growth index in the life of large ice fish: the first occurred in June and July with 21.4–22.1 of growth index, the second in October, with 18.1.

Growth in body weight and the index of condition

The body weight of large ice fish (*Protosalanx hyalocranius*) was simultaneously measured with the body length (Table 2). There were three periods with marked increases in body weight: the first period in June and July with 1.81 g of average increase, the second in September with 4.20 g of average increase, the third in November and December, in the sexual maturation phase, with 9.8 g of average monthly increase in females and 6.67 g in males. After that, there was a decline in body weight, possibly due to spawning.

Based on analysis on the index of condition, the lowest was 0.16 in its earlier phases (2–3 months of age in April and May). Then the index of condition

went up until in November and December reached a maximum, 0.36 in females and 0.34 in males. Finally, the index of condition decreased to 0.29 in females and 0.27 in males in January of the next year.

Relationship of L and W

It was calculated that the relation of L and W was

$$W = 1.2120 \times 10^{-6} L^{3.1820}$$

Growth equation

Based on Von Bertalanffy growth equation

$$L_t = L_{\infty}[1 - e^{-k(t-t_0)}], W_t = W_{\infty}[1 - e^{-k(t-t_0)}]^{1/3}$$

Where

- L_t : the body length when t month old,
- W_t : the body weight when t month old,
- L_{∞} : the maximum body length,
- W_{∞} : the maximum body weight,
- t_0 : the age when theoretical length was zero,
- k: average curvature of the growth curve.

It was calculated that

$$L_{\infty} = 193.03\text{mm},$$

$$W_{\infty} = 22.70\text{g},$$

$$k = 0.3050, \text{ and}$$

$$t_0 = 0.3328\text{mm}.$$

Table 1. Large ice fish (*Protosalanx hyalocranius*) growth in body length in Daoguanhe Reservoir.

Date	No.	Body length (mm)			Growth index	Relative growth rate
		Range	Mean±SD	SR		
17 April	30	19–34	26.5±0.94			
17 May	24	38–74	44.6±4.0	3.555	13.7	1.1200
17 Jun	21	69–92	72.2±8.0	1.725	21.4	1.9305
15 Jul	19	90–108	98.0±6.5	1.545	22.1	0.3573
16 Aug	31	95–121	111.4±5.50	1.336	12.6	0.1367
23 Sept	40	114–138	122.8±6.60	1.287	10.8	0.1023
19 Oct	39	139–161	142.4±5.6	1.591	18.1	0.2036
21 Nov	27Γ	125–178	148.9±17.0	5.95	6.35	0.0070
	12E	155–160	157.5±3.20	2.361	8.36	0.0656
20 Dec	33Γ	145–186	164.3±12.4	3.307	6.66	0.0431
	18E	155–190	169.8±13.9	4.582	5.41	0.0334
18 Jan	14Γ	143–174	161.5±9.1	2.515	-8.51	-0.0489
	28E	161–184	80.5±4.20	1.020	17.96	0.1176
Total	336					

*Relative growth rate [length increase ÷ (initial length × time)]

Table 2. Large ice fish growth in body weight in Daoguanhe Reservoir.

Date	No.	Weight			Monthly increase (g)	Average index of condition
		Range	Mean±SD	SE		
17 April	30	0.01–0.05	0.03±0.11	0.1350		0.16
17 May	24	0.36–1.16	0.98±0.32	0.1778	0.10	0.11
17 Jun	21	0.78–1.25	0.98±0.23	0.3302	0.55	0.26
15 Jul	19	1.60–3.90	2.77±1.12	0.2643	1.81	0.30
16 Aug	31	3.50–4.70	4.20±0.35	0.0843	1.23	0.30
23 Sept	40	4.30–5.60	4.96±0.35	0.0676	0.76	0.27
19 Oct	39	8.20–13.80	9.16±1.56	0.4499	4.20	0.32
21 Nov	27Γ	3.90–8.90	8.31±5.10	1.7850	-0.85	0.25
	12E	7.50–9.30	8.40±1.22	0.5205	-0.76	0.22
20 Dec	33Γ	9.80–21.00	14.98±3.49	0.4851	6.67	0.34
	18E	7.80–29.00	17.58±6.24	2.0347	9.18	0.36
18 Jan	14Γ	8.00–15.00	11.45±2.03	0.5620	-3.53	0.27
	28E	8.12–25.00	17.2±7.01	2.8200	-0.38	0.29
Total	336					

Index of condition: (weight × length³)100

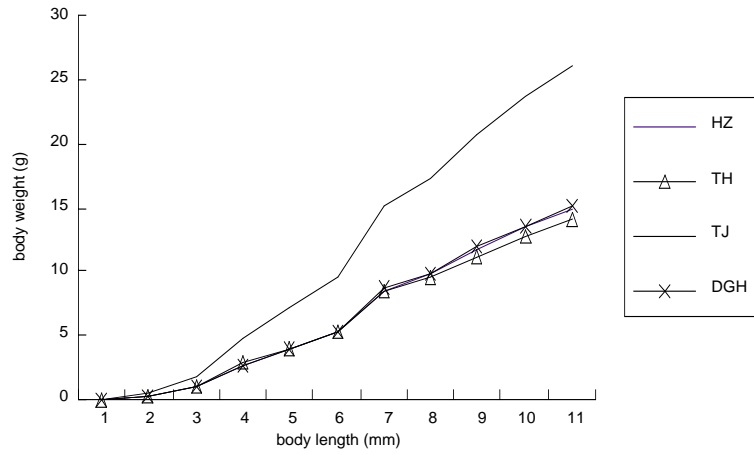

Figure 1. The relationship of length and weight of large ice fish (*Protosalanx hyalocranius*). H2 — Haizi Reservoir, TH — Taihu Lake, TJ — Tianjing Reservoir, DGH — Daoguanhe Reservoir.

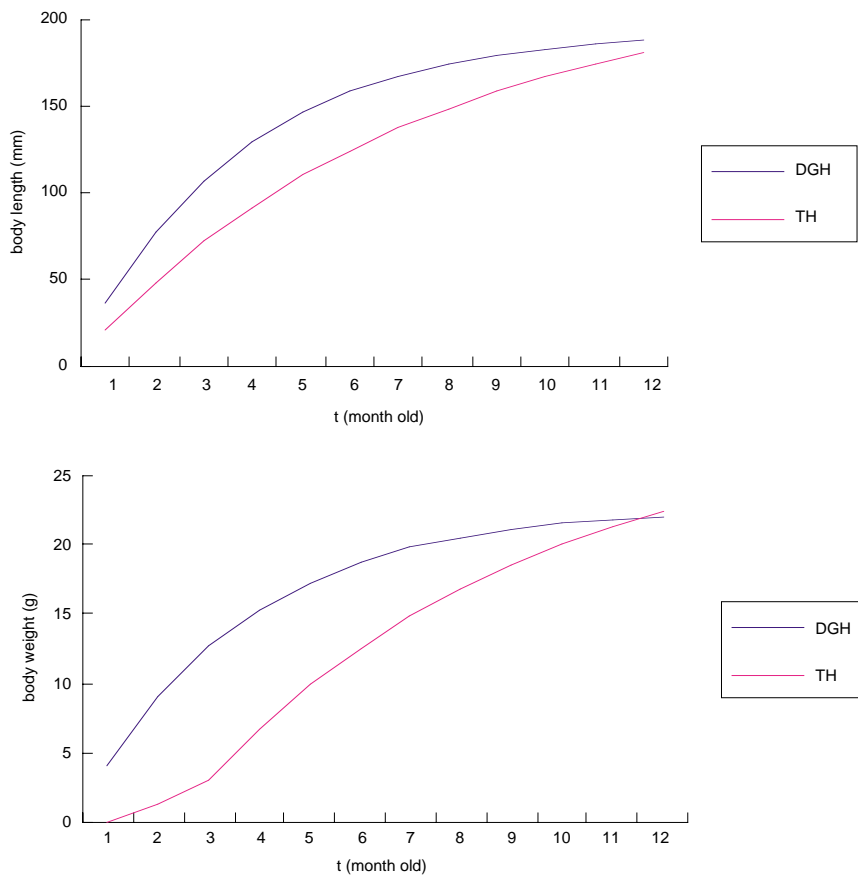

Figure 2. The growth curve of large ice fish (*Protosalanx hyalocranius*) in Daoguanhe Reservoir and Lake Taihu.

Discussion

Growth characters

The life of large ice fish in DGH Reservoir could be divided into four phases: the first phase was (about 1–3 months of age) from April to May when its food changed from yolk to zooplankton. Low condition, slow growth, small size and higher related growth rate were characteristics in this period. The second phase was June to October (4–8 months) when it fed on small fish but with less growth and condition. The third phase was in the sexual maturation period (8–10 months) with little increase in body length and much increase in body weight and maximum condition, especially in females. Decreased body weight characterised the last phase (10–12 months).

Comparison with the growth of large ice fish in other reservoirs

As Figure 1 shows, the relationship curve of the length (L) and the weight (W) of large ice fish in DGH Reservoir basically coincides with that in Haizi Reservoir (Zhu 1985), close to that in Lake Taihu (Wang and Jiang 1992; Seng 1995). It shows that the growth of large ice fish in its earlier life stage was faster.

In addition, the time at which the body weight of large ice fish greatly increased in DGH, Haizi Reservoir and Taiu Lake was later than in Tianjing Reservoir (TJ).

Conclusion

The growth characteristics of large ice fish were observed to be the same as in other reservoirs in China. They showed that the fish is widely adaptive to environment and can grow in most reservoirs in the north catchment areas of Changjiang River and the north of China.

Acknowledgment

Wuhan Science Committee, China supported this study.

References

- Seng Qizhang 1995. The study report of transplanting large ice fish (*Protosalanx hyalocranius*) to Haizi Reservoir in Beijing, China. Reservoir Fisheries, (1): 27–28 (in Chinese).
- Wang Yufen and Jiang Quanwen. 1992. The studies on the growth characters of large ice fish (*Protosalanx hyalocranius*) in Lake Tai, China. Lake Science, 4(1): 56–62 (in Chinese).
- Wang Yupei et al. 1992. The technique of protecting and propagation of large ice fish (*Protosalanx hyalocranius*) resources in Tianjing, China. Reservoir Fisheries, (6): 25–28 (in Chinese).
- Zhu Chende, 1985. Primary study on the growth and food of large ice fish (*Protosalanx hyalocranius*) in Lake Tai, China. Acta Aquaculture, 9(3): 275–287 (in Chinese).

Estimation of the New Icefish *Neosalanx taihuensis* Yield in Zhanghe Reservoir, China

Jiashou Liu¹, Jianhua Peng¹, Fuhu Yu¹, Jie Jiang¹, Xianquin Yao²
and Yuanhong Yi¹

Abstract

Zhanghe Reservoir covers 7000 ha and is important in the flood control of the middle and lower reaches of the Yangtze River. The new icefish *Neosalanx taihuensis* was introduced into the reservoir and has become the only fish of economic value. A study was carried out in Zhanghe Reservoir from June to November 1997 and from June to September 1998. The new icefish were sampled monthly with a trawlnet driven by two boats in three sampling stations, which were located in the upper, middle and lower parts of the reservoir. Zooplankton was also sampled at the same time. The distribution depth of the fish at dawn and dusk in the reservoir was about 5 m. It was estimated that the maximum yearly sustainable yield of the icefish in the reservoir was 150 t and the rational capture yield was 120 t.

ICEFISH (Salangidae) are a group of small-sized, transparent or translucent fish characterised by early onset of sexual maturity, short life span, a high reproductive potential (Chen 1956), delicious meat and a high market price (Dou and Chen 1994). More than 20 species of icefish have been found in China (Dou and Chen 1994), among which the large icefish *Protosalanx hyalocranius* and the new icefish *Neosalanx taihuensis* are the most valuable and widely translocated species (Hu et al. 1998). The large icefish feed mainly on small-sized fish and shrimp (Zhu 1985) and the new icefish mainly on zooplankton (Chen 1956).

The large icefish is mainly introduced into reservoirs in northern China, especially in Shandong, Liaoning, Tianjing provinces and Inner Mongolia, whereas the new icefish is mainly introduced into reservoirs in Central and Southern China, especially in Yunnan, Hubei, Zhejiang, Jiangsu, Guangdong and Guangxi (Hu et al. 1998). The introduction of icefish into reservoirs has brought good economic returns, especially in Shandong and Yunnan provinces. In some reservoirs, they have become

the dominant species. The icefish in reservoirs are normally captured 2 to 4 years after translocation (Hu et al. 1998). However, the shared problem for the two species is that the capture yield is not often sustainable.

The new icefish was first introduced into Dianchi Lake, Yunnan Province, in 1979 and the highest production reached 3500 t in 1985. But currently, the production is lower than 50 t. Heavy water pollution was thought to be the main reason for the rapid decrease of the new icefish yield in Dianchi Lake (Peng 1997). The other reason may be over fishing.

The new icefish was first introduced into Geheyan Reservoir, Hubei Province in 1996 and the highest production was over 300 t in 1998, but it was only 1 t in 1999 because of over fishing. Therefore, precise estimation of the new icefish production in reservoirs is important to determine sustainable production levels.

Estimation of the maximum sustainable yield can be achieved by the application of models, e.g. the Beverton-Holt Model, the Ricker Model and the Chapman-Roson Model (Zhan 1997). However, all of these models have been developed for fish with a long life span, which may not be strictly applicable to new icefish, because the lifespan of the new icefish is only one year (Hu et al. 1998).

Zhanghe Reservoir, located in the centre of Hubei Province, was impounded in 1966, with a surface

¹Institute of Reservoir Fisheries, the Chinese Ministry of Water Resources and the Chinese Academy of Sciences, Zhuo Dao Quan, Wuhan 430079, P.R. China

²Administration Bureau of Zanghe Reservoir, Jingmen, Hubei 448156, P.R. China

area of 7000 ha, a storage of $2.035 \times 10^{10} \text{m}^3$, a mean water depth of 29 m and a catchment area of 2212 km². Its main functions are flood control and irrigation. The fertilised eggs and broodstocks of the new icefish were introduced in 1992, and the yield was 126 t in 1996. The purpose of the study was to determine the fish production and sustainable yield of the new icefish in the reservoir.

Materials and Methods

The study was carried out in Zhanghe Reservoir from June to November 1997 and from June to September 1998. The new icefish were sampled at dawn and dusk with a trawl net driven monthly by two boats in three sampling stations, which were located in the upper, middle and lower parts of the reservoir, respectively (Figure 1), since dawn and dusk are the time for the icefish to be active in the water surface (ITSG 1995). Zooplankton was also sampled at the same time. Each boat was driven by two engines of 30 hp. The trawl net was 18.2 m wide, 2.0 m deep and 20 m long. The trawl speed was 0.56 m/s. The sampling time was 20 to 30 minutes each time. The catch from each sampling station was measured (to the nearest 0.1 g) and 20 g of fish was randomly collected from the catch and counted, and the total length (to the nearest 0.1 mm) and body weight (to the nearest 0.01 g) of individual fish were determined. The von Bertalanffy equation (von Bertalanffy 1936) was used to describe the growth characteristics of the fish.

Zooplankton biomass was calculated using the methods of Zhang and Huang (1989).

The standing crop of the new icefish in the reservoir was calculated using the following equation:

$$P = S \times H \times R$$

where P is the standing crop of the new icefish in the reservoir (t); S is the surface area of the reservoir (ha); H is the valid water depth in which the new icefish normally distribute at dawn and dusk (m) and R is the mean catch per cubic m (g/m^3). H was determined by trawling the new icefish at nine different water depths at dawn and dusk at Station III in September of 1988. Each depth was trawled three times and each time was kept for 30 minutes. The catch per m³ at each sampling station ($R, \text{g}/\text{m}^3$) was calculated with the following equation:

$$R = W/V$$

where W is the catch at each sampling station (g); V is the volume of water filtered (m^3). V was calculated with the following equation:

$$V = v \times t \times L \times h$$

where v is the trawling speed (m/s); t is the trawling time at each sampling station (s); and L is the mouth width of trawl net (m); and h is the height of the trawl net.

All the statistical calculations were done with STATISTICA 5.0 (StatSoft 1994).

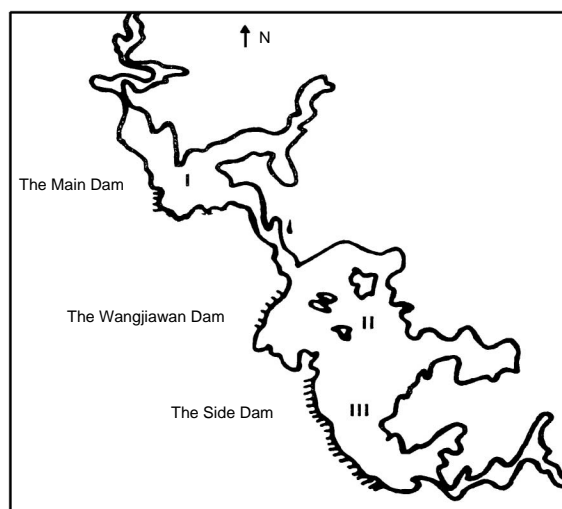

Figure 1. Distribution of sampling stations in Zhanghe Reservoir.

Table 1. The mean total length and body weight of the new icefish in Zhanghe Reservoir.

Sampling time	1997						1998			
	June	July	Aug	Sept	Oct	Nov	June	July	Aug	Sept
Total length (mm)	38.79	41.70	44.27	46.82	51.93	56.53	38.21	41.30	46.27	50.81
Body weight (g)	0.149	0.197	0.226	0.247	0.287	0.477	0.141	0.200	0.276	0.350

Results

Growth of the new icefish

A total of 8619 new icefish from Zhanghe Reservoir was used for growth measurements, among which 5400 were collected in 1997 and 3219 in 1998. Table 1 lists the monthly mean total length and body weight of the new icefish. The mean body weight and mean length of icefish caught in August to October were significantly ($P < 0.05$) higher than in the other months (Table 1). In the remaining months, these parameters did not differ significantly.

Catches of the new icefish at different water depths in Zhanghe Reservoir

Table 2 shows the results of the catches of the new icefish collected in 30 minute hauls at dawn and dusk from different water depths at Station I. Analysis of variance showed no significant differences in the catch among water depths from 0–2, 1–3 to 2–4 metres ($P > 0.05$) (Table 2). However, the catch significantly decreased with further increase in depth ($P < 0.05$) (Table 2).

Table 2. The catches of the new icefish from different water depths collected at dawn and dusk.

Water depth (m)	Mean catch (kg) \pm s.e. ¹
02	3.714 \pm 1.212 ^a
13	3.953 \pm 1.089 ^a
24	3.021 \pm 0.678 ^{ab}
35	2.845 \pm 0.154 ^b
46	2.122 \pm 0.169 ^c
57	1.021 \pm 0.078 ^d
68	0.367 \pm 0.025 ^c
79	0.212 \pm 0.012 ^f
810	0.041 \pm 0.009 ^g

¹ Values with the same superscript are not significantly different from each other ($P > 0.05$).

The standing crop and exploitable yield of the new icefish in Zhanghe Reservoir

Based on the trawl catches, the standing crop of new icefish in the reservoir was estimated. Accordingly, in 1997, the standing crop of the new icefish in Zhanghe Reservoir increased from 35.7 t in June to

103.2 t in September, and then decreased to 28.7 t in November (Table 3). In 1998, the tendency of the standing crop of the fish in the reservoir was comparable to that at the same time in 1997 (Table 3).

Table 3. The standing crop of the new icefish in Zhanghe Reservoir in 1997 and 1998.

Sampling time	R (g/m ³) ¹	P (t) ²
22 June 1997	0.102	35.70
21 July 1997	0.156	54.75
21 August 1997	0.191	66.77
21 September 1997	0.295	103.18
20 October 1997	0.146	51.20
20 November 1997	0.082	28.70
20 June 1998	0.098	34.37
20 July 1998	0.161	56.35
20 August 1998	0.178	62.30
20 September 1998	0.281	98.35

¹ R is the mean catch of the new icefish per cubic metres within the valid depth.

² P is the standing crop (t) of the new icefish in the reservoir.

The commercial fishery for icefish in the reservoir is very seasonal and occurs only for a few months in the year. In 1997, it commenced on 22 September and ended on 15 November. In 1997, the yield was 68.5 t until 19 October, and 123.6 t until 15 November. In 1998, capture for the new icefish started on 23 September and ended on 13 November. The yield was 59.5 t until 19 October, 103.2 t until 13 November.

Growth rate of the new icefish in Zhanghe Reservoir

The size of the new icefish in Zhanghe Reservoir is much smaller than that in other water bodies. For example, the mean length and weight were 51.9 mm in total length and 0.29 g in Zhanghe Reservoir in October (Table 1). However, at a comparable time, the mean length and weight were 70.0 mm and 1.171 g in Fushui Reservoir, Hubei Province (Gong et al. 1977), 68.9 mm and 1.21 g in Taihu Lake, Jiangsu Province (ITSG 1995), 66.0 mm and 1.7 g in Dianchi Lake, Yunan Province (Gao and Zhuang 1989), respectively.

The new icefish is a zooplankton feeder (Chen 1956). Its growth rate is dependent on the trophic level of water bodies. Zhanghe Reservoir is oligotrophic, but Fushui Reservoir, Taihu Lake and Dianchi Lake are eutrophic. The zooplankton biomass was only 0.02–0.13 mg/L in Zhanghe Reservoir from June to November of 1977, showing a decreasing tendency with increasing fish size (Figure 2), perhaps indicative of food limitation in the latter part of the year. Transplantation of the new icefish is not recommended into water bodies with a zooplankton biomass less than 2.8 mg/L (Rong and Zhang 1997). The practice in Zhanghe Reservoir indicated that sizeable populations of the fish could still occur in oligotrophic water bodies, though it has much lower growth rate.

Zhanghe Reservoir recorded the heaviest flooding in 1998. Heavy rains brought plenty of nutrients into the reservoir and improved its trophic conditions.

The zooplankton biomass was 0.09–0.22 mg/L in Zhanghe Reservoir from June to September (Figure 3) which was higher than that in the same time of 1997. Consequently, the size of the new icefish in August and September in 1998 was significantly bigger than that in the same time of 1997 ($P < 0.05$) (Table 1), indicating again that the growth of the new icefish was dependent on food availability. If the zooplankton availability could be improved artificially, the size of the new icefish in Zhanghe Reservoir may be improved.

Valid water depth of distribution at dawn and dusk of the new icefish in Zhanghe Reservoir

The new icefish is strongly phototactic. They move upwards to the water surface at dawn, dusk and on moonlit nights (ITSG 1995), a behavioural trait exploited by fishers. In some reservoirs, e.g. Xinanjiang Reservoir, Zhejiang Province, people around

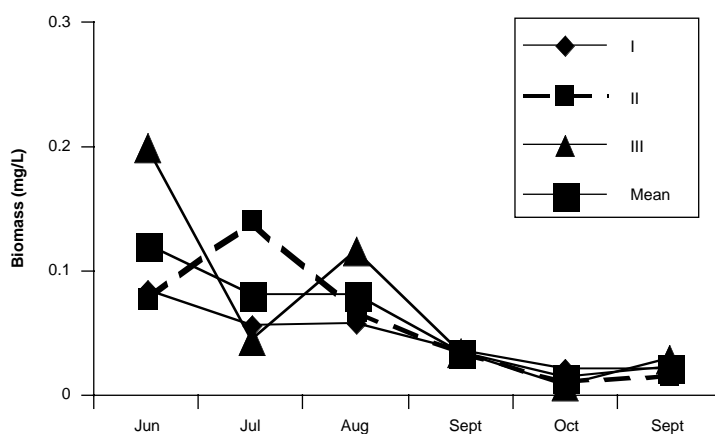

Figure 2. Biomass of zooplankton at three sampling stations in Zhanghe Reservoir in 1997.

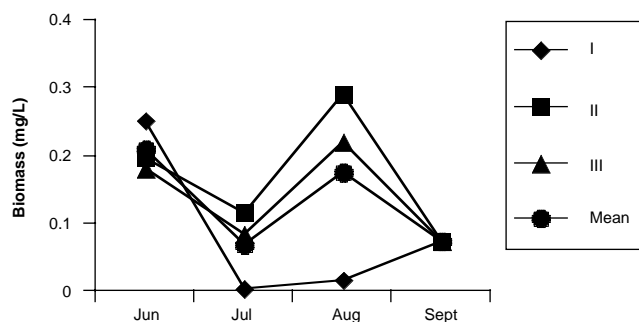

Figure 3. Biomass of zooplankton at three sampling stations in Zhanghe Reservoir in 1998.

the reservoir catch the fish by luring the fish with artificial lights (ITSG 1995). We captured the fish at different water depths and found no significant differences in the catch at depths of 0–2, 1–3 and 2–4 m (Table 2).

Acknowledgments

We would like to thank Dr S.S. De Silva at the Deakin University for checking the manuscript and making valuable proposals. Thanks also to Professor Chuanlin Hu and Mr Daoming Huang at the Institute of Reservoir Fisheries, the Chinese Ministry of Water Resources and the Chinese Academy of Sciences for providing some useful information. The study was jointly founded by the Chinese Ministry of Science and Technology (originally the Chinese Commission of Science and Technology) (Project No. 96-008-02-04) and the Water Resources Bureau of Hubei Province.

References

- Chen, N.S. 1956. Primary studies on *Neosalanx tangkaheii taihuensis* Chen. *Acta Hydrobiologica Sinica*, 2: 324–334.
- Dou, S.Z. and Chen, D.G. 1994. Taxonomy, biology and abundance of icefish, or noodelfishes (*Salangidae*) in the Yellow River estuary of the Bohai Sea, China. *Journal of Fish Biology*, 45: 737–748.
- Gao, L. and Zhuang, D. 1989. Studies on the transplanted new icefish *Neosalanx taihuensis* in Dianchi Lake. *Lake Science*, 1(1): 79–88 (in Chinese).
- Gong, S., Wu, M., Jin, D. and Wang, A. 1997. Growth of the new icefish *Neosalanx taihuensis* in Fushui Reservoir and its maximum economic yield. *Reservoir Fisheries*, 1997 (special): 125–128 (in Chinese).
- Hu, C., Chen, W. and Liu, J. 1998. Status of transplantation and enhancement of icefishes in China and their development strategies. *Reservoir Fisheries*, 1998(2): 3–7 (in Chinese).
- ITSG (Icefish Transplantation Survey Group) 1995. Status of icefish transplantation and strategies in Chinese large- and medium-sized water bodies. *Reservoir Fisheries*, 1995(3): 3–5 (in Chinese).
- Peng, Q. 1997. Studies on the biology of the new icefish *Neosalanx taihuensis* in Dianchi Lake and the reasons for its resource succession. *Reservoir Fisheries*, 1997 (special): 147–150 (in Chinese).
- Rong, C. and Zhang, H. 1997. Studies on the ecological environments of water bodies for transplantation of icefishes. *Reservoir Fisheries*, 1997 (special): 115–118 (in Chinese).
- StatSoft 1994. *STATITICA Users Guide*, Version 4.1. Tulsa, OK. Statsoft Inc.
- von Bertalanffy, L. 1936. A quantitative theory of organic growth (Inquiries on growth laws II). *Human Biology*, 10: 181–213.
- Zhan, B. 1997. *Assessment of Fisheries Resources*. Beijing, Agriculture Press.
- Zhang, Z. and Huang, X. 1989. *Research Methods for Freshwater Plankton*. Beijing: Science Press. 414 p (in Chinese).
- Zhu, C. 1985. Preliminary studies on the growth and feeding habits of the large icefish. *J. Fish.* 9(3): 275–287 (in Chinese).

Population Dynamics of Potential Fish Species for Exploitation in Presently Underdeveloped Fisheries of Some Perennial Reservoirs in Sri Lanka

M.J.S. Wijeyaratne and W.M.D.S.K. Perera*

Abstract

Fish resources in some perennial reservoirs of Sri Lanka are presently under exploited or unexploited mainly because these reservoirs are located in close proximity to marine fish landing sites or in urban areas where marine fish are readily available. The asymptotic length (L_{∞}), von Bertalanffy growth coefficient (K) and natural mortality coefficient (M) of fish species inhabiting five such reservoirs in the western coastal region in Sri Lanka, namely, Boralasgamuwa (16 ha), Lunuwila (14 ha), Madampe (81 ha), Mahawewa (60 ha) and Mattegoda (4 ha) reservoirs, were evaluated in order to determine the feasibility of their sustainable exploitation. Of the 17 fish species recorded, only three species had L_{∞} values > 15 cm. L_{∞} of two species were < 5 cm. The K values of most of the species were > 1.0/year. Since no fishing is carried out in these reservoirs, the fish are subjected to natural mortality only. The M values of all species other than three species were found to be > 2.0/year. High K and M values of most of the fish indicate that they have high production per biomass (P/B) ratios. Most of the fish species inhabiting these reservoirs could be subjected to heavy fishing mortalities. These species have a high economic value both as ornamental and food fish. The results indicate that there is a high potential to develop capture fisheries in these reservoirs to harvest both food and ornamental fish.

THE inland fish production of Sri Lanka, after a steady decrease from 39 721 mt in 1989 to 12 000 mt in 1994, has increased in the past few years, to reach a level of 27 250 mt in 1997 which is about 11% of the total fish production of the country (NARA 1999). This production has been obtained mainly from man made reservoirs which have a total extent of around 191 382 ha (NARA 1998).

However, fish resources in some perennial reservoirs of Sri Lanka are under exploited or unexploited mainly because these reservoirs are either in close proximity to marine fish landing sites or in urban areas where marine fish are readily available. This study was carried out in five such reservoirs, namely, Boralasgamuwa (16 ha), Lunuwila (14 ha), Madampe (81 ha), Mahawewa (60 ha) and Mattegoda (4 ha) in the western coastal region of Sri Lanka (Figure 1)

with an objective of estimating the asymptotic lengths (L_{∞}), von Bertalanffy growth coefficient (K) and natural mortality rates (M) of the fish species inhabiting these reservoirs, to determine the feasibility of their sustainable utilisation.

Materials and Methods

The fish populations in the Boralasgamuwa, Lunuwila, Madampe, Mahawewa and Mattegoda reservoirs in the western and northwestern provinces of Sri Lanka were sampled in 1992–1993 using a cast-net of 2.0 cm stretched mesh. No fishing is done in these reservoirs so no commercial catch was available for sampling. In each reservoir, sampling was done once a month for 12 months. The fish caught were identified using Munro (1955) and Pethiyagoda (1991) and their total lengths measured to the nearest mm. Length frequency data were analysed using FiSAT version 1.0 software package (Gayani et al. 1996). The value for L_{∞} obtained by Powell Wetherall method (Sparre and Venema 1992)

*Department of Zoology, University of Kelaniya, Kelaniya, Sri Lanka. E-mail: zoomjs@kln.ac.lk

incorporated in the FiSAT software package in some instances was considerably lower than the largest fish recorded in the sample. Hence, L_{∞} was taken as $L_{\max}/0.95$ where L_{\max} is the length of the largest fish in the sample (Moreau 1987). This is considered as a reasonably good estimate of L_{∞} in small fish whose L_{\max} is < 50 cm (Moreau 1987).

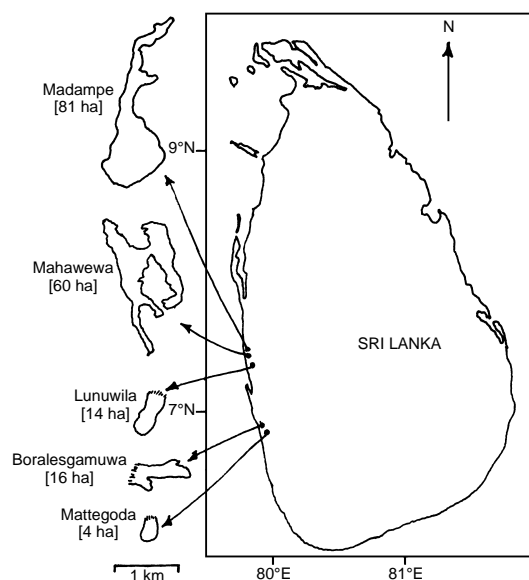

Figure 1. The location of the reservoirs studied.

Values for K and M were determined only for the fish species that were recorded for more than 6 months during the study period. Using the value for L_{∞} preliminary values of K were scanned and the value of K that gave the highest R_n value (Goodness of fit index value) was obtained. These K and L_{∞} values together with the values for growth performance index were cross-checked with the FishBase information as much as possible. K and L_{∞} values were then changed within a reasonable range considering the values obtained from FishBase information and the values that gave the highest R_n value was taken as the K and L_{∞} values of the population.

The natural mortality coefficients of the fish populations were estimated using Pauly's empirical formula (Pauly 1980) expressed in the FiSAT software package. The temperature value used in this formula was 28.5°C which is the mean annual water temperature of the lowland reservoirs of Sri Lanka (Amarasinghe et al. 1983). These values were compared with the values for mortality coefficients obtained from the catch curve.

Results

Altogether, 17 species of fish were recorded from the five reservoirs studied (Table 1). Thirteen of these species, either as adults or juveniles, have a high economic value as ornamental fish both in local and international markets. Of these 13 species, seven species are also important as food fish. Four species, *Amblypharyngodon melettinus*, *Channa punctata*, *Labeo dussumieri* and *Oreochromis mossambicus*, are important only as food fish. *A. melettinus* is used as food particularly after being sun-dried.

Only three species were recorded in all five reservoirs. They were *A. melettinus*, *Puntius vittatus* and *Rasbora daniconius*. Three species were recorded in four reservoirs, and five species recorded in only one reservoir each (*Acanthocobitis botia*, *Heteropneustes fossilis*, *Labeo dussumieri*, *Mystus vittatus* and *Pseudosphronemus cupanus*).

The length frequency distributions and the estimated growth curves for the fish species in the five reservoirs studied are shown in Figures 2–6. The R_n values obtained in the present evaluation ranged from 0.40 to 0.60. The values for L_{∞} , K and M are given in the Table 2. The M value obtained using Pauly's empirical formula was always within the 95% confidence limit of the M value obtained from the catch curve.

Only three species, *O. mossambicus*, *L. dussumieri* and *Trichogaster pectoralis*, had L_{∞} values above 15 cm. The highest value, 18.8 cm, was recorded for *O. mossambicus* in Madampe reservoir. L_{∞} values of *A. botia* and *P. vittatus* were < 5 cm in all the reservoirs where they were present.

In Mahawewa, Lunuwila and Boralasgamuwa reservoirs, the highest L_{∞} value was recorded for *T. pectoralis*. These were the only reservoirs where this species was recorded in the present study. In the other two reservoirs, the highest L_{∞} value was recorded for *O. mossambicus*. Of the 17 species recorded, only 6 had L_{∞} values above 10 cm (Table 2).

The values for K estimated for the fish species recorded in six months or more ranged from 0.60/year recorded for *T. pectoralis* in the Boralasgamuwa reservoir to 1.86/year recorded for *A. melettinus* in the Madampe reservoir. Most K values were > 1.0 /year. However, the K values for *T. pectoralis* and *O. mossambicus* were always < 1.00 /year (Table 2).

The M values estimated using Pauly's empirical formula ranged from 1.53/year recorded for *O. mossambicus* in the Madampe reservoir to 4.37/year recorded for *P. vittatus* in Mahawewa reservoir. Most of the M values estimated were > 2.0 /year. However, in *T. pectoralis*, M values were always < 2.0 /year (Table 2).

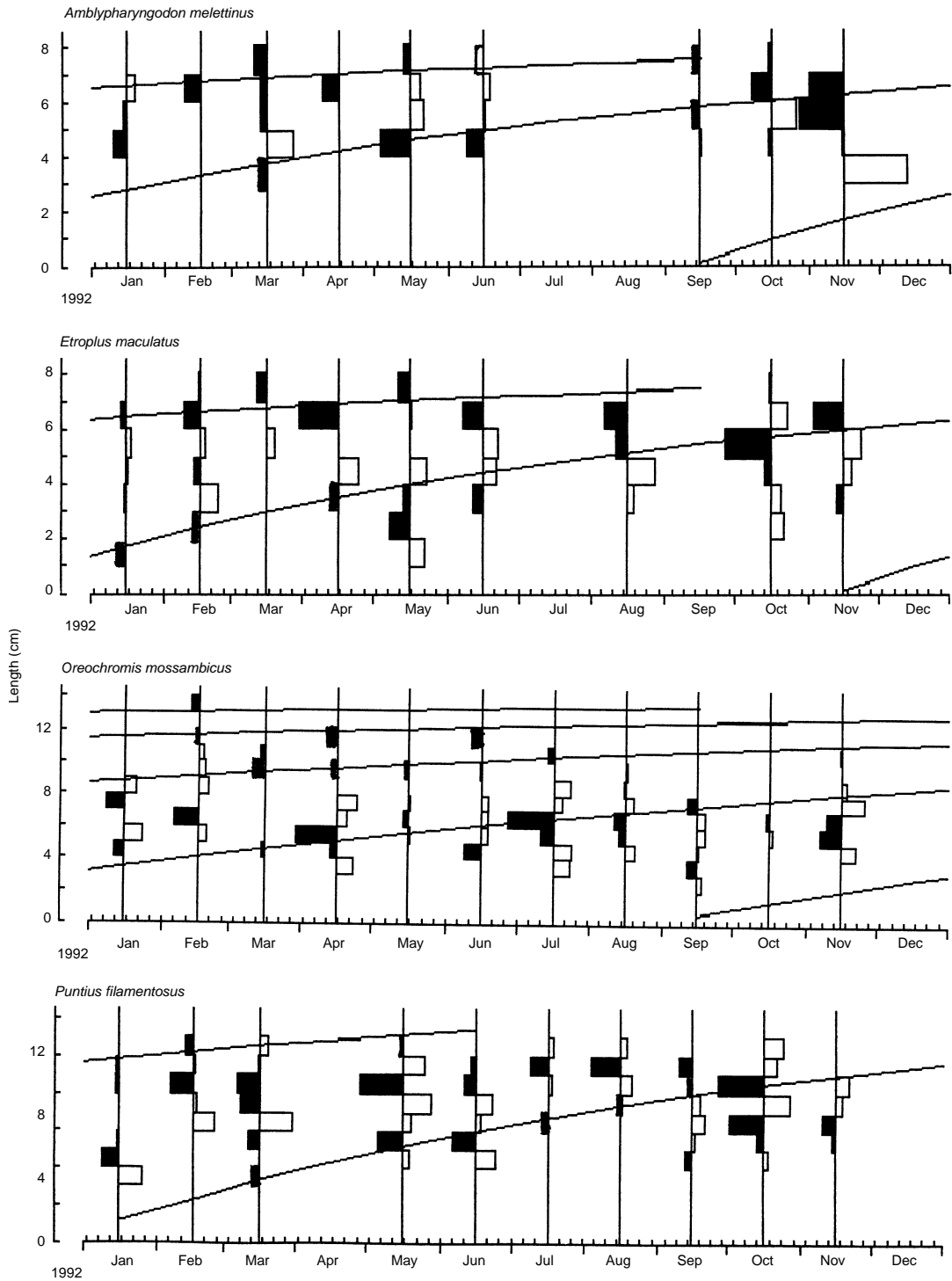

Figure 2. The length frequency distribution and estimated growth curves of the fish species of Mahawewa reservoir.

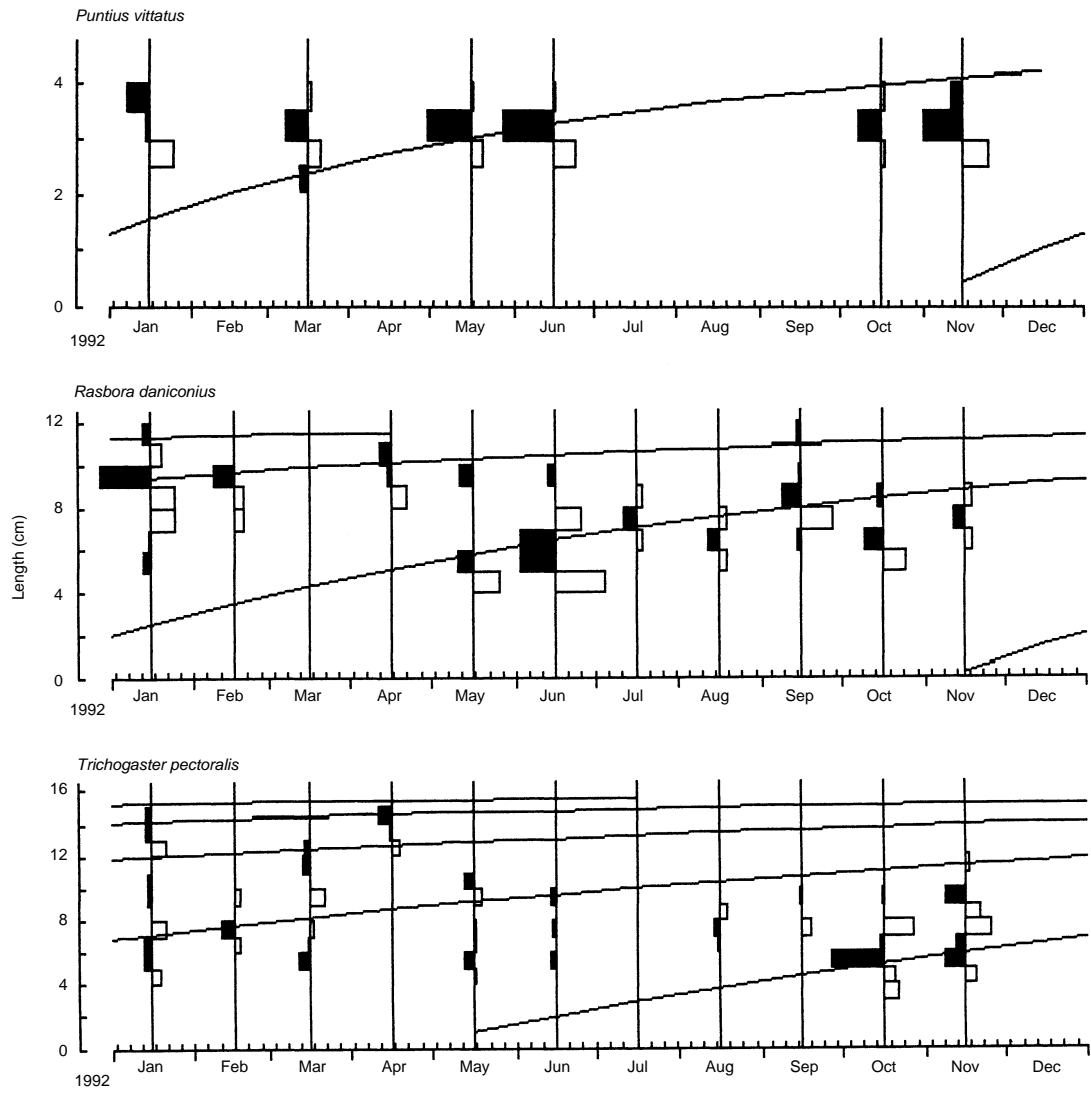

Figure 2 (cont.). The length frequency distribution and estimated growth curves of the fish species of Mahawewa reservoir.

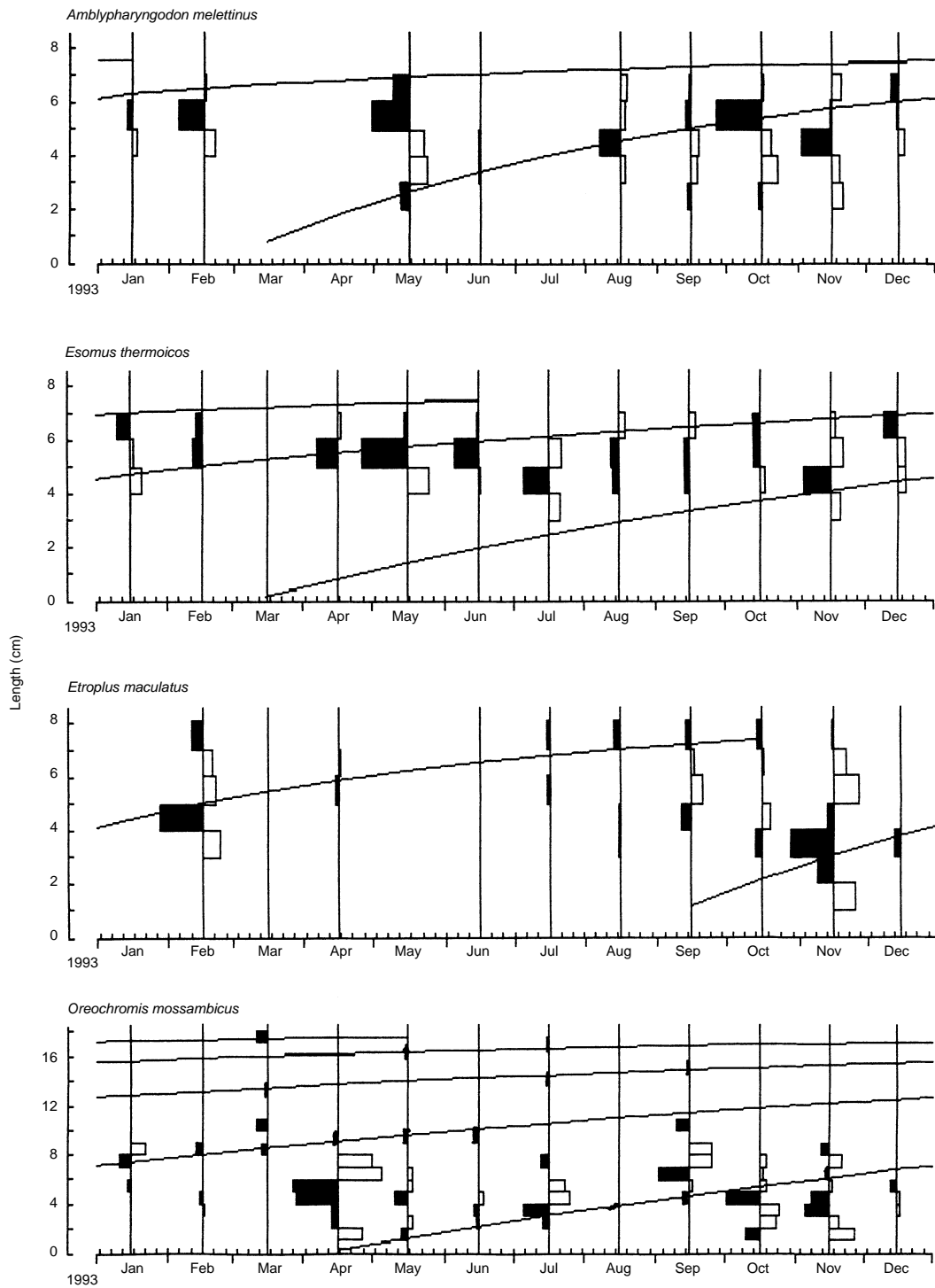

Figure 3. The length frequency distribution and estimated growth curves of the fish species of Madampe reservoir.

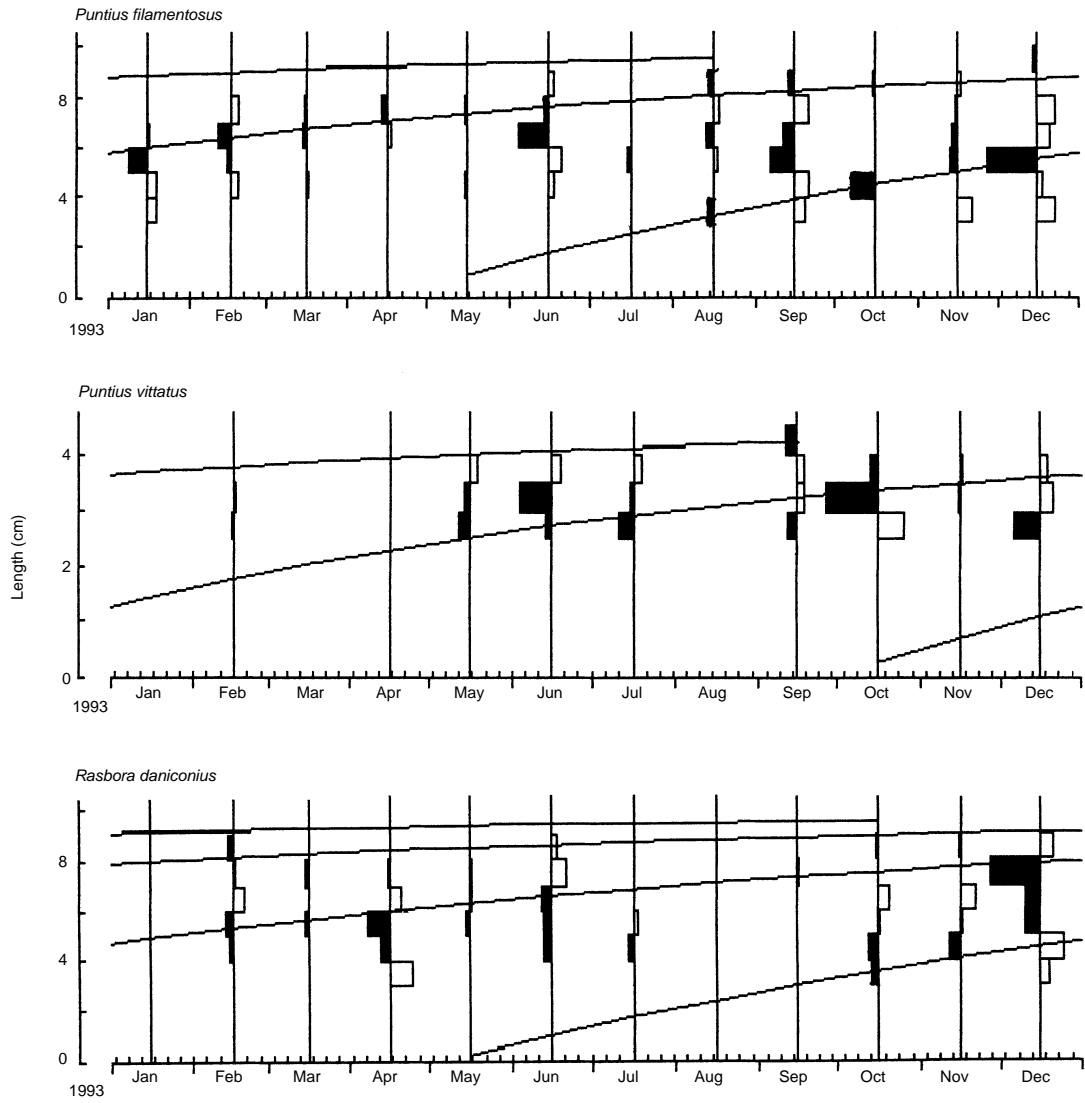

Figure 3 (cont.). The length frequency distribution and estimated growth curves of the fish species of Madampe reservoir.

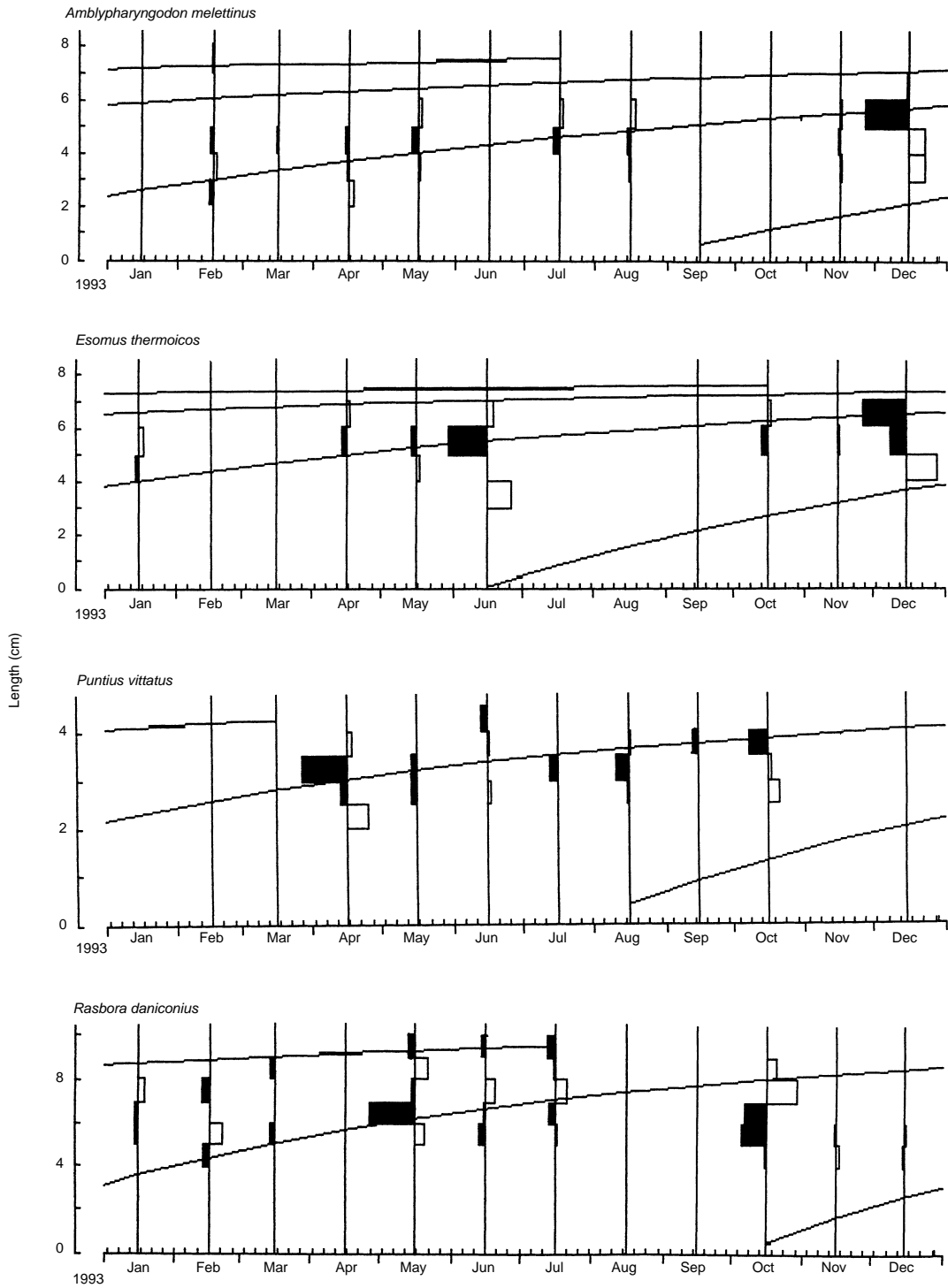

Figure 4. The length frequency distribution and estimated growth curves of the fish species of Lunuwila reservoir.

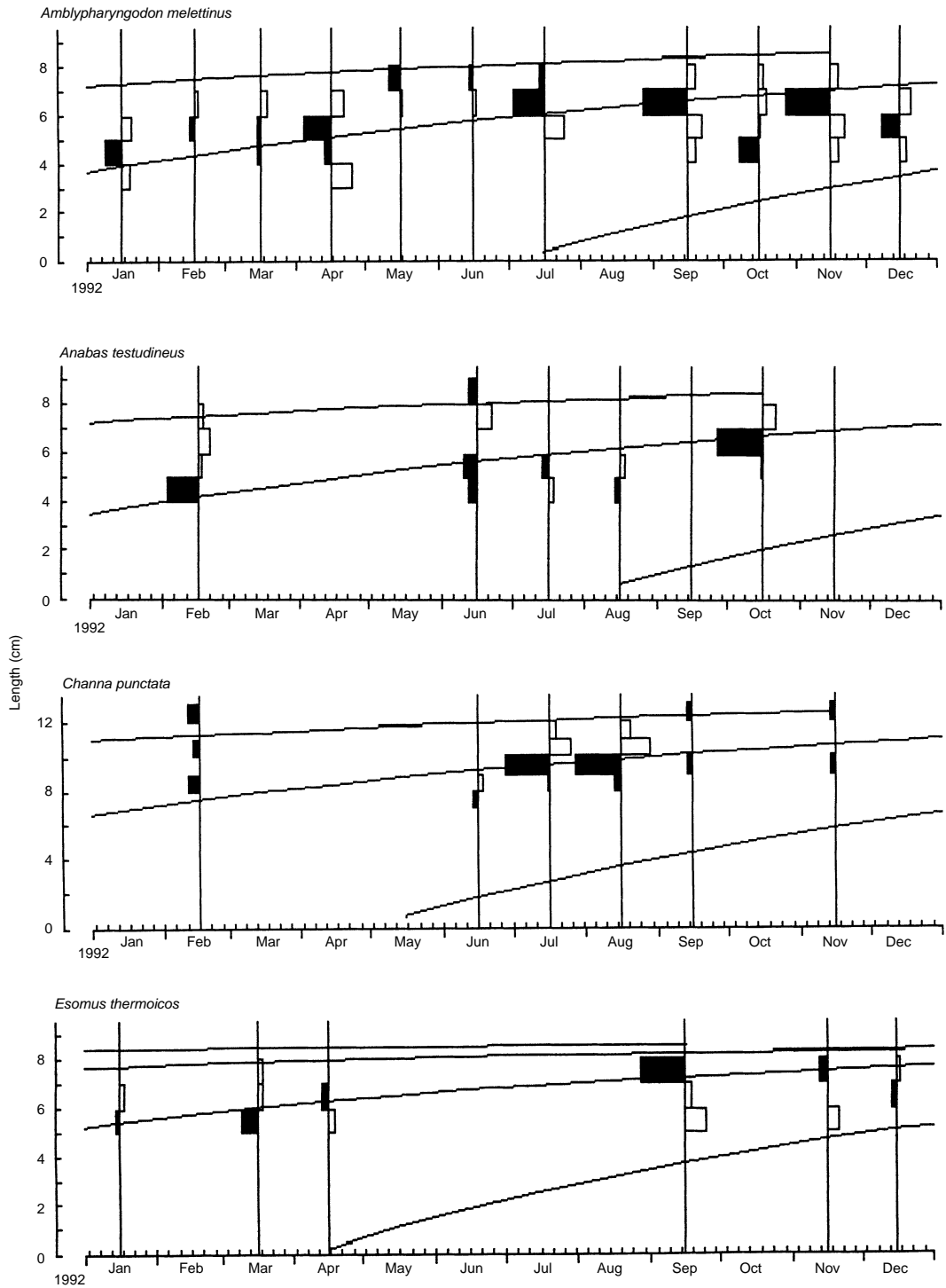

Figure 5. The length frequency distribution and estimated growth curves of the fish species of Boralasgamuwa reservoir.

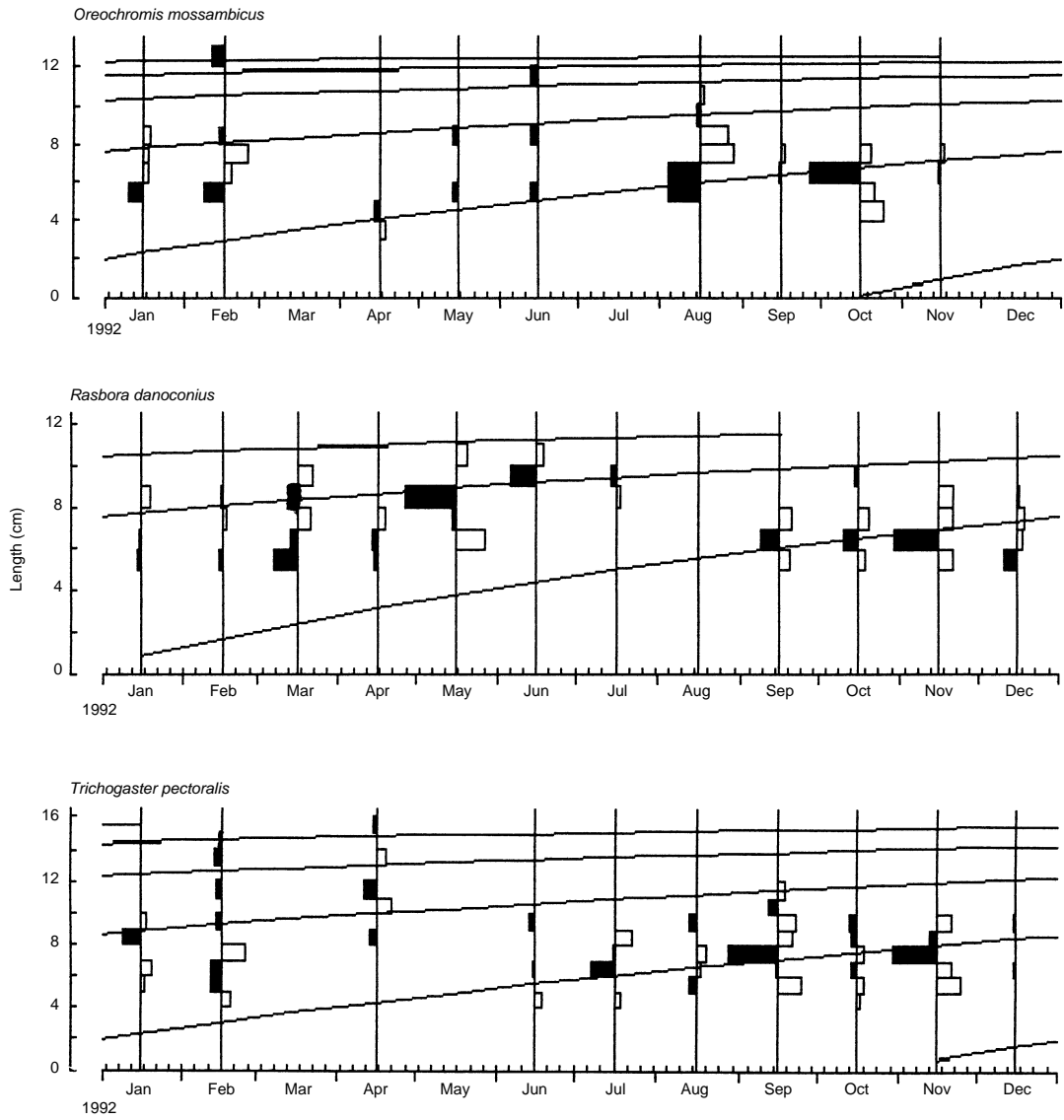

Figure 5 (cont.). The length frequency distribution and estimated growth curves of the fish species of Boralasgamuwa reservoir.

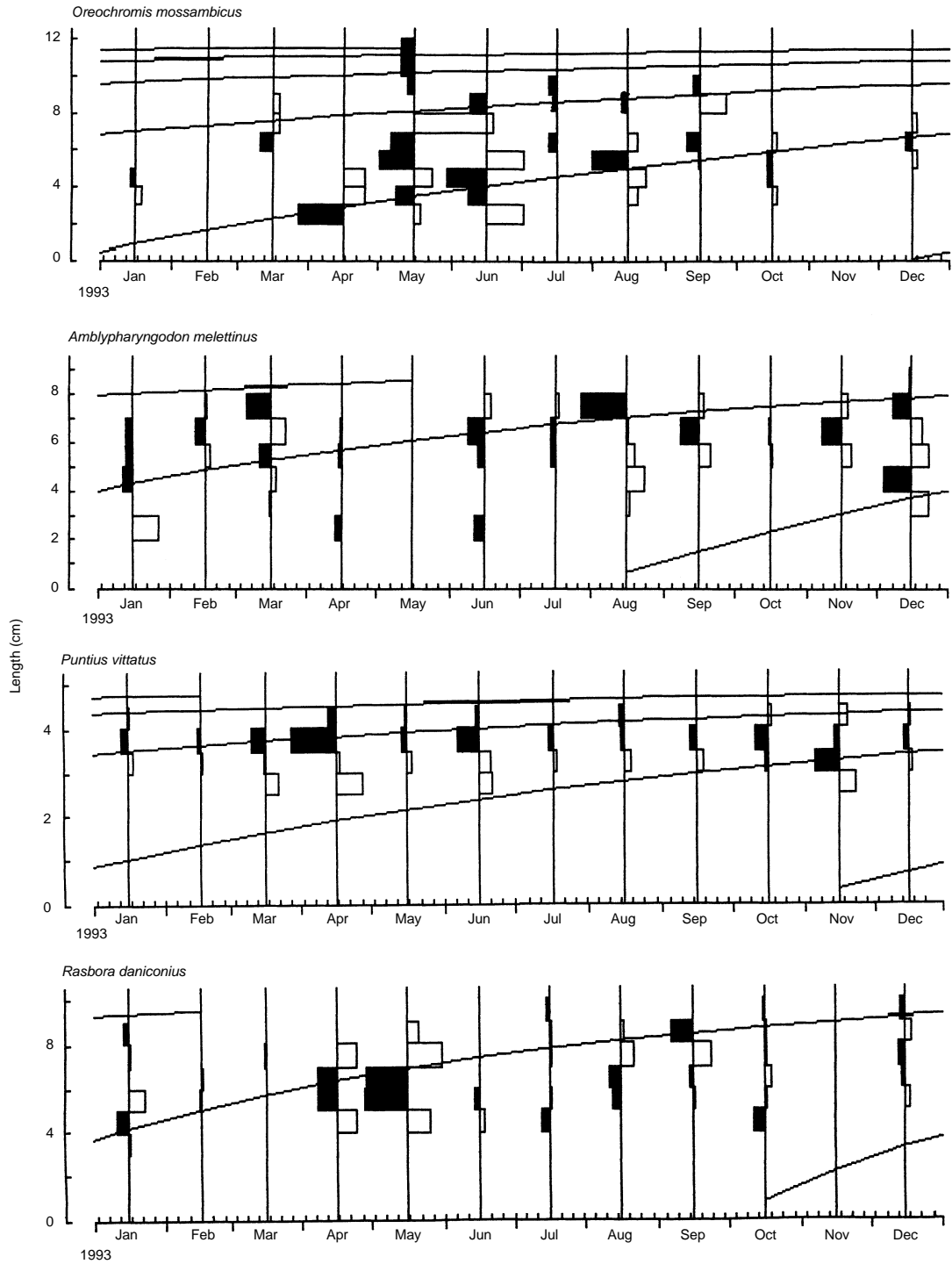

Figure 6. The length frequency distribution and estimated growth curves of the fish species of Mattegoda reservoir.

Table 1. Fish species recorded in the present study and their economic importance [A = Ornamental fish species; F = food fish species].

Scientific name and the Family	Common name	Economic importance
<i>Acanthocobitis botia</i> (Balitoridae)	Tiger loach	A
<i>Amblypharyngodon melettinus</i> (Cyprinidae)	Silver carplet	F
<i>Anabas testudineus</i> (Anabantidae)	Climbing perch	AF
<i>Channa punctata</i> (Channidae)	Spotted snakehead	F
<i>Chela laubuca</i> (Cyprinidae)	Blue laubuca	A
<i>Esomus thermoicos</i> (Cyprinidae)	Flying barb	A
<i>Etroplus maculatus</i> (Cichlidae)	Orange chromide	AF
<i>Heteropneustus fossilis</i> (Heteropneustidae)	Singing catfish	AF
<i>Labeo dussumieri</i> (Cyprinidae)	Common labeo	F
<i>Mystus vittatus</i> (Bagridae)	Striped dwarf catfish	A
<i>Oreochromis mossambicus</i> (Cichlidae)	Tilapia	F
<i>Pseudosphronemus cupanus</i> (Belontiidae)	Spike-tailed paradise fish	A
<i>Puntius dorsalis</i> (Cyprinidae)	Long-snouted barb	AF
<i>Puntius filamentosus</i> (Cyprinidae)	Filamented barb	AF
<i>Puntius vittatus</i> (Cyprinidae)	Silver barb	A
<i>Rasbora daniconius</i> (Cyprinidae)	Striped rasbora	AF
<i>Trichogaster pectoralis</i> (Belontiidae)	Snakeskin gourami	AF

Table 2. The values for asymptotic length (L_{∞} , mm), growth coefficient (K/year) and instantaneous natural mortality coefficient (M/year) for the fish species recorded in the five reservoirs studied.

	Mahawewa reservoir (60)			Madampe reservoir (81)			Lunuwila reservoir (14)			Boralasgamuwa reservoir (16)			Mattegoda reservoir (4)		
	L_{∞}	K	M	L_{∞}	K	M	L_{∞}	K	M	L_{∞}	K	M	L_{∞}	K	M
Ab							4.8								
Am	8.2	1.20	2.89	7.7	1.86	3.91	8.0	0.93	2.46	9.3	1.00	2.47	9.4	1.30	2.93
At	6.3			9.3						9.4	1.02	2.50	9.5		
Cp	10.6									13.5	1.00	2.23			
Cl				6.9			6.7								
Et	9.4			8.4	.96	2.48	7.6	1.26	3.04	8.5	1.07	2.65			
Em	8.2	1.30	3.04	8.4	1.80	3.74									
Hf										9.4					
Ld				18.2											
Mv													11.2		
Om	14.4	.67	1.68	18.8	0.65	1.53				12.8	0.73	1.84	11.8	.80	2.03
Pc	5.1														
Pd	8.1									8.6					
Pf	13.7	1.19	2.49	10.1	1.20	2.72	9.1			11.1					
Pv	4.8	1.80	4.37	4.6	1.26	3.50	4.7	1.40	3.73	4.8			4.9	1.02	3.00
Rd	12.6	1.30	2.73	9.8	1.06	2.44	10.1	1.55	3.22	12.6	0.90	2.09	10.5	1.69	3.37
Tp	16.1	0.77	1.79				12.8			16.8	0.60	1.50			

Ab = *Acanthocobitis botia* ;

At = *Anabas testudineus* ;

Cl = *Chela laubuca* ;

Em = *Etroplus maculatus* ;

Ld = *Labeo dussumieri* ;

Om = *Oreochromis mossambicus* ;

Pd = *Puntius dorsalis* ;

Pv = *Puntius vittatus* ;

Tp = *Trichogaster pectoralis*

Am = *Amblypharyngodon melettinus* ;

Cp = *Channa punctata* ;

Et = *Esomus thermoicos* ;

Hf = *Heteropneustus fossilis* ;

Mv = *Mystus vittatus* ;

Pc = *Pseudosphronemus cupanus* ;

Pf = *Puntius filamentosus* ;

Rd = *Rasbora daniconius* ;

Discussion

The values for asymptotic length of five fish species recorded in the present study are considerably lower than the maximum lengths recently recorded for these species in other regions of the country (Pethiyagoda 1991). These species are *A. testudineus*, *H. fossilis*, *L. dussumieri*, *O. mossambicus* and *P. dorsalis*. Records indicate that *O. mossambicus*, the main contributor to inland fish production in Sri Lanka (Amarasinghe 1994), usually grows up to 35 cmTL (Pethiyagoda 1991). However, in the present study the highest value recorded for L_{∞} for this species was 18.8 cm in Madampe reservoir, which is the largest among the five reservoirs studied. According to FishBase information, L_{∞} values in the range obtained in the present study have been reported from aquaculture tanks and ponds in Thailand, USA and Zambia while those reported for Parakrama Samudra and Pimburettewa reservoir stocks in Sri Lanka, 34.9–40.6 cm and 39.3 cm respectively (Amarasinghe 1987) were considerable higher than those estimated in the present study.

Although the L_{∞} value recorded for *L. dussumieri* is 18.2 cm, this species is reported to reach a size of 40 cm in total length in Sri Lanka (Pethiyagoda 1991). Similarly, *A. testudineus*, *H. fossilis* and *P. dorsalis* are reported to reach sizes of 15 cm, 30 cm and 25 cm respectively (Pethiyagoda 1991) although in the present study, the L_{∞} values of these species were estimated to be less than 10 cm. The L_{∞} values estimated for the other 12 species recorded in the present study were either very close to or slightly above the maximum lengths recorded by Pethiyagoda (1991).

The K values estimated for *O. mossambicus* were higher than those recorded in FishBase data for this species in Parakrama Samudra and Pimburettewa reservoirs (Amarasinghe 1987). Closer values for those recorded in this study have been reported in FishBase data for this species in fish ponds in Egypt and De Hoop Vlei and Doorndrai Dams in South Africa. The K values recorded in FishBase data for *H. fossilis* are considerably lower than the value estimated in the present study. Most fish species are omnivorous, aquatic macrophytes and detritus being their major food items (Wijeyaratne and Perera 1999). Aquatic macrophytes and detritus are highly abundant in these reservoirs (Wijeyaratne and Perera 1999).

Since no fishing is carried out in these reservoirs the fish are subject to natural mortality only. The lowest M values in the present study were recorded for *O. mossambicus* and *T. pectoralis*. However, even these values were very much higher than those

recorded for *O. mossambicus* in Pimburettewa (Amarasinghe 1987) and Parakrama Samudra reservoirs (Amarasinghe 1988b).

The main reason for the high natural mortality observed in the present study may be the high growth rate coupled with the small size of the fish. High K and M values also indicate that these fish have high turnover rates or production per biomass (P:B) ratios.

Among fish, natural mortality is found to be positively correlated with reproductive success (Gunderson 1997). High growth rates, small asymptotic lengths and high natural mortality indicate that the fish species in these reservoirs mature early in life and have a small life span, as stated by Sparre and Venema (1992).

If M is high, fish soon reach the age where loss due to natural mortality exceeds the gain in biomass due to growth. Therefore, fishing mortality should be high to catch the fish before they die of natural causes (Sparre and Venema 1992). Fish populations are considered to be under optimal exploitation when fishing mortality equals natural mortality. Hence, it appears that the fish populations in these reservoirs could be subjected to heavy fishing mortality as their natural mortalities are high. The results of this study therefore indicate a high biological potential to develop capture fisheries in these reservoirs. However, since these reservoirs are very close to marine fish landing sites and in urban areas where marine fish are readily available, the exploitation of these fish as food may not be economically viable. There is a high potential to exploit the resource for ornamental purposes, at present a rapidly growing industry in Sri Lanka.

Acknowledgments

The financial support provided by Natural Resources Energy and Science Authority of Sri Lanka (presently National Science Foundation, Sri Lanka) (Research Grant No: RG/90/WW/1) is gratefully acknowledged. The authors also wish to thank Professor U.S. Amarasinghe of the Department of Zoology, University of Kelaniya, for his useful suggestions and comments and help in the preparation of Figures and Ms K.R.D. Padminie of the Office of the Dean/Faculty of Science of the University of Kelaniya for secretarial assistance.

References

- Amarasinghe, U.S. 1987. Status of the fishery of Pimburettewa Wewa, a man-made lake in Sri Lanka. *Aquaculture and Fisheries Management*, 18: 375–385.

- 1988. Empirical determination of a desirable mesh size for the gill net fishery of *Oreochromis mossambicus* (Peters) in a man made lake in Sri Lanka. *Asian Fisheries Science*, 2: 59–69.
- 1994. A Synthesis on the management of the capture fisheries of Sri Lankan perennial reservoirs. *Vidyodaya Journal of Science*, 5 (1): 23–40.
- Gayanilo, F.C. Jr., Sparre, P and Pauly, D. 1996. The FAO-ICLARM Stock Assessment Tools (FiSAT) User's Guide. FAO Computerised Information Series (Fisheries) No. 8. FAO, Rome, 126 p.
- Gunderson, D.R. 1997. Trade off between reproductive effort and adult survival in oviparous and viviparous fishes. *Canadian Journal of Fisheries and Aquatic Science*, 54: 990–995.
- Moreau, J. 1987. Mathematical and biological expression of growth in fish: recent trends and future developments. In: Summerfelt, R.C. and Hall, G.E. ed. *Age and Growth of Fish*, Iowa State University Press. Ames, Iowa, 81–113.
- Munro, I.S.R. 1955. *Marine and Freshwater Fishes of Ceylon*, Department of External Affairs, Canberra, Australia, 349 p.
- NARA 1998. *Sri Lanka Fisheries Year Book, 1997*. National Aquatic Resources Research and Development Agency, Sri Lanka. 81 p.
- NARA 1999. *Sri Lanka Fisheries Year Book, 1998*. National Aquatic Resources Research and Development Agency, Sri Lanka. NARA-SED-FY-Vol. 2. 56 p.
- Pauly, D. 1980. On the interrelationships between natural mortality, growth parameters and mean environmental temperature in 175 fish stocks. *J. Cons. CIEM*. 29(2): 179–192.
- Pethiyagoda, R. 1991. *Freshwater Fish of Sri Lanka*. World Heritage Trust. Colombo, Sri Lanka, 362 p.
- Sparre, P. and Venema, S.C. 1992. *Introduction to Tropical Fish Stock Assessment. Part 1. Manual*, FAO Fisheries Technical Paper No. 306/1. FAO, Rome, 376 p.
- Wijeyaratne, M.J.S. and Perera, W.M.D.S.K. 1999. Studies on the feasibility of using indigenous fish to control aquatic macrophytes in Sri Lanka. *Journal of Aquaculture in the Tropics* (in press).

Trophic Relationships and Possible Evolution of the Production under Various Fisheries Management Strategies in a Sri Lankan Reservoir

J. Moreau¹, M.C. Villanueva¹, U.S. Amarasinghe² and F. Schiemer³

Abstract

The ECOPATH trophic model has been used to describe an extensive study of the trophic relationships of Parakrama Samudra reservoir, Sri Lanka, during the 1970s. It has supported preliminary assessments made regarding the importance of unexploited fish stocks and can possibly provide the link to understanding the further evolution of the lake under various fisheries management schemes.

IN SRI LANKA for a long time, reservoir fisheries have been characterised by high levels of production (Moreau and De Silva 1990) and by the dominance of *Oreochromis mossambicus* (Peters), an African cichlid fish introduced in 1952 (De Silva 1985, 1988; Welcomme 1988). It was only after the investigations reported by Schiemer (1983) and by Newrkla and Duncan (1983) on the Parakrama Samudra reservoir that the possible importance of autochthonous small fish species has been recognised (De Silva and Sirisena 1987; Sirisena and De Silva 1989). Further, the possible competition and ecological overlap existing in terms of habitat and food availability between the introduced and native populations have been considered (Pet and Piet 1993; Piet and Guruge 1997). The present contribution deals with an ancient man-made lake, which has been highly documented (the Parakrama Samudra reservoir).

This study aims to provide a quantitative description of the ecosystem as it appeared during the bulk of the field work reported by Schiemer in 1983 and

to show how such an analysis contributes to the identification and significance of unexploited fish stocks. Attempts to evaluate the ecological overlap in terms of food partitioning can possibly link and provide an explanation for the evolution of the fish community during the 1980s and the 1990s, following the development of small-mesh gill-netting.

This contribution is not only expected to help in the investigation and understanding of adaptive mechanisms that might have contributed to the recent evolution observed and recorded on other Sri Lankan reservoirs, but also to aid in understanding those same mechanisms in other Asian countries by identifying bottlenecks, i.e. research to be specifically carried out for that purpose.

The Parakrama Samudra reservoir

The Parakrama Samudra reservoir (Figure 1), (latitude 10°45'N, longitude 35°20'E, altitude 212 m above sea level (m.a.s.l.) and area of approximately 25 km²), is a shallow (average depth at maximum water level 5 m and maximum depth 12 m) and eutrophic reservoir created by damming the Ambang Ganga, in the dry zone of Sri Lanka, about 150 km east of Colombo (Schiemer 1983). The reservoir is drawn down yearly to 206 m.a.s.l. Parakrama Samudra is an 'open water reservoir' with a distinct pelagic zone. The dam was closed centuries ago. The reservoir is divided by chains of islands into three basins and even at high water levels, these three basins keep a distinct limnological identity.

¹Dept. of Inland Fisheries, I.N.P./E.N.S.A.T., BP 107 Auzeville Tolosane 31 326 CASTANET TOLOSAN France

²Department of Zoology, Kelaniya University, Kelaniya, Sri Lanka

³Department of Zoology, The University of Vienna, A 1010 Vienna, Austria

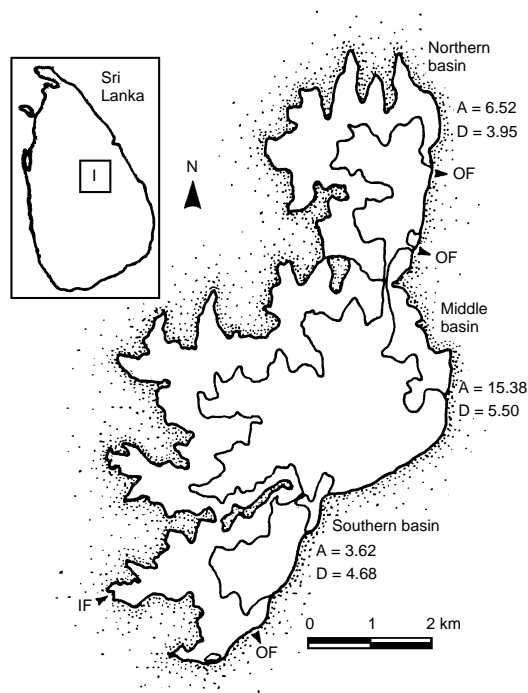

Figure 1. General map of Parakrama Samudra reservoir. Redrawn from Schiemer (1983).

However, in this study, the lake will be considered as a whole. The commercial fisheries are active and deal mostly with introduced tilapiine fish, and recently, during the early 1980s, with small cyprinids (Amarasinghe 1990). The present work pertains to the end of the 1970s but it has to be mentioned that during the field activity of the Austrian group working with F. Schiemer, the lake experienced an unusual draw down in order to repair the dike that was destroyed by a typhoon.

Material and Methods

We have used the well-documented steady state ECOPATH model of trophic interactions in ecosystems. ECOPATH 4 as used here is a modified and extended version by Christensen and Pauly (1992, 1993, 1995, 1996) and Walters et al. (1997) of the original ECOPATH model of Polovina (1984) and Polovina and Ow (1985). When using ECOPATH, the system is partitioned into boxes comprising species having a common physical habitat, similar diet and life history characteristics. The data required for ECOPATH are assembled and standardised to the same units (i.e. here tonnes/km²). Once the necessary

inputs are provided, the model produces estimates of mean (annual) biomass, (annual) biomass production and (annual) biomass consumption or what is called ecotrophic efficiency (see below) for each of the boxes in the ecosystem. It is assumed that the ecosystem considered is near equilibrium conditions, which means that input to a group should equal output from it for the period considered.

The equilibrium ecosystem condition allows one to establish a system of biomass budget equations which, for each considered group (e.g. boxes), is:

Production – all predation on this species (or group) – non predatory mortality – all exports = 0.

ECOPATH expresses each term in the budget equation as a linear function of the mean biomass. The resulting budget equations become a system of simultaneous linear equations of the following form :

$$B_i (P/B)_i EE_i - Y_i - \text{Sigma} (B_j Q/B_j DC_{ji}) = 0 \quad (1)$$

where B_i is the biomass of the group i ;

P/B_i its production/biomass ratio, usually assumed as equal to the total mortality Z as defined in fisheries sciences (Allen 1971; Lévêque et al. 1977);

EE_i its ecotrophic efficiency (i.e. the proportion of the ecological production which is consumed by predators and/or exported, Ricker 1969);

Y_i its yield (= fishery catch), usually obtained through fisheries statistics;

B_j the biomass of its predator j ;

Q/B_j the food consumption per unit biomass of j , a parameter which expresses the food consumption of an age-structured population of fish relative to its biomass, taking into account the fact that young individuals are more numerous than old ones and consume much more food (compared to their weight) than old fish (Pauly 1986; Palomares and Pauly 1998);

DC_{ji} the fraction of i in the diet of j , as expressed in percentage in weights or volume.

In addition to balancing the model by computing any unknown parameter in each equation such as (1), ECOPATH 4 has additional routines called ECOSIM (Walters et al. 1997), which allows simulation of the evolution of the ecosystem under various fishing management strategies, and ECOSPACE (Walters et al. 1998), which helps to describe the trophic functioning of the ecosystem as distributed over space. This required some groups (plankton) to be defined into several groups and also to take into account available information about the spatial distribution of fish and related feeding behaviour to construct a more stable model.

The Implementation of the Present Ecopath Model

The backbone of the present study is the bulk of the field work carried out at the end of the 1970s by a group of European and Sri Lankan scientists, summarised in Schiemer (1983).

The following groups are considered:

Fish eating birds: They are mainly *Phalacrocorax carbo*, *P. fuscicollis* and *P. niger*. Their biomass and relative food consumption (Q/B) are known from Winkler (1983), which established their total food consumption between 12.3 and 18.6 tonnes of fish per km². tilapiine fish (at that time, *O. mossambicus*) contributes for 60% of their diet whereas small cyprinids and other fish are additional prey (Piet and Vijverberg 1998). P/B was derived from Hustler (1997).

Top predatory fish: The following species are included: *Anguilla nebulosa*, *Ompok bimaculatus*, *Channa striatus*, *Glossogobius giuris*, *Wallago attu*. P/B has been set to 1.0 for an estimated average longevity of 5 years (Lévêque et al. 1977) and Q/B = 5 resulting in an estimate of GE = 0.20, usual for predatory fish (Palomares 1991). EE has been set to a value of 0.8 because the exploitation of these fish is limited but they are highly predated by birds. Diet is mainly from Piet (1998).

***O. mossambicus*:** P/B has been derived from growth performance, M value and high exploitation rate, in agreement with the data of Amarasinghe et al. (1989) concerning the demographical structure of the population. Q/B has been computed from data of Schiemer (1983) and Palomares (1991). EE is 0.95 because of high exploitation and predation. The diet is from Hofer and Schiemer (1983), Schiemer and Duncan (1988) and Maitipe and De Silva (1985).

***O. niloticus*:** This species was not exploited during Schiemer's studies, as it was very scarce. It is incorporated here for further simulations using ECOSIM. P/B = M as derived from Amarasinghe and De Silva (1992) for Minneryia reservoir near Parakrama Samudra. GE set to 0.025 i.e. higher than for *O. mossambicus* as usually mentioned (see Pullin and Mac Connell 1982). Catch is assumed to be very low and the EE value is also low as the fish were poorly exploited (De Silva 1988). The diet is the same as for *O. mossambicus* (Maitipe and De Silva 1985).

***Amblypharyngodon melettinus*:** This is an abundant small pelagic cyprinid pointed out and studied by Schiemer (1983) and was not exploited. Therefore, P/B = M (natural mortality) has been computed according to the maximum observed size, expected longevity and K using Pauly's equation (1980) and in agreement with Wijeyaratne and Perera (these

Proceedings). Q/B has been computed from data of Hofer and Schiemer (1983) using MAXIMS (Jarre et al. 1990). EE was set at 0.10 as this fish was not exploited and was consumed only to a small extent by predatory fish. The diet is from Hofer and Schiemer (1983), Schiemer and Duncan (1988) and Bitterlich (1985) and U.S. Amarasinghe (pers. comm.).

***Puntius filamentosus*:** This is an abundant littoral cyprinid species. Though it was only exploited occasionally by cast-nets, for instance (Schiemer pers. comm.), EE is set to 0.50 because of predation by fish-eating birds and top predatory fishes. P/B is derived from the longevity (U.S. Amarasinghe pers. com) and in agreement with Wijeyaratne and Perera (these Proceedings), Q/B originates from field work on other reservoirs (W. Weliange, pers. comm.) as confirmed by the predictive model of Palomares and Pauly (1998). The diet is from data collected by Hofer and Schiemer (1983) and Schiemer and Duncan (1988).

Other cyprinids: These are mainly small zoobenthophagous *Puntius* spp. (mostly *P. chola* and *P. dorsalis*). P/B was assumed to be M computed using Pauly's equation (see the previous group). Q/B computed using the model of Palomares and Pauly (1998). The EE value is 0.50 (see previous group). Diet is from Piet (1998) and also from personal observations from F. Scheimer and U.S. Amarasinghe.

***Ehirava fluviatilis*:** Biomass, P/B and diet composition were obtained from Newrkla and Duncan (1984). Q/B was computed using the model of Palomares and Pauly (1998). The diet was derived from data as observed by Newrkla and Duncan (1984).

***Hemiramphus gaimardi*:** This fish exists in the lake with a still undetermined biomass. P/B was computed according to the expected longevity while Q/B was determined by using the model designed by Palomares and Pauly (1998). EE is set at 0.10 to express a very low level of predation and/or exploitation. Diet is mostly zooplankton (U.S. Amarasinghe and F. Schiemer pers. comm.).

Zooplankton: Biomass, P/B and Q/B were derived from Schiemer (1983) and Fernando and Rajapaksa (1983). It consists essentially of rotifers with high turnover. It has been categorised into those found in the open water and those existing as littoral zooplankton as quoted above.

Zoobenthos: For this group, P/B and Q/B are average estimates made by Christensen and Pauly (1993) and Mavuti et al. (1996). Biomass estimate was taken from Schiemer (1983).

Phytoplankton: Biomass and P/B were obtained from Schiemer (1983) and Schiemer and Duncan (1988). This has been categorised between pelagic and littoral phytoplankton.

Macrophytes: They were incorporated in this study because during flooding periods, they are considered to be important food and energy sources for some populations such as *Puntius filamentosus* and average P/B ratios taken from Christensen and Pauly (1993) and Mavuti et al. (1996). EE was set at a low range because of limited predation by fish overall.

Benthic producers: They are important for bottom feeders and P/B was from Christensen and Pauly (1993).

Detritus: A detritus box is always incorporated in an ECOPATH model. For the Parakrama Samudra reservoir, the detritus contributes to the diet of several important groups.

The catch estimates for the period under consideration are from Schiemer and Hofer (1983) except for small cyprinids and other fish (Amarasinghe 1990; Sirisena and De Silva 1989). The weight units have been standardised to wet weight: tonnes/km².

Results

The trophic relationships in the Parakrama Samudra reservoir

Estimates of biomass, ecotrophic efficiencies, gross conversion rates, food consumptions and trophic levels (Lindeman 1942) obtained from the input parameters for each group are presented in Table 1 whereas the feeding matrix is given in Table 2. The trophic relationships are summarised in Figure 2.

The total biomass of fish in Parakrama Samudra is 54.7 t/km² which is quite high but this pertains to an average low water level. The introduced tilapiine fish contribute to a significant part of it (45%) in agreement with the findings for the end of the 1970s (Schiemer and Duncan 1988), during which there was a flourishing fishery towards *O. mossambicus*. Interestingly, the model provides estimates of 'possibly' living biomasses of fish stocks which were poorly exploited at that time. This has been possible by setting reasonably low values of EE (0.10 to 0.5) in agreement with the known level of predation and getting estimates of biomass compatible with a sustainable utilisation of the main food sources (EE from 0.618 to 0.954). The biomass of the unexploited cyprinids is 16.4 t/km² and that of small pelagic zooplankton is 9.5 t/km².

It can be emphasised that the ecological production of the exotic tilapiine fish (36.8 t/km²/yr) is lower than that of the native cyprinids (42.6 t/km²/yr), a feature already expected by various authors (Schiemer and Duncan 1988; Sirisena and De Silva 1989; Amarasinghe 1990).

The total annual food consumption for birds (16.2 t/km²) fell within the range suggested by

Winkler (1983) and represents about 75% of what is caught by fishermen (22.1 t/km²), a feature which has been often recorded: see for instance Moreau et al. (1993) in Lake George, Mavuti et al. (1996) in Lake Ihema (Africa) or Moreau et al. (1997) in Lake Kariba. In this particular case, it should be mentioned that birds are catching small size tilapiine (less than 16 cm TL, Winkler 1983), whereas large sizes are exposed to fisheries with large mesh gill-nets (see below). The competition between fishermen and birds is therefore limited.

The gross efficiency of the fisheries (actual catch/primary production = 0.0023) is quite low when compared to other tropical inland water bodies which are intensively exploited (Christensen and Pauly 1993; Mavuti et al. 1996; Baijot et al. 1997). This is mainly due to the existence of unexploited stocks. In addition, some food sources are not fully exploited.

The niche overlap

One issue often discussed (for instance, Piet and Vijverberg, 1998) is the possible competition for zooplankton between young tilapiine fish and native fish fauna. From the data of Tables 1 and 2, it can be computed that tilapiine populations consume only 18.4 tonnes/km²/yr of zooplankton whereas zooplanktophagous fish eat a total of 350 tonnes/km²/yr. Zooplankton itself is responsible for a consumption of 60.5 t/km²/yr because of cannibalism. This means that it cannot be really inferred that tilapiine fish are competitors of native zooplanktophagous fish. In addition, young tilapias are living in the littoral zones of the lake, consuming littoral zooplankton whereas local zooplanktophagous species are widespread all over the lake. Generally, it appears with the appropriate routine of ECOPATH (Table 3) that the ecological overlap in terms of prey between tilapiine fish and indigenous small species is about 0.05, thus confirming that the introduced species are not serious competitors of native zooplanktophagous ones. The competition between tilapiine fish and local small cyprinids is also limited (0.5 to 0.6) by virtue of their distribution in the reservoir (Piet and Guruge 1998; Amarasinghe pers. obs.) and difference in feeding habits.

The main zooplanktophagous fish species, *E. fluviatilis* and *Hemiramphus* spp., have no competitors in terms of food supply in this lake. They are, however, competing with each other without any possible significant detrimental effect due to their difference in habitat. *Hemiramphus* spp. is mostly a littoral living in surface water whereas *E. fluviatilis* is mostly pelagic and colonises the deeper layers of the water column. In addition, it seems that these two fish populations are feeding at different times of the day.

Table 1a. Key features of the ECOPATH model of the Parakrama Samudra reservoir, Sri Lanka. The trophic levels, the flow to detritus, the biomass of sih (except *E. fluviatilis*) and ecotrophic efficiencies for groups other than fish have been computed by the model.

Group name	Trophic level	Biomass (t/km ² /y)	Prod./biom. (/year)	Cons./biom. (/year)	Ecotrophic efficiency	Prod./consumpt.	Flow to detr. (t/km ² /y)
1 Fish-eating birds	3.21	0.250	0.350	65.000	0.000	0.005	3.338
2 Top predators	3.16	3.750	1.000	5.000	0.800	0.200	4.500
3 <i>O. mossambicus</i>	2.01	24.289	1.500	75.000	0.950	0.020	368.164
4 <i>O. niloticus</i>	2.01	0.329	1.200	48.000	0.500	0.025	3.358
5 <i>A. melettinus</i>	2.01	7.546	2.700	125.000	0.100	0.022	206.995
6 <i>P. filamentosus</i>	2.05	3.760	2.500	60.000	0.500	0.042	49.820
7 Other cyprinids	2.51	5.110	2.500	16.000	0.500	0.156	22.740
8 <i>E. fluviatilis</i>	2.97	6.000	5.000	35.000	0.027	0.143	71.175
9 <i>Hemiramphus</i> spp.	2.96	3.458	3.000	25.000	0.100	0.120	26.629
10 ZP open waters	2.01	5.500	50.000	550.000	0.618	0.091	710.167
11 ZP littoral	2.01	5.500	50.000	550.000	0.730	0.091	679.187
12 Insects/larvae	2.01	11.000	6.000	40.000	0.935	0.150	92.293
13 Open water PP	1.00	36.000	120.000	0.000	0.871	–	559.429
14 Littoral phytop.	1.00	36.000	120.000	0.000	0.797	–	878.430
15 Macrophytes	1.00	50.609	6.000	0.000	0.500	–	151.828
16 Benthic prod.	1.00	72.668	10.000	0.000	0.950	–	36.334
17 Detritus	1.00	5.000	–	–	1.363	–	0.000

Table 1b. Landings (which are an input in ECOPATH). Note that they have been segregated among various current and potential fishing gears for a proper utilisation of ECOSIM.

Group/catch value	Pelagic scoop nets	Longlines	Littoral small mesh	Large mesh	Cast-nets	Total catch value
1 Top predators	1.00					1.00
2 <i>O. mossambicus</i>				18.30		18.30
3 <i>O. niloticus</i>				0.01		0.01
4 <i>A. melettinus</i>	0.10					0.10
5 <i>P. filamentosus</i>					1.20	0.20
6 Other cyprinids					1.30	1.30
7 <i>E. fluviatilis</i>	0.10					0.10
8 <i>Hemiramphus</i> spp.			0.10			0.10
9 Total catch	1.20	0.000	0.10	18.31	2.50	22.11
10 Trophic level	3.05	0.000	2.96	2.01	2.29	2.10

Table 2. Diet composition of the various group for ECOPATH in Parakrama Samudra reservoir, Sri Lanka.

Prey/predator	1	2	3	4	5	6	7	8	9	10	11	12
1 Fish-eating birds												
2 Top predators	0.100	0.020										
3 <i>O. mossambicus</i>	0.600	0.350										
4 <i>O. niloticus</i>		0.010										
5 <i>A. melettinus</i>	0.050	0.060										
6 <i>P. filamentosus</i>	0.100	0.100										
7 Other cyprinids	0.140	0.150										
8 <i>E. fluviatilis</i>	0.010	0.030										
9 <i>Hemiramphus</i> spp.		0.050										
10 ZP open waters								0.500	0.400	0.010		
11 ZP littoral		0.050	0.010	0.010	0.010		0.050	0.450	0.500		0.010	
12 Insects/larvae		0.150				0.050	0.450	0.010	0.050			0.010
13 Open water PP			0.250	0.250	0.450			0.010	0.010	0.950		
14 Littoral phytop.			0.150	0.190	0.450	0.050	0.050	0.010	0.010		.0900	
15 Macrophytes			0.040			0.350						
16 Benthic prod.			0.250	0.250		0.050	0.050					0.490
17 Detritus		0.030	0.300	0.300	0.090	0.500	0.400	0.020	0.030	0.040	0.090	0.500
18 Import												
19 Sum.	1.000	1.000	1.000	1.000	1.000	1.000	1.000	1.000	1.000	1.000	1.000	1.000

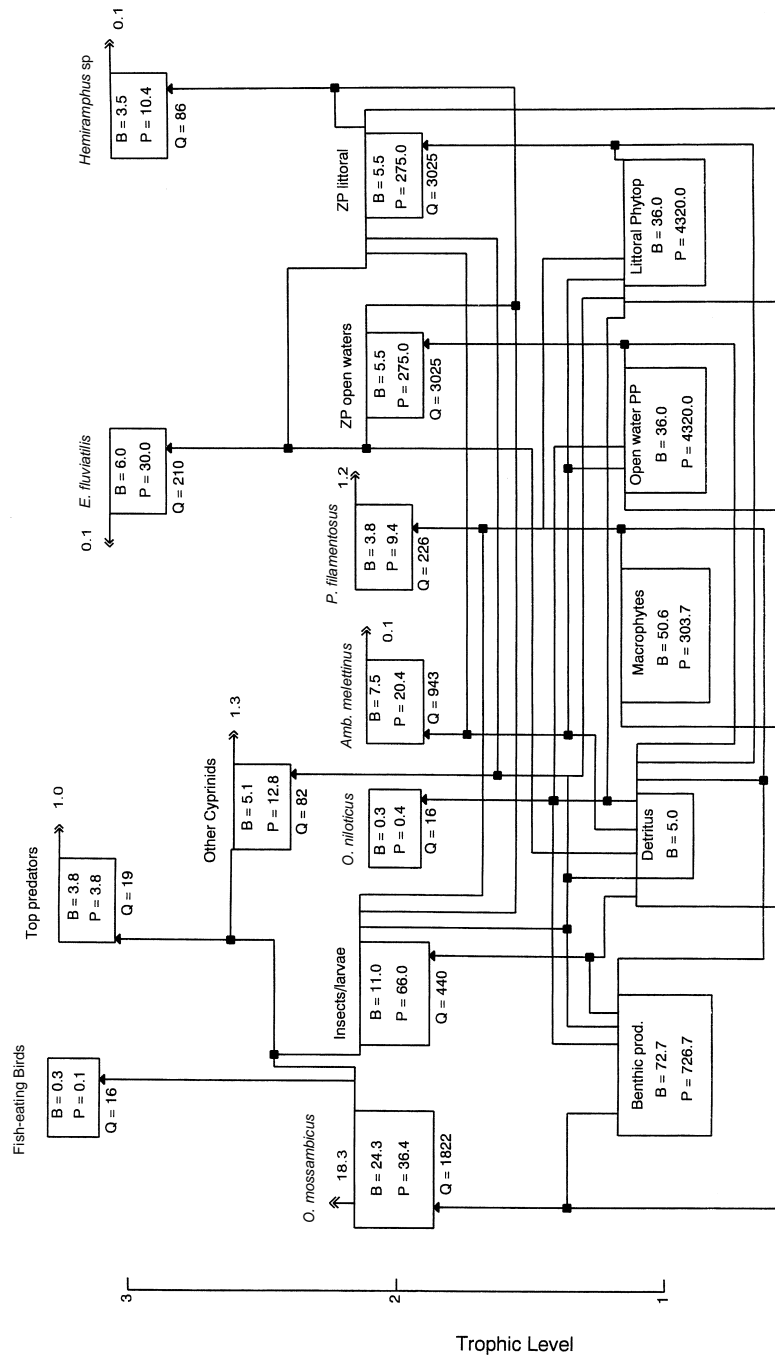

Figure 2. The ECOPATH model of Parakrama Samudra reservoir for the end of the 1970s indicating relative biomass of each group and the major flows connecting them. Less important flows are omitted as are backflows to the detritus box for the sake of clarity. The horizontal axis of symmetry of each box is aligned with the trophic level of the box in question. The numbered value of a trophic level is fractional because it depends on the diet composition of this group and on the trophic levels of its prey (Christensen and Pauly 1992).

Trophic structure analysis

When using the trophic aggregation routine of ECO-PATH, the reservoir system was divided into trophic levels which are integers (Lindeman 1942). It appears that most of the biomasses and flows are concentrated on trophic levels 1 and 2 (primary producers and their direct consumers), as summarised in Table 4. These hold true for flows from primary producers and from detritus, as well, and also from all combined trophic levels. The fishery is also clearly operating at a low trophic level (3.1).

Considering the transfer efficiency, a rather low value (4.6%) is recorded at trophic level II mainly due to the rather low utilisation of primary producers. The even lower efficiency on trophic level III (2.1%) is due to the low utilisation of pelagic and littoral zooplankton and of *E. fluviatilis* and *H. gaimardi*. These fish are not utilised by fish predators, fisheries and fish eating birds (see the low EE of these various groups).

The trophic structure of the lake is represented in terms of fish biomass and production by the pyramids in Figure 3 in the way used by Schiemer and Silva (these Proceedings) which helps to show that this ecosystem relies mostly on the lower trophic levels. This seems to be the case for most of the Sri Lankan reservoirs, whatever is the importance of the introduced fish stocks/native species (U.S. Amarasinghe and F. Schiemer, pers. obs.). In this aspect, the Sri Lankan reservoir appear to be unique when compared to larger reservoirs in other Asian countries (see Chookajorn et al. 1994 and various contributions in these Proceedings).

Mixed trophic Impacts

Based on input and output analysis, the impact an individual group in the system would have on the

other groups were quantified. The results show that a 10% increase on fishing activity could make no significant change in the system. Some exhibited a minor decrease, if there were any, but probably since there is no major competing groups in the system for both food and habitat.

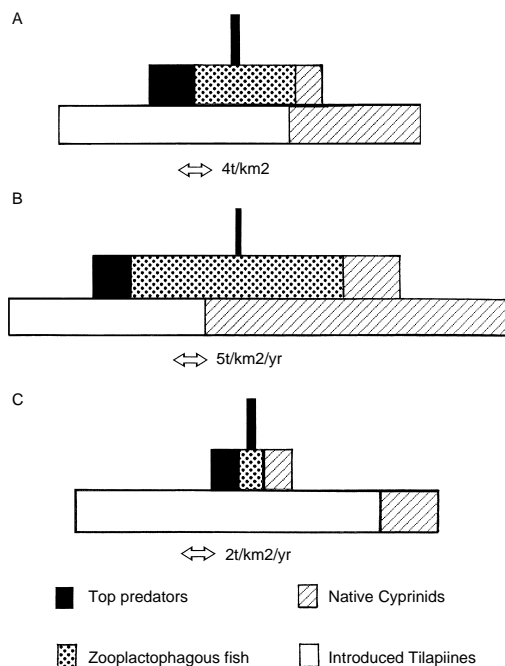

Figure 3. Trophic pyramids showing the biomasses (A), ecological production (B) and catch (C) of the fish community in Parakrama Samudra at each interger trophic level, starting from level 2 for comparison with the contribution of Scheimer et al. (these Proceedings).

Table 3. Competition for food sources among the fish community of Parakrama Samudra reservoir as assessed by computing the niche overlap for preys with the proper routine of ECOPATH, based on the method of Pianka (1973).

Group name	2	3	4	5	6	7	8	9	10	11	12	
1 Fish-eating birds	1.000	-	-	-	-	-	-	-	-	-	-	
2 Top predators	0.834	1.000	-	-	-	-	-	-	-	-	-	
3 <i>O. mossambicus</i>	-	0.044	1.000	-	-	-	-	-	-	-	-	
4 <i>O. niloticus</i>	-	0.043	0.993	1.000	-	-	-	-	-	-	-	
5 <i>A. melettinus</i>	-	0.011	0.635	0.678	1.000	-	-	-	-	-	-	
6 <i>P. filamentosus</i>	-	0.079	0.594	0.545	0.170	1.000	-	-	-	-	-	
7 Other cyprinids	-	0.294	0.461	0.459	0.151	0.607	1.000	-	-	-	-	
8 <i>E. fluviatilis</i>	-	0.077	0.042	0.042	0.035	0.026	0.086	1.000	-	-	-	
9 <i>Hemiramphus</i> spp.	-	0.111	0.055	0.055	0.040	0.045	0.153	0.984	1.000	-	-	
10 ZP open waters	-	0.002	0.432	0.432	0.654	0.031	0.025	0.023	0.022	1.000	-	
11 ZP littoral	-	0.006	0.370	0.370	0.671	0.150	0.137	0.024	0.027	0.004	1.000	
12 Insects/larvae	-	0.049	0.735	0.735	0.100	0.632	0.532	0.021	0.034	0.29	0.069	1.000

Table 4. Summary of the trophic structure of the Parakrama Samudra ecosystem when splitted into trophic levels which are intergers (Lindman 1942), Flow of biomass from primary producers (A) and detritus (B), transfer efficiency (C), distribution of the biomass (D) and catch (E) among the different trophic levels.

(A)

Trophic level (TL)\flow	Import	Cons. by pred.	Export	Flow to Det.	Respiration	Throughput
VI		0.00	0.00	0.00	0.00	0.00
V		0.00	0.00	0.04	0.15	0.19
IV		0.19	0.12	0.88	2.68	3.88
III		3.88	1.21	103.13	224.39	332.61
II		332.61	13.40	1812.51	5885.80	8044.32
I	0	8044.32	0.00	1626.02	0.00	9670.34
Sum.		8381.00	14.73	3542.58	6113.02	18051.33

(B)

Trophic level (TL) \ flow	Import	Cons. by pred.	Export	Flow to Det.	Respiration	Throughput
VI		0.00	0.00	0.00	0.00	0.00
V		0.00	0.00	0.01	0.06	0.07
IV		0.07	0.04	0.43	1.38	1.92
III		1.92	0.68	16.46	40.03	59.09
II		59.09	6.66	302.90	1033.61	1402.26
I	0	1402.26	2460.13	0.00	0.00	3862.39
Sum.		1463.34	2467.50	3190.80	1075.08	5325.73

(C)

Source\TL	2	3	4	5	6
Producer	4.3	1.5	8.0		
Detritus		4.7	4.4	6.1	
All flows		4.4	2.0	7.4	0.0
Proportion of total flow originating from detritus: 0.23					

(D)

Trophic level (TL)	Biomass
VI	0.000
V	0.004
IV	0.657
III	15.334
II	60.498
I	195.277

(E)

Trophic level (TL)	Catch
VI	0.000
V	0.000
IV	0.164
III	1.861
II	20.056
I	0.000

Sri Lankan reservoirs are under a process of eutrophication which can be assessed here by the possible increase of biomass of primary producers (phytoplankton, primary producers, macrophytes). It would result in a variable increase of their direct consumers but no adverse effects on any other group.

The evolution of the fish community assessed with ECOSIM

The ECOSIM routine has been used according to the instructions which appear in the Help files of ECOPATH 4 in order to simulate the possible evolution of the fish community during the first ten years after the end of the field work of the group headed by Scheimer (1983). For that purpose, the catch has been split into different possible fishing gears operating toward specific target fish:

- longlines: large predatory fish;
- large mesh gill-nets: tilapiine fish, mostly *O. mossambicus*;
- pelagic small mesh (scoop-nets): *E. fluviatilis* and *A. mellettinus*;
- small mesh gill-nets: *Hemiramphus* spp.;
- cast-nets: *P. filamentosus* and other small cyprinids.

As suggested by Amarasinghe (1990), the fishing effort has been assumed to double within 10 years (from the end of the 1970s to the end of the 1980s) for tilapiine fisheries. For other target fish, the fishing effort has been simulated, as if it would have been more strongly developed and it has been assumed to have trebled.

The runs performed considered both aggregated and total fishing effort, and categorised by the different gears utilised (see above).

Combining all gears generated patterns of decline in the biomass of most groups, but an increase of biomass of *O. niloticus* by 50% was evident. Increasing yield patterns of all individual groups were observed.

The patterns of declines of biomass were also observed for groups such as top predators, *O. mossambicus*, and *P. filamentosus* as responses for increase in effort using the long-lines, large mesh-sized gears and cast-nets, respectively. Yield of *O. mossambicus* displayed a limited increase when considering the increase of fishing effort with large mesh sizes. Increase in fishing efforts using scoop-nets generated increased yields for *A. meletinus* and *E. fluviatilis* while yields of *Hemiramphus* increased when littoral small mesh sized are utilised. In both scoop-nets and littoral small mesh gears, biomass remained unchanged and slight increases for biomass of top predators, *E. fluviatilis* and *O. niloticus*, while

increasing yield patterns of all individual groups were recorded.

An increase of fishing effort towards predatory fish would not have any significant impact on *A. mellettinus* or *E. fluviatilis*, since these populations were and are currently not controlled by predators. This seems to be a general observation in Sri Lankan reservoirs as quoted by Piet and Vijverberg (1998).

An increasing effort towards the small pelagic fish (*E. fluviatilis* and *A. mellettinus*) would not harm the existing fisheries of tilapiine fish because these small clupeids are spatially segregated from the juvenile tilapias. These small pelagics could be exploited in open water zones.

A particular case has to be made for *O. niloticus* which has gained an increasing importance in the fish catch and is estimated, considering its short life-span and still smaller biomass, to be relatively more exploited as compared to *O. mossambicus* (Amarasinghe and De Silva 1992).

It is interesting to see that the relationship of catch vs. fishing mortality is flat topped for a wide range of fishing mortality for groups with high P/B values: thus suggesting a Beverton and Holt recruitment curve type i.e. flat on the right part of the curve. For top predators with low PB/value, the curve is bell-shaped, showing more sensitivity to the fishing effort.

The same routine on *E. fluviatilis* and *H. gaimardi* (Figure 5) showed that increased fish yields of these individuals have no effects on other organisms since they are completely independent due to their varied food preferences and even feeding habits (i.e. feeding time within the day).

The distribution of organisms and ECOSPACE

ECOSPACE is another simulation program that was recently incorporated in ECOPATH. It allows one to have a graphical view of the whole ecosystem being considered and to observe each individual group occurring in their specific habitats. It is also possible to observe different possible biomass scenarios (levels are color-coded) induced by the movement patterns of any individual group, in a specified habitat, to other existing organisms.

The fluctuations of biomass, as recorded, show to what extent the model as designed will remain in equilibrium with time. This was shown by oscillating trends formed without increase or collapse of any particular group.

Discussion

The major difficulty in building ecological models, such as ECOPATH, is usually the availability and collection of the necessary information for basic input. In the present exercise, the key data which

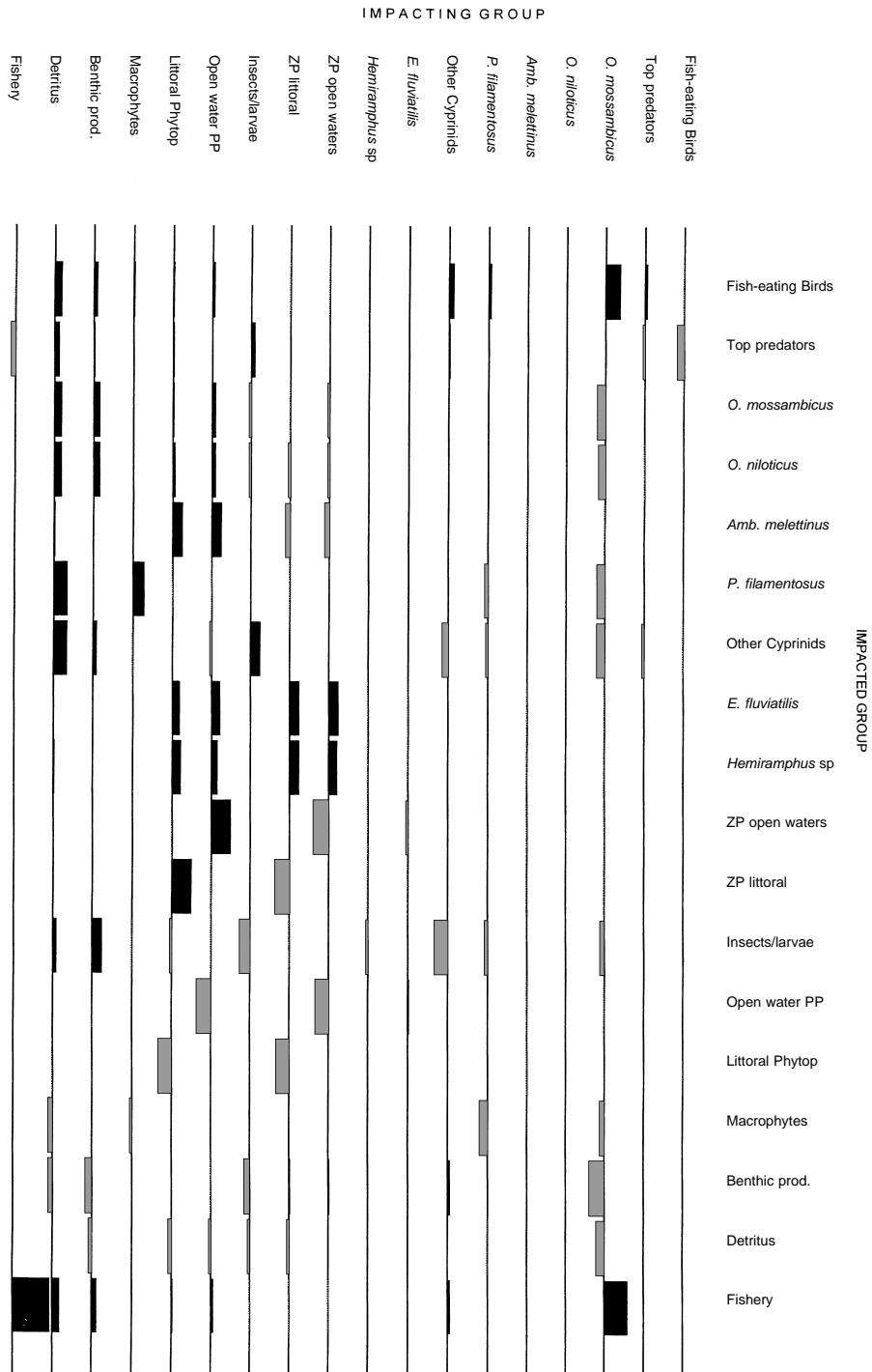

Figure 4. The mixed trophic impacts in Parakrama Samudra ecosystem. Impact of an increase in the biomass of the groups on the left on the group noted horizontally. Positive impact are shown above the base line, negative impacts below.

have been obtained from published literature and some uncertainties regarding some input data were overcome by adopting published data from other reservoirs with similar consumer organisms (Piet 1998). The use of a three-dimensional design, considering the trophic, spatial, and temporal factors, is the best way to design the niche occupation (and potential overlap) of important fish species (Piet 1998). Trophic dimension focuses on the diet composition, the spatial dimension on the distribution, while the temporal dimension deals on the specified time of the day when a particular species is actively foraging (Piet and Vijberberg 1998). Here, only the trophic and spatial dimensions were considered. However, the limited observed overlaps could be partly explained by the knowledge of the time dimensions, as documented in other Sri Lankan reservoirs (see, for instance, Piet and Guruge 1997) and as it is documented within the FISHSTRAT Project (Schiemer and Silva, these Proceedings; R. Hoffer and G. Winckler pers. obs.).

The ECOSIM routine normally requires the top predators to be split into two boxes, the juveniles and

adults which have different feeding habits and different demographical status (P/B values). This is of no considerable relevance here because the impact of these fishes on the whole ecosystem is highly limited by their low biomass and production. In addition, demographical information on these species is not really available. Top predators are always scarce in Sri Lankan reservoirs, at least in the harvests of fishers. One reason is that they are originally riverine species not really adapted to lacustrine conditions (Piet and Vijverberg 1998). The evolution of the fish community, as described by analysing the impact of each fishing gear separately, helps to understand the recent evolutionary trends in the Sri Lankan reservoirs' fish communities. Pauly's (1998) view is that for clarification of management analyses, functional groups in the ECOPATH suite should be defined by one food type, one fishing gear, and one habitat. This is confirmed by the present exercise.

The contribution of detritus to the whole ecosystem (18%) is in the range of what is observed in other tropical water bodies (Christensen and Pauly 1993).

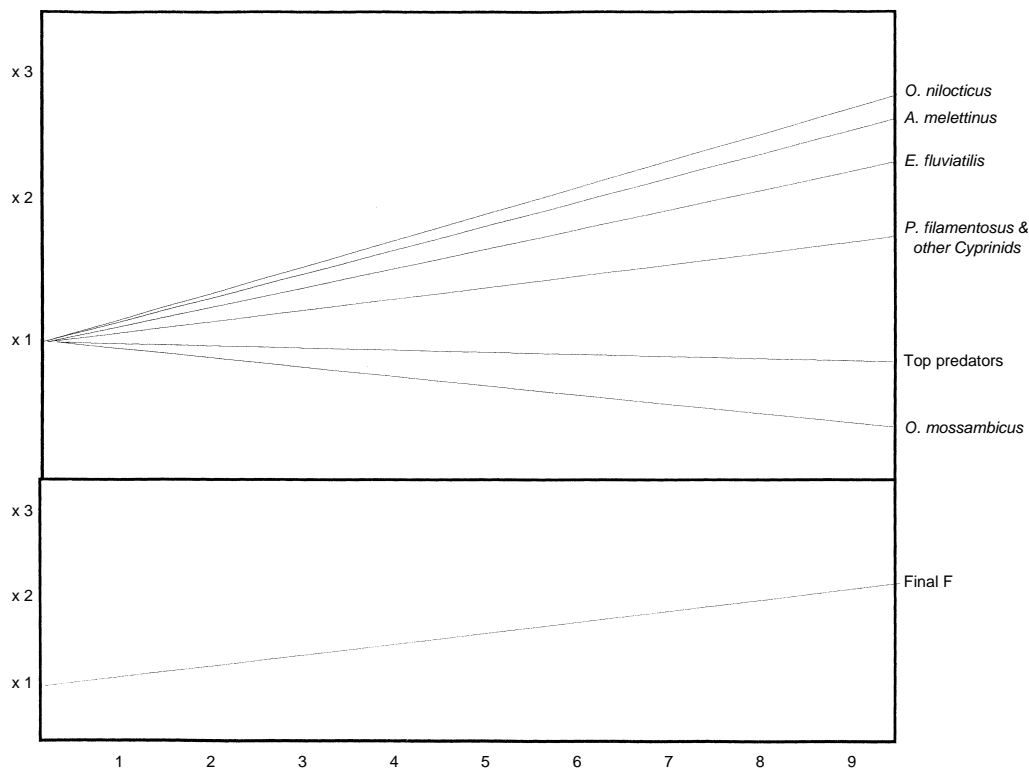

Figure 5. Variations of catch between 1980 and 1990 for the main fish groups under an increasing fishing effort as described using ECOSIM.

Conclusion

The present contribution shows that the use of ECO-PATH has made it possible to balance the biomass and annual production of the key interacting groups in Parakrama Samudra, at least during the late 1970s. This was achieved by using the data gathered from the literature and through the personal knowledge of the lake by resident scientists. It shows as well that the ecological overlap between introduced cichlid species and native species in terms of food resources is very limited. This is partly due to the difference of distribution patterns over the day of the various species under consideration.

The ECOSIM routine has shown that the increasing fishing effort through the use of various fishing gears has a strong influence on the main target but has limited impacts on other fish groups. Again, this is related to the distribution patterns of the fish observed. The stock recruitment relationships seem to follow a Beverton and Holt model

(Figure 6). Notice the emergence of flat curves in the beginning of the trend (right part), mainly for short-lived species. Our understanding of the functioning and dynamics of this ecosystem has been improved by the use of ECOSPACE, which took into account the distribution of fish and fishing effort in littoral and open waters.

It is expected that other reservoirs which are investigated within the FISHSTRAT Project have similar trophic structure and that similar investigations in terms of fisheries management will therefore be possible.

Acknowledgments

The authors are extremely grateful to Villy Christensen for helpful advice when using ECOSIM and interpreting the output. This work has been carried out under the EU INCO/DC 'FISHSTRAT' Project IC18CT-0190, under the management of Annie Duncan and, afterwards, David Simon.

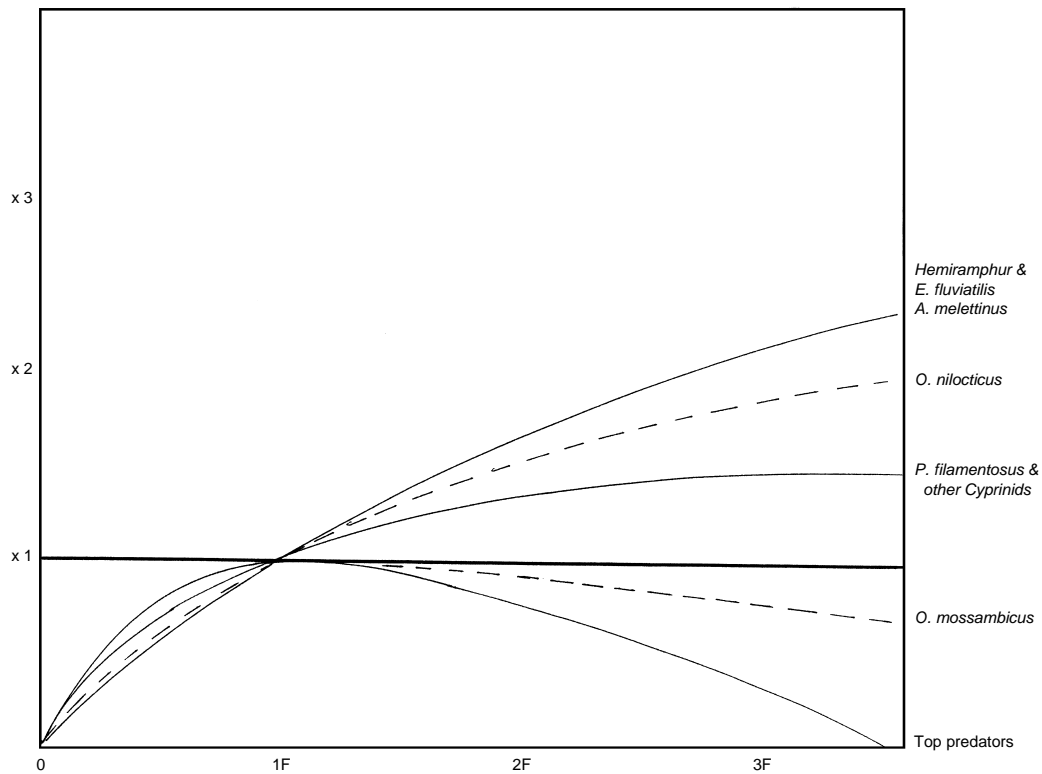

Figure 6. Relationships between catch and fishing mortality as expressed using ECOSIM, showing the flat plateau observed with most species, except fish predators. It shows a Beverton and Holt stock recruitment relationships.

References

- Allen, K.R. 1971. Relation between production and biomass, *Journal of the Fisheries Research Board of Canada*, 28:1573-1581.
- Amarasinghe, U.S. 1990. Minor Cyprinids resources in a man made lake in Sri Lanka: a potential supplementary source of income for fishermen. *Fisheries Research*, 9: 81-89.
- Amarasinghe, U.S. and De Silva, S.S. 1992. Populations dynamics of *Oreochromis mossambicus* and *Oreochromis niloticus* (Cichlidae) in two reservoirs in Sri Lanka. *Asian Fisheries Sciences*, 5: 37-61.
- Amarasinghe, U.S., De Silva, S.S. and Moreau, J. 1989: Spatial changes in growth and mortality and their effect on the fisheries of *Oreochromis mossambicus* in a man made lake in Sri Lanka. *Asian Fisheries Sciences*, 3: 57-68.
- Baijot, E., Moreau, J. and Zigani, R. 1997. Hydrobiology and fisheries in small reservoirs of the Sahelian region. Publ. C.C.E. Brussels - C.T.A. Wageningen, The Netherlands, 250 p.
- Bitterlich, G. 1985. The nutrition of stomachless phytoplanktonic fish in comparison with tilapia. *Hydrobiologia*, 121: 173-179.
- Chookajorn, T., Leenanond, Y., Moreau, J. and Sricha-roendam, B. 1994. Evolution of trophic relationships in Ubolratana reservoir (Thailand) as described using a multispecies trophic model. *Asian Fisheries Sciences*, 7: 201-213.
- Christensen, V. and Pauly, D. 1992. ECOPATH II a software for balancing steady state ecosystems models and calculating network characteristics. *Ecological Modelling*, 61: 169-185.
- (eds.). 1993. *Trophic Models of Aquatic Ecosystems*, ICLARM Conference Proceedings 26: 390 p.
- 1995. Fish production, catches and the carrying capacity of the world oceans. *NAGA, The ICLARM Quarterly*, 18 (3): 34-40.
- 1996. *Ecological Modelling for all*, NAGA, The ICLARM Quarterly, 19(2): 25-26.
- De Silva, S.S. 1985. Status of the introduced cichlid *Sarotherodon mossambicus* (Peters) in the reservoir fishery of Sri Lanka: a management strategy and ecological implications. *Aquaculture and Fisheries management*, 1: 91-102.
- De Silva, S.S. 1988. Reservoirs of Sri Lanka and their fisheries. *FAO Fisheries Technical Papers*, 298: 128 p. Publ. FAO Rome
- De Silva, S.S. and Sirisena, H.K.G. 1987. New fish resources of reservoirs in Sri Lanka, feasibility of introduction of a subsidiary gill-net fisheries for minor cyprinids. *Fisheries Research*, 6: 17-34.
- Fernando, C.F. and Rajapaksa, R. 1983. Some remarks on long-term and seasonal changes in the zooplankton of Parakrama Samudra. In: Schiemer, F. ed. 1983. *Limnology of Parakrama Samudra*, Sri Lanka, Developments in Hydrobiology, Dr W. Junk Publisher, 77-84.
- Hofer, R. and Schiemer, F. 1983. Feeding ecology; assimilation efficiency and energetics of two herbivorous fish *Sarotherodon mossambicus* (Peters) and *Puntius filamentosus* (Cuvier and Valenciennes) In: Schiemer, F. ed. 1983. *Limnology of Parakrama Samudra*, Sri Lanka, Developments in Hydrobiology, Dr W. Junk Publisher, 154-164
- Hustler, K. 1997. The ecology of fish-eating birds and their impact on the inshore fisheries of Lake Kariba. In Moreau, J. (ed) *Advances in the Ecology of Lake Kariba*. University of Zimbabwe Publications, Zimbabwe, 196-218.
- Jarre, A., Palomares, M.L., Soriano, M.N., Sambilay, V.C. and Pauly, D. 1990. A User's Manual for MAXIMS. A computer program for estimating food consumption of fishes from diel stomach content data and population parameters. ICLARM software 4. Publ. International Center for Living Aquatic Resources Management, Manila Philippines: 27 p.
- Lévêque, C., Durand, J.R. and Ecoutin, J.M. 1977. Relation entre le rapport P/B et la longévité chez les organismes. *Cahiers de l'ORSTOM, série Hydrobiologie*, 11: 17-32.
- Lindeman, R.L. 1942. The trophic dynamic aspect of ecology. *Ecology*, 23: 399-418.
- Maitipe, P. and De Silva, S.S. 1985. Switches between zoophagy, phytophagy and detritivory of *Sarotherodon mossambicus* (Peters) populations in twelve sri lankan man-made lakes. *Journal of Fish Biology*, 26: 49-61.
- Mavuti, K., Moreau, J., Munyandorero, J. and Plisnier, P.D. 1996. Trophic relationships in two shallow lakes of Africa, Lake Naivasha (Kenya) and Lake Ihema (Rwanda) comparison with Lake George. *Hydrobiologia*, 321: 89-110.
- Moreau, J. ed. 1997. *Advances in the ecology of Lake Kariba*, Harare, Univ. Zimbabwe Publ. 270 p.
- Moreau, J. 1999. The adaptation and impact on trophic relationships of introduced cichlids in Southeast Asian lakes and reservoirs. In: van Densen, W.L.T. and Morris, M.J. eds. *Fish and fisheries of lakes and reservoirs in Southeast Asia and Africa*. Westbury Publishing. Otley, UK, 207-228.
- Moreau, J., Christensen, V. and Pauly, D. 1993. A trophic model for Lake George, Uganda. In: Christensen V. and Pauly, D. eds. 1993. *Trophic Models of Aquatic Ecosystems*, ICLARM Conference Proceedings 26: 124-129.
- Moreau, J. and De Silva, S.S. 1990. Predicting yield models for lakes and reservoirs in Philippines, Sri Lanka and Thailand. *F.A.O. Fish. Tech. Pap.* 319: 42 p.
- Moreau, J., Cronberg, G., Games, I., Hustler, K., Kautsky, N., Kiibus, M., Machena, C. and Marshall, B. 1997. Biomass and flows in Lake Kariba: Towards an ecosystem approach. In Moreau J. ed. 1997. *Advances in the ecology of Lake Kariba*, Harare, Univ. Zimbabwe Publ. 219-230.
- Newrkla, P. and Duncan, A. 1984. The biology and density of *Ehirava fluviatilis* (clupeoid) in Parakrama Samudra. *Verh. Internationale Vereinungen Limnology*, 22: 1572-1578.
- Palomares, M.L. 1991. *La consommation de nourriture chez les poissons; étude comparative, mise au point d'un modèle prédictif et application à l'étude des réseaux trophiques*, Ph.D. Thesis, Institut National Polytechnique de Toulouse France, 210 pp.
- Palomares, M.L. and Pauly, D. 1998. Predicting food consumption of fish populations as functions of mortality, food type, morphometrics, temperature and salinity. *Marine and Freshwater Research*, 49(5): 447-453.

- Pauly, D. 1980. On the interrelationship between natural mortality, growth parameters and the mean environmental temperature in 175 fish stocks. *J. Cons. Explor. Mer.*, 39(3): 175–192.
- Pauly, D. 1986. A simple method for estimating the food consumption of fish populations from growth data and food conversion experiment. *Fisheries Bulletin*, 84: 827–839.
- Pauly, D. ed. 1998. A workshop on Ecosim and Ecospace. The Fisheries Center, Univ. British Columbia, Vancouver, Canada var. pages.
- Pet, J.S. and Piet, G.J. 1993. The consequences of habitat occupation and habitat overlap of the introduced *Tilapia Oreochromis mossambicus* and indigenous fish species for fishery management in a Sri Lankan reservoir. *Journal of Fish Biology*, 43(A): 193–208.
- Piet, G.J. and Guruge, W.A.H.P. 1997. Diel variation in feeding and vertical distribution of ten co-occurring fish species: consequences for resources partitioning. *Environmental Biology of Fishes*, 50: 293–307.
- Piet, G.J. 1998. Impact of environmental perturbations on a tropical fish community. *Canadian Journal of Fisheries and Aquatic Sciences*, 55: 1842–1853.
- Piet, G.J. and Vijverberg, J. 1998. An ecosystem perspective for the management of a tropical reservoir fishery. *International Revue der gesamten Hydrobiologie*, special issue.
- Polovina, J.J. 1984. Model of a coral reef ecosystem. The ECOPATH model and its application to French Frigate Shoal. *Coral Reefs*, 3: 1–11.
- Polovina, J.J. and Ow, M.D. 1985. An approach to estimating an ecosystem box model. *Fisheries Bulletin*, 83: 457–460.
- Pullin, R.S.V. and MacConnell, R.H. 1982. The biology and culture of *Tilapia*. ICLARM Conference Proceedings 7, Publ. International Center for Living Aquatic Resources Management, Manila Philippines, 432 p.
- Ricker, W.E. 1969. Food from the Sea. In: *Resources and Man, A Study and Recommendations by the Committee on Resources and Man* (San Francisco U.S.A., W.H. Freeman), 87–108.
- Schiemer, F. ed. 1983. *Limnology of Parakrama Samudra, Sri Lanka. Developments in Hydrobiology*, Dr W. Junk Publisher, 150: 236 p.
- Schiemer, F. and Duncan, A. 1988. The significance of the ecosystem approach for reservoir management. In: de Silva, S.S. ed. *Reservoir Fisheries Management and Development in Asia*. Publ. IDRC Ottawa, Canada, 183–194.
- Schiemer, F. and Hofer, R. 1983. A contribution to the ecology of the fish fauna from the Parakrama Samudra reservoir. In: Schiemer, F. ed. 1983. *Limnology of Parakrama Samudra, Sri Lanka. Developments in Hydrobiology*, Dr W. Junk Publisher, 150: 135–148.
- Sirisena, H.K.G. and De Silva, S.S. 1989. New fish resources of reservoirs in Sri Lanka II: Further studies on a gill-net fishery for minor cyprinids. *Fisheries Research*, 7: 17–29.
- Walters, C., Christensen, V. and Pauly, D. 1997. Structuring dynamic models of exploited ecosystems from trophic mass balanced assessments. *Review of Fish biology and Fisheries*, 7: 139–172.
- Walters, C., Pauly, D. and Christensen, V. 1998. Ecospace, a software tool for predicting mesoscale spatial patterns in trophic relationships of exploited ecosystems with special reference to impacts of marine protected areas. ICES Annual Conference
- Welcomme, R.L. 1988. International introduction of inland aquatic species. *FAO Technical Paper*, 249: 318 p. Publ. FAO, Rome.
- Winkler, H. 1983. The ecology of cormorants (genus *Phalacrocorax*). In: Schiemer, F. ed. 1983. *Limnology of Parakrama Samudra, Sri Lanka. Developments in Hydrobiology*, Dr W. Junk Publisher, 150: 193–199.

Ecosystem Structure and Dynamics—A Management Basis for Asian Reservoirs and Lakes

F. Schiemer¹, U.S. Amarasinghe², J. Frouzova³, B. Sricharoendham⁴ and E.I.L. Silva⁵

Abstract

INCO-DC FISHSTRAT Project, funded by the European Commission, is an ongoing multi-disciplinary research program undertaken over the period 1998–2001. Three reservoirs in Sri Lanka (Victoria, Minneriya and Udawalawe) of different morphology, age and geographic location, Ubolratana reservoir, in Thailand, and Lake Taal, in the Philippines, are the object of this study. The scope of the project encompasses a comparison of the limnology, fisheries and socio-economic aspects of local communities in order to determine whether the trophic characteristics and key ecosystem processes sustain the available fisheries, and to examine the ecological potential for increased fish production by intensive cage culture. The paper first presents integrated results on trophic state, trophic structure and food web relationships of different water bodies. The results demonstrate the importance of ecosystem-orientated analysis in order to optimise management strategies. The broad spectrum of Asian water bodies studied allows testing of a set of hypotheses on: 1) the control of the trophic state of lakes and reservoirs by geographic, climatic and morphometric conditions; 2) the significance of the structure of the fish assemblages (biogeography, exotic species) on ecosystem processes; 3) bottom up versus top down control under Asian reservoir and lake conditions (in comparison to established concepts for water bodies in the temperate zone); and 4) the human impact and resilience of ecosystem processes and trophic conditions towards human impact.

A COLLABORATIVE international project funded by the European Union's INCO-DC Program is undertaking research in five water bodies (four reservoirs and one lake) in Sri Lanka, Thailand and the Philippines over the period 1998–2001. The partner institutions within this Project are from the three Asian

countries, the United Kingdom, Austria, France, the Netherlands and the Czech Republic.

The program combines three main research fields:

1. Ecosystem orientated limnological studies;
2. Fisheries and fish communities;
3. Socio-economics of the riparian fishing communities.

The aim of the program is to integrate the results from the three fields and to define their interdependencies. The ecology of the reservoir ecosystems determines the habitat quality and the carrying capacity for fish and provides the basis for its fisheries and local socio-economics. On the other hand, there are top-down influences on the aquatic ecosystems by fisheries management via exploitation, stocking practices, cage culture etc. and by the socio-economics of the local communities via land-use practices. Also the regulation of the hydraulic regime for irrigation and hydroelectric power generation, have profound impacts on the ecology of the aquatic resources (Figure 1).

¹Department of Limnology, Institute of Ecology and Conservation Biology, Althanstr. 14, PO Box 285, A-1091 Vienna, Austria. E-mail: friedrich.schiemer@univie.ac.at

²Department of Zoology, University of Kelaniya, Kelaniya 11600, Sri Lanka. E-mail: zoousa@kln.ac.lk

³Hydrobiological Institute AS CR, Na sadkach 7, 370 05 Ceske Budejovice, Czech Republic. E-mail: frouzova@hbu.cas.cz

⁴Department of Fisheries, National Inland Fisheries Institute, Pholyothin Road, Jatujak, Bangkok, 10900, Thailand. E-mail: boonsosr@fisheries.go.th

⁵Institute of Fundamental Studies, Hantana Road, Kandy, Sri Lanka. E-mail: sil@ifs.ac.lk

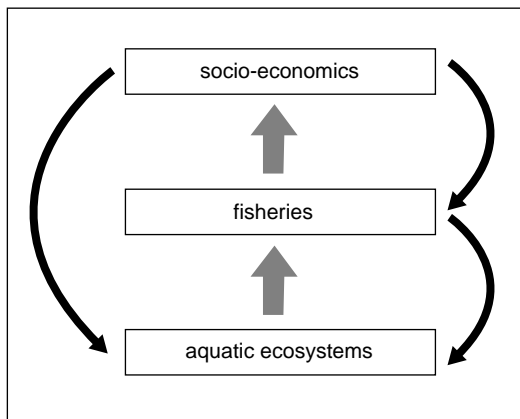

Figure 1. Research fields of the FISHSTRAT Program and their linkages.

A good understanding on the structure and function of tropical aquatic systems is required to optimise many uses and beneficiaries of reservoirs and lakes in the tropics with regard to the demand for irrigation, generation of hydropower, fisheries, and drinking water supply and also to maintain and conserve the indigenous biota and biodiversity. The lessons learned from the temperate zone limnology are only partially applicable to shallow tropical water bodies because the nature of the biota and characteristic pathways and processes differ to a large extent (Schiemer 1996).

We propose that reservoir management should be based on an ecosystem-oriented approach, focusing on the main functional processes and how they are dependent on human impacts and management practices.

From the point of view of fisheries development in Asian reservoirs and lakes, such an approach is particularly relevant in order to understand:

- the habitat conditions for the fish assemblages, for example, the extent of inshore zones, the conditions of the limnetic and open water area with regard to its thermal structure and possible deoxygenation of the deeper water strata;
- the carrying capacity of the resource base (food and energy) for the fish community as determined by primary and secondary production;
- the food web structure and the efficiency of its utilisation by the native fish community versus introduced exotics like *Oreochromis* spp.

This aspect also addresses the question of unutilised resources (vacant food niches) which is particularly relevant in countries like Sri Lanka and Thailand where an indigenous lacustrine fauna is essentially lacking. Trophic structure in such cases

may be unbalanced, particularly in new reservoirs due to the availability of vacant food niches.

Besides, such general aspects of limnological studies are required for analysing and solving practical problems, such as emergence of phytoplankton blooms and their toxic effects, the accumulation of toxic substances (i.e. pesticides and heavy metals) in the food chain.

The paper addresses the following three main aspects based on the preliminary results gathered during the FISHSTRAT Program:

1. It gives an overview on the basic limnological features and the trophic status of the water bodies studied and discusses the regulation of the trophic status by physiographic conditions as well as internal mechanisms and top-down control.
2. An attempt is made to provide information on the fish communities (i.e. occurrence, their size and biomass structure, spatio-temporal patterns, and trophic ecology)

Limnology and trophic state

Five water bodies being studied in the FISHSTRAT program of three reservoirs in Sri Lanka, namely Minneriya, Udawalawe and Victoria, Ubolratana reservoir in Thailand and Lake Taal in the Philippines. Figure 2 indicates the wide range of their morphometry. Minneriya and Udawalawe reservoirs are essentially shallow irrigation water bodies located in the lowland dry zone of Sri Lanka. Figure 2 also shows the Parakrama Samudra, a well-studied Sri Lankan reservoir (Schiemer 1983) as a comparison. Victoria, which is located in the uplands of Sri Lanka (450m above mean sea level) is one of the newly impounded deep ($z_{\max} = 105$ m) reservoirs built exclusively for hydroelectric power generation. Ubolratana is a large (410 k²) man impounded for a multipurpose utilisation (irrigation and hydropower). In contrast, Lake Taal is a large (260 k²) and very deep ($z_{\max} = 200$ m) volcanic lake.

In reservoirs, the seasonal water level fluctuation, governed by the requirements for irrigation and hydroelectric power generation, plays a particularly important role in the shallow basins like Minneriya, Parakrama Samudra, Udawalawe and Ubolratana. In Udawalawe, for example, the average annual amplitude in water level is 8 m which changes the aquatic area from 34.4 to 14 km², i.e. from 100 to 41% and the reservoir capacity from 268.6 to 80 MCM, i.e. from 100 to 30%. These fluctuations produce large draw-down areas with terrestrial plant growth which form a part of the energy and carbon sources of the aquatic ecosystem after inundation and cause dramatic changes in the internal exchange processes between the bottom sediment and the water column.

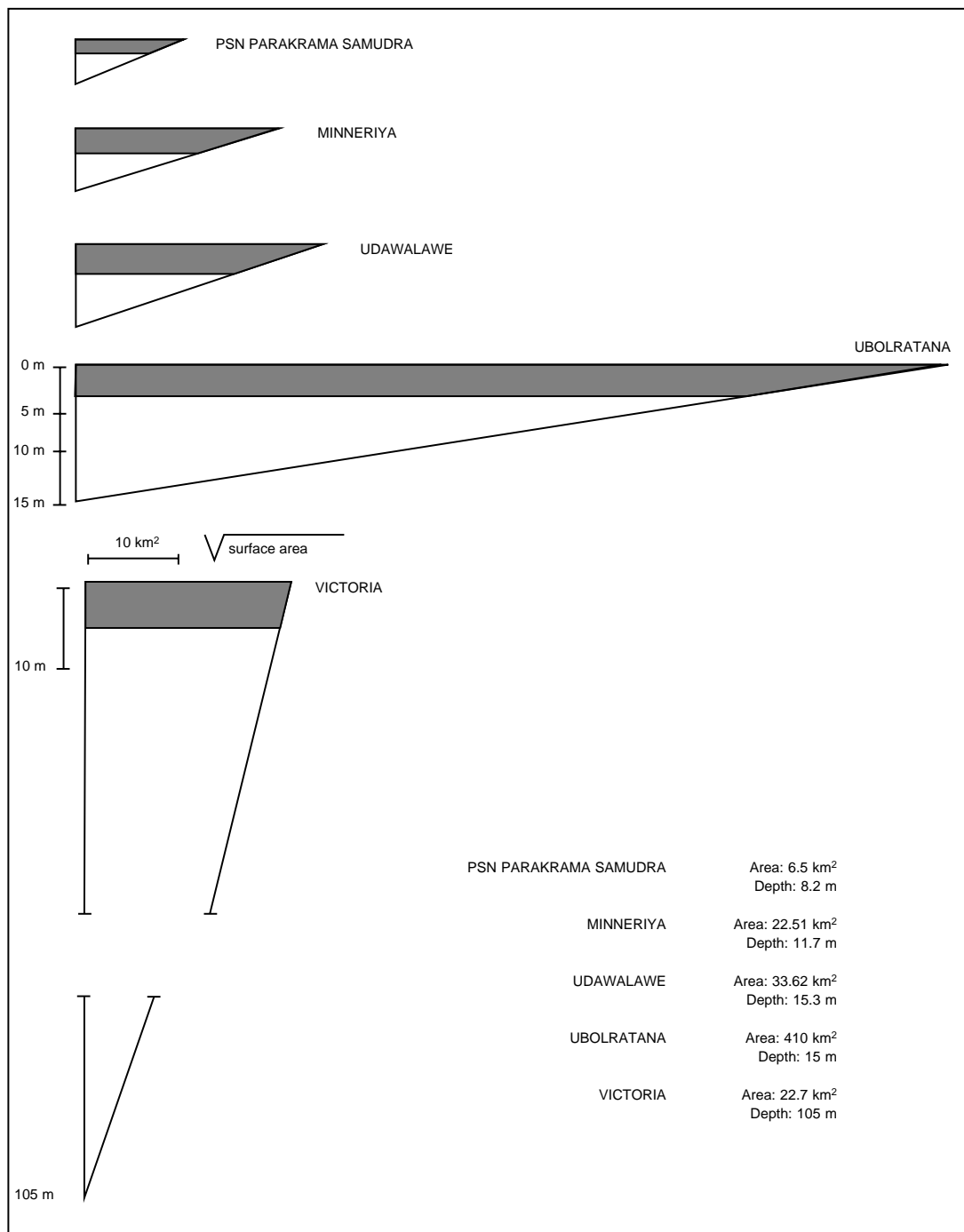

Figure 2. Basic features of the morphometry of the five water bodies studied. The maximal depth and the surface area at full supply level (square root) are drawn to scale.

In contrast, the seasonal water level fluctuation in the Victoria reservoir is of much lower significance due to the steeper basin and the higher capacity. In Lake Taal, seasonal water level fluctuation is insignificant.

The trophic status of the water bodies (i.e. the levels of primary production achieved) is primarily dependent on the nutrient pool (phosphorous and nitrogen).

Figure 3 provides a comparison of the overall nutrient availability in the five water bodies. The solid line is based on the ratio of P:N required for a balanced phytoplankton growth and indicates which of these two nutrients is potentially limiting. It is apparent that, except for Lake Taal, which is characterised by outstandingly high P concentrations due to its volcanic geology, all other water bodies have N in excess compared to P. The reservoirs studied lay within meso to eutrophic range with

reference to Organisation for Economic Cooperation and Development (OECD) (Vollenweider and Kerekes 1982) standards used for P in temperate zone water bodies.

The seasonal variability in nutrient levels is particularly high in the shallow lowland reservoirs in parallel with the seasonal water level fluctuations. The nutrient levels are high at low water levels. For example, there was a four-fold increase in the P levels at draw-down in August compared to higher water levels in February in the Minneriya reservoir. This clearly demonstrates that shallowness has a strong impact on nutrient concentrations due to internal loading from the sediment. In contrast, the seasonal changes in nutrients are less pronounced in the deep Victoria reservoir.

Chlorophyll-*a* content (Chl-*a*) is the most appropriate index of phytoplankton biomass and was

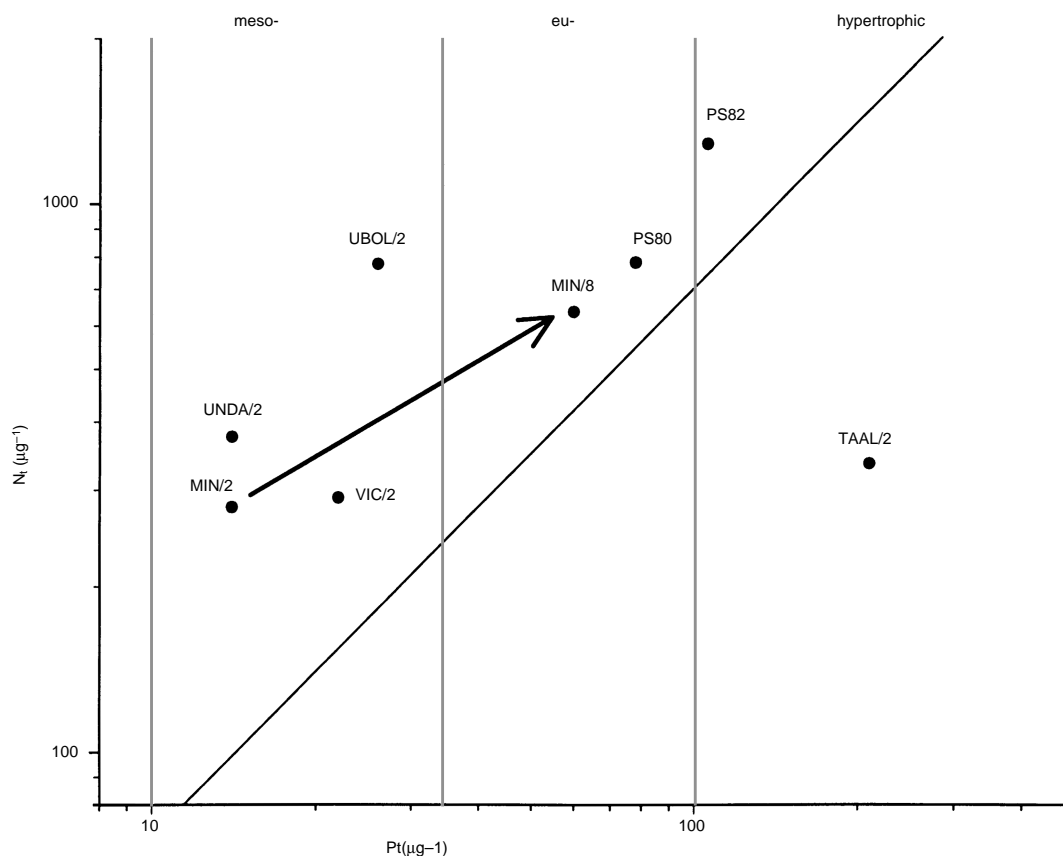

Figure 3. Total phosphorous and total nitrogen levels of the five water bodies studied. Values are for February 1999. For Minneriya, the increase of nutrients with the lowered water level in August 1999 is indicated. Values from the Parakrama Samudra Project (Schiemer 1983) are given for comparison. The solid line is the ratio in nutrient requirement (P:N) for algae.

determined as the standard method to define the trophic status. The significant relationship between total phosphorus (P_{tot}) concentrations and Chl-*a* contents (Dillon and Rigler 1974) established for temperate zone lakes and reservoirs, is used here (Figure 4) for comparative purposes and also as a standard. However, a strong scatter of data points was found for Asian reservoirs during this analysis. It appears that the Chl-*a* levels per unit P concentration are higher compared to the regression established for the temperate lakes. This can be attributed to faster recycling processes in the tropical reservoirs. The seasonal variation of Chl-*a* contents is very high especially in the shallow reservoirs and is correlated with the seasonal change in P_{tot} .

Lake Taal with its exceptionally high phosphorous levels is characterised by low phytoplankton biomass.

It is important to understand how primary production (PP) is controlled with respect to the management of reservoir ecosystems. Primary production is governed (Figure 5) by a wide range of external

influences and internal processes within the aquatic systems. In order to gain insight into the nature of these effects, the areal production (P_a) accumulated over the water column per m^2 can be used. P_a is the gross production, the amount of carbon fixed in the water column per unit area of the water body. It is the product of algal biomass (B in units of Chl-*a* $\mu g/L$) and its specific productivity. The specific photosynthetic rate is the amount of carbon fixed per unit Chl-*a* per hour. The algal biomass is the result of phytoplankton production minus the losses due to sedimentation, hydrological flushing and grazing by zooplankton and algivorous fish.

This specific production rate is dependent on:

- the size structure, taxonomic composition and physiological state of algal communities;
- the light climate in the water column (i.e. the total incoming irradiance and its attenuation controlled by the inorganic and organic turbidity); and
- availability of nutrients.

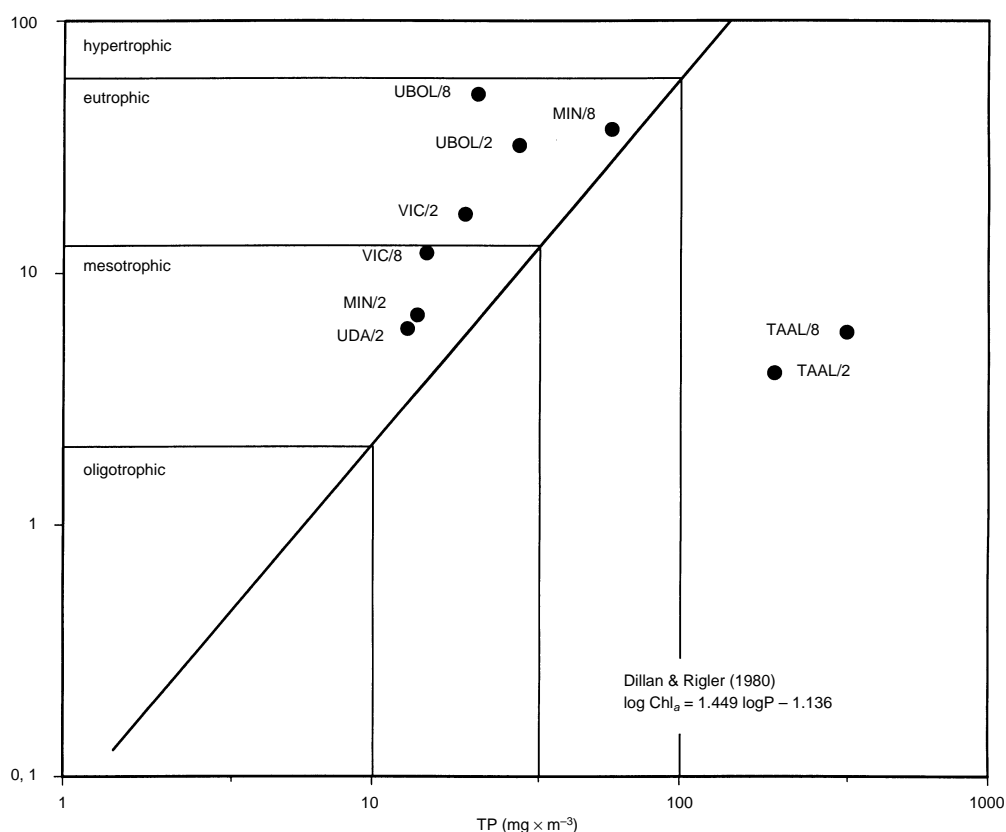

Figure 4. Relationship of total phosphorous and Chl-*a* of the water bodies studied. The regression line calculated by Dillon and Rigler (1974) for temperate zone water bodies is given for comparison.

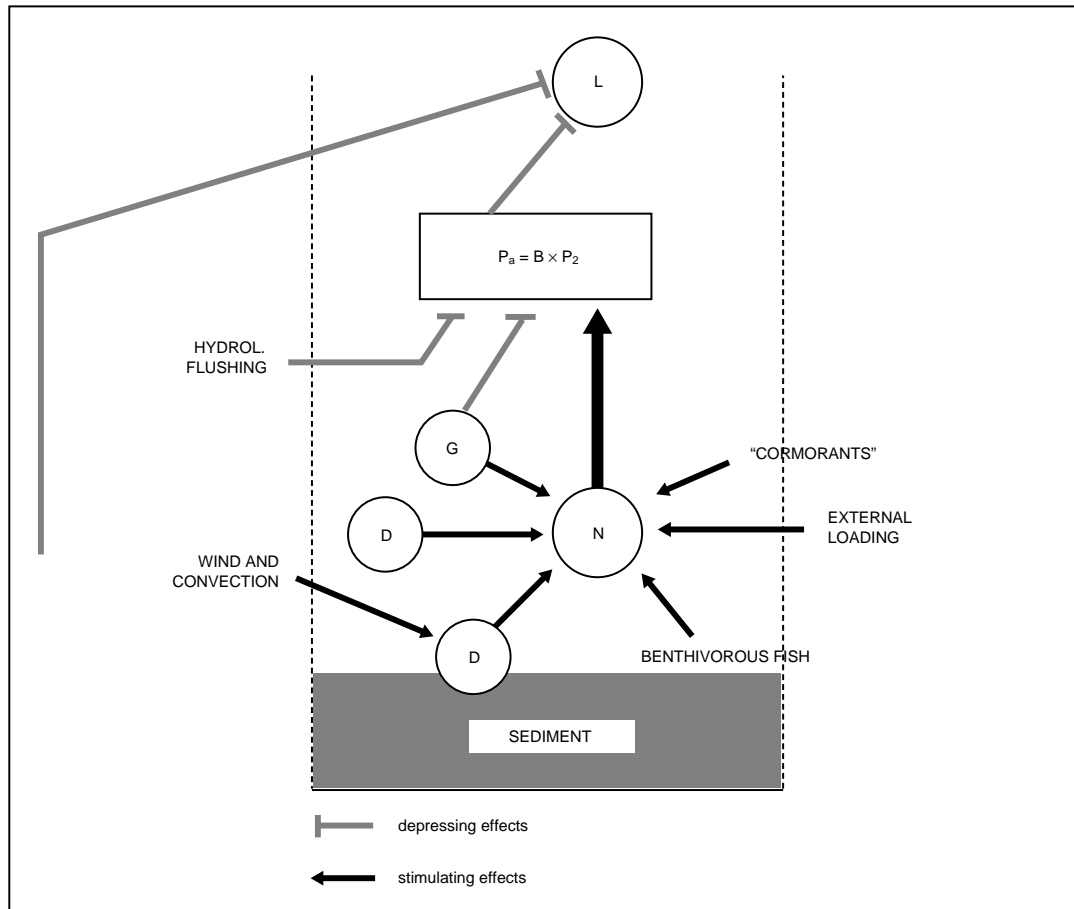

Figure 5. Regulation of primary production. P_a = areal production (per m^2 lake area); P_s = specific production per unit phytoplankton biomass (B); L = Light conditions: incoming irradiance and its attenuation within the water column; N = availability of limiting nutrients (phosphorus); D = decomposition processes in the water column and at the sediment surface; G = grazing of phytoplankton by zooplankton and filter-feeding fish (Schiemer 1996).

The latter is a result of nutrient intake from the catchment by inflow and diffuse sources (external loading). In shallow tropical water bodies, nutrient availability appears even to a larger extent to be determined by internal recycling processes, i.e. an internal loading by nutrient release from the sediments and grazing by zooplankton and fish. Table 1 presents some results obtained on primary production during FISHSTRAT. The areal gross primary production is generally high in the order of $2 \text{ g C/m}^2/\text{day}$. However, a high fraction of the assimilated energy is used up by the respiration of the algal and microbial community of the water body over the 24 h cycle. Therefore, the daily carbon budget is dependent on the irradiance level of the particular day. For example, on rainy days with low irradiance,

the carbon budget might be negative and the $\text{Chl-}a$ levels will decline accordingly.

A further important factor for the daily carbon budget of the mixed water column is the relationship between euphotic depth and the mixing depth. It occurs under windy situations when vertical mixing occurs beyond the depth of algal photosynthesis, the net column production declines. This is also expressed by low oxygen levels below saturation, of the mixed epilimnetic zone indicating that the carbon balance becomes negative. Thus, a tight budget exists between carbon gains and losses (Figure 6).

The net productivity calculated for the mixed water layer of the shallow irrigation reservoirs is in the order of $0.2 \text{ g/C/m}^2/\text{day}$ which roughly converts to a production of 10 tons of organic fresh weight/ha/y.

When we compare this figure with the high annual yield (785 kg/ha/y) achieved by fisheries in Chinese reservoirs (De Silva, these Proceedings) with intensive fish stocking practices ('culture based fisheries'), we find a high food chain efficiency of nearly 8% which is near the 10% rule of thumb.

Factors controlling primary production and the trophic state of reservoirs

The main factors controlling phytoplankton biomass and primary production are physiographic conditions like nutrient availability, irradiance and the thermal mixing pattern of the water column respectively, the ratio of $z_{eu}:z_{mix}$, i.e. the depth of the euphotic zone (z_{eu}) where photosynthesis occurs versus the depth of the mixed water column (z_{mix}).

There is clear evidence from our data, including old data set of the Parakrama Samudra study, that hydrological engineering of reservoirs exerts a profound influence on the phytoplankton biomass. Accordingly:

- phytoplankton biomass levels are reduced by high water through-flow, i.e. high flushing rates; and
- a reduction of water level of the shallow reservoirs leads to increased biomass accumulation. A reduction of water level increases the trophic status by increasing the interaction at the bottom-water inter-phase. Nutrients locked in the sediments are recycled at low water levels by mixing due to wind induced forces or convection currents.

However, it appears that the activity of dense populations of benthivorous fish including tilapias which feed in the larger size classes on the bottom layer are very important for the nutrient loading process recycling nutrients locked in the bottom compartment.

We know from temperate zone lakes that the trophic cascade, e.g. by zooplanktivorous fish exert a strong top-down effect. So far, such effects are little understood in the tropics. A very important aspect was raised and discussed at this workshop, i.e. to which extent phytoplanktivorous fish like *Oreochromis mossambicus* or *Amblypharyngodon meletinus* reduce gross primary production by decreasing algal biomass or enhance it by stimulating nutrient turnover rate. From our data set, we have some evidence that under certain conditions of a deeper water column, phytoplanktivorous fish can as a whole reduce algal biomass but it appears that especially *Oreochromis* with its high degree of feeding flexibility (Maitipe and De Silva 1985) and partially benthic feeding mode has as a whole rather a stimulating effect. This is a very controversial issue which requires research attention.

Research directed towards reservoir management should aim at defining predictive models on seasonal phytoplankton production based on careful assessments of irradiance, nutrient supply, water level fluctuations and mixing patterns of the water body and calibrating such models with a detailed monitoring on Chl-*a* levels.

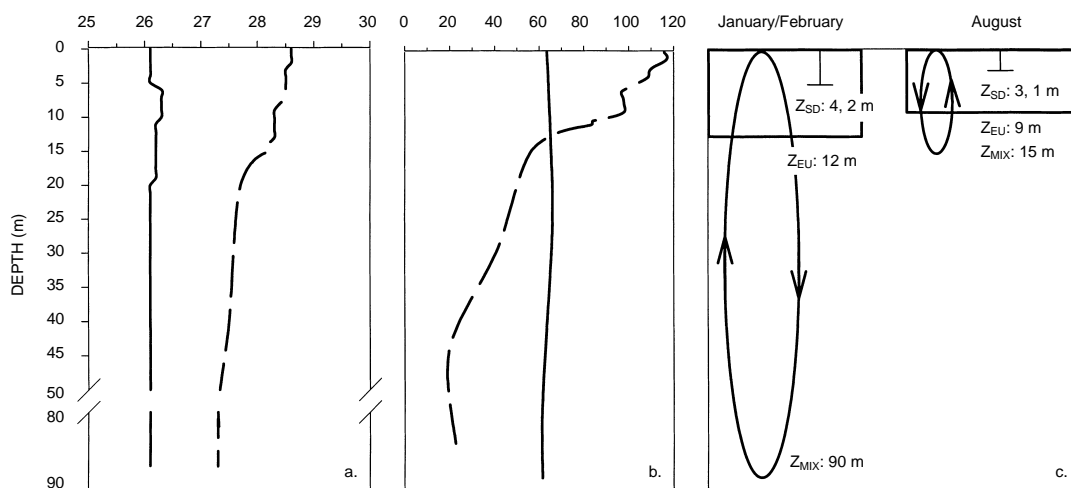

Figure 6. Temperature (a) and oxygen (b) stratification in the northern basin of lake Taal (max. depth 90 m) in February (full line) and August (broken line) 1999. The third graph (c) compares Secchi depth (z_{sd}), the depth of the euphotic zone (z_{eu}) and the mixing depth (z_{mix}) at the two seasons.

The fish assemblages: their size structure, spatial structure and trophic interrelationships

An important aspect of the FISHSTRAT program is a concise survey of the fish communities present in the five water bodies. Conventional methods based on experimental fishing, such as gill netting, beach seining etc., have their own limitations because these methods are highly selective and usually applicable only under well defined conditions. It was one of the particular challenges and the special interest of the coordinator of the program Dr Nan Duncan to apply

scientific acoustics for the first time on shallow tropical reservoirs. We use the results obtained in February 1999 in the Ubolratana reservoir in Thailand to demonstrate the advantages and shortcomings of the method in comparison to traditional experimental fisheries techniques

Figure 7 shows an echogram obtained by horizontal scanning with a moving boat in the offshore region of Ubolratana in February 1999 during day and night. The figure exhibits the aggregated pattern of fish swarms during the day and their dispersal during

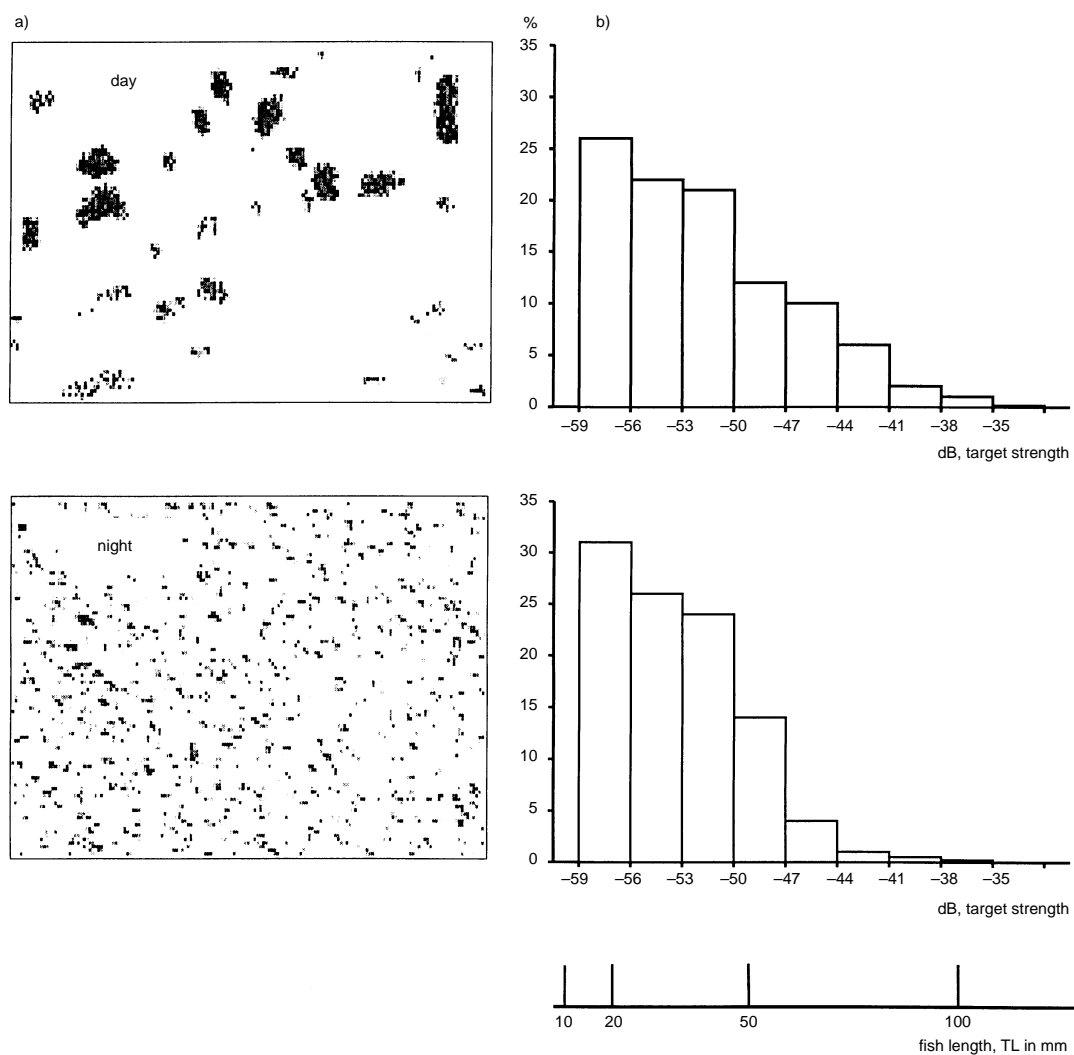

Figure 7. The fish distribution in the open water column at Ubolratana reservoir (Thailand) in February 1999 assessed by acoustics. Row a) compares the paper recordings of the fish signals at daytime (aggregated) and at night time (dispersed). Row b) gives the analysis of the signal strength (in dB) which corresponds to fish size.

night. The recorded target signals can be analysed with regard to the size structure of fish, and also allow computing of the amount of fish biomass per unit lake area. The very significant overall result of acoustics application in the four FISHSTRAT reservoirs and in Lake Taal is a high density of small sized fish yielding medium biomass levels compared with European water bodies (in the order of 10–50 kg/ha in Ubolratana and 50–200 kg/ha in the shallow Minneriya reservoir). These are first preliminary data from the open water limnetic zone which have to be combined with data of the near bottom layers.

Figure 8 compares the strength and weaknesses of acoustics vis-à-vis the traditional experimental fisheries techniques (e.g. gill netting) on the example of Ubolratana reservoir. The comparison of size-structured biomass data obtained clearly demonstrates the potential of the acoustics:

- (a) to search larger water volumes and to obtain a better analytical basis of the fish population;
- (b) to provide insight into size class distribution and allow assessment of the size structure precisely, including small-sized species and stages; and
- (c) to provide direct assessments of fish biomass.

The methodology, however, has its limitations in vegetated inshore areas and of course provides no information on the taxonomic structure of the fish assemblage.

Therefore, acoustics have to be supplemented by experimental fishing methodology, e.g. gill netting. On the other hand, it is apparent that with conventional experimental techniques a large proportion of fish numbers and biomass is overlooked.

A summary of the size structure of the fish population in a Sri Lankan reservoir and in Ubolratana reservoir, as being representative for large reservoirs in Thailand, is given Figure 9. The figure shows the relative quantity of biomass present in different size classes of fish. In order to construct this graph, a broad data set was integrated from the three Sri Lankan FISHSTRAT reservoirs plus data provided by earlier studies on Parakrama Samudra (Schiemer 1996) and Tissawewa (Piet and Vijverberg 1998) analysed by traditional methods (e.g. gill nets).

In the case of Ubolratana, we used the size and biomass structure obtained from the acoustic surveys of the open water fish community. The figure clearly indicates the significant proportion of biomass

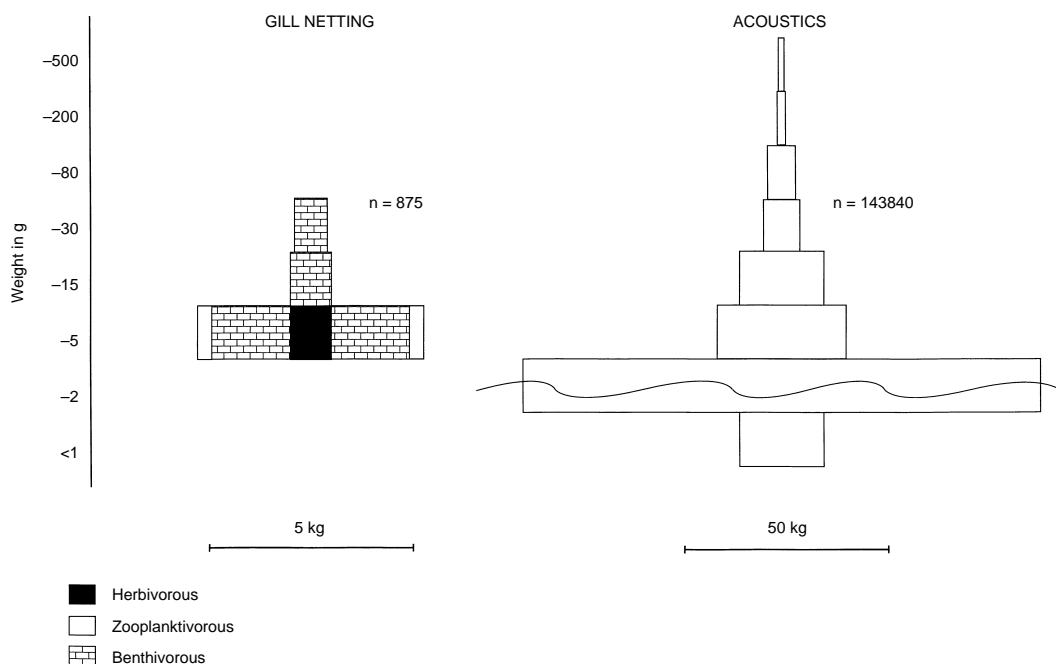

Figure 8. Comparison of the size-structured biomass distribution of the fish fauna in Ubolratana reservoir assessed by gill netting and by acoustics. Note the distinctly smaller database of the gill net survey both in terms of biomass and numbers. However, gill net surveys are important for species analysis and calibration of acoustic data.

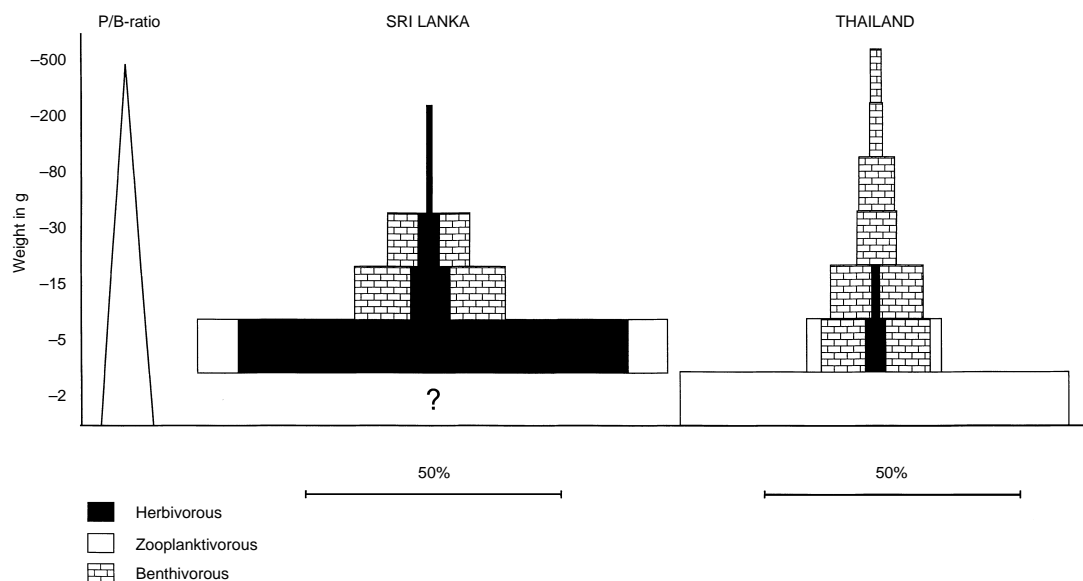

Figure 9. Comparison of the size, the biomass and the trophic structure of the fish community in Sri Lankan reservoirs and in Ubolratana. The biomass structure in Sri Lanka and the trophic characterisation is based on data from Parakrama Samudra (Schiemer and Duncan 1988), and additional information obtained during FISHSTRAT + during the Tissawewa study (Piet et al. 1999). The size structure of Ubolratana is based on acoustics and experimental fishing. The pyramids are given in percentages based on the assessed total biomass.

present in the form of small-sized fish, whereas the larger-sized fish, which are the main target of fisheries, contribute little to the overall fish biomass present in the reservoirs

Of course, the figure provides only a static picture for a dynamically changing situation. The pattern can change seasonally to some extent, for example, due to growing cohorts of mass fishes (e.g. *O. mossambicus* in Parakrama Samudra, Schiemer and Duncan 1988), but, from what we have seen during the FISHSTRAT Project, we propose that the basic pattern of biomass distribution essentially remains the same. The pattern for Ubolratana is biased to the open water community. With a better-structured survey carried out in February 2000, the size structure will show a slightly higher significance of middle-sized categories due to a better assessment of the near benthic fish community, but we reckon that the principal structure remains unchanged. Considering the higher secondary productivity of small-sized fish and the higher P/B ratios as shown by Viyverberg et al. (these Proceedings), the significance of small-sized fish will be even more pronounced.

The second aspect of Figure 10 concerns the trophic structure of the fish community, and demonstrates which feeding groups are represented in

which proportion in which size class. In this respect, the reservoirs in Sri Lanka and in Thailand exhibit striking differences. In Sri Lanka, which has a depauperated island fauna (approx. 25 spp in the reservoirs) herbivores in a broad sense play a significant role.

These herbivores utilise different carbon sources and pathways. A small-sized filter-feeding fish, *Amblypharyngodon meletinus* makes direct use of phytoplankton and organic debris derived from it. This species has a very peculiar feeding mode, which was analysed in detail in the course of the program. *A. meletinus*, in terms of biomass and productivity, is the most important fish in all the reservoirs studied.

A second herbivore, which contributes significantly to the total fishery, is *Puntius filamentosus*. It is a middle-sized fish in its adult stage. A third important component are the exotics *O. mossambicus* and *O. niloticus*. These three components have different modes of feeding ecology and use different food sources. The second most important group is zoobenthivorous fish which come in form of two abundant *Puntius* species (*P. chola*, and *P. dorsalis*).

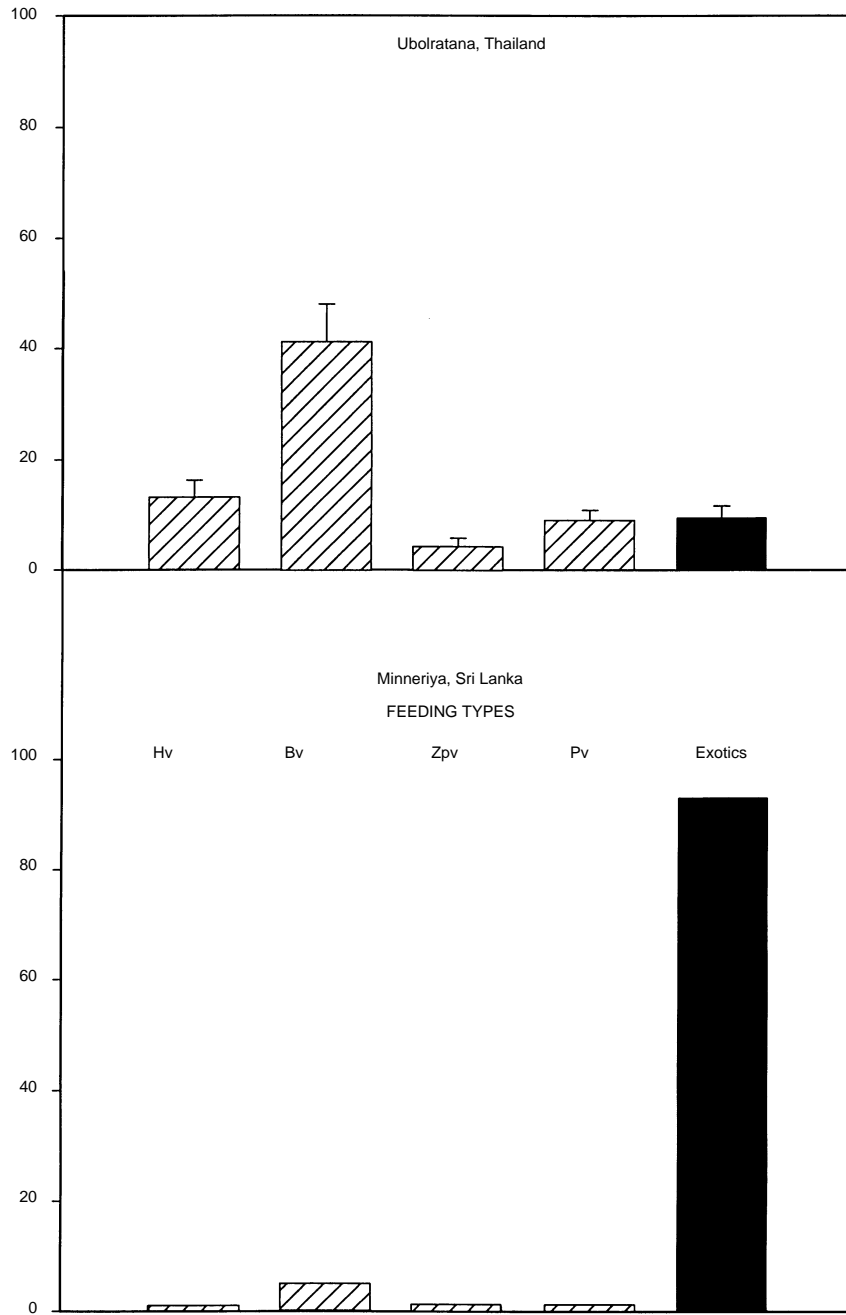

Figure 10. The biomass composition of the commercial catch in Ubolratana reservoir (average and range for the years 1994–1998) and Minneriya reservoir (1998) differentiated according to feeding types. Hv = herbivorous, Bv = benthivorous, Zpv = zooplanktivorous, Pv = piscivorous; Exotics = introduced herbivorous *Oreochromis* ssp.

Small-sized zooplankton feeding fish occur in form of *Rasbora daniconius* and in the lowland reservoirs in the form of *Hyporhamphus gaimardi* (Minneriya, Parakrama Samudra, Udawalawe). This species is, however, missing in the Victoria reservoir.

The most important aspect of the Thai reservoirs appears to be a distinctly lower significance of herbivores. With regard to the commercial catch, the contribution is more significant than suggested by the results of the experimental fishing. Commercially harvested herbivores are two small-sized cyprinids (*Cirrhinus jullieni* and *Osteochilus hasselti*) both of which take algae and detritus from the bottom layers, as well as the exotic species *O. niloticus*. Considering the vast inshore zones of the reservoir, littoral bound herbivores like *C. jullieni* and *O. hasselti* are more significant in the biomass pyramid than suggested by the graph. The biomass pyramid is characterised by the dominance of a small sized zooplanktivorous clupeid (*Clupeichthys aesarnensis*, Thai river sprat) and a number of zoobenthivorous fish especially *Puntioplites* and *Cyclocheilichthys*. Both groups constitute similar proportions to the total fish biomass of the reservoir.

The low proportion of herbivores is surprising considering the high fish biodiversity of the country (75 species recorded in the reservoir). It might be explainable by the lack of a lacustrine fish fauna, which, however, is also the case in Sri Lanka, and pinpoints to the necessity to take into account biogeographical and evolutionary aspects in fisheries management. It raises the question whether the reservoirs rich in fish diversity can only produce less yield compared to island reservoirs where fish diversity is low.

The low significance of herbivores in Ubolratana is also puzzling from the point of view of ecological energetics since the net primary production, immediately available for herbivores remains widely unused by fish. The summary data of the International Biological Program suggests as a rough rule of thumb an ecological conversion efficiency from primary production to secondary production of zooplankton of 10% and a much less efficient pathway to zoobenthos of 2–5% (however, there could be a more efficient pathway under shallow tropical conditions).

Our hypothesis for Ubolratana reservoir, therefore, is that the energy transfer to fish is less efficient compared to Sri Lankan reservoirs. This agrees with the higher commercial catches, e.g. in Minneriya 200 kg/ha compared to 20–40 kg/ha in Ubolratana, despite the fact that the local fishing community harvests intensively a much larger-sized range of fish compared to Sri Lanka.

References

- Amarasinghe, U.S., Duncan, A., Moreau, J., Schiemer, F., Simon, D. and Vijverberg, J. (in press): Promotion of sustainable fisheries and aquaculture in Asian reservoirs and lakes. *Hydrobiologia*.
- Chookajorn, T., Leenanond, Y., Moreau, J. and Sricha-roendham, B. 1994. Evolution of trophic relationships in Ubolratana reservoir (Thailand) as described using a multispecies trophic model. *Asian Fisheries Science*, 7: 201–213.
- Dillon, P. and Rigler, R.H. 1974. A test of a simple nutrient budget model predicting the phosphorus concentration in lake water. *J. Fish. Res. Bd. Canada*, 31: 1771–1778.
- Maitipe, P. and De Silva, S.S. 1985. Switches between zoophagy, phytophagy and detritivory of *Sarotherodon mossambicus* (Peters) adult populations in twelve man-made Sri Lankan lakes. *Journal of Fish Biology*, 26: 49–61.
- Piet, G.J., Vijverberg, J. and van Densen, W.L.T. 1999. Foodweb structure of a Sri Lankan reservoir. In: van Densen, W.L.T. and Morris, M.J. eds. *Fish and fisheries of Lakes and reservoirs in southeast Asia and Africa*. Westbury Academic & Scientific Publishing, 187–205.
- Schiemer, F. (ed.) (1983): *Limnology of Parakrama Samudra — a case study of an ancient man-made lake in the tropics*. Developments in Hydrobiology—series, Junk Publishers.
- Schiemer, F. (1996): Significance of filter-feeding fish in tropical freshwaters. In: Schiemer, F. & Boland, K.T. (eds.): *Perspectives in Tropical Limnology*. SBP Academic Publishing: 65–76.
- Schiemer, F. & A. Duncan (1988): The significance of the ecosystem approach for reservoir management. In: De Silva, S. (ed.): *Reservoir fishery management and development in Asia*. Proceedings series, International Development Research Centre. Ottawa, 183–194.
- Vollenweider, R. & J. Kerekes (1982): *Eutrophication of Waters, Monitoring Assessment and Control*. OECD, Paris.

Developing Fisheries Enhancement in Small Waterbodies: Lessons from Lao PDR and Northeast Thailand

C. Garaway¹, K. Lorenzen¹ and B. Chamsingh²

Abstract

Culture fisheries enhancements are widely practised in small waterbodies throughout the Mekong region. Although frequently initiated by local communities, enhancements have received considerable financial and logistic support from governments and some NGOs (non-government organisations). Firstly, this paper reviews the characteristics of their performance in terms of productivity, socioeconomic and environmental impacts. Secondly, it assesses the need and potential for improving the performance of enhancements, and explores how governmental organisations and NGOs can aid the sustainable development of enhancements through a process of participatory adaptive learning.

THE resources under consideration, small waterbodies, have been defined as 'small reservoirs and lakes less than 10 km² in area, small ponds, canals including irrigation canals, small seasonal inland floodplains and swamps, and small rivers and streams less than 100 km² in length' (Anderson 1987).

Experiences of stocking ventures in such waterbodies have shown that while stocking has the potential to yield substantial benefits, the actual outcomes (in terms of production, distribution of benefits, institutional sustainability, etc.) are often different from those initially expected (Samina and Worby 1993; Garaway 1995; Hartmann 1995; Cowan et al. 1997; Lorenzen and Garaway 1998; Garaway 1999).

The underlying reason for the prevalence of unexpected and sometimes undesirable outcomes of stocking in small waterbodies lies in (a) the inevitably limited prior knowledge of the physical, biological, technical and institutional characteristics of individual sites which show great variability, and (b), the complexity of the environments into which

enhancements are introduced, involving dynamic interactions between the biological characteristics of the resource, the technical intervention of enhancement and the people who use or manage it.

The paper seeks to highlight these points and suggests ways in which the constraints they pose can be addressed. It reviews some of the previous experiences specifically relating to small waterbodies, and focuses on the small waterbody research experience of the authors in Udon Thani Province, NE Thailand (1993–96) and Savannakhet Province, Lao PDR (1994–present).

The next section presents a brief review of some of the small waterbody stocking initiatives in the study countries and gives some examples of outcomes that have occurred. The following section highlights some general lessons that have been learnt from studying these processes and outcomes and, in particular, their constraints and opportunities. The section ends with recommendations for an adaptive process-oriented approach to management and suggests a possible role for governments and/or other external research and development agencies.

Case Studies from Lao PDR and NE Thailand

This section provides a brief review of some of the results and conclusions of previous work by the authors. Details can be found in Garaway (1995), Garaway et al. (1997), Lorenzen and Garaway

¹T.H. Huxley School of Environment Earth Science and Engineering, Imperial College, 8 Princes Gardens, London SW7 1NA, UK

²Livestock and Fisheries Section, Department of Agriculture and Forestry, PO Box 16, Savannakhet Province, Lao PDR

(1998), Lorenzen, Juntana et al. (1998), Lorenzen, Garaway et al. (1998), and Garaway (1999).

Small waterbodies and their role in rural livelihoods

In Savannakhet Province, Lao PDR, small waterbodies are ubiquitous and play a very important direct role in the livelihoods of almost all rural households, primarily for subsistence needs but also, and increasingly, for income generation (Garaway 1999). Household participation in such fisheries is almost universal (Claridge 1996; Garaway 1999). The province, like the country, is characterised by semi-independent rural villages engaged in subsistence agricultural production, rice farming being the primary economic activity, supplemented by other activities such as fishing and small livestock-rearing. Personal fishing in small waterbodies accounts for, on average, at least 70% of the fish acquired by rural households (Garaway 1999).

In NE Thailand, the growth of the agricultural sector has declined in recent years but, as in Lao PDR, rice production is still the most important sector in the region and people in rural areas combine farming with fishing activities. Small waterbodies, widespread, are the important fishery resources (Fedoruk and Leelapatra 1992; Garaway 1995). In the rural areas in the northeast, up to 80% of fish consumed was obtained from such sources (Prapertchop 1989). While it is expected that reliance is less now, a less detailed but later study suggested that reliance was still high, but that it varied between households of different socio-economic status (Garaway 1995).

In both research locations, it is believed that freshwater fish is the most important source of animal protein.

Promoting stocking and uptake

Lao PDR

In Savannakhet Province, stocking of small waterbodies, particularly with Nile tilapia *Oreochromis niloticus*, and to a lesser extent common and Indian major carp, has been promoted actively by the government since 1994, and the practice is spreading rapidly. Government policy has stated that 'priority in the short-, medium- and long-term is to be given to the reduction of declining harvests and the development of fisheries in the rivers, lakes and reservoirs ... these actions could allow the fisheries sub-sector to increase gradually its production figures from the current estimates' (Phonvisay 1994). The promotion of stocking in small waterbodies is seen as one way to do it.

Waterbodies currently subject to enhancement include oxbow lakes, natural depressions and reservoirs of sizes ranging typically 1–20 ha. Typically, these waterbodies are under the de facto ownership of one or two closely connected villages, and are adjacent to the villages concerned.

Government has been supporting villages through the provision of limited technical advice, through part-payment of fingerlings and through facilitating 'study tours' to villages already involved with stocking. Operational rules (including monitoring and enforcement) regarding management are predominantly devised (and carried out) by the local communities themselves, and hence there is considerable variation between villages, with villages also experimenting with their own rules, through time. Government staff give advice, particularly regarding who should be benefactors of the initiatives.

In Savannakhet Province, response to stocking in rural communities has been varied. Of 31 villages and waterbodies studied, 20 supplied new institutions to manage their newly enhanced waterbody and subsequently maintained these new institutions, while 11 did not (Garaway 1999). The types of institutions supplied are discussed in the next section. Research found that communities were more likely to supply new rules when there was a commitment to do so prior to stocking. Such communities devised the idea themselves or in partnership with the government fisheries department, and at least part-financed the stocking. Having information about benefits from stocking, in particular firsthand information gained from visiting other villages enhanced the commitment. Other factors encouraging supply of new rules included the presence of skilful leaders, entrepreneurs and district government staff in the village (Garaway 1999).

Northeast Thailand

In Northern Thailand, culture-based fisheries in village ponds have developed since the 1980s, following the expansion of government and private fish seed production, and various programs to build village ponds and to promote aquaculture. At the time of the research (1993–96), fish culture in communal ponds and reservoirs was being promoted by the Village Fisheries Programme (VFP) of the Department of Fisheries (DOF), one of the primary aims being the promotion of communal semi-intensive aquaculture. Again, waterbodies selected were generally under the de facto ownership of one or two closely connected villages and were adjacent to the villages concerned.

As in Lao PDR, under the program, village communities assumed responsibility for pond

management, and specific decisions on operational rules, including monitoring and enforcement, were taken by the village communities. Government support included brief training in management techniques such as nursing, feeding, fertilisation and integrated agriculture-aquaculture. Seed fish were partially subsidised in the first three years of any new village fish pond.

Department of Fisheries staff expressed dissatisfaction with the technology uptake in the VFP (Lorenzen, pers. comm.). Surveys show that many villages continued to manage the village pond actively after the first three years, but that few villages provided significant inputs other than seed fish (which were stocked at 2–3 cm without nursing) (Lorenzen, Juntana et al. 1998), and therefore villagers were not operating the communal semi-intensive aquaculture systems originally promoted.

Types of institutional change that stocking catalysed — a preliminary outcome of stocking

The stocking initiatives discussed above frequently catalysed changes in how waterbodies could be used and by whom, and many changes were often not anticipated by external agencies.

Commonly, in both countries, operational rules radically altered access rights and the nature of household benefits that could be obtained from resources.¹ For example, personal subsistence fishing, usually previously permitted, was commonly prohibited or very much restricted, the level of restriction depending on the extent to which individual fishers had access to other resources. Instead, the fishery became increasingly commercialised. Resources were harvested in a way that produced a village income for community development, and the allocation of fish not used for these commercial purposes, and other derived benefits from the waterbody, were determined by rules set up by local decision-makers.

In NE Thailand, by far the most common management regime that replaced subsistence or small-scale fishing was the holding of an annual fishing day where tickets were sold to individuals from within and outside the village, allowing them to fish with cast-nets and lift-nets. As well as generating income from the village, these days were also important social occasions (Chantarawarathit 1989; Garaway 1995). Outside this day, fishing was commonly prohibited.

¹ In Thailand, an exception to this was where waterbodies were purpose-built, and in these instances, rules were created rather than altered.

More common in Lao PDR was that the resource would be fished by teams under the supervision of a management committee in a period of low agricultural labour demand (between January and May). Payment to the fishers concerned varied between villages. Outside that time, fishing was also commonly prohibited. Why the institutions developed in Lao PDR were different to those in NE Thailand is not known, though a possible explanation is that the opportunity costs of team-fishing are far greater in Thailand than in Lao PDR. Other less common systems in Lao PDR included renting the waterbody to a group inside the village or, as in Thailand, holding an annual fishing day (Garaway 1999).

As well as these broad variations in institutions between village communities, there were numerous smaller variations. Villages also experimented with their own management rules over time, continually adapting to local objectives and circumstances.

Examples of some outcomes of stocking initiatives

This section gives a very brief review of some of the main technical, socioeconomic and environmental outcomes.

Technical outcomes (production potential and yields)

In Savannakhet Province, Lao PDR, a comparative study of waterbodies under different management regimes showed that the management systems described above, with a combination of access regimes and stocking, had a strong positive effect on both standing stocks and biological production potential (Lorenzen, Garawan et al. 1998). However, low levels of effort, brought about the access restrictions, and selected harvesting of the larger stocked species only meant that overall yields were not different between enhanced and non-enhanced fisheries, i.e. the potential for increased production was not realised (Garaway 1999). On the other hand, harvesting efficiency and hence the productivity of labour in the fishery increased greatly by up to a factor of three, and this was appreciated and valued highly by stakeholders (Garaway 1999).

An institutional analysis suggested that the low levels of effort were ultimately the result of a combination of the operational rules that governed access and low incentives for active involvement in the fishery. Crucially, while any of these rules could have been changed to increase effort, possibly leading to increased yields and associated benefits, all would have involved increased costs or lower economic returns to labour, and hence were not preferred (Garaway 1999).

In NE Thailand, stocking, catch and related data were collected for 16 village ponds. There was large

variation in technical outcomes, with yields ranging from 26 to 2881 (median 652) kg/ha/year. Yields were strongly related to the trophic status of the waterbody and to stocking density (with an optimum at 9800 fish/ha/year of 2–3 cm seed fish). Stocking performance varied greatly between species and was also influenced by the trophic status of the waterbody (Lorenzen, Juntana et al. 1998). Catches were dominated by tilapia in the most fertile water bodies and by carp species in all others, but catch species composition did not significantly influence yield when the effect of trophic status was accounted for.

The median yield of 652 kg/ha/yr was far less than villagers could have obtained had they managed the waterbodies as communal, semi-intensive aquaculture systems as originally promoted, instead of culture-based fisheries. For example, data for semi-intensive aquaculture, based on recommendations for farmer pond culture (AIT 1993), suggest yields of around two-and-a-half times that much, at 1563 kg/ha/yr.

The reason why local decision-makers chose this route was suggested by an economic analysis. It showed that the culture-based fishery provided much higher returns to communal labour and finance than semi-intensive aquaculture enterprises, and the fact that people opted for culture-based fisheries suggests that such communal labour and finance were in short supply (Lorenzen, Juntana et al. 1998). Therefore, operating a culture-based fishery was a successful adaptation of the extended technology to village needs.

In summary, in both these cases it can be seen that the operational rules devised by local communities had a crucial effect on what outcomes were achieved or were achievable, and these rules and consequent outcomes were not fully anticipated by external agencies. Closer analysis suggests that the rules had been chosen to fit local needs and circumstances.

Socioeconomic outcomes of enhancement initiatives

The section above discussed total benefits of stocking initiatives in terms of yields and harvesting efficiency. However, given that the stocking initiatives catalysed changes in both the allocation and nature of benefits from the fishery, it is important to understand how the changes affected the distribution of benefits among resource users.

As mentioned previously, the principal benefit of the stocking initiatives was the production of village income for community development. This is very different from the benefits from capture fisheries, and demonstrates that stocking can catalyse a fundamental shift in the role and function of small waterbodies. In a detailed study of four villages managing stocking

initiatives in Savannakhet Province, household benefits from the stocked waterbodies were found to include a cheap source of good quality fish, decreased personal cash contributions to the community development fund, increased community income for improved community services (in some cases), decreased personal fish contributions for when the village entertained guests, and payment (in fish or sometimes cash) for communal harvesting and marketing. Selling fish cheaply to individuals from surrounding villages and entertaining guests fulfilled a traditional social function of strengthening links between villages (Garaway 1999).

Regarding the distribution of these benefits, with their higher capacity to buy fish richer households were able to take more advantage of the new market supply of fish than the poorest socioeconomic groups. However, this saving was small, at less than US\$2/household/season. In addition, it could be argued that the poorest households, with less household economic surplus, benefited relatively more from the decreased personal cash and fish contribution needed to fulfil community obligations. In summary, it is believed that no socioeconomic group was benefiting substantially more than others (Garaway 1999).

However, research showed that members of the poorest rural households most utilised local fishery resources for their own purposes, and therefore had the highest total annual catches. This suggested that if they did not have access to suitable alternatives they would have most to lose from the restriction of individual access to small waterbody resources brought about by stocking initiatives. While this was the case, it should be noted that variation between the socioeconomic groups in terms of utilisation of the fishery was not large, and was found to be far greater between villages (Garaway 1999).

In fact, despite loss of personal use, villagers did not perceive they had been adversely affected by access restrictions. This was because either they had other convenient places to fish or, when this was not the case, it had been taken into consideration by the rule designers and the access restrictions were correspondingly less severe.

There is less information available on the benefits of stocked waterbodies and their distribution in NE Thailand, but they did not seem as wide-ranging as those in Lao PDR, the main benefit being community income, the social occasion of the fish-catching day, and the use of water for buffalo and vegetable irrigation. There is little information on whether these benefits were distributed evenly. One study suggested that some of the poorer households did not participate in the fish-catching day because of the ticket price. However, this did not appear to be

common (Garaway 1995). Regarding the costs of lost access to previous fishing resources, the same study suggested that, contrary to the situation in Lao PDR, it was middle-income farmers rather than poorer farmers who most utilised local fishery resources and would therefore be most affected by access restrictions (Garaway 1995). Again though, in the area studied, the loss of only one of many fishery resources was not perceived by resource users to have had a deleterious effect.

Evidence suggests therefore that while the nature of benefits had changed, local rules had been chosen that distributed the new benefits evenly across socio-economic groups and accounted for local fishing for subsistence needs.

Environmental outcomes

Information on environmental impacts is available only for Lao PDR.

In the comparative study of waterbodies under access restrictions and/or stocking or neither, it was shown that access restrictions, even in combination with the stocking of exotic species, had a significant positive effect on the standing stocks of wild fish, and there was no evidence of negative effects on their diversity (Lorenzen, Garaway et al. 1998). This was an unexpected outcome, brought about by the access restrictions and selected harvesting of the larger stocked species only for selling and entertaining guests. While stocking is not necessary for communities to introduce and enforce access restrictions, it has certainly facilitated such steps, and the net effect has been a rapid proliferation of restricted access fisheries in Savannakhet. Increased stocks in perennial small waterbodies are likely to have positive effects on the yield from seasonal habitats such as paddies, and may also have conservation benefits.

Again then, it can be seen that the changes to operational rules catalysed by stocking had a profound and unanticipated effect on fishing practices, which in turn led to unexpected and, in this case, possibly desirable environmental outcomes.

Discussion

Results show that stocking initiatives have provided benefits due to both (1) direct biological effects of stocking (increased recruitment of valuable species), and (2) indirect effects due to institutional change resulting from the investment in common pool resources (e.g. incentives for sustainable use, reduced fishing pressure and higher returns to labour).

However, as is also shown, outcomes have also been unpredictable, different from what has been

anticipated or less than optimal. Unexpected outcomes are caused by the fact that there is still a great deal of uncertainty surrounding both the direct and indirect effects of stocking.

Uncertainty associated with enhancement management

Firstly, uncertainty may result from the fact that the underlying biological processes (such as species interactions) are still not fully understood, or they are subject to 'random' variation linked to variation in external conditions (such as rainfall). Another problem is that even in cases when processes are understood, external agents such as governments are constrained by a lack of location-specific information (e.g. waterbody productivity, species composition and biomass), as resources for widespread research at such a specific and local level are often lacking. All these factors result in there being considerable technical uncertainty associated with stocking initiatives.

The same sources of uncertainty (lack of understanding about the underlying processes and lack of location-specific information) are also relevant when considering the institutional aspects of stocking initiatives. The act of stocking often catalyses institutional change, but such rule changes are frequently not considered or not anticipated pre-intervention, and the rules and their consequent effects rarely studied in a systematic way in ongoing initiatives. Because of this, there is still very little information about the underlying factors and processes that motivate different types of human action, actions that ultimately result in certain types of rules being devised and/or certain levels of rule compliance. This creates much institutional uncertainty about what changes are likely to accompany which type of initiative, and what institutions are likely to provide the more optimal outcome in any given set of ecological and social circumstance.

This lack of understanding is exacerbated by the fact that in many cases, even when there are resources to collect this type of information, many analysts are unaware of the value of doing so, instead relying on technical information only. Studying technical and biological interactions, though essential, does not enable us to understand, predict or improve outcomes in real settings, without understanding how they are affected by, or in turn effect, the institutions put in place to govern use (and investment). Even technical outcomes cannot be understood with reference to technical variables alone. Integrated research recognising the inter-relationship between the technical intervention, the nature of institutions, the resource and community characteristics is urgently required to address this point.

The uncertainty makes it difficult for external agencies to come up with context-specific management guidelines to produce predictable and desirable outcomes. The question to be addressed is what approach could such agencies take that would deal with or reduce these uncertainties, to increase the chances of that happening.

Dealing with uncertainty through participatory adaptive learning

Some uncertainties could be reduced by having more knowledge, pre-intervention. Others, which may be termed dynamic uncertainties (i.e. the response of certain variables to change), can be resolved only by actually observing them, either through time or across systems under different management. Other uncertainties such as 'random' variation in external conditions cannot easily be reduced at all.

It is suggested here that much could be gained and much uncertainty reduced by external agencies and local communities combining their strengths through a process of participatory adaptive learning, as described in Lorenzen and Garaway, 1998.

Adaptive learning has been described as a structured process of 'learning by doing' that involves learning processes in management rather than single solutions, or control, through management. The approach provides for an increase in knowledge about the resource systems in question that will, in turn, enable management policy to be refined. To produce this knowledge, and thereby reduce uncertainty, management is treated as an experimental process, aimed at yielding crucial information for the improvement of management regimes as well as more immediate benefits for the participating stakeholders. Participatory adaptive learning requires that the communities affected by the stocking initiatives take an active and equal role in the experimental process.

It is believed that such an approach could help to reduce the reducible uncertainties in the type of small waterbody enhancement management described in this paper, more quickly and at lower cost. Such an approach is possible because of the opportunities that the resource management systems described here provide.

Attributes of resource systems that facilitate adaptive learning

The ubiquitous nature of small waterbodies

Small waterbodies are ubiquitous throughout the environments being considered, and therefore there are opportunities to observe differences across different entities at the same time, thereby reducing the

time required for knowledge to accumulate. If this were done in a systematic way, there would be great opportunities for reducing dynamic uncertainties, by first identifying precisely what information is required to reduce the uncertainty, and, secondly, carefully selecting sites to yield that information.

The presence of variation that enables comparative study

The resource systems in question already show great variability in terms of their biology and the institutions set up to govern use. This means that much can be learnt from the careful selection and study of existing management resource systems without the need for any further intervention (so-called passive experimentation). There may be cases where more active experimentation would yield substantially more information and, in these cases, where such intervention can be implemented at appropriate levels of cost and risk and with the full participation of local communities, such an approach would be appropriate.

The time-and-place knowledge of local users

One of the major uncertainties to be addressed is the lack of location-specific information. While external agencies have not the resources to collect the information themselves, it should be recognised that local communities already have extensive knowledge about their resources, their communities, and the institutions they use to govern resource use. Such knowledge should be utilised.

The research has shown that under certain circumstances, communities can and do manage stocking initiatives in a way that produces satisfactory, if not necessarily, optimal, outcomes, because of their considerable local knowledge of the resources available to them and the communities that utilise them. Crucially, they have a far better understanding of local needs and local patterns of behaviour, knowledge that they can use when considering the design of operational rules for management. This means, in particular, that compared to external agencies they are far more likely to be able to predict whether certain operational rules are likely to be workable or not (i.e. meet the needs of users, be acceptable, be monitorable, and be enforceable). External agencies could learn much from that information.

The experimental approach of communities to resource management

Research has also shown that, given the opportunity to do so, communities will experiment with management through time, continually learning and

changing rules better to adapt them to local needs and circumstances. It suggests that the idea of experimentation is one that communities would embrace under certain circumstances (e.g. suitable levels of risk, information about the possible benefits of such experimentation). Communities particularly experiment with rules that distribute benefits and rules that motivate different types of human action. Experimentation with technical aspects, such as stocking densities and species combinations, is less common, as technical knowledge is limited and, particularly in Lao PDR, actions depend on what is available and affordable. Currently, with communities experimenting in isolation and without the same technical knowledge as external agencies, their process of learning is slow. However, external agencies could play a prominent role in change.

The wider reach and technical knowledge of external agencies

As suggested in the last section, external agencies have two vital attributes that complement community extensive local knowledge. Firstly, they have technical scientific knowledge (or access to it). Secondly, they have knowledge of, and access to, a large number of communities managing enhanced waterbodies. Were external agencies to facilitate communication and information exchange between communities (and between communities and external agencies), this could greatly increase the knowledge base of local communities.

The community interest in learning from the experience of other local communities

Finally, following the last point, the research conducted in Lao PDR has shown that communities have a great interest in, and benefit significantly from, communicating with other communities. This was a major factor that increased the chance of successful uptake of new enhancement technology in the province. Given that interest, it is expected that, were communities fully aware of the objectives of participatory adaptive learning, they would be interested in participating in an experimental approach that brought together a larger number of community experiences and ultimately provided better information for the management of their own enhanced fisheries.

The role of external agencies in a participatory adaptive learning approach

To best support an adaptive learning approach and hence reduce the considerable uncertainties associated with small waterbody enhancement, it is suggested that external agencies take the following steps:

- Collect initial information on key attributes of the resource systems under consideration (biological, social, and institutional) and current outcomes, with the full participation of local communities through participatory appraisals. The process should include identifying the objectives of enhancement management on the part of the user community.
- With the aid of scientific analysis, identify where the greatest uncertainties (technical and institutional) are in the first instance, and discuss with participating communities what experimental strategies are most likely to reduce these uncertainties at an appropriate level of risk while still achieving beneficial outcomes. It is at this stage that the local knowledge of communities and the technical knowledge of external agencies can be most fruitfully combined.
- Facilitate local experimentation and then local monitoring of the outcomes of the process.
- Facilitate learning between communities, and between communities and external agencies, through scientific analysis, 'study tours' and workshops.
- Repeat the process until it is believed that the costs of further experimentation outweigh the benefits that can be gained from further reducing uncertainty.

The process is a continual one of adaptation, experimentation and learning. By repeating the process, uncertainty can be further reduced and management strategies further refined to produce greater benefits that meet the needs of the user community. Such a process has rarely been tried in the field of enhancement, and more research is required to assess the efficacy of the approach. Such research is now being carried out in Department for International Development-funded project in Savannakhet Province, Lao PDR in a joint collaboration between RDC, Savannakhet and MRAG Ltd, London. The project started in 1999 and is due to end in February 2002.

Acknowledgments

The authors would like to acknowledge financial support for this research from the Department for International Development of the UK. The views expressed are those of the authors and do not necessarily reflect the views of that agency.

References

- AIT 1993. An economic comparison of aquaculture with cropping options for small scale farmers in Northeast Thailand. AIT Aquaculture Outreach Project, Working Paper No 5. AIT, Bangkok.
- Anderson, 1987. The development and management of fisheries in small waterbodies. Symposium on the development and management of fisheries in small waterbodies, Accra, Ghana.
- Chantarawarathit, N. 1989. The DOF village fisheries project: an analysis of its problems and impact in Udonthani Province, Thailand. MSc thesis, Bangkok: Asian Institute of Technology.
- Claridge, G. 1996. An Inventory of Wetlands of the Lao PDR. IUCN Wetlands Programme, Bangkok.
- Cowan, V. Aeron-Thomas, M. and Payne, I.A. 1997. An evaluation of floodplain stock enhancement. Report, MRAG Ltd, London.
- Fedoruk, A. and Leelapatra, W. 1992. Rice field fisheries in Thailand. In: de la Cruz, C. ed. Rice-Fish Research and Development in Asia, ICLARM, Manila, 91-104.
- Garaway, C.J. 1995. Communal ponds in NE Thailand under different use-rights systems: a participatory rural appraisal of their differing roles in people's livelihoods. Report. London: MRAG Ltd, 106 p.
- 1999. Small waterbody fisheries and the potential for community-led enhancement: case studies from Lao PDR. PhD thesis, University of London, 414 p.
- Hartmann, W.D. 1995. Institutional development for common-pool resources management: a task in technical cooperation. In: Wahl, P. ed. Reinventing the Commons. Amsterdam: Transnational Institute.
- Lorenzen, K. and Garaway, C. J. 1988. How predictable is the outcome of stocking? In: Inland Fisheries Enhancements. FAO Fisheries Technical Paper 374, Rome, FAO, 133-152.
- Lorenzen, K., Juntana, J., Bundit, J. and Tourongruang, D. 1998. Assessing culture fisheries practices in small water bodies: a study of village fisheries in Northeast Thailand. *Aquaculture Research*, 29: 211-224.
- Lorenzen, K., Garaway, C.J., Chamsingh, B. and Warren, T.J. 1998. Effects of access restrictions and stocking on small waterbody fisheries in Laos. *Journal of Fish Biology*, 53 (Supplement 1): 349-357.
- Phonvisay, 1994. Inland fisheries development policies and strategies in Lao PDR with special emphasis on the Mekong Basin. Livestock and Fisheries Section, Ministry of Agriculture and Forestry, Vientiane, Lao PDR.
- Prapertchop, P. 1989. Analysis of Freshwater Fish Consumption and Marine Product Marketing in NE Thailand. Khon Khaen University, Khon Khaen.
- Samina, Z. and Worby, E. 1993. Nagashini beel: a case study of the transformation of a common property resource. *NAGA, The ICLARM Quarterly*, April-July 1993, 7-8.

Effectiveness of Stocking in Reservoirs in Vietnam

Nguyen Quoc An*

Abstract

There are about 2470 reservoirs of total area 184 000 ha in Vietnam (1995 data). Reservoir fisheries here mostly are stock-based. Chinese silver carp, bighead carp and grass carp are the predominant species used for stocking. More recently, Indian carps (rohu and mrigal) have been stocked. These species grow rapidly in southern Vietnam reservoirs, but results in the north are poor. Common carp and tilapia can reproduce in reservoirs to some extent, so they are mostly stocked only once or twice. These two species perform better in the south than in the north. Since most stocked species do not reproduce, stocking needs to be done every year. The cost of stocking can exceed the financial ability of many reservoir fishery agencies. Earlier, most State reservoir fisheries farms had losses because the value of fish sales could not recover the necessary expenses of maintaining the fishery. Between 1980 and 1990, stocking was stopped in 90% of previously stocked reservoirs. Under recently reformed policy, private leases have sometimes generated benefit. The study results given by the project 'Management of Reservoir Fisheries in the Lower Mekong Basin' in Dak Lak Province also proved the production and economical effectiveness of stocking the reservoirs under study. Stocking in reservoirs remains an important measure for developing fisheries in Vietnam reservoirs. In order to stock successfully, a series of optimal management systems for different types of reservoirs should be set up, including choice of suitable species, species combinations, stocking size and rate, and measures for preventing escape of stocked fish and the like. In this paper, data pertaining to the performance of stocked species in different sized reservoirs, and the economic feasibility of stocking are presented. Also, empirical relationships are derived in respect of stocking density and yield and other relevant parameters.

ACCORDING to data collected by the Research Institute for Aquaculture No. 1 (RIA1) in 1993, there were 768 reservoirs in 38 provinces with a combined area of 215 549 ha (Thai 1995) in Vietnam. Most reservoirs are distributed in the midland and highland provinces. The Institute of Fisheries Economics and Planning (1994) data indicate about 2470 reservoirs with a total area of 183 579 ha in the country. Among these, reservoirs greater than 5 ha in area total 1403, with a total area 181 176 ha (Chinh et al. 1994). The current number of reservoirs must be higher because many new reservoirs have been constructed in recent years.

From 1962 to 1970, fish culture was practised in 16% of the reservoirs, occupying 48% of the total area. The main measure was to stock popular cultured species like silver carp, bighead, grass carp, mud carp, common carp and tilapia. Harvests of stocked species contributed 15–90% of total reservoir fish production, depending on the situation of each reservoir.

*Management of Reservoir Fisheries, 68 Le Hong Phong, Ban Me Thuot, Vietnam. Email mrcfish@dng.vnn.vn

However, the fluctuation of reservoir fish production was closely related to the success of stocking activities. Since 1970, intensive stocking has tended to decline due to poor economic returns. Especially since 1980, economic crises and the termination of subsidies have led to the termination of stocking in most reservoirs. Recently, stocking has continued and remains viable in only a few reservoirs. Among these are small and medium-sized reservoirs in the Central Highlands, under study by the project 'Management of Reservoir Fisheries In the Lower Mekong Basin' (project MRFP), where stocking appears a very effective way of increasing fish production and generating economic benefits. This paper presents the general experience of culture-based reservoir fisheries in Vietnam, the role of stocking, and some related issues, experiences and recommendations.

Materials and Methods

Three different data sources are considered in this report:

- Data collected by the author in 1970–1972 in Cam-son Reservoir and in 1971–1976 in Thac-ba Reservoir. The catch samples were collected systematically, 10 days per month by the Fish Resources Survey Team of the Research Institute for Aquaculture No. 1. Catch composition was recorded for every sample. Age structure of cultivated species was recorded from annual rings on scales. Recapture rate was also calculated as the sum of number of fish of the same cohort from three continuous years of capture after stocking. Other data such as stocking cost and labour were collected from statistical data of the local Fisheries Companies.
- Data cited from published and unpublished documents of the Ministry of Fisheries and RIA 1.
- Reports and raw data of MRF Vietnam, collected by fish biologists, 1996–1999. Catch samples from reservoirs were collected systematically each month. For the smallest reservoir, the biologists censused the catch throughout the harvest period. They also were present during stocking, and obtained detailed data on species composition, weight stocked, and individual length and weight. Data for years prior to 1996 were supplied by local fishery agencies.

Results

Stocking status

In Vietnam, stocking has been considered a major component of reservoir fisheries management since 1962. By now, the technology of artificial breeding of cultivated fish species has been successfully applied and provides the opportunity for supplying mass stocking material. At the same time, a large number of reservoirs were built. State fisheries agencies were set up at most newly built reservoirs. But as mentioned above, since 1970 stocking activity has gradually declined. The government attempted to prevent the decline, but by 1993, many reservoir

fisheries all over the country had collapsed (see Table 1).

In 1993, only 8.1% of the total area of the reservoirs was stocked, and produced only 1028 t fish. The situation could improve if the effectiveness of stocking can be clarified and the right measures to manage fishing activities in reservoirs carried out.

Advantages of stocking

Effective use of natural resources

In newly built reservoirs, nutrients are rich and provide good conditions for developing phytoplankton and zooplankton. The average density of phytoplankton is 1–3 million cells/L and zooplankton is 300–800 individuals/m³ (Table 2). This compares with the density in good fish ponds, which can give yields of 1–2 t/ha. Among cultivated species, silver carp and bighead carp are the most suitable species for use as food sources. Also, the quantity of detritus produced from the decomposition of terrestrial organisms is much higher than in ponds.

After the closure of the dam, water volume increases so quickly that the density of natural fish populations becomes relatively low. Moreover, lack of recruitment is common in new reservoirs. Silver carp and bighead carp are considered the most appropriate available species for effectively using the food sources in new reservoirs. Meanwhile, benthic feeders like common carp and tilapia can also be considered for stocking since they utilise insect larvae and small crustacea like fresh water shrimp. Mud carp utilise periphyton.

In Thac-ba Reservoir, much money was spent to build fishing grounds by cutting down trees, making parts of the bottom even, and other measures to make harvesting easier. However, the work had practically no effect because fish did not concentrate in cleared places. In some small reservoirs where the forest was cut and burned, like Suoi-hai and Van-truc reservoirs, the natural food available was so poor that the reservoirs had very short eutrophic periods and

Table 1. General status of reservoir fisheries in Vietnam in 1993.

Regions	Total reservoir area (ha)	Under stocking		Production	
		No. (%)	Area (%)	Total catch (t)	Productivity kg/ha
Northern provinces	63 667	3.4	10.3	370.4	56.4
Northern Central provinces	20 775	33.9	8.9	92	50.0
Southern Central provinces	11 196	7.1	43.9	192	39.1
Central Plateau	12 424	3.2	3.2	59.5	150.6
Eastern Mekong region	73 105	19.0	1.3	314	330.9
Total	181 167	7.6	8.1	1027.9	70.1

become oligotrophic after only 5–6 years. Later, no clearing was done when new reservoirs were built.

Such uncleared areas should normally include expected breeding and nursing areas, such as at the mouths of any streams entering the reservoir. That will help to maintain continued recruitment.

Regulation of fish species composition

Vietnam is a tropical area, and the fish fauna is dominated by predators. The fish species composition in the reservoir reflects the situation. The main predators in northern reservoirs are *Elopichthys bambusa*, *Parasilurus asotus*, and *Channa maculata*, and in the south *C. maculata*, *Notopterus notopterus* and *Hampala* spp. Because they are at the end of long food chains, production tends to be low.

In order to increase fish yield, species composition and the size of the stocked fingerlings should be regulated. Dominant stocked species will compete for food with small fish, which are usually the prey for predators. This can suppress the development of prey fish, and hence suppress predators. Stocking of as many non-predatory species as possible is recommended, if maximum protein production is the priority.

Ease of harvesting

As mentioned above, clearing vegetation from an area to be flooded makes fishing easier, but the

vegetation is good for fish production (De Silva 1988). However, this makes fishing rather difficult because of irregular reservoir shape, obstacles of submerged trees, and an uneven bottom, but is good for fish production. Normally, it is advisable for reservoirs to have some cleared areas for fishing activities and some areas of flooded vegetation (De Silva 1988).

One fishing gear very effective in reservoirs is the integrated net, effective for the most important cultivated species, silver carp and bighead carp. This fishing method was first applied in 1971 at Tam-hoa Reservoir (30 ha), and one batch of silver carp totalling 26 t was caught. In 1974 in Cam-son Reservoir (2000 ha), the integrated net caught one batch of silver and bighead carp of 108 t. The use of the integrated net led to great increases in reservoir fish yields from stocked reservoirs. It led to increases in the catch of stocked species by 65 times in Thac-ba Reservoir, 11 times in Cam-son Reservoir, and 24 times in Nui-coc Reservoir (Nghì 1995).

Increased fish production

The role of stocking to increase fish production in reservoirs is recognised easily by analysing the proportion of stocked fish of the total catch. Normally in small stocked reservoirs, stocked species contribute more than 80% to the total yield, while, in larger

Table 2. Natural food sources of reservoirs in Vietnam.

Reservoirs	Area (ha)	Natural food density			Year closed
		Phytoplankton '000 cell/L	Zooplankton Ind/m ³	Zoobenthos mg/m ³	
Thac-ba	22 000	4 611	810	337	1971
Cam-son	2 000	142	14		1966
Nui-coc	2 000	3 140	97	70	1976
Nui-coc	2 000	490	133	343	1978
Van-truc	170	1 097	67		1966
Dong-mo	800	561	68	500	1971
Suoi-hai	960	694	485		1958
Hoa-binh	19 800	665	500		1986
Khe-da	500	415	34	350	
Khe-lang	110	71	66	40	1964
Cam-ly	200	434	317	480	
Phu-ninh	3 200	5 014	6	500	1986
Nui-mot	600	20 024	94	260 000	1980
Dac-uy	150	9 469	54	1 840	1977
Ea-kao	210	1 082	90	13 000	1979
Ea-kao	210	1 719	344	271 720	1998
Ea-kar	141	132	182	213 900	1997
Yang-re	56	13 978	88	221 100	1997
Ea-sup	600	189 200	148	49 820	1997
Tri-an	32 400	2 000	43	100 000	1987
Dau-tieng	27 000	340	182	3 200	1984

reservoirs, the proportion of stocked species is up to 40% of total fish production (Table 3).

Particularly in some of the smaller reservoirs listed here, yields of indigenous species are negligible. Stocking, then, is crucial to assure continued fish production from such water bodies.

The productivity of newly closed reservoirs is relatively low because of insufficient fingerlings for stocking. Productivity increases strongly when stocking continues. The largest reservoir in the north, Thac-ba (22 000 ha), had low productivity because there was not enough stocking material (mean stocking density only 217 individuals/ha). After four years of stocking, a maximum productivity of 18.6 kg/ha was obtained. Stocking was reduced since 1978 and then interrupted from 1990, and productivity dropped to about 10 kg/ha. Now, the catch depends only on self-recruiting species, and productivity is only about 5 kg/ha.

The medium-sized Cam-son Reservoir (2000 ha) was stocked intensively during its first five years, with a density of 1065 fish/ha (about 9.5 times higher than in Thac-ba). Productivity (103 kg/ha) reached a maximum in 1977. But later intensive stocking was not possible, and productivity dropped to 31.0 kg/ha in 1980. Recently, total catch was about 10–20 t/year, equal to 5–10 kg/ha.

Van-truc Reservoir (150 ha) is one of the most nutrient-poor reservoirs studied. But it was stocked intensively, 3644 fish/ha, and productivity reached a maximum of 315.5 kg/ha (Table 4).

High growth rate of cultivated species

All cultivated species reach large sizes, so they have high potential growth rate. Moreover, living conditions in reservoirs are much less crowded than in ponds, so growth rate can be two to five times higher than in ponds.

Growth characteristics of commonly stocked species are discussed here.

- Two strains of silver carp (either Vietnamese *Hypophthalmichthys harmadi* or Chinese *H. molitrix*) feed mostly on phytoplankton and grow rapidly in every reservoir. It is the most important stocked species in reservoirs. For middle-sized and large reservoirs, the number of fingerlings that can be stocked is often limited by the supply. Reservoirs tend to have a very high carrying capacity for phytoplankton-feeders, and silver carp is considered to be the best species to utilise that feed effectively. Silver carp can reach commercial sizes six to eight months after stocking, with a body weight of 0.8–1.2 kg in new reservoirs (Table 5). During the second year, the growth rate may reach 1–3 kg/year.
- Bighead carp (*Aristichthys nobilis*) is an exotic species introduced from China. This species effectively utilises zooplankton as food and is the largest among the stocked species. In new and large reservoirs, it can grow 5–7 kg per year. Maximum recorded body weight of bighead carp four years after stocking was 25 kg in Thac-ba Reservoir in 1976. Ordinarily, bighead grows 2–5 kg per year. The highest growth rate tends to be at the age two to three years. To maintain good growth rates, the proportion of bighead should not exceed 15% of total stocking density.
- Mud carp (*Cirrhina molitorella*) is an indigenous species living in the upper reaches of northern rivers. It feeds on detritus and periphyton, and breeds in strong currents of big rivers. In some reservoirs mud carp can spawn, but recruitment is low because its larvae do not survive well. Hence, it should be stocked in small numbers. Mud carp is very popular among local people for the quality of its flesh.

Table 3. Proportion of stocked fish in total catch in stocked reservoirs.

Reservoir	Area (ha)	Stocking density (ind/ha*)	Max. yield/ha (kg/ha)	Stocked species		Naturally recruited species		Data years
				(kg/ha)	(%)	(kg/ha)	(%)	
Suoi-hai	960	667	62.5	54.4	87.05	8.1	13.0	1966–73
Van-truc	150	3 644	31.0	28.4	91.7	2.6	8.3	1969–73
Dong-mo	800	1 065	55.0	52.8	96.0	2.2	4.0	1972–75
Cam-son	2 000	2 031	45.0	41.0	91.0	4.1	9.0	1971–72
Thac-ba	22 000	217	20.4	7.8	38.2	12.6	61.8	1971–75
Ea-kao	210	3 641	734.0	604.0	82.3	130.0	17.7	1997–99
Ea-kar	141	4 884	454.0	453.0	99.8	0.4	0.1	1997–99
Yang-re	56	4 686	584.0	501.0	85.8	83.0	14.2	1998–99
Ho 31	5.4	9 117	1 307.0	1 301.0	99.5	6.1	0.5	1997–98

* individuals/ha

Table 4. Dynamics of catch of some stocked reservoirs.

Year	Thac-ba (20 000 ha closed 1971)		Cam-son (2000 ha closed 1968)		Nui-coc (2000 ha closed 1976)		Suoi-hai (960 ha closed 1958)		Van-truc (170 ha closed 1966)		Dong-mo (800 ha closed 1971)		Ea-kao (210 ha closed 1979)	
	Catch (t)	(kg/ha)	Catch (t)	(kg/ha)	Catch (t)	(kg/ha)	Catch (t)	(kg/ha)	Catch (t)	(kg/ha)	Catch (t)	(kg/ha)	Catch (t)	(kg/ha)
1967							4.39	4.6	20	117.6				
1968							5.2	5.4	11	64.7				
1969							14	14.6	19	111.8				
1970			6	3			22	22.9	32.5	191.2				
1971	25	1.1	24	12			32	33.3	45	264.7				
1972	80	3.6	54	27			57	59.4	47.3	278.2				
1973	222	10.1	134	67			60	62.5	38.2	224.7	10	13		
1974	410	18.6	255	127.5			23	24.0	30	176.5	45	56		
1975	390	17.7	85	42.5			22	22.9			25	31		
1976	294	13.4	133	66.5	1.9	0.95	70	72.9			80	100		
1977	408	18.5	206	103	5.6	2.8	63	65.6			96	120		
1978	331	15.0	62	31	47	23.5	—	—			81	101		
1979	350	15.9	—	—	112	56	—	—			49	61		
1980	270	12.3	60	30	95	47.5	17	17.7			39.5	49		
1981	220	10.0	80	40	118	59	37.4	39.0			80	100		
1982	130	5.9	10	5	110	55	42.6	44.4			60	75		
1983	200	9.1	20	10	22.5	11.25	12	12.5			40	50		
1984	175	8.0	20	10	100	50								
1985	171	7.8	20	10	90	45							8.5	40.5
1986	166	7.5	—	—	95	47.5							25	119.0
1987	260	11.8	—	—	97	48.5							27	128.6
1988	250	11.4	10	5	56	28							29	138.1
1989	150	6.8	10	5	33	16.5							40	190.5
1990	50	2.3	10	5	12	6							17	81.0
1991	55	2.5	10	5	15	7.5							25	119.0
1992	80	3.6	—	—	17	8.5							32	152.4

Table 5. Growth performance of main fish species stocked in reservoirs.

Reservoir	Stocking species	Individual weight (kg) after stocking time				
		Year 1	Year 2	Year 3	Year 4	Year 5
Thac-ba (22 000 ha)	Silver carp	1.20	2.40	4.30	6.50	7.80
	Bighead	2.15	8.61	15.31	20.96	24.00
	Grass carp	1.78	2.96	4.65	6.75	7.81
Nui-coc (2000 ha)	Silver carp	1.20	1.63	2.67	3.25	
	Bighead	1.40	3.20	6.00	9.60	
	Grass carp	0.1	1.20	1.70	2.80	
Cam-son (2300 ha)	Silver carp	1.19	2.90			
	Bighead	1.56	4.20	15.60		
Suoi-hai (960 ha)	Silver carp	0.77	1.71	2.73	3.44	4.20
	Bighead	0.90	2.10	3.27	4.98	9.10
	Grass carp	0.80	1.83	2.75	3.80	
Ea-kao (240 ha)	Silver carp	0.54				
	Bighead	0.70				
Yang-re (46 ha)	Silver carp	0.49	1.24			
	Bighead	1.7				
Ho 31 (5.6 ha)	Silver carp	0.27	0.52			
	Bighead	2.5				

- Grass carp (*Ctenopharyngodon idellus*) is an exotic species introduced from China in 1962. It feeds on aquatic and terrestrial plants. Growth rate of grass carp in reservoirs is relatively low compared with silver and bighead carp. Production tends to depend on the availability of aquatic macrophytes, which varies greatly from reservoir to reservoir. Usually, it is stocked in limited quantities and does not breed in Vietnamese reservoirs.
- Tilapia, *Oreochromis mossambicus*, is popular in the north and *O. niloticus* in the south. Tilapia develop rather well in small and shallow reservoirs. In northern reservoirs, *O. mossambicus* can reach a maximal body weight of 0.5 kg at five years of age. It can reproduce in reservoirs, to some extent. In Van-truc Reservoir (150 ha, Vinh-phu Province) during 1967–1972, tilapia averaged 9.55% of the total catch. Maximum yield in 1967 was 19.0 t, 40% of the total catch. In Dong-tranh Reservoir (41 ha, Luong-son District, Hoa-binh Province), tilapia contributed 15% to the total catch (1966). In the south, *O. niloticus* contributed on average 4.7% to the total catch in Ea Kao Reservoir, but in other southern reservoirs, the yield is usually less than 0.1% of the catch.
- Common carp (*Cyprinus carpio*) can breed in most reservoirs, so small quantities should be

stocked in new reservoirs to supplement recruitment. Harvesting this bottom-living species can be very difficult, so common carp is not recommended for stocking deep reservoirs and those with uneven bottom. Common carp displays a low growth rate and low production in old northern reservoirs because of a lack of suitable natural food. However, growth rate in some southern reservoirs is high.

Besides their high productivity, the pelagic Chinese carps are popular for stocking because they are easily caught by various gear, in contrast to more benthic species.

Relationship between stocking density and yield

The general relationship between stocking density and fish production is presented in Figure 1. As the above-mentioned cultivated species contribute 30–99% of the total catch of the reservoir, fish production is closely related to stocking density and recapture rate. The dynamics tend to be unique to each reservoir, and as such a wide scatter is seen.

In small reservoirs like Ho-31, there are no self-recruited species so the catch depends on stocking. When the density exceeds optimum levels, growth and sometimes survival can be affected, and production, at best, does not increase much. For

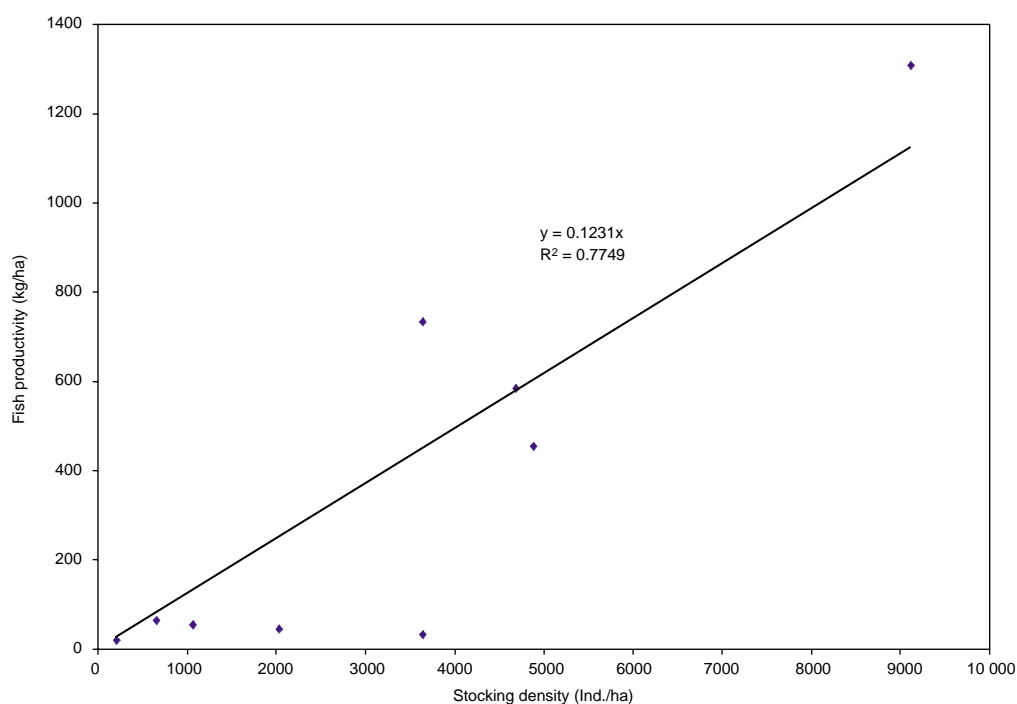

Figure 1. General relationship between stocking and total catch in reservoirs.

example, in 1996 a very high density of 11 173 fish/ha silver carp fingerlings was stocked in Ho-31 (5.37 ha). In 1997, 4579 kg silver carp with a mean weight of 272 g was harvested. Many were left in the reservoir for the next harvest. In 1998, another 4977 kg silver carp of 519 g mean weight were harvested (Cao, unpublished).

In the reservoirs studied by the project 'Management of Reservoir Fisheries in Dak Lak Province', the correlation between stocking rates and yields appears higher when stocking is compared with yields two years after stocking (Figures 2 and 3), rather than with yields in the following year (Figure 4). This may be due partly to the relatively small stocking sizes used. Examination of recruitment patterns suggests that recruitment begins about six months to one year after stocking, and the cohort becomes dominant several months later, assuming uniform stocking from year to year. Hence, a cohort will tend to dominate a fishery, beginning 12–18 months after stocking. Actual behaviour is highly cohort-, year-, and reservoir-specific.

Economic benefit of stocking

Table 6 suggests that the economics of stocking in northern reservoirs is only slightly lower than that in those of the Central Highlands. However, the northern reservoirs were managed by salaried workers whose income did not depend on the outcome of the fishery, while in the Central Highlands, controls were more stringent, since the welfare of the management team depended on income from the fishery. In all cases, the value of fish yields were considerably higher than the cost of stocking.

Another factor here is that the price of fingerlings has dropped relative to the price of harvested fish. The price of fingerlings per kilogram from the Central Highlands was about six times the price of harvested fish, while the ratio of per kilogram fingerling prices to harvested fish prices 20 years earlier in the north was closer to 20:1.

Other costs in addition to those of fingerlings are not considered in the above table. A more complete analysis of the economics of stocking in the Central Highlands is given in Table 7.

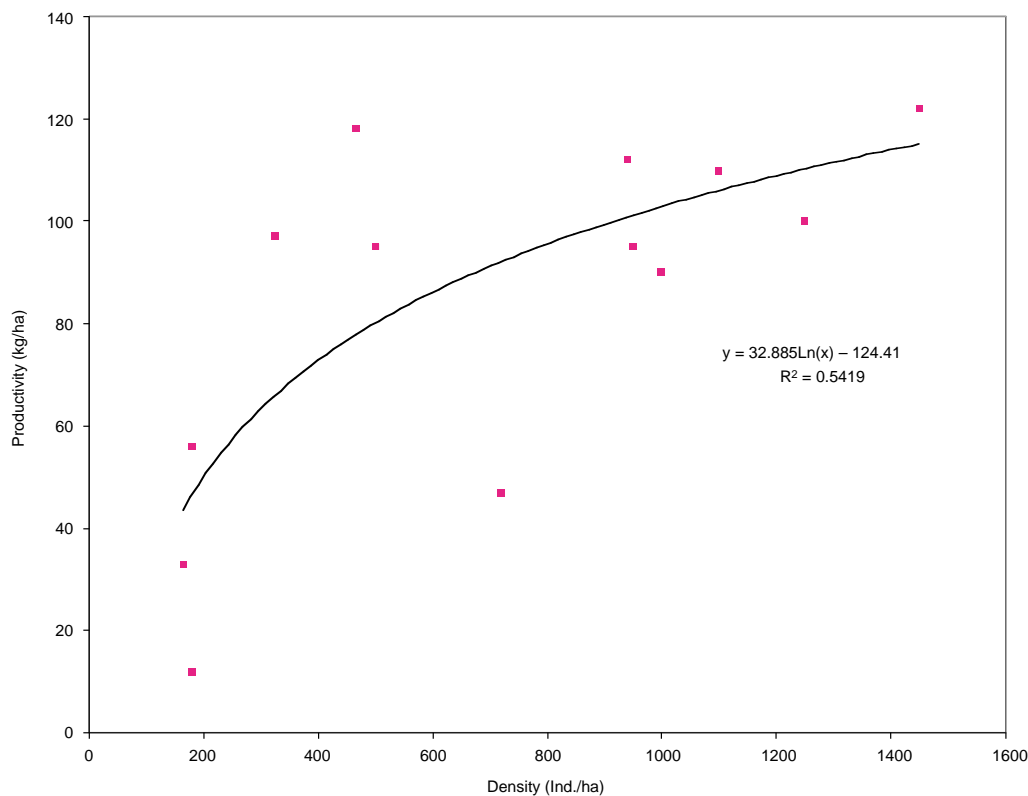

Figure 2. Productivity versus stocking density, third year in Nui-coc Reservoir.

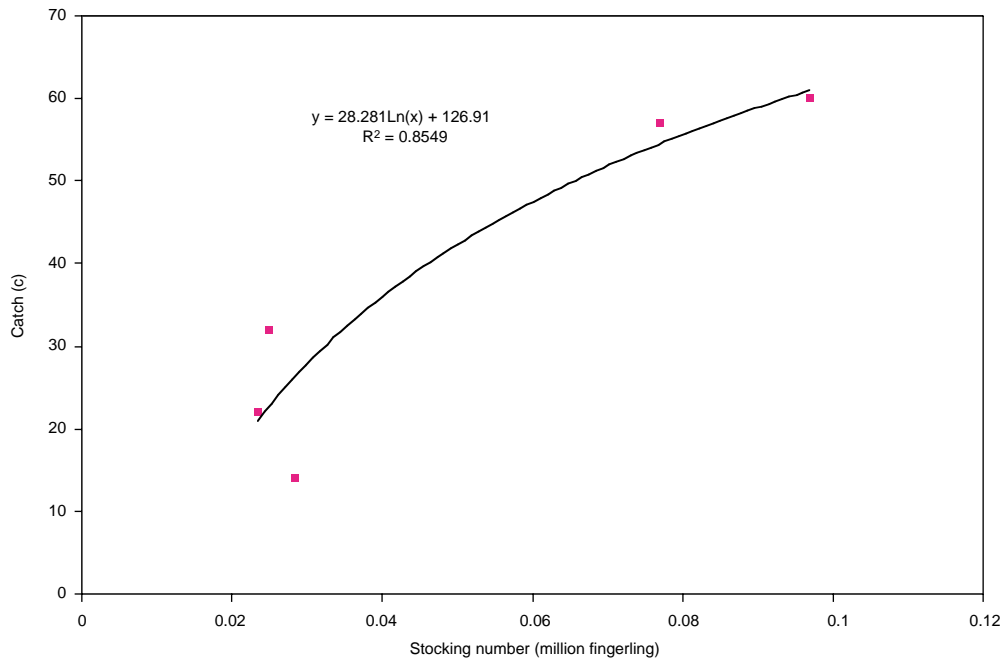

Figure 3. Relationship between stocking density and fish production of the third year in Suoi-hai Reservoir.

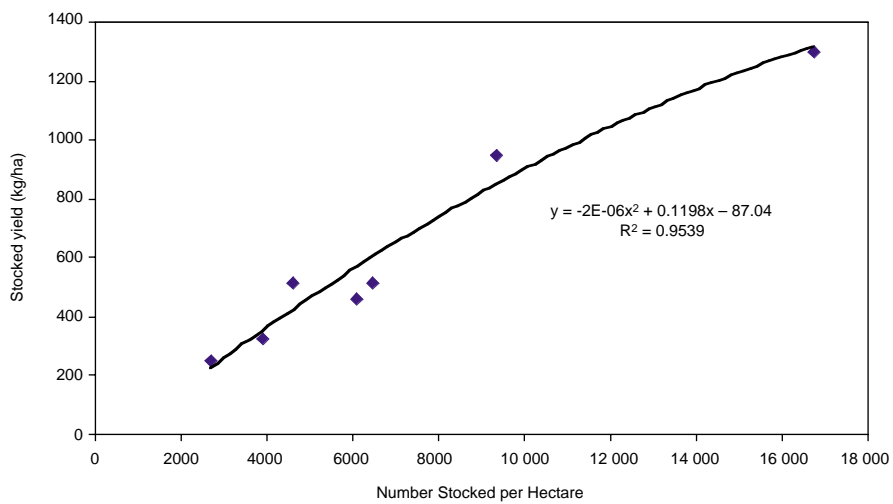

Figure 4. Relationship between stocking rates and yields two years later, four Dak Lak reservoirs.

'Other costs' in Table 7 does not include fees paid to fishers. When only stocking costs are considered, returns per hectare tended to drop with increasing reservoir area, and returns on investment (benefit to cost ratio) tend to increase with reservoir area. Although the economic efficiency of the operations can be improved in some ways, in all cases stocking proved economically viable.

Recapture rate of stocked species:

In order to ensure a high survival rate for stocked fish in reservoirs, fish seed must be large enough. Theoretically, Chinese carp should be 8–12 cm, but due to a lack of rearing ponds and high costs, only smaller (3–5 cm) fingerlings were stocked in most reservoirs.

In large and middle-sized northern reservoirs, the fish are recruited about one year after stocking, but are caught mainly in years 2 to 4 (Table 8). The method used here has been applied in order to estimate recapture rates in the other reservoirs listed in Table 9. Hence, effectiveness of stocking can be assessed only after many years of research.

Recovery rates tend to be inversely related to reservoir size (Table 9). Exceptions exist, such as Tam Hoa, a new reservoir with a high predator population. Recapture rates often are higher in slightly older reservoirs after predator populations diminish.

In general, recapture rates for silver and bighead carp in northern reservoirs tend to range from 10% to 15% in small to medium-sized reservoirs, and less than 5% in larger ones (Table 10). Stocking in larger

Table 6. Economics of stocking in some Central Highlands reservoirs 1996–99.

Reservoir	Year	Stocked cost (VND)	Harvested value (VND)	Net benefit (VND)	Benefit: cost ratio
Suoi Hai	1974	25 317	221 521	196 204	7.75
Dong Mo	1974	30 594	195 328	164 734	5.38
Ho 31	1996	9 000	18 686	9 686	1.08
	1997	6 015	32 867	26 852	4.46
	1998	3 910	29 554	25 644	6.56
Yang Re	1997	28 968	249 569	220 601	7.62
	1998	6 971	168 150	161 179	23.12
Ea-kar	1996	33 525	326 849	293 324	8.75
	1997	34 791	469 135	434 344	12.48
	1998	40 742	329 736	288 994	7.09
Ea-kao	1996	29 525	545 996	516 471	17.49
	1997	20 430	495 384	474 954	23.25
	1998	31 412	250 642	219 230	6.98

Table 7. Economics of stocking in some Central Highlands reservoirs, 1996–99.

Year	Invest cost (1000 VND)		Harvest value in year +1 (1000 VND)	Net benefit (1000 VND)	Net benefit/ha (1000 VND)	Net benefit: invest cost
	Stocking	Others				
Ho-31 Reservoir (5.37 ha)						
1996	9 000	4 800	18 606	4 806	895	0.34
1997	6 015	4 800	32 867	22 052	4 107	2.04
1998	3 910	4 800	29 554	20 844	3 882	2.39
Yang-Re Reservoir (56 ha)						
1997	28 968	31 000	249 569	189 601	3 386	3.16
1998	6 971	31 000	168 150	130 179	2 325	3.43
Ea-Kar Reservoir (141 ha)						
1996	33 525	103 100	326 849	190 224	1 349	1.39
1997	34 791	103 100	469 135	331 244	2 349	2.40
1998	40 742	103 100	329 736	185 894	1 318	1.29
Ea-Kao Reservoir (210 ha)						
1996	29 525	83 000	545 996	433 471	2 064	3.85
1997	20 430	83 000	495 384	391 954	1 866	3.79
1998	31 412	83 000	250 642	136 230	649	1.19

reservoirs is usually terminated about five years after closure, since production drops and recapture rates are too low to be economical.

Discussion

Almost all fisheries face the problem of lack of stocking material. Even though each company had at least one seed production station, the company could provide only larvae or small fingerlings (2–3 cm length). These cannot be stocked directly to the reservoirs because of abundance of predators. Ideally, each reservoir should have a seed production station

whose fingerling rearing pond area is 1/20–1/30 that of the reservoir, in order to ensure enough stocking material of standard body length of 8–12 cm. In fact, no reservoir can satisfy this demand, so reservoirs tend to be stocked with fewer fish of smaller sizes than desirable. This leads to high mortality and low actual stocking density. The lower the fish density, the more difficult and more expensive the fish are to catch.

Stocked species like silver carp, bighead carp, grass carp, common carp, and tilapia cannot breed, or breed with difficulty, in reservoirs. Water level fluctuation often leads to egg mortality, even when fish spawn successfully.

Table 8. Recapture data of stocked species in Suoi-hai Reservoir.

Stocking time	Stocked number	Recapture		Distribution of harvest (%)				
		No.	(%)	Year 1	Year 2	Year 3	Year 4	Year 5
Silver carp								
1968	230 120	11 655	5.1	6.32	25.2	28.6	34.9	5.0
1969	77 944	12 418	15.9	11.93	29.6	23.4	35.1	
Mud carp								
1968	94 500	3 809	4.0	3.89	11.5	61.5	21.2	1.9
1969	116 982	3 111	2.7	2.99	47.0	42.9	7.1	
Bighead carp								
1970	350 000	16 680	4.8	32.28	37.1	30.6		

Table 9. Average recapture rate (%) of stocked species in reservoirs North Vietnam (from Nguyen Van Hao 1974).

Reservoirs	Stocking species				Data
	Silver carp	Bighead	Grass carp	Mud carp	
Suoi-hai (960 ha)	9.0	4.77	—	9.3	12 years
Van-truc (172 ha)	21.2	24.4	—	8.0	6 years
Dong-tranh (42ha)	14.3	7.4	6.7	22.8	8 years
Tam-hoa (30 ha)	6.9	3.0	—	6.2	3 years
Dong-mo (1250 ha)	1.84	5.1	0.2	0.5	3 years

Table 10. Economical effectiveness of stocking in two reservoirs in North Vietnam.

	Stocking			Recapture		Fish price VND/kg	Harvest value VND
	Ind/ha	No.	Cost (VND)	(%)	No.		
Dong-mo reservoir (B/C = 195328/30594 = 5.38)							
Silver carp	622	777 500	11 429	1.84	14 306	1.5	29 334
Bighead	562	702 500	10 326	5.13	36 038	3	162 172
Mud carp	394	492 500	7 239	0.5	2 462	0.5	2 462
Grass carp	87	108 750	1 598	0.2	217	2.5	1 359
Total			30 594				195 328
Suoi-hai reservoir (B/C = 221521/25316 = 7.75)							
Silver carp	855	820 800	12 065	9	73 872	1.37	138 346
Bighead	491	471 360	6 928	4.77	22 483	1.47	49 576
Mud carp	448	430 080	6 322	9.3	39 997	0.42	33 597
			25 316			2	221 521

Because of the small size of the stocking material, the great majority is consumed by predators before recruitment. In rare cases when fish can spawn in reservoirs, recruitment is often very low because of the very low survival rate. Hence, continued stocking is required. Interruptions to stocking lead to reduced fish production immediately, the following year.

The cost of catching fish in reservoirs can be rather high. In recent years, gill-nets have become a popular fishing gear. However, the current in reservoirs is weak so it has a relatively low effect. Moreover, fishing gear is quickly worn out because of different kinds of obstacles like rocks and trees. Low yields in reservoirs led to increases in fishing effort, in the past. All these problems caused high cost of fishing and low returns.

In 1980, the country faced a long economic crisis. The situation affected developing fisheries in reservoirs. Many reservoir fisheries companies could not maintain their staff by selling fish products. The government stopped supplying money for stocking and other expenses, and even many of the strongest companies could not exist on their own. Staff numbers were reduced. Stocking was discontinued. Now most are carrying out their business only by fishing natural stocks. More recently, in some newly built reservoirs, some State fisheries companies are still stocking, as they have enough money and the stocking is cost-effective.

Stocking fish to the reservoir can improve quality of fish fauna, increase reservoir productivity, and hence increase fish yield. But, after many years of experience, it was realised that stocking could not be continued, because the State fisheries companies could not solve the management problems that obstructed them.

Conclusions

Stocking in reservoirs is effective in increasing fish production. Good results are still obtained in small and middle-sized reservoirs, but in large reservoirs, the work has led to almost no result.

Stocking with small fingerlings is popular in reservoir fisheries in Vietnam, and has led to a recapture rate of 20–30% in small reservoirs and 10–15% in middle-sized reservoirs.

In the small to medium-sized reservoirs of the Central Highlands, stocking remains economically viable. Returns appear highest with silver and bighead carp, which have high production potential, achieve a large size, and are relatively easy to harvest. These species normally occupy unexploited niches, and as plankton feeders, have very high production potential.

Fisheries management should be by a group of individuals whose welfare depends on the results of

the fishery, and who can cooperate with fishers to manage reservoirs together in order to assure equitable distribution of benefits.

Preserving or creating spawning grounds for useful species, restricting harvest of spawners in spawning season and in spawning grounds, and other measures are needed to maintain the wild fish fauna. While it cannot increase fish production as much as stocking, it requires only relatively small investment.

Especially in old reservoirs, fish productivity is normally low, and fishery potential is limited. The introduction of fish culture may increase economic output. Cage-fish culture should be considered because of the large areas available and relatively clean water. Moreover, pollution from cage culture should be low in reservoirs with deep water and a high flushing rate. Limits will also apply, so consideration is needed as to who should get cages, how many cages should be placed, and where cages should be placed.

Acknowledgments

This paper presents the work of all fish biologists of MRCP Vietnam component staff: Phan Dinh Phuc, Vo The Dung, Nguyen Quoc Nghi, Thai Ngoc Chien, Do Tinh Loi, Tran Thanh Viet, Nguyen Ngoc Vinh, and Phan Thuong Huy. Mr John Sollows gave valuable comments and spent time correcting the English manuscript. The author presents his sincere thanks to them all.

References

- De Silva, S.S. 1988. Reservoir bed preparation in relation to fisheries development: an evaluation. In: De Silva, S.S. ed. *Reservoir Fishery Management and Development in Asia*, IDRC, Ottawa, Canada, 121–130.
- Dinh Trong Thai, 1995. Reservoir fisheries status and future developing plan. *Proceedings of the Second National Reservoir Fisheries Workshop, Ha-bac 7/1995*, 2–10.
- Nguyen Duy Chinh, et al. 1994. *General Reservoir Fisheries Development Plan for 1995–2010 Period*. Institute of Economy and Planning for Fisheries; Hanoi, Dec.1994, 103 p.
- Nguyen Huu Nghi, 1995. Achievements, weakness and tendencies for development fishing method in reservoir. *Proceedings of the Second National Reservoir Fisheries Workshop, Ha-bac 7/1995*, 25–30.
- Truong Van Cao. Fisheries management and harvest status in Ho 31 reservoir, Dac-lac province, National Seminar 'Reservoir Fisheries Management', Nha-trang, May 1999 (unpubl.) 5 p.
- Nguyen Van Hao, 1974. Results of study on reservoir fisheries in small and middle size reservoirs North Vietnam, National Seminar 'Aquaculture in North Vietnam', 8–15 October 1974, Kien-xuong District, Thai-binh Province, 11p.

Investigation of the Fisheries in Farmer-Managed Small Reservoirs in Thainguyen and Yenbai Provinces, Northern Vietnam

Nguyen Hai Son, Bui The Anh and Nguyen T.T. Thuy*

Abstract

The present investigation was carried out 1998/1999 in two mountainous provinces, Thainguyen and Yenbai. Information on households involved in culture-based fishery activities in small reservoirs was collected based on questionnaires and direct interview of farmers. Some water-quality parameters were also determined twice a year at stocking (March–April) and harvesting (March–June) periods. It is noted that aquaculture in the small-scale reservoirs started in the mid-1990s when reservoirs were leased to farmers or farmer groups for long-term use. Prior to that the Provincial Department of Agriculture and Rural Development or local authorities managed the reservoirs mainly for irrigation, and fishery activities were non-existent. Results show that water quality of small reservoirs in both provinces is clear (transparency range 60–80 cm; DO (dissolved oxygen) value 5.4–7.4 mg/L; pH value 7.6–8.3) and the nutrient content generally low. Average fish yield was 331 kg/ha in Thainguyen and 251 g/ha in Yenbai. The study also deals with current fishery activities, which can also be considered an extensive form of aquaculture. Present farming practices in the reservoirs including seed supply, stocking rate and species, input level and economic efficiency are discussed. Although there is great potential for extensive aquaculture in these reservoirs, the study also identified technical constraints and policy issues that should be addressed in future development.

IN NORTHERN Vietnam, most reservoirs were constructed after 1960, primarily for the purposes of hydroelectric power generation and irrigation. Fisheries development, therefore, was of little concern. In recent years, due to the increasing demand for animal protein, especially in rural areas that also happen to be where reservoirs were impounded, fishery resources in most reservoirs tended to be over-exploited, and fish production in reservoirs has declined significantly.

Yenbai (6808 km²) and Thainguyen (3495 km²) are two northern provinces in one of the poorest regions of Vietnam (General Statistical Office 1993). The two provinces are reputed to have the highest population growth in the country. Agriculture and cash crops remain the predominant livelihood in the

region, producing mainly rice, tea and forest products. Reservoirs in the provinces are, therefore, used primarily for irrigation purposes. However, aquaculture has also been practiced, providing significant supplementary protein in diet locally.

Recognising the importance and the potential of reservoir fisheries in meeting the increasing demand for animal protein, as well as providing additional employment in rural areas, government policy in recent years has encouraged farmers to use reservoirs for fisheries development. Small reservoirs are leased to farmers or farmer groups for aquaculture. Management, therefore, has become simpler, and it is believed that reservoir resources can be used more effectively for enhancing fish production compared to earlier practices when reservoirs were managed by district or provincial fishery authorities.

Even though reservoir management has improved as a sequel to policy changes, fish yield in these water bodies is considered to be below optimal. For example, in the largest reservoir in the region, the

*Author for correspondence: E-mail: ria1@hn.vnn.vn.
Research Institute for Aquaculture No. 1. Dinh Bang – Tu Son – Bac Ninh, Vietnam

Thacba Reservoir, fish yield has been about 16–28 kg/ha/yr (Thai 1995), considerably less than that from even oligotrophic reservoirs in truly temperate regions such as in Russia, where average fish yield in reservoirs is normally 30–50 kg/ha/yr (Tuong 1995). This is thought to be due to the lack of a scientifically determined stocking and recapture strategy. Farmers determine stocking/recapture and/or management strategies based mainly on the availability of larvae and fry for stocking rather than on a strictly scientific basis. This paper aims to develop simple yield predictive models, which in turn can be used to determine suitable stock and recapture strategies for small farmer-managed reservoirs in Yenbai and Thainguyen provinces, the final outcome being increased fish production.

Methods

Surveys were carried out from March 1998 to October 1999 in 13 reservoirs in Yenbai and eight in Thainguyen provinces. Farmer-managed reservoirs were selected for the present study on the basis of consultation with provincial authorities. Sites studied are shown in Figure 1. For each reservoir, data pertaining to stocking practices, number and weight of each species stocked and details of the harvest, i.e. number and mean weight of each stocked species harvested and the total weight of naturally-recruited species (referred to as wild fish, here) were obtained. Information on marketing the catch was also collated from each farmer.

The water quality in each selected reservoir was determined twice a year, once at stocking and again at harvesting, then analysed in the Environmental Laboratory at the Research Institute for Aquaculture No. 1 (Vietnam) using standard techniques (AOAC 1984). Important water quality parameters included nitrate, phosphorus, chlorophyll-*a* and conductivity.

Potential statistical relationships (linear, curvilinear, exponential and second-order polynomial) and/or selected limnological characteristics to yield, and between the numbers and weight of stocked fish to the yield, were explored using the software package Excel 98.

Results

Reservoirs

The variation in size of small reservoirs in Yenbai and Thainguyen is relatively high. The smallest reservoirs include Docvien, Dambeo, Huongly and Lovoi with an area of 2 ha in Yenbai Province. The largest reservoir, Langday, is about 160 ha, also in this province. Water depth in each water body varied

mainly according to the geographical condition of the region, and ranged 2.5–11 m. Detailed data are presented in Table 1.

Table 1. Relevant morphometric characteristics of the reservoirs in the study.

Province/No. Reservoirs	Area (ha)	Depth (m)	Year impounded
Yenbai			
1 Trai Lam	3.0	6.0	1978
2 Dong Ly	41.0	7.0	1978
3 Doc Vien	2.0	4.0	1980
4 Tan Chung	25.0	5.0	1980
5 Doc Them	7.0	6.0	1984
6 Lang Day	160.0	12.0	1979
7 Nghia Trang	10.0	11.0	1984
8 Dong Ly	5.0	12.0	1978
9 Dam Chem	3.0	5.5	1986
10 Dam Beo	2.0	6.0	1984
11 Huong Ly	2.0	8.0	1985
12 Lo Voi	2.0	5.0	1978
13 Lo Xa	5.0	6.0	1982
Thainguyen			
1 Bao Linh	83.0	11.0	1987
2 Binh Son	65.0	9.0	1987
3 Quan Tre	41.5	6.0	1992
4 Phuong Hoang	20.2	10.0	1977
5 Suoi Lanh	48.0	9.0	1993
6 Phu Xuyen	18.2	5.0	1993
7 Doan Uy	16.2	6.0	1992
8 Ban Co	4.2	6.0	1966

Water quality

Even though the variation in temperature and dissolved oxygen (DO) has not been studied in detail, the preliminary data collected (Table 2) show that these parameters in all reservoirs studied are within the range suitable for fish culture. Variations of temperature and DO within and between reservoirs are relatively small. In March, temperature was about 27–28°C and in September increased to 30–31°C. It was also found that daytime DO concentrations are similar between March and September, as well as between reservoirs, ranging 6.8–8.8 mg/L and 6.5–8.5 mg/L in March and September respectively.

Concentrations of nitrogen in the form NO_3^- and phosphorus in the form PO_4^{3-} were relatively low. Nitrate concentration ranged 0.01–0.02 mg/L in March and 0.008–0.020 mg/L in September. Concentration of phosphorus ranged 0.02–0.07 mg/L and 0.02–0.05 mg/L in March and September, respectively. These two nutritional components also vary in

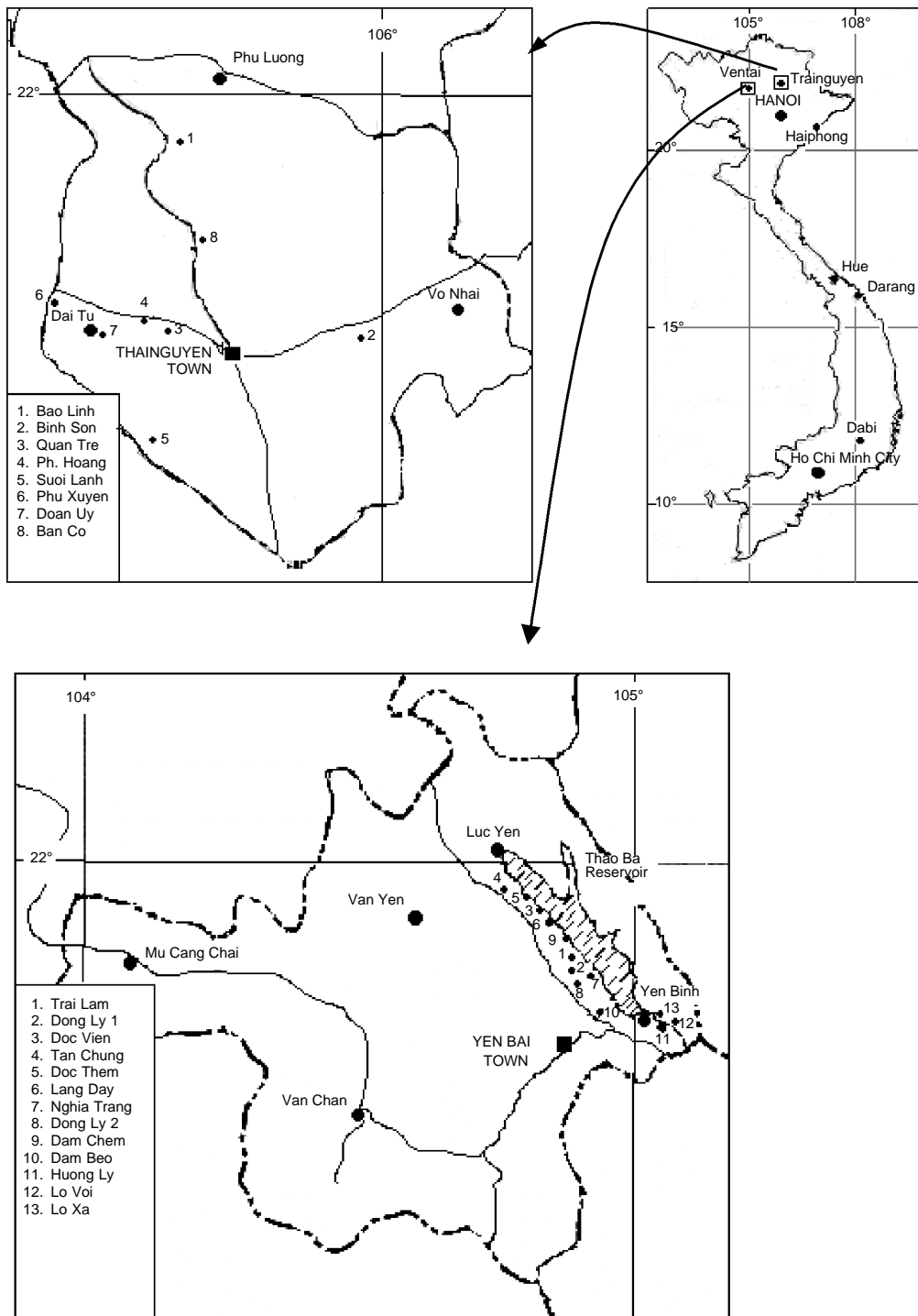

Figure 1. Detailed location of reservoirs sampled in Yenbai and Thainguyen provinces, and their location.

Table 2. Some water quality parameters in reservoirs in Yenbai and Thainguyen.

Province/ No.	March 99						September 99					
	T (°C)	DO (mg/L)	PO ₄ ³⁻ (mg/L)	NO ₃ ⁻ (mg/L)	Conductivity (µmho/cm)	Chlorophyll- α (mg/m ³)	T (°C)	DO (mg/L)	PO ₄ ³⁻ (mg/L)	NO ₃ ⁻ (mg/L)	Conductivity (µmho/cm)	Chlorophyll- α (mg/m ³)
Yenbai												
1	27.9	8.75	0.05	0.07	0.15	8.25	30.73	7.53	0.05	0.022	0.56	15.68
2	28.3	8.84	0.07	0.03	0.17	4.01	30.58	7.46	0.03	0.008	0.42	10.69
3	27.7	8.70	0.07	0.05	0.67	7.25	31.38	7.81	0.04	0.011	0.15	17.33
4	28.5	6.85	0.05	0.03	0.15	5.35	31.40	6.51	0.05	0.009	0.49	13.37
5	27.9	7.20	0.05	0.07	0.62	7.02	32.22	6.97	0.03	0.023	0.56	21.38
6	27.4	7.95	0.05	0.03	0.14	5.14	31.98	6.47	0.02	0.009	0.34	12.23
7	28.0	7.65	0.05	0.04	0.14	5.14	31.74	6.42	0.03	0.009	0.47	12.23
8	27.8	7.49	0.05	0.04	0.15	5.42	30.15	6.63	0.03	0.010	0.49	16.25
9	27.1	6.93	0.04	0.05	0.56	7.25	30.37	7.65	0.04	0.013	0.14	17.33
10	27.6	7.57	0.04	0.05	0.75	7.21	30.36	7.78	0.03	0.014	0.34	12.36
11	27.8	8.02	0.04	0.05	0.14	6.32	30.18	7.57	0.02	0.013	0.67	14.24
12	28.3	7.71	0.03	0.05	0.75	6.37	31.67	8.11	0.02	0.040	0.34	17.42
13	29.7	7.66	0.03	0.04	0.17	8.12	31.71	7.58	0.02	0.008	0.47	11.56
Thainguyen												
1	27.9	8.61	0.03	0.082	0.412	3.370	30.56	7.91	0.02	0.067	0.15	9.96
2	28.3	8.70	0.03	0.050	0.537	4.706	31.20	7.67	0.02	0.035	0.15	13.20
3	28.3	8.70	0.02	0.050	0.563	4.202	31.50	8.10	0.03	0.035	0.16	13.97
4	28.5	8.72	0.04	0.045	0.633	6.043	31.98	8.35	0.03	0.030	0.16	14.95
5	27.9	8.72	0.03	0.045	0.636	6.212	31.74	7.67	0.02	0.030	0.18	15.30
6	27.4	8.75	0.02	0.045	1.213	7.379	30.96	7.72	0.02	0.030	0.17	14.95
7	28.2	8.84	0.02	0.037	1.272	8.716	30.37	8.28	0.02	0.022	0.17	14.95
8	28.4	8.70	0.02	0.032	1.435	5.346	30.36	8.45	0.02	0.017	0.18	16.59

different sampling times, i.e. in March the values are higher than those in September.

Low concentrations of chlorophyll-*a* have been detected in all reservoirs, especially in March when they range 3.37–8.72 mg/m³. In September, they were higher (9.96–21.38 mg/m³) (Table 2). It was also found that the difference in terms of chlorophyll-*a* between reservoirs is not significant, e.g. in Thainguyen reservoirs it ranged 0.14–0.75 mg/m³ in March and 10.69–21.38 mg/m³ in September.

Similarly, concentrations of total ions in water are also shown at low levels, indicated by the value of conductivity. It was found that there is variation of conductivity between reservoirs, e.g. in March, about only 0.14 µmhos/cm whereas about 1.43 µmhos/cm in the other months. Generally, in most reservoirs conductivity in September was lower than in March except for some reservoirs in Yenbai Province.

The Fishery

Stocking

Stocking is normally carried out from March to April when fingerlings are available. Species of fish stocked depend mainly on availability in the regions and proximity to the supplies. In 1998 and 1999, both

in Yenbai and Thainguyen, fish stocked included grass carp (*Ctenopharyngodon idella*), silver carp (*Hypophthalmichthys molitrix*), big head carp (*Aristichthys nobilis*), common carp (*Cyprinus carpio*) and mrigal (*Cirrhinus mrigala*), of which silver carp and mrigal are considered two major species (Tables 3 and 4). This is not only because the seed of these two species is relatively cheaper and easy to harvest, but also their feeding habits are considered more suitable to the reservoir environment. In Yenbai, silver carp and mrigal were stocked in highest proportions, normally being more than 20% except where their seed was not available. Similarly, percentages of silver carp and mrigal stocked in Thainguyen were higher than 30% and 26%, respectively.

Fish yield can be enhanced by stocking a suitable number of fish, which in turn, however, depends on the financial status of farmers. Stocking density of most reservoirs studied is low, the major problem being limited availability of finance to purchase seed stock. Number of fish stocked in 1998 and 1999 in Yenbai reservoirs ranged 1205–8700 and 120–9386 fish/ha, and in Thainguyen 2076–9103 and 1979–6087 fish/ha respectively. There were differences in stocking density between reservoirs and even within reservoirs between the two years (Table 5).

Table 3. Weight (kg) of different species released into the reservoirs.

Province/No.	Grass carp		Silver carp		Bighead carp		Common carp		Mrigal	
	1997	1998	1997	1998	1997	1998	1997	1998	1997	1998
Yenbai										
1	80	70	200	120	40	20	10	20	90	120
2	50	50	200	150	0	25	0	0	100	95
3	100	60	100	100	0	20	0	10	50	80
4	0	150	400	250	0	80	0	8	500	262
5	150	70	100	190	0	45	0	15	50	80
6	200	120	400	300	0	100	0	12	500	368
7	30	80	120	160	0	30	0	20	30	60
8	50	75	150	140	0	10	50	9	20	66
9	150	100	100	150	60	20	80	11	60	189
10	250	80	350	120	90	45	90	12	350	93
11	180	20	120	70	30	10	25	10	115	40
12	50	40	100	90	0	15	20	10	50	85
13	200	70	300	180	0	45	100	15	100	90
Thainguyen										
1	75	100	375	250	75	15	95	30	580.0	455
2	55	160	425	360	50	25	0	60	350.0	395
3	60	200	160	200	25	40	40	45	1.3	215
4	501	80	120	150	40	30	50	45	140.0	115
5	85	90	275	200	75	50	65	30	0.3	130
6	40	150	135	210	180	20	45	55	150.0	165
7	100	180	220	190	70	29	50	30	210.0	291
8	80	80	130	110	40	25	70	50	130.0	115

Table 4. Percentage by number of each species released into reservoirs in Yenbai and Thainguyen Provinces.

Province/No.	Grass carp		Silver carp		Bighead carp		Common carp		Mrigal	
	1997	1998	1997	1998	1997	1998	1997	1998	1997	1998
Yenbai										
1	19.0	20.0	47.6	34.3	9.5	5.7	2.4	5.7	21.4	34.3
2	14.3	15.6	57.1	46.9	0.0	7.8	0.0	0.0	28.6	29.7
3	40.0	22.2	40.0	37.0	0.0	7.4	0.0	3.7	20.0	29.6
4	0.0	20.0	44.4	33.3	0.0	10.7	0.0	1.1	55.6	34.9
5	50.0	17.5	33.3	47.5	0.0	11.3	0.0	3.8	16.7	20.0
6	18.2	13.3	36.4	33.3	0.0	11.1	0.0	1.3	45.5	40.9
7	16.7	22.9	66.7	45.7	0.0	8.6	0.0	5.7	16.7	17.1
8	18.5	25.0	55.6	46.7	0.0	3.3	18.5	3.0	7.4	22.0
9	33.3	21.3	22.2	31.9	13.3	4.3	17.8	2.3	13.3	40.2
10	22.1	22.9	31.0	34.3	8.0	12.9	8.0	3.4	31.0	26.6
11	38.3	13.3	25.5	46.7	6.4	6.7	5.3	6.7	24.5	26.7
12	22.7	16.7	45.5	37.5	0.0	6.3	9.1	4.2	22.7	35.4
13	28.6	17.5	42.9	45.0	0.0	11.3	14.3	3.8	14.3	22.5
Thainguyen										
1	6.0	11.8	30.0	29.4	2.0	1.8	10.0	3.5	52.0	53.5
2	2.0	16.0	45.0	36.0	4.0	2.5	16.5	6.0	32.0	39.5
3	5.0	28.6	40.0	28.6	0.0	5.7	5.0	6.4	50.0	30.7
4	10.0	19.1	30.0	35.7	5.0	7.1	8.0	10.7	47.0	27.4
5	8.5	18.0	45.0	40.0	5.0	10.0	1.2	6.0	40.0	26.0
6	1.3	25.0	44.4	35.0	6.7	3.3	0.7	9.2	46.7	27.5
7	1.4	25.0	35.0	26.4	13.0	4.0	9.2	4.2	41.7	40.4
8	8.0	21.1	40.0	29.0	0.0	6.6	12.1	13.2	39.6	30.3

Table 5. Details of total stocked weight and number, yield and stocking efficiency of each reservoir.

Province/No.	Stocking				Yield		Stocking	
	(kg/ha)		(no./ha)		(kg/ha)		efficiency	
	1998	1999	1998	1999	1998	1999	1998	1999
Yenbai								
1	140.0	116.7	2 090	4 750	433	500	3.10	4.29
2	8.5	7.8	3 925	1 647	21	29	2.51	3.75
3	125.0	135.0	1 250	4 500	250	400	2.00	2.96
4	36.0	30.0	6 420	1 200	76	100	2.11	3.33
5	42.9	57.1	2 023	1 450	86	1 000	2.00	17.50
6	6.9	5.6	4 980	120	21	20	3.11	3.56
7	18.0	35.0	4 600	1 705	90	170	5.00	4.86
8	54.0	60.0	2 290	2 690	380	200	7.04	3.33
9	150.0	123.3	6 030	4 156	317	317	2.11	2.57
10	315.0	113.6	8 700	7 836	591	368	1.88	3.24
11	85.0	75.0	1 205	9 386	285	450	3.35	6.00
12	110.0	120.0	4 020	2 489	305	425	2.77	3.54
13	140.0	80.0	6 070	1 810	410	340	2.93	4.25
Thainguyen								
1	14.45	10.24	2 800	2 048	156.6	180.72	10.84	17.65
2	13.84	15.38	2 076	3 076	107.6	138.46	7.77	9.00
3	12.05	16.87	2 410	3 374	144.5	216.87	11.99	12.86
4	19.80	20.79	2 970	3 118	495.0	594.06	25.00	28.57
5	14.58	10.42	2 478	1 979	250.0	208.33	17.15	20.00
6	30.21	32.97	3 021	5 604	384.6	439.56	12.73	13.33
7	40.12	44.44	4 021	4 440	277.7	432.10	6.92	9.72
8	107.10	90.48	9 103	6 087	833.0	761.90	7.78	8.42

Size of fish stocked also varied depending on species as well as availability, and more often than not was affected by the price of fingerlings. Mostly, fish stocked are relatively small, as small fish are much cheaper than large fish. Average sizes of fish released into reservoirs are grass carp, 10–12 cm (25–30 g); silver carp, 6–8 cm (12–15 g); big head carp, 12–14 cm (20–25 g); common carp, 6–12 cm (15–20 g); and mrigal, 6–8 cm (8–10 g).

Harvesting

Harvesting is normally undertaken once a year from March to July, almost a year after stocking, when the water level is low after meeting irrigation requirements. Data in Table 6 show that stocked fish remain an important source of fish harvest, representing more than 90% of total weight of the harvest. Moreover, percentages of fish harvested in terms of species correlate with those stocked, e.g. silver carp, mrigal and grass carp remain the major contributions to production (Table 7).

Size of fish harvested was found to vary between species. However, fish within a species stocked in different reservoirs were similar in terms of weight.

Mean weight of each species at harvest was grass carp, 1.0–1.5 kg; silver carp, 0.5–1.0 kg; big head carp, 1.2–2.0 kg; common carp, 0.3–0.7 kg; and mrigal 0.3–0.6 kg.

Variation in yield between reservoirs was found to be significant. The yield in reservoirs in Yenbai ranged 21–591 and 20–1000 kg/ha/yr in 1998 and 1999, respectively, and that of reservoirs in Thainguyen 107–833 and 138–761 kg/ha/yr in 1998 and 1999, respectively. There were also notable differences in yield between the two years, particularly in Docthem Reservoir in Yenbai, where the yield in 1998 was only 86 kg/ha, but in 1999 reached 1000 kg/ha (Table 5).

Stocking efficiency

Stocking efficiency is defined as the ratio of yield of stocked fish (kg/ha) to the weight of fish stocked (kg/ha) (Li 1987). It is found that there is a significant difference in terms of the stocking efficiency of reservoirs in two provinces studied. The range of stocking efficiency in Yenbai in 1998 and 1999 was 1.88–7.04 and 2.57–17.50, respectively, while in Thainguyen ranged 6.92–25.0 and 8.42–28.57,

Table 6. The total stocked weight and the yield of stocked fish and wild fish (kg) in reservoirs of Yenbai and Thainguyen Provinces, 1998 and 1999.

Province/No.	1998			1999		
	Stocked weight	Stocked production	Wild production	Stocked weight	Stocked production	Wild production
Yenbai						
1	420	1 300	300	350	1 500	180
2	350	880	449.7	320	1 200	200
3	250	500	150	270	800	100
4	900	1 900	600	750	2 500	150
5	300	600	249.9	400	7 000	400
6	1 100	3 420	600	900	3 200	120
7	180	900	150	350	1 700	80
8	270	1 900	100	300	1 000	80
9	450	950	99.9	370	950	150
10	630	1 600	198	250	810	85
11	170	570	150	150	900	70
12	220	610	100	240	850	85
13	700	2 050	500	400	1 700	100
Thainguyen						
1	1 200	13 000	114.5	850	15 000	800
2	900	7 000	167.7	1000	9 000	700
3	500	6 000	52.2	700	9 000	600
4	400	10 000	101.2	420	12 000	300
5	700	12 000	31.2	500	10 000	800
6	550	7 000	27.3	600	8 000	250
7	650	4 500	0	720	7 000	200
8	450	3 500	282.7	380	3 200	160

Table 7. Percentage by weight of each stocked fish harvested in 1998 and 1999 in reservoirs of Yenbai and Thainguyen Provinces.

Province/No.	Grass carp		Silver carp		Bighead carp		Common carp		Mrigal	
	1998	1999	1998	1999	1998	1999	1998	1999	1998	1999
Yenbai										
1	15.4	23.3	30.8	36.7	23.1	10	15.4	8	15.4	22
2	11.4	14.2	45.5	33.3	0	8.3	11.4	4.2	31.8	40
3	40	18.8	40	37.5	0	17.5	0	10	20	16.3
4	10.5	12	42.1	18	10.5	7.2	0	2.4	36.8	60.4
5	50	4.3	33.3	35	0	4.2	0	2.7	16.7	53.8
6	8.8	8.8	43.9	24.4	0	18.6	3.5	3.1	43.9	45.2
7	22.2	11.8	55.6	20.6	0	4.4	0	4.7	22.2	58.5
8	18.4	19	39.5	30	10.5	8	10.5	8.4	21.1	34.6
9	53.3	23.2	26.7	26.3	0	8.4	6.7	4.2	13.3	37.9
10	43.8	18.5	22.5	29.6	10	9.9	5	9.9	18.8	32.1
11	35.1	22.2	35.1	30	17.5	5.6	3.5	8.3	8.8	33.9
12	32.8	11.8	32.8	23.5	0	8.2	9.8	11.8	24.6	44.7
13	19.5	11.2	29.3	25.3	7.3	7.4	14.6	3.5	29.3	52.6
Thainguyen										
1	10.4	2.3	30.7	8.7	23.1	4.3	3.2	0.7	32.7	84
2	3.6	5.2	47.1	10.8	8.6	7.8	3.7	2.1	37	74.1
3	4.6	2	40.8	12.2	0	4.7	3	2	51.6	79.1
4	7.5	2.9	35.5	9.2	10.5	7.1	8	1.8	38.5	79
5	0.2	1.7	8.3	12	12.5	0.9	6.3	1	72.8	84.4
6	1.4	3.1	45.7	18.8	28.6	5.3	3.9	1.9	20.4	71
7	13.3	3.9	32.2	10.7	21.6	3.1	5.3	1.9	27.6	80.4
8	4.3	13.4	38.6	27.2	0	8.4	9.1	4.7	48	46.3

Table 8. Summary of relationship between annual yield ($Y = \text{kg/ha/yr}$) and reservoir area ($A = \text{ha}$), stocked weight ($W = \text{kg/ha}$), chlorophyll- α concentration ($\text{Chl} = \text{mg/m}^3$) and conductivity ($\text{Con} = \mu\text{mhos/cm}$).

Relationship	Location	Equation	R ²	P-value
Yield vs area	Yenbai	$Y = 818.33 A^{-0.7384}$	0.84	<0.001
	Thainguyen	$Y = 2219.60 A^{-0.6154}$	0.85	<0.050
Yield vs stocked weight	Yenbai	$Y = -0.0138W^2 + 4.741W + 37.67$	0.62	<0.050
	Thainguyen	$Y = -0.0268W^2 + 9.6178W + 100.42$	0.74	<0.050
Yield vs chlorophyll- α	Yenbai	$Y = 751.97\text{Ln}(\text{Chl}) - 1470.4$	0.62	<0.050
	Thainguyen	$Y = 683.84\text{Ln}(\text{Chl}) - 1213.0$	0.30	<0.050
Yield vs conductivity	Yenbai	$Y = 1248.54 \text{Con} - 206.17$	0.68	<0.001
	Thainguyen	$Y = 1201.54 \text{Con} - 170.44$	0.58	<0.001

respectively (Table 5). According to Li (1987), reservoirs in Yenbai had both poor (less than 5) and good (5 to 10) stocking efficiency, whereas Thainguyen's reservoirs remain higher and ranged between good and excellent (more than 10). It is also found that stocking efficiencies in each reservoir were similar between two years, except for Docthem Reservoir where the values in 1998 and 1999 were 2 and 17.5.

Statistical relationships

The data were used to explore the existence of possible statistical relationship of yield to reservoir features, such as area, and water-quality parameters such as chlorophyll- α concentration and conductivity, and to stocking levels. In this attempt, for each reservoir, the mean for 1998 and 1999 was taken, and, in view of the climatic and other physical differences between the two provinces, the data on the reservoirs of the two provinces treated separately. Relationships are shown in Table 8. In both groups, the following relationships were found to be significant:

- Fish yield (kg/ha/yr) to reservoir area (ha) (Figure 2);
- Fish yield to stocked weight (kg/ha) (Figure 3);
- Fish yield to chlorophyll- α concentration (mg/m^3) (Figure 4); and
- Fish yield to conductivity ($\mu\text{mhos/cm}$) (Figure 5).

Economic efficiency

Data from Table 9 show the summary of economic efficiency in 1998 and 1999 of reservoir fisheries in Yenbai and Thainguyen, calculated for a one-ha water surface. Cost:benefit ratios are low, except Thainguyen in 1999 which had a ratio of approximately 78%. In terms of investment, capital costs represent only a small proportion of total cost, being 7.1–7.7% in Yenbai and 12.8–12.1% in Thainguyen. On the other hand, variable costs remained the bulk in which labour and fish seed required the highest investment, more than 60% of total costs. It is also

noted that in Thainguyen money spent on feed is more than in Yenbai. However, fingerling costs in Yenbai are much higher than those in Thainguyen, which could result in different cost:benefit ratios gained from fisheries in the reservoirs of the two provinces.

Table 9. Summary of capital and operating costs and cash flow analysis for the culture-based fisheries of reservoirs in Yenbai and Thainguyen Provinces.

	Yenbai		Thainguyen	
	1998	1999	1998	1999
Capital costs (1000 VND)				
Leasing	150.0	150.0	250.0	250.0
Total capital costs	150.0	150.0	250.0	250.0
Operating costs (1000 VND)				
Labour				
Protection	560.0	560.0	437.1	437.1
Others	140.4	120.5	138.5	285.8
Food	195.0	297.2	397.5	355.0
Seed	897.3	992.2	550.6	622.5
Total operating costs	1792.7	1969.9	1523.7	1700.4
Gross output (1000 VND)	2480.9	2558.3	2487.7	3343.5
Net income (1000 VND)	465.3	588.4	964.0	1520.2
Benefit:cost ratio	0.24	0.27	0.54	0.78

Discussion

Vietnam is estimated to have 242 725 ha of reservoirs distributed throughout the country, of which about 48.05% considered suited to culture-based fisheries (Hao et al. 1993). Over the last five to seven years, major policy changes have taken place in regard to reservoir fishery development and management in Vietnam. The most notable is the leasing of

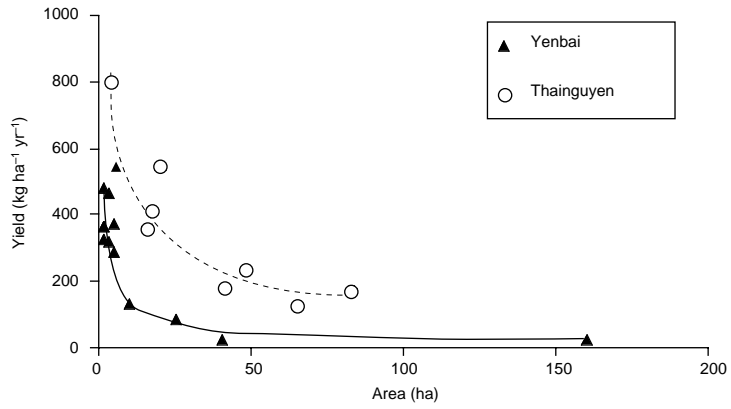

Figure 2. Relationship between annual yield and surface area of small reservoirs in Yenbai and Thainguyen.

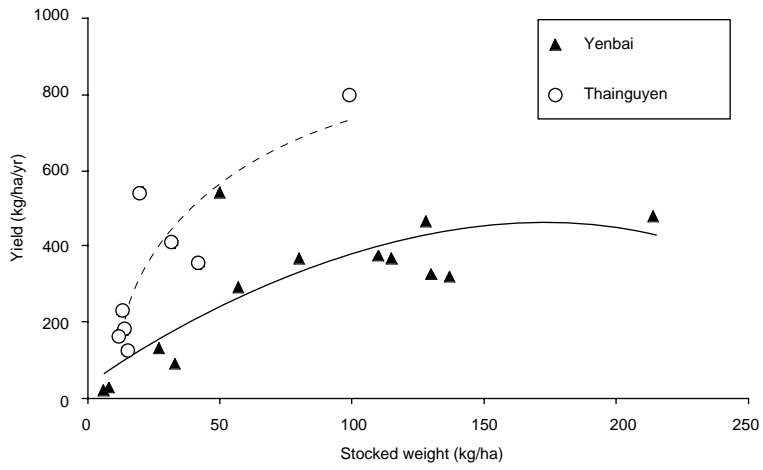

Figure 3. Relationship between annual yield (year $n+1$) and total stocked weight in reservoirs (year n) in Yenbai and Thainguyen.

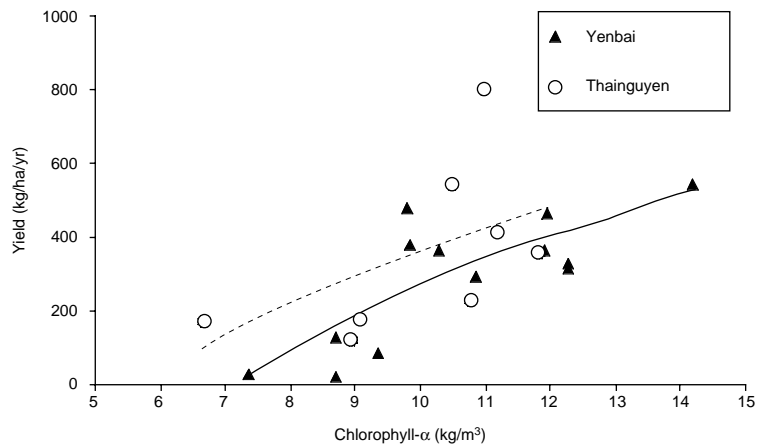

Figure 4. Relationship between annual yield and chlorophyll- a concentration in reservoirs in Yenbai and Thainguyen.

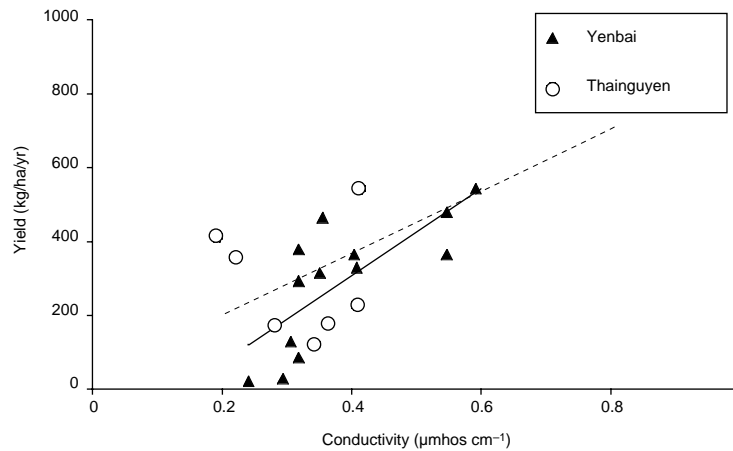

Figure 5. Relationship between annual yield and conductivity in reservoirs in Yenbai and Thainguyen.

small reservoirs by provincial authorities to individual and/or farmer groups for fishery activities, which have to be conducted in harmony with downstream irrigation needs. However, current fishery management is based on trial and error, and not scientifically based. Accordingly, it is thought that the full potential of the reservoirs is not realised.

This study is one of the first instigated on farmer-managed reservoirs in Vietnam. It is evident that there were large differences in fish yield between reservoirs and within reservoirs between years. Differences in fish yield among reservoirs in Vietnam is well documented (Hao et al. 1993; Hoan 1995; Nghi 1995; Thai 1995). This variation in fish production in reservoirs in Vietnam, as is the case elsewhere, has been a major issue that has remained unexplained (De Silva 1996). However, in the reservoirs studied presently, it is evident that the stocking efficiencies among them, and in most of them between years, were less variable than the yield. The implication of the observation is that with proper management, stocking efficiency can be further improved, and hence the yield as well as profits.

The results also indicated a number of statistically significant relationships of fish yield to other parameters, including the number of stocked fish. In general, statistical relationships of fish yield to morphometric and limnological parameters have been hitherto developed in respect of large perennial reservoirs and lakes (see De Silva 1996 for an appraisal). The current results are the first to be reported for culture-based fisheries in small reservoirs in Vietnam. The existence of such relationships, in reservoirs of both provinces in respect of

the same parameters, may also be indicative of the potential applicability of the findings to other regions for management purposes, particularly in reservoirs to be utilised for fish production for the first time. The statistical relationships of annual yield and stocked weight in reservoirs in Yenbai showed that the yield would decline if stocked weight exceeded 200 kg/ha. This is evident from the second-order polynomial relationship of yield to stocked weight, from which the most effective stocked weight for reservoirs in the province is about 175 kg/ha.

The results of water-quality analysis show that reservoirs studied are relatively poor in primary production, indicated by low concentration of chlorophyll-*a* and conductivity. In the range of data collected, fish yield has increased steadily following the increases in chlorophyll-*a* concentration and conductivity. Studies with respect to ways of improving primary production in small reservoirs, using locally available organic manures, are therefore warranted.

Returns from culture-based fisheries in small reservoirs in Yenbai and Thainguyen were considerably low and far from optimal due to lack of scientifically determined stocking and recapture strategies. In addition, the farmer lessees themselves lack of expertise in husbandry aspects, a factor that results in low production. Practices therefore should be technically improved by providing extension work on aquaculture to farmer lessees.

Acknowledgments

This study was funded by the Australian Centre for International Agricultural Research. We would like

to extend our sincere thanks to Professor Sena S. De Silva (Deakin University, Australia) for his guidance throughout the study and for invaluable advice during the preparation of this paper. Special thanks are given to Dr Le Thanh Luu for his support and encouragement and the staff of the Departments of Agriculture and Rural Development of Yenbai and Thainguyen provinces, without whose cooperation the study would not have been possible.

References

- AOAC (Association of Official Analytical Chemists) 1984. Official Methods of Analysis. 14th Williams, S. (ed.) AOAC, Arlington, VA, 1141 p.
- De Silva, S.S. 1996. The Asian Fishery with Special Reference to Reservoir Fisheries: A Reappraisal. In: Schiemer, F. and Boland, K.T. ed. Perspectives in Tropical Limnology, SBP Academic Publisher, Netherlands, 321–332.
- General Statistical Office 1993. Statistical Data on Basis Situation and Infrastructure of Rural Area in Vietnam. Statistical Publishing House, Hanoi.
- Hao, N.V., Nghi N.H. and Am P.X. 1993. Status of Reservoir Fisheries. Project Report, RIA 1 (in Vietnamese).
- Hoan, N.D. 1995. Status of reservoir fisheries in the central provinces of Vietnam. In: Proceedings of the Second Workshop on Reservoir Fisheries, Vietnam (in Vietnamese), 50–53.
- Nghi, N.H. 1995. Techniques in reservoirs harvesting: achievements and existences. In: Proceedings of the Second Workshop on Reservoir Fisheries, Vietnam (in Vietnamese), 25–34.
- Li, S. 1987. The principles and strategies of fish culture in Chinese reservoirs. In: Reservoir Fishery Management and Development in Asia, Proceedings of a Workshop held in Kathmandu, Nepal, 214–223.
- Thai, D.T. 1995. Current status of reservoir fisheries, strategies for its future development. In: Proceedings of the Second Workshop on Reservoir Fisheries, Vietnam (in Vietnamese), 2–10.
- Tuong, N.H. 1995. Chemical, Biological Characteristics, and Fish Fauna in Thacba Reservoir and Strategies to Enhance Fish Yield in Reservoir. Project Report RIA 1, Vietnam (in Vietnamese).

Using Population Models to Assess Culture-Based Fisheries: A Brief Review with an Application to the Analysis of Stocking Experiments

K. Lorenzen*

Abstract

Population dynamics models are powerful tools for the analysis of culture-based fisheries and the optimisation of stocking and harvesting regimes. Key population processes and the resulting dynamics of culture-based fisheries are briefly reviewed, and approaches to the practical assessment of management regimes are outlined. A model is developed for the analysis of stocking experiments, and applied to mrigal (*Cirrhinus mrigala*) stocking in Huay Luang reservoir, Thailand.

CULTURE-BASED fisheries are fisheries based mainly or entirely on the recapture of farm-produced seed fish (Lorenzen 1995). Culture based fisheries are widespread in the developed and developing world, operating on the largest scale in Chinese reservoirs (Welcomme and Bartley 1998). Yields and technical efficiency measures vary widely between culture-based fisheries, but the underlying reasons are poorly understood and the predictability of outcomes remains limited. There is therefore an urgent need for rigorous evaluation and analysis culture-based fisheries. Such analyses must go beyond merely diagnosing success or failure of particular fisheries: they must pinpoint underlying reasons, and identify improvement in management regimes where such potential exists.

In culture-based fisheries, hatchery-reared fish are released into water bodies not primarily managed for fish production, and recaptured upon reaching a desirable size. Mortality and growth of the stocked fish are dependent on the natural conditions of the stocked water body, and a key technological management problem is therefore to identify stocking and

harvesting regimes that make the best possible use of the given conditions.

The approaches used to identify optimal management regimes differ greatly between aquaculture and capture fisheries, being based largely on experimentation in the former, and on the use of stock assessment models in the latter. In culture-based fisheries, the scope for controlled experimentation is far lower than in aquaculture, yet the conventional assessment models for capture fisheries are inadequate to address the management problems posed by stocked fisheries. The development of models that capture the dynamics of culture-based fisheries adequately is therefore a key step towards the optimisation of management regimes. Conventional fisheries models divide the life cycle of fish into recruited phase where mortality is constant and growth independent of population density, and a pre-recruit phase where non-specified density-dependent processes give rise to a stock-recruitment relationship. In culture-based fisheries, fish are stocked at an intermediate stage of the pre-recruit phase, and population density can be manipulated to an extent that elicits strong compensatory responses even in the recruited stock. Hence, the size- and density-dependent processes in the juvenile and adult phases of the life cycle must be considered explicitly to evaluate management options.

In this paper, process models for mortality and growth applicable to culture-based fisheries, and the resulting dynamics of stocking and harvesting are briefly reviewed. The process of assessing culture-

*T.H. Huxley School of Environment, Earth Sciences and Engineering, Imperial College of Science, Technology and Medicine, 8 Princes Gardens, London SW7 1NA, United Kingdom. Tel: (+44) 171 594 9312; Fax: (+44) 171 589 5319

based fisheries is described, and an example application to the analysis of stocking experiments is provided. Finally, the potential for comparative analyses is discussed.

Population Process Models for Culture-Based Fisheries

Key population processes in culture-based fisheries are density-dependent growth and size-dependent mortality.

Density-dependent growth

Density-dependent growth is well documented in wild fish populations (e.g. Beverton and Holt 1957; Le Cren 1958; Backiel and Le Cren 1978; Hanson and Leggett 1985; Salojaervi and Mutenia, 1994) and in extensive aquaculture (Walter 1934; Swingle and Smith 1942; van Someren and Whitehead 1961). Building on earlier work by Beverton and Holt (1957), Lorenzen (1996a) developed a von Bertalanffy growth model for density dependent growth. In the model, asymptotic length is assumed to decline linearly with population biomass density. This leads to the following expression for asymptotic weight:

$$W_{4B} = (W_{4L}^{1/3} - c B)^3 \quad (2)$$

where W_{4B} is the asymptotic weight at biomass B and W_{4L} is the limiting asymptotic weight when biomass approaches zero. The competition coefficient c describes how steeply asymptotic weight declines with increasing biomass. For a given species, the limiting asymptotic weight W_{4L} is related to properties of the water body stocked, and in general W_{4L} is likely to be positively correlated with the productivity of the water body. Generalisations about the competition coefficient c are difficult to make at present, but are likely to emerge from comparative studies once the model has been applied to a wider range of populations.

Size-dependent mortality

Theoretical and empirical studies (Peterson and Wroblewski 1984; McGurk 1986; Lorenzen 1996b) point to the existence of an allometric relationship between natural mortality and body weight in fish of the form:

$$M_W = M_u W^{-b} \quad (1)$$

where M_W is natural mortality at weight W , M_u is mortality at unit weight, and b is the allometric exponent. Lorenzen (1996b) shows that mortality of fish in natural ecosystems is governed by a consistent

allometric relationship with parameters $b = -0.3$ and $M_u = 3/\text{year}$.

A meta-analysis of stocking experiments (Lorenzen unpublished) shows that average release size-survival relationships are well described by models based on allometric mortality with constant b , and that the mathematically convenient assumption of $b = -1/3$ is adequate for the analysis of release size. M_u was found to be highly variable between experiments. Hence in practical assessment work, b can be fixed at $-1/3$ a priori, while M_u has to be estimated separately for each fishery.

Population Dynamics of Culture-Based Fisheries

The population dynamics of culture-based fisheries governed by density-dependent growth and size-dependent mortality have been investigated by Lorenzen (1995). Key results of this analysis can be summarised as follows.

The optimal stocking regime is dependent on the harvesting regime and vice versa. This is illustrated schematically in Figure 1 where production is shown as a function stocking density and fishing effort. High fishing effort calls for high stocking densities and vice versa. High stocking densities combined with low fishing effort lead to overstocking, with low production due to slow growth and low survival from stocking to harvest. Conversely, low stocking rates combined with high fishing effort lead to overfishing. Note that both overstocking and overfishing can be alleviated by changes in either stocking density or fishing effort.

Potential production from stocked fisheries is inversely related to the size at which fish are harvested. Hence, in combination with the overall ecological productivity of the water body, the minimum size at which fish are marketable effectively limits the production that can be achieved from stocking. Where large fish are desired, stocking densities should be low and overall production will also be low. Where small fish are marketable, high production levels can be achieved when stocking densities are high and fish are harvested at the smallest marketable size. Where fish are marketable below their normal size at maturity, culture-based fisheries can achieve higher levels of production than wild stocks of the same species because large and somatically unproductive spawners can be replaced by a large number of small and somatically productive fish.

A wide range of different stocking sizes can be used to achieve similar levels of production, but the numbers that need to be stocked decrease in a non-linear way as size increases (Figure 2).

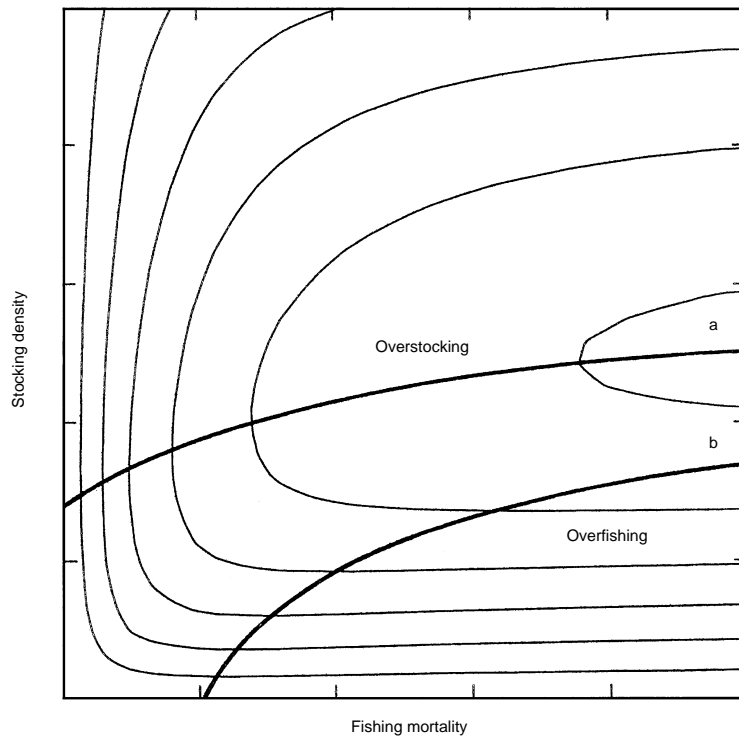

Figure 1. Production as a function of stocking density and fishing mortality (effort) in a culture-based fishery. Modified from Lorenzen (1995).

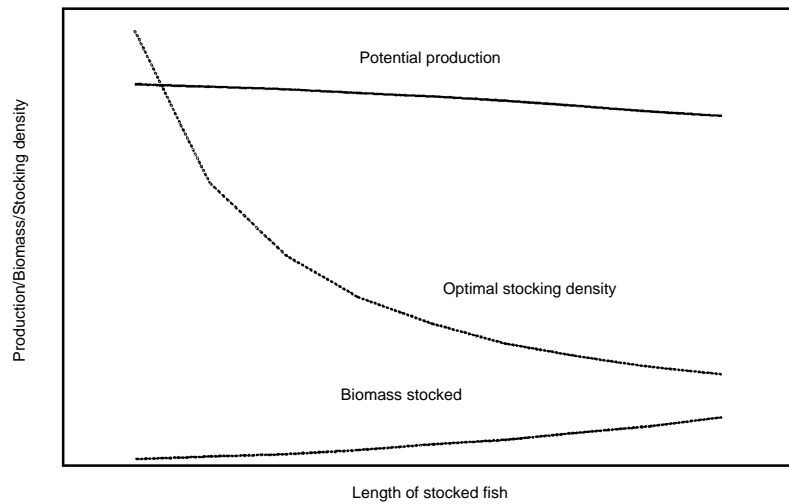

Figure 2. Maximum production and the corresponding optimal stocking density and weight stocked as a function of the length of seed fish. Modified from Lorenzen (1995).

This is a consequence of the allometric mortality-size relationship, and the fact that larger seed fish require less time to reach a harvestable size. The biomass of seed that needs to be stocked to achieve a given level of yield increases with increasing seed size, and so does the cost of producing the individual seed fish.

The above provides general rules that apply to a wide range of culture-based fisheries. Where natural reproduction is an important source of recruitment or there is strongly density-dependent mortality after stocking, there are further considerations.

Assessment of Management Regimes in Practice

Population models incorporating the key processes of size-dependent mortality and density-dependent growth can be used in a variety of practical assessment situations. This section provides a brief overview of data requirements and assessment procedures.

Data requirements

For a full assessment of management regimes, it is necessary to estimate natural and fishing mortality rates as well as parameters of the density-dependent growth model. A single stocking experiment is sufficient to obtain preliminary estimates of all parameters except the degree of density-dependence in growth (i.e. the competition coefficient c), which can only be established if growth data are available for a range of biomass densities.

The data required from a stocking experiment are the number and size of fish released, and the recaptures of stocked fish over time (numbers as well as individual weight and/or length). The temporal dimension of recaptures is crucial to the analysis and must be recorded, for example as numbers of fish recaptured per month and their average weight and/or length. If only total recaptures in numbers or weight are recorded, it is not possible to estimate model parameters.

As a general rule, the best data will be obtained if the stocked seed fish are batch-marked (individual identification is not required for this application). Using marked seed fish has the advantage that the temporal dimension of recaptures and growth is determined even when fish can not be aged directly (as is the case in many tropical situations), and that any possible natural recruitment of the species does not lead to bias in the parameter estimates. Where fish can be aged from hard parts and the possibility of natural recruitment can be excluded, age-structured

catch data will provide the same information as batch mark-recapture.

Where no mark-recapture or age-based data are available, analysis of catch-length data may provide information on growth and total mortality in the recruited size classes (e.g. Pauly and Morgan 1987). Such information may be used to estimate model parameters, but the precision of these estimates is likely to be lower than achievable from mark-recapture or age-based data.

Assessment procedure

A full assessment of management options in culture-based fisheries requires the following steps (Lorenzen et al. 1997):

- (1) Estimation of natural and fishing mortality rates and reconstruct the stocked cohort(s). In culture-based fisheries (where initial cohort numbers are known), the full information is obtained from a single analysis to which there are two different approaches: cohort analysis and statistical catch-at-age analysis (Hilborn and Walters 1992). An example of the use of cohort (or virtual population) analysis in culture-based fisheries is given in Lorenzen et al. (1997), while catch at age analysis is illustrated in a later section of this paper.
- (2) Estimation of density-dependent growth parameters. The growth model is fitted to weight or length-at-age data, using the reconstructed population biomass as an independent variable (Lorenzen et al. 1997). This analysis is possible only if growth data are available for several cohorts, under conditions of varying biomass density.
- (3) Project catches and other variables of interest (e.g. size of harvested fish) for different possible management regimes. This step requires a forward projection model such as that used in statistical catch-at-age analysis. For a full analysis accounting for the effects of density dependent growth, the model must involve a feedback loop between growth and biomass. Lorenzen et al. (1997) used an equilibrium model for the evaluation of management options, but dynamic models can be constructed in a similar way.

Where data on density-dependent growth are lacking, it is still possible to carry out a more restricted analysis of the present management regime. It must be remembered, however, that density-dependent growth will affect the outcomes of all management interventions that involve changes in biomass density.

Example: Preliminary Assessment Based on a Single Stocking Experiment

The stocking experiment

Siripunt et al. (1988) carried out a stocking experiment with batch-marked seed fish in Huay Luang reservoir (3100 ha), Northeast Thailand. Three differently marked cohorts of mrigal (*Cirrhinus mrigala*) were released at large (10 cm), medium (7 cm) and small (5 cm) size at the end of November 1987. Recaptures over the following 11 months were recorded on a monthly basis. The data are summarised in Table 1.

Information on the growth of stocked fish is summarised in Figure 1. The large and medium cohorts show a similar growth pattern, described well by a von Bertalanffy growth function

$$W_t = (W_4^{1/3} - (W^{1/3} - W_{t-1}^{1/3}) \exp(-K))^3 \quad (3)$$

with parameters $W = 58\,000\text{g}$ and $K = 0.034/\text{month}$. Growth in the cohort stocked at small size appeared to be far lower than in the others, with fish reaching only about 350 g on average as compared to about 2000 g for fish stocked at larger size. However, the very low recapture of the small cohort limits information on growth. In the following analysis, the measured mean weights are used, except in the case of the small cohort where an 'eye fit' von Bertalanffy growth function with $W_4 = 10\,000\text{g}$ and $K = 0.034/\text{month}$ has been used to predict overall recapture.

Population model and parameter estimation

Under the simplifying assumption that recaptures occur at the end of each monthly period (rather than

continuously throughout the month), a discrete time population model can be developed. Furthermore, it may be assumed that the allometric scaling of mortality is $b = -1/3$, and that gear selectivity is described by a logistic curve based on weight (Lorenzen et al. 1997).

The population model to project cohort abundance and catch over time is then:

$$N_t = (N_{t-1} C_{t-1}) \exp(-M_u((W_t + W_{t-1})/2)^{-1/3} t) \quad (4)$$

$$F_t = F' / (1 + \exp(p(W_c - W_t))) \quad (5)$$

$$C_t = N_t (1 - \exp(-F_t t)) \quad (6)$$

$$Y_t = C_t W_t \quad (7)$$

where N is the number of fish alive, F is the fishing mortality rate, C is the catch in numbers, Y is the yield (catch in weight), and t is the time difference between $t-1$ and t . The parameters of the logistic selectivity model (Equation 5) are the fishing mortality rate at full selection F' , the weight at 50% selection W_c , and the slope of the selection curve q .

The model was implemented in a spreadsheet as shown in Table 2. Parameters were estimated as the set that minimised the sum of squared residuals (SSQ) between the log transformed observed and predicted catches:

$$SSQ = \sum (\log(C_{\text{observed}}) - \log(C_{\text{predicted}}))^2 \quad (8)$$

Minimisation was performed numerically using the optimisation tool in the spreadsheet.

Following parameter estimation, the model was used to predict the effects of changes in stocking and harvesting regimes on recapture rates and yield per stocked fingerling.

Table 1. Stocking and recapture data for the *Cirrhinus mrigala* stocking experiment in Huay Luang reservoir (from Siripunt et al. 1989).

Stocking size	Large		Medium		Small	
	W[g]	C	W[g]	C	W[g]	C
Number stocked	18 941		20 759		17 370	
Recaptures						
Time [months]						
0	10.4		4.3		1.5	
1	36	185	18	8		
2	78	192	54	27		
3	132	222	132	222	32	2
4	332	541	216	170	95	2
5	471	200	394	125		
6	732	141	621	110		
7	1180	102	982	31		
8	1559	50	1313	18	1	1500
9	2100	33	1622	27		
10	2300	40	1905	19	9	346
11	2032	20	2309	9		

Table 2. Spreadsheet layout used in the analysis of the stocking experiment. The parameter estimates in cells C1-C5 were obtained by minimising the SSQ in cell F6.

	A	B	C	D	E	F
1	M at 1g		2.27			
2	F		0.19			
3	Wc		126			
4	p (7cm)		0.047			
5	p (10cm)		0.024			
6	SSQ					0.384
7						
8	Time	W[g]	N	C pred	C obs	SQ diff
9	Cohort 7 cm					
10	0	4.3	20759			
11	1	18	7495	8	8	0.001
12	2	54	3757	23	27	0.004
13	3	132	2260	229	222	0.000
14	4	216	1350	229	170	0.016
15	5	394	799	137	125	0.001
16	6	621	497	85	110	0.011
17	7	982	322	55	31	0.064
18	8	1313	215	36	18	0.097
19	9	1622	145	25	27	0.001
20	10	1905	100	17	19	0.001
21	11	2309	69	11	9	0.014
22	Cohort 10 cm					
23	0	10.4	18941			
24	1	36	8528	167	185	0.001
25	2	78	4628	206	192	0.000
26	3	132	2729	261	222	0.005
27	4	332	1703	291	541	0.072
28	5	471	1037	178	200	0.002
29	6	732	656	112	141	0.009
30	7	1180	431	74	102	0.019
31	8	1559	290	50	50	0.000
32	9	2100	200	34	33	0.000
33	10	2300	139	23	40	0.050
34	11	2032	96	16	20	0.006

Results

The model was fitted simultaneously to recapture data for the large and medium cohorts. Initially, a joint set of parameters was estimated for both cohorts. However, examination of residuals showed substantial inconsistencies between predicted and observed recaptures in the first three months, which suggested a difference in selection patterns for the two cohorts. Parameters were therefore allowed to vary between cohorts. Estimation of separate values for q (slope of the selection curve) for the two cohorts removed the discrepancies in residuals and drastically reduced the SSQ (from 0.94 to 0.38). Hence, the final model (Table 2), is based on joint estimates of all parameters except for q , which was allowed to vary between cohorts.

The estimated parameters, numbers alive and predicted as well as observed catches are shown in

Table 2. Observed and predicted catches are shown graphically in Figure 4. The estimated natural mortality rate at unit weight $M_u = 2.27/\text{month}$ (27.2/year) is extremely high. Fishing mortality is also high at $F' = 0.19/\text{month}$ (2.3/year). Combined with a weight of entry into the fishery of $W_c = 126$ g, this implies very high fishing pressure even on small fish.

The predicted and observed recapture rates (total recaptures as proportion of fish stocked) for the three release sizes are shown in Figure 5. The prediction for the small seed fish (1.5 g) is based on the selectivity pattern estimated for the middle group and the indicative growth curve for the small cohort (Figure 3).

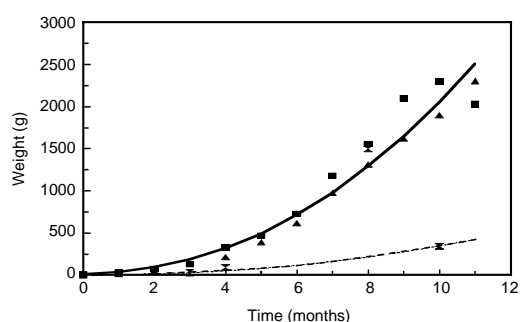

Figure 3. Growth of stocked *C. mrigala* in Huay Luang: The cohorts stocked at large (squares) and medium (triangles) size show similar growth patterns that can be described by a von Bertalanffy growth function with $W_4 = 58\ 000$ g and $K = 0.034/\text{month}$ (solid line). Growth appears to be much slower in the cohort stocked at 5 cm (hourglass). The data are not sufficient to fit a growth model, but the dashed line ($W_4 = 10\ 000$ g and $K = 0.034/\text{month}$) provides a reasonable 'eye fit'.

The predicted effects of changes in the harvesting regime (fishing mortality rate F and weight of entry into the fishery W_c) or the level of natural mortality M_u of the stocked fish are shown in Figure 6. The present harvesting regime ($F' = 0.19/\text{month}$, $W_c = 126$ g) is close to the optimum in terms of yield per fingerling, although recapture in numbers could be increased by harvesting at higher F' and lower W_c . Yields per fingerling are, however, very low at less than 18 g, and changes in the harvesting regime will not lead to any substantial improvements. The key factor limiting returns is the high level of natural mortality in the stocked fish, and any reduction in M_u is predicted to result in substantial improvements.

Discussion

The population model provides a good fit to the observed catches (Figure 4), and predicts the recapture

rates achieved for different release sizes well (Figure 5). Differences in overall recapture rates between release sizes are related primarily to the allometry of natural mortality, but are exacerbated by low growth in the cohort stocked at small size, and a more gradual entry into the fishery of the cohort stocked at large size.

The harvesting regime is characterised by high fishing mortality and a low size of entry into the fishery. However, high fishing pressure is not the primary cause of low returns, and no significant benefits could be derived from optimising exploitation patterns in this case.

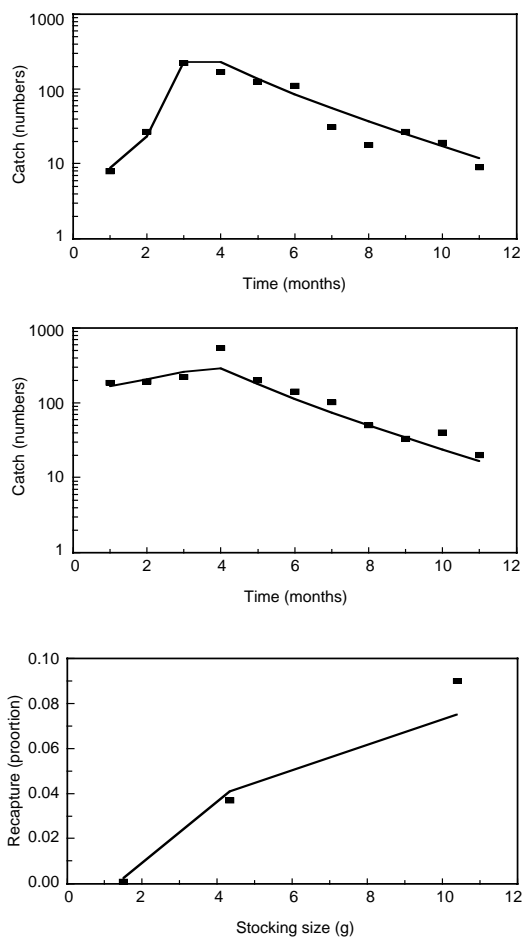

Figure 5. Observed (squares) and predicted (lines) recapture of stocked fish in relation to weight at release. The prediction for the small seed fish (1.5g) is based on the selectivity pattern estimated for the middle group and the indicative growth curve for small seed (see Figure 3).

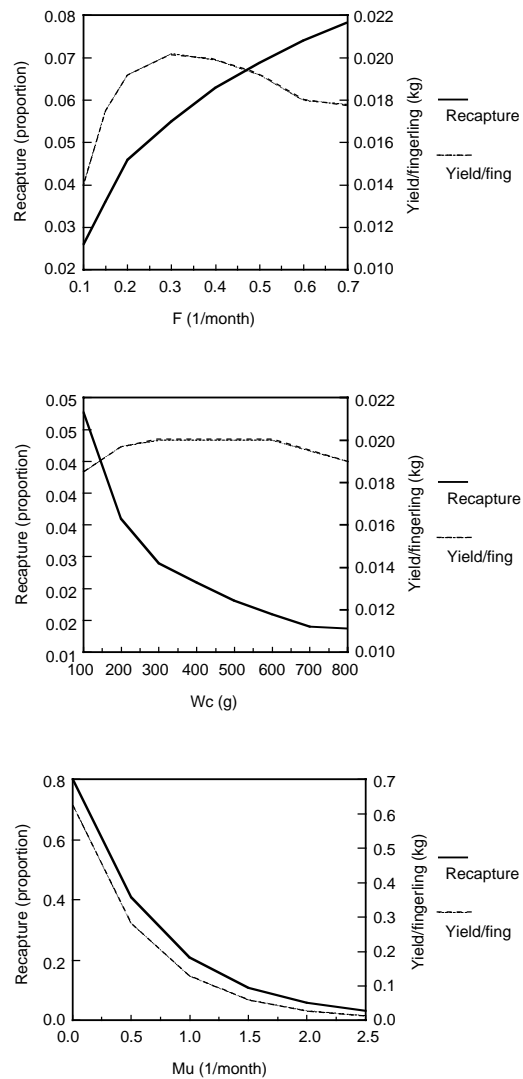

Figure 6. Predicted effect on recapture and yield per fingerling of changes in fishing mortality F (top), gear selection length (centre) or the level of natural mortality (bottom). All predictions for the middle size group.

The level of natural mortality in the stocked fish was extremely high at $M_u = 27.2/\text{year}$, compared to a wild stock average or $3.0/\text{year}$ (Lorenzen 1996b) or the value of $2.1/\text{year}$ determined for bighead carp in a Chinese reservoir (Lorenzen et al. 1997). The high level of mortality is the primary cause of low recapture and yield per fingerling in the experiment, and any management measures to reduce M_u would yield substantial improvements. This may be achieved by optimising rearing and release techniques, which

have been shown to influence survival of stocked fish (Berg and Joergensen 1991, 1994; Cowx 1994; Carlstein 1997). Any reductions in M_u would lead to increased biomass (unless stocking is reduced or fishing intensified), and a density-dependent growth response. The actual benefits of reduced mortality are therefore likely to be lower than predicted here, but the exact magnitude of this compensatory effect cannot be predicted without information on the degree of density dependence in growth.

The Need for Comparative Analyses

At present, most of the population model parameters have to be estimated for each particular fishery. An exception is the allometric scaling factor b of natural mortality, which has been found to be highly consistent in comparative analyses, and may therefore be considered known *a priori*. Other key parameters such as the competition coefficient c or the limiting asymptotic weight W_L are likely to be related to the species concerned and to characteristics of the water body stocked. Once these parameters have been determined for a range of fisheries, comparative analyses may lead to empirical generalisations that would greatly improve the predictability of outcomes of culture-based fisheries. Hence, more widespread use of population models in the assessment of culture-based fisheries would lead to synergistic benefits in addition to the immediate benefits to the fishery assessed.

Conclusions

Population models with explicit representation of the key processes of density-dependent growth and size-dependent mortality are powerful tools for the assessment of stocking and harvesting regimes in culture-based fisheries. Population models provide insights into the factors underlying observed outcomes, and allow a quantitative evaluation of management options. Such models also aid comparative studies because they allow estimation of parameters that can be compared between widely different fisheries, such as M_u or the asymptotic size for a standardised biomass density.

Widespread use of population models will allow comparative analyses to identify relationships between population model parameters and water body characteristics, which would further reduce data requirements for individual fisheries and provide a better basis for pre-stocking appraisal.

Acknowledgments

This work was supported by the Department for International Development of the United Kingdom (DFID), Fisheries Management Science Programme. The author gratefully acknowledges financial support from DFID and ACIAR for attending the workshop.

References

- Backiel, T. and Le Cren, E.D. 1978. Some density relationships for fish population parameters. In: Gerking, S.D. ed. *The Ecology of Freshwater Fish Production*. Blackwell, Oxford, 279-302.
- Berg, S. and Joergensen, J. 1991. Stocking experiments with 0+ and 1+ trout parr, *Salmo trutta* L., of wild and hatchery origin: post-stocking mortality and smolt yield. *J. Fish Biol.*, 39: 151-169.
- 1994. Stocking eel (*Anguilla anguilla*) in streams. In: Cowx, I.G. ed. *The Rehabilitation of Freshwater Fisheries*. Blackwell Science, Oxford, 314-325.
- Beverton, R.J.H. and Holt, S.J. 1957. On the Dynamics of Exploited Fish Populations. *Fish. Invest. Ser. II, Vol. 19*, 553 p.
- Carlstein, M. 1997. Effects of rearing technique and fish size on post-stocking feeding, growth and survival of European grayling, *Thymallus thymallus* (L.). *Fish. Manage. Ecol.*, 4: 391-404.
- Cowx, I.G. 1994. Stocking strategies. *Fish. Manage. Ecol.*, 1: 15-31.
- Hilborn, R. and Walters, C.J. 1992. *Quantitative Fisheries Stock Assessment: Choice, Dynamics and Uncertainty*. Chapman and Hall, New York.
- Hanson, J.M. and Leggett, W.C. 1985. Experimental and field evidence for inter- and intra-specific competition in two freshwater fishes. *Can. J. Fish. Aquat. Sci.*, 42: 280-286.
- Le Cren, E.D. 1958. Observations on the growth of perch (*Perca fluviatilis* L.) over twenty-two years with special reference to the effects of temperature and changes in population density. *J. Anim. Ecol.*, 27: 287-334.
- Lorenzen, K. 1995. Population dynamics and management of culture-based fisheries. *Fish. Manage. Ecol.*, 2: 61-73.
- 1996a. A simple von Bertalanffy model for density-dependent growth in extensive aquaculture, with an application to common carp (*Cyprinus carpio*). *Aquaculture*, 142: 191-205.
- 1996b. The relationship between body weight and natural mortality in fish: a comparison of natural ecosystems and aquaculture. *J. Fish Biol.*, 49: 627-647.
- Lorenzen, K., Xu, G., Cao, F., Ye, J. and Hu, T. 1997. Analysing extensive fish culture systems by transparent population modelling: bighead carp, *Aristichthys nobilis* (Richardson 1845), culture in a Chinese reservoir. *Aquacult. Res.*, 28: 867-880.
- McGurk, M.D. 1986. Natural mortality of marine pelagic fish eggs and larvae: role of spatial patchiness. *Mar. Ecol. Progr. Ser.*, 34: 227-242.

- Pauly, D. and Morgan, G.P. ed.(1987. The Theory and Application of Length-Based Methods of Stock Assessment. ICLARM, Manila.
- Peterson, I. and Wroblewski, J.S. 1984. Mortality rate of fishes in the pelagic ecosystem. *Can. J. Fish. Aquat. Sci.*, 41: 1117–1120.
- Salojaervi, K. and Mutenia, A. 1994. Effects of fingerling stocking on recruitment in the Lake Inari whitefish (*Coregonus lavaretus* L. s.l.) fishery. In: Cowx, I. ed. Rehabilitation of Inland Fisheries. Fishing News Books, Oxford, 302–313.
- Siripunt, N., Pawaputanond, O., Mahasarakham, N., Juntana, J. Weerawaitaya, N. and Sankorntanakit, T. 1988. Study on sizes of seed fishes for stocking in public waters. Technical Paper 11/1989; Inland Fisheries Division, Department of Fisheries, Thailand.
- Swingle, H.S. and Smith, E.V. 1942. Management of farm fish ponds. *Bull. Ala. agric. Exp. Stn.*, No. 254.
- van Someren, V.D. and Whitehead, P.J. 1961. The culture of *Tilapia nigra* (Guenther) in ponds. V. The effect of progressive alterations in stocking density on the growth of male *T. nigra*. *East African Agriculture and Forestry Journal*, 26: 145–155.
- Walter, E., 1934. Grundlagen der allgemeinen fischereilichen Produktionslehre, einschließlich ihrer Anwendung auf die Fütterung. *Handbuch d. Binnenfischerei Mitteleuropas*, 4(5): 481-662.
- Welcomme, R.L. and Bartley, D.M. 1998. Current approaches to the enhancement of fisheries. *Fish. Manage. Ecol.*, 5: 351–382.

Community-based Freshwater Fish Culture in Sri Lanka

K.B.C. Pushpalatha*

Abstract

In the recent past, planning and aquaculture development programs were a failure due to the absence of the participation of local communities. The programs completely collapsed when State patronage was discontinued in 1990. However, State support for aquaculture development has subsequently been revived and the importance of community participation in implementing the strategy is now well realised. This paper presents the results of attempts to increase fish production in the North Central Province of Sri Lanka through aquaculture with the participation of village-level organisations. The activities centered on fry to fingerling rearing of *Oreochromis niloticus*, *Labeo dussumieri* and *Cyprinus carpio* in net cages ($4 \times 2.5 \times 2$ m) in reservoirs and a number of village ponds (0.013–0.054 ha). The fingerlings produced were utilised in the culture-based fishery in seasonal reservoirs, and six seasonal tanks (area 7–18 ha) were stocked. The agricultural farmer organisations associated with seasonal tanks were trained in fish culture and were entrusted with stocking and harvesting fish. The general technological aspects of these culture systems, their advantages and constraints, with special reference to community participation, are discussed. The development strategy of identifying village-level organisations suitable for aquaculture activities, formation of new societies for pond fish culture, and of linking them to state-owned fish-breeding stations are discussed. Tools utilised for technology extension are also highlighted. The importance of providing financial assistance during the take-off stage is emphasised.

Sri Lanka is an island of 65 000 km² and vast water resources of more than 100 river systems and a multitude of reservoirs ranging in size from a few hectares to several thousand and some dating back about 2500 years. The total extent of reservoirs is about 175 000 ha (Fernando 1993). There is historical evidence that freshwater fisheries existed as early as 100 AD (Siriweera 1986). However, due to low fish yields from indigenous fish that thrived in these waters and also due to religious barriers, the inland fisheries remained sidelined for many years.

Government support for the sector was first provided in the 1950s. In the year 1950, two fish-breeding stations were set up by the government, one in Polonnaruwa and the other in Colombo. The exotic cichlid *Oreochromis mossambicus* (Peters) was introduced into reservoirs in 1952. With this introduction and combined with extension support,

fish production in the reservoirs increased dramatically. The fish catch of 400 t in 1956 rose to 8000 t by the year 1969 (Amarasinghe and De Silva 1999).

Due to various state-sponsored inland fisheries development activities, the country's annual inland fish production increased to 39 750 t in 1989. However, due to various religious and political reasons, State patronage for the inland fisheries and aquaculture was discontinued during 1990–1994 (Amarasinghe and De Silva 1999). During that period, fish production dropped to 12 000 t in 1994 (Table 1).

Failure to monitor reservoir fisheries by government resulted in over-exploitation of the resource, causing production to decline, thus indicating the ineffectiveness of a top-down approach for implementing management strategies (Amarasinghe 1998a). It was also evident that in reservoirs where there were well-organised fishing communities with their own fishery regulations to manage fish stocks, there was no over-exploitation even after withdrawal of State patronage (Amarasinghe 1998a; Amarasinghe and De Silva 1999). The policy of the government on inland fisheries reversed in 1994 and the

*National Aquaculture Development Authority of Sri Lanka, Fisheries Research Station, Dambulla, Sri Lanka

support of government to develop inland fisheries revived (Amarasinghe and De Silva 1999). Learning bitter lessons from the past, the government now places great emphasis on mobilising local communities for all planning and implementation of inland fishery and aquaculture development programs. This paper reports the importance of rural institutions, the formation of new organisations, methodologies adopted for participation of local communities, and the results of activities undertaken in conjunction with them in three aquafarming systems, namely, seasonal tank aquaculture, pond fish culture, and cage culture, in the North Central Province of Sri Lanka.

Table 1. Annual inland fish production in Sri Lanka 1978–94.

Year	Inland fish production $\times 10^2$ (mt)
1978	167
1979	174
1980	203
1981	296
1982	333
1983	361
1984	319
1985	327
1986	354
1987	365
1988	380
1989	397
1990	313
1991	238
1992	210
1993	180
1994	120

Source: Ministry of Fisheries and Aquatic Resources Development.

Materials and Methods

Seasonal tank aquaculture: a culture-based fishery

Seasonal tanks are small reservoirs (1–30 ha) that retain water for 8–10 months of the year and are built primarily for irrigating paddy fields. There are more than 10 000 small village tanks scattered over the dry zone of the country (Figure 1). The tanks dry up completely during some months of the year and are filled by monsoon rains in November–December each year. The tanks are controlled and managed by the Agrarian Services Department (ASD) of the government. At grassroots level, the paddy farmers who depend on the tanks for water form a farmer organisation (FO), with the help of the divisional officer (DO) of the ASD. The FOs are registered at

the ASD. Every month there is a divisional agriculture committee (DAC) meeting presided over by the Divisional Secretary (DS) at which DOs of the ASD, local technical officers and the office bearers of the FOs of that division attend. There is also a monthly meeting of DSs, aquaculturists, regional extension officers of the Ministry of Fisheries and other heads of relevant departments and organisations pertaining to agriculture in the district. That committee is called the District Agricultural Committee and is presided over by the District Secretary.

At the District Agricultural Committee meeting in Anuradhapura District, Sri Lanka, in 1998, members were informed of the seasonal tank aquaculture program, its benefits, and intended activities, and requested DSs to inform the FOs about it. A printed questionnaire was given to DSs to be handed to a maximum of four FOs in each DS division. The distributed questionnaire sought among other details about FOs, whether consent had been given by general members of the FOs to be involved in the proposed fisheries project. The DSs were requested to collect the completed questionnaire and return it to the regional aquaculture extension office with their comments. Seventy-seven FOs responded through the respective DSs during the survey in 1998. Based on its evaluation, initially 17 tanks were selected for inspection. The final selection was on the basis of their potential as a viable culture-based fishery. The size of the tank, absence of obstacles, and willingness of the FO to take responsibility to manage the tank decided viability. Finally, only 12 tanks were selected. The office-bearers of the FOs of the selected 12 tanks were trained in the operation and management of seasonal tanks for a culture-based fishery.

The government breeding station supplied most of the fingerlings augmented by purchases from private fry pond owners. However, due to a dearth of fish fingerlings, only six tanks were stocked.

Before stocking, members of the FOs participated in the removal of obstacles, and in placing fish-escape preventive devices at the spill. The tanks were stocked with fingerlings at about 2000 per ha, depending on their availability at the time. The Participatory Rural Development Project (PRDP) of the North Central Province funded by the International Fund for Agriculture Development (IFARD) provided financial assistance to purchase the fingerlings. After stocking, access to fishing was closed, and was monitored by the FOs. During the dry season when the water level of the tank receded to about 1 m, FOs decided the date of harvest and informed the fisheries extension office. The fisheries office loaned the gear required for the harvest. The FOs also decided the method of disposal of the harvest.

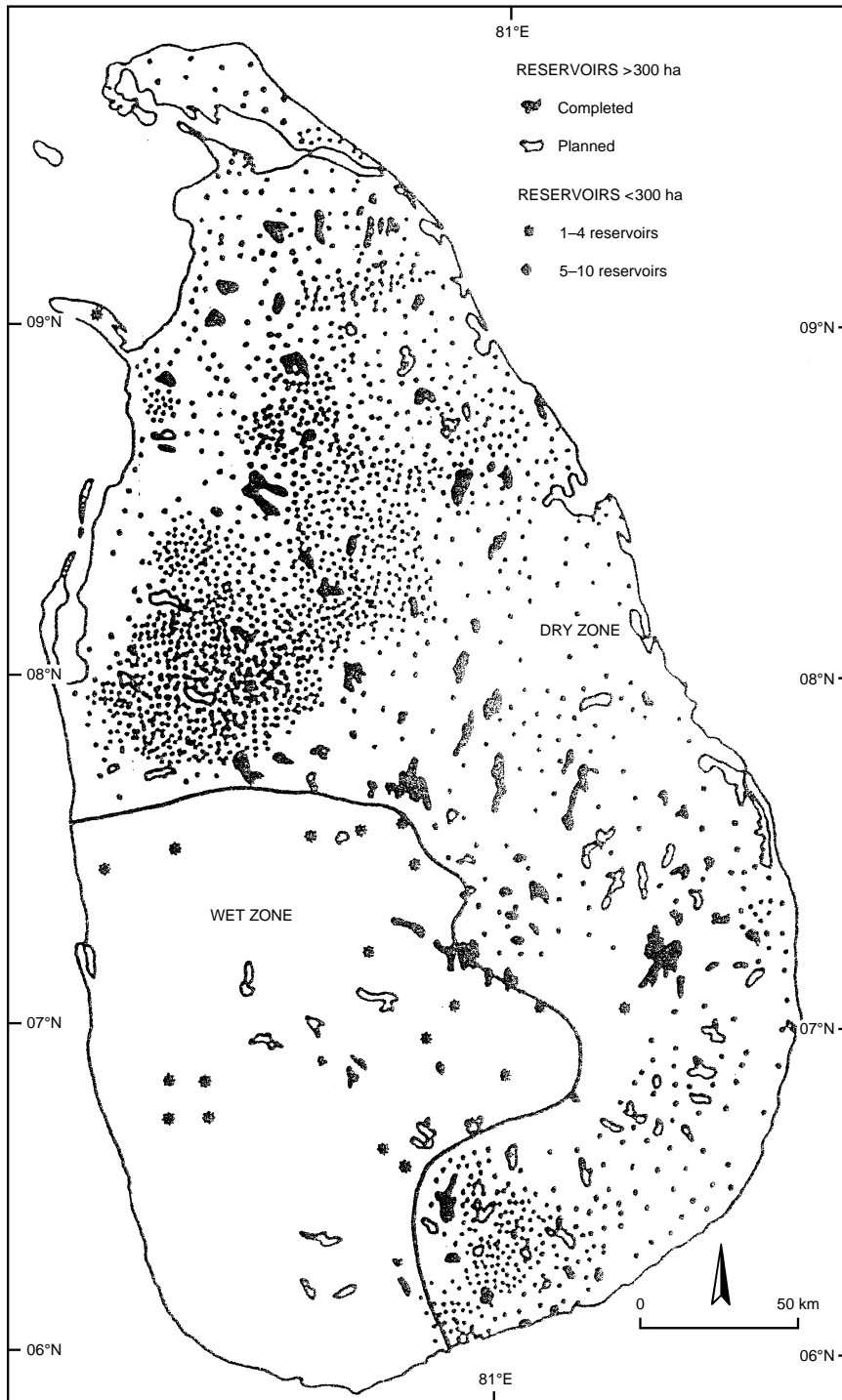

Figure 1. Reservoir distribution in Sri Lanka (updated from Fernando, 1971).

Pond fish culture

The village advancement program (VAP) of the North Central Province Rural Development Project funded by the Asian Development Bank selected some villages for development assistance. The VAP convened meetings of selected villages that various government agencies were invited to address and inform of the economic enterprises coming under purview. At these meetings, a brief introduction to pond fish farming, the available support services and its economic benefits were explained. Those interested were requested to contact the project director of VAP for further information. The VAP director reported that eight people from Ipalogama village, Anuradhapura District, had contacted VAP and shown interest in pond-fish farming. These eight sites were inspected to decide their suitability. Four further sites selected by the fisheries inspectors from their areas, those that had the necessary finances, were also selected. All fish farmers in the 12 sites were given on-site training in construction, operation and management of pond-fish culture. As the State-owned fish breeding stations lacked the required pond space for nursing fish fry, fish farmers were also encouraged to raise fry to fingerlings. Four from Ipalogama could not construct ponds due to logistic reasons. After training, the remaining eight were assisted to form a pond fish farmers' association.

Cage culture

In most major reservoirs, the fishers are encouraged to organise cooperative societies mainly to receive benefits from subsidy schemes. Ten reservoirs with active cooperative societies were selected for cage culture of fry to fingerling size. The members were given training in construction, operation, and management of fish cages. Each selected reservoir was installed with a floating cage of 4 m × 2.5 m × 2 m made of knotless HDPE and mesh size 4 mm. Bamboo and 135 L metal drums were used in the construction of the floating system. Fish fry were obtained from a government fish breeding station. The species used were *Oreochromis niloticus*, red tilapia, *Labeo dussumieri*, an indigenous cyprinid, and *Cyprinus carpio*. These species were stocked separately in the cages at a stocking density of 400/m³. When fish attained an average length of 5 cm, they were harvested, counted and released into the reservoir.

Results and Discussion

Culture-based fishery in seasonal tanks

Of the 77 FOs, two responded negatively for fish culture in their tanks (Table 2) probably due to

religious reasons. Poor leadership qualities of the officials of the organisations which failed to convince their members of the advantages of aquaculture to the community could also have brought about the negative response of members of the two FOs. Strong leadership could overcome religious barriers if there were any, and lead to members agreeing to the fish culture program. As a part of rural upliftment, the government is bound to strengthen rural organisations like the FOs by building their capacities and upgrading the leadership qualities of their officials. This is achieved through necessary training so that the organisation could bear the responsibilities of planning and implementing a program of fish culture. The FOs with strong leadership could lead the community to share the responsibilities and derive maximum benefit from the seasonal tank culture-based fishery.

The fish production obtained from the seasonal tanks in the first culture cycle is shown in Table 3. The average production from all six tanks was 164 kg/ha, and the highest was 246 kg/ha (Table 3). Production obtained was low because even under no management the tanks naturally stocked have been known to yield around 150 kg/ha (Mendis 1977). The seasonal tank aquaculture program implemented in 1980–1981 when the government was responsible for all planning, implementing, and other management decisions, achieved production in some tanks as high as 1960 kg/ha (Thayaparan 1982). However, such production was not sustainable, mainly due to the non-participation of rural communities in the activities.

In first cycle, the objective of most FOs in the seasonal tank aquaculture program was to offer cultured marketable fish from the tank to all its members rather than to achieve high production and monetary gains. The fish yield obtained from the first day of harvest was distributed to members of the FO and later fish were sold to vendors. In all tanks, the money raised from the sale of harvested fish was well in excess of that required to purchase fingerlings for the next culture cycle.

In Bulankulama tank, the FO, after setting aside money to procure fingerlings for the next cycle, used the balance to pay the hire of a tractor used for cultivating the paddy fields belonging to its members. With increased management experience, acquisition of knowledge of judicious selection of fish fingerlings for stocking, acquiring skills to eradicate predators and harvesting techniques and selective harvesting, the community would be able to obtain high sustainable fish production and economic benefit from the seasonal tanks. To increase revenue through the sale of harvested fish, the FOs should organise transport for fish to urban areas. The construction and operation

Table 2. Farmer organisations (FOs) which responded to the questionnaire.

Serial No.	Name of seasonal tank	No. of members	Consent to aquaculture	Serial No.	Name of seasonal tank	No. of members	Consent to aquaculture
1	Aluthwewa	56	Yes	40	Wambatuwewa	34	Yes
2	Seenikkulama	152	Yes	41	Kolaputtagama	52	Yes
3	Siyambalagaswewa	65	Yes	42	Lunuatulewa	56	Yes
4	Kiulekada	50	Yes	43	Athawetunuwewa	45	Yes
5	Puliyankulama	32	Yes	44	Pahalahlmillewa	39	Yes
6	Puwarasankulama	57	Yes	45	Mhadivulwewa	87	Yes
7	Karambewa	57	Yes	46	Atinniwetunuwewa	60	Yes
8	Bellankadawala	60	Yes	47	Gonuhatdenawewa	66	Yes
9	Galpottegama	74	Yes	48	MahaRalapanawa	27	Yes
10	Bogahawewa	25	Yes	49	Gulupoththawewa	60	Yes
11	Idipallama	30	Yes	50	Randuwa	26	Yes
12	Ihalapunchikulama	105	Yes	51	Katupotha	63	Yes
13	Wembuwewa	70	Yes	52	Pahalagama	138	Yes
14	Kuttikulama	78	Yes	53	Marasinghagama	30	Yes
15	Bulankulamawewa	28	Yes	54	Kudapalugollewa	30	Yes
16	Indigahawewa	110	Yes	55	Katukeliyawa	56	Yes
17	Rathmalgahawewa	110	Yes	56	Ihalakatukeliyawa	32	Yes
18	Makichchawa	134	No	57	Pandukabayapura	28	Yes
19	Lolugaswewa	52	Yes	58	Ambatale	52	Yes
20	Padikgama	110	Yes	59	Sembukulama	48	Yes
21	Puhudiula	77	Yes	60	Karaodagama	49	Yes
22	Atambagaskada	84	Yes	61	Kumbukwewa	42	Yes
23	Pahalakatukeliyawa	40	Yes	62	Ambagaswewa	48	Yes
24	Kukulbadidigiliya	52	Yes	63	Meegahawewa	25	Yes
25	Illipbothana	48	Yes	64	Katupangalama	68	Yes
26	Kulumeemakada	48	Yes	65	Viharagama	20	Yes
27	Rasnakawewa	97	Yes	66	Puliyankadawala	107	Yes
28	Walahawddawewa	54	Yes	67	Parangiyawewa	167	Yes
29	Agunochciya	39	Yes	68	Puhudiulwewa	15	Yes
30	Agunochciya	55	Yes	69	Kirimetiya	77	Yes
31	Mahamegaswewa	73	Yes	70	Mu/etaweerawewa	33	Yes
32	Kubukwewa	60	Yes	71	Kudarathmalewewa	27	Yes
33	Weragala	117	No	72	Aluthalmillewa	48	Yes
34	Itikulama	54	Yes	73	Kumbukwewa	52	Yes
35	Mahalindawewa	76	Yes	74	Athakada	47	Yes
36	Ambagahawewa	88	Yes	75	Paragoda	29	Yes
37	Adampane	50	Yes	76	Alagalla	37	Yes
38	Borupathwewa	50	Yes	77	Ranpathwila	69	Yes
39	Kumbukulpathwewa	45	Yes				

of fry rearing ponds by the community using agrowells would also help maximise benefits from the seasonal tanks.

As the harvest of seasonal tanks takes place between two seasons of paddy harvests, i.e. Yala (March–July) and Maha (October–February), the community would gain monetary benefits through the sale of harvested fish when they are most in need.

Even though women play an important role in village-level agriculture, their participation in seasonal tank aquaculture was not evident. A strategy has to be worked out to encourage their participation in these activities. At Lunuatulewa tank, all the officials of the FO were women yet they were

not participating in aquaculture activities, probably reflecting the prevailing influence of the culture and the strong gender bias in fisheries and aquaculture. With the support of the extension services, the women could be persuaded through education and training to play a role in eradicating weeds, mending nets and if necessary preserving fish, such as drying and curing.

Pond culture

Non-availability of land and the high investment cost of digging economically feasible fishponds are the major constraints to promoting pond-fish farming among the rural poor. The fry to fingerling rearing

Table 3. Number of fingerlings stocked and harvest obtained from the seasonal tanks. Notes: Reservoir area is expressed as the effective area (= 0.5 × area at full supply level).

Name of seasonal tank	Divisional Secretary Division	Effective area (ha)	Species	Total harvest (kg)	Culture period (months)	Remarks	
Gulupettawewa	Wilachchiya	7.6	Rh	1500	428	5	partial harvest
			cc	4500			
			On	5200			
			Ld	3000			
Rathmalgahawewa	Thirappane	8.5	Rh	1600	375	6	
			cc	4800			
			On	5600			
			Ld	2400			
Bulankulama	Thirappane	10.0	Mg	1600	1420	8	
			Rh	2000			
			cc	5500			
			On	6500			
Lunuatulewa	Kebethigollewa	11.3	Ld	3840	2780	6	officials of FO are women
			Mg	1000			
			Rh	2500			
			cc	6500			
Maharalapanawa	Kabethigollewa	12.8	On	8000	2635	6	partial harvest
			Ld	3500			
			Mg	1500			
			Rh	2500			
Galpottagama	Anuradhapura (west)	17.0	cc	7500	3400	6	
			On	8500			
			Ld	500			
			Mg	1200			
			Rh	1500			
			cc	4000			
			On	800			
			Ld	3000			

Rh = *Labeo rohita*; cc = *Cyprinus carpio*; On = *Oreochromis niloticus*; Ld = *Labeo dussumieri*; Mg = *Cirrihinus mrigal*

was more attractive to them as the area needed was smaller and the crop turn over rate is higher. Culturing marketable-size fish in small ponds requires high technology and input costs, both of which are beyond the reach of the rural poor. The fry survival rate was 33–86% (Table 4). Lower survival rates were mainly due to the absence of cover nets to prevent bird predation (Fernando 1980). Forming an association of pond fish farmers help to reduce the cost of pond construction. Through their association, Ipalogama fish farmers made representations to the Road Development Authority (RDA) to obtain the release of a back-hoe that came to the village (to rehabilitate the village road) for pond construction. Any individual requests would have been rejected by the RDA as against regulations to release the machines for private work. Close links between the pond farmers, extension staff and breeding station are vital to the timely disposal of fingerlings and

stocking of fish fry. It is critical for farmers who have obtained loans for pond construction, to avoid penal interest expenses. In pond fish farming, the loan servicing should be tied up to the cash flow generating capacity of the project, and not to standard monthly interest payment servicing normally adopted by commercial banks.

Cage rearing

The cooperative societies of the perennial reservoirs were mostly involved in activities connected with the subsidy schemes. When the State withdrew subsidy schemes, the societies became inactive (Amarasinghe and De Silva 1999). The introduction of cage fish farming in the reservoirs reactivated them. They realised that enforcement of regulations alone by the community would not suffice to increase fish production, and stocking fingerlings is a vital management aspect. Amarasinghe (1998) has shown that this

Table 4. Details of pond culture trials: stocking and harvesting details.

Name and address	Pond area (m ²)	Cycle 1					Cycle 2				
		Stocking fry (no.)	Harvesting fry (no.)	Survival (%)	Culture period (days)	Species	Stocking fry (no.)	Harvesting fry (no.)	Survival (%)	Culture period (days)	Species
S. Udugama	172	7000	4000	57	72	cc	7000	4575	65	67	Rh
Aswedduma, Kagama	146	6000	5000	83	65	cc	6000	4000	66	69	Mg
W.D. Siripala											
Kagama oya, Kagama	176	7000	3800	54	70	Ld					
B.M.K. Kumarihamy											
Kagama oya, Kagama	136	6000	2000	33	72	cc					
M.A. Siripala											
Aswedduma, Kagama	250	10 000	3800	38	71	cc	10 000	5 600	56	63	Ld
Susantha Priyadarshana											
Horiwila, Palugaswewa	350	10 000	5800		68	cc					
S. Junguwa											
Galenbindunuwewa	540	10 000	8000	80	76	Ld					
S.G.K. Somarathna											
6th mile post Saliyapura	350	15 000	10 000	66	78	Rh	8 000	10 000	53	62	cc
Indranatha Kerrthidarma											
Watagala, Dewahuwa											

Rh = *Labeo rohita*; cc = *Cyprinus carpio*; On = *Oreochromis niloticus*; Ld = *Labeo dussumieri*; Mg = *Cirrihinus mrigal*

Table 5. Stocking and harvesting details of fish cages (all stocked at 5000 fry per cage).

Name of tank	Area (ha)	D.S. Division	Cycle 1				Cycle 2			
			Species	Harvest (no.)	Survival (%)	Culture period (days)	Species	Harvest (no.)	Survival (%)	Culture period (days)
Nuwarawewa	1197	Anuradhapura (east)	<i>C. carpio</i>	4500	90	72	<i>L. dussumeiri</i>	4200	84	65
Mahakanadara	1157	Mihintale	<i>C. carpio</i>	4000	80	62		3800	76	65
Willachchiya	972	Wilachchiya	<i>C. carpio</i>	2750	55	58		3700	74	63
Manankattiya	372	Galenbindunuwewa	<i>L. dussumeiri</i>	4200	84	75	<i>L. dussumeiri</i>	4100	82	60
Ranawa	60	Palagala	<i>C. carpio</i>	3000	60	80	<i>L. rohita</i>	3500	70	64
Bellankadawala	66	Kekirawa	<i>Red tilapia</i>	3000	60	77	<i>O. niloticus</i>	3050	61	61
Rajanganaya	1619	Rajanganaya	<i>Red tilapia</i>							
Allewewa	168	Dimbulagala	<i>Red tilapia</i>	4600	92	70	<i>L. rohita</i>	4408	88	65
Pimburattewa	830	Dimbulagala	<i>Red tilapia</i>	2800	56	70	<i>C. carpio</i>	3000	60	67
Girithale	360	Higurakgoda	<i>L. rohita</i>	4000	80	61	<i>C. carpio</i>	4100	82	64

is true only for shallow (<750 ha) perennial reservoirs. The culture of fry to fingerlings in cages installed in the reservoirs was therefore well received by the fishing community. Fry rearing in cages in all the reservoirs was very satisfactory and the survival rates obtained were around 70% (Table 5). With the introduction of fish cages in reservoirs, the aquaculturists, extension officers and the fishing communities were closely linked, which augurs well for the industry.

For the sustainable development of culturing fish in seasonal tanks, ponds and cages installed in reservoirs with the participation of communities, it is necessary to transfer fish breeding techniques and nursery operations to these communities.

Acknowledgment

The author thanks Mr A.M. Jayasekara, Director-General, NAQDA for all encouragement, Mr V.K.J. Thalpapwila, Project Director, North Central Province Rural Development Project (Asian Development Bank) for providing facilities, and Dr U.S. Amarasinghe, Associate Professor, Department of Zoology, University of Kelaniya, for his guidance. Mr H.P. Amandakoon, consultant, North Central Province Rural Development Project, read the draft of this manuscript.

References

- Amarasinghe, U.S. 1998a. Reservoir fisheries management in Sri Lanka: achievements, mistakes and lessons for the future. *International Review of Hydrobiology* (Special Issue), 83: 523–530.
- U.S. 1998b. How effective are the stocking strategies for the management of reservoir fisheries in Sri Lanka? In: Cowx, I.G. ed. *Stocking and Introduction of Fish*. Fishing News Books, Blackwell Science Ltd, Oxford, 422–436.
- Amarasinghe, U.S. and De Silva, S.S. 1999. Sri Lankan reservoir fishery: A case for introduction of a co-management strategy. *Fisheries Management and Ecology*, 6: 387–399.
- Fernando, C.H. 1980. Tropical man-made lakes, African fish and cheap protein. *ICLARM Newsletter*, 3(1): 15–17.
- 1993. Impact of Sri Lankan reservoirs, their fisheries, management and conservation. In: Erdelen, W., Preu, C., Ishwaran, N. and Madduma Bandara, C.M. ed. *Proceedings of the International and Interdisciplinary Symposium, Ecology and Landscape Management in Sri Lanka, Colombo, Sri Lanka 12–16 March 1990*. Margraft Science Books, Weikersheim, Germany, 351–374.
- Mendis, A.S. 1977. The role of manmade lakes in the development of freshwater fisheries in Sri Lanka. *Proceedings of the Indo-Pacific Fisheries Council*, 17(3): 247–254.
- Siriweera, S.L. 1986. *The Inland Fisheries in Sri Lanka: A Historical Perspective*. Agrarian Research and Training Institute, Colombo, 44 p.
- Thayaparan, K. 1982. Role of seasonal tanks in the development of fresh-water fisheries in Sri Lanka. *Journal of Inland Fisheries, Sri Lanka*, 1: 133–167.

Status of Culture-based Fisheries in Small Reservoirs in India

V.V. Sugunan*

Abstract

Small irrigation impoundments on small streams constitute nearly half of the total 3.15 million ha of reservoirs in India. Most of these either dry up or retain very little water during summer, leaving little scope for natural recruitment of fish populations. Thus, culture-based fisheries become the most appropriate forms of management for these water bodies. As stocking of exotic carp and tilapia is not encouraged in reservoirs in India, the Indian major carps *Catla catla*, *Labeo rohita* and *Cirrhinus mrigala* are the most preferred options. Fish yield from small reservoirs in India ranges from 3.9 kg/ha in Bihar to 188 kg/ha in Andhra Pradesh, at a national average of 50 kg/ha, which is much lower than those of Sri Lanka (300 kg/ha) and Cuba (100 kg/ha). Physico-chemical parameters of Indian reservoirs suggest a conducive regime for organic productivity and they have impressive standing crops of plankton and other biotic communities. However, these positive attributes are not reflected in the fish catch due to inadequate stock and species management. In the absence of a clear policy or guidelines, stocking practices in the reservoirs of different Indian states is rather arbitrary. Some major aspects of culture-based fisheries, viz. size at stocking, stocking density, size at capture and harvesting schedule, have not received attention. Besides, there is a shortage of large-sized fingerlings for stocking reservoirs. Although India produces more than 18 000 million fry annually (mainly Indian major carps), they are seldom reared to fingerling size and stocked in reservoirs. Most fry are used for the pond culture segment which is in the private sector. The government and cooperative societies which manage the reservoir fisheries have inadequate facilities to raise the required number of fingerlings. Improved stock and species management, experimented in selected reservoirs across the country, has shown encouraging results. In Aliyar and Thirumoorthy reservoirs of Tamil Nadu, yield could be increased to 194 and 182 kg/ha respectively, against the state average of 48 kg/ha. Yields of Meenkara and Chulliar reservoirs in Kerala increased to 107 and 316 kg/ha, respectively (state average 53.5 kg/ha). Similar yield enhancements were achieved in Karnataka, Uttar Pradesh and Rajasthan. The average yield of nine such managed reservoirs is 150 kg/ha, which indicates the possibility for increasing the present yield (74 129 t) of small reservoirs by at least three times (to 222 839 t), if the norms of culture-based fisheries are followed.

RESERVOIRS constitute the single largest inland fisheries resource of India, both in terms of resource size and the production potential. The country receives an estimated annual 400 million ha-m rainfall, one of the highest in the world for a country of comparable size (Rama 1978). However, the temporal and spatial distribution of this rainfall exhibit wide variation within the country. The Western Ghats, Assam, parts of sub-Himalayan West Bengal and some higher

elevations of the Himalayas up to Punjab have more than 100 rainy days a year, while in extreme west Rajasthan, the number of rainy days is fewer than 10.

In more than one-third of the country, 90% of the rainfall and thereby surface flow is limited to a brief period of 2-3 months. This extreme seasonality in rainfall distribution makes the irrigation reservoirs a *sine qua non* for agriculture in India, especially in the rain shadows of peninsular India. The steep gradient and heavy discharge of water in the mountain slopes of the Western Ghats, the northeast and the Himalayas offer ideal opportunities for hydro-electric power generation. Many such projects have

*Central Inland Capture Fisheries Research Institute, Barrackpore 743101, West Bengal, India. Email: sugunan@gw1.dot.net.in

surfaced in these regions in recent years, reservoirs thus having become a common feature in the Indian landscape, dotting all river basins, minor drainages and seasonal streams.

Resource Size, Definition and Classification

Recently, the Government of India defined reservoirs as man-made impoundments created by obstructing the surface flow, by erecting a dam of any description on a river, stream or any water course (Sugunan 1997a). However, water bodies less than 10 ha in area have been excluded from this definition. The Ministry of Agriculture, Government of India classifies reservoirs as small (<1000 ha), medium (1000–5000 ha) and large (>5000 ha) for purposes of fishery management. Medium and large reservoirs are fewer in number and details of them are readily available from the irrigation, power and public works authorities. However, enumeration of small reservoirs is a tedious task as they are ubiquitous and numerous. There also exist ambiguities in the nomenclature followed by some of the states.

The word tank is often loosely defined and used in common parlance to describe small irrigation reservoirs. After removing these anomalies in nomenclature, it has been estimated that India has 19 134 small reservoirs with a total water surface area of 1 485 557 ha (Table 1). Similarly, 180 medium and 56 large reservoirs of the country have an area of 527 541 and 1 140 268 ha respectively. Thus the

country has 19 370 reservoirs covering 3 153 366 ha (Sugunan 1995).

Limnological Profile

Indian reservoirs are situated, mostly, in a tropical regime with rich nutrient status conducive to good organic productivity. The peninsular reservoirs are characterised by a narrow range of fluctuations in water and air temperatures during different seasons, a phenomenon which prevents the formation of thermal stratification. Many reservoirs in the Upper Peninsula undergo transient phases of thermal stratification during the summer, but wind-induced turbulence churns the reservoirs, facilitating the availability of nutrients at the trophogenic zone. Plankton, benthos and periphyton pulses of Indian reservoirs coincide with the months of least water level fluctuation and all these communities are at their ebb during the months of maximum water level fluctuation and water discharge.

Oligotrophic tendencies shown by some of the reservoirs in the Western Ghats and the northeast are mainly due to poor nutrient status and other chemical deficiencies. Mainly, poor water quality is the direct result of the catchment soil. In most cases, despite low levels of phosphate and nitrate, the production processes are not hampered.

This phenomenon is attributed to turnover of nutrients and their quick recycling. The highly seasonal rainfall and heavy discharge of water during the monsoon results in high flushing rates in the

Table 1. Distribution of small reservoirs and irrigation tanks in India.

State	Small reservoirs		Irrigation tanks		Total	
	No.	Area (ha)	No.	Area (ha)	No.	Area (ha)
Tamil Nadu	58	15 663	8 837	300 278	8 895	315 941
Karnataka	46	15 253	4 605	213 404	4 651	228 657
Andhra Pradesh	98	24 178	2 800	177 749	2 898	201 927
Gujarat	115	40 099	561	44 025	676	84 124
Uttar Pradesh	40	20 845	—	197 806	40	218 651
Madhya Pradesh	*6	172 575	—	—	*6	172 575
Maharashtra	—	—	—	—	—	119 515
Bihar	112	12 461	—	—	112	12 461
Orissa	1 433	66 047	—	—	1 433	66 047
Kerala	21	7 975	—	—	21	7 975
Rajasthan	389	54 231	—	—	389	54 231
Himachal Pradesh	1	200	—	—	1	200
West Bengal	4	732	—	—	4	732
Haryana	4	282	—	—	4	282
Northeast	4	1 639	—	600	4	2 239
Total	2 331	551 695	16 803	933 862	19 134	1 485 557

* not exhaustive

majority of the reservoirs. Such flushing does not favour colonisation by macrophytic communities. Similarly, inadequate availability of suitable substrata retards the growth of periphyton. Plankton, by virtue of drifting habit and short turnover period, constitute the major link in the trophic structure and events in the reservoir ecosystem. A rich plankton community with well-marked seral succession is the hallmark of Indian reservoirs, with blue-green algae the major component. On the basis of studies conducted so far, large reservoirs, on average, harbour 60 species of fish, of which at least 40 contribute to the commercial fisheries.

Fishery Management Practices

Classification of reservoirs into small, medium and large, based on their size, has limitations in setting management guidelines. The major consideration in choosing a particular management option is the degree to which the environmental parameters and fish stock can be manipulated to increase the yield.

In broad terms, management of medium and large reservoirs in India can be considered as more akin to *capture fisheries*. Although many of them are stocked, their fisheries continue to depend, to a large extent, on the wild or naturalised fish stock. Conversely, small reservoirs are managed as *culture-based fisheries* where the fish catch depends on stocking. However, there cannot be a thumb rule to differentiate the two systems, based on reservoir area. Fishing conditions, shallowness of the reservoir and natural recruitment are the major factors that determine whether capture or culture-based fishery is followed.

Culture-based fisheries of small reservoirs

More than 70% of the small reservoirs in India are small irrigation impoundments created to store stream water for irrigation. They either dry up completely or retain very little water during summer, thus ruling out any possibility of retaining brood stock for recruitment. Thus, culture-based fishing is the most appropriate management option for small reservoirs in India.

The common modes of enhancement relevant to inland water bodies of India are *species enhancement* (inducting new species to broaden the catch structure), *stock enhancement* (increasing the stock) and *environmental enhancement* (enriching the water quality through artificial eutrophication).

Species management

Prior to the development of carp seed production technology in the 1970s, fish seed collected from the

wild was stocked. While *Puntius* spp., *Labeo fimbriatus*, *Cirrhinus cirrhosa*, *Cirrhinus* spp., *Etroplus suratensis* and *Megalops cyprinoides* collected from the rivers and estuaries were stocked in small reservoirs of south India, riverine seed of Indian major carp was preferred in the Gangetic plains.

Today, all the states being capable of producing carp seed through hypophysation, the culture-based fisheries of small reservoirs in India largely centre on the three species of Indian major carp, *Catla catla*, *Cirrhinus mrigala*, and *Labeo rohita*. The Indian major carps have an impressive growth rate and their feeding habits are suitable to utilise various food niches. Instances where stocking Indian major carp became ineffective in small reservoirs are very rare.

Introduction of exotics

Although India has a rich and diverse fish genetic resource comprising 637 species, more than 300 fishes have already been introduced into the country (Jhingran 1989). While a vast majority are ornamental fish confined to aquaria, some like tilapia (*Oreochromis mossambicus*), silver carp (*Hypophthalmichthys molitrix*), grass carp (*Ctenopharyngodon idella*), and three varieties of common carp (scale carp *Cyprinus carpio communis*, mirror carp *C. carpio specularis* and leather carp *C. carpio nudus*) have been brought for aquaculture purposes. In recent years, the bighead carp (*Aristichthys nobilis*), Nile tilapia (*Oreochromis niloticus*) and African catfish, *Clarias gariepinus*, have been reported from the culture systems of eastern India. These fish are becoming popular among aquaculturists though their introduction is unauthorised.

O. mossambicus and common carp have been stocked in reservoirs. Jhingran (1991) reported a gradual decline in the size of tilapia in reservoirs of Tamil Nadu and Kerala over the years. Barring a very few reservoirs, tilapia-dominated fishery invariably lead to low yields. Moreover, it has a low consumer preference except in the state of Kerala. Today, fishery managers in India do not prefer *O. mossambicus* as a candidate for stocking. Silver carp, after an accidental introduction into the Gobindsagar (Himachal Pradesh), formed a breeding population and brought about a phenomenal increase in fish yield in the reservoir (from 16 kg/ha in 1970–1971 to more than 100 kg/ha at present; Sugunan 1995). Jhingran and Natarajan (1978) pointed out that silver carp, being a cold-water fish introduced to India, consumed food much in excess and grew faster, as expected of a true poikilotherm. A similar latitude-induced change was noticed as it matured in one year compared to five years in China. They cautioned against introducing the fish to Indian reservoirs

connected to major river systems as it might adversely affect catla and other indigenous carp.

Like tilapia, common carp found its way to all types of water bodies in the country. The relative ease with which the fish could be bred in controlled conditions prompted the state fish farms throughout the country to produce them in large numbers and to stock reservoirs. Being a sluggish fish, its chances of survival in predator-dominated reservoirs are very poor. It is not frequently caught in a passive fishing gear like gill-net due to its slow movement and bottom-dwelling habit. A more important disqualification of common carp is its propensity to compete with some indigenous carp like *Cirrhinus mrigala*, *C. cirrhosa* and *C. reba*, with which it shares a food niche. Mirror carp has affected the survival of native fish species in Gobindsagar Reservoir, upland lakes of Kashmir and Kumaon Himalayas (*Schizothorax* spp.), and Loktak Lake in the northeast (*Osteobrama belangiri*).

Indian policy disallows the introduction of exotic species in reservoirs. However, presence of tilapia, common carp, in reservoirs is a fait accompli. Common carp is very popular in reservoirs of the northeast where it enjoys a favourable microclimate and a good market. The three exotic species brought in clandestinely by the fish farmers, bighead carp, *O. niloticus* and African catfish, have not gained entry to the reservoir ecosystems so far, and they remain restricted to the culture systems.

Stock enhancement

Augmenting the stock of fish has been the most crucial management input to the reservoir fisheries. This is primarily due to the fact that the original fish stock of the parent stream is insufficient to support a fishery. Augmentation of stock is also necessary to prevent unwanted fish from utilising the available food niches and flourishing at the cost of economically important species. The major food niches of the Indian reservoirs are phytoplankton (Cyanophyceae, Chlorophyceae, Dinophyceae and Bacillariophyceae), zooplankton (copepods, cladocerans, rotifers and protozoans), and benthos (insect larvae and nymphs, oligochaetes, nematodes and molluscs). Significantly, many of the above niches, with the exception of insects, Cyanophyceae and molluscs, are shared between Indian major carp and uneconomic species.

Stocking rate

A large country like India, with too many water bodies to stock, has inadequate state machinery to meet the stocking requirements of all its reservoirs. Stocking densities need to be specified for individual water bodies or a group sharing common characteristics

such as size, presence of natural fish populations, predation pressure, fishing effort, minimum marketable size, amenability to fertilisation and multiple water uses.

The main considerations in determining the stocking rate are growth rate of individual species stocked, the mortality rate, size at stocking and the growing time. Recently, based on the National Consultation on Reservoir Fisheries (Sugunan 1997), the Government of India adapted the following formula (Welcomme 1976) to calculate the stocking rate for small reservoirs:

$$S = \left[\frac{q.P}{W} \right] e^{-z(t_c - t_o)}$$

- S Number of fish to be stocked (no./ha);
- P Natural annual potential yield of the water body (kg);
- q The proportion of the yield that can come from the species in question;
- W Mean weight at capture (g);
- t_c Age at capture;
- t_o Age at stocking;
- z Total mortality rate.

Environmental enhancement

By improving the nutrient status through the selective input of fertilisers in small reservoirs, stocks can be maintained at levels higher than the natural carrying capacity of the ecosystem. However, careful consideration of the possible impact on the environment is needed before this option is used. Scientific knowledge to guide the safe application of this type of enhancement and the methods to reverse the environmental degradation, if any, are still inadequate. Sreenivasan and Pillai (1979), Sreenivasan (1971), Sugunan and Yadava (1991a, b) have attempted this method with encouraging results. Environmental considerations and the possible conflicts of interest among various water users are the main factors that prevent the wide use of this option.

Fish Production Trends

In spite of a conducive physico-chemical regime, a good standing crop of plankton and a high rate of primary productivity, the fish yield from the reservoirs on a national level is very poor. It varies from 3.9 kg/ha in Bihar to 188 kg/ha in Andhra Pradesh. The average national yield from small reservoirs in India is nearly 50 kg/ha (Table 2), which is low (Sugunan 1997b), compared to other countries in Asia and Latin America such as Sri Lanka (300 kg/ha) and Cuba (100 kg/ha).

Table 2. Fish production trends in small reservoirs in India.

State	Yield (kg/ha)
Tamil Nadu	48.50
Uttar Pradesh	14.60
Andhra Pradesh	188.00
Maharashtra	21.09
Rajasthan	46.43
Kerala	53.50
Bihar	3.91
Madhya Pradesh	47.26
Himachal Pradesh	—
Orissa	—
Average	49.90

Reasons for low yield

Technological input like scientific management practices either receive low priority or are overlooked altogether in reservoir fisheries development in India. This has resulted in arbitrary stocking and non-adherence to sound stock management norms, leading to low productivity. Fish yield of small reservoirs, where the management is on the basis of culture-based fisheries, depends on a number of parameters such as growth rate, natural mortality and fishing mortality. Therefore stocking density, size at stocking, size at harvesting, rate of fishing mortality and harvesting schedule hold the key to achieving optimum yields. A close scrutiny of the fishery management practiced in the small water bodies indicates that these vital aspects of management have not received adequate attention.

Indian major carps are observed to congregate above the spillways for breeding, which results in heavy escapement of the brood. This poses a serious problem for building stocks of desirable fish in such reservoirs. The situation is exacerbated by heavy escapement of fingerlings and adults through irrigation canals. Development of fisheries in such water bodies, therefore, requires suitable screening of the spillway and the canal mouths. Such protective measures have been installed in some of the reservoirs paying rich dividends in enhancing fish yield. However, caution is to be exercised so that the screens erected across spillways do not clog during the flood season to the detriment of the dam. In some reservoirs, fish have also been observed to ascend upstream through spillways, whereas in others the spillways provide an insurmountable barrier to fish movement up the dam. To minimise escapement losses through spillways and canals, it would be economic to have an annual cropping policy so that the reservoir is stocked in September–October and harvested by June-end. However, this depends on the

growth of fish and general productivity of the water body.

There are no clearcut policy and guidelines on stocking and other management measures, without which the measures taken by various state governments become arbitrary. Strict monitoring of size at stocking and size at harvesting is often not done, leading to poor production. Overstocking, understocking, stocking at small size, catching fish at small size and lack of maintenance of stocking and harvesting schedule are the most common drawbacks noticed. Fish seed production has made rapid advances in India during the last three decades either through indigenous or imported technologies. Consequently, a number of hatcheries have come up for large-scale production of fish seed in both public and private sectors. Today the 900 hatcheries across the country produce more than 18 000 million fry of Indian major carp annually. But the fry are seldom reared to fingerling size for stocking reservoirs. Most fry produced in the hatcheries go to the aquaculture segment, managed by the private sector. The government and cooperative societies, that manage the reservoir fisheries, do not have enough infrastructure to raise the required number of fingerlings.

Better-managed reservoirs

Efforts made by the Central Inland Capture Fisheries Research Institute (CIFRI) by stocking Indian major carp in many small reservoirs across the country have been very effective in improving yields. The highlights of CIFRI's attempts:

- selection of the right species, depending on the fish food resources available in the system;
 - determination of a stocking density on the basis of production potential and growth and mortality rates;
 - proper stocking and harvesting schedule including staggered stocking and harvesting, allowing maximum grow-out period, taking into account critical water levels; and
 - in the case of small irrigation reservoirs with open sluices, the season of overflow and the possibilities of water level falling too low or completely drying up also being taken into consideration.
- Aliyar reservoir in Tamil Nadu is a standing testimony to the efficacy of the management strategy chosen by CIFRI. Salient features are:
- stocking is limited to Indian major carp (previously, all indigenous slow-growing carp were stocked);
 - increasing the size at stocking to 100 mm and above;
 - reducing the stocking density to 235–300/ha (rates used were erratic, ranging 500–2500/ha);

- staggering the stocking; and
- regulating mesh size strictly and banning the catch of Indian major carp of less than 1 kg.

A direct result of the above management practice was an increase in fish production from 2 kg/ha in 1964–1965 to 194 kg/ha in 1990. Successful stocking has also been reported from a number of small reservoirs in India. In Markonahalli, Karnataka, on account of stocking, the percentage of major carp has increased to 61% and the yield to 63 kg/ha. Yields in Meenkara and Chulliar reservoirs in Kerala have increased from 9.96 to 108 kg/ha and 32.3 to 316 kg/ha respectively, through sustained stocking. In Uttar Pradesh, Bachhra, Baghla and Gulariya reservoirs registered steep increase in yield through improved management, the main accent on stocking. An important consideration in Gulariya has been to allow maximum grow-out period between the date of stocking and the final harvesting i.e., before the levels go below the critical mark. The possible loss due to low size at harvest was balanced by the number harvested. Bundh Beratha in Rajasthan, stocked with 100 000 fingerlings a year (164/ha), gave a fish yield of 94 kg/ha, 80% of which was catla, rohu and mrigal (Table 3).

Table 3. High yields obtained in small reservoirs due to management based on stocking.

Reservoir	State	Yield (kg/ha)
Aliyar	Tamil Nadu	194
Tirumoorthly	Tamil Nadu	182
Meenkara	Kerala	108
Chulliar	Kerala	316
Markonahalli	Karnataka	63
Gulariya	Uttar Pradesh	150
Bachhra	Uttar Pradesh	140
Baghla	Uttar Pradesh	102
Bundh Beratha	Rajasthan	94

Recent trends

Preliminary results available from an ongoing World Bank-aided reservoir fisheries development project in India further confirm the validity of Indian major carp in the culture-based fisheries of small reservoirs. The project covers 78 reservoirs (24 613 ha) in three states, Andhra Pradesh, Orissa and Uttar Pradesh. The reservoirs belong to three categories, A (<100ha), B (100–300 ha) and (>300 ha), the stocking rates for which have been fixed at 1500/ha,

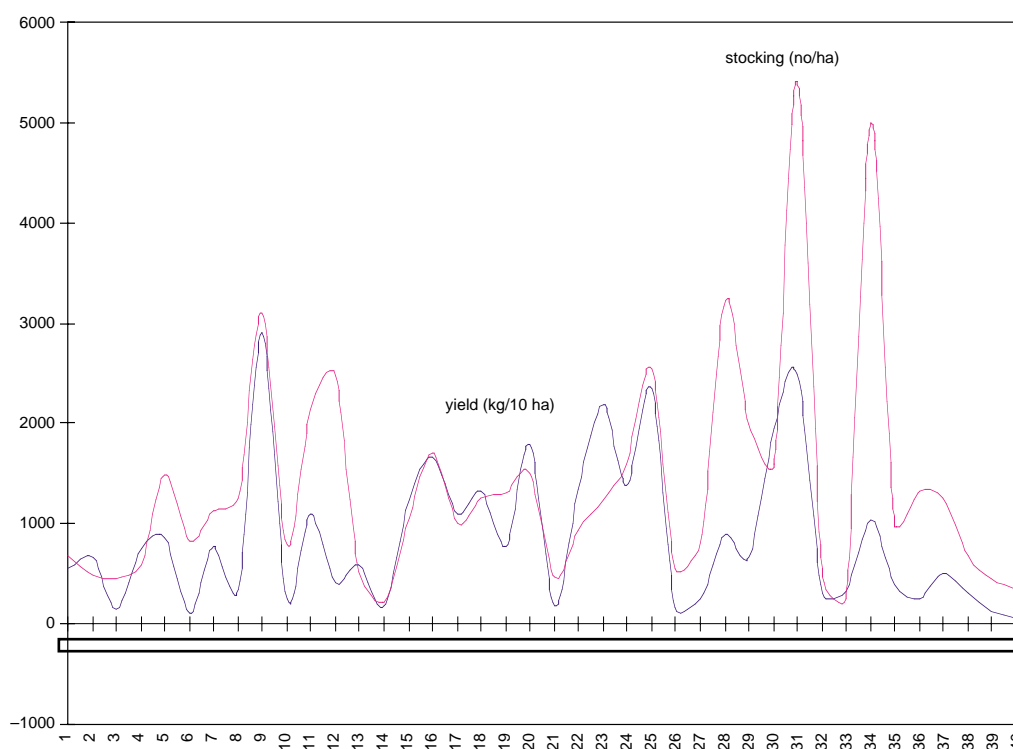

Figure 1. Stocking rate and fish yield in 40 reservoirs of Andhra Pradesh.

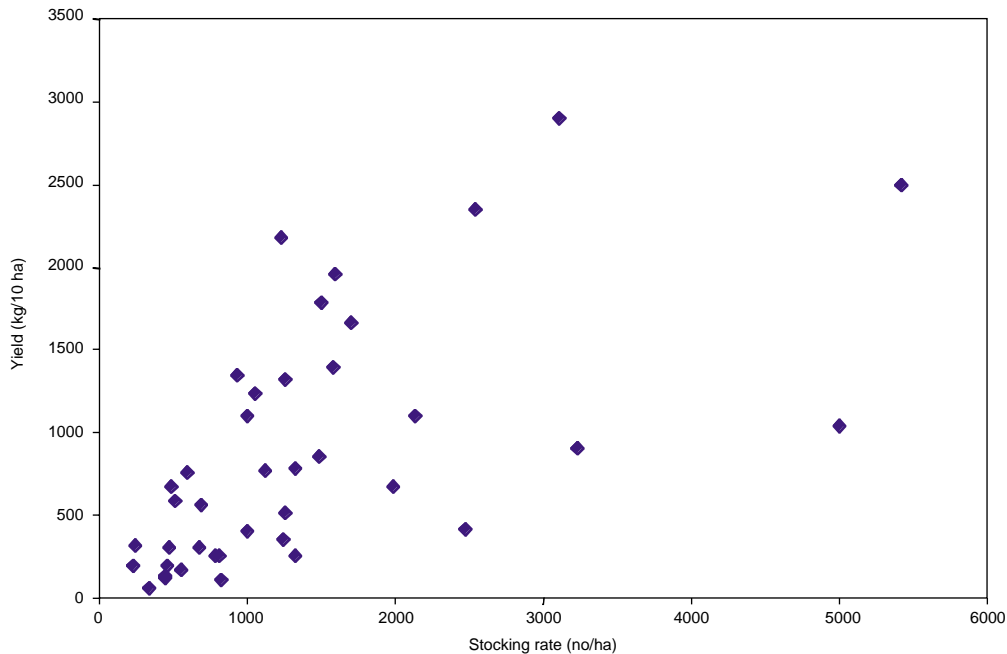

Figure 2. A scatter plot showing the relationship between stocking (no./ha) and fish yield (kg/10 ha) for 40 reservoirs in Andhra Pradesh.

1000/ha and 500/ha, respectively. The scheme provides for erecting pen nurseries in the reservoirs to ensure that the fish seed is reared to at least 100 mm before stocking. Loans are provided to the cooperative societies to purchase boats and nets. Results obtained so far have been very encouraging and a perceptible relation between stocking and yield can be observed (Figures 1–2).

References

- Jhingran, A.G. 1989. Role of exotic fishes in capture fishery waters in India. In: Jhingran, A. G. and Sugunan V.V. eds. Conservation and Management of Inland Fisheries Resources of India, Inland Fisheries Society of India, Barrackpore, 275 p.
- 1991. Performance of tilapia in Indian waters and its possible impact on the native ichthyofauna. In: FAO Fisheries Report No. 458. Food and Agriculture Organisation, Rome, 143–161.
- Jhingarn, V.G. and Natarajan, A.V. 1978. Recommendations for stocking silver carp in Gobindsagar (H.P.) and Nagarjunasgar (A.P.) together with an account of scope and limitations of silver carp stocking in rivers and reservoirs of India. Bulletin No. 28. Central Inland Fisheries Research Institute, Barrackpore, 743101 West Bengal, 8 p.
- Rama, 1978. Our Water Resources. National Book Trust, India, New Delhi, 115 .
- Sreenivasan, A. 1971. Liming of an upland lake. Madras J. Fish., 6: 9-13.
- Sreenivasan, A. and Pillai, K.V. 1979. Fertilisation of fishery waters—experimental fertilisation of a small reservoir. Madras J. Fish., 8: 143–145.
- Sugunan, V.V. 1995. Reservoir Fisheries in India. FAO Fisheries Technical Paper No. 345. Food and Agriculture Organisation of the United Nations, Rome, 423 p.
- 1997a. Guidelines for management of small reservoirs in India. Fishing Chimes, 17: 23–27
- 1997b. Fisheries Management of Small Water Bodies in Seven Countries in Africa, Asia and Latin America. FAO Technical Circular No. 933 Food and Agriculture Organisation of the United Nations, Rome, 149 p.
- Sugunan, V.V. and Yadava, Y.S. 1991a. Feasibility Studies for Fisheries Development of Kyrdemkulai Reservoir. Central Inland Capture Fisheries Research Institute, Barrackpore, 743101 West Bengal, 34 p.
- 1991b. Feasibility Studies for Fisheries Development of Nongmahir Reservoir. Central Inland Capture Fisheries Research Institute, Barrackpore, 743101 West Bengal, 30 p.
- Welcomme, R.L. 1976. Approaches to Resource Evaluation and Management in Tropical Inland Waters. Proceedings of the Indo-Pacific Fisheries Council, Food and Agriculture Organisation of the United Nations. Colombo October 1976, 500 p.

Livestock–Fish Integrated Systems and Their Application

Shenggui Wu¹, Chuanlin Hu¹ and Youchun Chen²

Abstract

Livestock–fish integrated systems are old practices, which interestingly are becoming popular. The common integration may be pig–fish, duck–fish, cattle–fish, livestock–poultry–fish, grass–livestock–fish and so on. The commonest and most efficient integrated system is the crop–livestock–fish integration. Some important factors, including dissolved oxygen content, depth of water, types of livestock manure used and level of input in integrated systems, all influence the nature of the operation. The introduction of crops to integrated systems has resulted in many positive outcomes from a human nutrition viewpoint. Studies of nutrient and energy cycles along the food web of integrated systems have also made the crop–livestock–fish integrated system the most understood, scientifically. Economic recycling of all kinds of nutrient matter has reduced fuel consumption and operational costs, resulting in an overall increase in economic efficiency. Under the integrated system, crops–livestock and fish production have increased faster than the rate of population increase. Fish output in integrated systems is about twice to 12 times that in a monoculture.

IN CHINA, the requirement of meat, eggs and fish (cultured fish) is 316.6 million t. Every person needs 274 kg of cereal a year and 1200 million people need 328.8 million t, for a total of 645.4 million t. The total cereal production is about 551.93 million t/year. That means there is a shortfall of 93.47 million t (Chen 1996). The livestock–fish combination may be one of the solutions to meeting this shortfall.

The reason for intensifying the fish–livestock integrated systems is the requirement to produce high-quality animal protein to replace plant protein. Some resources without nutritional value for human beings and animals could be turned into food in the fish–livestock integrated system, and consequently use less feed and produce more high-quality animal protein (Pekar and Olah 1992).

In China, the earliest record of an integrated livestock–fish system was in the Agriculture Encyclopedia, published in 1639, in the Ming Dynasty by Xu Guang-qì (1562–1633). In the early 1920s of the

Qing Dynasty, in the book Additions to Agriculture, a four-element culture was mentioned, namely planting–mulberry–fish–livestock.

Realising the potential of low-input of livestock–fish integration in boosting animal food production, international agencies, especially the FAO, helped to introduce the system to developing countries since the 1950s. The livestock–fish integration system has been a very fast development until now (Csavas 1992; Devendra 1996).

Models for Livestock–fish Integration

If certain species of domestic animals are chosen, the combinations of the integration may be pig–fish, duck–fish, cattle–fish, chicken–fish and so on. Each type of combination produces manure of a different character, which supplies nutrients suitable for different fish species. If the species of domestic animals are defined, the fish varieties can be matched.

Pig–fish integration

Pork is one of the most important animal protein resources in China. Pig–fish integration is quite popular and traditional. Pig slurry has a high content of nitrogen, with a N:C ratio 14.3:1, which is less than that for other animals. Manure input may increase

¹Institute of Reservoir Fisheries, the Chinese Ministry of Water Resources and the Chinese Academy of Sciences, Wuhan, 430079, China

²Institute of Animal Science, the Chinese Academy of Agriculture Sciences, Beijing 100094, China

phytoplankton and zooplankton to 20.61 mg/L and 7.73 mg/L, respectively, at a loading of 12 kg/m³ of water. The pig–fish integration is 35.1% more beneficial than a single fish culture and the cost of raising pigs decreases by 11.7% per kg of growth.

Duck–fish integration

This is one of the classical and traditional systems in Asia (Yadava and Vaishalli 1992). Ducks are animals with relatively short digestive tracts. Their digestive tracts are only about four times the body length, so a large amount of feed (34%) is excreted before being properly digested, resulting in higher manure content of organic matter.

Duck manure can help reduce 20–25% of inputs into a culture system comprising phyto- and zooplankton feeders of fish feed. The decay and decomposition of duck waste in pond waters lead to release of essential nutrients, enhancing the primary and secondary productivity of water bodies, ultimately boosting fish production, which can save about 50% of supplementary feeds for fish (Mukherjee et al. 1992).

A duck can drain 70 kg of faeces, or 5–10 kg in dry faeces in a year. It is concluded that each fattened duck is capable of producing 0.5–0.75 kg of fish. About 3–6 batches of ducks can be produced, depending on different climate zones. Taking four batches a year, fish production will be 260–390 kg and without any feed inputs, the daily fish production with only duck wastes could be 36.5 kg/ha.

The duck number must be in accordance with the fish number. From generalised experiments and practices, each hectare is matched to 1200–1500 ducks. In ponds, duck–fish integration systems fish must be polycultured to increase the feed utility and water holding capacity.

The survival rate of carp is related to the density of duck waste. The ‘safe’ level mentioned above is in the range of waste concentrations, possibly due to the existence of favourable hydrological conditions like water dissolved oxygen, pH and hardness. Under different densities of wastes in different times of testing, survival rates differ. Obvious mortality can be observed when the density of duck wastes is 0.02%, but becomes serious when it is 0.035%.

Ducks dive to devour fish, but only fingerlings under 4 g are ingested. Therefore, seed-fish ponds are unsuitable for integration with duck.

Cattle (horse)–fish integration

Cattle–fish integration has been practiced for a long time. Fish are integrated not only with cattle but also with horses and mules. Dairy cattle–fish is a new integration. The nutrients in cow dung are lesser than

in pig manure. The nitrogen contents are a little higher, but phosphorus comes in trace amounts only. ‘One milking cow and half ton fish’ is a common proverb among farmers.

Cow manure is fine, granular, floats for a long time, and is 33% heavier than pig slurry in dry weight. The total floating materials in the cow dung pond is 54.6% more than in pig, duck and chicken manure ponds. The floating character of cow dung granules increases feeding opportunities for fish and restricts accumulation of the oxygen-consuming materials. Consequently, less harmful gas is formed. Because feed in ruminants is digested by micro-organisms, their degradation needs less oxygen in comparison to other manure resources. Each kg of bull manure exhausted 20.6 g of oxygen in 5 days, while the pig slurry needs 30.0 g, which is 32% more. Therefore, cow dung is called ‘safe’ manure in livestock–fish integration.

A milking cow of 400–500 kg can produce about 13 600 kg of cow dung and 9000 kg of urine a year. Practices demonstrate that 0.17 kg of cow dung per m³ of water a week may produce one kg of fish.

Besides this, the wasted feeds from dairy barns are also rich — 9000–11 000 kg of grasses are supplied for a cow a year and 3000 kg are wasted. This amount is always spattered away during the summer time, when it is a good season for fish growth. In the cattle–fish integration with an output of 7500 kg a year, the manure of 15 head of cattle can contribute feed to meet the requirements of fish in a 1 ha pond.

Chicken–fish integration

In this system, 0.07 kg of chicken faeces is supplied per m³ of water, 5 kg of chicken faeces able to produce 1 kg filter-feeding fish. If the chicken faeces are fermented, the results can be better.

Other kinds of integration

Besides the above-mentioned integrated systems, sheep, goats and geese are all good for the purposes. A goose can supply 120–150 kg of faeces a year, and 25–30 kg of goose faeces can produce 1 kg of filter-feeding fish. In the Yangtze River area, geese are used for this purpose. In integration with fish, 750–900 geese are released in one ha. Goat/sheep–fish integration is found more in Northern China. Multi-livestock–fish is also common (Chen 1996).

Models for livestock–fish integration

Main models for livestock–fish integration are shown in Table 1.

Important Elements in Livestock–Fish Integration

Three important elements in livestock–fish integration are dissolved oxygen concentration, the depth of pond water and manure (Xu and Zhu 1992).

Dissolved oxygen

The dissolved oxygen concentration is different in different water levels (Figure 1), and so is the distribution of phytoplankton.

Dissolved oxygen concentrations lower than 1 mg/L are not suitable for fish growth. When the water level is 0.3 m, the oxygen content is normally higher than 2.6 mg/L; at 2 m deep, it is higher than 1.8 mg/L. Therefore, a pond 2.5 m deep is suitable for fish growth with sufficient oxygen. Phytoplankton development is related to strength of sunlight. The amount of phytoplankton is different at different depths. The deeper the water, the fewer phytoplankton were accounted (Table 2). Related to this, zooplankton numbers consequently change.

Fish such as silver carp and bighead carp feed on phytoplankton and zooplankton, respectively, and in less than 4 m grow better than in deeper water.

Depths of pond water

Choosing an appropriate water depth may increase fish production. Product performance for fish like black carp, grass carp, common carp and silver carp is closely related to water depth in ponds (Table 3).

It is suggested that 2.5 to 3 m deep is the best layer for carp habitation. Within this depth, a highly dissolved oxygen content and higher plankton number supply enough feed for aquatic animals. Therefore, it is beneficial for fish of any kind of feeding habit.

Manure

Livestock–fish integration in nature is the way to utilise animal excrement and waste for feeding fish. The nutrient contents of manures are shown in Table 4.

Table 1. Main models for livestock–fish integration.

Variants	Livestock (head)	Manure (kg)	Fish	Output (kg/ha)
Duck–fish	Usual 900–1500, intensified 1500–1800	40–50	Silver carp, bighead carp	4500–7500
Pig–fish	75	200	Silver carp, bighead carp	3000
Dairy cattle–fish	15	Faeces 13 600 Urine 9000 Wasted feeds 3000	Grass carp, bream	7500
Chicken–fish	2250–3000	70	Tilapia	4000–7500
Grass–livestock–fish	Duck 900/pig 60/ Dairy cattle 12 Grassland 1/3–1/2 ha		Grass carp, bream silver carp, bighead carp	7500

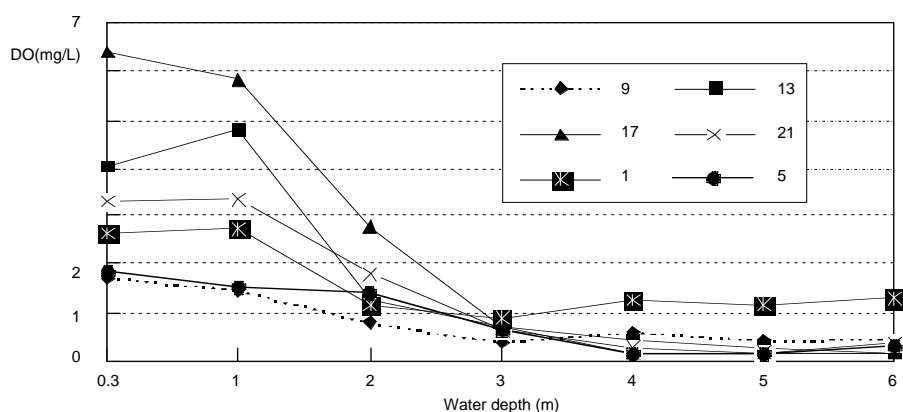

Figure 1. Oxygen concentrations at different strata of water in September (mg/L).

Table 2. Stratified amount of plankton in ponds (%).

Water depth (m)	Sept 7 17:00	Sept 8 5:00	Oct 20 17:00	Nov 14 15:00	Phytoplankton 10 ⁴ ind/L	Zooplankton ind/L
0.3	100.0	100.0	100.0	100.0	3378	35 875
1.0	80.96	96.29	85.60	90.01		
2.0	81.16	112.07	84.55	88.35	2587	
4.0	52.78	85.95	42.49	85.64		15 465
6.0	24.31	77.56	16.48	75.20	871	2 460

Table 3. Relationship between fish production and water depth in ponds (%).

Water depth (m)	Grass carp		Black carp		Common carp		Silver, bighead carp	
	Input	Net crop	Input	Net crop	Input	Net crop	Input	Net crop
1–1.5	100	100	100	100	100	100	100	100
1.5–2	129.3	165.5	158.6	152.9	145.7	108	113.5	135.1
2–2.5	155.2	129.3	179.3	207.1	171.6	112	114.9	147.3

Table 4. Nutrients in livestock and bird manure (%).

Manure	Water	Organic material	N	P ₂ O ₃	K ₂ O
Pig faeces	79	16.3	0.50	0.38	0.46
Pig urine	97	2.5	0.3–0.5	0.11	0.45
Dairy cow manure	85	11.4	0.36	0.32	0.20
Cattle urine	92–95	2.3	0.6–1.2	Trace	1.35
Chicken faeces	50.5	25.5	1.63	1.54	0.86
Egg chick faeces	44.2	35.1	1.44	1.62	1.44
Duck faeces	56.6	26.2	1.10	1.40	0.63
Goose faeces	71.1	23.4	0.55	0.50	0.50

According to the kinds of feeding habits of fish and their preferred water depths, if fish are integrated with domestic animals, pig or duck or others may be chosen separately or together. As manures from different animals are different, the combinations of fish from different living habits should be different.

Development of integration systems

Chinese people are looking for better combinations of integration systems. It is found that plants of various sources can be used as an important element in the integration.

Terrestrial plants

Terrestrial plants are the primary products of sunlight utilisation. Grasses possess stronger photosynthetic ability than phytoplankton. At normal light and water temperatures, the sunlight utilisation

abilities of ryegrass and sudan grass are 3.6 and 3.3 times as much as that of phytoplankton. Practices demonstrate that fish utilise 82% of energy from phytoplankton including zooplankton, but 98% of energy from ryegrass.

When grasses are involved in livestock–fish integration, fish use both terrestrial and water plants. A grass carp eats 48 kg of grass, and produces 24 kg of faeces. The nitrogen and phosphorus of grass carp faeces are three times more than that of pigs. This amount of manure supplies phytoplankton with enough nutrients.

The advantages of pig–grass–fish integration over pig–fish integration are: (1) the terrestrial grass yield may be increased by adding more fertilisers; and (2) the oxygen content of water is less affected by grasses.

Aquatic plants

Azolla was introduced to China in 1971 and was a very popular feed for pigs at first, and later for fish–livestock integration. It is a fast-growing plant, which may cover the whole water surface in a short time, so its intensive use is proposed. As compared with a rice–fish system, a rice–fish–azolla–duck system increases fish yield to 308 kg/ha in the wet season and 650 kg/ha in the dry season, when both azolla and ducks are used.

Other aquatic plants that maybe used are water lettuce and common water hyacinth; they are easier to collect but must be collected regularly to keep necessary oxygen requirements for other water habitants.

Methane products

Methane gas generation has been popularised in China for decades and the livestock manure and stems of crops are normally used for this purpose. Farmers often used liquid and sediment methane production as fertilisers for arable lands and also for fishponds. Practices demonstrate that the fish output reaches 6772 kg/ha from 965 kg of fish fingerlings due to the input of methane production to ponds.

Reasons for higher production include: (1) higher amount of chlorophyll or higher phytoplankton quantity; (2) higher dissolved oxygen; and (3) better food conversion efficiency in methane-fertilised ponds than in manure ponds (Table 5).

Table 5. Comparison of pig-manure and methane liquid fertilised pond.

Ponds	Lowest DO mg/L	Chl. mg/m ³	Phytoplankton		Output (kg/ha)
			Biomass (mg/L)	Amounts (10 ⁶ /L)	
Meth.Liq	1.1	107.46	21.39	19.755	3817.5
Manured	0.7	81.47	16.25	14.458	2781.0

New symbiotic species

Fish species used in pond culture in China have been limited mainly to the Chinese carps. However, these cannot meet new and developing market requirements. Accordingly, some new fish species have been used in the Pearl River Delta and Yangtze River Delta to boost production (Table 6). Fish species listed in Table 6 are carnivorous or omnivorous, usually considered unsuitable to combine in culture. However, experiments and field tests demonstrate that they can be used in integrated systems.

Efficiency of the livestock–fish integrated system

Under the right conditions, multi-element combinations may have advantages over single ones, but their investment intensity is also larger. Ponds are heavily loaded with nutrition inputs from different resources,

as shown in Table 7. Among them, the input for fish–plant variant is the highest, and the income rate is also the best (1.84) with cash income of 33 118.5 yuan per ha. The net income is the best, too. Obviously, the input level is the most important in getting a good harvest.

Integration of animals with cereal crops is a flexible system in agriculture. Any element can be included and have tremendous effects. Because of promotion, this system has had a big influence on rural economic development (Table 8). In Zhang-zhuang Village, Wu County, Jiangsu Province, with 567 families with 1962 people, owning 59.1 ha of land and 49.9 ha of pond, the introduction of a crop–livestock–poultry–fish integrated system made the economy improve. In this well-developed village, the multi-element integrated system was very well accepted, and as a result, the average crop output increased from 306.1 kg to 512.7 kg per person, pigs from 0.21 to 1.34 head, and chicken from 4 to 5 pieces. The communal financial accumulation increased by 2.5 times (Table 8).

The statistical data demonstrated that during 1985–1995 fish production increased 3.54 times, freshwater fish by 3.71 times and cultured fish by 3.95 times. In the intensified pond system in some regions, pond fish production has played an important role in freshwater fish cultivation systems. In Shanghai, Jiangsu and Guangdong provinces, the cultured-fish output accounted for 95.2, 81.4 and 95.1% of total pond fish yields, respectively. The usual pond yields were 2.9, 1.6 and 2.9 t/ha and the cultured pond yields were 5.7, 2.8 and 4.9 t/ha in 1990 (Table 9).

Integration systems gave 2–12 times more production than normal. The figures show the integrated systems are vivid and fast-growing, and under these systems, crops, livestock and fish production increase much faster than the increase in population.

Conclusions

There are three important elements in integration systems. Manure, which links the animals with plankton and fish directly and indirectly, is the most

Table 6. New fish species used in integrated systems in the Pearl River Delta.

Fish symbiosis	Length of fish fry	Density (no./ha)	Main feeds	Output (kg/ha)
Mandarin fish	>3 cm	30–50	Wild muss-fish	300–450
Largemouth bass	>3 cm	30–40	Mosquito-fish, insects, benthos	225–300
Japanese eel	10 g	20–30	Mosquito-fish, benthos, feed	75–150
Channel catfish	15 cm	50–100	Feed, insects, benthos	400–1125
<i>Piaractus brach.</i>	3 cm	30–50	Algae, insects, benthos	225–375

Table 7. Input and output of variants in different fish production combinations (8 yuan = US\$1).

Variants	Single fish	Fish-plant	Fish-livestock	Fish-crop-livestock
Fish fry (no.)	717	2 031	1 083	696
Cereals (kg/ha)	8 265	14 865	12 225	10 950
Grass (kg/ha)	19 050	133 155	36 735	47 265
Organic fertiliser (kg/ha)	4 320	11 655	14 370	12 120
Chemical fertiliser (kg/ha)	1 128	925	1 755	1 710
Fuel (kg)	1 065	1 890	1 380	705
Output of fish (kg/ha)	5 139	12 186	7 111.5	7 441.5
Cash Income (yuan)	13 524	33 118.5	17 487	17 541
Cost (yuan)	7 828.5	17 970	10 504.5	9 688.5
Fish/fish fry	7.17	6.00	6.57	10.70
Cereal/fish	1.61	1.22	1.72	1.47
Grass/fish	3.70	10.92	5.16	6.35
Net income (yuan)	5 695.5	16 498.5	6 983.5	7 848
Income rate	1.73	1.84	1.66	1.81

Table 8. Efficiency of the livestock-fish integrated farming system.

Items	Wheat, barley (kg/ha)	Rice (kg/ha)	Poultry (pieces)	Pig (head)	Fish (kg/ha)	Economy accumulation (Yuan)
1977	2 562.0	7 605.0	8 000	420.0	2 715.0	22 000.0
1983	5 875.5	11 304.0	10 000	2 630.0	11 790.0	58 000.0
Increase %	223.5	148.6	125	626.2	1 500.0	263.6

Table 9. Effect of integrated fish production.

Integrations	Integrated (t/ha)	Usual(t/ha)	Increased(%)	Year	Provinces
Duck-fish, tight integrated	12.2-13.7	2.6	498.0	1984	Jiangsu
Duck-fish, tight integrated	5.4	1.6	337.5	1983	Jiangsu
Duck-fish, slotted dike feeding	4.5	1.9	236.8	1984	Sichuan
Grass-livestock-fish	19.5	1.55	1258.0	1983	Guangdong

important one. Mud, which links the accumulated nutrients in the pond with crop production, is the second. The third element is human beings who create the recycling paths. This integration is one agro-alimentary-environmental system and humans are the leading factor.

In many integration systems, the livestock-fish-crop integration is the most efficient variant and plays a very important role in solving the food problems of the developing world.

References

- Chen, YC. 1996. Livestock-fish farming integration system in China. In: Proc. FAO/AAAP Symposium on Integrated Systems of Animal Production in the Asian Region, 77-82.
- Devendra, C. 1996. Overview of integrated animals-crops-fish production systems: achievements and future potential. In: Proc. FAO/AAAP Symposium on Integrated Systems of Animal Production in the Asian Region, 9-22.
- Csavas, Imre 1992. Regional review: on livestock-fish production systems in Asia. In: Proc. FAO/IPT. Int. Workshop on livestock-fish integrated production. Rome, Italy, 35-40.
- Mukherjee, T.K., Geeta, S., Rohani, A. and Phang, S.M. 1992. A study on duck-fish and goat-fish production systems. In: Proc. FAO/IPT Int. Workshop on livestock-fish integrated production, Rome, Italy, 41-48.
- Pekar, F. and Olah, J. 1992. Carbonic pathways, bioenergetic efficiencies and energy cost in fish cum livestock ecosystem. In: Proc. FAO/IPT Int. Workshop on livestock-fish integrated production. Rome, Italy, 78-84.
- Xu, H.C. and Zhu, S. 1992. Techniques for integrated fishponds. Agriculture Publishing House, Beijing, 95-140 (In Chinese).
- Yadava, N.K. and Vaishali, B. The duck-cum-fish farming integration systems. In: Proc. FAO/IPT Int. Workshop on livestock-fish integrated production. Rome, Italy. 135-139.

Livestock–Fish Integrated Systems and Their Application

Shenggui Wu¹, Chuanlin Hu¹ and Youchun Chen²

Abstract

Livestock–fish integrated systems are old practices, which interestingly are becoming popular. The common integration may be pig–fish, duck–fish, cattle–fish, livestock–poultry–fish, grass–livestock–fish and so on. The commonest and most efficient integrated system is the crop–livestock–fish integration. Some important factors, including dissolved oxygen content, depth of water, types of livestock manure used and level of input in integrated systems, all influence the nature of the operation. The introduction of crops to integrated systems has resulted in many positive outcomes from a human nutrition viewpoint. Studies of nutrient and energy cycles along the food web of integrated systems have also made the crop–livestock–fish integrated system the most understood, scientifically. Economic recycling of all kinds of nutrient matter has reduced fuel consumption and operational costs, resulting in an overall increase in economic efficiency. Under the integrated system, crops–livestock and fish production have increased faster than the rate of population increase. Fish output in integrated systems is about twice to 12 times that in a monoculture.

IN CHINA, the requirement of meat, eggs and fish (cultured fish) is 316.6 million t. Every person needs 274 kg of cereal a year and 1200 million people need 328.8 million t, for a total of 645.4 million t. The total cereal production is about 551.93 million t/year. That means there is a shortfall of 93.47 million t (Chen 1996). The livestock–fish combination may be one of the solutions to meeting this shortfall.

The reason for intensifying the fish–livestock integrated systems is the requirement to produce high-quality animal protein to replace plant protein. Some resources without nutritional value for human beings and animals could be turned into food in the fish–livestock integrated system, and consequently use less feed and produce more high-quality animal protein (Pekar and Olah 1992).

In China, the earliest record of an integrated livestock–fish system was in the Agriculture Encyclopedia, published in 1639, in the Ming Dynasty by Xu Guang-qì (1562–1633). In the early 1920s of the

Qing Dynasty, in the book Additions to Agriculture, a four-element culture was mentioned, namely planting–mulberry–fish–livestock.

Realising the potential of low-input of livestock–fish integration in boosting animal food production, international agencies, especially the FAO, helped to introduce the system to developing countries since the 1950s. The livestock–fish integration system has been a very fast development until now (Csavas 1992; Devendra 1996).

Models for Livestock–fish Integration

If certain species of domestic animals are chosen, the combinations of the integration may be pig–fish, duck–fish, cattle–fish, chicken–fish and so on. Each type of combination produces manure of a different character, which supplies nutrients suitable for different fish species. If the species of domestic animals are defined, the fish varieties can be matched.

Pig–fish integration

Pork is one of the most important animal protein resources in China. Pig–fish integration is quite popular and traditional. Pig slurry has a high content of nitrogen, with a N:C ratio 14.3:1, which is less than that for other animals. Manure input may increase

¹Institute of Reservoir Fisheries, the Chinese Ministry of Water Resources and the Chinese Academy of Sciences, Wuhan, 430079, China

²Institute of Animal Science, the Chinese Academy of Agriculture Sciences, Beijing 100094, China

phytoplankton and zooplankton to 20.61 mg/L and 7.73 mg/L, respectively, at a loading of 12 kg/m³ of water. The pig–fish integration is 35.1% more beneficial than a single fish culture and the cost of raising pigs decreases by 11.7% per kg of growth.

Duck–fish integration

This is one of the classical and traditional systems in Asia (Yadava and Vaishalli 1992). Ducks are animals with relatively short digestive tracts. Their digestive tracts are only about four times the body length, so a large amount of feed (34%) is excreted before being properly digested, resulting in higher manure content of organic matter.

Duck manure can help reduce 20–25% of inputs into a culture system comprising phyto- and zooplankton feeders of fish feed. The decay and decomposition of duck waste in pond waters lead to release of essential nutrients, enhancing the primary and secondary productivity of water bodies, ultimately boosting fish production, which can save about 50% of supplementary feeds for fish (Mukherjee et al. 1992).

A duck can drain 70 kg of faeces, or 5–10 kg in dry faeces in a year. It is concluded that each fattened duck is capable of producing 0.5–0.75 kg of fish. About 3–6 batches of ducks can be produced, depending on different climate zones. Taking four batches a year, fish production will be 260–390 kg and without any feed inputs, the daily fish production with only duck wastes could be 36.5 kg/ha.

The duck number must be in accordance with the fish number. From generalised experiments and practices, each hectare is matched to 1200–1500 ducks. In ponds, duck–fish integration systems fish must be polycultured to increase the feed utility and water holding capacity.

The survival rate of carp is related to the density of duck waste. The ‘safe’ level mentioned above is in the range of waste concentrations, possibly due to the existence of favourable hydrological conditions like water dissolved oxygen, pH and hardness. Under different densities of wastes in different times of testing, survival rates differ. Obvious mortality can be observed when the density of duck wastes is 0.02%, but becomes serious when it is 0.035%.

Ducks dive to devour fish, but only fingerlings under 4 g are ingested. Therefore, seed-fish ponds are unsuitable for integration with duck.

Cattle (horse)–fish integration

Cattle–fish integration has been practiced for a long time. Fish are integrated not only with cattle but also with horses and mules. Dairy cattle–fish is a new integration. The nutrients in cow dung are lesser than

in pig manure. The nitrogen contents are a little higher, but phosphorus comes in trace amounts only. ‘One milking cow and half ton fish’ is a common proverb among farmers.

Cow manure is fine, granular, floats for a long time, and is 33% heavier than pig slurry in dry weight. The total floating materials in the cow dung pond is 54.6% more than in pig, duck and chicken manure ponds. The floating character of cow dung granules increases feeding opportunities for fish and restricts accumulation of the oxygen-consuming materials. Consequently, less harmful gas is formed. Because feed in ruminants is digested by micro-organisms, their degradation needs less oxygen in comparison to other manure resources. Each kg of bull manure exhausted 20.6 g of oxygen in 5 days, while the pig slurry needs 30.0 g, which is 32% more. Therefore, cow dung is called ‘safe’ manure in livestock–fish integration.

A milking cow of 400–500 kg can produce about 13 600 kg of cow dung and 9000 kg of urine a year. Practices demonstrate that 0.17 kg of cow dung per m³ of water a week may produce one kg of fish.

Besides this, the wasted feeds from dairy barns are also rich — 9000–11 000 kg of grasses are supplied for a cow a year and 3000 kg are wasted. This amount is always spattered away during the summer time, when it is a good season for fish growth. In the cattle–fish integration with an output of 7500 kg a year, the manure of 15 head of cattle can contribute feed to meet the requirements of fish in a 1 ha pond.

Chicken–fish integration

In this system, 0.07 kg of chicken faeces is supplied per m³ of water, 5 kg of chicken faeces able to produce 1 kg filter-feeding fish. If the chicken faeces are fermented, the results can be better.

Other kinds of integration

Besides the above-mentioned integrated systems, sheep, goats and geese are all good for the purposes. A goose can supply 120–150 kg of faeces a year, and 25–30 kg of goose faeces can produce 1 kg of filter-feeding fish. In the Yangtze River area, geese are used for this purpose. In integration with fish, 750–900 geese are released in one ha. Goat/sheep–fish integration is found more in Northern China. Multi-livestock–fish is also common (Chen 1996).

Models for livestock–fish integration

Main models for livestock–fish integration are shown in Table 1.

Important Elements in Livestock–Fish Integration

Three important elements in livestock–fish integration are dissolved oxygen concentration, the depth of pond water and manure (Xu and Zhu 1992).

Dissolved oxygen

The dissolved oxygen concentration is different in different water levels (Figure 1), and so is the distribution of phytoplankton.

Dissolved oxygen concentrations lower than 1 mg/L are not suitable for fish growth. When the water level is 0.3 m, the oxygen content is normally higher than 2.6 mg/L; at 2 m deep, it is higher than 1.8 mg/L. Therefore, a pond 2.5 m deep is suitable for fish growth with sufficient oxygen. Phytoplankton development is related to strength of sunlight. The amount of phytoplankton is different at different depths. The deeper the water, the fewer phytoplankton were accounted (Table 2). Related to this, zooplankton numbers consequently change.

Fish such as silver carp and bighead carp feed on phytoplankton and zooplankton, respectively, and in less than 4 m grow better than in deeper water.

Depths of pond water

Choosing an appropriate water depth may increase fish production. Product performance for fish like black carp, grass carp, common carp and silver carp is closely related to water depth in ponds (Table 3).

It is suggested that 2.5 to 3 m deep is the best layer for carp habitation. Within this depth, a highly dissolved oxygen content and higher plankton number supply enough feed for aquatic animals. Therefore, it is beneficial for fish of any kind of feeding habit.

Manure

Livestock–fish integration in nature is the way to utilise animal excrement and waste for feeding fish. The nutrient contents of manures are shown in Table 4.

Table 1. Main models for livestock–fish integration.

Variants	Livestock (head)	Manure (kg)	Fish	Output (kg/ha)
Duck–fish	Usual 900–1500, intensified 1500–1800	40–50	Silver carp, bighead carp	4500–7500
Pig–fish	75	200	Silver carp, bighead carp	3000
Dairy cattle–fish	15	Faeces 13 600 Urine 9000 Wasted feeds 3000	Grass carp, bream	7500
Chicken–fish	2250–3000	70	Tilapia	4000–7500
Grass–livestock–fish	Duck 900/pig 60/ Dairy cattle 12 Grassland 1/3–1/2 ha		Grass carp, bream silver carp, bighead carp	7500

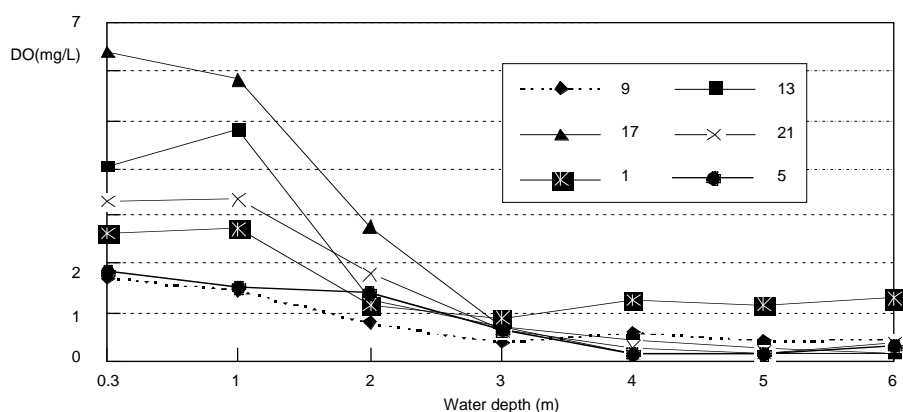

Figure 1. Oxygen concentrations at different strata of water in September (mg/L).

Table 2. Stratified amount of plankton in ponds (%).

Water depth (m)	Sept 7 17:00	Sept 8 5:00	Oct 20 17:00	Nov 14 15:00	Phytoplankton 10 ⁴ ind/L	Zooplankton ind/L
0.3	100.0	100.0	100.0	100.0	3378	35 875
1.0	80.96	96.29	85.60	90.01		
2.0	81.16	112.07	84.55	88.35	2587	
4.0	52.78	85.95	42.49	85.64		15 465
6.0	24.31	77.56	16.48	75.20	871	2 460

Table 3. Relationship between fish production and water depth in ponds (%).

Water depth (m)	Grass carp		Black carp		Common carp		Silver, bighead carp	
	Input	Net crop	Input	Net crop	Input	Net crop	Input	Net crop
1–1.5	100	100	100	100	100	100	100	100
1.5–2	129.3	165.5	158.6	152.9	145.7	108	113.5	135.1
2–2.5	155.2	129.3	179.3	207.1	171.6	112	114.9	147.3

Table 4. Nutrients in livestock and bird manure (%).

Manure	Water	Organic material	N	P ₂ O ₃	K ₂ O
Pig faeces	79	16.3	0.50	0.38	0.46
Pig urine	97	2.5	0.3–0.5	0.11	0.45
Dairy cow manure	85	11.4	0.36	0.32	0.20
Cattle urine	92–95	2.3	0.6–1.2	Trace	1.35
Chicken faeces	50.5	25.5	1.63	1.54	0.86
Egg chick faeces	44.2	35.1	1.44	1.62	1.44
Duck faeces	56.6	26.2	1.10	1.40	0.63
Goose faeces	71.1	23.4	0.55	0.50	0.50

According to the kinds of feeding habits of fish and their preferred water depths, if fish are integrated with domestic animals, pig or duck or others may be chosen separately or together. As manures from different animals are different, the combinations of fish from different living habits should be different.

Development of integration systems

Chinese people are looking for better combinations of integration systems. It is found that plants of various sources can be used as an important element in the integration.

Terrestrial plants

Terrestrial plants are the primary products of sunlight utilisation. Grasses possess stronger photosynthetic ability than phytoplankton. At normal light and water temperatures, the sunlight utilisation

abilities of ryegrass and sudan grass are 3.6 and 3.3 times as much as that of phytoplankton. Practices demonstrate that fish utilise 82% of energy from phytoplankton including zooplankton, but 98% of energy from ryegrass.

When grasses are involved in livestock–fish integration, fish use both terrestrial and water plants. A grass carp eats 48 kg of grass, and produces 24 kg of faeces. The nitrogen and phosphorus of grass carp faeces are three times more than that of pigs. This amount of manure supplies phytoplankton with enough nutrients.

The advantages of pig–grass–fish integration over pig–fish integration are: (1) the terrestrial grass yield may be increased by adding more fertilisers; and (2) the oxygen content of water is less affected by grasses.

Aquatic plants

Azolla was introduced to China in 1971 and was a very popular feed for pigs at first, and later for fish–livestock integration. It is a fast-growing plant, which may cover the whole water surface in a short time, so its intensive use is proposed. As compared with a rice–fish system, a rice–fish–azolla–duck system increases fish yield to 308 kg/ha in the wet season and 650 kg/ha in the dry season, when both azolla and ducks are used.

Other aquatic plants that maybe used are water lettuce and common water hyacinth; they are easier to collect but must be collected regularly to keep necessary oxygen requirements for other water habitants.

Methane products

Methane gas generation has been popularised in China for decades and the livestock manure and stems of crops are normally used for this purpose. Farmers often used liquid and sediment methane production as fertilisers for arable lands and also for fishponds. Practices demonstrate that the fish output reaches 6772 kg/ha from 965 kg of fish fingerlings due to the input of methane production to ponds.

Reasons for higher production include: (1) higher amount of chlorophyll or higher phytoplankton quantity; (2) higher dissolved oxygen; and (3) better food conversion efficiency in methane-fertilised ponds than in manure ponds (Table 5).

Table 5. Comparison of pig-manure and methane liquid fertilised pond.

Ponds	Lowest DO mg/L	Chl. mg/m ³	Phytoplankton		Output (kg/ha)
			Biomass (mg/L)	Amounts (10 ⁶ /L)	
Meth.Liq	1.1	107.46	21.39	19.755	3817.5
Manured	0.7	81.47	16.25	14.458	2781.0

New symbiotic species

Fish species used in pond culture in China have been limited mainly to the Chinese carps. However, these cannot meet new and developing market requirements. Accordingly, some new fish species have been used in the Pearl River Delta and Yangtze River Delta to boost production (Table 6). Fish species listed in Table 6 are carnivorous or omnivorous, usually considered unsuitable to combine in culture. However, experiments and field tests demonstrate that they can be used in integrated systems.

Efficiency of the livestock–fish integrated system

Under the right conditions, multi-element combinations may have advantages over single ones, but their investment intensity is also larger. Ponds are heavily loaded with nutrition inputs from different resources,

as shown in Table 7. Among them, the input for fish–plant variant is the highest, and the income rate is also the best (1.84) with cash income of 33 118.5 yuan per ha. The net income is the best, too. Obviously, the input level is the most important in getting a good harvest.

Integration of animals with cereal crops is a flexible system in agriculture. Any element can be included and have tremendous effects. Because of promotion, this system has had a big influence on rural economic development (Table 8). In Zhang-zhuang Village, Wu County, Jiangsu Province, with 567 families with 1962 people, owning 59.1 ha of land and 49.9 ha of pond, the introduction of a crop–livestock–poultry–fish integrated system made the economy improve. In this well-developed village, the multi-element integrated system was very well accepted, and as a result, the average crop output increased from 306.1 kg to 512.7 kg per person, pigs from 0.21 to 1.34 head, and chicken from 4 to 5 pieces. The communal financial accumulation increased by 2.5 times (Table 8).

The statistical data demonstrated that during 1985–1995 fish production increased 3.54 times, freshwater fish by 3.71 times and cultured fish by 3.95 times. In the intensified pond system in some regions, pond fish production has played an important role in freshwater fish cultivation systems. In Shanghai, Jiangsu and Guangdong provinces, the cultured-fish output accounted for 95.2, 81.4 and 95.1% of total pond fish yields, respectively. The usual pond yields were 2.9, 1.6 and 2.9 t/ha and the cultured pond yields were 5.7, 2.8 and 4.9 t/ha in 1990 (Table 9).

Integration systems gave 2–12 times more production than normal. The figures show the integrated systems are vivid and fast-growing, and under these systems, crops, livestock and fish production increase much faster than the increase in population.

Conclusions

There are three important elements in integration systems. Manure, which links the animals with plankton and fish directly and indirectly, is the most

Table 6. New fish species used in integrated systems in the Pearl River Delta.

Fish symbiosis	Length of fish fry	Density (no./ha)	Main feeds	Output (kg/ha)
Mandarin fish	>3 cm	30–50	Wild muss-fish	300–450
Largemouth bass	>3 cm	30–40	Mosquito-fish, insects, benthos	225–300
Japanese eel	10 g	20–30	Mosquito-fish, benthos, feed	75–150
Channel catfish	15 cm	50–100	Feed, insects, benthos	400–1125
<i>Piaractus brach.</i>	3 cm	30–50	Algae, insects, benthos	225–375

Table 7. Input and output of variants in different fish production combinations (8 yuan = US\$1).

Variants	Single fish	Fish-plant	Fish-livestock	Fish-crop-livestock
Fish fry (no.)	717	2 031	1 083	696
Cereals (kg/ha)	8 265	14 865	12 225	10 950
Grass (kg/ha)	19 050	133 155	36 735	47 265
Organic fertiliser (kg/ha)	4 320	11 655	14 370	12 120
Chemical fertiliser (kg/ha)	1 128	925	1 755	1 710
Fuel (kg)	1 065	1 890	1 380	705
Output of fish (kg/ha)	5 139	12 186	7 111.5	7 441.5
Cash Income (yuan)	13 524	33 118.5	17 487	17 541
Cost (yuan)	7 828.5	17 970	10 504.5	9 688.5
Fish/fish fry	7.17	6.00	6.57	10.70
Cereal/fish	1.61	1.22	1.72	1.47
Grass/fish	3.70	10.92	5.16	6.35
Net income (yuan)	5 695.5	16 498.5	6 983.5	7 848
Income rate	1.73	1.84	1.66	1.81

Table 8. Efficiency of the livestock-fish integrated farming system.

Items	Wheat, barley (kg/ha)	Rice (kg/ha)	Poultry (pieces)	Pig (head)	Fish (kg/ha)	Economy accumulation (Yuan)
1977	2 562.0	7 605.0	8 000	420.0	2 715.0	22 000.0
1983	5 875.5	11 304.0	10 000	2 630.0	11 790.0	58 000.0
Increase %	223.5	148.6	125	626.2	1 500.0	263.6

Table 9. Effect of integrated fish production.

Integrations	Integrated (t/ha)	Usual(t/ha)	Increased(%)	Year	Provinces
Duck-fish, tight integrated	12.2-13.7	2.6	498.0	1984	Jiangsu
Duck-fish, tight integrated	5.4	1.6	337.5	1983	Jiangsu
Duck-fish, slotted dike feeding	4.5	1.9	236.8	1984	Sichuan
Grass-livestock-fish	19.5	1.55	1258.0	1983	Guangdong

important one. Mud, which links the accumulated nutrients in the pond with crop production, is the second. The third element is human beings who create the recycling paths. This integration is one agro-alimentary-environmental system and humans are the leading factor.

In many integration systems, the livestock-fish-crop integration is the most efficient variant and plays a very important role in solving the food problems of the developing world.

References

- Chen, YC. 1996. Livestock-fish farming integration system in China. In: Proc. FAO/AAAP Symposium on Integrated Systems of Animal Production in the Asian Region, 77-82.
- Devendra, C. 1996. Overview of integrated animals-crops-fish production systems: achievements and future potential. In: Proc. FAO/AAAP Symposium on Integrated Systems of Animal Production in the Asian Region, 9-22.
- Csavas, Imre 1992. Regional review: on livestock-fish production systems in Asia. In: Proc. FAO/IPT. Int. Workshop on livestock-fish integrated production. Rome, Italy, 35-40.
- Mukherjee, T.K., Geeta, S., Rohani, A. and Phang, S.M. 1992. A study on duck-fish and goat-fish production systems. In: Proc. FAO/IPT Int. Workshop on livestock-fish integrated production, Rome, Italy, 41-48.
- Pekar, F. and Olah, J. 1992. Carbonic pathways, bioenergetic efficiencies and energy cost in fish cum livestock ecosystem. In: Proc. FAO/IPT Int. Workshop on livestock-fish integrated production. Rome, Italy, 78-84.
- Xu, H.C. and Zhu, S. 1992. Techniques for integrated fishponds. Agriculture Publishing House, Beijing, 95-140 (In Chinese).
- Yadava, N.K. and Vaishali, B. The duck-cum-fish farming integration systems. In: Proc. FAO/IPT Int. Workshop on livestock-fish integrated production. Rome, Italy. 135-139.

Fisheries Marketing Systems in Sri Lanka and Their Relevance to Local Reservoir Fishery Development

F.J. Murray¹, S. Koddithuwakku² and D.C. Little¹

Abstract

Poverty alleviation programs that focus on rural aquaculture or fisheries development typically stress the potential of increased fish production to both sustain and enhance food security and for income generation. Although most programs deal with the biotechnical aspects of production, few adequately assess the marketing situation and its impact on the potential of different wealth groups to benefit. Poor understanding of this aspect has resulted in misguided policy directives at national and local levels and undermined the sustainability of many development programs. This paper is based on research investigating the potential for integrated production of aquatic organisms in small-scale farmer-managed irrigation systems within the dry-zone of Sri Lanka, and the potential of such activities to diversify the livelihood strategies of marginal groups in this risk-prone environment. It begins with a brief consideration of the water resource and fish production and consumption trends within the country. The validity of regional and national production data (a major determinant of government development policy) is assessed in the light of field findings and data triangulation. It then assesses market infrastructure and examines the networks of actors participating in the market (producers, middlemen, retailers and consumers), differentiating between different levels of market space: inter-regional and sub-regional characterised by the markedly different nature of interaction between actors in these spaces. It assesses seasonal and historic demand and supply trends and consumer preferences for local fish varieties, different forms and substitutes, and the margins earned by actors at different levels of the market network. Throughout, it highlights the differences that exist between different wealth groups. Insights into the local market situation are also gained through contrast with markets in other fishery sectors. Data were assembled and triangulated using a variety of sources and methods including in-depth or semi-structured interviews with key actors, direct participant observation and focus group discussions at production and marketing sites. Consumer preferences were assessed using ranking and scoring exercises, part of wider livelihood analyses undertaken in project villages. Based on these findings the potential for future development of market networks and entry points for target beneficiaries (including women's groups) with respect to participation in marketing and processing activities is assessed, as is the potential of 'low-input' processing activities to bring benefit through addition of value to fisheries products. Finally the findings are considered in the light of existing regional development policies (governmental, non-governmental and research), drawing lessons that may have relevance to wider recommendation domains.

RESULTS presented in this paper were collected as part of an ongoing DFID-CARE-funded research program being undertaken within Northwest Province in the Dry Zone of Sri Lanka. The program is investigating the potential for integrated production of aquatic organisms in small-scale farmer-managed

irrigation systems and the potential of such activities to diversify the livelihood strategies of marginal groups in water-stressed areas. Taking a 'people-first', sustainable livelihoods approach incorporating farmer-managed trials, the project aims to develop innovative technologies capable of increasing or sustaining existing production.

Poverty alleviation programs focusing on rural aquaculture or fisheries development typically stress the potential of increased fish production to both sustain and enhance food security and increase income

¹Institute of Aquaculture, Stirling University, Stirling FK9 4LA, Scotland. E-mail: smallface@bigfoot.com

²Agribusiness Centre, Faculty of Agriculture, University of Peradeniya, Sri Lanka.

generation. In the past, many production programs, especially those incorporating an income generation objective, have failed due to poor understanding of prevailing marketing conditions, on which the determination of product quality, size, species, form, production scheduling, production and processing methods for economically viable production are contingent (Pillay 1990). Furthermore the accessibility, scale, seasonal and historic variation in existing markets for inland fish and their substitutes affect equitable distribution of benefits. Relationships between traders and resource users also have impact on the ability of different socioeconomic groups to benefit.

In Sri Lanka very little information exists with respect to socioeconomic attributes of the inland fishery and even less on purely marketing issues. Several workers (e.g. Chandrasiri 1986, Munasinghe 1984, Amarasinghe 1998a) have studied the socio-economic conditions of fishermen around perennial reservoirs in the dry zone, and wet zone (Nathaniel 1997), but have given limited attention to marketing.

Materials and Methods

A detailed market study was incorporated into a wide-ranging situation analysis, constituting the

initial phase of research. Primary data sources included regular semi-structured interviews over the course of one year (1998–99) with producers around perennial and seasonal tanks, assemblers, traders and retailers at all the different levels of the market network around major irrigation systems supporting commercial fisheries in Northern Kurunegala and Puttalam Districts (see Figure 1). Retailers in the urban areas of Kandy and Colombo were also interviewed to gain an understanding of the relationship between subregional (local, rural) and inter-regional, mostly urban, markets. Existing marketing systems, seasonal and historic trends in demand, supply and price, economic and non-economic ties between various actors and marketing constraints perceived by the various actors were each investigated. In addition to fresh inland fish, the market for substitutes (including marine fish, animal substitutes and vegetables), different sizes of fish and the potential for market diversification and value addition through transformation into different forms (fresh, cured, smoked etc.) were investigated. Ranking and scoring exercises were used to characterise consumption patterns and preferences of consumers in villages in rain-fed rural areas of Giribawa and Galgamuwa Divisional secretariats adjacent to the commercial fisheries described above (see Figure 1). Primary

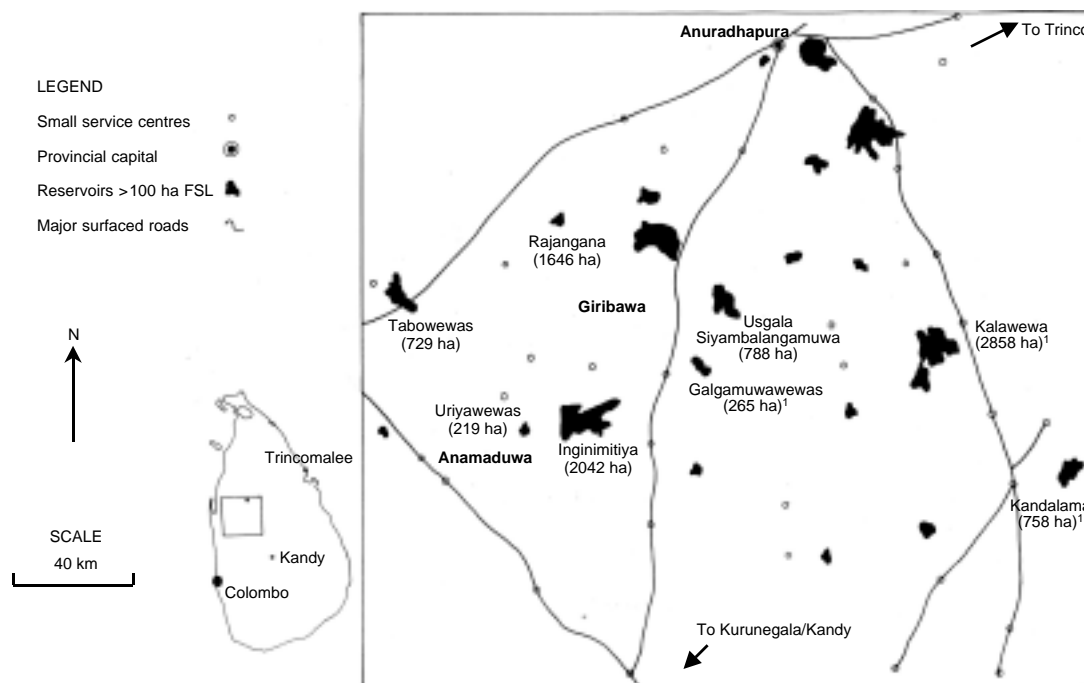

Figure 1. Location of reservoirs with commercial fisheries supplying local markets around primary research areas of Giribawa and Anamaduwa Division Secretariats. (¹Fisheries investigated with no relevance to local markets.)

production information was collected from a large perennial reservoir in Central Province by a local participant, and secondary data relating to national fisheries production were obtained from government ministries.

Background

Despite considerable development assistance, the combined fisheries sectors contributed only an estimated 1.6% of Sri Lanka's GNP in 1997 in contrast to the 24.5% provided by the agricultural sector (Central Bank 1998). However, both the marine and inland sectors of the industry are of vital importance to a large and expanding number of small-scale subsistence producers and market intermediaries. Fisheries are believed to support the livelihoods of over 10% of the population in many coastal areas directly, but no disaggregated figures exist for the inland sector. Fish products also represent the major source of animal protein in the Sri Lankan diet. An estimated 96% of all Sri Lankans regularly consume some form of fish while in 1996 fish products constituted an estimated 58.5% of the nation's total non-vegetable protein consumption (NARA 1999). Mean per capita consumption rose steadily during the 1980s to a peak of 18.6 kg more recently fluctuating

12–15.5 kg (see Figure 2). This is one of the highest levels of any of the developing countries in the region reflecting Sri Lanka's rich endowment of marine and inland water resources, and its predominantly Buddhist and Hindu religions, both cultures of low livestock holdings and consumption.

Figure 3 shows sector-wise landings in Sri Lanka according to available official statistics over recent years. Total landings have increased only slightly and were sufficient to meet only 53–76% of annual consumption over the previous decade. The deficit has been met through a trend of increasing processed fish imports, predominantly dried, salted marine fish and lesser amounts of canned fish.

Although fisheries production is dominated by the marine fish sector (Figure 3), demand for marine fish is concentrated around coastal production areas, urban areas (where consumers can afford the higher prices commanded by most marine varieties) and arterial routes between production and urban areas. In rural inland areas of the dry zone, home to a large proportion of the country's poorest and malnourished communities, demand is predominantly for cheaper, locally available inland fish, and for reasons expanded below, there is good reason to suppose this production is under-represented by official figures.

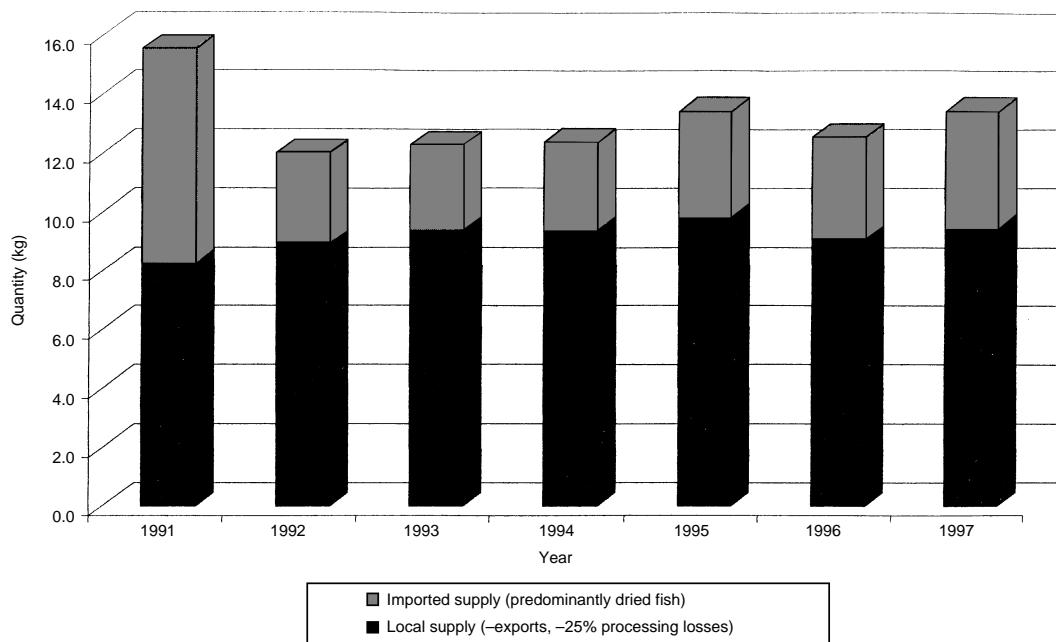

Figure 2. Average per capita fish consumption in Sri Lanka 1991–97 (NARA 1998).

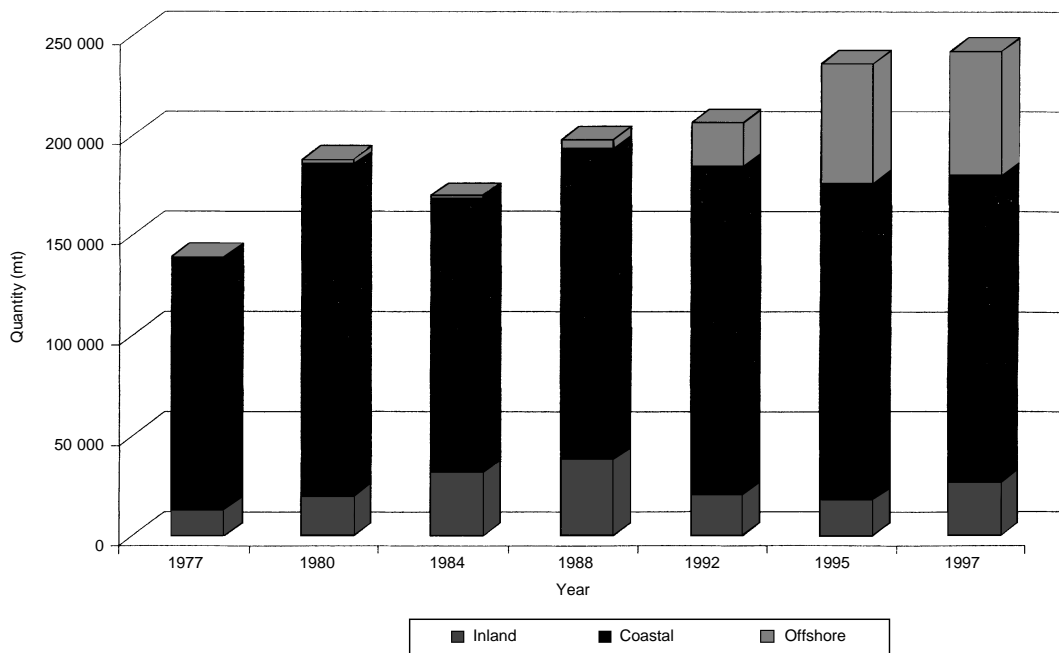

Figure 3. Sector-wise total fish landings for selected years in Sri Lanka (NARA 1997–98).

The water resource

Although Sri Lanka has no natural lakes, it has an ancient heritage of man-made reservoirs, built primarily for irrigation of rice-fields in the dry zone. These water-bodies cover 2–3% of total land area and their extent dominates all other freshwater resources combined. Although figures vary, there are estimated to be at least 10 000 such reservoirs in abandoned and operational conditions. Ten are of greater size than 5000 ha, 67 over 500 ha, 287 over 100 ha (Wijesuriya and Kamaladas 1997), whereas the great majority are rain-fed seasonal village tanks less than 20 ha in extent, holding water for 3–12 months of the year.

Within the research area, most of the fish entering commercial markets originated from two major reservoirs, Rajangana (1645 ha) to the north and Inginitiya (2041 ha) to the south. Lesser amounts are produced from several smaller perennial system reservoirs (i.e. supply augmented by diversion canals) ranging from 219 ha (Uriyawa) to 788 ha (Usgala Siyambalangamuwa — see Figure 1). In addition to these resources, the greatest concentrations of small seasonal village tanks in the country (Sakthivadivel et al. 1997) are found within Northwest and Central Provinces (including the research areas of Northern

Kurunegala and Puttalam Districts). Little of the production from this resource enters commercial networks, for reasons explained below.

Historic trends in inland fisheries production

The advent of the lucrative commercial inland fishery in Sri Lanka today can be attributed to the introduction of African tilapias, firstly *Oreochromis mossambicus* in the early 1950s followed by later introductions of *O. niloticus* and *Tilapia rendalli*. Previously only indigenous riverine species, poorly adapted to the shallow lacustrine reservoir environments, were available. These previously supported only a small subsistence fishery, usually undertaken on a casual basis (Siriweera 1986; Ulluwishewa 1995).

Following the introduction of tilapias, there came an exponential increase in production, estimated to have reached 30 000–40 000 tons annually by the late 1980s (NARA 1999). While no highly reliable figures are available, for the large shallow reservoirs fish yield is considered to be around 250–300 kg per year (De Silva 1988; Fernando 1999). Fernando has described this as perhaps the richest fishery in standing waters anywhere in the world, due primarily to the contribution of tilapias.

Despite decades of government and international development investment, attempts to introduce Chinese and Indian major carps as part of the perennial tank fisheries have so far been a failure due to a variety of political, socioeconomic, cultural and technical factors. Over the same period attempts to establish semi-intensive pond and extensive small tank culture fisheries stocking carps and tilapias have met with equal failure. These efforts can be contrasted with the tilapia-based fishery in the large reservoirs, where after initial stocking of tilapia, a sustainable and high-yielding fishery was established without any further government intervention.

Contribution of perennial and seasonal tanks

Only perennial reservoirs support full-time professional fishing communities, and it is estimated that 90% of all commercially available inland production originates from only 74 of the largest perennial reservoirs in the dry zone. These are essentially unmechanised shore and canoe-based, artisanal gill-net fisheries.

Stocking trials in rain-fed village tanks have demonstrated yield potentials in excess of 800kg/ha/yr (Chakrabarty 1983) though results have been highly variable and so far no sustained adoption has been achieved. Research indicates that even in the absence of stocking initiatives, substantial though erratic natural production occurs in such tanks. Interviews with subsistence fishermen in watersheds around Anamaduwa and Giribawa indicated production levels during seasonal collective fishing 150–200 kg/ha for tanks ranging from 3 to 7.5 ha (maximum water spread) retaining water for 9–12 months during the previous season. Negligible production (<25kg/ha) was recorded for the smallest highly seasonal tanks holding water for less than six months. Greatest variation exists in the production levels from medium-sized semi-seasonal tanks (drying intermittently) where potential for natural repopulation depends on seasonal hydrological linkages between tanks at the wider cascade level. Such linkages are in turn determined by a number of factors, principally seasonal rainfall patterns and tank rehabilitation practices. Village tank production, which is concentrated mostly during the dry season, remains invisible to official statistics, being used almost exclusively for local household consumption. Any surpluses are typically limited to neighbouring villages, undertaken by casual participants (mainly youth), often on a relational basis at highly discounted prices.

Current status in commercial inland fisheries production

The current production situation in the commercial inland fishery remains far from clear due to a unique

politically and economically inspired withdrawal of all government economic support to the sector in 1989–94, which saw an almost complete loss of institutional memory. Only the most rudimentary fisheries inspection capacity has since been re-established, yet official figures suggest substantial recovery since State support was resumed. As all the larger fisheries effectively remain open-access despite attempts to establish cooperatives and as no significant stock enhancement efforts have recently taken place, it is difficult to justify such claims. Furthermore, the effectiveness of earlier stocking initiatives in large perennial reservoirs remains undemonstrated (Amarasinghe 1998b). It is interesting to note that earlier surges in reported production appear to correlate with the provision of subsidised fishing gears and craft, the most notable example being the provision of more than 5000 canoes and fishing gears by the government during the late 1980s.

Key informant interviews with producers around the major reservoirs (shown in Figure 2) over the last year suggest a steady increase in the number of entrants to the fishery and total production, accompanied by a steady decrease in the mean size of landed fish and loss of indigenous varieties. Watson (1999) reports similar findings in reservoirs of the Mahaweli H system. Most respondents attributed the latter effect to the unregulated intensification of fishing effort and fishing practices.

Figure 4 shows production figures collected by a local participant over several low-season months from three landing sites (from which 12–15 canoes operated) around Kandalama, a large perennial reservoir of 758 ha in Central Province (see Figure 1). Accuracy of these figures was verified by regular field checks. Tilapias constitute some 95% of total landings during the period, reflecting the resilience of the species to intensive fishing pressure. The balance of the catch consists of a variety of mostly small indigenous species and a few large exotic carps, relics of earlier stocking programs. Estimates of the tilapia contribution to annual landings by fishermen and vendors around other commercial reservoirs within the research area ranged 75–90% of total catch.

Seasonal and historic variation in price for inland fish and substitutes

Figures 5 to 8 show mean monthly retail and wholesale prices (Sri Lankan Rupees) for dried and fresh inland and marine fish in Colombo during 11 months in 1998–99, with standard deviation bars indicating the degree of weekly variation each month. As a reference it should be borne in mind that agricultural

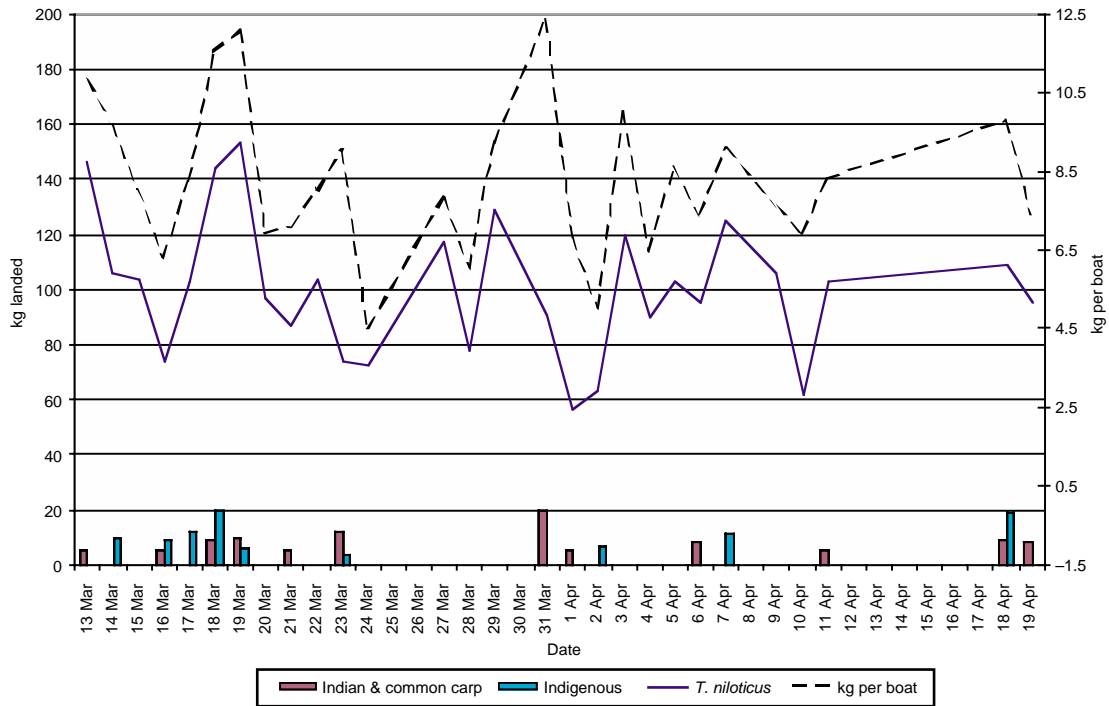

Figure 4. Mean weekly catch statistics from three landing sites on Kandamala Reservoir, April–May.

labourers and unskilled labourers typically earn Rs 150–200 day. Colombo prices are consistently higher than towns in rural areas for which no regular data for inland fish is available, but accurately reflect the general seasonal and historic trends prevailing in the country. Sardines and tuna are selected as representative of the highest and lowest-cost small marine varieties (including herring and anchovies). Dried and fresh, these are the main substitutes for fresh inland fish in the rural areas under study.

The highest prices for marine fish occur during April to June, the period of the south-west monsoon, which brings stormy weather to the south and south-west coasts which provide most of Colombo's supply (NARA 1999). Short-term fluctuations in prices are greatest for fresh marine varieties due to the high susceptibility of the fishery to adverse weather conditions (see Figure 5). By contrast only during the month of April is there a wide fluctuation in fresh tilapia prices (Rs 58–80), the result of a brief surge in demand during the Sri Lankan New Year celebrations. Otherwise supply and demand for tilapia are well-matched through the year with a maximum 17% fluctuation in price (Rs 50–60).

The volatile short-term nature of fresh marine fish prices is indicative of the lack of cold-storage capacity in the country, which, if available, could serve to iron out some of the seasonal fluctuation in demand and supply. To this end the Ceylon Fisheries Corporation, a government parasol organisation, was established primarily to regulate the market by setting ceiling and floor prices for fresh fish. However, never having handled more than 2% of total marine fish production due to lack of cold-storage capacity, this ambition was never realised. Jinadasa (1997) estimates that post-harvest losses of marine stocks as high as 40% are still not uncommon due to inadequate cold storage and cold-chain capacity in Sri Lanka. For reasons which will be discussed, this lack of capacity is far less critical to markets as they currently exist within the inland fishery sector.

A similar seasonal pattern exists for the wholesale prices of the same varieties (see Figure 6). However, monthly standard deviations, particularly for marine fish, are considerably wider than those for retail prices, suggesting that vendors shield their customers from some short-term price fluctuation. Smaller peaks in marine wholesale prices also occur during

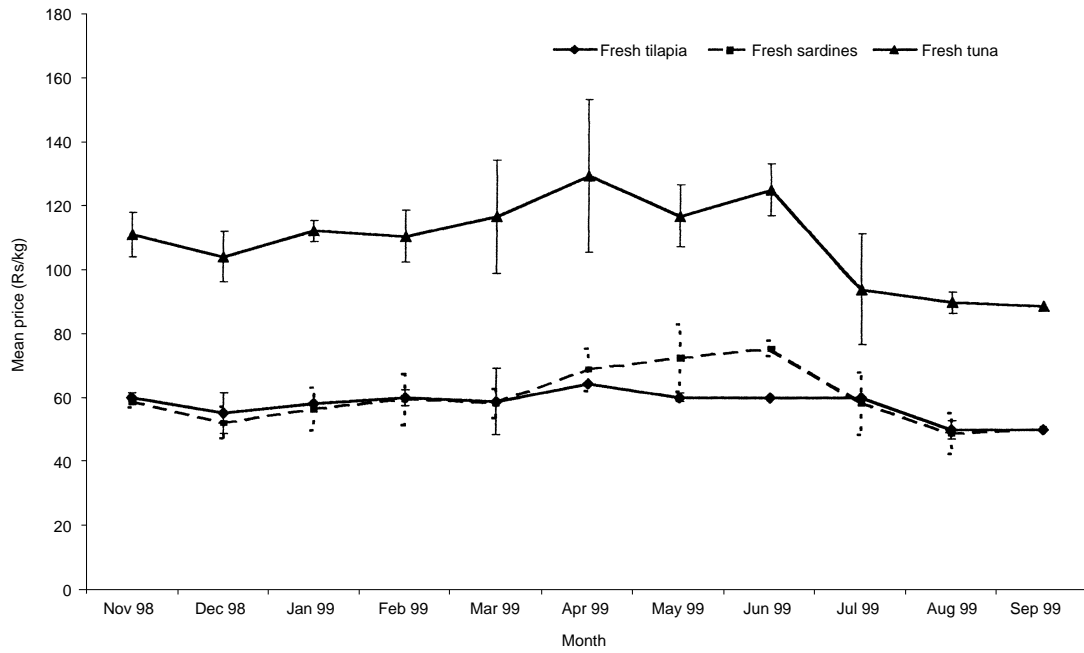

Figure 5. Mean monthly retail prices and standard deviations in weekly prices, for fresh marine and inland fish varieties, Colombo (ARTI 1998–99).

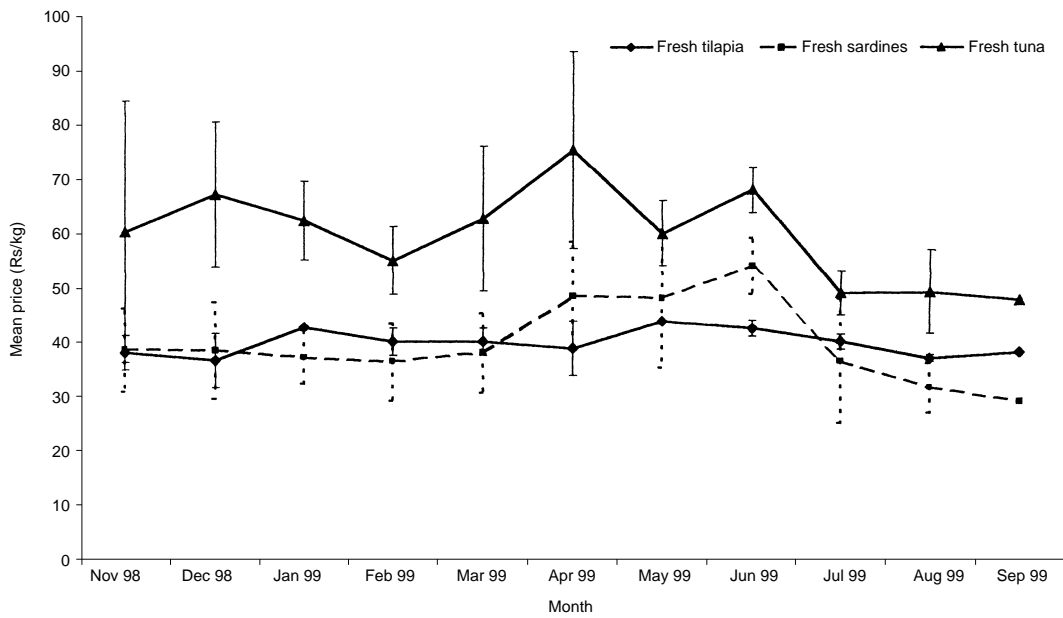

Figure 6. Mean monthly wholesale prices and standard deviations in weekly prices, for fresh marine and inland fish varieties, Colombo Pettah fish market 1998–99 (ARTI 1998–99).

December (when the NE monsoon reduces the secondary East Coast supply) and June, when seasonal winds (known as the Warakan) impede fishing on the west coast. July to November (after the cessation of the Warakan) is the high season for marine fish, during which prices fall to their seasonal low.

Munashinge (1984) reported a decline in the local dried fish industry as the proportion of total fish catch converted to dried fish declined from 29% to 9% during 1959–79. This was attributed to an improved transport and cold-chain infrastructure stimulating greater demand for fresh fish. Today, the availability of low-cost, imported dried marine fish means that this is still the main substitute for local dried varieties, the differential being greatest for the higher-price varieties (see Figure 7). The lower seasonal variation and monthly standard deviations in both wholesale and retail relative to their fresh counterparts (see Figures 7 and 8) are probably due to the good storage characteristics of this product and its consequent ability to withstand fluctuations in supply. No market for dried inland fish, imported or local, was found in the urban areas of Kandy or Colombo.

Other important animal protein substitutes consumed locally are chicken, beef and mutton. Although these products show high price stability, their high prices (Rs 144, 125 and 252, mean retail prices during 1999, respectively) are comparable with only the most high-value marine species, and consumption of commercial produce is low amongst lower income groups.

Figure 9 shows recent trends in the Colombo mean annual retail price of tilapia and meat substitutes with percentage increase calculated between 1992 and 1998. During this period inflation averaged 12.2% per year (Central Bank 1998), the equivalent of a 103% increase in price over the seven years. Price increases in most of these food commodities, including tilapia, have therefore merely kept pace with inflation, maintaining approximate parity with each other. The case of sardines is a notable exception whose price rose and fell, further reflecting the instability of the marine fish market. The seasonal and historical stability of the tilapia market suggests that despite fears of overexploitation of the fishery, the situation has not yet reached a critical state.

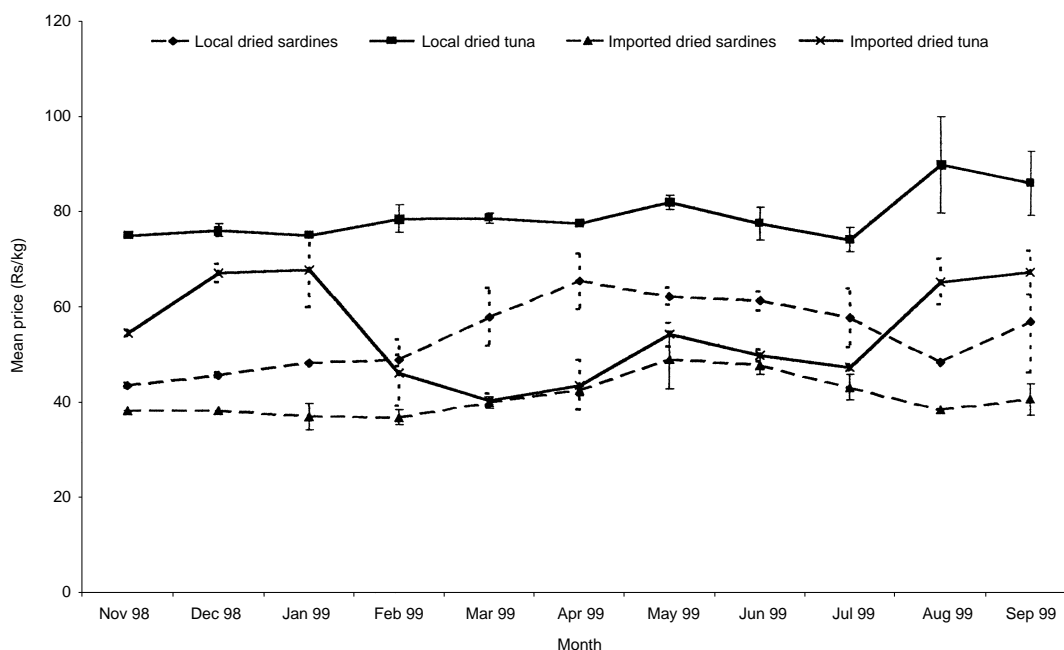

Figure 7. Mean monthly wholesale prices and standard deviations in weekly prices, for local and imported dried marine fish varieties, Colombo Pettah fish market 1998–99 (ARTI 1998–99).

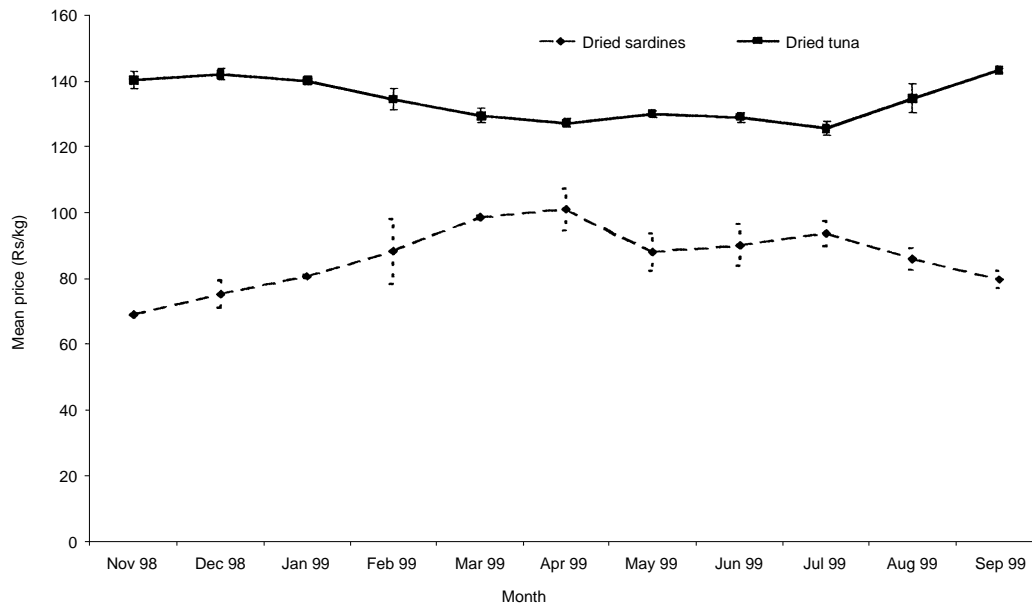

Figure 8. Mean monthly retail price and standard deviation in weekly prices, for dried marine fish varieties, Colombo 1998–99 (ARTI 1999–98).

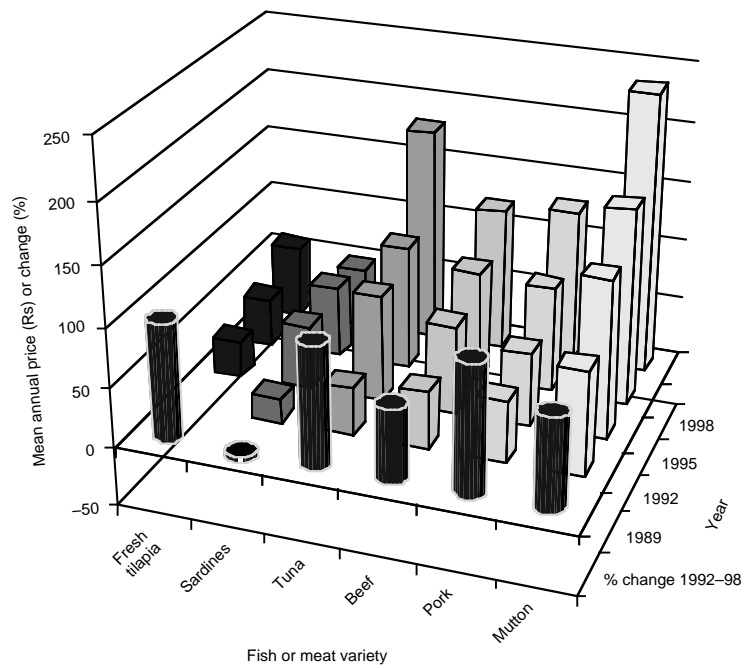

Figure 9. Historic trends in fresh fish and meat substitute retail prices, Colombo 1989–99 (ARTI 1989–98).

Seasonal patterns in rural livelihoods and fresh fish demand and supply

A seasonal calendar showing the major climatic and livelihood factors affecting the availability demand and supply of inland fish within the research area are shown in Figure 10. The calendar includes key aspects of agricultural livelihoods, the agricultural sector being the main consumer group for inland fish.

Peaks in production occur during the two dry seasons (March–April and July–September) associated with a bimodal rainfall distribution of the monsoons. Reductions in water-spread and depth at these times of the year increase the susceptibility of all species to the gill-net fishery. Greatest production and the lowest annual prices occur during lowest

water in the dry season (July–September), though intensive fishing in some reservoirs, particularly those of smaller size, was reported to result in a sharp fall-off in production by the end of this season. Increased water mixing and turbidity during the subsequent ‘maha’ rainy season (November–January) are reported to bring many fish to the surface, resulting in moderate but erratic production at this time. A third brief but highly intensive period of production occurs at the end of the rainy season (December–January), when many fish migrate in spillwaters or move to newly inundated littoral areas to feed and breed. Such fish are easily caught by a variety of gears used by professional fishermen and the many casual entrants to the fishery at this time. By early January, which is the end of the rainy season, tanks are at their maximum water-spread and

Month	Oct.	Nov.	Dec.	Jan.	Feb.	Mar.	Apr.	May	Jun.	Jul.	Aug.	Sep.
Weather cycle	NE Monsoon						SW Monsoon and 'Warakan' Winds					
Rainfall (total annual 950–1350 mm)	■	■	■	■	■	■	■	■	■			■
Perennial tank water availability												
Cultivation season	Maha (main cultivation season)				Dry		Yala (minor cultivation season)				Main Dry season	
Paddy cultivation	Field preparation and sowing		Irrigation		Harvest	Field preparation and sowing		Irrigation	Harvest			
Dryland cultivation	Sowing		Harvest		Fallow period						Field Preparation	
Off-farm labour	++	++	++		+++	+++						+
Income availability	---	--	+	--	+	+++	++	+	+	-	--	---
Inland fish availability												
Comments on availability	NE monsoon: Large fish rise. Highest catch during spill.			Max. water spread: Lowest catch			High water and winds impede netting			Lowest water — highest catch of small varieties		
Inland fish demand	++			+		++++ Harvest and New Year			++		+++ (esp. for small varieties)	
Price of inland fish	+++		+	+++	++	++++	++			+		
Marine fish availability	++++				++				++ (small varieties)			

Figure 10. Seasonal livelihood calendar (farmers) and inland fish market trends, Galgamuwa and Anamaduwa Districts, Sri Lanka, 1998–99. (Source: Interviews with farmers, fish producers and vendors). Note: +++ = greatest amount, --- = lowest amount.

depth, and production briefly falls to a seasonal low and prices rise (January–February). However, high irrigation demands and low rainfall during this period rapidly deplete water levels, allowing a secondary minor peak in production (March–April).

The minor SW monsoon (March to May) brings much lower and highly erratic rainfall. However, reduced irrigation demands during the minor cultivation season results in a slower rate of water depletion relative to the maha season. During the same period seasonal winds blow, impeding fishing. The combination of these factors means that moderate though variable production is maintained during this period (May–July).

Seasonal patterns in species composition

Seasonal variations also exist in the species composition of fish production. Bottom-feeding common carp are most susceptible to the gill-net fishery during the dry season, during which time a small number of fishermen specialise in this fishery using larger net sizes (up to 10"). However, most production is incidental through entanglement in the smaller gears (3½" to 2½") used to target a range of tilapia sizes. Smaller amounts of large common carp are also caught during the rainy season when they move to the surface. Catches of other stocked exotic carps are extremely low. Whether the continued catches of common carp are due to some breeding success (specimens <1kg were occasionally observed) or limited stocking activities requires further clarification.

Many fishermen resort to smaller mesh sizes (well below the legal 3½" stretched mesh size) as the dry season progresses, targeting not only small tilapias but many indigenous species including a variety of minor cyprinids. Nets as small as ¾" are used to harvest the so-called 'tank sardine' *A. melettinus* at this time. A secondary peak in the catch of many migrating indigenous species takes place during tank spill events during November to January.

High-value snakehead (*Channa striatus*) is also relatively immune to the gill-net fishery until the dry season when it becomes accessible to a variety of gears. These predatory air breathers are highly adapted to conditions in small seasonal tanks, where they are typically second in volume only to tilapia production within subsistence fisheries, representing a possible niche production area within this fishery.

Despite the marked seasonal variation in inland production described above, complementary variation in other agricultural livelihood factors serves to ensure that supply and demand are well matched and prices remain relatively constant throughout the year. Greatest demand for fresh fish occurs during the main (maha) harvesting period (February–April)

corresponding with the minor dry season peak in production. Farming incomes are highest and seasonal agricultural labourers are traditionally fed fish by their employees during this period. Only during the Sinhala New Year celebrations do prices increase briefly to their annual high as demand surges for 1–2 weeks. Greatest availability and lowest prices occur during the dry season when poorer farmers face the greatest difficulty achieving basic food security. Small tilapias are so plentiful and prices so low at this point that many poorer farmers reported that they substitute them for vegetables, which increase in price during the dry season. This observation underlines the truly low cost of inland fish and their importance to lower wealth groups. Marine fish availability is greatest and prices lowest during main rainy season (October to January) when the 'Warakan' ceases to blow, complementing the modest availability of inland fish at this time.

The marketing network

Figure 11 shows the principal marketing channels for inland fish within the research area. Most commercial production is undertaken by a large number of small-scale professional fishermen who land their catch at dispersed points around larger perennial reservoirs. Most professional fishing is carried out at night, with stocks being maintained alive in small wire keep-cages or partially flooded canoes. Vendors collect these fish at first light to take advantage of the cooler earlier hours to transport their stock as fresh as possible to the consumer. Most selling is completed by midday. During periods of increased production smaller secondary catches are distributed later in the day. Although professional fishermen were rarely found to retail their catch direct to the consumer, casual fishermen using hooks and cast-nets often sell smaller catches (particularly lower-volume, high-value species such as snakehead and eels along the roadside close to the source of production. Fish are sold almost exclusively by weight during the early part of the day. From mid-afternoon as retail opportunities decrease, surplus fish are likely to be sold at discounted rates. Secondary catches including those of casual fishermen made later in the day are generally sold as 'strings' of fish sorted by size and sold by approximate weight at favourable rates to the consumer, to ensure speedy sales.

Rural population levels within the research areas are high though widely dispersed within villages and small rural service centres. Densities in Puttalam and Kurunegala Districts averaged some 328 and 227 persons/km² respectively in 1997, having almost doubled over the last two decades (Central Bank

1998). Consequently out-with the dry season, fish supply is well matched by demand from the local population, even in the case of Rajangana and Inginimitiya, two of the largest fisheries investigated. To meet this demand which is predominantly for whole fresh fish, most retail distribution is undertaken on a low-volume, door-to-door basis, by a large number of small-scale 2-wheeler vendors selling around their home areas. These vendors are able to reach even the remotest villages investigated, some accessible only by path or track. The great majority of vendors use bicycles, distributing 5–50 kg of fish per day (typically 10–20 kg) while a smaller number of motorbikes retail or wholesale as much as 150 kg per day (typically 30–50 kg), volumes depending on the season.

Within the retail sector, primary and secondary networks of 2-wheeler vendors exist. Vendors within the primary networks purchase fish directly from landing sites distributing their stock to consumers close to source, while secondary networks are supplied by a large number of mostly small-scale wholesalers. The secondary retail sector operates at a wider market space beginning from as little as 3–4 km from the landing site and extending up to 87 km in the case of the Rajangana fishery. The boundary between the two market spaces is largely a function of bicycle journey time from production sources rather than distance per socioeconomic and is demarcated by a differential in retail prices. The boundary, along with the location of minor wholesale points, moves further from production sites, becoming less well-defined during periods of peak production. Bicycle vendors were found to travel to sites as far as 36 km distant from their source of supply when fish availability, the number of entrants and individual volumes are greatest during the dry season, resulting in increased competition to find market share.

Shorter distances, typically 4–20 km from source, are covered during the low season. Strategic selling points at busy road junctions are used as wholesale staging points for supply of fish to the secondary networks. These are also important retail points in their own right, particularly those located within or close to rural towns. The most strategic junctions are highly coveted and cartels of small traders often control the movement of fish through these nodes. These wholesaler/retailers either collect fish directly from landing points themselves or are supplied by other vendors. Wholesale supply is both by motorcycle and bicycle to junction sites up to 4–5 km from the landing sites visited and increasingly motorbikes alone thereafter. In the unlikely instance that junction vendors have not sold all their stock by midday, they will soon after sell it in situ at a discount rate or more rarely transport it into villages

themselves. Considerable flexibility therefore exists for actors to adjust their marketing strategies by movement between the various wholesale and retail functions as seasonal demand and supply dictates.

The low-volume local marketing patterns described and the excellent transport qualities of tilapias, which constitute the bulk of production distributed by 2-wheeler vendors in villages, mean that other than for larger seasonal truck and van wholesalers, there is no requirement for icing during transport. The high durability of tilapia meant they were commonly observed arriving alive at the point of sale even within secondary 2-wheeler networks. This means operational costs are kept down to just the cost of stock and bicycle maintenance for the smallest traders. Low capital requirements and the dispersed nature of the market and hence competition facilitate casual entry into and out of the sector. Many marginal farmers, sharecroppers and landless labourers take advantage of these factors to diversify their livelihood strategies by retailing fish for several months during the dry season, returning to agriculture shortly thereafter to commence cultivation with the onset of the rains.

Only during the dry season (July–September) when sufficient production surpluses exist and seasonal prices are lowest do larger wholesalers with vans and trucks enter the network on a regular basis. The availability of these surpluses also coincides with the marine low season (see Figure 10) creating greater demand for inland fish in larger rural towns and interestingly, also in coastal areas. Only the largest reservoirs studied, Rajangana, Inginimitiya and Kalawewas, where sufficient stock can rapidly be assembled to fill a truck or van, are visited consistently in this manner (on average 3–4 times per week). From Rajangana lorries take upwards of 1000 kg of fish per visit for distribution to rural towns up to 87 km including Puttalam and Chillaw, important marine landing centres in their own right. Smaller amounts of fish are also taken to secondary distribution points and roadside stalls on route to these markets. Very little of this production finds its way to the largest regional urban markets around Kandy and Colombo due to low demand and the inability of low-value inland species to bear long-distance refrigerated transport costs. The inland produce which does find its way to these markets is likely to originate from a few large reservoirs on the arterial routes between these cities and principal marine fish landing sites, including Kantale Reservoir close to Trincomalee on the east coast and Minneriya Reservoir, midway between Kandy and Trincomalee (see Figure 1). Surprisingly, little inland production finds its way into the hotels and restaurants within the rural areas investigated, such

establishments being frequented most regularly by hauliers and travellers in transit between towns, who generally prefer marine varieties.

Although high demand for dried fish (inland and marine) was identified, little is produced within the study area due to the greater profits to be made from selling fresh fish. Main outlets for dried fish are village and town boutiques (general stores) and the weekly agricultural fair or 'polas' held in most small rural towns. Specialised traders who wholesale fish to boutiques and move between polas where they both retail and wholesale stock are responsible for the bulk of supply. They bring mostly imported marine varieties from Colombo and lesser amounts of local produce from coastal locations on their transit routes. In addition to these retailer/wholesalers who dominate the central covered market areas, a large number of small-scale ground traders retailing locally produced dried fish operate in the periphery. These traders specialise in small low-cost varieties, mostly marine, usually self-produced or purchased at source. Entry into this section of the market is highly seasonal with the number of vendors (including many female participants) selling inland fish (mostly small to medium-sized tilapias) and marine varieties rising during the dry season and main rainy season respectively.

Estimates of the number of participants in the largest reservoirs varied widely (400–800 full-time fishermen in the case of Rajangana). For the smaller Usgala Siyambalangamuwa (788 ha — see Figure 1) Reservoir it was possible to determine the number of participants more accurately by visiting all the landing sites. In this case there were 39 canoes operated by 63 professional fishermen, approximately 130 participants mostly fishing smaller gill-nets in shallow littoral areas, in addition to an undetermined number of casual seasonal participants (i.e. 1 canoe per 20 ha and approximately one full-time fisherman per 3.7 ha). For much of the year the ratio of vendors to fishermen in the primary network is 1:1 or in favour of the fishermen creating competition among the vendors for reliable suppliers. During peak production in the dry season, many seasonal vendors enter the network around Rajangana, increasing the ratio to 2–3:1. The number of participants in the secondary retail networks also rises at this time.

Market intervention and relational aspects in marketing networks

The network outlined above can be contrasted with that for marine fish where the limiting consignment size is usually a lorry or van (required to take fish to distant markets in urban areas). In the inland networks investigated, it is typically a bicycle or

motorbike. The stages at each end of both networks are characterised by high inputs of labour and low inputs of capital, but only the central 'bulking' phase of the marine network offers the opportunity for major scale economies and consequently domination by middlemen who exploit them. Such middlemen or 'malu mudalali' often act as trader/financiers, guaranteeing themselves assured supplies and favourable future prices through the monopolistic supply of short-term production and personal capital. Although such relationships range from the exploitative to symbiotic depending on the local marketing context, experience in many developing countries (where capital is generally scarce) has shown that it is almost impossible to replace the range of services provided, at the same price, by institutional means (Lawson 1988).

Within the inland sector under investigation, producers operate in a seller's market for much of the year and competition exists among professional 2-wheeler vendors to find producers who will offer guaranteed supplies and extend regular short-term credit in the form of advances of fish stock. This involves a reciprocal commitment on the part of the 2-wheeler vendors to conform to the seasonal production strategies of their client fishermen. Many vendors cement their relationship further by offering seasonal credit to fishermen, who have greater recurrent operating costs, for replacement of fishing gears. The exact nature and duration of such relationships showed considerable variation, the longest recorded having lasted eight years, but more typically only 1–2 seasons, often dissolving during the dry season when surpluses temporarily create a buyer's market favouring the vendor. The high number of mostly youthful seasonal entrants to small-scale trading networks relative to the more static production base serves to enhance such flux. Only in Kalawewas (2858 ha), the largest single reservoir investigated, were significant numbers of fishermen aligned to larger traders. In such instances producers accepted a small drop in price but benefited through the year-round availability of credit, a generally more secure trading relationship, including avoidance of the risk of credit extension by themselves. The availability of credit during the low season (when small-scale vendors are least able to provide a supply) is particularly important in instances where fishermen have no secondary agricultural income. In the presence of abundant competition from the small-scale vending sector, such relationships were generally equitable with only a Rs 2–3/kg (10–12%) difference in the prices received by producers from 2-wheeler vendors and financier traders. By contrast much more exploitative tied marketing relationships exist between 'malu

mudalali' and producers as typical of the marine sector (Alexander 1995; Munasinghe 1984), fostered by the capital requirements for product bulking, greater producer overheads, the more seasonal nature of the fishery and lack of livelihood diversification by most participants in the fishery.

In a study of two reservoir fisheries in Hambantota District, southern region, Chandrasoma (1986) describes a market situation within the inland sector which contrasts markedly with that in our study areas to the northwest. There he observed tied monopsonic marketing relationships and poor terms of trade that were more comparable with the marine sector due to the greater number of wholesale traders and assemblers dominating the market. The difference may be attributable to the less favourable marketing conditions vis a vis the greater availability, lower cost and demand for marine fish in the locations studied (which were close to the coast) and the lower inland rural population densities in the southeast, and consequently a greater requirement to transport fish to more distant inland markets.

Credit relationships also exist between vendors and consumers, particularly where longer-term professional vendors are concerned. Such credit is short term, commonly lasting for less than one week, though up to a month in the case of salaried government officials who represent a low credit risk.

Participation of different socioeconomic groups

Early exploitation of the tilapia fishery from its inception in the 1950s was mostly by low-caste coastal fishermen. Mostly Christians, of Sinhalese and Tamil ethnicity, these fishermen seized the opportunity to augment their catches through seasonal migrations to inland water bodies during the marine low seasons until increasing cultural and ethnic tensions with Christian settlers saw a virtual termination to migration by the mid-1970s. However, many Christian fishermen remained as permanently encroached settlers around larger perennial tanks. Three such Christian villages around Rajangana tank represent some of the poorest communities in the area, having had no opportunity to legalise their land after 20 years of occupation, and consequently little opportunity to diversify their livelihoods.

As in many Asian cultures, fishing and its related activities are perceived as low-caste activities and in Buddhist Sri Lanka it is often described as 'pity work' by members of the upper (majority) farmer caste. However, as 'second generation problems' associated with irrigation developments have progressively reduced access to productive agricultural land, increasing numbers of younger participants from the farming caste have become involved in all

levels of the marketing network to supplement their agricultural income.

Although women have a variety of well-developed production roles with the agricultural sector, the entire marketing chain for inland fish as portrayed in Figure 11 is dominated by male actors. Only the preparation and retailing of small dried 'trash' species currently offer significant potential for women's independent participation within the inland areas under study. Here social taboos still present a formidable barrier, most of the participants interviewed being single or widowed women, from landless families, or travelling from coastal areas where women from lower-caste backgrounds have greater freedom to participate in a wider range of fisheries-related activities.

Marketing margins for network actors

Table 1 shows the price ranges and marketing margins earned by intermediaries at the various levels of the market network, for the main commercial inland species, forms and sizes within Galgamuwa and Anamaduwa Divisional Secretariats (see Figure 1). Seasonal ranges in price are identified for each species/form at different levels of the network.

Tilapia, the principal commercial species, is priced within small (<75 g) medium (75–175 g) and large (>175 g) size categories, the largest fish costing 50% more per unit weight than the smallest at the retail level. This has important consequences for patterns of consumption within different socioeconomic strata as discussed below. *Etioplos suratensis* (green chromid, like tilapia, a cichlid) is a brackishwater species, and has become successfully established in the freshwater fishery at a low though steady production level. Sharing similar consumption characteristics and growing to a modest size (mostly <200 g), its market performance is almost identical to the small and medium tilapia size classes, with which mixed sales are often made. The highest-value species are the predatory air-breathers, *Channa striatus* (snakehead) and several eel species (see footnotes Table 1). The latter commands a niche market amongst Muslim consumers, while the former is almost universally acclaimed as the choicest inland variety due to its superior taste, lack of bones, good handling qualities and the attribution of various medicinal properties. A variety of other mostly small indigenous species (SISs — see footnotes Table 1) make low-volume seasonal entries into the fisheries at the low end of the price range. Common carp almost exclusively available in larger sizes (>2 kg) with low and erratic availability achieves an almost identical market performance to the large tilapia category.

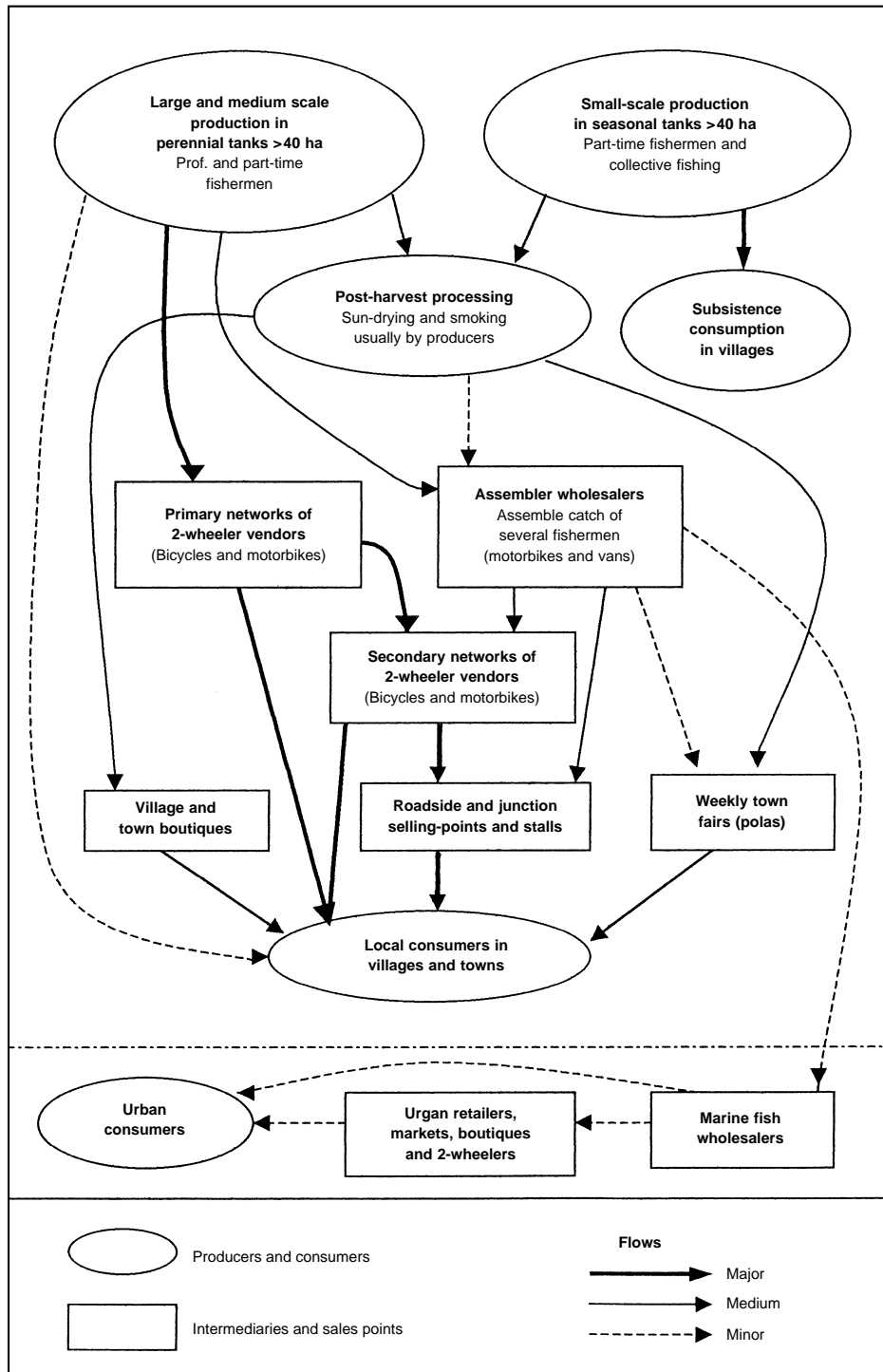

Figure 11. Principle marketing chains for inland fish in Northwest Province, Sri Lanka.

Table 1. Seasonal and geographic price ranges and profit margins for the principal inland fish varieties, sizes and forms at different levels of the market network 1998–99 (source: interviews with producers, vendors and consumers in Galgamuwa and Andamaduwa Districts, North West Province).

Species ¹	Fresh						Dried						Smoked
	Size range (g)	Landing price (RS) ²	Wholesale and primary retail price (Rs) ³	Wholesale and primary retail margin (%) ⁴	Retail price (Rs) ⁵	Retail margin (%) ⁶	Producer price (Rs) ⁷	Producer margin (%) ⁸	Wholesale price (Rs) ⁹	Wholesale margin (%) ¹⁰	Retail price (Rs) ¹¹	Retail margin (%) ¹²	Retail price (Rs) ¹³
1. Large tilapia	>180	30–40	40–50	25–33	60–80	50–60	55–60	-11 to -33	70–80	27–33	100–120	43–50	100–125
Med. tilapia	80–180	30–35	35–45	17–29	45–60	29–33	50–55	-14 to -33	60–80	20–45	90–120	50	100–125
Small tilapia	<80	20–30	25–35	17–25	30–40	14–20	35–45	-33 to -55	40–50	11–14	50–60	20–25	*
2. Green chromide	All (<200g)	20–30	25–35	17–25	40	14–20	35–45	-35 to -55	40–50	11–14	50–60	20–25	NA
3. Common carp	450 g->10 kg	35–40	45–50	25–27	60–80	33–60	NA	NA	NA	NA	NA	NA	NA
4. Snakehead	All sizes	50–60	60–70	17–20	70–100	17–43	60–70	-0.9	80–90	27–33	100–120	25–33	150–245
5. Eels (spp.)	All sizes	40–50	50–60	20–25	70–80	40–33	125–130	*	150	*	*	*	*
6. 'Tank sardine'	15–30 g	10–15	25–30	100–150	40	60–33	25–30	*	35–45	40–50	40–50	11–14	NA
7. Other SIS	50–250 g	15–30	30–40	100	40–50	33–25	25–35	*	40–50	43–60	50–60	20–25	NA
8. Marine sardines	30–60 g	8–20	18–40	100–125	30–60	50–67	*	*	*	*	*	*	NA

Notes: NA = Not applicable, * = No data available.

¹ 1. *O. mossambicus*, *O. niloticus* and hybrids. 2. *Etrophus suratensis*. 3. *Cyprinus cyprinus*. 4. *Channa striatus*. 5. *Anguilla bicolor*, *A. nebulosa*. 6. *Amblypharyngodon melettinus*. 7. SIS = small indigenous species including *Mytus keletius*, *M. gullo*, *M. vittatus*, *Heteropneustes fossilis*, *Puntius filamentosis*, *P. chola*, *P. sarana*, *Glossogobius giuris*, *Chana punctata*, *Anabas testudineus*, *Mastacembalus aratus*. 8. *Sardinella melanura*.

² Price paid by primary intermediaries (2-wheeler and van vendors) to professional fishermen at perennial reservoirs landing sites.

³ Wholesale price paid by secondary intermediaries (2-wheeler vendors and junction sellers) and price paid by consumers, at sites >3–4 km and <3–4 km from the site of production respectively.

⁴ Wholesale margin earned by primary intermediaries.

⁵ Retail price paid by the consumer to secondary intermediaries (2-wheeler vendors and junction sellers) in villages and rural towns not immediately adjacent to perennial reservoirs.

⁶ Retail margin earned by primary and secondary intermediaries.

⁷ Price received by fishermen for dried fish, by specialist traders at perennial reservoirs (occasionally the smallest SIS fish are purchased fresh and dried by traders).

⁸ Margin earned by fishermen producers of dried fish relative to the equivalent value of fresh fish, based on the processing losses calculated in Table 2.

⁹ Wholesale price paid by boutique retailers (general goods stores) to specialist traders (and casually by fresh fish 2-wheeler vendors) and price paid by consumers at polas (weekly fairs in rural towns) to small-scale specialist traders including women.

¹⁰ Margin earned by specialist traders.

¹¹ Price paid by the consumer to boutique retailers in villages and rural towns.

¹² Margin earned by boutique retailers.

¹³ Price charged to the consumer by boutique retailers for smoked fish. Such volumes are very low and highly seasonal.

Unsurprisingly, within the fresh fish market, margins for the more valuable species and larger sizes (snakehead, eels, common carp, large tilapia) are greatest at the upper end of the network (60–100%) reflecting the higher capital requirement and risk involved in trading at this level. However, without exception, the greatest margins accrue to the primary intermediaries for the lower-value varieties and sizes. This corresponds with a general stratification observed in the market whereby small low-value species are more likely to be sold to poorer consumers in remoter villages by the small-scale bicycle vendors, whereas more valuable varieties are bulked for distribution by motorcycle vendors in and around rural towns. Interestingly, at the primary retail level the greatest margins of all accrue to the smallest lowest value species, locally known as ‘tank sardines’ (*A. melettinus*). As its name suggests this variety shares many of the characteristics of marine sardines, including pricing and handling properties (shown for comparison in Table 1). However, this species carries a high risk of spoilage when being retailed un-iced in the fresh form. Similarly larger carps must typically be divided among several consumers, increasing the risk of spoilage between transactions. Although small and medium fresh tilapias achieve much lower margins (17–29%) their far greater durability means they can be transported further and sold later into the day, and are consequently the preferred stock of most bicycle vendors.

Producer margins are not presented, as overheads as a fixed proportion of production remain to be accurately calculated. Chandrasiri (1986) estimated fixed operating costs in Hambantota District, Southern Province to be 28% of the consumer price, of which producers receive approximately 50%. This is the lowest profit margin in the market network, which as indicated earlier is dominated by assemblers and wholesalers. In the current study producers receive 25–66% of the final consumer price. Interestingly the highest returns accrue to the small and medium tilapias, which constitute the bulk of production. The lowest returns accruing to ‘tank sardines’ are likely to be a consequence of the greater risk of spoilage losses taken by traders.

Margins for dried fish at different levels of the market network display a similar though less marked differential relative to fresh fish, again probably due to the lower relative risk of spoilage losses.

Product diversification, value addition and processing losses

Processing losses were investigated in order to assess their contribution to the pricing structure of fresh fish and potential for value addition by conversion to

dried and smoked fish forms (see Table 2). Most vendors will process fish free of charge only after a transaction such that all the losses are passed on to the consumer. The large size of exotic carps remaining in the fishery means most consumers will only purchase a proportion of the whole fish and in such instances a small surcharge again passes the processing losses on to the consumer. Losses ranged from 25.9% to 23.3% for the different species investigated (Tilapia spp., green chromide and snakehead), with large tilapia and snakehead showing the highest and lowest losses respectively. However, statistical analyses (1-way ANOVA) showed no significant difference (95% significance level) in losses between the different tilapia size classes ($P = 0.82$), combined species ($P = 0.37$) or between tilapias and snakehead ($P = 0.18$), discounting this as a factor in determining the relative pricing structure between these species or size categories. The losses for common carp remain to be assessed; however, vendors charge only a 14–17% surcharge for processed fish, indicating such losses are likely to be relatively low.

By contrast to most fresh fish transactions, processing losses incurred during the production of dried and smoked fish must be borne by the producer and passed on to the consumer in the product price. Losses associated with sun drying/curing ranged from 32.9% to 38.9% (see Table 2). However, no significant difference was found between the different tilapia sizes ($P = 0.352$) or between tilapia and snakehead ($P = 0.95$), again discounting this as a factor determining the relative pricing structure.

The opportunity cost of drying as opposed to marketing fresh fish impacts on the availability of dried inland fish coming from the perennial reservoir fishery. Pricing at different levels in the network is limited by the high availability and consumer preference for low-cost imported marine varieties. Table 2 shows that although good profits occur higher in the market network, for the extra effort involved in processing dried fish the producers lose between 9% (snakehead) and 55% (small tilapia and *Etroplus suratensis*) of the fresh form value.

For this reason, dried fish production is largely restricted to periods of seasonal glut and is concentrated on smaller highly perishable species, mostly indigenous small cyprinids (including the abundant ‘tank sardine’). Secondary production also takes place where there is restricted physical access to local fresh fish markets. Within the research area such restriction is limited to the rainy season which hinders access to remoter villages and reservoir landing sites. As drying becomes problematical at this time, smaller surpluses are typically smoked and largely used for home consumption. To the north of

Table 2. Processing losses incurred during fresh and dried processing of important commercial inland fish varieties 1998–99 (source: producers, 2-wheeler vendors, boutique owners and weekly market vendors, Galgamuwa and Anamaduwa Districts, North West Province).

Species ¹ and size	Fresh			Sun-dried/cured		
	Fresh weight range (g)	Mean processing loss (%) ²	STD mean processing loss (%)	Fresh weight range (g)	Mean processing loss (%) ³	STD mean processing loss (%)
Tilapia						
small	56–73	24.8	1.8	37–115	38.9 ⁴	5.3
medium	116–163	25.5	1.9	135–170	32.9	4.7
large	178–885	25.9	3.5	195–550	37	8.9
ANOVA P ⁵		0.82			0.352	
G. chromide	94–166	24.5	2	*	*	*
C. carp	*	*	*	NA	NA	NA
Snakehead	323–908	23.3	1.9	400–622	37	1.1
ANOVA P ⁶		0.367			*	
ANOVA P ⁷		0.18			0.95	

Notes: NA = Not applicable, * = Data not collected.

— Ten fish were sampled within each size-processing category.

— Fresh weights for dry processing loss calculations were extrapolated from a length/weight regression.

— No information was available for calculation of smoked fish processing losses.

¹ Tilapia = *O. mossambicus*, *T. niloticus* and hybrids. G. chromide = *Etroplus suratensis*. C. carp = *Cyprinus cyprinus*.

² Fresh processing by vendors after purchase includes: de-scaling, removal of lower head, gills, viscera and all fin cartilage.

³ Dry processing includes: de-scaling, removal of lower head, gills and viscera, salting and sun drying.

⁴ Dried fish in the small size range often have their skins removed producing a product known as *bata*.

⁵ Results of 1-way analysis of variance comparing differences in processing losses between different tilapia size classes.

⁶ 1-way ANOVA comparing mean processing losses between all species.

⁷ 1-way ANOVA comparing mean processing losses between snakehead and tilapia.

the research area, due to the continuing ethnic conflict, population levels are lower, transport infrastructure neglected and the movement of goods severely restricted. A greater proportion of production from perennial fisheries in these areas is therefore exported in the dried form. This is reflected in availability of larger dried varieties at weekly markets and boutiques in the research areas, most of which emanated from this source. Finally fish drying is resorted to as a salvage mechanism by vendors with surpluses left at the end of the day. As the volumes sold by 2-wheeler vendors are small and finely tuned to demand, this is most likely to be practised by larger static wholesalers and fish stallholders in larger towns who reserve refrigeration capacity for more valuable marine varieties.

Few other prospects for product diversification and value addition exist within the marketing network currently. The Ceylon Fisheries Corporation has a small tilapia filleting and freezing plant near Minneriya which it uses to process up to 3000 kg of larger sized fish (>250 g) for the local hotel trade and supermarkets in Colombo. Although the enterprise shows some potential for development of a market

for inland fish in urban areas, benefits of such diversification would bypass most of the existing small-scale market network above producer level. As already indicated some smoking of fish already takes place on a local basis, but in a very limited capacity.

The high retail value of smoked species, particularly snakehead, indicated in Table 2, combined with good demand identified both in rural and urban areas suggests there may be an unexploited niche market for such products. Much of the existing production and consumption take place at the household level, particularly with respect to production from seasonal tanks. However, processing losses, time and costs are greater than for dried fish production, and further investigation of potential profitability is required in these respects.

Consumer preferences and the seasonal tank fishery

An important finding in the study was a widely held perception among traders and consumers that seasonal tank tilapias are of inferior quality to perennial tank fish due to their typically smaller size, darker slimy appearance and muddy/soapy taste.

This could also be an additional factor excluding them from commercial networks. The problem becomes more severe with decreasing tank size and seasonality, probably as the relative effects of bathing residues and turbidity increase. In severe instances even sun-drying and removal of the skin cannot remove these off-flavours. In an attempt to try and overcome this problem farmers around several seasonal tanks have stocked *O. niloticus*, *O. mossambicus* hybrids obtained from local perennial tanks. The species is reported to grow faster than the purer strains of *O. mossambicus*, which are still more likely to be found in semi-seasonal tanks, allowing harvest before water-spread and water quality reach critical levels.

Snakehead (*C. striatus*), one of the most valuable inland species, is the second most important species by volume after tilapia produced from the seasonal tank fishery. The species does not encounter the perception problems described above, but the increased incidence of an uncharacterised ulcerative disease with an epizootic ulcerative syndrome (EUS) type pathology has created an alternative perception problem. Many vendors expressed a reluctance to retail snakehead from such tanks during the dry season when both production and the disease problem are greatest.

Seed marketing networks and the ornamental market

In the 1980s Singapore, the primary regional producer of ornamental freshwater fish, faced major disease problems, allowing Sri Lanka to enter previously closed export markets. The sector has continued to expand since (Mee 1993). For the development of an aquaculture sector involving exotic carps seed production marketing networks are a prerequisite for sustainability in the absence of major State investment. In Sri Lanka much of the former State production capacity remains long-leased to the private sector even after resumption of State patronage to the inland sector. These producers have eschewed food fish production in favour of the considerably more profitable ornamental export market.

Summary and Discussion

The preceding analysis underlines the key importance of the concept of market space in shaping market networks, more specifically, the relative density and distribution patterns of production resources retail points. In this respect, the dominance of small-scale actors in the research area can be attributed to two factors. Firstly the relatively dense,

though widely dispersed and inaccessible, village-based rural population) the consumer base for local fresh inland fish) and the large number of scattered landing points on larger reservoirs; secondly, and particularly in the case of Rajangana, the strategic location of other large commercial reservoir fisheries between larger markets in more populous areas around provincial capitals, or between arterial routes to these and other markets. The small-scale network is further enhanced by the excellent transport characteristics of tilapias increasing the market area that can be covered by bicycle vendors, with no requirement for cool storage.

The small-scale network offers opportunities to substantial numbers of the poorest sections of local communities to diversify and enhance their livelihood strategies through seasonal entry to the networks, particularly by disenfranchised male youth and small-scale landless farmers into low-overhead bicycle vendor networks. Seasonal opportunities for women are more restricted, though opportunities exist in the small-scale preparation and retailing of dried fish.

Analysis of margins associated with different species, sizes and forms produced from the fishery revealed an equitable spread of returns at different levels of the marketing network. Larger species which carry greater margins but higher capital risks are more likely to be sold to wealthier consumers in more accessible small rural towns and larger villages. Smaller tilapias (<180 g) which constitute the bulk of total landings are preferentially distributed by bicycle vendors in remoter villages, where a high demand for these lower-cost forms exists amongst poorer communities. Analysis of margins in dried fish networks revealed producers sustaining losses with respect to the opportunity cost of selling fresh fish in the context of high availability of cheap marine imports. Thus drying represents a salvage (rather than a value addition) where unfavourable marketing conditions exist for selling fresh fish.

What then is the potential for reforming or enhancing the existing market system to bring greater benefits to poorer sections of rural communities? The alternative aims and strategies for marketing reform available to the governments of less developed countries fall into two groups, those that give preferential assistance to the disadvantaged section of the population and assist with policies to promote full employment, and those that promote modernisation and increased efficiency. These are often equated with 'redistribution before growth' and 'growth at any cost' policies. The principal aims of these often-incompatible reform strategies with respect to markets for perishable food commodities are shown in Box 1. Over the last few decades with

its transition from a centrally planned to a free market economy Sri Lanka has seen an accelerated shift toward policies falling into the latter category and is now beginning to feel the full effects of global trade liberalisation on its agribusiness markets. These markets stand in sharp contrast to the market described above with respect to potential for the poor to benefit. Under the centrally planned economy, markets for agricultural produce were characterised by high levels of input subsidies and guaranteed markets designed to encourage national self-reliance in production. Although liberalisation has been accompanied by increased production it has failed to provide access to newly emerging markets for the majority of poorer farmers with small production surpluses. In many instances such farmers are instead resorting to subsistence production strategies with increased reliance on off-farm labour, while the means of production become concentrated in an ever-fewer number of hands (Kodithuwakku 1997).

The open and highly equitable nature of the inland fish market described above, which delivers a fresh high-quality product with little wastage, has brought benefits to a large number of small-scale producers, vendors and consumers alike in the absence of any significant government intervention or other institutional involvement. Few of the options outlined in Box 1 therefore have much relevance to the local situation, many having been attempted over the years, with little success but at great cost. This work has also demonstrated little potential for smaller traders to benefit from product diversification, the most feasible option, drying, losing rather than adding value.

Current government policy objectives as stated in the most recent National Fisheries Plan 1995–2000 (MOFARD 1995) require clarification and prioritisation. With respect to inland fisheries, they are to increase sustainable production, generate employment, uplift socioeconomic conditions among fishing communities, improve nutrition and increase foreign exchange earnings. To these ends, the government has progressively moved away from direct fiscal support and provision of inputs, concentrating instead on promoting private-sector development and facilitating community-based initiatives in collaboration with NGOs.

Findings from this research indicate that policy should be primarily people-focused and on local socioeconomic conditions, rather than production-focused and on the national economy. Priority should therefore be given to enhancing or simply sustaining the existing marketing network while avoiding the negative impacts of liberalisation as experienced in the agricultural sector. This should incorporate greater consultation with primary stakeholders

involved in the sector, including the small-scale trading components of the network, the dispersed nature of which has made them particularly inaccessible and hitherto overlooked. Production priority should be on promoting sustainable fishing practices and developing the ability of fisheries societies in self-regulation of reservoir fisheries. The preferential demand by low-income groups for smaller low-value tilapias must also be considered in this respect.

Perhaps because of the complexities involved in promoting self-regulation, particularly around larger institutionally managed reservoirs, the focus of most development organisations continues to be on production enhancement through stocking initiatives in smaller perennial reservoirs. In the absence of a sustainable private-sector or State fingerling production capacity, attempts have recently shifted to community-based fingerling production based on exotic carps and *O. niloticus*. In the past the availability of cheap, plentiful, highly popular and almost year-round production from the tilapia capture fishery has all too often been an overlooked contributory factor to the failure of attempts to establish inland culture fisheries based on carps. In this context, all but the most extensive options incurring limited overheads are likely to struggle to remain economically viable.

This is particularly the case if the high opportunity cost for seed production of food fish species is considered in the context of the highly lucrative export market that exists for ornamental fish in Sri Lanka. Furthermore, large exotic carps also have poorer transport characteristics, and it is doubtful that they would sustain their market price relative to tilapia in the event of increased production.

Our work has also shown potential for production from smaller semi-seasonal and seasonal tanks to enter commercial networks is severely restricted by consumer perceptions regarding off-flavours and disease, in addition to an unfavourable production cycle with respect to seasonal pricing. Yet most farmers in rain-fed areas have access only to such water resources. It is therefore recommended that greater research and development focus should be placed on enhancing subsistence options with greater reliance on local resources. Such options would have greatest relevance to poorer inland communities in the remoter areas including upper watershed areas and conflict areas to the north and east. Conflict-affected communities are often deprived of alternative off-farm labour opportunities, and preliminary work suggests many farmers in these areas already rely on a variety of self-caught small indigenous species for a large proportion of their daily protein intake. Research in the current research area has also shown that participation in the seasonal tank fishery

increasingly provides subsistence options to disenfranchised and landless youth, often from a wide surrounding area with little formal access to water resources. Innovative approaches are required to reach such target groups. Because of the importance of hydrological linkages between seasonal tanks in natural fisheries recruitment and the resource access by wider user groups, the watershed the natural space integrating such socioeconomic and hydrological functions, is the optimum scale to conduct future research.

Box 1. General aims of market reform strategies (after Bromley 1971). Note several of the options may be incompatible with one or more of the other aims.

1. To increase the prices received by producers for their products (value-addition).
2. To reduce the prices consumers pay for the goods they buy.
3. To increase the efficiency of the marketing process through improved transport, handling and reduction in breaks of bulk.
4. To reduce wastage through the application of appropriate preservation techniques.
5. Stabilisation of prices through subsidy or long-term stockpiling.
6. Standardisation and control of weights and measures and commercial practices to reduce corruption and the formation of monopolies.
7. To prevent trading in low quality or unhealthy goods.
8. To increase the efficiency of taxation on commercial activities.
9. Reorganisation of the locations or types or trading institutions through provision of regulated markets.
10. To diffuse information on prevailing prices through local media to encourage fair trading.
11. Encouragement or provision of credit and savings facilities to allow modernisation of production marketing techniques or reduction of dependence on money-lenders.
12. Encouraging vertical integration of commerce (i.e. producer involvement in marketing or assisting consumers to control marketing activities).
13. Encouraging horizontal integration of commerce (i.e. through promotion of cooperatives) to achieve scale economies and bargaining power possessed by large-scale competitors.

Acknowledgments

The current study is part of a research project (DFID project R7064) funded by the Aquaculture Research Program of the Department of International Development, UK. CARE Sri Lanka also provides generous support to the project. Yasanthe Navaratne, Bandara Samarakoon, Harsha Balasooriya and I.M. Gunewardene are acknowledged for their assistance in fieldwork.

References

- Alexander, P. 1995. *Sri Lankan Fishermen: Rural Capitalism and Peasant Society*. Charles Subasinghe and Sons, Colombo.
- ARTI 1998–99 Weekly Food Commodities Bulletin. Kobbekaduwa, H. ed. A publication of the food policy division of the Agrarian Research and Training Institute (ARTI). 113 Wijerama Mawatha, Colombo.
- Attapatu, A. 1994. The role of marketing development and fisheries cooperatives in improving socioeconomic conditions of small-scale fishermen. In: *Socioeconomic issues in Coastal Fisheries Management*. Proceedings of the IPFC symposium in conjunction with 24th session IPFC, Bangkok Thailand 23–26 Nov. 1993. FAO Indo-Pacific Fisheries Comm. 281–286.
- Amarasinghe, U.S. 1998a. The role of fishermen in implementing management strategies in the reservoirs of Sri Lanka. In: De Silva, S.S. ed. *Reservoir Fishery Management and Development in Asia*. Proceedings of a workshop held in Kathmandu, Nepal, 23–28 November 1987. IDRC, Ottawa, Canada, 158–163.
- 1998b. How effective are the stocking strategies for the management of reservoir fisheries in Sri Lanka. In: Cowx, I. ed. *Stocking Strategies for Inland Fisheries*.
- Bromley, R.J. 1971. Inter-regional marketing and alternative reform strategies in Ecuador. *European Journal of Marketing*, 8(3): 245–265.
- Central Bank of Sri Lanka, 1998. *Economic and social statistics of Sri Lanka*.
- Chakrabarty, R.D. 1983. Fish culture in seasonal tanks in Sri Lanka. *J. Inland Fish.*, 2: 123–140.
- Chandrasiri, J.K.M.D. 1986. Socio-economic conditions of inland fishermen in Sri Lanka. A pre-project study of five major reservoirs in the Hambantota District. Agrarian Research and Training Institute, Sri Lanka. No. 73. 95 p.
- De Silva, S.S. 1988. *Reservoirs of Sri Lanka and their Fisheries*. FAO Fisheries Technical Paper, Rome.
- Jinadasa, J. 1997. Fisheries. In: Somasekaram, T. ed. *Arjuna Atlas of Sri Lanka*. Arjuna Consulting Co., Colombo, 113–117.
- Kodithuwakku, S. 1997. Entrepreneurial processes in an apparently uniform context: a study of rural farmers in Sri Lanka. PhD thesis. Stirling; University of Stirling, Department of Management and Organisation, xii, 320 p.
- Lawson, R. 1988. Economics of the fish market. In: *Marketing in Developing Countries*. Blackwell, 97–157.

- Mee, J. 1993. An Overview of the Ornamental Aquatic Sector in Sri Lanka. The Agro-Enterprise Development Project, Sri Lanka. Colombo.
- Munasinghe, H. 1984. Socioeconomic conditions of small-scale fishermen in Sri Lanka. *Marga Quarterly Special Issue 7 (2 & 3)*: 11–36.
- MOFARD 1995. National Fisheries Development Plan 1995–2000. Ministry of Fisheries and Aquatic Resources Development, Maligawatta, Colombo 10, Sri Lanka.
- Murray, F.J. 1999. Fisheries marketing systems and consumer preferences in North West Province, Sri Lanka. Working paper. Institute of Aquaculture Stirling University (unpublished).
- NARA 1999. Sri Lanka Fisheries Year Book 1998. Socio-economic and Marketing Research Division, National Aquatic Resources Research and Development Agency (NARA). Colombo.
- Nathaniel, S. and Silva, E.I.L. 1998. Socioeconomics of the Fish Marketing System at the Victoria Reservoir, Sri Lanka, *Journal of Aquatic Sciences*, 3: 51–59.
- Pillay, T.V.R. 1990. Marketing of aquaculture products. In: *Aquaculture: Principles and Practices*. 244–252.
- Sakthivadivel, Fernando, R. and Brewer, J. 1997. Rehabilitation planning for small tanks in cascades: a methodology based on rapid assessment. Research Report 13. Colombo, Sri Lanka: International Irrigation Management Institute (IMI).
- Siriweera 1986. The Inland Fisheries in Sri Lanka, a Historical Perspective. Agrarian Research and Training Institute, 114 Wijerama Mawatha, Colombo 7. Occasional publication No. 33.
- Ulluwishewa, R. 1995. Traditional practices of inland fishery resources management in the dry zone of Sri Lanka: implications for sustainability. *Environmental Conservation*, 22(2): 127–132.
- Watson, I.G. 1999. Report to the Mahaweli Authority on the Potential for Improving Fisheries in the Mahaweli Systems. NRI Report 844. Natural Resources Institute, Chatham Maritime, Kent.
- Wijesuriya, L.T. and Kamaladas, G.B.U. 1997. Irrigation Schemes in Sri Lanka. In: Somasekaram, T., Perera, M.P. and Godellawata, H. (ed.) *Arjuna's Atlas of Sri Lanka*, Arjuna Consulting Co. Ltd, Colombo, 96–101.

Socio-economic Status of River Sprat (*Clupeichthys aesarnensis*, Wongratana 1983) Lift-net Fishers in Sirinthorn Reservoir, Thailand

T. Jutagate¹, Sena S. De Silva¹ and N.S. Mattson²

Abstract

River sprat (*Clupeichthys aesarnensis*, Wongratana 1983) or pla kaew³ is the main commercial fish species in Sirinthorn reservoir, and the main source of income for 165 fishers. Lift-net with luring lamp is the standard fishing gear and each fisher uses an average of 5.31 nets. About 90% of the catch from this gear is pla kaew. Fishing depends on the new moon cycle (about 15.4 days/month). Fishing households are rather homogenous in term of living status and fishing pattern. Middlemen play an important role in distribution since they provide advance payments for investments. They also provide fuel and spare parts to the fishers. Capital investment includes purchase of the boat, engine, lamp(s), bamboo(s) and net(s). No hired labour is employed. Initial investment is about 39 748 Baht. Fixed costs and running costs for one fishing year are about 16 093 and 20 088 Baht, respectively. Fishing effort and catches per fishing year are about 123.1 days and 6.74 t, respectively. Annual income from the fishing activity is about 69 723 Baht per fishing year, with 37.8% rate of return. Price at the open access bio-economic equilibrium stage is 7.51 Baht/kg compared with 10.31 Baht/kg, the current market price. Fermented (salted) fish is the main processed form of this fish, and some is sold in dried form.

FISHERY production is one of the indirect and/or secondary benefits of multipurpose dams, i.e. hydro-power, irrigation and flood protection. Poor people living in the vicinity of reservoirs catch fish, the cheapest animal protein source available, for domestic consumption and sale. There are also commercial fisheries in most reservoirs, for example, for the river sprat (*Clupeichthys aesarnensis*, Wongratana 1983) fishery in Sirinthorn reservoir, Thailand. The river sprat, or pla kaew in Thai, is a common commercial fish species in many reservoirs in the Mekong River Basin and is common in Sirinthorn, Ubol Ratana, and Lam Poa reservoirs, Thailand, and Nam Ngum reservoir in Lao PDR (Chookajorn et al. 1977; Sirimongkolthaworn 1992; Bamrungrajhiran et al. 1998). In Sirinthorn reservoir, the standard fishing

gear used for river sprat is the lift-net. Fishing is carried out at night using the light from a lamp to attract fish. This fishing method was initiated at Khoa Lam reservoir in Kanjanaburi Province, western Thailand, and introduced into Sirinthorn 8 years ago. The gear is widely used around the reservoir, but more intensive fishing takes place near the dam site. The average operational nights/month are about 15, and fishing takes place during the dark part of the lunar cycle. The fishing season is from September to April, the remaining four months being the closed season. A frame survey of the Mekong River Commission (unpublished report) found that the number of lift-net fishers and lift-nets in Sirinthorn reservoir are 165 and 650, respectively. The average yield is 38.11 t/month, which accounts for 80% of the total yield (Wannaphapha, in press). Most of the catch is sold to middlemen to be processed as fermented (salted) fish. The objective of this study was to determine the socio-economic status of the pla kaew lift-net fishers around Sirinthorn reservoir and the cost of investment and operation and income of the fishing activity, including living pattern.

¹School of Ecology and Environment, Faculty of Science and Technology, Deakin University, Warrnambool, Victoria, Australia 3280

²Project for the Management of Reservoir Fisheries in the Mekong Basin (PO Box 7035, Vientien, Lao PDR)

³Please note that in the Laotian dialect this species is referred to as Pa Keo

Materials and Methods

The preliminary survey was conducted by interviewing 15 pla kaew lift-net fishers, using a questionnaire. Five fishers were randomly selected in each zone: near, middle, and far from the dam site.

Results and Discussion

The average family size of the pla kaew fishing household is 4.5 ± 0.66 which compares closely with average Thai family size, 4–6 persons (Juntarashote 1986). All households of the interviewed fishers are poor and are in financial debt. Most of the fishers have reached the primary level (grades 4–6) of education, and only two out of 15 have vocational education. The age ranged 25–50 years. Prior to fishing pla kaew, most worked as hired labour and as farmers (rice and jute). Two-thirds of fishers do not own the farmed land, and farming activities are carried out on rented fields. The reasons for shifting to pla kaew fishing were high income, lack of land for agricultural activities, and financial incentives from middlemen. In the past, fishing was only at a subsistence level, and pla kaew was not targeted.

Pla kaew fishers who have their own rice fields continue to farm, but mainly for home consumption. The farming season coincides with the season when fishing is closed. During this period, fishers without land have no source of income. Only one member of the family engages in fishing, usually the head of the household. No labour is hired in operating the lift-net, apart from occasional help from another male member of the family. The lift-net is considered the standard gear for pla kaew fishing at Sirinthorn reservoir. The average number of lift-nets per household is 5.3 ± 0.63 . The fishers have been engaged in lift-net operations for an average of 5.92 ± 2.29 years. At the furthest zone from the dam site, fishing activity started two years ago. In contrast, intensive fishing, highest number of lift-nets, has been going on for 8 years at the dam site zone. Some fishers have moved their fishing ground away from the dam site.

The initial investment for pla kaew fishing mostly comes from the middlemen (80%). Others sources include family savings (13.3%) and bank loans (6.7%). Bank loans are usually intended for farming purposes, but the fishers use some of it to invest in

Table 1. Average cost of initial investment for different components (Baht).

Fishing vessel				
Component	Cost Mean	Salvage cost Mean	Life span (yr) Mean	
Boat	5200 ± 2641	0 ¹	4.5 ± 1.3	
Engine	16 846 ± 3464	4115 ± 582	7.0 ± 0.6	
Total	22 046 ± 6 105			
Lift-net component				
Component	@ Mean	Per raft Mean	Per fisher Mean	Life span (yr) Mean
Bamboo	50 ± 1	1450 ± 68	7700 ± 1029	2.23 ± 0.44
Lamp	769 ± 309	769 ± 309	4046 ± 1558	4.89 ± 1.21
Net	600 ± 0	600 ± 0	3185 ± 378	3.69 ± 0.48
Rope	80 ± 0	320 ± 0	1698 ± 202	1.00
Winch	190 ± 0	190 ± 0	1008 ± 120	1.00
Total		3329 ± 377	17 637 ± 3 287	
Other costs				
	@ Mean	Per fisher Mean	Life span (yr) Mean	
Basket	20 ± 0	65 ± 9	0.96 ± 0.14	

pla kaew fishing because banks do not give loans to fishers who have no land as collateral. Thus, the middlemen play an important role in the pla kaew fishery. They not only provide cash for investment but also provide fuel and spare parts to meet recurring costs. The fisher has to sell his catch to the middleman with whom he deals. The price paid to the fisher is about 20% lower than the market price, to cover loan repayments, and is determined by the middleman. Payment to the fisher is made regularly at the end of the month.

Financial analysis

The financial analysis of pla kaew lift-net fishing operation is shown in the accompanying Tables. The currency used is Thai Baht (1 Baht = 0.04 Australian dollars and = 0.025 US dollars).

The initial investment costs of boat, engine, and lamp have high standard deviations because of differences in price of raw materials and types. In general, the higher the price, the longer the life span. From this study, the initial investment cost of pla kaew fishing using five lift-nets is about 39 748 Baht. Only the engine has a salvage cost. Other items are discarded when they do not function. The fishers change the rope and winch annually when the fishing season starts. Each raft needs 4 kg of rope and one winch.

Table 2. Average fixed costs.

Average depreciation cost			
Fishing vessel	Depreciation cost (Baht/yr) Mean		Depreciation rate (%) Mean
Boat	1122 ± 324		23.52 ± 5.70
Engine	1836 ± 384		10.89 ± 0.96
Total	2958 ± 708		

Lift-net			
	Depreciation cost (Baht/yr)		Depreciation rate (%)
	Per raft Mean	per fisher Mean	Mean
Bamboo	669 ± 110	3535 ± 663	46.15 ± 7.31
Lamp	155 ± 35	823 ± 206	22.05 ± 6.24
Net	165 ± 24	873 ± 125	27.56 ± 4.00
Rope	320 ± 0	1698 ± 202	100.00
Winch	190 ± 0	1008 ± 120	100.00
Total	1499 ± 169	7937 ± 1316	

Others	Depreciation cost (Baht/yr) Mean	Depreciation rate (%) Mean
Basket	69 ± 18	107.69 ± 27.14

Average repair and maintenance cost		
Fishing vessel	per month Mean	per fishing year Mean
Boat	85 ± 21	682 ± 168
Engine	92 ± 7	738 ± 58
Total	177 ± 28	1420 ± 226

Lift-net	Fisher/month Mean	Fisher/fishing year Mean
Lamps	464 ± 83	3 709 ± 662

Depreciation costs and rates are calculated using the straight-line method assumption, in which the depreciation cost and rate are equally distributed throughout the lifespan of the equipment (Rijirawanich and Ploytongkum 1986);

$$DC = (P-S) / L \quad (1)$$

and

$$DR = [(1-S/P) / L] * 100 \quad (2)$$

when

DC = Depreciation cost (Baht)

DR = Depreciation rate (%)

P = Price (Baht)

S = Salvage cost (Baht)

L = Life span (Year)

The average depreciation rate of the basket was more than 100% because some fishers mentioned that the life span of the basket is about half a year. The repair and maintenance costs for the vessel focus on resin (used as a sealant) and lubricants. It was difficult for the fishers to give a figure for the repair and maintenance cost of the lift-nets since they rarely repair these components. Maintenance cost for the lamp is uniform. In each lamp, the curved pipe, socket and inner axle are changed every two years. The outer axle and pump seal are changed every two months. Other parts are replaced monthly. The costs are about 64 Baht/lamp/month. Variations in lamp maintenance costs come from changing the cover glass of the lamp. One or two out of five lamps need a new cover glass each month.

Table 3. Average running cost of a set of lift-nets.

	per night Mean	per month Mean	per fishing year Mean
Petrol	67.50 ± 16	1032 ± 207	8256 ± 1660
Kerosene	71 ± 10	1089 ± 180	8715 ± 1432
Alcohol	–	60 ± 0	480 ± 0
Mantle	–	160 ± 25	1280 ± 199
Food and others	11 ± 11	170 ± 172	1357 ± 1374
Total	149.50 ± 37	2511 ± 584	20 088 ± 4665
Grand total cost for one fishing year operation			36 181 ± 7595

Petrol and kerosene cost 13 and 15 Baht/L, respectively, if the fishers buy themselves, while they cost 11.50 and 13 Baht/L if they buy through middlemen. Each lamp consumes one litre of kerosene per night of operation whereas the amounts of petrol depend on the distance to the fishing ground. Three bottles of alcohol are used every month for lighting the lamp. On average, two dozen mantles (type of wick) are used every lunar cycle. The standard deviation value of food and other costs is high because some fishers do not bring food, cigarettes or snacks when they go out to fish.

Table 4. Average fishing effort, yields and income.

	per month Mean	Per fishing year Mean
Fishing effort (fisher-days)	15.4 ± 0.9	123.1 ± 7.0
Catch (MT)	0.84 ± 0.17	6.74 ± 1.33
Income (Baht)	8715 ± 2025	69 723 ± 16 198

The fishing effort per fisher depends on the lunar cycle and weather conditions. Average catch per unit of fishing effort (CPUE) is 54.7 ± 9.7 kg/day/fisher while the average catch is 0.84 ± 0.17 t/month. During the closed season, the average CPUE and catch are 34.6 ± 17.9 kg/day/fisher and 0.4 ± 0.27 t/month, respectively, which coincides with the rainy season (Jutagate, unpublished data). The fish are not attracted to the light in rough weather. Income is lower than that of the average fisher in the Mekong River — 72 250 Baht/yr (Anon. 1995), but higher than the average income of Thai farmers and fishers, about 35 042.91 Baht/yr (Anon. 1996).

Price analysis

The fishery resources in Thailand are regarded as public wealth (Bhukasawan 1987). The fishery has

open access, and from this viewpoint, fishing at the break-even point is a major concern as a reference point for fisheries management (Caddy and Mahon 1995). This is where returns to fishers just balance the total cost of fishing (where no profits are made) (King 1995). At this equilibrium stage:

$$P * CPUE * f = RC + FC \quad (3)$$

and

$$P = [RC + FC] / CPUE * f \quad (4)$$

where

P = Price (Baht/kg)

f = Fishing effort (days)

RC = Total running cost (Baht/yr)

FC = Total fixed cost (Baht/yr)

The running costs include the minimum labour wage rate per day of 120 Baht. From this financial analysis, the price at the bio-economic equilibrium stage is estimated at 7.51 Baht/kg. At present, the mean market price is 10.31 ± 0.75 Baht/kg, while the rate of return from this occupation is 37.8%. Therefore, it seems that pla kaew fishing by lift-net is still a viable occupation for people around Sirinthorn reservoir.

Catch disposal

Pla khab khong, or Siamese glassfish (*Psuedambassis notatus*, Blyth 1860) is the main by-catch of this fishery and accounts for 5–10% by weight of each haul. Fishers do not separate them from pla kaew. All the catch, except for the catch from fishers who use their own money to invest, is sent to the middlemen, of whom there are four around Sirinthorn reservoir. Only a small amount is kept by the fisher for family consumption. Fishers not associated with the middlemen sell about 90% of catch to a fish processing plant directly. However, these plants are owned by the middlemen. The remaining 10% is dried and sold. Other by-catch includes redbtail barb (*Discherodontus ashmeadi*, Fowler 1937), eyespot barb (*Hampala dispar*, Smith 1934), barb (*Luciosoma bleekeri*, Steindachner 1879) and needlefish (*Xenetodon cancila*, Hamilton 1822). Small-sized pla kaew are found in the mouths and stomachs of these fishes, and it seems safe to assume that these fish predate on pla kaew (Jutagate, unpublished data). The by-catch is used for family consumption and sometimes sold to neighbours.

Conclusion

A preliminary study of the socio-economic status of the pla kaew luring lift-net fishers in Sirinthorn reservoir revealed that fishing households of this reservoir are rather homogenous in terms of the living

status and fishing patterns. It was also found that this occupation produces high incentive for investment, especially for poor people who do not own land. Current market price of pla kaew is about 10.5 Baht/kg, whereas the break even price is 7.1 Baht/kg.

Acknowledgment

The authors wish to thank Mr Henrik Nilsson, MRC Socio-economics Advisor for his valuable comments and suggestions, and Mr Chalermchon Bamrungrajhiran for field survey assistance. The research was made possible through a grant from a Deakin University Research Scholarship for International Students (DURSI).

References

- Anon. 1995. Socioeconomic Study of the People around Pak Mun Reservoir, Ubon Ratchathani Province. Planning and Policy Division. Royal Thai Department of Fisheries, Bangkok. 24 p (in Thai).
- Anon., 1996. Agricultural Economics Indicator of Thailand. Center for Agricultural Information. Office of Agricultural Economics, Ministry of Agriculture and Cooperative. 72 p (in Thai).
- Bhukasawan, T. 1987. Inland Fisheries. In: Thai Fisheries in the Future, SEAFDEC, Samut Prakarn, 150–194 (in Thai).
- Bamrungrajhiran, C., Degen, P., Janesirisak, S. et al. 1998. A preliminary assessment of the Pla Kaew (*Clupeichthys goniognatus*) fishery of Sirindhorn Reservoir, Thailand. A poster presented at the Fifth Asian Fisheries Forum held in Chaing Mai, Thailand, 11–14 November 1998.
- Caddy, J.F. and Mahon, R. 1995. Reference Points for Fisheries Management. FAO Fisheries Technical Paper 347. FAO, Rome, 83 p.
- Chookajorn, T., Somprasong, N., and Chotikul, S. 1977. Thai River Sprat Fishery in Northeast Thailand. Thai Fisheries Gazette, 30: 93–99 (in Thai).
- Jantarashote, K. 1986. Socioeconomic status of fishing households around the Bang Larng Dam, Yala Province In: Proceedings of the 24th Kasetsart University Conference; Fisheries Section, National Inland Fisheries Institute, Kasetsart University, Bangkok, 332–342.
- King, M. 1995. Fisheries Biology, Assessment and Management. Blackwell Science Ltd, 342 p.
- Rijirawanich, W. and Ploytongkum, C. 1986. Engineering Economics. Science, Engineering and Education Co. Ltd, Bangkok. 351 p (in Thai).
- Sirimongkolthaworn, R. 1992. The Biology and Feeding of the Freshwater Sardine *Clupeichthys aesarnensis* in Ubolratana Reservoir, Thailand, MSc thesis, University of Waterloo, Canada, 131 p.

Fisheries Co-management in Two Large Reservoirs — Problems and Challenges

H. Nilsson¹, S. Phonsavath¹, M. Khumsri² and W.D. Hartmann¹

Abstract

Co-management of natural resources is believed to lead to more sustainable and equitable resource use. The Lower Mekong Basin has shown examples from small water bodies with positive results. However, larger water bodies are characterised by a complexity of users and interests as well as being important sources of revenue. Hence, local involvement of the overall management is limited. Surveys carried out at Nam Ngum Reservoir (370 km²) in Lao PDR and Sirindhorn Reservoir (288 km²) in Thailand showed that the main problems are related to theft of fishing gear and that fisheries issues are discussed at meetings in only few villages. Stakeholder meetings, however, revealed major problems such as decreasing catches, environmental issues and lack of alternative economic activities. Experiences with involvement of resource users cover fishing cooperatives, conservation volunteers, local participation in data collection, and awareness meetings. Enabling and disabling factors for co-management are discussed, and the main challenges ahead are presented.

MOST inland fisheries of the Mekong Basin are de jure under state management. De facto, however, such fisheries are managed by local resource users. Lately, national governments and international donors have been encouraging the setting-up of co-management systems, where all stakeholders, i.e. user communities and local and national governments, share in aquatic resource decision-making.

A recent survey of a number of co-management cases in the four countries of the Lower Mekong Basin showed that many such initiatives have been successful in small water bodies, 0.5–30 ha of water-spread, utilised by communities which commonly use available natural resources in an integrated way (Phonsavath et al. 1999). Strengthening reservoir fisheries co-management has been a major objective during Phase I of the Management of Reservoir Fisheries Component of the Mekong River Commission

(MRC) Fisheries Program. However, in Lao PDR and Thailand the project targeted large water bodies utilised by rural populations whose livelihoods did not depend traditionally on commercial fishing.

Larger water bodies (e.g. large reservoirs and river systems) are normally characterised by a complexity of users and interests, as well as being important sources of revenue. These have been sufficient reasons for putting the management of these resources under government control with little or no influence by resource users.

Introduction of co-management of natural resources is believed to lead to more sustainable resource use. Furthermore, it leads to a more equitable distribution of benefits and ideally also to a more efficient use of the resources. National governments and international donors have now recognised a role for co-management. The approach has been defined as a cornerstone for the Management of Reservoir Fisheries Component (Phase II) of the MRC Fisheries Program.

This paper presents results obtained during the project's efforts directed at identifying and analysing existing institutions and processes which, once strengthened, could lead to effective co-management systems.

¹Management of Reservoir Fisheries Project, Mekong River Commission, PO Box 7035, Vientiane, Lao PDR. Email resfish@laonet.net

²Ubon Ratchathani Inland Fisheries Development Center, 40 Soi Jangsanit, Jangsanit Road, Muang District, Ubon Ratchathani 3400, Thailand. Email resfish@ubon.lxinfo.co.th

Methods

Study areas

Nam Ngum Reservoir is a 370 km² large reservoir in Lao PDR (MRF, in prep.). It was built as a hydro-power reservoir and completed in 1971. Apart from electricity generation, the reservoir serves as a rich source of fishing for the 30 villages surrounding it. Other activities related to the reservoir include small-scale irrigation of reservoir-shore farming, underwater and forestry logging and a lakeshore resort. The population residing immediately in the 30 reservoir villages is estimated at 16 658.

The similar-sized Sirindhorn Reservoir of North-eastern Thailand (288 km²) was also completed in 1971 (MRF, in prep.). The purpose of its construction was electricity generation while irrigation of agricultural lands for some of the reservoir villages has become an important benefit. Fishing is also an important activity for many of the 37 800 people in the 50 reservoir villages.

Data collection

Information on management issues at the two reservoirs has been collected by a number of methods. Traditional questionnaire surveys have been carried out at village and household levels. At Nam Ngum Reservoir, 100 randomly selected households were interviewed on management perceptions (fisheries-related problems and suggestions for their solution, and what various stakeholders could do and should not do in order to improve the fisheries). Among the responding households, 72% had a fisher among their members. At village and unit (sub-village) levels, representatives were asked to what extent fisheries issues were discussed at local meetings.¹ Interviews covered 30 respondents at village level and 64 at unit level. At Sirindhorn Reservoir group questionnaire interviews were carried out with fishers in all 50 villages surrounding the reservoir.

An in-depth field study for a MSc thesis was carried out in two villages at Nam Ngum Reservoir (Phounsavath 1998). Methods included questionnaire interviews with 150 households and semi-structured interviews with key informants and rapid rural appraisal (RRA). The two villages (Ban Xai Oudom and Ban Phonsavat), where fishing is the main economic activity, were chosen as sites for this study.

A short study was carried out around Sirindhorn Reservoir to identify co-management initiatives. This

¹ All 30 villages were selected for this exercise, as were all 64 units in 11 sample villages. Representatives of these levels were trained in filling out the forms, which also included issues relating to fishing effort, catch and marketing.

was guided by information available at the Conservation Unit. Interviews were held with fishers, school leaders and pupils, abbots and staff at the Conservation Unit.

Finally, stakeholder meetings were held with the aim of facilitating the joint management process between the various groups of resource users and government agencies. The meetings included fishers and village representatives of all villages, project associated data collectors (locally based, government-contracted but unpaid), conservation volunteers, sub-district and district representatives, technical staff from district and provincial level and representatives of the local electricity authority. At Nam Ngum, a two-day meeting was held with 48 participants. At Sirindhorn, meetings were held within each of the three districts involving a total of 172 participants. At both sets of meetings, participants were given brief feedback of the main findings from the surveys carried out by the Management of Reservoir Fisheries Component. This was followed by a stakeholder-wise identification of problems related to the reservoir management, their causes and possible activities to address them. A prioritisation of the problems, and hence the activities, was made.

Results

Survey findings

The survey at Nam Ngum found that fisheries management issues are not frequently discussed at local meetings. As many as 67% of representatives among village respondents had no mention of any fishery-related issues discussed at village meetings (MRF, in prep.). In villages where such issues were raised they covered illegal fishing (23% of villages), fish prices (10%), theft of fishing gears (10%) and fishery control (7%). Other issues discussed in single cases were the need for an awareness campaign, means for resolution of fisher conflicts, measures against theft of fishing gear, agreement on retrieving time of fishing gears, needs for training in fish cage-culture and raising small livestock, needs for cheap sources of fishing, supply and consumption goods, need for improvement of the fish marketing system and exchange of common fishing experiences.

At unit level, management issues were an even rarer feature. Only 9% of the 64 units surveyed had these issues on the agenda. However, issues discussed included the need for exchange of fishing experiences and a ban on dynamite fishing (5% each), and a ban on the use of both air pumps for diving fishing and impermeable firecrackers for light fishing of small clupeids (3% each). Other issues mentioned once were the ban on the use of spear gun and drifting

gill-nets, exchange of experiences of gill-net fishing, long distances to landing sites, needs for training in fish cage-culture and raising small livestock.

At Sirindhorn Reservoir, fisheries-related issues were discussed in 28% of the villages (MRF, in prep.). The issues included fishing at the reservoir in general (20%), interventions of the Fishing Patrol (10%), conflicts over fishing grounds (6%) and water use for irrigation (affecting the water level, 6%).

With fishing such an important activity to the reservoir population, it is worthwhile considering why issues related to fishing are apparently not discussed at village level to a larger extent, especially at Nam Ngum Reservoir.

The main problem identified at the two reservoirs was theft of fishing gear. This was mentioned by 82% of respondents (group of fishers) at Sirindhorn Reservoir and 40% of respondents (head of household) at Nam Ngum Reservoir. Other issues mentioned at Sirindhorn were drowned fishers (30%) and spoiled fish due to lack of traders (22%). At Nam Ngum, decreasing catches (11%) and dynamite fishing (4%) were mentioned.

It may appear strange that overall so little attention is given to decreasing catches. Stakeholder meetings at both reservoirs, however, clearly demonstrated that fishers are individually experiencing smaller catches than previously (see below). However, this reflects the value of different methods, especially in the given cultural context. According to Thai and Lao culture, people do not easily bring forward their problems to strangers with whom they talk only for the length of an interview, and especially not government officers, the enumerators at

the present surveys. Sufficient confidence is not gained in such short time. A participatory research approach (PRA) exercise or in-depth village study might have generated the trust and confidence needed. Nevertheless, the stakeholder meetings, executed in a participatory style, managed to engage the resource user side in presenting many details of the problems faced.

Respondents in the two surveys came up with suggestions on how various stakeholders could act to improve the fishing situation. The key stakeholders are presented in Table 1. Respondents at the Thai Sirindhorn Reservoir found that the provincial fisheries authority could assist through stocking (42%) and the promotion of aquaculture (34%), while the few respondents at the Lao Nam Ngum Reservoir focused on improved management of the fishery, including organisation of the fishers (10%). Introduction of sanctuaries was mentioned by a few respondents at both reservoirs.

At Sirindhorn Reservoir, fellow-fishers were recommended to start aquaculture or introduce a fishing committee (10% each). Other suggestions hardly reflect any poor fishing practices. The reverse situation is found when recommendations are given for fishers outside the respondent's village. Suggestions are that these should avoid using illegal gear (4% at Nam Ngum and 22% at Sirindhorn), refrain from stealing fishing gear (10% and 16%) and fish only in allocated areas (12% and 16%, respectively). However, bearing in mind the Lao and Thai culture refraining people from talking badly about fellow-villagers, the hints to outside fishers might actually reflect a more general situation.

Table 1. Main stakeholder perceived roles in improved fisheries management, according to respondents at Nam Ngum and Sirindhorn reservoirs.

Stakeholder	Issue	Nam Ngum Reservoir (N = 100 households) (%)	Sirindhorn Reservoir (N = 50 villages; group interview with fishers) (%)
Provincial fisheries authority	Stocking fish or prawn	2	42
	Promote aquaculture	1	34
	Make sanctuaries	5	12
	Manage fishery/organise fishers	10	—
Village-based fishers	Start aquaculture	—	10
	Introduce fishing committee	—	10
	Improve market strategy	2	6
	Join efforts to prevent theft	2	—
Outside fishers	Avoid use of illegal gear	4	22
	Don't steal fishing gear	10	16
	Fish only in allocated areas	12	16
	Register with village authority	8	—

Note: Only main categories of answers are presented here. For full details, see MRF (in prep.)

Stakeholder meetings

Stakeholder workshops were organised by the project in November–December 1999 to assemble all the involved stakeholders of the reservoirs in an attempt to initiate a participatory forum with the objective of improving existing fisheries management. Various stakeholders took part in the workshop, namely local fishers, village headmen, data collectors working with the project, conservation volunteers, district officers from fisheries, agriculture and other sectors, and provincial fisheries authorities.

Participants identified a list of problems related to fishing as well as their causes. The dominating problem identified at all workshops was the decreasing catch that fishers are facing. Other issues focused on degradation of the environment (habitats and spawning grounds) and the need for alternative economic activities, especially if the closed season is adhered to. This led to a series of activities designed to address those causes as well as the identification of stakeholders responsible for subsequent actions.

Discussion

Co-management initiatives

Even though genuine co-management processes cannot be said to be in place at any of the reservoirs, there are structures and procedures in place, which, if further developed, could lead to co-management situations.

In the late 1970s, fisher cooperatives were established in seven villages at Nam Ngum Reservoir. They provided a government-run enterprise with fish at a fixed (and low) price and in return received supplies of fishing gear and food at fixed prices. However, the fishers lost interest in this setup after a few years when supplies were often not available and better prices for the fish could be obtained on the free market (Phounsavath 1998).

This example shows that handing over (in this case economic) power to local resource users is not sustained in the longer term if those users have not been partners in the process of designing and managing the set-up. Literature from other parts of the world shows the importance of the initiative and involvement of the community. Locally formed user groups at the major lakes of Malawi were established with the aim of acting as link between fishers and the Fisheries Department (Scholtz et al. 1998). After seeing the initial success of this set-up, it was soon amended into the national Fisheries Conservation and Management Act and used as a model country-wide. Barbosa and Hartmann (1998) found that although community organisation could be instigated

by outsiders, its sustainability would depend on the communities and their dedicated and persistent leaders.

A recent initiative in Thailand saw the establishment of groups of Conservation Volunteers at major water bodies (including Sirindhorn and Ubolratana reservoirs). They are villagers with a couple of days training who are requested to take care of the fishery resources, i.e. propagate awareness of the resources and report illegal fishing practices. The volunteers are not formally employed and have no power to apprehend illegal fishers. However, they enjoy some status in the local environment, being equipped with a uniform. While it is still early to say how this institution will work, it appears that the Conservation Volunteers serve as the extended arm of the Fisheries Conservation Division. One could have hoped for a greater involvement with the local communities to which they belong. However, whereas their status arises from the linkage to the DoF, their personal status in the village might not necessarily be high. As many of the volunteers are relatively young, it could be difficult to generate respect for any initiative.

At both reservoirs, local participation in data collection has been sought in order to improve the quality of the data. Data covers length/weight-frequency related to effort. This collaboration has been in place since 1998. Although a major motive for the fishers to participate seems to be the small incentives paid, project staff involved feel that the fishers are also interested in the collaboration itself.²(Ticheler 1998) found that proper feedback from the research involving local fishers as data collectors could lead to enhanced awareness among fishing communities regarding exploitation patterns and management consequences. However, such collaboration should be taken even further, as fishers could take part in the design of the survey itself. This would not only improve the relevance and quality of the data but also lead to a better understanding of the results and an appreciation of the work carried out.

Fisheries authorities at both reservoirs have regular awareness meetings with village leaders to remind them of the fisheries regulations. At the same time, fisheries staff obtain information about fishing and possible problems. Surveys indicate that fishers in general are quite aware of the regulations in place.

² Fishers at Sirindhorn Reservoir are paid 200 Baht (US\$5.41) per month for daily recording individual lengths of each fish caught. Fishers at Nam Ngum Reservoir receive 2000 Kip (US\$0.27) per day for allowing project staff to measure their catch.

Enabling factors

Various factors enabling and disabling the co-management process are presented. They include legal, institutional, political, financial and cultural aspects of the resource management (Table 2).

The most notable development in Thailand has been the decentralisation or devolution of management of natural resources. The new constitution from 1997 has established the *Orngarn Borihan Tambon* or *or-bor-tor* (i.e. organisation for sub-district administration) in order to increase local participation in the management of natural resources. The *or-bor-tor* consists of the headman and a directly elected representative from each village in the *tambon* (sub-district). The *or-bor-tor* is given the authority to make project proposals and has access to a budget. Collection of licence fees is seen as one possible source for this budget. The *or-bor-tor* is also given the right to allocate areas for various activities as well as acting as mediator in case of conflict. Local regulations can also be made but only following a hearing among the general public.

In Lao PDR, there are local institutions in place which could play a role in management of natural resources and conflict resolution, i.e. the traditional village committee, the negotiation unit (consisting of elders, the village guard and the headman) and district-based development volunteers (Phounsavath 1998)

Garaway (1999) notes that

... in Lao the fisheries department do not have the resources to monitor or enforce management strategies that are not seen as desirable by communities. It is therefore suggested here, that the best way they [the department] can achieve their objectives is to fully understand those of the local community and investigate ways that the two can be combined. (p. 337)

Though the government might give higher priorities to enforce management at larger reservoirs due to their greater national importance, observation at Nam Ngum Reservoir shows that enforcement is limited to occasional meetings in the villages.

Despite the much better staff situation within the Department of Fisheries (DoF) in Thailand, it is

Table 2. Enabling framework for fisheries co-management in Lao PDR and Thailand.

Determining factor	Lao PDR	Thailand
Decentralisation/devolution	Declared decentralisation legislation and policies. In practice decentralised to province, district and village levels (based on acceptance by state of its limited management capacity at village level). Lack of clarity about forms of co-management to be adopted. Uncertainty.	Declared decentralisation legislation and policies. Decentralised to sub-district level. Uncertainty in interagency relationships and jurisdictions.
Property rights	'National common property'. Officially 'open-access' but de facto management rights in the hands of individuals, groups and communities. Diversity. Lack of security.	No exclusive property rights. 'Open-access'. DOF planning procedures undercut local management capacity and initiative. Lack of certainty. Lack of security.
User organisation	Blanket village organisation legally established and efficient, supported by traditional organisational forms. Freedom to organise on ad hoc basis and coordinate resource use at supra-village level. Flexibility.	Existence of traditional forms of organisation, but in decline. Emergence of network of NGOs. Flexibility.
External support	Close relationship with government. Support sought: training (technical, organisational), livelihood improvement, credit. Need for clarification/streamlining of state and community responsibilities.	Lack of communication/collaboration between users and government. Support sought: training (technical, organisational), livelihood improvement, credit. Need for streamlining state responsibilities.

Source: Modified from Phounsavath et al. 1999.

recognised by senior officers within DoF that detailed management cannot be supervised and enforced by the Department due to budget constraints (MRF 2000). It is foreseen that within the next 10 years more and more responsibility for management will be delegated to *or-bor-tor* level.

The situation in both countries is therefore in principle conducive to co-management. Legal and organisational structures are in favour of, or at least not directly hindering, such an approach.

Disabling factors

Realising that the present situation has not led to further development of co-management at larger reservoirs necessitates a look at the factors disabling the process.

In Thailand, reservoir fisheries management is dealt with by two separate divisions within the Department, i.e. the Inland Fisheries Development Research Centre and the Fisheries Conservation Division. At Ubolratana Reservoir, Prompoj (1994) found that there was a need for a single organisation to be responsible for all management tasks of the reservoir fisheries. However, present experience from Sirindhorn Reservoir does not seem to indicate that this split is a major reason for not developing the management further. Nevertheless, it must be recognised that local resource users might find it difficult to know who is in charge of the management from the government side.

The management set-up in Lao PDR and Thailand is to a large extent centred on awareness creation and enforcement of regulations. Enforcement is carried out by patrolling. At Nam Ngum fisheries, staff focus on patrolling the main estuary, which is considered a very important reproduction site for many species. As settlement in that area is illegal, the task is carried out together with the provincial security staff. Hence, the situation is often tense. Not only is the fishing ground at stake here but also the entire livelihood of families staying in the area, as they also depend on livestock-keeping and shifting cultivation. Prompoj (1994) reported from Ubolratana Reservoir similar hostility toward fisheries staff. Here fishers were even supported by locally based government staff (district head and MP). Prompoj further found from a review of the annual reports of the fisheries station '... that there was not much emphasis on disseminating fisheries knowledge (i.e. specified as a village seminar) but rather the emphasis was on policing' (p. 132).

Fisheries staffs at both reservoirs have their experience in patrolling, meeting the villagers and data collection. A more participatory approach involving the fishers in controlling the resources is a new concept for them. While the staff might be willing to try

this new approach, it is difficult to push unless a green light is given from above. As community-based management of natural resources is not a new concept, the constraints seem to be more budgetary than political.

Fishers are often equally inexperienced with participatory approaches when working with government. This takes time to develop. Further, fishers at these large reservoirs feel little ownership toward their resource. The studies carried out by the project showed that abandoning illegal fishing practices was an important part of the roles fellow-fishers could play (although these probably for sensitivity reasons were directed toward fishers from other villages). Hence, although fishers might have high awareness of the resources, there is still a low degree of stewardship among them.

Conclusion and Recommendations

Problems identified through surveys and stakeholder meetings at Nam Ngum and Sirindhorn Reservoir focused on theft of fishing gear, decreasing catches, environmental issues and lack of alternative economic activities.

Co-management initiatives at the two reservoirs included establishment of fishing co-operatives, deployment of Conservation Volunteers, semi-participatory data collection and awareness meetings. Apart from the data collection, these initiatives have all been introduced by the respective fisheries authorities. Experiences from various cases showed that the success of such initiatives depends on to what extent resource users have been involved in the design and implementation.

Enabling factors for co-management at Nam Ngum and Sirindhorn Reservoirs include decentralisation of responsibility for natural resource management (typically caused by budgetary constraints) and legal space for local user organisations.

Among the disabling factors were lack of experience with joint management and participatory approaches among government agencies as well as resource users. Others were uncertainty of relationships and the jurisdiction of various government agencies.

Another problem is the potential conflict between the multiple uses and interests related to large reservoirs. Fishing has usually second priority to hydro-power generation and irrigation. In Thailand, communication between government fisheries agencies and local resource users is limited and where found usually reflects an unwillingness to listen to the users.

The strengthening and involvement of existing traditional local institutions could play a greater role in more effective management of the fisheries at the

Nam Ngum and Sirindhorn Reservoirs. Specific local organs evolved at various levels could be further involved in the management process. They are the traditional village committee, the negotiation unit, district development volunteers (Lao PDR), Conservation Volunteers and *or-bor-tor* (Thailand). Traditional informal ethnic institutions should also be considered such as ethnic clans/leaders (e.g. Hmong ethnic group at Nam Ngum). Other non-government organisations could also be involved in different management activities such as mass organisations (youth, women, NGOs, etc.).

The challenges ahead for the co-management process therefore include the task of getting all important stakeholders involved in developing proper communication and management fora. This might necessitate training in conflict resolution and participatory processes for government staff as well as resources users.

Acknowledgments

We would like to thank people who in one way or another have contributed to this paper. In Lao PDR, Khemkham Vanthanouvong, Vankham Keophimphone, Khambao Sihalat, Khankeo Siharath, Khantong Chanmany and Boungou Phantavong from the Nam Ngum Development and Management Project assisted with data collection. Khamla Phommachan and Saleumphone Chanthavong from the Management of the Reservoir Fisheries in the Mekong Basin assisted with data collection and processed the data. In Thailand, Mallika Wannaprapha of Kanchanaburi Inland Fisheries Development Centre assisted with data collection and was in charge of data processing. Praneet Ngamsnae of Ubon University and Chalermchon Bamrungrajhira of Ubon Ratchathani Inland Fisheries Development Center facilitated a short survey on co-management initiatives.

References

- Barbosa, F.I. and Hartmann, W.D. 1998. Participatory management of reservoir fisheries in North-eastern Brazil. In: *Inland fisheries enhancements*. FAO Technical Paper 374.
- Garaway, C.J. 1999. *Small Water Body Fisheries and the Potential for Community-led Enhancement: Case-studies from Lao PDR*. PhD thesis, University of London, London 414 p.
- MRF 2000. *Facilitators report on MRFP Stakeholder workshops, Sirindhorn Reservoir, Ubon Ratchathani, Thailand. Management of Reservoir Fisheries Component*.
- MRF. *The Fishery of Nam Ngum Reservoir, Lao PDR. Management of Reservoir Fisheries Component (in prep.)*.
- MRF. *The Fishery of Sirindhorn Reservoir, Thailand. Management of Reservoir Fisheries Component (in prep.)*.
- Phounsavath, S. 1998. *Community-based fisheries management as an approach to participatory management of reservoir fisheries — a case study two fishing villages at the Nam Ngum Reservoir, Lao PDR*. MSc thesis. Bangkok: Asian Institute of Technology, School of Environment, Resources and Development.
- Phounsavath, S., Hartmann, W., Thouk, N., Degen, P. and Logarta, M. 1999. *Are State-user relations conducive to fisheries co-management in the Lower Mekong Basin? Paper presented at the MRC/Fisheries Program Technical Symposium, 13–14 December, 1999*.
- Prompoj, W. 1994. *Planning for sustainable reservoir fisheries in Thailand*. PhD thesis. Waterloo, Canada.
- Scholtz, U.F., Njaya, F.J., Chimatiro, S., Hummel, M., Donda, S. and Mkojo, B.J. 1998. *Status and prospects of participatory fisheries management programs in Malawi*. In: *Inland Fisheries Enhancements*. FAO Technical Paper 374.
- Ticheler, H.J. 1998. *Participation of local fishermen in scientific fisheries data collection: a case study from the Bangweulu Swamps, Zambia*. *Fisheries Management and Ecology*, 5: 81–92.

Some Imperatives for Co-management of the Fishery in Ea Soup Reservoir

Truong Ha Phuong, Nguyen Thi Nhung, Mercedes Logarta, J.D. Sollows,
Nguyen Thi Bich and Ho Ngoc Dan*

Abstract

Deforestation, siltation and associated flooding are major problems in the Central Highlands of Vietnam. Between 1979 and 1994, the percentage of forest cover in Dak Lak Province dropped from 75 to 59. The increasing cultivation of coffee and other crops is partly responsible for this reduction. Besides land, water is crucial for agriculture. Most is stored in 370 reservoirs with a total estimated area of 8500 ha. Though maintained mainly for irrigation, reservoirs have also been used for fisheries. While yielding high production, they are also vulnerable to unchecked exploitation. Sustainable ways of managing the fishery therefore need to be identified and strengthened. The project 'Management of Reservoir Fisheries in the Lower Mekong Basin' is attempting to identify management schemes that will ensure the sustainability of the fishery resource by involving all stakeholders, especially the fishing communities. This paper documents the relevant experience of the project in one reservoir. In Ea Soup Reservoir, most fish species are indigenous. Access to the fishery has been open, with little effective enforcement of regulations. Enhancement of yields through stocking may not be viable because of periodic flooding. Protection and other ways of suitably managing the fishery are being piloted. Ea Soup is a relatively new district, with high immigration, in spite of an official policy to stop settlement in the area and consequently more pressure is put on the fishery resource, and on the surrounding forests. The absence of an established management system provides an opportunity to test and develop co-management. Constraints encountered and preliminary lessons learned are discussed.

Two common phenomena in fisheries are declining yields in the face of over exploitation, and unequal distribution of benefits among resource users. Frequently, the two are interrelated, since wealthier users often prioritise immediate gains rather than sustainable production, which is of greater concern to small-scale users, whose welfare depends more fully on the resource.

Regulation of fisheries by government has varying effectiveness. Enforcement can be expensive, the needs and concerns of small-scale fishers can easily be ignored, and management may be less responsive than desirable to changing circumstances.

Involvement of resource users in management puts to use their knowledge of the fishery and local circumstances, and takes into account their needs and

concerns. They are in the best logistical position to respond to these circumstances, and have a strong interest in maintaining sustainable yields from the resources on which they depend. The self-reliance generated by such an approach makes them less dependent on external support.

Co-management

While user participation in resource management is becoming increasingly recognised as essential to issues of sustainability and equitability, the involvement of concerned public officials and agencies is also necessary. They have the responsibility and authority to ensure sustainable management of natural resources and the welfare of the population at large. They are also in the best position to support and guide resource users in management of the resources. Hence, the concept of co-management, defined here as 'a formalised and replicable process

*Management of Reservoir Fisheries in the Lower Mekong Basin, 68 Le Hong Phong, Ban Me Thuot. E-mail: johns@netnam2.org.vn

of sharing of authority and responsibility between government and organised groups of stakeholders with identical or complementary roles and functions in a decentralised approach to decision-making aiming at improved participatory and democratic resource management' (Phounsavath et al. 1999).

The process of developing a co-management scheme depends on the situation, the perceptions and aims of the resource users, and of the agencies concerned. In order for co-management to be successful, it has to satisfy a number of requirements, which will be dealt with later.

The project 'Management of Reservoir Fisheries in the Lower Mekong Basin' operates in Laos, Thailand, and Vietnam and has as its development objective 'sustained high yields of fish achieved from reservoirs managed under local community agreement with government'. Hence, the project is identifying management schemes that ensure the sustainability of reservoir fisheries through the active involvement of all stakeholders, but especially the fishing communities. The initial step is to develop a sufficient understanding of local conditions that will help determine the nature of the final co-management scheme. In Vietnam, initial efforts have been concentrated in Ea Soup Reservoir, Dak Lak Province.

Provincial and local situation

Dak Lak is the largest (19 530 km²) of the Central Highlands provinces of Vietnam. Its population grew from about 350 000 in 1975 to an estimated 1.2 million in 1994. Current estimates put it at close to 1.5 million, of whom about 20% live in Buon Me Thuot.

The province is known for its rich basaltic soil. Agricultural land expanded from 93 350 ha in 1979 to 291 320 ha in 1994, a 312% increase (SWAP 1996). With suitable climate and fertile soil, the province has become the largest coffee-producer in the country. Over that period, the area under coffee production increased from 18 000 ha to 82 980 ha, or 461%. A recent estimate (March 1999) from Dak Lak Department of Agricultural and Rural Development (DARD) estimate the current area under coffee at about 170 000 ha. Conversion to coffee farming continues, although steps are being taken to slow the expansion. The crop places considerable demand on water resources, and requires fertilisers and pesticides.

Reservoirs are an important source of water for agriculture, and the number is increasing, in response to growing demand. The most recent (March 1999) estimate by DARD suggests about 370 reservoirs in the province, 8500 ha in area. While the great majority were built for irrigation, fishery is an important secondary use.

In 1979, an estimated 75.1% of the province was forested. Almost 400 000 ha was deforested between 1979 and 1994, when only about 59% of the area was forested. Deforestation tends to lead to erosion and reduced retention of water in the catchment area, and therefore siltation and less stable water flows in streams and reservoirs.

Ea Soup is a relatively new district, occupying the northwest corner of Dak Lak, bounded by Cambodia to the west and Gia Lai Province to the north. It was established in 1977 and was divided into Ea Soup and Cu Mgar districts in 1983. In 1995, it was further divided into Ea Soup and Ban Don districts. Before formal establishment, the area was inhabited mainly by indigenous Ede and Jrai peoples, but now Kinh people account for about 74%, Jrai about 10%, and the 16% remaining is Muong, Giao, Tay, Nung, Ede, and Thai people.

The population density of the district is low (17.8 inhabitants/km², 1999), but growing rapidly. Data indicate that the population of the entire district grew from 24 150 in May 1997 to 31 269 in April 1999, an annual increase of 14.7%. Most is due to immigration, mainly from the north. While current policies discourage such migration, it still continues.

In contrast to most of Dak Lak, the soils of Ea Soup district are relatively poor in basaltic elements, and sandy. The relatively poor soil probably helps account for the historically low population in the area, and suggests that even when more fully settled, Ea Soup should have a lower population-carrying capacity than many parts of the central highlands.

Its economy is primarily agricultural. The fishery is also an important protein source for the district, with about 52 tons from Ea Soup Reservoir (Phuc et al., in press) and about 97 tons from aquaculture (Dak Lak Statistic Office, 1998) annually.

Ea Soup Reservoir has an open-access fishery under the nominal control of local authorities. They are aware of their limitations here, and were open to the idea of allowing the fishing community to help manage the fishery. This paper documents project experience in ongoing work to facilitate the establishment of fishery co-management in Ea Soup Reservoir, and to extract some preliminary lessons.

Ea Soup Reservoir

Ea Soup Reservoir was impounded in 1980 by the Dak Lak Water Resources Scheme. Though it was intended to irrigate about 1600 ha of mainly low-lying rice, its capacity at present is estimated at only about 1000 ha. The reservoir has an area of 240 ha at fsl, a dam height of 12 m and a length of 3500 m.

The spillway is wide (200 m), considering the area of the reservoir. However, the catchment area of the

reservoir is about 350 km². At times of high water, the dam beside the spillway is breached to allow excess water to flow out.

While impounded for irrigation, its fishery is of important secondary use. A few families living near the irrigation canal also use the water for domestic washing.

Fisheries management there has gone through various stages since the reservoir was impounded. From 1982-85, a group of 10 fishers was organised by the district and expected to sell their catch to a government-operated company whose purchases were subsidised at a relatively high price. The fish was then sold at a lower price to end-consumers. In 1986, the subsidies stopped, the arrangement no longer became viable. The management was passed on to the three communes: Ea Soup, Ea Le and Ea Bung. The communes managed the reservoir on a two-year rotation while paying the district taxes during their respective terms.

In 1986, Ea Soup commune managed the reservoir. Two private traders bought the catch and sold them to end-users. In 1988-89, Ea Le took over but did not control the fisheries. It allowed anyone who wanted to, to catch fish, and two other traders purchased and sold fish. In 1989-90, Ea Soup took on the management again, since Ea Bung did not take the responsibility. This time, anyone was allowed to catch fish, and fishers could sell on their own. Taxes were collected at 10% on the catches over the period, until 1993, when it was judged that catches were too low to allow further taxation. Since 1993, no taxes have been collected.

The district regulates the fishery to the extent believed possible: blasting, poisoning and electro-fishing are banned. The rules do not completely eliminate the practices due to insufficient capital, low enforcement capacity, insufficient public awareness of the need for management, and a lack of agreement among fishers. An effective mechanism therefore does not exist. Battery-powered electro-fishing is widespread, and six fishers operate electro-fishing dynamos at certain times, as well.

Fishing in the reservoir is not lucrative. Project survey results suggest that mean income from fishing is not more 25% of the mean annual family income for the commune. Hence, it is more of a last-resort occupation, rather than a first choice.

Fishers believe that fish yields from the reservoir have declined in both quantity and quality over time. The catch now is dominated by small, lower-priced species. Electro-fishing is commonly blamed as an important cause. Deforestation in the watershed causes siltation and turbidity, which will shorten the life of the reservoir and interfere with food production in certain seasons. Pollution by pesticide-laden

runoff is suspected by some fishers at some times of years, when minor fish mortalities are noticed.

Stocking is a widespread and very cost-effective practice in many reservoirs in Dak Lak (Phuc and Sollows, these Proceedings). However, in the absence of effective controls for fishing activities and because of concern about loss of fish due to flooding, Ea Soup has not been stocked.

Beginning in 1993, a couple of fishers introduced cage culture of grass carp into the reservoir. By 1996, the number of cages had exceeded 150. At that point, disease broke out, and most cage owners suffered financial losses, which discouraged further attempts until June 1998, when three fishers, jointly with the project, tested modifications to the old technology.

Recent trends indicate that the fishing community around Ea Soup is growing rapidly. The population of the three villages around the reservoir grew from an estimated 942 in May 1997 to 1382 in April 1999, or by about 23% annually. The number of fishers more than doubled over this period from about 40 to slightly over 100.

Estimated annual total yield between June 1997 and May 1999 increased from about 51.5 to 60.5 t (17.5%). However, annual catch per unit effort for all gear types has dropped over the reporting period. Declines of about 14% and 24% were estimated for gill-nets and lift-nets, respectively, while that for long-lines amounted to only 6.9%. The declines are not surprising, in light of the higher number of fishers.

During the survey period, project staff identified 53 species in the catches from the reservoir. The proportion of the annual yield occupied by non-native species dropped from 7.4% to 4.6%. Most represent escapes from fish culture operations, although common carp makes up a respectable proportion of the total yield (3.1%), and is probably established there. The very high diversity of species and yields of wild fish may be explained by two factors: the low draw-down allows an abundant growth of aquatic plants, which provide feed, shelter, and substrate for many species, and the large catchment area also allows some migratory species to reproduce upstream of the reservoir.

Work on a new upper Ea Soup dam, which will lie about three km upstream from the current reservoir, began in October, 1999. It will have unpredictable effects on fish yields. Construction work could increase the turbidity of the lower reservoir, and toxic runoff from construction operations could also present problems.

In the longer term, the dam will effectively block upstream migration of many species, which could lead to some local extinctions. The local fish fauna in Ea Kao Reservoir declined considerably a year or

two after Ea Chukap dam was completed about 10 km upstream from Ea Kao (Anh pers. comm.). Hence, while 18 native species were identified in Ea Kao prior to the start of the project (MRFP 1997), many no longer occur. Twelve native species identified in catches during the project period made up only about 1.3% of total yield.

The new dam should effectively control flooding of the old reservoir, eliminating the annual periodic breach of the dam near the spillway. Hence, fish loss from the lower reservoir should be reduced. Reduced turbidity in the lower reservoir can also be anticipated, along with a corresponding reduction in nutrient loading.

The fishery is under rapidly increasing pressure (number of fishers, deforestation, destructive fishing methods, siltation, etc.). Rapid immigration to the area could have other effects on aquatic life. And the upper dam, now under construction, will have profound effects on the present fishery.

Project Activities

Project activities in Ea Soup began in March, 1997 with three surveys.

A qualitative socioeconomic survey addressed a variety of questions, including relative importance of economic activities, uses of the reservoir and importance of these uses, diet, seasonality of activities, spatial and temporal fisheries trends, and problem-scoring.

A quantitative household survey was carried out concurrently to obtain more rigorous data on such factors as economic activities, income, diet, and the importance of the fishery.

The biological survey began in March 1997, but only in June 1997 could it be modified to allow quantitative estimates of monthly fish yields. The survey is ongoing.

Results of the various research activities are summarised above. In the course of work, district officials acknowledged that their regulation of the fishery was, largely, nominal, and they were open to the involvement of the project in order to involve the community in establishing a more effective management system. This attitude was formalised in late June 1998, when the project held discussions with local officials of the various options possible for reservoir fisheries management. The officials again indicated that they were open to involving the fishing community in fisheries management, and allowed the project to help organise the fishers, with this in mind.

Initially, a series of four two-day training sessions in environmental awareness and related fisheries management concerns was held for fishers in Ea

Soup from July to December 1998. Trainees totalled 60 (about 60% of the local fishers). While the level of comprehension of details varied, there was wide consensus among them at the end of the courses that they needed to work together to assure high, sustainable yields from the reservoir fishery.

Twelve participants selected from the courses were subsequently invited to form a core group to work with the fishing community. Through the first half of 1999, the group worked with the fishing community to carry out a poster campaign against electrofishing, and organised a membership drive that culminated on 5 August 1999 in the formal establishment of the Fishers' Union.

Two-exposure trips for Ea Soup and Lak fishers were held in September 1999, and led to the testing of shrimp traps and fence nets as alternatives to existing fishing gear.

A livelihood survey was conducted in November 1999 with the local Agriculture Extension Office, to identify possible options open to fishers in the field of agriculture and livestock-rearing, and to discover suitable fishing gears to replace current electrofishing methods.

The union executive met the Director of Dak Lak Aquatic Products Company and Ea Kao reservoir fishery manager to give initial consideration to stocking the reservoir in the year 2000.

In December 1999, the project organised a three-day training course in Organisational Mechanics and Leadership for the union executive and likely future executive members.

With the guidance of project staff, the union is currently considering relevant regulations and how to implement them. The search for alternatives to non-sustainable fishing practices is ongoing. Discussions are underway with local officials and line agencies to establish a sustainable co-management mechanism that would involve all three parties in future management of the reservoir fishery.

Imperatives and Related Needs in Ea Soup

Training

The process of establishing resource co-management must have a beginning point. Once all concerned agree on the need, training appears to be that point. The nature and targets of training can be variable, but normally, from the fishers' point of view, an initial focus on environmental awareness and its relevance to maintaining sustainable fisheries yields may be a reasonable first topic. A session for concerned officials, followed by an appropriate number of sessions for fishers and other resource-users, is a normal pattern.

Such training courses are an opportunity for participants to relate their perspectives and experiences as well, making the first steps in communication with and feedback among all concerned.

Training needs in other areas evolve as the co-management process is established. For Ea Soup, the exposure tours and training in organisational mechanics and leadership are cases in point.

Leadership

Local leadership is a critical and necessary condition for the success of co-management. Local leaders set an example for others to follow, set out courses of action, and provide energy and direction for the process. The community must look inward to develop local leadership itself. Buhat (1994) indicated that core group formation was strategic in identifying and developing leaders. Core groups normally took responsibility for the initial implementation of co-management strategies.

A core group was formed in Ea Soup at the end of a series of 2-day training sessions, in late 1998. While the group could not, by itself, fulfil all the necessary management tasks, it worked with members of the fishing community on activities that led ultimately to the establishment of a union on 5 August 1999.

There must be incentive and willingness on the part of fishers to participate actively, with time, effort and money, in fisheries management.

The training course already given in organisational mechanics and leadership should help assure that the union will be satisfactorily effective in working with the fishing community at large, as well as local officials and line agencies. There is not yet unanimous support for it among the fishing community. Further work is needed, initially with fishers who have joined the union, and later with all fishers using the reservoir, after the new election held 9 January 2000 of the Fishers' Union executive.

Membership

The number of fishers with rights to fish in the reservoir should be clearly defined, and illegal fishers should be controlled.

Many non-registered and illegal fishers use the reservoir. Once the membership is as high as realistically possible, a list of legal and illegal fishers should be defined by the Fishers' Union and may be announced to local authorities. Illegal fishing activities could then be more easily curtailed.

Support from authorities

Property rights over fisheries resources should address legal ownership of the resource. Without

legally supported property rights, resource-users have no standing to enforce claim over the resource against outsiders and other illegal users.

Effective links between local government and line agencies will enhance co-management arrangements. The agencies may be able to provide administrative, technical, and financial support.

Pomeroy (1999) indicated that in some case studies in the Philippines, where the local political 'power structure' was not included in the process or was opposed to the project for some reason, community-based management interventions failed to be sustained after the project ended.

Co-management requires the existence of legitimate organisations that have a clearly defined membership, mandate, and duration for that mandate. The organisations should have the legal right to exist and to make arrangements related to their needs (Pomeroy 1999). The organisations should also represent the majority of resource-users in the community.

The Fishers' Union of Ea Soup received in December 1999 a mandate from the district to allow the fishers to monitor and manage the reservoir with the help of other local agencies. The mandate also indicates that fisher union members should be registered in Ea Soup Commune. They should also establish a guarding group to protect and enforce regulations restricting outsiders and other illegal fishers. However, the union still needs protection from the authorities against repercussions by illegal fishers.

Other support is also needed. The union has insufficient financing, and the participation of authorities and line agencies needs more encouragement.

Well-defined communications and co-management mechanisms

Individual and community empowerment is a central element. Empowerment is concerned with the capacity-building of individuals and the community to greater social awareness, to gain greater autonomy in decision-making, to gain greater self-reliance, and to establish a balance in community power relations.

In Ea Soup, local government agencies are quite willing to devolve decisions regarding fisheries management to the union, but the details need further discussion and agreement. A continuing role for these agencies in managing the reservoir could well be necessary.

A regular communications mechanism among all concerned needs to be established. The nature of this mechanism and the roles of the various actors need to be mutually agreeable. Resource-users will normally not be able to manage the resource alone. They require the permission, guidance and support of

local governments and concerned line agencies. All concerned agencies can provide guidance and administrative, technical and financial support to the local organisation and the co-management arrangement. The cooperation of local government must always be stimulated, solicited and nurtured by the partners, as without it it may be difficult to implement co-management arrangements.

Regulation

Given the rapid increase in population, changes in catch composition, declines in harvesting efficiency by major gear, fishers realise that they must work together to assure sustainable fish yields for themselves and their children. Effective regulations are widely regarded as necessary. Monitoring and enforcement should be effected and shared by all fishers. The need for regulations which can adjust to changing circumstances is understood by all, but a few challenges remain before such regulating can be effective.

Fishers can monitor and report illegal activities, but need protection against repercussion from any who are penalised for illegal activities. The support of local authorities, including the police, is needed if the regulations are to be effective. Therefore, the cooperation of local government and the enforcement authority is necessary in the co-management arrangement. Incentives for local police to support co-management are normally necessary. There must be willingness by all parties to share the benefits, costs, responsibility and authority.

Alternate livelihoods

The imminent construction of the upper dam will likely have profound effects on the current fishery. In particular, adverse effects should be expected in any migratory species.

In that light, the need to regulate present fishing practices, livelihood options to fishing, and, particularly, unsustainable fishing practices, is necessary.

Fishers engaged in unsustainable practices will be in a better position to comply with regulations. While there are a number of livelihood possibilities, no single option is likely to address this issue completely.

Use of new, more selective gears would allow fishers to exploit particular stocks in the reservoir. The project has cooperated with the union in the introduction of shrimp traps and fence-nets. The shrimp traps do not appear economically feasible. A few fishers have had initial success with fence-nets, but initial indications are that the gear is not likely to become widely popular.

Cage culture has been reintroduced. It is expected that a limited number of fishers who live near the reservoir, who can afford the cage and fingerling costs, and who find the modest returns worth the time they must invest in feeding, will find this technology appropriate.

As a result of survey of livelihood options and planned extension work, some agricultural and live-stock-based activities may be adopted by some fishers.

Stocking has proved very successful both in terms of increasing production and economics in many reservoirs in Dak Lak. There are questions about its viability in Ea Soup. The floods which run through the breached spillway would lead to the loss of an unknown number of fish. Ea Soup is much richer in wild fish fauna than most stocked reservoirs, and interactions between stocked and unstocked fish must be kept in mind. Finally, the Ea Soup Reservoir fishery is not yet sufficiently regulated to allow a satisfactory return on stocking. If the union can address the issue successfully, experimental stocking deserves serious consideration.

Land-based aquaculture could also occupy the energies of some fishers. There are already a few local successes with ponds, and with the increasing population and improved infrastructure, current marketing limitations are likely to diminish in importance. The current supply of fish does not meet future demand, and the risk of pollution in the reservoir is likely to grow with population. Other types of aquaculture, such as rice-fish culture, deserve consideration and testing. Training for interested fishers is desirable.

No list of livelihood options is complete, and no single option is expected to satisfy the needs of the community. A major concern is that the options be environmentally and economically sustainable. Another issue is that, unlike fishing, most options do not have an immediate payback. Therefore, once successfully tested by fishers, they cannot be expected to replace fishing immediately, nor completely, but should eventually allow fishers to relax the pressure put on fish stocks in the reservoir. A final concern is that fishers will need finance to begin many of the activities, and sources of financing have not yet been identified.

Training in, finance, and follow-up of newly introduced livelihood options are needed to assure success.

Catchment area management and resource-user participation

Fishers are aware that the catchment area affects the fishery in the reservoir. Siltation and pollution are cases in point. Ultimately, other resource users in the catchment area should be involved in maintaining the resource base.

References

- Buhat, D. 1994. Community-Based Coral Reef and Fisheries Management, San Salvador Island, Philippines. In: White, A., Hale, L., Renard, Y. and Cortesi, L. ed. Collaborative and Community-Based Management of Coral Reefs: Kumarian Press.
- Dak Lak Statistical Yearbook, 1998
- Phounsavath, S., Hartmann, W.D., Logarta, M. and Degen, P. 1999. Are State-User Relations Conducive to Fisheries Co-Management in the Lower Mekong Basin. Second MRC Fisheries Technical Symposium, December, 1999. Phnom Penh, 29 p.
- Phuc, P.D., Vinh, N.N., Nhung, N.T., Dung, L.T.A., Dan, H.N., Huy, P.T., Bich, N.T., Yen, N.T.H., An, N.Q., Logarta, M.D. and Sollows, J.D. In press. Management of Reservoir Fisheries: Findings from Ea Soup, 1997–1999. MRFP Technical Report No. VN4-99. 41 p.
- Logarta, M. 1999. Prospects for Co-Management of Reservoir Fisheries in Dak Lak. National Reservoir Fisheries Seminar, May 1999, Nha Trang, Viet Nam.
- Pomeroy, R.S. 1999. Key Conditions and Principles for Successful Fisheries Co-Management. The Fisheries Co-management Research Project. Manila: ICLARM.
- SWAP/Action Plan for Water Resources Development Phase III; Upper Srepok Basin, Vietnam. 1996. Watershed Changes in Upper Srepok Basin and Dak Lak. Working Paper No. 17. 24 p.

Cage Culture of Finfish in Australian Lakes and Reservoirs: A Pilot-scale Case Study of Biological, Environmental and Economic Viability

G.J. Gooley¹, Sena S. De Silva², B.A. Ingram¹, L.J. McKinnon¹,
F.M. Gavine¹ and W. Dalton¹

Abstract

With an increasing emphasis on ecologically sustainable development of natural resources, the need to integrate where possible appropriate farming practices to enhance farm productivity and water use efficiency is becoming increasingly apparent in Australia. This combination of environmental and economic imperatives is now resulting in serious consideration being given to more innovative inland water uses such as commercial scale aquaculture in both private and public waters, including cage culture of finfish in lakes and reservoirs. In the present study, an investigation of experimental-scale cage culture in irrigation lakes and reservoirs was undertaken within the Goulburn-Broken catchment of the Goulburn-Murray Irrigation District (GMID) of Victoria, in an attempt to objectively evaluate biotechnical, environmental and economic viability of a potential commercial enterprise. Results of the field trials indicate that cage culture in lakes and reservoirs within the GMID is biotechnically feasible, if not optimal, for at least some species in which suitable water quality and ambient water temperatures can be achieved. Economic analysis indicates the need to optimise system design and fish production parameters to maximise profitability. However, at a catchment scale, cage culture of finfish in lakes and reservoirs potentially can accommodate effective recovery of full external (environmental) costs of water usage, and potentially offers investors a significant competitive advantage over other irrigated agribusiness sectors. The outcomes of the present study should facilitate the formulation of draft Best Practice technical and environmental management guidelines for potential cage culture developments in Australian lakes and reservoirs.

AUSTRALIA is a relatively dry country, with half the landmass having a mean annual rainfall of less than 300 mm, and only 20% having more than 600 mm. The majority of the rainfall occurs in the tropical far north and the cold temperate far south of the country. The level of water storage and diversion for irrigated agriculture varies widely, with the highest rates of diversion frequently occurring in areas where surface runoff is limited and water resources are almost fully committed (Thomas 1999).

Australia's water use exceeds 20 000 GL per annum, an increase of 25% in the period from 1983/84

¹Marine and Freshwater Resources Institute, Aquaculture Program, Private Bag 20, Alexandra, Victoria 3714, Australia ph: +61 3 5774 2208 fax: +61 3 5774 2659. E-mail: geoff.gooley@nre.vic.gov.au

²School of Ecology & Environment, Deakin University, Warrnambool, Victoria 3280

to 1995/96, due largely to increased demand from irrigated agriculture (presently about 72% of national water demand). Production of irrigated commodities represents about one third of Australian farm exports, worth approximately AUD\$6400 million in 1995/96 (Thomas 1999). The total irrigated area in Australia of about 2.25 million ha consists primarily of cotton (13.2%), pasture/dairy (41%), horticulture (11.1%), sugar (10%) and cereal/rice (15%) production (source Bureau of Rural Sciences, Australia, and Australian Bureau of Statistics based on 1996/97 census). Associated with this production is an extensive network of water storages mostly situated in or adjacent to the defined irrigation areas around the country (Figure 1) (Hallows and Thompson 1997).

Within the Goulburn-Murray Irrigation District (GMID) of Victoria (Figure 2) alone there are approximately 490 000 ha of irrigated farmland

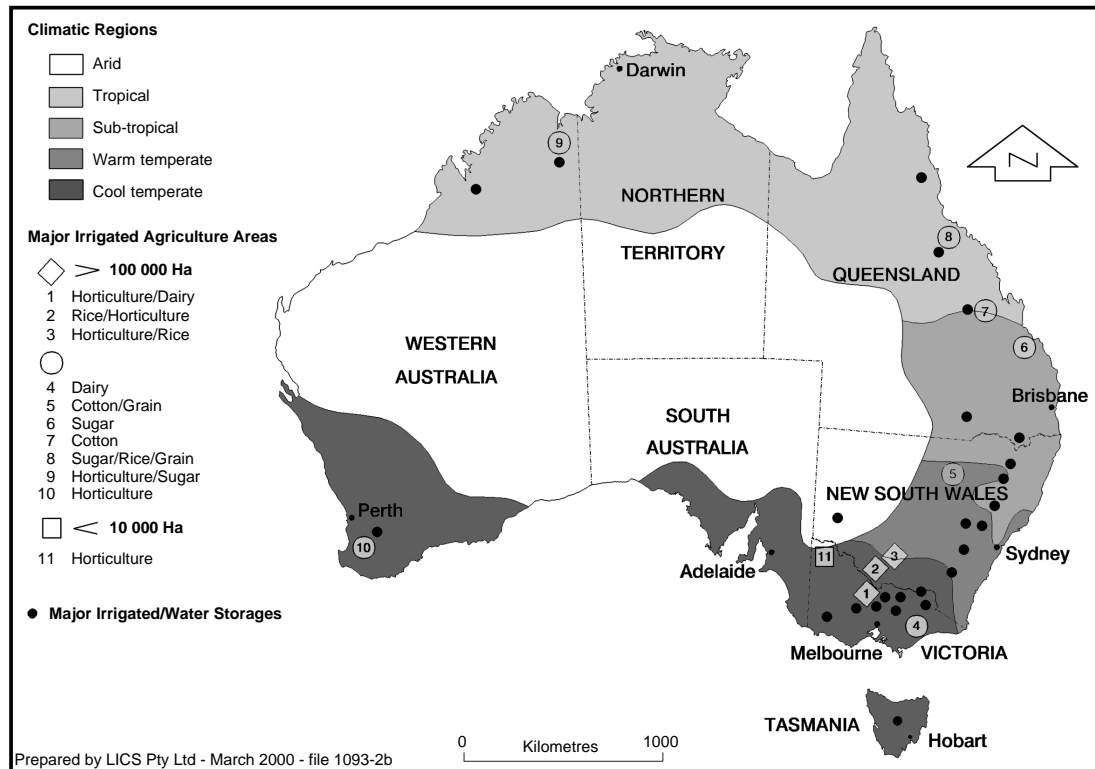

Figure 1. Map of Australia indicating major climatic regions, major irrigated agriculture areas and sectors, and major water storages.

which consumes on average about 2.6 million ML of water per annum worth about \$60 million in costs to farmers. This cost represents almost 10% of the overall dollar value of the total annual agricultural produce from the GMID, the major irrigated food-producing region in the country (Gooley 2000).

With an increasing emphasis on ecologically sustainable development of natural resources, the need to integrate, where possible, appropriate farming practices to enhance farm productivity and water use efficiency is becoming increasingly apparent in Australia. Recent developments in the reform and restructuring of the Australian water industry have also seen a progressive shift towards the production of higher value irrigated crops. This is in order to make better use of the limited water resources and to achieve increased accountability for the environmental impacts of commercial water usage, such as large-scale eutrophication and salinisation of surface and ground waters (Thomas 1999; HLSGOW 1999). This combination of environmental and economic imperatives is now resulting in serious consideration

being given to more innovative inland water uses such as commercial scale aquaculture in both private and public waters, including cage culture of finfish in lakes and reservoirs (Gooley et al. 1999a, b; Kolkovski et al. 1999).

Australian inland aquaculture

Compared with agriculture, the Australian aquaculture industry is relatively small and predominantly marine based. Total production of 30 700 t and 9.3 million juveniles in 1997/98 was worth approximately AUD\$517 million (O'Sullivan and Roberts 1999). The inland aquaculture sector is dominated by various salmonid species, mainly rainbow trout (*Onchorhynchus mykiss*), and barramundi/Asian sea bass (*Lates calcarifer*), produced semi-intensively in private waters.

More recently, however, barramundi are also now being produced on a commercial scale in cages in Lake Argyle, a large irrigation storage reservoir (980 km² surface area) in north-western Western Australia (Gooley et al. 1999a; Kolkovski et al. 1999)

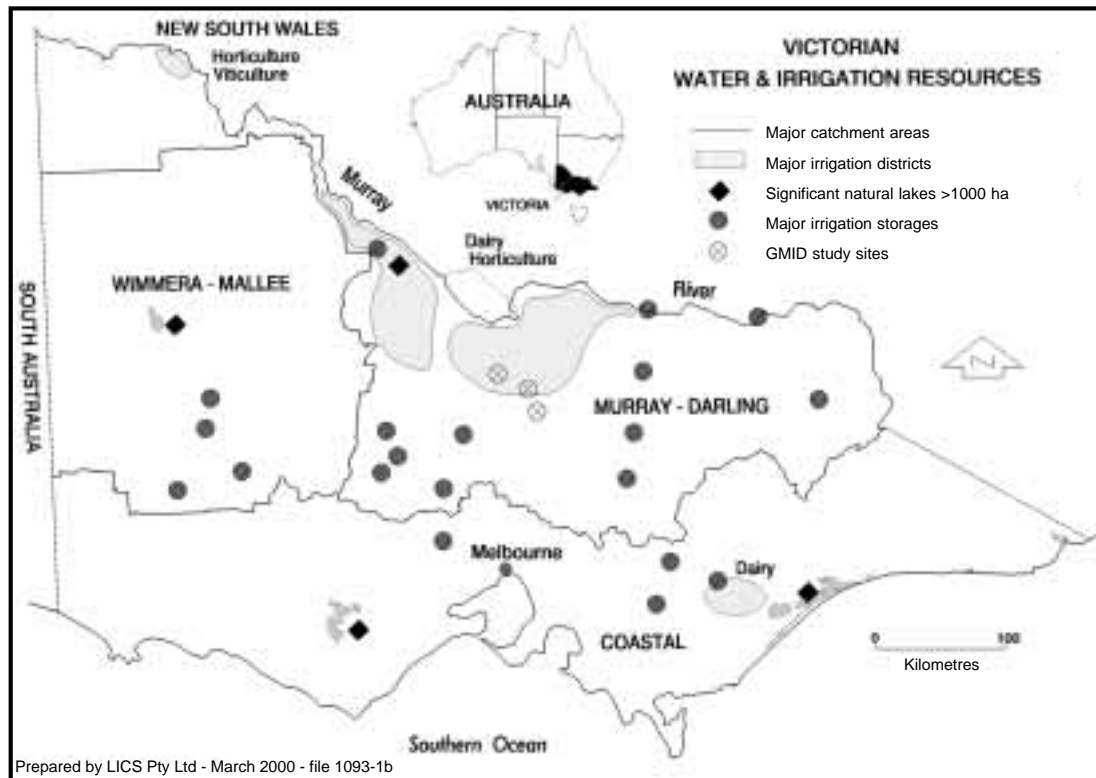

Figure 2. Map of Victorian water and irrigation resources showing location of major catchment areas, irrigation districts and farming sectors, significant natural lakes and major irrigation storages.

(see also Figure 3). This is the only such aquaculture operation in an Australian lake or reservoir, and is the preliminary stage of a projected 10 000 t per annum barramundi cage culture industry in the lake (Kolko-vski et al. 1999). In other developments, consideration is now being given to cage culture of Atlantic salmon parr in Tasmanian freshwater lakes, including hydro-electric storage reservoirs, as a cost-effective means of increasing hatchery capacity for the AUD\$80 million pa Tasmanian salmon industry (Anon. 1999). The key issue potentially constraining commercial development of this type in Australia is the threat of environmental impact from excessive nutrient discharge on water quality. Other issues include perceived loss of visual amenity to the community at large, threat of horizontal disease transmission to co-habitant wild fish stocks, escape of hatchery stocks which may compete with and/or compromise the genetic integrity of wild stocks, and overall general conflict with other water users, e.g. recreational fishing and boating.

The resource planning and associated Government policy implications for Australian inland aquaculture are complex, and dictate the need for decision support databases which enable objective analysis of relevant issues, establishment of relevant environmental, economic and fish production 'Best Practice' benchmarks, and the development of relevant management tools for industry and resource managers. In the present study, an investigation of experimental-scale cage culture in irrigation lakes and reservoirs was undertaken within the Goulburn-Broken catchment of the GMID of Victoria (Figure 2), in an attempt to objectively evaluate biotechnical, environmental and economic viability of a potential commercial enterprise. This study is one of several being undertaken within the greater Murray-Darling Basin, Australia's major food-producing region (Figure 1), which are investigating various aspects of integrated agri-aquaculture systems (Gooley 2000; Gooley et al. 1999a,b; Ingram et al. 1999).



Figure 3. Finfish cage culture in Australian lakes and reservoirs; a) Lake Argyle on the upper reaches of the Ord River in north-west region of Western Australia; b) Barramundi cage culture in Lake Argyle, Western Australia; c) Cage cultured barramundi, Lake Argyle, Western Australia; d) 'Norwegian-style' cages for farming barramundi in Lake Argyle, Western Australia; e) Lake Eildon on the upper reaches of the Goulburn River in north-central Victoria; f) Goulburn Weir in the Goulburn-Murray Irrigation District, north-central Victoria; g) Lake Cooper in the Goulburn-Murray Irrigation District, north-central Victoria; h) Waranga Basin in the Goulburn-Murray Irrigation District, north-central Victoria.



Figure 4. Finfish cage culture in Australian lakes and reservoirs; a) Floating cages used in trials during the present study; b) Pilot-scale cage culture system in Goulburn Weir, Victoria during the present study; c) Pilot-scale cage culture system in Lake Cooper, Victoria during the present study; d) Silver perch stockers at the start of cage culture trials during the present study; e) Cage cultured silver perch harvested at the completion of cage culture trials during the present study; f) Introduced wild carp, common in GMID lakes and reservoirs in Victoria; g) Endemic, fish eating cormorants, common throughout GMID lakes and reservoirs in Victoria; h) Endemic, fish eating water rats, common throughout GMID lakes and reservoirs in Victoria.

Materials and Methods

Study sites and experimental design

The case study specifically focuses on cage culture of silver perch (*Bidyanus bidyanus*), an endemic warm water Murray-Darling species, and the introduced salmonids, rainbow trout (*Onchorhynchus mykiss*) and Atlantic salmon (*Salmo salar*), in three lakes and reservoirs within the GMID, viz. Lake Cooper (1100 ha surface area; 24 000 ML capacity), Waranga Basin (5850 ha surface area; 411 000 ML capacity) and Goulburn Weir (1120 ha surface area; 25 000 ML capacity) (Figures 2–4). All three waters are relatively shallow (mean depth 2–3 m) and used to varying degrees for irrigation water storage and, the latter two at least, for flow regulation. Goulburn Weir is an on-river storage, located in the mid-reaches of the Goulburn-Broken catchment, and supplies water directly to Waranga Basin. The other two waters are off-river storages located further downstream in the catchment, with Waranga Basin specifically regulating flows to much of the irrigation supply channels within the GMID. Lake Cooper is predominantly a terminal storage for surplus irrigation and drainage waters within the GMID.

The performance of fish in all three waters was statistically compared in terms of growth rates and survival for trials using silver perch (first of two trials) and rainbow trout (single trial only). Subsequent trials using both silver perch (second trial) and Atlantic salmon were completed at Goulburn Weir only. No attempt was made to statistically compare growth and survival of fish between waters and species over the full term of the study due to the inherent temporal and spatial variability involved in such a comparison. Qualitative comparisons, however, were made to assess relevant trends.

Trials were completed at different times of the year to optimise ambient climatic conditions for the target species. Cages were of a floating, rectangular design and 2 m³ in capacity (Figure 4). Stocked fish were hatchery-bred and feeding was by hand and/or by auto feeders using commercially available, extruded pellets. All systems were standardised where appropriate with respect to design, and all treatments were replicated to enable statistical analysis where appropriate.

Analysis of fish growth (%SGR) and survival rates for relevant trials were analysed where appropriate using the SAS General Linear Models Procedure and Tukey's Multiple Range Test, following testing for homogeneity using Cochran's Test (SAS Institute Inc. 1990). Standard error bars for all graphs were generated from SAS and were equal to two standard deviations of the mean.

A full suite of water quality parameters was measured for the purpose of correlating with fish production levels, and for evaluating the level of environmental impact on the culture waters themselves. Parameters measured included total ammonia as nitrogen (TAN), pH, total phosphorus (surface and sediment), dissolved oxygen, temperature, total alkalinity, suspended solids, conductivity, Secchi disk depth and turbidity. Measurements were replicated and water samples were collected weekly from two sites, viz. one from among the cages and a second at a reference point 200 m away from the cages.

In this paper, only summary results of selected biotechnical and water quality parameters measured and analysed during the present study are presented. A more detailed description of experimental design and results is provided by Ingram et al. (1999).

Nutrient mass balance model

In natural waters, phosphorus (P) occurs predominantly as phosphate, which may be in several forms including orthophosphates, condensed phosphates and organically bound phosphates, while nitrogen (N) occurs as ammonia (NH₃), ammonium (NH₄⁺), nitrite (NO₂⁻) and nitrate (NO₃⁻) (Baldwin 1999). These may be soluble, bound to detritus or in the bodies of aquatic organisms. Nutrients in the effluent waters from a fish farm are primarily derived from feed waste (fines/dust and feed not eaten by fish), dissolved metabolic waste (NH₃) excreted from the gills of the fish and excreted faecal wastes. Nutrients discharged from fish farms are characterised by both dissolved and solid components (including suspended solids), the relative proportions of which will vary during the production cycle. Dissolved outputs are primarily composed of N in the form of ammonia and urea produced by fish metabolism (excreted wastes), and P leached from solid wastes.

The simplified nutrient mass balance model developed and utilised in the present study (Figure 5) provides the framework for quantifying estimated nutrient flux, based on target species, feed type/rate, food conversion ratio and fish stocking density, within an inland finfish cage culture system. Specifically the model derives estimated levels of N and P discharged from the cage culture system to the environment, and is based on models developed for trout farming (GBWQWG 1995b; Ingram 1999a, b) and integrated irrigation farming of silver perch (Gooley et al. 1999a, b) in Victoria. For the purposes of the economic analysis undertaken as part of the present study, P is assumed to be the primary nutrient which predominantly limits algal blooms and overall levels of eutrophication in temperate inland waters of Australia.

Simplified nutrient mass balance model

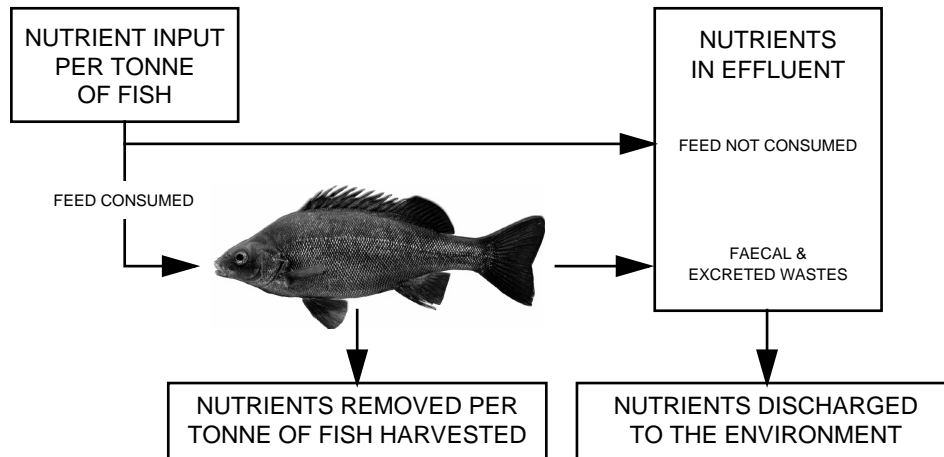

Figure 5. Simplified nutrient mass balance model showing flow and fate of nutrients (N and P) associated with feeding artificial diets to cage cultured finfish (from Gooley et al. 1999b)

Economic analysis

A conceptual economic model of cage culture in Australian lakes and reservoirs has been undertaken to determine economic viability on two levels, viz.

1) Individual cage farm cost-benefit analysis

This level is a cost-benefit analysis of any one hypothetical cage farm located in a lake or reservoir, for a range of key parameters, in terms of standard economic indices of Profit Margin (PM) and Internal Rate of Return (IRR). For this level, to analyse the impact of varying selected key fish production parameters, selected key system design parameters are fixed at nominal median values. Conversely, to analyse variation of the key system design parameters, key fish production parameters are fixed at nominal median values. For ease of analysis, some of these parameters are also linked. The range and median values, including linkages, of key parameters used in the analysis are as follows:

Fish production

- Fish stocker size (g):price (AUD\$)–7.5:1.00, 15:1.25 and 30:1.50;
- Specific growth rate (% weekly):Food Conversion Ratio–5.0:2.5, 7.5:2.0 and 10:1.5;
- Stocking density (kg/m³)–10, 15 and 20.

System design

- Total annual production (t)–1, 5 and 10;
- Cage cost (AUD\$)/m³ capacity:fish survival rate (%)–50:25, 100:50 and 150:75;
- Market sale price (AUD\$/kg)–5, 7.50 and 10.

Using an existing proprietary, spreadsheet-based, economic software package (Aquafarmer™), every combination of fixed and variable fish production and system design parameter was tested to estimate PM and IRR in order to define the hypothetical range of such parameters at which economic viability of the farm operations may be optimised. This also enables actual fish production and system design performance to be effectively benchmarked against specified economic performance indicators. Aquafarmer™ accounts for a range of capital costs, such as cage construction, depreciation etc., and variable (production) costs, including lease (of water/area), labour, seedstock, feed, maintenance etc.

The model also includes a nominal P (variable) cost to cover expected environmental impacts. The actual P cost used in the present study was fixed at AUD\$6/kg of P discharged to the environment from aquaculture, a median value estimated by Muir et al. (1999) and based largely on conventional domestic and industrial waste treatment costs in the USA. Such a P cost could theoretically be imposed as a government levy on the farmer for offsetting catchment scale nutrient remediation works, or could be a

nutrient allocation for the farm 'purchased' on a 'nutrient trading market' from the government by the farmer as part of a catchment scale 'nutrient budget'.

1) Catchment scale gross margin analysis

For this level of economic analysis, the Gross Margins (GMs) for a hypothetical reservoir or lake-based cage aquaculture enterprise are compared against known GMs for existing major irrigated agribusiness sectors in Australia at a catchment scale. The GM of each sector is defined as the value of the output of the sector less its variable costs. The most important element of the output is the market value of produce. It should be noted that in practice, GMs can therefore vary widely from one year to the next due to differences in market prices, weather conditions and efficiency.

Specifically, comparisons are made with the dairy, viticulture and horticulture sectors within the Goulburn-Broken catchment of Victoria. GMs for these sectors, along with estimates of water consumption, are routinely provided for the agricultural industry, thus enabling comparison for both GM per ha utilised and GM per ML water consumed (adapted from Downs and Sime 1999; Floyd 1999). GMs for the hypothetical cage culture enterprise are calculated using outputs of the individual cage farm cost-benefit analysis for one, five and ten t annual production scenarios of medium level financial viability, viz. 12.7, 24.1 and 25.5% PM and 7, 24 and 26% IRR respectively. For each of these scenarios, key system design and fish production parameters are set at equal values to enable direct comparisons. Also, the analysis assumes that the hypothetical cage culture operation 'borrows' at any one time (without actually consuming) a nominal five ML of water (to hold fish) and leases a nominal water surface area of one ha to support a range of fish production scenarios of one, five or ten t of marketable fish per annum.

A comparison is also provided of amounts and cost of P discharged to the environment for cage culture operations of one, five and ten t annual production, each at FCRs of 1.5, 2.0 and 2.5 respectively, and for other irrigated agribusiness sectors in the Goulburn- Broken catchment, on a per ha (surface area) and per ML (water consumed) basis. The cage farm analysis assumes a nominal median concentration of 18 kg of P/t of feed added to the system, of which an FCR dependent proportion is lost to the environment (GBWQWG 1995b). The amount of P lost to the environment for each FCR is costed to the farm at a rate of AUD\$6/kg of P (Muir et al. 1999). Estimates of P discharged to the environment and associated costs for the other

sectors are adapted from GBWQWG (1995a, b, c) and Thompson and Standen (1998).

Results

Biotechnical

A summary of key experimental parameters for pilot-scale finfish cage culture trials undertaken during the present study is presented in Tables 1–3, and Figures 6 and 7 (SGR and survival respectively).

The results indicate that, of the species tested, the highest growth and survival rates and best FCRs were achieved by rainbow trout during the spring season in Goulburn Weir, with the latter two parameters being consistent with, or exceeding, industry standards. Silver perch performed relatively poorly in all waters compared with industry standards in terms of growth rate, although relatively high survival was achieved in Goulburn Weir during the summer/autumn trial. A qualitative comparison of growth and survival rates for all trials undertaken in Goulburn Weir at different times also suggests that silver perch performed relatively poorly compared with both rainbow trout and Atlantic salmon. Similar growth rates were achieved for both Atlantic salmon and rainbow trout trials during the spring season in consecutive years, however survival for the salmon did not meet industry standards.

The relatively low growth rates of silver perch during the trials are primarily attributable to the ambient water temperatures in the GMID being less than optimal. Silver perch is at the extreme southern limit of its natural range within the GMID and under normal conditions during the irrigation season, the period of optimal growth (temperature > 23–25°C) may be as short as 6–8 weeks only. Conversely, trout and salmon have a broader range of temperatures suitable for consistent growth (12–20°C), which is more typical of the prevailing cool temperate climate in this area (see Figure 1; Tables 1–3).

The higher levels of production of both silver perch and rainbow trout at Goulburn Weir compared with the other waters, is attributable to this site being less exposed and having generally better water quality. This water body is upstream of both other sites within the catchment and water quality is typically less impacted by development and associated land use. Also, the cage site was located near to the shoreline and was reasonably protected from prevailing weather, whereas the other two sites were located in mid-water and fully exposed to wave action from prevailing winds.

At all sites and for all trials and species, FCRs, growth rates and survival were detrimentally affected by a combination of other external factors, including

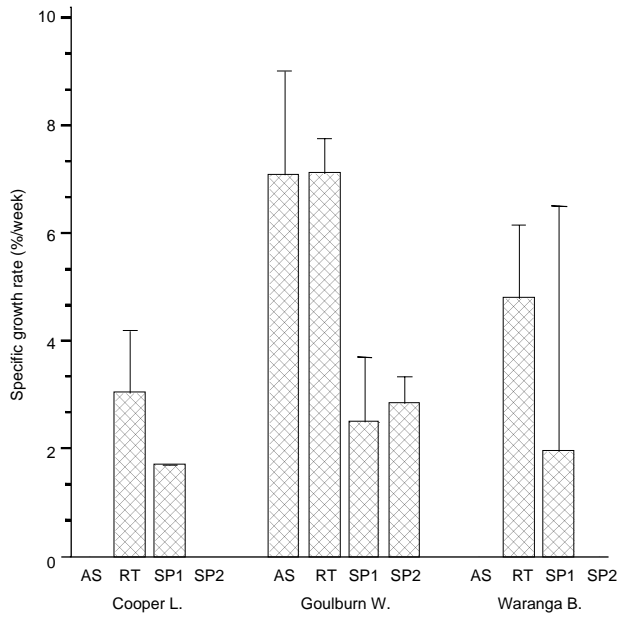

Figure 6. Comparison of Specific Growth Rates (mean and 95% confidence limits) in separate trials for Atlantic salmon (AS), rainbow trout (RT), and silver perch (SP1 for first trial and SP2 for second trial) reared in three different reservoirs within the GMID, Australia (AS and SP2 only trialed at Goulburn Weir).

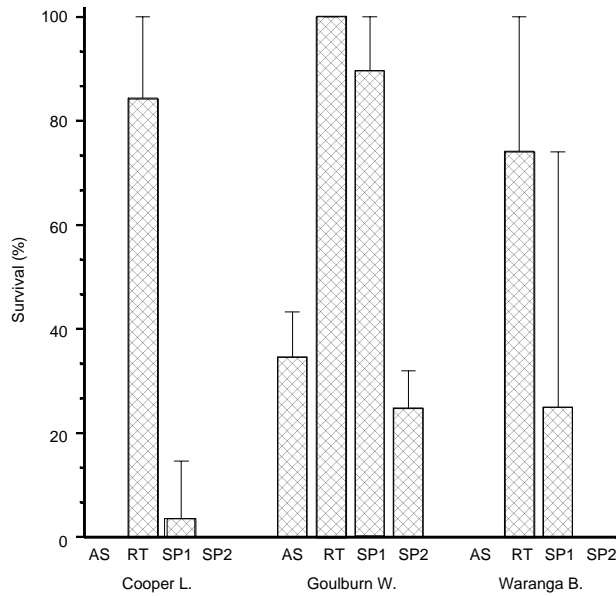

Figure 7. Comparison of survival rates (mean and 95% confidence limits) in separate trials for Atlantic salmon (AS), rainbow trout (RT), silver perch (SP1 for first trial and SP2 for second trial) reared in three different reservoirs within the GMID, Australia (AS and SP2 only trialed at Goulburn Weir).

Table 1. Summary of rainbow trout cage culture trials undertaken during spring 1997 in three irrigation storages in the Goulburn-Murray Irrigation District, Victoria, Australia, as part of the present study; weights and lengths include standard error.

	Lake Cooper	Goulburn Weir	Waranga Basin
Species	Rainbow Trout	Rainbow Trout	Rainbow Trout
Duration of Trial	17 weeks	17 weeks	17 weeks
No. fish/replicate	95	95	95
Initial Weight (g)	109 ± 3.4	114 ± 5.3	103 ± 3.1
Final Weight (g)	180 ± 4.7	372 ± 13.7	231 ± 7.9
Initial Length (mm)	203 ± 2.3	206 ± 3.0	201 ± 2.1
Final Length (mm)	234 ± 2.0	286 ± 3.6	256 ± 3.0
SGR (%/week)*	3.06 (10)	7.35 (10)	5.12 (10)
FCR*	4.46 (1.5–2.5)	1.79 (1.5–2.5)	2.66 (1.5–2.5)
Survival* (%)	85 (90–95)	100 (90–95)	74 (90–95)
Water Temp. °C mean (range)	12 (6–19)	12 (9–18)	12 (7–17)

* industry standard in parentheses

Table 2. Summary of silver perch cage culture trials undertaken during summer/autumn 1996/7 in three irrigation storages in the Goulburn-Murray Irrigation District, Victoria, Australia, as part of the present study; weights and lengths include standard error.

	Lake Cooper	Goulburn Weir	Waranga Basin
Species	Silver Perch	Silver Perch	Silver Perch
Duration of Trial	23	23	23
No. fish/replicate	100	100	100
Initial Weight (g)	134 ± 8.4	115 ± 8.4	131 ± 7.2
Final Weight (g)	203 ± 26.3	219 ± 13.4	238 ± 14.9
Initial Length (mm)	203 ± 3.8	189 ± 4.9	204 ± 3.6
Final Length (mm)	226 ± 8.7	231 ± 3.9	243 ± 4.8
SGR (%/week)*	1.73 (7–10)	2.82 (7–10)	2.66 (7–10)
Survival (%)*	3.5 (90–95)	89.8 (90–95)	25.0 (90–95)
Water Temp. °C mean (range)	19 (13–26)	17 (14–22)	18 (12–25)

* industry standard in parentheses

Table 3. Summary of finfish cage culture trials for a range of species and seasonal conditions undertaken during 1996–99 in Goulburn Weir, Victoria, Australia, as part of the present study; weights and lengths include standard error.

	Atlantic salmon		Silver perch		Rainbow trout
	Spring	Summer/Autumn	Summer	Spring	
Duration of trial	8 weeks	23 weeks	20 weeks	17 weeks	
No. fish/replicate	100	100	100	100	
Initial weight (g)	57 ± 0.71	115 ± 8.34	101 ± 1.46	114 ± 5.3	
Final weight (g)	101 ± 1.89	219 ± 13.4	177 ± 5.31	372 ± 13.7	
Initial length (mm)	170 ± 0.69	189 ± 4.9	185.4 ± 0.85	206 ± 3.0	
Final length (mm)	208 (± 1.26)	231 (± 3.87)	221 (± 1.88)	286 ± 3.6	
SGR (%/week)*	7.23 (7–10)	2.82 (7–10)	2.81 (7–10)	7.35 (10)	
Survival (%)*	34.5 (90–95)	89.8 (90–95)	24.8 (90–95)	100 (90–95)	
Water temp. °C mean (range)	20 (17–23)	17 (14–22)	20 (13–24)	12 (9–18)	

predation by the endemic water rat, *Hydromys* sp., chronic harassment by cohabitant carp, *Cyprinus carpio*, and cormorants, *Phalacrocorax* sp., and periodic interference by human intruders (e.g. Figure 4). Other problems included cage design faults which resulted in escapement of fish and intrusion of pest species (e.g. carp), theft of fish by human intruders, stress related mortalities during acclimation of fish in cages following transport and handling, and restricted access to offshore cages for feeding purposes during poor weather conditions.

All water quality parameters measured during the trials in the present study were deemed to be generally within the range suitable for commercial production of the target species, although not necessarily optimal. Specific limitations included ambient water temperatures < 23–25°C during silver perch trials (Tables 2 and 3) which negatively impacted on growth rates for about 50% of the duration of the two trials for this species in all waters, and high ambient nutrient loadings in Lake Cooper as a result of irrigation drainage, which caused significant biofouling on the cages. Site specific water quality impacts from the trials, as measured by Total P, were considered negligible compared with controls (Figure 8).

Nutrient mass balance model

According to *Nutrient Loads from Intensive Animal Industries in the Goulburn-Broken Catchment* (GBWQWG 1995b), existing land-based trout farms contribute to the catchment approximately 68–95 kg N/t and 16–27 kg P/t of fish produced. These figures, however, are based on a simplified nutrient mass balance model for rainbow trout farming only. There is no information on the relative nutrient contribution to the environment of other potential fish farming practices, including the cage culture of silver perch, rainbow trout and Atlantic salmon in Australian lakes or reservoirs.

The two main sources of N and P on fish farming operations are the fish themselves, and the feeds fed to the fish (Figure 5). The N and P content in commercially available feeds for the fish studied range from 5.5 to 8.5% (median 7.0%) and 1.0 to 2.04% (median 1.5%), respectively (Table 4). N and P in excess of the requirements of the fish are excreted. The N and P content of whole fish is approximately 2.0–3.4% and 0.4–1.2% of fresh weight, respectively (Table 5). Considerable diurnal and seasonal variations occur in concentrations of N and P in effluent water discharged from fish farming operations,

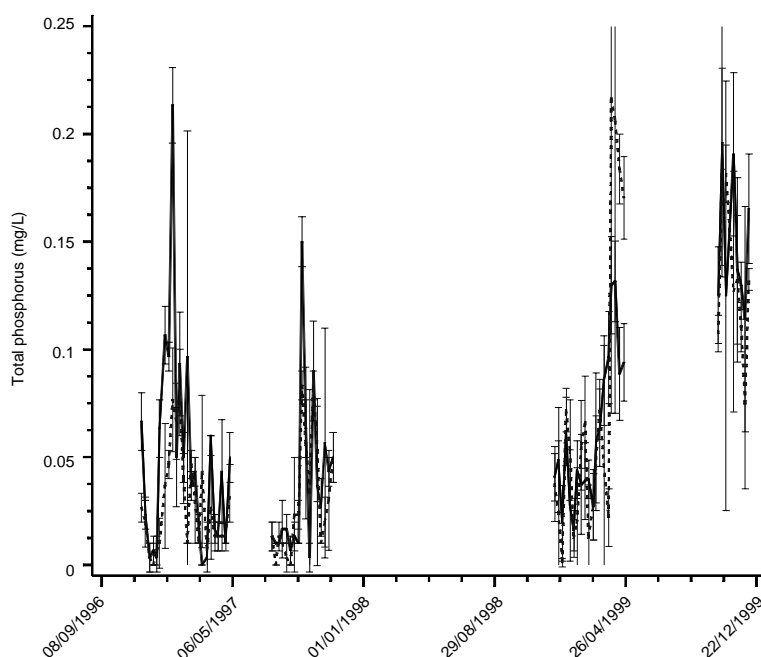

Figure 8. Phosphorus concentrations (mean \pm standard error) in water amongst cages (solid line) and at a control point 200 meters from the cages (dashed line) for the four trials conducted at Goulburn Weir only.

Table 4. N and P content of fish feeds and recommended feed rates as used during the present study.

Fish Species	Feed size	P in feed (%)	N in feed (%)	Recommended feed rate (% body wt)
Silver perch ¹	Grower	1.2–1.6	6.1–7.2	1–3
Rainbow trout ^{1,2}	Grower	1.24–2.04	5.5–7.0	0.7–3.3
Atlantic salmon ^{3,4}	Grower	1.0–2.0	6.1–8.5	0.4–2.6

¹ Source: Ridley Corporation Ltd.

² Source: Ridley Corporation Ltd.; Ingram and Pettit (1996).

³ Source: Piedrahita (1994).

⁴ Source: Gibson's (1998).

Table 5. Estimated P and N content of fish species used in the present study.

Fish Species	P content fresh weight (%)	N content fresh weight (%)	Source
Silver perch	0.8–1.2	3.0–3.4	De Silva, Deakin University (pers comm.)
Rainbow trout	0.4–0.45	2.7–2.8	Ingram and Pettit (1996)
Atlantic salmon	0.4–0.6	2–3	Piedrahita (1994)

which may be related to fish activity and feeding regimes, feed types, harvesting etc. For more detailed analysis, appropriate monitoring regimes need to be established to take into account these variations and to obtain accurate information on waste outputs from farms.

All variables presented in the model are represented as kg of total nitrogen and total phosphorus per t of fish produced (e.g. kg P/t). The FCR is the mass (wet weight) of food consumed by fish divided by the increase in mass (wet weight) of fish. FCRs derived from experiments conducted during the present study were highly variable (e.g. Table 1). It is thought that due to relatively low survival in several of the trials, much feed may have drifted out of, or sunk through, the cages and not consumed by fish. Therefore, in the model, FCR values of between 0.7 and 2.3 were used which represent a range of published FCRs for the species used in the trials (Table 6).

Table 6. FCR values determined for silver perch and rainbow trout.

Species	FCR	Source
Silver perch	0.7–2.3	Rowland (1994, 1995); Rowland et al. (1995)
Rainbow trout	0.95–1.53	Ingram and Pettit (1996)

Less than 5%, to as much as 30%, of fish feed is not consumed by fish (Cho et al. 1991). This component represents both dust and uneaten pellets, which either sink through the bottom of the cage, sink to the bottom of the pond, or otherwise flow out of the cage. The amount of feed not consumed in silver perch culture units is not known. In practice, the amount of uneaten food lost from silver perch culture units will depend on the ability of the farmer to provide the correct amount of quality food (i.e. with minimal dust) to avoid over-feeding.

Using the lowest and highest values presented for the P content of feed, FCR and P content of fish, the amount of P discharged to the environment is estimated in the model to range from less than zero (where FCR was lowest and P content highest), to 28.8 kg P/t fish (Table 7). When compared to the performance of other major sources of nutrients in the catchment, the model suggests that a cage culture industry of up to 2000 t per annum based in lakes and reservoirs within the Goulburn-Broken catchment, would impose a P loading on the environment comparable to existing intensive animal industries, but less than for dryland farming, urban, sewage and irrigation sources (Figure 9). It should be noted that the primary source of P for the existing intensive animal industries sector is from an existing 1000+ t per annum, land-based rainbow trout farming industry based in the catchment (GBWQWG 1995b).

Table 7. The amount of P discharged to the environment from a hypothetical lake or reservoir-based cage culture system, as estimated in the present study.

P in feed (low & high) (%)	FCR (low & high)	P% in fish (low & high)	P discharged (kg P/t fish)
1.2	0.7	0.8	0.4
1.2	0.7	1.2	-3.6
1.2	2.3	0.8	19.6
1.2	2.3	1.2	15.6
1.6	0.7	0.8	3.2
1.6	0.7	1.2	-0.8
1.6	2.3	0.8	28.8
1.6	2.3	1.2	24.8

Economic analysis

1) Individual cage farm cost-benefit analysis

A summary of profitability (PM and IRR) for a range of key cage culture fish production parameters, with key, median, fixed-value system design and capacity parameters for a hypothetical lake or reservoir-based enterprise is provided in Table 8. The same information is provided for a range of key cage culture system design and capacity parameters, with median

level fish production parameters fixed, in Table 9. All fixed values are as previously outlined. Only profitable (positive PM and IRR) combinations of fish production and system design are shown. All other combinations were found to be unprofitable (negative PM and/or IRR).

Table 8. Summary of profitability for range of key cage culture fish production parameters, with key, median, fixed-value system design and capacity parameters for a hypothetical lake or reservoir-based enterprise.

Fish stockers (AUD\$/g)	Growth-FCR (%SGR)	Stock density (kg/m ³)	PM %	IRR %
1.00-7.5	10-1.5	10	18.1	6
1.25-15	10-1.5	10	23.2	12
1.50-30	10-1.5	10	26.6	15
1.50-30	7.5-2.0	15	9.5	1
1.00-7.5	10-1.5	15	21.2	20
1.25-15	10-1.5	15	26.6	27
1.50-30	10-1.5	15	30	31
1.50-30	7.5-2.0	20	11.1	11
1.00-7.5	10-1.5	20	23.1	33
1.25-15	10-1.5	20	28.2	41
1.50-30	10-1.5	20	31.7	46

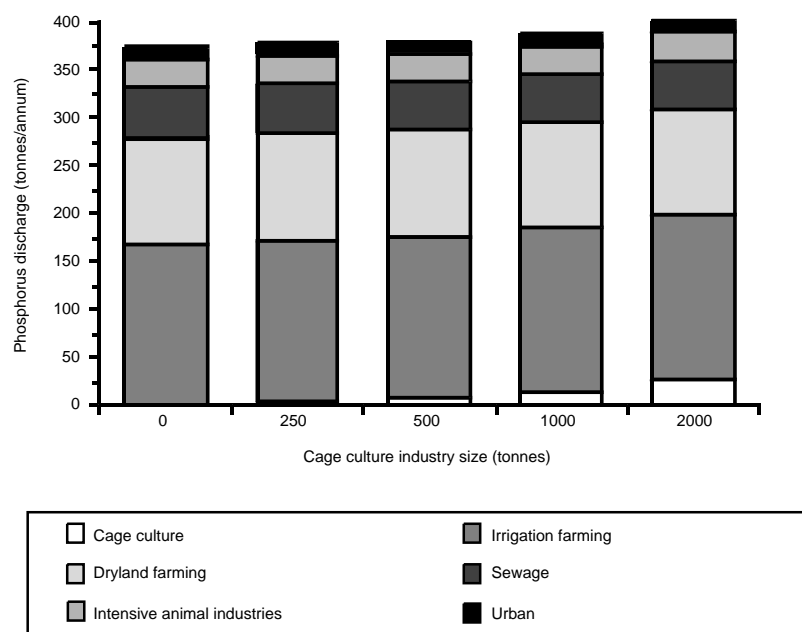

Figure 9. Contribution of cage culture in reservoirs at different production levels to the Goulburn-Broken Catchment phosphorus loading (based on median value of 14.4 kg P/t fish) (i.e. median of 0 to 28.8 as determined in the model). Figures for each sector obtained from the GBWQWG (1995b). Note that these are figures for the 1993/94 period, and have not been updated since then, but there have been some reductions in P discharge in some sectors during this period.

Table 9. Summary of profitability for range of key cage culture system design and capacity parameters with key, median, fixed-value fish production parameters for a hypothetical lake or reservoir-based enterprise.

Production (t pa)	Cage cost–fish survival (AUD\$/m ³ -%)	Market price (AUD\$/kg)	Profit margin (%)	IRR (%)
1	100–50	10	6.9	1
5	100–50	10	15.4	19
10	100–50	10	16.5	21
1	150–75	10	12.1	4
5	150–75	10	20.6	16
10	150–75	10	21.7	17

The results indicate that profitability increases with stocker size (and price), at all stocking densities, and that growth rate and FCR must be optimal in most cases in order to achieve profitability. When analysing the results the most sensitive variable is market price for the final fish product (\$/kg). If a premium product can be produced to achieve the appropriate price required by the farmer then the influence of this variable will outweigh all other costs. At a market price of AUD\$10/kg, profitability can be achieved at all production capacities, but improves markedly between one and five t per annum, and only marginally by increasing from five to ten t per annum. The most appropriate annual production level therefore is considered to be 5 t, because the marginal difference in profitability between 1 and 5 t is far greater than from 5 to 10 and the risk much less. Profitability is also higher using more expensive cages to achieve higher survival rates (linked parameters) i.e. cage costs of at least AUD\$100/m³ cost to achieve fish survival of at least 50% during production.

2) Catchment scale Gross Margin analysis

A comparison of rates and costs of P discharged to the environment and GMs for existing irrigated

agribusiness sectors and a hypothetical lake or reservoir-based finfish cage culture operation of varying production capacities in the Goulburn-Broken catchment, is provided on a per ha of surface area occupied and per ML of water utilised/consumed basis in Tables 10–12.

Table 10. Quantity and cost of P discharged to the environment from a hypothetical, lake or reservoir based cage culture enterprise for a range of fish production capacities and FCRs.

Production 1 t	P kg/ha	P cost \$/ha	P kg/ML
FCR = 1.5	22	132	4.4
FCR = 2.0	31	186	6.2
FCR = 2.5	40	240	8
Production 5 t			
FCR = 1.5	110	660	22
FCR = 2.0	155	930	31
FCR = 2.5	200	1200	40
Production 10 t			
FCR = 1.5	220	1220	44
FCR = 2.0	310	1860	62
FCR = 2.5	400	2400	80

The results indicate that rates and cost of P discharged to the environment from the hypothetical cage culture operation increases proportionately with tonnage and FCR, exceed existing horticulture and dairy sectors in most cases on a per ha basis, but are consistent with or lower than dairy at all production levels on a per ML basis. GMs for cage culture are consistent with or higher than most other sectors on both a per ha and per ML basis at fish production levels of 5–10 t per annum. It should be noted, however, that projected GMs for commercial finfish cage culture operations recognise the real/full cost of P

Table 11. Comparison of rates of P discharge to the environment, per ha of surface area occupied and per ML of water consumed/utilised, for existing major irrigated agribusiness sectors in the Goulburn-Broken catchment of Victoria, and a hypothetical lake or reservoir-based, finfish cage culture operation with one, five or ten t per annum production (FCR set at 2:1; all other key parameters set to achieve average profitability).

Industry Sectors	P kg/ha	P cost AUD\$/ha	P kg/ML	P cost AUD\$/ML
Dairy (pasture & shed waste)	270.9	61.6	57	448
Horticulture (fruit/grapes, vegetables)	2.03	16.24	0.4	3.25
Aquaculture (1 t–FCR 2.0)	31	186	6.2	37.20
Aquaculture (5 t–FCR 2.0)	155	930	31	186
Aquaculture (10 t–FCR 2.0)	310	1860	62	372

discharged to the environment, whereas the published GMs for other sectors do not. The effect of including the full cost of such environmental externalities on existing irrigated agribusiness sectors is likely to further increase the relative profitability of cage aquaculture by comparison on a GM basis. These results also reflect the fact that cage aquaculture in lakes and reservoirs is essentially a non-consumptive water use compared with other irrigated agribusiness sectors, thus providing cage aquaculture with a major competitive advantage.

Table 12. Comparison of Gross Margins per ha of surface area occupied and per ML of water consumed/utilised by the enterprise for existing major irrigated agribusiness sectors in the Goulburn-Broken catchment of Victoria, and a hypothetical lake or reservoir-based finfish cage culture operation with one, five or ten t annual production (all other parameters set to achieve average profitability).

Industry sectors	Gross margin AUD\$/ha	Gross margin AUD\$/ML
Viticulture (Wine grapes)	14 010	2 802
Viticulture (Table grapes)	6 296	1 049
Dairy	801	133
Horticulture (Stonefruit)	13 237	1 927
Cage aquaculture @ 1 t pa	1 335	273
Cage aquaculture @ 5 t pa	12 696	2 539
Cage aquaculture @ 10 t pa	26 863	5 372

Discussion

In the present study, results of the field trials indicate that small-scale cage culture in lakes and reservoirs within the GMID is biotechnically feasible, if not optimal, for at least some species in which suitable water quality and ambient water temperatures can be achieved. Indeed, no one trial was considered to have achieved commercially viable standards in all respects. One practical problem experienced at all sites was the fact that the surface area:volume ratio of the cages was limited by the relatively shallow mean water depth (2–3 m) of the storages. The actual depth, surface area and associated footprint of the cages for any potential commercial-scale production would also therefore be similarly constrained.

Nonetheless, Goulburn Weir achieved the best result for all tested species when sites (lakes and reservoirs) were compared. This was thought to be a result of better overall water quality and better protection for the cages at this site, compared to the other sites. The fact that Goulburn Weir is an on-river, upstream (more elevated) storage compared

with the other sites (both downstream, off-river storages) means that it is more routinely flushed with cooler, higher quality water. Such flushing is known to moderate nutrient levels and associated water quality impacts (Zampatti et al. 1996), as well as moderating the effects of ambient summer temperatures (Tables 1–3).

Specifically, FCR and survival, but not growth rate, of cage-reared rainbow trout achieved industry standards in Goulburn Weir, but not in other waters. Conversely, Atlantic salmon achieved commercial growth but not survival rates, and silver perch achieved commercial survival but not growth rates in Goulburn Weir (Rowland 1994, 1995; Rowland et al. 1995; Ingram and Pettit 1996).

Although stocking densities were set initially at conservative rates in all trials ($\leq 5 \text{ kg/m}^3$) to ensure that density was not a limiting factor to production, it is also noted that high variability in subsequent growth and survival rates at all sites dictated that subsequent stocking densities were equally variable (range approx. 2–20 kg/m^3) throughout and at the completion of the trials. This is likely therefore to have had some confounding effect on overall production.

Overall, the results of the present study suggest that ambient conditions in the GMID generally appear to be more conducive to autumn-spring production of cold water salmonid species in upper level water storages, when compared with warmer water species such as silver perch. The latter species are thought likely to be more suited to cage rearing at more northerly latitudes and at lower elevations within the Murray-Darling Basin. Improved system design to reduce impacts from predatory and nuisance species is also thought likely to significantly improve productivity and economic viability of all culture species at all sites. Indeed cage culture of selected finfish in Waranga Basin and/or Lake Cooper, including both warm and cold water species, may also yet prove to be feasible with such improved designs, albeit perhaps on a somewhat short-term, seasonal basis.

Increased risk of eutrophication of surrounding waters is one of the major environmental impacts resulting from semi-intensive cage culture of finfish in public waters. The greatest risk is from phosphorus (P), often considered the major nutrient limiting algal growth and eutrophication in natural freshwater systems. Dissolved (soluble) P directly affects water quality and is immediately available as a nutrient for plant growth. Studies on the impacts of phosphorus discharge from cage culture of salmonids in Scottish lakes indicate that physical characteristics of the lakes, including flushing rates, are key constraints to development. Furthermore, it is known

that phosphorus is relatively insoluble in freshwater lakes and if it reaches the substrate up to 50% tends to remain bound in the sediment under aerobic conditions (Gavine et al. 1995). However, it is also noted that if the cages are badly sited, an accumulation of sedimentary P can occur which under anaerobic conditions may result in a regeneration of phosphorus into the water column (Gavine et al. 1995). The types and amount of phosphorus escaping into the environment is also significantly impacted by feed quality, FCRs, fish size and management practices (e.g. Gavine et al. 1995; Ingram and Petit 1996). The clear management implication for future development in Australia is therefore to ensure that site selection for cage culture in lakes and reservoirs needs to be undertaken in a responsible manner following an initial, comprehensive environmental impact assessment, as well as subsequent employment of Best Practice farm design and operational guidelines.

The impact on phosphorus levels of freshwater cage culture in Scotland and Australia has previously been assessed using a mass balance approach by Beveridge (1984) and Gooley et al. (1999) respectively. The combination of these models can be used to determine both the total P loading on the environment from a given culture system, as well as the impact of that phosphorus on the immediate aquatic environment in which the culture system is located. In the present study, the immediate site-specific impacts of the cage trials on total P were predictably negligible, given the relatively small scale of P inputs and associated high dilution of discharged nutrients, although some accumulation of sedimentary P directly below the cages was observed.

Nevertheless, the cumulative impact of larger scale cage aquaculture at a catchment scale may be more significant and the use of the Conceptual Nutrient Mass Balance model, as developed in the present study, is considered to be an appropriate management tool. Although Goulburn Weir is a relatively well-flushed storage, thus ensuring adequate dispersal of nutrients from various sources, the mass balance evaluation of the downstream cumulative impacts of nutrient emissions are critical to overall sustainability of any existing or potential agri-business enterprise within the catchment, including aquaculture. This approach is also being considered presently by the Western Australian government as one means by which the potential environmental impact of increasing barramundi cage culture production in Lake Argyle will be assessed (Gooley et al. 1999a).

Economic analysis indicates the need to optimise system design and fish production parameters, and that commercial scale operations at 5–10 t per annum are most likely to be viable. Marketing of cage

cultured produce will need to be addressed to ensure that optimal sale prices can be achieved. The co-operative production and marketing of multiple, small-scale operations conveniently located within the same or adjacent waters is considered a possible option.

At a catchment scale, the fact that cage culture of finfish in lakes and reservoirs potentially can accommodate effective recovery of full external (environmental) costs of water usage, potentially offers investors a significant competitive advantage over other irrigated agribusiness sectors. Specifically, the concept of a nutrient budget, as used in the present study, is intended to provide the framework for recovering the full cost of water delivery and utilisation by agribusiness and aquaculture sectors, as part of a process to facilitate more equitable and cost-effective allocation of related environmental costs. If applied in practice, these arrangements would provide incentive for farmers to direct investment towards production of those commodities that provide higher levels of profitability. Proponents of finfish cage culture in Australia necessarily should factor in such hypothetical costs in order to realistically address what will otherwise be a potentially major constraint at this early formative stage of industry development.

General Conclusions

In a report to the Council of Australian Governments (HLSGOW 1999), an outline of processes which have been put in place to facilitate the ongoing reform and restructure of the Australian water industry is presented. Key imperatives include the need to address the longer term ecological sustainability of irrigation water usage, the need to provide the flexibility for commercial water usage to move to higher value commodities, and the need to fully account for the external costs associated with irrigation water usage (e.g. eutrophication and salinisation of inland waterways) (HLSGOW 1999; Thomas 1999). By way of example, the full external costs (including environmental clean-up costs) in Britain of farming specifically have been quoted as exceeding £2.3 billion annually, almost equal to the industry's income (Pearce 1999).

Accordingly, the ability to commercially trade in water, salt and nutrient allocations at a catchment and/or basin scale is considered to be a logical, probably inevitable, outcomes of this reform process in the medium to longer term. Holland and Brown (1999) infer that resource conflicts in aquaculture are partly attributable to society's conventional, but otherwise inappropriate reliance on markets. They further suggest that in the absence of efficient

markets, inefficient allocation of resources may result to the detriment of aquaculture development, but that increased use of more appropriate economic instruments may have the reverse effect.

A combination of economic and environmental assessment in the present study indicates that cage aquaculture as a potential commercial enterprise in lakes and reservoirs compares favourably with existing irrigated agribusiness sectors in the GMID. This comparison, therefore, also dictates the need that such forms of aquaculture should be considered equitably by resource managers and the community in the ongoing water resource allocation process.

In the case of the Murray-Darling Basin, it is now generally agreed that water diversion is at, or in some cases has exceeded, maximum sustainable levels. Specifically, almost half of the mean annual runoff from the Basin has been diverted for urban, industrial and agricultural use, with about 95% of the water being diverted for the irrigation industry. This scenario seriously threatens not only the environmental integrity of the largest river basin in the country, draining catchments across four States, but also threatens the longer term viability of the dependent industries. Accordingly, from July 1997, the Murray-Darling Basin Ministerial Council has set an upper limit on the amount of water that can be taken from the river system (Gooley 2000; Thomas 1999). In short, there is no more water to exploit from this basin, and further industry growth will need to come from more efficient and/or multiple water use, and a shift increasingly towards higher value production (Gooley 2000).

These imperatives are considered consistent with apparent opportunities for the commercial cage culture of finfish in Australian lakes and reservoirs. Now, however, commercial inland cage culture in public waters is limited exclusively to Lake Argyle in Western Australia (Gooley et al. 1999a; Kolkovski et al. 1999). It is also recognised that natural resource management agencies generally lack effective policy and planning processes and information to effectively evaluate and facilitate new opportunities. Economic analysis to date has been informal and ad hoc, limited to site specific applications only, with no attempt to recover full external costs associated with the environmental impacts of water usage in any sector. There has also been no catchment scale economic analysis of cage aquaculture, nor any attempt to compare potential economic returns on water usage or nutrients discharged across such new and existing agribusiness sectors.

The scale of such resources and infrastructure which exists within the irrigated farming sector in Australia clearly offers considerable scope for diversification into aquaculture, and specifically cage

culture of finfish in public lakes and reservoirs. However, in combination with the broader environmental imperatives, there is also clearly great potential for increasing the effectiveness and efficiency of irrigation water resources. Improving both economic return from this water and overall sustainability of the resource, by the development of multiple use strategies through integration of agriculture and aquaculture farming systems, has intrinsic merit for Australian primary industries and rural communities. Further opportunities may also exist in the use of hydro-electric water storages such as in Tasmania (Anon. 1999). Indeed, the fact that cage aquaculture is a non-consumptive user of water provides it with a significant inherent advantage over all existing and potential commercial, consumptive water users in the water resource allocation process.

The present study partly addresses these information gaps and will facilitate the formulation of draft Best Practice technical and environmental management guidelines for cage culture in Australian lakes and reservoirs. However, on final a cautionary note, notwithstanding commercial trends and potential in the Australian water industry, likely resource management, environmental and multiple use conflicts will need to be comprehensively evaluated and effectively resolved through development of appropriate government policy and legislative support, before any significant expansion of the inland cage culture sector could be envisaged in Australian lakes and reservoirs.

Acknowledgments

Funding support for this case study was provided by the Australian Centre for International Agricultural Research (ACIAR) and the Victorian Department of Natural Resources and Environment (Fisheries Victoria, Australia). In kind assistance was provided by Goulburn-Murray Water, through provision of access to study sites in the GMID, and through the assistance of Kevin Preece and Steve Hall. Technical staff of the Marine and Freshwater Resources Institute (MAFRI), and local residents, including Keith Holland, Vic Henry and Dave Francis assisted with field trials; Peter Rawlinson (Fisheries Victoria) assisted with the Aquafarmer™ analysis and general economic modelling; Stuart Vallis (MAFRI) assisted with photographs and Wayne Fulton (MAFRI) provided comment on the manuscript. The support and contributions provided collectively by all of these agencies and individuals is greatly appreciated by the authors.

References

- Anon. 1999. Government policy on inland cage culture in Tasmania. On the Rise, Tasmanian Inland Fisheries Service Newsletter, 28:3, 6.
- Baldwin, D.S. 1999. Nutrients in freshwater ecosystems. In: Ingram, B.A. ed. Towards Best Practice in Land-based Salmonid Farming: Options for Treatment, Re-use and Disposal of Effluent. Marine and Freshwater Resources Institute, Alexandra, 18–25.
- Beveridge, M.C.M. 1984. Cage and Pen Fish Farming: Carrying Capacity Models and Environmental Impact. FAO Fisheries Technical Paper 255. FIRI/T255. FAO, Rome. 131 p.
- Cho, C.Y., Hynes, J.D., Wood, K.R. and Yoshida, H.K. 1991. Quantitation of fish culture wastes by biological (nutritional) and chemical (limnological) methods: the development of high nutrient dense (HND) diets. In: Cowey, C.D. and Cho, C.Y. ed. Nutritional Strategies and Aquaculture Waste. Proceedings of the First International Symposium on Nutritional Strategies in Management of Aquaculture Waste. Fish Nutrition Research Laboratory, University of Guelph, Guelph, Ontario.
- Downs, A. and Sime, A. 1999. Horticultural gross margins for the Loddon Murray Region. 1999–2000. Department of Natural Resources and Environment. Victoria.
- Floyd, P. 1999. North-East Gross Margins, 1998–1999. Department of Natural Resources and Environment, Farm Smart. Victoria.
- Gavine, F.M., Phillips, M.J. and Murray, A. 1995. Influence of improved feed quality and food conversion ratios on phosphorus loadings from cage culture of rainbow trout, *Oncorhynchus mykiss* (Walbaum), in freshwater lakes. Aquaculture Research, 26: 483–495.
- GBWQWG 1995a. Dryland diffuse source nutrients for Goulburn Broken Catchment. Goulburn Broken Water Quality Working Group Issues Paper No. 2.
- 1995b. Nutrient Loads from Intensive Animal Industries in the Goulburn Broken Catchment. Goulburn Broken Water Quality Working Group Issues Paper No. 3.
- 1995c. Nutrients in irrigation drainage water from the Goulburn and Broken Catchments. Goulburn Broken Water Quality Working Group Issues paper.
- Gibson's 1998. Feed Management Guidelines for Salmonids. Gibson's Limited, Rosny, Tasmania, 137 p.
- Gooley, G.J. 2000. R&D Plan for Integrated Agri-Aquaculture Systems 1999–2004. A report from a workshop in September 1998. RIRDC Publication No. 99/153. Rural Industries R&D Corporation, Canberra, 32 p.
- Gooley, G.J., De Silva, S.S., Hone, P.W., McKinnon, L.J. and Ingram, B.A. 1999a. Cage aquaculture in Australia: A developed country perspective with reference to integrated aquaculture development within inland waters. In: Proceedings of First International Symposium on Cage Aquaculture in Asia, Tungkang, Taiwan, 2–6 November, 1999 (in press).
- Gooley, G.J., McKinnon, L.J., Ingram, B.A. and Gasior, R. 1999b. Agriculture/aquaculture systems integration to enhance farm productivity and water use efficiency. Final Report to the Rural Industries Research and Development Corporation, Canberra, Australia, (in press).
- Holland, P. and Brown, D. 1999. Resource conflicts in aquaculture: international experiences. Aquaculture Magazine, November/December, 39–46, 48.
- Hallows, P.J. and Thompson, D.G. 1997. The History of Irrigation in Australia. Australian National Committee on Irrigation and Drainage. 126 p.
- HLSGOW 1999. Progress in implementation of the COAG water reform framework. Report to the Council of Australian Governments by the High Level Steering Group On Water, Occasional Paper Number 1, Canberra, Australia, 113 p.
- Ingram, B.A. 1999a. An interactive software program for estimation of nitrogen and phosphorus levels discharged from trout farms. In: Ingram, B.A. ed. Towards Best Practice in Land-based Salmonid Farming: Options for Treatment, Re-use and Disposal of Effluent. Marine and Freshwater Resources Institute, Alexandra, 42–49.
- (1999b). A phosphorus model for trout farming in the Goulburn-Broken Catchment. In: Ingram, B.A. ed. Towards Best Practice in Land-based Salmonid Farming: Options for Treatment, Re-use and Disposal of Effluent. Marine and Freshwater Resources Institute, Alexandra, 26–41.
- Ingram, B. and Pettit, J. 1996. The effects of feed type on the feeding and growth of rainbow trout and the quality of discharge water. Report prepared on behalf of the Australian Trout & Salmon Farmers Association to obtain information for its members, the Environmental Protection Authority, Ridley Agriproducts Pty. Ltd. and Gibson's Ltd. Marine and Freshwater Resources Institute, Alexandra.
- Ingram, B.A., Gooley, G.J., McKinnon, L.J. and De Silva, S.S. 1999. Aquaculture-agriculture systems integration: an Australian perspective. Fisheries Management and Ecology, 6: 1–11.
- Kolkovski, S., Jenkins, G.L. and Lee, C.L. 1999. Cage aquaculture in Western Australia: Current status and future plans. In: Proceedings of First International Symposium on Cage Aquaculture in Asia, Tungkang, Taiwan, 2–6 November, 1999 (in press).
- Muir, J.F., Brugere, C., Young, J.A. and Stewart, J.A. 1999. The solution to pollution: the value and limitations of environmental economics in guiding aquaculture development. Aquaculture Economics and Management, 3: 1.
- O'Sullivan, D. and Roberts, N. 1999. Status of Australian aquaculture in 1997/98. In: Austasia Aquaculture Trade Directory 1999, 14–28. Turtle Press, Hobart, Tasmania.
- Pearce, F. 1999. Crops without profit. New Scientist, 18 December, 1999: 10.
- Piedrahita, R.H. 1994. Managing environmental impacts in aquaculture. Bulletin of the National Research Institute of Aquaculture Suppl. 1: 13–20.
- Rowland, S.J. 1994. Preliminary evaluation of the Australian freshwater fish silver perch, *Bidyanus bidyanus*, for pond culture. Journal of Applied Aquaculture, 4(1): 39–48.
- Rowland, S.J. 1995. High density pond culture of silver perch, *Bidyanus bidyanus*. Asian Fisheries Science, 8: 73–79.

- Rowland, S.J., Allan, G.L., Hollis, M. and Pontifex, T. 1995. Production of the Australian freshwater silver perch, *Bidyanus bidyanus* (Mitchell), at two densities in earthen ponds. *Aquaculture*, 130: 317–328.
- Thomas, J.F. 1999. Water and the Australian economy. Australian Academy of Technological Sciences and Engineering. Community Summary, April, 1999, Parkville, Victoria. 18 p.
- Thompson, C. and Standen, R. 1998. Managing nutrients on irrigated dairy farms. Goulburn Broken Catchment Management Authority. Victorian Nutrient Management Initiative.
- Zampatti, B., Loone, J. and Hunter, K. 1996. Lake Nagambie Water Quality Study Final Report. Water EcoScience Report No. 57/96. Water EcoScience Pty Ltd, Melbourne, 37 p.

Cage Rearing of Fry to Fingerling of Carp Species in Large Reservoirs in Northern Vietnam

Bui T. Anh and Nguyen H. Son¹

Abstract

In North of Vietnam, culture-based fisheries and small scale aquaculture is often constrained by the lack of suitably sized seed stock. Although large amounts of fry are produced there is dearth of fingerlings for stocking purposes, thereby inducing fry to be stocked for aquaculture and culture-based fisheries. The present experiments were instigated to evaluate the feasibility of using cage culture technology, in large reservoirs, for fry to fingerling rearing. The paper describes the results of experiments conducted in Thac Ba and Nui Coc reservoirs, in northern Vietnam, in 1997 to 1999, on the rearing of carp species. The technical, economical and environmental feasibility of fry to fingerling rearing in large reservoirs were evaluated based on experiments conducted using a randomised block design, in bamboo and net cages, when the optimal stocking density, feeding regime and cage type were determined. Water quality parameters were investigated in and outside the cages to evaluate the influence of cage culture on reservoir water quality. Finally, the data were used to determine the economic feasibility of cage rearing of fry to fingerling in large reservoirs.

THE NORTHERN mid-highland region of Viet Nam has 1705 reservoirs with an acreage of 65 629 ha, representing 69% and 36% of the total number and acreage, respectively in Viet Nam. The development of reservoir fisheries in mountain areas is also expected to generate new avenues of employment and provide an additional source of income to displaced persons who have lost their livelihood due to impoundment of larger reservoir (ACIAR 1997).

In the north of Vietnam, culture-based fisheries and small-scale aquaculture are often constrained by the lack of suitably sized seed stock. Although there is a large quantity of fry of cultured species, in particular carp species produced in north Vietnam, fingerling production has lagged behind due to economic and land constraints. Consequently, most aquaculture and culture-based fishery activities are dependent on fry for stocking purposes, resulting in higher losses during transportation and during culture.

The advantages of cage rearing are well known. Cage rearing uses utilise existing water bodies, are easy to harvest and enable fish to use the natural productivity of water bodies, such as reservoirs (Phuong 1998).

However, the nursing of fry to fingerling stage in large reservoirs has not been carried out before in the mid-highlands of Northern Vietnam. Therefore, this study was conducted between 1997–1999 with the following objectives:

- to assess the environmental effects of nursing fry in cages;
- to determine a suitable type of feed, type of cage and stocking density; and
- to evaluate the economic feasibility of rearing fry to the fingerling stage in cages.

Materials and Methods

The experiments were conducted in Thac ba reservoir, and Nui coc reservoirs in Yen Bai Thai Nguyen provinces, respectively, in the mid-highland region of Northern Vietnam, between July 1997 and November 1999.

Experimental design

In 1997 two types of cages were used: bamboo and net cages. All cages were 2 × 2 × 1.5 m and were anchored in a water depth of 3 m in each of the reservoirs. The experiments were designed to test the following: effectiveness of bamboo and net cages, the optimum stocking density for each of the cultured species (three densities were tested for each

¹Research Institute for Aquaculture No. 1, Dinh Bang, Tu Son, Bac Ninh, Vietnam. E-mail: anhhung@hn.vnn.vn

species) and commercial feed versus locally prepared feed. In all instances, the treatments were tested in triplicate and a randomised block design was used (Biradar 1986). Details of the experiments conducted are summarised in Table 1.

The experiments were based on three carp species, the choice being based on the importance of each of these in aquaculture and culture-based fisheries in the region. The three species used were, common carp (a hybrid variety) *Cyprinus carpio*, grass carp, *Ctenopharyngodon idella*, and mrigal, *Cirrhinus mrigal*.

In the course of each of the experiments, growth was monitored by sub-sampling (at least 30 fish from each treatment) fortnightly. At the end of the experiment, the number and the bulk weight of the fish were determined, and the mean was estimated by weighing a sub-sample. Feed were provided in plastic trays, morning and afternoon, approximating 10% of the biomass per day in each cage initially and reduced to about 3% gradually. Feed was in the form of crumbles and the ingredient composition of the local feeds used is given in Table 2.

Table 1. The duration, location and experimental design of fry to fingerling rearing cage trials conducted in Thac Ba and Nui coc reservoirs in mid-highland region, Northern Vietnam.

Period	Species	Treatments	Stocking densities (fry/m ²)	
			Thac ba	Nui coc
July–October, 1997	Hybrid common carp	SD ₁ -FT ₁ -CTB SD ₁ -FT ₁ -CTN SD ₂ -FT ₂ -CTB SD ₂ -FT ₂ -CTN	SD ₁ - 1250 SD ₂ - 2500	
May–August, 1998	Hybrid common carp	SD ₁ -FT ₁ -CTB SD ₁ -FT ₁ -CTN SD ₁ -FT ₂ -CTN SD ₂ -FT ₁ -CTN SD ₂ -FT ₂ -CTN SD ₃ -FT ₁ -CTN	SD ₁ - 4200 SD ₂ - 6300 SD ₃ - 8400	SD ₁ - 3280 SD ₂ - 4420 SD ₃ - 6160
September–November, 1998	Grass carp	SD ₁ -FT ₁ -CTB SD ₁ -FT ₁ -CTN SD ₁ -FT ₂ -CTN SD ₂ -FT ₁ -CTN SD ₂ -FT ₂ -CTN SD ₃ -FT ₁ -CTN	SD ₁ - 3000 SD ₂ - 4500 SD ₃ - 6000	SD ₁ - 12000 SD ₂ - 18000 SD ₃ - 24000
May–August, 1999	Hybrid common carp	SD ₁ -FT ₁ -CTB SD ₁ -FT ₁ -CTN SD ₁ -FT ₂ -CTN SD ₂ -FT ₁ -CTN SD ₂ -FT ₂ -CTN SD ₃ -FT ₁ -CTN	SD ₁ - 5714 SD ₂ - 8571 SD ₃ - 11429	SD ₁ - 7768 SD ₂ - 11652 SD ₃ - 15536
September–November, 1999	Mrigal	SD ₁ -FT ₁ -CTB SD ₁ -FT ₁ -CTN SD ₁ -FT ₂ -CTN SD ₂ -FT ₁ -CTN SD ₂ -FT ₂ -CTN SD ₃ -FT ₁ -CTN	SD ₁ - 6214 SD ₂ - 9321 SD ₃ - 12429	SD ₁ - 6429 SD ₂ - 9643 SD ₃ - 12857

Note SD- stocking density; FT₁-commercial feed; FT₂-local material feed (cassava, rice bran, CTB- Bamboo cages; CTN — cage type net; CTB — cage type bamboo

Table 2. The ingredient composition (by percent weight) of the locally made feed used in the trials.

Feed	Fish meal	Soybean meal	Peanut cake	Maize	Rice bran	Cassava	Duck weed	Notes
FT ₁	30	10	10	30	16	3	—	Used in all trials
FT ₂	10	10	15	—	—	65	—	Fermented by <i>Saccharomyces</i>
FT ₃	10	5	5	—	5	15	60	For grass carp and mrigal

% Proximate compositions (P — protein, TL — total lipid, A — ash) on a dry matter basis:

FT₁; 35% P; 14% L; 12% A

FT₂; 23% P; 11%L; 9% A

FT₃; 17% P; 8% L; 18% A

Limnological studies

Regular water quality monitoring was carried out through out the experiment. In each instance, 11 sites were sampled in each reservoir, the sites being 0, 4, 8, 12, 16 and 20 m on two lines perpendicular to each other from the centre of the cages. At each site, sampling was carried out at the surface and at 1 m depth.

The water quality parameters studied were temperature, DO, pH, conductivity (all using a YSI model 610D probe) and total nitrate and total phosphate concentration (APHA 1995).

Data analysis

One-way ANOVA was used to determine treatment difference between stocking densities, feed types and types of cage. Two-way ANOVA was used to compare between stocking densities, feed types. Treatment means for final mean weight, survival rate and average daily growth (% ADG) were compared.

Economic analysis

Net income analysis was used to assess the financial effectiveness of fry to fingerling rearing in cages in large reservoirs, from the equation:

Table 3. Water quality parameters (mean \pm SEM) in the center of the cages and the 20 m from the center during the period of 1997–1999, in the two reservoirs. NA — data not available.

Year/parameter	Thac ba reservoir				Nui coc reservoir			
	Trial 1 Center 20 m		Trial 2 Center 20 m		Trial 1 Center 20 m		Trial 2 Center 20 m	
1997								
Temperature (°C)	NA	NA	29.0	29.0	NA	NA	NA	NA
			± 0.75	± 0.75				
DO (mg/L)	NA	NA	6.75	6.75	NA	NA	NA	NA
			± 0.01	± 0.01				
1998								
Temperature (°C)	34.1	34.3	30.5	29.8	30.1	30.0	27.6	27.5
	± 0.70	± 1.40	± 1.53	± 1.49	± 0.85	± 1.5	± 0.70	± 0.81
DO (mg/L)	7.67	7.50	7.04	7.17	6.40	6.37	6.90	6.88
pH	± 0.12	± 0.07	± 0.28	± 0.20	± 0.30	± 0.28	± 0.10	± 0.15
	8.1	8.2	8.1	8.1	NA	NA	NA	NA
	± 0.80	± 0.74	± 1.0	± 0.8				
Conductivity (μ mho/cm)	2.10	2.15	3.86	4.0	NA	NA	NA	NA
	± 0.50	± 0.48	± 0.57	± 0.50				
Phosphorous (mg/L)	0.05	0.03	0.04	0.02	1.03	1.00	0.85	0.80
	± 0.00	± 0.01	± 0.01	± 0.01	± 0.02	± 0.01	± 0.01	± 0.01
Nitrate (mg/L)	0.20	0.15	0.32	0.234	0.43	0.40	0.54	0.50
	± 0.01	± 0.01	± 0.02	± 0.01	± 0.02	± 0.02	± 0.02	± 0.02
Chlorophyll- <i>a</i> (mg/L)	11.03	12.16	24.16	27.05	3.38	3.50	8.42	8.53
	± 0.80	± 1.00	± 1.40	± 1.00	± 0.76	± 0.52	± 0.52	± 0.40
1999								
Temperature (°C)	33.2	33.0	31.0	31.0	31.5	31.0	24.9	25.0
	± 1.10	± 1.00	± 1.20	± 1.00	± 0.50	± 0.46	± 0.61	± 0.24
DO (mg/L)	7.74	7.70	6.94	6.72	6.60	7.20	7.20	7.10
	± 0.23	± 0.10	± 0.15	± 0.10	± 0.17	± 0.08	± 0.08	± 0.10
pH	8.4	8.4	8.3	8.3	NA	NA	NA	NA
	± 0.5	± 0.6	± 0.5	± 0.5				
Conductivity (μ mho/cm)	1.47	1.15	2.68	2.26	NA	NA	NA	NA
	± 0.51	± 0.42	± 0.64	± 0.42				
Phosphorous (mg/L)	0.07	0.05	0.05	0.04	0.06	0.05	0.04	0.04
	± 0.00	± 0.01	± 0.01	± 0.01	± 0.01	± 0.01	± 0.01	± 0.01
Nitrate (mg/L)	0.16	0.12	0.25	0.20	0.20	0.07	0.34	0.30
	± 0.02	± 0.02	± 0.01	± 0.03	± 0.20	± 0.02	± 0.02	± 0.02
Chlorophyll- <i>a</i> (mg/L)	13.26	14.05	21.38	21.40	6.71	7.05	9.36	14.00
	± 0.96	± 0.67	± 0.89	± 1.20	± 0.75	± 0.67	± 0.50	± 0.41

$$\text{Gross margin} = \text{Gross Output} - (\text{Total Fixed Cost} + \text{Total Variable Cost})$$

The total variable cost included seed cost, feed cost, and labour cost and cage maintenance. The total fixed cost included cage costs and depreciation of cages was taken into account as the experiment progressed. Depreciation was calculated using the declining balance method (Curtis 1993) and the constant percentage value used for each year of the item's life was 10%.

Results

Water quality

Data on water quality and environmental factors are presented in Table 3. The limnological data were in a suitable range for fish to grow. Water temperature was a little bit high in summer, but stable and better than that in autumn. Water temperature did not fluctuate

too much. The concentrations of dissolved oxygen were in a favourable range to culture fish, e.g. Thac ba reservoir ranged from 7.04 to 7.67 mg/L; Nui coc reservoir ranged from 6.40 to 6.90 mg/L.

Fry to fingerling rearing

The mean initial weight, mean final weight, percent average daily growth [% ADG= 100 (mean final weight – mean initial weight ÷ mean initial weight × time in days)] and percent survival in each of the trials conducted in Thac ba and Nui coc reservoirs are given in Tables 4 and 5, and Figures 1 and 2, respectively. The results indicate that there was no significant difference between bamboo and net cages, when growth was considered but survival was better in net cages than in bamboo cages.

Fry performance, in all three species, was related to stocking density. There were no significant difference ($P > 0.05$) and interaction between stocking

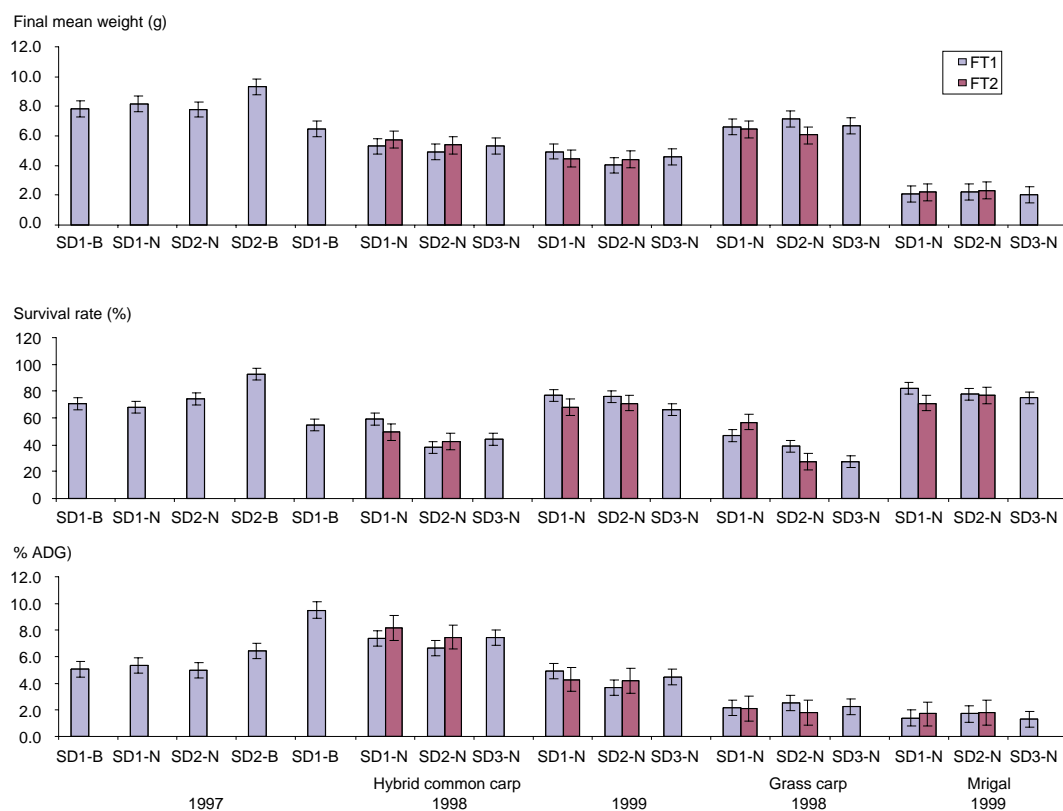

Figure 1. The mean survival rate, mean weight and % ADG (\pm SE) of different species of fry reared in cages, at different stocking densities and feeding regimes, in Thac ba reservoir. SD- stocking density, B- & N refer to bamboo and net cages, respectively. The different treatments correspond to those given in Table 1.

densities and feed types on survival rate, % ADG, and final mean weight. There was also no difference between two types of feed, and indeed grass carp fry appeared to do well on the locally-prepared feed. Fish grew equally well on the locally made feed. Of the three species tested, hybrid common carp grew best, and had the best survival.

Economic analysis of rearing experiments

The economic viability of fry to fingerling rearing in both reservoirs was assessed after harvesting. Cost and return of the experiments are presented in Tables 5 and 6 for the two sets of experiments, in the two reservoirs. The results are also summarised in Figures 3 and 4. It is seen that the fry rearing of hybrid common carp was the most economically efficient. It had high growth and production and a high market value (60 000 VND/kg to 75 000 VND/kg of fingerling). Grass carp and mrigal did not yield high

economic returns. However, trials conducted in Nui coc reservoir showed a negative economic benefit.

Discussion

The water quality parameters monitored appeared to be conducive to cage culture. Also, culture activities appeared to have little impact on the water quality in the immediate vicinity (20 m from the centre of the cages). However, it was apparent that the total nitrate and total phosphorus contents were relatively low, compared to those in most tropical and sub-tropical reservoirs (for example, Schiemer and Silva et al. these Proceedings). Similarly, the chlorophyll-*a* was also low, ranging from 13.26 to 21.38 mg/m³ through the year. The low productivity of the two reservoirs may be indicative of the fact that cage culture practices in the reservoirs will be successful only if the fish were to be provided with a supplemental feed.

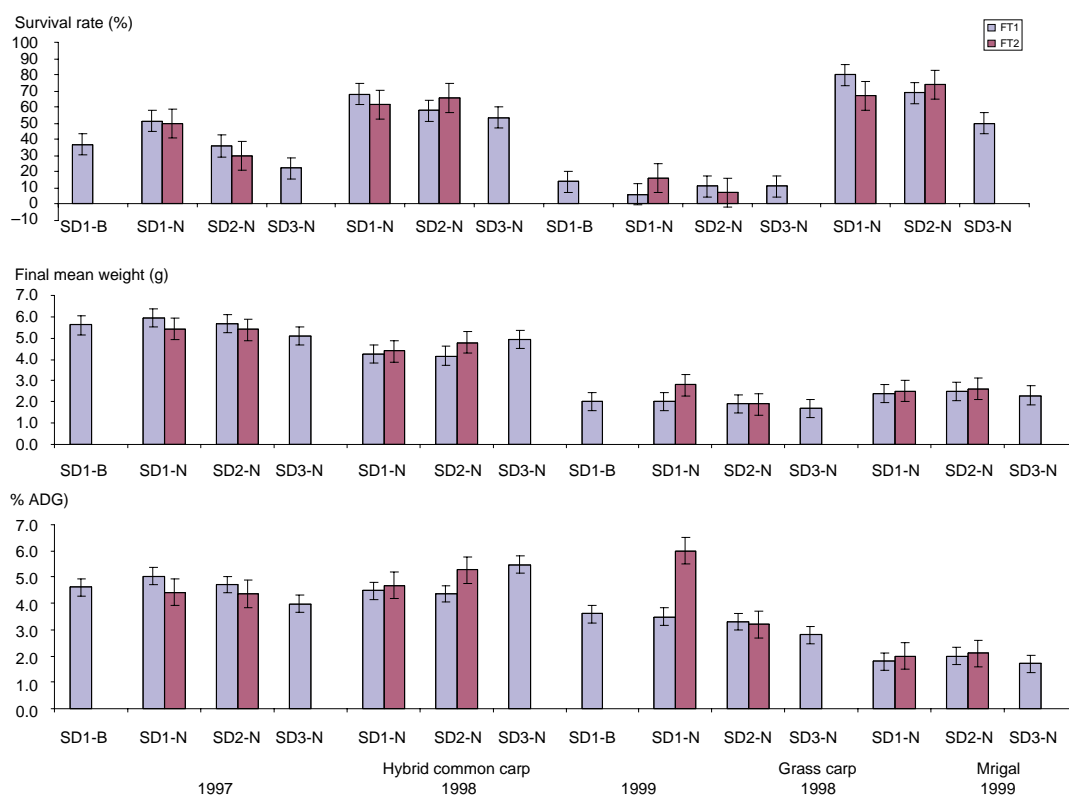

Figure 2. The mean survival rate, mean weight and % ADG (\pm SE) of different species of fry reared in cages, at different stocking densities and feeding regimes, in Nui coc reservoir. SD- stocking density, B- & N refer to bamboo and net cages, respectively. The different treatments correspond to those given in Table 1.

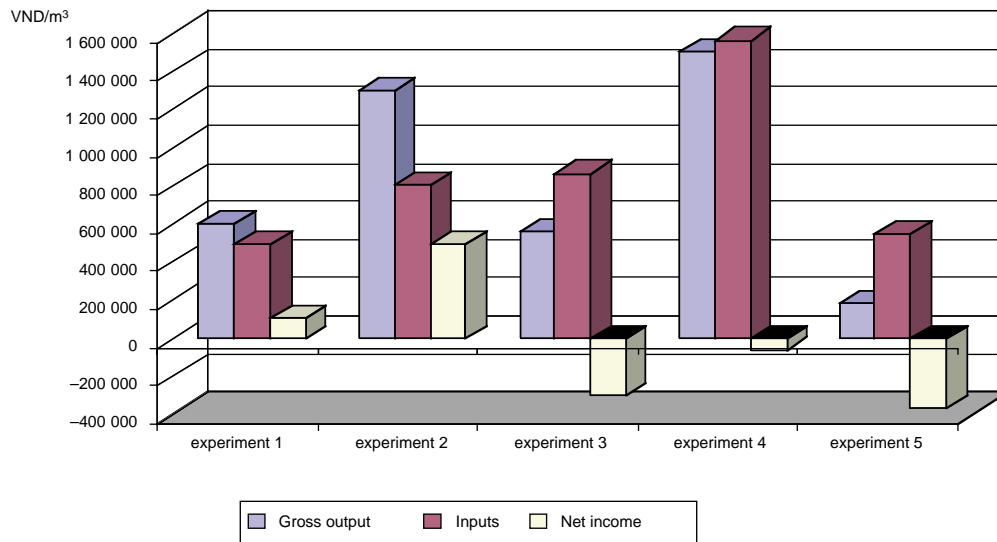

Figure 3. A summary of the results of the financial analysis of fry to fingerling rearing in cages in Thac ba reservoir.

Table 4. Mean initial weight, mean final weight, % ADG and percentage survival rate of fish species in fry to fingerling rearing trials in Thac ba reservoir. Where appropriate \pm SE are also given.

Rearing cycle	Treatment	Weight (g) Initial	Final	% ADG	Survival (%)
1997					
Hybrid common carp	SD ₁ -FT ₁ -CTB	2.39 \pm 0.25	7.81 \pm 0.55	5.04 \pm 0.51	70.88 ^a \pm 0.80
	SD ₁ -FT ₁ -CTN	2.39 \pm 0.25	8.16 \pm 0.36	5.36 \pm 0.34	67.52 ^a \pm 1.04
	SD ₂ -FT ₂ -CTB	2.39 \pm 0.25	7.78 \pm 0.19	5.01 \pm 0.18	73.76 ^a \pm 2.06
	SD ₂ -FT ₂ -CTN	2.39 \pm 0.25	9.31 \pm 0.70	6.43 \pm 0.63	92.32 ^a \pm 1.50
1998					
Hybrid common carp	SD ₁ -FT ₁ -CTB	1.23 \pm 0.18	6.49 \pm 0.45	9.50 \pm 0.82	41.33 ^x \pm 14.70
	SD ₁ -FT ₁ -CTN	1.23 \pm 0.18	5.29 \pm 0.17	7.35 \pm 0.31	59.14 ^x \pm 05.27
	SD ₁ -FT ₂ -CTN	1.23 \pm 0.18	5.75 \pm 0.28	8.16 \pm 0.51	49.50 ^b \pm 03.53
	SD ₂ -FT ₁ -CTN	1.23 \pm 0.18	4.90 \pm 0.44	6.63 \pm 0.79	38.23 ^y \pm 05.58
	SD ₂ -FT ₂ -CTN	1.23 \pm 0.18	5.37 \pm 0.10	7.48 \pm 0.18	42.35 ^b \pm 03.17
	SD ₃ -FT ₁ -CTN	1.23 \pm 0.18	5.34 \pm 0.43	7.42 \pm 0.79	32.81 ^z \pm 10.97
	2. Grass carp				
2. Grass carp	SD ₁ -FT ₁ -CTB	NA	NA	NA	NA
	SD ₁ -FT ₁ -CTN	3.33 \pm 0.29	6.60 \pm 0.60	2.18 \pm 0.39	35.70 ^x \pm 12.70
	SD ₁ -FT ₂ -CTN	3.33 \pm 0.29	6.45 \pm 0.16	2.08 \pm 0.11	44.08 ^b \pm 18.73
	SD ₂ -FT ₁ -CTN	3.33 \pm 0.29	7.12 \pm 0.26	2.53 \pm 0.18	20.22 ^y \pm 05.05
	SD ₂ -FT ₂ -CTN	3.33 \pm 0.29	6.04 \pm 0.27	1.81 \pm 0.18	27.22 ^b \pm 03.78
	SD ₃ -FT ₁ -CTN	3.33 \pm 0.29	6.68 \pm 0.17	2.23 \pm 0.11	27.48 ^z \pm 03.28
1999					
Hybrid common carp	SD ₁ -FT ₁ -CTB	NA	NA	NA	NA
	SD ₁ -FT ₁ -CTN	1.25 \pm 0.09	4.95 \pm 0.65	4.93 \pm 0.87	76.50 ^x \pm 6.31
	SD ₁ -FT ₂ -CTN	1.25 \pm 0.09	4.47 \pm 0.37	4.29 \pm 0.49	68.02 ^b \pm 6.00
	SD ₂ -FT ₁ -CTN	1.25 \pm 0.09	4.02 \pm 0.44	3.69 \pm 0.59	75.45 ^y \pm 6.30
	SD ₂ -FT ₂ -CTN	1.25 \pm 0.09	4.40 \pm 0.36	4.20 \pm 0.48	70.93 ^b \pm 3.05
	SD ₃ -FT ₁ -CTN	1.25 \pm 0.09	4.61 \pm 0.14	4.48 \pm 0.18	65.80 ^z \pm 6.57
Grass carp	SD ₁ -FT ₁ -CTB	NA	NA	NA	NA
	SD ₁ -FT ₁ -CTN	1.11 \pm 0.08	2.07 \pm 0.17	1.44 \pm 0.26	81.88 \pm 2.51
	SD ₁ -FT ₂ -CTN	1.11 \pm 0.08	2.25 \pm 0.17	1.70 \pm 0.26	70.70 \pm 6.12
	SD ₂ -FT ₁ -CTN	1.11 \pm 0.08	2.24 \pm 0.22	1.69 \pm 0.33	78.41 \pm 2.80
	SD ₂ -FT ₂ -CTN	1.11 \pm 0.08	2.33 \pm 0.30	1.83 \pm 0.44	77.18 \pm 5.00
	SD ₃ -FT ₁ -CTN	1.11 \pm 0.08	2.00 \pm 0.16	1.33 \pm 0.23	75.06 \pm 2.54

(NA: data not available)

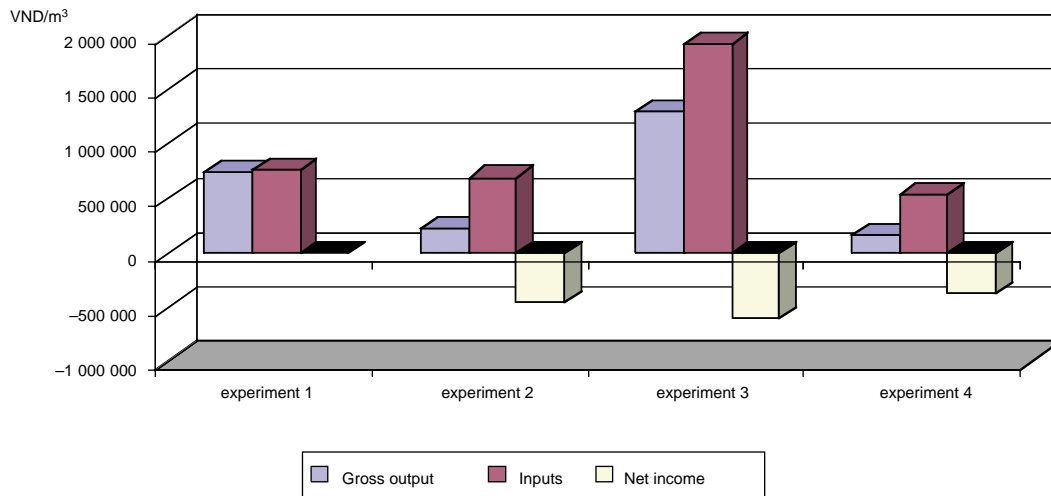

Figure 4. A summary of the results of the financial analysis of fry to fingerling rearing in cages in Nui coc reservoir.

Table 5. Mean initial weight, mean final weight, % ADG and percentage survival rate of fish species in fry to fingerling rearing trials in Nui coc reservoir. Where appropriate \pm SE are also given.

Rearing cycle	Treatment	Weight (g) Initial	Final	%ADG	Survival (%)
1998					
Hybrid common carp	SD ₁ -FT ₁ -CTB	1.82 \pm 0.12	5.60 \pm 0.45	4.61 \pm 0.54	36.97 \pm 3.80
	SD ₁ -FT ₁ -CTN	1.82 \pm 0.12	5.95 \pm 0.59	5.04 \pm 0.72	51.26 \pm 4.96
	SD ₁ -FT ₂ -CTN	1.82 \pm 0.12	5.44 \pm 0.44	4.41 \pm 0.54	49.73 \pm 8.85
	SD ₂ -FT ₁ -CTN	1.82 \pm 0.12	5.68 \pm 0.49	4.71 \pm 0.60	36.06 \pm 3.91
	SD ₂ -FT ₂ -CTN	1.82 \pm 0.12	5.39 \pm 0.32	4.35 \pm 0.39	30.12 \pm 3.37
	SD ₃ -FT ₁ -CTN	1.82 \pm 0.12	5.08 \pm 0.31	3.98 \pm 0.38	22.22 \pm 1.23
Grass carp	SD ₁ -FT ₁ -CTB	0.76 \pm 0.04	2.00 \pm 0.28	3.61 \pm 0.83	14.23 \pm 0.76
	SD ₁ -FT ₁ -CTN	0.76 \pm 0.04	1.96 \pm 0.30	3.50 \pm 0.08	5.55 \pm 2.89
	SD ₁ -FT ₂ -CTN	0.76 \pm 0.04	2.81 \pm 0.58	5.98 \pm 1.70	15.76 \pm 6.12
	SD ₂ -FT ₁ -CTN	0.76 \pm 0.04	1.89 \pm 0.19	3.29 \pm 0.56	11.09 \pm 2.14
	SD ₂ -FT ₂ -CTN	0.76 \pm 0.04	1.86 \pm 0.50	3.22 \pm 1.46	6.53 \pm 2.51
	SD ₃ -FT ₁ -CTN	0.76 \pm 0.04	1.70 \pm 0.12	2.76 \pm 0.35	11.12 \pm 1.14
1999					
Hybrid common carp					
	SD ₁ -FT ₁ -CTB	NA	NA	NA	NA
	SD ₁ -FT ₁ -CTN	1.45 \pm 0.06	2.37 \pm 0.17	1.77 \pm 0.25	79.98 \pm 4.49
	SD ₁ -FT ₂ -CTN	1.45 \pm 0.06	2.55 \pm 0.17	2.02 \pm 0.25	66.59 \pm 8.83
	SD ₂ -FT ₁ -CTN	1.45 \pm 0.06	2.54 \pm 0.22	2.02 \pm 0.32	69.26 \pm 11.42
	SD ₂ -FT ₂ -CTN	1.45 \pm 0.06	2.62 \pm 0.29	2.15 \pm 0.42	73.85 \pm 9.10
	SD ₃ -FT ₁ -CTN	1.45 \pm 0.06	2.30 \pm 0.16	1.67 \pm 0.22	49.68 \pm 7.42
Grass carp					
	SD ₁ -FT ₁ -CTB	NA	NA	NA	NA
	SD ₁ -FT ₁ -CTN	1.15 \pm 0.03	4.24 \pm 0.35	4.48 \pm 0.51	67.96 \pm 2.69
	SD ₁ -FT ₂ -CTN	1.15 \pm 0.03	4.38 \pm 0.22	4.68 \pm 0.32	61.45 \pm 3.52
	SD ₂ -FT ₁ -CTN	1.15 \pm 0.03	4.16 \pm 0.20	4.36 \pm 0.29	57.79 \pm 0.64
	SD ₂ -FT ₂ -CTN	1.15 \pm 0.03	4.79 \pm 0.43	5.28 \pm 0.62	65.67 \pm 1.84
	SD ₃ -FT ₁ -CTN	1.15 \pm 0.03	4.93 \pm 0.22	5.47 \pm 0.31	53.47 \pm 2.07

(NA: data not available)

Table 6a. The total weight of fingerlings harvested (Wt), price per kg (VND/kg), total income (in VND) for each treatment, and an economic analysis of fry to fingerling rearing trials in Thac ba reservoir.

Financial analysis for the experiment 1												
Items	Treatment 1			Treatment 2			Treatment 3			Treatment 4		
	Wt. (kg)	VND/kg	VND	Wt. (kg)	VND/kg	VND	Wt. (kg)	VND/kg	VND	Wt. (kg)	VND/kg	VND
Gross output	36	2 500	90 377	34	2 500	86 097	75	2 500	188 098	94	2 500	235 428
Total fixed cost			10 417			10 417			10 417			10 417
Depreciation			10 417			10 417			10 417			10 417
Total variable cost			75 234			75 234			150 370			150 423
Maintenance												
Feeding	65	192	12 387	65	192	12 387	131	192	25 023	131	192	2 5066
Seedling	15	4 167	62 500	15	4 167	62 500	30	4 167	125 000	30	4 167	125 010
Labour (VND/day)			347			347			347			347
Net Income			4 726			446			27 312			74 588

Financial analysis for experiment 2																		
Items	Treatment 1			Treatment 2			Treatment 3			Treatment 4			Treatment 5			Treatment 6		
	Wt. (kg)	VND/kg	VND	Wt. (kg)	VND/kg	VND	Wt. (kg)	VND/kg	VND	Wt. (kg)	VND/kg	VND	Wt. (kg)	VND/kg	VND	Wt. (kg)	VND/kg	VND
Gross output	61	3 750	228 128	52	3750	196 035	48	3 750	181 165	48	3 750	179 098	57	3 750	214 078	80	3 750	299 466
Total fixed cost			20 313			20 313			20 313			20 313			20 313			20 313
Depreciation			18 750			18 750			18 750			18 750			18 750			18 750
Total variable cost			114 134			114 134			110 477			168 786			163 504			223 540
Maintenance			1 563			1 563			1 563			1 563			1 563			1 563
Feeding	84	313	26 124	84	313	26 124	84	269	22 467	121	313	37 726	121	269	32 444	158	313	49 430
Seedling	14	250	86 100	14	6250	86 100	14	6 250	86 100	21	6 250	129 150	21	6 250	129 150	28	6 250	172 200
Labour (VND/day)			347			347			347			347			347			347
Net Income			95 244			63 151			51 938			-8 438			31 824			57 176

Items	Treatment 2			Treatment 3			Treatment 4			Treatment 5			Treatment 6		
	Wt. (kg)	VND/ kg	VND	Wt. (kg)	VND/ kg	VND	Wt. (kg)	VND/ kg	VND	Wt. (kg)	VND/ kg	VND	Wt. (kg)	VND/ kg	VND
Gross output	60.08	1 875	112 657	64.05	1 875	120 098	62.41	30 000	117 019	47.75	30 000	89 528	64.71	30 000	121 330
Total fixed cost			18 438			18 438			18 438			18 438			18 438
Depreciation			16 875			16 875			16 875			16 875			16 875
Total variable cost			116 732			100 555			172 910			148 966			230 437
Maintenance			1 563			1 563			1 563			1 563			1 563
Feeding	199	313	62 217	199	231	46 041	295	313	92 092	295	231	68 148	395	313	123 317
Seedling	20.04	2 625	52 605	20	2 625	52 605	30.06	2 625	78 908	30.06	2 625	78 908	40	2 625	105 210
Labour (VND/day)			347			347			347			347			347
Net Income			-22 825			792			-74 641			-78 188			-127 857

Items	Treatment 2			Treatment 3			Treatment 4			Treatment 5			Treatment 6		
	Wt. (kg)	VND/ kg	VND	Wt. (kg)	VND/ kg	VND	Wt. (kg)	VND/ kg	VND	Wt. (kg)	VND/ kg	VND	Wt. (kg)	VND/ kg	VND
Gross output	62	3 750	231 769	55	3 750	206 020	91	3 750	342 790	86	3 750	322 262	106	3 750	398 659
Total fixed cost			16 750			16 750			16 750			16 750			16 750
Depreciation			15 188			15 188			15 188			15 188			15 188
Total variable cost			213 875			209 425			316 602			310 835			426 357
Maintenance			1 563			1 563			1 563			1 563			1 563
Feeding	94	356	33 402	94	313	29 300	133	356	47 196	133	313	41 429	190	356	67 638
Seedling	29	6 250	178 563	29	6 250	178 563	43	6 250	267 844	43	6 250	267 844	57	6 250	357 156
Labour (VND/day)			347			347			347			347			347
Net Income			1 019			-20 280			9 313			-5 448			-44 573

Financial analysis for the experiment 5

Items	Treatment 2			Treatment 3			Treatment 4			Treatment 5			Treatment 6		
	Wt. (kg)	VND/ kg	VND	Wt. (kg)	VND/ kg	VND	Wt. (kg)	VND/ kg	VND	Wt. (kg)	VND/ kg	VND	Wt. (kg)	VND/ kg	VND
Gross output	44	625	27 779	38	625	23 985	64	625	39 905	63	625	39 277	81	625	50 929
Total fixed cost			15 231			15 231			15 231			15 231			15 231
Depreciation			13 669			13 669			13 669			13 669			13 669
Total variable cost			68 556			65 289			99 782			95 618			134 156
Maintenance			1 563			1 563			1 563			1 563			1 563
Feeding	67	356	23 769	67	313	20 850	95	356	33 904	95	313	29 741	131	356	46 833
Seedling	29	1 500	42 877	29	1 500	42 877	43	1 500	64 315	43	1 500	64 315	57	1 500	85 760
Labour (VND/day)			347			347			347			347			347
Net Income			-54 446			-55 320			-73 893			-70 357			-97 243

Table 6b. The total weight of fingerlings harvested (Wt), price per kg (VND/kg), total income (in VND) for each treatment, and an economic analysis of fry to fingerling rearing trials in Nui coc reservoir.

Financial analysis for experiment 1																		
Items	Treatment 1			Treatment 2			Treatment 3			Treatment 4			Treatment 5			Treatment 6		
	Wt. (kg)	VND/ kg	VND	Wt. (kg)	VND/ kg	VND	Wt. (kg)	VND/ kg	VND	Wt. (kg)	VND/ kg	VND	Wt. (kg)	VND/ kg	VND	Wt. (kg)	VND/ kg	VND
Gross output	27	3 750	101 250	38	3 750	142 500	37	3 750	138 750	36	3 750	135 000	30	3 750	112 500	31	3 750	116 250
Total fixed cost			6 250			6 250			6 250			6 250			6 250			6 250
Depreciation			6 250			6 250			6 250			6 250			6 250			6 250
Total variable cost			96 563			6 035			93 544			8 008			124 188			10 820
Maintenance			0			0			0			0			0			0
Feeding	69	313	21 563	69	313	1 348	69	269	18 544	90	313	1 758	90	269	24 188	114	313	2 227
Seedling	12	6 250	75 000	12	6 250	4 688	12	6 250	75 000	16	6 250	6 250	16	6 250	100 000	22	6 250	8 594
Labour (VND/day)			313			313			313			313			313			313
Net Income			-18 75			129 902			38 644			120 430			-18 250			98 867

Financial analysis for the experiment 2																		
Items	Treatment 2			Treatment 3			Treatment 4			Treatment 5			Treatment 6					
	Wt. (kg)	VND/ kg	VND	Wt. (kg)	VND/ kg	VND	Wt. (kg)	VND/ kg	VND	Wt. (kg)	VND/ kg	VND	Wt. (kg)	VND/ kg	VND			
Gross output	9	30 000	16 875	26	30 000	48 750	28	30 000	52 500	16	30 000	30 000	37	30 000	69 375			
Total fixed cost			6 250			6 250			6 250			6 250			6 250			
Depreciation			6 250			6 250			6 250			6 250			6 250			
Total variable cost			99 792			83 616			148 455			124 511			198 467			
Maintenance			0			0			0			0			0			
Feeding	199	5 000	62 217	199	3 700	46 041	295	5 000	92 092	295	3 700	68 148	395	5 000	123 317			
Seedling	20	30 000	37 575	20	30 000	37 575	30	30 000	56 363	30	30 000	56 363	40	30 000	75 150			
Labour (VND/day)			347			347			347			347			347			
Net Income			-89 514			-41 463			-102 552			-101 108			-135 690			

Items	Treatment 2			Treatment 3			Treatment 4			Treatment 5			Treatment 6		
	Wt. (kg)	VND/kg	VND	Wt. (kg)	VND/ kg	VND	Wt. (kg)	VND/ kg	VND	Wt. (kg)	VND/kg	VND	Wt. (kg)	VND/kg	VND
Gross output	56	60 000	210 000	50	60 000	187 500	71	60 000	266 250	81	60 000	303 750	88	60 000	330 000
Total fixed cost			16 042			16 042			16 042			16 042			16 042
Depreciation			5 625			5 625			5 625			5 625			5 625
Total variable cost			263 475			258 750			395 925			388 750			519 631
Maintenance			10 417			10 417			10 417			10 417			10 417
Feeding	108	5 700	38 475	108	5 000	33 750	164	5 700	58 425	164	5 000	51 250	213	5 700	75 881
Seedling	36	100 000	225 000	36	100 000	225 000	54	100 000	337 500	54	100 000	337 500	71	100 000	443 750
Labour (VND/day)			313			313			313			313			313
Net Income			-69 829			-87 604			-146 029			-101 354			-205 985

Items	Treatment 2			Treatment 3			Treatment 4			Treatment 5			Treatment 6		
	Wt. (kg)	VND/kg	VND	Wt. (kg)	VND/ kg	VND	Wt. (kg)	VND/ kg	VND	Wt. (kg)	VND/kg	VND	Wt. (kg)	VND/kg	VND
Gross output	45	10 000	28 125	37	10 000	23 125	58	10 000	36 250	62	10 000	38 750	55	10 000	34 375
Total fixed cost			16 042			16 042			16 042			16 042			16 042
Depreciation			5 625			5 625			5 625			5 625			5 625
Total variable cost			67 582			64 663			98 717			94 553			132 646
Maintenance			10 417			10 417			10 417			10 417			10 417
Feeding	67	5 700	23 769	67	5 000	20 850	95	5 700	33 904	95	5 000	297 41	131	5 700	46 833
Seedling	29	24 000	43 500	29	24 000	43 500	43	24 000	64 500	43	24 000	64 500	57	24 000	85 500
Labour (VND/day)			313			313			313			313			313
Net Income			-55 811			-57 892			-78 821			-72 157			-114 625

It is common for small-scale fish farmers to use bamboo cages, primarily because of its ready availability in Vietnam. However, the present study has shown that bamboo cages were inferior to net cages; fry survival and growth were higher in net cages. Furthermore, net cages were easier to assemble and also facilitated harvesting. The better performance of fry in net cages may be due to a higher rate of water exchange with net cages, and also reduced damage to stock caused by the rigid structure of the bamboo cages.

The present trials indicate that the optimal stocking density for fry to fingerling rearing is from about 3000 to 4000 fry/m³. Apart from common carp, the size dispersion at the end of the rearing period was narrow, and as such, minimised any potential cannibalism.

The economic effectiveness of mrigal and grass carp was very low because of low selling prices and high inputs. Local feed is an advantage for rearing fish in cages. The farmers can gain more from cage culture by reusing farm by-products, local feed types.

Acknowledgement

This study was funded by Australian Centre for International Agriculture Research (ACIAR). We

would like to thank Yen Bai Fisheries Center, Department of Agriculture and Rural Development of Yen Bai and Thai Nguyen provinces for their help during the completion of this study. Finally, we would like to express our gratitude to Professor Sena S. De Silva and Dr Le Thanh Luu for giving invaluable advice and for their encouragement.

References

- ACIAR 1997. Memorandum of subsidiary arrangement ACIAR Project FIS/97/68. Reservoir.
- Fishery development and Management in Northern Mid Highland region, Vietnam.
- APHA, 1995. Standard methods for the Examination of Water and Wastewater. 19th edition. American Public Health Association, Washington DC, USA.
- Biradar, R.S. 1986. Course Manual of Fisheries Statistics. Central Institute of Fisheries.
- Education, Indian Council of Agricultural research, New Delhi, India.
- Phuong, Truong ha 1998. Assessment and preliminary trials of nursing common carp in cages in Eakao reservoir, Vietnam. MSc Thesis, Asian Institute of Technology, Bangkok, Thailand.

Performance of Cage-reared Fingerlings of Commonly Cultured Fish Species in Response to Different Feeds

M.H.S. Ariyaratne*

Abstract

Fingerling-rearing in net cages in perennial reservoirs of Sri Lanka is a recent development introduced by the government. It includes the involvement of reservoir fishing communities. Rice bran and locally formulated fish feed were used as feed in the culture practices. The potential of using small cyprinids, abundant in reservoirs of Sri Lanka, was also evaluated in this strategy.

Twenty-four net cages ($2 \times 4 \times 2.5$ (20 m³)) were installed in three Sri Lankan reservoirs, Chandrikawewa, Kiriibbanwewa and Muthukandiyawewa, and were stocked with fry of one of five cyprinid species, i.e. *Cyprinus carpio*, *Catla catla*, *Labeo rohita*, *L. dussumieri*, *Hypophthalmichthys molitrix* and one cichlid species, *Oreochromis niloticus*. The trials were conducted to rear fry up to advanced fry (rearing period 21–45 days) and fry to fingerling (rearing period: 70–80 days). Members of fisheries cooperative societies were trained to operate this aquaculture system. Three feed types were used. Rice bran (RB), a commercial fish feed (Cf) and farmer-made aquafeed (Mf) were compared with a treatment in which feed was not presented. The main ingredients used for preparing Mf were locally available RB, fishmeal (prepared from cyprinids in reservoirs) and cooked cassava tubers.

Of the six species cultured, the lowest percentage survival occurred in *C. catla* in Chandrikawewa (<1%). In Muthukandiyawewa, where fishing communities are better experienced in cage-culture, high survival was observed for *L. rohita* (37.1–55.1%), and *C. carpio* (36.6–78.5%). The indigenous cyprinid *L. dussumieri* performed well in two reservoirs when survival as high as 95.1% in Kiriibbanwewa was recorded. Based on survival, *L. dussumieri*, *L. rohita*, *C. carpio* and *O. niloticus* can therefore be considered as better candidates for cage aquaculture for fry to fingerling rearing than *C. catla* and *H. molitrix*. Percentage average daily growth (%ADG) was always lower in cages with high survival than in cages with low survival, perhaps due to the competition for food. RB and Cf gave better survival rates in most trials. Proximate composition of Mf (dry matter, 51–71%; moisture, 28–48%; ash, 5–12%; protein, 17–33% and fat 2–12%) which is comparable to Cf, can be used to reduce the cost of feeding.

ASIAN aquaculture is dominated by semi-intensive culture systems. The most commonly used groups of fish in semi-intensive aquaculture practices in Asian countries are carp, milkfish and tilapias. According to Anderson and De Silva (1997), the opportunity exists for inclusion of agricultural by-products and wastes in the feed for these species. However, requirement of animal protein, at least to a lesser extent, cannot be disregarded in preparing farmer-made aquafeed. Minor cyprinid resources, found in large quantities in reservoirs (Amarasinghe 1985; De Silva and Sirisena

1987; Amarasinghe 1990; Pet and Piet 1993), have the potential to be used in feed preparation as an animal protein source. Anderson and De Silva (1997) emphasised the importance of feed formulation of low-cost diets instead of nutritionally wholesome diets for semi-intensive culture practices.

In Sri Lanka, an aquaculture development plan has been implemented since 1995. Under the program, a strategy to rear fish fry to fingerling size in floating net cages has been introduced in several perennial reservoirs. This aquaculture practice is carried out through community participation. Fingerlings reared in net cages are used for stocking seasonal reservoirs and small village reservoirs. In Sri Lanka, there is a paucity of fingerling availability for culture practices,

*National Aquatic Resources Research and Development Agency, Crow Island, Colombo-15, Sri Lanka

this being one of the reasons to encourage the use of perennial reservoirs through cage-culture for fingerling production. However, there has been little work done on the viability of such practices, and indeed the overall feasibility of using cages for fingerling production. This study was designed to investigate such feasibility, through the use of different diets.

Specifically an attempt is made to compare the performance of three different feed types in cage-culture of fish fingerlings in three perennial reservoirs, and compare it with the performance of fry that depend entirely on natural food supplies.

Materials and Methods

Three reservoirs (i.e. Chandrikawewa, Kiriibbanwewa and Muthukandiyawewa) in the dry zone of Sri Lanka were selected for the installation of the cages (4 m × 2 m × 2.5 m). Eight floating cages were set up in each reservoir using bamboo (*Bambusa spinosa*), coir, kuralon and nylon ropes and plastic barrels, etc. Cages were fabricated of HDPE (high density polyethylene) webbing material with webbing thickness 0.5–1.5 mm and mesh size 4 mm knotless.

Three feed types, RB (rice bran), Cf (formulated commercial feed), Mf (farmer-made aquafeed — see below for method of preparation) and Nf (without supplementary feeding) were used in the trials. All trials were carried out in duplicate. The cages were stocked with the fry of one of the following: *Cyprinus carpio*, *Catla catla*, *Labeo rohita*, *L. dussumieri*, *Hypophthalmichthys molitrix* and *Oreochromis niloticus*. The trials were conducted as advance-fry rearing and fingerling rearing. The rearing period was 21–45 days for advance-fry rearing cycles and 70–80 days for fry-to-fingerling rearing cycles. The cages in Chandrikawewa were stocked with *C. carpio* at a stocking density of 100/m³, and in Kiriibbanwewa and Muthukandiyawewa at 200/m³. The stocking density of *C. catla* in Chandrikawewa and Kiriibbanwewa was 200 fry/m³. For advance fry rearing of *L. rohita* in Muthukandiyawewa, stocking densities of 150 fry/m³ and 200 fry/m³ were used. *L. dussumieri*, *H. molitrix* and *O. niloticus* were reared in Kiriibbanwewa at stocking densities of 150, 200 and 150 fry/m³, respectively. Species used, stocking densities and feeding regimes used in the three reservoirs are given in Table 1.

Table 1. Species used, stocking densities and feeding regimes used in cage aquaculture in three reservoirs.

Culture procedure/ reservoir/culture trial	Species used	Stocking density (fry/m ³)	Feed type
Advance fry rearing			
Chandrikawewa			
Trial-1	<i>Cyprinus carpio</i>	100	RB, Cf, Mf, Nf
Kiriibbanwewa			
Trial-1**	<i>Cyprinus carpio</i>	100	RB
Trial-2	<i>Cyprinus carpio</i>	100	RB, Cf, Mf, Nf
Trial-3	<i>Labeo rohita</i>	660	RB
Muthukandiya Trial-1	<i>Cyprinus carpio</i>	200	RB, Cf, Mf, Nf
Trial-2	<i>Labeo rohita</i>	200	RB, Cf, Mf, Nf
Fry-to-fingerling rearing			
Chandrikawewa			
Trial-1	<i>Labeo rohita</i>	660	RB
Trial-2**	<i>Cyprinus carpio</i>	500	RB
Trial-3	<i>Catla catla</i>	200	RB, Cf, Mf, Nf
Trial-4	<i>Labeo dussumieri</i>	150	RB, Cf, Mf, Nf
Trial-5*	<i>Hypophthalmichthys molitrix</i>	100	RB, Cf, Mf, Nf
Trial-6•	<i>Labeo rohita</i>	200	RB, Cf, Mf, Nf
Trial-7	<i>Labeo dussumieri</i>	400	RB, Cf, Mf, Nf
Kiriibbanwewa			
Trial-1**	<i>Cyprinus carpio</i>	100	RB
Trial-2	<i>Catla catla</i>	200	RB, Cf, Mf, Nf
Trial-3	<i>Hypophthalmichthys molitrix</i>	100	RB, Cf, Mf, Nf
Trial-4	<i>Labeo dussumieri</i>	150	RB, Cf, Mf, Nf
Trial-5	<i>Oreochromis niloticus</i>	150	RB, Cf, Mf, Nf

(RB — rice bran, Cf — commercial feed, Mf — farmer-made aquafeed, Nf — without supplementary feeding).

* Fingerlings released two days before harvesting due to a storm.

• Fry died due to thermal shock as proper fry releasing method not applied by fishers.

** These trials were to educate fishers in rearing practices, thus did not use four feed types.

Feeding trays were used to feed fish fry. The feed was supplied at 10% of body weight in two equal portions in the morning (0830 hr) and in the evening (1630 hr). However, the amount of feed given was changed slightly, depending on the amount utilised by the fish.

Cages were cleaned using coir brushes once in five days, to remove debris attached to the walls. Temperature (°C), dissolved oxygen concentration (DO in mg/L), biological oxygen demand (BOD in mg/L), chlorophyll-*a* (Chl-*a* in mg/L) and pH were measured fortnightly inside the cages. Secchi disc depths (in cm) in reservoirs were also measured outside the cages. These measurements were made mainly to investigate the effect of different feeding regimes on the water quality of reservoirs. Construction and installation of cages and the feeding and cleaning of cages were done regularly by members of the fisheries cooperative societies.

Preparation of farmer-made aquafeed

Small indigenous fish species available in individual reservoirs, and not presently exploited by the commercial fishery were caught using small mesh (18–38 mm) gill-nets, drag-nets or fyke net. Species caught were *Amblypharyngodon melettinus*, *Esomus*

danrica thermoicos and *Puntius filamentosus* (mostly juvenile), *Rasbora daniconius*, *Danio malabaricus*, *Glossogobius giuris*, *Hyporhamphus gaimardi* and Attyid shrimps. Small cyprinids formed a major portion of the catch.

The harvested small indigenous fishes were mixed with a small amount of powdered salt, and spread on thin metal sheets and sundried for three days. This dried fish were wrapped in paper and hung under a fireplace for further drying for 5–7 days, and powdered using mortar and pestle.

To prepare the aquafeed, powdered dried fish was used as the major protein source. The other ingredients used were RB and cooked cassava tubers as a binding agent. The required amounts of RB and fishmeal were mixed together and a dough prepared by mixing with a small piece of cooked cassava tuber.

Results

Mean initial length and weight of fry, mean final length and weight of advance fry after the culture period in net cages, percentage average daily growth (%ADG) and percentage survival of different species in the three reservoirs are given in Table 2. Similar data from fingerling rearing cages are given in Table 3.

Table 2. Mean initial length (ML int.), Mean final length (ML final), Mean initial weight (ML int.), Mean final weight (MW final) and percentage survival of cyprinids in the advanced fry rearing trials.

Reservoir rearing cycle/fish spp.	Feed used	ML int	ML final	MW int	MW final	%ADG	Survival (%)
Chandrikawewa							
1. <i>C. carpio</i>	RB	1.76±0.29	3.5±1.05	0.12±0.07	0.66±0.70	9.375	38.7
	Cf	1.76±0.29	3.3±0.81	0.12±0.07	0.50±0.38	6.597	64.4
	Mf	1.76±0.29	2.4±0.45	0.12±0.07	0.19±0.15	1.215	36.5
	Nf	1.76±0.29	2.9±1.10	0.12±0.07	0.35±0.56	3.993	34.3
Kiriibbanwewa							
1. <i>C. carpio</i>	RB	1.53±0.18	3.84±0.63	0.05±0.01	1.01±0.64	16.08	36.6
	RB	1.68±0.09	3.36±1.02	0.15±0.07	0.74±0.86	8.9	38.0
2. <i>C. carpio</i>	Cf	1.68±0.09	3.37±0.8	0.15±0.07	0.63±0.56	7.26	48.5
	Mf	1.68±0.09	6.02±0.67	0.15±0.07	3.89±1.54	56.47	9.7
	Nf	1.68±0.09		0.15±0.07			
	RB	2.11±0.23	2.52±0.43	0.13±0.21	0.17±0.41	0.285	91.94
Muthukandiyawewa							
1. <i>L. rohita</i>	RB	1.83±0.47	3.8±0.88	0.05±0.05	0.51±0.29	20.66	55.1
	Cf	1.83±0.47	3.63±0.83	0.05±0.05	0.56±0.31	16.44	51.4
	Mf	1.83±0.47	2.98±1.02	0.05±0.05	0.94±0.57	26.66	39.95
	Nf	1.83±0.47	3.8±0.62	0.05±0.05	0.65±0.27	22.8	37.1
2. <i>C. carpio</i>	RB	1.66±0.11	2.89±0.96	0.028±0.01	0.33±0.33	23.89	78.45
	Cf	1.66±0.11	2.81±0.47	0.028±0.01	0.31±0.19	41.74	70.65
	Mf	1.66±0.11	3.55±0.76	0.028±0.01	0.55±0.41	22.46	41.9
	Nf	2.67±0.53	2.77±0.26	0.25±0.14	0.32±0.21	0.613	36.6

NA — Data not available as fish escaped from cages. Where appropriate ±SD are also given. The rearing cycle is as given in Table 1.

Table 3. Mean initial length (ML int.), Mean final length (ML final), Mean initial weight (ML int.), Mean final weight (MW final) and percentage survival of cyprinids in the fry-to-fingerling rearing trials.

Reservoir rearing cycle/ fish spp.	Feed used	ML int.	ML final	MW int.	MW final	%ADG	% survival
Chandrikawewa							
1. <i>L. rohita</i>	RB	1.94±0.53	3.5±0.70	0.17 ±0.06	1.79±0.27	2.83	63.1
2. <i>C. carpio</i>	RB	1.26±0.098	3.93±2.7	0.034±0.006	0.62±0.17	1.010	17.0
3. <i>C. catla</i>	RB	1.89±0.13	7.35±2.51	0.07 ±0.16	2.19±3.08	71.48	<1.0
	Cf	1.89±0.13	3.50±1.23	0.07 ±0.16	0.73±0.56	22.37	<1.0
	Mf	1.89±0.13	4.08±1.23	0.07 ±0.16	0.64±0.48	19.15	<1.0
	Nf	1.89±0.13	4.8 ±0.94	0.07 ±0.16	1.26±0.86	40.06	<1.0
4. <i>L. dussumeiri</i>	RB	2.99±0.46	5.11±0.66	0.19 ±0.13	0.95±0.43	5.686	42
	Cf	2.99±0.46	5.20±0.58	0.19 ±0.13	0.86±0.24	4.982	48
	Mf	2.99±0.46	5.35±0.73	0.19 ±0.13	1.12±0.41	6.96	49
	Nf	2.99±0.46	5.07±0.95	0.19 ±0.13	0.94±0.37	5.61	40
7. <i>L. dussumeiri</i>	RB	+	+	0.05 ±0.01	+	+	<1.0
	Cf	+	+	0.05 ±0.01	+	+	1.5
	Mf	+	+	0.05 ±0.01	+	+	10.6
	Nf	+	+	0.05 ±0.01	+	+	13.8
Kiriibbanwewa							
2. <i>C. catla</i>	RB	1.89±0.13	4.41±1.02	0.07 ±0.01	1.17±1.22	33.2	23.25
	Cf	1.89±0.13	3.48±1.32	0.07 ±0.01	0.64±0.87	17.13	46.5
	Mf	1.89±0.13	3.30±1.31	0.07 ±0.01	0.55±0.79	14.49	25.25
	Nf	1.89±0.13	4.03±1.42	0.07 ±0.01	0.98±1.15	27.34	25.0
3. <i>H. molitrix</i>	RB	3.05±0.39	4.93±1.31	0.25 ±0.11	1.24±1.34	4.95	19.5
	Cf	3.05±0.39	4.97±1.3	0.25 ±0.11	1.25±1.55	5.03	40.5
	Mf	3.05±0.39	5.37±1.28	0.25 ±0.11	1.58±1.86	6.67	34.15
	Nf	3.05±0.39	5.23±1.42	0.25 ±0.11	1.56±1.6	6.59	24.05
4. <i>L. dussumeiri</i>	RB	2.68±0.46	10.32±1.55	0.33 ±0.17	12.86±5.72	60.99	12.45
	Cf	2.68±0.46	5.92±1.34	0.33 ±0.17	2.47±1.88	10.55	95.1
	Mf	2.68±0.46	5.42±0.74	0.33 ±0.17	1.66±0.75	6.56	61.5
	Nf	2.68±0.46	8.20±1.09	0.33 ±0.17	6.12±2.74	28.28	17.85
5. <i>O. niloticus</i>	RB	2.3±0.21	5.45±0.97	0.16 ±0.04	1.02±0.68	2.15	88.35
	Cf	2.35±0.51	5.92±1.11	0.24 ±0.17	2.6±0.962	4.72	39.87
	Mf	2.35±0.51	5.57±0.61	0.24 ±0.17	2.57±1.14	4.66	26.0
	Nf	2.35±0.51	5.05±0.87	0.24 ±0.17	2.69±1.07	4.90	30.15
6. <i>L. rohita</i>	RB	2.36±0.21	NA	0.18 ±0.08	1.39±1.01	2.28	21.46

The rearing cycle is as given in Table 1. + These data were not considered as the fishers paid less attention to feeding. NA — Data not available as fish escaped from cages. Where appropriate ±SD are also given.

Percentage survival and % ADG of *C. carpio* in three reservoirs are shown in Figures 1a and 1b respectively for advance fry rearing cages. Similar data for *C. catla* cages in Kiriibbanwewa and Chandrikawewa are shown in Figures 2a and 2b. *L. dussumeiri* in the same reservoirs are shown in Figures 2c and 2d. Values for *O. niloticus* and *H. molitrix* in Kiriibbanwewa are shown in Figures 2e and 2f, respectively. Percentage survival and % ADG of *C. carpio*, *C. catla*, *H. molitrix* and *L. dussumeiri* in Mf feeding regimes during five rearing cycles are shown in Figure 3.

Proximate compositions of farmer-made aquafeed, rice bran and commercial feed are given in Table 4. Percentage protein in farmer made aquafeed increased when fine powdered fishmeal was used to prepare Mf (Table 5). Percentage protein levels in Mf prepared using fine powdered fishmeal were significantly higher than in Mf prepared using coarse powdered fishmeal ($t=1.943181$; $p<0.05$).

Table 4. Proximate analysis (%) of commercial feed (Cf), Rice bran (RB) and farmer-made aquafeed (Mf) in Chandrikawewa (C), Kiriibbanwewa (K) and Muthukandiyawewa (M). The values with similar superscripts in any one column are not significantly different ($p>0.05$; Sheffe's test).

Reservoir	Feed	Dry matter	Moisture	Ash	Protein	Fat
C, K, M	Cf	92.7 ^A ±0.2	7.2 ^C ±0.2	9.5 ^F ±0.0	37.1 ^L ±2.2	6.6 ^P ±1.7
C, K, M	RB	85.2 ^A ±3.9 56.6 ^B	14.9 ^D ±3.8	10.7 ^G ±4.6	13.2 ^M ±0.4	2.8 ^R ±0.1
K	Mf	±5.8 56.4 ^B	43.3 ^E ±5.9	7.3 ^H ±1.9	24.1 ^N ±7.2	2.6 ^S ±0.5
C	Mf	±1.9 61.0 ^B	43.5 ^E ±1.9	9.1 ^K ±0.8	25.7 ^N ±3.0	9.3 ^T ±0.0
M	Mf	±5.9	38.9 ^E ±5.9	6.9 ^K ±0.7	31.4 ^N ±2.4	12.0 ^U ±0.1

Table 5. Proximate composition of farmer-made aquafeed prepared using coarse-powdered and fine-powdered fish-meal in Kiriibbanwewa (\pm SD).

Used fish meal	% Dry matter	% Moisture	% Ash	% Protein	% Fat
Coarse-powdered	59.2 \pm 0.6	40.7 \pm 0.6	6.5 \pm 0.4	16.7 \pm 8.0	3.2 \pm 0.1
Fine-powdered	96.9 1.3	3.1 \pm 1.2	19.4 \pm 0.7	70.9 \pm 1.0	2.1 \pm 0.1

Rearing *C. catla* fry was not successful in Chandrikawewa for any of the four feeding regimes.

Nevertheless, it was successful in Kiriibbanwewa (Figures 2A and 2B) with a survival of 46.5% and a % ADG of 17.1 with the Cf feeding regime. Indigenous fish species *L. dussumieri* showed considerably better survival and growth on Cf and Mf food types than in cages with Nf and RB food types in Kiriibbanwewa. In Chandrikawewa, *L. dussumieri* showed almost similar survival and % ADG for all four food types. *L. rohita* showed a better survival and % ADG in RB food type in Chandrikawewa than in cages with the same food type in Kiriibbanwewa (Table 3).

Water quality parameters in the respective reservoirs are shown in Table 6. DO and BOD did not vary inside and outside the cages.

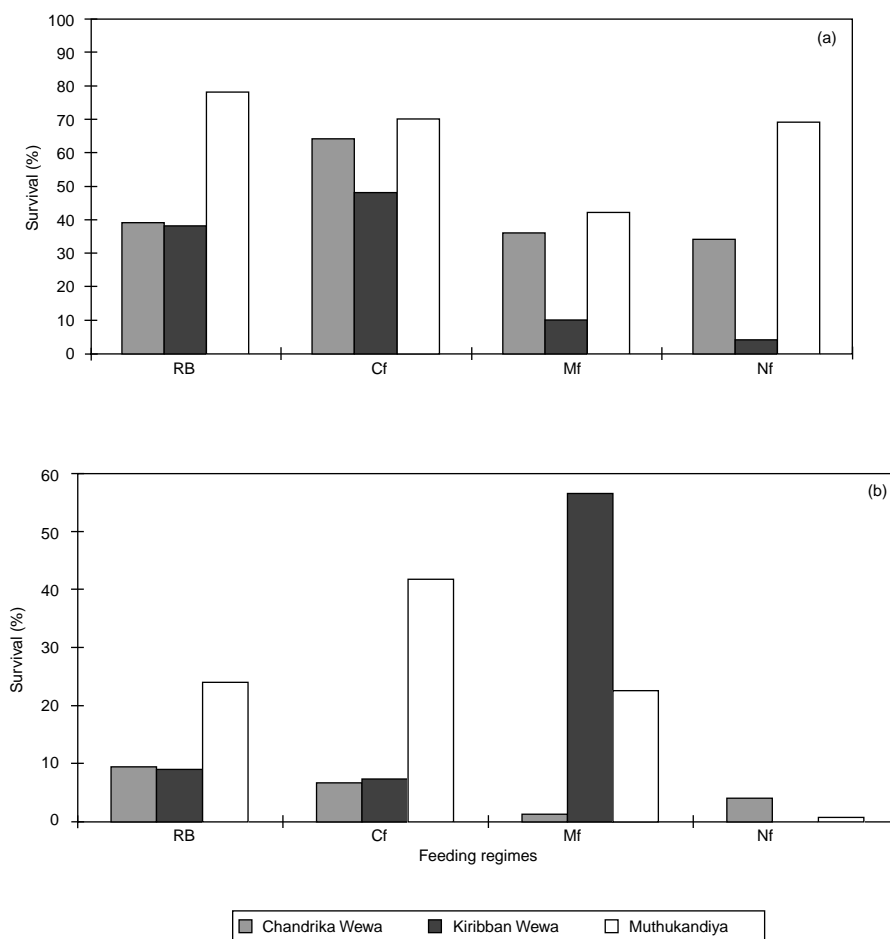

Figure 1. (a) Percentage survival (% survival); (b) percentage average daily growth (%ADG) of *Cyprinus carpio* fry reared in floating cages in Chandrikawewa, Kiriibbanwewa and Muthukandiawewa.

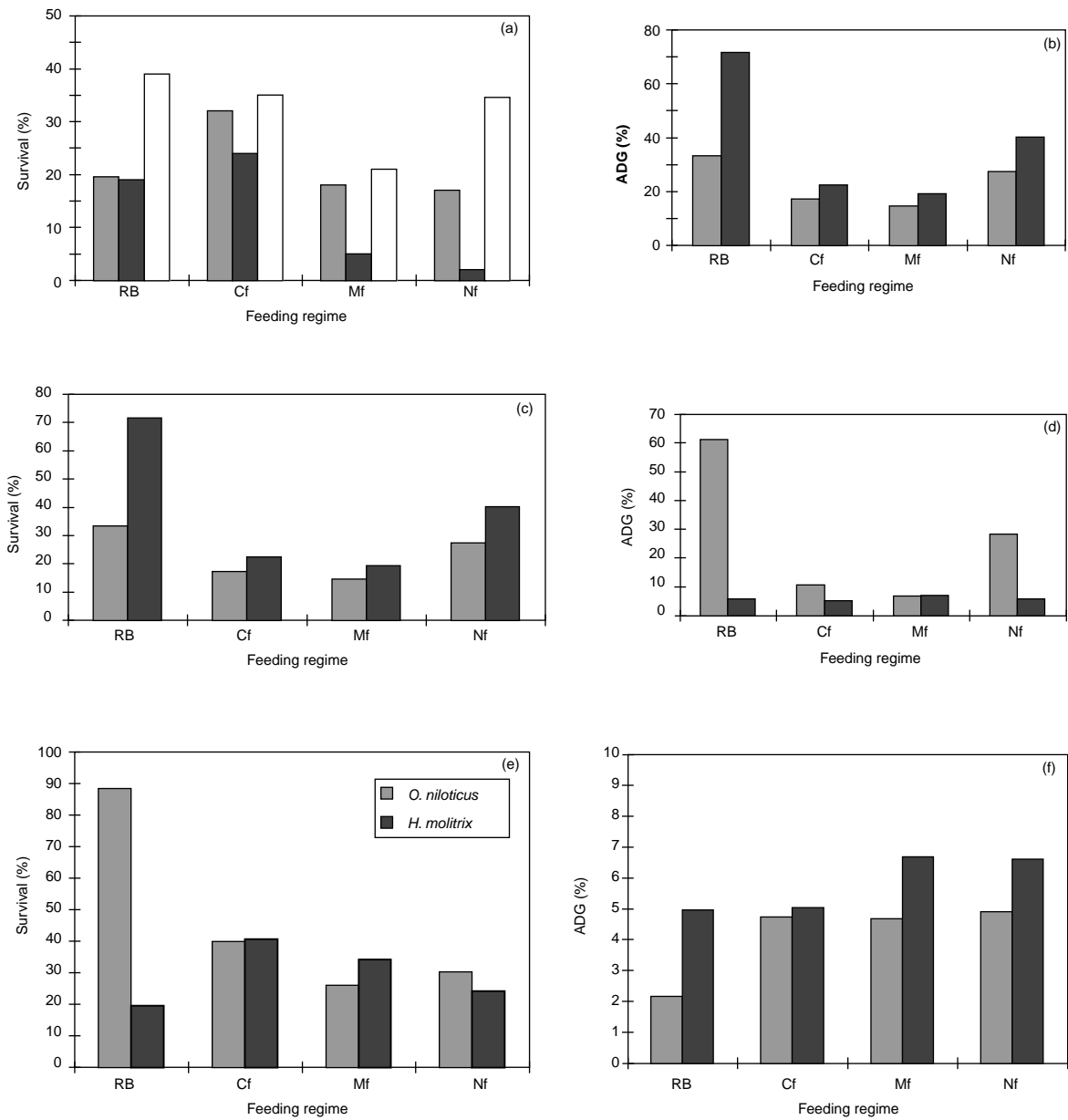

Figure 2. (a) Percentage survival (% survival), (b) percentage average daily growth (%ADG) of *Catla catla* fry reared in floating cages in Chandrikawewa and Kiriibbanwewa; (c) percentage survival (% survival); (d) percentage average daily growth (%ADG) of *Labeo dussumieri* fry reared in floating cages in Chandrikawewa and Kiriibbanwewa; and (e) percentage survival (% survival) and (f) percentage average daily growth (%ADG) of *Hypophthalmichthys molitrix* and *Oreochromis niloticus* fry reared in floating cages in Kiriibbanwewa (feed types: RB, rice bran; Cf, commercial feed; Mf, farmer-made aquafeed; Nf, without supplementary feeding).

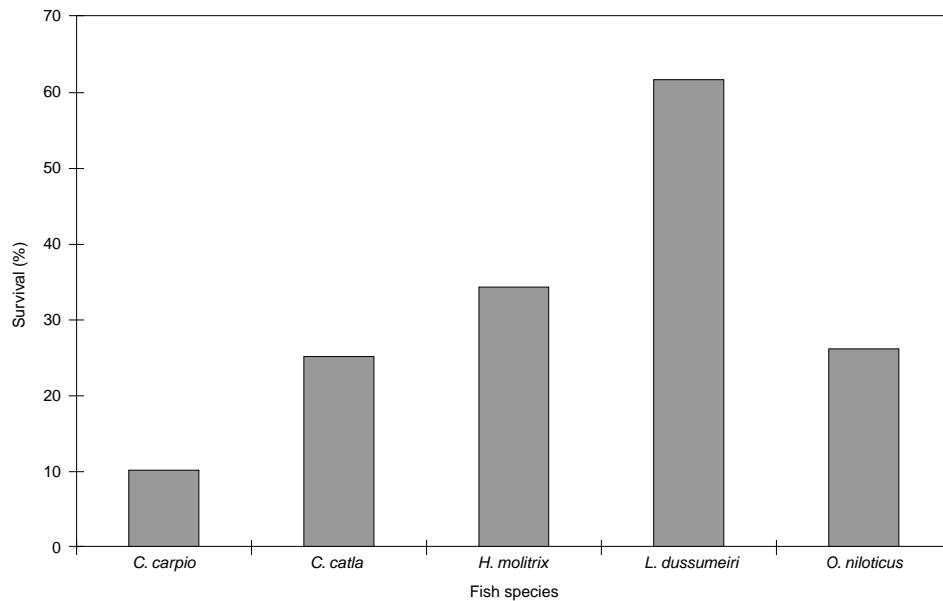

Figure 3. Percentage survival (% survival) of *Cyprinus carpio*, *Catla catla*, *Hypophthalmichthys molitrix*, *Labeo dussumieri* and *Oreochromis niloticus* fry reared in floating cages with farmer-made aquafeed (Mf) in Kiriibbanwewa in five rearing cycles.

Table 6. Means of some physico-chemical parameters (dissolved oxygen (DO), biological oxygen demand (BOD), pH, Secchi depth (SD), chlorophyll-*a* (Chl-*a*) and temperature (Temp.) in different cage culture cycles of cyprinids and cichlids in three reservoirs.

Reservoir/ Rearing trial	Fish sp.	Air Temp. (°C)	Water Temp. (°C)	pH	SDD (cm)	DO (mg/L)	BOD (mg/L)	Chl- <i>a</i> (mg/L)
Advance fry rearing								
Chandrikawewa								
Trial-1	<i>C. carpio</i>	30.0	34.0	8.09	152	4.4	1.6	12.72
Kiriibbanwewa								
Trial-1	<i>C. carpio</i>	30.5	32.5	8.19	130	5.5	3.1	18.19
Trial-2	<i>C. carpio</i>	32.5	31.5	8.64	115	5.36	3.5	24.14
Trial-3	<i>L. rohita</i>	30.2	31.5	8.31	110	5.0	1.2	29.77
Muthukandiyawewa								
Trial-1	<i>L. rohita</i>	30.2	34.0	8.2	120	4.0	1.2	84.05
Trial-2	<i>C. carpio</i>	30.0	33.5	8.5	120	4.6	1.3	37.56
Fry-to-fingerling rearing								
Kiriibbanwewa								
Trial-1	<i>C. carpio</i>	32.5	33	8.41	120	5.4	1.3	21.16
Trial-2	<i>C. catla</i>	31.5	30.2	9.32	110	4.8	4.0	29.03
Trial-3	<i>H. molitrix</i>	29	29	9.45	120	5.41	1.87	23.12
Trial-4	<i>L. dussumieri</i>	31.6	29.6	7.4	160	7.05	2.91	19.72
Trial-5	<i>O. niloticus</i>	30	29	7.97	130	6.12	3.02	12.41
Trial-6	<i>L. rohita</i>	27	28	8.63	135	5.1	1.2	12.91
Chandrikawewa								
Trial-1	<i>C. carpio</i>	30.5	33.5	8.47	95	3.9	2.7	11.08
Trial-2	<i>L. rohita</i>	29.0	32.0	8.76	100	4.0	2.1	6.79
Trial-3	<i>C. carpio</i>	30.5	33.5	8.47	95	3.9	1.9	6.94
Trial-4	<i>C. catla</i>	32.0	30.1	8.55	90	4.17	2.2	8.0
Trial-5	<i>L. dussumieii</i>	32.0	32.0	9.20	110	5.27	1.65	12.56
Trial-6	<i>H. molitrix</i>	33.0	29.0	8.74	90	4.25	1.9	9.82
Trial-7	<i>L. dussumieri</i>	29.5	29.3	9.14	110	4.20	2.1	11.72

Discussion

De Silva (1989) and Amarasinghe (1990) indicated that the minor cyprinids found in large quantities in Sri Lankan reservoirs could be differentially exploited and utilised to produce fishmeal for the aquaculture industry. According to the present study, it is clear that fisher communities are able to learn the preparation of aquafeed for semi-intensive cage aquaculture. For example, in Kiriibbanwewa, fishers gradually obtained better results in the culture trials, possibly due to learning the feed preparation strategy (Figure 3).

The percentage protein in farmer-made aquafeed improved when fine-powdered fishmeal was used. At the beginning of the Mf feeding regime in the second rearing trials, survival of *C. carpio* was 9.7% in Kiriibbanwewa (Table 2). In the second rearing trial with *C. catla* fingerlings and the same food type in Kiriibbanwewa it improved up to 25.2%. At the third fingerling rearing trial on *H. molitrix*, it increased to 34.1%. Survival of 61.5% was achieved by *L. dussumieri* in Kiriibbanwewa (Table 3). The learning factor significantly contributed to the success of the aquaculture strategy. In Chandrikawewa, too, increased survival of *C. carpio* (36.5%) in Mf feeding regime was achieved in advanced fry rearing cages (Table 2).

Percentage survival of *L. dussumieri* fingerling reared in cages in that reservoir increased from 42% to 49% (Table 3). However, in the seventh rearing trial of *L. dussumieri* fry to fingerling size in Chandrikawewa, the highest survival rate that could be obtained was 13.8% (Table 3), due to poor attention paid by the farmer community to this aquaculture strategy. The %ADG of *C. carpio* fry in Mf feeding regime was as low as 1.2%, possibly due to low protein content in the feed in Chandrikawewa (Tables 2 and 5). Both survival and growth rates could be improved through increasing % protein in farmer-made aquafeed in Chandrikawewa. In Muthukandiyawewa, survival varied with the Mf feeding regime, and was relatively high and ranged 39.5–41.9% (Table 2).

Similarly, % ADG values in this reservoir also ranged 22.4–26.7% (Table 2). According to the results of a culture trial done by the fisheries women's organisation (a non-government organisation) only 15% survival was achieved with *C. catla* fry reared on a RB feed in Chandrikawewa. The high protein level (31–34%) in Mf in Muthukandiyawewa (Table 4) may be responsible for the high survival and high growth rates in the cage-culture trials. This is further substantiated by the high survival and high growth observed in most culture trials with Cf (Table 2), when the crude protein content was 37.1%.

Entry of wild fish to the cages was a serious problem during the initial trials in the three reservoirs. *A. melettinus*, *E. danrica thermoicos*, *P. filamentosus*, *R. daniconius* and *D. malabaricus* were present in cages and perhaps competed for feed. Predatory fish species such as *Glossogobius giuris* and *Heteropneustes fossilis* were also present in the cages. These predators may also have accounted for the observed low survival in the cages. According to the analysis of water quality parameters in reservoirs where cage-culture trials were carried out (Table 6), so far no evidence has been found to suggest a deterioration of water quality due to rearing fish fingerlings in floating cages. However, continuous monitoring of the water quality of the three reservoirs is needed to determine optimal cage density. On the other hand, it is unlikely that the cage-culture in perennial reservoirs would be intensified indefinitely because the fisher communities rely on capture fisheries in reservoirs as a source of their main income, and the two activities may come into conflict if the number of cages is increased significantly.

Acknowledgments

This study was conducted with the financial support of a research grant from the Australian Centre for International Agricultural Research (ACIAR).

References

- Anderson, T.A. and De Silva, S.S. 1997. Strategies for low-pollution feeds and feeding. *Aquaculture Asia*, 11(1): 8–22.
- Amarasinghe, U.S. 1985. Studies on the exploitation of minor cyprinids in Parakrama Samudra, a man-made lake in Sri Lanka, using gillnets. *Journal of National Aquaculture Resources Research Agency (Sri Lanka)*, 32: 11–23.
- . 1990. Minor cyprinid resources in a man-made lake in Sri Lanka: a potential supplementary source of income for fishermen. *Fisheries Research*, 9: 81–89.
- De Silva, S.S. 1989. The trends in the Sri Lankan reservoir fishery with special reference to the role of cyprinids. In: Petr, T. ed., *Indo-Pacific Fisheries Commission, Papers contributed to the Workshop on the Use of Cyprinids in the Fisheries Management of Larger Inland Water Bodies of the Indo-Pacific, Katmandu, Nepal, 8–10 September 1988*, FAO Fisheries Report No. 405 Supplement, 34–35. FAO, Rome, 35–45.
- De Silva, S.S. and Sirisena, H.K.G. 1987. New fish resources of reservoirs in Sri Lanka: feasibility of introduction of a subsidiary gillnet fishery for minor cyprinids. *Fisheries Research*, 6: 17–34.
- Pet, J.S. and Piet, G.J. 1993. The consequences of habit occupation and habitat overlap of the introduced *Oreochromis mossambicus* and indigenous fish species for fishery management in a Sri Lankan reservoir. *Journal of Fish Biology*, 43 (Supplement A), 193–208.

Cage Fish Trials in Ea Soup Reservoir, Vietnam

Phan Thuong Huy, Phan Dinh Phuc, Nguyen Ngoc Vinh and J.D. Sollows*

Abstract

Reservoirs in the Central Highlands of Vietnam are numerous and growing in number. Dak Lak Province has about 370 reservoirs of varying sizes with a total estimated area of 8500 ha. While constructed primarily for irrigation, these reservoirs have great potential for fish culture in the area. Ea Soup Reservoir lies in a remote district of Dak Lak. It covers an estimated 240 ha at upper storage level, and has a drawdown of about 2.5 m. Probably for this reason, there is an abundant supply of macrophytes in the reservoir. Compared to most reservoirs in the Central Highlands, Ea Soup has a relatively large catchment area (350 Km²). While a number of species have cage culture potential, grass carp (*Ctenopharyngodon idella*) is popular in many parts of Vietnam. The species feeds almost entirely on macrophytes, so cash requirements for feed are minimal. This is suitable for most poor farmers in the area. The market price of this species, about \$0.65/kg, is higher than that for many species. In Ea Soup Reservoir, cage culture of grass carp commenced in 1993, and rapidly expanded. By 1996, there were about 157 cages. Stocks were hit by disease, and were decimated late in the year. Many owners suffered heavy financial losses. Pollution, poor circulation in the cages, high stocking density and overcrowding of cages may have contributed to the disease problem. From June 1998, the project, jointly with three fishers, has tested culture of grass carp combined with small numbers of tilapia and common carp in cages with new materials, somewhat larger mesh size, and lower stocking density. The economic viability of this modified technology will depend mainly on the lifetime of the cages. Nevertheless, fishers are continuing to culture at their own expense. This suggests that the technology has some sustainability in the reservoir. The extent to which cage culture can be practised remains to be seen, but any expansion must be cautious.

THE Central Highlands of Vietnam have hundreds of reservoirs of varying sizes. Virtually all are less than 500 ha in area. The current estimate by this project suggests a total of 370 reservoirs covering 8500 ha in Dak Lak Province.

Most of the reservoirs were built mainly for irrigation, with flood control and occasionally, hydroelectricity, as secondary functions.

Ea Soup Reservoir lies about 68 km northwest of Ban Me Thuot in a remote district bordering Gia Lai Province and Cambodia. Construction began in 1978 and finished in 1980. The reservoir covers an estimated 240 ha at upper storage level, and has a drawdown of only 2.5 m. Probably for this reason, there is an abundant supply of macrophytes in the reservoir.

While a number of species have cage culture potential, grass carp (*Ctenopharyngodon idella*) is particularly popular. The species feeds almost entirely on macrophytes, so cash requirements for feed are minimal. The market price (about VND 10 000/kg (US \$0.91, \$1 = VND 14 000) is higher than that for many species. On the negative side, the species eats voraciously; therefore, the cage culturist must have the time and/or labour needed to gather and supply the needed plant material (which must also be conveniently available in sufficient quantities). This feeding habit assures heavy competition for feed, which tends to lead to increasingly uneven sizes among the fish; this can be remedied by periodic separation of fish according to size. Finally, grass carp are susceptible to a number of diseases, and this susceptibility increases when the fish are stressed. Overcrowding, combined with poor water quality, can therefore easily lead to disease outbreaks which are very difficult to treat, especially in cages.

*Management of Reservoir Fisheries Project, 69 Le Hong Phong, Ban Me Thuoc, Vietnam
Email johns@netnam2.org.vn

In Ea Soup Reservoir, cage culture of grass carp commenced in 1993, and rapidly expanded. By 1996, there were 157 cages. Stocks were hit by disease, and decimated late in the year. The losses were a strong discouragement to continuation of the practice. Many owners suffered heavy financial losses.

The causes of the disease outbreak are open to speculation. Pesticide runoff was blamed by some. However, the presence of *Branchiomyces* in at least some specimens suggested that overcrowded, polluted conditions may have been a factor. Most cages were situated in the widest part of the reservoir, near the irrigation outlet of the dam. The distances among the cages were small. The bottoms of some cages near the reservoir shore were next to the ground. The cages were made of wooden lathes, most of which had only 1–2 cm separation between them. Stocking densities, while variable, appear to have been high, with up to 56 fish/m³. The quantity of feed (water weeds) often put in the cages occupied up to 25–35% of the volume of the cages, and more feed would not be given till the fish finished what had been given, which could take 2–3 days. The remaining unused feed (e.g. stems of cassava) was not removed from the area of the cages, polluting the environment, and helping cause the outbreak.

To see whether cage culture could be restored in Ea Soup, the project, jointly with three fishers, tested culture of grass carp, combined with small numbers of tilapia and common carp in cages with new materials, somewhat large mesh size, and lower stocking density. Trials began in June 1998. Results from the first culture cycle are reported here.

Materials and Methods

The fishers were not willing to make the entire investment in the cages. They each invested VND 500 000 (AUD\$36) in their cages, the project paid the remainder.

The project supplied black plastic mesh of size $a = 26$ mm, and a nylon mesh liner of mesh size $a = 10$ mm. The fishers found their own timber for frames, side lathes, and covers.

A cost estimate for each cage:

Grow-Out Cage Costs (Ea Soup)	
Wood: frame:	VND 500 000 (\$36)
Wooden slats:	VND 300 000 (\$21)
Bamboo:	VND 180 000 (\$13)
Hut:	VND 200 000 (\$14)
Mesh:	(a) 1.8 m roll: (15 m of 30m) × VND 900 000 (\$64) = VND 450 000 (\$32)

(b) 0.9 m roll: (8 m of 30m)	
× VND 380 000 (\$27)	
= VND 50 667 (\$4)	
Total: VND 500 667	

(6) Nylon liner: 10 kg 39.2/kg	
× VND 1 411 000 (\$101)	
= VND 349 949 (\$25)	
(7) Labour: VND 150 000 (\$11)	
Total construction cost: VND 2 180 616 (\$156)	

The wooden slats served to maintain the shape of the plastic mesh, which was tied to them and the wooden frame. They were also used to make the cover of the cage. The nylon liner was necessary because of the large size ($a = 26$ mm) of the plastic mesh. It would not have been possible to find in sufficient quantity fingerlings, which could not escape from a cage of such a large mesh size. Each cage was floated by a bundle of bamboos (each about 10–15 cm in diameter) on each of two sides of the cage.

Cage dimensions were 5 m × 2 m × 2 m deep. Of this, about 1.4 m was submerged for a total submerged volume of 14 m³.

Each cage has a hatch of about 40 cm × 40 cm in the cover, for stocking and feeding.

It was felt that a polyculture situation with grass carp as the predominant species was worth trying. One author had seen satisfactory results from including a few common carp with grass carp in cages in Nepal. The common carp consume the excreta of the grass carp, thereby converting a pollutant into a fish feed. Tilapia may do the same, and may also help keep the cages clean of periphytes, which would clog the mesh and impede circulation.

Fingerlings were stocked 25 June 1998. The stocking density was set by agreement with the fishers. Each cage received 488 grass carp (*C. idella*) of mean weight 9.18 g, 60 common carp (*Cyprinus carpio*), and 40 tilapia (*Oreochromis niloticus*) of similar size. Total fingerling cost per cage was VND 600 000. Total stocking density, then, was 42/m³ (34 grass carp/m³).

Over the first 10 days, a total of 103 grass carp, 13 common carp and 10 tilapia were found dead. The grass carp were replaced by fish of a similar size in mid-July, each cage receiving the number noted dead.

The fishers managed the cage systems themselves. All had previous experience in grass carp cage culture. As a rule, feeding was twice a day, morning and afternoon. During the first month, the fish were fed mainly rice bran and cassava leaves. Water weeds were introduced late in the first month, and gradually became the predominant feed. Excess feed

(mainly stems) was removed each day. Cages were also cleaned as necessary, roughly every week.

Each fisher was given a book to record data related to inputs, mortalities and catches. In practice, one of the three was more diligent than the others in completing the information, so the method was supplemented by interviews.

Inputs were weighed periodically in order to check estimates by the fishers.

Project staff checked the growth of the fish each month. Samples were weighed, counted, then released back into the cages.

After approximately 12 months of culture, all fish were harvested.

Results

In the following Tables, each cage is identified by the name of the owner (Nghi, Huong, Than).

Inputs

Inputs are summarised by cage in Table 1.

Table 1. Inputs by cage, 27 May 1999.

Owner	Nghi	Huong	Than
Fingerlings (no.)	588	588	588
Cost (VND)	600 000	600 000	600 000
Rice bran (kg)	72.4	48	24.4
Cost (VND)	202 720	110 400	92 320
Soy cake (kg)	3	0	9
Cost (VND)	15 000		18 000
Cassava (kg)	255	2 225	305
Labour (man-hours)	120	135	110
Water weeds (kg)	31 880	32 000	26 000
Labour (man-hours)	358	405	340
Cage cleaning (man-hours)	34.5	21.5	66.5
Cash (VND)	817 720	710 400	710 320
Labour (man-hours)	512.5	561.5	516.5

Note:

Labour involved in providing rice bran and soybean cake is included in labour for giving cassava.

Water weed and cassava weights include stems as well as leaves. Stem material is not consumed.

Huong's 'cassava' includes 50 kg young grass.

It should be noted that these are approximations, based on fishers' records and monthly interviews, which depend on recollection, and hence are not precise. However, it is believed that they reflect reality to the closest extent possible.

The soybean cake was given during the first month of operations. Most of the rice bran and cassava was given during the first two months, after which the dosages tapered off rapidly. Waterweeds were the predominant feed from month 3 (September) until

April. In two of the cages (Huong's and Than's), cassava and water weeds were fed on alternate days in May.

Labour inputs are not converted into cash, since family labour was used in all three cages. The current labour rate in Ea Soup was estimated by the fishers as VND 30 000 per eight-hour day. Work required to feed fish and clean cages usually does not compete much with other activities — normally, it takes about one hour to carry out a feeding. Hence assigning opportunity cost on the basis of eight-hour days is not realistic, and overestimates the cash value of time invested.

It is also worth noting here that Than gave considerably less feed than the other two owners, especially during the third to fifth month of culture. He ran a coffee farm, which put relatively high demands on his family labour force, and as a result, did not give sufficient feed.

Recovery

Fish in each cage were counted in September, January, and April (see Table 2). It should be noted that the counts were not complete, and the focus was on grass carp.

Table 2. Fish count from the three cages.

Owner	Nghi	Huong	Than
Date	Grass carp	Grass carp	Grass carp
25/6/98	488	488	488
27/9/98	310	280	330
26/1/99	270	130	330
28/4/99	210	120	298
Final number caught	284	118	352

Grass carp mortalities during the first five days after stocking totalled 64, 33, and 10 in the cages of Nghi, Huong, and Than, respectively.

Following the 28 April check, as mentioned above, grass carp in Nghi's and Huong's cages suffered heavy mortality (see Table 3).

No signs of disease were noted in the cages, except for those possibly associated with stocking injuries.

Nevertheless, recovery rates were lower than desirable. While causes of the losses are open to speculation, the following possibilities can be advanced.

1. Escape from the cages at stocking: the fish were checked against the mesh size of the nylon liner before being packed. Some minor losses may still have occurred. Damage to the nylon liner could have caused other escapes.

Table 3. Grass carp mortality details: 29 April–1 May 1999.

Cage	Nghi	Huong
Number dead	103	60
Weight dead (kg)	69.98	59.40
Mean weight (g)	679	990
Income (VND)	545 670	370 600
Remarks	Included three fish (1.35 kg) fed to pigs, and 40 live, healthy fish (24 kg) harvested 1 May and sold for VND 216 000.	Included one fish (1 kg) eaten and counted as income at VND 10 000, and four fish (4.8 kg) fed to pigs.

*Fish fed to pigs were given a price of VND 0/kg.

- Higher-than-reported initial mortalities: most of the fish which died after stocking were counted, but undoubtedly a few were missed.
- Predation: attacks by puffer fish (*Tetradontidae*) probably led to additional mortalities. A few fish with damaged tails were noted, and the damage ascribed to attacks by puffers.
- Escape from the tops of the cages: the bamboos used to float the cages initially were old, and becoming waterlogged by late September. The weight of a large human on such a cage was enough to submerge the cage above the level of the plastic mesh. The fishers collected new bamboos to replace the old, but Huong, in particular, delayed. It is suspected that this may explain the high loss he suffered between September and January.

Growth

The chart (Figure 1) graphically presents growth in the three cages. Growth was not checked in the cages of Than and Huong until late September, when the situation was rectified.

Than had more fish than the others, and the greatest difficulty feeding them. The two factors combined to explain the inferior growth noted in his cage.

The sharp increase in the size of fish in Huong's cage between the October and November checks (days 125 and 159) probably indicates the time he lost his fish. The low number of fish in his cage allowed them to achieve the largest size.

Nghi and Than sold fish (44 kg and 9 kg, respectively) just before Vietnamese New Year in mid-February (around day 230). They selected the largest

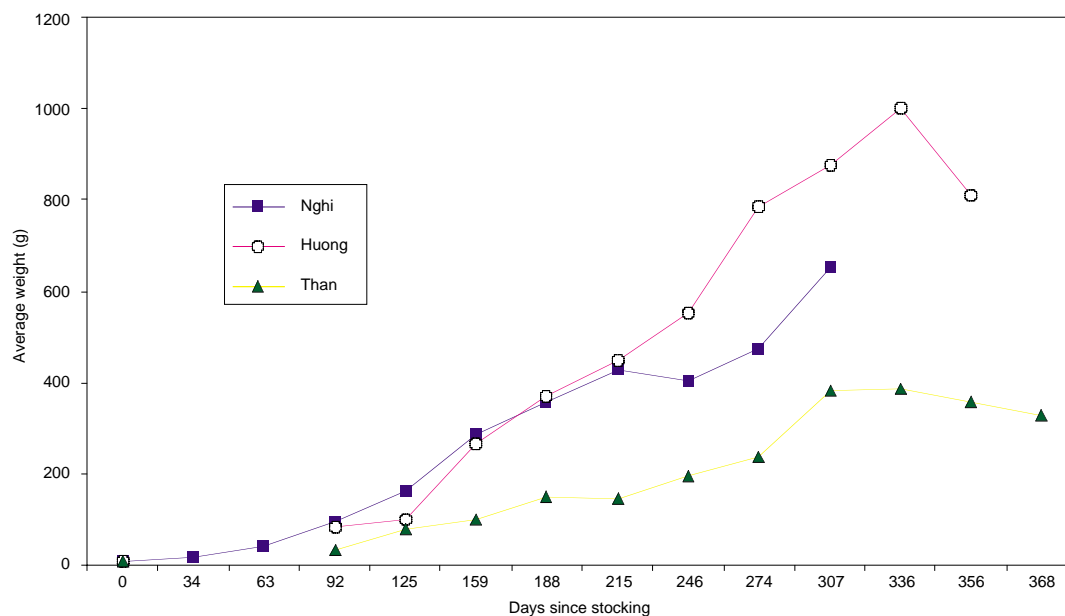

Figure 1. Mean individual weight of grass carp in Ea Soup cages, 25 June 1998–28 June 1999.

fish they had; therefore, the mean size of fish was lower in late February (day 246). Heavy mortality in the cages following the April check (day 307) led to sales from all cages. Nghi harvested all his fish in May, and Huong half of his. Subsequently, Than sold about 25% of his stock (by number), selecting the largest fish, which explains the apparent absence of growth in his cage in May (days 307–336).

Huong and Than gave little feed in June, and the remaining fish, at least in Than's cage, may have been stunted, which may explain the drop in size at final harvest.

Production

Fish production estimates made before final harvest are calculated from the sum of the total weight fish caught and the estimated remaining biomass, based on number counted and mean weight in each cage. The final production figure for each cage is based on total weight caught from each cage. The contribution of common carp and tilapia to the estimate is ignored, since sampling tended to net them very irregularly. Final numbers harvested, also, were almost negligible.

After 11 months of culture (for Nghi), and 12 months (for Huong and Than), the estimates of grass carp production per cubic metre are 12.0, 7.6, and 9.8 kg/m³, respectively.

Economics

The following chart estimates the production value of the fish through time (Figure 3).

Intermediate data take into account the sum of the value of fish caught from the cages and the estimated value of fish biomass remaining in the cages. Since some fish had to be sold at low prices, production values climbed more slowly than actual production. Final values are those of all grass carp harvested from the cages.

The production value assigned to Nghi's stock reflects the high price he was able to get for most of his catch, and the large size of his fish. At the time of heavy fish mortality in late April, Huong could sell his caught fish for only VND 6000 (\$0.43)–7000 (\$0.50)/kg, depending on condition. The low production value assigned to Than's fish reflects their smaller size.

These data consider only grass carp, but values for all three stocked species were considered, as per harvest data (see Table 4). Nghi harvested three common carp totalling 2.1 kg, Huong two common carp totalling 1.8 kg, and one tilapia (600 g), and Than two common carp, totalling 1.6 kg.

The labour investment has not been equated to cash, for reasons explained earlier. Instead, cash return on labour has been calculated.

Capital investment in the cages (about VND 2.2 million per cage (\$157)) has not yet been considered. Based on the results, if the culture situation repeated, Nghi would be able to pay for his cage in three years. It would take Huong 11 years, and Than four years, to pay for his cages. The situation should improve for all cages if there were no future accidents, which force sales at a low price, and if all fish can reach a size suitable for selling at a higher price.

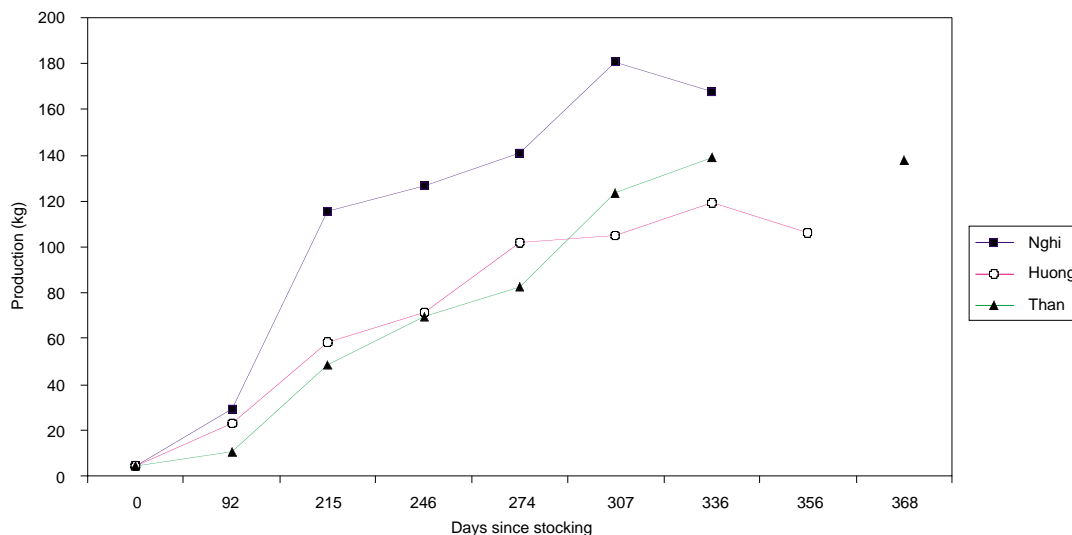

Figure 2. Estimated production of grass carp from Ea Soup cages, 25 June 1998–28 June 1999.

Discussion and Conclusion

Cage culture in Ea Soup appears to be of modest viability. As expected, in contrast to the situation in 1996, disease did not present a serious problem. There were far fewer cages in operation. There was also less internal cage pollution: water circulation through the cages was better, stocking densities of grass carp were slightly lower, the few common carp and tilapia in the cages would have consumed much of the grass carp excreta, and remaining unused feed was removed from the area of the cages.

Judging by the growth of fish in Huong's cage, following a loss of fish in November, it is likely that the stocking density used (35 grass carp/m³) is higher than ideal. This may be suitable as an initial density for nursing fingerlings, but the stock should

be thinned, and preferably segregated by size between two cages after two or three months of culture. The final appropriate number of fish would depend on the labour force and free time available to each interested family.

Problems reported by fishers and already mentioned include initial mortality and attacks by puffer fish, waterlogging of bamboos, loss of fish through the growing season, and insufficient labour, at least on Than's part, adequately to feed the fish. Otherwise, the fishers felt that growth was slower than in previous years, and suspected that fingerling quality may be partly to blame. They also mentioned that it would be much better for each individual to manage two cages — labour needed to feed the fish in two cages is only marginally higher than that needed to feed one, and this would allow large and small fish

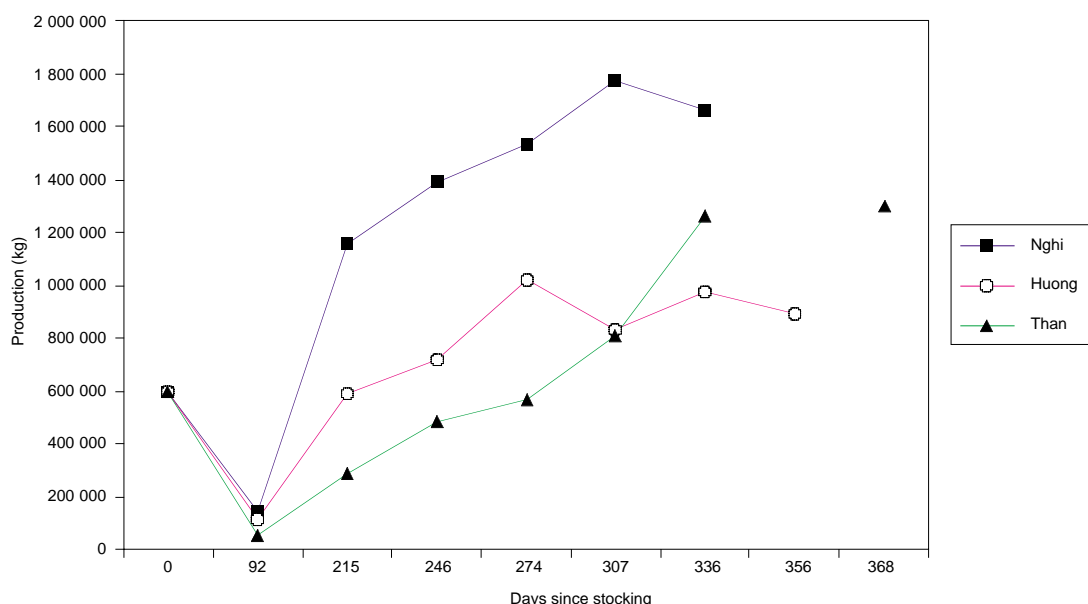

Figure 3. Production value of grass carp from cages in Ea Soup, 25 June 1998–28 June 1999.

Table 4. Economic indicators for three cages.

Owner	Nghi	Huong	Than
Production value (dong)	1 683 770	911 600	1 313 400
Cash costs (dong)	817 720	710 400	710 320
Net benefit (dong)	866 050	201 200	603 080
Labour investment (man-hours)	512.5	561.5	516.5
Benefit: cost ratio	1.059	0.283	0.849
Benefit/man-day (dong)	13 519	2 867	9 341

Note: One man-day is set at eight man-hours.
Running costs only are considered in the above cash costs.

to be separated. Competition among the fish would thus be reduced, and overall growth and production higher.

In 1999, the three fishers restocked their cages on their own and at their own expense, with fish from a local nursing. Reported stocking densities were similar to those used in 1998, but count made later indicated considerably lower number. A fourth fisher constructed and stocked his own cage. Results are awaited.

Given results to date, the profitability of the practice will be modest, at best. It may well be suitable for families living near the reservoir who have a boat for other purposes, and who have the necessary combination of time and available labour to feed fish and maintain cages. The practice will probably be of more interest to families who find the modest returns worth the time investment — well-off families are less likely to be interested.

The events of 1996 suggest strongly that the reservoir has a limited carrying capacity for cage fish culture. It should not be exceeded. The massive mortality of 1996 may have been due in part to overcrowding of cages near the dam.

Other factors may also impose advisable upper limits on the number of cages. Adverse effects on other fish species, due either to pollution from the cages or depletion of waterweeds may need consideration. Some villagers report that when a large number of cage operators were selling fish in 1996, market prices for local fish were depressed (Phillips 1998). Waste and stems from the cages also reportedly clogged the irrigation outlet from the reservoir at times. Most people living around the irrigation outlet of the reservoir also use reservoir water for domestic washing. They may be affected by disease due to pollution from overcrowded cages.

The risks associated with water quality problems are underlined by the mortality rate in two of the cages at the end of April. Sporadic water quality checks indicated relatively low oxygen levels at certain times of year, particularly in the early rainy season.

Closing the irrigation outlet about 20 April led to poor circulation of water through the cages. The water level of the reservoir was kept lower as a precaution against floods, and that crowded the fish. Waterweeds also died in the area, as water levels dropped. The weather had been cloudy for several days prior to the checks, and it continued through to early May. Some mortality of natural species, including *Puntius brevis* and *Corica* sp., was also noticed. Following census and growth check of each cage April 27–28, mortalities were noticed in Nghi's and Huong's cages. As mentioned earlier, in the early morning some large grass carp were noticed

floating in the two cages, and other fish showed signs of severe stress, gaping at the surface and displaying swollen lips. Only large fish were severely affected. Than's cage was in deeper water, and his fish were smaller. Also, Nghi and Huong gave their fish large quantities of feed after the check. Than did not feed his fish.

It is suspected that the fish were already under stress due to low oxygen levels. The handling added to their stress, and may have led to death. Large fish could have suffered more from collision in the course of handling, and their oxygen requirements would have been higher.

Removal of the nylon liner (10 mm mesh) would probably have improved circulation through the cages to some extent. However, the fishers found this very difficult to achieve, and the liners were left in.

The experience raises several points:

- cage operators would do well to sell part of their stock as soon as it reaches a size which commands a satisfactory price, particularly advisable at such times as holidays, when fish sell for a higher price than usual. That would reduce density and competition in the cages, making for higher overall production, and assure that emergency sales are kept to a minimum;
- caution in handling fish is essential at times when water quality problems are suspected. Closure of the irrigation outlet would have reduced circulation in the area of the cages, and the low reservoir water level and prolonged periods of cloudy weather would have led to very low oxygen conditions;
- cages should be set in deep water, with at least 1.5–2 m between the cage bottom and the bottom of the reservoir, when water levels are low. This allows for better circulation and less pollution from bottom sediment, including waste from the cages;
- as fish grow, every effort should be made to maximise cage mesh size. Liners should be set in such a way that they can be removed easily when escape is no longer possible. Otherwise large mesh cages should be used when the fish grow large enough.

A few other cage management considerations and precautions apply to the reservoir, in general.

- It is difficult to say exactly how many cages the reservoir can support, but 104 cages were reportedly in place in 1995, and no problems presented at that time, though the number is probably much higher than advisable. Given recent experience, the expansion of cage culture in Ea Soup should develop very gradually, with 10–20 cages as a current maximum.
- Who should get cages? Fishing families of appropriate means are probably in the best logistical

position, since they live near the reservoir and have boats. They must be able to afford the necessary inputs, and yet find the modest returns satisfactory.

- Placement of cages needs consideration. Cages should be set in deep enough water to facilitate waste disposal. They should be sheltered from rough weather, yet where currents can augment circulation of water through them. Individuals managing cages should also consider placing them near their houses, where management and surveillance are more convenient.
- New material allows better circulation of water through the cages than previously. The stocking density of grass carp and the number of common carp and tilapia needs further study, but should not be higher than that tested and reported here, and not too much feed should be given, especially when water quality problems are suspected.

Applicability of these results to other reservoirs deserves consideration. Compared to most reservoirs in the Central Highlands, Ea Soup has a relatively

large catchment area (350 km²), and therefore should have a high flushing rate. The low draw-down has allowed a very profuse growth of waterweeds, which makes culture of grass carp convenient. Ea Soup is relatively remote, and there is therefore a strong incentive for self-sufficiency, but also a limited market capacity. The negative factors are likely to diminish in importance as immigration to the area continues and improvements to the road connecting Ea Soup and Ban Me Thuot are made.

The availability of feed and the high flushing rate suggest that the potential for cage culture of grass carp is probably high in Ea Soup, compared to most reservoirs in the Central Highlands. However, given experience to date, any expansion in cage culture is likely to be very limited.

Reference

- Phillips, M.J. 1998. Freshwater Cage Culture Development in the Reservoirs of Central Highlands of Vietnam. Prepared for the Mekong River Commission. 123 p.

The Biology and Fishery of Indigenous Gobies of Mainit Lake, Philippines

A.M. Calicia Jr and N.A. Lopez*

THE paper presents information of the results of a 17-month study of the biology, fishery and population structures of gobies (Order Gobioidae) *Glossogobius giurus* (Family Gobiidae) and *Hypseleotris agilis* (Family Eleotridae) caught by beach seine in Lake Mainit from August 1997 to December 1998.

The study is a component of a research grant funded by the Government of Spain which covers a 3-year research study of the biology and fishers of 7 major lakes in the Philippines.

Glossogobius giurus, locally known as Pedianga and *H. agilis*, locally known as Buguan, are among the most abundant fish species of commercial value of the family Gobiidae and Eleotridae found in the lake. Fish-landing records from beach seiner showed that the highest catch of *G. giurus* and *H. agilis* were recorded during the months of April and September, respectively. The lowest were recorded during the months of November and December for both species. Mean catch per unit effort (CPUE) for both species were recorded on a monthly basis. The equivalent mean CPUE for *G. giurus* was estimated at 19.87 kg/hr, and 5.79 kg/hr recorded for *H. agilis*.

Aspects of the biology of the species, namely size and species composition, growth, seasonality, length/weight relationship, gonadal maturity, sex ratio, spawning months, size at first maturity and plankton composition were studied and correlated.

Collected data on sexual maturity revealed the appearance of matured, gravid and spent individuals throughout the year for both species, indicating that spawning is continuously taking place all year round, but peak spawning is evident for both species. Estimates of size at first maturity also indicated the early maturity of *H. agilis* over *G. giurus* for both sexes, while sex ratio of both species indicated the dominance of female over male as much as 16% for the former and 27% the latter. Management policies for the conservation of the fisheries are also discussed.

*Bureau of Fisheries & Aquatic Resources, 860 Quezon Avenue, Quezon City, Metro Manila 3008, Philippines

Dam and Fish Diversity: Case Study of the Pak Mun, Thailand

C. Vidthayanon¹ and S. Premcharoen¹

THE Mekong basin supports the third highest fish species diversity in the world, with an estimated number of fish species exceeding 1200. Basin-wide in Thailand alone, 290 species, and possibly up to 350 species, have been previously reported.

The best representative is the Mun River tributary which is reported to have 256 native species. Its diversity impact from dam construction has been controversial. The preliminary post-impounded assessment when compared to the species record has shown a decline, possibly due to habitat alteration, loss of migration routes accompanied with over fishing.

Although a fish ladder was installed, only 62 species, 3 cm to 30 cm, are able to utilise it. At least 30 strictly riverine species are disappearing. As well, five artisanal fishing methods were abandoned upstream of the Mun River.

Post-impounded assessment needs to be continued for future planing of impact mitigation and habitat rehabilitation of the river.

¹Fisheries Museum Division Department of Fisheries, Zoology Section, Faculty of Liberal Art and Science, Kasetsart University Kamphaengsaen campus

Workshop Issues and Recommendations

THE Asian region has the highest population concentration in the world. Its current annual average fish consumption is about 17.2 kg as opposed to the world average of 15.8 kg. Its population is expected to reach 4.16 billion by year 2020. If the current fish consumption rate is to be maintained the region will require 70 million t fish by 2020, an increase of nearly 26 million t from the present Asian production of 44 million t. With little growth in the supply of aquatic products from the marine capture fishery, it is envisaged that inland fisheries and aquaculture in the region will become increasingly important.

Asia also has one of the world's highest densities of reservoirs and a relatively low river index compared to the other continents, as well as a relatively small acreage of natural lakes. Damming natural waterways is a controversial issue. However, reservoirs are rarely or never impounded for fishery purposes. Once a reservoir is created, the resources thereof, and in particular the fishery resources and their aquaculture potential, should nevertheless be utilised effectively and efficiently for food production and poverty alleviation, and to provide alternative employment for displaced persons. In that context it is imperative that reservoir fisheries and aquaculture constitute an important component of future fish supplies in the region.

A holistic approach to fisheries management

The workshop resolved:

...that reservoir fisheries management in the region needs to adopt a more holistic approach than is presently the case.

This approach needs to ensure that a reservoir, per se, is considered a component of the whole watershed, and that socioeconomic, policy development and management issues and actions are all effectively integrated to optimise and sustain fisheries development in reservoirs. A conceptual summary is shown in Figure 1.

To facilitate increased emphasis on more holistic management of reservoir fisheries in the region, the workshop identified a range of issues and drafted a suite of recommendations for the consideration of key stakeholders.

Issues and Recommendations

1. Integrated management

The workshop recognised that:

- there is a paucity of empirical models depicting inter-relationships of fish yield/production to

catchment and limnological characteristics, as well as yield and fishing effort of reservoirs in watersheds; existing models have limited application to integrated catchment-scale management of fisheries and aquaculture in reservoirs;

- the existing models and databases in most countries in the region are unavailable and/or unreliable and inadequate; and
- the development of suitable models will be the only solution to upscale results from site-specific studies.

Recommendations

- 1.1 To encourage and support the development of cost-effective empirical models across different watersheds in the region based on catchment and limnological characteristics (such as Secchi depth, chlorophyll-*a*, nutrient levels), using standardised methodologies and/or GIS and remote sensing, and reservoirs be grouped into appropriate 'classes' (e.g. size) to facilitate model development and application;
- 1.2 to develop indicators (e.g. fish yields) and management characteristics (e.g. fishing effort), where appropriate and relevant;
- 1.3 to identify and develop appropriate criteria for reservoir classification from multivariate analyses.
- 1.4 to conduct research in partnership with fishers and other stakeholders where possible. This will require involvement of stakeholders in the identification of research priorities, study design, data collection and analysis, and should contribute to the achievement of stakeholder objectives.

The Workshop recognised:

- a lack of a policy framework(s) to facilitate integrated catchment-scale management for fisheries and aquaculture;
 - a lack of an effective voice for fisheries and aquaculture and a relative lack of understanding of the influence of non-fisheries activities that have hindered the development of reservoir fisheries in most nations; and
 - most current reservoir fisheries yields tend to be suboptimal, often impacted by catchment externalities, underexploited and based on few species, and large biomasses of mostly indigenous species hitherto underexploited.
- 1.5 To develop an effective linkage to decision-making/policy development processes within catchments across the region.

- 1.6 To establish a better understanding of other watershed-user needs and to develop management guidelines within appropriate time frames.
- 1.7 To improve the ability to sustainably exploit 'new' resources through focused research and development (R&D), and to explore the potential of markets for direct and/or indirect utilisation of such harvest.
- 1.8 To develop more effective and efficient interaction (vertical and horizontal linkages) with other catchment uses, user groups and their respective management institutions.
- 1.9 To continue to appraise issues on exotic species of reservoir fisheries where relevant, in compliance with international codes of practices in relation to new species introductions.
- 1.10 To analyse (using appropriate frameworks such as Institutional Analysis and Development) and develop institutional arrangements for the management of reservoirs fisheries at local and catchment levels.
- 1.11 To appraise potential for and support where appropriate the development of culture-based fisheries through appropriate institutional arrangements and research activities.

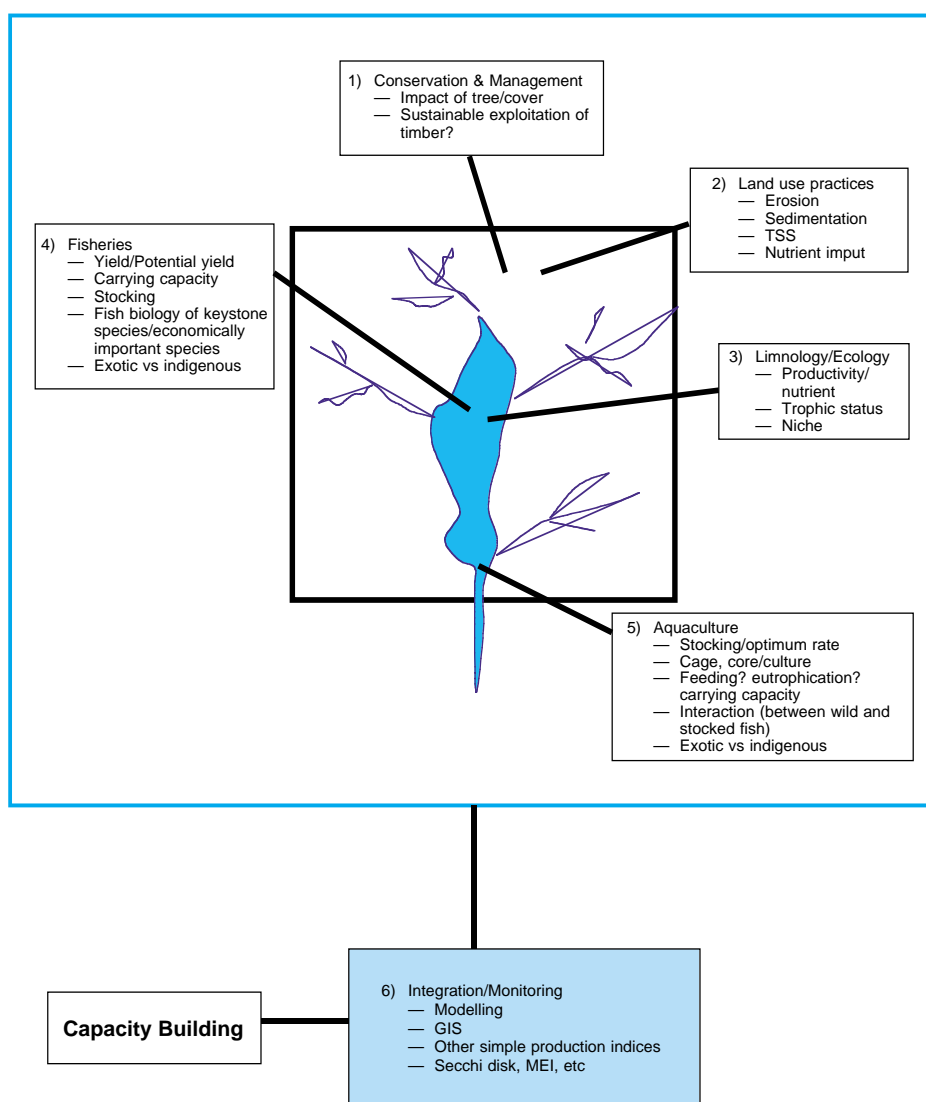

Figure 1. The interaction of different entities of the watershed that would influence development of a reservoir fishery.

2. Socioeconomics

The workshop recognised that socioeconomic aspects of reservoir fisheries development have hitherto received less attention than deserved, and indeed are required for optimisation of benefits to the community, which happens to be more often than not rural and poor. It also acknowledged that it is impractical, if not prohibitive, to develop a general research agenda on socioeconomic aspects of reservoir fisheries covering many countries.

In spite of these limitations, it was agreed that in developing such an agenda the following aspects should be taken into consideration:

- identification of research should start with consultation with reservoir communities, whom the research eventually will benefit; and
- recognition of the need for such research.

The workshop recommended that the following questions be addressed in socioeconomic research agendas.

- 2.1 How can fisheries development address the needs of the poorer people; in particular, identify ways to improve fish prices and economic output for fishers without depriving the poorer people of a cheap supply of protein (issues related to fishery management, processing and marketing).
- 2.2 The various ways through which communities are internally differentiated, and the consequent results in unequal access to and control of resources.
- 2.3 How to address the problems of women and children in usually male-centred fisheries development (e.g. fish culture, net-making, processing, marketing).
- 2.4 How to empower the local community in terms of technical and administrative capacities.
- 2.5 How to value fisheries resources.
- 2.6 The socioeconomic benefits of reservoirs (at community and national levels) and their distribution.
- 2.7 The social impact of reservoir impoundment; and
- 2.8 its costs and benefits, especially in stock enhancement measures.

3. Policy development toward an holistic approach to resource management

The use of participatory research approach (PRA) methods at catchment/watershed level and the employment of GIS and remote sensing technologies in resource assessment permit consultation to set and prioritise objectives at the relevant scale. However, it is suggested that stakeholder consensus is necessary in developing policy although it may not always be easily achieved. In this regard 'outsiders' may help

develop appropriate conflict resolution measures, which may be situation-specific.

The interactive nature of such a policy development structure is schematically represented in Figure 2.

- 3.1 To take into consideration the existing national, provincial and local institutional and policy framework.

The workshop also recognised the following aspects which may be taken into consideration:

- Institutional/management arrangements and the importance of the issue must be balanced against the ability to achieve the goals.
- Participatory methodologies for addressing issues holistically need to be developed and/or implemented.
- Resource-users may understand quickly the need for restraints to existing practices, but in the absence of alternate livelihood opportunities may not be able to comply fully. The immediate payback from fishing activities (and some other resource extraction activities) gives these activities an additional competitive advantage to alternatives.
- The degree to which the user depends on the resource is of great importance. Also, resource users fall into different categories (e.g. level of wealth), and some will be able to move to alternative livelihoods more easily than others. They may react to changes in different ways. Risk-reduction in moving to new livelihoods is an important issue, and the solution is likely to depend on local context.

The Workshop also noted that:

- managing a fishery to assure sustainable livelihood may be more appropriate than managing to assure optimal yields;
- the aims and practices of the main reservoir users need to be accommodated, and will determine the stakes for other users. Good communications between fishers and the main users are important and may lead to improved management of the resource for all;
- user institutions are likely to evolve continuously, as needs and opportunities are identified;
- external organisations such as government departments may help resource users to assess and optimise management regimes through a process of participatory adaptive learning.

- 3.2 To move toward co-management arrangements with major stakeholders, duly identified in a participatory stakeholder analysis.

It was agreed that primary stakeholder (resource user) perceptions tend to synthesise pertinent issues more holistically than those of anyone, and even more so, their perceptions are highly often pragmatic and should be given priority in relevant analysis.

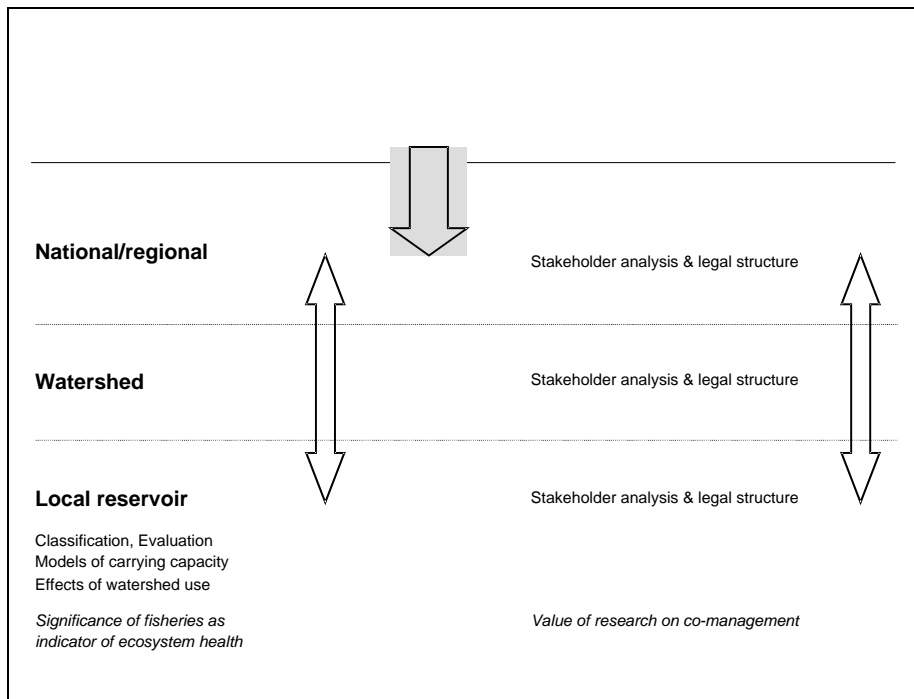

Figure 2. Asian platform for discussing the role of fisheries in watershed management.

4. Stakeholder involvement

Stakeholder involvement in reservoir management is imperative.

- 4.1 To conduct stakeholder analyses in connection to the identification of opportunities and problems for stakeholder involvement; in conducting such exercises it should be noted that 'outsiders' are sometimes in a relatively better position to help identify such opportunities.
- 4.2 To apply some or all of the following tools in stakeholder analysis, and their use should be encouraged throughout the region: PRA methods at reservoir catchment/watershed levels, GIS for resource assessment.
- 4.3 To take into consideration the existing national/provincial/ local institutional and policy framework when conducting respective exercises, and
- 4.4 to develop and disseminate participatory methodologies for addressing issues holistically.
- 4.5 To manage a fishery to assure sustainable livelihood may be more appropriate than managing to assure optimal yields.
- 4.6 To establish effective communications between fishers and the main users so as to bring about compromises in favour of the fishery, leading to improved management of the resource for all.

4.7 To continue to encourage user institutions to evolve continuously, in accordance with needs and opportunities.

4.8 To provide training for fishers to 'optimise' yields according to their own priorities.

4.9 To develop relevant policy structure, involving all stakeholders to ensure a holistic approach to management to ensure sustainable use of the resource.

5. Specific production systems and interventions

This section entails recommendations from detailed discussions at the end of each session, and includes:

- the role of culture-based fisheries in food security;
- the role of exotics and their apparent affects on biodiversity;
- disease transmission and possible extension of the range of distribution within watersheds;
- more popularisation of indigenous species-based fisheries, etc.

5.1 Culture-based fisheries

Culture-based fisheries have the potential to generate significant yields as well as income for individuals and/or communities, in particular from small and medium-sized reservoirs. They require adequate

institutional arrangements to sustain investment in stocking and to regulate exploitation. Stocking and harvesting regimes must be tailored to local conditions to maximise benefits. It is recognised also that stocking can facilitate more active management of reservoir fisheries in general, leading to wider benefits such as more efficient exploitation.

- 5.1.1 To support the development of culture-based fisheries by creating conducive external institutional arrangements, and co-management systems where appropriate. This may be facilitated by wider application of institutional analysis and development.
- 5.1.2 Stocking and harvesting regimes for culture-based fisheries should be optimised for local conditions to maximise benefits. Population and empirical models, particularly when combined and integrated in comparative studies, are highly cost-effective tools for identifying optimal management regimes. The wider use of such tools should be encouraged and supported.
- 5.1.3 Participatory adaptive learning from management experience holds great potential for the optimisation of culture-based fisheries. This may promote effective linkages between local user organisations and research.

5.2 The role of exotics

The workshop noted that more often than not exotic species have been targeted as the causative agent for the disappearance of certain indigenous species, in spite of lack of scientific evidence.

- 5.2.1 Implementation of a comprehensive desk study to address the following issues: contribution of exotics to food security in the region; evaluation of the relative merits of the contribution of exotics against the importance of indigenous species; assessment of the impact of exotics on biodiversity-related issues; evaluation of the probabilities of 'invasion' of new watersheds, causing detrimental impacts.

5.3 Ecosystem studies

Even though an holistic approach was recommended for effective and sustainable management of the resource, the workshop recognised the importance and relevance of 'ecosystem' studies of selected, representative reservoirs of different watersheds in the region. It was acknowledged that such studies enrich understanding of the dynamics of reservoir ecosystems and the influence of the catchment on the reservoir ecosystem, and will enable better understanding potential impacts of other human activities of the catchment on reservoir ecology.

- 5.3.1 To encourage whenever possible ecosystem studies of reservoirs of different watershed, and that such studies be an integral component of reservoir management plans per se.
- 5.3.2 To make use of new technologies such as echo-sounding techniques for biomass assessment that will contribute to better utilisation of fish resources.

5.4 Cage culture

The workshop considered the 'pros' and 'cons' of development of cage culture in reservoirs, and accepted that in certain circumstances it will play an important role in providing a means of sustainable fish production. The workshop accepted that it will be difficult, if not impossible, to predict the extent of cage culture activities that can be sustainably achieved in large reservoirs in the tropics.

- 5.4.1 Cage culture activities in upstream areas of reservoirs should not be encouraged.
- 5.4.2 A complete economic appraisal should be conducted, and feed or feed ingredient supplies, markets, etc. be taken into consideration in such analysis.
- 5.4.3 Attempts be made to apply nutrient mass-balance models in determining the extent of cage culture activities that could be sustained in a reservoir.

6. Capacity-building

The workshop recognised that there is dearth of skilled human resources to collate, analyse and continually monitor all aspects pivotal to introducing an holistic approach to sustainable utilisation of the resource(s).

It was recognised that capacity-building at all levels is needed to realise the goals set out earlier, and in all sectors is imperative to achieving food security and poverty alleviation, particularly of the rural poor.

- 6.1 To build human capacity on aspects relevant to reservoir fishery management (such as population dynamics, fish biology, aquatic ecology, limnology, socioeconomics) as a priority, and that such skill development be integrated in a way so as to make the outcome cost-effective.
- 6.2 To develop mechanisms to network reservoir fishery management and monitoring teams operating in the region.
- 6.3 To establish, as an initial step, an electronic discussion group through the world-wide web, initially restricting participation to the workshop participants, and if found effective and useful, extended to a wider audience.

Sena S. De Silva
15 March 2000

Participants

Professor Sena De Silva

School of Ecology and Environment
Deakin University
Warrnambool Campus
PO Box 423
Warrnambool VIC 3280
AUSTRALIA
Email: sena@deakin.edu.au

Mr Geoff Gooley

Marine and Freshwater Resources
Institute
Snobs Creek
Private Bag 20
Alexandra Vic 3714
AUSTRALIA
Email: geoff.gooley@nre.vic.gov.au

Mrs Christine Harris

School of Ecology and Environment
Deakin University
Warrnambool Campus
PO Box 423
Warrnambool Vic 3280
AUSTRALIA
Email: harris@deakin.edu.au

Mr Peter Lynch

ACIAR
GPO Box 1571
Canberra ACT 2601
AUSTRALIA
Email: lynch@aci.gov.au

Mr Colin Magilton

School of Ecology and Environment
Deakin University
Warrnambool Campus
PO Box 423
Warrnambool Vic 3280
AUSTRALIA
Email: colinm@deakin.edu.au

Mr Barney Smith

ACIAR
GPO Box 1571
Canberra ACT 2601
AUSTRALIA
Email: bsmith@fisheries.nsw.gov.au

Professor Fritz Schiemer

Department of Zoology
University of Vienna
14 Althanstr
A-1090 Wien
AUSTRIA
Email:
Friedrich.Schiemer@univie.ac.at

Dr M.R. Hassan

Department of Aquaculture
Faculty of Fisheries,
Bangladesh Agricultural University
Mymensingh 2202
BANGLADESH
Email: mrhasan@citechco.net

Professor Jacques Moreau

Department of Inland Fisheries
I.N.P./E.N.S.A.T., B.P. 107
Auzeville Tolosane 31326
Castanet Tolosan
FRANCE
Email: moreau@ensat.fr

Professor Ahyaudin B. Ali

School of Biological Science
University of Sains
11800 Penang
MALAYSIA
Email: ahyaudin2@yahoo.com

Mr Vongpachhang Balavong

Management of the Reservoir
Fisheries in the Mekong Basin
Mekong River Commission
Namngum Reservoir Management
and Development Project
PO Box 7035
Vientiane LAO PDR
Email: resfish@laonet.net

Mr Wolf Hartman

Management of the Reservoir
Fisheries in the Mekong Basin
Mekong River Commission
PO Box 7035
Vientiane LAO PDR
Email: resfish@laonet.net

Dr Niklas Mattson

Management of the Reservoir
Fisheries in the Mekong Basin
Mekong River Commission
PO Box 7035
Vientiane
LAO PDR
Email: mattson@laonet.net

Mr Henrik Nilsson

Management of the Reservoir
Fisheries in the Mekong Basin
Mekong River Commission
PO Box 7035
Vientiane
LAO PDR
Email: resfish@laonet.net

Mr Sommano Phonsavath

Management of the Reservoir
Fisheries in the Mekong Basin
Mekong River Commission
Living Aquatic Resources Research
Centre
PO Box 7035
Vientiane
LAO PDR
Email: resfish@laonet.net

Mr Abundio M. Galicia

Bureau of Fisheries & Aquatic
Resources
860 Quezon Avenue
Quezon City, Metro Manila 3008
PHILIPPINES
TeleFax: 373 0792
Tel:410-9981

Nelson A. Lopez

Bureau of Fisheries & Aquatic
Resources
860 Quezon Avenue
Quezon City, Metro Manila 3008
PHILIPPINES
Telefax: 373 0792
Tel: 410-9981

Associate Professor Daoming Huang

Institute of Reservoir Fisheries
Zhuo Dao Quan
Wuhan 430079
P.R. CHINA
Email:

Dr Jiashou Liu

Institute of Reservoir Fisheries
Zhuo Dao Quan
Wuhan 430079
P.R. CHINA
Email: jsliu@public.wh.hb.cn

Associate Professor Shenggui Wu

Institute of Reservoir Fisheries
Zhuo Dao Quan
Wuhan 430079
P.R. CHINA

Associate Professor Hongjuan Wu

Institute of Reservoir Fisheries
Zhuo Dao Quan
Wuhan 430079
P.R. CHINA
Email: hjwu@public.wh.hb.cn

Mr Edwin Oreihaka
Chief Fisheries Officer
Fisheries Division/Dept. of Agri &
Fisheries
Ministry of Lands, Agriculture &
Fisheries
PO Box G13
Honiara
SOLOMON ISLANDS
Email: sbfish@fla.int.

Dr Upali Amarasinghe
Department of Zoology
Kelaniya University
Kelaniya
SRI LANKA
Email: zoousa@kln.ac.lk

Ms Soma Ariyaratne
National Aquatic Resources
Authority
Crow Island
Mattakkuliya Colombo 15
SRI LANKA
Email: soma@nara.ac.lk

Mr Chandana Nissanka
Department of Zoology
Kelaniya University
Kelaniya
SRI LANKA
Email: chandu@kln.ac.lk

Dr Swarna Piyasiri
Department of Biology
Sri Jayawardenapura University
Gangodawila
Nugegoda
SRI LANKA
Email: piyasiri@slt.lk

Ms K.B.C. Pushpalatha
Aquaculture Extension Centre
Fisheries Corporation Building
Anuradhapura
SRI LANKA

Associate Professor E.L.L. Silva
Institute of Fundamental Studies
Hantana
Kandy
SRI LANKA
Email: sil@ifs.ac.lk

Professor M.J.S. Wijeyaratne
Department of Zoology
Kelaniya University
Kelaniya
SRI LANKA
Email: zoomjs@kln.ac.lk

Mr Tuatong Jutagate
Faculty of Agriculture
Ubon Rachathani University
Warin Champrab
Ubon Rathchathani 34190
THAILAND
Email: tjuta@rocketmail.com

Mr Boonsong Sricharoendham
National Inland Fisheries Institute
Department of Fisheries
Agriculture and Co-operatives
Ministry
THAILAND
Email: boonsosr@fisheries.go.th

Mr Cherdasak Virapat
Small Holder Aquaculture Research
and Development
Fisheries Engineering Division
Department of Fisheries
Phaholyothin Road
Bangkhen Bangkok 10900
THAILAND
Email: cvirapat@hotmail.com or
cherdsav@fisheries.go.th

Dr J. Vijverberg
Centre of Limnology
Netherlands Institute of Ecology
Rijksstraatweg 6
3631 AC Nieuwersluis
THE NETHERLANDS
Email: vijverberg@cl.nioo.knaw.nl

Dr Caroline Garaway
T.H. Huxley School
Imperial College
8 Princes Gardens
LONDON SW7 1NA
UK
Email: c.garaway@ic.ac.uk

Dr Kai Lorenzen
T.H. Huxley School
Imperial College
8 Princes Garden
LONDON SW7 1NA
UK
Email: k.lorenzen@ic.ac.uk

Mr Francis Murray
Ph D Student
Institute of Aquaculture
Stirling University
SCOTLAND
Email: smallface@bigfoot.com

Professor David Simon
Professor of Development Geography
Dept. of Geography
Royal Holloway University of
London
EGHAM
Surrey TW20 0EX
UK
Email: d.simon@rhbnc.ac.uk

Dr Nguyen Quoc An
Reservoir Fisheries Project
C/- Mekong River Commission
68 Le Hong Phong
Ban Me Thuot
Dak Lak
VIETNAM
Email: mrcfish@dng.vnn.vn

Mr Bui The Anh
Research Institute for Aquaculture
No. 1
Dinh Bang, Tien-Son
Bac Ninh
VIETNAM
Email: anhhung@hn.vnn.vn

Mr Thai Ngoc Chien
Reservoir Fisheries Project
C/- Mekong River Commission
68 Le Hong Phong
Ban Me Thuot
Dak Lak
VIETNAM
Email: johns@netnam2.org.vn

Mr Phan Thuong Huy
Reservoir Fisheries Project
C/- Mekong River Commission
68 Le Hong Phong
Ban Me Thuot
Dak Lak
VIETNAM
Email: johns@netnam2.org.vn

Ms Mercedes Logarta
Reservoir Fisheries Project
C/- Mekong River Commission
68 Le Hong Phong
Ban Me Thuot
Dak Lak
VIETNAM
Email: verselo@hcmc.netnam.vn

Dr Le Thanh Luu
Research Institute for Aquaculture
No. 1
Dinh Bang, Tun-son
Bac Ninh
VIETNAM
Email: ria@hn.vnn.vn

Ms Nguyen Thi Nhung
Reservoir Fisheries Project
C/- Mekong River Commission
68 Le Hong Phong
Ban Me Thuot
Dak Lak
VIETNAM
Email: johns@netnam2.org.vn

Mr Truong Ha Phong
Reservoir Fisheries Project
C/- Mekong River Commission
68 Le Hong Phong
Ban Me Thuot
Dak Lak
VIETNAM
Email: johns@netnam2.org.vn

Mr Phan Dinh Phuc
Reservoir Fisheries Project
C/- Mekong River Commission
68 Le Hong Phong
Ban Me Thuot
Dak Lak
VIETNAM
Email: johns@netnam2.org.vn

Mr John Sollows
Reservoir Fisheries Project
C/- Mekong River Commission
68 Le Hong Phong
Ban Me Thuot
Dak Lak
VIETNAM
Email: johns@netnam2.org.vn

Mr Nguyen Hai Son
Research Institute for Aquaculture
No. 1
Dinh Bang, Tien-son
Bac Ninh
VIETNAM
Email: rial@hn.vnn.vn

Ms. Nguyen Thi Thu Thuy
Research Institute for Aquaculture
No.1
Dinh Ban, Tien-son
Bac Ninh
VIETNAM

Mr Tran Thanh Viet
Reservoir Fisheries Project
C/- Mekong River Commission
68 Le Hong Phong
Ban Me Thuot
Dak Lak
VIETNAM
Email: johns@netnam2.org.vn

Dr V.V. Sugunan
Central Inland Capture Fisheries
Research Institute
Barrackpore 743101
WEST BENGAL
Email: sugunan@gwl.dot.net.in

Dr K.I. Matics
C/- Mekong River Commission
MRC Secretariat
PO Box 1112
Phnom Penh
CAMBODIA
Email: kmatcs@hotmail.com

Dr Jeanineke Dahl Kristensen
Fishery Adviser
2, Asiatisk Place
DK-1448 Copenhagen K
DENMARK
Email: jedakr@um.dk

Mr Malasri Khumsri
Fisheries Biologist
Ubonratchathani Inland Fisheries
Development Centre
Jangsanit Road
Amphur Muang
Ubon THAILAND 34000
Email: resfish@ubon.loxinfo.co.th

Mr Jorgen G. Jensen
Mekong River Commission
PO Box 1112
Phnom Penh
KINGDOM OF CAMBODIA
Email: mracs@bigpond.com.kh