

# Agronomy Research

Established in 2003 by the Faculty of Agronomy, Estonian Agricultural University

## **Aims and Scope:**

*Agronomy Research* is a peer-reviewed international Journal intended for publication of broad-spectrum original articles, reviews and short communications on actual problems of modern biosystems engineering incl. crop and animal science, genetics, economics, farm- and production engineering, environmental aspects, agro-ecology, renewable energy and bioenergy etc. in the temperate regions of the world.

## **Copyright:**

Copyright 2009 by Estonian University of Life Sciences, Latvia University of Life Sciences and Technologies, Vytautas Magnus University Agriculture Academy, Lithuanian Research Centre for Agriculture and Forestry. No part of this publication may be reproduced or transmitted in any form, or by any means, electronic or mechanical, incl. photocopying, electronic recording, or otherwise without the prior written permission from the Estonian University of Life Sciences, Latvia University of Life Sciences and Technologies, Vytautas Magnus University Agriculture Academy, Lithuanian Research Centre for Agriculture and Forestry.

## ***Agronomy Research* online:**

*Agronomy Research* is available online at: <http://agronomy.emu.ee/>

## **Acknowledgement to Referees:**

The Editors of *Agronomy Research* would like to thank the many scientists who gave so generously of their time and expertise to referee papers submitted to the Journal.

## **Abstracted and indexed:**

SCOPUS, EBSCO, CABI Full Paper and Thompson Scientific database: (Zoological Records, Biological Abstracts and Biosis Previews, AGRIS, ISPI, CAB Abstracts, AGRICOLA (NAL; USA), VINITI, INIST-PASCAL).

## **Subscription information:**

Institute of Technology, EULS  
St. Kreutzwaldi 56, 51014 Tartu, ESTONIA  
E-mail: [timo.kikas@emu.ee](mailto:timo.kikas@emu.ee)

## **Journal Policies:**

Estonian University of Life Sciences, Latvia University of Life Sciences and Technologies, Vytautas Magnus University Agriculture Academy, Lithuanian Research Centre for Agriculture and Forestry, and Editors of *Agronomy Research* assume no responsibility for views, statements and opinions expressed by contributors. Any reference to a pesticide, fertiliser, cultivar or other commercial or proprietary product does not constitute a recommendation or an endorsement of its use by the author(s), their institution or any person connected with preparation, publication or distribution of this Journal.

**ISSN 1406-894X**

# CONTENTS

<b>T. Ahmadi, C.A. Casas Díaz, Y.E. García Vera and N. Escobar Escobar</b> A prototype reactor to compost agricultural wastes of Fusagasuga Municipality. Colombia .....	314
<b>K. Andersson, J. Eklund and A. Rydberg</b> Lean-inspired development work in agriculture: Implications for the work environment.....	324
<b>P. Barbaś and B. Sawicka</b> Dependence of potato yield on weed infestation .....	346
<b>V. Bulgakov, I. Holovach, S. Kiurchev, S. Pascuzzi, M. Arak, F. Santoro, A.S. Anifantis and J. Olt</b> The theory of vibrational wave movement in drying grain mixture .....	360
<b>D. Chodová and E. Tůmová</b> Insects in chicken nutrition. A review.....	376
<b>D. Derevjanko, I. Holovach, V. Bulgakov, V. Kuvachev and J. Olt</b> Theoretical and experimental research into impact of threshing tools in combine grain harvesters on quality of cereal crop seeds .....	393
<b>S.B. Ismuratov, T.V. Bedych, T.I. Gluchshenko, D.S. Ismuratov and V.S Kukhar</b> Production of bioethanol from biomass in the conditions of Northern Kazakhstan .....	404
<b>A. Jansons, J. Dzenis, R. Matisons, V. Samariks and B. Jansone</b> Intra-annual height growth dynamics of Scots and lodgepole pines and its relationship with meteorological parameters in central Latvia.....	410

<b>I. Kakabouki, A. Tzanidaki, A. Folina, I. Roussis, E. Tsiplakou, P. Papastylianou, P. Kanatas and D.J. Bilalis</b>	
Teff ( <i>Eragrostis tef</i> (Zucc.) Trotter) fodder yield and quality as affected by cutting frequency .....	422
<b>S. Karydogianni, M.K. Darawsheh, I. Kakabouki, Ch. Zisi, A.E. Folina, I. Roussis, Z. Tselia and D. Bilalis</b>	
Effect of nitrogen fertilizations, with and without inhibitors, on cotton growth and fiber quality .....	432
<b>M. Khajbullin, G. Kadaeva, B. Akhiyarov, A. Valitov and R. Gajfullin</b>	
The quality of spring rape seeds and its dependence on the doses of mineral fertilizers under the conditions of Southern Urals .....	450
<b>O.A. Kiseleva, O.G. Loretts and D.V. Veselkin</b>	
Seed size and cold stratification affect <i>Acer negundo</i> and <i>Acer ginnala</i> seeds germination.....	461
<b>I. Kuznetsov, F. Davletov, N. Anokhina, I. Akhmadullina and F. Safin</b>	
Influence of weather condition on the field peas ( <i>Pisum sativum</i> L. ssp. sativum) vegetation period and yield .....	472
<b>L.G. Muhamedyarova, M.A. Derkho, G.V. Meshcheriakova, O.A. Gumenyuk and S.S. Shakirova</b>	
Influence of bio-humus on soil fertility, productivity and environmental safety of spring wheat grain .....	483
<b>S.V. Murashev, S.D. Kiru, V.G. Verzhuk and A.V. Pavlov</b>	
Potato plant growth acceleration and yield increase after treatment with an amino acid growth stimulant .....	494
<b>S. Rakutko, A. Avotiņš, I. Alsina and K. Berzina</b>	
New assessment tool for artificial plant lighting: case of tomato ( <i>Lycopersicon Esculentum</i> Mill.) .....	507

**M. Rasva and E. Jürgenson**

Changes of agricultural producers in Estonia according to the size of land use..... 516

**R.R. Rodrigues, S.C. Pizetta, G.M. Pereira, M.E.P.C. Jaeggi, R.S. Rocha,  
I.M. Pereira, D.P. Cruz, J.N. Batista, R.K.G. Silva, P.M. Bernardes,  
A.S. Fonseca, G.C. Entringer and G.A. Gravina**

Potential for macro and micronutrients extraction from tomato plants with different soil water stresses ..... 529

**D.S. Sattarov, S.Kh. Vyshegurov and R.R. Galeev**

Monitoring the species diversity of medicinal plants typical for the south slope of Hissar Ridge / Tajikistan / ..... 543

**I. Sepelevs, J. Zagorska and R. Galoburda**

A food-grade antioxidant production using industrial potato peel by-products..... 554

**P. Svoboda, I. Raimanová, R. Duffková, P. Fučík, G. Kurešová and  
J. Haberle**

The effects of irrigation on root density profiles of potato, celery, and wheat ..... 567

**A. Széles and L. Huzsvai**

Modelling the effect of sowing date on the emergence, silking and yield of maize (*Zea mays* L.) in a moderately warm and dry production area ..... 579

**I. Travlos, A. Tataridas, P. Kanatas, I. Kakabouki and P. Papastylianou**

Weed management in soybean with a special focus on the control of purple nutsedge (*Cyperus rotundus*)..... 595

**J.R. Trettel, M. D.S. Queiroz, M.M. Andrade and H.M. Magalhães**

*In vitro* effects of regulators on growth and morphogenesis of *Ocimum basilicum* L. ‘Alfavaca Green’ stem apices ..... 603

**O. Ulianych, K. Kostetska, N. Vorobiova, S. Shchetyna, G. Slobodyanyk and K. Shevchuk**

Growth and yield of spinach depending on absorbents' action ..... 619

**E. Wilczewski, G. Harasimowicz-Hermann and G. Lemańczyk**

Effect of sowing method and density on the physical properties of the seed bed and oilseed rape yield ..... 628

**N.A. Yurina, D.V. Osepchuk, M.P. Semenenko, E.V. Kuzminova and E.G. Chuprina**

The study of new feed additives in the ration in newly-calved high producing cows ..... 640

**A. Zapalowska, Cz. Puchalski, S. Stankowski and M. Gibczyńska**

Fertilisation with ash from wood and with sewage sludge versus contents of macro-and microelements in the soil following cultivation of *Helianthus tuberosus* L. .... 650

**D. Zeka, P. Sedlák, V. Sedláková, P. Vejl, Sh. Fetahu, I. Rusinovci and S. Aliu**

Study of correlation among ploidy level and steroid glycoalkaloids content in resistance in cultivated and uncultivated potato species from an *in vitro* genebank ..... 662

## **A prototype reactor to compost agricultural wastes of Fusagasuga Municipality. Colombia**

T. Ahmadi<sup>1,\*</sup>, C.A. Casas Díaz<sup>1</sup>, Y.E. García Vera<sup>1</sup> and N. Escobar Escobar<sup>2</sup>

<sup>1</sup>Universidad de Cundinamarca, Facultad de Ingeniería, Diagonal 18 No. 20-29, Fusagasugá, Cundinamarca, Colombia

<sup>2</sup>Universidad de Cundinamarca, Facultad de Ciencias Agropecuarias, Diagonal 18 No. 20-29, Fusagasugá, Cundinamarca, Colombia

\*Correspondence: [tahmadi@ucundinamarca.edu.co](mailto:tahmadi@ucundinamarca.edu.co)

**Abstract.** Crop and animal production generate a high level of organic waste that causes negative effects on the environment and communities. The use of composting processes can improve the quality of these biowastes. Additionally, the application of technologies such as telemetry and remote sensors, allows optimizing the transformation of organic matter in a more controlled and efficient way. The city of Fusagasugá is well known in agriculture. However, it lacks sustainable management of the organic waste system.

In this study, after a three-dimensional electromechanical design, a prototype reactor to compost agricultural wastes of Fusagasuga municipality will provide. The capacity of this prototype reactor is considered to be 20 litres. In order to control temperature and humidity of biowastes in different working conditions, it is used A PI controller with 3 temperature and a humidity sensors. With these sensors the compost materials temperature and humidity will remain at 65 °C and 55–60%. By using a special form of temperature sensor placement, the time to oxygenate the compost materials will be found. Furthermore, this system is integrated by a Human-Machine Interface (HMI), which allows the supervision and manipulation from a remote access user.

**Key words:** composting, environment, sensors, telemetry.

### **INTRODUCTION**

A compost is an element with plenty of plant nutrients, is very useful as organic fertilizer for soil crops, and is produced by the decomposition of organic matter from plant and animal residues, done by microorganisms in an adequate humidity, pH and oxygen environment.

Around 193 million tons of organic materials are obtained in the photosynthetic process (De Heer et al., 2005). However, most of these materials become a source of environmental pollution, especially what is considered by manufacturers to be ‘waste’ or ‘garbage’. This tragedy is due to the lack of management techniques or to the inappropriate characteristics of these materials for direct human or animals’ consumption. As a consequence, soil, air and water pollution, the reduction of the biology and the waste of the energy of containment in the organic residues take place. Its effect generates high environmental and public health costs (Antil et al., 2014). In this regard, in (Fan et

al., 2017) it is mentioned that the commercialization and use of compost in agricultural production have not been used efficiently.

For this reason, the composting method has been introduced as a convenient and easy-to-use alternative in tropical regions (Coelho et al., 2013; Oviedo Ocaña, 2015). This method allows to use of biowastes, reduce environmental pollution and recover the productive conditions of the soil. The common methods for compost production usually are traditional methods and don't involve any technological process (Rodríguez & Córdova, 2006; Gómez Betancourt, 2017; Galeano Barrios, 2018) that improves production times or production quality.

Composting of municipal and residential biowastes has been widely used. However, the optimal application periods have not been established, as well as the maturation time (Ravindran et al., 2019). Research is required not only to establish quality parameters, but also to carry out technological innovations that improve the decomposition process and reduce CO<sub>2</sub> generation (Knoop et al., 2018).

In some cases, organic wastes are used to produce compost in a rudimentary way. The common methods for compost production usually are traditional methods and do not involve any technological process (Corzo-Romero et al., 2016; Calderón Gómez & Calderón Ospina, 2016; Gómez Betancourt, 2017) that improves production times or production quality. According to the above, the objective of this study is to contribute to a technological innovation process, when designing a prototype that allows the optimization of the composting process. Preliminary results of a pilot test will be presented.

## METHODOLOGY

To obtain a mixture with high energy content, it is needed an adequate proportion of materials with a rich content of Carbon and Nitrogen (Peña, 2011). After that, those materials are chopped to improve the speed of microorganism biodegradation. As mentioned in literature (Peña, 2011; Galeano et al., 2016), the process that homogeneously mixes the organic matter, the substrate soil and the atmosphere inside the reactor, improves the chemical properties like pH and oxygen concentration and also homogenizing the temperature in its thermophile phase. It is shown that if the rotation process is done every 24 hours, it will increase the maximum peak of the thermophilic phase. In (Bringhenti et al., 2018; Oliveira et al., 2018) it is shown that it is more efficient to keep the compost materials temperature and humidity at 65 °C and 55–60%.

In most cases, bacteria predominate about 100 times more than fungi. In (Golueke, 1977; Castrillón et al., 2006; Calbrix et al., 2007) it is presented that at least 80–90% of the microbial activity in composting is due to the presence of bacteria. The actual population of bacteria depends on the type of basic material, the local conditions and the amendments used. The microbial community in the starting substrates, together with the factors that colonize the compost pile from the surrounding environment constitute the set of biological agents responsible for the biotransformation process. As mentioned in (Morales-Corts et al., 2014), the predominant type of microorganism in each phase depends on its competitive efficacy and its survival capacity against prevailing conditions.

In (Ranjard & Richaume, 2001) it is presented that the plants which are decomposed to varying degrees by bacteria, actinobacteria and fungi, remains in the

form of simple sugars, hemicelluloses and cellulose. These organisms synthesize their polysaccharides and other carbohydrates, which constitute the majority of the carbohydrates found in the soil. In (Paul, 2014) it is reported that nitrates prefer the activity of bacteria. On the other hand, ammonia and amino acids are best to use by mycobacteria and fungi. The application of nitrates, ammonia, urea and manure increase the speed of decomposition (such as the substrates used in the preparation of the mixtures). In this regard, in (Ryckeboer et al., 2003) it is mentioned that the first microorganisms come with the organic residues. In some cases, they multiply in early stages. As a result, environmental conditions change and become more suitable for the other microbial group.

In (Sundberg et al., 2004), pH varies with temperature, especially in the change from the thermophilic to the mesophilic phase. They showed that the rate of decomposition of municipal biowastes especially of vegetable origin, is very small in the pH ranges between 5 and 8 at temperatures of 36 °C. However, if the temperature rises to 46 °C, the decomposition reduces at low PHs, and increases for PHs above 6.5. This difference can be explained by the sensitivity of microorganism communities to the combined effect of acidity and temperature conditions. Microorganisms can tolerate extreme environmental factors, for example, high temperatures or low PHs, but not both at the same time. Another possibility is the existence of different groups of microorganisms: some mesophilic (which is acid tolerant) and another thermophilic (which does not tolerate acidic conditions).

In (Ferrer et al., 1994; Lazcano et al., 2008) it is reported that the pH is adjusted to a range between 7.5–8.5 at the end of the composting process and can be critical if it exceeds 8.5 levels by the volatilization of ammonia (NH<sub>3</sub>), which generates nitrogen loss and bad odor. A mature compost has the following characteristics: dark colour, no odor, ambient temperature, average particle size of 10 mm and final C.N<sup>-1</sup> ratio ranges from 10 to 15. In (Morales-Corts et al., 2014) and (Brito et al., 2010) it is indicated that the ideal C.N<sup>-1</sup> ratio for a fully mature compost is close to 10, similar to humus. The compost evaluated according to the values and parameters mentioned, generated a mature compost.

In (Benito et al., 2003) it is explained that the Cationic Interchange Capacity (CIC) ascends as a function of humification due to the formation of the carboxyl and phenolic functional groups. The macro-elements, N, P and K elements presented values within the appropriate range in the three treatments. In (Pierre et al., 2009) obtained values of N (4.4–5.9%) and K (2.5–3.6%) higher than those found in this research. In (Diaz-Ravina et al., 1989) it is indicated that some microorganisms are able to establish mutualistic symbiosis with plants, such as the growth-promoting rhizobacteria of the genus *azospirillum* that fix the atmospheric nitrogen in the endo-rizosfera of grasses, and others like the arbuscular mycorrhizae that colonize the roots of plants.

In this study, the search and analysis of information will be carried out, as well as the quantification and characterization of the biowastes and the elaboration of the basic design. The system will be built and the initial trials will be carried out. Furthermore, the final construction, the three-dimensional of the prototype structure and the elaboration of the respective instructions of use and handling will be presented. Additionally, similar to (Casas et al., 2013), an instrumentation and control phase will be incorporated for the transducers and actuators of temperature and humidity, integrated by a HMI, that allows



the supervision and manipulation from a remote access user. Table 1 shows the methodology and the proposed activities to fulfil each objectives of the project.

**Table 1.** Detailed methodology in phases and activities

PHASES	ACTIVITIES
<p>PHASE 1: information for preliminary design analysis. Actions aimed at the quantification and characterization of Organic Waste, as well as the definition of the most efficient prototype model to be implemented. In addition, we worked on the identification of variables to be quantified, and thus finally the preliminary design was obtained.</p>	<ul style="list-style-type: none"> <li>• State of the art analysis on organic solid biowastes treatment and HMI systems, as well as communication protocols for information remotely transmitting.</li> <li>• Determine the most appropriate process for the transformation of organic solid biowastes into compost, from the science of electronic engineering, and identify the variables to be analysed.</li> <li>• Quantification and characterization of organic solid agricultural residues.</li> <li>• Determination and measurement of physic-chemical and biological variables involved in the decomposition of organic waste.</li> <li>• Preparation of the preliminary design, a technical outline of the possible prototype from three-dimensional models as well as the electronic system, taking into account the C.N<sup>-1</sup> ratio calculations and integrating them into the electronic system.</li> </ul>
<p>PHASE 2: construction and preliminary system. Trials Actions aimed at the development of the prototype from the input elements obtained in the previous phase, and realization of data collection and initial performance tests.</p>	<ul style="list-style-type: none"> <li>• Development of data acquisition and measurement systems (DAQ).</li> <li>• Development of the Man-Machine interface as a monitoring and control tool for remote monitoring of variables.</li> <li>• Conditioning of input and output variables, from the sensors selected in the electronic instrumentation stage.</li> <li>• Articulation of the components and construction of the final prototype with the automation system.</li> <li>• Development of tests and monitoring processes, study variables and evaluating results.</li> <li>• Prepare manuals, plans and other technical aspects of the system.</li> </ul>
<p>PHASE 3: Preliminary progress of microbiological and chemical variables of composting.</p>	<ul style="list-style-type: none"> <li>• Quantification of general groups of microorganisms.</li> <li>• Determination of chemical variables present in the compost.</li> </ul>

### **Organic solid waste (OSW) management**

The agricultural residues that are identified with greater representativeness in the municipality of Fusagasugá are shells, husks, fruits, vegetables, leaves, seeds and aromatic herbs. At this time, these residues are crushed up to get particles sizes between 1 and 5 cm, (Zhalnina et al., 2015) allowing a better microorganism decomposition and a homogeneous matter at the end of the process with the mature compost.

The reactor is designed with a rotary system (Fig. 1) using a set of rotating opposite blades joined to a rotating shaft in the centre of the reactor. In (Fig. 2), the 3D model of the turning system is shown.

A prototype reactor is built based on the results of computer-assisted simulation and validation. A standard-size barrel with an isolated anti-corrosive coating layer is used as reactor base. Furthermore, the turning blade is made with metallic sheets of

calibre 12. The blades and the shaft are covered with an anti-corrosive layer. Fig. 3 shows the reactor built with a temporary manual rotation system.



**Figure 1.** 3D model of the prototype reactor.



**Figure 2.** 3D model of the turning system.

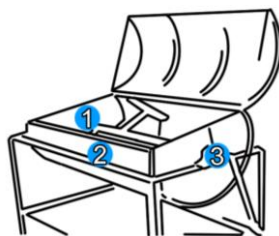
### Prototype System

In this section, based on the simulated 3D model, a prototype system (Fig. 3) is constructed. This system basically consists of a cylindrical barrel of 20 litres, which common in closed composting systems (Peña, 2011). To facilitate rotation and material homogenization a rotary axis is embedded in the system. As can be seen from Fig. 3, this axis consists of a metal tube and blades. Similar to (Galeano et al., 2016), the whole structure is covered with insulation and anti-corrosive paint. In this prototype system, the temperature and humidity are monitored by four sensors distributed inside of the bioreactor. With these sensors the compost materials temperature and humidity will remain at 65 °C and 55–60%.

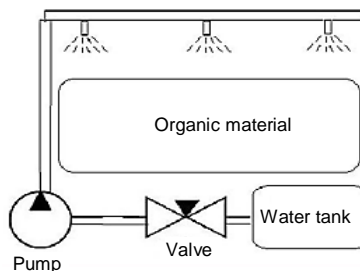
The main issue is that the microorganism activity will reduced at low temperatures. As shown in Fig. 4, the temperature sensors are located at the two ends (sensor 1 and 3) and centre (sensor 2) of the bioreactor tank. In this study, A PT100 sensor is used due to its lineal behaviour. However to increase sensitivity, a Wheatstone bridge and amplifier INA106 are used, which is a good option for measuring small resistance changes (Hoque & Islam, 2018). Using this placement method, when Sensor 2 has a different value than Sensors 1 and 3, it indicates that it is necessary to oxygenate materials by overturning is necessary.



**Figure 3.** Prototype reactor with a temporary manual rotation system.



**Figure 4.** Sensors location inside the prototype system.



**Figure 5.** Irrigation system.

Since the organic matter is subjected to microbial action and artificial heating to regulate the optimal temperature, an additional system is needed to control the humidity of the material. It consists of a dryer and a water supply system. Using a linear controller

and L-69 sensor, the humidity of the materials is kept at the optimal level. The dryer system includes of a heating system and air extractors in order to extract excess humidity from the reactor. The water supply system consists of a 12-volt electric pump, a water tank, an electrical valve and a nebulizer system (Fig. 5).

The aeration process is essential to accelerate OSW degradation. Therefore, a hot air circulation system is needed to perform the aerobic process. This system controls the oxygen and temperature levels of the organic material in the reactor. The heating system provides a constant air flow with variable temperature based on resistance electrical elements and an air turbine together in a housing (Fig. 6).

With a 10 Ohm resistance and a maximum voltage of 120 VAC, this system can provide a maximum of 1440W of heat power. A TRIAC-based converter with a PWM (pulse width modulator) controller is used to control the heating system.

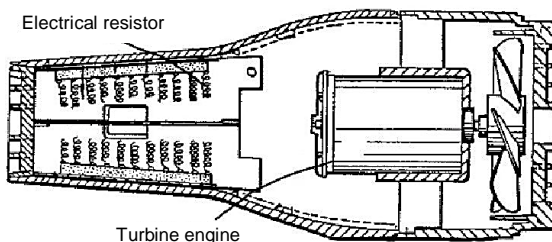


Figure 6. Temperature actuator.

### Design and implementation of the controller

The main issue is that the microorganism activity will reduced at low temperatures. As a first design action of the controller, it is needed to do a system characterization test to define its linearity, operation range and the appropriate control technique to implement. For this reason, the Step response for temperature is extracted (Fig. 7).

Given that the system is linear, a PI controller is selected to reduce the steady-state error found by the step input test performed on the system. This model is shown in the Fig. 8. These parameters are synchronized with the real model to improve the overall system response.

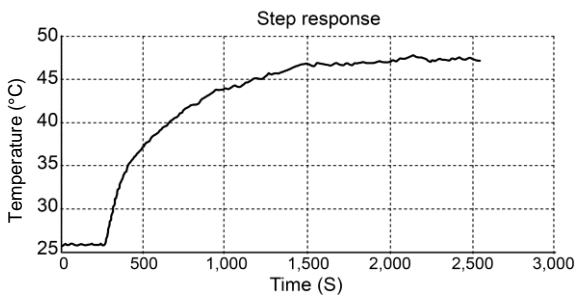


Figure 7. Step response for temperature.

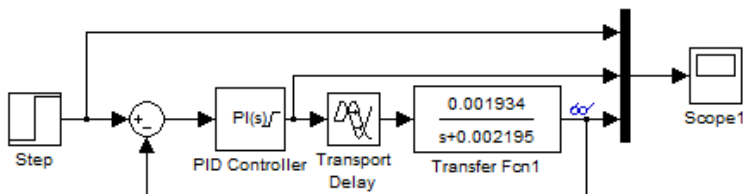


Figure 8. Simulink model controller.

## RESULTS AND DISCUSSION

### Humidity and temperature behaviour

The physicochemical variables that are evaluated and controlled for the composting process are the temperature and humidity (Hoque & Islam, 2018).

Comparison between a reference pile covered with a single piece of plastic and the compost processed in the prototype reactor with the adequate physical conditions for composting process were performed. Data obtained from the trials shown that the compost in the prototype reactor got a temperature of 60 °C, compared with the temperature of 55 °C reached by the reference pile. This temperature was not maintain for long time, because as soon as the temperature reached 50 °C the rotation process was performed to oxygenate the microorganisms in the compost (Oliveira et al., 2018). As shown in Fig. 9, after 12 days, the temperature tends to stabilize.

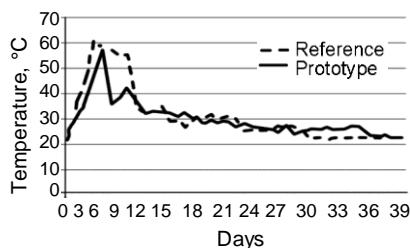


Figure 9. Composting Temperature vs Time.

Since the materials used in the experiment have high humidity (such as in the case of organic residues), the humidity level is high as shown in the Fig. 10. However, after 24 days the humidity level is stabilized in the reactor, as opposite to the reference pile that got stabilized after 38 days.

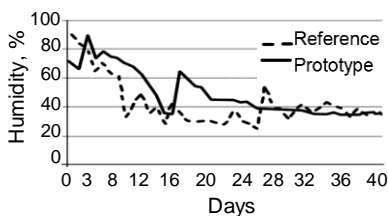


Figure 10. Composting Humidity vs Time.

The HMI for the reactor prototype is intended to monitor and control all its systems (air flow, watering and heating) remotely from the Internet. The lab view is used for the HMI due to its capabilities for data processing and virtual instrumentation.



Figure 11. View of HMI control panel from a web navigator.

The local workstation is geographically near of the prototype reactor, which is necessary to have physical access in case of emergency. This situation allowed to use a local area network (LAN) based on Ethernet to communicate the workstation and the Arduino module. In order to implement the communication between the HMI and the Arduino board through the LAN, a User Datagram Protocol (UDP) based communication is used because

Table 2. Laboratory Analysis results

Results No.	Scientif Name	Population
1	Fungus	< 10 CFU g <sup>-1</sup>
2	Yeast	11×10E 7 CFU g <sup>-1</sup>
3	Mesophilic Bacteria	24×10E 7 CFU g <sup>-1</sup>
4	Pseudomonas	17×10E 5 CFU g <sup>-1</sup>

a connected oriented communication like Transmission Control Protocol (TCP) is not needed, UDP allows fast response and also UDP is simpler to work with.

For the remote communication the tool 'Web Publishing Tool' from Labview is used. This tool runs a web server in the computer running the HMI that serves an HTML page with the same content visualized in the HMI, allowing users to see in real time all the process development. Fig. 11 is shown the panel control viewed from a computer. Composting is characterized by the interaction and succession of several types of microorganisms that present different nutritional and environmental demands. In Table 2, the results of microbiological groups are presented, within which the bacteria predominate in the compost sample.

The results of the experiments show a higher percentage of the bacterial population. In (Rebollido et al., 2008) the bacterial population is specified by 44.6%, followed by actinobacteria 32.3% and fungi 23.1% are found to be predominantly colonized by microbial populations during the composting process of municipal solid organic waste. Table 3 shows the results of the compost chemical parameters for the compost test.

**Table 3.** Compost Chemical parameters

Parameter	Value	Unit
Dry-Bulk Density	0.200	g cm <sup>-3</sup>
Ph Saturated paste	7.54	%
E.C Saturation Extract	23.80	dS m <sup>-1</sup>
Moisture	31.89	%
Ashes	25.87	%
Acid Insoluble Residue	16.71	%
Cation-exchange capacity or CEC	31.19	Meg.100 <sup>-1</sup>
Total Nitrogen	1.47	%
Total Potassium	2.13	%
Total P2O5	0.68	%
Total MgO	0.44	%
Total K2O	2.56	%
Total CaO	1.98	%
Total Calcium	1.41	%
Total Magnesium	0.27	%
Total phosphorus	0.30	%
Sulfur	0.06	%
Boron	0.005	%
Copper	0.001	%
Manganese	0.03	%
Iron	0.39	%
Zinc	0.007	%
Sodium	0.18	%
Total Oxidizable Organic Carbon	16.31	%
Carbon-to Nitrogen Ratio C.N <sup>-1</sup>	11.09	
Moisture Retention	147.58	%
volatilization losses	42.24	%

## CONCLUSIONS

The closed system implementation used in the prototype, created a controlled environment for the production of compost that reduced the variations produced by climatic conditions specifically temperature and humidity, compared to the traditional system in piles, just as the closed system facilitates the Oxygenation from the voltage and the measurement of the variables and the transmission of the remote way through the telemetry system.

The introduced electronic control system regulated the variations of temperature inside the bioreactor generated by the temperature changes of the area where the prototype of the plant was located, as well as the generation of a historical and real time data record through. The human machine interface allowed to control and monitor the process by industrial control methods.

It stands out in this prototype plant that had desirable physical conditions (humidity of 55% and temperature between 25°–65 °C), the time of compost was reduced considerably obtaining compost in a time of approximately 9 weeks. In addition, it obtained a mature compost according to physical and chemical variables.

**ACKNOWLEDGEMENTS.** The authors wish to thank the Research Direction of the University of Cundinamarca for their financial support in this project. And thanks to the Engineer Faculty, particularly to the Electronics Engineer program for their time assignments in this project.

## REFERENCES

- Antil, R.S., Raj, D., Abdalla, N. & Inubushi, K. 2014. Physical, chemical and biological parameters for compost maturity assessment: A review. *In: Composting for Sustainable Agriculture*, Springer, pp. 83–101.
- Benito, M., Masaguer, A., Moliner, A., Arrigo, N. & Palma, R.M. 2003. Chemical and microbiological parameters for the characterisation of the stability and maturity of pruning waste compost. *Biology and Fertility of Soils* **37**, 184–189.
- Bringhenti, J.R., Korres, A.M.N., Moreira, A.M.M., Rocha, S.M. & Günther, W.M.R. 2018. Organic Waste Composting and Vermicomposting as Sustainable Practice in Higher Education Institutions. *In: Towards Green Campus Operations*, Springer, pp. 159–173.
- Brito, L., Mourão, I., Coutinho, J. & Smith, S. 2010. Physicochemical dynamics of composting screw pressed cattle slurry amended with Italian ryegrass straw or gorse bulking agents. *Compost science & utilization* **18**, 119–126.
- Calbrix, R., Barray, S., Chabrerie, O., Fourrie, L. & Laval, K. 2007. Impact of organic amendments on the dynamics of soil microbial biomass and bacterial communities in cultivated land. *Applied Soil Ecology* **35**, 511–522.
- Calderón Gómez, L. & Calderón Ospina, O.H., 2016. Integral solid waste management plan of the municipality of Facatativá, department of Cundinamarca (Plan de gestión integral de residuos sólidos del municipio de Facatativá, departamento de Cundinamarca). *Master thesis in civil engineering*. Colombia, University of La Salle, 15–45 (in Spanish).
- Casas, C., García, Y., Restrepo, A. & Cedeño, E. 2013. Design and implementation of an experimental plant for composting. *ENGI Revista Electrónica de la Facultad de Ingeniería* **2**.
- Castrillón, O., Bedoya, O. & Montoya, D. 2006. Effect of pH on the growth of microorganisms during the maturation stage in static compost piles. *Producción+ Limpia* **1**, 8–12.
- Coelho, L., Reis, M. & Dionísio, L. 2013. Variation in microbial population during composting of agro-industrial waste. *Applied microbiology and biotechnology* **97**, 4179–4186.
- Corzo-Romero, S., Rivero-Bautista, D., Palma-López, D. & Mendoza-Hernández, J. 2016. Organic management of vegetables in Tenosique, Tabasco, México. *AGROProductividad* **9**.
- De Heer, M., Kapos, V. & Ten Brink, B. 2005. Biodiversity trends in Europe: development and testing of a species trend indicator for evaluating progress towards the 2010 target. *Philosophical Transactions of the Royal Society B: Biological Sciences* **360**, 297–308.
- Diaz-Ravina, M., Acea, M. & Carballas, T. 1989. Microbiological characterization of four composted urban refuses. *Biological wastes* **30**, 89–100.
- Fan, J., Xiao, J., Liu, D., Ye, G., Luo, J., Houlbrooke, D., Laurenson, S., Yan, J., Chen, L. & Tian, J. 2017. Effect of application of dairy manure, effluent and inorganic fertilizer on nitrogen leaching in clayey fluvo-aquic soil: A lysimeter study. *Science of the Total Environment* **592**, 206–214.
- Ferrer, J.R., Páez, G. & Chirinos, M. 1994. Aerobic bioprocess of coffee pulp. *Revista Técnica de la Facultad de Ingeniería*. Universidad Del Zulia 17.

- Galeano Barrios, L.E. 2018. Integral solid waste management plan (PGIRS) university of Cundinamarca – Fusagasugá.
- Galeano, C.A.B., Cadavid, M.I.V., Vergara, D.C.P. & Arango, Á.J.A. 2016. Use of organic waste generated at the Center for Commerce, Industry and Tourism (CCIT) of the SENA Regional Córdoba for compost production. *Revista Sennova: Revista Del Sistema de Ciencia, Tecnología e Innovación* **2**, 164–181.
- Golueke, C.G. 1977. Biological reclamation of solid wastes.
- Gómez Betancourt, L.J. 2017. Use of recyclable solid waste in the municipality of Pereira.
- Hoque, M. & Islam, S. 2018. Temporal Changes of Physical Parameters of Solid Waste during Barrel Composting. *Journal of Environmental Science and Natural Resources* **11**, 153–157.
- Knoop, C., Dornack, C. & Raab, T. 2018. Effect of drying, composting and subsequent impurity removal by sieving on the properties of digestates from municipal organic waste. *Waste management* **72**, 168–177.
- Lazcano, C., Gómez-Brandón, M. & Domínguez, J. 2008. Comparison of the effectiveness of composting and vermicomposting for the biological stabilization of cattle manure. *Chemosphere* **72**, 1013–1019.
- Morales-Corts, M.R., Gómez-Sánchez, M.Á., & Perez-Sanchez, R. 2014. Evaluation of green/pruning wastes compost and vermicompost, slumgum compost and their mixes as growing media for horticultural production. *Scientia Horticulturae* **172**, 155–160.
- Oliveira, M.M.d., Coldebella, A., Belli Filho, P. & Oliveira, P.A.V.d. 2018. Aeration frequency on accelerated composting of animal carcasses. *Ciência e Agrotecnologia* **42**, 653–665.
- Oviedo Ocaña, E.R. 2015. Strategies for process optimization and product quality of bio-waste composting in smaller municipalities in developing countries. (Estrategias para la optimización del proceso y la calidad del producto del compostaje de biorresiduos en municipios menores de países en desarrollo) *Doctoral dissertation, PhD thesis in engineering*, Colombia, University of Valle, 43–78.
- Paul, E.A. 2014. Soil microbiology, ecology and biochemistry, *Academic press*, pp. 187–218.
- Peña, J.R.A. 2011. How to make compost, *Editorial Paraninfo*, pp. 11–78.
- Pierre, F., Rosell, M., Quiroz, A. & Granda, Y. 2009. Chemical and biological evaluation of coffee pulp compost in Caspito, Andrés Bello municipality, Lara state, Venezuela. *Bioagro* **21**, 105–110.
- Ranjard, L. & Richaume, A. 2001. Quantitative and qualitative microscale distribution of bacteria in soil. *Research in microbiology* **152**, 707–716.
- Ravindran, B., Nguyen, D.D., Chaudhary, D.K., Chang, S.W., Kim, J., Lee, S.R., Shin, J., Jeon, B.H., Chung, S. & Lee, J. 2019. Influence of biochar on physico-chemical and microbial community during swine manure composting process. *Journal of environmental management* **232**, 592–599.
- Rebollido, R., Martínez, J., Aguilera, Y., Melchor, K., Koerner, I. & Stegmann, R. 2008. Microbial populations during composting process of organic fraction of municipal solid waste. *Applied ecology and environmental research* **6**, 61–67.
- Rodríguez, M. & Córdova, A. 2006. Municipal composting manual: urban solid waste treatment. *Municipal composting manual*, pp. 28–60.
- Ryckeboer, J., Mergaert, J., Coosemans, J., Deprins, K. & Swings, J. 2003. Microbiological aspects of biowaste during composting in a monitored compost bin. *Journal of Applied microbiology* **94**, 127–137.
- Sundberg, C., Smårs, S. & Jönsson, H. 2004. Low pH as an inhibiting factor in the transition from mesophilic to thermophilic phase in composting. *Bioresource Technology* **95**, 145–150.
- Zhalnina, K., Dias, R., de Quadros, P.D., Davis-Richardson, A., Camargo, F.A., Clark, I.M., McGrath, S.P., Hirsch, P.R. & Triplett, E.W. 2015. Soil pH determines microbial diversity and composition in the park grass experiment. *Microbial ecology* **69**, 395–406.

## **Lean-inspired development work in agriculture: Implications for the work environment**

K. Andersson<sup>1,2,3,\*</sup>, J. Eklund<sup>1,3</sup> and A. Rydberg<sup>2</sup>

<sup>1</sup>KTH Royal Institute of Technology, School of Engineering Sciences in Chemistry, Biotechnology and Health, Department of Biomedical Engineering and Health Systems, Division of Ergonomics, Hälsovägen 11C, SE-141 57 Huddinge, Sweden

<sup>2</sup>RISE - Research Institutes of Sweden, Division of Bioeconomy and Health, Agriculture and Food, Box 7033, SE-750 50 Uppsala, Sweden

<sup>3</sup>HELIX - Competence Centre, Linköping University, SE-581 83 Linköping, Sweden

\*Correspondence: [karin.andersson@ri.se](mailto:karin.andersson@ri.se)

**Abstract.** Farmers operate in a turbulent environment that includes international competition, weather conditions and animal behaviour, for example, and is difficult for them to control. However, economy and productivity always have a high priority. As a consequence, farms have started to implement lean-inspired work systems. At the same time, health and safety are of urgent concern in the sector. This article explores how farmers apply lean-inspired work processes. It identifies work environment changes during and after a lean implementation, as well as possible developments in the work environment following implementation of the lean philosophy. Data were collected from three groups: lean, lean-light and development-inclined reference farms (in total 54 farms), using a questionnaire and interviews. The results indicate that a majority of the lean farms were applying several lean principles and tools, and the lean philosophy. The lean-light farms applied parts of the lean concept, while the reference farms applied some of the more general tools, used in lean and elsewhere, such as visualisation in various forms and to various extents. The results showed positive effects of lean on the psychosocial work environment, better work structure and improved information, communication and co-operation. The physical work environment was improved to some extent by lean, where advantages such as a more structured and practical work environment with less physical movements and locomotion could be noticed. The lean concept provided a more structured and systematic approach to dealing with work and production environmental issues, for managers as well as for employees.

**Key words:** farm, farm business, Lean Production, physical work environment, psychosocial work environment, safety and health, structure, work organisation.

### **INTRODUCTION**

Swedish farm structure is evolving towards larger units with more animals and/or more acres (Ekman & Gullstrand, 2006; Swedish Board of Agriculture, 2017). In the EU the number of regular employees is falling and the standard output per holding is increasing, indicating a trend towards more productive farms (European Commission, 2015). This development is a part of a rationalisation trend that makes farm strategy and management increasingly important (Rydberg et al., 2011). In other sectors, Lean



Production (lean) has had a substantial impact as a productivity concept. Swedish agricultural stakeholders have therefore implemented a lean programme for farms.

Alongside this restructuring and rationalisation, there is concern about the work environment and safety. Furthermore, having bigger farm units implies more employees and increased management responsibility for the work environment. This paper examines the work environment and safety when lean is introduced in agriculture.

### **Lean Production**

Lean is a quality and productivity concept that originates from Toyota's production system (Womack et al., 1991). In 1984, researchers concluded that North American and European car manufacturers were incapable of learning from their competitors in Japan, who had increased their share of the automobile market. The International Motor Vehicle Program (IMVP) was established, from which Krafcik (1988) concluded that Toyota's production system seemed to be more 'lean', with fewer buffers, better productivity and better quality.

Since then the concept has spread from the production sector to the service, public and private sectors. Lean is based on four principles: philosophy, processes, people and problem solving (Liker, 2004). The philosophy is based on responsible long-term thinking, which may be at the expense of short-term economic goals. The philosophy and principles aim to continuously improve processes and increase customer value. People, such as employees and temporary staff, are a highly important group because they are the main part of the organisation. Challenges, development and letting people take responsibility create an environment that motivates employees to contribute. Problem solving is related to continuous learning and to understanding the organisation and its processes. Lean has the advantage of giving an overview of several business production factors simultaneously by means of the lean tool Value Stream Mapping (VSM). VSM enables processes and waste, among other things, to be visualised and possibly removed (Colgan et al., 2013). The concept has been proven to contribute to better quality and productivity (Simons & Zokaei, 2005) in various organisations, although the influence on the work environment is open to debate, as described below.

Several literature reviews have examined lean in relation to the work environment, health and well-being (Landsbergis et al., 1999; Brännmark & Håkansson, 2012; Hasle et al., 2012; Toivanen & Landsbergis, 2013). Landsbergis et al. (1999) and Toivanen & Landsbergis (2013) point out the lack of evidence to support the empowerment of manufacturing workers according to lean. They also mention a noticeably increased work pace and work demands, although decision-making authority, skills and decision latitude continue to be low. Hasle et al. (2012) report ambiguous results, with a slight predominance of negative impacts of lean on the work environment, such as a trend of reduced job autonomy, higher demands (such as cognitive demands), and a higher work pace, work load and work intensity. The positive aspects are improved job content, broader job roles, skill utilisation, social relations, empowerment of employees and task involvement. A literature review by Brännmark & Håkansson (2012), with the focus on work-related musculoskeletal disorders (WMSD) and their risk factors, provided inconclusive results, with individual studies giving positive or negative results and others showing mixed results. Overall, according to Brännmark & Håkansson (2012), there are more negative results from studies in non-Swedish contexts, and there are both positive and negative effects for employees. A recent literature review showed how Just-in-time

(JIT) and standardised work intensify work processes, which contributes to negative effects on the physical and psychosocial work environments (Koukoulaki, 2014). Westgaard & Winkel (2011) also list the negative outcomes of lean (higher repetitiveness and work intensification) and positive outcomes (increased involvement in the process of change and increased focus on quality), and conclude that workers with more routine jobs have a higher risk of negative outcomes. They also highlight the important match between resources and responsibility.

Hasle et al. (2012) conclude that lean takes many different shapes, from perspectives on how it is implemented to the context with which it interacts and how it is used in a practical sense. These different shapes affect the work environment in different ways.

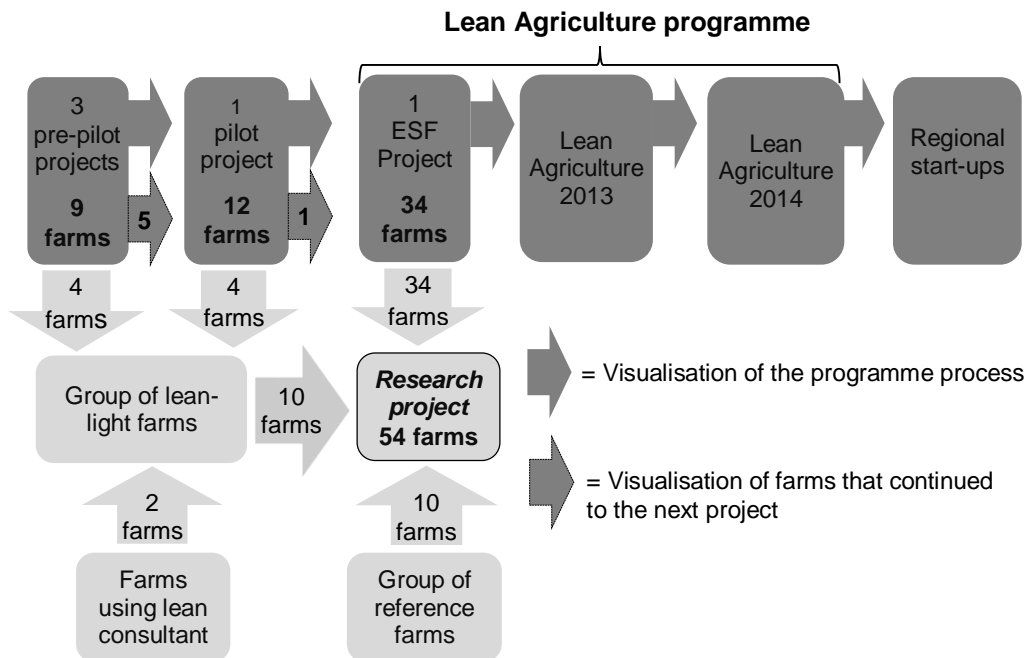
New research areas are evolving in relation to lean, e.g. environmental performance (Dieste et al., 2019). Another new area aims to deepen the understanding of how the work environment and ergonomics could be integrated naturally in lean tools as a part of holistic sustainability (Brito et al., 2019). Lean's strong emphasis on a safe work environment has also spurred interest in how safety management and lean-inspired work could be integrated and performed more effectively (Hafey, 2017).

Following the recognition of lean in the manufacturing industry and in services, it has now started to be implemented in the agricultural sector. In the UK, aspects of lean, especially VSM and Value Stream Analysis (VSA), have been implemented in the meat value chain (Keivan Zokaei & Simons, 2006; Taylor, 2006). In Italy, VSM has been implemented on the farm level (Colgan et al., 2013). In both cases, the focus is on productivity and efficiency, and the conclusion is that lean may be an approach to enhancing productivity and efficiency. In Denmark, an agricultural advisory stakeholder has introduced lean in its services (Fladkjær Nielsen, 2013). These services focus mainly on lean tools such as whiteboards, meeting structure and VSM. In the USA, farms have started to use a more holistic lean approach, including lean tools, principles and philosophy (Hartman, 2015).

### **Lean implementation in Swedish agriculture**

In the Swedish manufacturing industry, lean is seen as an opportunity to enhance production processes. A programme implemented in the manufacturing industry, the Production Leap (Brännmark, 2010; Medbo & Carlsson, 2013), influenced stakeholders in the agricultural sector. After trial implementations of smaller parts of the lean concept and the implementation methodology (see Rydberg et al., 2011; Åström & Melin, 2012; Melin et al., 2013; Olsson et al., 2014), a European Social Fund (ESF) project followed as the first project in the lean implementation programme Lean Agriculture (see Fig. 1).

A detailed description of how the implementation was executed and what was included in the lean implementation is given by Barth & Melin (2018), who based their contribution on the same project as this study. The ESF project started in autumn 2012 and ended in spring 2014. The lean farms in the project comprised various farm enterprises such as dairy, egg, broiler, pig, beef, grain and garden nurseries. There were also combinations of these on mixed farms, which is common in agriculture. The farms had an average of five employees. However, the composition of the workforce differed substantially between farms. On some farms the workforce consisted only of family members, while other farms had only externally employed staff. Full-time, part-time and hourly employment differed between farms. The employment of immigrants in the workforce also varied between none and a major extent.



**Figure 1.** Visualisation of progress and development in Lean Agriculture (marked by dark grey colour) and its relation to this research project (marked by light grey colour).

### Physical work environment in Swedish agriculture

Health and safety issues in agriculture are highlighted by Tómasson et al. (2011), who argue that Swedish agriculture (including forestry, hunting and fishing) has one of the highest levels of fatal occupational accidents in the country. Several studies report that the most common injuries are related to machinery, falls and animals (Lindahl et al., 2012). After scrutinising 3007 male and female respondents in the dairy industry, Gustafsson et al. (1994) concluded that the majority of them, irrespective of gender, had musculoskeletal problems. Age, years of working in the industry, working hours per day and personal physical characteristics strongly affected the extent of musculoskeletal symptoms. The lower back, knees, shoulders and neck had the highest frequency of symptoms. However, that study did not identify the specific activities or movements that pose the greatest risk. In a systematic literature review, Osborne et al. (2012) identified different risks of musculoskeletal disorders (MSDs) among workers and owners in agriculture and found that the two major risk factors were worker age and dairy farming. Lunner Kolstrup (2012) reports that despite improved and restructured technology in the sector, musculoskeletal strains, especially in the back, hand/wrist and knees, are common on dairy farms.

### Accidents in Swedish agriculture

Between 2007–2016, the number of employees in Swedish agriculture fell by 3% (to 171,400 in 2016) (Swedish Work Environment Authority, 2017). However, the number of work-related and fatal accidents remains high (see Table 1). Corresponding numbers from the EU countries are questionable due to inconsistent data collection

(Merisalu et al., 2019). Large intervention and information campaigns (see Danielsson, 2012) have not had prolonged effects. According to Donham & Thelin (2016), achieving sustained effects from interventions in the agriculture sector is problematic.

It is in general important to integrate health and safety improvements as a management matter (Kuimet et al., 2016). In a survey among Irish farmers, 27% of the respondents related the causes of accidents at the farm to organisational matters (Griffin et al., 2019).

Comprehensive health and safety plans are rarely developed in agricultural management (Murphy, 2016), despite work planning being an important factor in reducing risk-taking behaviour that might lead to injury (Salminen, 1997). After analysing relationships between quality of management and injury risk, Suutarinen (2004) suggested that work procedures that integrate ergonomics can contribute to a better work environment in agriculture. Better management would mean, for example, having enough work capacity for the intended task, which could reduce the risk of injury. According to Hasle & Limborg (2006), a good way to prevent accidents is to merge action-based health and safety initiatives with organisational management and its goals. Health promotion also plays a vital part when the organisation wants to enhance work motivation and efficiency and reduce labour turnover (Kuimet et al., 2016).

### Psychosocial work environment in Swedish agriculture

According to Glasscock et al. (2006), the work environment of farmers differs from those of other occupations. Farmers often work alone, for longer hours, and with very varied work tasks. At the same time, they are expected to deal with (changing) laws and regulations, various administrative tasks, changing weather, (global) economics, and livestock diseases. Other factors affecting farmers are taxes, unexpected expenses and a negative attitude in society towards farming (Lunner Kolstrup et al., 2013). These types of factors are reported to contribute to psychosocial disorders such as anxiety, substance abuse, increased rate of injury and sleep problems (Lunner Kolstrup et al., 2013). Other factors, such as the unexpected behaviour of farm animals and rapidly changing weather conditions, simultaneously contribute to an unpredictable work environment that farmers and employees can control only to a minor extent.

**Table 1.** Reported work injuries with sick leave, fatal accidents and gainfully employed in agriculture (2009–2018). Data include agriculture, forestry and fishing (SNI codes = 01, 02, 03)

Year	Reported work injuries	Fatal accidents	Gainfully employed
2009	301 <sup>*1</sup>	7 <sup>*2</sup>	95,276 <sup>*3</sup>
2010	351 <sup>*1</sup>	7 <sup>*2</sup>	100,252 <sup>*4</sup>
2011	354 <sup>*1</sup>	13 <sup>*2</sup>	100,264 <sup>*3</sup>
2012	357 <sup>*1</sup>	6 <sup>*2</sup>	100,130 <sup>*4</sup>
2013	349 <sup>*1</sup>	4 <sup>*2</sup>	100,907 <sup>*4</sup>
2014	377 <sup>*1</sup>	10 <sup>*2</sup>	100,564 <sup>*4</sup>
2015	342 <sup>*1</sup>	6 <sup>*2</sup>	99,312 <sup>*4</sup>
2016	287 <sup>*1</sup>	6 <sup>*2</sup>	94,772 <sup>*4</sup>
2017	318 <sup>*1</sup>	12 <sup>*2</sup>	96,551 <sup>*5</sup>
2018	326 <sup>*1</sup>	10 <sup>*2</sup>	Not available

<sup>1</sup> Swedish Work Environment Authority (2019a);

<sup>2</sup> Swedish Work Environment Authority (2019b);

<sup>3</sup> Official Statistics of Sweden (2015); <sup>4</sup> Official Statistics of Sweden (2018); <sup>5</sup> Olsson (2019).

Note that both SNI codes and the definition of gainfully employed may have changed slightly during the period 2009–2018.

Established stressors in the agriculture work environment, compiled by Kallioniemi et al. (2016), are: ‘policy or new legislation’, ‘public perception or the position of the farmers’, ‘future of the farm’, ‘administrative burden’, ‘the amount of paper work’, ‘long hours of work or amount of work’, ‘machinery breakdown’, ‘uncontrollable natural forces’, ‘animal diseases’, ‘media criticism’, ‘finances’, ‘health problems’, ‘isolation’ and ‘family problems’.

‘Agricultural policy of the EU’, ‘the treatment of farmers in society and the media’, ‘the future of the agricultural sector’, ‘administration of the farm’, ‘amount of work’ and ‘lack of possibility to predict work situations’ are major stressors among Finnish dairy farmers (Kallioniemi et al., 2016). Those authors concluded that stressors related to social relationships and individual matters were not among the most prevalent stressors. Glasscock et al. (2006) found that stressors with economic characteristics, stress symptoms and insufficient safety procedures were connected to accidental injury. Kolstrup et al. (2008) conducted a study of the psychosocial work environment of pig and dairy farmers in Sweden and found, among other things, that feedback, social support and the quality of leadership need improvement on dairy farms.

Several studies have shown that farmers have a greater risk of developing mental illness, such as depression, and that farmers have a higher suicide rate than the general population (Roberts & Lee, 1993; Booth & Lloyd, 2000). Some studies reviewed by Fraser et al. (2005) reported a higher level of anxiety and depression among farmers than in the general population, while other studies found no such pattern. Booth et al. (2000) discuss whether the increased suicide rate among farmers may be due to their access to firearms and having greater difficulties than urban populations in accessing medical care. Associations have been shown between MSDs and risk factors in the psychosocial and personal areas (Osborne et al., 2012), and especially between depression symptoms and lower back injury (Sprince et al., 2007).

The effects of the lean concept on the work environment are open to debate, so it is important to scrutinise lean’s effects when it is implemented in an agricultural context, which is already associated with negative work environmental issues, such as the many accidents. Lean implementation in agriculture started as an initiative to increase productivity in the industry, being viewed initially as a concept with the potential to contribute to farm competitiveness.

The primary aim of the present study was to explore how farmers apply lean-inspired work processes. A secondary aim was to identify work environment changes during and after lean implementation.

## **MATERIALS AND METHODS**

Data were collected using mixed methods (Creswell & Clark, 2017). A longitudinal quantitative questionnaire was followed by semi-structured deep interviews based on the answers from the questionnaire. Occasional observations were made during visits to farms. However, those observations were not generalised because of the varying durations of different agricultural processes. Triangulation was used to validate data from the questionnaires and the interviews and, to some extent, from the observations (Morse, 1991). Data were collected from three respondent groups.

## **Respondent groups**

The first of the three respondent groups consisted of farms participating in an ongoing project in the Lean Agriculture programme (see Fig. 1). Those are defined as lean farms. The lean farms included all farms attached to the ESF project and were at the beginning of the 18-month lean implementation process. The second group, the lean-light group, comprised four of the nine farms included in the three pre-pilot projects, and four farms from the pilot project. Those are defined as lean-light farms because their lean implementation consisted of a one-day workshop, a study visit and two days when implementation researchers visited the farms. The main methods and tools taught and used were 5S (sort, set in order, shine, standardise and sustain), VSM, fishbone diagram, spaghetti diagram, PDCA, and visualisation (see Langstrand, 2012). Those interventions were also conducted one year before the lean farms started their lean implementation process. Two farms with a private consultant were added to the lean-light group because their lean implementations were more similar to the lean-light group than to the lean farm group. The third group was a reference group of farms that did not use lean (see Fig. 1). The reference group was chosen from a larger group of farms that was considered to be inclined to improvements and development projects because of previous contact and participation in various research projects, with a more technical approach, at Research Institutes of Sweden (RISE). The reference group was established through an email survey at RISE. In this, research colleagues were asked to recommend development-inclined farms. Research colleagues with suitable contacts contributed contact information. The method of choosing farms and respondents thus involved ‘spreading the net’ (Hignett & McDermott, 2015). The reference farms were selected to match the lean farms in terms of size, production sector and geographical location.

The maturity of and interest in continuous improvement and organisational development could be assumed to differ among the three respondent groups. The reference group had primary experience of development from a more technical approach. The lean-light farms were more interested in the development of their operations.

## **The questionnaire**

A questionnaire was developed and validated to capture the present statuses of the physical and psychosocial work environments and the improvement and development work on the farms (Wilson & Sharples, 2015). The validated questionnaire comprised four sections: physical workload, discomfort in locomotive organs and eyes, psychosocial work environment and improvement work. It was sent out to farms in the fifth month of their lean implementation. In the questionnaire, lean was equated to improvement and development work and was covered by nine questions, which are presented in Table 2.

The questions were taken from a questionnaire developed in the Leadership and Organisation for Health and Production (LOHP) project (Fagerlind Ståhl, 2015). The questionnaire was validated by five individuals working on a farm, with three or more individuals related to the farm operation. The lean coaches distributed the questionnaires in person to farm owners and employees during their regular visits. They reminded them at the next two meetings. On the reference farms, the questionnaire was sent directly to the individual farm owner, who distributed the questionnaire to employees. The reference group was reminded by telephone twice, with one month between reminders.

**Table 2.** Specific statements related to improvement and development work posed to respondents in different sections (E5, E6 and E9a-i) of the questionnaire

Position in questionnaire /statement no. <sup>1</sup>	Statement	Referred to below as:
Improvement work E5	Is there a vision for improvement work in your business?	E5
Improvement work E6	Is there an overall goal for improvement work in your business?	E6
Improvement work E9a	I participate in a group that works with suggestions for improvement	A
Improvement work E9b	I take part in the work to develop guiding principles on values for our department	B
Improvement work E9c	I am involved in value stream mapping and analysis	C
Improvement work E9d	I take part in improvement projects	D
Improvement work E9e	I am involved in efforts to shorten waiting times	E
Improvement work E9f	We practise a standardised work approach	F
Improvement work E9g	We work systematically on keeping things in order	G
Improvement work E9h	We use a follow-up board (e.g. whiteboard) at our daily meetings	H
Improvement work E9i	We use a follow-up board/improvement board in our improvement work	I

### Semi-structured in-depth interviews

Semi-structured interviews (Yin, 2009; Kvale & Brinkmann, 2014) were conducted to extend and expand the questionnaire data. The interviews were carried out according to a developed interview guide divided into four sections. The first section invited the respondent to talk freely about the farm and farm operations. In this section, interviewees were encouraged to talk about their work on lean/development and improvement work. The second part dealt with goals, business metrics and their assessment, productivity and efficiency. The subsequent sections gave the respondent the opportunity to describe the effects on the physical and psychosocial work environments.

There was diversity among the respondents in terms of their agricultural sector, employer/employee, geographical location, and the lean coach serving the farm. There were 28 respondents from 14 farms (see Table 3). There were two interviews

**Table 3.** Number of interviews performed with different respondent groups

No. of interviews	Lean	Lean-light	Reference
Employers	5	1	1
Employees	5	1	1

on each farm, so the owner was self-appointed and was asked to invite an employee representative of the median age among employees. The interviews lasted between 40

<sup>1</sup>Statements E9a-E9i used a five-point Likert scale: ‘Don’t know’ (0) ‘Not at all’ (1), ‘To a fairly minor extent’ (2), ‘Partly’ (3), ‘To a fairly major extent’ (4), and ‘To a major extent’ (5). A sixth choice, ‘Don’t know’, was excluded from the analysis and is accounted for separately.

and 75 minutes. The interviews were recorded, transcribed verbatim and thematically analysed, both by hand and using NVivo software (Hignett & McDermott, 2015).

### Pulse meetings

Pulse meetings between the ESF project leaders and lean coaches were observed. A pulse meeting is a short and frequently convened (daily/weekly/monthly) meeting that aims to help guide work. Those observations aimed to use triangulation to validate data from the interviews at the lean farms. The pulse meetings gave the project leader an opportunity to check how the lean coaches' work was going at the farms. Before the meetings, the coaches were meant to mark their own farms with a green, yellow or red colour according to how well the lean-inspired work was going at the farms.

## RESULTS AND DISCUSSION

### Results

The qualitative data are presented in representative quotations throughout the discussion, while the results from the quantitative data are presented in Table 4. The questions from the questionnaire were first analysed by an independent sample Kruskal-Wallis test (Field, 2013). Medians, variances and significance levels are shown in Table 4. Kruskal-Wallis pairwise comparisons were made continuously for questions that indicated significance with the Kruskal-Wallis test. The significance levels and effect sizes are also shown in Table 4.

**Table 4.** Results of questionnaire for the three different respondent groups subjected to Kruskal-Wallis test and pairwise comparison. Medians, variances and significance levels are shown. Lean farms (L.):  $n = 56$ , lean-light farms (L.-l.):  $n = 19$  and reference farms (R.):  $n = 12$ ,  $P > 0.005$

Question	Group	Kruskal-Wallis test			Kruskal-Wallis test pairwise comparison		<i>r</i>
		$\tilde{x}$	$s^2$	Sign.	Group	Sign.	
A: I participate in a group that works with suggestions for improvement	L.	4	1.90	0.001	R. - L.-l.	0.001	
	L.-l.	4	3.09		R. - L.	0.001	
	R.	1	1.36		L.-l. - L.	1.00	
B: I take part in the work to develop guiding principles on values for our department	L.	3	2.31	0.006	R. - L.-l.	0.049	
	L.-l.	3	2.65		R. - L.	0.005	
	R.	1	1.52		L.-l. - L.	1.00	
C: I am involved in value stream mapping and analysis	L.	3	2.12	0.002	R. - L.-l.	0.052	
	L.-l.	2	2.81		R. - L.	0.001	
	R.	1	1.55		L.-l. - L.	1.00	
D: I take part in improvement projects	L.	4	1.71	0.001	R. - L.	0.002	
	L.-l.	4	1.62		R. - L.-l.	0.001	
	R.	1	2.45		L. - L.-l.	0.924	
E: I am involved in efforts to shorten waiting times	L.	3	2.27	0.033	R. - L.-l.	0.333	
	L.-l.	3	3.32		R. f. -L.	0.028	
	R.	1	2.81		L.-l. - L.	1.00	
F: We practise a standardised work approach	L.	3	1.27	0.005	R. - L.-l.	0.109	
	L.-l.	3	1.92		R. - L.	0.003	
	R.	1	1.54		L.-l. - L.	1.00	



Table 4 (continued)

G: We work systematically on keeping things in order	L.	4	0.73	0.061	R. - L.-l.	.	.
	L.-l.	4	0.72		R. - L.	.	.
	R.	4	2.64		L.-l. - L.	.	.
H: We use a follow-up board (e.g. whiteboard) at our daily meetings	L.	4	1.42	0.015	R. - L.	0.022	
	L.-l.	4	2.59		R. - L.-l.	0.024	
	R.	2	1.54		L. - L.-l.	1.00	
I: We use a follow-up board/improvement board in our improvement work	L.	4	0.901	0.001	R. - L.	0.012	
	L.-l.	3	1.93		R. - L.	0.001	
	R.	2	2.02		L.-l. - L.	0.765	

This study provides an indication of how lean is applied and implemented and the effects it can bring within a new sector (agriculture). The study contributes to the beginning of a conceptualisation of lean in agriculture. The data presented provide insights into how farm employers and employees are approaching lean, for example as a set of tools, as a philosophy, or both. It also shows how lean is applied, in terms of the extent to which a sample of Swedish farmers is working systematically according to lean. The study explores applications to improve the understanding of how lean influences the work environment. The results provide suggestions for how the implementation of a lean approach might reduce the frequency and severity of physical and psychosocial work environmental concerns.

### The philosophy

The philosophy is reported to be an important part of the lean concept in successful lean implementation (Bhasin & Burcher, 2006). Liker (2004) defined the philosophy as how the long-term thinking (mission) outweighs the short-term gains, as well as the focus on customers' demands.

The results in Tables 4, 5 and 6 show that parts of the lean philosophy have been conveyed and implemented. Barth & Melin (2018) show how the lean farms defined challenges and developed visions, goals and values for their organisation at the beginning of the lean implementation. Those visions, goals and values are connected to the lean philosophy and how lean organisations should approach the long run. However, Barth & Melin (2018) stated how all 34 farms had applied the lean philosophy with a focus on reducing waste and

**Table 5.** Results of question E5. The question asks whether farm respondents consider there is a vision for improvement work (lean)

Is there a vision for improvement work in your business?				
	No	Yes	Don't know	Total
L.	1.4% (1)	92.9% (65)	5.7% (4)	100% (70)
L.-l.	3.8% (1)	96.2% (25)	0.0% (0)	100% (26)
R.	0.0% (0)	100% (14)	0.0% (0)	100% (14)
Total	1.8% (2)	94.5% (104)	3.6% (4)	100% (110)

improving customer value but without a long-term perspective. What is remarkable are the results from lean-light farms, which have established visions and goals to the same extent as the lean farms but with much less or no training. The lean philosophy is an important part of the work environment because it avoids the short-term (economic) gains and rationalisations that seldom encourage a healthy and safe work environment (Westgaard & Winkel, 2011). Lean theory emphasises not only the importance of

defining values and goals for the business, but also the incorporation of the guiding principles (Liker, 2004; Barker, 2011). Question B highlights the extent to which the three different groups recognise themselves in the work on developing their guiding principles. The lean farms and the lean-light farms had a lukewarm response to their participation, and participation at the reference farms was non-existent. Barth & Melin (2018) showed how all 34 farms had an extended, defined in their paper as ‘to a large degree’, focus on lean principles such as values for customers. The lean farms identified steps in production processes that added value and activities that enhanced process flow. However, they also developed leaders devoted to the lean philosophy. They developed an applied and individual version of the ‘Lean house’ (Åström, personal communication, 2018) that defined the farm’s guiding principles. It is questionable how it is possible to develop and apply visions, goals and principles while scoring ‘partly’ in question B *I take part in the work to develop guiding principles on values for our department*. In this case they would probably also have scored lower in the other lean activities. One possible explanation is that only a few of the employees participated in the development of the guiding principles, and the rest of the group was better informed/educated about them.

**Table 6.** Results of question E6. The question asks whether farm respondents consider there is an overall goal for improvement work (lean)

	Is there an overall goal for improvement work in your business?			
	No	Yes	Don't know	Total
L.	4.3% (3)	88.6% (62)	7.1% (5)	100% (70)
L.-l.	0.0% (0)	88.5% (23)	11.5% (3)	100% (26)
R.	0.0% (0)	100% (14)	0.0% (0)	100% (14)
Total	2.7% (3)	90% (99)	7.3% (8)	100% (110)

### Continuous improvement

A review of the literature concluded that several technical tools, a long-term view of lean, work on continuous improvement (CI), and culture changes including empowerment and the value chain are necessary for successful lean work (Bhasin & Burcher, 2006). CI is promoted as a lean principle closely connected to the lean philosophy. The farmers reported that they often support CI work with tools such as visualisation, whiteboards and standardisation, while their way of achieving CI often involves teamwork and employee interaction. The reference farms indicate that the use of those kinds of aids is poor, and it is common for the owner or manager him/herself to be seen by the employees as the person responsible for solving and improving processes.

‘I wouldn’t say we had any... So in the dialogue with, with the so to speak personnel, what they perceive as problematic I will try to find a solution for.’ (R.)

In relation to question H, both lean and lean-light farms use tools such as visualisation, whiteboards and standardisation that aid their day-to-day processes as well as their development work.

‘We already had a weekly plan, a whiteboard, that was very good support for young lads, who... Yes we work quite a lot with newly trained lads who are not very structured.’ (L.-l.)

CI is an easy tool to use, and is also a general and logical tool that could be used at different system levels. This mind-set is systematically practised to a greater extent on the lean and lean-light farms, although it is also a general activity on the reference farms. CI is planned in regular periods that include follow-ups more often on the lean farms

than on the other two farm types. The median reveals on question A, *I participate in a group that works with suggestions for improvement*, how the lean and lean-light farms are more likely to relate to their participation in suggestions for improvements than are the reference farms. Improvements, especially CI, are one of the fundamental pillars in lean. It therefore becomes more logical that those two groups, with externally organised lean implementation, score higher. As the interviews reveal, CI is something they work on more regularly and systematically. The regular and systematic approach ensures suggestions for improvements are handled by a chain of integrated activities. The integrated activities provide a cognitive aid to judging how the work is going.

Question D, *I take part in improvement projects*, is closely connected to question A (*I participate in a group that works with suggestions for improvement*). D indicates that suggestions for improvements are taken to the next step in the organisation and really are dealt with. It seems clearer that the respondent participates in CI tasks than that the respondent participates in a group that works on CI. The meaning and definition of ‘group’ and/or ‘works’ could be questionable in A. There are significant differences between the reference farms versus both lean and lean-light farms, but not between lean versus lean-light farms.

### **Visualisation**

The progress of CI is often managed through visualisation using whiteboards, among other things. Question I, *We use a follow-up board/improvement board in our improvement work*, provides evidence of how farmers in the lean farm group make more use of visualisation such as different kinds of boards in their work on CI. The lean farms were trained in the meaning and importance of visualisation, while individual farms developed and designed the boards in response to their own needs.

The data analysis underpins the results for the lean farms’ use of visualisation related to CI, with the lean-light farms working partly with it. The reference farms use this tool to only a small extent. This question also indicates a significant difference between lean and lean-light farms versus reference farms, but not between lean versus lean-light farms. The reference farms scored fairly low. There are several possible explanations. Workers might not relate to the term ‘group’ because the farms could be defined mostly as micro businesses. Alternatively, the workers do not talk explicitly about suggestions for improvement or they do not work on them systematically. An interview with a reference farm revealed that they work on improvements but less systematically.

### **Value stream mapping**

VSM was taught and implemented on 34 of the lean farms by carrying out a VSM of one process on the farm with employees. The farms were meant to choose a process on their farm and perform a VSM with employees (Barth & Melin, 2018). None of the lean farms mentioned VSM during the interviews, which could be a sign of no further engagement in VSM and its results. The tool could contribute to the organisation’s operations from several angles. For instance, it could be used both to increase productivity and improve the work environment (Jarebrant et al., 2016). The farm employees would then be able to jointly analyse important processes, discuss them and create an understanding of the parts of the process in practice. This tool was tested on the lean-light farms, but only to show participants the need for improvement. It was not

used on the reference farms. Question C provides an expected result, in the sense that lean farms scored higher ( $\tilde{x} = 3, s^2 = 2.12$ ) than lean-light farms ( $\tilde{x} = 2, s^2 = 2.81$ ) and the reference farms ( $\tilde{x} = 1, s^2 = 1.55$ ). This could be explained by the extent to which the lean and lean-light farms were trained in the tools and by the non-use of VSM in the reference farms group. The result indicates that VSM was not one of the mostly used tools within the lean concept. There is significant difference only between the lean and reference farms in this case. The difference between this result and that of Barth & Melin (2018) could once again be related to the time of measurement. As Andreadis et al. (2017) discussed, on the basis of results from manufacturing industries and support from the literature, VSM is likely to be implemented when an organisation implements lean. Early in the process, however, the 5S tool is preferred over VSM. A lack of understanding of VSM was one of the major reasons why companies have not implemented it. A secondary reason was the tendency for there to be a shortage of trained workers and support. ‘Lack of management commitment’, ‘lack of documented or properly defined processes’ and ‘lack of employee training’ were the biggest hindrances during implementation (Andreadis et al., 2017). A concluding remark was a suggestion that organisations apply 5S to start the lean journey, to make the workspace easier to picture and measure and in preparation for the subsequent VSM. What is remarkable in the results is the use of VSM on the lean-light farms. This group had not been trained in the VSM method by the project’s management. This knowledge could be obtained in this case from agricultural interest parties such as advisers or consultancies and/or by themselves through books, etc. The difference between the reference and lean farms is significant and could indicate how farms without lean integrated into their processes do not work according to the VSM method. VSM visualises waste, for example time of waiting, which is covered by question E *I am involved in efforts to shorten waiting times*. The results from the lean, lean-light and reference farms seem to correlate with C logically but with a wider spectrum of variance. It is perhaps remarkable that the median of lean-light farms’ deployment of shortening waiting times ( $\tilde{x} = 3$ ) was higher than their median representing their use of VSM ( $\tilde{x} = 2$ ). This could be due to VSM methodology being a holistic and systematic visualisation of a whole process, while efforts to reduce waiting times could easily be made ad-hoc by an individual worker in a delimited activity. The narrower variance of C could also provide an input for VSM as a methodology that includes a certain frame of theory, while the wider variance in E should signal ‘shortening waiting times’ as a less specific tool. What does the tool include and exclude?

## 5S

The 5S and inventory reduction tools are more commonly used on all farms. In an agricultural context, 5S includes an effort to work on those issues using a holistic approach and at the same time continuously improve. Since farmers have applied 5S, their inventories and storage have reduced (in both space needed and number of items). Respondents from the lean farms more commonly reported organising storage, removing material they have not needed for years and placing the materials they use more often on the most convenient shelves.

Question G, *We work systematically on keeping things in order*, applies to 5S. It covers all the steps in 5S and is related to the expected outcome. According to Barth & Melin (2018), the 5S tool is used to a certain extent by the lean farms. A total of 26 of

the 34 farms have implemented 5S. This result shows  $\tilde{x} = 4$  in all three groups. The lean and lean-light farms have similar and narrow  $s^2$  of 0.72 and 0.73 respectively, which could be an indication of how the farms refer to the same lean tool when interpreting the question as a result of their knowledge of and training in the tool. However, the reference group also makes wide use of keeping things in order, while its  $s^2$  is much wider ( $s^2 = 2.64$ ), which could be interpreted as a greater spread in the respondents' interpretation of the question's content. The biggest difference between how the three groups are 'keeping things in order' is the consciousness of the value an integrated 5S could add. The lean farms have integrated 5S into their systematic structure in their efforts to develop better production. 'Keeping things in order' is, for example, integrated not only into the development and use of standardisation but also into the work on CI. The reference farms approach 'keeping things in order' merely as 'keeping things in order' and nothing else.

'...and I have always been one for neatness and tidiness and... I want it around me because I hate it when it's like untidy and slipshod and so on' (R.)

### **Standardisation**

A standardised work approach, which Barth & Melin (2018) define as standardised operating procedures, is trained for on all lean farms and implemented by 27 of them. Examples of standardised work tasks include 'procedures for calf rearing, milking, stalls cleaning, and animal health checks' (Barth & Melin, 2018). On the lean-light farms, examples of standardised work tasks include checklists of the tasks and tools needed when the tractor driver leaves the farm for a working day in the fields. Beyond that, standardisations may be legal requirements. Examples are the standardisation of the handling and use of chemical pesticides, and of how to manage manure to avoid leakage or to manage processes related to spraying to minimise negative environmental impacts. However, standardisation seldom takes a holistic view of the work environment. On the lean and lean-light farms in this study, there was broader use of detailed process standardisation, such as of the milking process and standard inductions for new employees. However, those farms also showed an understanding of conscious improvement of the standards.

'As you know there is a standard here for how to feed a straw press and there is a visualisation and documentation that it is done. Then you can write a comment that it is done... It is not the finished item, but a first attempt now that... It is like night and day compared with what we had before.' (L.-1.)

E9f reveals how the lean ( $\tilde{x} = 3$ ,  $s^2 = 1.27$ ) and lean-light farms ( $\tilde{x} = 3$ ,  $s^2 = 1.92$ ) have a partially standardised work approach while the reference farms ( $\tilde{x} = 1$ ,  $s^2 = 1.54$ ) have no standardised work. According to Barth & Melin (2018), standardised work was fully implemented at the end of the lean farms' 18-month implementation period.

### **General discussion**

#### Time of measurement

It must be emphasised that Barth & Melin (2018) depict the planned content of the lean implementation at the same time as the data for this article were collected. This means that this paper's results should be 'lower' or 'less' than those of Barth & Melin (2018), whose data were collected before, during and after the 18 months and whose Appendix (Barth & Melin, 2018) is interpreted in this article as a concluding result

following the 18-month implementation. Also open to discussion is the extent to which the lean training affected the answers from the lean farms. Questionnaire and interview data were collected during the lean farms' training during the lean implementation. The positive mind-set and the wish to achieve the goals, with the lean concept being a means to reach them, could affect the data positively. A common trait in the analysis is the differences between the three groups. There was a significant difference between the lean and reference farms and between the lean-light and reference farms. However, there was no significant difference between the lean and lean-light farms. There was a noteworthy difference between the implementations, in terms of both duration and content, so it might be logical to assume there should be a significant difference between the two groups.

#### Lean – a concept of inclusion

This study's results give a clear view of high employee participation in the lean implementation, in both the lean and lean-light groups.

The reference farms group has a notably lower score for their participation in organisational activities. Question A-I are all framed in terms of the individual's engagement in a specific activity or as the individual's engagement as a member of a group.

The high degree of employee inclusion in the lean and lean-light farm groups could be related to the importance of teamwork in the concept and to how lean activities are often performed or established through group meetings and joint decisions. Teamwork has become an important ingredient in the daily production process on lean farms where regular pulse meetings provide opportunities to raise the need for help with certain work tasks. This way of structuring production and working activities might also become more important with the changing structure of farms, towards larger units with more animals and/or greater area (Ekman & Gullstrand, 2006). The farms need to organise their work in other ways because the number of employees is increasing, which can have other impacts on the work environment. The new structure with regular meetings at which employees are involved in work planning provides a clear picture of the tasks to be managed during the day or the week. When the tasks are presented using a clear visual approach like this, employees can plan tasks together. Both the planning process and the need to be part of the team in the practical execution of particular tasks create teamwork. Employee involvement and the feeling of individual inclusion are not as obvious as in the two other groups.

#### Lean provides a systematic development approach

The lean concept gave the lean farms an underlying philosophy and principles as well as hands-on tools. The philosophy, principles and tools are closely interrelated in the lean concept, and are used in different combinations, on different organisational levels and in a chain of activities. This is something not found in the reference farms. The lean-light group scored fairly high in terms of the lean training they received and the time elapsing between the lean training and implementation and the time of measurement. As an example from the observations, visualisation could be used as an aid in the pulse meeting, where important information needs to be shared, as well as for suggestions and the state of the CI activities. The concept created a standardised arena for cause-and-effect tools such as '5 Why' in which troubleshooting was organised. This

integrated and systematic approach was found in the lean farm group. However, while the other groups also carried out troubleshooting, there was no great effort to find the core reasons for problems or any help to deal with the core reason. This could be due to the training component of the lean project, in which the farmers were taught how important it is to find the core reason for a problem so that it never recurs. VSM was applied in the lean farms that integrate waste elimination. Waste elimination is one of the main methods used on the lean farms (Åström, personal communication, 2019), and has been integrated systematically into daily operations. The owner/foreman and employees often employ a waste 'lens' with the eight wastes in mind. In the two other groups of farms, waste elimination is not integrated into processes, and established structures for handling new ideas for improvements are not present to the same extent.

#### Lean and the agricultural psychosocial work environment

The context discussed reveals an application where soft lean characteristics are taken into greater consideration. Questions A (*I participate in a group that works with suggestions for improvement*), B (*I take part in the work to develop guiding principles for our department*), D (*I take part in improvement projects*), H (*We use a follow-up board (e.g. whiteboard) at our daily meetings*) and I (*We use a follow-up board/improvement board in our improvement work*) related to organisational and human-centred activities. In contrast, questions C (*I am involved in value stream mapping and analysis*), E (*I am involved in efforts to shorten waiting times*), F (*We practise a standardised work approach*) and G (*We work systematically on keeping things in order*) related to a more instrumental way of approaching lean. However, instrumental approaches often involve and include soft approaches. For example, VSM and work on shortening waiting times include teamwork. Standardisation is often developed in a context of more than one person. In a small company, involving a greater part of the company makes co-operation unavoidable.

The psychosocial work environment on farms appears to have been affected most positively by lean. The respondents reported major positive changes in their psychosocial work environment when lean or lean-inspired pulse meetings were introduced into daily or weekly operations. The meetings mean that employees know what their colleagues are doing, so tasks can be redistributed to employees with less work or arranged to enable some employees to get help with tasks that they are unable to complete by themselves. This was experienced by respondents as a more open environment in which employees have better insights into farm operations. Pulse meetings give employees the opportunity to take responsibility and plan daily operations together. They also facilitate aspects of daily operations such as CI. Working according to lean or in a lean-inspired way was reported to contribute not only to teamwork, but also to a feeling of empowerment and belonging.

The lean farms in particular have established regular structured and systematic pulse meetings that are separate from coffee breaks. These pulse meetings have become the hub of the lean-inspired work systems, because whether they are daily or weekly, they provide an opportunity to improve operations and establish communication. This communication can be defined as a dialogue among employees, but also between employer and employees, which was uncommon before the implementation of the lean-inspired work systems. The meetings also contribute to participation and interaction with colleagues.

### Scandinavian lean

The results of this study also point to a more humanised approach for lean-inspired work. However, the results cannot determine the reason for the humanised approach. It should be noted that unions have not had an active part in the ESF project or in the Lean Agriculture programme. The Scandinavian countries seem to have a tradition and a heritage of a sociotechnical culture, which might affect the way lean is applied and the effects of lean in the work environment (Berggren, 1993; Sederblad, 2013). Lean can be discussed from two points of view: one in which the lean characteristics are related to organisational and human activities, and another in which the characteristics are related to economic and rational activities. There seem to be more lean tools used and principles that relate to organisational and human activities, which might argue for a more human-centred approach with lean that aligns with the sociotechnical heritage. This has been defined as the Scandinavian Lean.

### Insufficient consciousness of the physical work environment

The effects on the physical work environment, as revealed in the interviews, were minor. The effects were connected with fewer locomotive movements due to things like alarm systems such as sounds or signals.

For example, automatic feed barrows have a signal system that reduces physical movement in that the farmer does not have to go and see whether the feed barrow is moving. Having the right tools where they are needed and in standardised places (according to 5S) also reduces the amount of physical movement.

It has been theorised that 5S could contribute to workplace safety (Srinivasan et al., 2016), but there is little empirical evidence for this (Ab Rahman et al., 2010; Srinivasan et al., 2016). The data obtained in the present study showed no indications that 5S has actually improved workplace safety on the farms surveyed. Due to issues in the farm work environment, where MSDs are a major problem, the lean-inspired work system does not provide any greater contributions in the short term. The farmers surveyed have to some extent implemented systems such as signals. They have also analysed work environment movements using tools such as spaghetti diagrams to minimise waste by eliminating redundant movements. Over a longer period, the lean-inspired work system could encourage farms to implement a more conceptual and holistic approach that includes CI, and to plan and execute improvements to the physical environment, for example rebuilding work stations such as milking parlours and workshops.

It is also important to understand the aim of the ESF project and the prerequisite that it provides for lean farms. The project had a clear aim of increasing productivity in Swedish farms and improving their competitiveness. Without any clear and expressed focus on the work environment, the whole work environment or specific areas within it are at risk of being affected negatively. Because the implementation of lean has been directed to a great extent towards organisational aspects, the psychosocial work environment has been affected automatically. The physical work environment has not been included, so no reflections have been made upon it. The physical work environment is seldom actively managed on farms, and the very few reflections on the area have not been related to the work with lean but on the farm's ordinary perceptions and work in the area of the physical work environment.

The work environment has a low priority in agriculture. The safety and work environment on farms depends on farmers' perceptions of the subject (Elkind, 2008).



Farmers with confidence in their own ability to manage and prevent accidents, near-accidents and health issues tend to act differently from farmers that think the area is outside their control (Elkind, 2008). Lean-inspired development work can contribute several tools and methods to the work environment that make farmers and employees more conscious of the risks and how to prevent them. For example, pulse meetings could provide a forum in which issues are discussed jointly and transferred to the list of CI. Another example is standards, which could describe how an employee handles a specific dangerous work task.

One of the greatest implications for Swedish farmers is the systematic and structured approach lean provides to the work organisation. The systematic work system connects smaller work tasks to a greater picture that both visualises and makes employees more involved and engaged in the work processes. This type of programme also provides positive effects in implementations with recurrent support from lean coaches. However, the implementation of lean should emphasise a clearer view of the work environment to obtain a better outcome.

## CONCLUSIONS

Lean farms received systematic and thorough training in the lean concept that was supported by lean coaches, generally every third week. The farms continuing work with lean did not fully cover the whole training content. The main tools and methods applied were planning, continuous improvement and visualisation. Tools and methods were continuously developed and integrated with each other and into the organisation. However, despite the lean-light farms having had less comprehensive lean training and no coaches, the lean concept was integrated surprisingly extensively. The main tools and methods used were planning, continuous improvement and visualisation (as on the lean farms), but these were less integrated compared with the lean farms. However, the reference farms showed a wider variation in the incorporated tools and principles, and these were not integrated. The reference farms had not applied the lean concept, so there were no signs of an integrated and holistic lean philosophy.

The implementation of lean-inspired work systems was found to improve the psychosocial work environment on the lean and lean-light farms. For example, cooperation and structure as well as information and interaction improved. In some cases, the results also revealed changes to the physical work environment due to the implementation of lean-inspired visualisation systems. Farmers and employees changed their patterns of movement. These changes in mobility patterns were not directed at reducing established risks in the work environment because the changes were a result of the project's aim of improving productivity. However, the physical work environment was improved to some extent by lean, with observed advantages such as a more structured and practical work environment with less physical movement and locomotion. The lean concept provided a more structured and systematic approach to dealing with work and production environmental issues, for managers as well as for employees.

Improving the work environment is, generally, not a main objective in the agricultural sector, and is not seen as the top priority for an industry in which farmers and employees are experiencing pressure from external factors and managing an internally strained economy. Integrating lean practices, as a productivity enhancement strategy, could imply some unintended work environment changes.

Further research into and deeper knowledge of how lean-inspired work systems affect the physical work environment in agriculture are needed because the data obtained in the present study showed no indications of actually improved workplace safety. The significant differences between lean and lean-light farm data provide a good opportunity to further explore the methodology of implementing lean-inspired systems in farms, i.e. in micro businesses.

**ACKNOWLEDGEMENTS.** The authors would like to express their gratitude to the farmers and their employees for the time they took to contribute to the research. The authors would also like to acknowledge Lean Lantbruk (Lean Agriculture) for structural help in the research. The research was made possible by contributions from the SLO fund 2012–2014 (project number 11–0001–SLO) and from AFA Insurance for the project ‘How Lean can provide a safer work environment in agriculture: 2015–2017’ (project number 140216). Lean coaches, project managers and project evaluators played an interactive role during the project.

## REFERENCES

- Ab Rahman, M.N., Khamis, N.K., Zain, R.M., Deros, B.M. & Mahmood, W.H.W. 2010. Implementation of 5S practices in the manufacturing companies: A case study. *American Journal of Applied Sciences* **7**, 1182–1189.
- Andreadis, E., Garza-Reyes, J.A. & Kumar, V. 2017. Towards a conceptual framework for Value Stream Mapping (VSM) implementation: An investigation of managerial factors. *International Journal of Production Research* **55**, 7073–7095.
- Åström, H. & Melin, M. 2012. *Lean 12*. LRF -The Federation of Swedish Farmers and The Rural Economy and Agricultural Societies in Halland, Halmstad (in Swedish), pp. 1–19.
- Barker, J.A. 2011. Hoshin Kanri Align Vision, Goals, and Plans for Continuous Improvement. In Liker, J. & Convis, G.L. (eds), *The Toyota way to lean leadership: Achieving and sustaining excellence through leadership development*. McGraw-Hill Education, 147–184.
- Barth, H. & Melin, M. 2018. A Green Lean approach to global competition and climate change in the agricultural sector—A Swedish case study. *Journal of Cleaner Production* **204**, 183–192.
- Berggren, C. 1993. *Alternatives to lean production: Work organization in the Swedish auto industry*, Cornell University Press. <https://doi-org.focus.lib.kth.se/10.7591/9781501722165>
- Bhasin, S. & Burcher, P. 2006. Lean viewed as a philosophy. *Journal of Manufacturing Technology Management* **17**, 56–72.
- Booth, N., Briscoe, M. & Powell, R. 2000. Suicide in the farming community: methods used and contact with health services. *Occupational and Environmental Medicine* **57**, 642–644.
- Booth, N.J. & Lloyd, K. 2000. Stress in farmers. *International Journal of Social Psychiatry* **46**, 67–73.
- Brito, M.F., Ramos, A.L., Carneiro, P. & Gonçalves, M.A. 2019. Ergonomic Analysis in Lean Manufacturing and Industry 4.0—A Systematic Review. In Alves, A., Kahlen, F.J., Flumerfelt, S. & Siriban-Manalang, A.B. (eds), *Lean Engineering for Global Development*. Springer, Cham, pp. 95–127.
- Brännmark, M. 2010. Implementation of Lean in medium-sized companies: A learning evaluation of sustainable development. *HELIX Working Papers*, Linköping, pp. 1–53 (in Swedish).
- Brännmark, M. & Håkansson, M. 2012. Lean production and work-related musculoskeletal disorders: overviews of international and Swedish studies. *Work: A Journal of Prevention, Assessment and Rehabilitation* **41**, 2321–2328.
- Colgan, C., Adam, G. & Topolansky, F. 2013. Why try Lean? A Northumbrian Farm case study. *International Journal of Agricultural Management* **2**, 170–181.

- Creswell, J.W. & Clark, V.L.P. 2017. *Designing and conducting mixed methods research*. Sage Publications, London, pp. 1–492.
- Danielsson, A. 2012. Safe Farmers Common Sense - a Swedish campaign to reduce accidents. In Lundqvist, P. (ed), *Nordic Meeting on Agricultural Occupational Health and Safety*. The Swedish University of Agricultural Sciences, Department of Work Science, Business Economics and Environmental Psychology, Ystad, 24.
- Dieste, M., Panizzolo, R., Garza-Reyes, J.A. & Anosike, A. 2019. The relationship between lean and environmental performance: practices and measures. *Journal of Cleaner Production* **224**, 120–131.
- Donham, K.J. & Thelin, A. 2016. Prevention of illness and injury in agriculture. In Donham, K.J. (ed), *Agricultural Medicine: Rural Occupational and Environmental Health, Safety, and Prevention*. 2nd ed. New Jersey: John Wiley & Sons, 503–550.
- Ekman, S. & Gullstrand, J. 2006. *Agriculture & competitiveness*. Swedish Institute for Food and Agricultural Economics, Lund, pp. 1–110 (in Swedish).
- Elkind, P.D. 2008. Perceptions of Risk, Stressors, and Locus of Control Influence Intentions to Practice Safety Behaviors in Agriculture. *Journal of Agromedicine* **12**, 7–25.
- Fagerlind Ståhl, A.-C. 2015. *Live long and prosper: Health-promoting conditions at work*. Linköping University Electronic Press, Linköping. doi: 10.3384/diss.diva-117064
- Field, A. 2013. *Discovering statistics using IBM SPSS statistics*, Sage, London, pp. 1–915.
- Fladkjær Nielsen, V. 2013. Major savings on maintenance costs using Lean. *Magasinet Kvæg*. LandbrugsMedierne, Copenhagen, pp. 1–184 (in Danish).
- Fraser, C., Smith, K.B., Judd, F., Humphreys, J.S., Fragar, L. & Henderson, A. 2005. Farming and mental health problems and mental illness. *International Journal of Social Psychiatry* **51**, 340–349.
- Glasscock, D.J., Rasmussen, K., Carstensen, O. & Hansen, O.N. 2006. Psychosocial factors and safety behaviour as predictors of accidental work injuries in farming. *Work & Stress* **20**, 173–189.
- Griffin, P., Phelan, J., Kinsella, J., Field, W. & McNamara, J. 2019. Farm health and safety adoption through engineering and behaviour change. *Agronomy Research* **17**(5), 1953–1959.
- Gustafsson, B., Pinzke, S. & Isberg, P. 1994. Musculoskeletal symptoms in Swedish dairy farmers. *Swedish Journal of Agricultural Research*, **24**, 177–188.
- Hafey, R. 2017. *Lean safety: Transforming your safety culture with lean management*. Productivity Press, New York, pp. 1–163.
- Hartman, B. 2015. *The Lean Farm: How to Minimize Waste, Increase Efficiency, and Maximize Value and Profits with Less Work*. Chelsea Green Publishing, Vermont, pp. 1–244.
- Hasle, P., Bojesen, A., Jensen, P.L. & Bramming, P. 2012. Lean and the working environment: a review of the literature. *International Journal of Operations & Production Management* **32**, 829–849.
- Hasle, P. & Limborg, H.J. 2006. A review of the literature on preventive occupational health and safety activities in small enterprises. *Industrial Health* **44**, 6–12.
- Hignett, S. & McDermott, H. 2015. Qualitative Methodology. In Wilson, J.R. & Sharples, S. (eds), *Evaluation of human work*. CRC Press, Florida, pp. 119–138.
- Jarebrant, C., Winkel, J., Johansson Hanse, J., Mathiassen, S.E. & Öjmertz, B. 2016. ErgoVSM: a tool for integrating value stream mapping and ergonomics in manufacturing. *Human Factors and Ergonomics in Manufacturing & Service Industries* **26**(2), 191–204.
- Kallioniemi, M.K., Simola, A., Kaseva, J. & Kymäläinen, H.R. 2016. Stress and burnout among Finnish dairy farmers. *Journal of Agromedicine* **21**(3), 259–268.
- Keivan Zokaei, A. & Simons, D.W. 2006. Value chain analysis in consumer focus improvement: A case study of the UK red meat industry. *The International Journal of Logistics Management* **17**, 141–162.

- Kolstrup, C., Lundqvist, P. & Pinzke, S. 2008. Psychosocial work environment among employed Swedish Dairy and Pig Farmworkers. *Journal of Agromedicine* **13**, 23–36.
- Koukoulaki, T. 2014. The impact of lean production on musculoskeletal and psychosocial risks: An examination of sociotechnical trends over 20 years. *Applied Ergonomics* **45**(2), 198–212.
- Krafcik, J.F. 1988. Triumph of the lean production system. *MIT Sloan Management Review* **30**(1), 41–52.
- Kuimet, K., Järvis, M. & Virovere, A. 2016. Integrating ergonomics principles and workplace health protection and promotion to improve safety and health at work: Evidence from Estonia. *Agronomy Research* **14**(2), 460–474.
- Kvale, S. & Brinkmann, S. 2014. *The qualitative research interview*, Studentlitteratur, Lund, pp. 1–370 (in Swedish).
- Landsbergis, P.A., Cahill, J. & Schnall, P. 1999. The impact of lean production and related new systems of work organization on worker health. *Journal of Occupational Health Psychology* **4**(2), 108–130.
- Langstrand, J. 2012. *Exploring organizational translation: a case study of changes toward Lean Production* PhD Thesis, Linköping University, Linköping, 167 pp.
- Liker, J.K. 2004. *The Toyota Way—14 Management Principles from the World's Greatest Manufacturer*, McGraw-Hill, New York, pp. 1–354.
- Lindahl, C., Lundqvist, P. & Norberg, A.L. 2012. Swedish dairy farmers' perceptions of animal-related injuries. *Journal of Agromedicine* **17**, 364–376.
- Lunner Kolstrup, C. 2012. Work-related musculoskeletal discomfort of dairy farmers and employed workers. *Journal of Occupational Medicine and Toxicology* **7**(1), 23–31.
- Lunner Kolstrup, C., Kallioniemi, M., Lundqvist, P., Kymäläinen, H.-R., Stallones, L. & Brumby, S. 2013. International perspectives on psychosocial working conditions, mental health, and stress of dairy farm operators. *Journal of Agromedicine* **18**, 244–255.
- Medbo, L. & Carlsson, D. 2013. Implementation of Lean in SME, experiences from a Swedish national program. *International Journal of Industrial Engineering and Management* **4**, 221–227.
- Melin, M., Rydberg, A., Sundström, B., Östergren, K. & Berglund, M. 2013. Lean for competitive and climate-effective milk production. *Agriculture and Industry*, JTI - Swedish Institute of Agricultural and Environmental Engineering, Uppsala (in Swedish).
- Merisalu, E., Leppälä, J., Jakob, M. & Rautiainen, R. 2019. Variation in Eurostat and national statistics of accidents in agriculture. *Agronomy Research* **17**(5), 1969–1983.
- Morse, J.M. 1991. Approaches to qualitative-quantitative methodological triangulation. *Nursing research* **40**(2), 120–123.
- Murphy, D.J. 2016. Agricultural safety & health management *Finland Safety 2016 World Conference*, In BMJ Journals, Injury Prevention, Tampere, Finland. doi:10.1136/injuryprev-2016-042156.145
- Official Statistics of Sweden. 2015. Agricultural statistics 2015 including food statistics – tables. Örebro, pp. 1–303 (in Swedish).
- Official Statistics of Sweden. 2018. Agricultural statistics 2018 including food statistics – tables. Örebro, pp. 1–310 (in Swedish).
- Olsson, J., Sundström, B., Rydberg, A., Åström, H. & Berglund, M. 2014. Lean – for efficient and sustainable grain production. *Agriculture and Industry*, JTI - Swedish Institute of Agricultural and Environmental Engineering, Uppsala, pp. 1–43 (in Swedish).
- Osborne, A., Blake, C., Fullen, B.M., Meredith, D., Phelan, J., McNamara, J. & Cunningham, C. 2012. Risk factors for musculoskeletal disorders among farm owners and farm workers: A systematic review. *American Journal of Industrial Medicine* **55**, 376–389.
- Roberts, R. & Lee, E. 1993. Occupation and the prevalence of major depression, alcohol, and drug abuse in the United States. *Environmental Research* **61**, 266–278.

- Rydberg, A., Melin, M., Sundström, B., Östergren, K. & Berglund, M. 2011. More competitive pig producers with Lean – Methodology for how Lean can be introduced on pig farms. *Agriculture and Industry*, JTI - Swedish Institute of Agricultural and Environmental Engineering, Uppsala, pp. 1–51 (in Swedish).
- Salminen, S. 1997. *Risk taking, attributions and serious occupational accidents*. PhD thesis, Finnish Institute of Occupational Health, Hesinki, Finland. pp. 1–227.
- Sederblad, P. 2013. *Lean in the working life*. Liber, Stockholm, pp. 1–325 (in Swedish).
- Simons, D. & Zokaie, K. 2005. Application of lean paradigm in red meat processing. *British Food Journal* **107**, 192–211.
- Sprince, N., Park, H., Zwerling, C., Whitten, P., Lynch, C., Burmeister, L., Thu, K., Gillette, P. & Alavanja, M. 2007. Risk factors for low back injury among farmers in Iowa: A case-control study nested in the agricultural health study. *Journal of Occupational and Environmental Hygiene* **4**, 10–16.
- Srinivasan, S., Ikuma, L.H., Shakouri, M., Nahmens, I. & Harvey, C. 2016. 5S impact on safety climate of manufacturing workers. *Journal of Manufacturing Technology Management* **27**, 364–378.
- Suutarinen, J. 2004. Management as a risk factor for farm injuries. *Journal of Agricultural Safety and Health* **10**, 39–50.
- Swedish Board of Agriculture. 2017. *Farm Labour Force in 2016*. Report JO 30 SM 1701, pp. 1–32 (in Swedish).
- Swedish Work Environment Authority. 2017. *Accident statistics in agriculture*. Available at: <https://www.av.se/en/production-industry-and-logistics/agriculture-and-forestry/agriculture/accident-statistics-in-agriculture>. Accessed 23.5.2019.
- Swedish Work Environment Authority. 2019a. Agriculture, forestry, fishing – Industry trends Overview tables. Generated from SAS System ('SASApp', X64\_SRV12) den 01 april 2019 2:31:56 PM. Available at: <https://www.av.se/arbetsmiljoarbete-och-inspektioner/arbetsmiljostatistik-officiell-arbetskadestatistik/> (in Swedish).
- Swedish Work Environment Authority. 2019b. Accidents at work with fatal outcomes 2008–2019. Available at: <https://www.av.se/arbetsmiljoarbete-och-inspektioner/arbetsmiljostatistik-officiell-arbetskadestatistik/> (in Swedish).
- Taylor, D.H. 2006. Strategic considerations in the development of lean agri-food supply chains: a case study of the UK pork sector. *Supply Chain Management: An International Journal* **11**, 271–280.
- The European Commission. 2015. [Http://ec.europa.eu/agriculture/rural-area-economics/briefs/pdf/009\\_en.pdf](http://ec.europa.eu/agriculture/rural-area-economics/briefs/pdf/009_en.pdf). Accessed 29.9.2016.
- Toivanen, S. & Landsbergis, P. 2013. Lean and workers' health. In: Sederblad, P. (ed) *Lean in the working life*. Liber, Stockholm (in Swedish), pp. 84–101.
- Tómasson, K., Gústafsson, L., Christensen, A., Solberg Røv, A., Gravseth, H.M., Bloom, K., Gröndahl, L. & Aaltonen, M. 2011. *Fatal occupational accidents in the Nordic countries 2003–2008*. Nordic Council of Ministers, Copenhagen, pp. 1–40.
- Westgaard, R.H. & Winkel, J. 2011. Occupational musculoskeletal and mental health: Significance of rationalization and opportunities to create sustainable production systems– A systematic review. *Applied Ergonomics* **42**, 261–296.
- Wilson, J.R. & Sharples, S. 2015. *Evaluation of human work*. Taylor and Francis Group, Florida, pp 1–999.
- Womack, J.P., Jones, D.T. & Roos, D. 1991. *The Machine That Changed The World: The story of lean production*. Harper Perennial & Rawson Associates, New York, pp. 1–323.
- Yin, R.K. 2009. *Case study research: Design and methods*, Sage publications, Los Angeles, pp. 1–219.

## Dependence of potato yield on weed infestation

P. Barbaś<sup>1,\*</sup> and B. Sawicka<sup>2</sup>

<sup>1</sup>Department Agronomy of Potato, Plant Breeding and Acclimatization Institute – National Research Institute, Jadwisin Research Center; Szaniawskiego street 15, PL05-140 Serock, Poland

<sup>2</sup>University of Life Sciences in Lublin, Department of Plant Production and Commodities Science, Akademicka street 15, PL20-950 Lublin, Poland

\*Correspondence: p.barbas@ihar.edu.pl

**Abstract.** Results of the research were based on a field experiment carried out in 2007–2009 at the Experimental Plant of the IHAR-PIB in Jadwisin, on podzolic soil with a granulometric composition of loamy sand. The experiment was established by means of a random sub-block method in a dependent split-plot pattern, in triplicate. The first order factor were the potato cultivars: ‘Irga’ and ‘Fianna’, the second order factor were the methods of weeds regulation: 1) control – without chemical protection; 2) extensive mechanical treatments (every 2 weeks) from planting to closing the rows; 3) Sencor 70 WG – 1 kg ha<sup>-1</sup> before potato emergence; 4) Sencor 70 WG – 1 kg ha<sup>-1</sup> + Titus 25 WG – 40 g ha<sup>-1</sup> + Trend 90 EC – 0.1% before potato emergence; 5) Sencor 70 WG – 0.5 kg ha<sup>-1</sup> after potato emergence; 6) Sencor 70 WG – 0.3 kg ha<sup>-1</sup> + Titus 25 WG – 30 g ha<sup>-1</sup> + Trend 90 EC – 0.1% after potato emergence; 7) Sencor 70 WG – 0.3 kg ha<sup>-1</sup> + Fusilade Forte 150 EC – 2 dm<sup>3</sup> ha<sup>-1</sup> after potato emergence; 8) Sencor 70 WG – 0.3 kg ha<sup>-1</sup> + Apyros 75 WG 26.5 g ha<sup>-1</sup> + Atpolan 80 SC – 1 dm<sup>3</sup> ha<sup>-1</sup> after potato emergence. The number, floristic compositions, fresh weight and dry matter of weeds were determined. A high, yield-protective effect of herbicides was obtained as a result of limited competition of weeds. Mechanical care contributed to the increase in the total potato yield by 36.2%, and the marketable yield by 45.7%, as compared to the control object.

**Key words:** potato, cultivars, weeds infestation, yield.

### INTRODUCTION

Potato tuber yields are shaped by agrotechnical treatments, cultivars and environmental conditions (Mišovic et al., 1997; Đalovic et al., 2008; Gugala & Zarzecka, 2013; Hassannejad & Porheidar, 2013; Caldiz et al., 2016). One of the most important factors limiting the yield is the occurrence of weeds in cropland communities (Hashim et al., 2003 and Arora et al., 2009). In the potato cultivation, weeds are particularly harmful at the beginning of the growing season (so-called primary weed infestation) and at the end of this period (secondary weed infestation) (Hashim et al., 2003; Hassannejad & Porheidar, 2013). Research performed by Jones et al. (2007) showed that primary weed infestation reduced the yield by 54% and before potato harvest by 16%. Weeds are characterized by the highest potential for lowering the yields – by 34%, while pests by 18% and diseases by 16%, on average (Fernandes-Quintanilla et al., 2008; Merga &

Dechassa 2019). Yielding of potato, as a result of the presence of weeds in the analysis carried out by Mondani et al. (2011) decreased by 54.8%, while in the studies of Sharshar et al. (2015) – by 61.4–74%. In domestic studies, depending on the state and degree of weed infestation, the yield losses of potato tubers were estimated at 10–50% (Azadbakht et al., 2017; Walkowiak et al., 2017; Gugala et al., 2018) and up to 70% (Zarzecka et al., 1999; Zarzecka 2004). Therefore, the use of chemical protection has become an indispensable and permanent element in technologies of growing agricultural plants. Almost all agrotechnical operations carried out on a potato plantation serve, among others, to reduce weed infestation. The sum of losses caused by weeds usually exceeds damage caused by diseases and pests. Sometimes, with little aggravation of diseases or pests, weed control can be given up. In the case of weeds, this situation is extremely rare. Thus, limiting the number and weight of weeds is now considered the main plant protection procedure, and herbicides are the basic group of pesticides. The skillful use of herbicides makes it possible to eliminate the competitive impact of weeds on arable crops from the beginning of potato vegetation, as well as to limit the subsequent emergence of weeds (secondary weed infestation). Therefore, the aim of this work was to determine whether and to what extent different ways of protecting plantations against weeds can limit the negative relationships between the general and marketable yield and the degree of weed infestation.

## MATERIAL AND METHODS

Results of the research were based on a field experiment carried out in 2007–2009 at the Plant Breeding and Acclimatization Institute – National Research Institute in Jadwisin (52°28'44" N, 21°2'38" E) on podzolic soil with a granulometric composition of loamy sand of weak rye complex with acidic to slightly acidic reaction (pH 4.7–5.5) (WRB, 2014). The experiment was established by means of a random sub-block method in a dependent split-plot pattern, in triplicate. The first order factor were the potato cultivars: 'Irga' and 'Fianna', the second order factor were the methods of weeds regulation: 1) control – without chemical protection; 2) extensive mechanical treatments (every 2 weeks) from planting to closing the rows; 3) Sencor 70 WG – 1 kg ha<sup>-1</sup> before potato emergence; 4) Sencor 70 WG – 1 kg ha<sup>-1</sup> + Titus 25 WG – 40 g ha<sup>-1</sup> + Trend 90 EC – 0.1% before potato emergence; 5) Sencor 70 WG – 0.5 kg ha<sup>-1</sup> after potato emergence; 6) Sencor 70 WG – 0.3 kg ha<sup>-1</sup> + Titus 25 WG – 30 g ha<sup>-1</sup> + Trend 90 EC – 0.1% after potato emergence; 7) Sencor 70 WG – 0.3 kg ha<sup>-1</sup> + Fusilade Forte 150 EC – 2 dm ha<sup>-1</sup> after potato emergence; 8) Sencor 70 WG – 0.3 kg ha<sup>-1</sup> + Apyros 75 WG 26.5 g ha<sup>-1</sup> + Atpolan 80 SC – 1 dm ha<sup>-1</sup> after potato emergence. Metribuzin (4-amine-6-tert-buthyl-3-(methylation)-as-triazine-5(4H)-one) was used in a form of Sencor 70 WG, sulfosulfurone (1-(4,6-dimethoxypyrimidin-2-yl)-3-(2-ethylsulfonylimidazol(1,2-a)pyridin-3-ylsulfonyl) – as Apyros 75 WG, rimsulfurone (1-(4,6-dimethoxypyrimidin-2-yl)-3-(3-ethylsulfonylpyridin-2-yl) sulfonylurea) – in a form of Titus 25 WG herbicide, fluazyfop ((R)-2-(4-((5-(trifluormethyl)-2-pyridinyl)-oxy) phenoxy) propionic acid – as Fusilade Forte 150 EC preparation. Organic fertilization in the study consisted of straw plowed after harvesting in the amount of 4–5 t ha<sup>-1</sup> with the addition of nitrogen (1 kg of N per 100 kg of plowed straw) and white mustard post-crop in the amount of 15–16 t ha<sup>-1</sup> of fresh weight, plowed in autumn. Every year, in autumn, mineral phosphorus-potassium fertilization was applied in the

amount of 39.3 kg P ha<sup>-1</sup> and 116.2 kg K ha<sup>-1</sup>, which were plowed with pre-season plowing. Nitrogen fertilizers were used in spring in the amount of 100 kg N ha<sup>-1</sup> by mixing them with the soil using a cultivating unit (cultivator + string roller). Potato tubers were planted manually at the end of April, with a spacing of 75×33 cm. The propagating material was in the C/A class. Herbicide spraying was done manually using a backpack sprayer. Protection of the potato against diseases and pests was applied in accordance with the IOR-PIB recommendations. Following preparations were used to protect against alternariosis and late blight: Tattoo C 750 SC at a dose of 2.5 dm<sup>3</sup> ha<sup>-1</sup>, Altima 500 SC – 0.4 dm<sup>3</sup> ha<sup>-1</sup>, Python Consento 450 SC – 2.0 dm ha<sup>-1</sup>. In order to reduce potato beetle, following insecticides were used: Actara 25 WG at a dose of 0.4 kg ha<sup>-1</sup>, Calypso 480 SC – 0.75 dm<sup>3</sup> ha<sup>-1</sup> and Mospilan 20 SP in an amount of 0.05 kg ha<sup>-1</sup>. In the field experiment were used insulations belts accordance with the principles of good agricultural practice, and the plot area given in the research methodology concerned only to the harvesting area. Plot area, assuming experiment, was 31.0 m<sup>2</sup>, while for harvesting – 25 m<sup>2</sup>.

In order to compare the effectiveness of the examined methods of pre-harvest tuber treatment, weed infestation was assessed using a quantitative and qualitative method, Weed Infestation Analysis, Tuber Yield and Its Components.

Analysis of fresh weight of weeds in experimental plots just before tuber harvest was performed using the quantitative and weight method when plants entered the stage 97 based on the BBCH scale (Roztropowicz, 1999; Bleinholder et al., 2001). The frame was tossed three times diagonally across the ridges and weeds within the frame were collected (Adamczewski & Matuszewski 2011). The number, floristic compositions, fresh and dry matter of weeds were determined on three randomly selected areas of each plot, marked with a frame (1.0 m<sup>2</sup>). The dominant weed species in the experiment were: *Echinochloa crus-galli*, *Chenopodium album*, *Stellaria media*, *Lycopsis arvensis*, *Viola arvensis*. Each year prior to harvest, tubers of ten plants selected at random from each plot were dug to determine the following: to determine the number and weight of tubers < 35, 35–45, 45–55, 55–65 and > 65 mm in diameter. Potato tubers were harvested at physiological maturity (phase BBCH 97) (Roztropowicz, 1999; Bleinholder et al., 2001) at the end of September. During the harvest, representative samples of tubers were collected from each plot to assess the potato yielding. Total tuber yield consisted of the weight of tubers harvested from the whole plot area and the weight of previously taken samples, both converted to t ha<sup>-1</sup>. Marketable yield included tubers with the diameter of over 35 mm without external and internal defects (Regulation of the Minister of Agriculture, 2003).

Results of weed infestation assessment concerning the total number of weeds, number of monocotyledonous and dicotyledonous weeds, fresh and air-dry weed matter, as well as total and marketable yield were subjected to descriptive statistics, Pearson's analysis of simple correlation and multiple regression analysis. The basic assumption of the linear regression model was that for each observation of the independent variable there is a relationship with the value of the dependent variable and that the dependent variable has a normal distribution with a constant expected value and variance. The following assumptions were made: the explanatory variables are non-random, their values are fixed real numbers; explanatory variables are not collinear, i.e. there is no exact linear relationship between them; the random component has a normal distribution and is independent for any two different observations (i.e. no autocorrelation). The



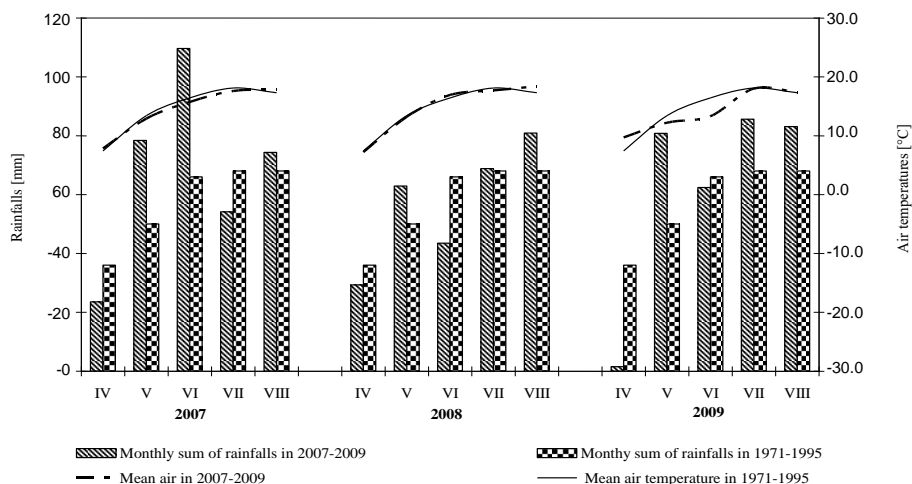
expected value of the probability distribution of the random component is zero. It was assumed that the variance of the random component is constant for all observations, because the random disorder is not a function of the explanatory variables of the model (exogeneity of independent variables). These dependencies were considered within the scope of standard deviation of independent variables from the arithmetic mean. Parameters of the function were determined by the least-squares method and the significance verification by the t-Student's test. Assessment of the significance of differences between compared average values was made using multiple Tukey intervals (Raudonius, 2017).

Before starting the field experiment, soil samples were taken for physicochemical analyzes in each study year. Soil acidity determined in a 1 mL solution of KCl dm<sup>-1</sup> ranged from acidic (4.7 pH) to slightly acidic (5.4 pH). The content of organic weight in the arable layer was low and ranged from 0.68 to 0.73% (WRB 2014). Soil's phosphorus abundance ranged from very low (2009) to very high (2007) (1.7–10.4 mg of P 100 g<sup>-1</sup> of soil). Soil compostability in absorbable forms of potassium was also characterized by considerable variability in the years of research and ranged from low to high (6.1–18.4 mg K 100 g<sup>-1</sup>gleby). The average abundance of available magnesium was found in the soil collected for analysis in 2009 third year of research (3.6 mg Mg 100 g<sup>-1</sup>), and very high – in 2007 the first year (12.1 mg Mg 100 g<sup>-1</sup>) (Table 1).

**Table 1.** Physicochemical properties of soil in Jadwisin, in 2007–2009

Year	The content of assimilable forms (mg.100 g <sup>-1</sup> d.m. soil)			pH (1M KCl)	Content of the organic substance (%)
	P	K	Mg		
2007	10.4	18.4	12.1	4.7	0.73
2008	4.3	13.9	9.3	5.4	0.68
2009	1.7	6.1	3.6	5.0	0.70
Mean	5.5	12.8	8.3	5.0	0.70

Source: own research based on the designations at the Chemo-Agricultural Station in Wesola.



**Figure 1.** Rainfalls and air temperature during the growing season of potato according to the weather station IHAR-PIB in Jadwisin (2007–2009), against the average of the multiannual.

Conditions during the growing season in 2007–2009 were characterized by diversified air and rainfall temperatures (Fig. 1). The year 2007 can be described as quite dry, year 2008 as dry, and 2009 – with the most favorable humidity and thermal conditions for potato development (Skowera et al., 2016).

## RESULTS AND DISCUSSION

Relations between the total and marketable yield vs. degree of weed infestation were considered in the scope of standard deviation from the arithmetic mean (Table 2 and 3).

**Table 2.** Statistical characteristics of dependent and independent variables

Weed control*	Arithmetical means	Standard deviations	Variability coefficient V (%)	
<b>Total yield of tubers (t ha<sup>-1</sup>)</b>				
1	27.4	10.2	37.3	1. Control – without chemical protection;
2	30.8	9.3	30.2	2. Extensive mechanical treatments (every 2 weeks) from planting to closing the rows;
3	32.5	11.7	36.4	
4	32.0	9.7	30.4	
5	28.2	7.9	28.2	
6	30.5	7.8	25.6	3. Sencor 70 WG – 1 kg ha <sup>-1</sup> before potato emergence;
7	34.6	13.0	37.6	
8	35.1	12.8	36.5	
<b>Marketable yield of tubers t ha<sup>-1</sup></b>				
1	24.4	11.1	45.4	4. Sencor 70 WG – 1 kg ha <sup>-1</sup> + Titus 25 WG - 40g ha <sup>-1</sup> + Trend 90 EC – 0.1% before potato emergence;
2	29.0	12.8	44.1	
3	32.0	11.7	36.6	5. Sencor 70 WG – 0.5 kg ha <sup>-1</sup> after potato emergence;
4	30.1	9.9	32.9	
5	26.7	8.1	30.3	
6	28.7	7.7	26.8	6. Sencor 70 WG – 0.3 kg ha <sup>-1</sup> + Titus 25 WG – 30 g ha <sup>-1</sup> + Trend 90 EC – 0.1% after potato emergence;
7	31.6	13.9	44.0	
8	32.0	13.8	43.1	
<b>Total numbers of weeds per 1 m<sup>2</sup></b>				
1	46.0	43.0	92.9	7. Sencor 70 WG – 0.3 kg ha <sup>-1</sup> + Fusilade Forte 150 EC – 2 dm ha <sup>-1</sup> after potato emergence;
2	43.0	44.0	103.3	
3	19.2	17.6	91.6	
4	10.8	13.2	122.2	8. Sencor 70 WG – 0.3 kg ha <sup>-1</sup> + Apyros 75 WG 26.5 g ha <sup>-1</sup> + Atpolan 80 SC – 1 dm ha <sup>-1</sup> after potato emergence.
5	11.4	7.3	64.0	
6	13.2	6.8	51.5	
7	58.0	52.0	89.5	
8	36.0	31.0	85.2	

Among the assessed variable characteristics, the total yield of tubers was characterized by the highest stability ( $V = 32.8\%$ ), while the number of dicotyledonous weeds – by the highest variability ( $V = 112.5\%$ ) (Table 2 and 3). Arithmetic mean as well as standard deviation influenced the value of this rating indicator. Stability of the total yield was the highest after application of the mixture of Sencor (active substance metribuzin) + Fusilade Forte (active substance flauzafop-propionic acid) herbicides

( $V = 37.6\%$ ), and the lowest after the post-emergence application of Sencor (active substance metribuzin) + Titus (active substance rimsulfurone) + Trend, as wetter ( $25.6\%$ ). Variability coefficient for marketable yield was at the level of  $26.8\text{--}50.4\%$ . Meanwhile, variability of dicotyledonous weeds was the highest after the use of Sencor + Titus + Trend ( $V = 184.4\%$ ), and the lowest due to Sencor herbicide applied after the emergence of the crop ( $V = 81.2\%$ ). The coefficient of variability in the statistical analysis carried out in the case of fresh weight of weeds was  $62.1\text{--}153.8\%$ , while dry matter –  $31.3\text{--}97.1\%$ . The highest stability of fresh weed weight was obtained after application of Sencor herbicide before the emergence of potato ( $V = 62.1\%$ ), and the lowest, after application of the mixture of preparations Sencor + Fusilade Forte ( $V = 172.4\%$ ). Stability of weed dry matter was the highest when weed control was carried out mechanically ( $V = 31.3\%$ ), and the lowest after application of Sencor + Titus + Trend herbicide before emergence of the crop ( $V = 85.6\%$ ).

Our research indicates a close relationship between tuber yield and the degree of weed infestation (Table 4).

Pearson's simple correlation analysis showed a significant, negative relationship between total, commercial and seed potatoes yield, and fresh and air-dry weed matter (Table 4). Zarzecka (2004) also proved that Pearson's simple correlation coefficients show a high negative correlation between potato yield and the number and dry weight of weeds determined at the beginning and end of crop vegetation. In addition, Zarzecka (2004) showed that the relationship between the number and weight of weeds and crop features is straightforward, which was not confirmed by the research.

**Table 3.** Statistical characteristics of dependent and independent variables

Weed control*	Arithmetical means	Standard deviations	Variability coefficient V (%)
Number of monocotyledonous weeds per 1 m <sup>2</sup>			
1	28.0	31.0	111.1
2	19.0	30.0	162.2
3	9.0	6.9	76.6
4	6.6	6.8	103.0
5	8.1	4.3	83.9
6	8.0	4.3	75.0
7	34.0	31.0	90.4
8	22.0	25.0	114.2
Number of dicotyledonous weeds per 1 m <sup>2</sup>			
1	18.0	22.0	119.6
2	24.0	22.0	90.9
3	10.1	13.0	126.7
4	4.5	8.0	184.4
5	3.2	3.0	81.2
6	5.2	6.0	113.4
7	5.1	24.0	100.8
8	3.1	12.0	82.8
Fresh weight of weeds g m <sup>-2</sup>			
1	576.9	143.0	153.8
2	321.6	100.0	120.5
3	231.6	144.0	62.1
4	111.3	82.0	73.5
5	260.5	189.0	72.6
6	227.5	142.0	62.6
7	142.5	200.0	172.4
8	161.1	100.0	107.5
Dry matter of weeds g m <sup>-2</sup>			
1	236.7	33.0	97.1
2	142.7	10.0	31.3
3	76.6	44.0	56.7
4	55.8	48.0	85.6
5	90.1	70.0	77.2
6	94.5	60.2	63.7
7	63.1	42.5	62.4
8	62.8	53.6	85.3

\*the explanations as in Table 2.

Both the total number and number of mono- and dicotyledonous weeds had smaller impact on the total yield and marketable yield of tubers than on the fresh and air-dry weight of weeds (Table 5–8). Similar results were obtained by Różyło & Pałys (2008) and Mondani et al. (2011). The decrease in the total and marketable yield under the influence of fresh and air-dry weed weight took the parabolic character in the experiment, 2° and 3°. These dependencies were used to calculate the maximum weight of weeds, which does not negatively affect the yield. Zarzecka (2004) showed a greater negative effect of weed infestation on crop characteristics before tuber harvesting than before shorting of potato rows.

Considering the relationship between total and marketable yield vs. fresh weed weight (Table 6 and 8), in the scope of standard deviation from the arithmetic mean, the parabolic relationship was the most reliable in the case of mechanical-chemical treatment using the mixture of Sencor (active substance metribuzin) + Titus (active substance rimsulfurone) + Trend, as wetter applied before potato emergence, for which the coefficient of determination was over 50%. Fresh weight of weeds calculated from regression equations, the level of which the yield does not reach amounted to 6.3 g in the case of total yield and 10.6 g m<sup>-2</sup> in the case of marketable yield of tubers. In the studies of Sawicka et al. (2006) admissible threshold value of fresh weight of weeds, which did not significantly affect the yield, was at the level of 802 g for total yield and 840 g m<sup>-2</sup> for commercial yield in the organic farming system, while for integrated cultivation: 279 and 246 g m<sup>-2</sup>, respectively. Gugala et al. (2018), Mystkowska et al. (2018) and Zarzecka et al. (2020) also they found that integration of mechanical and chemical practices as well as biostimulant application increases weed control efficiency and positively affects potato yield performance.

Depending on the commercial yield from air-dry and fresh weight of weeds, a significant linear relationship was found when using Sencor 70 WG (1 kg ha<sup>-1</sup>) before emergence and Sencor 70 WG (1 kg ha<sup>-1</sup>) + Titus 25 WG (40 g ha<sup>-1</sup>) + Trend 90 EC (0.1%) after potato emergence. The coefficient of determination of these dependencies reached the level of over 50%, which confirms the adopted method (Kranz, 1988). Różyło & Pałys (2008) showed a significant negative relationship between weed infestation rates (number and weight of weeds) and the yield of potato tubers. Also, Zarzecka et al. (2020) they found that herbicides and herbicide + biostimulant mixtures applied in potato cultivation contributed to an increase in marketable tuber yields, ranging 27.5–61.0% compared with mechanical weed control, due to removal of competition with weeds and improved utilization of crop plant yield-formation potential. The total yield of potato tubers on heavy soil was also significantly negatively correlated with the number of monocot weeds. On the light soil, however, these relations occurred only before the rows were shorted.

**Table 4.** Coefficients of Pearson's simple correlation between crop weeds and yield in potato tubers

Independent variables	Dependent variables		
	y <sub>1</sub>	y <sub>2</sub>	y <sub>3</sub>
x <sub>1</sub>	- 0.183	- 0.194	- 0.120
x <sub>2</sub>	- 0.055	- 0.063	0.034
x <sub>3</sub>	- 0.429**	- 0.437**	- 0.416**
x <sub>4</sub>	- 0.378*	- 0.391*	- 0.385*

Source: Own research; \*\* significant at the level of p<sub>0.01</sub>; \* significant at the level of p<sub>0.05</sub>; y<sub>1</sub> – total yield of tubers; y<sub>2</sub> – commercial yield of tubers; y<sub>3</sub> – yield of seed potatoes; x<sub>1</sub> – number of weeds per 1 m<sup>2</sup> before closing of rows; x<sub>2</sub> – number of weeds per 1 m<sup>2</sup> before harvest of tubers; x<sub>3</sub> – fresh weed weight before harvesting (g m<sup>-2</sup>); x<sub>4</sub> – dry matter of weeds before harvesting (g m<sup>-2</sup>).

**Table 5.** Relationships between total yield of tubers and total numbers of weeds, number of mono- and dicotyledonous weeds

Weed control <sup>a</sup>	Regression equations	Significance level	Coefficient of determination (%)
The total numbers of weeds			
1	$y = 0.001x^4 - 0.108x^3 + 3.701x^2 - 49.161x + 239,001$	0.026	56.3
2	$y = 9E-0.6x^6 - 0.001^5 + 0.181x^4 - 8.516x^3 + 217.080x^2 - 2846.300x + 15007.000$	0.008	29.5
3	$y = 5E- 06x^5 - 0.001x^4 + 0.004x^3 + 0.536x^2 - 14.557x - 104.010$	0.007	29.1
4	$y = 4E-05x^5 - 0.006x^4 + 0.339x^3 - 9.354x^2 + 121.650x - 582.540$	0.006	16.3
5	$y = -0.022x^2 + 0.983x + 2.405$	0.128*	56.0
6	$y = 0.001x^5 - 0.038x^4 + 1.901x^3 - 55.547x^2 + 790.260x - 4363.900$	0.001	36.5
7	$y = 3E-0.5x^4 - 0.0111x^3 + 0.8291x^2 - 22.038x + 202.76$	0.026	35.4
8	$y = 0.033x^3 - 0.3097x^2 + 9.3665x - 84.62$	0.013	0.5
The number of monocotyledonous weeds			
1	$y = -1E -0.5x^6 + 0.002x^5 - 0.116x^4 + 3.431x^3 - 53.353x^2 + 413.790x - 1252.600$	0.218*	48.3
2	$y = 2E-05x^6 - 0.003x^5 + 0.292x^4 - 13.234x^3 + 327.590x^2 - 4195.800x + 21721.000$	0.010	27.7
3	$y = 0.001x^4 - 0.019x^3 + 0.0889x^2 - 15.256x + 84.168$	0.046	24.0
4	$y = 3E-05x^5 - 0.005x^4 + 0.272x^3 - 7.377x^2 + 93.455x - 437.230$	0.008	28.9
5	$y = - 0.2172x + 9.404$	0.419**	41.9
6	$y = - 0.001x^5 - 0.017x^4 + 1.017x^3 - 29.281x^2 + 410.180x - 22.344$	0.004	34.8
7	$y = 0.004x^4 - 0.053x^3 + 2.511x^2 - 50.922x + 374.580$	0.000	24.4
8	$y = 0.001x^4 - 0.094x^3 + 4.433x^2 - 90.850x + 681.230$	0.054	21.1
The number of dicotyledonous weeds			
1	$y = -1E -0.5x^6 + 0.002x^5 - 0.1159x^4 + 3.4314x^3 - 53.353x^2 + 413.79x - 1252.6$	0.218*	48.3
2	$y = 2E-05x^6 - 0.0033x^5 + 0.2921x^4 - 13.234x^3 + 327.59x^2 - 4195.8x + 21721$	0.010	27.7
3	$y = 0.00001x^4 - 0.0194x^3 + 0.0886x^2 - 15.256x + 84.168$	0.046	24.0
4	$y = 3E-05x^5 - 0.0047x^4 + 0.272x^3 - 7.3766x^2 + 93.455x - 437.23$	0.008	28.9
5	$y = - 0.2172x + 9.4044$	0.419**	41.9
6	$y = - 0.0001x^5 - 0.0172x^4 + 1.0171x^3 - 29.281x^2 + 410.18x - 22.34.4$	0.004	34.8
7	$y = 0.0004x^4 - 0.0527x^3 + 2.5105x^2 - 50.922x + 374.58$	0.000	24.4
8	$y = 0.0007x^4 - 0.0938x^3 + 4.4331x^2 - 90.85x + 681.23$	0.054	21.1

<sup>a</sup>the explanations as in Table 2; \*significant at the level of p<sub>0.05</sub>; \*\*significant at the level of p<sub>0.01</sub>.

**Table 6.** Relationships between total yield of tubers and fresh weight and air-dry matter of weeds

Weed control <sup>a</sup>	Regression equations	Significance level	Coefficient of determination (%)
The fresh weight of weeds			
1	$y = 0.002x^5 - 0.022x^4 + 11.010x^3 - 258.320x^2 + 2841.900x - 10964.000$	0.042	23.8
2	$y = 0.001x^6 - 0.037x^5 + 3.332x^4 - 138.140x^3 + 3343,000x^2 - 42002,000x + 214040,000$	0.002	24.7
3	$y = 0.0001x^4 + 0.0188x^3 - 0.1213x^2 + 1571.000x + 206.050$	0.463**	61.1
4	$y = -6.339x + 314.620$	0.570**	76.9
5	$y = -0.046x^3 + 3.924x^2 - 117.200x + 1472.500$	0.189*	50.5
6	$y = -9.0456x^3 + 3.924x^2 - 117.200x + 1472.500$	0.283**	58.3
7	$y = 0.001x^4 - 0.053x^3 + 2.511x^2 - 50.922x + 374.580$	0.001	31.8
8	$y = 1.2141x^2 - 84.49x + 1438.3$	0.046	29.9
The dry matter of weeds			
1	$y = 0.001x^5 - 0.117x^4 + 5.749x^3 - 134.360x^2 + 1478.800x - 5830.200$	0.000	30.3
2	$y = 7E-09x^6 - 0.138x^5 + 1.154x^4 - 50.228x^3 + 1203.800x^2 - 0.01915045.000x + 76737.000$	0.019	11.3
3	$y = 0.001x^4 - 0.079x^3 + 3.601x^2 - 70.286x + 599.160$	0.506**	60.2
4	$y = 0.007x^3 - 0.654x^2 + 14.475x + 24.480$	0.595**	64.3
5	$y = 0.001x^4 - 0.111x^3 + 6.781x^2 - 164.890x + 1485.700$	0.099	20.3
6	$y = 0.063x^3 - 5.929x^2 + 174.260x - 1487.400$	0.352**	58.3
7	$y = -0.003x^5 + 0.426x^4 - 25.047x^3 + 718.810x^2 - 100420x + 54650.000$	0.001	33.2
8	$y = 0.012x^4 - 1.337x^3 + 56.831x^2 - 1045.700x + 7080.600$	0.042	25.9

<sup>a</sup>the explanations as in Table 2; \*significant at the level of p<sub>0.05</sub>; \*\* significant at the level of p<sub>0.01</sub>.

**Table 7.** Relationships between marketable of tubers and total numbers of weeds, number of mono- and dicotyledonous weeds

Weed control <sup>a</sup>	Regression equations	Significance level	Coefficient of determination (%)
The total numbers of weeds			
1	$y = 0.007x^3 - 0.537x^2 + 13.636x - 57.426$	0.027	51.7
2	$y = -0.001x^5 + 0.031x^4 - 1.766x^3 + 48.346x^2 - 634.150x + 3200.100$	0.012	14.8
3	$y = 3E-05x^5 + 0.005x^4 - 0.326x^3 + 9.2884x^2 - 119.11x + 543.880$	0.007	27.9
4	$y = -8E-07x^6 + 0.001x^5 - 0.018x^4 + 0.826x^3 - 19.010x^2 + 213.180x - 895.410$	0.002	18.9
5	$y = 3E-05x^5 - 0.003x^4 - 0.147x^3 - 3.0519x^2 + 27.089x - 57.236$	0.147*	58.1
6	$y = 0.001x^5 - 0.038x^4 + 2.162x^3 - 60.481x^2 + 824.480x - 4370.500$	0.001	41.0
7	$y = 0.007x^5 + 0.614x^2 - 16.542x + 152.420$	0.016	41.3
8	$y = -0.001x^4 - 0.034x^3 - 1.495x^2 - 28.24x - 187.580$	0.009	0.1

Table 7 (continued)

The number of monocotyledonous weeds			
1	$y = 4E-0.5x^5 - 0.004x^4 + 0.198x^3 - 4.053x^2 + 37.887x - 109.800$	0.002	17.2
2	$y = 0.001x + 7.671$	0.070	32.2
3	$y = -0.002x^4 - 0.021x^3 + 0.854x^2 - 13.516x + 77.233$	0.046	32.8
4	$y = -0.232x + 13.588$	0.114*	51.4
5	$y = 0.001x^4 - 0.079x^3 + 3.445x^2 - 63.029x - 417.910$	0.030	28.8
6	$y = 0.001x^5 - 0.025x^4 + 1.427x^3 - 40.003x^2 + 547.050x - 2911.00$	0.000	18.9
7	$y = 0.061x + 4.720$	0.005	39.8
8	$y = 0.001x^3 - 0.066x^2 + 1.743x - 9.7063$	0.012	1.9
The number of dicotyledonous weeds			
1	$y = -9E-0.5x^5 + 0.0116x^4 - 0.54394x^3 + 11.396x^2 - 103.06x + 327.03$	0.021	47.0
2	$y = 0.1242x + 9.837$	0.179*	53.9
3	$y = 0.0002x^4 - 0.02144x^3 + 0.8935x^2 - 13.91x + 68.708$	0.054	20.7
4	$y = 4E-0.5x^5 - 0.0063x^4 + 0.3451x^3 - 8.7894x^2 + 103.67x - 445.96$	0.015	31.7
5	$y = -0.2013x + 8.651$	0.373**	67.2
6	$y = -1.004x^3 + 0.3316x^2 - 8.538x + 73.791$	0.000	22.4
7	$y = 0.0005x^4 - 0.0067x^3 + 3.0172x^2 - 58.139x + 408.28$	0.002	17.8
8	$y = 0.0012x^3 + 0.103x^2 - 2.751x + 25.095$	0.066	7.2

<sup>a</sup>the explanations as in Table 2; \*significant at the level of  $p_{0.05}$ ; \*\* significant at the level of  $p_{0.01}$ .

In the case of potato weed control: Sencor 70 WG – 0.3 kg ha<sup>-1</sup> + Titus 25 WG – 30 g ha<sup>-1</sup> + Trend 90 EC – 0.1% - after potato emergence, a curvilinear relationship was found, 3<sup>rd</sup> degree between the fresh and the dry matter of weeds and the commercial yield of tubers (Table 8). The credibility of this equation is confirmed by quite high determination coefficients (Kranz, 1988).

Weed infestation studies carried out by Deveikyte & Seibutis (2006) showed a higher yield of sugar beet after herbicide mixtures than phenmedipham + desmedipham + ethofumesate. The authors also proved that reducing the dose of phenmedipham + desmedipham + ethofumesate and triflusaluron, chloridazon, metamiltron, chloridazon + quimerac caused an increase in dry matter of weeds by 25% but the beet yield did not decrease significantly.

Doses of tested herbicides in corn cultivation in the Auškalnienė & Auškalnis (2006) studies differentiated the weed infestation of this plant. Rimsulfuron-methyl and nicosulfuron-methyl were effective against *Echinochloa crus-galli* a primisulfuron-methyl had no effect on this weed species. Nicosulfuron – methyl and primisulfuron-methyl were effective against *Chenopodium album*, however, rimsulfuron methyl did not destroy that weed as effectively.

The dry matter of weeds proved to be the most useful indicator for determining the weight and total yield losses. Drop in the yield under the influence of dry matter of weeds growth, in the scope of standard deviation from the arithmetic mean, a most often took on the character of curvilinear, second, or third degree. These dependencies were used to calculate the tolerated weed weight. This does not cause a yield decrease. In the case of total yield, for mechanical and chemical care with the use of Sencor herbicide, it was 6 g, when applying the treatment with the use of Sencor (active substance metribuzin) +

Titus (active substance rimsulfurone) + Trend, as wetter – 72 g and in the case of marketable yield, these values were respectively: 2 g and 3 g m<sup>-2</sup>. The coefficient of determination for these dependencies postulated by (Kranz, 1988) achieved 50% level, which makes it possible to consider the accepted method as reliable.

**Table 8.** Relationships between marketable of tubers of fresh weight and dry matter of weeds

Weed control <sup>a</sup>	Regression equations	Significance level	Coefficient of determination (%)
The fresh weight of weeds			
1	$y = - 0.0012x^5 + 0.1469x^4 + 6.6463x^3 - 131.81x^2 + 13.463x - 4016.400$	0.029	25.9
2	$y = 0.0017x^5 - 0.257x^4 - 14.997x^3 + 419.600x^2 - 5601.00x + 2870.800$	0.001	19.7
3	$y = - 6.210x + 298.270$	0.344**	66.4
4	$y = - 10.68x + 545.610$	0.467**	70.7
5	$y = - 9.854x + 510.380$	0.189*	60.9
6	$y = 0.132x^3 - 11.794x^2 + 325.250x - 2510.800$	0.290**	65.3
7	$y = - 0.008x^4 + 1.071x^3 - 50.112x^2 + 1019.800x - 7425.5$	0.000	6.7
8	$y = - 3.919x + 277.310$	0.064	42.9
The dry matter of weeds			
1	$y = 0.001x^5 + 0.074x^4 + 3.310x^3 - 69.130x^2 - 666.050x - 2078.500$	0.001	31.9
2	$y = 0.001x^4 - 0.003x^3 - 0.737x^2 + 30.058x - 163.220$	0.022	16.9
3	$y = - 2.739x + 164.500$	0.345**	54.5
4	$y = - 3.879x + 172.620$	0.449**	64.9
5	$y = 0.001x^5 - 0.083x^4 + 4.563x^3 - 121.220x^2 + 1541.800x - 7385.100$	0.118*	50.2
6	$y = 0.068x^3 - 6.152x^2 + 172.360x - 1388.000$	0.371**	59.6
7	$y = - 0.303x^2 + 17.172x - 166.740$	0.007	11.2
8	$y = 0.025x^3 - 2.161x^2 + 67.357x - 507.14$	0.024	37.0

<sup>a</sup>the explanations as in Table 2; \*significant at the level of p<sub>0.05</sub>; \*\*significant at the level of p<sub>0.01</sub>.

The increase in the total number of weeds, ranging from 10 to 58 plants m<sup>-2</sup>, lowered the total and marketable yield of tubers in the experiment. The decrease in yield took a parabolic character (Tables 5 and 7). The empirical model allowed explaining 36.5% of the real total yield variability – in the case of care using Sencor + Titus + Trend and 35.4% due to Sencor + Fusilade Forte herbicides as well as 41.0% and 41.3%, respectively for the variability of marketable yield of tubers. Poddar et al., (2017) proved that all mechanical and mechanical-chemical treatments result in significantly lower efficiency than manual weed control.

In research of Zarzecka et al. (1999) an increase in weed infestation about one plant per 1 m<sup>-2</sup> resulted in a decrease in the total yield by 0.23 t and marketable yield fraction of tubers by 0.28 t ha<sup>-1</sup>; the increase in weed infestation by one ton of their dry matter per 1 ha decreased the yields by 2.6 and 3.2 t ha<sup>-1</sup>, respectively.

The polynomial regression analysis showed a significant parabolic dependence of tuber yield on the number of monocotyledonous weeds (Tables 5 and 7). Polynomial regression model explained 36.7% of the actual total yield variation for weed control using pre-emergence Sencor and only 14% when applying the Sencor + Titus + Trend



preparations mixture, whereas for the marketable yield – 32.8% and 18.9% of variability, respectively.

The increase in weed infestation with dicotyledonous weeds, ranging from 2 to 24 plants m<sup>-2</sup> contributed to a linear reduction in the total yield at the care with the use of Sencor herbicide after the emergence of the crop by 2.1 t, while the mixture of Sencor + Titus + Trend – 0.22 t ha<sup>-1</sup>. In the case of marketable yield, this reduction was recorded only due to the application of Sencor herbicide after potato emergence, which amounted to 2.0 t ha<sup>-1</sup> (Table 5 and 7). The coefficients of determination for the discussed equations were not high. This means that also other parameters, not included in the equation, may have contributed to the fall in the total and marketable yield. In addition, it should be considered that segetal vegetation is not a direct cause of this phenomenon. It makes, especially during the high rainfall in May-June period are favorable conditions for the development of *Phytophthora infestans*, as well as other fungal diseases that limit the assimilation of plants and thus prevent achieving the maximum yield of moderately early and early potato cultivars. Merga & Dechassa (2019) found significant interaction of cultivars with the use of herbicides.

## CONCLUSIONS

1. The use of herbicides in the reduction of weed infestation, especially mixtures of preparations, enabled a larger spectrum of chemical agent action and resulted in a greater efficiency of their destruction than mechanical regulation of weed infestation.

2. Mechanical care was less effective in combating the infestation than using mechanical and chemical methods of protection against weeds.

3. The dry matter of weeds proved to be the most useful indicator for determining the total and marketable yield losses. The decrease in yield under the influence of the weed dry matter has taken on a curved, second- or third-degree character.

4. The tolerated, dry matter of weeds that does not cause any yield decrease was determined. In the case of total yield, for mechanical and chemical care with the use of Sencor herbicide, it was 6 g, while for the care with preparations: Sencor + Titus + Trend – 72 g m<sup>-2</sup>.

5. A high yield-protective effect of herbicides was obtained as a result of limited competition of weeds. Mechanical treatment contributed to the increase in the total potato yield by 36.2%, and the marketable yield by 45.7%, as compared to the control object. Methods of mechanical and chemical care increased the total yield by 24.7–50% and the marketable yield by 43.7–60.8%, in relation to the control object. The greatest yield-protective effect, of both total and marketable yield, was obtained with the pre-emergence use of Sencor.

## REFERENCES

- Adamczewski, K. & Matysiak, K. 2011. *Compendium of Growth Stage Identification Keys for Mono- and Dicotyledonous Plants*. K. Adamczewski, K. Matysiak (translation and adaptation). Ed. 1, *Inst. Ochr. Roślin*, Poznań, 134 pp.
- Auškalnienė, O. & Auškalnis, A. 2006. Effect of sulfonylurea herbicides on weeds and maize. *Agronomy Research* 4(Special issue), 129–132.

- Azadbakht, A., Akbar, M.T. & Ghavidel, A. 2017. The effect of chemical and non-chemical control methods on weeds in potato (*Solanum tuberosum* L.) cultivation in Ardabil Province, Iran. *Applied Ecology and Environmental Research* **15**(4), 1359–1372.
- Arora, A., Tomar, S.S. & Gole, M.K. 2009. Yield and quality of potato as influenced by weed management practices and their residual study in soil. *Agriculture Sciences Digest* **29**(2), 39–41.
- Bleinholder, H.L., Weber, E., Buhr, L., Feller, C., Hess, M., Wicke, H., Meier U., Van Den Boom, T., Lancashire, P., Buhr, D.L., Hack, H., Klose, R. & Stauss, R. 2001. *Compendium of growth stage identification keys for mono- and dicotyledonous plants. BBCH Monograph*. 2<sup>nd</sup> ed. Edited by the Federal Center for Agricultural and Forest Biological Research Uwe Meier. <https://doi.org/10.5073/bbch0461>
- Caldiz, D.O., De Lasa, C. & Bisio, P.E. 2016. Management of Grass and Broadleaf Weeds in processing potatoes (*Solanum tuberosum* L.) with clomazone in the Argentinian Pampas. *American Journal of Plant Sciences* **7** 2339–2348. <http://dx.doi.org/10.4236/ajps.2016.716205>
- Đalovic, I., Milošević, D., Macák, M. & Týr, Š. 2008. Impact of weed control on potato infestation and yield. *Research Journal of Agricultural Science* **40**(1), 385–388.
- Deveikyte I. & Seibutis V. 2006). Broadleaf weeds and sugar beet response to phenmedipham, desmedipham, ethofumesate and triflurosulfuron-methyl. *Agronomy Research* **4**(Special issue), 159–162.
- Fernandes-Quintanilla, C., Quadranti, M., Kudsk, P. & Bärberi, P. 2008. Which future for weed science? *Weed Research* **48**, 297–301.
- Gugała, M. & Zarzecka, K. 2013. Relationship between potato yield and the degree of weed infestation. *African Journal of Agricultural Research* **8**(46), 5752–5758.
- Gugała, M., Zarzecka, K., Dołęga, H. & Sikorska, A. 2018. Weed Infestation and Yielding of Potato under Conditions of Varied Use of Herbicides and Bio-Stimulants. *J. Ecol. Eng.* **19**, 191–196.
- Hashim, S., Marwat, K.B. & Hassan, G. 2003. Chemical weed control efficiency in potato (*Solanum tuberosum* L.) under agroclimatic conditions of Peshewar. Pakistan. *Pakistan Journal Weed Science Research* **9**(1–2), 105–110.
- Hassannejad, S. & Porheidar, G.S. 2013. Effect of environmental factors on weed species distribution. *Technical Journal of Engineering and Applied Sciences* **3**(4), 355–360.
- Jones, C.A., Ciuberkis, S., Bernotas, S. & Raudonius, S. 2007. Effect of weed emergence time and intervals of weed and crop competition on potato yield. *Weed Technology* **21**(3), 612–617.
- Kranz, J. 1988. Measuring plant disease, In, *Experimental Techniques in Plant disease Epidemiology*. Kranz J, Rotem J (eds). Springer Verlag, Berlin, pp. 35–50.
- Merga, B. & Dechassa, N. 2019. Growth and productivity of different potato cultivars. *J. Agric. Sci.* **11**, 528–534.
- Mišović, M.M., Bročić, Z.A., Momirović, N.M. & Šinžar, B.C. 1997. Herbicide combination efficacy and potato yield in agro-ecological conditions of Dragacevo. *Acta Horticulturae* **462**, 363–368.
- Mondani, F., Golzardi, F., Ahmadvand, G., Ghorbani, R. & Moradi, R. 2011. Influence of weed competition on potato growth, production and radiation use efficiency. *Notulae Scientia Biologicae* **3**(3), 42–52.
- Mystkowska, I. 2018. Biostimulators as a factor affecting the yield of edible potato. *Acta Agrophys.* **25**, 307–315.
- Poddar, R., Ghosh., R.K., Bera, S. & Das, H. 2017. Yield and Nutrient Uptake of Potato as Influenced by Different Weed Management Approaches. *Indian Journal of Ecology* **44**, 95–100.

- Raudonius, S. 2017. Application of statistics in plant and crop research, important issues. *Zemdirbyste-Agriculture* **104**(4), 377–382.
- Regulation of the Minister of Agriculture and Rural Development 29, 2003 on Detailed Requirements for Commercial Quality of Potatoes, *Dz. U. 2003 No 194, item 1900*, ISAP–Internet System of Legal Acts, Warsaw, Poland, 2003, pp. 13086–13088. <http://prawo.sejm.gov.pl/isap.nsf/DocDetails.xsp> (accessed on 4 February 2020). Accessed et 03.034.2020 (in Polish).
- Roztropowicz, S. 1999. Methodology of Observation, Measurements and Sampling in Agricultural Experiments with Potatoes, *Plant Breeding and Acclimatization Institute*, Section Jadwisin, Poland, 1999, pp. 1–50 (in Polish).
- Różyło, K. & Pałys, E. 2008. Correlations between the influence and yield of potato tubers and its structure depending on fertilization systems and agronomic category of soil. *Acta Sci. Pol., Agricultura* **7**(2), 125–132.
- Sawicka, B., Barbaś, P. & Kuś, J. 2006. The influence of weed infestation of potato canopy on the total and trade yield under organic and integrated crop production systems. *Pamiętnik Puławski* **142**, 429–443 (in Polish).
- Skowera, B., Kopcińska, J., Ziernicka-Wojtaszek, A. & Wojkowski, J., 2016. Shortages and Surpluses of Rainfalls During the Growing Season of late potato in Opole Voivodeship (1981–2010) (in Polish). *Acta. Sci. Pol., Formation Circumiectus* **15**(3), 137–149. doi:10.15576/ASP.FC/2016.15.3.137
- Sharshar, A.A.H., Hassanein, E.H., Omayma, S., Mona, S.M.Y. & El-Gamal, A.M. 2015. Determination of the critical period for weed control on potato (*Solanum tuberosum* L.) crop. *Middle East Journal of Agriculture Research* **4**(2), 240–249.
- Walkowiak, R., Podsiadłowski, S. & Czajka, M. 2017. The effect of integrated tillage of light soil on potato yields. *Biometrical Letters* **54**(2), 187–201.
- WRB. 2014. *World reference database for soil resources*. <http://www.fao.org/3/a-i3794e.pdf>
- Zarzecka, K., Ceglarek, F. Gąsiorowska, B. & Gruszewska, A. 1999. Impact of weed control on potato infestation and yielding. *EJPAU* **2**(2), #07.
- Zarzecka K. 2004. Evaluation of different methods of potato weed control Part II. Relationships between weed infestation and yielding. *Acta Sci. Pol., Agricultura* **3**(2), 195–202 (in Polish).
- Zarzecka K., Gugala, M., Sikorska, A., Grzywacz, K. & Niewęglowski, M. 2020. Marketable Yield of Potato and Its Quantitative Parameters after Application of Herbicides and Biostimulants. *Agriculture* **10**(49). doi:10.3390/agriculture10020049

## The theory of vibrational wave movement in drying grain mixture

V. Bulgakov<sup>1</sup>, I. Holovach<sup>1</sup>, S. Kiurchev<sup>2</sup>, S. Pascuzzi<sup>3</sup>, M. Arak<sup>4</sup>, F. Santoro<sup>3</sup>,  
A.S. Anifantis<sup>3</sup> and J. Olt<sup>4,\*</sup>

<sup>1</sup>National University of Life and Environmental Sciences of Ukraine, 15 Heroyiv Oborony Str., Kyiv UA 03041, Ukraine

<sup>2</sup>Dmytro Motorny Tavria State Agrotechnological University, 18B Khmelnytsky Ave, UA 72310, Melitopol, Zaporozhye Region, Ukraine

<sup>3</sup>University of Bari Aldo Moro, Department of Agricultural and Environmental Science, Via Amendola, 165/A, IT70125 Bari, Italy

<sup>4</sup>Estonian University of Life Sciences, Institute of Technology, 56 Kreutzwaldi Str., EE51006 Tartu, Estonia

\*Correspondence: [jyri.olt@emu.ee](mailto:jyri.olt@emu.ee)

**Abstract.** This paper outlines a theory that involves the vibrational wave transportation of bulk grain during the course of passing that grain under an infrared radiation source, in a working thermal radiation drying chamber, and using a vibrational wave transporter belt that has been developed by the authors of this paper. The main outstanding feature of the proposed design is the presence of mechanical off-centre vibration drives which generate the vibration in the working rollers at a preset amplitude and frequency, thereby generating a mechanical wave on the surface of the flexible transporter belt which ensures the movement of bulk grain along the processing zone which itself is being subjected to infrared radiation. A calculation method was developed for the oscillation system that is used in conjunction with the vibrational transportation of the grain mass, in order to be able to determine the forces that may be present in the vibrational system and to prepare the differential calculations for the movement of the vibrational drive's actuators, utilising for this purpose Type II Lagrange equations. The solving of the aforementioned integral equations on a PC yielded a number of graphical dependencies in terms of kinetic and dynamic parameters for the vibrational system described above; the analysis of those dependencies provided a rational structural, along with kinetic and dynamic indicators. According to the results that were taken from theoretical and experimental studies on the functioning of the developed infrared grain dryer combined with a vibrational exciter, stable movement for its working roller takes place if the angular velocity of a drive shaft is changed within the range of between 50–80  $\text{rads}^{-1}$ , whereas the amplitude of the indicated oscillations falls within the range of 3.0–4.0 mm. It has been discovered that a rational speed when transporting soy seeds during infrared drying falls between the range of between 0.15–0.60  $\text{cm s}^{-1}$ , whereas the amplitude of the indicated oscillations falls within the range of 3.0–4.0 mm. An increase of this parameter within the stated limits increases the time that it takes to achieve the stage in which a constant drying soy speed is reached by more than 2.5 times (from 205 seconds to 520 seconds), stabilising the figure at a level of 520 seconds, which makes it possible to recommend a range of transport speeds of between 0.15–0.40  $\text{cm s}^{-1}$  under infrared radiation for the seeds in order to achieve the required moisture content with a single pass of the produce on the wave transporter.

With that in mind, the power consumption levels for the vibrational exciter do not exceed 50W, while the angular velocity of the drive shaft's rotation falls within the range of between 100–120  $\text{rads}^{-1}$ . The results of the experimental study that has been conducted indicated that a rational transportation speed for the soy seeds on the wave transporter under infrared radiation is between 0.15–0.40  $\text{cm s}^{-1}$

**Key words:** drying, grain, kinetic and dynamic parameters, model, quality, transportation.

## INTRODUCTION

The drying of cereal and oil crop seeds holds an important place in the technology that covers their processing and storage. The use of high-performance grain dryers significantly shortens the time needed to prepare the seeds for long-term storage, while also reducing losses, and creating the necessary conditions for further processing.

On the other hand, the preparation of seeds for long-term storage and subsequent sowing requires significant consumption of heat and mechanical energy. There are currently a good many different designs of dryer in use.

The convective dryer, which is widely used worldwide, has significant shortcomings, such as the fact that the evaporation of moisture from the material that is being processed takes place rather slowly. Drying by means of thermal radiation (under an infrared radiator) eliminates that shortcoming thanks to its ensuring the coincidence of the heat beam's gradient and the material's moisture content which, together with the high energy absorption levels, makes sure this process has one of the best outcomes of all of the methods to be used when intensifying the bulk's heat transfer.

The only limitation in drying by means of thermal radiation is the transparency of the layer of seeds for the infrared radiation, ie. the radiation must penetrate the entire layer, for which purpose the layer's thickness must not exceed a depth of 15mm.

The best method for ensuring the necessary layer thickness of the material that is being dried and its movement along the working area is the use of vibrating technology in the course of the drying process.

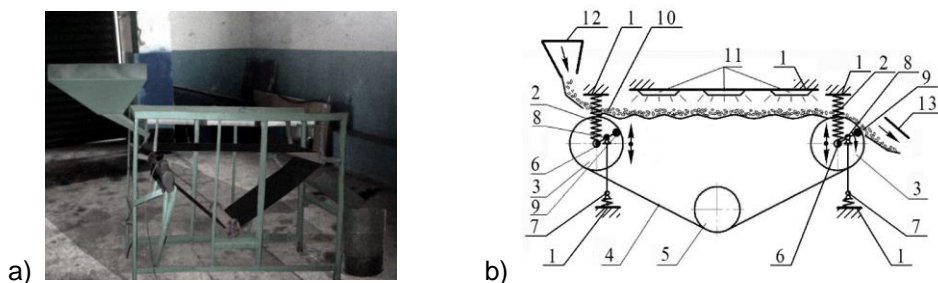
But, in our opinion, the best outlook is displayed by thermal radiation dryers with infrared technology, as used in the process of drying grain and seed material. And yet the bulk grain needs to be moving along the drying chamber's working area while it undergoes the process of infrared irradiation of the bulk.

The drying of agricultural materials, in particular grain, requires constant transportation. Therefore the use of belt, conveyor, screw, or other types of transporter is not entirely suitable. Upon ordinary transportation, bulk grain does not become mixed; in addition, such transporters need more metal and energy to make and operate.

Therefore, nowadays the method used in vibrational transportation is also widely used in the transportation of various bulk materials while drying them. There are a number of vibrational transporter designs in use for this purpose, all of which ensure the effective vibrational transportation of bulk grain. For example, in machines which employ a process of constant vibration, a vibrating belt conveyor is used as the transportation element of the design, providing for guaranteed movement of the bulk material. Despite this popularity, all of the aforementioned designs of vibration equipment have significant shortcomings.

Therefore, we have developed a thermal radiation dryer which employs a somewhat novel design, one which uses a vibrational wave transporter belt that moves the bulk grain through the drying chamber's working area in which infrared irradiation and therefore the drying of the bulk grain all takes place. It must be noted that the belt conveyor itself remains stationary (not performing a translational movement); the bulk material is shifted only by a mechanical wave that is generated along its elastic belt by means of vibrational exciters.

Figure 1 provides an overall view of the developed thermal radiation dryer and its novel design which uses a vibrational wave transporter belt (a), and a diagram of its technological design (b).



**Figure 1.** Infrared dryer with a vibrational wave transporter belt: a – overall view; b – technological diagram: 1 – frame; 2 – elastic elements; 3 – rollers; 4 – elastic belt; 5 – tensioning cylinder; 6 – roller axes; 7 – vibration dampers; 8 – off-centre drive shafts; 9 – counterweights; 10 – bulk grain; 11 – infrared radiator; 12 – feeder; 13 – receiving hopper.

The main benefits in using this dryer are its simple design, reliable functioning, and low energy consumption for its operation.

The infrared dryer with its vibrational wave transporter belt has the following design features: the frame (1) houses two vibrational exciters in the form of rollers (3) which are installed onto shafts (6) that are connected to the frame (1) via elastic elements (2). These two rollers (3), installed at the same level as each other, are surrounded by an elastic belt (4). The elastic belt has a horizontal section at the top, between two rollers (3), and a tensioning cylinder (5) at the bottom; the cylinder pulls the belt down under gravity due to its own weight, thereby generating preliminary tensioning in the horizontal top part of the belt.

The insides of the rollers (3) are penetrated by the off-centre drive shafts (8), which have attached counterweights (9) on the outside of one of the side elements of the rollers. The off-centre drive shafts are installed on the frame with the aid of vibration dampers (7). This way, the off-centre drive shafts are connected to the frame via the vibration dampers at the bottom and to the frame via axes (6) and elastic elements (2) at the top. The counterweights (9) offset the inertial forces emerging while the rollers work. Upon the off-centre drive shafts (8) within the rotating rollers, each shaft (3) produces vibrational movement that, if certain parameters have been selected regarding frequency and amplitude, makes it possible for each roller to generate a dynamic wave on the surface of the elastic belt (4) (in the form either of a standing or running wave). This makes it possible to transport the seed bulk (10), but also to mix its layers, and to dry the seed bulk in the working area of the infrared radiator (11). Moreover, when varying the

vibration parameters of the two vibrational exciters in the form of the rollers, the speed of movement of the seed bulk that is coming from the feeder (12) in the working area and the intensity of its mixing can both be changed. Thereafter, the dried seed bulk (10) is moved via vibrational waves into the receiving hopper (13) at the transporter's other end.

In this way, when employing vibrational wave transportation for seed bulk, the bulk is also loosened due to the forces being applied to it by means of their alternating directions, leading to a decrease in the bulk's internal friction and viscosity, as well as to its uniform thermal treatment.

The infrared dryer that has been developed for bulk grain, using a vibrational transporter, is a combination of a belt transporter (without the translational movement of the transporter belt) and a vibration machine with a combined kinetic manner in which it is able to generate oscillations. It establishes the conditions for constant movement and the simultaneous infrared treatment of the continually-fed seed bulk, ensuring its loosened state and guaranteed its drying. This is accompanied by a reduction of the oscillating mass of the vibration drive.

By means of this method - using the equipment that has been developed and which is now being proposed by us - with its two vibrational exciters, it becomes possible to reduce the oscillating mass of the entire drive and provides the levelling of any unwanted oscillations by means of the incorporated flexible elements. This type of design for a drive unit, together with a wave transporter with a deforming transportation element, makes it possible to provide a significantly improved system for balancing the dryer's vibrational drive.

Therefore the implementation of the proposed design for a vibrational dryer with its kinetic method of providing vibrational excitation provides a significantly increased intensive process for removing free and physically-bound moisture from the fed seed bulk on account of having creating a pseudo-levitating state of the material that is being processed, and also makes it possible to ensure lower stress levels in the equipment and lower costs, as well as ensuring the conditions for the effective balancing of the oscillation system.

An analysis of various methods being used in the process of drying cereal and oil crops is provided in previous papers (Boyce, 1965; Safarov, 1991; Bruce & Giner, 1993; Malin, 2005; Moroz et al., 2011; Aboltins & Upitis, 2012; Hemis et al., 2012; Rudobashta et al., 2016; Gilmore et al., 2019; Giner, 2019; Kliuchnikov, 2019; Rugovskii et al., 2019), where the basis for classifying these methods is the one that involves the transferral of heat to the material that is being dried. The convective dryer, which is widely used worldwide, has significant shortcomings, such as the fact that the evaporation of moisture from the material that is being processed happens rather slowly. Drying by means of thermal radiation (under an infrared radiator) eliminates that shortcoming thanks to its ensuring the coincidence of the heat beam's gradient and the material's moisture content which, together with the high energy absorption levels, makes sure this process has one of the best outcomes of all of the methods to be used when intensifying the bulk's heat transfer.

The method used in drying plant materials utilising short-wave infrared radiation is presented in previous papers (Filonenko & Grishin, 1971; Bezbakh & Bakhmutyan, 2006). The only limitation in drying by means of thermal radiation is the transparency of the layer of seeds for the infrared radiation, ie. the radiation must penetrate the entire layer, for which purposes the layer's thickness must not exceed a depth of 15mm.

The best method for ensuring the necessary layer thickness of the material that is being dried and its movement along the working area is the use of vibrating technology in the course of the drying process.

The problem of creating a high-performance drying unit is discussed in previous papers (Goncharevich & Frolov, 1981; Grochowski et al., 2004; El Hor et al., 2005; Palamarchuk et al., 2018), which present the mathematical model for the drying processes, along with the results of experimental studies, the design diagrams for wave-based and vibrational transportation equipment, and proof that one of the most effective methods of intensifying the processes that have been studied is the use of a vibrational field.

The goal of the paper is to increase the productivity and quality in terms of drying the grain and seeds of various crops by means of developing and scientifically reasoning out the rational parameters of a new type of thermal radiation dryer.

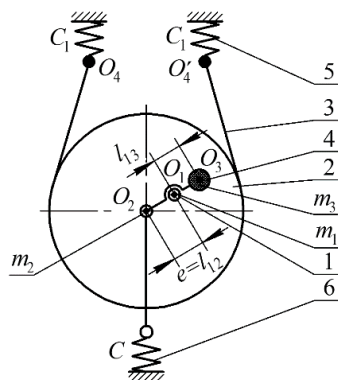
### MATERIALS AND METHODS

For a theoretical description of the vibrational wave-based movement of bulk grain in the dryer that has been developed by us, it is first necessary to discuss the functioning of the kinetic vibrational exciter which serves to generate the oscillations in an elastic belt, and which effects the process of wave-based movement in the bulk grain that is fed onto it from one end.

First of all, based on the technological design diagram for the thermal radiation dryer with its vibrational transporter belt (Fig. 1), and on the description of its functioning that has been provided above, it is necessary to develop a calculation diagram for the kinetic vibrational exciter that is to be used with the elastic transporter belt's oscillations in its initial position (in a balanced state) and, thereafter, in any of its working positions, i.e. when offsetting the work roller's centre of mass from its balanced state. The relevant calculation diagrams are presented in Figs 2 and 3.

The diagram in Fig. 2 indicates these parameters for the oscillating system:  $m_1$  – is the drive shaft's mass;  $m_2$  – is the roller's mass;  $m_3$  – is the counterweight's mass;  $C_1$  – is the elastic support's rigidity levels;  $C$  – is the vibration damper's rigidity levels;  $e$  – the offset from centre, which is defined by distance  $l_{12} = O_1O_2$ ;  $l_{13} = O_1O_3$  – the distance from a drive shaft (point  $O_1$ ) to a counterweight's axis (point  $O_3$ ).

For further study of the movement of the oscillating system being discussed, we shall establish an equivalent diagram which indicates the offset for a roller's centre of mass from the balanced state when carrying out

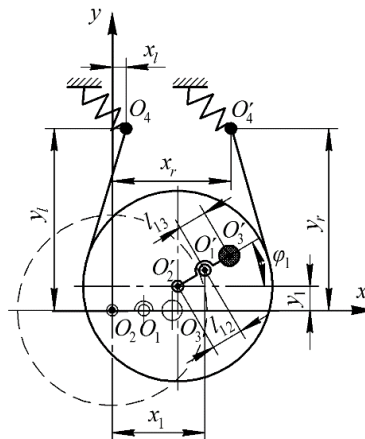


**Figure 2.** Initial position of the oscillating system: 1 – the vibrational exciter's drive shaft; 2 – roller; 3 – elastic band; 4 – counterweight; 5 – elastic support; 6 – vibration damper.



any oscillating movements. For this purpose, we shall select and display on the equivalent diagram a fixed Cartesian coordinate system  $O_2xy$ , the starting point of which is  $O_2$  which is located at the roller's centre (in its initial position), while the axis  $O_2x$  is directed horizontally towards the right, and the axis  $O_2y$  is directed vertically towards the upwards position.

The equivalent diagram in Fig. 3 displays the following indicators:  $x_1$  – linear horizontal offset for a drive shaft's centre of mass from the balance position;  $y_1$  – linear vertical offset for a drive shaft's centre of mass from the balance position;  $\varphi_1$  – angle of rotation for the vibrational exciter's drive shaft from the balance position;  $x_i, y_i$  – coordinates for point  $O_4$  when attaching the left-hand end of the belt to the left-hand elastic support in a random position;  $x_r, y_r$  – coordinates for point  $O'_4$  when attaching the right-hand end of the belt to the right-hand elastic support in a random position.



**Figure 3.** An equivalent diagram for the oscillating system in which the roller's centre of mass is offset from the balance position.

Furthermore, we shall create the differential equations for the movement of the oscillating system being discussed, utilising Type II Lagrange equations for this very purpose.

Within this context it has to be noted that the aforementioned oscillating system is characterised by three degrees of freedom: the linear shifts  $x_1, y_1$  of a drive shaft's centre of mass (point  $O_1$ ) in relation to the axes of the coordinates  $O_2x$  and  $O_2y$ , respectively, and the rotational angle  $\varphi_1$  of the vibrational exciter's drive shaft (measured from the balance position).

## RESULTS AND DISCUSSION

It must also be noted that the oscillating system incorporates three masses:  $m_1$  – a drive shaft's mass;  $m_2$  – a roller's mass;  $m_3$  – a counterweight's mass.

To be able to establish the differential equations of movement by means of the aforementioned method, we shall first determine the kinetic energy of the oscillating system.

It is evident that the summary kinetic energy  $T$  of the oscillating system equals:

$$T = T_1 + T_2 + T_3, \tag{1}$$

where  $T_1$  – is the kinetic energy of the translational movement of a drive shaft;  $T_2$  – is the kinetic energy of the parallel plane movement of a roller;  $T_3$  – is the kinetic energy of the parallel plane movement of a counterweight.

Within that context, the kinetic energy  $T_1$  equals:

$$T_1 = \frac{m_1 V_1^2}{2}, \quad (2)$$

where  $m_1$  – is a drive shaft’s mass;  $V_1$  – is a drive shaft’s translational movement’s speed.

The kinetic energy  $T_2$  of a roller’s parallel plane movement is determined as the kinetic energy of the module  $O_1O_2$ , namely:

$$T_2 = \frac{m_2 V_2^2}{2} + \frac{I_2 \omega_1^2}{2}, \quad (3)$$

where  $m_2$  – is the mass of a roller (module  $O_1O_2$ );  $V_2$  – is the speed of the translational movement of a roller (module  $O_1O_2$ );  $\omega_1$  – is the angular velocity of a drive shaft;  $I_2$  – is the moment of inertia in a roller (module  $O_1O_2$ ) in relation to the point  $O_1$ .

The kinetic energy  $T_3$  is determined as the kinetic energy of the module  $O_1O_3$  in its parallel plane of movement:

$$T_3 = \frac{m_3 V_3^2}{2} + \frac{I_3 \omega_1^2}{2}, \quad (4)$$

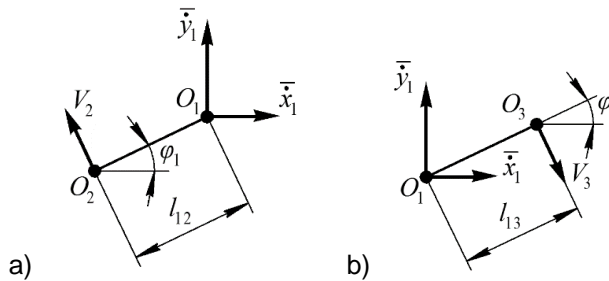
where  $m_3$  – is the mass of a counterweight (module  $O_1O_3$ );  $V_3$  – is the translational movement’s speed of a counterweight (module  $O_1O_3$ );  $\omega_1$  – is the angular velocity of a drive shaft;  $I_3$  – is the moment of inertia of a counterweight (module  $O_1O_3$ ) in relation to the point  $O_1$ .

Furthermore, we shall determine the kinetic characteristics (linear and angular velocities) of the points and modules of the moving masses  $m_1$ ,  $m_2$  and  $m_3$ .

It is evident that, within the coordinate system of  $O_2xy$ , the square of speed  $V_1$  is:

$$V_1^2 = \dot{x}_1^2 + \dot{y}_1^2 \quad (5)$$

To determine the speeds  $V_2$  and  $V_3$ , we shall establish calculation diagrams for the modules  $O_1O_2$  and  $O_1O_3$ , making parallel plane movements. These calculation diagrams are provided in Fig. 4.



**Figure 4.** Calculation diagrams to determine the speeds of the oscillating system’s modules: a) module  $O_1O_2$ ; b) module  $O_1O_3$ .

As the provided calculation diagrams indicate, the following expressions are yielded for the speed  $V_2$ . The vector form of this is:

$$\vec{V}_2 = \vec{V}_1 + \vec{V}_{21} \quad (6)$$

Considering that the value of the speed  $V_{21}$  equals:

$$V_{21} = l_{12} \cdot \dot{\varphi}_1 \quad (7)$$

and after a number of translations, we get to the following:

$$V_2^2 = V_1^2 + 2l_{12} \cdot \dot{\varphi}_1 (0.5 \cdot l_{12} \cdot \dot{\varphi}_1 - \dot{x}_1 \cos \varphi_1 - \dot{y}_1 \sin \varphi_1) \quad (8)$$

Similarly, from the calculation diagram in Fig. 4, the expression for the speed  $V_3$  is ultimately:

$$V_3^2 = V_1^2 + 2l_{13} \cdot \dot{\varphi}_1 (0.5 \cdot l_{13} \cdot \dot{\varphi}_1 + \dot{x}_1 \cos \varphi_1 + \dot{y}_1 \sin \varphi_1) \quad (9)$$

Furthermore, we shall determine the moments of inertias  $I_1$  and  $I_2$  of the modules  $O_1O_2$  and  $O_1O_3$ , in relation to a drive shaft's axis (point  $O_1$ ), which are, respectively:

$$I_2 = m_2 \cdot l_{12}^2 \quad (10)$$

$$I_3 = m_3 \cdot l_{13}^2 \quad (11)$$

Inserting the expressions (5), (8) – (11) into the expressions (2), (3), (4), we get the following expressions for the relevant kinetic energies:

$$T_1 = \frac{m_1 (\dot{x}_1^2 + \dot{y}_1^2)}{2} \quad (12)$$

$$T_2 = \frac{m_2}{2} [\dot{x}_1^2 + \dot{y}_1^2 + 2l_{12} \cdot \dot{\varphi}_1 (0.5l_{12} \cdot \dot{\varphi}_1 - \dot{x}_1 \cos \varphi_1 - \dot{y}_1 \sin \varphi_1)], \quad (13)$$

and

$$T_3 = \frac{m_3}{2} [\dot{x}_1^2 + \dot{y}_1^2 + 2l_{13} \cdot \dot{\varphi}_1 (0.5l_{13} \cdot \dot{\varphi}_1 + \dot{x}_1 \cos \varphi_1 + \dot{y}_1 \sin \varphi_1)]. \quad (14)$$

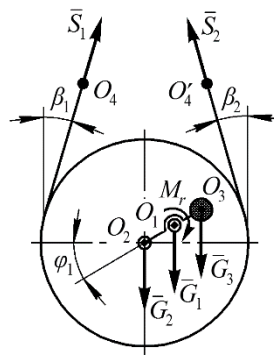
Inserting the expressions (12), (13) and (14) into the expression (1), we get the expression for determining the summary kinetic energy of the oscillating system:

$$T = 0.5 \cdot (m_1 + m_2 + m_3) \cdot (\dot{x}_1^2 + \dot{y}_1^2) + m_2 \cdot l_{12} \cdot \dot{\varphi}_1 (0.5 \cdot l_{12} \cdot \dot{\varphi}_1 - \dot{x}_1 \cos \varphi_1 - \dot{y}_1 \sin \varphi_1) + m_3 \cdot l_{13} \cdot \dot{\varphi}_1 (0.5 \cdot l_{13} \cdot \dot{\varphi}_1 + \dot{x}_1 \cos \varphi_1 + \dot{y}_1 \sin \varphi_1) + 0.5 (m_2 \cdot l_{12}^2 + m_3 \cdot l_{13}^2) \cdot \dot{\varphi}_1^2. \quad (15)$$

To determine the generalised forces that are included on the right-hand side of the Type II Lagrange equation, it is necessary to establish an equivalent diagram of forces for the oscillating system that is being studied (Fig. 5).

This equivalent diagram indicates the following forces and inertias:

- $\bar{G}_1$  – the force of a drive shaft's weight;
- $\bar{G}_2$  – the force of a working roller's weight;
- $\bar{G}_3$  – the force of a counterweight's weight;
- $\bar{S}_1$  – the tensioning force of the elastic belt's left-hand section;
- $\bar{S}_2$  – the tensioning force of the elastic belt's right-hand section;
- $\bar{M}_T$  – the torque moment in a drive shaft.



**Figure 5.** An equivalent diagram of forces in the oscillating system that is being studied.

Additionally, the diagram indicates:

$\varphi_1$  – the turning angle of a drive shaft;

$\beta_1$  – the angle between the elastic belt's left-hand section and the vertical;

$\beta_2$  – the angle between the elastic belt's right-hand section and the vertical.

Furthermore, we shall enter the expression that will be used to determine all forces and moments indicated into the equivalent diagram of Fig. 5:

$$G_1 = m_1 \cdot g, \quad (16)$$

where  $m_1$  – a drive shaft's mass;  $g$  – gravitational acceleration;

$$G_2 = m_2 \cdot g, \quad (17)$$

where  $m_2$  – is a roller's mass;

$$G_3 = m_3 \cdot g, \quad (18)$$

where  $m_3$  – is a counterweight's mass.

The belt's tensioning forces  $S_1$  and  $S_2$  are equivalent to the elastic forces occurring upon the deformation of the elastic elements; therefore we shall determine them as follows:

$$S_1 = C_1 \cdot \Delta l_1 \quad (19)$$

$$S_2 = C_1 \cdot \Delta l_2 \quad (20)$$

where  $C_1$  – is an elastic support's levels of 'hardness';  $\Delta l_1$  and  $\Delta l_2$  – is the linear deformations of the left-hand and right-hand elastic support respectively.

The deformations  $\Delta l_1$  and  $\Delta l_2$  in the elastic elements are determined on the basis of a geometric analysis in the oscillating system.

As a result:

$$S_1 = C_1 \left( \sqrt{(x_l - x_l - l_{12} \cdot \sin \varphi_1)^2 + (y_l - y_l - l_{12} \cdot \cos \varphi_1)^2 - R^2} - \sqrt{x_l^2 + y_l^2 - R^2} \right), \quad (21)$$

and

$$S_2 = C_1 \left( \sqrt{(x_r - x_l + l_{12} \cdot \sin \varphi_1)^2 + (y_r - y_l - l_{12} \cdot \cos \varphi_1)^2 - R^2} - \sqrt{x_r^2 + y_r^2 - R^2} \right), \quad (22)$$

where  $R$  – is a roller's radius.

Next we shall determine the generalised forces in the oscillating system, corresponding to each of the independent generalised coordinates.

For the generalised coordinate  $\varphi_1$ , the generalised force  $Q_{\varphi_1}$  is equal to the arithmetic sum of the moments of all forces in relation to the point  $O_1$ , namely:

$$Q_{\varphi_1} = M_r - (G_2 \cdot l_{12} - G_3 \cdot l_{13}) \cos \varphi_1 + S_1 (R + l_{12}) \cdot \sin(\varphi_1 + \beta_1) - S_2 (R + l_{12}) \cdot \sin(\varphi_1 - \beta_1). \quad (23)$$

For the generalised coordinate  $x_1$ , the generalised force  $Q_{x_1}$  is equal to the arithmetic sum of the projections of all forces indicated in Fig. 5 on the axis  $O_2x$ , namely:

$$Q_{x_1} = S_1 \cdot \sin \beta_1 - S_2 \cdot \sin \beta_2 - C_x \cdot x_1 \quad (24)$$

where  $C_x$  – is a vibration damper's hardness in the direction of the axis  $O_2x$ , and  $x_1$  – is a vibration damper's linear deformation in the direction of the axis  $O_2x$ .

For the generalised coordinate  $y_1$ , the generalised force  $Q_{y_1}$  is equal to the arithmetic sum of the projections of all forces indicated in Fig. 5 on the axis  $O_2y$ , namely:

$$Q_{y_1} = S_1 \cdot \cos \beta_1 + S_2 \cdot \cos \beta_2 - C_y (y_1 - \delta_{st}) - G_1 - G_2 - G_3 \quad (25)$$

where  $C_y$  – is a vibration damper’s levels of ‘hardness’ in the direction of the axis  $O_2y$ ;  $y_1$  – is a vibration damper’s linear deformation in the direction of the axis  $O_2y$ ; and  $\delta_{st}$  – is a vibration damper’s static deformation.

In this way, the generalised forces are determined for each generalised coordinate of this oscillating system.

In addition, we shall determine the necessary partial differentiations of the kinetic energy  $T$  in this oscillating system which corresponds to the conditions that are contained in the left-hand sections of the Type II Lagrange equations. We get the following expression for the partial differentiation of the generalised coordinate  $\phi_1$ :

$$\begin{aligned} \frac{\partial T}{\partial \dot{\phi}_1} = & m_2 \cdot l_{12} (0.5 \cdot l_{12} \cdot \dot{\phi}_1 - \dot{x}_1 \cdot \cos \varphi_1 - \dot{y}_1 \cdot \sin \varphi_1) + \\ & + 0.5 \cdot m_2 \cdot l_{12}^2 \cdot \dot{\phi}_1 + m_3 \cdot l_{13} (0.5 \cdot l_{13} \cdot \dot{\phi}_1 + \dot{x}_1 \cdot \cos \varphi_1 + \dot{y}_1 \cdot \sin \varphi_1) + \\ & + 0.5 \cdot m_3 \cdot l_{13}^2 \cdot \dot{\phi}_1 + (m_2 \cdot l_{12}^2 + m_3 \cdot l_{13}^2) \cdot \dot{\phi}_1 ; \end{aligned} \quad (26)$$

also:

$$\begin{aligned} \frac{d}{dt} \left( \frac{\partial T}{\partial \dot{\phi}_1} \right) = & m_2 \cdot l_{12} (0.5 \cdot l_{12} \cdot \ddot{\phi}_1 - \ddot{x}_1 \cdot \cos \varphi_1 + \dot{x}_1 \cdot \sin \varphi_1 \cdot \dot{\phi}_1 - \\ & - \ddot{y}_1 \cdot \sin \varphi_1 - \dot{y}_1 \cdot \cos \varphi_1 \cdot \dot{\phi}_1) + 0.5 \cdot m_2 \cdot l_{12}^2 \cdot \ddot{\phi}_1 + \\ & + m_3 \cdot l_{13} (0.5 \cdot l_{13} \cdot \ddot{\phi}_1 + \ddot{x}_1 \cdot \cos \varphi_1 - \dot{x}_1 \cdot \sin \varphi_1 \cdot \dot{\phi}_1 + \\ & + \ddot{y}_1 \cdot \sin \varphi_1 + \dot{y}_1 \cdot \cos \varphi_1 \cdot \dot{\phi}_1) + 0.5 \cdot m_3 \cdot l_{13}^2 \cdot \ddot{\phi}_1 + (m_2 \cdot l_{12}^2 + m_3 \cdot l_{13}^2) \cdot \ddot{\phi}_1 = \\ = & 0.5 \cdot m_2 \cdot l_{12}^2 \cdot \ddot{\phi} + m_2 \cdot l_{12} (-\ddot{x}_1 \cdot \cos \varphi_1 + \dot{x}_1 \cdot \sin \varphi_1 \cdot \dot{\phi}_1 - \\ & - \ddot{y}_1 \cdot \sin \varphi_1 - \dot{y}_1 \cdot \cos \varphi_1 \cdot \dot{\phi}_1) + 0.5 \cdot m_2 \cdot l_{12}^2 \cdot \ddot{\phi} + \\ & + 0.5 \cdot m_3 \cdot l_{13}^2 \cdot \ddot{\phi} + m_3 \cdot l_{13} (\ddot{x}_1 \cdot \cos \varphi_1 - \dot{x}_1 \cdot \sin \varphi_1 \cdot \dot{\phi}_1 + \ddot{y}_1 \cdot \sin \varphi_1 + \\ & + \dot{y}_1 \cdot \cos \varphi_1 \cdot \dot{\phi}_1) + 0.5 \cdot m_3 \cdot l_{13}^2 \cdot \ddot{\phi} + (m_2 \cdot l_{12}^2 + m_3 \cdot l_{13}^2) \cdot \ddot{\phi} = \\ = & 2(m_2 \cdot l_{12}^2 + m_3 \cdot l_{13}^2) \cdot \ddot{\phi} + m_2 \cdot l_{12} (-\ddot{x}_1 \cdot \cos \varphi_1 + \dot{x}_1 \cdot \sin \varphi_1 \cdot \dot{\phi}_1 - \\ & - \ddot{y}_1 \cdot \sin \varphi_1 - \dot{y}_1 \cdot \cos \varphi_1 \cdot \dot{\phi}_1) + m_3 \cdot l_{13} (\ddot{x}_1 \cdot \cos \varphi_1 + \dot{x}_1 \cdot \sin \varphi_1 \cdot \dot{\phi}_1 + \\ & + \ddot{y}_1 \cdot \sin \varphi_1 + \dot{y}_1 \cdot \cos \varphi_1 \cdot \dot{\phi}_1). \end{aligned} \quad (27)$$

The partial differentiation of the kinetic energy of the generalised coordinate  $\varphi_1$  is:

$$\begin{aligned} \frac{\partial T}{\partial \varphi_1} = & m_2 \cdot l_{12} \cdot \dot{\phi}_1 (\dot{x}_1 \cdot \sin \varphi_1 - \dot{y}_1 \cdot \cos \varphi_1) + \\ & + m_3 \cdot l_{13} \cdot \dot{\phi}_1 (-\dot{x}_1 \cdot \sin \varphi_1 + \dot{y}_1 \cdot \cos \varphi_1). \end{aligned} \quad (28)$$

For the generalised coordinate  $x$ , we get the following expressions of partial differentiations in the oscillating system’s kinetic energy  $T$ :

$$\frac{\partial T}{\partial \dot{x}_1} = (m_1 + m_2 + m_3) \cdot \dot{x}_1 - m_2 \cdot l_{12} \cdot \dot{\varphi}_1 \cdot \cos \varphi_1 + m_3 \cdot l_{13} \cdot \dot{\varphi}_1 \cos \varphi_1 \quad (29)$$

also:

$$\begin{aligned} \frac{d}{dt} \left( \frac{\partial T}{\partial \dot{x}_1} \right) &= (m_1 + m_2 + m_3) \cdot \ddot{x}_1 - m_2 \cdot l_{12} \cdot \ddot{\varphi}_1 \cdot \cos \varphi_1 + \\ &+ m_2 \cdot l_{12} \cdot \sin \varphi_1 \cdot \dot{\varphi}_1^2 + m_3 \cdot l_{13} \cdot \ddot{\varphi}_1 \cdot \cos \varphi_1 - m_3 \cdot l_{13} \cdot \dot{\varphi}_1^2 \cdot \sin \varphi_1 ; \end{aligned} \quad (30)$$

and finally:

$$\frac{\partial T}{\partial x_1} = 0 \quad (31)$$

For the generalised coordinate  $y_1$ , we get the following expressions of partial differentiations in the kinetic energy  $T$ :

$$\frac{\partial T}{\partial \dot{y}_1} = (m_1 + m_2 + m_3) \cdot \dot{y}_1 - m_2 \cdot l_{12} \cdot \dot{\varphi}_1 \cdot \sin \varphi_1 + m_3 \cdot l_{13} \cdot \dot{\varphi}_1 \sin \varphi_1 \quad (32)$$

also:

$$\begin{aligned} \frac{d}{dt} \left( \frac{\partial T}{\partial \dot{y}_1} \right) &= (m_1 + m_2 + m_3) \cdot \ddot{y}_1 - m_2 \cdot l_{12} \cdot \ddot{\varphi}_1 \cdot \sin \varphi_1 - \\ &- m_2 \cdot l_{12} \cdot \cos \varphi_1 \cdot \dot{\varphi}_1^2 + m_3 \cdot l_{13} \cdot \ddot{\varphi}_1 \cdot \sin \varphi_1 + m_3 \cdot l_{13} \cdot \dot{\varphi}_1^2 \cdot \cos \varphi_1 ; \end{aligned} \quad (33)$$

and finally:

$$\frac{\partial T}{\partial y_1} = 0 ; \quad (34)$$

When inserting the resulting expressions (23), (24), (25), (27), (28), (30), (31), (33) and (34) into the initial Type II Lagrange equation for each generalised coordinate and performing the required translations, we get the following system of differential equations for the oscillating system's movement:

$$\left. \begin{aligned} &2 \left( m_2 \cdot l_{12}^2 + m_3 \cdot l_{13}^2 \right) \ddot{\varphi} = -m_2 \cdot l_{12} \left( -\ddot{x}_1 \cdot \cos \varphi_1 + \dot{x}_1 \cdot \sin \varphi_1 \cdot \dot{\varphi}_1 - \right. \\ &- \ddot{y}_1 \cdot \sin \varphi_1 - \dot{y}_1 \cdot \cos \varphi_1 \cdot \dot{\varphi}_1 \left. \right) - m_3 \cdot l_{13} \left( \ddot{x}_1 \cdot \cos \varphi_1 - \dot{x}_1 \cdot \sin \varphi_1 \cdot \dot{\varphi}_1 + \right. \\ &+ \ddot{y}_1 \cdot \sin \varphi_1 + \dot{y}_1 \cdot \cos \varphi_1 \cdot \dot{\varphi}_1 \left. \right) + m_2 \cdot l_{12} \cdot \dot{\varphi}_1 \left( \dot{x}_1 \cdot \sin \varphi_1 - \dot{y}_1 \cdot \cos \varphi_1 \right) + \\ &+ m_3 \cdot l_{13} \cdot \dot{\varphi}_1 \left( -\dot{x}_1 \cdot \sin \varphi_1 + \dot{y}_1 \cdot \cos \varphi_1 \right) + M_r - \left( m_2 \cdot l_{12} - \right. \\ &- m_3 \cdot l_{13} \left. \right) \cdot g \cdot \cos \varphi_1 + S_1 \left( R + l_{12} \right) \cdot \sin \left( \varphi_1 + \beta_1 \right) - S_2 \left( R + l_{12} \right) \cdot \sin \left( \varphi_1 - \beta_1 \right), \\ &\left( m_1 + m_2 + m_3 \right) \ddot{x}_1 = m_2 \cdot l_{12} \cdot \ddot{\varphi}_1 \cdot \cos \varphi_1 - m_2 \cdot l_{12} \cdot \sin \varphi_1 \cdot \dot{\varphi}_1^2 - \\ &- m_3 \cdot l_{13} \cdot \ddot{\varphi}_1 \cdot \cos \varphi_1 + m_3 \cdot l_{13} \cdot \sin \varphi_1 \cdot \dot{\varphi}_1^2 + S_1 \cdot \sin \beta_1 - S_2 \cdot \sin \beta_2 - C_x \cdot x_1, \\ &\left( m_1 + m_2 + m_3 \right) \ddot{y}_1 = m_2 \cdot l_{12} \cdot \ddot{\varphi}_1 \cdot \sin \varphi_1 + m_2 \cdot l_{12} \cdot \cos \varphi_1 \cdot \dot{\varphi}_1^2 - \\ &- m_3 \cdot l_{13} \cdot \ddot{\varphi}_1 \cdot \sin \varphi_1 - m_3 \cdot l_{13} \cdot \cos \varphi_1 \cdot \dot{\varphi}_1^2 + S_1 \cdot \cos \beta_1 + S_2 \cdot \cos \beta_2 - \\ &- C_y \left( y_1 - \delta_{st} \right) - \left( m_1 + m_2 + m_3 \right) g . \end{aligned} \right\} \quad (35)$$

This system of differential equations (35) is one that involves non-linear differential equations of Type II, and can be solved using digital methods on a PC such as, for example, with the MathCAD software.

The initial conditions for the system of differential equations are as follows:  
If  $t = 0$ :

$$x_{10} = l_{12}, \quad y_0 = 0, \quad \dot{x}_{10} = 0, \quad \dot{y}_{10} = 0, \quad \text{and} \quad \varphi_{10} = 0 \quad (36)$$

For digital calculations in the MathCAD software, the following values were set up for the constant parameters that were included in the system for differential equations (35). Based on the calculations that have been recorded during the design and subsequent manufacture of the experimental specimen of the infrared dryer, but also based on the results of testing and redesigning the dryer, the following values have been taken for constant parameters:

- a drive shaft’s mass  $m_1 = 5.4$  kg;
- a roller’s mass  $m_2 = 6.2$ kg;
- a counterweight’s mass  $m_3 = 1.2$  kg;
- the distance from a drive shaft’s axis to a roller’s axis (the offset rate)

$$l_{12} = 0.003\text{m};$$

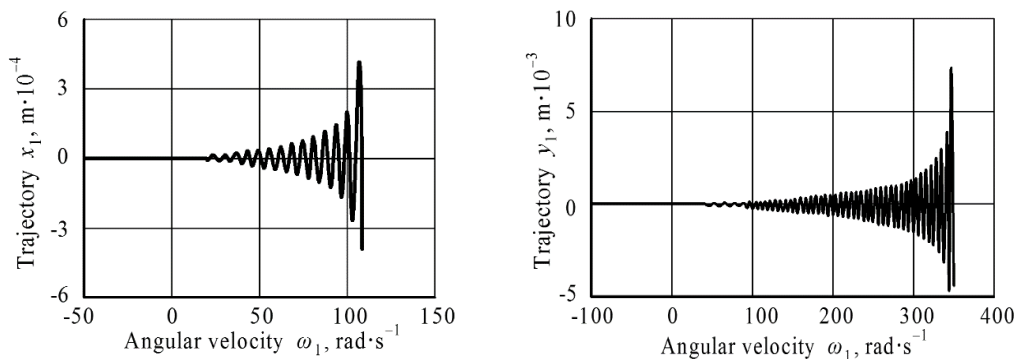
– the distance from a drive shaft’s axis to a counterweight’s axis is determined by this condition. From  $m_3 \cdot l_{13} = m_1 \cdot l_{12}$ , the following results:

$$l_{13} = \frac{m_1 \cdot l_{12}}{m_3} = \frac{5.4 \cdot 0.003}{1.2} = 0.0135 \text{ m}.$$

On the basis of our designing, manufacturing, and testing the new type of vibrational dryer with its vibrational wave transporter belt, which confirmed its functioning, we also take the following values as constants for the following parameters:

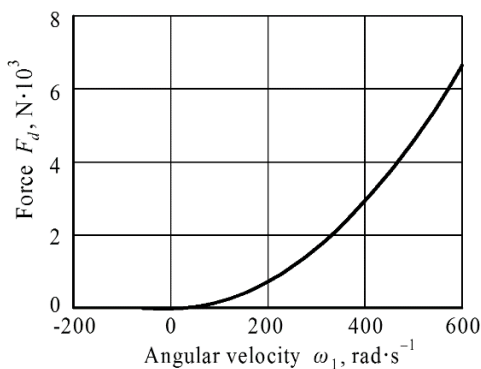
- a vibration damper’s ‘hardness’ in the direction of the axis  $O_2x$ :  $C_x = 9,800 \text{ N m}^{-1}$
- a vibration damper’s ‘hardness’ in the direction of the axis  $O_2y$ :  $C_y = 31,000 \text{ N m}^{-1}$ ;
- a drive shaft’s rotational moment  $M_r = 4.2 \text{ kNm}$ .

The digital calculations for the system of differential equations as carried out on a PC (35) provided dependencies for the movement (trajectory) of the rollers along the axis of the coordinates  $O_2x$  and  $O_2y$ , as depicted in Fig. 6.

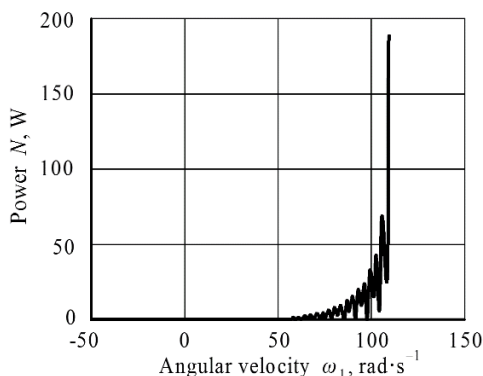


**Figure 6.** The trajectories of a roller’s centre of mass along the coordinates  $O_2x$ ,  $O_2y$ , depending on the angular velocity  $\omega_1$ .

We also used digital modelling on a PC to get the dependence of the excitation force  $F_d$  on the angular velocity  $\omega_1$  (Fig. 7) and also the dependence of the power consumption  $N$  on the angular velocity  $\omega_1$  (Fig. 8).



**Figure 7.** The dependence of the excitation force  $F_d$  on the angular velocity  $\omega_1$ .



**Figure 8.** The dependence of the consumer power figure  $N$  on the angular velocity  $\omega_1$ .

As the graphs in Fig. 6 indicate, a stable oscillating movement in a roller takes place when changing a drive shaft’s angular speed  $\omega_1$  within the range of 100–120  $\text{rad s}^{-1}$ . With that occurring, a roller’s oscillation amplitude changes within the limits of  $1.0\text{--}4.0 \cdot 10^{-3}$  m in the direction of the axis  $O_2x$  and within the limits of  $1.0\text{--}2.0 \cdot 10^{-3}$  m in the direction of the axis  $O_2y$ , which ensures the generation of a necessary wave on the elastic belt’s surface, ie. the necessary vibrational wave-type movement of the bulk grain along the elastic belt’s surface, simultaneously with the bulk grain being mixed under the infrared radiator that is drying the bulk grain.

The graphical dependencies pictured in Fig. 7 indicate that the value of the excitation force  $F_d$  starts increasing significantly (going above  $1 \cdot 10^3$  N) if a drive shaft’s angular velocity  $\omega_1$  is increased to 220  $\text{rad s}^{-1}$ . At a drive shaft’s angular velocity  $\omega_1$  reaching 120  $\text{rad s}^{-1}$ , the value of the aforementioned force does not exceed 350 N (0.35 kN). Therefore, when considering the reliability of the vibrational exciter, it is not recommended that the angular velocity  $\omega_1$  be increased above 120  $\text{rad s}^{-1}$ , because the power consumption level may increase to infinity.

Moreover, the graphs in Fig. 8 indicate that, upon increasing a drive shaft’s angular velocity  $\omega_1$  to 120  $\text{rad s}^{-1}$ , the power consumption level of the vibrational exciter reached 50 W, which is more acceptable in a situation which requires minimum energy spend in return for the high quality performance of the technological process.

Therefore, all of the graphs that have been discussed above indicate that the rational values for the angular velocity  $\omega_1$  of the vibrational exciter’s drive shaft must fall within the range of 100–120  $\text{rad s}^{-1}$ .

We also carried out experimental studies to investigate the process involved in the infrared drying of soy seeds on a vibrational transporter that had been developed by us.

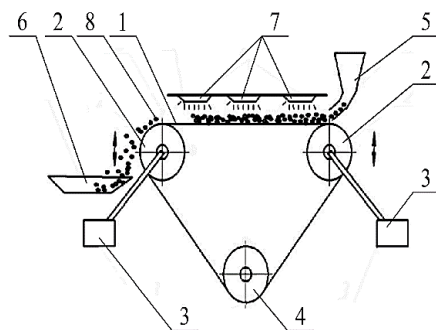
An experimental installation was established on the basis of that concept, and a diagram of it is provided in Fig. 9. The operating principle of the experimental installation is similar to that of the industrial model of an infrared dryer with a novel design, incorporating into it a vibrational belt transporter.



In the course of the experimental studies, portions of soy seeds with fixed moisture parameters were taken out at moisture levels of between 0.1% to 7.0%. The speed at which the bulk grain was being transported was also set at levels of between 0.15 to 0.6  $\text{cm}\cdot\text{s}^{-1}$ . The time spent by each portion of the seeds under the infrared lamps was recorded. The data received from this enabled us to determine the drying speed (the speed at which moisture is removed). For each portion of the seeds and to ensure individually-noted transportation speed readings, triple tests were carried out. The measurement and calculation results were processed with specially developed software on a PC.

Based on the results of the experimental studies, the speed at which the soy seed can be dried in the aforementioned dryer was all assessed. The experimental data was used to prepare a table which indicated the data of the infrared drying speed (removing moisture from the dried bulk grain over time) at various speeds of transporting the bulk grain on the vibrational belt and at various levels of moisture content in the bulk grain (Table 1).

The details given in the table indicates that the speed of infrared drying (moisture removal) for bulk seed depends upon both its initial moisture content and the speed of its vibrational transport. Within that context, the drying time for the bulk grain also changes. At a constant speed of vibrational transport for bulk grain, and with an increase of its initial relative moisture content, the time actually lengthens for the stage at which a constant drying speed can be achieved for drying soy seeds. As can be seen from the table above, for a vibrational transportation speed of 0.15  $\text{cm}\cdot\text{s}^{-1}$ , when the relative moisture content changes from 0.70% to 6.80%, the time needed to attain a constant speed of  $12.1\text{--}13.2\cdot 10^{-3}\ \%\cdot\text{s}^{-1}$  in terms of drying the bulk grain changes from 85 s to 520 s.



**Figure 9.** A diagram of an experimental installation in order to study the process of the infrared drying of soy seeds: 1) elastic belt; 2) rollers; 3) roller drive; 4) tensioning roller; 5) feeder hopper; 6) collector for dried seeds; 7) infrared radiator; 8) soy seeds.

**Table 1.** Individual energy and technology parameters for the infrared drying of soy seeds

Specific moisture content of the seeds, $\Delta W, \%$	Speed of vibrational transportation of the seeds, $V, \text{cm}\cdot\text{s}^{-1}$	Drying time, $\tau, \text{s}$	Speed at which moisture is removed, $dW\cdot(dt)^{-1}, \%\cdot\text{s}^{-1}\cdot 10^{-3}$
0.70	0.15	85	8.24
2.70	0.15	205	13.17
4.60	0.15	380	12.11
6.80	0.15	520	13.10
0.10	0.40	45	2.22
0.30	0.40	84	7.97
1.70	0.40	160	10.63
2.90	0.40	235	12.34
0.15	0.60	50	3.00
0.58	0.60	95	6.10
1.20	0.60	140	8.57
2.40	0.60	320	7.50

For a vibrational transportation speed of  $0.40 \text{ cm}\cdot\text{s}^{-1}$ , when changing the relative moisture level from 0.10% to 2.9% and when the drying speed stabilises at the level of  $12.3\cdot 10^{-3} \text{ }\%\cdot\text{s}^{-1}$ , the drying time for the soy seeds changes from 45 s to 235 s.

And finally, at a vibrational transportation speed of  $0.60\text{cm}\cdot\text{s}^{-1}$  and with the drying time as set out in the table, the drying speed for soy deeds does not exceed  $8.6\cdot 10^{-3} \text{ }\%\cdot\text{s}^{-1}$ , ie. a drying speed level of  $12\cdot 10^{-3} \text{ }\%\cdot\text{s}^{-1}$  is not attained in this case.

Therefore, based on the data gained from the experimental studies that have been carried out here, a rational speed for the vibrational transportation of soy seeds in infrared drying falls within the range of between  $0.15$  to  $0.40 \text{ cm s}^{-1}$ .

## CONCLUSIONS

1. A thermal radiation dryer of a novel design has been developed using a vibrational wave transport element which generates a mechanical wave on the surface of the flexible transporter belt, which itself ensures the movement of bulk grain along the processing zone that is currently being treated with infrared radiation.

2. On the basis of the calculation diagrams that have been developed, a mathematical model was prepared of the vibrational process that was the subject of the study, namely involving the use of Type II Lagrange equations which resulted in a system of differential equations for the movement of the vibrational exciter with its novel design, as proposed by the authors.

3. The solving of the aforementioned integral equations on a PC yielded a number of graphical dependencies for the kinetic and dynamic parameters of the vibrational system that has been described above.

4. It has been demonstrated that the stable movement of a working roller takes place if the angular velocity  $\omega_1$  is changed within the range of  $100\text{--}120 \text{ rad s}^{-1}$ , while the rational amplitude of the vibrational exciter's oscillations does not exceed 4 mm.

5. The fact has been identified that a rational speed for transporting soy seeds during infrared drying falls between the range of  $0.15\text{--}0.60 \text{ cm s}^{-1}$ . This parameter within the stated limits increases the time taken until the stage of constant drying speed can be achieved for soy by more than 2.5 times, from 205 s to 520 s, stabilising at a level of 520 s.

6. At a drive shaft's angular velocity  $\omega_1$  being  $120 \text{ rad s}^{-1}$ , the value of the excitation force  $F_d$  does not exceed 0.35 kN but, when it does actually exceed it, the excitation force starts increasing significantly.

7. When increasing a drive shaft's angular velocity  $\omega_1$  to  $120 \text{ rads}^{-1}$ , the power consumption of the vibrational exciter reached 50W, which again confirms the finding that the rational range when it comes to changing a drive shaft's angular velocity falls between  $100\text{--}120 \text{ rad s}^{-1}$ .

8. As shown by the results of the experimental studies that have been conducted, a rational speed for the vibrational transportation of soy seeds in infrared drying falls between  $0.15$  to  $0.40 \text{ cm s}^{-1}$ .

## REFERENCES

Aboltins, A. & Upitis, A. 2012. Experimental and theoretical investigation of agricultural material drying process. *Engineering for Rural Development* **11**, 93–98.

- Bezbakh, I.V. & Bakhmutyan, N.V. 2006. Investigation of the drying process of fruits and berries in a suspended layer. *Scientific works of ONAHT*, Odessa, **28**, pp. 112–116.
- Boyce, D.S. 1965. Grain moisture and temperature changes with position and time during through drying. *Journal of Agricultural Engineering Research* **10**(4), 333–341. doi: 10.1016/0021-8634(65)90080-6
- Bruce, D.M. & Giner, S.A. 1993. Mathematical modelling of grain drying counter-flou beds: Investigation of crossover of air and grain temperatures. *Journal of Agricultural Engineering Research* **55**(2), 143–161. doi: 10.1006/jaer.1993.1039
- El Hor, H., Linz, S.J., Grochowski, R., Walzel, P., Kruelle, C.A., Rouijaa, M., Götzendorfer, A. & Rehberg, I. 2005. Model for transport of granular matter on vibratory conveyors. *Powders and Grains 2005 - Proceedings of the 5th International Conference on Micromechanics of Granular Media* **2**, 1191–1195.
- Filonenko, G.K. & Grishin, M.A. 1971. *Drying of food plant materials*. Moscow, Food Industry, 231 pp. (in Russian)
- Gilmore, C., Asefi, M., Nemez, K., Paliwal, J. & LoVetri, J. 2019. Three dimensional radio-frequency electromagnetic imaging of an in.bin grain conditioning process. *Computers and Electronics in Agriculture* **167**, Article no. 105059. doi:10.1016/j.compag.2019.105059
- Giner, S.A. 2019. Estimation of the influence of variable boundary when using thin layer equations for grain dryer simulation. *Biosystems Engineering* **186**, 228–233. doi: 10.1016/j.biosystemseng.2019.08.004
- Goncharevich, I.F. & Frolov, K.V. 1981. *The theory of vibration technique and technology*. Moscow: Nauka, 217 pp. (in Russian).
- Grochowski, R., Walzel, P., Rouijaa, M., Kruelle, C.A. & Rehberg, I. 2004. Revising granular flow on a vibratory conveyor. *Applied Physics Letter* **84**(6), 1019–1021. doi: 10.1063/1.1646219
- Hemis, M., Choudhary, R. & Watson, D.G. 2012. A coupled mathematical model for simultaneous microwave and convective drying of wheat seeds. *Biosystems Engineering* **112**(3), 202–209. doi: 10.1016/j.biosystemseng.2012.04.002
- Kliuchnikov, A. 2019. Development of new method of drying at energy-saving universal dryer to improve quality of crops used in fodder production. *Engineering for Rural Development* **18**, 105–111. doi: 10.22616/ERDev2019.18.N125
- Malin, N.I. 2005. *Grain storage technology*. Moscow, Kolos, 280 pp.
- Moroz, S.M., Vasilkovsky, M.I., Vasilkovsky, O.M. & Goncharov, V.V. 2011. Analysis of the multilayer movement of grain on a fixed working surface. *Design, production and operation of agricultural machinery, Proceedings of Kirovograd National Technical University, Kirovograd*, **41**, pp. 203–208.
- Mujumar, A.S. 1995. *Handbook of Industrial Drying*, New York: Dekker, 742 pp.
- Palamarchuk, I.P., Kurchev, S.V. & Verkholtantseva, V.A. 2018. Trends in the development of conveyor vibratory dryers. In: *The development of technical sciences: problems and solutions: Proceedings of the international research and practical conference (April, 27–28, 2018)*, Brno, pp. 9–12.
- Rogovskii, I.L., Titova, L.L., Trokhaniak, V.I., Solomka, O.V., Popyk, P.S., Shvidia, V.O. & Stepanenko, S.P. 2019. Experimental studies on druing conditions of grain crops with high moisture content in low-pressure environment. *INMATEH – Agricultural Engineering* **57**(1), 141–146.
- Rudobashta, S.P., Zueva, G.A. & Kartashov, E.M. 2016. Heat and mass transfer when drying a spherical particle in an oscillating electromagnetic field. *Theoretical Foundations of Chemical Engineering* **50**(5), 718–729. <http://www.kluweronline.com/issn/0040-5795>. doi: 10.1134/S0040579516050365
- Safarov A.F. 1991. *Moisture and thermal processing of oilseeds*. A Thesis for applying for the degree of Doctor in Engineering Sciences, Tashkent, 288 pp.

## **Insects in chicken nutrition. A review**

D. Chodová\* and E. Tůmová

Czech University of Life Sciences Prague, Faculty of Agrobiolgy, Food and Natural Resources, Department of Animal Science, Kamýcká 129, CZ165 00 Prague, Czech Republic

\*Correspondence: chodova@af.czu.cz

**Abstract.** Increasing chicken meat production needs an alternative and easily available protein source as a potential substitute for soybean meal or fishmeal. The insect meals seem to be the most appropriate alternative. Of all insect species, *Tenebrio molitor*, *Hermetia illucens* and *Musca domestica* are the most suitable species for commercial exploitation in poultry feed. On the basis of numerous studies, insect meals contain sufficient nutrients (high quality protein and fat) for broiler production. Potential of insect meals used for feed of chickens is discussed based on published data. Many reviews summarizing the latest insights about the insect meals as an alternative protein source in poultry have been written. However, the present work describes not only the insect production, nutritional value and digestibility of the insect meals, but mainly the effect on performance, carcass characteristics and meat quality of chickens fed insect meals, which has not been in any review summarized yet. The study describes also the risks and safety of the insect meals. Based on numerous studies, insect meals can have a positive influence on growth without negative impact on carcass and meat quality characteristics.

**Key words:** chicken, insect meals, meat quality, protein source.

### **INTRODUCTION**

Protein is the major nutrient required for optimal broiler production and an increasing poultry production call for growing amount of protein to cover requirement of amino acids. One of the main sources of protein and fat in the feeding of poultry is soybean (Woods et al., 2019). Livestock production in the western hemisphere is consuming 85% of global soya production (Stamer, 2015). However, due to high cost of soybean and the competition between livestock and humans for consumption of arable crops, there is an increased request for the alternative and easily available protein sources (Khan et al. (2016, 2018); Woods et al., 2019). Currently, there is an increasing interest in the use of the insects as an alternative protein source either for total or partial replacements of commonly used protein sources as for example soybean or fishmeal in poultry diet, due to a high nutritive value. Insect meals are safe and do not have negative effect on the environment contrary to soybean (global warming, biodiversity loss, deforestation and destruction of ecosystems, increasing greenhouse gas emissions, large carbon footprint, FEAC, 2012) or fishmeal (decline in native fish stock, biodiversity loss, high disease rate and coastal habitat impairment, Henry et al., 2015) production.

However, in the European Union, the insect meals utilization in livestock nutrition is banned (Regulation (EC) No. 1069/2009) because these compounds are considered to be processed animal protein (PAP, Regulation (EC) No. 999/2001) prohibited in feeding of farmed animals (Kierończyk et al., 2018). Nevertheless, insect feed is currently allowed in pet food and in fish feed. Only a few insect species are allowed in the European Union for aquatic animals' nutrition. Due to the potential ecological advantages and good acceptance among farmers and consumers (Verbeke, 2015), it is probable that the political framework may change in the future and make use of the insect protein possible also in poultry diets (Leiber et al., 2017). One of the reasons for a likely permit is that poultry consume insects as part of their natural diet.

Many reviews reported the information about the insect meals as an alternative protein source in poultry nutrition. However, there is a lack studies summarizing the results on slaughter parameters and meat quality of chickens. Therefore, the aim of this work was to update, present and discuss the previous studies regarding the insect as a potential alternative protein source and describe its effect on poultry performance, carcass traits and meat quality.

## INSECTS PRODUCTION

Approximately 2,000 species of insects are known to be a highly digestible and edible protein source for humans or animals (Ramos-Elorduy, 2005). Insects have several useful physiological characteristics such as high reproductive ability, high feed conversion rate and easy rearing with low feed cost (Liu et al., 2011). Insect species are efficient feed converters because they are cold-blooded (Cullere et al., 2016) and do not use energy to maintain body temperature (Biasato et al., 2018a). Insects effectively utilize water and, in most cases, the feed is the main source of water (Józefiak & Engberg, 2015). Generally, the breeding of insects does not require a complex infrastructure and their care is simple (Khusro et al., 2012). Insects can grow on various substrates as for example cereals, decomposing organic materials, fruit or vegetables, poultry, pigs and cattle manure, industry by-products or waste products, which would be environmental problems (Sánchez-Muros et al., 2014; Cullere et al., 2016). However, in European Union is forbidden to use manure and other animal by-products in insects nutrition which are produced as a feed for livestock (Article 7 and Annex IV to Regulation (EC) No 999/2001; Regulation (EC) No 1069/2009). Khan et al. (2016) reported that use of insect meals or larvae meals (Kareem et al., 2018) can decrease the cost of poultry feed especially if it is reared on bio-waste. Insects can transform waste into valuable biomass (Nguyen et al., 2015) and convert low-quality plant waste into high-quality crude protein, fat and energy in short time (Makkar et al., 2014). The amount of manure is reduced by at least 50% and the resulting product contains nutrients such as phosphorus (60% to 70%) and nitrogen (30% to 50%; van Huis et al., 2013). The other advantage is the ability of larvae to decrease bacterial growth in the manure and thus reduce odour (Józefiak & Engberg, 2015).

The growth rate of insects depends on microclimate. The optimal temperature for most insect species rearing is 27–30 °C (Józefiak et al., 2016). The larvae of insects are the most effective for production and it is possible to produce more than 180 kg of live weight of *Hermetia illucens* larvae in 42 days from 1 m<sup>2</sup> (Józefiak et al., 2016).

The insect market for animal feed is continually increasing in the world, especially focused on *Tenebrio molitor* larvae (mealworm). *T. molitor* and *H. illucens* (black soldier fly) are two of the most promising insect species for commercial exploitation and for use in poultry feeds (Józefiak et al., 2016), their production is seamless and well understood (Kierończyk et al., 2018).

## INSECT NUTRITIVE VALUE

Insects have high nutritive value, not only in crude protein but, also for fats, minerals, and vitamins (Khusro et al., 2012). Nevertheless, the nutrient concentration of insects depends on the production technology and feed composition for insect production and on the life stage of insects (Józefiak & Engberg, 2015). Insects are a potential protein source in fish, pigs and poultry (Bovera et al., 2016; Józefiak et al., 2016). Larval and pupal stages of *Musca domestica* (maggot meal), *T. molitor* or *H. illucens* (Kareem et al., 2018) are rich sources of crude protein (40–60%) which is similar to soybean meal (Ramos-Elorduy et al., 2002; Ghaly & Alkoaik, 2009; Tran et al., 2015). All species of insects are rich in essential amino acids (Al-Qazzaz et al., 2016) and according to Rumpold & Schluter (2013) have a better balance of essential amino acids (methionine and lysine) than most grains. However, Bovera et al. (2016) reported that the insect meals protein had a low content of essential amino acids of methionine, cysteine, lysine, and tryptophan. On the other hand, Tschirner & Simon (2015) showed that *H. illucens* larvae have a particularly advantageous amino acid profile with high proportions of lysine and methionine. Moreover, Woods et al. (2019) stated that the addition of fish guts to the substrate improved the amino acid content, mainly essential amino acid, in the larvae of *H. illucens*; however, the usage of animal by-products to feeding insects is not allowed in European Union. According to Makkar et al. (2014) and Khan et al. (2018) the *T. molitor* had a better nutritive profile than silkworm, *M. domestica* and soybean meal because contains a higher amount of crude protein, fats, amino acid, and mineral content.

Meal from larvae of *H. illucens* is according to Schiavone et al. (2017) excellent source of apparent metabolizable energy for broiler chickens. The fat content in the selected insect species was determined on the level of 30.8% and 33.6% for *T. molitor* and *Zophobas morio*, respectively (Kierończyk et al., 2018). Likewise, Ramos-Elorduy et al. (2002) and Ghaly & Alkoaik (2009) reported that larval and pupal stages of *T. molitor* and other insects are rich in fat (35% in dry matter). The lipid content of insects depends on many factors, such as the diet or the life stages of insects. Therefore, the chemical composition of the insects could affect the growth substrate and the time of harvest (Sprangers et al., 2017). Woods et al. (2019) found that the fat content of larvae *H. illucens* was modified by the growing substrate, while the crude protein content was constant. Kierończyk et al. (2020) have shown that crude protein, and other nutrients in *H. illucens* larvae can be modified by the organic waste used as a substrate.

The final composition of animal fat reflects the fatty acid composition of the diet. The fatty acid profiles of insect oils showed higher saturated fatty acids contents (SFA; mainly palmitic acid C16:0 and stearic acid C18:0), and higher concentrations of monounsaturated fatty acids (MUFA; mainly oleic acid C 18:1, n-9; Al-Qazzaz et al., 2016). The degree of unsaturated insect fatty acids is similar to fish oil, but insect fatty acids are richer in polyunsaturated fatty acids (PUFA; De Foliart, 1991; Kierończyk et al., 2018). For example, *T. molitor* larvae contained high levels of unsaturated fatty acid

and had suitable unsaturated fatty acid to saturated fatty acid ratio which may have resulted in the maintenance of fat digestibility (Finke, 2002). The fat content of *H. illucens* prepupae was around 32%, where the main fatty acid group was saturated fatty acids (SFA) in which lauric acid (C12:0) was the predominant one (67% of total SFA; Surendra et al., 2016). The larvae of *H. illucens* have the disadvantageous n-6/n-3 ratio (Woods et al., 2019). Nevertheless, the fatty acid profile of insects depends on the growth substrate. Kierończyk et al. (2020) reported that the organic wastes can modify fatty acid profile and wheat bran compared to cabbage or carrots used as a substrate for *H. illucens* production reduce the lauric acid (C12:0).

The insects also have sufficient content of copper, iron, magnesium, phosphorus, and zinc for requirements of domestic birds (Barker et al., 1998). However, the majority of insects had low concentrations of calcium to meet chicken dietary needs, but this is important especially for laying hens, not for broiler chickens (Khusro et al., 2012). Moreover, calcium to phosphorus ratio is mainly detrimental in insect meals is mainly detrimental from nutritional issues, and due to this fact, it should be taken into consideration during calculations of poultry diets.

### **Chitin**

The chitin content can affect the digestibility and nutritional properties of insects. Chitin is the most common form of fiber in insects (Al-Qazzaz et al., 2016); however, due to the nitrogen absence is also analysed by Kjeldahl method as a crude protein and is included to the nitrogen-to-protein conversion factor of 6.25, which overestimated the protein content. Because of this reason, Janssen et al. (2017) suggested conversion factor of  $5.60 \pm 0.39$ . Chitin is a polysaccharide (linear polymer of  $\beta$ -(1-4) *N*-acetyl-d-glucosamine units) of the exoskeleton of arthropods (Sánchez-Muros et al., 2014). Chitin has been considered as indigestible fibre for a long time. However, in some mammals and birds like chickens the gastrointestinal tract (GIT) produces enzyme chitinase (in chickens in the proventriculus and hepatocytes, Suzuki et al., 2002), which degrades chitin into its derivatives chitosan, chitoooligosaccharides, and chitoooligomers that are easily absorbed into blood circulation (Borrelli et al., 2017; Tabata et al., 2017). Kramer et al. (1995) showed that the chitin content creates up to 40% of the exuvial dry mass depending on the insect species and its stages and differs with the cuticle types. Average chitin yields were 18.01% and 4.92% of dry weight from the exuvium and whole body of the *T. molitor* larvae (Song et al., 2018). The chitin composition depends on species and development stadium of insect (Al-Qazzaz et al., 2016).

On the other hand, chitin have a positive effect on the functioning of the immune system and thus on the health in poultry. Prebiotic effect of chitin was observed by increasing caecal production of butyric acid (Bovera et al., 2010; Khempaka et al., 2011), by improving the immune response of birds (Bovera et al., 2015) or due to lowering the albumin to globulin ratio (Loponte et al., 2017). Chitin and its derivatives can help to maintain a balanced and the healthy GIT microbiota that keeps the amounts of potentially pathogenic bacteria (for example *Escherichia coli*, *Salmonella typhimurium*) low (Benhabiles et al., 2012) and decreases the risk of intestinal diseases. By reducing the number of pathogenic microbiota, chitin encourages the proliferation of commensal bacteria. A positive effect of chitin on increasing population of Bifidobacteria and *Lactobacillus* spp. showed Lee et al. (2002) and van Huis et al. (2013), who also stated that diet containing 3% of chitin decreased *Escherichia coli* and *Salmonella* spp. in the

intestine. Chitin also has antifungal and antimicrobial properties (Khoushab & Yamabhai, 2010).

## INSECT MEALS ANTIMICROBIAL PROPERTIES

Various populations of microbiota colonize all segments of the GIT in poultry (Józefiak & Engberg, 2017). The main taxa of the broiler chickens GIT are cellulolytic and amylolytic *Clostridia*, *Bacillus* spp., *Lactobacillus* spp., and *Enterococcus* spp. GIT microbiota seems to be crucial for GIT health determination, can affect intestinal morphology through modifications of villus height and crypt depth, and may modulate synthesis and composition of mucins (Forder et al., 2007). Mucins constitute a digestion- and absorption-assisting medium and represent the first line of protection against bacteria and other pathogens (Forstner & Forstner, 1994). The GIT microbiota is mainly influenced by the nutrition. Insects have high medium chain fatty acids (MCFAs) and lauric acid (C12:0) contents (Spranghers et al., 2017). MCFAs have been shown to improve the intestinal morphology and function, through their beneficial effects on crypt cell renewal (Jenkins & Thompson, 1993). On the other hand, Spranghers et al. (2018) in their study did not detect the differences in small intestine morphology between piglets under various diets. MCFAs have also antimicrobial effect on GIT microbiota, while lauric acid (C12:0) is particularly active against Gram-positive bacteria. The antimicrobial activity of MCFAs and lauric acid is related to the reduction of pH. In the proximal small intestine with pH from 4.0 to 6.0, most of the lauric acid will be undissociated, and can freely penetrate through the peptidoglycan membrane of the Gram-positive bacteria into the cytoplasm (Spranghers et al., 2018). In the *in vitro* experiment, Spranghers et al. (2018) exhibited that the high amount of lauric acid in the *H. illucens* fat extracts had antimicrobial effect against D-streptococci, but no effect on coliforms.

In addition to the above-mentioned positive effect of chitin, MCFAs, and lauric acid on the immune system, insects are also able to synthesize antimicrobial peptides (AMPs) which have revealed a broad spectrum of activity against both Gram-positive and Gram-negative bacteria, fungi, and viruses. Moreover, this activity does not lead to the development of natural bacterial resistance (Józefiak & Engberg, 2017). Benzertiha et al. (2019b) showed that AMPs are probably responsible for decrease of bursa of Fabricius size playing an important role in the differentiation of B-lymphocytes. Józefiak et al. (2018) found that inclusion of small amounts (0.05 to 0.2%) of insect full-fat meals can modulate the microbiota composition of the GIT in the broiler chickens and do not result in the development of natural bacterial resistance. Biasato et al. (2018b) showed in the caeca of free-range chickens fed with *T. molitor* the most predominant genera *Bacteroides*, unclassified members of *Bacteroidales* order, *Clostridium* and *Ruminococcus*. The genera *Clostridium* and *Ruminococcus* produce organic acids, including butyrate, acetate, lactate or formate (Józefiak et al., 2018). Furthermore, *Ruminococcus* genus can produce other short chain fatty acids, which are an important source of energy for enterocytes and are vital for intestinal health (Biasato et al., 2018b). In chickens fed with *T. molitor* meal increased the number of *Clostridium*, *Oscillospira*, *Ruminococcus*, *Coprococcus* and *Sutterella* genera in their caecal community (Biasato et al., 2018b). *Clostridium* genus, *Oscillospira* and *Coprococcus* include bacteria capable of producing butyrate that have a positive role on intestinal villus structure and



pathogen control as mentioned above. Józefiak et al. (2018) reported that greater quantity of *Clostridium leptum* and *Eubacterium rectale* in chickens fed with insect meals can be a good indicator of the butyrate-producing microbiota, which indirectly affect epithelial cell structure and function, particularly in the lower regions of the GIT (Józefiak et al., 2018). The ileal digesta of the broiler chickens from treatment supplemented with insect meals had the highest counts of *Clostridium coccoides*-*Eubacterium rectale* cluster and *Lactobacillus* spp./*Enterococcus* spp. Counts increased with the addition of *T. molitor* meal. *H. illucens* supplementation increase *Bacteroides*-*Prevotella*, *Clostridium coccoides*-*Eubacterium rectale* cluster and *Streptococcus* spp./*Lactococcus* spp. in the caeca (Józefiak et al., 2018). *C. coccoides* are commensal GIT microbiota and are considered a group of bacteria playing important role in immunology, nutrition, and pathological processes (Józefiak et al., 2019). Free-range chickens fed with *T. molitor* meal showed increased abundances of *Firmicutes* and decreased abundances of *Bacteroidetes* phyla, and higher *Firmicutes*:*Bacteroidetes* ratios. *Firmicutes* phylum have an important role in the digestion of feed and the host health, while greater *Firmicutes*:*Bacteroidetes* ratios have been related to bacterial profile with higher capacity of energy harvesting (Biasato et al., 2018b).

The increased levels of commensal bacteria can have beneficial effect on health due to immune system stimulation. The results of Józefiak et al. (2018) showed that the low inclusion of the insect full-fat meals affected GIT microbiome and decreased the pH value in the crop and in caeca. This acidification can reveal the potential bacteriostatic role of insect meals in the GIT of poultry.

## NUTRIENT DIGESTIBILITY

The nutrient concentration of insects depends on their life stage, rearing conditions and the substrate used for insect production (Makkar et al., 2014). Measuring digestibility is a way how to estimate the availability of nutrients.

Results of the digestibility trial of Woods et al. (2019) showed a higher apparent digestibility for dry matter and organic matter for *H. illucens* larvae fed quail compare to the control fed group. Contrary, Bovera et al. (2016) found 2% lower ileal digestibility coefficients of dry matter and organic matter in broilers fed the *T. molitor* diet than those fed the soybean diet. In laying hens, Cutrignelli et al. (2018) detected the reduced coefficients of the apparent ileal digestibility (AID) of dry and organic matter when fed the *H. illucens* meal diet. This decreasing were according to these authors mainly due to the strong reduction of the crude protein digestibility that was related to the presence of the chitin in the insect meals, which negatively influences the crude protein digestibility. If we compare digestibility coefficients of the dry matter between *T. molitor* meal and *H. illucens* meal, no differences were found (De Marco et al., 2015).

Woods et al. (2019) observed a higher apparent metabolizable energy for *H. illucens* larvae fed quail compare to the control fed group. Nevertheless, in this study, *H. illucens* meal has resulted more digestible than the *T. molitor* meal in case of fat. Similar results showed Benzertiha et al. (2019a) who did not find the differences among *T. molitor* oil and palm oil on AID of crude fat, and metabolizable energy. The apparent metabolizable energy of the *T. molitor* meal and *H. illucens* meal (De Marco et al., 2015) was higher than all the ingredients normally used in poultry feeds.

Hwangbo et al. (2009) in their experiment fed 4-week old chickens with a diet substituting 300 g kg<sup>-1</sup> dried *M. domestica* and found very high apparent digestibility coefficient of crude protein for *M. domestica* larvae (0.98) compared to soybean. Pretorius (2011) substituted 500 g kg<sup>-1</sup> of a maize meal-based diet with *M. domestica* larvae meal for 3-week old broiler chickens and detected a crude protein digestibility of 0.69. De Marco et al. (2015) found no difference between *T. molitor* meal and *H. illucens* meal in digestibility coefficient of the crude protein. Benzertiha et al. (2019a) studied the *T. molitor* oil as total replacement for palm oil in chicken diet. They observed no effect on apparent crude protein digestibility in chickens. On the other hand, Schiavone et al. (2014) observed lower crude protein digestibility when chickens were fed *T. molitor* larvae as well as Bovera et al. (2016) who found 8.2% lower crude protein digestibility in chickens fed *T. molitor* compared to soybean diet.

De Marco et al. (2015) found that the AID of amino acids in the *T. molitor* meal was higher and showed less variation than in the *H. illucens* meal. In this study, threonine (0.80) and methionine (0.80) for *T. molitor*, and methionine (0.42) and isoleucine (0.45) for *H. illucens* were the least digested indispensable amino acids. The AID coefficients of the indispensable amino acids (phenylalanine and arginine in the *T. molitor* meal, and arginine and histidine in the *H. illucens* meal) was greater than 0.80.

According to above-mentioned results, insect meals can be alternative crude protein source for soybean meal or fishmeal.

## INSECTS IN POULTRY NUTRITION

Insects in various stages (adult, larval and pupal forms) are naturally consumed by wild bird and free-range poultry (Biasato et al., 2018a).

Birds including chickens have a low taste bud number and thus low taste acuity compared to mammals (Liu et al., 2011). Chickens have different sensitivities to the bitter taste (Woods et al., 2019). Cullere et al. (2016) made a feed-choice test in quails and observed that the birds preferred the diet including *H. illucens* meal compared to soybean meal. In particular studies, insects are fed to poultry in the form of meal or oil, but according to Moula et al. (2017), feeding live insects may be more adequate than after processing. On the other hand, some insects cannot be used directly because they secrete toxins or harmful minerals (Vijver et al., 2003). Therefore, they should be processed to make them safe for use in poultry diets. Live insects can also be difficult for handling and incompatible with automated feeding systems and can act as vectors in the transmission of infectious and viral diseases (Khusro et al., 2012). Live insects also may be difficult to mix them with ingredients in the diet, so processed insects can be easier to handle (Al-Qazzaz et al., 2016).

Pretorius (2011) showed that the housefly larvae can be added at the level of 25% of diet without negative effect on growth and feed efficiency which means that insect meals can replace other crude protein sources such as soybean meal or fishmeal. Johnson & Boyce (1990) revealed that increasing amount of insect meal added in the diet improved survival and growth rate of chickens. Mortality of quails was not affected by the inclusion of 10% dried *H. illucens* larvae (Woods et al., 2019). Correspondingly, the results obtained by Kareem et al. (2018) showed that excreta Enterobacteriaceae count was lower in birds fed with larvae meal supplemented diets than the control.

## THE GROWTH PERFORMANCE

Insect meals can affect the growth performance, and the level of influence depends on the added insect meals amount and its quality.

The effect of insect meals in the diet on body growth can be due to the different impact on the digestive system and the GIT microbiota modulation. Ballitoc & Sun (2013) found that the small intestine weight increased at up to 10% when the broilers fed *T. molitor* compared to control. The results of Bovera et al. (2016) showed that the length and weight of ileum and caeca increased when chickens were fed with *T. molitor* larvae meal supplementation.

In the final phase of nutrient digestion, morphology of intestine plays the main role. Villus height and crypt depth are microscopic structure parameters that are good indicators of intestinal development, health and functionality, and influencing nutrient digestion and absorption (Schiaivone et al., 2018). If the digestibility of nutrients is limited, it resulted in the increasing villi length and the villi to crypt ratio in the duodenum and jejunum and thereby increasing area for nutrient absorption (Laudadio et al., 2012; Zeitz et al., 2015). However, the changes in morphology, length and weight of intestine depends on the protein source-level substitution with insect meals and on the insect species. Biasato et al. (2018a) observed in the birds fed with 15% level of *T. molitor* inclusion shorter villi, deeper crypts compared to 5% level of *T. molitor* inclusion or control. According to Bovera et al. (2010), chitin contained in insect meals in a broiler diet increased in caeca the production of butyric volatile fatty acid which is considered the prime enterocyte energy source and can stimulate the growth of ileal mucosal cells and thus to have an impact on the body growth.

Despite the effect of feeding the insect meals on the structure and length of the intestines, the effect on growth itself is not clear. Some authors did not find the influence of insect meals on growth. No effect of *T. molitor* inclusion level from 5 to 10% in partial substitution of soybean meal on growth performance was detected by Ramos-Elorduy et al. (2002) in fast-growing chickens as well as Biasato et al. (2016) in medium-growing chickens, who substituted 7.5% of corn gluten meal with *T. molitor* meal. Likewise, Kierończyk et al. (2018) replaced soybean oil by *T. molitor* oil or *Z. morio* oil and they did not detect effect on growth, as well as Schiaivone et al. (2017; 2018) in case of *H. illucens* oil supplementation. Similar results observed also Benzertihia et al. (2019a) who used *T. molitor* oil to replace palm oil in the diet of chickens. Cullere et al. (2016) reported no difference in daily weight gain in quails fed defatted *H. illucens* meal and control group. On the other hand, Bovera et al. (2015, 2016) showed improved growth performance when 29.6% of soybean meal was replaced by *T. molitor* meal, and also Khan et al. (2018) reported significantly higher weight gain in birds by substituting insect meals. Moreover, Biasato et al. (2018a) detected that the live weight of the birds improved with increasing level of *T. molitor* meal in feed. Similarly, higher live weight of chickens fed with mealworm showed Khan et al. (2018) or Altmann et al. (2018) for chickens fed with the diet containing *H. illucens* larvae meal. On the other hand, Bovera et al. (2015) examined a 30% *T. molitor* meal inclusion (equal to a 100% soybean meal replacement) in broiler diets, and they did not detect any differences in live weight after a 64-day feeding trial. Correspondingly, Awoniyi et al. (2003) showed that the replacement of fishmeal with larvae meal in broiler diets did not influence live weight. It seems that

the influence of growth and thus live weight depends on the insect species and on the protein source-level substitution with insect meals.

Cullere et al. (2016) reported no difference in average daily feed intake (FI) from the conventional feed when intensively reared growing quails were fed on defatted *H. illucens* meal. Similarly, daily FI was not influenced by the partial or total replacement of soybean oil by *H. illucens* larvae fat (Schiavone et al., 2018). Broiler chickens fed with mealworm exhibited lower FI compared to those fed with soybean (Khan et al. (2016, 2018)). The lower FI in chicken can be attributed to the high lipid content (Poorghasemi et al., 2013) or higher crude protein percentage of insect meals (Makkar et al., 2014). On the other, Kierończyk et al. (2018) have stated that the energetic value of *T. molitor* oil is similar to soybean oil. Chickens fed the diet with *T. molitor* meal had better feed conversion ratio (FCR) compared to the control group (Bovera et al., 2016). Moreover, Khan et al. (2018) evaluated different insects and found that FCR improved in *T. molitor*-substituted group followed by silkworm, *M. domestica* meal and soybean meal. Better FCR can be due to efficient utilization of crude protein and quality of amino acids.

## CARCASS TRAITS

Most of the studies did not find significant differences in carcass traits of young chickens when fly larvae or pupae replaced soybean meal. No effect on carcass traits was observed after house *M. domestica* meal was added to the diet of broiler chickens (Hwangbo et al., 2009). Similarly, *T. molitor* meal inclusion did not affect the carcass traits of experimental groups in the trial of Bovera et al. (2016) or Biasato et al. (2016, 2018a). Contrary, in the study of Pieterse et al. (2014) animal protein-based diets (i.e. fishmeal and larvae meal) resulted in heavier carcasses compared to soy-based diet. Likewise, Altmann et al. (2018) detected heavier carcass in chickens fed with diet where 50% of the soy-based protein was substituted by *H. illucens* larval meal than in control group, probably because of *H. illucens* meal diet was substantially higher in crude protein and ether extract and chickens fed with this diet had higher final live weight.

When fishmeal was replaced by larvae meal in broiler diets, the dressing out percentage was not affected (Awoniyi et al., 2003). In agreement, Cullere et al. (2016) fed broiler quails on 0, 10, and 15% inclusion levels of *H. illucens* meal and did not find a difference between the conventional and insect-based diet on dressing out percentage. On the other hand, Hwangbo et al. (2009) observed higher dressing percentages for broilers fed house fly meal included at levels from 5% to 20%.

The results of the percentage of the main valuable parts in poultry fed insect meals are ambiguous. Awoniyi et al. (2011) showed no effect of replacement fishmeal by larvae meal on muscle yield. Cullere et al. (2016), Onsongo et al. (2018) and Kareem et al. (2018) did not observe the effect of *H. illucens* meal inclusion on breast meat percentage in quails or chickens, respectively. However, when soy-based diet was partially replaced with insect meals, it resulted in higher breast and thigh muscle weights (Hwangbo et al., 2009) or higher breast meat percentage (Pieterse et al., 2014).

## MEAT QUALITY

Meat quality can be described by chemical composition, physical meat characteristics (pH value, colour, tenderness) or sensory value. The chemical composition of meat can be influenced by the crude protein and energetic concentrations in the diet, whereas the impact of the crude protein source is still unclear (Özek et al., 2003). Regarding the change of protein in the diet, Pieterse et al. (2014) and Bovera et al. (2016) found that when the soybean meal was completely replaced by *T. molitor* meal as a crude protein source, it did not affect the proximate composition of meat. Pieterse et al. (2019) showed that the inclusion of *H. illucens* meal in the broiler chicken diet did not influence moisture, crude protein, fat and ash content of cooked meat. The assimilation of dietary fats by chickens is higher for unsaturated than for saturated fatty acids (SFA). Unsaturated fatty acids spontaneously formed mixed micelles with monoglycerides and conjugated bile salts and then are transported to the mucosal surface where they are absorbed by the small intestine (Tanchaenrat et al., 2014). With increasing *H. illucens* larvae inclusion rate, the proportion of SFA in breast meat of broiler chickens enlarged to the detriment of the PUFA fraction. PUFA are responsible for various functions in the body and are precursors of cellular functions molecules (Abdulla et al., 2019). *T. molitor* oil supplementation increased n-3 and n-6 fatty acids in breast meat of chickens (Benzertiha et al., 2019a). On the contrary, MUFA fraction was unaffected (Schiavone et al., 2017). It seems that insect meals used in broiler chickens have the potential to produce meat with comparable chemical traits compared to those fed diets containing traditional feed ingredients (Pieterse et al., 2019).

From physical meat properties, the pH value is important for the detection of meat defects like PSE (pale, soft, exudative meat) if the pH value measured 15 minutes *post mortem* is lower than 5.6. Cullere et al. (2016) obtained that quails fed *H. illucens* at 10 or 15% had a pH value of around 5.67, that is slightly lower than in control group fed soy-based diet. On the other hand, according to the study of Bovera et al. (2016), poultry fed with insect meals had higher pH value. In contrast, Pieterse et al. (2019) showed that no treatment differences were found regarding to the initial and ultimate pH of the thigh muscles. Despite this, the addition of insect meals did not lead to negative changes in pH values that could indicate meat defects.

Nutrition can also affect meat colour, as it is the main sources of pigments in animal life. Consumers consider meat colour an important quality clue at the point of purchase (Fletcher, 1999). Secci et al. (2018) have recently found that 1 kg of *H. illucens* larval meal contained around 42 g of total tocopherols and 2 mg of total carotenoids. The pigments in animal feeding are derived from all the ingredients utilized for the formulation. No significant treatment differences for colour were observed regarding the colour characteristics of the broiler breast muscle (Fletcher, 1999). Secci et al. (2018) did not find any differences in meat colour parameters between barbary partridge fed with soybean meal, insect meals or vegetable oils.

Another meat quality parameter important for the consumer is meat tenderness, which was not affected by the introduction of insect meals in the diet (Bovera et al., 2016; Pieterse et al., 2019). Water holding capacity of meat can be described by the drip loss or cooking loss when the meat is heat-treated. Drip loss was the lowest for the larvae-fed samples compared to those with soybean (Pieterse et al., 2014). However, when meat was heat-treated poultry fed with insect meals had higher cooking losses

(Bovera et al., 2016). In another study, no significant treatment differences were found for thaw loss and cooking loss (Pieterse et al., 2019).

Broilers are monogastric animals, any variation in the chemical composition of the feeds could potentially influence (positively or negatively) the sensory profile of the meat (Pieterse et al., 2019). According to the study of Hwangbo et al. (2009), the organoleptic characteristics of broiler meat were not affected by insect meals in the diet. Likewise, the sensory test of Onsongo et al. (2018) suggests that inclusion of *H. illucens* meal in broiler diets does not affect consumer preference for broiler chicken breast meat consumption because the insect meals inclusion did not change the taste and aroma of the meat as well as in study of Pieterse et al. (2019).

On the other hand, fresh chicken breast filets score had the most intensive flavour in *H. illucens* fed group (Altmann et al., 2018). The larvae-fed meat samples scored significantly higher for sustained juiciness compared to the soy and fish meal-fed samples and it also provides an indication that broilers fed larvae meal could have juicier meat (Pieterse et al., 2014).

Therefore, it can be concluded that the substitution of soy-based protein with insect meals expressed very modest or no changes in the meat quality for many of the meat quality parameters.

## SAFETY

Safety aspects of insects for feed production are not well-known until now. Insects can receive certain substances from the feed or growing substrate. Goumperis (2012) reported potential hazards of insects for feed production. Feed for insects can be contaminated with mycotoxins, heavy metals, pesticides etc. (Van der Spiegel et al., 2013). Mycotoxins from feed or substrate for insects rearing can affect the growth, inhibit larval development or increase mortality of insects. Consumption of mycotoxin-contaminated insect can present a risk to animals. However, Schrogel & Wätjen (2019) reviewed the effect of mycotoxins on insect safety. These authors showed that no accumulation of various mycotoxin concentration was observed in different feeding experiments with various insect species; even up, the mycotoxin concentration in substrate was 25-times more than maximum limit. According to results, it is better to starve insect of at least 24 hours before harvesting to eliminate mycotoxins in the insect's body.

Toxicity of heavy metals (e.g., cadmium, arsenic, cobalt, copper, nickel etc.) is due to interference with vital cellular components. Vijver et al. (2003) showed upon the uptake and accumulation of heavy metals (cadmium, copper, lead, zinc) from soil by *T. molitor* larvae. If the level of contaminants were very low, no additional hazard to animals or animal products was expected (Schrogel & Wätjen, 2019). According to the review of these authors, *H. illucens* is capable to accumulate cadmium and *T. molitor* accumulates arsenic. Diener et al. (2015) showed that the insect larvae could accumulate some heavy metals in their body, such as cadmium or plumbum immobilized in the exoskeleton. Accumulation of heavy metals occurred to varying outspread dependent on metal type, insect species and its stages. The contamination is especially for the insect adults which eats grass.

Potential risk of the insects themselves can be allergens, pesticides, contaminant or pathogens (Van der Spiegel et al., 2013). Insects also contained chemical defence substances as toxins produced by the exocrine gland. The presence of pathogenic

microorganisms in insects used as feed or its constituent presents a potential health risk that can be prevented by farming or processing conditions (Rumpold & Schlüter, 2013). The prevention of these risks is rearing insects on pollutant-free substrate.

On the other hand, Jin et al. (2016) did not detect the effect of mealworm on blood IgG and IgA concentration as an immune response. Benzertiha et al. (2019b) showed that the small amount of *T. molitor* and *Z. morio* (0.2 and 0.3%) full-fat meals to the diet of broiler chickens decreased the levels of IgM and IgY and may have a significant effect on the immune response. According to these authors, the antimicrobial effects of insect components such as chitin and antimicrobial peptides could explain this effect. Belluco et al. (2013) showed that insects have no additional hazards compared to usually consumed animal products. Likewise, *T. molitor* meal inclusion did not impair the blood parameters, which verifies the safety of insect meals inclusion in poultry diet (Bovera et al., 2015; Biasato et al., 2018a).

## CONCLUSIONS

Overall, the literature reviews verify that insect meals contain sufficient nutrients for broiler production and have no negative effect on most of carcass and meat characteristics. Insect meals can be suitable alternative protein source for the feeding of chickens. However, in the European Union, the insect meals are defined as processed animal protein and its utilization in livestock nutrition is banned.

If the feeding will be allowed, the limited quantity of produced insects could be a significant obstacle. Likewise, the prices for insect meals are presently high and it is necessary to develop automated process technologies for rearing and harvesting (Rumpold & Schlüter, 2013; Józefiak et al., 2016). Therefore, further research is needed to maintain safety and good technological practices for the possible production of insects as a source for poultry feed.

**ACKNOWLEDGEMENTS.** The study was supported by the Ministry of Agriculture of the Czech Republic (Project NAAR No. QK1910387).

## REFERENCES

- Abdulla, N.R., Loh, T.C., Foo, H.L., Alshelmani, M.I. & Akit, H. 2019. Influence of Dietary Ratios of n-6: n-3 Fatty Acid on Gene Expression, Fatty Acid Profile in Liver and Breast Muscle Tissues, Serum Lipid Profile, and Immunoglobulin in Broiler Chickens. *J. Appl. Poultry Res.* **28**, 454–469.
- Altmann, B.A., Neumann, C., Velten, S., Liebert, F. & Mörlein, D. 2018. Meat quality derived from high inclusion of a micro-alga or insect meal as an alternative protein source in poultry diets: a pilot study. *Foods Basel Switz.* **7**, 34.
- Al-Qazzaz, M.F.A., Ismail, D., Akit, H. & Idris, L.H. 2016. Effect of using insect larvae meal as a complete protein source on quality and productivity characteristics of laying hens. *R. Bras. Zootec.* **45**, 518–523.
- Awoniyi, T., Aletor, V. & Aina, J. 2003. Performance of broiler-chickens fed on maggot meal in place of fishmeal. *Int. J. Poult. Sci.* **2**, 271–274.
- Ballitoc, D.A. & Sun, S. 2013. Ground yellow mealworms (*Tenebrio molitor* L.) feed supplementation improves growth performance and carcass yield characteristics in broilers. *Open Sci. Reposit. Agric.* doi: 10.7392/openaccess.23050425

- Barker, D., Fitzpatrick, M.P. & Dierenfeld, E.S. 1998. Nutrient composition of selected whole invertebrates. *Zoo Biology* **17**, 123–134.
- Belluco, S., Losasso, C., Maggioletti, M., Alonzi, C.C., Paoletti, M.G. & Ricci, A. 2013. Edible insects in a food safety and nutritional perspective: A critical review. *Compr. Rev. Food Sci. F.* **12**, 296–313.
- Benhabiles, M.S, Salah, R., Lounici, H., Drouiche, N., Goosen, M.F.A & Mameri, N. 2012. Antibacterial activity of chitin, chitosan and its oligomers prepared from shrimp shell waste. *Food hydr.* **29**, 48–56.
- Benzertiha, A., Kierończyk, B., Rawski, M., Kołodziejcki, P., Bryszak, M. & Józefiak, D. 2019a. Insect oil as an alternative to palm oil and poultry fat in broiler chicken nutrition. *Animals.* **9**, 116.
- Benzertiha, A., Kierończyk, B., Kołodziejcki, P., Pruszyńska-Oszmałek, E., Rawski, M., Józefiak, D. & Józefiak, A. 2019b. *Tenebrio molitor* and *Zophobas morio* full fat meals as functional feed additives affect broiler chickens growth performance and immune system traits. *Poult. Sci.* **0**, 1–11.
- Biasato, I., De Marco, M., Rotolo, L., Renna, M., Dabbou, S., Capucchio, M.T., Biasibetti, E., Costa, P., Gai, F., Pozzo, L., Dezzutto, D., Bergagna, S., Martinez, S., Tarantola, M., Gasco, L. & Schiavone, A. 2016. Effects of dietary *Tenebrio molitor* meal inclusion in free-range chickens. *J. Anim. Physiol. Anim. Nutr.* **100**, 1104–1112.
- Biasato, I., Gasco, L., De Marco, M., Renna, M., Rotolo, L., Dabbou, S., Capucchio, M.T., Biasibetti, E., Tarantola, M., Sterpone, L., Cavallarin, L., Gai, F., Pozzo, L., Bergagna, S., Dezzutto, D., Zoccarato, I. & Schiavone, A. 2018a. Yellow mealworm larvae (*Tenebrio molitor*) inclusion in diets for male broiler chickens: Effects on growth performance, gut morphology, and histological findings. *Poult. Sci.* **97**, 540–548.
- Biasato, I., Ferrocino, I., Biasibetti, E., Grego, E., Dabbou, S., Sereno, A., Gai, F., Gasco, L., Schiavone, A., Cocolin, L. & Capucchio, M.T. 2018b. Modulation of intestinal microbiota, morphology and mucin composition by dietary insect meal inclusion in free-range chickens. *BMC Vet. Res.* **14**, 383.
- Borrelli, L., Coretti, L., Dipineto, L., Bovera, F., Menna, F., Chiariotti, L., Nizza, A., Lembo, F. & Fioretti, A. 2017. Insect-based diet, a promising nutritional source, modulates gut microbiota composition and SCFAs production in laying hens. *Sci. Rep.* **7**, 16269.
- Bovera, F., Loponte, R., Marono, S., Piccolo, G., Parisi, G., Iaconisi, V., Gasco, L. & Nizza, A. 2016. Use of *Tenebrio molitor* larvae meal as protein source in broiler diet: Effect on growth performance, nutrient digestibility, and carcass and meat traits. *J. Anim. Sci.* **94**, 639–647.
- Bovera, F., Piccolo, G., Gasco, L., Marono, S., Loponte, R., Vassalotti, G., Mastellone, V., Lombardi, P., Attia, Y.A. & Nizza, A. 2015. Yellow mealworm larvae (*Tenebrio molitor*, L.) as a possible alternative to soybean meal in broiler diets. *Brit. Poultry Sci.* **56**, 569–575.
- Bovera, F., Marono, S., Di Meo, C., Piccolo, G., Iannaccone, F. & Nizza, A. 2010. Effect of mannanoligosaccharides supplementation on caecal microbial activity of rabbits. *Animal* **4**, 1522–1527.
- Cullere, M., Tasoniero, G., Giaccone, V., Miotti-Scapin, R., Claeys, E., De Smet, S. & Dalle Zotte, A. 2016. Black soldier fly as dietary protein source for broiler quails: Apparent digestibility, excreta microbial load, feed choice, performance, carcass and meat traits. *Animal* **10**, 1923–1930.
- Cutrignelli, M.A., Messina, M., Tulli, F., Randazzo, B., Olivotto, I., Gasco, L., Loponte, R., Bovera, F. 2018. Evaluation of an insect meal of the black soldier fly (*Hermetia illucens*) as soybean substitute: Intestinal morphometry, enzymatic and microbial activity in laying hens. *Res. Vet. Sci.* **117**, 209–215.
- De Foliart, G.R. 1991. Insect fatty acids: similar to those of poultry and fish in their degree of unsaturation but higher in the polyunsaturates. *Food Insects. Newsl.* **4**, 1–4.



- De Marco, M., Martínez, S., Hernandez, F., Madrid, J., Gai, F., Rotolo, L., Belforti, M. Bergero, D., Katz, H., Dabbou, S., Kovitvadh, A., Zoccarato, I., Gasco, L. & Schiavone, A. 2015. Nutritional value of two insect larval meals (*Tenebrio molitor* and *Hermetia illucens*) for broiler chickens: Apparent nutrient digestibility, apparent ileal amino acid digestibility and apparent metabolizable energy. *Anim. Feed Sci. Technol.* **209**, 211–218.
- Diener, S., Zurbrugg, C. & Tockner, K. 2015. Bioaccumulation of heavy metals in the black soldier fly, *Hermetia illucens* and effects on its life cycle. *J. Insects Food Feed.* **1**, 261–270.
- FEFAC. 2012. *Environment report*. 2<sup>nd</sup> ed. Bruxelles, Belgique, 36 pp.
- Finke, M.D. 2002. Complete nutrient composition of commercially raised invertebrates used as food for insectivores. *Zoo Biol.* **21**, 269–285.
- Fletcher, D. 1999. Broiler breast meat color variation, pH, and texture. *Poult. Sci.* **78**, 1323–1327.
- Forder, R.E., Howarth, G.S., Tivey, D.R. & Hughes, R.J. 2007. Bacterial modulation of small intestinal goblet cells and mucin composition during early posthatch development of poultry. *Poult. Sci.* **86**, 2396–2403.
- Forstner, G. & Forstner, J.F. 1994. Gastrointestinal mucus. In: Johnson, L.R., editor. *Physiology of the gastrointestinal tract*. Raven Press, New York, pp. 1255–1284.
- Ghaly, A.E. & Alkoaik, F.N. 2009. The yellow mealworms as a novel source of protein. *Am. J. Agric. Biol. Sci.* **4**, 319–331.
- Goumperis, T. 2012. Insects and food security: food/feed safety considerations. Assessing the potential of insects as food and feed in assuring food security. *Technical Consultation Meeting*, 23–25 January 2012. Rome: FAO.
- Henry, M., Gasco, L., Piccolo, G. & Fountoulaki, E. 2015. Review on the use of insects in the diet of farmed fish: past and future. *Anim. Feed Sci. Technol.* **203**, 1–22.
- Hwangbo, J., Hong, E., Jang, A., Kang, H., Oh, J., Kim, B. & Park, B.S. 2009. Utilization of house fly-maggots, a feed supplement in the production of broiler chickens. *J. Environ. Biol.* **30**, 609–614.
- Janssen, R.H., Vincken, J.P., van den Broek, L.A.M., Fogliano, V. & Lakemond, K.M.M. 2017. Nitrogen-to-protein conversion factor for three edible insects: *Tenebrio molitor*, *Alphitobius diaperinus*. And *Hermetia illucens*. *J. Agric. Food Chem.* **65**, 2275–2278.
- Jenkins, A.P. & Thompson, R.P.H. 1993. Does the fatty-acid profile of dietary-Fat influence its trophic effect on the small intestinal mucosa. *Gut.* **34**, 358–364.
- Jin, X.H., Heo, P.S., Hong, J.S., Kim, N.J. & Kim, Y.Y. 2016. Supplementation of Dried Mealworm (*Tenebrio molitor* larva) on Growth Performance, Nutrient Digestibility and Blood Profiles in Weaning Pigs. *Asian-Australas. J. Anim. Sci.* **29**, 979–986.
- Johnson, G.D. & Boyce, M.S. 1990. Feeding trials with insects in the diet of sage grouse chicks. *J. Wild. Manage.* **54**, 89–91.
- Józefiak, D. & Engberg, R.M. 2015. Insects as poultry feed. In: *Proc. 20<sup>th</sup> European Symposium on Poultry Nutrition*. Prague, Czech Republic, pp. 73–80.
- Józefiak, D., Józefiak, A., Kierończyk, B., Rawski, M., Świątkiewicz, S., Długosz, J. & Engberg, R.M. 2016. Insects – A natural nutrient source for poultry – A review. *Ann. Anim. Sci.* **6**, 297–313.
- Józefiak, A. & Engberg, R.M. 2017. Insect proteins as a potential source of antimicrobial peptides in livestock production. *J. Anim. Feed Sci.* **26**, 87–99.
- Józefiak, A., Kierończyk, B., Rawski, M., Mazurkiewicz, J., Benzertiha, A., Gobbi, P., Nogales-Mérida, S., Świątkiewicz, S. & Józefiak, D. 2018. Full-fat insect meals as feed additive – the effect on broiler chicken growth performance and gastrointestinal tract microbiota. *J. Anim. Feed Sci.* **27**, 131–139.
- Józefiak, A., Nogales-Mérida, S., Mikołajczak, Z., Rawski, M., Kierończyk, B., Mazurkiewicz, J. 2019. The utilization of full-fat insect meal in rainbow trout (*Oncorhynchus mykiss*) nutrition: the effects on growth performance, intestinal microbiota and gastrointestinal tract histomorphology. *Ann. Anim. Sci.* **19**, 747–765.

- Kareem, K.Y., Abdulla, N.R., Foo, H.L., Mohd, A.N., Zamri, N.S., Loh, T.C. & Alshelmani, M.I. 2018. Effect of feeding larvae meal in the diets on growth performance, nutrient digestibility and meat quality in broiler chicken. *Indian J. Anim. Sci.* **88**, 1180–1185.
- Khan, S., Khan, R.U., Sultan, A., Khan, M., Hayat, S.U. & Shahid, M.S. 2016. Evaluating the suitability of maggot meal as a partial substitute of soya bean on the productive traits, digestibility indices and organoleptic properties of broiler meat. *J. Anim. Physiol. An. N.* **100**, 649–656.
- Khan, M., Chand, N., Khan, S., Khan, R.U. & Sultan, A. 2018. Utilizing the house fly (*Musca Domestica*) larva as an alternative to soybean meal in broiler ration during the starter phase. *Braz. J. Poult. Sci.* **20**, 9–14.
- Khempaka, S., Chitsatchapong, C. & Molee, W. 2011. Effect of chitin and protein constituents in shrimp head meal on growth performance, nutrient digestibility, intestinal microbial populations, volatile fatty acids, and ammonia production in broilers. *J. Appl. Poult. Res.* **20**, 1–11.
- Khoushab, F. & Yamabhai, M. 2010. Chitin Research Revisited. *Mar. Drugs.* **8**, 1988–2012.
- Khusro, M., Andrew, N.R. & Nicholas, A. 2012. Insects as poultry feed: a scoping study for poultry production systems in Australia. *World Poult. Sci. J.* **68**, 435–446.
- Kierończyk, B., Rawski, M., Józefiak, A., Mazurkiewicz, J., Światkiewicz, S., Siwek, M., Bednarczyk, M., Szumacher-Strabel, M., Cieslak, A., Benzertiha, A. & Józefiak, D. 2018. Effects of replacing soybean oil with selected insect fats on broilers. *Anim. Feed Sci. Technol.* **240**, 170–183.
- Kierończyk, B., Sypniewski, J., Rawski, M., Czekala, W., Światkiewicz, S. & Józefiak, D. 2020. From waste to sustainable feed material: the effect of *Hermetia illucens* oil on the growth performance, nutrient digestibility, and gastrointestinal tract morphometry of broiler chickens. *Ann. Anim. Sci.* doi: 10.2478/aoas-2019-0066
- Kramer, K.J., Hopkins, T.L. & Schaefer, J. 1995. Applications of solids NMR to the analysis of insect sclerotized structures. *Insect Biochem. Mol. Biol.* **25**, 1067–1080.
- Laudadio, V., Passantino, L., Perillo, A., Loprestu, G., Passantino, A., Khan, R.U. & Tufarelli, V. 2012. Productive performance and histological features of intestinal mucosa of broiler chickens fed different dietary protein levels. *Poult. Sci.* **91**, 265–270.
- Lee, H.W., Park, Y.S., Jung, J.S. & Shin, W.S. 2002. Chitosan oligosaccharides, dp 2-8, have prebiotic effect on the *Bifidobacterium bifidum* and *Lactobacillus* sp. *Food Microbiol.* **8**, 319–324.
- Leiber, F., Gelencsér, T., Stamer, A., Amsler, Z., Wohlfahrt, J., Früh, B. & Maurer, V. 2017. Insect and legume-based protein sources to replace soybean cake in an organic broiler diet: Effects on growth performance and physical meat quality. *Renew. Agr. Food Sys.* **32**, 21–27.
- Liu, N., Abe, M., Sabin, L.R., Hendriks, G.J., Nagvi, A.S., Yu, Z., Cherry, S. & Bonini, N.M. 2011. The exoribonuclease Nibbler controls 3' end processing of microRNAs in *Drosophila*. *Curr. Biol.* **21**, 1888–1893.
- Loponte, R., Nizza, S., Bovera, F., Riu De, N., Fliegerova, K., Lombardi, P., Vassalotti, G., Mastellone, V., Nizza, A. & Moniello, G. 2017. Growth performance, blood profiles and carcass traits of barbery partridge (*Alectoris barbara*) fed two different insect larvae meals (*Tenebrio molitor* and *Hermetia illucens*). *Res. Vet. Sci.* **115**, 183–188.
- Makkar, H.P., Tran, G., Heuzé, V. & Ankers, P. 2014. State-of-the-art on use of insects as animal feed. *Anim. Feed Sci. Technol.* **197**, 1–33.
- Moula, N., Scippo, M.L., Douny, C., Degand, G., Dawans, E., Cabaraux, J.F., Hornick, J.L., Medigo, R.C., Leroy, P., Francis, F. & Detilleux, J. 2017. Performances of local poultry breed fed black soldier fly larvae reared on horse manure. *Anim. Nutr.* **4**, 73–78.
- Nguyen, T.T.X., Tomberlin, J.K. & Vanlaerhoven, S. 2015. Ability of Black Soldier Fly (*Diptera: Stratiomyidae*) Larvae to recycle food waste. *Environ Entomol.* **44**, 407–410.

- Onsongo, V.O., Osuga, I.M., Gachuri, C.K., Wachira, A.M., Miano, D.M., Tanga, C.M., Ekesi, S., Nakimbugwe, D. & Fiaboe, K.K.M. 2018. Insects for income generation through animal feed: effect of dietary replacement of soybean and fish meal with black soldier fly meal on broiler growth and economic performance. *J. Econ. Entomol.* **111**, 1966–1973.
- Özek, K., Yazgan, O. & Bahtiyarca, Y. 2003. Effects of dietary protein and energy concentrations on performance and carcass characteristics of Chukar Partridges (*Alectoris chukar*) raised in captivity. *Brit. Poultry Sci.* **3**, 419–426.
- Pieterse, E., Erasmus, S.W., Uushona, T. & Hoffman, L.C. 2019. Black soldier fly (*Hermetia illucens*) pre-pupae meal as a dietary protein source for broiler production ensures a tasty chicken with standard meat quality for every pot. *J. Sci. Food Agric.* **99**, 893–903.
- Pieterse, E., Pretorius, Q., Hoffman, L.C. & Drew, D. 2014. The carcass quality, meat quality and sensory characteristics of broilers raised on diets containing either *Musca domestica* larvae meal, fish meal or soya bean meal as the main protein source. *Anim. Prod. Sci.* **54**, 622–628.
- Poorghasemi, M., Seidavi, A., Qotbi, A.A., Laudadio, V. & Tufarelli, V. 2013. Influence of dietary fat source on growth performance responses and carcass traits of broiler chicks. *Asian-Australas. J. Anim. Sci.* **26**, 705–710.
- Pretorius, Q. 2011. *The evaluation of larvae of Musca domestica (common house fly) as protein source for broiler production*, Doctoral dissertation, Stellenbosch University. 95 pp.
- Ramos-Elorduy, J. 2005. Insects: a hopeful food source. In M.G. Paoletti, ed. *Ecological implications of minilivestock*. Science Pub., Enfield NH, USA pp. 263–291.
- Ramos-Elorduy, J., Gonzalez, E.A., Hernandez, A.R. & Pino, J.M. 2002. Use of *Tenebrio molitor* (Coleoptera: *Tenebrionidae*) to recycle organic wastes and as feed for broiler chickens. *J. Econ. Entomol.* **95**, 214–220.
- Rumpold, B.A. & Schlüter, O.K. 2013. Potential and challenges of insects as an innovative source for food and feed production. *Innov. Food Sci. Emerg. Technol.* **17**, 1–11.
- Sánchez-Muros, M.J., Barroso, F.G. & Manzano-Agugliaro, F. 2014. Insect meal as renewable source of food for animal feeding: A review. *J. Clean. Prod.* **65**, 16–27.
- Schiavone, A., De Marco, M., Rotolo, L., Belforti, M., Martinez Mirò, S., Madrid Sanchez, J., Hernandez Ruiperez, F., Bianchi, C., Sterpone, L., Malfatto, V., Katz, H., Zoccarato, I., Gai, F. & Gasco, L. 2014. Nutrient digestibility of *Hermetia illucens* and *Tenebrio molitor* meal in broiler chickens. In: *Proc. Conference Insects to Feed The World, Abstract Book*. Netherlands, pp. 84.
- Schiavone, A., Cullere, M., De Marco, M., Meneguez, M., Biasato, I., Bergagna, S., Dezzutto, D., Gai, F., Dabbou, S., Gasco, L. & Dalle Zotte, A. 2017. Partial or total replacement of soybean oil by black soldier fly larvae (*Hermetia illucens* L.) fat in broiler diets: Effect on growth performances, feed-choice, blood traits, carcass characteristics and meat quality. *Ital. J. Anim. Sci.* **16**, 93–100.
- Schiavone, A., Dabbou, S., De Marco, M., Cullere, M., Biasato, I., Biasibetti, E., Capucchio, M.T., Bergagna, S., Dezzutto, D., Meneguz, M., Gai, F., Dalle Zotte, A. & Gasco, L. 2018. Black soldier fly larva fat inclusion in finisher broiler chicken diet as an alternative fat source. *Animal*. **12**, 2032–2039.
- Schroegel, P. & Wätjen, W. 2019. Insects for food and feed-safety aspects related to mycotoxins and metals. *Foods*. **8**, 288.
- Secci, G., Bovera, F., Nizza, S. & Baronti, N. 2018. Quality of eggs from Lohmann Brown classic laying hens fed black soldier fly meal as substitute for soya bean. *Animal* **8**, 1–7.
- Song, Y.S., Kim, M.W., Moon, C., Seo, D.J., Han, Y.S., Jo, Y.H., Noh, M.Y., Park, Y.K., Kim, S.A., Kim Y.W. & Jung, W.J. 2018. Extraction of chitin and chitosan from larval exuvium and whole body of edible mealworm, *Tenebrio molitor*. *Entomol. Res.* **48**, 227–233.

- Spranghers, T., Ottoboni, M., Klootwijk, C., Owyn, A., Deboosere, S., De Meulenaer, B., Michiels, J., Eeckhout, M., De Clercq, P. & De Smet, S. 2017. Nutritional composition of black soldier fly (*Hermetia illucens*) prepupae reared on different organic waste substrates. *J. Sci. Food Agric.* **97**, 2594–2600.
- Spranghers, T., Michiels, J., Vrancx, J., Owyn, A., Eeckhout, M., De Clercq, P. & De Smet, S. 2018. Gut antimicrobial effects and nutritional value of black soldier fly (*Hermetia illucens* L.) prepupae for weaned piglets. *Anim. Feed Sci. Technol.* **235**, 33–42.
- Stamer, A. 2015. Insect proteins – a new source for animal feed. *Embo Reports* **16**, 678–680.
- Surendra, K.C., Olivier, R., Tomberlin, J.K., Jha, R. & Khanal, S.K. 2016. Bioconversion of organic wastes into biodiesel and animal feed via insect farming. *Renew Energy* **98**, 197–202.
- Suzuki, M., Fujimoto, W., Goto, M., Morimatsu, M., Syuto, B. & Toshihiko, I. 2002. Cellular expression of gut chitinase mRNA in the gastrointestinal tract of mice and chickens. *J. Histochem. Cytochem.* **50**, 1081–1089.
- Tabata, E., Kashimura, A., Wakita, S., Ohno, M., Sakaguchi, M., Sugahara, Y., Kino, Y., Matoska, V., Bauer, P.O. & Oyama, F. 2017. Gastric and intestinal proteases resistance of chicken acidic chitinase nominates chitin-containing organisms for alternative whole edible diets for poultry. *Sci. Rep.* **7**, 6662.
- Tancharoenrat, P., Ravindran, V., Zaefarian, F. & Ravindran, G. 2014. Digestion of fat and fatty acids along the gastrointestinal tract of broiler chickens. *Poult Sci.* **93**, 371–379.
- Tran, G., Heuzé, V. & Makkar, H.P.S. 2015. Insects in fish diets. *Animal Frontiers* **5**, 37–44.
- Tschirner, M. & Simon, A. 2015. Influence of different growing substrates and processing on the nutrient composition of black soldier fly larvae destined for animal feed. *J. Insects Food Feed.* **1**, 249–259.
- Van der Spiegel, M., Noordam, M.Y. & Van der Fels-Klerx, H.J. 2013. Safety of novel protein sources (insects, microalgae, seaweed, duckweed, and rapeseed) and legislative aspects for their application in food and feed production. *Compr. Rev. Food Sci. F.* **12**, 662–678.
- Van Huis, A., van Itterbeeck, J., Van Klunder, H., Mertens, E., Halloran, A. & Muir, G. 2013. *Edible insects. Future prospects for food and feed security*. Forestry paper 171. Food and Agriculture Organization, Rome, 187 pp.
- Verbeke, W. 2015. Profiling consumers who are ready to adopt insects as a meat substitute in a Western society. *Food Qual. Prefer.* **39**, 147–155.
- Vijver, M., Jager, T., Posthuma, L. & Peijnenburg, W. 2003. Metal uptake from soils and soil-sediment mixtures by larvae of *Tenebrio molitor* (L.) (Coleoptera). *Ecotoxicol. Environ. Safety* **54**, 277–289.
- Woods, M.J., Cullere, M., Van Emmenes, L., Vincenzi, S., Pieterse, E., Hoffman, L.C. & Zotte, A.D. 2019. *Hermetia illucens* larvae reared on different substrates in broiler quail diets: effect on apparent digestibility, feed-choice and growth performance. *J. Insect. Food Feed* **5**, 89–98.
- Zeitz, J., Fennhoff, O.J., Kluge, H., Stangl, G.I. & Eder, K. 2015. Effects of dietary fats rich in lauric and myristic acid on performance, intestinal morphology, gut microbes, and meat quality in broilers. *Poultry Sci.* **94**, 2404–2413.

## **Theoretical and experimental research into impact of threshing tools in combine grain harvesters on quality of cereal crop seeds**

D. Derevjanko<sup>1</sup>, I. Holovach<sup>2</sup>, V. Bulgakov<sup>2</sup>, V. Kuvachev<sup>3</sup> and J. Olt<sup>4,\*</sup>

<sup>1</sup>Zhytomyr National Agroecological University, 7, Staryi Blvd, UA 10008 Zhytomyr, Ukraine

<sup>2</sup>National University of Life and Environmental Sciences of Ukraine, 15, Heroyiv Oborony street, UA 03041 Kyiv, Ukraine

<sup>3</sup>Dmytro Motornyi Tavria State Agrotechnological University, 18<sup>B</sup>, Khmelnytsky Ave, UA 72310 Melitopol, Zaporozhye Region, Ukraine

<sup>4</sup>Estonian University of Life Sciences, Institute of Technology, Kreutzwaldi 56, EE 51006 Tartu, Estonia

\*Correspondence: [jyri.olt@emu.ee](mailto: jyri.olt@emu.ee)

**Abstract.** The theoretical and experimental research into the micro-damaging of cereal crop seeds in the process of their harvesting by combine grain harvesters in relation to the strains, forces and stresses imparted to them by the threshing tools has been carried out. The propagation of deformations and cracks in the seeds as well as the nature of their strength and the damage that is sustained, when the critical load is applied, have been investigated. It has been established that the onset of cracks, the direction of their propagation and their quantity in the bodies of grain seeds depends in the majority of cases on the direction of action of the external forces and the specifics of the seeds' internal biological properties. It has been established that the strength of the grain seed is, apart from the arisen cracks, also under the significant effect of the microtraumas in the germ, endosperm as well as the seed coat and shell. Theoretical calculations have been carried out on the PC and the effect that the drum and rotor threshing apparatus have on the deformation and damage sustained by cereal crop seeds has been substantiated. The said calculations and the obtained graphic relations support the results of the experimental investigations and prove that the macro- and especially micro-damage sustained by the seeds of winter wheat and rye is different, when they are threshed with the use of different types of threshing apparatus, which has a considerable impact on the final quality of the harvested cereal crop seeds. The results obtained in the experimental investigations, field and laboratory tests on the topic of the effect of mechanical loading on the sustained damage and quality of seeds indicate that the damage rate accounted for the work processes of the reaping and postharvest treatment of the cereal crop heaps of different winter wheat varieties with the use of rotor threshing apparatus is 3.1% as compared to the drum threshing apparatus – 6.4%, that is, 2 times lower. The total amount of the seeds with microtraumas collected in the hopper after threshing amounts to 23.0% and 54.0%, respectively, which is a significant difference. Similar results have been obtained in the experimental investigations on the effect of the equipment on the sustained damage and quality of seeds in the cleaning, chemical treatment and sowing of cereal crops.

**Key words:** damage, deformation, drum and rotor threshing apparatus, grain, quality, seed, strength.

## INTRODUCTION

It is common knowledge that winter wheat, rye and other most important valuable cereal crops that occupy large areas of cultivated land play a significant part in, first of all, the food procurement. Therefore, it is of vital necessity to provide for the production of seeds with high quality indices (Harms & Meier, 2006).

In the second half of the last century, research scientists, plant breeders and producers proved and justified the fact that only high quality seeds, subject to all other provisions being equal, provide for the generation of the major part of the further harvest (Vasilenko, 1960). At the same time, the important fact to be pointed out is that there is certain lagging in the development, production and implementation of advanced equipment and technologies for the gathering and postharvest processing of the grain heap, the preparation, transportation, loading and chemical treatment of the seeds and their sowing (Derevyanko et al., 2012; Derevyanko, 2015; Golovvach et al., 2017).

The completed investigations (Drincha, 2006; Derevyanko et al., 2017) have proved that the reduction of the effect that the tools in the equipment have on the process of damaging the caryopses in the course of the performed work processes contributes to substantial improvement of the seed quality indices and growth of the cereal crop yield.

The macro- and micro-damaging, partial and complete breaking of caryopses result from their exposure to mechanical loading in many elements of the work process, starting from the gathering and processing and finishing by the later drilling.

The studies by Golovvach et al. (2017), Derevyanko et al. (2012, 2015, 2017), Fadeyev (2015a, 2015b), Pugachov (1976), Strona (1974), Tarasenko (2003) and others indicate that the caryopses damage rate at the threshing stage exceeds 20%, while at the stages of the further processing of the grain heap and the preparation of the seeds for drilling the damage rate increases significantly, reaching sometimes levels of 60–80%.

According to the data by Drincha (1997, 2006), the rate of damage inflicted on the caryopses at the threshing stage amounts sometimes to 30–35%, while during their preparation even to more than 50%, depending on the moisture content and structure of the grain heap and the mechanical loading.

In recent years, considerable efforts were made by Fadeyev (2015a) for developing conceptually new cleaning and grading units and processing lines and implementing them in the production.

In the formation of the fundamental scientific basis for the theory of interaction between the working surfaces of mechanisms and various materials, including grain mass, a significant contribution has been Vasilenko (1960), Goncharov (1963), Chazov et al., 1981; Adams et al., (1993), Kutzbach et al., 1996; Beck (1999), Drincha (1997; 2006), Strona (1974), Maertens & De Baerdemaeker, (2003), Tarasenko (2003), Tischenko et al. (2011), Miu & Kutzbach, (2008) and Miu (2016).

The intensity of pressing the seeds down and, accordingly, their micro-damaging during the contact between the caryopses and the working surface of the screw, if considered in relation to the angle of helix, has the lowest value, when the said helix angle stays within the range of  $\alpha = 5-10^\circ$ . When the helix angle exceeds  $15^\circ$ , the intensity of the growth is proportional to the angle of helix of the screw turns (Derevyanko, 2015, 2017).

The research by Derevyanko (2015 and 2017) proves that the intensity at which the seeds are pressed and, accordingly, the levels of micro-damage that are inflicted upon them during contact between the caryopses and the screw's working surface, when considered in relation to the angle of helix, has the lowest value when said helix angle remains within the range of  $\alpha = 5-10^\circ$ . When the helix angle exceeds  $15^\circ$ , the intensity of the growth of micro-damage is proportional to the angle of the helix in the screw's turns.

Thus, the profound and comprehensive research into the physical mechanical and biological features of seeds and the development of new technologies together with the modernisation of the tools in order to provide for the minimum amount of caryopses micro-damaging are the efforts that will ensure the production of high quality seeds in compliance with the agricultural engineering requirements and standards.

The aim of this study is to improve the quality of seed separation, and to reduce seed damage rates in all stages of the harvesting process where a grain harvester is used, by way of defining separator tool types and the operating modes in which they are used, and also by developing equipment that is needed for the implementation of such processes in production operations.

## MATERIALS AND METHODS

The impact produced by the deformation, the strength and the damaging of cereal crop seeds during the work processes of their handling from the gathering to the drilling was investigated with the use of the standard methods based on the appropriate sampling and examination of seeds with the use of a tensile-compression test machine (Fig. 1) and a microscope (Fig. 2).

The tensile-compression test machine (Fig. 1) has two drives which can be used to apply a load onto the seeds: one being electromechanical and the hand-operated. For precisely-defined loads, the study used manual loading. The electromechanical drive was used only for large differences in jaw positions. The machine can also store a graph in a PC showing the loading operation.

Tests that were carried out with the bursting machine were conducted in the following sequence: firstly, the

seeds were placed into the bursting machine's jaws. The load could be applied along the longer or shorter axis of the seed. The seed was pressed until it burst. The pressure graph was stored and was then used as a basis for determining the maximum compression load. The maximum deviation for pressure measurements was 1%.



**Figure 1.** A tensile-compression test machine Istron 5969 being used to assess the grain's compression resistance.

The following parameters were determined for the seeds, from the image on the microscope's screen (Fig. 2): the form of endosperm and germ, and the number of cracks and lesions on the endosperm and the germ. These parameters were stored on a PC.

The pneumatic separation unit with rubber coating was improved by introducing the rubber cladding of the casing, which contributes to the reduction of the seed damaging rate and the improvement of the quality of seeds.

The laboratory equipment for the investigation of the effect the mechanical factors have on the strength and damaging of the caryopsis was engineered.

The theoretical investigations and calculations were done by way of the mathematical modelling of the operation of equipment and the work processes, the application of the fundamental laws of mechanics and the state-of-the-art computation methods.

The experimental investigations were carried out under the laboratory and field conditions with the use of field-collected samples of the winter wheat variation, 'Odesskaya - 237' (reproduction - elite).

Once the experimental studies were being conducted, any random variations in the parameters being studied were assessed with the help of the variation coefficient  $\hat{E}$ . Based on its numerical value, the random variations of each parameter were assessed in relation to their average values:

$$\hat{E} = \frac{\sigma}{\bar{x}} \quad (1)$$

where  $\sigma$  – is the standard deviation of the parameter being studied;  $\bar{x}$  – is the average value of the parameter being studied.

The use of the variation coefficient  $\hat{E}$  in the studies made it possible to assess the dispersion of values without being constrained by the scale of the parameter or its unit of measurement. If the coefficient's value was below 10%, the parameter's variation was considered negligible, while within the range of 10% to 20% it was placed at 'medium', and above 20% it was classed as 'significant'.

In accordance with the developed procedure of experimental investigations, the number of samples taken in each type of combine at each frequency of rotation of its threshing drum or rotor and for each variety of wheat was at least 100. Further, in each of the taken samples the broken and micro-damaged caryopses were detected and recorded following also a specially developed procedure in laboratory conditions with the use of the AxioImager 2 microscope with a magnification ratio of 25–1,000. That said, it had been specially arranged that only grain material samples with the mass of 1,000 kernels equal to 42–54 grams were selected. In addition to that, the grain material in the samples was analysed with the use of the standard set of instruments with respect



**Figure 2.** Microscope AxioImager 2 for the macro and micro assessment of seeds.



to its gluten composition, which varied within the range of 28–32%, and protein composition – 13.5–4.5%.

## RESULTS AND DISCUSSION

In the performance of the work processes of gathering a cereal crop, processing the grain heap, preparing the seeds and drilling them, it is necessary to take into account the impact on the caryopsis of those external and internal factors, which give rise to stresses in the caryopsis. The stresses, in their turn, induce the active displacement of the whole organic mass and that causes the distances between individual parts to grow, which results in the weakening of the strength, that is, the reduction of the resistance to breaking of the whole caryopsis. It has also been established that in the further course of the work process, the gradual increase of the mentioned impact takes place, which leads to the growth of the distances between atoms and promotes the development of the conditions that are favourable for overcoming the potential barrier in the transition from the stable equilibrium condition to the unstable one, and later, the said distance between layers of atoms becomes very large, creating all prerequisites for the rise of a slit-shaped formation – the opening that does not close even after the load is removed.

However, the breaking of caryopses, i.e. the development of cracks in them, has to be viewed as a process that takes place in two stages: the rise of the conditions for the generation of the future crack, which implies the physical features of breaking, and the development of its propagation, which involves the fracture mechanics. The disintegration processes at each of these stages follow different patterns, but the relations between these patterns have not until now been analysed sufficiently well. Meanwhile, knowing these relations is exactly what would make it possible to fully understand the process of damaging and especially the interrelation between macro-damaging and micro-damaging.

Among the strength criteria, the conditions triggering the dangerous state at a certain point within the time period under consideration – a topic of the classical theory of failure, are of great importance.

Under a stable strain, the crack remains stationary under the action of constant external loads. Accordingly, for the crack to start developing such loads have to increase, that is, under the effect of changing external factors the damage grows and this happens, when the intensity factor reaches its critical value. The start of the crack propagation, i.e. the crossing of the fracturing boundary, is just that additional criterion needed for solving the problem of the limit equilibrium of a solid with a crack.

Due to the fact that the progress of the process is gradual, a plastic zone emerges at the end of the crack – that means that at the onset of the breaking process the forces are not transmitted via it, but with the growth of the stress at the end of the breaking process additional forces arise in the plastic deformation zone.

As a result of the growth and accumulation of such additional forces, the build-up of micro-faults takes place in the plastic deformation zone and these micro-faults are the basis for the development of conditions for the future rupture or crack formation followed by the complete break-up.

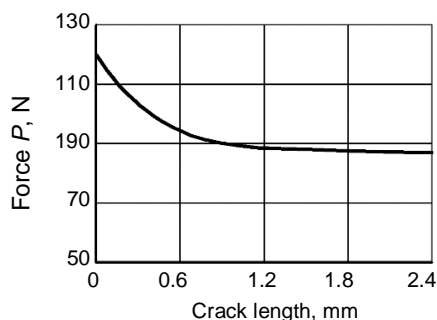
Hence, the disintegration of the caryopsis occurs only in case the maximum stress  $\sigma$  caused by mechanical or other effects exceeds the permissible stress  $\sigma_1$ . Thus, in order to avoid the caryopsis breaking, it is necessary to meet the condition  $\sigma \leq \sigma_1$ .

In those cases, where several cracks of different lengths exist, the greatest threat is constituted by the crack that is the first to start propagating. In all cases, the crack propagation mechanism is uniform and operates with certain fluctuations.

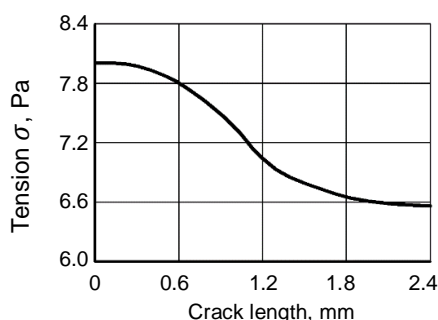
The pattern of caryopses breaking, i.e. to what extent more often and in which plane they break, depends on the propagation of the cracks and how many of them have under the current external load reached the critical length. The direction, in which the crack will propagate, depends in the majority of cases on the direction of the external loads and the biologic state of the caryopsis.

On the basis of the above-mentioned, a conclusion can be made that the strength of caryopses depends on their damaging and rise of cracks in them, while the increase of the latter's sizes causes the caryopses to break, i.e. to sustain macro-damage.

The analysis of the experimental data obtained by the authors makes it obvious that, as the crack's length increases, the force needed to break the caryopsis decreases (Fig. 3). Similarly, the maximum stress needed for breaking, also becomes lower (Fig. 4).



**Figure 3.** Effect of crack's length on force sufficient for breaking caryopsis.



**Figure 4.** Effect of crack's length on maximum stress.

The authors have also established that the strength of caryopses depends also on the damaging of the germ, endosperm and seed coats, i.e. on the micro-damaging (Table 1).

**Table 1.** Effect of various types of damaging on strength of caryopsis

Type of damaging	Breaking force $P$ (N)	Breaking deformation $\Delta L$ (mm)	Maximum stress $\sigma$ (Pa)
Knocked-out germ	46.5	0.15	3.46
Damaged endosperm	78.0	0.24	5.79
Damaged germ	84.4	0.22	6.30
Damaged coats of germ and endosperm	95.3	0.22	7.08
Damaged coat of endosperm	103.6	0.22	7.69
Damaged coat of germ	104.5	0.22	7.70
No damage after threshing	108.3	0.22	8.07
Variation factor %	14.2	9.6	12.8

The analysis of the data presented in Table 1 proves that the caryopses, in which the cracks have propagated to a depth of 0.25–0.75 of the endosperm size or deeper, have significantly lower strength in comparison with those free from such damage.

Table 1 shows that the strength of caryopses is affected by the applied forces that damage the germ, endosperm and coats.

The extent of any variations in the parameters being studied in Table 1 was acceptable, i.e. classed as being at medium, as evidenced by the variation coefficient not exceeding 14.2%.

The maximum stress has effect on the growth of deformations, damaging and breaking, i.e. the micro- and macro-damaging of caryopses.

Hence, the greater loading the caryopses suffer in the course of the work processes, the lower their strength becomes and the greater possibility of their damaging arises.

During the theoretical, field and experimental research into the effect the tools in the threshing machines of combine grain harvesters have on the damaging and quality of caryopses, it was established that the primary areas, where the greatest damaging and breaking was sustained by the caryopses, were situated at the points, where the grain flow velocity vector changes sharply. In view of the fact that the vector can change in terms of both its magnitude and direction, the area of the greatest damaging is located in the first half of the threshing process.

Comparing the makeup of the first half of the threshing process in drum and rotor threshing machines, it becomes obvious that this leg of the process is considerably more ‘economical’ in rotor threshers and that results in significantly lower caryopsis damaging and breaking rates in them, as compared to the drum machines.

The damaging of caryopses results from the impact impulse, which can be determined with the use of the impulse-momentum theorem for the case of impact interaction written in the vector form (Derevyanko, 2015):

$$m\bar{V}_2 - m\bar{V}_1 = \bar{S}(t), \quad (2)$$

where  $\bar{S}(t) = \int_{t_1}^{t_2} \bar{F}(t)dt$  – impact impulse;  $\bar{V}_1$  and  $\bar{V}_2$  – velocity vectors of the grain heap element before its interaction with the beaters in the threshing machine and after passing them, respectively.

The Eq. (2) in terms of its projections on the Cartesian axes appears as follows:

$$\left. \begin{aligned} mV_{2x} - mV_{1x} &= S_x(t), \\ mV_{2y} - mV_{1y} &= S_y(t). \end{aligned} \right\} \quad (3)$$

By using the above-mentioned theorem, from the Eqs (3) the authors have derived analytically the ratio  $P$  between the impact impulses generated in the first half of the threshing process by the drum apparatus and the similar impact impulses in the rotor thresher, which has the following form:

$$P = \sqrt{\frac{V_1^2 + V_{ps}^2 + 2V_1V_{ps} \sin \beta}{V_1^2 + (V_{ps} \cdot \sin \alpha)^2 - 2V_1V_{ps} \sin \alpha \cdot \cos(\alpha + \beta)}}, \quad (4)$$

where  $\beta$  – angle between the velocity vector  $\bar{V}_1$  (i.e. the velocity of grain particles before colliding with the beater bar in the drum thresher or with the rotor in the rotary axial threshing and separating machine) before the impact and the horizontal;  $\alpha$  – angle

between the velocity vector  $\bar{V}_2$  and the horizontal;  $\bar{V}_{ps}$  – circumferential velocity of rotation of the drum or the rotor; also,  $V_2 = V_{ps} \cdot \sin \alpha$

As a result of the subsequent calculations, it has been established that the value of the impact impulse generated, when using drum threshing and separating machines, is considerably higher than that in case of using rotor threshers.

The experimental data for the damage sustained by grain during its threshing in the DON-1500B combine grain harvesters with drum type threshing apparatus and the rotor type threshing and separating apparatus of the John Deere S760 harvesters have been analysed statistically. The analysis of the caryopsis damage rates in relation to the rotation frequencies of the drum and rotor threshing machines presented in Tables 2 and 3 in percentages (i.e. caryopsis micro-damaging and breaking) The said data were obtained as a result of the field experimental investigations carried out in the same conditions by means of threshing with the use of a drum thresher-separator and with the use of a rotor threshing and separating machine and sampling the grain immediately after the threshing. The grain moisture content during the threshing and at the time of sampling was measured with high accuracy and its value was within the range of 13.5–21.5%. The rotation frequencies of the threshing and separating machines in both types of combine grain harvesters were set up at different levels and monitored and recorded in the PC with the use of special sensing elements.

**Table 2.** Damage inflicted on caryopses by drum threshing apparatus in DON-1500B combine grain harvester

Indicator	Caryopsis damage rate (%)							$\hat{E}$
	600	700	750	800	820	900	980	
Drum apparatus revolutions (rpm)	600	700	750	800	820	900	980	-
Broken caryopses	0.79	0.81	1.36	1.44	3.28	4.97	6.14	9.6
Micro-damaged caryopses	26.40	26.86	28.40	31.22	36.60	42.40	52.70	8.8

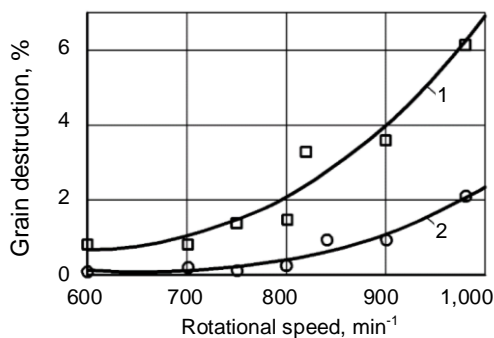
The extent was negligible of variations in the parameters being studied in Table 2 and Table 3, as evidenced by the variation coefficient not exceeding 10.2%.

**Table 3.** Damage inflicted on caryopses by rotor threshing apparatus in John Deere S760 combine grain harvester

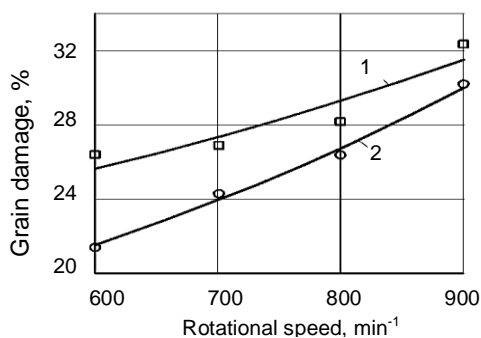
Indicator	Caryopsis damage rate (%)							$\hat{E}$
	600	700	750	800	840	900	980	
Rotor apparatus revolutions (rpm)	600	700	750	800	840	900	980	-
Broken caryopses	0.07	0.17	0.11	0.23	0.75	0.95	2.08	10.2
Micro-damaged caryopses	21.38	24.29	25.07	26.35	28.37	30.12	31.95	9.6

The diagram in Fig. 5 shows the graphic relations between the percentage rates of the caryopses broken by the threshing apparatus of the drum and rotor types and the rotation frequencies of the drum and rotor, respectively.

The graphic relations between the percentage rates of the caryopses micro-damaged by the threshing apparatus of the drum and rotor types and their rotation frequencies are shown in Fig. 6.



**Figure 5.** Relation between percentage rate of broken caryopses and frequency of rotation: 1) drum threshing apparatus; 2) rotor threshing apparatus.



**Figure 6.** Relation between percentage rate of micro-damaged caryopses and frequency of rotation: 1) drum threshing apparatus; 2) rotor threshing apparatus.

The extensive experimental, field and laboratory investigations of the effect produced by the mechanical loads applied during the work processes from the harvesting to the drilling, which have for several years been carried out in various farm units of the Ukrainian Forest Steppe and Polesye with various cereal crops, give evidence of the substantial difference in the micro-damaging of winter wheat seeds harvested with combine grain harvesters equipped with drum threshing machines, as compared to their harvesting with the use of combine grain harvesters with rotor threshing apparatus (Table 4). For example, in the PP Ukraine in the Zhitomir Oblast, the amount of macro-damaging increases to 6.4% after the threshing in a combine grain harvester equipped with a drum thresher, while in a combine grain harvester with a rotor threshing machine it reaches only 3.1%, which means a more than two-fold difference.

**Table 4.** Damage sustained by winter wheat seeds during their harvesting with the use of combine grain harvesters with drum and rotor threshing apparatus

Farm unit (wheat variety)	Exami- nation stages	Macro- damage, %	Micro-damage, %		Total damage of bran	Intact	Composit e index of damage
			Germ Knocked out	Damaged			
PP Ukraine,	in header	3.2	2.2	4.0	22.4	77.6	14.91
Zhitomir Oblast	after drum	6.4	4.0	6.2	41.6	58.4	25.52
(Odesskaya – 237)	in hopper	7.8	4.6	7.8	54.0	45.0	31.64
SVK Mayak	in header	2.8	1.8	2.4	17.2	82.2	6.28
Vinnitsa Oblast	after rotor	3.1	2.2	2.8	21.2	79.8	8.24
(Odesskaya – 237)	in hopper	3.9	2.9	3.1	23.0	77.0	9.23
Variation factor %		10.4	8.8	9.6	12.2	11.8	12.4

As is obvious from the data in Table 4, the total amount of the seeds with micro-damage in the hopper of the combine grain harvester equipped with a drum threshing machine is equal to 54.0%, while in the output of the combine grain harvester with a rotor threshing machine they total 23%. These figures indicate an obvious and substantial difference, that is, a two-fold increase, which is due first of all to the modes of operation

of the threshing implements under consideration, the difference in their revolution rates, and also to the velocity of the grain heap prior to entering and passing the threshing work process.

It is also worth noticing that the macro- and micro-damaging and cracking take place in organic matter, that is, in a biologically living caryopsis, which implies a considerable effect on the quality factors, on which the yield depends to a significant extent.

The extent of any variations in the parameters being studied in Table 4 was acceptable, ie. they were classed as being at medium, as evidenced by the variation coefficient not exceeding 12.2%.

In the above context, the obtained data can be considered as a convincing proof of the need for the practical application of efficient and high-performance equipment during the harvesting, processing and drilling of the seeds with the aim of ensuring their higher quality, which will provide for obtaining high yield and a considerable growth of the gross output of grain – a fundamental element in the human food supply.

## CONCLUSIONS

1. The completed research work has proved that various kinds of macro- and micro-damaging have a substantial impact on the strength of caryopses, in particular, the breaking forces increase more than 2.5 fold, the breaking deformation increases to 0.22 mm, the maximum stress increases more than twofold.

2. The ratio between the impact impulses generated in the first half of the threshing process by drum and rotor machines has been found analytically.

3. The analytical calculations carried out prove that the impact impulse generated in the drum threshing apparatus considerably exceeds the one in the rotor machine, which is supported by the results of the experimental investigations on grain damaging.

4. When the revolution rate of the drum increases from 600 to 980 rpm, the amount of macro-damaged caryopses increases from 26.4% to 52.7%, while the same speed-up of the rotor results in a change from 21.38% to 31.95%.

5. Hence, the theoretical calculations and the obtained graphic relations for the caryopsis micro-damaging and breaking rates support the results of the experimental field research, which indicate that these negative indicators are significantly higher in case of employing drum threshing machines, as compared to the rotor threshers, that is, the damaging and breaking of winter wheat and rye seeds during their harvesting with the use of rotor combine grain harvesters is significantly less intensive, therefore, the quality of seeds is higher.

## REFERENCES

- Adams, A., Bloomfield, D., Booth, P. & England, P. 1993. *Investment mathematics and statistics*. Kluwer Law International, London, 410 pp.
- Beck, F. 1999. *Simulation der Trennprozesse im Mädröschler*. [Simulation of separation process in combine harvesters] PhD dissertation, Stuttgart University, Fortschritt-Berichte, VDI Reihe 14(66).
- Chazov, S., Šelepen, P. & Vochky, Z. 1981. Damaging seeds and ways of reducing that in power-driven processing, threshing, screening. *Ukrainian Crop Fields* 8, 41–43.

- Derevyanko, D.A. 2015. *Effect of technical means and work processes on damaging and quality of seeds*. Monograph, Zhitomir, 772 pp. (in Ukrainian).
- Derevyanko, D., Sukmaniuk, E. & Derevjnko, O. 2017. Grain crops injuries and drying modes while seeds preparation. *INMATEH – Agricultural Engineering Journal* **53**(3), pp. 89–94.
- Derevyanko, D.A., Tarasenko, O.P. & Orobinski, V.I. 2012. *Impact of damaging on quality of cereal crops*. Monograph, Zhitomir, 438 pp. (in Ukrainian).
- Drincha, V.M. 2006. *Research into separation of seeds and development of machine technologies for their preparation*. Voronezh, 382 pp. (in Russian).
- Drincha, V.M. & Sukonin, L.M. 1997. Technology and set of machines for cleaning grain and seeds. *Agriculture* **3**, 34–35 (in Russian).
- Fadeyev, L.V. 2015a. *Strong seeds into every field*. Kharkov, SPETs EMM, 176 pp. (in Russian).
- Fadeyev, L.V. 2015b. *Don't beat seed – it is basis of human life*. Kharkov, 96 pp. (in Russian).
- Golovach, I.V, Derevyanko, D.A. & Derevyanko, O.D. 2017. Damaging seeds when drying them with technical means. *All-Ukraine Research and Technology Journal, VNAU* **96**(1), 78–82. (in Ukrainian).
- Goncharov, Ye.S. 1963. *Research into process of separation of grain materials using centrifugal and vibration screens*: Abstract of Candidate of Science (Engineering) Thesis. Kiev, 40 pp. (in Russian).
- Harms, H.-H. & Meier, F. 2006. *Yearbook Agricultural Engineering / Jahrbuch Agrartechnik*. Band 18, VDMA Landtechnik, 267 pp.
- Kutzbach, H.-D., Wacker, P. & Reitz, P. 1996. *Developments in European combine harvesters*. AgEng Paper 96A-069.
- Maertens, K. & De Baerdemaeker, J. 2003. Flow rate based prediction of threshing process in combine harvesters. *Applied Engineering in Agriculture* **19**(4), 383–388.
- Miu, P. 2016. *Combine Harvesters. Theory, Modeling Design*. CRC Press, Taylor & Francis Group, 460 pp.
- Miu, P. & Kutzbach, H.-D. 2008. Modeling and simulation of grain threshing and separation in threshing units. Part II. Application to tangential feeding. *Computers and Electronics in Agriculture* **60**(1), 105–109.
- Pugachov, M.A. 1976. *Damaging grain by machines*. Moscow, 320 pp. (in Russian).
- Strona, I.G. 1974. Damaging of cereal crop seeds and yield. *Biology and technology of seeds*. Kharkov, 122–129 (in Russian).
- Tarasenko, A.P. 2003 *Reduction of seed damaging in harvesting and postharvest treatment*. Voronezh, 301 pp. (in Russian).
- Tishchenko, L.N., Olshanski, V.P. & Olshanski, S.V. 2011. *Separation of grain mixtures with vibrating screens*. Kharkov, Gorpechat (City Print), 280 pp. (in Russian).
- Vasilenko, P.M. 1960. *Theory of particle's motion on rough surfaces of agricultural machines*. Kiev: UAAS, 284 pp. (in Russian).

## **Production of bioethanol from biomass in the conditions of Northern Kazakhstan**

S.B. Ismuratov<sup>1</sup>, T.V. Bedych<sup>1</sup>, T.I. Gluchshenko<sup>2</sup>, D.S. Ismuratov<sup>3</sup> and V.S. Kukhar<sup>4,\*</sup>

<sup>1</sup>M. Dulatov Kostanay Engineering and Economic University, Department of Energy and Mechanical Engineering, 59 Chernyshevskogo Str., KZ110000, Kostanay, Kazakhstan

<sup>2</sup>A. Baitursynov Kostanay State University, Agricultural and Technical Institute, Department of Energetics, Str., Baitursynova 47, KZ110000, Kostanay, Kazakhstan

<sup>3</sup>Almaty Management University, Doctoral PhD, Str., Rozybakieva 227, KZ050060 Almaty, Kazakhstan

<sup>4</sup>Ural State Agrarian University, Faculty of Engineering Technology, Street Karl Liebknecht 42, RU620075, Yekaterinburg, Russia

\*Correspondence: viktorurgau@mail.ru

**Abstract.** This article describes using renewable energy for bioethanol production. Kostanay Region is a developed agricultural region. Most part of its area is under grain crops and corn, oil crops and vegetables. In the course of production, transportation, storage and processing of agricultural crops, a large part of them becomes unsuitable for use; in future they cannot be used for the intended purpose. Substandard product often stays in the fields to rot or is thrown away. Information considered in this article demonstrates that agricultural waste can be used to produce rather inexpensive bioethanol. Most part of the population in this region is rural. Settlements are far apart from each. It would be reasonable to use bioethanol as a source of electric and thermal energy to meet the needs of rural residents and infrastructure. Wastes from bioethanol production can be used for feeding animal stock what is also important for rural areas and reduces environmental burden. In the course of human life, solid waste is formed that is suitable for producing bioethanol, and consequently, for generating thermal and electric energy. Presented calculations show the feasibility of processing municipal solid waste into bioethanol. EU countries successfully use researches performed by their scientists for developing technologies for the production of bioethanol and synthetic fuels. Kazakhstan, with its experience in cultivation of oilseeds and required planted area, can successfully develop bioethanol industry. No researches in this respect have been conducted to this day in Kazakhstan. Using bioethanol provides consumers with their own energy sources that meet quality standards, thereby increasing energy security of region, reducing the amount of harmful emissions into the atmosphere, and creating small-scale energy enterprises where rural residents can work.

**Key words:** biomass, bioethanol, municipal solid waste, sewage sludge, renewable energy sources.



## INTRODUCTION

Biomass is the most universal source of renewable energy. As a result of photosynthesis, plants are able to accumulate energy and to flexibly use it for different purposes. As a rule, solid biomass, gas obtained from biomass and liquid combustible substances suitable for combustion in internal combustion engines and furnaces are used. Using biomass can reduce the problems associated with the processing of household and agricultural waste. Moreover, agricultural regions receive a double benefit: they create additional jobs both in agriculture and forestry, and in the process of bioenergy conversion (Rocha-Meneses et al., 2017). Growing crops for bioenergy provides farmers with a new activity area.

Bioenergy allows decentralizing energy production and creates a closed cycle of materials and energy. Biomass emits only the amount of carbon dioxide that was absorbed by plants during their growth. Biofuel is neutral in terms of CO<sub>2</sub> balance (Kundas et al., 2009).

Bioenergy sources can vary a lot. They differ in the way of generation, properties obtained during burning, and possible use. Bioenergy can be used to produce solid, liquid and gaseous fuels (Sibikin & Sibikin, 2009; Chetoshnikova, 2010).

Solid biomass being the most widely used renewable energy source has been used for generating energy for a long time all around the world. Solid biomass includes all types of dry or dried plants or their parts, in particular, wood, wood pellets and briquettes, wood chips, straw and straw granules, rice husk, etc. Energy obtained from burning solid biomass in modern heating systems is used with high performance (Yang et al., 2019). Wood is the primary source of energy, especially in the form of firewood, chips and pellets (McKendry, 2002; Girones & Peduzzi, 2018).

Biogas is used mainly in block-type thermal power stations but it is also used for direct supply to natural gas supply systems.

Currently, the main types of biofuels are biodiesel and bioethanol. Bioethanol is mainly used for vehicles.

Plants containing a large amount of oils, such as rapeseed, sunflower seeds, soybeans, nuts and palm seeds (Ismuratov et al., 2019), are used to produce biodiesel. Bioethanol is obtained from biomass containing sugar and starch.

Using biofuels is less dangerous for people and environment. Biofuel combustion is almost neutral in terms of CO<sub>2</sub> balance.

Like ordinary alcohol, bioethanol is obtained by fermentation of sugars with yeast and then purified. If grain crops are used, then enzymatic reaction leads to starch breaking and its conversion into sugar. This results in the formation of a by-product in the form of distillers grain that contains about 30% protein and is therefore a valuable animal feed (Glushchenko et al., 2019). In the production of bioethanol from sugar beets, the waste is distillers grain and the pulp of sugar beets that are used as animal feed or fertilizer (Kundas et al., 2009). Production of one liter of bioethanol results in one kilogram of post-alcohol distillers grain. Thus, one hectare of sugar beet produces amount of fuel that is sufficient for a mileage of more than 80,000 km, and the resulting feed is enough for 9 months, per 1 cow.

The goal of this research is to study potential sources for developing bioethanol production in the region. It offers a comprehensive solution to the problem of environmental pollution, as well as meeting social needs for environmentally friendly

fuel sources and development of renewable energy in combination with the existing cultivation of agricultural crops and the processing of human waste.

Watermelons are grown in the northern part of Kazakhstan, and their waste can be used for bioethanol production. More than 5,103.4 tons of melons are grown in the Kostanay region. Farm households of the region grow 3,673 tons. In addition, melons are imported from other regions of Kazakhstan. The most part of these cultures is produced in southern regions: South Kazakhstanskaya (64%), Zhambylskaya (15%), Kyzylordinskaya (6.4%) and Almatinskaya (5.4%) regions. More than 80% of melons are grown in farm households (Source: Republic of Kazakhstan Statistics Committee, 2018). Analysis of statistical data shows that increased production of melons leads to increased waste from these cultures. Therefore, it is reasonable for this region to develop the production of bioethanol as a by-product. Traditional farms of the Kostanay region grow cereals, corn, sunflower and potatoes; waste from these crops is suitable for obtaining bioethanol. Another high-potential source for bioethanol production is municipal solid waste (Chandra et al., 2012; Raud et al., 2014). The amount of household waste is calculated exponentially. Human activity generates waste, and only human is able to change this process for the benefit of society and environment.

## **MATERIALS AND METHODS**

### **Analysis of the potential for obtaining bioethanol from biomass**

To determine the potential, a comparative analysis of crops used for bioethanol production was carried out based on the experience of EU and American countries. Standards for bioethanol yield from different crops were studied. For this, academic papers made by world-class scholars in this field were used. Based on statistical reports of the Ministry of Agriculture of the Republic of Kazakhstan and Agriculture Department of the Kostanay region over the past ten years, we determined crops among those grown in the Kostanay region that were suitable for bioethanol production. Based on this material, a list of crops with their gross yield, amount of waste and bioethanol yield was developed. Based on world prices for bioethanol, total cost of bioethanol was defined.

### **Analysis of the potential for obtaining bioethanol from municipal solid waste**

Studying and analyzing the experience of leading countries in recycling municipal solid waste allows making conclusions on its application in the region. On the basis of materials provided by Atameken National Chamber of Entrepreneurs, the country has a very low rate for the recycling municipal solid waste, in particular, plastic. Waste potential was defined using methods for assessing the gross potential of municipal solid waste according to population data. Population base of the region was determined on the basis of demographic data for this region.

## **RESULTS AND DISCUSSION**

Only in the Kostanay Region, cereals and oil crops are annually grown (Table 1) that produce significant amount of waste, and they can be used to obtain bioethanol.

The agricultural sector of Kazakhstan has traditionally been growing watermelons for public consumption (Glushchenko et al., 2019). In recent years, the area under gourds

increased by about 40%. Production of gourds in Kazakhstan fully meets the needs of population.

If we talk about watermelons, overripe and damaged during growth watermelons remain in fields. Watermelons can be damaged by birds, so they can't reach full ripeness, lose marketable appearance and rot in fields. Part of them is damaged during transportation and becomes unsuitable for use.

More than 20% of watermelons do not hit store shelves due to the lack of a 'marketable' appearance: they are damaged or irregular in shape, so, they can be used to produce bioethanol.

**Table 1.** Potential for producing bioethanol from crops

Type of biomass	Gross yield, (thousand tons)	Amount of waste, (thousand tons)	Ethanol yield per ton of raw material, (thousand tons)	Ethanol yield, total (ton)	Price per ton, (tenge)	Total, (thousand tenge)
Grain crops	4,454.56	668,184	455	304,023.7	52,780	16,046,371.9
Corn for grain	125.06	18,759	412	7,728,708	49,010	378,783.9
Watermelons	205.83	41,166	21	864,486	36,569	31,613.4
Potatoes	373.31	37,331	94	3,509,114	60,320	211,669.8
<b>TOTAL</b>						<b>16,636,825.6</b>

In addition to specified biomass sources, ethanol can be produced from straw and fruits of cultivated plants: apples, cherries, pears. In the area of Northern Kazakhstan, despite its extremely continental climate, fruits are cultivated; so, the waste and low-quality fruits can be used for ethanol production (Bauer et al., 2009; Vissarionov, 2009).

This study demonstrates the feasibility of processing agricultural waste into bioethanol.

In addition to abovementioned sources for the production of ethanol, municipal public owned treatment plants, organic waste from certain industrial sectors, and municipal solid waste landfills can also be used (Raud et al., 2014).

Norms for municipal solid waste (MSW) are the following:

- for urban residents – 1.2 kg per<sup>1</sup> day at the humidity of 50%;

- for rural residents – 0.52 kg per<sup>1</sup> day (it is assumed that food waste in rural areas is used for feeding domestic animals and birds and is not included in waste).

**Table 2.** Economic potential of solid waste

Name of district or settlement	Population (number)	Gross energy potential (SW) (ton of reference fuel)
Altynsarinsky	14,114	535.77
Amangeldinsky	16,673	632.91
Auliekolsky	42,991	1,631.94
Denisovsky	18,824	714.56
Dzhangildinsky	12,550	476.40
Dzhetygarynysky	48,755	1,850.74
Kamystinsky	12,764	484.52
Karabalyksky	27,966	1,061.59
Karassusky	25,834	980.66
Kostanaysky	70,468	2,674.97
Mendygarynysky	27,841	1,056.84
Naurzumsky	11,080	420.60
Sarykolsky	20,976	796.25
Taranovsky	25,432	965.40
Uzunkolsky	21,479	815.34
Fedorovsky	25,953	985.18
Arkalyk	41,354	3,622.61
Kostanay	239,652	20,993.52
Lisakovsk	40,842	3,577.76
Rudny	130,068	11,393.96
<b>TOTAL</b>		<b>55,671.52</b>

Calorific value (MSW) is set equal to 0.2 tons of reference fuel (oil equivalent) per ton of dry matter (MSW). Household waste is considered dry at the humidity of 50% (Vitkovskaya et al., 2012).

Economic potential of solid waste generated in the region during one year is shown in Table (Table 2).

According to ‘Atameken’ National Chamber of Entrepreneurs, by 2018 Kazakhstan produced over 43 billion tons of production and consumption waste, only 9% of which are recycled. Paper, tires and some types of plastic are most often recycled in this country. Separate waste collection campaigns have been started in major cities, and new processing plants are being launched. Main raw material here is recycled waste paper.

Paper and packaging waste is collected throughout Kazakhstan: it is not only about 14 regional centers and three cities of republican subordination. There are also partners in several border regions of Russia.

As a result of solid waste recycling, about one million tons of ethanol can be produced (Table 3).

If we assume that every third resident uses about two kilograms of newspapers and magazines a year, then we can additionally get more than six hundred tons of ethanol (Grinin, 2002).

**Table 3.** Potential for bioethanol production from solid waste

Type of biomass	Gross yield, (thousand tons)	Ethanol yield per ton of raw material, (ton)	Ethanol yield, total (ton)	Price per ton, (tenge)	Total (thousand tenge)
SW	55,671.52	17	946,415.8	9,425	8919,969,292
Newspapers and magazines	22,182	29	643,278	5,655	3637,737

## CONCLUSIONS

The above calculations show that settlements of the region can in whole or partially meet its needs for energy sources. Considering that about one million tons of solid waste is burned in Kostanay landfills during one year, waste recycling will completely provide the city with fuel.

In addition to saving energy resources, such a source creates a culture of waste processing and the most careful attitude to nature and provides energy independence from centralized suppliers of electric and thermal energy. As a result of this study, we can make the following conclusions:

- Processing agricultural waste into bioethanol will allow peasant farms receiving an additional source of renewable energy;
- Distillers grain being the result of processing crop waste can be used for feeding animals;
- plastic recycling will reduce environmental stress, contribute to establishing plants for processing this waste and offer the society a non-waste production algorithm;
- Obtained this way environmentally friendly fuel can be used for the production of thermal and electric energy in conditions of remoteness of consumers from the central gas supply.

## REFERENCES

- Bauer, A., Busch, P., Friedl, A. & Amon, T. 2009. Analysis of methane potentials of steam-exploded wheat straw and estimation of energy yields of combined ethanol and methane production. *Journal of Biotechnology* **142**(1), 50–55.
- Chandra, R., Takeuchi, H. & Hasegawa, T. 2012. Methane production from lignocellulosic agricultural crop wastes: A review in context to second generation of biofuel production. *Renewable and Sustainable Energy Reviews* **16**(3), 1462–1476.
- Chetoshnikova, L.M. 2010. *Unconventional Renewable Energy Sources*. Study Guide, Chelyabinsk, Russia, 69 pp.
- Girones, V.C. & Peduzzi, E.F., 2018. On the Assessment of the CO<sub>2</sub> Mitigation Potential of Woody Biomass. *Frontiers in Energy Research: Book 5*, Article No.: UNSP 37 Published: JAN 24.
- Glushchenko, T., Bedych, T., Podvalnyy, V. & Cherkasov, Y. 2019. The structure of closed energy cycle with self- regenerating soil fertility. *Atlantis press Advances in Intelligent Systems Research*, volume **167** *International Scientific and Practical Conference Digitization of Agriculture – Development Strategy*, (ISPC 2019), pp. 306–309.
- Grinin, A.S. 2002. *Industrial and household waste. Storage, utilization, recycling*. Moscow, Russia, Grand FAIR-PRESS, pp. 330–334.
- Ismuratov, S.B., Bedych, T.V., Glushchenko, T.I., Ismuratov, D.S. & Kukhar, V.S. 2019. Forecasting model for capacity of autonomous power station. *International Journal of Mechanical Engineering and Technology (IJMET)*, Volume **10**, Issue 02, 0976-6340 and ISSN Online: 0976-6359
- Kundas, S.P., Pozniak, S.S. & Shenets, L.V. 2009. *Renewable energy sources*, Minsk, Belarus, 315 pp.
- McKendry, P. 2002. Energy production from biomass (part 2): conversion technologies *Bioresource Technology* **83**, pp 47–54.
- Raud, M., Kesperi, R., Oja, T., Olt, J. & Kikas, T. 2014. Utilization of urban waste in bioethanol production: Potential and technical solutions. *Agronomy Research* **12**, 397–406.
- Rocha-Meneses, L., Raud, M., Orupöld, K. & Kikas, T. 2017. Second-generation bioethanol production: A review of strategies for waste valorization. *Agronomy Research* **15**(3), 830–847.
- Sibikin, Yu,D. & Sibikin, M.Yu. 2009. *Unconventional renewable energy sources*. Moscow, Russia, 232 pp.
- Vitkovskaya, S.E. 2012. Solid domestic waste is an anthropogenic link in biological cycle. St. Petersburg, Russia, 132 pp.
- Vissarionov, V.I. 2009. *Methods for calculating renewable energy resources*. Study Guide. Moscow, Russia, 144 pp.
- Yang, Ziqi, Wu, Yuanqing, Zhang, Zisheng. 2019. Recent advances in co-thermochemical conversions of biomass with fossil fuels focusing on the synergistic effects. *Renewable & sustainable energy reviews Book 103*, Published: APR, pp 384–398.

## **Intra-annual height growth dynamics of Scots and lodgepole pines and its relationship with meteorological parameters in central Latvia**

A. Jansons<sup>1,\*</sup>, J. Dzenis<sup>2</sup>, R. Matisons<sup>1</sup>, V. Samariks<sup>1</sup> and B. Jansone<sup>1,3</sup>

<sup>1</sup>Latvian State Forest Institute ‘Silava’, Rigas 111, LV 2169 Salaspils, Latvia

<sup>2</sup>Nature Conservation Agency, Baznīcas 7, LV 2150 Sigulda, Latvia

<sup>3</sup>Latvia University of Life Sciences and Technologies, Forestry Faculty, Liela 2, LV-3001 Jelgava, Latvia

\*Correspondence: aris.jansons@silava.lv

**Abstract.** The Scots pine (*Pinus sylvestris* L.) is the second-most widely used tree species in forestry in Latvia and is the only species used for afforestation on nutrient poor soils that cover considerable forest land in Latvia. Several studies have shown that, in such conditions, the lodgepole pine (*Pinus contorta* var. *latifolia*) may be more productive in terms of biomass and yield. It is important to consider climate change studies to assess the potential for a larger-scale use of the lodgepole pine in forestry. The aim was to assess the intra-annual height growth patterns of both species, the differences between them, and the influence of meteorological parameters on their height growth. Their height growth was monitored on a weekly basis in two sampling sites in central Latvia, and the height increment curves were described by Gompertz’s model. The height growth dynamics of individual trees and species differed notably, indicating the potential for the selection of the best-adapted genotypes. Our results indicate that the early onset of the active growth phase might be the most important factor determining the total height increment for both species. Temperature-related meteorological parameters were the only ones with a statistically significant influence on pines height growth and only when at least one of the variables were standardised prior to the analysis. A temperature increase had a slightly stronger positive effect on the growth of the lodgepole pine, indicating that it might be suitable for more intensive use in forestry under the climate change scenarios for Latvia.

**Key words:** apical growth, growth intensity, height increment, *Pinus contorta*, *Pinus sylvestris*.

### **INTRODUCTION**

The adaptation of forestry to the foreseen climate change scenarios might be one of the greatest challenges for modern forestry (Millar et al., 2007; Lindner et al., 2010; McLane et al., 2011a). Apical or the height growth of trees is among the most important factors to assess regarding species selection for future forestry to ensure that the use of species and families is as productive as possible and is less vulnerable to the changing environment (Neimane et al., 2016). Over the last several decades, the vast majority of studies in the field of dendroclimatology have focused on assessing the influence of climate on tree radial growth (Speer, 2010; McLane et al., 2011a; Seidling, 2012;

Rimkus et al., 2018). However, studies on the relationship between climate and height growth have been scarce (McCarroll et al., 2003; Lindholm et al., 2009a), presumably due to the complexity of gathering data on height increments in comparison to collecting data on radial increments (Jansons et al., 2013). Furthermore, in most of these studies, the climate effect on the inter-annual height growth has been assessed (Pensa et al., 2005; Lindholm et al., 2009b), while the intra-annual height growth and its determinants have been less studied (Neimane et al., 2016).

The height growth of monocyclic tree species, such as the Scots pine (*Pinus sylvestris* L.) and lodgepole pine (*Pinus contorta* var. *latifolia*), is influenced by the conditions of the previous growing season, affecting bud development and inducing stem units and storage of carbohydrates, and of the current growing season, affecting the timing and speed of shoot elongation as well as assimilation (Jalkanen & Tuovinen, 2001; Salminen & Jalkanen, 2005; Lindholm et al., 2009a). Regarding pine species, most studies on height growth and the climate relationship have been conducted in areas close to the northern distribution border of particular species (Jalkanen & Tuovinen, 2001; Pensa et al., 2005). In northern regions, due to the short length of the growing season, the role of the current-year meteorological conditions in determining the annual height increment might be less important than in regions with a longer growing season.

Another obstacle to assess climate and the intra-annual height growth relationship is the sigmoidal pattern of height growth with the obvious phase of active growth and the less intense growth prior and afterwards, which does not correspond to the intra-annual trend of meteorological conditions. However, this intra-annual height growth trend can be described using nonlinear growth models, such as Gompertz's model (Fekedulegn et al., 1999). The coefficients of these models can be used to evaluate the growth dynamics between species, families of particular species, or even on the tree level, thus providing a tool for selecting genotypes with the necessary traits (e.g. higher total increment or more rapid growth) (Neimane et al., 2016).

The Scots pine is the most widely used species in forestry in Latvia, covering 33% of all the forest area (Ministry of Agriculture, 2019). One of the major causes for such intense use and natural distribution of the Scots pine is its ability to occupy nutrient-poor and sandy soils (Richardson, 2000). Forests growing on nutrient-poor soils compose 16% of the total forest area in Latvia. From these forests, a notable part is located on sandy soils, occupying 282,000 ha of forest land. Currently, afforestation is ongoing to a large extent in nutrient-poor soils, and these areas are used only for establishing Scots pine stands.

However, several studies have shown that the lodgepole pine can demonstrate higher productivity (both in terms of yield and biomass) in such conditions (Elfving & Norgren, 1993; Elfving et al., 2001; McLane et al., 2011b; Jansons et al., 2013; Fries et al., 2017). Moreover, information on the cause of such differences in productivity between these two *Pinus* species is scarce. Furthermore, several recent studies have focused on solutions, such as early thinning, using small-scale forest machinery, and simplifying the assortment system to secure high growth rates in such afforested territories (Kalēja et al., 2014; Prindulis et al., 2015; Lazdiņš et al., 2016), while the potential of a wider use of the lodgepole pine has been poorly analysed. The aim of the study was to assess the formation of the intra-annual height increment of the Scots pine and lodgepole pine and the relationship between the meteorological parameters and

height growth to better understand the potential for a more intense use of these species in Latvia, considering the foreseen changes in the climate.

## MATERIALS AND METHODS

### Study area and sampling sites

The sampling sites were located in central Latvia, 13 km apart in Zvirgzde (56°39' N, 24°27' E) and Daugmale (56°47' N, 24°35' E) for the lodgepole pine and Scots pine, respectively. Both sampling sites were situated on a flat relief, and the elevation was between 20 and 30 m a.s.l. The lodgepole pine sampling site in Zvirgzde was an experimental (provenance) trial planted in 2000 with two-year-old bare-rooted seedlings. The forest type in the lodgepole pine sampling site according to the classification system used in Latvia (Bušs, 1976) corresponded to *Vacciniosa* in nutrient-poor mineral soil. The Scots pine was represented by open pollinated families of plus-trees selected in Latvia. Each family consists of progenies of a single mother tree, all together there were 22 families. The Scots pine sampling site in Daugmale was located in nutrient-poor mineral soil and corresponded to the *Cladinoso-callunosa* forest type (Bušs, 1976). The age of the trees at the time of measurement was 6 years.

The climate in the study area is determined by dominant western winds that bring moist and warm air masses from the Baltic Sea and the Atlantic, resulting in mild and oceanic weather throughout the year. According to the data from the nearest meteorological station of the Latvian Environment, Geology, and Meteorology Centre, the mean annual temperature is about 5.5 °C, and the annual precipitation ranges from 500 to 650 mm. The monthly mean air temperature ranges from ~-5 °C to 17 °C. January is the coldest month, and July is the warmest month. The length of the vegetation period is around 185 to 190 days.

### Sampling and meteorological data

The intra-annual height growth of both species was monitored on a weekly basis by measuring the increment of the apical shoot. The measurements started in year 2012 in the middle of April for the Scots pine and at the beginning of May for the lodgepole pine sampling site and ended in the middle of July (2012) for both sites. For height growth monitoring in both sampling sites, trees were selected randomly, avoiding trees with visible insect or browsing damage. In total, the height growth was monitored for 71 lodgepole pines and 468 Scots pines.

Near the Zvirgzde sampling site, the meteorological conditions were monitored on-site for the whole time of analysis by the meteorological station Wireless Vantage Pro2 (Davis Instruments) to obtain data on the air temperature, precipitation, air humidity, solar radiation, and atmospheric pressure. Daily temperature data were also obtained from the nearest meteorological station of the Latvian Environment, Geology, and Meteorology Centre – Lielpeci.

### Data analysis

To describe the intra-annual height growth of the monitored trees (individually, between and within species) the nonlinear Gompertz model was fitted (1):



$$f(A) = \alpha \exp(-\beta \exp(-\kappa A)) \quad (1)$$

where  $\alpha$  – asymptote parameter;  $\beta$  – displacement parameter or biological constant;  $\kappa$  – growth rate parameter;  $A$  – days since the beginning of the year.

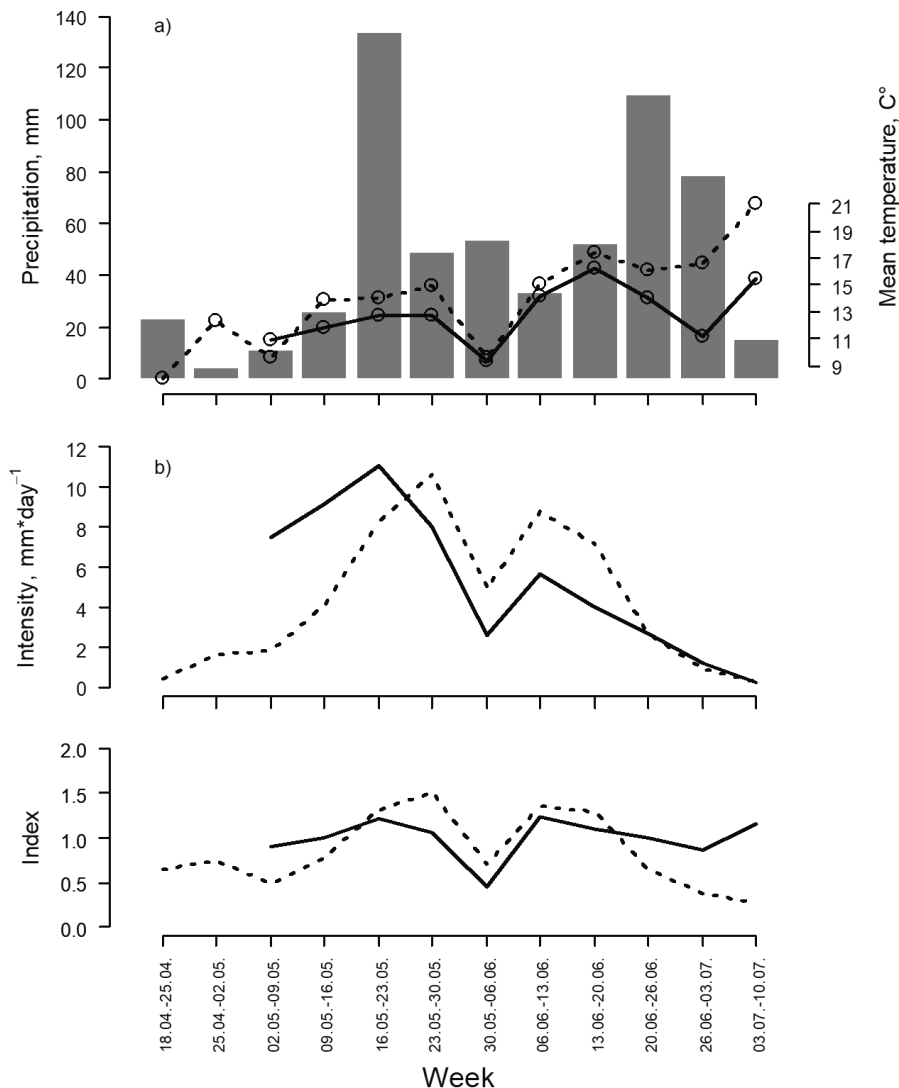
Gompertz's model has been used for both intra-annual height growth (Fekedulegn et al., 1999) and intra-annual radial growth (Seo et al., 2011) curve development in biology. The coefficients of Gompertz's model parameters were used to assess the differences in height growth trends at a species level: lodgepole pine vs. Scots pine, as well as within species (between Scots pine families). The  $F$  test was used to compare the variances of the Gompertz model coefficient values between the two species, whereas the  $t$ -test was performed to compare the mean values (the normality was checked by graphical inspection). The differences in values of the Gompertz model parameters between families of Scots pine were assessed using the analysis of variance. Pearson's correlation analysis was used to assess the relationship between the total annual height increment and the coefficients of Gompertz's model.

During the first stage of analysis, the raw data of both the height growth intensity (intensity defined as height increment  $\text{mm day}^{-1}$ ) and meteorological parameters were used. Prior to the next two steps of analysis, either data on the height growth intensity or data on both the height growth intensity and meteorological parameters were standardised. The standardisation was conducted by applying a cubic-smoothing spline, thus reducing the intra-annual biological and meteorological trends of the analysed variables. The cubic-smoothing spline is an empirical model that uses a flexible curve, which is allowed to adjust at a regular interval and has been considered to provide an organic fit to the data (Speer, 2010). All steps of the data analysis were carried out using the statistical software R 3.3.2. (R Core Team, 2013).

## RESULTS AND DISCUSSION

Even though the height growth intensity trends of the lodgepole pine and Scots pine showed similar patterns, especially the sharp decrease in height growth intensity in the last week of May, the correlation of these variables was not statistically significant ( $r = 0.59$ ;  $P > 0.05$ ). Due to the too-late start of height growth monitoring in the sampling site at Zvirgzde in this study, the exact onset of the height growth was missed for the lodgepole pine. Both species reached the maximum of their height growth intensity within May 2012, but slight differences exist in the timing of the most intense growth. The lodgepole pine reached the peak of its height growth intensity of  $11.02 \pm 2.12 \text{ mm day}^{-1}$  (mean  $\pm$  standard deviation) earlier than the Scots pine, and after reaching the peak, the height growth intensity gradually decreased (Fig. 1, b, c). Meanwhile, the Scots pine reached a maximum height growth intensity of  $10.61 \pm 2.71 \text{ mm day}^{-1}$  (mean  $\pm$  standard deviation) one week later but kept relatively intense growth for a slightly longer period. Such intense height growth early in the growing season is associated with the use of stored carbohydrates along with the ability of the pine species to produce around 30% of the whole growing season in photosynthates in spring in favourable conditions (Dougherty et al., 1994; Hansen & Beck, 1994; Strand et al., 2002). Considering the small distance between both sampling sites, the different timing of the most active phase of height growth might be caused by

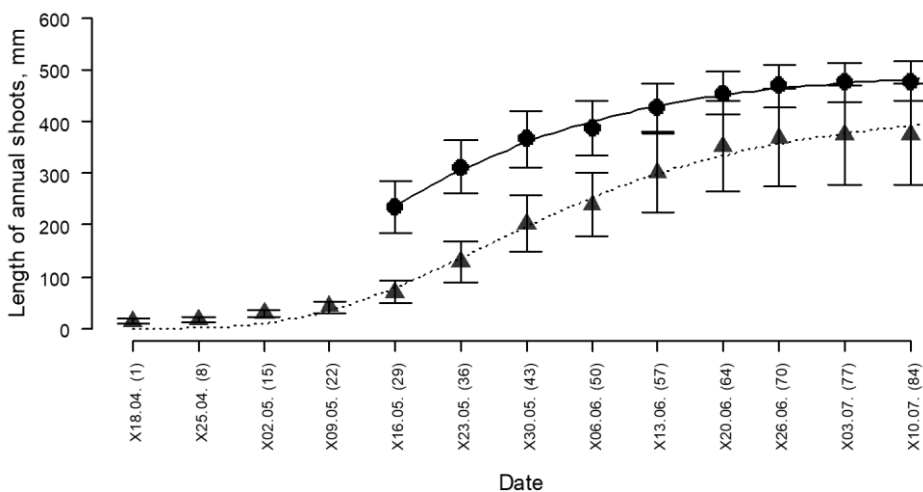
the phenology of the two species (Dougherty et al., 1994; Chuine et al., 2006) rather than by meteorological conditions.



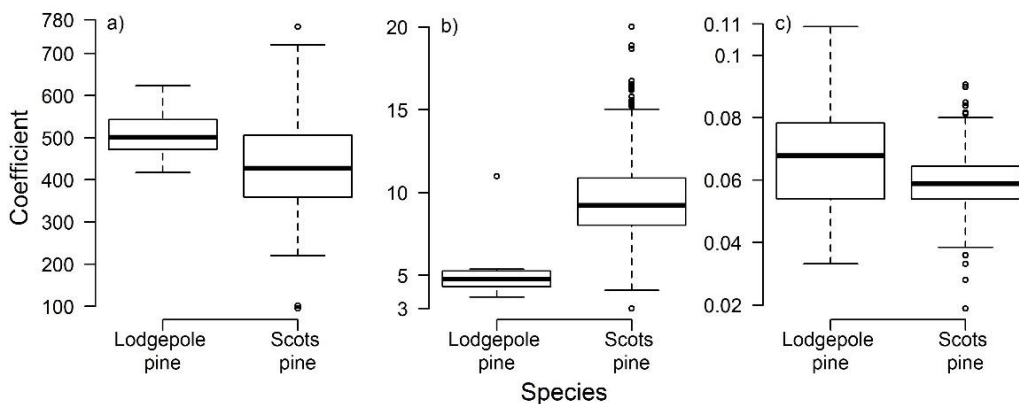
**Figure 1.** a) Meteorological parameters (weekly mean temperature recorded near the sampling site (points joined by a solid line) and at the nearest meteorological station (points joined by a dashed line) and precipitation sums (bars) recorded near sampling sites) during height growth monitoring; b) Raw and c) standardised data on the height growth intensity of lodgepole pine (solid line) and Scots pine (dashed line).

The Gompertz model was successfully fitted to the height-increment curves of all trees that continued height growth at least until the middle of the monitoring period and to the mean height-increment curves per species (Fig. 2). Similarly, on the intra-annual height growth of the Norway spruce (*Picea abies* (L.) Karst.), Neimane et al. (2016) reported that the variance of the Gompertz model coefficients showed that the

intra-annual growth curves of the studied trees differed notably (Fig. 3). However, no statistically significant differences were found in the mean value and variance of the asymptote parameter values of the Gompertz model between both species (Fig. 3). Although the homogenous variance and mean value of the asymptote parameter indicated that the total annual height increment of the studied trees did not differ significantly between the species, from the forestry point of view, these differences were notable because the mean annual height increment of the lodgepole pine in the analysed year was 19.85% higher. Similar slightly higher but insignificant results for certain provenance of lodgepole pine in comparison to Scots pine were reported in study by Jansons et al., 2013. The mean values of the growth rate parameter of the two species were not statistically different, whereas the variances of this parameter differed ( $P < 0.001$ ). The homogenous mean values of the growth rate show that the average rate at which the total height increment was reached during the active growth phase did not differ between both species. The mean value of the biological constant or displacement parameter in the Gompertz model was higher for the Scots pine in comparison to the lodgepole pine, and this difference was statistically significant ( $P < 0.001$ ) even though there were no statistically significant differences in variances of this constant between the species. The lower value of the biological constant means that the lodgepole pine started the active growth phase sooner after the onset of height growth than the Scots pine. The height growth trends of both species and the above-mentioned differences in the timing of the peak of the height growth intensity corresponded to this finding. Nevertheless, differences in the mean value of the biological constant might also be affected by the missed height growth onset for the lodgepole pine. All Gompertz model coefficients differed significantly ( $P < 0.001$ ) between the Scots pine families (group of progenies of a single plus-tree), thus indicating the potential for the selection of genotypes with the necessary height growth patterns. Similar results were reported by Neimane et al. (2016) on the height growth of the Norway spruce.



**Figure 2.** Mean total height increment of lodgepole pine (dots) and Scots pine (triangles) and fitted curves of the Gompertz model (solid and dashed lines for the lodgepole and Scots pine, respectively) during height growth monitoring. Whiskers show the standard deviation and number in brackets represent day of growth.

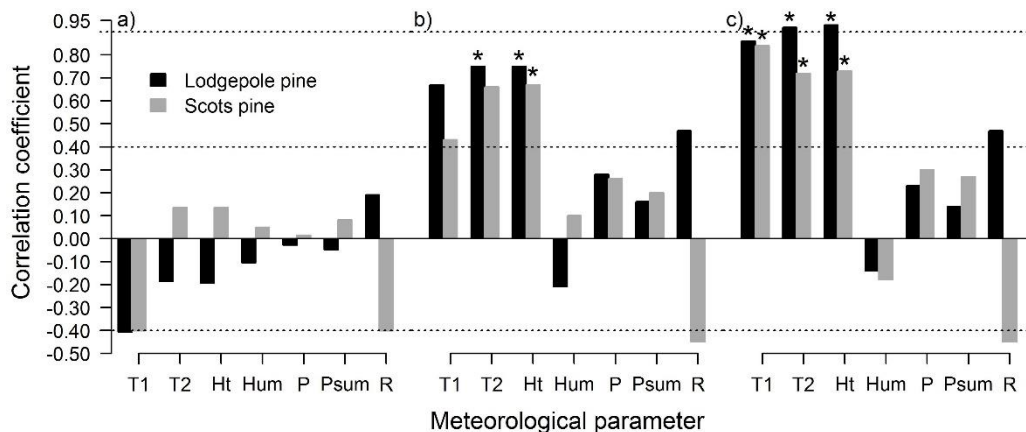


**Figure 3.** Variation of a)  $\alpha$  – asymptote parameter; b)  $\beta$  – biological constant, and c)  $\kappa$  – growth rate coefficient values of the nonlinear Gompertz model fitted to the intra-annual height increment of individual trees of the lodgepole pine and Scots pine. Bold lines represent the median. Boxes correspond to the lower and upper quartiles. Whiskers show the minimum and maximum values (within 150% of the interquartile range from the median), and outliers are shown by circles.

All Gompertz model coefficients of the Scots pine showed statistically significant relationships with the total height increment, whereas this relationship for the lodgepole pine was insignificant in all cases, presumably due to the insufficient sample size. The strong correlation of the asymptote parameter with the total height increment ( $r = 0.97$ ;  $P < 0.001$ ) of the Scots pine trees can be explained using the total height increment as one of the starting values for fitting the Gompertz model. Scots pine trees with a longer period between the onset of growth and the start of the active growth phase tended to have a shorter total height increment, as indicated by the negative correlation ( $r = -0.23$ ;  $P < 0.001$ ) between the biological constant and the total height increment. The negative correlation between the total height increment and growth rate parameter ( $r = -0.29$ ;  $P < 0.001$ ) showed that Scots pine trees that grow faster during the active growth phase tend to have a shorter total height increment. These results might be explained by the strong correlation between the biological constant and the growth rate observed for both the Scots pine ( $r = 0.78$ ;  $P < 0.001$ ) and the lodgepole pine ( $r = 0.88$ ;  $P < 0.05$ ), indicating that the studied trees unsuccessfully tried to compensate for the late start of the active growth phase by growing faster during it.

None of the meteorological parameters showed a significant relationship with the height growth intensity when neither the height growth intensity data nor the data on the meteorological parameters were standardised (Fig. 4, a) prior to the analysis. The standardisation of the growth data time series has been a commonly applied practice in dendroclimatology and increases the signal of interest by removing the biological growth trends and variability that can be considered noise when the climate-growth relationship is studied (Speer, 2010). The height growth of trees is among such traits with an expressed biological trend, for example, growth intensity is the highest during the middle of the growing season, whereas at the beginning and end of the growing season, height growth is significantly slower (Fekedulegn et al., 1999; Seo et al., 2010). This growth trend is mainly determined by physiological processes of trees, for example, towards the end of the growing season, the secondary growth exceeds the primary growth and excess

assimilates are stored for the next growing season (Pallardy, 2008; Speer, 2010). Both species reached the peak of their height growth intensity in the middle of May (Fig. 1, b), while the temperature continued to increase until July and August (Fig. 1, a), which are usually the months with the highest amount of precipitation (Kļaviņš et al., 2008). Therefore, the analysis of un-standardised data might provide erroneous results.



**Figure 4.** Coefficient values of the Pearson correlation between the meteorological parameters and height growth intensity of the lodgepole pine and Scots pine when a) raw data on both variables are used; b) raw data on meteorological parameters and standardised data on the height growth intensity are used and c) both variables are standardised prior to the analysis. Asterisks indicate statistically significant coefficient values ( $P < 0.05$ ). T1 – mean growing season temperature at the nearest meteorological station; T2 – mean growing season temperature recorded near sampling sites; Ht – heat index; Hum – air humidity; P – mean precipitation; Psum – sum of precipitation; R – solar radiation.

When the height growth intensity data prior to the analysis was standardised using the cubic-smoothing spline heat index, the mean temperature recorded near the sampling sites showed the strongest correlation with the height growth intensity of both species (Fig. 4, b). Almost identical correlation values for these two factors can be explained by the high correlation between them ( $r = 0.99$ ,  $P < 0.001$ ). The relationship between temperature and height growth was even further emphasised when the data on both height growth intensity and meteorological parameter were standardised before the analysis (Fig. 4, c). The mean temperature recorded at the nearest meteorological station showed a relatively high positive correlation with the standardised data on the height growth intensity, but this relationship was statistically significant only when both variables were standardised. The positive effect of temperature on the height growth of both species can be explained by the direct influence of the temperature on the assimilation and meristematic activity (e.g. cell division, differentiation, and elongation) (Pallardy, 2008). The temperature during the months of the growing season showed a significant positive relationship with the inter-annual height increment of the lodgepole pine in previous studies conducted in the same study area in Latvia, but the strength of this relationship differed between families (Jansons et al., 2013). Similarly, as in this study, Jansons et al. (2013) found no significant relationship between the temperature during the growing season and the inter-annual height increment of the Scots pine. In

another study, Salminen & Jalkanen (2007) suggested that the cessation of the annual height growth occurs when a location's specific temperature sum threshold is attained. Such a threshold-related cessation of height growth would lead to a positive relationship between the height growth and temperature during the first part of the growing season and to no relationship at the last part of the season, thus possibly resulting in an insignificant relationship when the whole growing season is analysed together. The lack of relationship between the unstandardised data on the height growth and meteorological parameters is furthermore explained by the allocation of carbon for height growth from the reserves of the previous year, resulting in a lower influence on the meteorological conditions during the growth season (Jalkanen & Tuovinen, 2001; Salminen & Jalkanen, 2004). However, our results indicate that, in areas with a longer growing season, the meteorological parameters during the season might have a more important role in determining the total annual height increment than in areas further north where the previously mentioned studies have been conducted.

None of the precipitation-related meteorological parameters (e.g. the sum of precipitation, mean precipitation, and humidity) showed a statistically significant correlation with the height growth of both species. These results indicate that water availability is not the limiting factor for the height growth of both pine species in the study area. Water availability has often been reported as the main limiting factor for the growth of trees closer to the southern border of their distribution area (Lindner et al., 2010; Speer, 2010). In regions like Latvia, where the precipitation exceeds evapotranspiration (Kļaviņš et al., 2008), the lack of a relationship between the height growth and precipitation is not surprising, especially considering the high drought resistance of the pine species (Richardson, 2000). Similarly, the precipitation-related meteorological parameters of growing season have not shown a significant relationship with the inter-annual height growth of the Scots pine (Jansons et al., 2013, 2015) and the intra-annual height growth of the hybrid aspen (*Populus tremula* L. × *P. tremuloides* Michx.) (Jansons et al., 2014) and the lodgepole pine (Jansons et al., 2013) in other studies conducted in Latvia. The exceptions are for the height growth of the Scots pine, which was affected by the precipitation in October of the year preceding the growth, and for the height growth of the lodgepole pine, which was affected by the precipitation in February of the growth year (Jansons et al., 2013, 2015).

## CONCLUSIONS

The intra-annual height growth dynamics of both the lodgepole pine and Scots pine were successfully described by the Gompertz model, but notable differences exist at the individual tree level. The relationship between the Gompertz model coefficients and total annual height increment indicate that trees starting the active growth phase earlier after the onset of height growth had a higher total annual increment, but the faster growth during the active growth phase did not compensate for the too-late start of the active growth phase. Thus, the reduced time between the onset of the height growth and the start of the active growth phase might be a more important parameter for the selection of faster-growing trees than the maximal height growth intensity.

The height growth of the lodgepole pine showed a slightly stronger relationship with the meteorological parameters than the height growth of the Scots pine, indicating that it is more sensitive to variations in meteorological parameters. Our results indicate that the increased use of the lodgepole pine in forestry might be beneficial in the long term considering the increase in temperature and the more frequent occurrence of extreme temperatures during the growing season that are foreseen in the climate change scenarios for Latvia (Kļaviņš et al., 2008; Avotniece et al., 2010).

ACKNOWLEDGEMENTS. The study was carried out in the project: 'Forest management risks: prognosis and minimization'.

## REFERENCES

- Avotniece, Z., Rodinov, V., Lizuma, L., Briede, A. & Kļaviņš, M. 2010. Trends in frequency of extreme climate events in Latvia. *Baltica* **23**, 135–148.
- Bušs, K. 1976. *Forest classification in Latvia*. Science and manufacturing congregation 'Silava', Rīga: LRZTIPI. 24 pp. (in Latvian).
- Chuine, I., Rehfeldt, G.E. & Aitken, S.N. 2006. Height growth determinants and adaptation to temperature in pines: A case study of *Pinus contorta* and *Pinus monticola*. *Canadian Journal of Forest* **36**, 1059–1066.
- Dougherty, P.M., Whitehead, D. & Vose, J.M. 1994. Environmental influences on the phenology of pine. *Ecological Bulletins* **43**, 64–75.
- Elfving, B. & Norgren, O. 1993. Volume yield superiority of lodgepole pine compared to Scots pine in Sweden. *Proc. IUFRO meeting and Frans Kempe Symposium 1992 on Pinus contorta provenances and breeding 1992*, 69–80.
- Elfving, B., Ericsson, T. & Rosvall, O. 2001. The introduction of lodgepole pine for wood production in Sweden – a review. *Forest Ecology and Management* **141**, 15–29.
- Fekedulegn, D., Mac Siurtain, M.P. & Colbert, J.J. 1999. Parameter estimation of nonlinear growth models in forestry. *Silva Fennica* **33**, 327–336.
- Fries, A., Elfving, B. & Ukrainetz, N.K. 2017. Growth and survival of lodgepole pine and Scots pine after 25 years in a reciprocal transplant experiment in Canada and Sweden, *Scandinavian Journal of Forest Research* **32**(4), 287–296.
- Hansen, J. & Beck, E. 1994. Seasonal changes in the utilization and turnover of assimilation products in 8-year-old Scots pine (*Pinus sylvestris* L.) trees. *Trees Structure and Functions* **8**, 172–182.
- Jalkanen, R. & Tuovinen, M. 2001. Annual needle production and height growth: better climate predictors than radial growth at treeline? *Dendrochronologia* **19**(1), 39–44.
- Jansons, A., Matisons, R., Lībiete-Zālīte, Z., Baders, E. & Rieksts-Riekstiņš, R. 2013. Relationships of height growth of lodgepole pine (*Pinus contorta* var. *latifolia*) and Scots pine (*Pinus sylvestris*) with climatic factors in Zvirgzde, Latvia. *Baltic Forestry* **19**(2), 236–243.
- Jansons, Ā., Matisons, R., Zadiņa, M., Sisenis, L. & Jansons, J. 2015. The effect of climatic factors on height increment of Scots pine in sites differing by continentality in Latvia. *Silva Fennica* **49**(3), id1262, pp. 1–14 pp.
- Jansons, Ā., Zeps, M., Rieksts-Riekstiņš, J., Matisons, R. & Krišāns, O. 2014. Height increment of hybrid aspen *Populus tremuloides* x *P. tremula* as a function of weather conditions in south-western part of Latvia. *Silva Fennica* **48**(5), id 1124.

- Kalēja, S., Lazdiņš, A. & Zimelis, A. 2014. Impact of assortments' structure on harvesting productivity and costs of pre-commercial thinning. *Proceedings of Research for Rural Development 2014* **2**, 83–90.
- Kļaviņš, M., Blumberga, D., Bruņiniece, I., Briede, A., Grišule, G., Andrušaitis, A. & Āboliņa, K. 2008. *Climate change and global warming*. University of Latvia Press, Riga, pp. 1–174 (in Latvian).
- Lazdiņš, A., Prindulis, U., Kalēja, S., Daugaviete, M. & Zimelis, A. 2016. Productivity of Vimek 404 T5 harvester and Vimek 10 forwarder in early thinning. *Agronomy Research* **14**(2), 475–484.
- Lindholm, M., Jalkanen, R. & Salminen, H. 2009a. High-frequency reconstruction of mid-summer temperatures from annual height increment of Scots pine at the northern timberline since 1846. *Dendrochronologia* **27**, 113–119.
- Lindholm, M., Ogurtsov, M., Aalto, T., Jalkanen, R. & Salminen, H. 2009b. A summer temperature proxy from height increment of Scots pine since 1561 at the northern timberline in Fennoscandia. *Holocene* **19**, 1131–1138.
- Lindner, M., Maroschek, M., Netherer, S., Kremer, A., Barbati, A., Garcia-Gonzalo, J., Seidl, R., Delzon, S., Corona, P., Kolstrom, M., Lexer, M.J. & Marchetti, M. 2010. Climate change impacts, adaptive capacity, and vulnerability of European forest ecosystems. *Forest Ecology and Management* **259**, 698–709.
- McCarroll, D., Jalkanen, R., Hicks, S., Tuovinen, M., Gagen, M., Pawellek, F., Eckstein, D., Schmitt, U., Autio, J. & Heikkinen, O. 2003. Multiproxy dendroclimatology: A pilot study in northern Finland. *The Holocene* **13**, 829–838.
- McLane, S.C., Daniels, L.D. & Aitken, S.N. 2011a. Climate impacts on lodgepole pine (*Pinus contorta*) radial growth in a provenance experiment. *Forest Ecology and Management* **262**(2), 115–123.
- McLane, S.C., LeMay, V.M. & Aitken, S.N. 2011b. Modeling lodgepole pine radial growth relative to climate and genetics using universal growth-trend response functions. *Ecological Applications* **21**(3), 776–788.
- Millar, C.I., Stephenson, N.L. & Stephens, S.L. 2007. Climate change and forests of the future: Managing in the face of uncertainty. *Ecological Applications* **17**(8), 2145–2151.
- Ministry of Agriculture. 2019. Latvian Forest Sector in facts and figures 2019. Zaļās mājas, Riga, 53 pp.
- Neimane, U., Katrevis, J., Sisenis, L., Purins, M., Luguza, S. & Adamovics, A. 2016. Intra-annual dynamics of height growth of Norway spruce in Latvia. *Agronomy Research* **14**(3), 853–861.
- Pallardy, S.G. 2008. *Physiology of woody plants*. Third ed. Elsevier, London, 454 pp.
- Pensa, M., Salminen, H. & Jalkanen, R. 2005. A 250-year-long height-increment chronology for *Pinus sylvestris* at the northern coniferous timberline: A novel tool for reconstructing past summer temperatures? *Dendrochronologia* **22**, 75–81.
- Prindulis, U., Lazdiņš, A. & Kalēja, S. 2015. Impact of biomass extraction method on damage to remaining trees in mechanized thinning of deciduous stands. *Proceedings of Research for Rural Development 2015* **2**, 77–80.
- R Core Team. 2013. *R: A language and environment for statistical computing*. R Foundation for Statistical Computing, Vienna, Austria. Available at: <http://www.R-project.org/>.
- Richardson, D.M. 2000. *Ecology and Biogeography of Pinus*. Cambridge University Press, Cambridge, 527 pp.



- Rimkus, E., Edvardsson, J., Kažys, J., Pukienė, R., Lukošūnaitė, S., Linkevičienė, R., Corona, C. & Stoffel, M. 2018. Scots pine radial growth response to climate and future projections at peat and mineral soils in the boreo-nemoral zone. *Theoretical and Applied Climatology* **136**, 639–650.
- Salminen, H. & Jalkanen, R. 2007. Intra-annual height increment of *Pinus sylvestris* at high latitudes in Finland. *Tree Physiology* **27**, 1347–1353.
- Salminen, H. & Jalkanen, R. 2005. Modelling the effect of temperature on height increment of Scots Pine at high latitudes. *Silva Fennica* **39**(4), 497–508.
- Salminen, H. & Jalkanen, R. 2004. Does current summer temperature contribute to the final length of *Pinus sylvestris*? A case study at the northern conifer timberline. *Dendrochronologia* **21**(2), 79–84.
- Seidling, W., Ziche, D. & Beck, W. 2012. Climate responses and interrelations of stem increment and crown transparency in Norway spruce, Scots pine, and common beech. *Forest Ecology and Management* **284**, 196–204.
- Seo, J.-W., Eckstein, D., Jalkanen, R. & Schmitt, U. 2011. Climatic control of intra and inter-annual wood-formation dynamics of Scots pine in northern Finland. *Environmental and Experimental Botany* **72**, 422–431.
- Seo, J.-W., Salminen, H., Jalkanen, R. & Eckstein, D. 2010. Chronological Coherence between Intra-Annual Height and Radial Growth of Scots Pine (*Pinus sylvestris* L.) in the Northern Boreal Zone of Finland. *Baltic Forestry* **16**(1), 57–65.
- Speer, J.H. 2010. *Fundamentals of tree-ring research*. The University of Arizona Press, Tucson. 333 pp.
- Strand, M., Lundmark, T., Söderbergh, I. & Mellander, P.-E. 2002. Impacts of seasonal air and soil temperatures on photosynthesis in Scots pine trees. *Tree Physiology* **22**, 839–847.

## **Teff (*Eragrostis tef* (Zucc.) Trotter) fodder yield and quality as affected by cutting frequency**

I. Kakabouki<sup>1</sup>, A. Tzanidaki<sup>1</sup>, A. Folina<sup>1</sup>, I. Roussis<sup>1</sup>, E. Tsiplakou<sup>2</sup>,  
P. Papastylianou<sup>1</sup>, P. Kanatas<sup>1</sup> and D.J. Bilalis<sup>1,\*</sup>

<sup>1</sup>Agricultural University of Athens, Department of Crop Production, 75 Iera Odos Str., GR11855 Athens, Greece

<sup>2</sup>Agricultural University of Athens, Department of Nutritional Physiology and Feeding, 75 Iera Odos Str., GR11855 Athens, Greece

\*Correspondence: bilalisdimitrios@gmail.com

**Abstract.** Teff (*Eragrostis tef* (Zucc.) Trotter) is a well-adapted, fast-growing crop with competitive forage quality as its nutritive value for livestock fodder is similar to other grasses utilized as hay or ensiled feeds. Two field experiments were conducted from May to October 2017 in order to determine the effect of cutting frequency on yield and quality of teff (*Eragrostis tef*) as fodder crop under Mediterranean climatic conditions. The agronomic performance and nutritive value of teff was analyzed in order to define alternatives to local forages for animal feeding in the Mediterranean region. The experiments conducted at two sites (Western and Central Greece) were laid out in a completely randomized design with three replicates and three cutting frequencies (10, 20, 30 days' interval between cuttings - F10, F20, and F30, respectively). The results of this study demonstrate that the cutting interval has a marked effect on the fodder yield and quality. The highest total dry matter yield (6,322–6,778 kg ha<sup>-1</sup>) was found in F10 treatment. In terms of qualitative characteristics, the highest fat levels and lowest ADF levels was found in F30 treatment, the highest protein levels and the lowest NDF levels in F10 treatment, and the highest levels of fibrous substances, ADF and NDF, in F20 treatment. Data suggest that teff could be successfully integrated into Mediterranean grasslands with the prospect for improving their nutritional quality and the possibility for increasing protein yield through the application of frequent cuttings.

**Key words:** alternative fodder crop, Mediterranean region, crude protein, acid detergent fiber, neutral detergent fiber.

### **INTRODUCTION**

For sustainable and stable food production, the genetic diversity maintenance of crop types is increasingly being realized as the most indispensable action. This is further emphasized by unpredictable human food needs, changes in taste, and the biotic and the abiotic production constraints that change with the environments (Ketema, 1997). At the same time, meat production and consumption increase likewise plant materials are required for this production (Herak, 2016; Raphaeli & Marinova, 2016). Nowadays, there is a great demand of innovative fodder crops and many new crops evaluated as quinoa, chia etc. (Kakabouki et al., 2014, Bilalis et al., 2016).

Teff (*Eragrostis tef* (Zucc.) Trotter) is a self-pollinated, warm season, annual grass that belongs to Poaceae family (Watson & Dallwitz, 1992) and it is native to Ethiopia. Although its attractive nutrition profile made it worldwide known mostly for its grains - as it is predominantly grown as a cereal crop - teff is also used as a livestock forage or pasture crop. It is characterized as an 'orphan crop', a term used to describe plants that have not been genetically improved and are highly underutilized (Chanyalew et al., 2019). These orphan (or minor) crops are considered to be an alternative solution to the economic dependence on the major cereals and will help the cropping and farming system (Chanyalew et al., 2019). Low productivity is the main restriction for these kinds of crops to be cultivated but in case of *Eragrostis tef* several studies have shown potential of great economic and scientific importance in terms of quality and yield (Roseberg et al., 2005; Roussis et al., 2019).

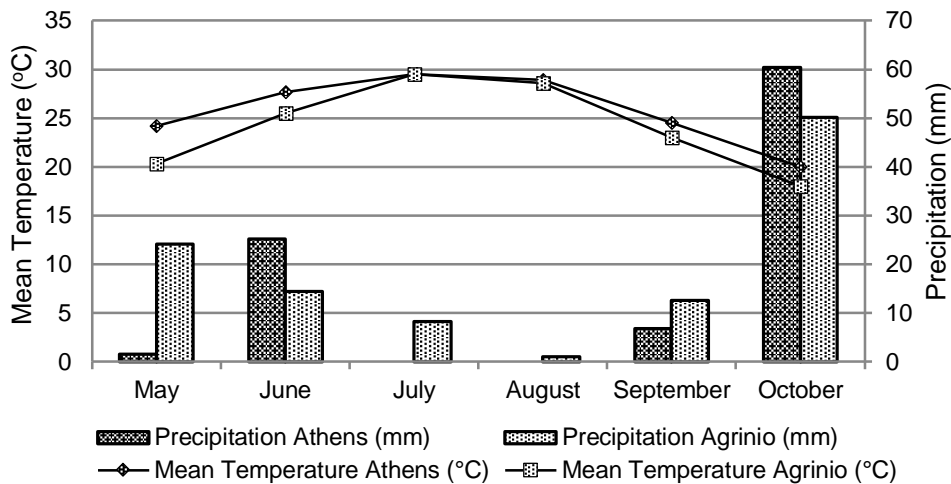
The increasing interest for this crop gravitates to its wide range of adaptation. Teff is well suited to various marginal growing conditions; from arid areas, salt-affected and drought-stressed soils to waterlogged soils (Hunter et al., 2007). Besides this, it is a fast-growing crop with competitive forage quality. Teff is typically fed as hay or straw for livestock, including ruminants, while, it is also relatively popular as forage for horses in the form of hay or pasture grass (Yami, 2013). The nutritive value of teff for livestock fodder is similar to other grasses utilized as hay or ensiled feeds (Boe et al., 1986; Twidwell et al., 2002). Its ability to produce high-quality hay in a relatively short growing season with relatively low inputs makes teff a promising forage crop. Moreover, its straw is highly preferred feed for livestock, compared to the other cereal straws, especially during the dry season with somewhat deficient in nitrogen supply (Mengistu & Mekonnen, 2012).

Although many studies have demonstrated the beneficial properties in animals and trait diversity, limited data are available regarding the fodder yield and quality of teff crop (Mengistu & Mekonnen, 2012; Yami, 2013; Bilalis et al., 2018). Forage yields of teff are highly dependent upon planting date and number of cuttings (Stallknecht et al., 1993). In addition, climate change effect is expected to lead to large reductions in crop productivity of the Mediterranean region and a strategy to cope with the increasing demand for feed production includes the introduction of alternative crops, such as teff characterized by adequate yield and exceptional nutritional value (Bilalis et al., 2018; Roussis et al., 2019). Therefore, the objective of this study was to determine the effects of cutting frequency on dry matter, yield protein and quality of teff crop in order to define alternatives to local forage sources for animals feeding in the Mediterranean region.

## MATERIALS AND METHODS

The experiments were conducted from May to October 2017 growing season on two experimental sites. The first site is situated in the experimental field of the Agricultural University of Athens (Central Greece, Latitude: 37° 5'01.8"N, Longitude 23° 4'07.3" E, Altitude 170 m above sea level). The soil is classified as a Clay Loam (35.9% sand, 29.8% clay and 34.3% silt), with pH 7.21 (1:1 water H<sub>2</sub>O), 0.113% total nitrogen, available phosphorus (P) 47 mg kg<sup>-1</sup> soil, available potassium (K) 338 mg kg<sup>-1</sup> soil, 16.82% CaCO<sub>3</sub> and 1.39% organic matter content (Wakley & Black, 1934). The second site was located in the Agrinio region (Western Greece, Latitude: 38°35' N, Longitude: 21°25' E, Altitude: 80 m above sea level). The soil type was a Silt Loam

(13.9% sand, 61.2% loam, and 24.9% clay) with 1.46% organic matter, 0.156% total nitrogen, available phosphorus (P) 172 mg kg<sup>-1</sup> soil, available potassium (K) 621 mg kg<sup>-1</sup> soil, 14.34% CaCO<sub>3</sub>, and a pH of 7.44. The sites were managed according to organic agricultural guidelines (EC 834/2007).



**Figure 1.** Meteorological data (mean temperature: °C and precipitation: mm) for the experimental sites (Athens and Agrinio) during the experimental period (May-October 2017).

Mean values of meteorological data concerning air temperature and precipitation of the experimental sites are presented in Fig. 1. Each experiment was set up according to a Completely Randomized Design with three replicates and three cutting frequencies. The cutting interval was every 10 (F10), 20 (F20) and 30 days (F30), since 41 DAS (Table 1) in three levels. The experimental area was 90 m<sup>2</sup>, which was devised in 3 replicates with 3 plots (10 m<sup>2</sup>) each. Soil tillage encompasses agronomical ploughing at a depth of 20 cm. Organic fertilizer (2,000 kg ha<sup>-1</sup> seaweed compost, 1–2% N) was applied as basal fertilization by hand on the soil surface and then harrowed in. Teff was sown at the beginning of May by a 10- rows manual seed planter (seed rate 3.7 kg ha<sup>-1</sup>). A drip irrigation system was installed in the experimental plots. The drip irrigation frequency was designed to be 7 days, and the irrigation amount was 10–15 mm each time.

Mean values of meteorological data concerning air temperature and

**Table 1.** The cutting dates in treatments (F10: 10 days’ interval, F20: 20 days’ interval, F30: 30 days’ interval). The dates expressed as days after sowing (DAS) are the same for both of the experimental sites (Athens and Agrinio)

	Interval between cuttings		
	F10	F20	F30
41 DAS	x	x	x
51 DAS	x		
61 DAS	x	x	
71 DAS	x		x
81 DAS	x	x	
91 DAS	x		
101 DAS	x	x	x
111 DAS	x		
121 DAS	x	x	
131 DAS	x		x
141 DAS	x	x	
151 DAS	x		

precipitation of the experimental sites are presented in Fig. 1. Each experiment was set up according to a Completely Randomized Design with three replicates and three cutting frequencies. The cutting interval was every 10 (F10), 20 (F20) and 30 days (F30), since 41 DAS (Table 1) in three levels. The experimental area was 90 m<sup>2</sup>, which was devised in 3 replicates with 3 plots (10m<sup>2</sup>) each. Soil tillage encompasses agronomical ploughing at a depth of 20 cm. Organic fertilizer (2,000 kg ha<sup>-1</sup> seaweed compost, 1–2% N) was applied as basal fertilization by hand on the soil surface and then harrowed in. Teff was sown at the beginning of May by a 10- rows manual seed planter (seed rate 3.7 kg ha<sup>-1</sup>). A drip irrigation system was installed in the experimental plots. The drip irrigation frequency was designed to be 7 days, and the irrigation amount was 10–15 mm each time.

Dry weight sampling dates were the same as cutting frequency. So, there are 12 samples for 10 days' frequency, 6 samples for 20 days' frequency and 4 samples for 30 days' frequency (Table 1). Dry weight was determined after drying for 72 h at 75 °C.

The samples were chosen randomly within each plot. All samples were analyzed for neutral detergent fiber (NDF) assayed without a heat stable amylase and expressed inclusive of residual ash and acid detergent fiber (ADF) expressed exclusive of residual ash according to Van Soest et al. (1991). Furthermore, the total nitrogen and protein content was determined by the Kjeldahl method (Bremner, 1960) using a Buchi 316 device. After all, the AOAC method 920.39 used to determine crude fat (AOAC, 2000).

The Total Dry Matter and Protein Yield were estimated by the following mathematical equations.

$$\text{Total Dry Matter} = \sum_{i=1}^n DW_i$$

where  $n = 12$  (cutting frequency 10 days),  $n = 6$  (cutting frequency 20 days),  $n = 4$  (cutting frequency 30 days).

$$\text{Protein Yield} = \sum_{i=1}^n (\text{Protein Content}_i * DM_i)$$

where  $n = 12$ ,  $n = 6$ ,  $n = 4$  (respectively for each treatment).

Analysis of variance was carried out on data using the Statistica (StatSoft Inc., 2300 East 14th Street, Tulsa, OK 74104, USA) statistical software as a Completely Randomized Design. The significance of differences between treatments was estimated using LSD test and probabilities equal to or less than 0.05 ( $P \leq 0.05$ ) considered significant.

## RESULTS AND DISCUSSION

In the present study, it was indicated that teff growth in the experimental site in Athens was significantly affected ( $F = 85.01$ ;  $P < 0.001$ ) by cutting frequency. More specifically, the plants in F30 treatment had the greatest height (73.06 cm) followed by the plants in F20 and F10 with a height of 59.83 cm and 41.51 cm, respectively. A same trend was also noticed in Agrinio region ( $F = 64.82$ ;  $P < 0.001$ ) with the highest plant (69.45 cm) observed in F30 treatment. The cutting frequency effects on teff growth and yields are shown in Table 2.

Although in F20 the plant' height levels increased during the second cut, from the third cut until the last have been showed a decrease. In the experiment of Kannika et al. (2011), the studding objective was the cutting frequency impact on yield biomass and

growth components of Napiergrass (*Pennisetum purpureum* Schumach) in Thailand (tropical climate), where the height process indicated an upward trend until the fourth cut, while in the fifth cut it declined in all of the three varieties.

Regarding the total dry matter yield, our results revealed that there were statistically significant differences among the cutting treatments. Teff total dry matter yield in the experimental site in Athens ranged from a low of 3,656 to a high of 6,778 kg ha<sup>-1</sup> for the F30 and F10 treatment, respectively (Table 2). A same trend observed in the experimental site in Agrinio with total dry matter yield ranged from a low of 3,708 to a high of 6,322 kg ha<sup>-1</sup> for the F30 and F10 treatment, respectively, and the mean difference were statistically significant between F10- F20 and F10-F30. In general, it was found that the total dry matter yield was increased as the cutting interval increased from every 10<sup>th</sup> to 30<sup>th</sup> days. Similar results were also noticed by Slepetyts (2010) for the biomass yield of galega (*Galega officinalis* L.) crop.

The crude protein constitutes a critical component in cattle diet and the deficiency of this component can lead to reduced growth and milk production (Ul-Allaha et al., 2014). The results of this research indicated that protein content was influenced by the cutting frequency with F10 at 18.93% DM / 17.25% DM, F20 at 17.53% DM / 15.52% DM and F30 16.63% DM / 14.21% DM (Athens / Agrinio, respectively) (Table 2). As the cutting interval increased from every 10<sup>th</sup> to 30<sup>th</sup> days, the protein content decreased. This might be due to higher maturity by harvesting less frequently such as every 30<sup>th</sup> day cutting treatment. Protein content at the most frequent cutting treatment (12 cuttings during growing season) was significantly ( $F = 113.9; P < 0.001; F = 101.3; P < 0.001$  in Athens and Agrinio, respectively) higher than other cutting frequency treatments. This might be due to a lower maturity stage for the most frequently harvesting treatment (i.e., every 10th day) than rest of cutting intervals.

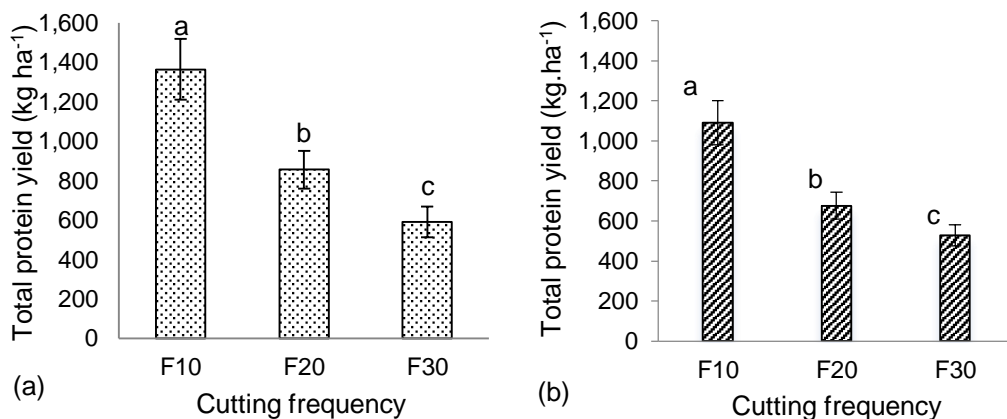
**Table 2.** Effects of cutting frequency (F10: 10 days' interval, F20: 20 days' interval, F30: 30 days' interval) on height (cm), total dry matter (DM) yield (kg ha<sup>-1</sup>), protein (% DM), ether extract: EE (% DM), acid detergent fiber: ADF (% DM) and neutral detergent fiber: NDF (% DM) of teff, in Athens and Agrinio area

Cutting frequency	Athens			Agrinio		
	Height (cm)	Total DM yield (kg ha <sup>-1</sup> )	Protein (% DM)	Height (cm)	Total DM yield (kg ha <sup>-1</sup> )	Protein (% DM)
F10	41.51 a	6778 a	18.93 a	38.42 a	6322 a	17.25 a
F20	59.83 b	4989 b	17.53 b	57.61 b	4355 b	15.52 b
F30	73.06 c	3656 b	16.63 c	69.45 c	3708 b	14.21 c
$F_{cutting\ frequency}$	85.01***	19.43**	113.9***	64.82***	11.21*	101.3***
	EE (% DM)	ADF (% DM)	NDF (% DM)	EE (% DM)	ADF (% DM)	NDF (% DM)
F10	2.06 c	26.12 ab	56.79 a	2.00 c	25.61 ab	54.47a
F20	2.23 b	26.66 a	57.95 b	2.17 b	27.01 a	58.02b
F30	2.27 a	25.65 b	56.99 a	2.30 a	23.22b	55.03 a
$F_{cutting\ frequency}$	1496.9***	13.24**	14.75**	711.2***	10.87*	10.11*

F-test ratios are from ANOVA. Significant at \*, \*\* and \*\*\* indicate significance at  $P = 0.05, 0.01$  and  $0.001$ , respectively and ns: not significant ( $P > 0.05$ ). Mean values within each column followed by different letters, differ significantly according the LSD test ( $P \leq 0.05$ ).

The results of the present study are suitable to previous studies; on *Festuca scabrella* (Willms & Beauchemin, 1991) was noted that the levels of protein content increased by proliferate the frequency of cuts. Moreover, in the research study of Puteri et al. (2015) investigating the productivity and nutritional quality of sorghum at different cutting rates appeared that as the interval between the cuts raised, the protein levels reduced. Decline of protein content levels has been recorded in many studies (Kidunda et al., 1990, Seyoum et al., 1998, Zewdu et al., 2002) and is predominantly attributed to the dilution of the protein content of the feed crops by the rapid accumulation of cell carbohydrates in the late stages of growth (Bayble et al., 2007). On the other hand, Baghdadi et al. (2017) noticed that crude protein of silage could be affected and increased by the increase of plant-available nitrogen.

The total protein yield is a function of total dry matter yield and protein content. Besides that, as expected, in Athens area, total protein yield ranged from 1,283.03 to 607.92 kg ha<sup>-1</sup> for the F10 and F30 treatment, respectively, (Fig. 2, a) and in Agrinio area ranged from 1,090.55 to 526.9 kg ha<sup>-1</sup> (Fig. 2, b) for the F10 and F30 treatment, respectively. For both areas, there is significant differences among values of the three cutting frequencies. Moreover, the correlations between the mean total protein yield (kg ha<sup>-1</sup>) and dry matter (kg ha<sup>-1</sup>) of the two experimental areas in F10, F20 and F30 treatments were also calculated (Table 3). The F30 treatment displayed no significant linear regression ( $y = ax + b$ ;  $R^2 = 0.26$ ,  $p > 0.05$ ). Contrastingly, in F10 and F20 treatments identical correlations noticed with  $R^2 = 0.49$  ( $p < 0.01$ ) and  $R^2 = 0.47$  ( $p < 0.05$ ), correspondingly. During the time of teff's biomass increased simultaneously the total yield protein increased. The equation slope of F20 was higher ( $a = 4.4$ ) than F10 ( $a = 1.7$ ). That result led to the conclusion that cutting every 20 days, protein yield growth rate is higher than cutting every 10 days.



**Figure 2.** Effects of cutting frequency (F10: 10 days' interval, F20: 20 days' interval, F30: 30 days' interval) on total protein yield (kg ha<sup>-1</sup>) of teff plant a) in Athens and b) in Agrinio area. Values belonging to the same characteristic with different letters within a column denote significant differences on cutting treatments (LSD test,  $P < 0.05$ ). Vertical bars indicate standard deviation.

**Table 3.** Line correlation equations between protein yield (kg ha<sup>-1</sup>) and total dry matter yield (kg ha<sup>-1</sup>). Significant at \*, \*\* and \*\*\* indicate significance at  $P = 0.05$ ,  $0.01$  and  $0.001$ , respectively and ns: not significant ( $P > 0.05$ )

<i>Treatments</i>	<i>Equation</i>	<i>Slope</i>	<i>R<sup>2</sup></i>	<i>P- Level</i>
F10	$y = 1.713x + 271.79$	1.7	0.4898	**
F20	$y = 4.4053x + 203.74$	4.4	0.4733	*
F30	$y = -2.8924x + 1340.5$	-2.8	0.2569	ns

In addition, it has been observed that as the interval between the cuts increases, the percentage of the strain increases while the protein concentration decreasing and the cell wall contents increasing (fibrous substances, NDF and ADF) (Bach & Munck, 1985).

ADF and NDF are important components of forage and are frequently used as a factor to define forage quality (Collins & Fritz, 2003). Analysis of variance revealed that cutting frequency affected both ADF and NDF (Table 2), though the differences among the treatments were significant differences between values on F10 and F30, in both areas.

NDF levels in teff biomass were significantly higher in F20 (57.95% DM), followed by F30 (56.99% DM) and F10 (56.79% DM) treatments in Athens, and the same trend was found in Agrinio with the values being 58.02% DM at F20, 55.03% DM at F30, and 54.7% DM at F10 (Table 2) with significant differences among them. In the F30 treatment, there was an increase in NDF levels in the second and third cutting, and a decrease in the fourth cutting (data not shown). In correspondence with the results of this research, the research by Staniar et al. (2010) found that NDF levels increased during the second cutting and decreased on the third one.

The response of neutral detergent fiber (ADF) was similar to the above-mentioned for NDF, with the highest values observed in F20 treatment (26.66% DM and 27.01% DM in Athens and Agrinio, respectively), followed by F10 and F30 treatments. Willms & Beauchemin (1991) indicated that the levels of ADF content decreased by increasing the frequency of cuts. In the present study, the levels of NDF and ADF are acceptable and lower than Staniar et al. (2010) approach for ruminants. Moreover, these authors observed that the fiber constituents, NDF and ADF, increased as the cutting interval and stage of maturity increased. For most forages, as the plant cell walls thicken with advancing plant maturity, the amount of fiber content (cell wall constituents) is generally increased (Van Soest et al., 1991).

The ether extract has a heterogeneous composition and is formed by lipids (galactolipids, triglycerides, and phospholipids) and all other non-polar compounds, such as phosphatides, steroids, pigments, fat-soluble vitamins, and waxes. Its amount in forage is generally low, with values usually less than 3% of the dry matter (Coleman & Henry, 2002). According to Table 2, ether extract was increased as the cutting interval increased from every 10<sup>th</sup> to 30<sup>th</sup> days. As mentioned above, this might be due to higher maturity by harvesting less frequently such as every 30<sup>th</sup> day cutting treatment. A significant increase in the NDF, ADF, and ether extract (EE) contents of tumbleweed (*Gundelia tournefortii* L.) were reported with increasing maturity of plants (Kamalak et al., 2005).



## CONCLUSIONS

The analysis of the results revealed that the highest total yield of dry weight biomass was observed in F10 (10 days' interval) treatment, while the lowest was observed in F30 (30 days' interval) treatment for both sites. In general, F10 treatment exhibited the highest levels of quantitative and qualitative characteristics. In terms of qualitative characteristics, the highest fat levels and lowest ADF levels was found in F30 treatment, the highest protein levels and the lowest NDF levels in F10 treatment, and the highest levels of fibrous substances, ADF and NDF, in F20 treatment. Despite its versatility in adapting to extreme environmental conditions, the productivity of teff is low and is similar to the quantity produced by natural grasslands of Greece at annual basis (1.5 tonnes ha<sup>-1</sup>). Although, the high ADF, NDF and relatively high CP content characterized teff biomass can meet the requirements of lactating animals. In conclusion, teff could be successfully integrated into Mediterranean grasslands with the prospect for improving their nutritional quality and the possibility for increasing protein yield through the application of frequent cuttings.

## REFERENCES

- Bach Knudsen, K.E. & Munck, L. 1985. Dietary fibre contents and compositions of sorghum and sorghum-based foods. *Journal of Cereal Science* **3**(2), 153–164.
- Baghdadi, A., Balazadeh, M., Kashani, A., Golzardi, F., Gholamhoseini, M. & Mehrnia, M. 2017. Effect of pre-sowing and nitrogen application on forage quality of silage corn. *Agronomy Research* **15**(1), 11–23.
- Bayble, T., Melaku, S. & Prasad, N.K. 2007. Effects of cutting dates on nutritive value of Napier (*Pennisetum purpureum*) grass planted sole and in association with Desmodium (*Desmodium intortum*) or Lablab (*Lablab purpureus*). *Livestock Research for Rural Development* **19**, 11.
- Bilalis, D.J., Roussis, I., Cheimona, N., Kakabouki, I. & Travlos, I. 2018. Organic Agriculture and Innovative Feed Crops. In P. Gorawala & S. Mandhatri (eds.), *Agricultural Research Updates, vol. 23.*, Nova Science Publishers, New York, USA, 55–100.
- Bilalis, D., Tabaxi, I., Zervas, G., Tsiplakou, E., Travlos, I., Kakabouki, I. & Tsioros, S. 2016. Chia (*Salvia hispanica*) fodder yield and quality as affected by sowing rates and organic fertilization. *Communications in Soil Science and Plant Analysis* **47**(15), 1764–1770.
- Boe, A., Sommerfeldt, J., Wynia, R. & Thiex, N. 1986. A preliminary evaluation of the forage potential of teff. *Proceedings of the South Dakota Academy of Science* **33**, 314–324.
- Bremmer, J.M. 1960. Determination of nitrogen in soil by Kjeldahl method. *Journal of Agricultural Science* **55**, 1–33.
- Coleman, S.W. & Henry, D.A. 2002. Nutritive Value of Herbage. In M. Freer & H. Dove (eds.), *Sheep Nutrition*. CABI Pub. in association with CSIRO Pub., Wallingford, UK, 1–26.
- Collins, M. & Fritz, J. 2003: Forage quality. In *Forages. Vol. 1. An Introduction to Grassland Agriculture*. Iowa State Press Ames, IA, USA, 363–390.
- Chanyalew, S., Ferede, S., Damte, T., Fikre, T., Genet, Y., Kebede, W., Tolossa, K., Tadele, Z. & Assefa K. 2019. Significance and prospects of an orphan crop tef. *Planta* **250**, 753–767.
- Herak, D. 2016. Image analysis of the shapes and dimensions of Teff seeds (*Eragrostis tef*). *Agronomy Research* **14**(S2), 1299–1305.
- Hunter, M., Barney, P., Kilcer, T., Cherney, J., Lawrence, J. & Ketterings, Q. 2007. *Teff as emergency forage*. Cornell University Cooperative Extension, Agronomy Fact Sheet, 24.

- Kakabouki, I., Bilalis, D., Karkanis, A., Zervas, G., Tsiplakou, E. & Hela, D. 2014. Effects of fertilization and tillage system on growth and crude protein content of quinoa (*Chenopodium quinoa* Willd.), an alternative forage crop. *Emirates Journal of Food and Agriculture* **26**(1), 18–24.
- Kamalak, A., Canbolat, O., Gurbuz, Y., Erol, A. & Ozay, O. 2005. Effect of maturity stage on chemical composition, in vitro and in situ dry matter degradation of tumbleweed hay (*Gundelia tournefortii* L.). *Small Ruminant Research* **58**, 149–156.
- Kannika, R., Yasuyuki, I., Kunn, K., Pichit, P., Prapa, S., Vittaya, P., Pilanee, V., Ganda, N. & Sayan, T. 2011. Effects of inter-cutting interval on biomass yield, growth components and chemical composition of napiergrass (*Pennisetum purpureum* Schum.) cultivars as bioenergy crops in Thailand. *Grassland Science* **57**, 135–141.
- Ketema, S. 1997. *Tef (Eragrostis tef (Zucc.) Trotter), Promoting the Conservation and Use of Under-utilized and Neglected Crops*. Institute of Plant Genetics and Crop Plant Research, Gatersleben/International Plant Genetic Resources Institute, Rome, Italy, 12 pp.
- Kidunda, R.S., Lowga, E.J. & Mtengeti, E.J. 1990. Utilization of Pasture Research Results in Tanzania. PANESA/ARNAB (Pasture Network for Eastern and Southern Africa / African Research Network for Agriculture By-products). Utilization of research results on forage and agricultural by products as animal feed resources in Africa. *Proceedings of the first Joint workshop held in Lilongwe, Malawi. 5-9 December 1988*. PANESA/ARNAB, Addis Ababa, Ethiopia, pp. 705–735.
- Mengistu, A., Ebro, A., Assefa, T., Hirpa, A. & Shenkute, B. 2007. Effect of supplementation of tef (*Eragrostis tef*) straw with different levels of noug (*Guizotia abyssinica*) meal on worked Arsi oxen (*Bos indicus*). *Tropical Science* **47**(1), 49–51.
- AOAC. 2000. Official Methods of Analysis. 17th Edition, The Association of Official Analytical Chemists, Gaithersburg, MD, USA, Official Method 920.39.
- Puteri, R.E., Karti, P.D.M.H. & Abdullah, L. 2015. Productivity and nutrient quality of some sorghum mutant lines at different cutting ages. *Media Peternakan* **38**(2), 132–137.
- Roseberg, R.J., Norberg, S., Smith, J., Charlton, B., Rykbost, K. & Shock, C. 2005. Yield and quality of teff forage as a function of varying rates of applied irrigation and nitrogen. In: *Research in the Klamath Basin: 2005 Annual Report*. Klamath Experiment Station, Oregon, USA, pp. 119–136.
- Roussis, I., Folina, A., Kakabouki, I., Kouneli, V., Karidogianni, S., Chroni, M. & Bilalis, D. 2019. Effect of organic and inorganic fertilization on yield and yield components of teff [*Eragrostis tef* (Zucc.) Trotter] cultivated under Mediterranean semi-arid conditions. *Scientific Papers. Series A. Agronomy* **62**(1), 138–144.
- Seyoum, B., Zinash, S., Tadesse, T.T. & Liyusew, A. 1998. Evaluation of Napier (*Pennisetum purpureum*) and Hybrids (*Pennisetum purpureum* x *Pennisetum typhoides*) in the central highlands of Ethiopia. *Proceedings of the Fifth Conference of Ethiopian Society of Animal Production (ESAP). 15-17 May 1997*. Ethiopian Society of Animal Production, Addis Ababa, Ethiopia. pp. 194–202.
- Slepetys, J. 2010. Influence of cutting and management regimes on fodder galega for forage and seed production. *Agronomy Research* **8**(S3), 711–720.
- Stallknecht, G.F., Gilberstone, K.M. & Ekohff, J.L. 1993. Food crop for people and animals. In: Janick, J., Simon, J.E. (Eds.), *New Crops*. Wiley, New York, USA, pp. 231–234.
- Staniar, W.B., Bussard, J.R., Repard, N.M., Hall, M.H. & Burk, A.O. 2010. Voluntary intake and digestibility of teff hay fed to horses. *Journal of Animal Science* **88**(10), 3296–3303.
- Twidwell, E.K., Boe, A. & Casper, D.P. 2002. Teff: A new annual forage grass for South Dakota? *SDSU Extension Extra Archives* **278**. [https://openprairie.sdstate.edu/extension\\_extra/278](https://openprairie.sdstate.edu/extension_extra/278)
- Ul-Allaha, S., Khanb, A.A., Fricke, T., Buerkert, A & Wachendorf, M. 2014. Fertilizer and irrigation effects on forage protein and energy production under semi-arid conditions of Pakistan. *Field Crops Research* **159**, 62–69.

- Van Soest, P.J., Robertson, J.B. & Lewis, B.A. 1991. Methods for dietary fiber, neutral detergent fiber and non starch polysaccharides in relation to animal nutrition. *Journal of Dairy Science* **74**, 3583–3597.
- Wakley, A. & Black, I.A. 1934. An examination of the Degtiareff methods for determining soil organic matter and a proposed modification of chromic acid titration method. *Soil Science* **37**, 29–38.
- Watson, L. & Dallwitz, M.J. 1992. The families of flowering plants: descriptions, illustrations, identification, and information retrieval. Version: 30th September 2017. <http://www.delta-intkey.com>.
- Willms, W.D. & Beauchemin, K.A. 1991. Cutting frequency and cutting height effects on forage quality of rough fescue and parry oat grass. *Canadian Journal of Animal Science* **71**(1), 87–96.
- Yami, A. 2013. Tef straw: A valuable feed resource to improve animal production and productivity. In: Assefa, K., Chanyalew, S. & Tadele, Z. (eds.), *Achievements and Prospects of Tef Improvement*. Institute of Plant Sciences, University of Bern, pp. 233–251.

## Effect of nitrogen fertilizations, with and without inhibitors, on cotton growth and fiber quality

S. Karydogianni<sup>1</sup>, M.K. Darawsheh<sup>2</sup>, I. Kakabouki<sup>1</sup>, Ch. Zisi<sup>1</sup>, A.E. Folina<sup>1</sup>,  
I. Roussis<sup>1</sup>, Z. Tselia<sup>1</sup> and D. Bilalis<sup>1,\*</sup>

<sup>1</sup>Agricultural University of Athens, Department of Crop Science, Laboratory of Agronomy, 75 Iera Odos Str., GR11855 Athens, Greece

<sup>2</sup>Hellenic Agricultural Organization - Demeter/Institute of Industrial & Forage Crops - National Cotton Classification Centre, 1st km Karditsa-Mitropili, Gr43100 Karditsa, Greece

\*Correspondence: bilalisdimitrios@gmail.com

**Abstract.** Considering cotton, one of the most non environmentally friendly crops, new types of fertilizers, such as the urease inhibitor, are now being used for fertilization. Furthermore, the need of increasing the nutrient use efficiency which is an important contributor to yield has arisen. The objective of this study was to assess the impacts of four different urea combinations (Urea, Urea+NI+UI, Urea+NI, Urea+UI) on cotton (*Gossypium hirsutum* L.) yield and fiber traits. For this purpose, different inhibitors used on urea fertilizer such as nitrification inhibitor (NI), dicyandiamide (DCD), urease inhibitor (UI), N-(n-butyl) thiophosphoric triamide, and a combination of urease (UI) and nitrification inhibitor (NI) (double inhibitor). Additionally, Nitrogen indicators were also used to evaluate the efficiency of these combinations. Two field experiments were conducted in Agrinio and Copaida region, Central Greece during 2019. The total dry weight ranged from 13,027 to 14,481 kg ha<sup>-1</sup> in Agrinio area and from 12,567 to 14,136 kg ha<sup>-1</sup> in Copaida area. The highest seed cotton yield was recorded under Urea+NI+UI fertilization at 5,145 kg ha<sup>-1</sup> application in Copaida area and 5,318 kg ha<sup>-1</sup> application in Agrinio area. Also, the total plant nitrogen uptake (kg N ha<sup>-1</sup>) was affected by the inhibitors NI and UI. The range for Nitrogen Utilization Efficiency (NUE) index was 9.27 to 23.06. Moreover, results indicated that NI and UI inhibitors have a marked effect on fiber quality such as strength (g Tex<sup>-1</sup>). In the Mediterranean region of Greece, the combined use of inhibitors UI and NI resulted in higher yield and finest fiber quality.

**Key words:** cotton, fiber quality, nitrogen inhibitor, iNUE.

### INTRODUCTION

Cotton (*Gossypium hirsutum* L.), is considered one of the major industrial plants, for most countries, including Greece (Avgoulas et al., 2005; Bilalis et al., 2010).

Nitrogen is most often the major limiting nutrient to cotton cultivation. It is classified among the soil minerals that get absorbed by cotton, and influences the crop's height, fruiting, yield and fiber quality (Ma et al., 2008; Ducamp et al., 2012). N deficiency, affects the number of leaves per plant, thus reducing the photosynthetic capacity and accumulation of sugars in the boll set and ultimately affecting the plant's

maturation and height (Wullschleger & Oosterhuis 1990; Emará & El-Gammaal 2012). Dong et al. (2012) report a 10% increase of the biological yield, the photosynthesis and protein concentration, when high nitrogen amounts are applied. Urea production rose to 174.3 million tons in 2016, down 0.6% to 2015.

Overall, nitrogen is an essential macronutrient for cotton cultivation, due to its pivotal role in cotton growth and yield. The right amount of nitrogen during the plant growth, affects the photosynthetic capacity of leaves, providing the growing of the productive components (Bondada & Oosterhuis, 2001; Wullschleger & Oosterhuis, 1990). Furthermore, nitrogen has an impact on boll and seed formation by increasing their size and weight (Bondada et al., 1996 and Saleem et al., 2010). Cotton yield showed a significant increase which followed the increase of N application rates and the mulching consistently exerted the additive effect of N fertilization on cotton growth and yield (Allanov et al., 2019).

Since cotton fibers are primarily composed of cellulose, any influence on the plant's photosynthetic rate and production of carbohydrates will cause similar influence on fiber growth. Micronaire (MIC) measures the rate of airflow, under pressure, of a plug of lint cotton (of known weight) compressed into a chamber of fixed volume. Micronaire, is often treated as the fiber maturity measurement in classing-office (Bradow & Davidonis, 2000). Micronaire is considered more important in spinning and fiber maturity and seems to impact more on dye-uptake rate. Maintaining fiber quality standards is essential for growers in order to avoid price reduction, however the expression of fiber properties genetic potential depends on complex interaction among crop management and growth environment (Darawsheh, 2010). Micronaire (fineness-maturity), length, strength and color grade are very important parameters for spinning, while maturity, elongation, and short fiber index are also important fiber quality characteristics (Christidis, 1965; Deussen, 1986). Fiber quality parameters is a genetic characteristic (Bauer et al., 2000; Davidonis et al., 2004; Bednarz et al., 2006), however these fiber parameters are significantly affected by crop management and environmental conditions (Subhan et al., 2001; Darawsheh et al., 2009).

The use of urea based fertilizers leads to high Nitrogen losses due to ammonia volatilization. During the volatilization, ammonium is converted to ammonia and is lost in the atmosphere. Through the years 2006 to 2016, the tendency of urea production was to annually increase by 2.8%. The biggest producing countries are at the same time the largest consumers, referring to China and India. China is self-sufficient for nitrogen fertilizers, but India's demand for imports is significant. Most of the new nitrogen capacity in the world is in the form of urea, so naturally the production/consumption growth rates are higher for urea than for ammonia/total nitrogen. Nowadays, the difference has been quite large, as urea has a market share. Compared to other products, urea has high nitrogen content (46%), a fact that makes its transport relatively cheap. The most commonly used N fertilizer is urea (46-0-0), due to high N content, low cost and easy transport storage and application (Glibert et al., 2006).

One of the most useful Nitrogen Indicators is the Internal crop Nitrogen Use Efficiency (iNUE). This indicator refers to the ratio between the applied nitrogen and the nitrogen that is removed by the crop. In addition, iNUE calculates the nitrogen loss to the environment (Brentrup & Lammel, 2016). Other indicators are Nitrates ( $\text{NO}_3^-$ ) and ammonium ( $\text{NH}_4^+$ ), which are the major forms of organic N in agricultural soils. Nitrate

is water soluble and is commonly used to calculate the availability of N in soils. Ammonium is often used for the same purpose as well (Maynard et al., 2016).

The most widely used inhibitors are the urease inhibitor, thiophosphorictriamide (NBPT) and the nitrification inhibitor, dicyandiamide (DCD) (Li et al., 2020). Urease inhibitors delay urea hydrolysis in soil, by reducing the formation of  $\text{NO}_3^-$  and  $\text{NH}_4^+$ . In that way, the toxic effect of high ammonia concentration on seed germination is narrowed. The existence of the inhibitor in the soil, affects the effectiveness of controlling  $\text{NH}_3$  losses. According to Krol et al. (2020), urease inhibitors, when added to urea, reduced ammonia loss and thus increased cotton yield and N uptake, compared to single urea application. Due to the fact that N is a component of the chlorophyll structure, the addition of NBPT causes an increase of the chlorophyll content in the leaves (Makino & Osmond, 1991). Liu et al. (2017) reported that the nitrification inhibitor did not alter yield; however the N use efficiency of cotton increased, under a drip-fertigation system. Double inhibitor NBPT and DCD, are unknown to slow down the N conversion to meet the crop's needs (Li et al., 2020). As for crops an increase on 5–12% to iNUE is reported, while urease inhibitor increase the yield of cotton crop Cantarella et al., 2018). On the other hand, Li et al. (2020), demonstrated that cotton boll yield, lint percentage, lint yield and fiber quality, were not affected by fertilizer treatments, including polymer-coated urea (ESN) and urease inhibitors.

The scope of this study is to determine the improvement of the fertilizer yield by adding nitrification (DCD) and urease (NBPT) inhibitors in urea.

## MATERIAL AND METHODS

### Location and soil classification of the experimental site

The experiments were conducted as an open-field experiment at two areas in Greece, during 2019. The first site was located in Agrinio region, West Greece (Latitude: 38°35' N, Longitude: 21°25' E, Altitude: 80 m above sea level). The type soil is characterized as Clay Loam (40.9% clay, 26.5% silt and 32.6% sand), organic matter content in the topsoil of approximately 1.46% (Wakley & Black, 1934) and pH 7.44. The second experimental field was located in the drained Copaida basin, Veotia prefecture, Central Greece (Latitude: 38° 24' N, Longitude: 22° 59' E, Altitude 110 m above sea level) in an alluvial plain of lake deposits, intensively cultivated with maize, wheat and cotton. The experimental soil of Copaida area was (43.7% clay, 25.6% silt and 30.7% sand), pH 7.32 and organic matter 2.29.

The meteorological data, collected from a nearby weather station, regarding temperature and rainfall during the crop growing season is given in Fig. 1.

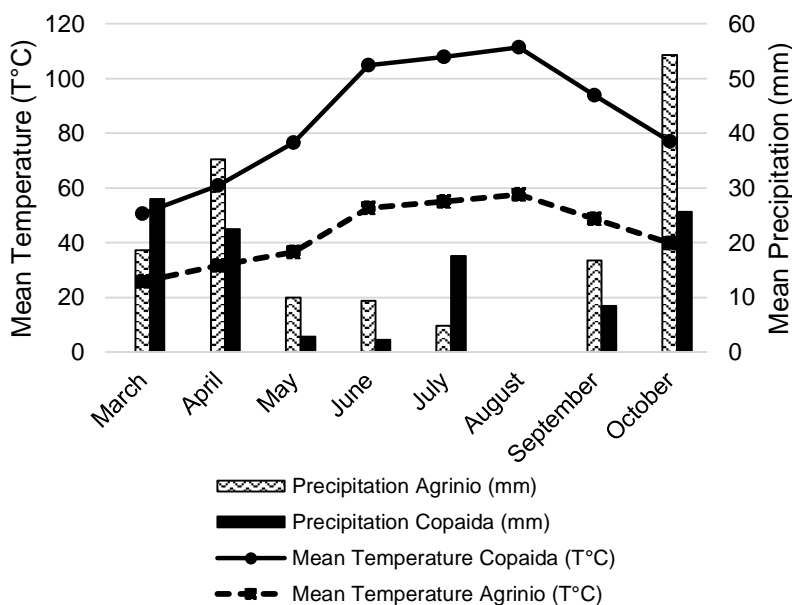
### Experimental design and treatments

A randomized complete block design (RCBD) with factorial arrangement (taking urea combinations and application methods as factors with equal importance) was followed with 4 replications and plot size of 5.0 m × 6.0 m. The total experimental area was 600 m<sup>2</sup>, which was devised in 4 replicates with 5 plots. The experiment consisted of four Urea combinations (Urea, Urea+NI+UI, Urea+NI, Urea+UI) and control. In all experiments, the following treatments and doses applied as followed:

1) Control (0 kg N ha<sup>-1</sup>) 2) Urea (46-0-0): at a rate of 160 kg N ha<sup>-1</sup>, 3) Urea + Nitrification Inhibitor (NI) + Urease Inhibitor (UI): at the same rate as urea. 4) Urea+NI:

at the same rate as urea. 5) Urea+UI: at the same rate as urea. Half dose was applied before sowing and the remaining half was side-dressed applied 4 weeks after sowing. The nitrification inhibitor was dicyandiamide (DCD) and urease inhibitor was N-(n-butyl) thiophosphoric triamide (NBPT).

For the purpose of this experiment, we used the very early maturity cotton variety ST 402. The planting of cotton (*Gossypium hirsutum* L.) took place on April 22 & 24, 2019 (at Agrinio & Copaida region, respectively) by using 20 kg seed ha<sup>-1</sup>. The plant density was evaluated over row spacing 95 cm and intra- row spacing 4 cm. Soil tillage encompasses 35 cm deep agronomic chisel plough, followed by rotary hoeing. Drip lines irrigation system was applied over the soil surface and water was being distributed every 10 days. Two manual hoeings were carried out to achieve weed control. The final hand picking took place in October 3<sup>rd</sup>.



**Figure 1.** Meteorological data, mean month temperature and precipitation for experimental site during the growing periods in Agrinio and Copaida regions (April-October, 2019).

### Samplings, measurements and methods

#### Agronomic traits

The height of plants was measured from the base of the plant to the tip of the main stem. Leaf Area Index (LAI) was measured by using SunScan ΔT devices. Total weight of opened bolls (g) was counted per plant.

#### Yields

The *Total Dry Weight* (kg ha<sup>-1</sup>) was measured during the harvest period. A number of 10 plants was selected from the middle rows and was dried at 64°C for 48 h. Then the Seed Cotton Yield (kg ha<sup>-1</sup>) was calculated according to Eq. (1).

$$\text{Seed Cotton Yield} = \text{Density} \times \text{Number of Bolls} \times \text{Bolls Yield} \quad (1)$$

The Above-Ground N Content (%) & Seed Cotton N Content (%) were determined by the Kjeldahl method (Bremner, 1960) using a Buchi 316 device.

Seed Cotton N Yield (kg N ha<sup>-1</sup>)

To estimate the N yield in seed cotton, N concentration (%) is multiplied by the dry weight of the seed cotton (kg ha<sup>-1</sup>) resulting the yield in N (kg ha<sup>-1</sup>).

Total Plant Nitrogen Uptake (kg N ha<sup>-1</sup>)

Once the seed cotton was calculated less than 13%, it was ginned on a 10\_saw, and after ginning the lint yield (kg ha<sup>-1</sup>) determination followed.

Fiber quality

To estimate fiber quality parameters and lint proportion, 500 g. seed cotton was selected for each plot; subsequently a laboratory gin machine with saw ginning system was used to separate the fibers from the seeds. Fiber quality characteristics, micronaire, length, strength, uniformity and **spinning consistency index (SCI)** were determined under standard ambient laboratory conditions (21 ± 1°C and 65% ± 2% relative humidity) by High Volume Instrument (HVI-100), USTER Technologies AG., according to the international standards, ASTM D586 (standard test methods of measurements of physical properties of raw cotton classification instruments). Cotton samples before measurement were air conditioned for 12 hour according to ASTM D1776 (standard practice for conditioning and testing textiles).

The Uniformity Ratio expresses the ratio of the Mean Length to the Upper Half Mean Length, expressed as a percentage according to Eq. (2).

$$\text{Uniformity Ratio} = \text{Mean Length} / \text{Upper Half Mean Length} \quad (2)$$

Spinning consistency index (SCI) was calculated based on a regression equation (Eq. 3) which considers the measured indexes.

$$\text{SCI} = -414.67 + 2.9 \times \text{strength} - 9.32 \times \text{micronaire} + 49.17 \times \text{length} ({}^\circ) + 4.74 \times \text{uniformity} + 0.65 \times \text{RD} + 0.36 \times \text{b} \quad (3)$$

Nitrogen indicators

Nitrogen Utilization Efficiency (NUE) and internal crop Nitrogen Use Efficiency (iNUE) indicators were used to evaluate the efficiency of nitrogen in cotton cultivation (Gerloff & Gabelman, 1983). The NUE is calculated according to Eq. (3).

$$\text{NUE} = \text{seed yield (kg ha}^{-1}\text{)} / \text{total plant N uptake (kg ha}^{-1}\text{)} \quad (4)$$

This ratio shows the seed yield (kg ha<sup>-1</sup>) to the N concentration (kg ha<sup>-1</sup>) in the above-ground part of the plant per crop.

Crop iNUE was determined in field experiments by Eq. (4) and it indicates how efficiently cotton produces lint in relation to the amount of N, accumulated by the crop. Crop iNUE measurements have been reported for cotton (Bronson 2008; Zhang et al., 2008a; Rochester, 2011).

$$\text{iNUE} = \text{kg lint kg}^{-1} \text{ crop N uptake} \quad (5)$$

Soil Nitrate N\_NO<sub>3</sub> and extractable Ammonium N\_NH<sub>4</sub> estimated by flow injection Analyzer Method (Kenney & Nelson, 1982) at 3 different stages, 60, 100 and 140 DAS (days after sowing).



## Statistical analysis

Analysis of variance was carried out on data using the STATISTICA (Stat Soft, 2011) logistic package as a Completely Randomized Design. The significance of differences between treatments was estimated using the *LSD* test and probabilities equal to or less than 0.05 were considered significant.

## RESULTS

All different fertilizers had an effect on total dry weight and in seed cotton yield, in both areas, as shown in Table 1. The values in total dry weight ranged from 7,941 to 14,136 kg ha<sup>-1</sup> in Copaida area and from 8,206 to 14,881 kg ha<sup>-1</sup> in Agrinio area. The total dry weight resulting from fertilization with Urea+NI+UI containing inhibitors, Nitrification (NI) and Urease (UI) and fertilization with Urea+UI containing inhibitor Urease showed statistically significant difference comparing to all other treatments. Urea+NI+UI treatment marked the highest value in total dry weight, in both areas. It is worth emphasizing that  $F_{\text{Copaida} * \text{Agrinio}}$  was not statistically significant (Table 1,2,3) due to the fact that Copaida and Agrinio areas are characterized by similar type of soil and climatic conditions. For all the above reasons there is no differentiation.

**Table 1.** Agronomic characteristics as affected by fertilizer treatments in Copaida and Agrinio regions

	Plant Height (cm)	LAI	Total Dry Weight (kg ha <sup>-1</sup> )	Seed Cotton Yield (kg ha <sup>-1</sup> )	Weight of open bolls per plant (g)	Lint yield (kg ha <sup>-1</sup> )
<b>Copaida</b>						
Urea + NI + UI	131.20 <sup>a</sup>	4.75 <sup>a</sup>	14,136 <sup>a</sup>	5,145 <sup>a</sup>	80.29 <sup>a</sup>	2,287.20 <sup>a</sup>
Urea + UI	119.70 <sup>ab</sup>	4.58 <sup>ab</sup>	14,028 <sup>a</sup>	5,105 <sup>b</sup>	79.27 <sup>ab</sup>	2,255.30 <sup>a</sup>
Urea + NI	112.50 <sup>ab</sup>	4.43 <sup>ab</sup>	13,564 <sup>b</sup>	4,932 <sup>b</sup>	73.74 <sup>ab</sup>	2,188.30 <sup>a</sup>
Urea	101.10 <sup>bc</sup>	3.70 <sup>b</sup>	12,567 <sup>b</sup>	4,568 <sup>b</sup>	62.75 <sup>b</sup>	1,939.80 <sup>b</sup>
Control(0 kg)	81.30 <sup>c</sup>	2.28 <sup>c</sup>	7,941 <sup>c</sup>	1,634 <sup>c</sup>	25.22 <sup>c</sup>	687 <sup>c</sup>
<b>Agrinio</b>						
Urea + NI + UI	139.80 <sup>a</sup>	4.94 <sup>a</sup>	14,881 <sup>a</sup>	5,318 <sup>a</sup>	85.11 <sup>a</sup>	2,442.50 <sup>a</sup>
Urea + UI	127.60 <sup>ab</sup>	4.87 <sup>a</sup>	14,794 <sup>a</sup>	5,201 <sup>ab</sup>	84.09 <sup>ab</sup>	2,406.50 <sup>a</sup>
Urea + NI	117.40 <sup>ab</sup>	4.57 <sup>a</sup>	14,106 <sup>b</sup>	4,953 <sup>ab</sup>	76.09 <sup>ab</sup>	2,256 <sup>b</sup>
Urea	105.40 <sup>bc</sup>	3.88 <sup>ab</sup>	13,027 <sup>b</sup>	4,572 <sup>b</sup>	66.06 <sup>b</sup>	1,986 <sup>b</sup>
Control	84.80 <sup>c</sup>	2.34 <sup>b</sup>	8,206.50 <sup>c</sup>	1,650.25 <sup>c</sup>	26.14 <sup>c</sup>	707.30 <sup>c</sup>
<i>F</i> <sub>Copaida Value</sub>	8.46*	10.91**	20.85**	51.26***	25.34**	18.22**
<i>F</i> <sub>Agrinio value</sub>	6.14*	8.27*	24.92**	42.34**	16.47**	40.53**
<i>F</i> <sub>Copaida*Agrinio</sub>	<i>ns</i>	<i>ns</i>	<i>ns</i>	<i>ns</i>	<i>ns</i>	<i>ns</i>

F-test ratios are from ANOVA. Different letters within a column indicate significant differences according to Tukey's test ( $\alpha = 0.05$ ). Significance levels: \*  $p < 0.05$ ; \*\*  $p < 0.01$ ; \*\*\*  $p < 0.001$ ; ns, not significant ( $p > 0.05$ ).

The values of the seed cotton yield ranged from 1,634 to 5,145 kg ha<sup>-1</sup> in Copaida area and from 1,650 to 5,318 kg ha<sup>-1</sup> in Agrinio area, respectively. Urea+NI+UI treatment showed statistically significant difference comparing to all other treatments in Copaida area, whereas in Agrinio area, Urea showed statistically significant difference

comparing to Urea+NI+UI treatment and Control. As for the plant height factor, in both regions, Urea+NI+UI treatment showed statistically significant difference comparing to Urea. The highest value was reported in Agrinio area at 39.80 cm, when using Urea with inhibitors Nitrification (NI) and Urease (UI) treatment, while the lowest value was reported in Copaida area at 81.30 cm, in Control (Table 1). LAI values (Leaf Area Index), in Agrinio area, ranged from 2.34 to 4.94 (highest value, in Urea+NI+UI fertilization). Urea with inhibitors Nitrification (NI) and Urease (UI), Urea+UI and Urea+NI treatments showed statistically significant difference with Control. On the contrary, in Copaida area, Urea+NI+UI treatment showed statistically significant difference comparing to Urea and Control, with LAI values ranging from 2.28 to 4.75 (Table 1). The weight of open bolls per plant values ranged from 25.22 to 80.29 g in Copaida area whereas in Agrinio area the range value was from 26.14 to 85.11 g, respectively. Concerning, the Lint yield factor, Urea showed statistically significant difference comparing to other treatments, in Copaida region. Urea+NI+UI and Urea when containing inhibitor Urease (UI) treatments showed statistically significant difference comparing to Urea+NI and Urea treatments, in Agrinio region (Table 1). The lint yield values ranged from 687 to 2,287.20 kg ha<sup>-1</sup> in Copaida region and from 707.30 to 2,442.50 kg ha<sup>-1</sup> in Agrinio region. Moreover, in Agrinio area, Urea containing inhibitors Nitrification (NI) and Urease (UI) treatment marked a higher value from the corresponding treatment in Copaida area (Table 1). In the current study, statistically significant differences were found among the fertilizer treatments, concerning the agronomic characteristics of cotton such as total dry weight, seed cotton yield, lint yield, LAI and plant height. The Inhibitors used in this study, were NBPT (Urease inhibitor), DCD (Nitrification inhibitor) and double inhibitors NBPT+DCD.

Our results indicated that the different treatments in both regions (Agrinio & Copaida) showed statistically significant difference, in both Nitrogen Utilization Efficiency (NUE) and Internal crop N use efficiency (iNUE) sectors. The values of iNUE, ranged from 6.82 to 9.81 in Copaida area and from 6.10 to 9.16 in Agrinio area. Respectively, the values of NUE ranged from 16.20 to 23.06 in Copaida area and from 9.27 to 13.74 in Agrinio area. Urea with double inhibitors showed statistically significant difference with Urea+NI, Urea+UI and with Urea, in Copaida area. Also, Urea's value with inhibitor Urease, in Copaida area, was 21.53, higher from the corresponding treatment in Agrinio area, which were 12.94. It is worth pointing out that, the treatments showed statistically significant difference comparing to control (Table 2).

Furthermore, the Seed Cotton N Content, Seed Cotton N Yield and Total Plant Nitrogen Uptake showed statistically significant difference between treatments in Copaida and Agrinio regions. The fertilizations that Urea showed statistically significant differences were Urea+NI+UI, Urea+UI, Urea with inhibitor Nitrification (NI) treatments and Control in Copaida area (Table 2). The seed cotton N yield values ranged from 43 to 179.25 kg N ha<sup>-1</sup> in Copaida area and from 48.50 to 211.75 kg N ha<sup>-1</sup> in Agrinio area. The seed cotton N content values ranged from 2.64 to 3.48% in Copaida area and from 2.71 to 3.66% in Agrinio area. In regard to total plant nitrogen uptake, the values ranged from 103.50 to 250.50 kg N ha<sup>-1</sup> in Copaida area and from 117.75 to 286.75 kg N ha<sup>-1</sup> in Agrinio area. In total, plant nitrogen uptake value in Urea was 198.50 kg N ha<sup>-1</sup> in Copaida area, and it was lower than the value of Urea in Agrinio area (218 kg N ha<sup>-1</sup>). In the above ground N content, the value ranged from 1.29 to 1.77% in Copaida area and from 1.42 to 1.94% in Agrinio area. Urea+NI+UI and Urea with

inhibitor Urease (UI) showed statistically significant difference with Urea in Copaida area, and Urea+NI+UI and Urea+UI showed statistically significant difference with Urea+NI and Urea in Agrinio area.

Also, in Agrinio area, all treatments marked higher values when compared to the ones in Copaida area. The highest values in all parameters concerning nitrogen content are given by Urea with inhibitors Nitrification (NI) and Urease (UI) in both areas (Table 2).

**Table 2.** Content nitrogen in seed cotton, cotton yield, in plant, NUtE, iNUE as affected by fertilizer treatments in Copaida and Agrinio regions

	Above Ground N Content (%)	Seed Cotton N Content (%)	Seed Cotton N Yield (kg N ha <sup>-1</sup> )	Total Plant Nitrogen Uptake (kg N ha <sup>-1</sup> )	Nitrogen Utilization Efficiency (NUtE)	Internal crop N use efficiency (iNUE)
<b>Copaida</b>						
Urea + NI + UI	1.77 <sup>a</sup>	3.48 <sup>a</sup>	179.25 <sup>a</sup>	250.50 <sup>a</sup>	23.06 <sup>a</sup>	9.81 <sup>a</sup>
Urea + UI	1.74 <sup>a</sup>	3.45 <sup>a</sup>	176 <sup>a</sup>	245.50 <sup>a</sup>	21.53 <sup>b</sup>	9.56 <sup>a</sup>
Urea + NI	1.69 <sup>ab</sup>	3.34 <sup>a</sup>	164.75 <sup>a</sup>	229.25 <sup>a</sup>	20.79 <sup>b</sup>	9.17 <sup>b</sup>
Urea	1.57 <sup>b</sup>	3.08 <sup>b</sup>	140.50 <sup>b</sup>	198.50 <sup>b</sup>	20.52 <sup>b</sup>	9.12 <sup>b</sup>
Control (0 kg)	1.29 <sup>c</sup>	2.64 <sup>c</sup>	43 <sup>c</sup>	103.50 <sup>c</sup>	16.20 <sup>c</sup>	6.82 <sup>c</sup>
<b>Agrinio</b>						
Urea + NI + UI	1.94 <sup>a</sup>	3.66 <sup>a</sup>	211.75 <sup>a</sup>	286.75 <sup>a</sup>	13.74 <sup>a</sup>	9.16 <sup>a</sup>
Urea + UI	1.89 <sup>a</sup>	3.62 <sup>a</sup>	204.75 <sup>ab</sup>	282.25 <sup>ab</sup>	12.94 <sup>a</sup>	9.07 <sup>a</sup>
Urea + NI	1.76 <sup>b</sup>	3.42 <sup>ab</sup>	183.75 <sup>b</sup>	249 <sup>bc</sup>	12.05 <sup>b</sup>	8.51 <sup>b</sup>
Urea	1.66 <sup>b</sup>	3.16 <sup>b</sup>	157.50 <sup>c</sup>	218 <sup>c</sup>	11.97 <sup>b</sup>	8.50 <sup>b</sup>
Control (0 kg)	1.42 <sup>c</sup>	2.71 <sup>c</sup>	48.50 <sup>d</sup>	117.75 <sup>d</sup>	9.27 <sup>c</sup>	6.10 <sup>c</sup>
<i>F Copaida Value</i>	25.34**	26.30**	73.31***	37.38**	5.56*	6.21*
<i>F Agrinio value</i>	30.73**	22.31**	69.23***	35.01***	6.44*	9.56*
<i>F Copaida * Agrinio</i>	<i>ns</i>	<i>ns</i>	<i>ns</i>	<i>ns</i>	<i>ns</i>	<i>ns</i>

F-test ratios are from ANOVA. Different letters within a column indicate significant differences according to Tukey's test ( $\alpha = 0.05$ ). Significance levels: \*  $p < 0.05$ ; \*\*  $p < 0.01$ ; \*\*\*  $p < 0.001$ ; ns, not significant ( $p > 0.05$ ).

Generally, micronaire was higher in Copaida than in Agrinio region (Table 3). However, in both regions it was significant higher (4.04–4.30) when Urea+NI+UI treatment was applied and lower in Control and Urea treatments (3.25–3.39). Micronaire in all other treatments (Urea+UI and Urea+NI) marked intermediate values of about 3.80 and 4.07 in Copaida and Agrinio regions, respectively.

SCI (Spinning Consistency Index) generally was higher in Agrinio than in Copaida region. In Copaida area, SCI marked significant lower values in Urea and Control (137.52 and 125.31 respectively) whereas the values were the same in the rest three treatments (Urea+NI+UI, Urea+UI and Urea+NI) (Table 3). In Agrinio area, SCI showed significant differences between all treatments, marking the higher value in Urea+NI+UI (158.16) treatment, the lower value in Control (129.33), and intermediate values in all the rest treatments ( Urea+UI, Urea+N & Urea, 149.66, 140.31 and 140.06, respectively). As for the other fiber parameters, fiber length in both two regions (Copaida and Agrinio), was significantly higher in Urea+NI+UI treatment (28.50, 28.35 mm in

both two regions respectively) and lower in Control (26.94 and 26.33 mm in both two regions respectively).

**Table 3.** Fiber quality as affected by fertilizer treatments in Copaida and Agrinio regions

	Upper Half Mean Length (mm)	Strenght g Tex <sup>-1</sup>	Elongation (%)	Micronaire	Spinning Consistency Index	Lint Propotion (%)
<b>Copaida</b>						
Urea + NI + UI	28.50 <sup>a</sup>	30.47 <sup>a</sup>	9.18 <sup>a</sup>	4.04 <sup>a</sup>	140.38 <sup>a</sup>	43.87 <sup>a</sup>
Urea + UI	28.14 <sup>b</sup>	30.07 <sup>a</sup>	9.06 <sup>a</sup>	3.83 <sup>a</sup>	139.17 <sup>a</sup>	43.82 <sup>a</sup>
Urea + NI	28.02 <sup>b</sup>	29.95 <sup>a</sup>	9.02 <sup>b</sup>	3.81 <sup>a</sup>	138.52 <sup>a</sup>	43.55 <sup>b</sup>
Urea	27.75 <sup>c</sup>	28.71 <sup>b</sup>	8.94 <sup>b</sup>	3.39 <sup>b</sup>	137.78 <sup>b</sup>	42.52 <sup>b</sup>
Control (0 kg)	26.94 <sup>d</sup>	27.62 <sup>b</sup>	8.69 <sup>c</sup>	3.25 <sup>b</sup>	125.31 <sup>c</sup>	41.49 <sup>c</sup>
<b>Agrinio</b>						
Urea + NI + UI	28.35 <sup>a</sup>	32.34 <sup>a</sup>	9.76 <sup>a</sup>	4.3 <sup>a</sup>	158.16 <sup>a</sup>	46.20 <sup>a</sup>
Urea + UI	28.32 <sup>a</sup>	31.82 <sup>a</sup>	9.66 <sup>a</sup>	4.07 <sup>ab</sup>	149.66 <sup>ab</sup>	45.91 <sup>a</sup>
Urea + NI	27.64 <sup>b</sup>	31.06 <sup>ab</sup>	9.41 <sup>b</sup>	3.99 <sup>ab</sup>	140.31 <sup>bc</sup>	45.57 <sup>ab</sup>
Urea	27.17 <sup>b</sup>	29.85 <sup>bc</sup>	9.20 <sup>b</sup>	3.54 <sup>bc</sup>	140.06 <sup>c</sup>	43.94 <sup>bc</sup>
Control (0 kg)	26.33 <sup>c</sup>	28.61 <sup>c</sup>	9.06 <sup>c</sup>	3.39 <sup>c</sup>	129.33 <sup>c</sup>	42.86 <sup>c</sup>
<i>F Copaida Value</i>	62.23***	8.71**	21.97**	19.83**	19.28**	5.34*
<i>F Agrinio value</i>	16.12**	11.01**	22.67**	ns	6.67*	5.11*
<i>F Copaida * Agrinio</i>	ns	ns	ns	ns	ns	ns

F-test ratios are from ANOVA. Different letters within a column indicate significant differences according to Tukey's test ( $\alpha = 0.05$ ). Significance levels: \*  $p < 0.05$ ; \*\*  $p < 0.01$ ; \*\*\*  $p < 0.001$ ; ns, not significant ( $p > 0.05$ ).

Fiber strength (Table 3) data demonstrates the same alterations with SCI, marking significant higher values in Urea+NI+UI (30.47 g tex<sup>-1</sup>), in Urea+UI (30.07 g tex<sup>-1</sup>) and in Urea+NI (29.95 g tex<sup>-1</sup>) treatments in Copaida region and lower values in Urea and Control treatments (28.71 and 25.62 g tex<sup>-1</sup>, respectively). Additionally, in Agrinio region significant differences between all treatments were marked but the values were significantly higher in Urea+NI+UI treatment (32.34 g tex<sup>-1</sup>) and significantly lower in Control (28.61 g tex<sup>-1</sup>). Also, fiber strength was significantly higher in Agrinio than in Copaida region.

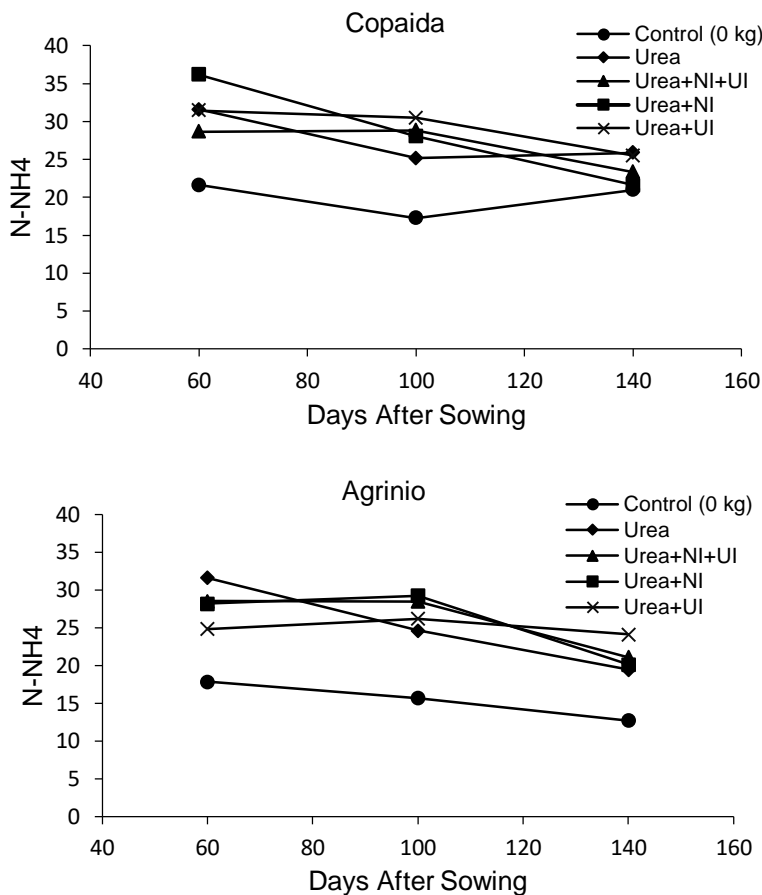
Fiber elongation, showed similar variations for both two regions. It was significantly higher in Urea+NI+UI and Urea+UI treatments (9.18% and 9.76% in Copaida and Agrinio regions, respectively) and it was lower in the rest of the treatments (Urea+NI, Urea and Control). Finally, it was higher in all treatments, in Agrinio region.

Lint proportion was generally higher in Copaida than in Agrinio region, marking significant higher values in Urea+NI+UI and Urea+UI treatments rather than in all other treatments.

It is emphasized that the application of Urea containing Nitrification (NI) and Urease (UI) inhibitors as fertilizer, resulted all fiber quality parameters to mark the highest values in both regions (Copaida&Agrinio), as shown in the Table 3.

Fig. 2 depicts the N-NH<sub>4</sub> concentrations in different DAS (Days After Sowing). Observing the case of Copaida area, it is demonstrated that at 40 DAS, all treatments marked high values, ranged from 23 ppm to 37 ppm. Urea+NI treatment marked the

highest value and Control the lowest. At 100 DAS a value decrease was noticed, with Urea+NI, Urea treatments and Control demonstrating 26 ppm, 24 ppm and 16 ppm  $N_{NH_4}$  concentrations, respectively. Although at 140 DAS, Control showed an increased value compared to 100 DAS, still, it marked the lowest values along with Urea+NI treatment (23 ppm for both treatments). The highest values were marked by Urea+UI and Urea treatments. It is worth pointing out that while Urea+NI treatment showed originally the highest value at 60 DAS, it shows the lowest at 140 DAS.

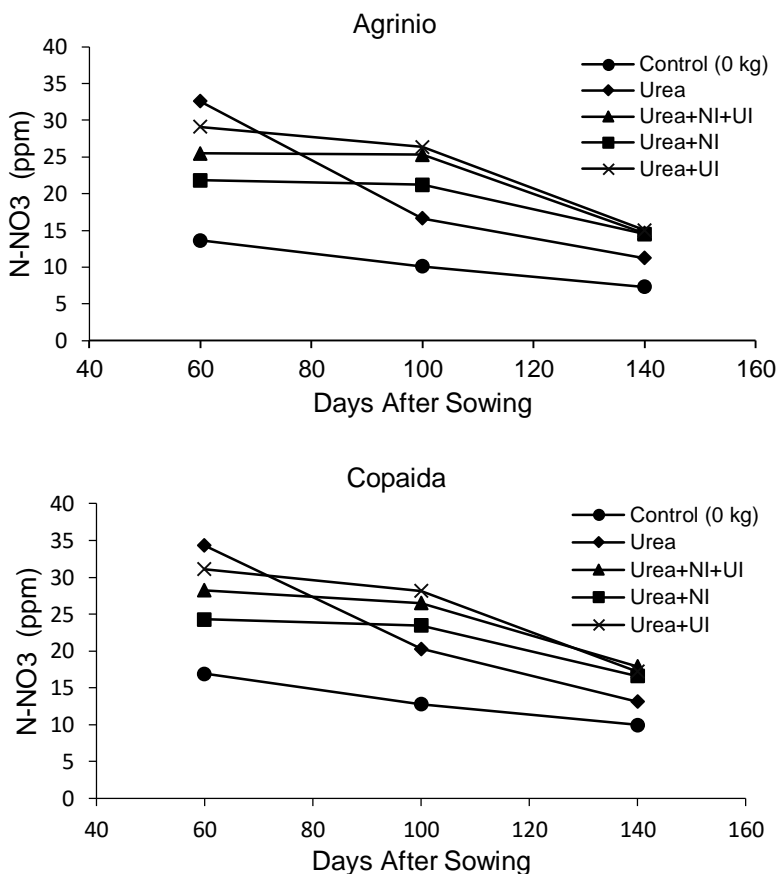


**Figure 2.** Ammonium concentrations ( $N_{NH_4}$ ) in Copaida and Agrinio regions at 60, 100 and 140 DAS.

Observing Agrinio area, at 60 DAS Urea marked the highest value and Control the lowest. At 100 DAS Urea value decreased. At 140 DAS the lowest value is given by Control and the highest by Urea+UI treatment, (14 ppm and 25 ppm, respectively). The remarkable fact is that we noticed a decrease in Urea, at 140 DAS in Agrinio area, while the highest value marked at 60 DAS. On the contrary, in Copaida area, Urea+NI treatment showed the highest value at 60 DAS, and then it decreased at 140 DAS. Additionally, we observed that Control in Copaida area demonstrates an increase at

140 DAS compared to 100 DAS while in Agrinio area it continuously declines until 140 DAS.

Fig. 3 depicts the N-NO<sub>3</sub> concentrations at different DAS (Days After Sowing). While noticing Copaida area, it is demonstrated that Urea marks the highest value at 60 DAS but at the same time Urea marks low values at 140 DAS (35 ppm and 15 ppm, respectively). The values of Control are the lowest at 60, 100 and 140 DAS (17 ppm, 14 ppm and 12 ppm respectively). Urea marked the highest decrease in comparison with all other treatments. From 60 DAS to 140 DAS the decrease in all treatments was impressive.



**Figure 3.** Nitrate concentrations (N-NO<sub>3</sub>) in Copaida and Agrinio regions at 60, 100 and 140 DAS.

In Agrinio area, Control values at 60 DAS and 140 DAS were 14 ppm and 10 ppm respectively. Urea value at 60 DAS was 35 ppm but at 140 DAS was 15 ppm. Urea+NI+UI, Urea+NI and Urea+UI treatments marked the same value at 140 DAS (20 ppm). At 60 DAS all three fertilizations marked different values (27 ppm, 30 ppm and 24 ppm respectively). Control's values are significantly lower than the corresponding in Copaida area. The values of all treatments decreased from 60 DAS to 140 DAS.

## DISCUSSION

### Agronomic characteristics

Urea with inhibitors Urease and Nitrification treatment demonstrated significant differences in the total dry weight. Similar studies have also demonstrated a positive effect of NBPT on Urea especially in total dry matter (Oosterhuis et al., 1983; Bondada & Oosterhuis, 2001).

In the present research, during treatment with double inhibitors, differences in LAI were recorded. Similar results presented by Makino & Osmond (1991), who demonstrated that NBPT increases the leaf chlorophyll concentration. This is due to the positive correlation between N and leaf chlorophyll concentration in cotton (Buscaglia & Vacro, 2002).

Seed cotton yield and lint yield were higher when Urea was applied along with NBPT and DCD. Also, seed cotton yield and lint yield marked a significant positive correlation with above ground N, total plant nitrogen Uptake and with seed cotton N (Table 4). Meaning that, these forms of N enhances the seed cotton yield and lint yield. Kawakami et al. (2012) in his study, also demonstrated, that N uptake, in Urea and NBPT treatment, results in higher cotton lint and seed yields.

**Table 4.** Correlation matrix between nitrogen index, plant growth parameters and yields

	Total Dry Weight (kg ha <sup>-1</sup> )	Seed Cotton Yield (kg ha <sup>-1</sup> )	Lint yield (kg ha <sup>-1</sup> )	LAI	Plant Height (cm)
Above-Ground N (%)	.83***	.80***	.82***	.76***	.76***
Seed Cotton N (%)	.84***	.81***	.83***	.78***	.74***
Seed Cotton N Yield (kg N ha <sup>-1</sup> )	.97**	.93**	.98**	.92**	.83***
Total Plant Nitrogen Uptake (kg N ha <sup>-1</sup> )	.98**	.94**	.96**	.92***	.87***
Nitrogen Utilization Efficiency (NUE)	.18 <sup>ns</sup>	.32*	.26 <sup>ns</sup>	.18 <sup>ns</sup>	.04 <sup>ns</sup>
Internal crop N use efficiency (iNUE)	.60***	.74***	.72***	.56***	.39*

F-test ratios are from ANOVA. Different letters within a column indicate significant differences according to Tukey's test ( $\alpha = 0.05$ ).

Significance levels: \*  $p < 0.05$ ; \*\*  $p < 0.01$ ; \*\*\*  $p < 0.001$ ; ns, not significant ( $p > 0.05$ ).

### Quality characteristics

Fiber growth and development is affected by most factors that also influence the plant's growth. Since the fiber is primarily cellulose, any influence on the plant's photosynthetic capacity and production of carbohydrate will cause similar influence on fiber growth (Bange et al., 2009). Variations in fiber maturity were linked with source-sink modulations related to flowering date (Bradow et al., 1997).

In this study, while comparing Control and Urea treatments, micronaire was higher when Urea+NI+UI, Urea+NI and Urea+UI treatments were applied. Additionally, micronaire marked significant positive correlation with plant N uptake (Table 5) and with the N content in the above the ground part of plants. Therefore, these forms of N

enhances the micronaire, and this may be related with the higher LAI values in Urea+NI+UI, Urea+NI and UI treatments.

**Table 5.** Correlation matrix between nitrogen index and cotton parameters quality

	Micronaire	Upper Half Mean Length (mm)	Strength (g Tex <sup>-1</sup> )	Elongation (%)	Spinning Consistency Index	Lint Proportion (%)
Above-Ground N Content (%)	.68***	.73***	.72***	.72***	.67***	.72***
Seed Cotton N Content (%)	.67***	.81***	.72***	.64***	.62***	.66***
Seed Cotton N Yield (kg N ha <sup>-1</sup> )	.71***	.80***	.74***	.71***	.71***	.70***
Total Plant Nitrogen Uptake (kg N ha <sup>-1</sup> )	.71***	.81***	.73***	.71***	.68***	.72***
Nitrogen Utilization Efficiency (NUE)	-.07 <sup>ns</sup>	.34*	-.22 <sup>ns</sup>	-.44**	-.10 <sup>ns</sup>	-.34*
Internal crop N use efficiency (iNUE)/ Nitrogen Physiological Use Efficiency (NPUE)	.29 <sup>ns</sup>	.49**	.29 <sup>ns</sup>	.22 <sup>ns</sup>	.42**	.28 <sup>ns</sup>

F-test ratios are from ANOVA. Different letters within a column indicate significant differences according to Tukey's test ( $\alpha = 0.05$ ). Significance levels: \*  $p < 0.05$ ; \*\*  $p < 0.01$ ; \*\*\*  $p < 0.001$ ; ns, not significant ( $p > 0.05$ ).

N is a component of both proteins and chlorophyll. For instance, Bondada et al. (1996) found a strong relationship among lint yield, canopy photosynthesis, and soil N. From a fiber development perspective, changes in the relationship between canopy leaf area and boll number affect the maturity (thickness of the secondary cell wall) of developing fibers leading to differences in micronaire (Bange et al., 2009).

The N effect on canopy photosynthesis is probably predominately caused by the effect N has on leaf area production and light interception. N deficiency also impacts photosynthesis through effects on both the dark and light reaction components of photosynthesis, something that isn't unusual, considering that N is a component of both proteins and chlorophyll Reddy et al. (1996), Pettigrew (2016) demonstrated a close relationship between CER, Rubisco activity, and leaf N concentration. Based on previous reports regarding the effect of N on cotton fiber micronaire, the results of the present research, indicated that the same can be assumed regarding the other fiber parameters (length, strength, SCI and lint proportion) that marked significant higher values, as in the case of micronaire, when comparing Control and Urea treatment with Urea+NI+UI, Urea+NI and Urea+UI treatments.

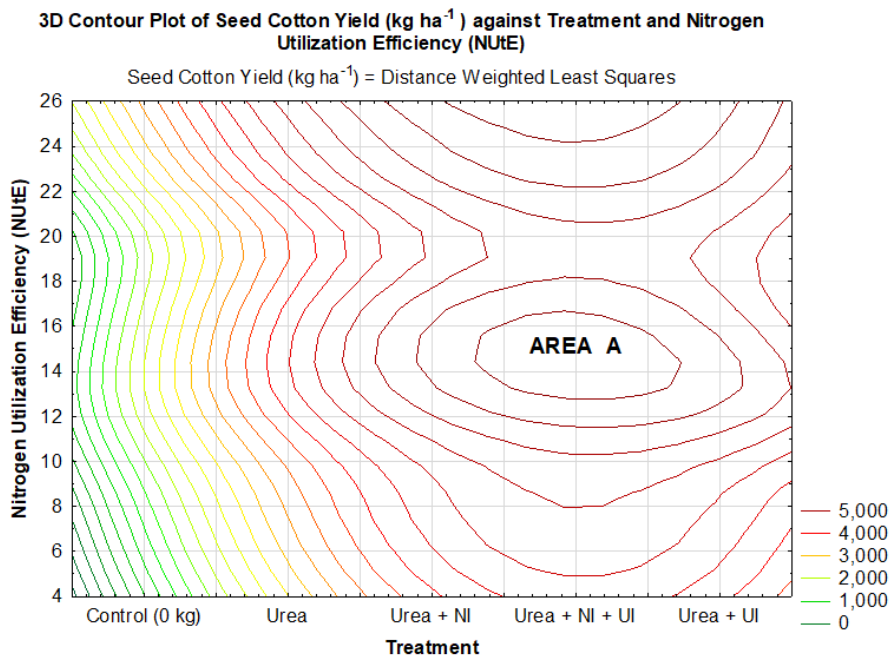
Also, all the fiber quality parameters demonstrated significant positive correlation, as in micronaire, with N content in cotton seed, with above the ground part of plants and with total plant N uptake. The degree of deposition of cellulose in the fiber cell is significantly affected by factors that affect photosynthesis (Bange et al., 2009). The present research findings showed this factor may be LAI since it marked significant higher values when Urea and Control treatments compared to Urea with inhibitor nitrification (NI), Urea with inhibitor Urease (UI) treatments.



Few agronomic or climatic conditions indicated a consistent effect on fiber bundle strength, as the loss of leaf area can reduce photosynthesis. The strength of cotton fibers is related to the degree of wall thickening. Important, however, substantial differences in strength of fibers will depend on the chemical structure of the cellulose being laid down in the secondary wall. The longer the cellulose molecule chains that are laid down, the stronger the fiber becomes. The length of fiber is analogous to the yarn's strength (the longer the fiber is, the yarn is made stronger). The different fiber strength among cotton varieties is related to the composition of the cellulose. Nitrogen and potassium nutrition can have a significant effect on fiber quality (Pettigrew, 2016).

According to Boquet et al. (1993), the nitrogen fertilization demonstrated significant impacts on plant growth, lint yields and fiber quality.

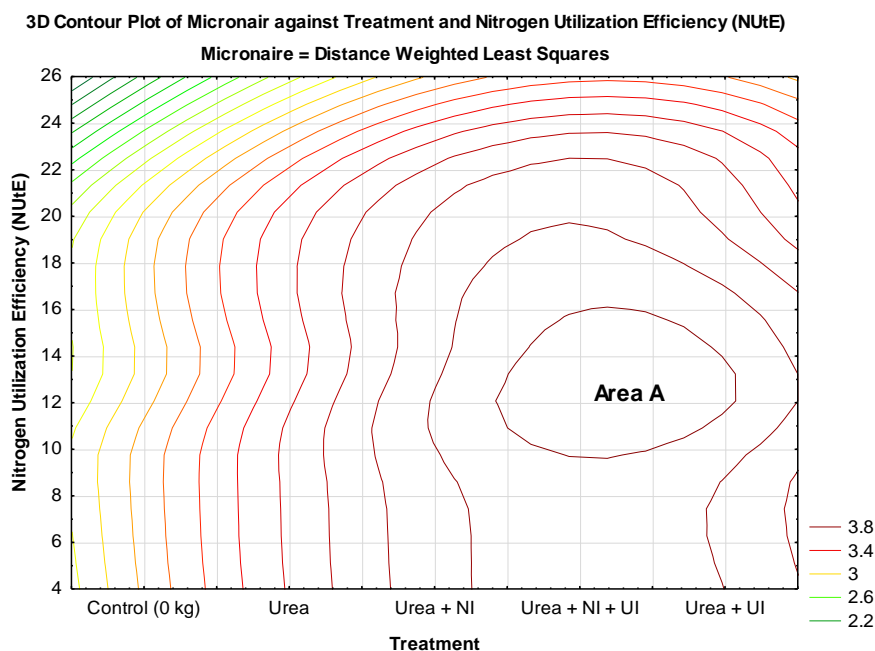
Higher values in treatments with inhibitors, were observed mainly because Urease inhibitors delay Urea hydrolysis in soil and, this way, decreases the intensity of the soil pH while  $\text{NH}_3/\text{NH}_4^+$  concentration is increased in the surrounding area of the fertilizer granule, thus reducing the toxic effect of high ammonia concentration on seed germination (Xiaobin et al., 1995; Grant & Bailey, 1999). The benefit of using Urea with inhibitor Urease (UI) fertilization in crops is well documented (Norman et al., 2006; Mozaffari et al., 2007). The nitrification inhibitor, by blocking nitrification, caused the soil  $\text{NH}_3/\text{NH}_4^+$  concentration to remain high for a longer period, allowing volatilization losses to continue (Soares et al., 2012). The use of Urea with inhibitor nitrification has been reported to positively affect N fertilization and yield of crops (Di & Cameron, 2002).



**Figure 4.** 3D-plot of seed yield against treatments and NUE.

Each year larger amounts of N fertilizers are applied to croplands and cost billions of money (Nour, 2015). The estimated efficiency of applied N ranges from about 30% to about 70% (John D., 2007). Concerning to Nitrogen Utilization Efficiency (NUE), we created Fig. 4, which shows the optimal area. According to Table 1 and Fig. 4, Urea with double inhibitors marked higher seed yield (12.63%), Urea+UI (11.76%) and Urea+NI (7.97%) than Urea. It should be noted that the same quantities of fertilizers were used in all treatments. In general, the efficiency of the inhibitors can reduce from 12.63% to 7.96% the quantities of Urea and therefore the losses arising from its use.

Corresponding to Fig. 5, the optimal area is depicted, when using Urea+NI+UI treatment. Under the same quantities of fertilizers, Urea+NI+UI treatment increases micronaire by 20.34%, Urea+UI treatment by 13.99% and Urea+NI treatment by 12.55% compared to Urea. This results from improved Nitrogen Use Efficiency (NUE), which leads to better fiber quality.



**Figure 5.** 3D-plot of micronaire value against treatments and NUE.

## CONCLUSION

The findings of the present study clearly indicate that, Urea with inhibitors Nitrification (NI) and Urease (UI) results in better plant growth, Nitrogen Indices as NUE, and better fiber quality, compared to Urea. Urea with Urease (UI) inhibitor and Urea with Nitrification (NI) inhibitor showed the immediate best results in cotton cultivation. It is emphasized that the above apply in both experimental regions (Agrinio and Copaida). According to the above, when using the same amount of fertilizer in all treatments, Urea with double inhibitors increases the seed yield by 12.63% and micronaire by 20.34% compared to Urea. Fertilizers that contain inhibitors, have the

potential to increase yields, as well as quality characteristics with less losses to the environment.

## REFERENCES

- Allanov, Kh., Sheraliev, Kh., Ulugov, Ch., Ahmurzayev, Sh., Sottorov, O., Khaitov, B. & Park, K.W. 2019. Integrated Effects of Mulching Treatment and Nitrogen Fertilization on Cotton Performance under Dryland Agriculture, *Soil Science and Plant Analysis*. doi: 10.1080/00103624.2019.1648496
- American Society for Testing and Materials (ASTM). 2002. Standard test method for length and length distribution of cotton fibers (array method) (D 1440). In Annual Book of ASTM Standards. Vol. 07.01 Textiles. ASTM International, West Conshohocken, PA
- Avgoulas, C., Bouza, L., Koutrou, A., Papadopoulou, S., Kosmas, E. & Makridou, E., Papastylianou, P. & Bilalis, D. 2005. Evaluation of five most commonly grown cultivars (*Gossypium hirsutum* L.) under Mediterranean conditions: Productivity and fibre quality. *Journal of Agronomy Crop Science*. **191**, 1–9. doi:10.1111/j.1439-037X.2004.00139.x
- Bange, M.P., Constable, G.A., Gordon, S.G., Long, R.L., Naylor, G.R.S. & van der Sluijs, M.H.J. (CSIRO). 2009. FIBREpakA Guide to Improving Australian Cotton Fibre Quality, *The Cotton Catchment Communities Cooperative Research Centre*. ISBN 978-1-863-1005-0
- Bauer, P.J., Frederick, J.R., Bradow, J.M., Sadler, E.J. & Evans, D.E. 2000. Canopy photosynthesis and fiber properties of normal- and late-planted cotton. *Agronomy Journal*. **92**, 518–523. doi:10.2134/agronj2000.923518x
- Bednarz, C.W., Nichols, R.L. & Brown, S.M. 2006. Plant density modifies within-canopy cotton fiber quality. *Crop Science*. **46**, 950–956. doi:10.2135/cropsci2005.08-0276
- Bremner, J.M. 1960. Determination of nitrogen in soil by Kjeldahl method. *J. Agric. Sci.* **55**, 11–33.
- Bilalis, D., Patsiali, S., Karkanis, A., Konstantas, A., Makris, M. & Efthimiadou, A. 2010. Effects of cultural system (organic and conventional) on growth and fiber quality of two cotton (*Gossypium hirsutum* L.) varieties. *Renewable Agricultural Food System* **25**, 228–235.
- Brentrup, F. & Lammel, J. 2016. Nitrogen Use Efficiency, Nitrogen balance, and Nitrogen productivity – a combined indicator system to evaluate Nitrogen use in crop production systems. *International Nitrogen Initiative Conference. "Solutions to improve nitrogen use efficiency for the world"*, 4–8 December 2016, Melbourne, Australia. [http://www.ini2016.com/pdf-papers/INI2016\\_Brentrup\\_Frank.pdf](http://www.ini2016.com/pdf-papers/INI2016_Brentrup_Frank.pdf) (accessed 6 Mai 2020).
- Bondada, B.R. & Oosterhuis, D.M. 2001. Canopy Photosynthesis, Specific Leaf Weight, and Yield Components of Cotton under Varying Nitrogen Supply. *Journal of Plant Nutrition* **24**, 469–477.
- Bondada, B.R., Oosterhuis, D.M., Norman, R.J. & Baker, W.H. 1996. Canopy Photosynthesis, Growth, Yield, and Boll 15N Accumulation under Nitrogen Stress in Cotton. *Crop Science* **36**, 127–133.
- Boquet, D.J., Moser, E.B. & Breitenbeck, G.A. 1993. Nitrogen Effects on Boll Production of Field-Grown Cotton. *Agronomy Journal* **85**, 34–39.
- Bradow, J.M. & Davidonis, G.H. 2000. Quantitation of Fiber Quality and the Cotton Production-Processing Interface. *The Journal of Cotton Science* **4**, 34–64.
- Bradow, J.M., Bauer, P.J., Hinojos, O., Sassenrath-Cole, G. 1997. Quantitation of cotton fibre-quality variations arising from boll and plant growth environments. *European Journal of Agronomy* **6**(3–4), 191–204
- Bronson, K. 2008. Nitrogen use efficiency of cotton varies with irrigation system. *Better Crops with Plant Food* **92**, 20–22.
- Buscaglia, H. & Vacro, J. 2002. Early detection of cotton leaf nitrogen status using leaf reflectance. *Journal of plant Nutrition* **25**, 2067.

- Cantarella, H., Otto, R., Rodrigues, S.J. & Aijânio, G.B.S. 2018. Agronomic efficiency of NBPT as a urease inhibitor. *Journal of Advanced Research* **13**, 19–27
- Christidis, G.V. 1965. The cotton. Univ. of Thessaloniki, Thessaloniki, Greece, pp. 145–152
- Darawsheh, M.K. 2010. Cotton fiber quality parameters response to cultivation system as influenced by limited and normal irrigation. *Journal of Food, Agriculture & Environment* **8**(2), 527–530.
- Darawsheh, M.K., Chachalis, D., Aivalakis, G. & Khah, E.M. 2009. Cotton row spacing and plant density cropping systems II. Effects on seedcotton yield, boll components and lint quality. *Journal of Food, Agriculture & Environment* **7**(3&4), 262–265.
- Davidonis, G.H., Johnson, A.S., Landivar, J.A. & Fernandez, C.J. 2004. Cotton fiber quality is related to boll location and planting date. *Agronomy Journal* **96**, 42–47. doi:10.2134/agronj2004.0042
- Deussen, H. 1986. Stressing high strength, low micronaire may require a rethinking of breeding and marketing methods. In: W. Spencer, editor, Cotton International. 53<sup>rd</sup> (ed.) *Meister Publishing Co.*, TN. 32–36.
- Di, H. & Cameron, K. 2002. The use of a nitrification inhibitor, dicyandiamide (DCD), to decrease nitrate leaching and nitrous oxide emissions in simulated grazed and irrigated grassland. *Soil Use and Management* **18**, 395–403.
- Dong, H., Li, W., Eneji, A.E., Zhang, D. 2012. Nitrogen rate and plant density effects on yield and late-season leaf senescence of cotton raised on a saline field. *Field Crops Research* **126**, 137–144.
- Ducamp, F., Arriaga, F.J., Balkcom, K.S., Prior, S.A., van Santen, E. & Mitchell, C.C. 2012. Cover Crop Biomass Harvest Influences Cotton Nitrogen Utilization and Productivity <https://doi.org/10.1155/2012/420624>
- Emara, M.A. & El-Gammaal, A.A. 2012. Effect of Plant Distribution and Nitrogen Fertilizer Levels on New Promising Hybrid Cotton (Giza 89 × Giza 86). *Journal of Agricultural Research* **38**, 54–70.
- Gerloff, G.C. & Gabelman, W.H. 1983. Genetic Basis of Inorganic Plant Nutrition. In: Läuchli, A. and Bielecki, R.L., (Eds.), *Encyclopaedia of Plant Physiology New Series*, Volume, Springer-Verlag, New York, **15**(B), 453–480.
- Glibert, P.M., Harrison, J., Heil, C. & Seitzinger, S. 2006. Escalating worldwide use of urea – a global change contributing to coastal Eutrophication. *Biogeochemistry* **77**, 441–463.
- Grant, C.A. & Bailey, L.D. 1999. Effect of seed-placed urea fertilizer and N-(n-butyl) thiophosphoric triamide (NBPT) on emergence and grain yield of barley. *Canadian Journal of Plant Science* **79**(4), 491–496.
- John, D. 2007. Nitrogen Efficiency and Management. *Nutrient Management. Technical Note No. 6*.
- Kawakami, E., Derrick, M., Oosterhuis, A., John, L., Snider, B. & Morteza, M. 2012. Physiological and yield responses of field-grown cotton to application of urea with the urease inhibitor NBPT and the nitrification inhibitor DCD. *European Journal of Agronomy* **43**, 147–154.
- Krol, D.J., Forrestal, J.P., Wall, D., Lanigan, J.G., Sanz-Gomez, J. & Richards, G.K. 2020. Nitrogen fertilizers with urease inhibitors reduce nitrous oxide and ammonia losses, while retaining yield in temperate grassland. *Science of the Total Environment* **725**, 138329 doi.org/10.1016/j.scitotenv.2020.138329
- Li, Y., Mingfang, H., Tenuta, M., Ma, Z., Gui, D., Li, X., Zeng, F. & Gao, X. 2020. Agronomic evaluation of polymercoated urea and urease and nitrification inhibitors for cotton production under drip-fertigation in a dry climate. *Scientific Reports* **10**, 1472.
- Liu, T., Liang, Y. & Chu, G. 2017. Nitrapyrin addition mitigates nitrous oxide emissions and raises nitrogen use efficiency in plastic-film mulched drip-fertigated cotton field. *Plos One* **12**(5), e0176305. <https://doi.org/10.1371/journal.pone.0176305>

- Ma, R. H., Xu, Y.N., Zhang, X.C., Li, F.W., Feng, Y., Qu, L., Wang, H.Y. & Zhou, G.Z. 2008. Physiological mechanism of sucrose metabolism in cotton fiber and fiber strength regulated by nitrogen. *Acta Agronomica Sinica* **34**, 2143–2151. doi: org/10.1016/S1875-2780(09)60023-7
- Makino, A. & Osmond, B. 1991. Effects of nitrogen nutrition on nitrogen partitioning between chloroplasts and mitochondria in pea and wheat. *Plant Physiology* **96**, 355–362.
- Maynard, D.G., Kalra, Y.P. & Crumbaugh, J.A. 2016. Nitrate and Exchangeable Ammonium Nitrogen. In Schoenau, J.J & O'Halloran, I.P. (eds). *II. Diagnostic methods for soil and environmental management*. Taylor & Francis Group, LLC, 2–12
- Ming, Y., Fang, Y., Sun, D. & Shi, Y. 2016. Efficiency of two nitrification inhibitors (dicyandiamide and 3, 4-dimethylpyrazole phosphate) on soil nitrogen transformations and plant productivity: a meta-analysis, *Scientific reports*. doi: 10.1038/srep22075
- Mozaffari, M., Slaton, A.N., Long, J., Kelley, J., Chlapecka, R. & Wimberley, R. 2007. Effect of urea and urea treated with Agrotain™ on corn grain yield in Arkansas. *AAES Research Series 558: W.E. Sabbe Arkansas Soil Fertility Studies*, pp. 38–40.
- Norman, R.J., Frizzell, L.D., Wilson, E.C. & Slaton, A.N. 2006. Influence of urea and agrotain applied to a dry clay soil several days prior to flooding on the grain yield of delayed-flood rice. *UA Research Series 550: B.R. Wells Rice Research Studies*, pp. 298–302.
- Nour, Ali. 2015. Review: Nitrogen Utilization Features in Cotton Crop. *American Journal of Plant Sciences* **6**, 987–1002.
- Oosterhuis, D.M., Chipamaunga, J. & Bate, G.C. 1983. Nitrogen Uptake of Field-grown Cotton. I. Distribution in Plant Components in Relation to Fertilization and Yield. *Experimental Agriculture* **19**(1), 91–101
- Pettigrew, W.T. 2016. Cotton Photosynthetic Regulation through Nutrient and Water Availability. *The Journal of Cotton Science* **20**, 237–245.
- Reddy, A.R., Reddy, K.R., Padjung, R. & Hodges, H.F. 1996. Nitrogen nutrition and photosynthesis in leaves of Pima cotton. *Journal Plant Nutrition* **19**, 755–770.
- Rochester, I.J. 2011. Assessing internal crop nitrogen use efficiency in high-yielding irrigated cotton. *Nutrient Cycling Agroecosystems* **90**, 147–156.
- Saleem, M.F., Bilal, M.F., Awais, M., Shahid, M.Q. & Anjum, S.A. 2010. Effect of Nitrogen on Seed Cotton Yield and Fiber Qualities of Cotton (*Gossypium hirsutum* L.) Cultivars. *The Journal of Animal & Plant Sciences* **20**, 23–27.
- Soares, J.R., Cantarella, H. & Menegale, M.L.C. 2012. Ammonia volatilization losses from surface-applied urea with urease and nitrifications inhibitors. *Soil Biology and Biochemistry* **52**, 82–90.
- StatSoft, Inc. 2011. STATISTICA (data analysis software system), version 10. www.statsoft.com.
- Subhan, M., Khan, H.U. & Ahmed, R.O. 2001. Population analysis of some agronomic and technological characteristics of upland cotton (*Gossypium hirsutum* L.). *Pakistan Journal Biology Science* **1**, 120–123.
- Wakley, A. & Black, I.A. 1934. An examination of the Destyareff method for determining soil organic matter and a proposed modification of the chromic acid titration method. *Soil Science* **37**, 29–38.
- Wullschleger, S.D. & Oosterhuis, D.M. 1990. Canopy Development and Photosynthesis of Cotton as Influenced by Nitrogen Nutrition. *Journal of Plant Nutrition* **13**, 1141–1154.
- Xiaobin, W., Jingfeng, X., Grant, C.A. & Bailey, L.D. 1995. Effects of placement of urea with a urease inhibitor on seedling emergence, N uptake and dry matter yield of wheat. *Canadian Journal of Soil Science* **75**, 449–52.
- Zhang, L., Spiertz, J.H.J., Zhang, S., Li, B. & Werf, W. 2008. Nitrogen economy in relay intercropping systems of wheat and cotton. *Plant Soil* **303**, 55–68. doi:10.1007/s11104-007-9442-y

## **The quality of spring rape seeds and its dependence on the doses of mineral fertilizers under the conditions of Southern Urals**

M. Khajbullin<sup>1,\*</sup>, G. Kadaeva<sup>2</sup>, B. Akhiyarov<sup>2</sup>, A. Valitov<sup>3</sup> and R. Gajfullin<sup>4</sup>

<sup>1</sup>Federal State Budgetary Educational Institution of Higher Education Bashkir State Agrarian University, Department of Soil science, botany and plant breeding, 50-letiya Ocyabrya Str., 34, RU450001 Ufa, Russia

<sup>2</sup>Federal State Budgetary Educational Institution of Higher Education Bashkir State Agrarian University, Department of Crop production, plant breeding and biotechnology, 50-letiya Ocyabrya Str., 34, RU450001 Ufa, Russia

<sup>3</sup>Federal State Budgetary Educational Institution of Higher Education Bashkir State Agrarian University, Department of Plant growing and agriculture, 50-letiya Ocyabrya Str., 34, 450001, Ufa, Russia

<sup>4</sup>Federal State Budgetary Educational Institution of Higher Education Bashkir State Agrarian University, Department of Crop production and agriculture, 50-letiya Ocyabrya Str., 34, RU450001 Ufa, Russia

\*Correspondence: [khaibullinmuhamet@rambler.ru](mailto:khaibullinmuhamet@rambler.ru)

**Abstract.** Spring rape is a high-marginal crop that can be used in different areas of the national economy. Despite this, the area used for sowing this crop in the Russian Federation is still small, and the quality of its seeds does not always meet the standards. The purpose of the research is to identify the most effective doses of mineral fertilizers that allow obtaining the planned harvest of high-quality spring rape seeds in the southern forest-steppe of the Republic of Bashkortostan. The paper presents the results of triennial field researches (2016–2018) on the effect of mineral fertilizers on some indicators of the quality of spring rape seeds of the Iubileynyi variety. The research was carried out in the educational and scientific center of Bashkir State Agrarian University (Ufa, the Russian Federation) on leached black soils of heavy loam granulometric composition. The positive effect of calculated doses of mineral fertilizers on the object of interest was evident. Fertilization increased the spring rape yield capacity and its oil content by 0.34–0.51 t ha<sup>-1</sup> and 0.1–1.8%, respectively. The yield of oil per hectare also increased. The use of fertilizers increased the content of nitrogen and potassium, averaging over three years 3.32–3.36% and 1.00–1.03%, respectively. The use of fertilizers did not significantly effect the content of phosphorus. The content of phosphorus did not exceed 1.74–1.79%. Crude protein content was 19.4–19.6% for researched period.

**Key words:** crude protein, mineral fertilizers, oil content, quality, spring rape.

## INTRODUCTION

Spring rape is a high-marginal crop. It is used in many different ways in national economy (Zotz et al., 2018; Zemeckis et al., 2019). In recent years the crop areas have been increasing all over the world as well as in the Russian Federation (FAO, 2019; Statistics of The Russian Federation, 2018). China, Canada, countries of the European Union and India are the world leaders in growing rape today. These countries harvest 58 million tons in total, which is equal to 57% of the world's crop. The main exporters of rape seed in the world are Europe, Canada and Australia. The main importers are China, Mexico, Japan, Bangladesh, Pakistan and a number of other countries (FAO, 2019). These countries regulate the market for oil seeds using market and political conditions. There is a guaranteed area for oilseeds cultivation allotted for countries of the EU, which is established every year and is at least 10% of the total area. The EU policy on oilseeds has a certain export quota for rape and a system of per-hectare surcharges (Venus et al., 2017; Forleo et al., 2019). It should be noted that the structure of Russian market for oilseeds differs from that one worldwide. Sunflower occupies the main share of oilseed production, while rape accounts for 3–4% of Russian production.

There are two forms of rape: spring and winter rape. In Canada, for example, spring rape is widespread as conditions for winter rape are unfavorable, while in European countries (Germany, Poland, France, Great Britain, etc.) the climate is more favorable for winter rape cultivation, the yield of which there is almost twice higher than that of spring rape. In Sweden, the same attention is paid to both forms of rape. In the continental climate of Eastern Europe the cultivation of winter rape is a risky business. In Russia, spring rape is mainly grown. Rape production area in Russia was 1,387 thousand hectares and 37 thousand hectares in the Republic of Bashkortostan in 2018. The gross yield in the Russian Federation amounted to 2,216.3 thousand tons with an average yield of 1.4 t ha<sup>-1</sup> in the country (Statistics of The Russian Federation, 2018).

Both forms of rape are very demanding of nutrients and require high doses of fertilizers. Many farms in the country are unable to apply the necessary amount of fertilizers due to the disparity in prices prevailing in the market, the lack of necessary state subsidies and available loans. Therefore, farms need to develop such a system of fertilization, when the natural potential of plants and soil is used to the maximum extent possible. At the same time, non-production expenses are minimized, and the necessary doses of fertilizers are applied. Thus, our research plays an important role in solving the problem of increasing the efficiency of fertilizers applying.

To develop a rational system of fertilization, it is necessary to take into account numerous parameters, such as the content of nutrients in the soil, the biological needs of plants, the phytosanitary situation of sowings, etc. (Hu et al., 2017; Xiao-Bo et al., 2017). The use of rational doses of fertilizers will allow agricultural producers to obtain maximum yields of high-quality spring rape seeds (Nurlygaianov et al., 2019a). If the amount of fertilizers is insufficient, the seeds of spring rape may not get ripened. Deficit of any nutrient leads to development disorders. For example, a lack of potassium, can lead to the accumulation of ammonia in plant cells. Excessing nitrogen can lead to the accumulation of nitrates in the seeds (Kasiuliene et al., 2016; Szczepanek & Siwik-Ziomek, 2019). Fertilization system requires correct calculation and precise compliance with the technological process (Queiros et al., 2015).

Soil and climatic conditions, phytosanitary situation and biological requirements are important for developing recommendations for the rational spring rape cultivation. The purpose of the research is to identify the most effective doses of mineral fertilizers for obtaining high yield of high-quality spring rape seeds in the southern forest-steppe of the Republic of Bashkortostan. The increase in the doses of mineral fertilizers can affect the quality of spring rape seeds. Macronutrients content (N, P, K) is important marker of fertilization efficiency. Oil and crude protein content may depend on fertilizer system.

## MATERIALS AND METHODS

Researches were conducted in 2016–2018 in the Training and Research center of the Bashkir State Agrarian University of the Republic of Bashkortostan (Russian Federation, 54.769 °N, 55.866 °E). Field experiment was carried out on leached heavy loam black soils. The arable layer contained 6.8–7.2% of humus, 90 mg of easy hydrolysable nitrogen per 1 kg of soil, 110 mg of mobile phosphorus per 1 kg, 160 mg of exchange potassium per 1 kg. The soil was slightly acidic (pH<sub>KCl</sub> = 5.2).

Iubileinyi recognized variety was studied according to the scheme: the control variant (without fertilizers); nitrogenous fertilizers were applied in one step for pre-sowing cultivation in a dose of N<sub>125</sub>P<sub>80</sub>K<sub>50</sub>; the dose of nitrogen fertilizers was adjusted according to the soil diagnostics results and was applied in one step in a dose of N<sub>75–80</sub>P<sub>80</sub>K<sub>50</sub>; split nitrogen fertilizing was used, where 2/3 of the dose was applied for pre-sowing cultivation and 1/3 – for feeding in a dose of N<sub>125(2/3 of the dose for pre-sowing cultivation, 1/3 – for fertilization)</sub>P<sub>80</sub>K<sub>50</sub>; split nitrogen fertilizing was used, where the dose was adjusted according to the soil diagnostics results in a dose of N<sub>75(2/3 of the dose for pre-sowing cultivation, 1/3 – for feeding)–80</sub>P<sub>80</sub>K<sub>50</sub>; nitrogen fertilizers were applied in one step for pre-sowing cultivation, but potassium deficit increased – N<sub>125</sub>P<sub>80</sub>K<sub>60</sub> (Table 1).

**Table 1.** Experiment scheme

Experiment Variant	N, %		P, %	K, %
	pre-sowing	feeding		
Without fertilizers(control variant)	-	-	-	-
N <sub>125</sub> P <sub>80</sub> K <sub>50</sub>	125	-	80	50
N <sub>75(80)*</sub> P <sub>80</sub> K <sub>50</sub>	75(85)	-	80	50
N <sub>125(2/3 for a pre-sowing cultivation and 1/3 for fertilization)</sub> P <sub>80</sub> K <sub>50</sub>	83.33	41.67	80	50
N <sub>75(2/3 for a pre-sowing cultivation and 1/3 for feeding)(80)*</sub> P <sub>80</sub> K <sub>50</sub>	50(56.67)	25(28.33)	80	50
N <sub>125</sub> P <sub>80</sub> K <sub>60</sub>	125	-	80	60

Variants was arranged in a classified order, in three replications. The harvest area of the plot is 50 m<sup>2</sup>. During the experiments, we followed generally accepted recommendations for research institutions (Dospekhov, 2012).

Farm machinery used during the research corresponded to the scientific system of agriculture recommended for the zone (Puponina, 2010). Phosphorus and potassium fertilizers were applied in autumn for basic soil treatment. Nitrogen fertilizers were applied manually for pre-sowing cultivation and at the stage when spring rape had 4 leaves.



Treatment of spring rape seeds was performed with Kruiser agrichemical in a dose of  $15 \text{ dm}^3 \text{ t}^{-1}$ . It was established that to improve drum treatment process, a transit mode of seeds moving inside the working drum is necessary (Khasanov et al., 2019). Fertilizers were introduced in the form of potassium chloride, ammophos, cal urea and ammonium saltpeter. The crop was sown in an ordinary way in the second decade of May with a seed application rate of 2.5 million germinating seeds per hectare. One-phase harvesting conducted when moisture content was lower 25%.

Mean annual precipitation in 2016 was twice less compared to normal rate, averaging 37.3 mm during the growing season. 2017 was characterized by heavy precipitation reaching record values of 166 mm, and the air temperature was below the standard. Climate conditions in 2018 were amounting to the long-term average annual values (Hydrometeorological Center of Russia, 2016–2018).

Statistical processing of research results was carried out by the variance and correlation analysis using standard computer software packages such as Microsoft Excel and Statistica 8.0 application. Arithmetic averages, standard errors, standard deviations, variances, confidence intervals, and coefficients of variation were calculated. The reliability of differences for the 95% level of significance was determined by Student's test between the variants of the experiment.

Agrochemical analysis of plants:

- determination of dry matter content and gyroscopic moisture according to All Union State standard 8719-58;
- determination of nitrogen content using the Nessler chemical agent (Jeong, Park & Kim, 2013);
- determination of phosphorus content using vanadomolybdate method (Lew & Jakob, 1963);
- determination of potassium using the flame photometry method (All Union State standard 26726-85, 1987);
- the oil content was determined by extracting it with the use of the Soxhlet apparatus (All Union State standard 10857-64, 1964);
- crude protein content was determined according to All Union State standard 28074-89 (1990).

## RESULTS AND DISCUSSION

Oil content is an important indicator of seed quality (Arrua et al., 2017; Nurlygaianov et al., 2019b). The study of the effect of calculated doses of mineral fertilizers on the quality of spring rape products led to the increase in both yield and oil content by  $0.34\text{--}0.51 \text{ t ha}^{-1}$  and  $0.1\text{--}1.8\%$ , respectively. The use of fertilizers resulted in the increase in oil yield which amounted to  $0.902\text{--}0.909 \text{ t ha}^{-1}$  (Table 2).

Oil content of seeds in all of the studied variants was lower in 2016 compared to 2017 and 2018. This is caused by a decrease in the synthesis of nutrients during the formation of seeds. The decrease in the synthesis was caused by a high air temperature and moisture deficit.

The yield of oil per unit of area is increased by increasing the yield of seeds. Increasing the doses of mineral fertilizers heightened the yield of oil from 1 hectare compared to the control variant by 210 kg due to increased seed yield.

**Table 2.** Oil content and oil yield of Iubileinyi variety, depending on the calculated doses of mineral fertilizers (average over 2016–2018)

Experiment variant	Yield, t ha <sup>-1</sup>	Oil content, %	Oil yield, t ha <sup>-1</sup>
Without fertilizers (control variant)	1.76 <sup>b</sup>	41.7 <sup>b</sup>	0.740
N <sub>125</sub> P <sub>80</sub> K <sub>50</sub>	2.14 <sup>a</sup>	43.0 <sup>a</sup>	0.903
N <sub>75(80)*</sub> P <sub>80</sub> K <sub>50</sub>	2.10 <sup>a</sup>	42.3 <sup>b</sup>	0.903
N <sub>125</sub> (2/3 for a pre-sowing cultivation and 1/3 for fertilization) P <sub>80</sub> K <sub>50</sub>	2.27 <sup>a</sup>	41.8 <sup>b</sup>	0.902
N <sub>75</sub> (2/3 for a pre-sowing cultivation and 1/3 for feeding)(80)*P <sub>80</sub> K <sub>50</sub>	2.18 <sup>a</sup>	42.7 <sup>ab</sup>	0.909
N <sub>125</sub> P <sub>80</sub> K <sub>60</sub>	2.13 <sup>a</sup>	43.5 <sup>a</sup>	0.909
LSD <sub>0.05</sub>	0.25	0.69	0.01

The same results were obtained by Indian scientists. They studied the effect of macronutrients on the yield and oil content of rape in their research. Increasing the nitrogen dose to 100 kg a. m. per ha increased the yield of spring rape seeds. Further increase in the dose did not lead to an increase in the yield (Liu et al., 2019).

Oil content in the N<sub>125</sub>P<sub>80</sub>K<sub>60</sub> variant of Iubileinyi variety was maximum and amounted to 42.5%. In the variant, where fertilizers were applied in the dose of N<sub>125</sub>P<sub>80</sub>K<sub>50</sub>, oil content was 42%, and 41.7% – in the variant with the fertilizers dose of N<sub>75</sub>(2/3 for pre-sowing cultivation, 1/3 for feeding) (80)\*P<sub>80</sub>K<sub>50</sub>.

Quality of seeds depend on mineral fertilizers content of macronutrients in the seeds of spring rape can show efficiency of applied fertilizers. Feeding qualities of rape seed are decreases for high rates of fertilizers. Nitrogen is an element that plays a major role in plant metabolism, being a part of complex and simple proteins (Gamzikov et al., 2000).

Research results for 2016–2018 showed that the use of fertilizers increased the nitrogen content by 0.68–0.72%, amounting to 3.32–3.36% per completely dry matter (Table 3). In 2016, due to dry and hot weather, the increase was higher compared to other years of research and amounted to 3.51–3.58% for fertilized variants.

**Table 3.** Nitrogen content in spring rape seeds, % per completely dry matter

Variant	2016	2017	2018	On average over three years	Increase compare to control
Without fertilizers (control)	2.75	2.48	2.63	2.64	-
N <sub>125</sub> P <sub>80</sub> K <sub>50</sub>	3.58	3.03	3.46	3.33	0.69
N <sub>75(80)*</sub> P <sub>80</sub> K <sub>50</sub>	3.52	3.11	3.43	3.32	0.68
N <sub>125</sub> (2/3 for a pre-sowing cultivation and 1/3 for feeding) P <sub>80</sub> K <sub>50</sub>	3.51	3.16	3.48	3.36	0.72
N <sub>75</sub> (2/3 for a pre-sowing cultivation and 1/3 for feeding)(80)* P <sub>80</sub> K <sub>50</sub>	3.54	3.11	3.42	3.33	0.69
N <sub>125</sub> P <sub>80</sub> K <sub>50</sub>	3.53	3.12	3.41	3.33	0.69
LSD <sub>0.05</sub>	0.26	0.22	0.24	-	-

Phosphorus compounds in a living organism are fundamental. They perform a certain function in the energy volume, formation of adenosine triphosphate, etc. (Postnikov et al., 2001).

The results of the research indicate that the use of calculated doses of mineral fertilizers did not effect on the phosphorus content, and made up 1.74–1.79% (Table 4).

Potassium plays an important role in plant photosynthesis and is involved in many different types of reactions (Predein, 1991).

In the course of research, it was found that the potassium content of spring rape seeds strongly depended on the calculated doses of fertilizers used by us (Table 4). The potassium content increased by 0.13–0.16% to 1–1.03%. The maximum potassium content in spring rape seeds was observed in the N<sub>125</sub> variant (2/3 for a pre-sowing cultivation and 1/3 for feeding) P<sub>80</sub>K<sub>50</sub> and was 1.07%.

**Table 4.** Phosphorus content in spring rape seeds, % per completely dry matter

Variant	2016	2017	2018	On average over three years
Without fertilizers (control variant)	1.73	1.65	1.7	1.69
N <sub>125</sub> P <sub>80</sub> K <sub>50</sub>	1.80	1.69	1.78	1.76
N <sub>75(80)*</sub> P <sub>80</sub> K <sub>50</sub>	1.80	1.68	1.75	1.74
N <sub>125(2/3 for a pre-sowing cultivation and 1/3 for feeding)</sub> P <sub>80</sub> K <sub>50</sub>	1.86	1.72	1.80	1.79
N <sub>75(2/3 for a pre-sowing cultivation and 1/3 for feeding)(80)*</sub> P <sub>80</sub> K <sub>50</sub>	1.82	1.7	1.78	1.77
N <sub>125</sub> P <sub>80</sub> K <sub>50</sub>	1.81	1.71	1.77	1.76
LSD <sub>0.05</sub>	0.05	0.04	0.05	-

Accumulation of potassium in spring rape seeds was largely dependent on the use of fertilizers (Table 5). At the same time, on average, the content of this element increased by 0.15–0.17% in the fertilized variants over four years.

**Table 5.** Potassium content in spring rape seeds, % per absolutely dry matter

Variant	2016	2017	2018	On average over three years	Increase
Without fertilizers (control variant)	0.87	0.89	0.86	0.87	-
N <sub>125</sub> P <sub>80</sub> K <sub>50</sub>	0.95	1.06	1.02	1.01	0.14
N <sub>75(80)*</sub> P <sub>80</sub> K <sub>50</sub>	0.94	1.05	1.01	1.00	0.13
N <sub>125(2/3 for a pre-sowing cultivation and 1/3 for feeding)</sub> P <sub>80</sub> K <sub>50</sub>	0.98	1.07	1.05	1.03	0.16
N <sub>75(2/3 for a pre-sowing cultivation and 1/3 for feeding)(80)*</sub> P <sub>80</sub> K <sub>50</sub>	0.95	1.06	1.02	1.01	0.14
N <sub>125</sub> P <sub>80</sub> K <sub>50</sub>	0.96	1.07	1.03	1.02	0.15
LSD <sub>0.05</sub>	0.15	0.16	0.14	-	-

Experiments conducted in Central Europe (Poland) to study the effect of nitrogen, phosphorus and potassium on the accumulation of phosphorus and potassium showed that with average doses of fertilizers, there is an increased accumulation of phosphorus and potassium in shoots and roots during flowering and seed ripening. Very high doses of fertilizers cause the plant to heavily absorb phosphorus and potassium (Szczepanek & Siwik-Ziomek 2019).

It is necessary to determine the content of crude protein in spring rape seeds, because this indicator is one of the most important in determining the quality of products. Proteins play a major role in metabolism, performing structural and catalytic functions.

Our studies have shown that the content of crude protein in fertilized versions of spring rape seed varied on average over three years from 20.0–20.3% per absolutely dry matter and showed an increase of 3.5–3.9% (Table 6). The content of crude protein of 20.3% was noted in the N<sub>125</sub> application variant (2/3 for a pre-sowing cultivation and 1/3 for feeding) P<sub>80</sub>K<sub>50</sub>.

Over the years of research, the maximum increase in the content of raw protein was observed in 2016 due to weather conditions. It was 20.5–20.7% in fertilized variants. The minimum increase was noted in 2017 and was 19.4–19.9%.

**Table 6.** The content of crude protein in spring rape seeds when using calculated doses of mineral fertilizers, % per absolutely dry matter

Variant	2016	2017	2018	On average over three years	Increase
Without fertilizers (control variant)	17.2	15.9	16.3	16.5	-
N <sub>125</sub> P <sub>80</sub> K <sub>50</sub>	20.6	19.5	19.8	20.0	3.5
N <sub>75(80)*</sub> P <sub>80</sub> K <sub>50</sub>	20.7	19.4	20.2	20.1	3.6
N <sub>125(2/3 for a pre-sowing cultivation and 1/3 for feeding)</sub> P <sub>80</sub> K <sub>50</sub>	20.7	19.9	20.4	20.3	3.9
N <sub>75(2/3 for a pre-sowing cultivation and 1/3 for feeding)(80)*</sub> P <sub>80</sub> K <sub>50</sub>	20.6	19.7	20.3	20.2	3.7
N <sub>125</sub> P <sub>80</sub> K <sub>50</sub>	20.5	19.8	20.2	20.2	3.7
LSD <sub>0.05</sub>	0.27	0.25	0.24	-	-

The results of our research confirm previously published works about the effect of nitrogen fertilizers on protein content in crop yields (Charbonnier et al., 2019).

The study on the effect of calculated doses of mineral fertilizers on the yield and quality of spring rape seeds proved that climatic conditions had a significant impact on these indicators. Therefore, we need to determine the effect of our calculated doses of mineral fertilizers and weather conditions on variability.

Fluctuations in the yield of spring rape seeds show that 87% of it was determined by weather conditions, 11% by the calculated doses of mineral fertilizers used, and 2% by other factors (Table 7).

The variability of nitrogen content in the yield of spring rape seeds was almost equally determined by weather conditions

and doses of mineral fertilizers. Fluctuations in phosphorus content in seeds by 82% depended on weather conditions, by 15% – on mineral fertilizers, and by 3% – on other factors.

Fluctuations in the potassium content mainly depended on the calculated doses of mineral fertilizers (61%), in 32% – on weather conditions, and in 7% – on other factors. Oil content depended almost equally on weather conditions and calculated doses of mineral fertilizers.

Studies on the impact of various factors on the yield and quality of spring rape seeds, conducted in Canada and the United States, have shown that water supply, balanced nutrition, early planting at low depth, high seeding rate, and a diverse crop rotation are among the best management methods for increasing the yield of spring rape seeds (Assefa et al., 2018).

**Table 7.** Influence of various factors on crop fluctuations and the content of nitrogen, phosphorus, potassium and oil in spring rape seeds, %

Factor	Seed yield	Content of spring rape seeds			
		N	P	K	Oils
Weather conditions	87	50	82	61	51
Calculated doses of mineral fertilizers	11	46	15	32	45
Other	2	4	3	7	4

Under production conditions, the planned level of yield of spring rape seeds is not formed, and its actual value is lower than the planned one. Increasing the dose of mineral fertilizers and changing types and methods of their application lead to the increase in the growing season by 19 days. At the same time, yield varied from 1.3 to 2.2 t ha<sup>-1</sup>, and the oil content – from 43.0 to 46.0% (Nurlygaianov et al., 2019a).

Low availability of nitrogen in sowing time leads to the reduction in yields and oil content (Liu et al., 2019). The study showed that plant height, the number of branches, pods, seeds per pod and weight of 1000 seeds significantly depend on nitrogen and phosphorous fertilizer levels. The use of fertilizers in a dose of N<sub>100</sub>P<sub>50</sub> allowed to get the highest yield. But the increase in the dose of nitrogen fertilizers above 100 t ha<sup>-1</sup> does not allow to get higher yields of rapeseeds (Singh et al., 2019).

During three years of studies, conducted in the conditions of the Republic of Bashkortostan, the average concentration of digestible protein per 1 spring rape feed unit was 147.2–153.8 g., 191.2–197.8g. per 1 spring vetch feed unit and 202.1–209.0g. per 1 feeding mallow feed unit. The use of these crops in mixed sowing together with Sudan grass allowed increasing the concentration of digestible protein to the level of 102.4–190.4 g. When the control concentration was 92.9–98.8 g., the highest concentration of digestible protein was noted with a ratio of 20+80 of N<sub>56</sub>P<sub>67</sub>K<sub>54</sub> mineral nutrition level. High concentration of digestion protein allows improving feeding diet for highly productive dairy cows, beef cattle, and other types of farm animals and poultry (Kuznetsov et al., 2018).

Thus, our results confirm earlier published works on the reduction of seeds oil content with the increase in doses of nitrogen fertilizers (Ahmadi & Bahrani, 2009; Nurlygaianov et al., 2019b). But as it can be seen, the yield of oil from 1 hectare of spring rape crops increases together with the increase in crop yield. In our studies, the use of fertilizers slightly increased the content of nitrogen and potassium in spring rape seeds and amounted to 0.68–0.72% and 0.13–0.16%, respectively. But if we compare our results with the research of Polish scientists, we can distinguish some differences (Szczepanek & Siwik-Ziomek, 2019). According to the results of their research, the introduction of increased doses of fertilizers (N<sub>180</sub>P<sub>70</sub>K<sub>132</sub>) leads to the increase in the accumulation of phosphorus and potassium. But our results prove, that the increase in doses of nitrogen fertilizers does not have a significant effect on the accumulation of phosphorus in the seeds of spring rape.

It should be noted that Russia lag manifold behind the rest of the world in the volume of fertilizer application (Statistics of The Russian Federation, 2018), though our country is in the top 5 for fertilizer production (FAO, 2019), and the results of different countries will have significant differences (Xiao-Bo et al., 2017; Abdulkhaleq et al., 2018; Jankowski & Sokólski, 2018; Kachel-Jakubowska et al., 2018; Meifang et al., 2018).

Our research makes it possible to note once again, that a balanced nutrition plays an important role in obtaining high yields of high-quality rape seeds.

## CONCLUSION

According to the results of the study, a positive effect of calculated doses of mineral fertilizers is confirmed. Fertilization has increased the spring rape yield capacity and its oil content. In particular, it is proved that the maximum oil content corresponds to the

use of nitrogen fertilizers  $N_{125}P_{80}K_{60}$ . The current research reveals the reduction of seeds oil content with the increase of nitrogen fertilizer dosage. However, at the same time, the yield of oil from 1 hectare of spring rape crops increases together with the increase in seed yield. The reduction in oil content may be caused by high air temperature and moisture deficit, associated with a decrease in the synthesis of nutrients during seed formation. It is also found that the use of calculated doses of mineral fertilizers on average over three years leads to an increase in the content of nitrogen, potassium, and raw protein in spring rape culture. In turn, the accumulation of phosphorus in the seeds remains the same. The analysis shows that the yield and phosphorus in spring seeds are more dependent on weather conditions, and less on the calculated doses of used fertilizers. The identical effect of weather changes and fertilization is noted on the content of nitrogen and oil. In turn, fluctuations in the potassium mainly depend on the estimated doses of fertilizers, and in a less degree on weather conditions. Considering the results achieved, various factors should be taken into account when calculating doses of mineral fertilizers to increase the yield and quality of spring rape seeds. Our developments can be applied to study the yield of other crops, being highly relevant and promising due to global climate change.

## REFERENCES

- Abdulkhaleq, D.A., Hama, S.J., Ahmad, R.M. & Tawfiq, S.I. 2018. Response of some Rapeseed (*Brassica napus* L.) varieties to Zn fertilizer Under Dryfarming Conditions. *Journal of ZankoiSuLAMani* 1, 143–156.
- Ahmadi, M. & Bahrani, M.J. 2009. Yield and Yield Components of Rapeseed as Influenced by Water Stress at Different Growth Stages and Nitrogen Levels. *American-Eurasian Journal of Agricultural and Environmental Sciences* 5(6), 755–761.
- All Union State standard 26726-85. Reagents. Flame-photometric method for the determination of sodium, potassium, calcium and strontium as impurities. Implementation date – 01-01-1987.
- All Union State standard 10857-64. Oil seeds. Methods of determination of oil content. Implementation date – 22-04-1964.
- All Union State standard 28074-89. Vegetable feeds. Method for determination of crude protein solubility. Implementation date – 01-01-1990.
- Arrua, M.M., Duarte, J.B., Tomm, G.O., Augustinho, B., Mezzalira, E., Piva, A.L., Anderson, S. & Tsutsumi, C.Y. 2017. Agronomic characteristics and oil content of different genotypes of canola (*Brassica napus* L. var. *oleifera*). *African Journal of Agricultural Research* 12, 2002–2007.
- Assefa, Y., Prasad, V.V., Foster, C., Wright, Y., Young, S., Bradley, P., Stamm, M. & Ciampitti, I.A. 2018. Major Management Factors Determining Spring and Winter Canola Yield in North America. *Crop Science Society of America* 58, 1–16.
- Charbonnier, E., Fugeray-Scarbel, A. & Lemarie, S. 2019. Colza: quelle valorisation pour des variétés plus efficientes en azote dans le contexte français? *Oilseeds & fats Crop and Lipids* 26, 1–8 (in French).
- Dospekhov, B.A. 2012. *Method of field experience (with the basics of statistical processing of research results)*. Moscow, Book on demand, 352 pp.
- FAO. 2019. *The State of World Fisheries and Aquaculture 2019 (SOFIA): Contributing to food security and nutrition for all*, Food and Agriculture Organization, Rome, pp. 200.

- Forleo, M.B., Palmieri, N., Suardi, A., Coaloa, D. & Pari, L. 2019. The eco-efficiency of rapeseed and sunflower cultivation in Italy. Joining environmental and economic assessment. *Journal of Cleaner Production* **172**, 3138–3153.
- Gamzikov, G.P., Vlasenko, N.G. & Chichkan, T.N. 2000. Features of nitrogen nutrition of field cabbage crops in the forest-steppe of Western Siberia. *Russian Academy of Agricultural sciences* **6**, 15–18.
- Hu, Q., Hua, W., Yin, Y., Zhang, X., Liu, L., Shi, J., Zhao, Y., Qin, L. & Chen, C. 2017. Hanzhong Wang Rapeseed research and production in China. *The Crop Journal* **5**, 127–135.
- Hydrometeorological Center of Russia. 2018. Available at: <https://meteoinfo.ru/>
- Jankowski, K.J. & Sokólski, M. 2018. The effect of micro-granular starter fertilizer on the biomass quality of winter oilseed rape. *Journal of Elementology* **23**, 1243–1255.
- Jeong, H., Park, J. & Kim, H. 2013. Determination of NH<sub>4</sub><sup>+</sup> in Environmental Water with Interfering Substances Using the Modified Nessler Method. *Journal of Chemistry*, **9**.
- Kachel-Jakubowska, M., Sujak, A. & Krajewska, M. 2018. Effect of Fertilizer and Storage Period on Oxidative Stability and Color of Rapeseed Oils. *Polish Journal of Environmental Studies* **27**(2), 1–10.
- Kasiuliene, A., Paulauska, V. & Kumpiene, J. 2016. Influence of nitrogen fertilizer on Cd and Zn accumulation in rapeseed (*Brassica napus* L.) biomass. *Agronomy Research* **14**(2), 418–427.
- Khasanov, E., Gabitov, I., Mudarisov, S., Khamaletdinov, R., Rakhimov, Z., Akhmetyanov, I., Farkhutdinov, I., Masalimov, I. & Musin, R. 2019. Justification of parameters of seed treater with an eccentrically fixed drum influencing the motion character and seed treatment modes. *Bulgarian Journal of Agricultural Science* **25**(S2), 119–128.
- Kuznetsov, I.Y., Akhiyarov, B.G., Asylbaev, I.G., Davletov, F.A., Sergeev, V.S., Abdulvaleyev, R.R., Valitov, A.V., Mukhametshin, A.M., Ayupov, D.S. & Yagafarov, R.G. 2018. The Effect of Sudan grass on the mixed sowing chemical composition of annual forage Crops. *Journal of Engineering and Applied Sciences* **13**(S8), 6558–6564.
- Lew, R. B. & Jakob, F. 1963. Interference of silicon in the determination of phosphorus by the vanadomolybdate method. *Talanta* **10**(3), 322–324.
- Liu, Q., Ren, T., Zhang, Y., Li, X., Cong, R., White, P.J. & Lu, J. 2019. Yield loss of oilseed rape (*Brassica napus* L.) under nitrogen deficiency is associated with under-regulation of plant population density. *European Journal of Agronomy* **103**, 80–89.
- Meifang, S., Yitao, H., Shuai, H., Junfeng, H., Fowen, C., Jialong, Z. & Jifu, L. 2018. Effects of long term potassium fertilizer application on crop yield and potassium distribution in soil aggregates in paddy-upland rotation system. *Journal of Southern Agriculture* **49**, 1082–1088.
- Nurlygaianov, R., Ismagilov, R., Islamgulov, D., Ahiyarov, B., Abdulvaleev, R., Ismagilov, K. & Ginijtova, F. 2019a. Agro-Technical Basis for Spring Rape Seed Productivity Depending on Different Climatic Zones of the Russian Federation. *International Journal of Advanced Science and Technology* **27**(1), 222–230.
- Nurlygaianov, R.B., Ismagilov, R.R., Akhiyarov, B.G., Ismagilov, K.R. & Alimgafarov, R.R. 2019b. Peculiarities of mineral nutrition of spring rape. *International agricultural journal* **1**(367), 29–31.
- Postnikov, D.A., Noiman, G. & Romkheld, F. 2001. Accumulation of phosphorus by white mustard and rapeseed when applying various forms of phosphates to the soil. *Izvestiia (news) of Timiriazev Academy of Agriculture* **1**, 113–124.
- Predein, Iu.A. 1991. The content of mineral elements in the dry matter of spring cabbage. In: *Effective use of organic and mineral fertilizers in the Cis-Ural region*. Perm, pp. 84.
- Puponina, A.S. 2010. *Land husbandry*. Moscow, Kolos, 550 pp.

- Queiros, J., Malça, J. & Freire, F. 2015. Environmental life-cycle assessment of rapeseed produced in Central Europe: addressing alternative fertilization and management practices. *Journal of Cleaner Production* **99**, 266–274.
- Singh, R., Lal, M., Singh, G. & Kumar, T. 2019. Effect of nitrogen and phosphorus on growth parameter and yield of canola (*Brassica napus* L.). *Journal of Pharmacognosy and Phytochemistry* **8**, 380–384.
- Statistics of the Russian Federation. 2018. Publication catalog: Federal State Statistics service. Available at:  
[http://www.gks.ru/wps/wcm/connect/rosstat\\_main/rosstat/ru/statistics/publications/catalog/doc\\_1265196018516](http://www.gks.ru/wps/wcm/connect/rosstat_main/rosstat/ru/statistics/publications/catalog/doc_1265196018516).
- Szczepanek, M. & Siwik-Ziomek, A. 2019. P and K accumulation by rapeseed as affected by biostimulant under different NPK and S fertilization doses. *Agronomy* **9**(9), 477.
- Venus, T.J., Drabik, D. & Wesseler, J. 2017. *The Interaction among the Regulation of New Plant Breeding Techniques, GMO Labeling, and Coexistence and Segregation Costs. The Case of Rapeseed in the EU 2017*. LICOS Discussion Paper Series. No. 389/2017.
- Xiao-Bo, G., Yuan-Nong, L. & Ya-Dan, D. 2017. Optimized nitrogen fertilizer application improves yield, water and nitrogen use efficiencies of winter rapeseed cultivated under continuous ridges with film mulching. *Industrial Crops and Products* **109**, 233–240.
- Zemeckis, R., Dautartė, A., Kretavičius, J. & Drożdż, J. 2019. Effects of winter and spring rape seed treatment with neonicotinoids on honey bees. *Zemdirbyste-Agriculture* **106**, 173–182.
- Zotz, A., Bernhard, U. & Bonin, J. 2018. KORVETATM – a new herbicide for the control of a wide range of broadleaf weeds in winter oilseed rape applied in spring. *Julius-Kühn-Archiv* **458**, 359–362.



## Seed size and cold stratification affect *Acer negundo* and *Acer ginnala* seeds germination

O.A. Kiseleva<sup>1,\*</sup>, O.G. Loretts<sup>2</sup> and D.V. Veselkin<sup>3</sup>

<sup>1</sup>Institute Botanic Garden, Ural Branch, Russian Academy of Sciences, street 8 March 202 A, RU620144 Yekaterinburg, Russia

<sup>2</sup>Ural State Agrarian University, street Karl Liebknecht 42, RU620075, Yekaterinburg, Russia

<sup>3</sup>Institute of Plant and Animal Ecology, Ural Branch, Russian Academy of Sciences, street 8 March 202, 620144 Yekaterinburg, Russia

\*Correspondence: [kiselevaolga@inbox.ru](mailto:kiselevaolga@inbox.ru)

**Abstract.** The aim of this work is to determine how the germination of seeds of the invasive tree *Acer negundo* depends on the period of cold stratification under the snow and the duration of stratification in the air on the branches of the trees. For comparison with *A. negundo*, we used seeds of *Acer ginnala*, introduced but not invasive tree in the Middle Urals. The period of stratification in the air modeled by collecting seeds in October and December. The duration of cold stratification under the snow was 0, 1, 2, 3 and 4 months. We hypothesized that the duration of stratification in the air did not affect the germination of *A. negundo* and *A. ginnala* seeds. Cold stratification under the snow had a positive effect on seed germination of both species. The best seed germination of *A. negundo* and *A. ginnala* was after 4 months of cold stratification under the snow, the germination rate differs: in *A. negundo*  $12 \pm 4\%$  (small seeds) and  $79 \pm 7\%$  (large seeds), in *A. ginnala* –  $1 \pm 2\%$  (small seeds) and  $18 \pm 4\%$  (large seeds). In both species, large seeds germinated at 7 to 18 times more intensively than small ones. In *A. ginnala* case, even after cold stratification under snow for 4 months, no more than 22% of the seeds germinated. The germination of *A. ginnala* seeds was 4–5 times lower than that of *A. negundo* seeds.

**Key words:** *Acer ginnala*, *Acer negundo*, cold stratification, invasive plants, propagule press, seed biology.

### INTRODUCTION

*Acer negundo* L. (boxelder maple) is a North American native tree and intentionally introduced in Europe for horticulture and landscaping purposes (Merceron et al., 2016). It is invasive in Northern Eurasia, particularly in Russia (Vinogradova et al., 2010). *A. negundo* develops mainly in disturbed and semi-natural territories (Tret'yakova, 2011; Straigytė et al., 2015; Merceron et al., 2016; Gusev et al., 2017; Kostina et al., 2017). *A. negundo* actively spread in the urbanized forests of the Middle Urals (Veselkin et al., 2018; Veselkin & Korzhinevskaya, 2018). In Europe and Asia *A. negundo* invasion leads to a replacement of economically important trees (Ryabinina & Nikitina, 2009; Bottollier-Curtet et al., 2012; Gusev, 2016). In the forest management, the search

for the most efficient methods to kill and remove invasive *A. negundo* in invaded natural habitats is continuing (Merceron et al., 2016; Kostina et al., 2017).

*A. negundo* may form monospecific stands (Ryabinina & Nikitina, 2009; Tret'yakova, 2011; Lamarque et al., 2012; Gusev et al., 2017), reducing both native species richness and abundance (Saccone et al., 2010, Bottollier-Curtet et al., 2012). Therefore, *A. negundo* is a convenient subject for studying the penetration mechanisms of invasive alien plants into natural communities. It remains unclear how seed germination conditions related to propagation mechanisms. The outcomes of penetration depend on a number of factors, such as the generative maturity age, the spread of seeds, and their susceptibility to pathogens and others. They are important for predicting the ability to create propagule pressure in recipient communities (Colautti et al., 2006, Johnston et al., 2009; Dyderski & Jagodziński, 2018). Searching for optimal seed germination conditions needs to clarify the reproduction success of *A. negundo* over its original communities.

The seed germination of the Far Eastern maple *Acer ginnala* Maxim analyzed in comparison with seed germination of *A. negundo*. These two maple species are the most common maples in urban plantings in the Middle Ural (Mamaev & Dorofeeva, 2005). *A. ginnala* is an adventive alien decorative plant for Yekaterinburg (Tret'yakova, 2015). Single individuals planted throughout the city, but *A. ginnala* does not extend beyond plantations of trees and shrubs, despite annual fruiting. The only dense thickets of *A. ginnala* in Yekaterinburg is located in the Institute Botanic Garden (Ural Branch, Russian Academy of Sciences).

Both maple species are stable in culture, although they are slightly frostbitten during severe winters (Mamaev & Dorofeeva, 2005). Thus, *A. ginnala* is similar to *A. negundo*, but not an invasive species.

Many species of the genus *Acer* are of practical importance and are usually propagated by seeds. Therefore, some conditions for maple seed germination are known (Mamaev & Dorofeeva, 2005; Solarik et al., 2016). It was stated that the seeds of *A. negundo* do not have a dormancy (Mamaev & Dorofeeva, 2005) or have a shallow dormancy from 2–5 months (Aksenova, 1975) to 2 years (Möllerová, 2005; Kostina et al., 2017). At the same time, during the growing season, seeds of *A. negundo* may have an extended germination period (Kostina et al., 2017). Estimates of *A. negundo* seed germination vary in the ranges of 37–48% (Agishev, 2016), 36–80% (Khudonogova & Tyapaeva, 2019), 73–85% (Sofi et al., 2014). There are indications of 'high germination' (Kostina et al., 2017).

According to various sources and practical recommendations, cold stratification is necessary for the germination of *Acer* species. Its duration for *A. negundo* recommended for about 40 days and for other *Acer* species for a longer time (Rastorguev, 1960). There are no information in the introduction about morphological heterogeneity of *A. negundo* and *A. ginnala* seeds and its effect on seed germination. Our study provides the first analysis of seeds size, stratification type and cold period effect on seed germination of these species.

The aim of the work was to find answers to the questions: 1. How does *A. negundo* and *A. ginnala* seed germination depend on the period of cold stratification on the soil surface under snow? 2. Does *A. negundo* seed germination depend on the time of cold stratification in the air? 3. Is *A. negundo* and *A. ginnala* seed size related to the success of their germination?

## MATERIALS AND METHODS

### Study area

Yekaterinburg is a large industrial city in the Middle Urals with an area of 49.8 thousand hectares with a population of about 1.4 million inhabitants. Yekaterinburg is located in the southern taiga subzone. In the surrounding territories, pine forests of natural origin prevail on soddy podzolic soil and brown forest soil. The territory of Yekaterinburg is heavily polluted (Sturman, 2008) due to a large number of industrial enterprises and the high density of the motor transport network.

The climate is temperate continental, bordered by continental, with cold winters and warm summers. The average annual temperature is + 3 °C. The average annual rainfall is 542 mm. The average snow cover depth in February is 20–25 cm, and the average snow accumulation season is 160–180 days (Borisov, 1967).

### Weather conditions

The weather conditions during stratification and seed germination obtained from the meteorological observing station (experimental area in the Institute Botanic Garden, Yekaterinburg, Sverdlovsk region, Russia) and presented in Table 1.

**Table 1.** The weather conditions of experimental period

Month and year	Snow cover depth on the last day of the month, cm	Air temperature (°C)		
		monthly average	maximum	minimum
October 2018	11	4.3	18.5	-5.7
November 2018	10	-5.5	3.3	-19.4
December 2018	14	-11.0	-0.9	-25.3
January 2019	21	-12.6	-1.6	-22.7
February 2019	39	-11.1	1.5	-31.9
March 2019	16	-1.1	10.3	-12.1
April 2019	9	4.3	18.8	-10.4

### Seed collection

Seeds of *A. negundo* collected from dense thicket (monospecific stands) in three locations in the city Yekaterinburg. Seeds of *A. ginnala* were collected in one habitat (the only dense thicket of this maple in the city). Seeds of each species in each location were collected during two tours: October 20, 2018 (tour I) and after 52 days on December 11, 2018 (tour II).

The dry double winged fruit of maples when ripe easy breaks up into two samaras. Each of samara is one seed with wing. They were removed from the trees by hands, then dried and stored in linen bags in a cool room. The air drying was carried out for 5 days at room temperature (20 °C). Seeds from different species, habitats (locations) were stored, sown and analyzed separately.

### Determination of field germination

Vegetation experiments with stratification and seed germination were carried out from November 2018 to May 2019. The field germination experiment was the main one. Before the experiment, seeds with obvious mechanical, fungal, or bacterial damage were rejected. Then the seeds were sorted into large and small by manual separation

(Figs 1, 2). The criterion for separation was the length of the winged seeds, the seeds were considered large: more than 35 mm for *A. negundo*; seeds larger than 15 mm for *A. ginnala*. Plastic boxes of 50×30×12 cm with a standard peat substrate were used for seed germination.



**Figure 1.** Seed heterogeneity of *Acer negundo*.



**Figure 2.** Seed heterogeneity of *Acer ginnala*.

On December 28, 2018, large and small seeds of *A. negundo* from each tour of collection were sown in boxes in isolation from each other. The seeds from different habitats were arranged systematically in the boxes. In each combination, ‘seed size’ × ‘tour’, a block of 5 boxes contained seeds from only one of the three habitats. In total 60 boxes, steps of 15 boxes of each variant: 15 boxes with small seeds from tour I, 15 boxes with small seeds from tour II, 15 boxes with large seeds from tour I, 15 boxes with large seeds from tour II. In each box 40 seeds were sown.

Also, large and small seeds of *A. ginnala* from each tour of collection were sown in boxes in isolation from each other (in total 20 boxes, steps of 5 boxes of each variant: 5 boxes with small seeds from tour I, 5 boxes with small seeds from tour II, 5 boxes with large seeds from tour I, 5 boxes with large seeds from tour II). In each box 40 seeds were sown.

Seeds germination was carried out in a greenhouse of Institute Botanic Garden, Ural Branch, Russian Academy of Sciences. Mean daily air temperatures

during germination ranged from +18 to +23 °C. Boxes with seeds were exposed to the 10-a-clock lighting under OSRAM HPS Grow Lamps (photon flux density 150–220  $\mu\text{mol m}^{-2} \text{s}^{-1}$ ).

A single number of boxes with each sowing variant taken from individual habitats of *A. negundo* and *A. ginnala* was left in the greenhouse for germination without stratification under snow 12 boxes with *A. negundo* seeds, 4 boxes with *A. ginnala* seeds. Thus, the seeds in these boxes were not exposed to additional exposure to cold. The designation ‘Str0’ is a variant of the experiment without cold stratification under the snow.

The remaining 48 boxes with *A. negundo* seeds and 16 boxes with *A. ginnala* seeds were carried outside. Boxes were placed on the surface of the soil and covered with a layer of snow of the same height as it was in the surrounding area. Thus, the seeds in these boxes were exposed to cold - an experiment with cold stratification under the snow. From the 56 boxes, twelve boxes with *A. negundo* seeds and 4 boxes with *A. ginnala* seeds were placed in a greenhouse for seed germination on February 1 (designation ‘Str1’), similarly on March 1 (‘Str2’), April 1 (‘Str3’) and May 1 (‘Str4’).

Thus, the duration of cold stratification under the snow was: Str1 - 1 month, Str2 - 2 months, Str3 - 3 months, Str4 - 4 months. The number of germinated seeds was counted on the 20th day after sowing in the Str0 variant or on the 20th day after the boxes were placed in a greenhouse in the Str1 - Str4 variants.

### **Determination of viable seeds**

On the 20th day of the germination experiment the viability of all the seeds was determined after determining germination. For this purpose, the seed peel of the unsprouted seeds was opened with a scalpel and it was determined whether the embryo was alive. The criterion of viability was the color of the embryo – cream or yellow-green without oil according to GOST 13056.7-93. Sprouted seeds were also considered viable.

### **Determination of laboratory germination**

Laboratory experiments were carried out in May 2019. We performed laboratory measurements according to standard (GOST 13056.6-97) to compare with other authors results. Samples were germinated on filter paper with wicks dipped in water (daylight 300 lux, temperature from +18 to +23 °C). We used only the seeds from second lot of collection (tour II). We took the combined average sample of the seeds from three habitats of *A. negundo* and average sample of the seeds of *A. ginnala* from one habitat. Then the seeds were sorted into large and small by manual separation (Figs 1, 2). The seeds were not additionally treated by cold stratification under the snow. Large seeds were sown apart from small to compare laboratory and field germination. Each average sample had 200 seeds (100 large and 100 small). There were 4 sowing variants in total: for *A. negundo* large and small seeds; for *A. ginnala* large and small seeds. The number of seedlings was counted on the 25th day of germination.

### **Data analysis**

The influence of all tested factors on field germination was evaluated by 4-way ANOVA. Factors in ANOVA in different combinations were: 1) the species of tree – *A. negundo* or *A. ginnala*; 2) seed collection tour – I or II; 3) the duration of cold stratification – Str0, Str1, Str2, Str3 or Str4; 4) seed size – large or small. Another

analyzed source of variability was habitat (factor ‘location’), i.e. the place where the seeds were collected. In ANOVA, viable and sprouted seed fractions were analyzed after arcsine transformation.

The figures and text show the untransformed values of viable and sprouted seeds. Designations in the text and in the table: *SD* – standard deviation; *dF* – the number of degrees of freedom; *F* – the value of the Fisher criterion; *P* – the significance level. All differences were considered statistically significant if  $P < 0.05$ .

## RESULTS AND DISCUSSION

### Germination

The species of the seeds, the duration of stratification on the soil surface and the size of the seeds significantly influenced the germination of the seeds individually and in some interactions (Table 2). The duration of stratification in the air did not affect seed germination either independently or in interactions with other factors (Table 2). Consequently, the presence of seeds on the tree branches in October – December (additional 52 days) did not affect their germination. In further analysis, the time of air stratification was not considered.

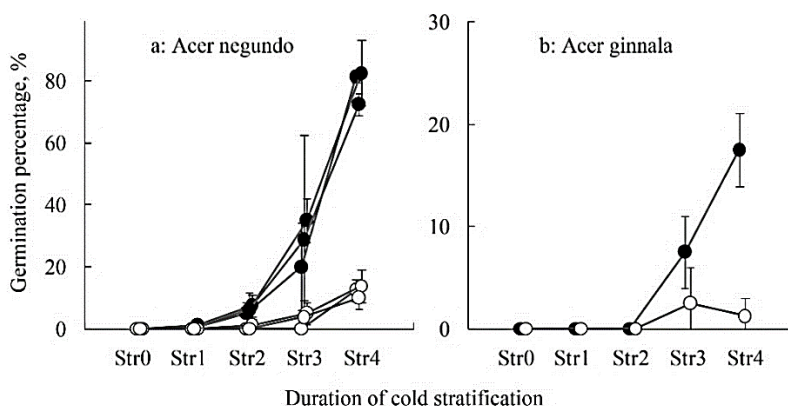
**Table 2.** The effect of species membership (‘species’), duration of stratification in the air (‘tour’), duration of cold stratification under snow (‘stratification’) and seed size (‘seed size’) on the germination and viability of seeds (*dF* – the number of degrees of freedom; *F* – the value of the Fisher criterion; *P* – the significance level). All differences were considered statistically significant if  $P < 0.05$

Factors and interactions	<i>dF</i>	Germination		Viability	
		<i>F</i>	<i>P</i>	<i>F</i>	<i>P</i>
Species [1]	1	32.89	< 0.0001	3.87	0.0560
Tour [2]	1	1.86	0.1800	2.76	0.1046
Stratification [3]	4	51.40	< 0.0001	1.07	0.3829
Seed size [4]	1	53.53	< 0.0001	726.15	< 0.0001
[1] × [2]	1	0.05	0.8281	0.00	1.0000
[1] × [3]	4	10.48	< 0.0001	0.47	0.7573
[2] × [3]	4	0.62	0.6538	1.43	0.2409
[1] × [4]	1	11.59	0.0015	4.10	0.0497
[2] × [4]	1	0.33	0.5713	3.14	0.0841
[3] × [4]	4	15.44	< 0.0001	0.82	0.5207
[1] × [2] × [3]	4	0.42	0.7902	0.45	0.7720
[1] × [2] × [4]	1	0.61	0.4394	0.20	0.6582
[1] × [3] × [4]	4	1.98	0.1166	0.96	0.4426
[2] × [3] × [4]	4	0.47	0.7602	0.27	0.8932
[1] × [2] × [3] × [4]	4	0.07	0.9912	0.14	0.9659

Seed germination of two *Acer* species almost exponentially depended on the duration of their stratification under the snow (Fig. 3). In the absence of cold under snow stratification and with under snow cold stratification of 1 month, the seeds did not germinate. After 4 months of cold stratification under the snow, the germination rate differs: in *A. negundo*  $12 \pm 4\%$  (small seeds) and  $79 \pm 7\%$  (large seeds), in *A. ginnala* –

1 ± 2% (small seeds) and 18 ± 4% (large seeds). In both species, large seeds germinated at 7 to 18 times more intensively than small ones.

Habitat conditions did not affect seed germination (Fig. 3). In the 3-way ANOVA (factors: ‘stratification’, ‘seed size’, and ‘location’), the differences associated with the factor ‘location’ were insignificant ( $F(2; 30) = 2.24; P = 0.1234$ ). After 4 months of cold stratification under the snow, the range of germination average values in three habitats was small: at 73 to 83% for large seeds and at 10 to 14% for small seeds of *A. negundo*.



**Figure 3.** Germination ( $\pm$  SD) of large (●) and small (○) seeds of *Acer negundo* (a; data for three different habitats) and *Acer ginnala* (b) depending on the duration of cold stratification under the snow (Str0 - without stratifications; Str1 – Str4 – stratification 1–4 months, respectively). Attention should be paid to the difference in scale along the ordinate axis in Figures a and b. SD – standard deviation.

### Viability

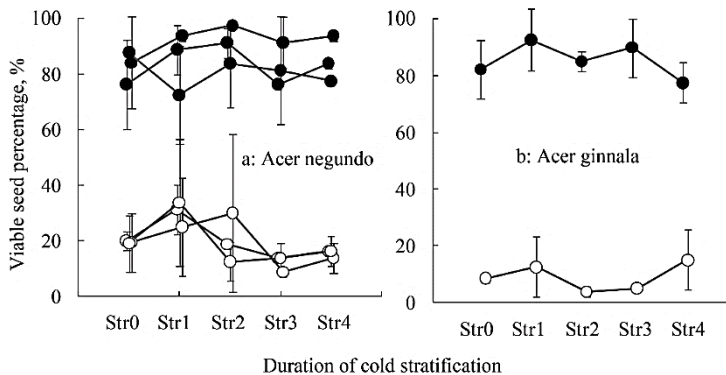
Viability was significantly related to the size of the seeds (Table 2) and was not related to other factors (‘species’, ‘tour’, ‘stratification’, ‘seed size’). Seed viability also did not differ significantly between the two species of maples. Large seeds were more viable (78–93%), small seeds were less viable (5–30%) (Fig. 4). Viability depended neither on the time of seed collection (October or December) nor on the duration of cold stratification under the snow (Table 2).

The results confirmed that the duration of cold stratification under the snow is crucial for stimulating seeds germination of both *Acer* species. In the absence of cold stratification under snow or if its duration was at 1 to 2 months, the germination of *A. negundo* and *A. ginnala* seeds is limited. In such cases, no more than 10% of germinable seeds sprouted on the soil (Fig. 3).

Laboratory germination, which is determined without stratification, is also low in both types of maples. The average laboratory germination of *A. negundo* large seeds was 13%, small – 0%. The average laboratory germination of *A. ginnala* large seeds was 6%, small – 0%.

The average field germination of *A. negundo* seeds was about 50–70%. This value depends on the ratio of large/small seeds and it was 2/1 based on our assessment. This is close to other similar estimates, under which *A. negundo* seed germination ranges

between 37–48% (Agishev, 2016), 36–80% (Khudonogova & Tyapaeva, 2019) and 73–85% (Sofi et al., 2014). The average germination of *A. negundo* and the ratio of large/small seeds in the climatic and environmental conditions of the Middle Ural and other regions need to clarify.



**Figure 4.** Viability ( $\pm$  SD) of large (●) and small (○) seeds of *Acer negundo* (a; data for three different habitats) and *Acer ginnala* (b) depending on the duration of cold stratification under snow (Str0 – without stratifications; Str1 – Str4 – stratification 1–4 months, respectively). SD – standard deviation.

The duration of cold stratification under the snow of about 4 months raises the level of the actual *A. negundo* seeds germination toward the optimal germination (Fig. 3). After such stratification, the proportion of germinated *A. negundo* seeds from seeds that are capable to germinate was 93% among large seeds and 80% among small ones.

The proportion of viable seeds in *A. ginnala* is the same as in *A. negundo*. But in *A. ginnala* case, even after cold stratification under snow for 4 months, no more than 22% of the seeds germinated (Fig. 3). Thus, *A. ginnala* seeds apparently require some other conditions for optimal germination.

Our estimates are generally consistent with existing knowledge on *A. negundo* and *A. ginnala* seed germination. It is known that the viability of *A. negundo* and *A. ginnala* seeds are close (Aksenova, 1975), as in our estimate. It is also known that the seeds of *A. ginnala* germinate much less vigorously (Khudonogova & Tyapaeva, 2019), as we found. Thus, our data confirm that the *A. negundo* ability to create propagule-pressure is higher than that of *A. ginnala*. This is consistent with its invasive status in the region. In particular, this is in agreement with the existence of a strong positive relationship between the adult plant number and young plant number of *A. negundo* in urban forest parks (Veselkin & Korzhinevskaya, 2018).

Our estimates point to the need for a long, up to 4 months, cold stratification under the snow for *A. negundo* seeds, while in the literature were recommended 30–40 days as enough time of stratification (Rastorguev, 1960; Aksenova, 1975). Seed germination of *A. negundo* and *A. ginnala* did not change after 52 days of additional stratification in the air during the cold season. This is consistent with the fact that the seeds of *A. negundo* that have fallen to the soil surface either sprout quickly or lose their germination rate quickly (Aksenova, 1975), but seeds held on branches retain germination ability to 2



years (Kostina et al., 2017). The opinion that the seeds of *A. negundo* do not have dormancy (Mamaev & Dorofeeva, 2005) has not been confirmed.

Our results showed that the seed size of *A. negundo* and *A. ginnala* is uniquely associated with germination. In other words, size is a convenient criterion for selecting quality seeds. Perhaps seed size affected germination due to the different stages of fruit maturity.

Seed size may reflect the fitness of the parent plants (Fenner, 1985; Silvertown, 1989). Large seeds of trees and herbs have usually higher germination in comparison with small ones (Gross, 1984; Shipley & Parent, 1991; Bursem & Miller, 2001; Deb & Sundriyal, 2017). One possible explanation of such success is the large seeds have more resources that provide greater survival (Harper, 1977; Fenner, 1985; Moles & Westoby, 2004). Seed size is the principal factor that affects the germination and seedling growth along with many internal and external factors (Moles & Westoby, 2004; Sahi et al., 2015).

The seed heterogeneity of *A. negundo* may be manifested for example, due to abiotic conditions of the habitat of mother trees (Erfmeier et al., 2011). But we did not study this phenomenon. We collected seeds in different habitats on the territory of a big city. These were both relatively vast areas of green space, and areas near residential buildings and highways. However, the seed germination of *A. negundo* did not differ significantly among seeds collected in the different habitats.

Our data allow us to raise some questions. Is the achieving of maximum germination after 4 months of cold stratification related to the synchronization of the *A. negundo* seeds ripening with the regional climate? How geographic variation in the optimal stratification period for *A. negundo* seeds differ in other regions?

The results of this study allow us to discuss the reasons for *A. negundo* distribution in Northern Eurasia. We assume that the absence of prolonged cold stratification under the snow can limit the distribution of harmful *A. negundo* in regions where the climate is hot. Probably global climate warming should reduce the *A. negundo* propagation activity and the ability to spread.

Our results can be used in the control of *A. negundo* invasion. Cold stratification under the snow affects the success of germination. Therefore, all ways to disturb this optimal condition should be effective to diminish seed germination.

## CONCLUSIONS

We elucidated that *A. negundo* seeds germinate significantly greater than the *A. ginnala* seeds to improve understanding of invasive plants biological characteristics. This may be one of the explanations of the different status of these species in the region: *A. negundo* is invasive, actively spreading species; *A. ginnala* is alien, but not spreading plant. In other respects, our research is mainly monitoring. The results are consistent with previously known.

These are two conclusions: 1) the duration of cold stratification under the snow is crucial for the germination of seeds from *A. negundo* and *A. ginnala*; 2) the duration of cold stratification of seeds from *A. negundo* and *A. ginnala* in the air does not affect their germination. In practical terms, our data allow us to recommend the use seed size of *A. negundo* and *A. ginnala* as an effective predictor of their ability to germinate and it

requires prolonged cold stratification under the snow to ensure their optimal germination.

ACKNOWLEDGEMENTS. This work was carried out within the state assignment of IPAE UB RAS and within the state assignment of Institute Botanic garden UB RAS and with financial support from the Ural State Agrarian University.

## REFERENCES

- Agishev, V.S. 2016. Germination rate of ash-leaved maple seeds in laboratory conditions. *Simvol Nauki*. **14**, 10–13 (in Russian).
- Aksenova, N.A. 1975. *Maples*. MSU, Moscow, 96 pp. (in Russian).
- Borisov, A.A. 1967. *Climates of the USSR* Moscow, 295 pp. (in Russian).
- Bottollier-Curtet, M., Charcosset, J-Y., Poly, F., Planty-Tabacchi, A-M. & Tabacchi, E. 2012. Light interception principally drives the understory response to boxelder invasion in riparian forests. *Biological Invasions* **14**, 1445–1458.
- Burse, D.F.P. & Miller, J. 2001. Seed size, germination and seedling relative rates in three tropical tree species. *J Tropical Forest Science* **13**, 148–161.
- Colautti, R., Grigorovich, I. & MacIsaac, H. 2006. Propagule pressure: a null model for biological invasions. *Biol. Invasions* **8**, 1023–1037.
- Deb, P. & Sundriyal, R.C. 2017. Effect of seed size on germination and seedling fitness in four tropical rainforest tree species *Indian Journal of Forestry* **40**(4), 313–322.
- Dyderski, M.K. & Jagodziński, A.M. 2018. Drivers of invasive tree and shrub natural regeneration in temperate forests. *Biol. Invasions* **20**, 2363–2379.
- Erfmeier, A., Böhnke, M. & Bruelheide, H. 2011. Secondary invasion of *Acer negundo*: the role of phenotypic responses versus local adaptation. *Biol. Invasions* **13**(7), 1599–1614.
- Fenner, M. 1985. *Seed Ecology*. Chapman and Hall. London. 151 pp.
- GOST 13056.6-97 Interstate standard. Tree and shrub seeds. Method of germination evaluation. Date of introduction 1998-07-01 (in Russian).
- GOST 13056.7-93 Interstate standard. Seed of trees and shrubs. Methods for determination of viability. Date of introduction 1993-10-21 (in Russian).
- Gross, K.L. 1984 Effects of seed size and growth form on seedling establishment of six monocarpic perennial plants. *British Ecological Society* **72**(2), 369–387.
- Gusev, A.P. 2016. Alien species transformers as the reason for blocking the recovery processes (for example, the SouthEast Belarus). *Ross. Zh. Prikl. Ekol.* **3** (7), 10–14.
- Gusev, A.P., Shpilevskaya, N.S. & Veselkin, D.V. 2017. The influence of *Acer negundo* L. on progressive successions in Belarusian landscapes. *Vestn. Vitebsk. Dzyarzh. Univ.* **94**(1) 47–53 (in Russian).
- Harper, J.L. 1977. *Population biology of plants*. Academic Press, London, 892 pp.
- Johnston, E.L., Piola, R.F. & Clark, G.F. 2009. The role of propagule pressure in invasion success. In Rilov G. & Crooks J.A. (eds): *Biological Invasions in Marine Ecosystems. Ecological Studies (Analysis and Synthesis)*. **204**, Springer, Berlin, Heidelberg, pp. 133–151.
- Khudonogova, E.G. & Tyapaeva, M.A. 2019. Seeds germination of the genus *Acer* L. *Vestnik Irkutskoy gosudarstvennoy selskokhozyaistvennoy akademii* **19**, 48–56 (in Russian).
- Kostina, M.V., Yasinskaya, O.I. & Barabanshchikova, N.S. 2017. Development of scientifically based approach to using box elder (*Acer negundo* L.) as an ornamental tree in Moscow. *Social'no-ekologicheskie tekhnologii* **3**, 51–64 (in Russian).
- Lamarque, L.J., Delzon, S., Sloan, M.H. & Lortie, C.J. 2012. Biogeographical contrasts to assess local and regional patterns of invasion: A case study with two reciprocally introduced exotic maple trees. *Ecography* **35**, 803–810.

- Mamaev, S.A. & Dorofeyeva, L.M. 2005. *Introduction of maple in the Ural*. UB RAS, Yekaterinburg, 103 pp. (in Russian).
- Merceron, N.R., Lamarque, L.J., Delzon, S. & Porté, A.J. 2016. Killing it softly: girdling as an efficient eco-friendly method to locally remove invasive *Acer negundo* L. *Ecol. Restor.* 2016. Vol. **34**(4), 297–305.
- Moles, A.T. & Westoby, M. 2004. Seedling survival and seed size: a synthesis of the literature. *J Ecol.* **92**(3), 372–396.
- Möllerová, J. 2005. Notes on invasive and expansive trees and shrubs. *J. For. Sci.* **51**, 19–23.
- Rastorguev, L.I. 1960. *Maples in the greening of cities*. MCS RSFSR, Moscow, 44 pp. (in Russian).
- Ryabinina, Z.N. & Nikitina, N.V. 2009. Succession of the floodplain forests of the Ural River within the Orenburg urban-industrial complex. *Vestn. Orenb. Gos. Univ.*, **6**(112), 319–321 (in Russian).
- Saccone, P., Pagès, J-P., Girel, J., Brun, J-J. & Michalet, R. 2010. *Acer negundo* invasion along a successional gradient: Early direct facilitation by native pioneers and late indirect facilitation by conspecifics. *New Phytol.* **187**, 831–842.
- Sahi, C., Vibhuti, Bargali, K. & Bargali, S.S. 2015. How seed size and water stress affect the sward germination and seedling growth in wheat varieties. *Curr. Agric. Res.* **3**, 60–68.
- Shiple, B. & Parent, M. 1991. Germination responses of 64 wetland species in relation to seed size, minimum time to reproduction and seedling relative growth rate. *British Ecological Society* **5**(1), 111–118.
- Silvertown, J.W. 1989. The paradox of seed size and adaptation. *Trends in Ecology and Evolution.* **4**, 24–26.
- Sofi, P.A., Islam, M.A. & Altaf, M. 2014. Influence of growing media and container type on quality plant production of Boxelder (*Acer negundo* L.) in Kashmir Valley. *Vegetos.* **27**(2), 248–253.
- Solarik, K.A., Gravel, D., Ameztegui, A., Bergeron, Y. & Messier, C. 2016. Assessing tree germination resilience to global warming: a manipulative experiment using sugar maple (*Acer saccharum*). *Seed Sci. Res.* **26**(2), 153–164.
- Straigytė, L., Cekstere, G., Laivins, M. & Marozas, V. 2015 The spread, intensity and invasiveness of the *Acer negundo* in Riga and Kaunas. *Dendrobiology* **74**, 157–168.
- Sturman, V.I. 2008. Natural and technogenic factors responsible for atmospheric air pollution in Russian cities. *Vestn. Udmurt. Gos. Univ. Ser. Biol. Nauki o Zemle.* **2**, 15–29 (in Russian).
- Tret'yakova, A.S. 2011. *Flora Ekaterinburga (Flora of Ekaterinburg)*. Ural. Gos. Univ., Yekaterinburg. 215 pp. (in Russian).
- Veselkin, D.V. & Korzhinevskaya, A.A. 2018. Spatial factors of understory adventization in park forests of a large city. *Izv. Akad. Nauk. Ser. Geogr.* **4**, 54–64 (in Russian).
- Veselkin, D.V., Korzhinevskaya, A.A. & Podgayevskaya, E.N. 2018. The species composition and abundance of alien and invasive understory shrubs and trees in urban forests of Yekaterinburg. *Vestnik Tomskogo gosudarstvennogo universiteta. Biologiya* **42**, 102–118 (in Russian).
- Vinogradova, Yu.K., Maiorov, S.R. & Khorun, L.V. 2010. *The Black Data Book of the Flora of Central Russia: Alien Plant Species in Ecosystems of Central Russia*. GEOS, Moscow. 512 pp. (in Russian).

## **Influence of weather condition on the field peas (*Pisumsativum* L. ssp. *sativum*) vegetation period and yield**

I. Kuznetsov<sup>1,\*</sup>, F. Davletov<sup>2</sup>, N. Anokhina<sup>1</sup>, I. Akhmadullina<sup>1</sup> and F. Safin<sup>1</sup>

<sup>1</sup>Federal State Budgetary Educational Institution of Higher Education “Bashkir State Agrarian University”, Department of Plant Growing, Plant Breeding and Biotechnology, 50 Anniversary of October Str., 34, RU450001 Ufa, Russia

<sup>2</sup>Federal State Budgetary Educational Institution of Higher Education “Bashkir State Agrarian University”, Laboratory of Biochemical Analysis and Biotechnology, 50 Anniversary of October Str., 34, RU450001 Ufa, Russia

\*Correspondence: kuznecov\_igor74@rambler.ru

**Abstract.** Field pea (*Pisumsativum* L. ssp. *sativum*) is a universal pulse crop. One of the actual problems in its production is the influence of weather condition on the variability of pea economic characters and its properties. The purpose of the research (2009–2018) was to compare the vegetation period and interstage periods of the Hangildin and Chishminskiy 229 pea varieties with weather condition and seed yield. According to the results of the conducted research, it can be seen that the duration of the vegetation period and the yield of field pea grain was influenced by weather condition. The average daily air temperature affected the duration of the sowing-sprouting period in pea varieties Hangildin and Chishminskiy 229. The duration of the two periods (sprouting-flowering and flowering-ripeness) was influenced by features of the used varieties and the temperature condition ( $r = -0.472$ , the link is significant and  $r = -0.788$ ). The duration of the sprouting-ripeness period depended on the average daily temperatures ( $r = -0.481$ ), the amount of precipitation ( $r = 0.937$ ), and the HTC (hydrothermal coefficient) ( $r = 0.927$ ). Precipitation increased the duration of the full vegetation period ( $r = 0.892$ ). On average, over 10 years of research on field pea it should be noted that there was a close relationship between the duration of its vegetation period ( $r = 0.844$ ), the duration of the flowering-ripeness period ( $r = 0.679$ ) and the yield of seeds. The relationship between the seed yield and the sowing - sprouting period ( $r = 0.451$ ) and between the seed yield and the sprouting - flowering period ( $r = 0.446$ ) was revealed. The connection was found positive. The connection with the average daily air temperature of this period was negative ( $r = -0.213$ ). The results of the research can be successfully used during cultivation of domestic and foreign varieties of field pea. In international practice, the results of this experiment can be successfully applied in selective improvement of field pea and the development of new, high-tech varieties.

**Key words:** field pea, variety, weather condition, vegetation period, yield.

### **INTRODUCTION**

Grain legumes have important food and fodder value (Dahl et al., 2012). In many countries around the world, an increase in production of grain legumes, including peas is observed. The production is increased in order to solve the problem of food and fodder

protein (Rungruangmaitree & Jiraungkoorskul, 2017). This is due to the fact that the proteins of grain legumes are dissolved in water, weak solutions of alkalis and neutral salts. As a result they are well absorbed by the bodies of both humans and animals (Kuznetsov et al., 2018). American scientists point out that research on incorporating more effective and sustainable production strategies into existing agricultural and food systems is necessary for growing agricultural crops in order to reduce the negative impact on the environment. The inclusion into the daily diet of organic, alternative main food crops such as nutritious field pea can ease the problem of micro-element deficiencies and enable more sustainable farming methods worldwide (Powers & Thavarajah, 2019).

Pea is one of the most popular leguminous plants in Western Europe. In Poland, it is particularly important due to its short vegetation period. It is cultivated throughout the entire country. Due to its high demand, the number of publications related to modeling the yield of this crop has lately increased (Grabowska & Kuchar, 2008). According to French scientists, increasing the yield stability of peas is the main selection goal. Therefore, it is very important that breeders understand the basis of the phenomenon of yield instability in order to create stable and high-yielding varieties (Kosev & Vasileva, 2019).

Field pea is a universal leguminous crop that is successfully cultivated in various soil and climatic zones of the Russian Federation. Field pea is widely spread in the middle Volga region as well as, in the Central black earth and North-Western regions. It occupies large areas in the Ural, lower Volga, Volga-Viatka and North Caucasus regions of the Russian Federation. Pea culture has a high ecological plasticity, when judging it by its distribution areas and cultivation zones. As a result, the study of bio-climatic parameters of field pea is important (Badretdinov et al., 2019).

One of the important issues in pea cultivation technology is the optimal temperature for its growth and development. According to scientists (Davletov et al., 2016; Ayupov et al., 2019), -25 °C are considered to be the optimal temperature. When cool weather conditions occur, there is an increase in the duration of the vegetative period of field pea and its reduction under hot weather conditions. The sum of active temperatures for field pea, depending on the vegetation period is 1,360–2,790 °C (Ayupov et al., 2019).

Pea is the main leguminous crop in the Republic of Bashkortostan. Its share in the structure of sown areas in individual agricultural facilities reaches 9% (Davletov & Gainullina, 2013). The yield of field pea in recent years has not been high enough (Davletov et al., 2016).

Review of the research on the influence of weather condition on the duration of the vegetative period and the yield of pea grain shows the need to conduct research on specific varieties of field pea, which are adapted to specific growing conditions. The purpose of our research was to compare the vegetation and interstage periods of Hangildin and Chishminskiy 229 pea varieties with weather condition and seed yield.

## **MATERIALS AND METHODS**

Field experiments were conducted in 2009–2018 on experimental fields of an educational and scientific center of BSAU (Bashkir State Agrarian University). As part of the research, the reaction of 15 most promising varieties of seed peas for the conditions of the Ural region and the Republic of Bashkortostan was studied. The article

presents the results of research on the most productive varieties of field pea (Hangildin and Chishminskiy 229). All studies were performed in 4 repetitions. The soil type on the experimental site is leached black soil with a heavy loamy mechanical composition (humus -10.5%, total phosphorus -0.19%, total nitrogen -0.5% and potassium-1.2%, pH with a salt extract of 6.0–6.2).

It was found that weather conditions influence the duration of vegetation, interstage periods and grain yield. In accordance with this, there were many problems being solved in the research, such as; determination of the sowing-sprouting period duration for Hangildin and Chishminskiy 229 pea varieties; the relationship of seed yield of pea with the length of the full vegetation period and amount of precipitation; determination of the dependence of the sowing-sprouting period duration on the average daily air temperature, HTC (hydrothermal coefficient) and the amount of precipitation. Selyaninov hydrothermal moisture coefficient (HTC) – characteristic of the level of water availability of the territory. The ratio of precipitation during the active vegetation period to the sum of average daily temperatures over the same time. Calculated by the formula:  $K = R \times 10 / \Sigma t$ ; where R is the sum of precipitation in millimeters over a period with temperatures above +10 °C,  $\Sigma t$  is the sum of temperatures in degrees Celsius (°C) over the same time; the relationship of seed yield of pea with the length of the full vegetation period and the sowing - sprouting period; the relationship of seed yield of pea with the length of the full vegetation period and the average daily air temperature.

A unique aspect in the Republic of Bashkortostan is its climate. It is moderately warm in summer and cold in winter. The frost-free period is 93–123 days. According to the average annual data, frosts are observed in the summer period (beginning of June). Autumn frosts are observed in the last 10 days of August. The sum of active temperatures (above +10 °C) is equal to 1,810–2,210 °C (over the vegetation period). Annual precipitation is 410–505 mm (132–185 mm during the vegetation period) (Ayupov et al., 2019). The weather conditions during the of experimental period was unfavourable, i.e. 2010, 2012, and 2013 were characterized by very dry conditions 2009, 2015, 2016 and 2018 were dry, but 2011, 2014 and 2017 were characterized by wet conditions.

Agricultural technique used in the experiments was generally accepted for the zone. Predecessor was winter rye. Primary tillage was carried out, followed by moldboard plowing to a depth of 30 cm. Pre-sowing treatment of soil included carrying out early spring harrowing with heavy harrows followed by cultivation in the aggregate with medium harrows. The accepted parameters of mineral fertilizers application in the experiments were taken on the basis of general recommendations for their use around the zone (Gabitov et al., 2014) and made up  $N_{30}P_{60}K_{40}$ . The experimental plots were sown in optimal time, with 130 seeds per  $m^2$  and row spacing (15 cm) using the RS-1 selective seeder. The area of each option was 10  $m^2$ , the repeatability was four times. Crop tending is generally accepted for the zone. Experimental work with field pea was conducted in accordance with the guidelines of the All-Russian Institute of Genetic Plant Resources named after N.I. Vavilov. On the territory of Russia, all research with promising varieties is controlled by the state Commission of the Russian Federation for testing and protection of breeding achievements. Published 5 issues of guidelines for all crops. In our research, we were guided by the requirements of the first and second issues (Fedin, 1985; Methods of statevariety testing of agriculturalcrops (issue two), 1989). Mathematical processing of research results was carried out using B.A. Dospekhov's method (Dospekhov, 1985). Snedecor application program was used.

## RESULTS AND DISCUSSION

The duration of the vegetation period plays a crucial role in the cultivation of any crop in one or another region. The duration of each stage such as sowing-shoots (initial), shoots-flowering (average) and flowering-maturation (final) is of interest for selection and production. This largely depends on specific soil and climate conditions.

According to the existing data in our study, the duration of interstage periods in the years of research in varieties Hangildin and Chishminskiy 229 was within the limits of as follows: sowing-sprouting - 10–12 days (same for both varieties); sprouting-flowering - 27–38 days (Hangildin variety) and 28–44 days (Chishminskiy 229), flowering-ripeness - 23–38 days (same for both varieties); sprouting-ripeness - 53–75 days and 56–78 days; sowing-ripeness - 63–86 days (Hangildin variety) and 66–90 days (Chishminskiy 229). Duration of the periods between stages was different for each variety. Thus, the vegetation period of pea varieties depended on the characteristics of the variety and environmental conditions. In some years (2010, 2012), the Hangildin early ripening variety matured in 54–55 days, while the mid ripening Chishminskiy 229 variety matured in 57 days. Serious attention to the formation of pea yields from the vegetation period is paid by Turkish scientists. The yield of dry matter is influenced not only by the number of days of the vegetation period (from 78 to 91 days), but also by the height of plants (68–102 cm), the degree of lodging and other factors. The collection of dry matter in the cultivation of field pea, depending on these factors, can range from 4,861 to 6,853 kg ha<sup>-1</sup> (Tan et al., 2013). This is in many ways combined with our research results. The characteristics of the varieties affected the passage of interstage periods.

According to the results of our experiments, the duration of the vegetation and interphase periods is largely determined by the combination of heat and moisture, as well as the reaction of the genotype of varieties to these conditions. This is in agreement with the results of Kosev's research (2015) during the formation of the model of high-productive varieties in forage pea. Kristal variety had high ecological plasticity and could be considered as close to an ideal type as possible. It can be grown in a wide range of environments. This is also confirmed by research of Chinese scientists. It has a stronger influence on the daily variability of the water potential of spring wheat leaves and field pea (Zhang et al., 2008).

### **Sowing-sprouting period**

According to Davletov et al. (2016), pea seeds begin to germinate at a temperature of 1–4 °C (if they are provided with enough moisture). With an increase in temperature from 11 to 19.5 °C the sowing – sprouting period is noticeably reduced. The sowing-sprouting period for field pea during our experiments was 10–12 days with an average of  $10.9 \pm 0.29$  days (variation coefficient  $V = 8.6\%$ ). During this period, the average daily air temperature was 11.6–18.6 °C with an average of  $14.0 \pm 0.91$  °C (variation coefficient  $V = 20.7\%$ ). The amount of precipitation for the period was 0.8–35.1 mm (on average  $14.8 \pm 3.89$  mm). HTC (Hydrothermic coefficient) - 0.04–2.71 (average  $1.06 \pm 0.29$ ).

The shortest duration of the sowing-sprouting period was observed in 2010, from 2013 to 2014 and in 2018. At that time the average daily temperature of air was above 14 °C. So, based on the results of ten years of research, we can note a significant

connection between the duration of the sowing-sprouting period and the average daily air temperature. In our studies the sowing - sprouting period and the temperature conditions had a negative relationship ( $r = -0.506$ ). Correlation analysis of the duration of the sowing - sprouting period with the amount of precipitation for the sowing - sprouting period had a very low correlation ( $r = 0.019$ ). This is due to the sufficient amount of moisture reserves in the arable layer (45–55 mm in years), which was enough for seeds swelling.

### Sprouting-flowering period

During this period, compared to the previous period, the need for heat is increased. Period 6°C is the lowest period, the optimal periods were periods 16–18 °C. During this period, the need for moisture in pea increases (Davletov & Gainullina, 2013).

The average daily temperature of air during the years of the experiments varied from 14.4 °C (2017) to 20.7 °C (2015). At the same time, the change in the amount of precipitation varied from 12.2 mm (2009) to 131.1 mm (2017). The duration of the sprouting-flowering period in Hangildin pea variety was closer related to the amount of precipitation ( $r = 0.583$ , the link is significant). The relationship between the duration of the sprouting-flowering period and the temperature level ( $r = -0.472$ , the link is significant) was mid negative. The sprouting-flowering period was within 26–44 days in our experiments. The amount of precipitation for the period was 12.3–131.5 mm (on average  $45.0 \pm 11.65$  mm). HTC (Hydrothermic coefficient) - 0.21–2.32 (average  $0.72 \pm 0.20$ ). The variability of the sprouting-flowering period in Hangildinvariety was  $V = 11.7\%$  and Chishminskiy 229 pea variety by year was  $V = 11.3\%$  (Table 1).

In our experiments the correlation coefficient for the duration of the sprouting-flowering period with precipitation was  $r = 0.583$ , with HTC- $r = 0.575$ . The experiments showed an increase in the duration of interstage periods with an increase in precipitation and a decrease in the average daily air temperature. In 2017, the sprouting-flowering period of the Hangildin variety lasted 38 days (the amount of precipitation was 131.0 mm, the temperature was 14.5 °C). The sprouting-flowering period of the Chishminskiy 229 variety lasted 44 days (the amount of precipitation was 131.5 mm, the temperature was 14.6 °C). The shortest duration of the sprouting-flowering period was observed in 2015, when the average daily air temperature was 20.8 °C. It lasted 27 days for Hangildin variety and 229–28 days for Chishminskiy 229 variety.

Thus, the analysis of data collected over many years showed that the duration of the sprouting-flowering period is closely related to weather conditions. It is significantly influenced by varietal characteristics and the genotype.

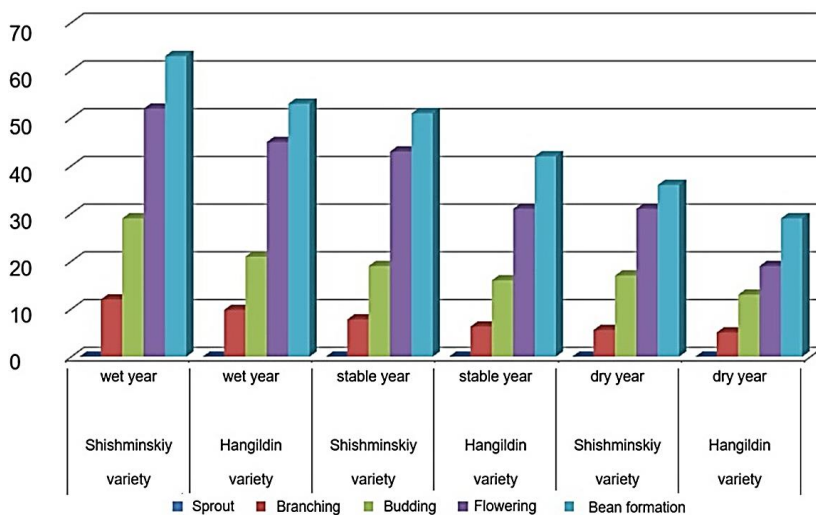
**Table 1.** Correlation coefficient of the duration of the vegetation and interphase periods of peas with weather conditions (2009–2018)

Interstage periods	Correlation coefficient *		
	Precipitation	Daily air temperature	HTC
Sowing-sprouting	0.019	-0.506	0.052
Sprouting-flowering	0.583	-0.472	0.575
Flowering-ripeness	0.408	-0.788	0.241
Sprouting-ripeness	0.937	-0.481	0.927
Sowing-ripeness	0.892	-0.166	0.877

\* Note: – the correlation coefficient is significant at 5% of the significance level (0.22).



In the course of research, it was found that pea plants of different varieties differ in the growth rate in the initial phase of vegetation. Depending on the conditions of the year in the branching phase, their height reached 5.1–12 cm. On average, in 2009–2018, the growth reached its maximum value in the flowering phase (from 4.1 to 5.3 cm per day). In our experiments, the increase in height was greater in wet years. Under the influence of drought and elevated temperatures, growth processes were suppressed (Fig. 1).



**Figure 1.** Influence of humidification conditions on the growth of pea plants of the Chishminskiy 229 and Hangildin varieties for 2009–2018, cm.

### Flowering-ripeness period

According to French scientists Roche et al. (1999), the time of flowering in pea is mainly related to the photoperiod (P) and mean temperature (T(m)) during the vegetation period. In field conditions, both variables depend mainly on the latitude (LAT) and the date of sowing (RDS). The lowest limits of temperature for pea should not be lower than 10 °C (Davletov et al., 2016). The optimum temperature is 18–20 °C.

The variability of the flowering-ripeness period in Hangildin and Chishminskiy 229 pea varieties by year was  $V = 17.3–17.6\%$ . The coefficient of variation of the flowering-ripeness period with HTC and precipitation for 2009–2018 was 47.7–47.8% and 50.0–50.1%, respectively.

The duration of the flowering-ripeness period, according to our research, had a close relationship with precipitation and temperature conditions. This is confirmed by the results of the research done by French scientists. Their research shows high yield variability, which depends on provision of soil with water during the flowering period (Biarnès-Dumoulin et al., 1996).

In 2010, 2012, 2013, 2016, 2018 the flowering-ripeness period for Hangildin and Chishminskiy 229 variety lasted 23–27 days (the average daily air temperature was 21.4–23.2 °C). In 2014 with a temperature of 17.1 °C it was only 38 days. The amount of precipitation for the period was 5.0–70.1 mm (on average  $40.3 \pm 6.30$  mm). HTC

(Hydrothermic coefficient) - 0.09–1.10 (average  $0.65 \pm 0.03$ ). The correlation coefficient between the number of days during the flowering-ripeness period and the average daily air temperature was  $r = -0.788$ . The duration of the flowering-ripeness period was influenced by the amount of precipitation ( $r = 0.408$ ).

According to Molchanov (2003) in the period of budding-full ripeness, the relationship between the yield of peas of the Malyshok variety and hydrothermal factors was as follows: between the yield and the duration of the growing season, the dependence was highly positive  $r = 0.92$ , between the amount of rainfall and yield positive  $r = 0.67$ , between the yield and average daily air temperature - negative ( $r = -0.32$ ). The results of the experiments have a similar trend with our research, the influence of varieties and cultivation conditions (Kuban) is manifested.

As can be seen in our research, the most difficult period for the development of pea plants is the flowering-ripeness period. This is confirmed by the results obtained by Hungarian researchers. Most favourable part of the vegetation period is in spring, when precipitation and evapotranspiration increase month after month. The least favorable period for soil moisture conditions lasts from July to September, when evapotranspiration significantly exceeds the amount of precipitation (Varga-Haszonits et al., 2008). In our experiments, a weak connection between the duration of the flowering-ripeness period and HTC was found  $r = 0.241$  (Table 1).

### **Sprouting-ripeness period**

The duration of the sprouting-ripeness period in Hangildin variety was closely related to the amount of precipitation ( $r = 0.937$ ). The duration of the sprouting-ripeness period had an average negative connection with the temperature level ( $r = -0.481$ ). The sprouting-flowering period in our experiments was within 53–78 days. The variability of the sprouting-ripeness period in pea varieties Hangildin and Chishminskiy 229 by year was  $V = 9.5–10.1\%$ .

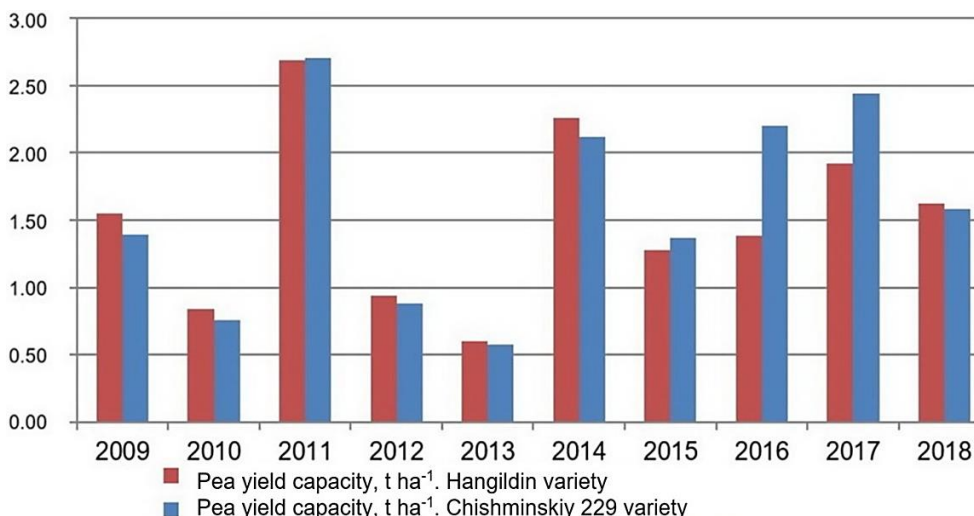
The experiments showed an increase in the duration of interstage periods with an increase in precipitation and a decrease in the average daily air temperature. The high dependence between pea seed yield and the period of sowing-ripeness was shown in the studies of Indian scientists Nagarajan et al. (2002). With delay in sowing, there was an increase in flowering days (7–26 days). In their experiments, they came to the conclusion that the change in thermal units during the growing season of pea had a high correlation with seed yield per ha ( $r = 0.937$ ,  $P = 0.0015$ ). Therefore this coincides with the results of our research. In 2014 and 2017, the sprouting - ripeness period of the Hangildin pea variety lasted 69–75 days (with a temperature of 17.1 to 17.5 °C). The sprouting-ripeness period of the Chishminskiy 229 variety lasted 71–78 days (with a temperature of 17.2 to 17.5 °C). The coefficient of variation for the sprouting-ripeness period and the average daily air temperature was 6.2–6.4%. With an increase in the average daily air temperature, there was a reduction in the period from sprouting to ripeness. In the experiments, the shortest duration of the sprouting-maturation period was observed in the Hangildin pea variety and was 53 days. The shortest period of sprouting-maturation for Chishminskiy 229 pea variety was 56 days in 2010. The average daily air temperature during this period was 20.8 °C the amount of precipitation - 27.2 mm. The duration of the period from sprouting to ripeness in Hangildin pea variety is closely, in a good way, correlated with the amount of precipitation ( $r = 0.937$ ) and the HTC ( $r = 0.927$ ). In all legumes crops waterlogging at flowering led to damage, which

could not be recovered during seed filling (Pampana et al., 2016). The connection between the duration of the period from sprouting to ripeness and the average daily air temperature was negative ( $r = -0.481$ ).

Data on the coefficients of variation (V, %) of the interstage periods of pea development and weather conditions. The conducted analysis shows that precipitation and HTC are more variable. Analysis of weather conditions for the entire vegetation period shows the negative impact of excess precipitation and low air temperature. This is more obvious during the flowering period of pea.

### Grain yield

The creation of technologically advanced high yielding varieties is one of the main directions of selection. In ten years of research, the maximum grain yield was obtained in 2011. It was obtained during favorable for the growth and development of pea plants conditions. It was  $2.69 \text{ t ha}^{-1}$  for Hangildin pea variety and  $2.70 \text{ t ha}^{-1}$  for Chishminskiy 229 pea variety. The lowest grain yield was observed in a very dry year of 2010 and in a dry year of 2013 (Fig. 2).

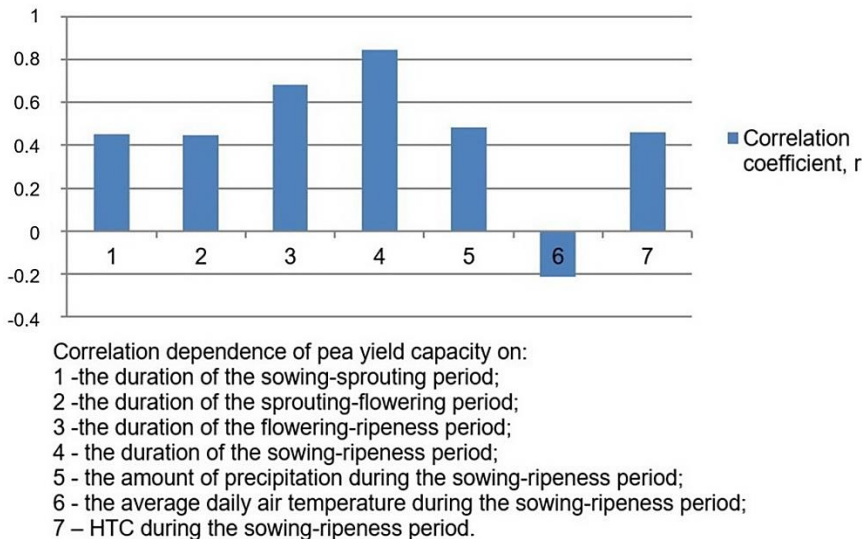


**Figure 2.** Pea grain yield for 2009-2018 ( $\text{t ha}^{-1}$ ).

As can be seen in figure 1, during research years, the yield of pea grain in Hangildin pea variety and in Chishminskiy 229 variety ranged from  $0.60$  to  $2.69$  and from  $0.58$  to  $2.70 \text{ t ha}^{-1}$ , respectively (coefficients of variation –  $40.96$  and  $42.84\%$ ). The average yield of Hangildin pea variety was  $1.50 \text{ t ha}^{-1}$  and  $1.60 \text{ t ha}^{-1}$  for the Chishminskiy 229 pea variety.

In the experiments of Shevtsova (2000) in the conditions of the Saratov Region (Russia), the influence of weather conditions on the yield of sowing peas is noted, which has a similar tendency with our research. On average for 1967–2000. Yields in wet years were  $3.01 \text{ t ha}^{-1}$ , in dry years -  $1.51 \text{ t ha}^{-1}$  and in extremely dry years -  $0.61 \text{ t ha}^{-1}$ . The coefficient of variation was  $45.8\%$ .

It was found that, on average for 2009–2018, the yield of pea grain had a close correlation with the duration of the periods sowing-ripeness ( $r = 0.844$ ) and flowering-ripeness ( $r = 0.679$ ). A weaker positive correlation ( $r = 0.451$  and  $r = 0.443$ , respectively) was observed between the duration of the sowing-germination and germination-flowering periods (Fig. 3).



**Figure 3.** Correlation dependence of pea grain yield on the duration of the vegetation period, the duration of interstage periods and weather conditions (2009–2018).

\* Note: – the correlation coefficient is significant at 5% of the significance level.

For Hangildin pea variety during the sowing-ripeness period, there was a weak negative correlation between the yield of pea grain and the temperature regime ( $r = -0.213$ ), and a positive correlation between the yield, the amount of precipitation and the HTC ( $r = 0.486$  and  $r = 0.449$ , respectively). The Chishminsky 229 variety had a similar trend. During the sowing-maturation period, there was also a weak negative correlation between the yield of pea grain and the temperature regime of the variety ( $r = -0.217$ ), positive correlation between the yield, the amount of precipitation and the HTC ( $r = 0.478$  and  $r = 0.475$  respectively). Analysis of research results, data from Figs 1 and 3, Table 1 shows a high dependence of pea yield on the amount of precipitation during the growing season.

At the same time, according to Masilionytė & Maikštėnienė (2011) when using organic fertilizers in the organic farming system, there was a strong connection between pea yield and the amount of precipitation. There was no such high dependence when  $N_{30}P_{60}K_{60}$  mineral fertilizers were applied. A more significant relationship between the yield and the amount of precipitation is observed during the warm period. During this period, plants are able to use their moisture reserves more effectively.

## CONCLUSIONS

The results of the research showed that weather conditions affect the duration of the growing season and the yield of field peas. The duration of the vegetation and interphase periods is determined largely by the combination of heat and moisture, as well as the reaction of the genotype of varieties to these conditions. In some years (2010, 2012), the early-matured variety of hangildin's Memory matured in 54–55 days, and the medium - matured Chishminsky 229 - in 57 days. The experiments showed an increase in the duration of interphase periods with an increase in precipitation and a decrease in the average daily temperature. This is most acute during the flowering period of peas. With an increase in the average daily air temperature, there was a reduction in the period from germination to maturation. The highest yield during 2009–2018 was formed by the medium-ripened variety of peas sown Chishminsky 229.

A comparative study of the vegetation period and interstage periods with weather condition and seed yield should help researchers to choose the starting material for the creation of new high-yielding, technological pea varieties for the conditions of the Republic of Bashkortostan.

## REFERENCES

- Ayupov, D.S., Davletov, F.A., Asylbaev, I.G., Kuznetsov, I.Y., Akhmadullina, I.I., Dmitriev, A.M. & Irgalina, R.S. 2019. Selection of high-yielding, high-tech varieties of field pea (*Pisumsativum* L.). *Legume Research-An International Journal* **42**(5), 615–619.
- Badretdinov, I., Mudarisov, S., Lukmanov, R., Permyakov, V., Ibragimov, R. & Nasyrov, R. 2019. Mathematical modeling and research of the work of the grain combine harvester cleaning system. *Computers and Electronics in Agriculture* **165**, 104966.
- Biarnès-Dumoulin, V., Denis, J.B., Lejeune-Héanut, I. & Etévé, G. 1996. Interpreting yield instability in pea using genotypic and environmental covariates. *Crop Science* **36**(1), 115–120.
- Dahl, W.J., Foster, L.M. & Tyler, R.T. 2012. Review of the health benefits of peas (*Pisumsativum* L.). *British Journal of Nutrition* **108**(S1), S3–S10.
- Davletov, F.A., Gainullina, K.P. 2013. Studying the polymorphism of micro-satellite loci of seed peas (*Pisumsativum* L.). *Bulletin of Bashkir State Agrarian University* **2**(26), 10.
- Davletov, F.A., Gainullina, K.P. & Karimov, I.K. 2016. Influence of meteorological conditions on the formation of the pea grain crop. *Grain economy of Russia* **5**, 10–16.
- Dospekhov, B.A. 1985. *Method of field experience*. M. Agronom publishing.
- Fedin, M.A. 1985. *Methods of state variety testing of agricultural crops (first issue)*. Moscow, 268.
- Gabitov, I.I., Mudarisov, S.G., Ismagilov, R.R., Rakhimov, Z.S., Imaletdinov, M.M., Davletshin, M.M., Kamaletdinov, R.R., Samigullin, A.S., Hasanov, E.R., Galliamov, F.N., Badretdinov, I.D., Farkhutdinov, I.M., Sharafutdinov, A.V., Khabirov, I.K., Asylbayev, I.G., Khaibullin, M.M., Iukhin, I.P., Gaifullin, R.R., Negovora, A.V. & Bakiev, I.T. 2014. *System of machines and equipment for implementation of innovative technologies in crop production and animal husbandry of the Republic of Bashkortostan*. Ministry of Agriculture of the Russian Federation, Ministry of Agriculture of the Republic of Bashkortostan, Bashkir State Agrarian University, National Academy of Sciences of Belarus, Scientific and Practical Center of the National Academy of Sciences of Belarus on Agricultural Mechanization. Ufa.
- Grabowska, K. & Kuchar, L. 2008. Prediction of pea yield (*Pisum sativum*) for north-central Poland using weather-crop model. *Italian Journal of Agronomy* **3**, 777–778.

- Kosev, V. 2015. Model of high-productive varieties in forage pea. *Journal of Central European Agriculture* **16**(2), 172–180.
- Kosev, V. & Vasileva, V. 2019. Adaptive capabilities and productive potential of initial material from peas (*Pisum Sativum*). *Indian Journal of Agricultural Sciences* **89**, 1, 138–144.
- Kuznetsov, I.Y., Akhiyarov, B.G., Asylbaev, I.G., Davletov, F.A., Sergeev, V.S., Abdulvaleyev, R.R. & Yagafarov, R.G. 2018. The Effect of sudan grass on the mixed sowing chemical composition of annual forage Crops. *Journal of Engineering and Applied Sciences* **13**(S8), 6558–6564.
- Masilionytė, L. & Maikštėnienė, S. 2011. The effect of agronomic and meteorological factors on the yield of main and catch crops. *Zemdirbyste-Agriculture* **98**(3), 235–244.
- Methods of statevariety testing of agriculturalcrops (issue two). 1989. Moscow, 197.
- Molchanov, I.B. 2003. Variability of quantitative traits in peas depending on vegetation conditions and doses of fertilizers. Abstract of the dissertation of the candidate of agricultural sciences. P. Persiakovsky, p. 20.
- Nagarajan, S., Pandita, V.K. & Sinha, S.N. 2002. Thermal requirement in garden pea (*Pisumsativum*) for seed production. *Indian journal of agricultural science* **72**(11), 667–669.
- Pampana, S., Masoni, A. & Arduini, I. 2016. Response of cool-season grain legumes to waterlogging at flowering. *Canadian Journal of Plant Science* **96**(4), 597–603.
- Powers, S.E. & Thavarajah, D. 2019. Checking Agriculture's Pulse: Field Pea (*Pisum Sativum* L.), Sustainability, and Phosphorus Use Efficiency. *Frontiers in Plant Science* **10**, 1489.
- Roche, R., Jeuffroy, M.H. & Ney, B. 1999. Comparison of different models predicting the date of beginning of flowering in pea (*Pisumsativum* L.). *Ecological Modelling* **118**(2–3), 213–226.
- Rungruangmaitree, R. & Jiraungkoorskul, W. 2017. Pea, *Pisumsativum*, and its anticancer activity. *Pharmacognosyreviews* **11**(21), 39.
- Shevtsova, L.P. 2000. Formation of highly productive agrophytocenoses of legumes in the arid Volga region. *Abstract of the dissertation of a doctor of agricultural sciences*. Saratov. 46 pp.
- Tan, M., Koc, A., Dumlu Gül, Z., Elkoca, E. & Gül, İ. 2013. Determination of dry matter yield and yield components of local forage pea (*Pisumsativum*ssp. *arvense* L.) ecotypes. *Tarim Bilimleri Dergisi* **19**(4), 289–296.
- Varga-Haszonits, Z., Varga, Z., Lantos, Z., Enzsölné Gerencsér, E. & Milics, G. 2008. Effect of soil water supply on the water demand of plants. *Agrokémiaéstalajtan* **57**(1), 7–20.
- Zhang, M., Zhang, R.Z. & Cai, L.Q. 2008. Leaf water potential of spring wheat and field pea under different tillage patterns and its relationships with environmental factors. *The journal of applied ecology* **19**(7), 1467–1474.

## **Influence of bio-humus on soil fertility, productivity and environmental safety of spring wheat grain**

L.G. Muhamedyarova\*, M.A. Derkho, G.V. Meshcheriakova, O.A. Gumenyuk  
and S.S. Shakirova

Federal State Funded Educational Institution of Higher Education  
‘South-Urals State Agrarian University’, Department of natural Sciences,  
RU457100, Chelyabinsk region, Troitsk, Russia

\*Correspondence: muhamedyarovaliliya@mail.ru

**Abstract.** The influence of bio humus on chemical indicators of the arable layer of soil, productivity and ecological safety indicators of spring wheat of ‘Chelyaba - 75’ variety during the period of 2017–2019 were studied. The object of research was samples of the soil arable layer from the control and experimental field, the structure of wheat yield from control and experimental plots. Bio humus aqueous extract was introduced in the soil of the experimental field before wheat sowing and in the phase of spring tillering at the rate of 10 L/200 L /1 hm<sup>2</sup> using the trailer sprayer ‘Zarya’ (Russia) during the dark hours of day.

In the study of soil and grain samples, generally accepted methods and techniques were used. It is established that regular chernozems under the conditions of technogenic impact of emissions of thermal power plants are characterized by low humus content (4.58–4.60%) and weak acid reaction of medium (pH = 6.1–6.5); imbalance between biochemically active (copper, zinc, cobalt) and toxic (lead, nickel, cadmium) elements, as confirmed by soil contamination coefficients: for copper ( $C_0 = 1.50$ – $1.58$ ), zinc ( $C_0 = 0.79$ – $0.85$ ). The introduction of bio humus in the tilth top soil before sowing and during tillering of spring wheat contributed to the increase in humus composition by 1.88 times, the change in acidity to pH = 6.9–7.0, reduction of lead and cadmium concentrations in 1.63 and 1.20 times against the background of increased zinc and cobalt levels by 15.62% and 7.98%; increase of field germination of spring wheat from  $75.0 \pm 0.4$  to  $82.0 \pm 0.9$ %; quantity of developed stems to be harvested per 1 m<sup>2</sup> by 10.15%, productive tillering capacity by 8.33%, average quantity of spikes per ear by 20.00%, average quantity of grain per ear by 7.69%, mass of 1,000 grains by 16.12%, and wheat yield increase by 10.2 hwt ha<sup>-1</sup> and decrease in spring wheat grain concentration of lead and cadmium at 14.00 and 16.00%.

**Key words:** bio humus, soil, humus, heavy metals, detoxication, spring wheat, yield.

### **INTRODUCTION**

One of the crucial tasks of modern crop production is creation of optimal conditions for growing strategically important grain crop wheat, taking into account agro-ecological features of its cultivation territories while preserving soil fertility (Kolesnikova, 2012; Marenych et al., 2019).

An effective method of increasing agricultural productivity is the application of fertilizers. Their use should take into account the method and mode of application,

agrochemical properties of soil, biological features of crops grown, natural and climatic conditions of territories, etc. (Zharova, 2016; E et al., 2017; Zhang et al., 2017). This, on the one hand, allows to increase the useful properties of fertilizers by 25–30% (Zharova, 2016), and on the other hand, realize the genetic potential of plants and stabilize the yield, increase their resistance to adverse environmental factors (Marenych et al., 2019), improve soil fertility (E et al., 2017).

In recent years in agriculture, humin-containing fertilizers are widely used, which improve the ecological condition and fertility of the soil, saturating it with minerals, vitamins and amino acids and increase the activity of soil microflora, stimulate plant growth through better absorption of nutrients, intensify biosynthesis of proteins, carbohydrates and vitamins, increase resistance to adverse environmental factors (Marenych et al., 2019). This allows to reduce the ripening time of plant crops, increase their yield and improve the quality of produced products. In addition, humic fertilizers reduce the plant extraction degree of heavy metals and pesticides from soil, allowing to obtain environmentally sound products (Ali Mohamed Elyamine et al., 2018).

The use of bio humus (vermicompost) is a promising technique to increase soil fertility, yield and environmental safety of plant organisms. It is prepared by vermicomposting a variety of organic waste into a humus-like material (Bernard et al., 2011; Zhao et al., 2016; Strachel et al., 2017; Sartaj Ahmad Bhat et al., 2018). Bio humus has physical, chemical and biological effects on soil (Lim et al., 2015). When applied to the soil, it improves its aeration, porosity, density and moisture retention capacity, changes the content of organic and mineral substances, conductivity and pH. All this creates conditions for better plant growth and higher yield.

Given that in the territory of Chelyabinsk region (one of the industrialized regions of Russia) is concentrated a large number of nature-polluting and nature-destructive industries, the fertility of soils in most agricultural land is very low. This is due to the peculiarities of the territories' geochemical background, and the ability of the soil to accumulate and retain various pollutants in its composition for a long time (Baishanova & Kedelbaev, 2016; Huang et al., 2017; Schosler et al., 2018), and with the application of a huge amount of different inorganic fertilizers and plant protection products, and with the disregard of crop rotations, and with non-compliance to technological discipline (Antille et al., 2019). These factors together determine low crop yields (Vitkovskaya et al., 2013; Dogra et al., 2019). Therefore, there is an urgent need to restore or increase the fertile potential of arable land (Vodyanitsky, 2011; Naumkin et al., 2013; Rai et al., 2019). For these purposes, it is efficient to use bio humus, which allows to quickly replenish organic nutrients in the soil.

However, vermicompost acts positively on soil fertility, plant growth and yield when applied in a highly regulated quantity and under certain regimes (Lim et al., 2015; Doan et al., 2015). According to data (Baldotto et al., 2016) it improves plant development only in complex with mineral fertilizers. In addition, the properties of vermicompost depend on the raw materials used to produce it (Doan et al., 2015; Conselvanet et al., 2017; Sartaj Ahmad Bhat et al., 2018), as well as on cultivated agricultural crops (Manzoor et al., 2014; E et al., 2017). This determines the recommended amount, dose of application and concentration of fertilizer, compatibility with other fertilizers (Marenych et al., 2019). Therefore, the technique of using bio humus to increase soil fertility and plant growth in particular agro-ecological conditions has specific features.



Taking into account the above mentioned, the aim of the work was to study the influence of bio humus on the ecological condition of soils, germination, productivity and ecological safety of spring wheat in conditions of biogeochemical province of the Southern Urals.

## MATERIALS AND CONDITIONS OF RESEARCH

Research work was carried out during 2017–2019 in the conditions of the Peasant farm holding ‘PE Khayrullina R.R.’ (Troitskiy district, Chelyabinsk region), Department of Natural Sciences and the Laboratory of the Innovative Research Center of the South Ural State Agrarian University (Chelyabinsk region, Troitsk, Russian Federation).

The object of the study was: a) the arable soil layer of agricultural land of the peasant farm holding ‘PE Khayrullina R.R.’; b) spring wheat of the variety ‘Chelyaba 75’, grown in the fields of the farm.

Weather conditions during the research period are shown in Table 1 according to the data of the Troitsk weather station (Chelyabinsk region, Russia). Their analysis showed that the air temperature in the growing period of 2017–2019 was not much different from the average for previous years, although May and June were colder and July was warmer. At the same time, precipitation was unevenly distributed by months. In 2017 and 2018, precipitation was higher in May and June, with July, August and September lower than the previous year average. To some extent, this has negatively affected the growth, development and formation of plant yields. May and August of 2019 were dry, with June, July and September more rainy.

**Table 1.** Weather data in the growing period of 2017–2019

Indicators	Year	May	June	July	August	September
Air temperature, °C						
Average monthly	2017	12.4	17.4	20.4	19.6	11.8
	2018	11.5	16.1	21.7	17.4	13.3
	2019	12.2	18.1	21.3	17.9	9.8
Average annual	1936–2019	13.2	19.1	20.1	17.8	11.7
Precipitation, mm						
Monthly	2017	78.0	48.0	51.0	44.0	29.0
	2018	41.0	53.0	28.0	47.0	13.0
	2019	12.0	52.0	65.0	34.0	43.0
Average annual	1936–2019	39.0	43.0	63.0	48.0	31.0

Consequently, the weather conditions during 2017–2019 were not very favorable, which allowed to assess the effectiveness of bio humus impact on the studied indicators more reliably.

Bio humus was obtained from cattle manure by worm composting in a container way using earthworms ‘Staratel’. Vermicomposting duration - 3 months. Aqueous extract of bio humus was prepared in 5 m<sup>3</sup> tanks, mixing it with water at a rate of 1:10 and using a compressor for air supply. The filtered aqueous extract was a dark brown odorless liquid with neutral to slightly alkaline medium reaction (ph 7.0–7.2).

Scientific and production experiment is performed according to the following scheme. Firstly, the influence of bio humus on the chemical composition of the arable

layer of soil has been studied. To this end, in the conditions of peasant farming two fields were chosen considering the wind rose (control 9.2 h m<sup>2</sup>, experimental 8.3 h m<sup>2</sup>). They were located in the southern forest-steppe part of Chelyabinsk region and exposed to air emissions of thermal power complex JSC Second Generating Company of the wholesale electricity market of PJSC Branch 'Troitskaya GRES' (Troitsk) - the main source of anthropogenic pollution in the city of Troitsk and Troitsk district.

On the experimental site, aqueous extract from bio humus was applied to the soil before sowing wheat and in the tillage phase of spring tillering at the rate of 10 L/200 L /1 hm<sup>2</sup> using the trailer sprayer 'Zarya' (Russia) during the dark hours of day.

Monitoring plots (control, experimental) of 1 hm<sup>2</sup> were set on each field. On these fields spot samples of topsoil (regular chernozem) were taken by layers; samples were taken before wheat sowing (May) and after harvesting (September), using envelope method by soil tube. Average sample was formed out of spot samples using quartering.

Secondly, the influence of bio humus on environmental safety and productivity of spring soft wheat 'Chelyaba-75' has been studied. For this purpose, the control and experimental field was sown in the 2nd decade of May with reproductive seeds. Seeding standard - 5 million germination grains per 1 hm<sup>2</sup>.

In order to assess the quality of wheat crop in control and experimental fields, record plots of 25 m<sup>2</sup> in 4 times repetition were laid. Harvesting was carried out in a phase of complete ripeness with the harvester 'Polesie GS12'. The actual yield was determined by weighing the grain and bringing it to a standard humidity of 14%.

## METHODS OF RESEARCH

Scientific and production experiment was performed during 2017–2019. The object of the study was samples of the arable layer of soil from control and experimental fields, the structure of wheat yield from control and experimental plots and the ecological safety of the grain obtained.

The pH of<sub>KCl</sub> was determined determined in the average sample of the arable layer of soil, the content of humus - according to Turin in modification of Qinao, the concentration of mobile forms of metals (copper, zinc, lead and cadmium) after ashing of 1M with nitric acid using the Minotavr device (Russia) by atomic absorption spectrophotometry on the spectrophotometer Kvant-2 (Russia) in the flame of propane-air (Kuznetsov et al., 1992).

**The following indicators were taken into account in the analysis of crop structure:** laboratory germination by the number (%) of normally germinated sample seeds (100 grains) on filter paper in Petri dishes at t 20 °C for 10 days and germination energy for 5 days; field germination by calculating the density of plant standing on the accounting sites in the phase of full growth; number of developed stalks for harvesting, productive tilling capacity, the average number of developed ears and the average number of grains in an ear, the mass of 1,000 grains according to the methods recommended for grade testing (Pylneva, 2016). In addition, heavy metals (lead, cadmium, copper, zinc) were determined in the samples of wheat grain; determination was carried out according to GOST 13586.3-83, 2001. by atomic absorption spectrophotometry (GOST 26929-1994, 1996).

To assess the ecological condition of soils and ecological safety of grain, the level of metals, including toxic ones, was compared with the regulatory data regulated by

GN 2.1.7.2041-2006. medical and biological requirements and sanitary standards of quality of food raw materials and food products (1996). In addition, the pollution factor was calculated in order to estimate the coefficient of soil contamination ( $C_0$ ) by the formula:

$$C_0 = \frac{Ac}{S_{MPCp}} \quad (1)$$

where  $Ac$  – the actual content of the element in the soil;  $S_{MPC}$  – the value of the element's MPC in the soil.

The results of the research are subject to mathematical processing on the personal computer using the ‘Analysis Package’ add-on in the program for spreadsheets processing ‘Microsoft Excel-2007’. Statistical processing of the data included determining the average value and its deviations. Reliability of differences between groups of traits was assessed using the t-criterion of Student.

## RESULTS AND DISCUSSION

On monitoring sites of control and experimental fields regular chernozem prevailed, which before wheat sowing was marked by low content of humus (4.58–4.60%) and slightly acidified medium reaction ( $pH = 6.1–6.5$ ). Copper concentration fluctuated within range  $4.54 \pm 0.11 – 4.75 \pm 0.10 \text{ mg kg}^{-1}$ , which exceeded MPC value ( $K_0 = 1.51–1.58$ ). On the contrary, zinc content did not reach MPC value, which was  $18.32 \pm 0.21 – 19.54 \pm 0.16 \text{ mg kg}^{-1}$  ( $K_0 = 0.79–0.85$ ) (Table 2).

**Table 2.** Chemical composition of topsoil in average during 2017–2019

Indicator	Control site		Experimental site		MPC
	Before sowing	After harvesting	Before sowing	After harvesting	
pH <sub>KCl</sub>	$6.25 \pm 0.37$	$6.30 \pm 0.31$	$6.35 \pm 0.34$	$6.95 \pm 0.28^*$	-
Humus, %	$4.58 \pm 0.13$	$3.96 \pm 0.11$	$4.60 \pm 0.16$	$7.90 \pm 0.14^*$	-
Lead, mg kg <sup>-1</sup>	$10.50 \pm 0.36$	$9.75 \pm 0.33$	$10.92 \pm 0.38$	$6.70 \pm 0.19^*$	-
Cadmium, mg kg <sup>-1</sup>	$0.32 \pm 0.03$	$0.29 \pm 0.01$	$0.41 \pm 0.04$	$0.18 \pm 0.006^*$	-
Copper, mg kg <sup>-1</sup>	$4.54 \pm 0.11$	$4.62 \pm 0.13$	$4.75 \pm 0.10$	$4.56 \pm 0.10$	3
Zinc, mg kg <sup>-1</sup>	$18.32 \pm 0.21$	$19.27 \pm 0.56$	$19.54 \pm 0.16$	$22.59 \pm 0.93$	23

Note: \* –  $p < 0.05$  compared to the control site.

Lead content in soil samples of monitoring plots of control and experimental sites was  $10.50 \pm 0.36 – 10.92 \pm 0.38 \text{ mg kg}^{-1}$ . The main sources of soil contamination of the peasant farm holding with lead and nickel were atmospheric emissions, as of local nature (PJSC ‘Troitskaya GRES’ Branch, including ash dump), and transboundary transfer from the side of the city of Magnitogorsk, which is one of the most ecologically disadvantaged cities in the world. It should be noted that lead in the soil loses its toxicity due to the formation of complex compounds with phosphates and humates (Zybalov & Popkova, 2018). Therefore, countries such as England ( $300 \text{ mg kg}^{-1}$ ), Canada ( $500–1,000 \text{ mg kg}^{-1}$ ) and the USA ( $2,000 \text{ mg kg}^{-1}$ ) have dramatically increased the MPC value compared to Russia (Table 2).

Although the content of the mobile cadmium form in the soil is not normalized, it is one of the most toxic elements in the environment. The main source of pollution of the territory of Troitsky district of Chelyabinsk region by this metal is emissions of PJSC

Branch 'Troitskaya GRES', which in the technological cycle uses Ekibastuz coal with high ash content. Therefore, the concentration of cadmium in arable soil samples of monitoring sites fluctuated between  $0.32 \pm 0.03 - 0.41 \pm 0.04 \text{ mg kg}^{-1}$ . It should be noted that the presence of this element in the soil negatively affects the ecological safety of soils, slowing the growth and development of plants (Table 2).

In estimating the degree of soil pollution by the value of the pollution coefficient it was found that  $C_0$  exceeded the unit of copper, indicating its intensive accumulation in the arable layer. Consequently, the soil monitoring plots of control and experimental sites showed degradation, as indicated by low humus content, weak acidic reaction and excessive content of, firstly, toxic elements. Together this determined the biological and physico-chemical properties of the soil and its barrier geochemical functions.

Therefore, as a method of fertility restoration and detoxification of soils, we introduced aquatic extract of bio humus in the soil of the experimental field before sowing and in the phase of spring wheat tillering. At the same time, we proceeded from the fact that bio humus is a complex fertilizer of organic origin, which contains high concentrations of humus, nitrogen, phosphorus, potassium and microelements (Ali Mohamed Elyamine et al., 2018; Rékási et al., 2019).

Analysis of samples of arable soil layer from monitoring sites of control and experimental sites after harvest showed that application of bio humus contributed to increase of organic matter (humus  $7.90 \pm 0.14\%$ ). Its content in experimental field soil was increased by 1.88 times compared to the control field. Due to this, the acidity of soils also changed – the pH value was approaching the neutral level (pH = 6.9–7.0). The positive influence of bio humus is seen in the content of chemical elements in the soil of agricultural fields. Thus, in the samples of the soil of the experimental field, compared with the control site, the content of typical ecotoxicants decreased significantly: lead and cadmium by 1.63 and 1.20 times, due to their ability to form poorly soluble and stiff complex compounds with organic components of bio humus. In addition, changes in soil pH were reflected at the level of the exchange cations of biogenic elements, determining an increase in the concentration of zinc (by 15.62%) in soil samples. At the same time, the use of bio humus practically did not affect the content of iron and copper.

Similar conclusions in their studies were obtained by (Moslehi et al., 2019; Trentin et al., 2019). The authors noted that bio humus affects the bioavailability of lead and cadmium in soil, but does not have this effect on copper.

When assessing the influence of bio humus on the structure of wheat yield and its mineral composition, the following was revealed.

Laboratory germination of spring wheat seeds of the variety 'Chelyaba 75' (Table 3), from control and experimental plots had practically no difference, which indicates same-type nutrients reserve in grains. A similar dependence has been found in relation to germination energy. At the same time, the difference between laboratory germination and germination energy characterizing the activity of biochemical processes in germinating seeds was only 3%, reflecting the high quality of obtained grain.

Wheat field germination had significant differences between plots (Table 3). at the experimental plot with comparable seed control data the average field germination level was  $82.0 \pm 0.9\%$  ( $p < 0.05$ ). Therefore, the use of bio humus had a positive impact on the formation of sprouts of spring wheat.

Similar conclusions in their research was obtained by (Devi et al., 2020). They noted that the introduction of bio humus to the soil increases seed germination by

1.05–1.3 times. According to (Gong et al., 2019) the seed germination index increased by 1.46–1.48 times.

The process of plant development was associated with the plot, reflecting their ability to respond to changes in soil fertility. Thus, against the background of application of biofertilizer the best growth and development of plants was observed, which has further influenced the wheat yield structure. Thus, the number of developed stems for harvesting per 1 m<sup>2</sup> increased by 10.15%, productive tilling capacity increased by 8.33%, and average number of developed spikes per ear by 20.00%. This determined average grain quantity per ear, as well as the size of the formed seeds and the yield of spring wheat (Table 3).

**Table 3.** Structural elements of spring wheat yield in average during 2017–2019

Indicator	Control plots	Experimental plots
Laboratory germination, %	90.0 ± 0.3	91.0 ± 0.6
Germination energy, %	87.0 ± 1.1	88.0 ± 0.7
Field germination, %	75.0 ± 0.4	82.0 ± 0.9*
Quantity of developed stems for harvesting per 1 m <sup>2</sup>	315.0 ± 2.5	347.0 ± 3.9*
Productive tilling capacity	1,2 ± 0.1	1,3 ± 0.1
Average quantity of developed spikes per ear, pcs.	10.0 ± 0.5	12.0 ± 0.4
Average grain quantity per ear, pcs.	26.0 ± 0.6	28.0 ± 0.6
Weight of 1,000 grains, g	31.0 ± 0.6	36.0 ± 0.7*
Yield, hwt ha <sup>-1</sup>	25.4 ± 0.2	35,60 ± 0.2

Note: \* –  $p < 0.05$  compared to the control plots.

Therefore, the introduction of bio humus into the soil created more favorable conditions for the yield formation of wheat and the realization of biological potential of sowing material. According to data (Suslov et al., 2011) the use of bio humus creates conditions for stable increase of soil fertility, providing plants with necessary organic and mineral substances.

At the same time in the work of (Sarma et al., 2018) it is noted that the effect of vermicompost on yields is comparable to the action of biochar. According to (Manzoor et al., 2014) humic substances increase wheat yield only when combined with inorganic fertilizers. Perhaps the appearance of biological properties of bio humus is influenced by the type of soil of agricultural land.

When assessing the environmental safety of grain, it determined the content of elements, the level of which is controlled by regulatory documents (Medico-biological requirements and Sanitary standards for the quality of food raw materials and food products, 1996). Thus, the introduction of bio humus into the soil of the experimental site contributed to a decrease in the concentration of lead, cadmium, copper and zinc in the resulting products. The greatest impact of the use of biofertilizer had on the level of the most toxic elements (lead, cadmium), the content of which decreased in grain by 14.00 and 16.00% (Table 4). In our opinion, this is the result of reduced mobility of chemical elements in the soil due to change of its reaction medium and their binding by humus components into hardly soluble compounds. Consequently, this fact is reflected in the migration mobility of elements from soil to plants.

**Table 4.** Metal content in spring wheat grain (mg kg<sup>-1</sup>)

Indicator	Permissible level	Control site	± % to PL	Experimental site	± % to PL
Lead	0.5	0.25 ± 0.02	-50.00	0.18 ± 0.01*	-64.00
Cadmium	0.1	0.036 ± 0.002	-64.00	0.020 ± 0.003*	-80.00
Copper	10	5.40 ± 0.21	-46.00	4.50 ± 0.12*	-55.00
Zinc	50	34.66 ± 0.88	-30.68	29.33 ± 1.66*	-41.34

Note: \*  $-p < 0.05$  compared to the control site; PL according to biomedical requirements and sanitary quality standards of food raw materials and food products, 1996.

Research (Moslehi et al., 2019) also confirmed the effectiveness of bio humus application to reduce lead and cadmium concentration in sunflower.

Therefore, the introduction of bio humus helped to reduce the imbalance of microelements in soils of agricultural lands, increase of organic matter, which had a positive impact on the structure of yield of spring wheat and ecological safety of the received grain.

The results of the conducted tests testify to the potential of using bio humus as an element of biologized technologies and means of increasing the yield of wheat. At the same time, an important environmental problem of waste disposal of livestock is solved. At the same time, further research is needed to better assess the potential of bio humus in the soils of the southern forest-steppe.

## CONCLUSIONS

1. Chernozem under the conditions of technogenic influence of emissions of thermal power plants are characterized by low humus content (4.58–4.60%) and weak acid reaction of medium (pH = 6.1–6.5); imbalance between biochemically active (copper, zinc, cobalt) and toxic (lead, cadmium) elements, as confirmed by soil contamination coefficients: for copper (C0 = 1.50–1.58), zinc (C0 = 0.79–0.85), cobalt (C0 = 0.42–0.55).

2. The introduction of bio humus in the arable layer of soil before sowing and during tillering of spring wheat contributes to the increase in humus composition by 1.88 times, the change in acidity to pH = 6.9–7.0, decrease in lead and cadmium concentrations of 1.63 and 1.20 times against the background of an increase in zinc and cobalt at the levels of 15.62% and 7.98%.

3. Bio humus has a positive effect on the value of structural elements of spring wheat yield. Field germination rate of wheat is increased from 75 to 82% at the same values of seed control of seed material (laboratory germination of 90–91%, germination energy 87–88%), as well as the processes of plant growth and development, which determine the increase in the number of developed stalks for harvesting per 1 m<sup>2</sup> by 10.15%, productive tilling capacity by 8.33%, average number of developed spikes per ear by 20.00%, the average number of grains in the ear by 7.69%, the mass of 1,000 grains by 16.12%, the yield of spring wheat increases by 10.2 hwt ha<sup>-1</sup>.

4. Introduction of bio humus in the soil contributes to the reduction in the composition of the spring wheat received grain of lead and cadmium concentration by 14.00 and 16.00%, determining the level of its ecological safety.

## Suggestions for production

Based on the obtained results of scientific and production experiment during 2017–2019, in order to increase soil fertility and spring wheat yield we recommend to introduce aqueous extract of bio humus to the soil before sowing and in the spring phase of grain culture in the dark time of the day calculated as per 10 L/200 L /1 hm<sup>2</sup>.

## REFERENCES

- Ali Mohamed Elyamine, Mohamed, G. Moussa, Marwa A., Ismael, Jia, Wei, Yuanyuan, Zhao, Yupeng, Wu & Chengxiao, Hu. 2018. Earthworms, Rice Straw, and Plant Interactions Change the Connections in Organic Soil and Promote the Decontamination of Cadmium in Soil. *International Journal Environmental Research Public Health* **15**(11), 2398. doi.org/10.3390/ijerph15112398
- Antille, D.L., Peets, S., Galambošová, J., Botta, G.F., Rataj, V., Macak, M., Tullberg, J.N., Chamen, W.C.T., White, D.R., Misiewicz, P.A., Hargreaves, P.R., Bienvenido, J.F. & Godwin, R.J. 2019. Review: Soil compaction and controlled traffic farming in arable and grass cropping systems. *Agronomy Research* **17**(3), 653–682. doi.org/10.15159/AR.19.13
- Baishanova, A.E. & Kedelbaev, B.Sh. 2016. Problems of soil degradation. Analysis of the Current Status of Fertility of Irrigated Soils of the Republic of Kazakhstan. *Scientific Review. Biological Sciences* **2**, 5–13.
- Baldotto, M.A., Rocha, J.E., Andrade, F.D.P., Giũdice, M.P.D. & Baldotto, L.E.B. 2016. The plant stimulant humic acid extracted from organic waste recycled by composting combined with liming and fertilization. *Semina-Ciencias Agrarias* **37**(6), 3955–3963.
- Bernard, L., Chapuis-Lardy, L., Razafimbelo, T., Razafindrakoto, M., Pablo, A.L., Legname, E., Poulain, J., Brũls, T.O., Donohue, M., Brauman, A., Chotte, J.L. & Blanchart, E. 2011. Endogeic earthworms shape bacterial functional communities and affect organic matter mineralization in a tropical soil. *The ISME Journal* **6**(1), 213–222. doi.org/10.1038/ismej.2011.87
- Conselvan, G.B., Pizzeghello, D., Francioso, O., Foggia, M.D., Nardi, S. & Carletti, P. 2017. Biostimulant activity of humic substances extracted from leonardites. *Plant and Soil* **420**(1–2), 119–134.
- Devi, J., Deb, U., Barman, S., Das, S., Sundar Bhattacharya, S., Fai Tsang, Y., Lee, J.H. & Kim, K.H. 2020. Appraisal of lignocellulosic biomass degrading potential of three earthworm species using vermireactor mediated with spent mushroom substrate: Compost quality, crystallinity, and microbial community structural analysis. *Sci. Total Environ* **716**, 135215. doi: 10.1016/j.scitotenv
- Doan, T.T., Henry-des-Tureaux, T., Rumpel, C., Janeau, J.L. & Jouquet, P. 2015. Impact of compost, vermicompost and biochar on soil fertility, maize yield and soil erosion in Northern Vietnam: a three year mesocosm experiment. *Sci. Total Environ* **514**, 147–154. doi: 10.1016/j.scitotenv.2015.02.005
- Dogra, N., Sharma, M., Sharma, A., Keshavarzi, A., Minakshi, Bhardwaj, R., Thukral, A.K. & Kumar, V. 2019. Pollution assessment and spatial distribution of roadside agricultural soils: a case study from India. *International Journal Environmental Health* **20**, 1–14. doi: 10.1080/09603123
- E, S.Z., Yang, Z.Q., Zeng, X.B., Wang, Y.N., Luo, Z.X., Yuan, J.H., Che, Z.X. & Guo, Y.J. 2017. Effects of Long-Term Fertilization on Nitrogen Fertilizer Use Efficiency in Loessial Soil Region on the Loess Plateau, Northwest China. *Ying Yong Sheng Tai Xue Bao* **28**(1), 151–158. doi: 10.13287/j.1001-9332.201701.011

- GN 2.1.7.2041-06. 2006. Maximum permissible concentrations (MPC) of chemicals in soil. Moscow: Federal Center of Hygiene and Epidemiology of Russian Agency for Health and Consumer Rights, 3 pp.
- Gong, X., Li, S., Carson, M.A., Chang, S.X., Wu, Q., Wang, L., An, Z. & Sun, X.J. 2019. Spent mushroom substrate and cattle manure amendments enhance the transformation of garden waste into vermicomposts using the earthworm *Eisenia fetida*. *Environ Manage* **248**, 109263. doi: 10.1016/j.jenvman
- GOST 13586.3-83, 2001. Grain. Acceptance rules and sampling methods. Moscow: IEC Publishing House of Standards, 2001. 5 pp.
- GOST 26929-94 Raw materials and food products. Sample preparation. Mineralization to determine the content of toxic elements. Moscow: Publishing House of Standards, 1996. 122 pp.
- Huang, X., Hu, J., Qin, F., Quan, W., Cao, R., Fan, M. & Wu, X. 2017. Heavy Metal Pollution and Ecological Assessment around the Jinsha Coal-Fired Power Plant (China). *International Journal Environmental Research and Public Health* **14**(12), 1589 (doi.org/10.3390/ijerph14121589)
- Kolesnikova, Y.R. 2012. Influence of agroecological factors on the productivity of spring soft wheat and the development of diseases pathogens in the conditions of the northwest of the Russian Federation: author's abstract of dissertation... Candidate of Agricultural Sciences: 06.01.01; 06.01.07. Saint Petersburg: Saint Petersburg State University, pp. 23
- Kuznetsov, A.V., Fesyun, A.P., Samokhvalov, S.G. & Makhonko, E.P. 1992. Methodical instructions for determination of heavy metals in soils of farmland and crop production (ed. 2, revised and enlarged). Moscow: *Central Research Institute of Agricultural Service* 64 pp.
- Lim, S.L., Wu, T.Y., Lim, P.N. & Shak, K.P. 2015. The use of vermicompost in organic farming: overview, effects on soil and economics. *J Sci Food Agric* **95**(6), 1143–1156. doi: 10.1002/jsfa.6849)
- Manzoor, A., Khattak, R.A. & Dost, M. 2014. Humic acid and micronutrient effects on wheat yield and nutrients uptake in salt affected soils. *International Journal of Agriculture and Biology* **16**(5), 991–995.
- Marenych, M.M., Hanhur, V.V., Len, O.I., Hangur, Yu.M., Zhornyk, I.I. & Kalinichenko, A.V. 2019. The efficiency of humic growth stimulators in pre-sowing seed treatment and foliar additional fertilizing of sown areas of grain and industrial crops. *Agronomy Research* **17**(1), 194–205. doi.org/10.15159/AR.19.023
- Medical and biological requirements and sanitary standards of quality of food raw materials and food products. Moscow: Publishing House of Standards, 1996, 182 pp.
- Moslehi, A., Feizian, M., Higuera, P. & Eivand, H.R. 2019. Assessment of EDDS and Vermicompost for the Phytoextraction of Cd and Pb by Sunflower (*Helianthus Annuus* L.). *Int J Phytoremediation* **21**(3), 91–199. doi: 10.1080/15226514.2018.1501336
- Naumkin, A.V., Khlopyanikov, A.M., Khlopyanikova, G.V., Stebakov, V.A. & Lopachev, N.A. 2013. Optimization of cultivation technologies of field crops in the conditions of the Central Chernozem region. *Bulletin of the Kursk state agricultural academy* **7**, 31–33.
- Pylnev, V.V. 2016. Practical course on breeding and seed production of field crops. Saint Petersburg: *Publishing House Lan*, 448 pp.
- Rai, P.K., Lee, S.S., Zhang, M., Tsang, Y.F. & Kim, K.H. 2019. Heavy metals in food crops: Health risks, fate, mechanisms, and management. *Environ Int* **125**, 365–385. doi: 10.1016/j.envint
- Rékási, M., Mazsu, N., Draskovits, E., Bernhardt, B., Szabó, A., Rivier, P.A., Farkas, C., Borsányi, B., Pirkó, B., Molnár, S., Kátay, G. & Uzinger, N. 2019. Comparing the agrochemical properties of compost and vermicomposts produced from municipal sewage sludge digestate. *Bioresour Technol* **291**, 1218–1261. doi: 10.1016/j.biortech



- Sarma, B., Farooq, M., Gogoi, N., Borkotoki, I., Katak, R. & Garg, A. 2018. Soil organic carbon dynamics in wheat - Green gram crop rotation amended with vermicompost and biochar in combination with inorganic fertilizers: A comparative study. *Journal of Cleaner Production* **201**, 471–480. doi.org/10.1016/j.jclepro.2018.08.004
- Sartaj, Ahmad Bhat, Sharanpreet, Singh, Jaswinder, Singh, Sunil, Kumar, Bhawana, & Adarsh, Pal Vig. 2018. Bioremediation and Detoxification of Industrial Wastes by Earthworms: Vermicompost as Powerful Crop Nutrient in Sustainable Agriculture. *Bioresour Technol* **252**, 172–179. doi: 10.1016/j.biortech.2018.01.003
- Schossler, T.R., Marchão, R.L., Santos, L.D., Santos, D.P., Nóbrega, J.C.A. & Santos, G.G. 2018. Soil Physical Quality in Agricultural Systems on the Cerrado of Piauí State, Brazil. *Acad Bras Cienc* **90**(4), 3975–3989. doi: 10.1590/0001-3765201820180681
- Strachel, R., Wyszowska, J. & Baćmaga, M. 2017. The Role of Compost in Stabilizing the Microbiological and Biochemical Properties of Zinc-Stressed Soil. *Water Air Soil Pollution* **228**(9), 349. doi: 10.1007/s11270-017-3539-6
- Trentin, E., Facco, D.B., Hammerschmitt, R.K., Avelar Ferreira, P.A., Morsch, L., Belles, S.W., Ricachenevsky, F.K., Nicoloso, F.T., Ceretta, C.A., Tiecher, T.L., Tarouco, C.P., Pasquetti Berghetti, Á.L., Toselli, M., Brunetto, G. 2019. Potential of Vermicompost and Limestone in Reducing Copper Toxicity in Young Grapevines Grown in Cu-contaminated Vineyard Soil. *Chemosphere* **226**, 421–430. doi: 10.1016/j.chemosphere.2019.03.141
- Vitkovskaya, S.E. & Hoffman O.V. 2013. Assessment of ecological state of agro-ecosystems (on the example of field experience). *Bulletin of St. Petersburg State University* **3**(1), 102–112.
- Vodyanitsky, Yu.N. 2011. On dangerous heavy metals/metalloids in soils. *Bulletin of Soil Institute named after V.V. Dokuchaev* **68**, 56–82.
- Zhang, S.T., Song, X.N., Li, N., Zhang, K., Liu, G.S., Li, X.D., Wang, Z.Z., He, X.B., Wang, G.F. & Shao, H.F. 2017. Influence of high-carbon basal fertiliser on the structure and composition of a soil microbial community under tobacco cultivation. *Res. Microbiol.* **169**(2), 115–126. doi: 1016/j.resmic.2017.10.004
- Zhao, S., Chen, X., Deng, S., Dong, X., Song, A., Yao, J., Fang, W. & Chen, F. 2016 The Effects of Fungicide, Soil Fumigant, Bio-Organic Fertilizer and Their Combined Application on Chrysanthemum Fusarium Controlling Wilt, Soil Enzyme Activities and Microbial Properties. *Molecules* **21**(4), 526. doi.org/10.3390/molecules21040526
- Zharova, T.F. 2016. Effect of crop rotation on soil fertility and yield of spring wheat in the forest-steppe zone of the Republic of Tyva.// *Agrarian Science of Euro-North-East* **5** (54), pp. 48–52.
- Zybalov, V.S. & Popkova, M.A. 2018. Influence of heavy metals on agrochemical indicators of soils of the Southern Urals. *Bulletin of South Ural State University. Series: Chemistry* **10**(2), 33–40. doi:10.14529/chem180204

## **Potato plant growth acceleration and yield increase after treatment with an amino acid growth stimulant**

S.V. Murashev<sup>1</sup>, S.D. Kiru<sup>2,\*</sup>, V.G. Verzhuk<sup>3</sup> and A.V. Pavlov<sup>3</sup>

<sup>1</sup>ITMO University, Faculty of Food Biotechnologies and Engineering, Lomonosova street 9, RU191002 St. Petersburg, Russia

<sup>2</sup>Saint-Petersburg Agrarian University, Faculty of Agrotechnologies, soil science and ecology, Department of Plant Production named I.A. Stebut, Peterburgskoe highway 2, RU196601 Saint-Petersburg, Russia

<sup>3</sup>N.I. Vavilov All-Russian Institute of Plant Genetic Resources (VIR), Bolshaya Morskaya street 42–44, RU190000 St. Petersburg, Russian Federation

\*Correspondence: s.kiru53@mail.ru

**Abstract.** An increase in the productivity of potato plants and natural resistance of tubers to external influences during growth, while preserving the qualitatively new properties of tubers in the process of low-temperature preservation, can be achieved through the effect of bioactive compounds on the metabolism of potato plants in our work, we used a regulator derived from the hydrolysis of natural collagen down to low molecular weight fractions and pure glycine. The evidence of its effectiveness is based on shortening the growing season and increasing plant productivity as well as the content of bioactive and nutrient compounds in their storage organs, reducing losses during low-temperature preservation caused by natural biological processes, physiological diseases and damage by microorganisms. The paper deals with issues related to the growth and development of potato plants and their storage organs until the growing season is over and a possible increase of potato productivity after the planting material was treated with an amino acid growth regulator.

**Key words:** glycine, potato, tubers, dormancy breaking, phenological phases, yield.

### **INTRODUCTION**

Different growth stimulants are widely used in agriculture to increase crop yields (Marenych et al., 2019, Mazur et al., 2019). There are many different studies indicating the effect on potato yield and quality of various methods of treating potato seed tubers by different stimulating factors before planting. Different methods are used for breaking potato tuber dormancy. Physical methods of impact (temperature, electric current), chemical treatment, and biochemical methods based on the use of phytohormones are being actively studied. So, in the studies of Kocacaliskan et al. (1989), Deligios et al. (2017), Haider et al. (2019) proved the effectiveness of applying electric current to disturb the dormancy of potato tubers. V. Ereemeev et al. (2008 and 2012) successfully used thermal shock for tuber dormancy breaking. The use of GA<sub>3</sub> contributes to an increase in tuber yield (Bruinsma et al 1967; Salimi et al., 2010; Virtanen et al., 2013;

Gemeda et al., 2017). However, a negative effect of GA<sub>3</sub> on the development of sprouts and plants after such GA<sub>3</sub> artificial termination method has been proven by Bruinsma et al. (1967). Thiourea terminates the dormancy of tubers in potato cultivars with weak dormancy or in which the dormancy period ends (Struik & Wiersema 1999). Various sources of scientific literature have shown that thiourea acts as a catalase inhibitor and leads to an increase in the concentration of hydrogen peroxide, which plays an important role in the mechanism of interruption of tuber dormancy (Mani et al., 2013). Its application terminates the dormancy of tubers and enhances their germination on potato tubers. The most effective for disturbing the dormant period and increasing the number of sprouted micro-tubers is a method when they are treated with 250 mM of thiourea and 60 mM of hydrogen peroxide. Both of these substances affect the hormonal regulation and antioxidant effect of enzymes, which leads to dormancy in tubers (Virtanen et al., 2013; Gemeda et al., 2017). In addition, it was proved that the treatment with thiourea accelerates the emergence of seedlings, and has a positive effect on the number and height of stems, as well as on the yield of tubers (Suttle, 2008; Hosseini et al., 2011; Germchi et al., 2011; Mani et al., 2013). The feasibility of effective use of bromoethane for tuber dormancy breaking has been proved by W. Coleman (1982).

In order to increase the effectiveness of the effect of artificial dormancy of tubers on plant development and, accordingly, to increase the potato yield, many researchers have proved the advantage of combining several agents simultaneously. W. Coleman (1987), as well as R. Fazal et al. (2001) and L. Secretaria et al. (2018), used several chemicals and growth regulators in experiments to disturb dormancy of potato tubers, as well as to verify their subsequent exposure on the productivity in greenhouse conditions. Rindit-treated tubers showed the highest germination rate among all varieties. Thiourea-treated tubers caused the highest number of germinated sprouts compared to all other treatments. A comparison of two dormancy methods was carried out by Wróbel et al (2017), using aqueous solution of GA<sub>3</sub> and kinetin (standard 1) as well as aqueous solution of GA<sub>3</sub>, thiourea and daminoside (standard 2) with the method based on ethanol. They also tested the effect of ethanol alone or in combination with GA<sub>3</sub> and / or kinetin on dormancy and the germination of potato tubers. They showed that the use of an aqueous solution of gibberellic acid (GA<sub>3</sub>) and kinetin (standard 2) is the most effective method for to disturbance of dormancy and stimulation of growth of sprouts. Experiments have shown that the use of a standard 2 - aqueous solution of GA<sub>3</sub>, thiourea and daminoside is the most effective approach to overcome dormancy, especially for varieties with a long dormant period. W. Coleman, (1998) reported the high efficiency of the use of carbon dioxide, oxygen and ethylene for breaking the dormancy of tubers and increasing the rate of germination.

The effect of amino acid treatment with collagen hydrolysate on the biochemical processes occurring in potato plants is expressed in the accumulation of bioactive and nutrient compounds in the storing organs of plants and in the acquisition of increased natural resistance to stresses required for longer low-temperature preservation in the process of growth and development. Such influence can be achieved only through the impact on intracellular metabolism. The mechanism of glycine's effect on plant development is described in detail in a number of publications (Murashev et al., 2009; Kolomicheva & Murashev, 2011; Murashev et al., 2011). They discuss the development of plants, the characteristics of plant products that are developed under the effect of glycine, and the protective mechanisms acquired by a plant's storage organs.

The biochemical features of storage organs in plants and their permanently functioning protective mechanisms, enabling longer low-temperature preservation with retained consumer qualities, nutritional and biological value, are formed under the effect of the treatment with a plant growth regulator. In view of this, it is necessary to consider the processes developing in the planting material immediately after processing in collagen hydrolysate water solution as well as during the formation of tubers, while simultaneously observing the development of the above-ground parts of potato plants and their development phases. So, the purpose of this work is to consider issues related to the changes occurring in potato seed material when it is treated with a growth regulator and during the formation of storage organs in potato plants, including the problem of yield, as well as the formation of potato plants themselves in the context of improving quality indicators of raw plant produce.

## **MATERIALS AND METHODS**

The influence of the growth regulator obtained by collagen hydrolysis on plant development and the formation of productive parts of plants was studied on the Nevsky and Izora potato varieties for five years (2014–2019). The studies were carried out in triplicate, with the calculation of the standard deviation during mathematical processing of the reliability of the data (Dospekhov, B.A., 2012). Potato tubers were treated in an aqueous solution of collagen hydrolyzate for 10 min by completely immersing them in solution. The control was tubers of the same grade and quantity treated with water containing no drug. After processing, the tubers immediately planted the earth. The work presents the results of experiments obtained when processing potatoes with an effective concentration at which the results of the action on plant development and tuber formation achieve the maximum effect (Bolshakov, 1999).

To study the effect of the growth regulator on the growth processes of tubers, the seed tubers of cv. Nevsky was soaked in aqueous solutions of collagen hydrolyzate with various concentrations, then dried and stored for 10 days at a temperature of 12 ... 14 °C. The control was tubers of the same variety, treated only with water that did not contain the drug, and stored similarly as experimental ones. After 10 days, the change in the chemical composition (on the content of solids, monosaccharides, sucrose, starch, ascorbic acid), the enzymatic activity (on the activity of catalase) and the darkening (enzymatic and chemical) in the experiment and control were evaluated.

During the growing season of potato plants and after harvesting, the chemical composition, enzymatic activity and darkening were determined in the experimental and control versions of tubers. By visual observation, the effect of collagen hydrolyzate on the rate of passage of the growth phases of the experimental and control plants of the Nevsky and Izora varieties was determined. When assessing the effect of collagen hydrolyzate on the yield of Nevsky and Izora varieties, the average weight of tubers from one bush for each of the varieties was determined, depending on the treatment.

The biochemical and physico-chemical studies of potato tubers were carried out according to the following methods given by A. Ermakov (Ermakov, 1988): the starch content in potatoes was determined by the polarimetric method; the content of mono- and disaccharides was determined by the cyanide method ; the level of enzymatic and chemical darkening was determined by the photolorimetric method; catalase activity was determined by permanganometric method; ascorbic acid was determined by titration

with Tilmans paint; determination of the activity of hydrolytic enzymes ( $\alpha$  and  $\beta$ -amylases) was carried out by the colorimetric method; the content of water and solids was determined by drying the sample to constant weight.

## RESULTS AND DISCUSSION

It is known that the nutrients of potato tubers are a source of plastic material and energy during plant germination. Potato tubers grown from seed material that has undergone pre-treatment with an amino acid growth regulator acquire a higher nutritional and biological value, as well as the ability to be stored for a longer time. Results of a study of the effect of treatment with an amino acid growth regulator on maternal potato tubers Nevsky are presented in Tables 1 and 2.

**Table 1.** The effect of collagen hydrolysate on the changes in the chemical composition of seed potato tubers of cv. 'Nevsky'

Components of chemical composition, g per (100 g, wet weight)	Control	Experiment
Dry matter, %	20.0 $\pm$ 0.01	19.8 $\pm$ 0.01
Total sugar (monosaccharides + sucrose)	1.14 $\pm$ 0.05	1.26 $\pm$ 0.05
Monosaccharides	1.00 $\pm$ 0.05	1.04 $\pm$ 0.05
Sucrose	0.140 $\pm$ 0.01	0.220 $\pm$ 0.02
Starch	9.02 $\pm$ 0.4	8.82 $\pm$ 0.4
Browning, absorbance units		
total	0.056 $\pm$ 0.005	0.068 $\pm$ 0.005
enzymatic	0.025 $\pm$ 0.003	0.031 $\pm$ 0.003
chemical	0.031 $\pm$ 0.003	0.037 $\pm$ 0.003
Catalaze (CA) activity, mg H <sub>2</sub> O <sub>2</sub> g <sup>-1</sup>	0.030 $\pm$ 0.005	0.038 $\pm$ 0.005
Vitamin C, mg per (100g, wet weight)	15.4 $\pm$ 1	14.0 $\pm$ 1

**Table 2.** The effect of collagen hydrolysate on the changed in the chemical composition of seed potato tubers, cv. 'Nevsky' calculated on a dry weight basis

Components of chemical composition, g per (100 g, dry weight)	Control	Experiment
Dry matter, %	20.0 $\pm$ 0.01	19.8 $\pm$ 0.01
Total sugar (monosaccharides + sucrose)	5.69 $\pm$ 0.3	6.38 $\pm$ 0.3
Monosaccharides	4.99 $\pm$ 0.3	5.26 $\pm$ 0.3
Sucrose	0.699 $\pm$ 0.05	1.11 $\pm$ 0.1
Starch	45.0 $\pm$ 1	44.6 $\pm$ 1
Vitamin C, mg per (100 g, dry weight)	61.5 $\pm$ 4	56.9 $\pm$ 4

From an analysis of the results, presented in Tables 1 and 2, it follows that the treatment of seed with a collagen hydrolyzate activates hydrolytic processes in tubers. This is indicated by a decrease in starch content and an intensive accumulation of mono- and disaccharides in seed tubers. The total content of low molecular weight carbohydrates, represented by the sum of monosaccharides and sucrose, in comparison with the control increases by 10.5%, mainly as a result of an increase in the sucrose content in the tubers processed.

The reason for these changes is the action of endogenous auxin, the synthesis of which in tubers is enhanced as a result of treatment with a growth stimulator. It is known that under the action of auxin, hydrolytic enzymes are activated (Kuznetsov &

Dmitrieva, 2005), which leads to a more intensive conversion of starch and other spare substances in germinating potato tubers into well-soluble and easily transported substances that quickly reach the growth points.

In addition, another direction of action of auxin is to increase the intensity of respiration (Medvedev, 2004). Therefore, the increase in glucose in stimulated tubers is not as significant as sucrose due to its immediate use as a substrate for respiration. This is also indicated by a decrease in the solids content in stimulated tubers. Therefore, glucose in experimental tubers is more involved in the respiration process during which ATP synthesis occurs, without which the implementation of energy-dependent processes of germination of potato tubers is impossible.

Thus, endogenous auxin accelerates the germination of potato seed tubers due to activation of hydrolytic enzymes and respiratory enhancement (Medvedev & Sharova, 2014). During which glucose is consumed and ATP (adenosine triphosphoric acid) is synthesized to realize energy-dependent growth processes. The accelerated decomposition of reserve nutrients, which occurs under the influence of amino acid treatment, creates the necessary conditions for their rapid involvement in plant growth processes and the beginning of the formation of healthy plant materials capable of long-term refrigerated storage.

There are two types of darkening - enzymatic and non-enzymatic (chemical) (Burton, 1985; Flaumenbaum et al., 1986). Processing potato seed tubers with a growth regulator increases both enzymatic and chemical browning in tubers. The reason for the increase in non-enzymatic browning of tubers is the activation of starch hydrolysis and the accumulation of glucose, which is capable of non-enzymatic glycosylation.

The treatment of tubers reduced the vitamin C content of tubers by 9.4% compared with the control. This is due to the activation of metabolic and redox processes in the seed material. This is also indicated by the activation of catalase, the induction of which occurs with an increase in the content of reactive oxygen species (ROS - reactive oxygen species). This fully applies to the increase in the content of hydrogen peroxide during oxidation-reduction processes occurring in potato tubers under the influence of the growth regulator, which catalase breaks down (Sharova, 2016).

As follows from the data in Tables 1 and 2, in the mother tubers, catalase is activated under the influence of treatment with the growth regulator. The active state of catalase prevents the formation and accumulation of ROS in cells, which slows down the development of free radical oxidative processes in plant tissues (Sharova, 2016). Thus, DNA molecules are protected from damage, which ensures the normal development of plants. Violations of DNA molecules resulting from oxidation are considered as the main cause of developmental abnormalities and accelerated aging of living organisms. The active state of catalase is a characteristic feature that the modified plant material acquires under the influence of collagen hydrolyzate treatment. Catalase activation is consistent with the theoretical model of the action of an amino acid preparation on developing plants and continues to persist during the cold storage of plant generative organs (Murashev et al., 2014; Murashev, 2015 and 2016)

The effect of processing potato seed material with collagen hydrolyzate on the quality of potato storage organs has been investigated during plant vegetation. For this purpose, the composition of the experimental and control tubers of the Nevsky variety was analyzed in the middle of the growing season (the second half of July is 55 days after planting). The research results are presented in Table 3. From the presented data it

follows that in the emerging tubers of experimental potatoes, the solids content increased by about 20%; the content of starch, sucrose and monosaccharides became significantly higher - by 50.1%, 93.8% and 164%, respectively; the vitamin C content in the experimental tubers is also 5.70% higher. Consequently, the action of the growth stimulator positively affects the vegetation of plants and the accumulation of bioactive and nutrients in storage parts. This is possible due to a fuller use of solar energy during photosynthesis of experimental plants under the influence of auxin (Kuznetsov & Dmitrieva, 2005).

In addition, studies were carried out on the chemical composition of tubers of experimental and control Nevsky potatoes after harvesting at the end of August (90 days after planting), which are shown in Table 3. It is interesting to compare the analysis results not only between the control and experimental potato varieties obtained in the end of the potato growing season, but also obtained in the middle of the growing season. By the time of harvesting in the tubers of the control and experimental potatoes, there was a significant increase in the dry matter content in the control, compared with the middle of the growing season. Therefore, the control potato is much closer to the experimental option for the solids content; and the excess solids content in the experimental tubers compared with the control potato tubers is only 1.20%.

**Table 3.** The effect of collagen hydrolysate treatment on the chemical composition of the emerging potato tubers of cv. ‘Nevsky’ in the process of growth and after harvesting, calculated on a wet weight basis

Components of chemical composition,	In the process of tuber growth		In freshly harvested tubers	
	Reference	Experiment	Reference	Experiment
G per (100 g, wet weight)	Reference	Experiment	Reference	Experiment
Dry matter, %	14.8 ± 0.01	17.8 ± 0.01	21.5 ± 0.01	22.7 ± 0.01
Total sugar (monosaccharides + sucrose)	0.820 ± 0.05	1.26 ± 0.08	0.730 ± 0.05	0.70 ± 0.05
Monosaccharides	0.560 ± 0.03	0.950 ± 0.06	0.310 ± 0.05	0.320 ± 0.05
Sucrose	0.260 ± 0.02	0.310 ± 0.02	0.420 ± 0.03	0.400 ± 0.03
Starch	5.21 ± 0.3	7.82 ± 0.5	13.0 ± 0.7	15.2 ± 0.8
Vitamin C, mg per (100 g, wet weight)	13.3 ± 1	14.1 ± 1	27.2 ± 2	35.0 ± 3
Browning, absorbance units				
total	0.022 ± 0.002	0.030 ± 0.002	0.021 ± 0.002	0.04 ± 0.003
enzymatic	0.017 ± 0.001	0.021 ± 0.001	0.018 ± 0.001	0.00 ± 0.00
chemical	0.005 ± 0.001	0.009 ± 0.001	0.003 ± 0.001	0.04 ± 0.003

On total sugar content (monosaccharides + sucrose), the control and experimental potato varieties also almost leveled at the time of harvesting, but only in this case there was a significant decrease in the total sugar content in both potato varieties compared to the middle of the growing season. Moreover, in the experimental samples of potatoes, this decrease was more significant. Therefore, in experimental potato tubers, the total sugar content was slightly lower than in control potatoes - by 0.2%. At the same time, the dynamics of changes in the content of individual monosaccharides and sucrose in the tubers of both potato varieties is very interesting as they approach the end of the growing season.

The sucrose content in both potato varieties after harvesting increased, comparing with middle of the growing season, and the monosaccharide content decreased. Moreover, the decrease in the content of monosaccharides in both potato varieties occurred by a more significant value than the increase in sucrose content. If we consider the results of the control and experimental variants separately, then in the experimental potato the monosaccharide content decreased by a more significant amount than the sucrose content compared with changes in the tubers of the control potato. During the harvesting period, the monosaccharide content in the tubers of the potato treated with collagen hydrolyzate was only slightly (by 0.010%) higher than their content in the control potato tubers. The sucrose content in the tubers of the processed potato after harvesting turned out to be less than in the tubers of the control potato by 0.020%. A change in the content of monosaccharides in potato tubers is associated with a change in the dynamics of non-enzymatic browning of potato.

On starch content, the control variant approached the experimental one by the end of the growing season, nevertheless, this difference continued to remain significant and amounted to 2.20% compared with 2.61% in the middle of the growing season. Thus, the carbohydrate system, due to the processing of collagen hydrolyzate in experimental potatoes, prevailed over the control in terms of the most important indicator - starch content.

Along with the starch content, there is one more indicator according to which the experimental version of potato significantly exceeded the control one - this is the content of vitamin C. The tubers of the experimental potato at the end of the growing season contained 17.3% more starch, and in terms of vitamin C content they exceeded the control version by 28, 9 %. The increased content of vitamin C in the experimental plant products is a common pattern that arises under the influence of the processing of seed material with an amino acid solution (Kuznetsov & Dmitrieva, 2005). It indicates a large recovery potential that appears as a result of optimization of metabolic processes in cells.

During the growing season, significant changes occur in the values of the levels of darkening, both general and enzymatic and chemical. As follows from the data of Table 3 in the middle of the growing season, the experimental potato tubers significantly exceeded the control in all indicators of browning. At the end of the growing season, the situation changed to the opposite. The total and enzymatic browning in the potato treated with the growth regulator became much less than in the control.

Only by chemical darkening, the processed potatoes at the time of harvesting slightly continued to exceed the control variant. This is probably due, although with an insignificant, but higher content of monosaccharides in the experimental version compared to control tubers. The decrease in the level of chemical darkening of the experimental potato occurred during the growing season more significantly, in comparison with the control. If at the end of the growing season both varieties of potatoes did not differ much in chemical darkening, then during the growing season the experimental variant exceeded the control one in this indicator. The reason for this may be the equalization of the content of low molecular weight forms of carbohydrates in both variants as the potatoes ripen. In the experimental version, as the ripening, both the content of monosaccharides and the level of chemical darkening decreased. The chemical darkening accounts for an average of only 15% of the total level of darkening. According to Table 3, this ratio between chemical and enzymatic darkening is satisfied.



Since the bulk of the darkening is due to enzymatic darkening, it needs to be considered in more detail.

As mentioned earlier, both potato varieties, control and experimental, during the growing season, but even more at the time of harvesting, differ in the level of enzymatic darkening of tubers. The enzymatic component of the browning process directly depends on the activity of the polyphenol oxidase enzyme (Medvedev, 2004). This enzyme is activated by damage to plant organisms. Therefore, it is especially active in freshly harvested potatoes due to its participation in the healing of injuries received by tubers during harvesting (Polevoy, 1989). At the time of ripening of tubers in the control potato, the level of enzymatic browning is increasing, while in the potato treated with the growth regulator, enzymatic browning exceeds this the indicator of control potatoes during the growing season and then sharply decreases by the time of harvesting.

The low activity of polyphenol oxidase is a characteristic feature of plant products grown using the amino acid growth regulator (Murashev et al., 2013, 2014; Murashev, 2016). The low activity of polyphenol oxidase promotes the accumulation of phenolic compounds that perform various protective functions in plant tissues. They take part in the formation of lignin, and many phenols are inhibitors of IAA oxidase (Kuznetsov & Dmitrieva, 2005), which contributes to the accumulation of indolylacetic acid. Changes in the hormonal status of plants affect the characteristics of the relationship between the host and the parasite. Given that experimental potatoes are more resistant to phytopathogens, a change in hormonal status has a significant effect.

On the other side, with high activity of polyphenol oxidases, quinones formed from phenols, which are active and nonspecific oxidizing agents, can disrupt the normal functioning of cells (Polevoy, 1989). The phenolic metabolism activated in this case requires significant energy expenditures and the consumption of nutrients for respiration. This situation occurs in the control, not processed potatoes. Processed potatoes have the ability to intensively form the wound periderm (Murashev, 2015). This ability probably compensates for the absence of the need to activate the protective system (polyphenol oxidase + phenols), which actively functions in the control potato in order to prevent infection through epidermal ruptures during the injury of tubers.

The effect of treatment with an amino acid growth stimulator was also reflected in the tuber ripening. This parameter is determined by the ratio of starch / sugar and sucrose / monosaccharides, the higher these ratios, the higher the degree of maturity and the better the ability to store potatoes. According to the results in Table 3, it follows that the ratio of sucrose / monosaccharides for both potato varieties during harvesting was equal to 1.30, and the ratio of starch / sugar was more favorable for experimental potatoes, for which it was 20.5. For control, this ratio turned out to be less - 17.7.

In cultivated potato the tuberization occurs at any length of daylight hours, however, a reduction in the duration of daylight hours, as well as lower temperatures at night, inhibiting vegetation, stimulate tuberization. In addition, the ability to form tubers depends on the stage of development of potato plants; it appears only when the plants come into maturity and this is due to a change in the hormonal background of plants (Medvedev 2004; Medvedev & Sharova, 2014). The ability to tuberization, as already mentioned, depends on the hormonal background, namely: on the ratio of auxins and cytokinins. Their ratio is affected by the length of the day, the reduction in daylight changes the ratio between auxins and cytokinins in favor of the latter. As aging in plant organisms increases the activity of IAA oxidase, as well as other oxidative enzymes.

IAA oxidase oxidizes auxin; as a result, the auxin content in plant tissues decreases with aging (Kuznetsov & Dmitrieva, 2005).

Tuberization is promoted by the reduced activity of oxidative enzymes such as polyphenol oxidase and peroxidase (Medvedev & Sharova, 2014). This may be due to several reasons. First of all, one should pay attention to the fact that the oxidation pathways catalyzed by non-mitochondrial oxidases (polyphenol oxidase, ascorbate oxidase) are not associated with the synthesis of ATP (Medvedev, 2004), which ensures the occurrence of all energy-dependent processes, including the need for accelerated plant development and intense tuber formation.

The formation of tubers requires a high content of low molecular weight carbohydrates. While in the ripened tubers the amount of low molecular weight carbohydrates (glucose + sucrose) decreases and the starch content increases (Kuznetsov & Dmitrieva, 2005). This is what is observed in practice mainly for experimental variant.

Thus, a whiter, higher degree of maturation is established for experimental potatoes. A high degree of maturity of storage organs of plants suggests a higher rate of their development during the growing season. The rate of passage of growth phases by potato plants is characterized by the duration of the interphase ‘sprouting period – budding’, presented in Table 4.

According to the data given in Table 4, the experimental plants passed the growth and development phases at an accelerated pace, as a result of which the ripening time of the crop is reduced by an average of 5–10 days. Such a reduction is very significant for the northern regions with a short and unstable warm summer period suitable for crop production in open ground. The reduction in ripening time is the result of achieving the optimal ratio between the metabolic pathways of the conversion of substances in plant tissues, as a result of which the plastic material and plant hormones that control plant growth are synthesized in quantities necessary for accelerated growth and biomass accumulation.

The attractive effect of phytohormones, which affect the flow of nutrients to the storage organs of plants, accelerates their formation and is reflected in an increase in potato productivity. The effect of collagen hydrolysate on the productivity of potato plants is shown in Table 5.

**Table 4.** The effect of collagen hydrolysate on the passage speed of growth phases in potato plants of cvs. ‘Nevsky’ and ‘Izora’ for two years of observations

Potato cultivar	Treatment version	Mean duration of the sprouting-budding interphase period, days	
		1st year	2nd year
Izora	Reference	20	17
Izora	Experiment	16	14
Nevsky	Reference	26	19
Nevsky	Experiment	22	16

**Table 5.** The effect of collagen hydrolysate on potato yield of cvs. ‘Nevsky’ and ‘Izora’ for two years of observations

Potato cultivar	Treatment version	Mean weight of potato tubers per plant, g,	
		1st year	2nd year
Izora	Control	260.6	417.4
Izora	Experiment	287.8	769.0
Nevsky	Control	357.7	1,078.0
Nevsky	Experiment	385.1	1479.0

In terms of yield of potato plants, the experimental potatoes of the Nevsky and Izora varieties in the first year of testing did not significantly exceed the control. However, during the second year of testing, the average tuber yield as a result of processing increased by almost 1.5 times. Statistical processing of the values of the mass of tubers from one bush of a 2-year crop showed the reliability of such a significant increase. In the following years of testing, the experimental version also exceeded the yield control, which is a manifestation of the general trend. It is possible that weather and climatic conditions for growing potatoes are superimposed on the preparation. Nevertheless, despite the fluctuations in weather conditions, treatment with an amino acid stimulator demonstrates a steady increase in plant productivity.

The accelerated development of plants is due to the fact that IAA actively affects the phases of cell growth. This hormone stimulates cell stretching and provides accelerated formation of the stem of development. This is due to the fact that IAA causes an influx of water into the cells. The flow of water into the cells lowers the viscosity of the cytoplasm, which causes an increase in the rate of chemical reactions that occur in them. In addition, auxin significantly changes the intensity of energy processes in plants. Under its influence, the intensity of photosynthesis increases and respiration increases. The conjugation of oxidation and phosphorylation increases (Medvedev & Sharova, 2014), which leads to a more efficient use of the respiratory substrate for ATP synthesis. An increase in the conjugation of oxidation and phosphorylation also reduces the release of physiological heat in plants without performing useful work on the implementation of energy-dependent processes.

It should be noted that the plant material obtained using the growth regulator is not only larger, but also more attractive in appearance, since it is less susceptible to phytopathological influences. So, for example, sugar beet root crops grown using collagen hydrolyzate were less affected by scab and necrosis (Sapronov et al., 2002; Sapronov et al., 2005). In addition, plant products obtained using collagen hydrolyzate are characterized by a more perfect form, characteristic for this type of plant products. The protective properties of root crops are enhanced even more when pure glycine is used as a growth regulator.

Thus, the experimental data confirm the provisions presented earlier about the mechanism of the effect provided by a glycine-containing amino acid preparation on the changes in maternal potato tubers, during the growth of potato plants and formation of their storage organs. This effect supposes changes in metabolic and energy flows within cells for acceleration of synthetic processes in plant organisms.

## CONCLUSIONS

A treatment of potato seed tubers with a water solution of the amino acid preparation made from hydrolyzed collagen and having an increased content of glycine accelerates disintegration of starch in maternal tubers with mono- and disaccharides being formed. The content of low molecular weight carbohydrates increases by 10.5%, and they are rapidly involved in the growth processes so than the shoots receive more abundant nutrition.

The measured sucrose/monosaccharides ratio for the potato treated with an amino acid growth stimulant was equal to 20.5. It is the evidence of a higher maturation rate within the same period of time as in the reference version. Potato tubers treated with the

growth stimulant also had a higher content of bioactive compounds, which grows on average by 15 to 50%. The increase of ascorbic acid content is approximately 8 mg per 100 g, fresh weight. The increase of starch content in potato averages 15 to 17% and reaches 15 to 16% of the tubers' wet weight.

A high degree of maturity in plant storage organs suggests an increased rate of their development during the growing season. Measuring the speed at which the potato plants had passed their growth phases showed that the length of the sprouting-budding interphase period reduced on average by 20%. The growing season of potato plants was 5 to 10 days shorter.

The treatment with an amino acid growth stimulant accelerates potato plant development, accompanied by a concurrent increase in productivity by 20 to 30%. Potato tubers grown with the use of collagen hydrolysate were prone to phytopathological changes to a considerably less extent.

The effective influence of the growth regulator produced from collagen on the development of potato plants and formation of their tubers is an evidence of fuller utilization of the potential reserved in plants.

## REFERENCES

- Bol'shakov, O.V., Kutsakova, V.E. & Murashev, S.V. 1999. Biostim A and Biostim M preparations - a new plant growth and development regulators. *Storage and Processing of Agricultural Raw Materials* **6**, 29–31 (in Russian).
- Bruinsma, J., Sinnema, A. Bakker, D. & Swart, J. 1967. The use of gibberellic acid (GA) and N-dimethylaminosuccinamic acid (B9) in the testing of seed potatoes for virus infection. *European Potato Journal* **10**, 136–152.
- Burton, W.G. 1985. Physiology of ripening and storage of food crops. Translated from English By I. Spichkina. Agropromizdat, Moscow, 359 pp. (in Russian)
- Coleman, W.K. 1982. An evaluation of bromoethane for breaking tuber dormancy in *Solanum tuberosum* L. *American Potato Journal* **60**, 161–167.
- Coleman, W.K. 1987. Dormancy release in potato tubers: a review. *American Potato Journal* **64**, 57–68.
- Coleman, W.K. 1998. Carbon dioxide, oxygen and ethylene effects on potato tuber dormancy release and sprout growth. *Annals of Botany* **82**, 21–27.
- Deligios, P.A., Rapposelli, E.M. & Marnetti, G. 2017. Effects of Physical, Mechanical and Hormonal Treatments of Seed-Tubers on Bud Dormancy and Plant Productivity *Am. J. Potato Res.* 2017 **94**, 544–555.
- Dospekhov, B.A. 2012. *The methodology of field experience* (with the basics of statistical processing of research results) Demand Book, Moscow, 352 pp. (in Russian).
- Eremeev, V., Löhmus, A., Lääniste, P., Jõudu, J., Talgre, L. & Lauringson, E. 2008. The influence of thermal shock and presprouting of seed potatoes on formation of some yield structure elements. *Acta Agriculturae Scandinavica, Section B - Plant Soil Science* **58**, 35–42.
- Eremeev, V., Lääniste, P., Tein, B., Lauk, R. & Alaru, M. 2012. Effect of tuber preplanting treatments and humic preparation on tuber yield and quality. *ESA12 Abstracts: 12th Congress of the European Society for Agronomy*. Helsinki, Finland, 20–24 August, 2012, pp. 324.
- Ermakov, A.I., Arasimovich, A.A., Smirnova-Ikonnikova, M.I., Yarosh, I.I. & Lukonikova G.A. 1988. *Methods of biochemical plant research*. Agropromizdat, Leningrad. 456 pp. (in Russian).

- Fazal, R., Lee, Seung Koo, Kim, Hyun Soon, Jeon, Jae Heung, Park, Ji-young & Hyouk, Joun 2001. Dormancy Breaking and Effects on Tuber Yield of Potato Subjected to Various Chemicals and Growth Regulators under Greenhouse Conditions. *Journal of Biological Sciences*, September Vol. **1**(9), 818–820.
- Flaumenbaum, B.L., Tanchev, S.S. & Grishin, I.A. 1986. Basics of food preservation. Agropromizdat, Moscow, 604 pp. (in Russian).
- Gemeda, M., Wassu, M., Nigussie, D. & Dandena, G. 2017. Effects of different dormancy-breaking and storage methods on seed tuber sprouting and subsequent yield of two potato (*Solanum tuberosum* L.) varieties. *Open Agriculture* **2**, 220–229.
- Germchi, S., Ghannadi-Behrooz, F. & Badri, S. 2011. Effect of thiourea on dormancy breaking and yield of potato (*Solanum tuberosum* L.) minitubers Marfona cv. in Greenhouse. *International Conference on environmental and agriculture engineering IPCBEE*, Singapore: IACSIT Press. Vol. **115**, pp. 19–24.
- Haider, M.W., Ayyub, C.M., Malik, A.U. & Ahmad, R. 2019. Plant growth regulators and electric current break tuber dormancy by modulating antioxidant activities of potato. *Pak. J. Agri. Sci.* **56**(4), 867–877.
- Hosseini, M.B., Afshari, R.T. & Salimi, K. 2011. Breaking dormancy of potato minitubers with thiourea. *Potato Journal* **38**, 9–12.
- Kocacaliskan, I., Kufrevioglu, I., Keha, E.E & Caliskan, S. 1989. Breaking of dormancy in potato tubers by electrical current. *J. Plant Physiol.* **135**, 373–374.
- Kolomicheva, E.A. & Murashev, S.V. 2013. The effect of amino acid treatment on the dormancy state of plants, fruit formation, and their cold storage (theoretical provisions). *Processes and Equipment of Food Industries* **2**(9), 132–140 (in Russian).
- Kuznetsov, V.V. & Dmitrieva, G.A. 2005. Plant Physiology. Vysshaya shkola, Moscow, 736 pp.
- Mani, F., Bettaieb, T. Doudech, N. & Hannachi, C. 2013. Effect of hydrogen peroxide and thiourea on dormancy breaking of microtubers and field-grown tubers of potato. *African Crop Science Journal* **21**(3), 221–234.
- Marenych, M.M., Hanhur, V.V, Len, O.I., Hangur, Yu.M., Zhornyk, I.I. & Kalinichenko, A.V. 2019. The efficiency of humic growth stimulators in pre-sowing seed treatment and foliar additional fertilizing of sown areas of grain and industrial crops *Agronomy Research* **17**(1), 194–205. <https://doi.org/10.15159/AR.19.023>
- Mazur, V.A., Pantsyreva, H.V., Mazur, K.V. & Didur, I.M. 2019. Influence of the assimilation apparatus and productivity of white lupine plants. *Agronomy Research* **17**(1), 206–219, <https://doi.org/10.15159/AR.19.024>
- Medvedev, S.S. 2004. Plant physiology. Publishing of St. Petersburg State University. Saint-Petersburg, 336 pp. (in Russian).
- Medvedev, S.S. & Sharova, E.I. 2014. *Biology of Plant Development*. (In 2 volumes) Publishing of Nizhnevartovsk State University, 2014. Volume 2. Growth and morphogenesis, 236 pp. (in Russian).
- Murashev, S.V. 2013. Induction of auxin synthesis, raising of energy efficacy and resistance of plants by means of treatment with glycine. In: Innovative trends in modern plant physiology. Proceed. Of All-Russian Scientific Conference with International Participation: Annual meeting of the Russian Society of Physiologists. Moscow, pp. 306–307 (in Russian).
- Murashev, S.V. 2015. Stimulating effect of glycine on the formation of wound periderm on potato tubers. *Proceedings of St. Petersburg State Agrarian University* **40**, 33–37 (in Russian).
- Murashev, S.V. 2016 Activation of oxidation processes and the possibility of increasing yield, environmental safety and storage ability of potatoes. Scientific journal NRU ITMO. Series: *Processes and Food Production Equipment* **1**, 82–89.

- Murashev, S.V., Bobko, A.L. & Verzhuk, V.G. 2014. The role of endogenous antioxidants in the adaptation of cultivated plants to the conditions of negative temperatures in the winter-spring period. *Vegetables of Russia* **1**(22), 58–59 (in Russian).
- Murashev, S.V., Kolomicheva, E.A., Verzhuk, V.G. & Burmistrov, L.A. 2011. Stimulating effect of glycine on the formation of Chaenomeles fruits and reducing losses during their storage. *Bulletin of the Russian Academy of Agricultural Sciences* **1**, 79–82 (in Russian).
- Murashev, S.V., Goncharova, E.A. & Bobko, A.L. 2013. Fermentative activity in plant tissues at rest and its relationship with the productivity and storage of storage organs in a cooled state. *Izvestia Samara Scientific Center of the Russian Academy of Sciences* **15**(3–5), 1670–1678.
- Murashev, S.V., Verzhuk, V.G. & Kolomicheva, E.A. 2009. Mechanism of the effect of glycine on the adaptation of plant organisms to low-temperature environments In: *Physical and chemical mechanisms of plant adaptation to anthropogenic pollution in the environments of the Far North*. Proceed. of Annual meeting of the Russian Society of Physiologists, abstracts of presentations, pp. 154–156 (in Russian).
- Muthoni, J., Kabira, J., Shimelis, J. & Melis, R. 2014. Regulation of potato tuber dormancy: (review). *Australian Journal of Crop Science* **8**(5), 754–759.
- Polevoi, V.V. 1989. *Plant Physiology*. Vysshaya shkola, Moscow, 464 pp. (pp. 72–73) (in Russian).
- Salimi, Kh., Afshari, R.T., Hosseini, M.B. & Struik, P.C. 2010. Effects of gibberellic acid and carbon disulphide on sprouting of potato minitubers. *Scientia Horticulturae* **124**, 14–18.
- Sapronov, N.M., Kurasova, L.M., Zubkov, A.S., Kutsakova, V.E., Murashev, S.V. & Polivanova, T.V. 2002. Improvement of technological qualities of sugar beet and improvement of its storage stability, based on the use of biotechnologies. *Sugar beet* **5**, 38–39 (in Russian).
- Sapronov, N.M., Morozov, A.N., Tsukanov, V.N., Kutsakova, V.E & Murashev, S.V. 2005. Biostim-M for increasing productivity and technological qualities of roots. *Sugar beet* **6**, 27–28 (in Russian).
- Secretaria, L.B., Molejon, M.L.A., Bayogan, E.R.V, Lacap, A.T. & Ekman, J.H. 2018. Evaluation of various methods to break dormancy of potato (*Solanum tuberosum* L. 'Granola') minitubers. *ISHS Acta Horticulturae International Symposia. on Tropical and Temperate Horticulture – ISTTH 2016*. doi:10.17660/ActaHortic.2018.1205.47
- Sharova, E.I. 2016. Publishing of Saint-Petersburg state university. Saint-Petersburg, pp. 46–47 (in Russian).
- Struik, P.C. & Wiersema, S.G. 1999. Seed potato technology. Wageningen: Wageningen Academic Pub., 245 pp.
- Suttle, J.C. 2008. Effects of Synthetic Phenylurea and Nitroguanidine Cytokinins on Dormancy Break and Sprout Growth in Russet Burbank Minitubers. *Am. J. Potato Res.* **85**, 121–128.
- Virtanen, E., Häggman, H., Degefu, Y., Välimaa, A.L. & Seppänen, M. 2013. Effects of Production History and Gibberellic Acid on Seed Potatoes. *Journal of Agricultural Science* **5**(12), 145–153.
- Wróbel, S., Keşy, J. & Treder, K. 2017. Effect of Growth Regulators and Ethanol on Termination of Dormancy in Potato Tubers. *American Journal of Potato Research* **94**(5), 544–555.

## New assessment tool for artificial plant lighting: case of tomato (*Lycopersicon Esculentum* Mill.)

S. Rakutko<sup>1</sup>, A. Avotiņš<sup>2</sup>, I. Alsina<sup>3</sup> and K. Berzina<sup>2</sup>

<sup>1</sup>Federal Scientific Agroengineering Center VIM, branch in Saint Petersburg, Tyarlevo, Pushkinsky distr., RU196625 St. Petersburg, Russia

<sup>2</sup>Riga Technical University, Faculty of Power and Electrical Engineering, Kalku street 1, LV-1658 Riga, Latvia

<sup>3</sup>Latvia University of Agriculture, Faculty of Agriculture, Institute of Plant and Soil Science, Liela street 2, LV-3001 Jelgava, Latvia

**Abstract.** Growing crops under artificial conditions need a very favourable environment, especially the spectral composition of radiation influencing the plant biometry greatly. The study objective was to find how to assess the closeness of real growing conditions to the optimal ones using a single coefficient, which would reflect several time dependencies of individual growth indicators. The plant growth friendliness factor ( $K_G$ ) was proposed for this purpose. Tomato transplants (*Lycopersicon Esculentum* Mill., ‘Polonaise F<sub>1</sub>’) were grown in a peat substrate under two lighting systems with different light quality. One system consisted of eight fluorescent lamps OSRAM L58W / 840 LUMILUX Cool White and eight lamps L58W / 77 FLUORA mounted on the standard frame, alternating the lamp types (Type I spectrum). In the other lighting system, the PCB Star LEDs with wavelengths of red 630 nm and far-red 735 nm were added (Type II spectrum). The irradiance level was maintained at  $140 \mu\text{mol m}^{-2} \text{s}^{-1}$ , the photoperiod was 16 h. The ratio of long-wave flux to the total flux  $K_L$  was calculated for these lighting systems (0.37 rel. units for Type I spectrum and 0.50 rel. units for Type II spectrum) and  $K_G$  factor was determined by the proposed formula. The value of  $K_G$  was found to be twice as small for Type I spectrum than for Type II spectrum. The significant difference in biometric parameters of tomato transplants grown under Type I and Type II spectra was revealed. The plants grown in the environment characterized by higher  $K_G$ , were higher; they had more significant wet mass and stem neck diameter.

**Key words:** greenhouse, plant lighting, *Lycopersicon esculentum*, light quality.

### INTRODUCTION

Tomato (*Lycopersicon Esculentum* Mill.) is a fruit of great commercial importance. It is considered one of the most widely spread vegetables in the world cultivated under various production systems - from field plantations to modern plant factories. In industrial greenhouses, certain crops are grown throughout the year, with all environmental factors being under control. Therefore, these facilities are essential for food supply and food security in many parts of the globe, especially in the high latitude countries. In addition to natural sunlight, artificial radiation sources are used. In some cases, plants are grown under artificial lighting only (city farms, grow boxes, green

walls, etc.). The plants require an optimal combination of environmental factors, with the light taking a special place among them. Variation in lighting conditions (intensity, duration, periodicity, and, particularly, the light quality) has a different effect on the growth and development of plants (Baeza et al., 2018).

The light quality is usually characterised by the share of energy in certain bands of photosynthetically active radiation (PAR) in blue (B) 400–500 nm, green (G) 500–600 nm, and red (R) 600–700 nm spectrum range. The far-red (FR) 700–800 nm energy plays an essential role in plant lighting. The general pattern is the intense light absorption by the plant leaves in B and R bands, and the reflection in G band. In FR band, both reflection and transmission are observed (Larcher, 2000). In several experiments, the effects of wavebands on plants were established. The B band radiation was found to be of critical importance. It affected the morphology of pepper stem and leaves and caused variations in the chloroplast composition (higher ratio of Chl a / Chl b) that improved the photosynthesis efficiency (Hoffmann et al., 2015). G radiation has a positive effect on the development of tomato and sweet pepper plants (Samuolienė et al., 2012). The FR radiation was revealed to increase the height of sweet pepper plants and the stem mass (Dale & Blom, 2004). The energy ratio in the above bands was found necessary for the normal photomorphogenesis of various plants as well (Kim et al., 2006).

The investigation results, available to date, prove an increased share of B radiation to contribute to the cell division and the emergence of first sprouts, and to prevent the seedling elongation. R radiation stimulates the root system development, influences the formation of fruits and seed germination, and promotes the flowering (Park & Runkle, 2018). The G wavelength has a minimal effect, although it is essential in the plant lighting, especially in the case of inter-lighting (Kim et al., 2004).

Advanced technical solutions associated with protected agriculture practices must focus on energy saving, in the first place, and provide the favourable environment for plants. In this context, the researchers need to take into account the recent fundamental scientific achievements. It is known that the low degree of optical energy conversion into the dry matter of plant tissues causes significant energy inputs in the lighting. Therefore, the use of artificial lighting sources brings forward the issues of energy efficiency and inside environment assessment (Rakutko & Patsukov, 2013).

The most important indicator of the plant lighting effectiveness is the plant growth dynamics, which is characterised by several biometric parameters. To create the mathematical models of their behavior is an important step towards the development of the theory and practice of plant lighting control. The obtained data can be used to develop the algorithms for plant performance control (Rakutko, 2018).

The mathematical relationship between the environmental factors and the productional process in plants will allow optimizing the plant growth and development by selecting the necessary combinations of parameters of these factors while achieving the maximum plant productivity. For this purpose, a dynamic model of a plant is required, which would consider the changes in its mass or the assimilating surface area in the growing process.

The study objective was to find how to assess the closeness of real growing conditions to the optimal ones using a single coefficient, which would reflect several dependencies of individual growth indicators on time.



## MATERIALS AND METHODS

The study object was tomato plants (*Lycopersicon Esculentum* Mill., 'Polonaise F<sub>1</sub>'). Tomato seeds were sown in one container with the peat substrate. The container was covered with film and placed in the room with the air temperature of +26 to 28 °C and the humidity of 70 to 75%. The first single sprouts appeared on the 3<sup>rd</sup> day. After the mass emergence of sprouts, when about 80% of their total number appeared, the plants were exposed to the round-a-clock lighting with the HPS lamp DNaz 400 (with irradiation 100  $\mu\text{mol m}^{-2} \text{s}^{-1}$ ). From this moment, the age of plants was recorded (DAE – the day after seedling emergence). On the 3<sup>rd</sup> DAE, the photoperiod was set at 16 hours. On the 10<sup>th</sup>DAE at the second true leaf phase, the plants were picked out in pots with the volume of one-litre filled with the 2:1 mix of peat and garden soil. The acidity of peat was neutralised with dolomite meal to pH of 6.0. One kilogramme of peat included the following mineral nutrients: K<sub>2</sub>O – 330.2 mg, P<sub>2</sub>O<sub>5</sub> – 42.8 mg, CaO – 151.6 mg, MgO – 102.8 mg, and N<sub>2</sub>O<sub>5</sub> – 63.1 mg. On the 14<sup>th</sup> DAE, the pots were placed under the lighting facilities. The plants were watered and fertilized as required. On the 20<sup>th</sup>DAE, the third true leaf appeared. The first measurements were carried out on the 22<sup>nd</sup>DAE, the second measurements – on the 30<sup>th</sup> DAE, the third measurements – on the 38<sup>th</sup> DAE, and the fourth measurements – on the 46<sup>th</sup> DAE.

A comparative experiment was carried out in a laboratory room (6×6×3.5 m), with the specialized equipment being installed to provide the required plant growing conditions: an air conditioning system, electric fans, a water evaporator, a combined sensor for microclimate parameters, a control panel, and irradiation facilities. The room was divided into two zones by the light tight screens made of white plastic film, protecting the plants from being irradiated by the unit in the adjacent section and from the natural light, but not impeding the airflow inside the sections. During the experiment, the same level of total photon flux density (PAR+FR) 140  $\mu\text{mol m}^{-2} \text{s}^{-1}$  in each zone was maintained by varying the height of the lighting facilities above the plant tops. The unevenness of irradiance in the zones characterized by the coefficient  $z = E_{\text{max}}/E_{\text{av}}$  did not exceed 10%.

In the first zone, the installed lighting system consisted of eight fluorescent lamps OSRAM L58W / 840 LUMILUX Cool White (5000–7000K) and eight lamps OSRAM L58W / 77 FLUORA (Germany), mounted on the standard frame, alternating the lamp types. In the second zone, the installed lighting system had the same lamps as in the first zone and PCB Star LEDs (China) with the wavelengths of red 630 and far-red 735 nm (40 pieces each) were added.

Photon flux density (PFD) was measured with a TKA VD / 04 (Russia) device. The results are shown in Fig. 1.

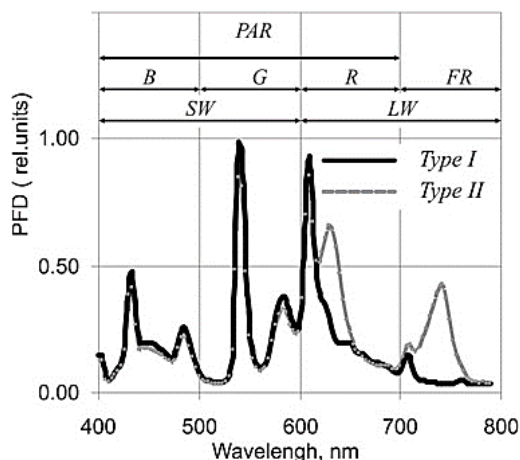


Figure 1. Photon flux density.

The methodological challenge in searching for the plant response to the light quality of radiation is that it is difficult to describe this composition by one indicator. In this study, the radiation fluxes in the blue and green wavelengths were totalled and considered as the radiation in the short-wavelength band (SW) of total radiation (PAR+FR). The radiation fluxes in the red and far-red wavelengths were totalled and considered as the radiation in the long-wavelength band (LW) of total radiation.

This approach made it possible to introduce a coefficient characterizing the share of long-wave radiation energy in the total radiation flux.

$$K_L = \frac{F_{LW}}{F_{SW} + F_{LW}}, \quad (1)$$

where  $F_{SW}$ ,  $F_{LW}$  is radiation flux in SW and LW bands, correspondingly.

This coefficient was used to describe the spectrum type in the experiment variants: Type I – the spectrum with a smaller share of the long-wave radiation energy ( $K_L = 0.37$ ); Type II – the spectrum with a larger share of the long-wave radiation energy ( $K_L = 0.50$ ). In order to change the light quality, an additional flux from the LEDs was used, which increased the  $K_L$  value. To maintain the same level of PFD, the height of the lighting systems over the plant tops was different (0.38 m for Type I spectrum and 0.71 m for Type II spectrum). Illumination in the plant growing zones was 11.9 kLk and 9.7 kLk, respectively. Due to this difference, the plants in the experiment looked more illuminated under Type I spectrum.

In the series of measurements on different DAEs, the main biometric parameters of tomato plants were recorded: 1) stem neck diameter  $D$  (with a calliper), 2) number of leaves  $N$ , 3) height of hypocotyl  $H$  (with a ruler), 4) wet mass of the plant  $M$  (with scales), 5) leaf surface area  $S$  (by taking a pictures with a digital camera), and 6) dry matter content  $\nu$  (by oven drying at 105 °C).

Variation dynamics in the stem diameter  $D(t)$  and the number of leaves  $N(t)$  were approximated by logarithmic curves. For example, the number of leaves

$$N(t) = Y_m(1 - e^{-B(t-T_m)}). \quad (2)$$

Variation dynamics in the height of hypocotyl  $H(t)$ , the wet mass  $M(t)$  and the leaf surface area  $S(t)$  were approximated by the Gompertz curves. For example, for the height of hypocotyl

$$H(t) = Y_0 + Y_m e^{-e^{-B(t-T_m)}}. \quad (3)$$

The dry matter content  $\nu(t)$  was approximated by the polynomial

$$\nu(t) = At^2 + Bt + C. \quad (4)$$

Parameters  $Y_m$ ,  $Y_0$ ,  $T_m$ ,  $A$ ,  $B$ ,  $C$  in the formulas 2-4 are approximating coefficients. They were obtained for both types of the spectrum. The best-fitting growth curve was selected based on the residual sum of square (Karadavut et al., 2008).

The energy and inside environmental conditions were assessed by the plant growth friendliness factor ( $K_G$ ), which showed how close was the adopted lighting practice to the suitable optimal or best available technique (BAT).

The closeness degree was estimated by the normalized Euclidean distance between the two trajectories for the real conditions ( $R$ ) and for the optimal (BAT) conditions ( $O$ ) in the  $n$ -dimensional factor space of the biometric parameters of plants. Symbolically, this can be expressed as

$$K_G = \begin{cases} \frac{1}{k} \sum_{t=1}^k \delta_t^{R-O} \\ O \in BAT \end{cases}, \quad (5)$$

where  $\delta_t^{R-O}$  is the mentioned normalized Euclidean distance.

Since the functional time dependences of plants' biometrics are given in the analytical form (equations 2-4), the expression for the plant growth friendliness factor takes the form

$$K_G = \frac{1}{T} \int_0^T \sqrt{\sum_{i=1}^n w_i \left( \frac{Y_i^R(t) - Y_i^O(t)}{Y_i^O(t)} \right)^2} dt, \quad (6)$$

where  $T$  is the estimated time period,  $Y_i^R(t)$  and  $Y_i^O(t)$  are the functional time dependences of the  $i$ -th parameter for real ( $R$ ) and optimal ( $O$ ) techniques, respectively,  $w_i$  is the weighting factor of the  $i$ -th parameter.

Optimal plant biometrics was taken from the expert opinion obtained during the interviews.

One-factorial experiments were arranged in three replications, with the mean values being calculated from six plants per replication. The curves were approximated in Excel 2013. The data were processed with STATISTICA 7.0 software packages. Statistical differences were analyzed using a one-way analysis of variance (ANOVA). The least significant difference (LSD) at the 0.95 level ( $P \leq 0.05$ ) was used to compare the mean values by Fisher's test.

## RESULTS AND DISCUSSION

According to expert estimates, Type I spectrum with the smaller share of LW radiation was found more favourable for plants (Fig. 2). The plants under such radiation were stronger and better met the transplant quality standards. Figs 3 and 4 show, respectively, the dependence between the number of leaves on a plant and time, and the dependence between the neck diameter and time. Plants under the radiation spectrum with bigger  $K_{LW}$  had the more significant height and wet mass, but the smaller leaf area.

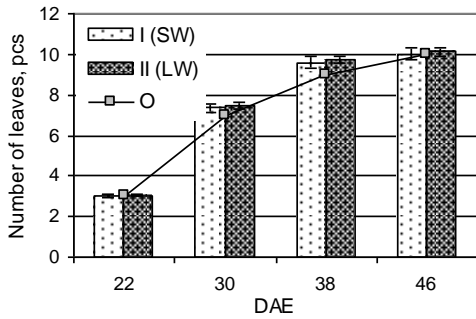
Statistically significant differences in these parameters in plants grown under the different radiation spectrum were not identified.

Figs 5, 6, and 7 show the dependencies between the hypocotyl height, its wet mass, and the leaf area and time. Dependencies have a characteristic sigmoid look. Fig. 8 shows the dependence between the plant dry matter content and time.

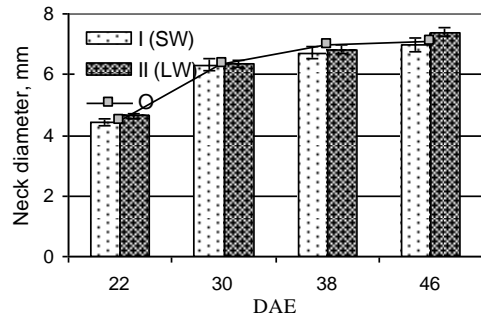


**Figure 2.** Tomato plants.

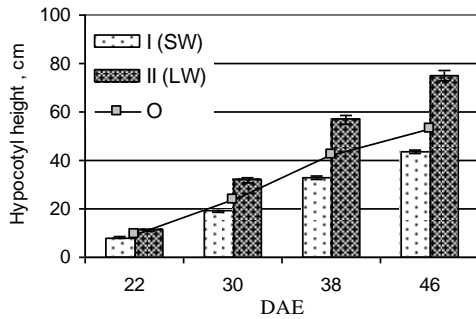
At the end of the experiment, the higher dry matter content was observed in plants exposed to radiation with lower  $K_L$ . The solid line in Figs 3 to 8 shows the development path of specific biometric parameters; it is plotted according to the expert estimates, based on the desired values of these parameters at any time point.



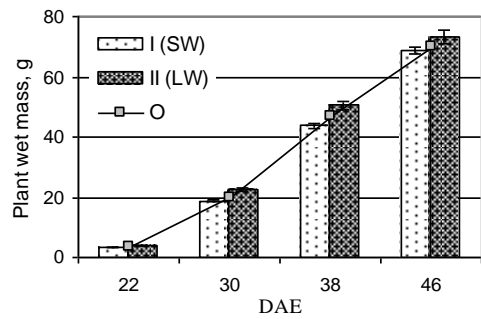
**Figure 3.** Number of leaves.



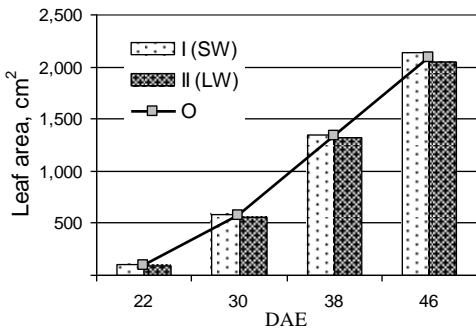
**Figure 4.** Neck diameter.



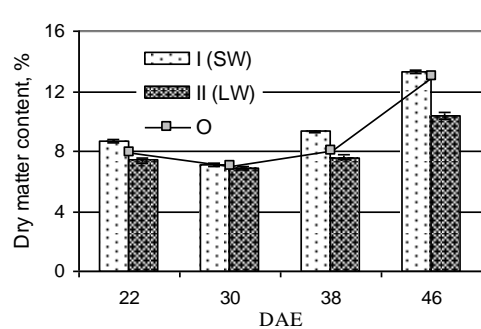
**Figure 5.** Hypocotyl height.



**Figure 6.** Plant wet mass.



**Figure 7.** Leaf area.



**Figure 8.** Dry matter content.

Table 1 presents the coefficients of approximation curves for the dynamics of specific biometric parameters for both types of spectrum, as well as for the optimal techniques.

The values of  $K_G$  calculated by the formula 6 are 0.22 rel. units for Type I spectrum and 0.38 rel. units for Type II spectrum.  $K_G$  increases with an increase in the share of the longwave radiation.

The proposed approach associated with  $K_G$ -based assessment is confirmed by the previously obtained knowledge that the blue radiation has a favourable effect on plant development at an early stage (Hoffmann et al., 2015). Insufficient light intensity or its inadequate light quality impairs the growth and development of tomato transplants, especially during the initiation of the first flower cluster that lowers the quality of transplants (Brazaityte et al., 2010).

For optimizing plant growth, it is quite possible to use only a rather simple  $K_G$ -based approach, which does not encapsulate the notion of the crop yield formation as such. This approach is designed to describe the dynamics of plant development adequately in the various environments and/or to give a short-term forecast of these dynamics based on extrapolation of the initial data. Similar approaches are quite popular in the practice of plant cultivation.

Such empirical method is associated with the comprehension of experimental data and selection of the most appropriate (usually simple) formulas or a system of equations for their adequate description. This method of quantitative generalization and approximation of experimental data often makes it possible to understand the mechanisms responsible for the plant response (Medina-Ruíz et al., 2011). Changes in the phenotype during the growth can be modelled using the growth curves. The properties of these curves depend on the plant species, its phenotype and environmental conditions (Karadavut et al., 2008).

The ratio of energy shares in the shortwave and longwave band of the total flux was used as an indicator of the light quality of radiation. This indicator allows to express the diversity of spectral information by one number quantitatively. The changes in biometrics of tomato plants in the growth process were described by mathematics.

**Table 1.** Coefficients of approximation curves

Parameter	Values		
	I (SW)	II (LW)	O
Model of the number of leaves $N = f(t)$ , pieces			
$Y_m$	10.686	10.806	11.000
$B$	0.110	0.110	0.087
$T_m$	19.027	19.034	18.325
Model of the stem neck diameter $D = f(t)$ , mm			
$Y_m$	6.984	7.594	7.213
$B$	0.161	0.098	0.143
$T_m$	15.724	12.355	15.175
Model of the plant height $H = f(t)$ , cm			
$Y_0$	5.296	5.008	6.941
$Y_m$	50.345	89.360	54.019
$B$	0.098	0.100	0.126
$T_m$	32.684	31.865	31.366
Model of the plant wet mass $M = f(t)$ , g			
$Y_0$	-0.674	-0.311	0.716
$Y_m$	117.900	101.137	97.802
$B$	0.077	0.096	0.097
$T_m$	37.706	34.126	35.004
Model of the leaf area $S = f(t)$ , cm <sup>2</sup>			
$Y_0$	-28.304	-37.546	-27.950
$Y_m$	3772.168	3366.178	3386.076
$B$	0.075	0.080	0.081
$T_m$	38.072	36.783	36.788
Model of the dry matter content $\nu = f(t)$ , %			
$A$	0.022	0.013	0.023
$B$	-1.287	-0.755	-1.345
$C$	26.337	17.823	26.592

As a result of the empirical approach based on the experimental data, the suitable, rather simple, formulas for the main biometrics of plants were chosen. The dependence of plant biometrics on the proposed indicator  $K_L$  was revealed. The shift of the share of long-wavelength band (R+FR) from 37% to 50% (by 13%) was found to lead to a significant difference in almost all biometric parameters of plants in their cultivation process and to variation in the plant growth friendliness factor  $K_G$  from 22% to 38% (by 16%).

In previous studies, we proposed a method for monitoring the energy and ecological compatibility in various plant growing conditions (Rakutko et al., 2016). In this study, a similar approach was applied for growing tomato transplants under different light quality. The obtained data can be used to optimize the process of growing plants by varying the lighting parameters, environmental conditions and other factors.

## CONCLUSIONS

The experiments confirmed the possibility to present the light quality of the radiation, usually given by the dependence of the radiation energy at each wavelength, with one number, namely the  $K_L$  indicator, which was numerically determined as the ratio of long-wave flux to the total flux.

A similar approach was applied to present the dynamic pattern of plant biometrics with  $K_G$  indicator, which characterized the proximity of real and optimal plant growing techniques.

The study experiments with tomato transplants demonstrated that the empirical dependence of  $K_G$  on  $K_L$  was a convenient tool for assessing the effectiveness of artificial plant lighting.

ACKNOWLEDGEMENTS. The study was supported by the European Regional Development Fund project 'New control methods for energy and ecological efficiency increase of greenhouse plant lighting systems (uMOL)', Grant Agreement Nr. 1.1.1.1/16/A/261.

## REFERENCES

- Baeza, E., Dobbelsteen, A., Tsafaras, I. & Stanghellini, C. 2018. Plant factories versus greenhouses: Comparison of resource use efficiency. *Agricultural Systems* **160**, 31–43.
- Brazaityte, A., Duchovskis, P., Urbonaviciute, A., Samuoliene, G., Jankauskiene, J., Sakalauskaite, J., Sabajeviene, G., Sirtautas, R. & Novickovas, A. 2010. The effect of light-emitting diodes lighting on the growth of tomato transplants. *Zemdirbyste Agriculture* **97**(2), 89–98.
- Dale, A & Blom, T.J. 2004. Far-red light alters primocane morphology of red raspberry. *HortScience* **39**(5), 973–974.
- Hoffmann, A.M., Noga, G. & Hunsche, M. 2015. Acclimations to light quality on plant and leaf level affect the vulnerability of pepper (*Capsicum annum L.*) to water deficit. *Journal of Plant Research* **128**(2), 295–306.
- Karadavut, U., Kayis, S.A., Palta, C. & Okur, O. 2008. A growth curve application to compare plant heights and dry weights of some wheat varieties. *American-Eurasian J. Agric. & Environ. Sci.* **3**(6), 888–892.
- Kim, H.H., Goins, G.D., Wheeler, R.M. & Sager, J.C. 2004. Greenlight supplementation for enhanced lettuce growth under red- and blue-light emitting diodes. *HortScience* **39**, 1617–1622.

- Kim, H.H., Wheeler, R.M., Sager, J.C., Goins, G.D. & Norikane, J.H. 2006. Evaluation of lettuce growth using supplemental green light with red and blue light-emitting diodes in a controlled environment: a review of research at Kennedy Space Center. *Acta Hort.* **711**, 111–119.
- Larcher, W. 2000. *Physiological Plant Ecology*. Springer, 513 pp.
- Medina-Ruíz, C.A., Mercado-Luna, I.A., Soto-Zarazúa, G.M., Torres-Pacheco, I. & Rico-García, E. 2011. Mathematical modelling on tomato plants: A review. *African Journal of Agricultural Research* **6**(33), 6745–6749.
- Park, Y. & Runkle, E.S. 2018. Spectral effects of light-emitting diodes on plant growth, visual color quality, and photosynthetic photon efficacy: Whit eversus blue plus red radiation. *PLoS ONE* **13**(8), e0202386.
- Rakutko, S. & Patsukov, A. 2013. Comparative application efficiency of optical flux delivered from led and gas-discharge sources in indoor plant cultivation. In *Engineering for Rural Development. The 12th International Scientific Conference*. Latvia University of Agriculture, Latvia, pp. 137–141.
- Rakutko, S., Rakutko, E., Kaposhko, D. & Vaskin, A. 2016. Monitoring technique of energy and ecological efficiency of indoor plant lighting. In *Engineering for Rural Development. The 15-th International Scientific Conference*. Latvia University of Agriculture, Jelgava, pp. 95–101.
- Rakutko, S. 2018. Energy and ecological efficiency as the property of the artificial bioenergetic system of indoor plant lighting. *Tekhnologii I tekhnicheskie sredstva mekhanizirovannogo proizvodstva produkcii rastenievodstva I zhivotnovodstva (Technologies and technical means of mechanized production of crop and livestock products)* **95**, 77–89 (in Russian, English abstr.).
- Samuolienė, G., Brazaitytė, A., Duchovskis, P., Viršilė, A., Jankauskienė, J., Sirtautas, R., Novičkovas, A., Sakalauskienė, S. & Sakalauskaitė, J. 2012. Cultivation of vegetable transplants using solid-state lamps for the short-wavelength supplementary lighting in greenhouses. *Acta Hort.* **952**, 885–892.

## **Changes of agricultural producers in Estonia according to the size of land use**

M. Rasva\* and E. Jürgenson

Estonian University of Life Sciences, Institute of Forestry and Rural Engineering, Chair of Geomatics, Kreutzwaldi 5, EE51006, Tartu, Estonia

\*Correspondence: [marii.rasva@emu.ee](mailto:marii.rasva@emu.ee)

**Abstract.** The purpose of this paper is to give an overview of the changes in Estonian agricultural producers according to the size of the land use. Data from the Estonian Agricultural Registers and Information Board (ARIB) data from 2011 and 2016 is used. This data shows that agricultural land use area per producer has increased and most of the agricultural land is used by agricultural producers in size groups 400–< 1,000 ha and > 1,000 ha. This means that a small number of agricultural producers are using a large area of agricultural land. For example, in 2016, the largest agricultural producer was using 27% of agricultural land located in Türi municipality. The outcome of the study shows a trend of farm size growth in Estonia; there is a need to find out if this model of agricultural production guarantees us food and a future of sustainability.

**Key words:** agricultural producer, Estonia, land use, sustainable agriculture.

### **INTRODUCTION**

#### **Motivation**

It is estimated that by 2050 another 2.5 billion people will be added to the current population of 7 billion (United Nations, n.d.; GIZ, 2012). This means that there is also a growing need for food and feed, which puts more pressure on agricultural production (Põldaru et al., 2018). Hence there has been a long ongoing debate on the effect of farm size on productivity. Are the family farms the ones that will lead us to a future of sustainable agriculture while feeding the population, or should we rely on large corporate agricultural businesses or mega-farms? What kind of balance should there be between them?

Agriculture is a significant user of natural resources (Bruinsma, 2003), although in different ways and to different extents depending on the farming system. Farming is also a major source of greenhouse gases, and as the world's greenhouse gas levels continue to rise, climate change is occurring much faster than anticipated (United Nations, 2019).

The number of people suffering from hunger has been on the rise since 2014 (Bruinsma, 2003; United Nations, 2019). To ensure that future agricultural production guarantees food security for the world's growing population, we need productive yet sustainable agriculture. Which agricultural model is best for sustainable growth in agricultural production? Opinions differ; some sources (Sheng & Chancellor, 2018; Rada & Fuglie, 2019; Ren et al., 2019) support intensive, industry-based production



models; others (Monbiot et al., 2018; Ricciardi et al., 2018; Glenn et al., 2019) are in favour of farming based on smallholders. Some studies show that small family farms are more diversified than large ones, but they are also less likely to conserve structural elements, they leave a higher share of their soils bare during winter, and use more of their fields for monoculture (Wuepper et al., 2020). The Sustainable Development Goals report (United Nations, 2019) states that small-scale food producers are a big part of the solution to world hunger. For example, in the European Union, 50% of farms are smaller than 2 hectares but operate on only about 2.4% of agricultural land (Graeub et al., 2016; Lowder et al., 2016). The share of agricultural land controlled by larger farms is higher in countries with larger average incomes (Lowder et al., 2016).

In many parts of the world, there is an ongoing process of farm size growth (Viira, 2014; Pöder, 2017; Hubert, 2018; Sheng & Chancellor, 2018). While the number of farms is decreasing, the average area of agricultural land use per farm is growing (Sheng & Chancellor, 2018; Wuepper et al., 2020). Mega-farms of up to 500,000 hectares appear in the countries of the former Soviet Union, Latin America, North America, Australia, and even Central Europe (IAMO, 2017). Large-scale agricultural producers are evolving because of the abundance of land resources in some parts of the world. Improved access to outside capital is one reason why large size farms attract investors that do not have experience in primary agriculture (Constantin et al., 2017). It is also believed that given the introduction of modern production technologies, large farms can achieve the expected returns much faster than small ones. Some studies (Ren et al., 2019) show that large-scale farming has no direct negative impact on the environment and lead to a positive environmental impact.

However, the question of whether large-scale farming is more efficient and profitable than the small or medium-size farms, remains. It is believed that small ones are diversified and contribute more to environmental sustainability, preservation of traditional values, and economic resilience than large farms (Graeub et al., 2016; van der Sluis et al., 2016; Rada & Fuglie, 2019). It is known that the smallest two farm size classes (0–1 ha and 1–2 ha) are the most significant contributors to global food production compared to all other classes (Graeub et al., 2016). Farms less than 2 ha produce 28–31% of total crop production and 30–34% of the global food supply (Ricciardi et al., 2018).

In the case of small farms, much of the labour comes from the household: family members are self-supervising, motivated to work with care, and flexible to accommodate the unpredictable timing of some farm operations (Llambí, 2010; Graeub et al., 2016). Large farms, on the other hand, often depend heavily on hired labour that needs to be recruited and supervised, thereby raising transaction costs and, thus, the implicit cost of labour (Llambí, 2010). Agriculture is the single largest employer in the world, providing livelihoods for 40% of today's global population (United Nations, n.d.) and small farms typically apply more labour per land unit than larger farms (Llambí, 2010; Rada & Fuglie, 2019). Thus, it is essential to maintain small farms (Constantin et al., 2017; Dell'Angelo et al., 2017) to support the livelihoods of rural populations.

By number, there are more than 570 million farms in the world; more than 475 million farms are smaller than 2 ha, and more than 500 million are family farms (Lowder et al., 2016). Accordingly, investing in small farms is a crucial way to increase food security and nutrition for the poorest, as well as food production for local and global markets.

The ongoing debate on the effect of farm size on productivity remains; however, the structural adjustment has seen resources shift from smaller and less productive farms to the larger ones. This, in turn, raises the question: is the large-scale model for agricultural production sustainable?

In 2015, countries adopted the 2030 Agenda for Sustainable Development and its 17 Sustainable Development Goals. Of these 17 goals, three are linked directly to agriculture and its sustainability. Goal 2 leads our attention to people suffering from hunger; this number has been on the rise since 2014. The purpose of this goal is to end hunger, achieve security and improved nutrition, and to promote sustainable agriculture. The United Nations, 2019 report on sustainable development goals states that special attention needs to be given to increasing the agricultural productivity and incomes of small-scale food producers. Small-scale food producers are a big part of the solution to world hunger.

The purpose of goal 13 is to take urgent action to combat climate change and its impacts. The purpose of goal 15 is to protect, restore, and promote sustainable use of terrestrial ecosystems, sustainably manage forests, combat desertification, and to halt and reverse land degradation and halt biodiversity loss. One of the primary drivers of biodiversity loss is habitat loss from unsustainable agriculture.

Therefore, it is essential to determine what is sustainable agriculture. Does this model include small-scale or large-scale farms or both, and in what proportions? To do so, there is a need to map the present situation. Therefore the purpose of this paper is to give an overview of the changes in Estonian agricultural producers according to the size of the land use. The paper is organized as follows: first, to clarify the changes that have taken place in Estonian agriculture, we present a historical overview based on literature and document analysis; second, an introduction of data and method used; third, presentation of the results of the case study of Estonia according to data from ARIB; fourth, discussion of the results and conclusions are given.

### **Historical overview of changes in Estonian agriculture**

Agriculture in Estonia has been through significant structural changes. From 1919 till today, there have been five major land reforms, each influencing Estonian agriculture. After the independence of Estonia in 1918, an extensive area of agricultural land was owned and used by large farms (owned mostly by Baltic Germans) (Grubbström, 2011; Grubbström & Sooväli-Sepping, 2012; Jürgenson, 2017). At the same time, the peasants had a strong desire for land ownership. These circumstances created a suitable environment for the 1919 land reform, the purpose of which was to create more landowners (Grubbström, 2011; Jürgenson, 2016). As a result, there evolved more than 40,000 landowners, while more than 20,000 land users were in the process of acquiring land (Rosenberg, 2019). The average area of one farm was 23 ha (Rosenberg, 2019). The number of small farms rose more than two times; however, the reform also created some bottlenecks. For example, there emerged many tiny and economically not-profit farms, and there were no longer enough workers in large farms (Jürgenson, 2017; Rosenberg, 2019).

In 1940 the Soviet Union occupied Estonia and started new land reform. Private ownership was abolished, and the land was included in state property (Grubbström, 2011; Jürgenson, 2016, 2017). The previous landowner became a land user, and the ceiling of the land-use area was supposed to be 30 ha (Jürgenson, 2017; Rosenberg,

2019). The area of state land fund was over 758,000 ha (Rosenberg, 2019). The outcome was that successful farms were weakened, and lots of small, economically not efficient farms were created. These were steps towards later agricultural collectivization.

In 1941 Germany occupied Estonia, and reform made by the Soviet Union was cancelled. The land was partly returned to the use of its earlier/rightful owners; however, the state still owned the land. Three years later, the Soviet Union occupied Estonia again and picked up with its land reform where it left off. All changes made during the German occupation were cancelled (Jürgenson, 2017). This time land reform comprised 42,274 landowners and equitable owners and 972,000 ha of land (Rosenberg, 2019). By this time, there were only 136,000 farms left in ESSR and living conditions in rural areas were getting worse (Rosenberg, 2019). The next step was compulsory collectivization, resulting in the creation of large collective farms and the disappearance of small farms.

In the Soviet Union planned economy, there was only one suitable form of agriculture: state farms - kolkhozes and sovkhoses (Jürgenson, 2017; Pöder, 2017). Because of that, the number of people living in rural areas and working in agriculture shrank quickly. A further result was the shrinking number of villages and peripheries that arose.

There was a large shortage in the peoples' food supply and it didn't get any better. In the middle of 1980, the Soviet regime decided to allow family farms, small co-operatives and by the year 1986, there were 206 collective farms in Estonia (Jürgenson, 2017; Rosenberg, 2019). Socialistic agriculture was in a jam, and one way to snap out of it was seen in establishing rental farms in the peripheries. A bit later, talk about proper farms and self-sufficiency were put on the table. By the end of 1988, there were about 100 farms in Estonia; only a year later, at the end of 1989, there were over 1,000 farms (Rosenberg, 2019).

The demise of the large socialistic farms had started already in December 1989. A single farm of up to 50 ha was permitted (Rosenberg, 2019). After the regaining of Estonian independence in 1991, restitution of farmlands based on the pre-Second World War ownership and privatisation of collective farms took place (Grubbström, 2011; Grubbström & Sooväli-Sepping, 2012; Viira, 2014; Jürgenson, 2017; Pöder, 2017). The land reform law and then the agriculture reform law both favoured agriculture based on small farms (Kasepalu, 1991; Lillak, 2003; van Dijk, 2007; Pöder, 2017). In the first ten years of regaining independence, the number of farms in Estonia increased from 7.4 thousand in 1991 to 55.7 thousand in 2001 (Viira, 2014). Many small agricultural users arose (Viira, 2014; Pöder, 2017) but in the following years this number decreased (Grubbström & Sooväli-Sepping, 2012; OECD, 2018; Jürgenson & Rasva, 2020).

Today, small-scale farms are family farms that were established due to the restitution of land, the disintegration of former collective farms, or the expansion of household plots (Viira, 2014; Jürgenson, 2017). Large-scale producers are mostly corporate or co-operative farms, with a few exceptions in individual farms that have grown and will continue to expand (Viira, 2014). Although the number of agricultural holdings has decreased, the number of final consumers of their production is steadily increasing – there are 7.5 billion inhabitants in the world, and they all need food (Viira, 2014).

## DATA AND METHODS

To introduce a more detailed overview of the recent changes in the pattern of agricultural landholdings in Estonia, ARIB<sup>2</sup> Field Register data from 2011 and 2016 is used. The Field Register is one of three registers in charge of ARIB, and area support is one of the subsidies that ARIB delivers. The digitalised database of agricultural plots is required for payment of area supports from the budget of the EU. In the process of delivering national and EU subsidies, ARIB collects information about the applicant (every applicant receives an ID number) and land that is filed for area support.

ARIB data about the agricultural land area and the number of producers were analysed to get an overview of changes in Estonian agricultural land users' land holdings in 2011 and 2016. Agricultural land users and land area per producer were summarized using GIS software ArcGIS for Desktop 10.4. As information about the producers' location was also included, it gave us information seen in Figs 2 and 3.

Using GIS software, producers were divided into six groups according to the size of their landholdings: 0–< 2 ha, 2–< 40 ha, 40–< 100 ha, 100–< 400 ha, 400–< 1,000 ha and >1,000 ha; data was taken on the basis of these size groups. The basis for this division comes from Farm Accountancy Data Network<sup>3</sup> (FADN), where the agricultural land area is divided into four size groups (0–< 40 ha, 40–< 100 ha, 100–< 400 ha, > 400 ha). To get a closer look at the smallest agricultural land users, FADN size group 0–< 40 ha was divided into size groups 0–< 2 ha and 2–< 40 ha. FADN size group > 400 ha was divided into size groups 400–< 1,000 ha and > 1,000 ha to characterise the largest agricultural land users. These size groups are presented in Tables 2 and 3. More detailed information about three producers are presented in Figs 4 and 5.



**Figure 1.** Location of Estonia (study area) in Europe and its administrative division (Jürgenson & Rasva, 2020).

There are currently 15 counties in Estonia, according to its administrative division (Fig. 1). This study is based on the division that existed before 01.01.2018. After administrative-territorial reform, the division was revised, and with it, the borders of counties also altered to some extent. The administrative division that existed before

---

<sup>2</sup> ARIB is responsible for the delivery of national and EU subsidies for agricultural activities.

<sup>3</sup> <https://maainfo.ee/index.php?page=9&>

01.01.2018 is used because the data from other sources precede the administrative-territorial reform as well.

Information about those 15 counties with their name, area (ha), agricultural land use area (ha) in 2016 and 2011 and the number of land users in 2011 and 2016 is presented in Table 1.

**Table 1.** Data concerning area (ha), agricultural land use area and the number of agricultural land users of the 15 counties in Estonia

County	Area (ha) <sup>1</sup>	Agricultural land use area (ha)		The number of agricultural land users	
		2016	2011	2016	2011
Harjumaa	432,669	71,098	61,417	1,232	1,023
Hiiumaa	103,244	13,957	12,188	364	352
Ida-Virumaa	297,158	36,384	31,028	570	606
Jõgevamaa	254,486	74,817	69,268	1,029	1,117
Järvamaa	267,415	80,544	76,776	785	785
Läänemaa	181,558	52,117	43,052	852	809
Lääne-Virumaa	369,572	109,356	101,711	1,129	1,133
Põlvamaa	182,335	53,310	48,377	1,102	1,212
Pärnumaa	541,873	85,783	78,622	1,535	1,556
Raplamaa	276,506	69,520	64,911	1,129	1,204
Saaremaa	293,765	53,637	46,822	1,200	1,116
Tartumaa	334,931	84,071	75,921	1,248	1,380
Valgamaa	191,709	45,265	41,333	1,144	1,220
Viljandimaa	342,003	85,601	77,829	1,156	1,254
Võrumaa	277,314	52,358	47,781	1,794	2,038
Estonia	4,346,538	967,816	877,036	15,456	16,226

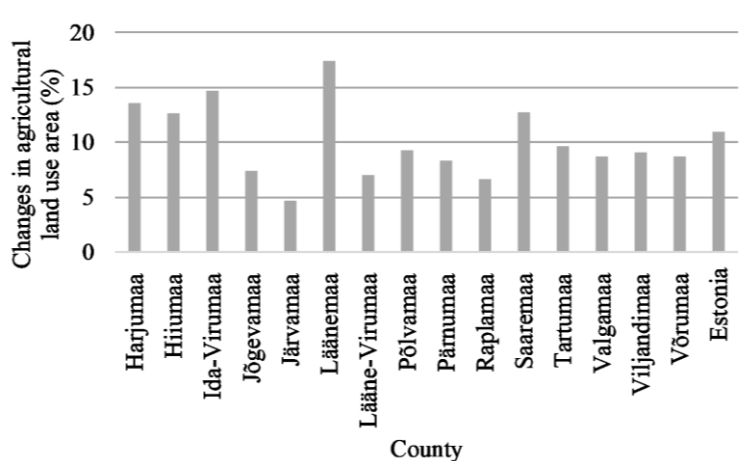
<sup>1</sup> County area (ha) before 01.01.2018.

This study concentrates on agricultural land users' land holdings that cover all plots which are used for agricultural production in Estonia. No distinction is made between land in ownership and leasehold land. Also, no differentiation was made between different production groups.

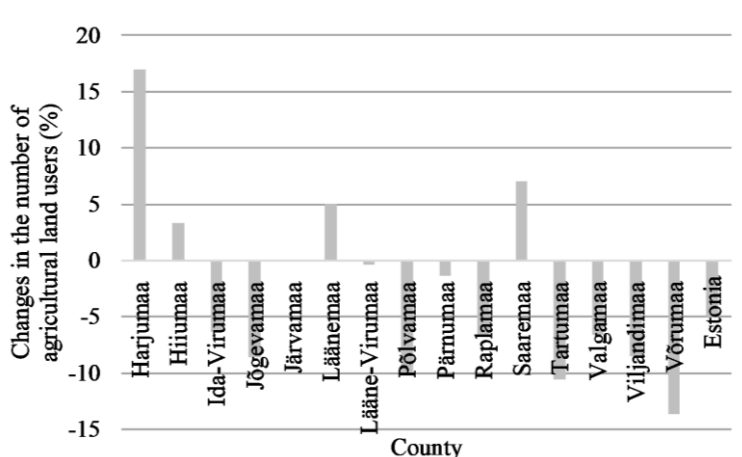
## RESULTS

According to ARIB data, agricultural land use area in Estonia has grown 11% between 2011 and 2016; the growth has taken place in all counties (Fig. 2). The largest growth of agricultural land use is in Läänemaa county (21%) and the smallest in the county of Järvamaa (5%).

The number of land users between 2011 and 2016 (Fig. 3) has dropped in nine counties (Ida-Viru, Jõgeva, Põlva, Pärnu, Rapla, Tartu, Valga, Viljandi, and Võru), representing a 5% drop. The number of land users has increased in four counties (Harju, Hiiu, Lääne, and Saare) and it is almost same in two counties (Järva and Lääne-Viru). The most significant drop in the number of agricultural land users took place in the county of Võrumaa (-12%); the largest increase in the number of agricultural land users took place in the county of Harjumaa (17%).



**Figure 2.** Changes (%) in agricultural land use area in counties between 2011 and 2016 (ARIB).



**Figure 3.** Changes (%) in the number of agricultural land users in counties between 2011 and 2016 (ARIB).

The majority of the producers in counties are in size group 2–< 40 ha (Table 2). The number of producers in size group 2–< 40 ha is the largest (1,338) in Võru county and smallest (249) in Hiiu county. The number of producers using land in size group >1,000 ha is the smallest in every county. The largest number (25) of producers in size group >1,000 ha is in Järva county. In Hiiu county, there are no producers using land over 1,000 ha. There are also very few producers in counties in size group 400–< 1,000 ha (in total 546). Producers division into size groups 0–< 2 ha, 40–< 100 ha and 100–< 400 ha is quite similar all over Estonia.

**Table 2.** Division of the agricultural users according to size groups in counties in 2016 (ARIB)

County	Number of agricultural land users in size groups					
	0–< 2	2–< 40	40–< 100	100–< 400	400–< 1,000	> 1,000
Harjumaa	79	845	119	129	47	14
Hiiumaa	33	249	43	32	7	0
Ida-Virumaa	52	375	52	63	21	8
Järvamaa	63	486	88	93	38	25
Jõgevamaa	92	691	93	97	39	23
Lääne-Virumaa	72	684	130	153	65	22
Läänemaa	48	568	91	105	34	8
Pärnumaa	115	1,058	152	152	44	13
Põlvamaa	153	691	104	111	44	11
Raplamaa	69	747	144	115	39	13
Saaremaa	110	850	121	93	18	8
Tartumaa	126	821	113	115	51	23
Valgamaa	81	831	104	87	30	11
Viljandimaa	80	766	125	124	43	19
Võrumaa	187	1,338	116	121	26	7
Estonia	1,360	11,000	1,595	1,590	546	205

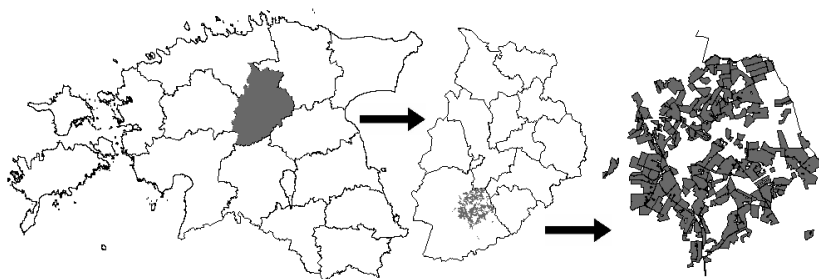
The largest area of agricultural land is used by land users in size groups 400–< 1,000 ha (in total 237,671 ha) and 100–< 400 ha (in total 260,957 ha) (Table 3). In counties like Järva, Jõgeva, Viljandi, Lääne-Viru and Tartu, land users in size groups 400–< 1,000 ha and >1,000 ha are using over 50% of the agricultural land. Most of the agricultural land in Estonia is used by size groups 100–< 400 ha, 400–< 1,000 ha, and > 1,000 ha (in total 750,739 ha). A small part of the agricultural land in counties is used by those in size group 0–< 2 ha, 2–< 40 ha and 40–< 100 ha (in total 217,077 ha).

**Table 3.** Division of agricultural land use between the land users in different size groups in counties in 2016 (ARIB)

County	Agricultural land use area in size groups (ha)					
	0–< 2	2–< 40	40–< 100	100–< 400	400–< 1,000	> 1,000
Harjumaa	112	9,790	6,403	21,507	22,745	10,540
Hiiumaa	51	2,696	2,662	5,652	2,896	0
Ida-Virumaa	77	3,741	3,133	9,859	9,257	10,334
Järvamaa	93	6,343	4,766	15,127	11,727	43,377
Jõgevamaa	135	7,511	5,083	16,158	14,551	31,471
Lääne-Virumaa	106	8,115	8,143	27,074	32,361	32,827
Läänemaa	71	6,787	5,196	18,040	14,402	7,832
Pärnumaa	175	12,286	9,136	25,180	20,362	18,380
Põlvamaa	228	6,884	5,600	13,470	16,773	10,649
Raplamaa	103	9,433	9,069	19,201	15,938	15,658
Saaremaa	166	9,491	7,353	16,172	11,001	9,454
Tartumaa	185	8,397	6,616	19,331	25,488	23,995
Valgamaa	125	8,886	5,565	12,689	10,563	7,170
Viljandimaa	120	9,331	7,696	23,333	19,478	25,646
Võrumaa	279	12,266	6,671	18,165	10,131	4,783
Estonia	2,026	121,959	93,092	260,957	237,671	252,111

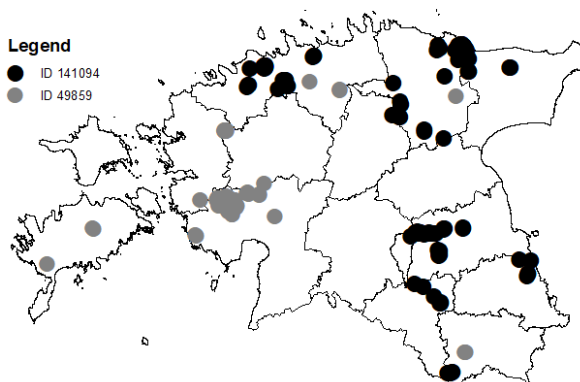
The area of land holdings varies a lot. For example, there were land holdings from 0.1 ha up to 5,756 ha in the year 2011. In 2011 the largest agricultural landholding was in the county of Järvamaa; it used 5,756 ha of land. The smallest was in the county of Harjumaa, and it used 0.1 ha of land. In 2016 the largest landholding was still the same as in 2011 and it used 5,523 ha land in the county of Järvamaa. In Tartumaa county, the smallest agricultural landholding was 0.3 ha in 2016; a different land holder used 0.1 ha of land in 2011. Land users with the smallest landholdings in 2011, and 2016 are self-employed workers, and the largest user is the corporate body.

The largest agricultural landholding area was 5,523 ha in 2016, situated in the county of Järvamaa (Fig. 4). The land plots were scattered over the Türi municipality. The area of these land plots formed 27% of the Türi municipality total land-use area registered in ARIB.



**Figure 4.** The location of the largest agricultural land user land plots in 2016 (ARIB).

While the largest land user in Estonia used land in only one municipality in 2016, some big producers used land throughout Estonia (Fig. 5). For example, land user ID 141094 used 1,341.37 ha of land, which was scattered over 147 plots. This user farmed land in eight different counties (Ida-Viru, Valga, Võru, Tartu, Viljandi, Põlva, Harju, and Lääne-Viru).



**Figure 5.** The location of two agricultural land user (ID 141094 and ID 49859) land plots in 2016 (ARIB).



Land user ID 49859 farmed 1,149.9 ha of land that was scattered over 90 plots. This user farmed land in six different counties (Pärnu, Saare, Võru, Harju, Lääne, and Lääne-Viru) and had land both on the island of Saaremaa and on continental Estonia.

## DISCUSSION AND CONCLUSIONS

While our population is growing, there is also a growing need for food and feed, which puts more pressure on agricultural production. At the same time, agriculture is a significant user of natural resources and greenhouse gas producers (Bruinsma, 2003). As the world's greenhouse gas level continues to rise, it has brought up questions about sustainability in agriculture and its production. The long ongoing debate on which farm structure could lead us to a future of sustainable agriculture and feeds our growing population remains. Some studies (Ren et al., 2019) show that farm size has a substantial influence on agricultural sustainability and supports the idea that large-scale farming has no direct negative impact on the environment. Are family farms the ones that lead us to the future of sustainable agriculture and feed the population, or should we rely on large corporate agricultural businesses or mega-farms? Additional and broader research is needed to formulate a direct answer to this question. In this paper, we aimed to provide ground for further discussions and studies.

As in many parts of the world, Estonia is in an ongoing process of farm size growth. The number of agricultural producers is decreasing, while the average area of agricultural land use per producer is increasing in size (Jürgenson & Rasva, 2020). The increasing competition among farmers has resulted in small and uncompetitive farmers being forced to end their activities; some are not able to find a successor after retirement (Beckers et al., 2018). According to ARIB data, agricultural land area in Estonia has grown 11% between 2011 and 2016, but the number of agricultural producers has dropped 5% in the same period. It shows that agricultural land use area per user has increased. According to OECD 2018 report, one reason is that CAP single area payments encouraged people to reclaim abandoned agricultural land.

From its history, we can see that Estonia has been through significant structural changes that have influenced the country's agriculture. Through different occupation periods and simultaneous reforms, Estonia has come to independence once again and has undertaken the most recent, still unfinished land reform. The land reform law and also the agriculture reform law both favoured agriculture based on small farms. At first, the number of farms in Estonia increased, and many small agricultural producers arose; however, as the years went by, this number has decreased and is still decreasing. According to ARIB data, the largest increase between 2011 and 2016 in the number of agricultural producers took place in Harjumaa (17%). At the same time, the land-use area grew there by 14%.

While the number of agricultural land users in Estonia has dropped, changes at the county level have been in different directions. As the number of land users dropped in nine counties, it increased in four counties and remained almost the same in two counties. The most significant drop in the number of agricultural land users took place in the county of Võrumaa (-12%), where the land area grew 10% at the same time. One possible reason for the change is Võrumaa's location in the southern part of Estonia, far from the capital.

Some studies (Beckers et al., 2018) indicate that farm size will continue to increase, with small farms disappearing. That structural shift to large, more effective agricultural producers is also seen in Estonia. The OECD report (2018) cited that farm consolidation in Estonia in the 2000s led to increase in average farm size and in the number of larger farms. However, analyses presented in this paper show that most producers in Estonian counties are in smaller size groups; most of the agricultural land is indeed used by agricultural producers in size groups 400–< 1,000 ha and >1,000 ha. In counties like Järva, Jõgeva, Viljandi, Lääne-Viru, and Tartu, these land users are using over 50% of the agricultural land. At the same time, the number of producers using land in these size groups is the smallest in every county. This indicates that a small group of agricultural producers is using a large area of agricultural land in Estonia. At the same time a small part of the agricultural land in counties is used by those in size group 0–< 2 ha, 2–< 40 ha and 40–< 100 ha; the number of agricultural land users in those small size groups is the biggest.

Some studies show that small agricultural producers are diversified and contribute more to environmental sustainability, preservation of traditional values, and economic resilience than large ones (Wuepper et al., 2020). It is also essential for rural livelihoods to maintain small farms because agriculture is the largest employer in the world, and small farms typically apply more labour per land unit than larger farms. However, still, today's structural adjustment in agriculture has seen resources shift from smaller and less productive farms to larger ones. This growth for survival will lead to larger farms, sometimes creating larger parcels, and this upscaling may lead to a decrease in landscape diversity and ecological value (Beckers et al., 2018). As in the case of Estonia, the largest agricultural producer in 2016 was using 27% of agricultural land located in the Türi municipality. While this user was using agricultural land within one municipality, some large agricultural producers are using land plots scattered throughout Estonia (some plots even on the island of Saaremaa).

History has shown us that from one point forward; large farms are no longer sustainable. As large state farms in the Soviet Union period collapsed, there is a need to think forward about what the future could hold for today's large agricultural producers. Future agricultural production must guarantee food security for the world's growing population. Productive yet sustainable agriculture is essential.

## REFERENCES

- Beckers, V., Beckers, J., Vanmaercke, M., Van Hecke, E., Van Rompaey, A. & Dendoncker, N. 2018. Modelling Farm Growth and Its Impact on Agricultural Land Use: A Country Scale Application of an Agent-Based Model. *Land* 7(3), 19. <https://doi.org/https://doi.org/10.3390/land7030109>
- Bruinsma, J. 2003. *World agriculture: towards 2015/2030. An FAO perspective*. Retrieved from <http://www.fao.org/3/a-y4252e.pdf>
- Constantin, C., Luminița, C. & Vasile, A.J. 2017. Land grabbing: A review of extent and possible consequences in Romania. *Land Use Policy* 62, 143–150. <https://doi.org/10.1016/J.LANDUSEPOL.2017.01.001>
- Dell'Angelo, J., D'Odorico, P., Rulli, M.C. & Marchand, P. 2017. The Tragedy of the Grabbed Commons: Coercion and Dispossession in the Global Land Rush. *World Development* 92, 1–12. <https://doi.org/10.1016/J.WORLDDEV.2016.11.005>
- GIZ. 2012. What is sustainable agriculture, pp. 32.

- Glenn, S. Scottish, L.C., MacKessack-Leitch, J. Scottish, L.C., Glass, J. Scotland's, R.C. & McMorran, R. Scotland's, R.C. 2019. *Investigation into the Issues Associated with Large scale and Concentrated Landownership in Scotland*. Retrieved from [https://www.researchgate.net/profile/Jayne\\_Glass/publication/333132708\\_Investigation\\_into\\_the\\_Issues\\_Associated\\_with\\_Large\\_scale\\_and\\_Concentrated\\_Landownership\\_in\\_Scotland\\_Investigation\\_into\\_the\\_Issues\\_Associated\\_with\\_Large\\_scale\\_Concentrated\\_Landownersh](https://www.researchgate.net/profile/Jayne_Glass/publication/333132708_Investigation_into_the_Issues_Associated_with_Large_scale_and_Concentrated_Landownership_in_Scotland_Investigation_into_the_Issues_Associated_with_Large_scale_Concentrated_Landownersh)
- Graeb, B.E., Chappell, M.J., Wittman, H., Ledermann, S., Kerr, R.B. & Gemmill-Herren, B. 2016. The State of Family Farms in the World. *World Development* **87**, 1–15. <https://doi.org/10.1016/J.WORLDDEV.2015.05.012>
- Grubbström, A. 2011. Emotional bonds as obstacles to land sale—Attitudes to land among local and absentee landowners in Northwest Estonia. *Landscape and Urban Planning* **99**(1), 31–39. <https://doi.org/10.1016/J.LANDURBPLAN.2010.08.010>
- Grubbström, A. & Sooväli-Sepping, H. 2012. Estonian family farms in transition: a study of intangible assets and gender issues in generational succession. *Journal of Historical Geography* **38**(3), 329–339. <https://doi.org/10.1016/j.jhg.2012.03.001>
- Hubert, C. 2018. Capital/Labour separation in French agriculture: The end of family farming? *Land Use Policy* **77**, 553–558. <https://doi.org/10.1016/J.LANDUSEPOL.2018.05.062>
- IAMO. 2017. Large scale agriculture gains in importance globally. (n.d.). Retrieved October 31, 2019, from <https://www.largescaleagriculture.com/home/news-details/large-scale-agriculture-gains-in-importance-globally/>
- Jürgenson, E. 2016. Land reform, land fragmentation and perspectives for future land consolidation in Estonia. *Land Use Policy* **57**, 34–43. <https://doi.org/10.1016/j.landusepol.2016.04.030>
- Jürgenson, E. 2017. *Implementation of the Land Reform in Estonia: Institutional Arrangement, Speed of Implementation and Land Plot Fragmentation* (Estonian University of Life Sciences). Retrieved from [https://dspace.emu.ee/xmlui/bitstream/handle/10492/3695/Evelin\\_Jürgenson\\_2017DO\\_T\\_T\\_äistekst.pdf?sequence=1&isAllowed=y](https://dspace.emu.ee/xmlui/bitstream/handle/10492/3695/Evelin_Jürgenson_2017DO_T_T_äistekst.pdf?sequence=1&isAllowed=y)
- Jürgenson, E. & Rasva, M. 2020. *Agricultural Land Holdings in Estonia and Possible Threat for Rural Areas*. <https://doi.org/https://doi.org/10.3390/land9020041>
- Kasepalu, A. 1991. *Mis peremees jätab, selle mets võtab* (E. Pajusalu, Ed.). Tallinn: Eesti teaduste Akadeemia Majanduse Instituut.
- Lillak, R. 2003. *Eesti põllumajanduse ajalugu*. Tartu: Trükikoda Trükipunkt.
- Llambí, L. 2010. The Future of Small Farms. *World Development* **38**(10), 1341–1348. <https://doi.org/10.1016/J.WORLDDEV.2009.06.013>
- Lowder, S.K., Scoet, J. & Raney, T. 2016. The Number, Size, and Distribution of Farms, Smallholder Farms, and Family Farms Worldwide. *World Development* **87**, 16–29. <https://doi.org/10.1016/J.WORLDDEV.2015.10.041>
- Monbiot, G., Grey, R., Kenny, T., Macfarlane, L., Powell-Smith, A., Shrubsole, G. & Stratford, B. 2018. *Land: For the many, not the few? Limitations on the Scale of Land Ownership*. Retrieved from [https://labour.org.uk/wp-content/uploads/2019/06/12081\\_19-Land-for-the-Many.pdf](https://labour.org.uk/wp-content/uploads/2019/06/12081_19-Land-for-the-Many.pdf)
- OECD Food and Agricultural Reviews Innovation, Agricultural Productivity and Sustainability in Estonia. 2018. OECD Publishing.
- Pöder, A. 2017. *The Socio-Economic Determinants of Entrepreneurship in Estonian Rural Municipalities* (Estonian University of Life Sciences). Retrieved from [https://dspace.emu.ee/xmlui/bitstream/handle/10492/3707/Anne\\_Pöder\\_DO2017.pdf?sequence=1&isAllowed=y](https://dspace.emu.ee/xmlui/bitstream/handle/10492/3707/Anne_Pöder_DO2017.pdf?sequence=1&isAllowed=y)
- Pöldaru, R., Viira, A.-H. & Roots, J. 2018. Optimization of arable land use to guarantee food security in Estonia. *Agronomy Research* **16**(4), 1837–1853. <https://doi.org/https://doi.org/10.15159/AR.18.161>

- Rada, N.E. & Fuglie, K.O. 2019. New perspectives on farm size and productivity. *Food Policy* **84**, 147–152. <https://doi.org/10.1016/J.FOODPOL.2018.03.015>
- Ren, C., Liu, S., van Grinsven, H., Reis, S., Jin, S., Liu, H. & Gu, B. 2019. The impact of farm size on agricultural sustainability. *Journal of Cleaner Production* **220**, 357–367. <https://doi.org/10.1016/J.JCLEPRO.2019.02.151>
- Ricciardi, V., Ramankutty, N., Mehrabi, Z., Jarvis, L. & Chookolingo, B. 2018. How much of the world's food do smallholders produce? *Global Food Security* **17**, 64–72. <https://doi.org/10.1016/J.GFS.2018.05.002>
- Rosenberg, T. 2019. *Eesti põllumajanduse 100 aastat* (K. Müller & E. Toots, Eds.). Tallinn: Printon, pp. pp. 224.
- Sheng, Y. & Chancellor, W. 2018. Exploring the relationship between farm size and productivity: Evidence from the Australian grains industry. *Food Policy*. <https://doi.org/10.1016/J.FOODPOL.2018.03.012>
- United Nations. 2019. The Sustainable Development Goals Report. (n.d.). Retrieved from <https://unstats.un.org/sdgs/report/2019/The-Sustainable-Development-Goals-Report-2019.pdf>
- United Nations. Food and Agriculture : The future of sustainability Food and Agriculture : The future of sustainability. (n.d.). Retrieved from [https://sustainabledevelopment.un.org/content/documents/agriculture\\_and\\_food\\_the\\_future\\_of\\_sustainability\\_web.pdf](https://sustainabledevelopment.un.org/content/documents/agriculture_and_food_the_future_of_sustainability_web.pdf)
- United Nations. Sustainable Development Goals. Goal 2: Zero Hunger. (n.d.). Retrieved October 31, 2019. from <https://www.un.org/sustainabledevelopment/hunger/>
- van der Sluis, T., Pedroli, B., Kristensen, S.B.P., Lavinia Cosor, G. & Pavlis, E. 2016. Changing land use intensity in Europe – Recent processes in selected case studies. *Land Use Policy* **57**, 777–785. <https://doi.org/10.1016/J.LANDUSEPOL.2014.12.005>
- van Dijk, T. 2007. Complications for traditional land consolidation in Central Europe. *Geoforum*, **38**(3), 505–511. <https://doi.org/10.1016/J.GEOFORUM.2006.11.010>
- Viira, A.-H. 2014. *Structural adjustment of Estonian agriculture – the role of institutional changes and socioeconomic factors of farm growth, decline and exit* (Estonian University of Life Sciences). Retrieved from [https://dspace.emu.ee/xmlui/bitstream/handle/10492/1419/Ants-Hannes\\_Viira\\_DO2014.pdf?sequence=2&isAllowed=y](https://dspace.emu.ee/xmlui/bitstream/handle/10492/1419/Ants-Hannes_Viira_DO2014.pdf?sequence=2&isAllowed=y)
- Wuepper, D., Wimmer, S. & Sauer, J. 2020. Is small family farming more environmentally sustainable? Evidence from a spatial regression discontinuity design in Germany. *Land Use Policy* **90**, 104360. <https://doi.org/10.1016/J.LANDUSEPOL.2019.104360>

## **Potential for macro and micronutrients extraction from tomato plants with different soil water stresses**

R.R. Rodrigues<sup>1</sup>, S.C. Pizetta<sup>1</sup>, G.M. Pereira<sup>1</sup>, M.E.P.C. Jaeggi<sup>2</sup>, R.S. Rocha<sup>2,\*</sup>,  
I.M. Pereira<sup>2</sup>, D.P. Cruz<sup>2</sup>, J.N. Batista<sup>2</sup>, R.K.G. Silva<sup>2</sup>, P.M. Bernardes<sup>3</sup>,  
A.S. Fonseca<sup>4</sup>, G.C. Entringer<sup>2</sup> and G.A. Gravina<sup>2</sup>

<sup>1</sup>Federal University of Lavras (FULA). Aquenta Sol, Lavras - MG, 37200-000, Brazil

<sup>2</sup>State University of North Fluminense / Postgraduate Program in Plant Production. Av. Alberto Lamego, 2000. Parque California, 28035-200, Campos dos Goytacazes, RJ, Brazil

<sup>3</sup>Belo Monte Agricultural Family School, 29400-000, Mimoso do Sul – ES, Brazil

<sup>4</sup>Ibitirama family Agricola school, 29540-000, Ibitirama – ES, Brazil

\*Correspondence: richardson\_sales@hotmail.com

**Abstract.** Different tomato cultivars may present differentiated water needs, making it indispensable to study water demand. Thus, the objective of this work was to evaluate the influence of six water stresses in the soil on the extraction potential of macro and micronutrients in the aerial part of tomato in vegetative stage, cultivar ‘Dominador’ F1, under protected cultivation and drip. The experiment was installed in a greenhouse with a randomized block design with four replications. The treatments consisted of six soil water stresses as indicative of the time of irrigation. The preset stresses were 20, 45, 70, 95, 120 and 145 kPa at 20 cm depth. At 140 days after transplanting, the variables evaluated were: the macro and micronutrient content of shoots. The results showed that to obtain higher levels of macro (P and S) and micronutrients (B and Cu) of the total aerial part of the ‘Dominador’ tomato plant F1, it was obtained at a voltage of 20 kPa, and its value was reduced linearly with the increase of the water tension in the soil.

**Key words:** *Solanum lycopersicon* L., production, quality.

### **INTRODUCTION**

Tomato (*Solanumly copersicon* L.) is one of the most cultivated vegetables in the world. Its fruits contain a large amount of water (93 to 95%), and the practice of irrigation is indispensable for its cultivation. It is one of the most demanding vegetables in the water, and the moisture content of the soil should show little variation. Both excess and water deficit are harmful to culture (Chitarra & Chitarra, 2005; Alvarenga et al., 2013).

Available water and soil fertility are among the main factors that affect crop productivity. Therefore, in the development of the tomato production system, irrigation management is extremely important. This practice increases the yield of the cultivated area, produces fruits with better quality and increases the efficiency of the absorption of macro and micronutrients by plants (Carrijo et al., 2004; Mantovani et al., 2009).

The main damages caused by inadequate irrigation management in tomatoes are morphological damages, such as: cracks, apical rot, fall of flowers and fruits, hollow fruits, less dry matter production, physiological changes due to the lack of absorption of nutrients that affect the nutritional quality of fruits. tomato, among other damages (Sun et al., 2013; Hott et al., 2014; Kuşçu et al., 2014).

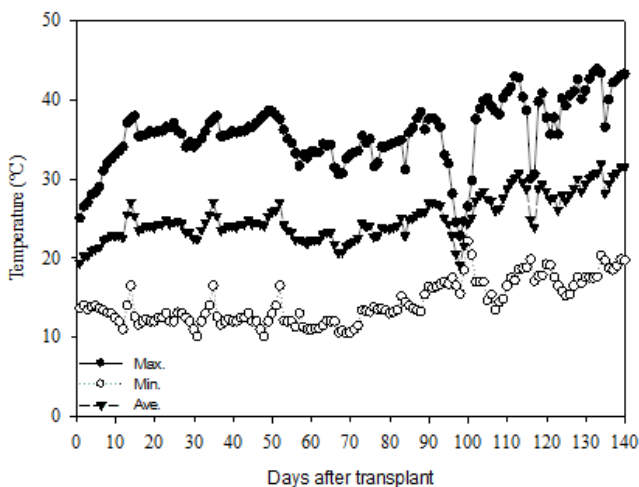
The study of adequate irrigation management cannot be generalized for tomatoes, as each cultivar responds differently to the water content in the soil. According to Marouelli et al. (2012), the recommended water stress in the soil to restart irrigation varies from 30 to 70 kPa. This variation in water tension in the soil demonstrates the need for more specific studies for tomatoes, as there are different responses between cultivars.

Morales (2012), when assessing the resistance to water deficit in 20 tomato families, observed greater fruit production, productivity, apical rot and water content in the leaves in some tomato cultivars to the detriment of others. This fact corroborates the importance of studying the water needs for each cultivar.

Thus, the objective of this work was to evaluate the influence of six water stresses in the soil on the extraction potential of macro and micronutrients in the aerial part of tomato in vegetative stage, cultivar Dominador F1, under protected cultivation and drip.

## MATERIAL AND METHODS

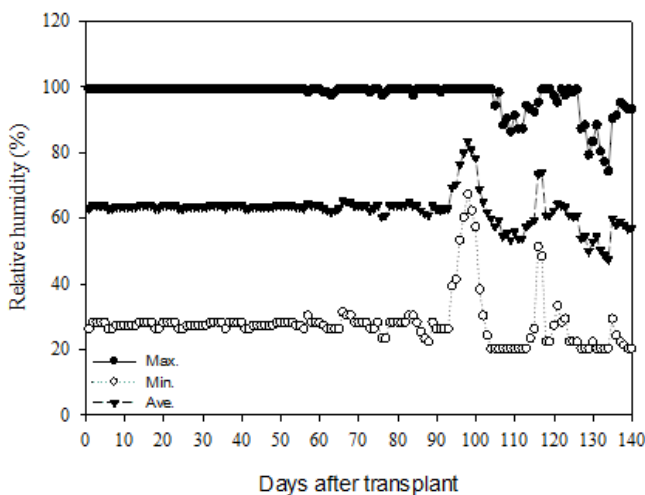
### Characterization of the experimental area



**Figure 1**, Maximum, minimum and average temperature (°C) of the air that occurred inside the greenhouse. UFLA, Lavras, MG, 2015.

The experiment was carried out in a greenhouse (protected environment) located in the experimental area of the Engineering Department of the Federal University of Lavras (UFLA), from March to October 2015. UFLA is located in the municipality of Lavras, south of Minas Gerais, which is at an average altitude of 910 meters, latitude 21°14' S and longitude 45°00' W. Fig. 1 and 2 shows the variation in temperature and relative humidity maximum, minimum and average air respectively inside the greenhouse,

measured throughout the experiment (140 days). The average air temperature inside the greenhouse was 25.0 °C, the minimum mean reached was 14.4 °C and the average maximum was 35.6 °C, resulting in a thermal amplitude of 21.2 °C.



**Figure 2.** Relative humidity (%) average and minimum occurred inside the greenhouse. UFLA, Lavras, MG, 2015.

### Irrigation equipment and management

The drip irrigation system was installed using in-line emitters, self-compensating and distanced by 0.30 m. The emitters presented an average flow rate of 1.74 L h<sup>-1</sup> with pressure of 1.95 kgf cm<sup>-2</sup>. Since each experimental plot was composed of two rows of plants, spaced at 1.0 m, in each line a drip tube was installed in order to provide water to the plants, that is, in each experimental plot two drip tubes were required.

A solenoid valve was used for each treatment. These valves were actuated by a controller previously programmed in each irrigation to function as long as necessary to replenish the blade indirectly estimated by the moisture sensors. In all irrigations, the humidity corresponding to the tension verified at the time of irrigation was increased to the field capacity.

The calculation of the operating time of the irrigation system in each treatment was made based on the installed humidity sensors. The moment of irrigation was established when four sensors, of six installed (three in block 1 and 2), presented the corresponding tension of the treatment, obtaining the mean reading. Irrigation management was performed based on soil moisture, using granular matrix sensors (watermark) and a matrix potential meter. All sensors used were previously tested. The net, crude depth and the operating time of the irrigation system, used to raise the current soil moisture to the field capacity, was determined by Eq. 1, 2 and 3, respectively.

$$LL = (\theta_{CC} - \theta_{atual}) z \tag{1}$$

$$LB = \frac{LL}{Ea CUD} \tag{2}$$

$$T = \frac{LB A}{e q a} \quad (3)$$

In which:  $LL$  = Liquid irrigation depth (mm);  $\theta_{cc}$  = Humidity in field capacity ( $\text{cm}^3 \text{cm}^{-3}$ );  $\theta$  actual = Current humidity ( $\text{cm}^3 \text{cm}^{-3}$ );  $Z$  = Effective depth of the root system (mm);  $LB$  = Crude irrigation depth (mm);  $Ea$  = Water application efficiency by irrigation system (dimensional) ( $Ea$  used = 95%);  $CUD$  = Uniformity coefficient of distribution of the irrigation system (dimensional);  $T$  = Irrigation time to raise soil moisture to field capacity (h);  $A$  = area occupied by the plant ( $\text{m}^2$ );  $qa$  = average flow of emitters ( $\text{L h}^{-1}$ );  $e$  = number of emitters per plant (two).

For the determination of the  $CUD$  (Eq. 4), the uniformity of water application in one of the treatments randomly chosen was evaluated, using the mean of four repetitions (four blocks). For this, the flow rates of the 16 emitters contained in the plot were collected. The  $CUD$  value found was 98%.

$$CUD = 100 \frac{q_{25}}{q_m} \quad (4)$$

In which:  $q_{25}$  = average value of the 25% lower flows observed,  $\text{L h}^{-1}$ ;  $q_m$  = mean flow of drippers,  $\text{L h}^{-1}$ . The initial irrigation management before the differentiation of the treatments, up to 18 days after the seedling snare, was performed with watermark sensors, whose critical stress established for the beginning of irrigations was 13 kPa, thus trying to maintain soil moisture, close to the field capacity.

#### Voltages and water depths applied

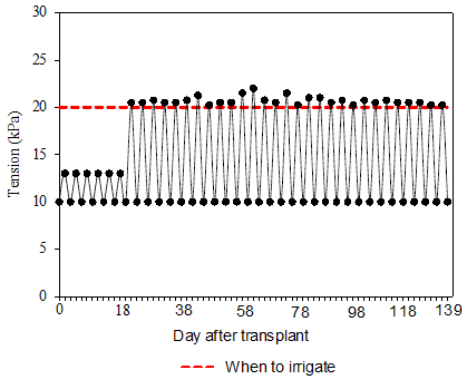
Table 1 presents data on the management of irrigation (treatments) of tomato during the experiment. For this, the applied blade was calculated based on two depths, being 20 cm until the end of flowering and 40 cm after flowering (Alvarenga, 2013).

**Table 1.** Water stresses in the applied soil (kPa stress), blades applied before differentiating the treatments (1), during the cycle (2), total (3), mean by irrigation (4), mean interval between irrigations (5) and number of irrigations (6). UFLA, Lavras, MG, 2015

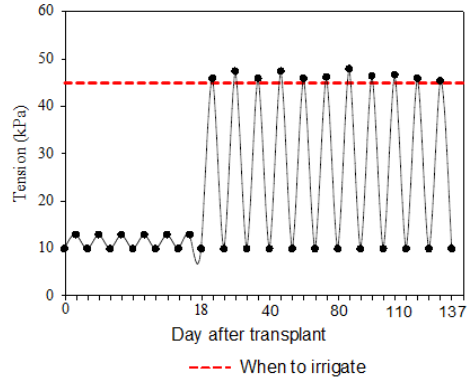
Tension (kPa)	Blade (mm)				5 (days)	6
	1	2	3	4		
20 (T1)	38.58	877.87	916.45	28.32	3.9	31
45 (T2)	38.58	481.24	519.82	43.75	10.7	11
70 (T3)	38.58	251.73	290.31	50.35	22.4	5
95 (T4)	38.58	159.39	197.97	53.13	33.3	3
120 (T5)	38.58	107.32	145.90	53.66	45	2
145 (T6)	38.58	108.57	147.15	54.28	49	2

In order to establish the crop, irrigations were made whenever the soil moisture sensor ('watermark') charged an average voltage of 13 kPa, resulting in a blade of 38.58 mm at 18 days after transplantation. On the 18th day after transplantation, the last irrigation of establishment was made and the differentiation of the treatments was initiated. The total water replaced by the crop throughout the cycle for each treatment was 916.45 mm (T1), 519.82 mm (T2), 290.31 mm (T3), 197.97 mm (T4), 145.90 mm (T5) and 147.15 mm (T6). Figs 3, 4, 5, 6, 7 and 8 show the average stresses recorded by the humidity sensors, installed at a depth of 20 cm, used for decision making and calculation of the applied irrigation depth.

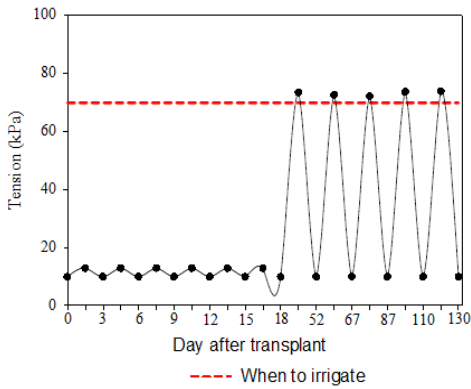




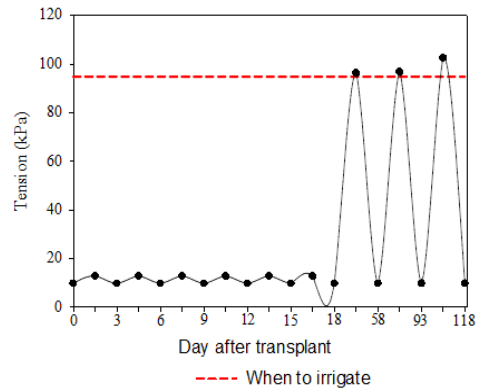
**Figure 3.** Variation of soil water stresses in treatment T1 (20 kPa) during conduction of the experiment. UFLA, Lavras, MG, 2015.



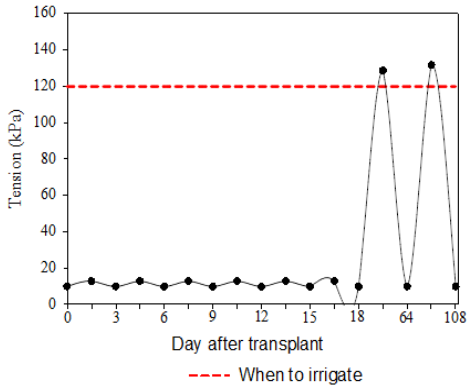
**Figure 4.** Variation of soil water stresses in the T2 treatment (45 kPa) during the conduction of the experiment. UFLA, Lavras, MG, 2015.



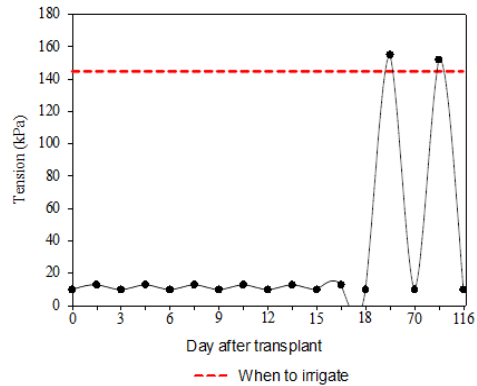
**Figure 5.** Variation of soil water stresses in the T3 treatment (70 kPa) during the conduction of the experiment. UFLA, Lavras, MG, 2015.



**Figure 6.** Variation of soil water stresses in T4 (95 kPa) during the conduction of the experiment. UFLA, Lavras, MG, 2015.



**Figure 7.** Variation of soil water stresses in the T5 treatment (120 kPa) during the conduction of the experiment. UFLA, Lavras, MG, 2015.



**Figure 8.** Variation of soil water stresses in the T6 treatment (145 kPa) during the conduction of the experiment. UFLA, Lavras, MG, 2015.

### **Design and experimental assembly**

A randomized complete block design (RCB) was used, with six (6) treatments and four (4) repetitions. The treatments consisted of six soil water stresses, as an indication of restarting irrigations (20, 45, 70, 95, 120 and 145 kPa). Four (4) granular matrix sensors (Granular Matrix Sensor, GMS, watermark® model 200SS) were installed, 3 (three) 'watermark' at 20cm of soil depth, which served as indirect indicators in each plot to know on when and how much to irrigate (decision sensors), and 1 (one) to 40 cm deep to only monitor soil moisture, at this depth, using the spacing between 60 cm sensors.

Each experimental plot was 1.40 m wide and 2.90 m long (4.06 m<sup>2</sup>). The experimental plots were composed of two rows of plants spaced 1.0 m between them and 0.60 m between plants. Useful plots were considered those composed by the central plants (four plants), because, in the total of 8 plants that composed each experimental plot, 4 plants were discarded, two plants at each end, aiming to reduce the border effect. The spacing between the plots was 0.80 m.

### **Macro and micronutrient content of shoots**

To obtain the levels of macro (N, P, K, Ca, Mg and S) and micronutrients (B, Cu, Mn, Zn and Fe) of the aerial part of the tomato, the plant was also divided into three thirds (lower, middle and upper). The content of the elements of the total shoot was obtained by the sum of the three thirds of the plant. Samples were taken from leaves and stem for drying in an oven at 65 ~ 70 °C until constant weight. The samples were crushed in a Wiley knife mill, conditioned in paper bags and taken to the Foliar Analysis Laboratory of the UFLA Chemistry Department, and the contents of the elements were determined by the methodology of Sarruge & Haag (1974) adapted by the laboratory.

### **Statistical analysis**

The statistical analysis of the data included the analysis of variance with the f test and regression analyses at 5% and 1% probability.

## **RESULTS AND DISCUSSION**

### **Macro and micronutrient content of shoots**

Tables 2, 3 and 4 present the abstracts of variance and regression analyses for the macronutrient contents of the lower, middle and upper third, respectively, of the Dominating Tomato F1 submitted to different water stresses in the soil. Table 5 shows this analysis for the total aerial part of the plant. According to the analysis, it was noted that there was no significant effect among treatments for macronutrient levels N, K, Ca and Mg in the three thirds of the plant and in the whole plant (mean of 5.59; 2.96; 9.12 and 1.73% - equivalent to 55.9; 29.6 and 17.3 g kg<sup>-1</sup> - for N, K, Ca and Mg, respectively). There was significant effect only for element P in the three thirds of the plant. And for element S the effect of the treatments was significant only in the lower third of the plant.

The results obtained in this study indicate that tomatoes require the same amounts of water to extract nutrients for the lower third and total plant. The best vegetative development of the tomato occurred at a tension of 20 kPa. however, the tomato has a lower water demand in the vegetative stage. The lower water consumption may be associated with the low evapotranspiration surface of the tomato during the vegetative period (Duarte et al., 2010).

**Table 2.** Summary of variance and regression analysis for macronutrient content of the lower third of Dominator Tomato F1, submitted to different water stresses in the soil

Source of Variation	D. F	M. S.					
		N	P	K	Ca	Mg	S
Tension	5	0.29 <sup>ns</sup>	0.01 <sup>**</sup>	0.03 <sup>ns</sup>	0.25 <sup>ns</sup>	0.00 <sup>ns</sup>	0.08 <sup>**</sup>
Block	2	0.29 <sup>ns</sup>	0.00 <sup>ns</sup>	1.11 <sup>**</sup>	0.28 <sup>ns</sup>	0.01 <sup>**</sup>	0.08 <sup>*</sup>
Residue	10	0.10	0.00	0.03	0.11	0.00	0.01
Mean (%)	-	1.78	0.13	1.09	3.10	0.58	0.62
C. V. (%)	-	17.83	17.19	15.76	10.66	4.51	18.54
Linear	1	-	0.05 <sup>**</sup>	-	-	-	0.31 <sup>**</sup>
Quadratic	1	-	0.01 <sup>**</sup>	-	-	-	0.05 <sup>ns</sup>
Cubic	1	-	0.00 <sup>ns</sup>	-	-	-	0.01 <sup>ns</sup>
Deviation	2	-	0.00 <sup>ns</sup>	-	-	-	0.00 <sup>ns</sup>
Residue	10	-	0.00	-	-	-	0.01

\*and\*\* significant at 5 and 1% probability by the F test, respectively; <sup>ns</sup>not significant. UFLA, Lavras, MG, 2015.

**Table 3.** Summary of variance and regression analysis for macronutrient content of the middle third of Dominator Tomato F1, submitted to different water stresses in the soil

Source of Variation	D. F	M. S.					
		N	P	K	Ca	Mg	S
Tension	5	0.22 <sup>ns</sup>	0.00 <sup>**</sup>	0.07 <sup>ns</sup>	0.14 <sup>ns</sup>	0.00 <sup>ns</sup>	0.03 <sup>ns</sup>
Block	2	0.29 <sup>ns</sup>	0.00 <sup>ns</sup>	0.41 <sup>**</sup>	0.13 <sup>ns</sup>	0.01 <sup>**</sup>	0.02 <sup>ns</sup>
Residue	10	0.08	0.00	0.05	0.16	0.00	0.01
Mean (%)	-	1.91	0.13	0.95	3.21	0.59	0.61
C. V. (%)	-	15.12	16.69	24.27	12.35	6.29	20.46
Linear	1	-	0.02 <sup>**</sup>	-	-	-	-
Quadratic	1	-	0.00 <sup>**</sup>	-	-	-	-
Cubic	1	-	0.00 <sup>ns</sup>	-	-	-	-
Deviation	2	-	0.00 <sup>ns</sup>	-	-	-	-
Residue	10	-	0.00	-	-	-	-

\*and\*\* significant at 5 and 1% probability by the F test, respectively; <sup>ns</sup>not significant. UFLA, Lavras, MG, 2015.

**Table 4.** Summary of variance and regression analysis for macronutrient content of the upper third of Dominator Tomato F1, submitted to different water stresses in the soil

Source of Variation	D. F	M. S.					
		N	P	K	Ca	Mg	S
Tension	5	0.22 <sup>ns</sup>	0.00 <sup>**</sup>	0.18 <sup>ns</sup>	0.17 <sup>ns</sup>	0.00 <sup>ns</sup>	0.03 <sup>ns</sup>
Block	2	0.16 <sup>ns</sup>	0.00 <sup>ns</sup>	0.37 <sup>**</sup>	0.01 <sup>ns</sup>	0.01 <sup>**</sup>	0.04 <sup>ns</sup>
Residue	10	0.10	0.00	0.07	0.11	0.00	0.01
Mean (%)	-	1.90	0.12	0.92	2.81	0.56	0.54
C. V. (%)	-	17.34	17.81	27.28	11.84	4.50	21.23
Linear	1	-	0.03 <sup>**</sup>	-	-	-	-
Quadratic	1	-	0.00 <sup>ns</sup>	-	-	-	-
Cubic	1	-	0.00 <sup>ns</sup>	-	-	-	-
Deviation	2	-	0.00 <sup>ns</sup>	-	-	-	-
Residue	10	-	0.00	-	-	-	-

\*and\*\* significant at 5 and 1% probability by the F test, respectively; <sup>ns</sup>not significant. UFLA, Lavras, MG, 2015.

**Table 5.** Summary of variance and regression analysis for the macronutrient content of the total aerial part of the Dominator Tomato F1, submitted to different soil water stresses

Source of Variation	D. F.	M. S.					
		N	P	K	Ca	Mg	S
Tension	5	0.53 <sup>ns</sup>	0.07 <sup>**</sup>	0.33 <sup>ns</sup>	1.23 <sup>ns</sup>	0.01 <sup>ns</sup>	0.42 <sup>*</sup>
Block	2	2.16 <sup>**</sup>	0.00 <sup>ns</sup>	5.28 <sup>**</sup>	0.99 <sup>ns</sup>	0.11 <sup>**</sup>	0.44 <sup>**</sup>
Residue	10	0.22	0.00	0.30	0.79	0.00	0.06
Mean (%)	-	5.59	0.38	2.96	9.12	1.73	1.77
C. V. (%)	-	8.38	14.99	18.24	9.75	3.91	13.90
Linear	1	-	0.30 <sup>**</sup>	-	-	-	1.74 <sup>*</sup>
Quadratic	1	-	0.05 <sup>**</sup>	-	-	-	0.23 <sup>ns</sup>
Cubic	1	-	0.00 <sup>ns</sup>	-	-	-	0.03 <sup>ns</sup>
Deviation	2	-	0.00 <sup>ns</sup>	-	-	-	0.04 <sup>ns</sup>
Residue	10	-	0.00	-	-	-	0.06

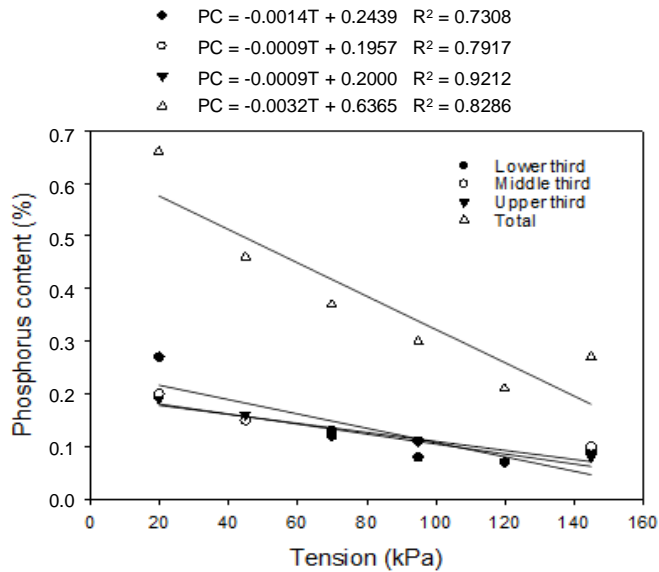
\*and\*\* significant at 5 and 1% probability by the F test, respectively. <sup>ns</sup>not significant. UFLA, Lavras, MG, 2015.

Delazari (2014) also found no significant effect of the applied irrigation depths on the levels of N, Ca and Mg. The values found by this author were between 36.1 to 61.9 g kg<sup>-1</sup> for N, between 56.7 to 66.4 g kg<sup>-1</sup> for Ca and between 5.8 to 8.4 g kg<sup>-1</sup> for Mg. According to Jones Junior (1999), the values considered ideal for tomato is 28 to 60 g kg<sup>-1</sup> for N (2.8 to 6.0%), from 9 to 72 g kg<sup>-1</sup> for Ca (9.0 to 7.2%) and from 4 to 13 g kg<sup>-1</sup> for Mg (0.4 to 1.3%).

The high production of biomass with the highest availability of water can be attributed to one of the processes played by the plant - loss of water through transpiration, to assimilate carbon dioxide (Steduto et al., 2007). Physiologically, CO<sub>2</sub> uptake by the stomatal cell occurs during sweating. However, stomatal closure directly implies phloem sap flow, allowing macro and micronutrient extraction to stagnate, one of the main mechanisms of vegetation to prevent water loss and directly reducing the assimilated photo (Taiz & Zeiger, 2009), which may have contributed to the lower extraction of macro and micronutrients submitted to greater water stress in the soil. (Hott et al., 2018) in studies with tomato crops subjected to a tension of 70 kPa observed less development of the root system with 56.31% compared to 15 kPa (Hott et al., 2014). In addition, (Silva et al., 2014) found an increase of 43% for the dry mass of the roots and 70% for the dry mass of the aerial part, when comparing the highest and lowest water depth.

Therefore, it is noted that the values found in the present study are within the ideal limits, with the exception of Mg, which is slightly above the upper limit of the ideal. When evaluating the macronutrient content in the total shoot, it was noted that the effect was significant only for P and S, not differing among the other treatments. The regression analysis for the phosphorus content in the three thirds of the plant and the total shoot is shown in Fig. 9.

It is noted that the phosphorus content presented decreasing linear behavior with the increase of water tensions in the soil. The highest values, in 20 kPa, were 0.27% in the lower third, 0.20% in the middle third, 0.19% in the upper third and 0.66% in the whole plant (sum of three thirds). When evaluating the total phosphorus content of the plant, it is observed that the minimum content found (0.28%) and the maximum (0.66%) within the limits (0.25 to 0.75%) adequate levels of this element obtained in leaf analysis for tomato crop, according to Embrapa (2006).



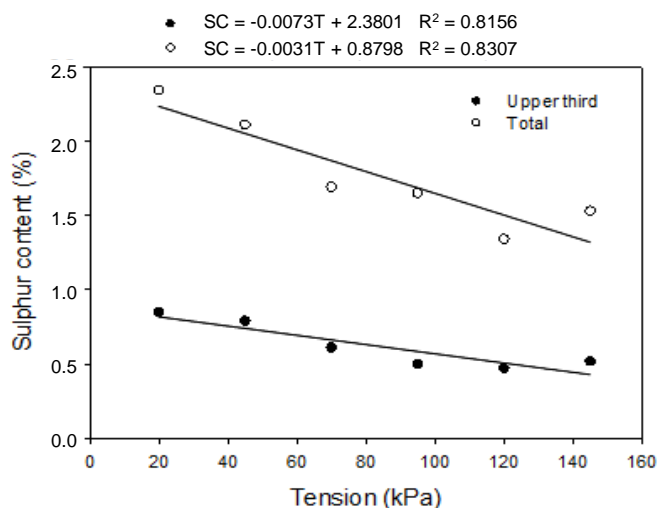
**Figure 9.** Phosphorus content (TP) in the lower, middle, upper and total third of the Dominating Tomato Plant F1 at different soil water stresses (20, 45, 70, 95, 120 and 145 kPa).

This difference was expected because, in water deficit conditions, there is greater root expansion due to the lack of moisture on the soil surface (Taiz & Zeiger, 2009; Nangare et al., 2016). On the other hand, the low availability of water causes a reduction in the leaf area to prevent sweating (Moreira et al., 2012), which may have contributed to the occurrence of greater variations in the extraction of nutrients from the aerial part at high tensions.

Delazari (2014), evaluating irrigation depths and nutrient doses, found a significant effect for irrigation depths on phosphorus content in the leaf of the commercial hybrid tomato carina TY, finding variations between 3.44 to 5.71 g kg<sup>-1</sup> of this nutrient, very close to those found in this study (2.8 to 6.6 g kg<sup>-1</sup>). Fig. 10 presents the regression analysis for the behavior of the sulfur content as a function of water tensions in the soil.

The sulfur content in the lower third and in the whole plant (total) showed a decreasing linear response with the increase of water tensions in the soil. The highest values were obtained in the voltage of 20 kPa (0.85 and 2.34% for the lower and total third of the plant, respectively) and the lowest were observed in the voltage of 145 kPa (0.52 and 1.53%, for the lower and total third of the plant, respectively). According to the equations generated, for both parties evaluated, more than 80% of the variation in sulfur content in the plant according to soil water stresses can be explained by the linear regressions presented.

Evaluating approximate values of stresses along the tomato cycle, Moreira et al., 2012 found that the highest productivity was obtained with the voltage of 28.5 kPa. However, the use of controlled water deficit during the vegetative stage provided the best performance of the tomato (Nangare et al., 2016), while the use of stresses below 35 kPa during the same period can affect the productivity of the plant (Marouelli & Silva, 2007). Therefore, it can be inferred that the best macronutrient extraction potential from tomatoes subjected to 20 kPa.



**Figure 10.** Sulfur content (TS) in the lower, middle, upper and total third of the Dominating Tomato Plant F1 at different soil water stresses (20, 45, 70, 95, 120 and 145 kPa).

Delazari (2014), when evaluating the influence of irrigation depths on the sulfur content on the tomato leaf, found a statistical difference between the treatments, and that the equation estimated by the regression analysis showed that the sulfur content in the leaf fell linearly with the increase of the applied water depth, presenting a content between 5.4 and 12.4 g kg<sup>-1</sup> (0.54 to 1.24%). For the lower third, the present study found values between 5.2 and 8.5 g kg<sup>-1</sup> (0.52 to 0.85%) and for the total shoot the values were higher (between 15.3 and 23.4 g kg<sup>-1</sup>) (1.53 to 2.34%). However, these values are within the considered adequate according to Jones Junior (1999), whose range should be between 3.0 and 42.0 g kg<sup>-1</sup> (0.3 to 4.2%). Tables 6, 7 and 8 present the abstracts of variance and regression analyses for the micronutrient contents of the lower, middle and upper third, respectively, of the Dominating Tomato F1 submitted to different water stresses in the soil. Table 9 shows this analysis for the total aerial part of the plant.

**Table 6.** Summary of variance and regression analysis for micronutrient content of the lower third of the Dominator Tomato F1, submitted to different soil water stresses

Source of Variation	D. F.	M. S.				
		B	Cu	Mn	Zn	Fe
Tension	5	51.06 <sup>ns</sup>	52.48 <sup>**</sup>	9,237.60 <sup>ns</sup>	209.74 <sup>*</sup>	9,433.69 <sup>ns</sup>
Block	2	97.40 <sup>ns</sup>	0.09 <sup>ns</sup>	111.33 <sup>ns</sup>	316.43 <sup>*</sup>	98,456.19 <sup>*</sup>
Residue	10	29.93	5.29	3,332.41	50.86	5,390.66
Mean (mg kg <sup>-1</sup> )	-	18.03	9.09	190.48	45.23	688.93
C. V. (%)	-	30.35	25.31	30.31	15.77	10.66
Linear	1	-	218.68 <sup>**</sup>	-	149.69 <sup>ns</sup>	-
Quadratic	1	-	43.33 <sup>*</sup>	-	201.79 <sup>ns</sup>	-
Cubic	1	-	0.06 <sup>ns</sup>	-	113.62 <sup>ns</sup>	-
Deviation	2	-	0.16 <sup>ns</sup>	-	291.79 <sup>*</sup>	-
Residue	10	-	5.29	-	50.86	-

\*and\*\* significant at 5 and 1% probability by the F test, respectively; <sup>ns</sup>not significant. UFLA, Lavras, MG, 2015.

**Table 7.** Summary of variance and regression analysis for micronutrient content of the middle third of Dominator Tomato F1, submitted to different water stresses in the soil

Source of Variation	D. F.	M. S.				
		B	Cu	Mn	Zn	Fe
Tension	5	106.94*	49.35**	2,614.03 <sup>ns</sup>	95.55 <sup>ns</sup>	19,260.07 <sup>ns</sup>
Block	2	1.85 <sup>ns</sup>	0.49 <sup>ns</sup>	3,967.84 <sup>ns</sup>	124.20 <sup>ns</sup>	43,161.99*
Residue	10	20.45	3.34	3,163.36	152.08	10,485.19
Mean (mg kg <sup>-1</sup> )	-	21.03	9.89	212.77	39.24	697.99
C. V. (%)	-	21.50	18.48	26.43	31.43	14.67
Linear	1	362.74**	181.72**	-	-	-
Quadratic	1	93.99 <sup>ns</sup>	60.47**	-	-	-
Cubic	1	7.23 <sup>ns</sup>	2.35 <sup>ns</sup>	-	-	-
Deviation	2	35.36 <sup>ns</sup>	1.11 <sup>ns</sup>	-	-	-
Residue	10	20.45 <sup>ns</sup>	3.34	-	-	-

\*and\*\* significant at 5 and 1% probability by the F test, respectively; <sup>ns</sup>not significant. UFLA, Lavras, MG, 2015.

**Table 8.** Summary of variance and regression analysis for the micronutrient content of the upper third of the Dominating Tomato F1, submitted to different water stresses in the soil

Source of Variation	D. F.	M. S.				
		B	Cu	Mn	Zn	Fe
Tension	5	73.62 <sup>ns</sup>	31.18**	3,825.98 <sup>ns</sup>	67.16 <sup>ns</sup>	20,720.46 <sup>ns</sup>
Block	2	21.85 <sup>ns</sup>	0.10 <sup>ns</sup>	5,701.31 <sup>ns</sup>	1.78 <sup>ns</sup>	26,810.88 <sup>ns</sup>
Residue	10	35.20	2.41	2,334.39	80.80	14,073.27
Mean (mg kg <sup>-1</sup> )	-	20.95	9.85	193.24	32.93	598.55
C. V. (%)	-	28.32	15.75	25.00	27.30	19.82
Linear	1	-	126.90**	-	-	-
Quadratic	1	-	16.02*	-	-	-
Cubic	1	-	8.25 <sup>ns</sup>	-	-	-
Deviation	2	-	2.34 <sup>ns</sup>	-	-	-
Residue	10	-	2.41	-	-	-

\*and\*\* significant at 5 and 1% probability by the F test, respectively; <sup>ns</sup>not significant. UFLA, Lavras, MG, 2015.

**Table 9.** Summary of variance and regression analysis for micronutrient content of the total aerial part of the Dominating Tomato F1, submitted to different water stresses in the soil

Source of Variation	D. F.	M. S.				
		B	Cu	Mn	Zn	Fe
Tension	5	454.08*	385.89**	27,211.59 <sup>ns</sup>	882.17 <sup>ns</sup>	31,481.52 <sup>ns</sup>
Block	2	177.30 <sup>ns</sup>	0.76 <sup>ns</sup>	59,517.71 <sup>ns</sup>	831.97 <sup>ns</sup>	442,269.36 <sup>ns</sup>
Residue	10	95.41	26.90	8,439.47	587.51	28,001.44
Mean (mg kg <sup>-1</sup> )	-	60.01	28.83	596.49	117.40	1985.47
C. V. (%)	-	16.28	17.99	15.40	20.65	8.43
Linear	1	2,110.90**	1,562.92**	-	-	-
Quadratic	1	50.04 <sup>ns</sup>	337.19**	-	-	-
Cubic	1	61.54 <sup>ns</sup>	21.64 <sup>ns</sup>	-	-	-
Deviation	2	23.95 <sup>ns</sup>	3.85 <sup>ns</sup>	-	-	-
Residue	10	95.41 <sup>ns</sup>	26.90	-	-	-

\*and\*\* significant at 5 and 1% probability by the F test, respectively; <sup>ns</sup>not significant. UFLA, Lavras, MG, 2015.

The analysis was noteworthy that there was a significant effect between treatments for the micronutrient contents Cu and Zn in the lower third, for B and Cu in the middle third, for Cu in the upper third and for B and Cu in the total aerial part of the plant (sum of three thirds). When evaluating the micronutrient content in the total shoot, it was found that the effect was significant for B and Cu, not differing for the other nutrients (Mn, Zn and Fe) (mean of 596.49; 117.40 and 1,985.47 mg kg<sup>-1</sup> respectively).

However, Delazari (2014) when evaluating and effect of irrigation depths on the micronutrient content in tomato leaves (leaf immediately below the bunch, at the time of harvesting the first ripe fruit), found significant effect only for the manganese nutrient (Mn), with reduction of this nutrient with increased irrigation depths. According to the author, the range obtained was between 360.5 and 718.9 mg kg<sup>-1</sup>, higher value just above the range considered appropriate by Jones Junior (1999), whose value should be between 250.0 and 500.0 mg kg<sup>-1</sup>. In the present work the manganese content was also slightly above (596.49 mg kg<sup>-1</sup>) than recommended by Jones Junior (1999). This fact can be justified by the fact that the samples were taken from the leaves and stem of the tomato plant and by the sum of the three thirds of the plant (total plant).

The average value of Zn content (117.40 mg kg<sup>-1</sup>) found in this study is slightly above the range considered appropriate by Jones Junior (1999), which is 20.0 to 100.0 mg kg<sup>-1</sup>. Delazari (2014) found no significant response to Zn content in tomato leaves submitted to different soil water stresses, observing levels between 35.3 and 45.4 mg kg<sup>-1</sup>. The mean Fe content found in this study (1,985.47 mg kg<sup>-1</sup>) is well above the range considered ideal by Jones Junior (1999), and should be between 40.0 and 300.0 mg kg<sup>-1</sup>. Delazari (2014) also found no significant response to this nutrient as a function of irrigation depths, observing levels between 254.8 and 389.0 mg kg<sup>-1</sup>. The regression analysis for the copper content in the three thirds of the plant and the total shoot is shown in Fig. 9.

The copper content showed decreasing linear behavior with the increase of water stresses in the soil in all parts of the plant evaluated. The highest values, in 20 kPa, were 16.2 mg kg<sup>-1</sup> in the lower third, 16.7 mg kg<sup>-1</sup> in the middle third, 14.3 mg kg<sup>-1</sup> in the upper third and 47.03 mg kg<sup>-1</sup> in the whole plant (sum of three thirds). Delazari (2014) did not observe a significant effect of irrigation depths on the copper content in tomato leaves. According to the author, the range observed in the leaf was between 660.2 to 868.1 mg kg<sup>-1</sup>. According to Malavolta et al. (1997) and Jones Junior (1999), the copper contents in plants varied between 2 and 75 mg kg<sup>-1</sup> of dry matter, considering levels between 5 and 20 mg kg<sup>-1</sup> as suitable for normal growth.

It is worth mentioning that phloem sap is the main conductor of mineral salts, contributing to translocation and distribution (Grange & Andrews, 1994). However, the transport of the elaborated sap, among other physiological processes, such as turgidity, stretching, cell division and expansion, is limited by water deficit (Taiz & Zeiger, 2009), hindering the potential for nutrient extraction. The use of the 20 kPa voltage throughout the culture cycle has demonstrated the potential to increase micro nutrient increments. However, the water demand of the tomato varies according to its phenological stage (Nangare et al., 2016). Therefore, in order to improve water use management, it is suggested to carry out irrigation management according to the tomato development stages. The results found in these studies indicate that plants obtain greater potential for the extraction of macro and micronutrients r with a tension of 20 kPa during the vegetative phase.



The copper contents in the present study, in the whole plant, were between 47.03 mg kg<sup>-1</sup> (20 kPa) and 21.67 mg kg<sup>-1</sup> being outside the limits considered ideal. Fig. 10 shows the variation in boron content as a function of soil water stress for the middle third and throughout the plant (sum of three thirds). The total boron content of the plant (sum of three thirds) presented decreasing linear behavior with increased soil water tension. The highest value was observed at the voltage of 20 kPa (80.57 mg kg<sup>-1</sup>) and the lowest in 145 kPa (45.40 mg kg<sup>-1</sup>). According to the equation generated, for each unit of tension added, there is a reduction in boron content of 0.2537 mg kg<sup>-1</sup>. Similar behavior was observed in the middle third of the plant, but with lower concentrations, ranging from 31.87 to 17 mg kg<sup>-1</sup> at stresses of 20 and 145 kPa, respectively.

Delazari (2014), when evaluating the effect of irrigation depths on boron content in tomato leaves, did not find a significant effect between treatments. The concentration range obtained was 49.4 to 84.0 mg kg<sup>-1</sup>, values close to those found in this study. According to Jones Junior (1999), the adequate values for Boron concentration should be between 25.0 to 100.0 mg kg<sup>-1</sup>.

## CONCLUSIONS

The highest values of the variables evaluated were found at the voltage of 20 kPa, suggesting the study in lower values of water tension in the soil. The highest levels of macro (P and S) and micronutrients (B and Cu) of the total aerial part of the Dominator tomato F1, was obtained at the voltage of 20 kPa, with its value reduced with the increase of water tension in the soil.

## REFERENCES

- Alvarenga, M.A.R. 2013. Tomato: field production, greenhouse and hydroponics. rev. and ampl. Lavras: UFLA.
- Carrijo, O.A., Souza, R.B., Marouelli, W.A. & Andrade, R.J. Fertirrigation of vegetables. Technical Circular 32, EMBRAPA, Brasília, 2004.
- Chitarra, M.I.F. & Chitarra, A.B. 2005. *Postharvest of fruits and vegetables: physiology and handling*. Lavras: UFLA, 785 pp.
- Delazari, F.T. 2014. *Production and quality of tomato fruits in the lush staking system according to the water-nutritional status*. Dissertation (Master in Agricultural Engineering) - Federal University of Viçosa, Viçosa, 68 pp.
- Duarte, G.R.B., Schöffel, E.R., Mendez, M.E.G. & Paula, V.A de. 2010) *Measurement and estimates of evapotranspiration of tomatoes grown under organic fertilization in a protected environment*. Semin Cienc Agrar. v. **31**, pp. 563–574.
- EMBRAPA. 2006. *Brazilian Agricultural Research Corporation. Tomato cultivation for industrialization*. Embrapa Vegetables. Production System, 1st and 2nd Ed., Electronic version.
- Grange, R.I. & Andrews, J. 1994. Expansion rate of young tomato fruit growing on plants at positive water potential. *Plant Cell Environ.*, v. **17**, pp. 181–187.
- Hanson, B.R., Hutmacher, R.B. & May, D.M. 2006. Drip Irrigation of Tomato and Cotton Under Shallow Saline Ground Water Conditions. *Irrigation and Drainage Systems*, Holanda, v. **20**, no. 2–3, pp.155–175.
- Hott, M.O., Lima, V.L.S., Pereira, L.R., de Souza, J.M. & dos Reis, E.F. 2014. Biomass production in the vegetative phase of tomato as a function of water tension in the soil. *Biosphere Encyclopedia*, Goiânia, v. **10**, n.18, pp. 2389–2398.

- Hott, M.O., dos Reis, E.F., Lima., V.L.S., Pereira, L.R. & Garcia, G. de O. 2018. Development and Productivity of Tomato Plants under Water Deficit. v. **21**, pp. 1–10.
- Jones, H.G. 2004. Irrigation scheduling: Advantages and pitfalls of plant-based methods. *Journal of Experimental Botany*, Oxford, v. **55**, n. 407, pp. 2427–2436.
- Kuşçu, H., Turhana, A. & Demir, A.O. 2014. The response of processing tomato to deficit irrigation at various phenological stages in a sub-humid environment. *Agricultural Water Management*, Amsterdam, v. **133**, pp. 92–103.
- Malavolta, E., Vitti, G.C. & Oliveira, S.A. 1997. *Assessment of the nutritional status of plants: principles and applications*. 2. ed. POTAFOS. Piracicaba, SP, 309 pp.
- Marouelli, W.A. & Silva, W.L.C. 2007. Water tension thresholds for processing tomatoes under drip irrigation in Central Brazil. *Irrigation Sci.* **25**, 411–418.
- Marouelli, W.A., da SILVA, H.R. & Silva, W.D.C. 2012. Tomato irrigation for processing. Embrapa Vegetables - Technical Circular (INFOTECA-E).
- Morales, R.G.F. 2012. *Resistance to water deficit in tomato families derived from Solanum pennellii*. Thesis (PhD in Phytotechnics) - Federal University of Lavras, Lavras, 93 pp.
- Moreira, J.A.A., Cardoso, A.F., Costa, L.L., Rodrigues, M.S., Peixoto, N. & Braz, L.T. 2012. Irrigation management to optimize productivity and quality of tomato fruits in a direct planting system. *Brazilian Journal of Irrigation and Drainage* **17**, 408–417.
- Nangare, D.D., Singh, Y. & Kumar, P.S. 2016) Minhas PS. Growth: fruit yield and quality of tomato (*Lycopersicon esculentum* Mill.) as affected by deficit irrigation regulated on phenological basis. *Agric Water Manag.* v. **171**, pp.73–79.
- Sá, N. S., Pereira, G.M., Alvarenga, M.A., Mattioli, W. & Carvalho, J.D.A. 2005. Behavior of tomato crop under different soil water tensions in a protected environment. *Brazilian Journal of Agricultural and Environmental Engineering / Revista Brasileira de Engenharia Agrícola e Ambiental/*, **9**(3), 341–347.
- Sarruge, J.R. & Haag, H.P. 1974. *Plant chemical analysis*. Piracicaba: ESALQ, 56 pp.
- Silva, J.A. da., Dutra, A.F., Cavalcanti, N.M. da, Melo, A.S. de., Silva, F.G. da. & Silva, J.M. da. 2014. Agronomic aspects of the tomato “Caline Ipa 6” grown under water regimes in a semi-arid area. *Agro @ mbiente magazine online*, v. 8(3), pp. 336–344.
- Steduto, P., Hsiao, T.C. & Fereres, A. 2007. On the conservative behavior of biomass water productivity. *Irrigation Sci.* v. **25**, 189–207.
- Sun, Y., Feng, H. & Liu, F. 2013. Comparative effect of partial root-zone drying and deficit irrigation on incidence of blossom-end rot in tomato under varied calcium rates. *Journal of Experimental Botany*. Oxford, v. **64**, n. 7, pp. 2107–2116.
- Taiz, L. & Zeiger, E. 2009. *Plant physiology*. 4. ed. Porto Alegre: Artmed; Portuguese.

## **Monitoring the species diversity of medicinal plants typical for the south slope of Hissar Ridge / Tajikistan /**

D.S. Sattarov<sup>1,\*</sup>, S.Kh. Vyshegurov<sup>2</sup> and R.R. Galeev<sup>2</sup>

<sup>1</sup>Tajik Academy of Agricultural Sciences, National Republican Center for Genetic Resources, Rudaki Avenue, 21/1, TJ734000 Dushanbe, Tajikistan

<sup>2</sup>Federal State Budgetary Educational Institution of Higher Education “Novosibirsk State Agrarian University”, Street Dobrolyubova, 160, RU630039 Novosibirsk, Russia

\*Correspondence: jamshed.hvilya@mail.ru

**Abstract.** This paper is a summary of literature reviews concerning the diversity of medicinal plants and the results of our many years studies. It includes scientific and practical justifications of the importance of monitoring species diversity of the studied object. Results of monitoring the species composition of wild medicinal plants in some areas of the southern slope of the Gissar Range are specified. As a result of studying 11 gorges (Gazhne, Safedchashma, Gusgarf, Shamal, Obi-Zugora, Gulobod, Yos, Yavroz, Semiganch, Odzhuk, Magov), 174 species of medicinal plants were found that belong to different botanical taxa. This number of plants includes representatives of 106 genera belonging to 46 families, among which representatives of the aster family predominate: Asteraceae (36 species), Rosaceae (19 species), Lamiaceae (16 species), etc. Compared with the number of known plants growing within the territory of the Republic of Tajikistan, the number of species found was 11.6%. In relation to the number of plants that are recognized as medicinal in the world, species diversity of the southern slopes of Gissar Range is less than one percent. However, the number of species is comparable to locations with similar climatic conditions.

**Key words:** biodiversity, medicinal plants, family, species, Gissar Range, agriculture.

### **INTRODUCTION**

The problem of rapidly declining biological diversity, including species diversity, is global concern rather widely discussed in modern scientific community (Altukhov, 1995; Iaconay et al., 2018). The number of species in an ecosystem determines its stability as of a functional unit over a long time period (Landscape Indicators, 2011). The more species inhabit an ecosystem, the greater their number is concentrated on the performance of similar functions what, in turn, is a kind of guarantee for maintaining ecosystem stability if any species suddenly becomes extinct (Markov, 2010). Some scientists believe that ecosystem stability is based on the laws of thermodynamics, in particular, on the concept of self-regulating mechanisms (Rosenberg & Zinchenko, 2014). Self-sustaining systems are thought to be the prerogative of living organisms (May, 1973). It is believed that the very fact of life appearance is a logical end to the formation of a global biochemical metabolism. Moreover living organisms are a peculiar

conservation factor due to the possibility of encoding hereditary information with the help of nucleic acids. It is also important that due to the appearance of living organisms, it is possible to use in biosphere more effective catalysts, such as enzymes (Markov, 2010; Moelling, 2016). Any biological species is an important, and sometimes irreplaceable, element of global biochemical mechanism – based on the fact that everything that is irrelevant sooner or later loses its competitive ability, and, accordingly, the extinction of such species due to natural selection is just about timing (Markov & Naimark, 2015). After all, as you know, freedom ends where it infringes on the freedom of others, and therefore, selfish, genetically determined desire of species for personal progress is limited by complex interspecific interactions where excessive egoists are at a disadvantage (Dawkins, 1978). Each biological species is a unique genetic reservoir; the total of them is a global allele pool of biosphere stability. Quantitative ratio of different species is also an evolutionarily developed mechanism. It is not for nothing that people thought about different concepts of the conservation of biological diversity what is specified in the provisions of different international conventions (Convention on Biological Diversity. Rio De Janeiro, 1993). In particular, the mountains of Central Asia are recognized as one of the most important global biological resources for the conservation of mountain biodiversity (Khan et al., 2013).

Wild medicinal plants are a meaningful part of biocenoses. In particular, the symbiosis of at least some of them with endophytic actinobacteria enriches biocenoses with various sodium compounds what is estimated as a valuable resource for chemical industry and agriculture (Golinska et al., 2015; Karlsons & Osvalde, 2019). It was demonstrated that the species composition of plants, including those used for medicinal purposes, closely correlates with the number of insects pollinators which, in turn, increase the efficiency of pollination, and therefore, reproduction (Gailis et al., 2017). It is well known that the biological diversity of wild medicinal plants is a fairly informative criterion for assessing the overall environmental situation. In particular, species composition of biocenosis is a rather informative visual tool for assessing the content of heavy metals (Ozyigit et al., 2018; Imeri et al., 2019; Salama et al., 2019). Their qualitative and quantitative composition is determined by a number of environmental factors (Khan et al., 2013). Medicinal plants are an integral part of high mountain ecosystems that are directly involved in stabilizing the functioning of lowland ecosystems where the most part of the planet's population is concentrated (Geist, 2005).

In addition, despite the development of biomedical technologies, medicinal plants are still a valuable resource for pharmacological industry (Sofowora et al., 2013). In developing countries up to 80% population use traditional system of medicine i.e. herbal formulations derived from plants (Navaneethan et al., 2011; Nautiyal et al., 2015). In the global volume of medicines, the number of herbal drugs is up to 5%, and investments in this industry amount to hundreds of millions of dollars (Dutra et al., 2016). Thus, monitoring the biological diversity of medicinal plants is a very important scientific and practical issue.

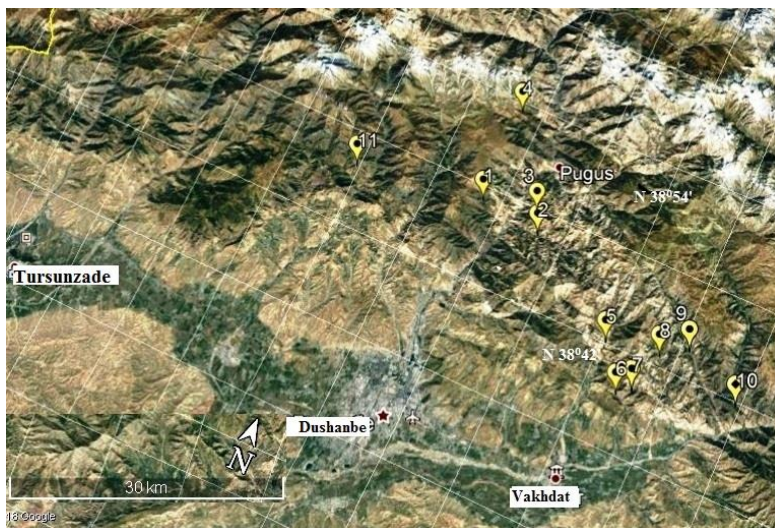
Tourism development, over population, as well as intensification of industrialisation are well-known factors in increasing the anthropogenic load by first decades of the 21st century. Expansion of agricultural land that reduces the area of unique natural ecosystems gives cause for special concern (Khan et al., 2013). In combination with changing climatic conditions, this is a risk of the decrease in species composition of flora and fauna. In particular, biodiversity of resources and the influence

of different environmental factors on the seed productivity of wild medicinal plants in the Republic of Tajikistan were studied (Sattarov et al., 2017, 2018, 2018a). In addition, geographical and species analysis of the flora of Central Pamir-Alai was carried out (Safarov, 2013, 2013a). Number and age composition of coenopopulations of *Thermopsis dolichocarpa* under conditions of Vakhsh and Gissar ranges (Rakhimov, 2010), and the productivity of high-mountain pastures of Gissar (Madaminov, 2010). Due to favorable climatic conditions, more than 1,500 species of wild medicinal plants grow in the Republic of Tajikistan (Khojimatov, 1989). Fortunately a number of measures are being taken to protect wild flora in the Republic of Tajikistan ([http://www.portali-huquqi.tj/publicadliya/view\\_qonunhoview.php?showdetail=&asosi\\_id=2866](http://www.portali-huquqi.tj/publicadliya/view_qonunhoview.php?showdetail=&asosi_id=2866)).

The aim of this research is to study the species composition of wild medicinal plants on the southern slope of Gissar Range, which is the natural buffer zone of the city of Dushanbe from the north, northwest, northeast, and east.

### RESEARCH OBJECTS AND METHODS

Studies were carried out in 2012–2017, on the southern slope of Gissar Range, on the territory of the Ramitsky gorge zone: sites (Semiganch, Safedchashma, Obi-Zugora, Magov, Yos, Yavroz), Varzob gorge zone (Gusgarf, Odzhuk, Gulobod, Gazhne) and Shamal gorge (Almasy river basin). Surveys of the sites were carried out to the upper limit of the middle-altitude belt, i.e. to an altitude of 2,500 m above sea level through visual counting during hiking expeditions (Fig. 1). Vegetation analysis of ethnomedical plants was carried out according to the method of stratified random sampling. The area of square plots was 100 m<sup>2</sup> for trees, and inside the main squares there were two plots of 25 m<sup>2</sup> for shrubs and four plots of 1 m<sup>2</sup> for grass.



**Figure 1.** Study area of Gissar Range: 1 – Gusgarf; 2 – Odzhuk; 3 – Gulobod; 4 – Gazhne; 5 – Semiganch; 6 – Safedchashma; 7 – Obi-Zugora; 8 – Magov; 9 – Yos; 10 – Yavroz, 11 – Shamal.

Processing and verification of herbarium material for determining plant species was carried out according to the reference book (Flora of the Tajik SSR, 1991), as well as an online plant guide (www.plantarium.ru). Taxon systematic affiliation was established according to the accepted classifier (Takhtadzhyan, 1987). It should be noted that Ramitsky and Varzbsky gorge zones are the most recreational areas of the Republic of Tajikistan, and are subject to great anthropogenic stress in the form of tourism and outdoor activities in the spring-summer and summer-autumn seasons.

## RESULTS AND DISCUSSION

As a result of studies performed, it was revealed that 174 species of medicinal plants that belong to different taxonomic groups were found on the territory of the abovementioned sites. Belonging to groups, classes, families, genera, and species was determined in accordance with the existing phylogenetic classification (Takhtadzhyan, 1987). It was found (Table 1) that medicinal plants of Varzob and Ramitsky gorge zones are represented by the groups of angiosperms, gymnosperms and fern-like plants. The group of angiosperms is represented by monocotyledonous and dicotyledonous plants. The class of monocotyledonous plants is formed by representatives of 9 families: Liliaceae, Hyacinthaceae, Asphodelaceae, Alliaceae, Asparagaceae, Convallariaceae, Amaryllidaceae, Iridaceae, Araceae and 14 genera, and the class of dicotyledons is formed by representatives of 35 families and 90 genera. The group of gymnosperms is represented by only one species of ephedra horsetail – *Ephedra equisetina* Bunge that belongs to the joint-fir class (Gnetopsida) and the coniferous family (Ephedraceae). The Group of fern-like plants is represented by one species, *Cystopteris filix-fragilis* (L.) Borbas that belongs to the family of ferns (Polypodiaceae R. BR.). As expected, most species belong to the world’s largest taxon – group of angiosperms (Markov, 2010).

**Table 1.** Systematic affiliation of medicinal plants found on the southern slopes of Gissar Range

Group	Class	Number of families	Number of genera	Number of species
Fern-like – Polypodiophyta	Polypodiaceae – Polypodiopsida	1	1	1
Gymnosperms – Pinophyta	Joint-fir –Gnetopsida	1	1	1
Angiosperms – Magnoliophyta	Monocotyledons –Liliopsida	9	14	33
	Dicotyledons –Magnoliopsida	35	90	139
Total		46	106	174

This is 11.6% in relation to the total number of species typical for the Republic of Tajikistan. Samples found include representatives of 106 genera belonging to more than 40 families. The most numerous were representatives of *Rosaceae* (19 species), *Asteraceae* (36 species), and *Lamiaceae* (16 species). According to the economic and practical classification, found plant species were distributed as follows. 20 species belonged to commonly recognized medicinal plants (Table 2), 56 species are used in the medicine of local peoples (Table 3). In addition, monitoring revealed several rare and endangered species; 8 of them are specified in the Red Book of the Republic of Tajikistan (Table 4), and another 18 species are unique to the Pamir-Alai flora (Table 5).

Representatives of four plant species were observed, which are a food resource regularly used by the local population (gray blackberry – *Rubus caesius* L. and *R. turkestanicus* Pavl., *Rheum gissaricum* Losinsk. and *R. maximowiczii* Losinsk). However, samples of plants commonly used as medicinal products were also taken, for example, of herb-Robert – *Geranium robertianum* L, common plantain – *Plantago major*, common dandelion – *Taraxacum officinale* Wigg., L., and chamomile – *Matricaria recutita* L.

**Table 2.** List of widely recognized medicinal plants

No	Name of plant	No	Name of plant
1	Marsh-mallow – <i>Althaea officinalis</i> L.	11	<i>Rosa korshinskyana</i> – <i>Rosa korshinskyana</i> Bouleng.
2	Elecampane – <i>Inula helenium</i> L.	12	<i>Rosa canina</i> – <i>Rosa canina</i> L.
3	St John’s wort – <i>Hypericum perforatum</i> L.	13	<i>Rosa ovchzinnikovii</i> – <i>Rosa ovchzinnikovii</i> Kocz.
4	Common dandelion – <i>Taraxacum officinale</i> Wigg.	14	<i>Rosa foetida</i> – <i>Rosa foetida</i> Herrm.
5	Broadleaf plantain – <i>Plantago major</i> L.	15	<i>Rosa divina</i> – <i>Rosa divina</i> Sumn.
6	Wormwood – <i>Artemisia absinthium</i> L.	16	<i>Rosa maracandica</i> – <i>Rosa maracandica</i> Bunge
7	Chamomile – <i>Matricaria recutita</i> L.	17	<i>Rosa corymbifera</i> – <i>Rosa corymbifera</i> Borkh.
8	Licorice – <i>Glycyrrhiza glabra</i> L.	18	Fedchenko’s rose – <i>Rosa fedtschenkoana</i> Regel
9	<i>Rosa achburensis</i> – <i>Rosa achburensis</i> Chrshan.	19	<i>Rosa ecae</i> – <i>Rosa ecae</i> Aitch.
10	Begger’s rose – <i>Rosa beggeriana</i> Schrenk	20	Horsetail ephedra – <i>Ephedra equisetina</i> Bunge

**Table 3.** List of found medicinal plants that are used in traditional medicine

No	Name of plant	No	Name of plant
1	<i>Arctium leiospermum</i> – <i>Arctium leiospermum</i> Jus. et Serg.	29	<i>Achillea biebersteinii</i> – <i>Achillea biebersteinii</i> Afan.
2	<i>Arum korolkowii</i> – <i>Arum korolkowii</i> Regel	30	<i>Achillea filipendulina</i> – <i>Achillea filipendulina</i> Lam.
3	<i>Berberis heterobotrys</i> – <i>Berberis heterobotrys</i> E.L. Wolf	32	<i>Amygdalus bucharica</i> – <i>Amygdalus bucharica</i> Korsh .
4	<i>Crataegus pontica</i> – <i>Crataegus pontica</i> C. Koch	33	Asian mint – <i>Mentha asiatica</i> Boriss.
5	<i>Crataegus turkestanica</i> – <i>C. turkestanica</i> Pojark.	34	Brittle bladder-fern – <i>Cystopteris filix-fragilis</i> (L.) Borbas
6	<i>Datisca cannabina</i> - <i>Datisca cannabina</i> L.	35	Clary sage – <i>Salvia sclarea</i> L.
7	<i>Dianthus baldshuanicus</i> – <i>Dianthus baldshuanicus</i> Lincz.	36	Common chicory – <i>Cichorium intybus</i> L.
8	<i>Dianthus seravschanicus</i> – <i>Dianthus seravschanicus</i> Schischk.	37	Common mugwort – <i>Artemisia vulgaris</i> L.
9	<i>Dianthus tetralepis</i> – <i>Dianthus tetralepis</i> Nevski	38	<i>Echinops maracandicus</i> - <i>Echinops maracandicus</i> Bunge (2)
10	<i>Erigeron Gissaricus</i> – <i>Erigeron Gissaricus</i> Botsch.	39	<i>Eremurus ambigens</i> – <i>Eremurus ambigens</i> Vved.

Table 3 (continued)

11	<i>Gentiana olivieri</i> – <i>Gentiana olivieri</i> Griseb.	40	<i>Ferula kuhistanica</i> – <i>Ferula kuhistanica</i> Korov.
12	<i>Gymnospermium albertii</i> – <i>Gymnospermium albertii</i> (Regel) Takht.	41	<i>Handelia trichophylla</i> – <i>Handelia trichophylla</i> (Schrenk) Heimerl
13	<i>Heracleum lehmannianum</i> – <i>Heracleum lehmannianum</i> Bunge	42	<i>Pedicularis olgae</i> – <i>Pedicularis olgae</i> Regel
14	<i>Hypericum elongatum</i> – <i>Hypericum elongatum</i> Ledeb.	43	<i>Polychryzum tadshikorum</i> – <i>Polychryzum tadshikorum</i> (Kudr.) Kovalevsk.
15	<i>Hypericum scabrum</i> – <i>Hypericum scabrum</i> L.	44	<i>Prangos pabularia</i> – <i>Prangos pabularia</i> Lindl.
16	<i>Inula macrophylla</i> – <i>Inula macrophylla</i> Kar. et Kir.	45	<i>Pseudohandelia umbellifera</i> – <i>Pseudohandelia umbellifera</i> (Boiss.) Tzvel.
17	Lemon balm – <i>Melissa officinalis</i> L.	46	<i>Pyrethrum parthenium</i> – <i>Pyrethrum parthenium</i> (L.) Smith
18	<i>Lychnis coronaria</i> – <i>Lychnis coronaria</i> (L.) Desr.	47	<i>Rhaponticum integrifolium</i> – <i>Rhaponticum integrifolium</i> C. Winkl.
19	<i>Megacarpaea gigantea</i> – <i>Megacarpaea gigantea</i> Regel in Bull.	48	Ribwort plantain – <i>Plantago lanceolata</i> L.
20	<i>Origanum tyttanthum</i> – <i>Origanum tyttanthum</i> Gontsch.	49	<i>Rumex paulsenianus</i> – <i>Rumex paulsenianus</i> Rech. f.
21	<i>Phlomis cashmeriana</i> – <i>Phlomis cashmeriana</i> Royle ex Benth.	50	<i>Salvia turcomanica</i> – <i>Salvia turcomanica</i> Pobed.
22	<i>Polygonum Gissaricum</i> – <i>Polygonum Gissaricum</i> M. Pop.	51	Sicilian sumac – <i>Rhus coriaria</i> L.
23	<i>Potentilla canescens</i> – <i>Potentilla canescens</i> Bess.	52	<i>Tanacetum pseudoachillea</i> – <i>Tanacetum pseudoachillea</i> C. Winkl.
24	<i>Potentilla kulabensis</i> – <i>Potentilla kulabensis</i> Th. Wolf.	53	<i>Thermopsis dolichocarpa</i> – <i>Thermopsis dolichocarpa</i> V. Nikit.
25	<i>Verbascum songaricum</i> – <i>Verbascum songaricum</i> Schrenk	54	<i>Ungernia victoris</i> – <i>Ungernia victoris</i> Vved.
26	<i>Vinca erecta</i> – <i>Vinca erecta</i> Regel	55	White nettle – <i>Lamium album</i> L.
27	<i>Ziziphora brevicalyx</i> – <i>Ziziphora brevicalyx</i> Juz.	56	Wild carrot – <i>Daucus carota</i> L.
28	<i>Ziziphora pamiroalaica</i> – <i>Ziziphora pamiroalaica</i> Juz.	57	Wild chamomile – <i>Matricaria suaveolens</i> (Pursch) Buch.

**Table 4.** List of found medicinal plants included in the Red Book of the Republic of Tajikistan

No	Name of plant	No	Name of plant
1	<i>Allium rosenbachianum</i> – <i>Allium rosenbachianum</i> Regel	5	<i>Paeonia intermedia</i> – <i>Paeonia intermedia</i> C.A. Mey.
2	<i>Allium stipitatum</i> – <i>Allium stipitatum</i> Regel	6	<i>Eremurus aitchisonii</i> – <i>Eremurus aitchisonii</i> Baker
3	<i>Allium suworowii</i> – <i>Allium suworowii</i> Regel	7	<i>Ungernia victoris</i> – <i>Ungernia victoris</i> Vved.
4	<i>Ostrowskia magnifica</i> – <i>Ostrowskia magnifica</i> Regel	8	<i>Juno nicolai</i> – <i>Juno nicolai</i> Vved.



Based on the fact that the number of widely recognized medicinal plants in the world is 13,787 species (Que et al., 2018), the proportion of medicinal plants found on the southern slopes of Gissar Range is 0.15%, however, the total number of species found is 1.27% of global fund. According to some estimates (Dasti et al., 2007), the biological diversity of the Iran-Turan region bordering Gissar range is 19,000 plant species. Simple calculations show that the number of plants found during expedition is less than one percent, even in comparison with the diversity of the neighboring region. However, it is worth considering that only plants somehow used for medical purposes were included in our study.

**Table 5.** List of found plants that are endemic to Central Asia and the Pamir-Alai

No	Name of plant	No	Name of plant
1	<i>Astragalus macropodium</i> – <i>Astragalus macropodium</i> Lipsky	10	<i>Oxytropis roseiformis</i> – <i>Oxytropis roseiformis</i> B. Fedtsch.
2	<i>Astragalus heterotrichus</i> – <i>Astragalus heterotrichus</i> Gontsch.	11	<i>Rheum Gissaricum</i> – <i>Rheum Gissaricum</i> Losinsk.
3	<i>Anemone verae</i> – <i>Anemone verae</i> Ovcz. et Scharip.	12	<i>Asparagus bucharicus</i> – <i>Asparagus bucharicus</i> Iljin
4	<i>Iris hoogina</i> – <i>Iris hoogina</i> Dykes	13	<i>Thermopsis dolichocarpa</i> – <i>Thermopsis dolichocarpa</i> V. Nikit.
5	<i>Cousinia tomentella</i> – <i>Cousinia tomentella</i> C. Winkl.	14	<i>Tulipa praestans</i> – <i>Tulipa praestans</i> Hoog
6	<i>Cousinia grigorievii</i> – <i>Cousinia grigorievii</i> Juz.	15	<i>Chesneya Gissarica</i> – <i>Chesneya Gissarica</i> Boriss.
7	<i>Potentilla kulabensis</i> – <i>Potentilla kulabensis</i> Th.Wolf.	16	<i>Rosa achburensis</i> – <i>Rosa achburensis</i> Chrshan.
8	<i>Pseudosedum condensatum</i> – <i>Pseudosedum condensatum</i> Boriss.	17	<i>Rosa korshinskyana</i> – <i>Rosa korshinskyana</i> Bouleng.
9	<i>Oxytropis baldshuanica</i> – <i>Oxytropis baldshuanica</i> B. Fedtsch.	18	<i>Eremurus brachystemon</i> – <i>Eremurus brachystemon</i> Vved.

As a comparison, we quote some monitoring data on the biodiversity of medicinal plants found in literary sources. In relatively neighboring Pakistan, 106 species of medicinal plants were identified, only 4% of them grew in mountainous areas (Akhtar et al., 2013). However, the diversity of the southern slope of Gissar Range was somewhat inferior to the diversity of families found (46 vs. 54). Up to 1,700 species of medicinal plants have been reported to grow in Indian Himalayas (Bhat et al., 2013), but not only angiosperms were taken into account for this study. In the vicinity of the capital of Colombia, Bogota, 409 species of medicinal plants were found (Bussmann et al., 2018). Only 100 species of medicinal plants were found in Dagala region (Bhutan) (Wangchuk et al., 2016). In Algeria, 90 species were reported belonging to 42 families (Bouasla & Bouasla, 2017). Global monitoring of the biological diversity of plant communities in high mountain regions indicates that Gissar Range is a location with one of the highest concentrations of species (Khan et al., 2013). This study generally confirms this point. Taking into account that monitoring was carried out earlier than 2013, it can be stated that over the past 5 years, the species diversity of the southern slopes of Gissar Range has undergone no significant changes (Khan et al., 2013).

The number of widely recognized medicinal plants was 11.49% of the number of species found. Almost every species is a fairly significant phytopharmacological resource. For example, the extract of *Althaea officinalis* has a coating property and is applied in the treatment for stomach diseases. Galenical preparations with this herb are used to treat for bronchitis and asthma (Sakovich et al., 1997). Elecampane is acknowledged to be an expectorant. It is also used for gastrointestinal diseases including inflammation of duodenum and gastric ulcers (Butko, 2013). Tincture of *Hypericum perforatum* proved to be an antifungal drug (Hovsepyan & Ghazaryan, 2019). Common dandelion, chamomile, wormwood, as well as various types of wild rose and licorice are perhaps the most well-known and widely used medicinal plants from among those found (Table 2). Common dandelion is a rather effective antidote to the poisons of insects and arachnids (Karomatov & Davlatova, 2018). Its presence in the ecosystem of Gissar Range, taking into account that there are species posing a danger to humans in the Middle Asia, is a rather significant resource for ensuring the safety of the local population to arthropod poisons. Dried parts of this herb compose a part of some gastric teas (Sukhanov, 2000). Antiseptic properties of common plantain are well-known; that's why for many centuries it served people as an alternative to all kinds of adhesives even after they were invented. In medicine, it is also used in the treatment for cancer and inflammatory diseases (Moiseev, 2009; Korepanov & Openko, 2012). Wormwood is used for a number of morpho-physiological systems of humans and animals: nervous, endocrine, urinary, respiratory, etc. (Karomatov & Kakhkhorova, 2018). Chamomile has proved to be an effective diaphoretic and antidote. It is also used to treat eczema, eye, ear, nose diseases, jaundice and yellow fever (Karomatov et al., 2018). Licorice root is used for making alcohol tinctures. Being sweet, it is an element of different herbal teas in order to improve their taste. This plant is used as an expectorant, general stimulant for tuberculosis, stomach diseases, allergic diseases. It is used for liver echinococcus, emphysema, bronchial asthma, and blood diseases (Karomatov, 2013). Different types of roses are known due to the high content of vitamin C. Plants are used as a diaphoretic in the treatment for colds and liver diseases (Baimurodov et al., 2017)

## CONCLUSION

As a result of the studies it was found that 174 species of medicinal plants belonging to 45 different families, including 35 dicotyledonous plants and 9 monocotyledonous plants are mainly distributed in some parts of Varzob and Ramit gorges, which are located in close proximity to the capital of the Republic –Dushanbe city and are its natural buffer zones.

Considering that the number of researched sites is less than 3% of the total area of Varzob and Ramit gorges and despite the fact that the researched sites are under rather high recreational and anthropogenic pressure, the presence of the above mentioned number of medicinal plants indicates relatively favorable growing conditions. Therefore, by organizing appropriate economic measures to protect and promote their natural renewal, the biological diversity of medicinal plants in this area can be significantly improved.

## REFERENCES

- Altukhov, Yu.P. 1995. Genetics of populations and conservation of biodiversity. *Soros Educational Journal* **1**, 32–43.
- Akhtar, N., Rashid, A., Murad, W. & Bergmeier, E. 2013. Diversity and use of ethno-medicinal plants in the region of Swat, North Pakistan. *Journal of Ethnobiology and Ethnomedicine* **9**, 25. doi: 10.1186/1746-4269-9-25
- Baimurodov, R.S., Karomatov, I.D. & Nurboboiev, A.U. 2017. Rose as a preventive and therapeutic agent. *Biology and Integrative Medicine* **10**, 87–105.
- Bhat, J.A., Kumar, M. & Bussmann, R.W. 2013. Ecological status and traditional knowledge of medicinal plants in Kedarnath Wildlife Sanctuary of Garhwal Himalaya, India. *J Ethnobiol Ethnomed.* **9**, 1. doi: 10.1186/1746-4269-9-1.
- Bouasla, A. & Bouasla, I. 2017. Ethnobotanical survey of medicinal plants in northeastern of Algeria. *Phytomedicine* **36**, 68–81. doi: 10.1016/j.phymed.2017.09.007
- Bussmann, R.W., Paniagua Zambrana, N.Y., Romero & C., Hart, R.E. 2018. Astonishing diversity-the medicinal plant markets of Bogotá, Colombia. *J. Ethnobiol. Ethnomed.* **14**(1), 43. doi: 10.1186/s13002-018-0241-8
- Butko, Yu.A. 2013. Pharmacotherapeutic aspects of using of plant raw materials of *Inula helenium* and *Inula britannica* in official and traditional medicine. *Scientific bulletin. Series Medicine. Pharmacy* **11**(154), 272–277.
- Convention on Biological Diversity*. Rio de Janeiro, 5 June 1992. United Nations, Treaty Series, vol. **1760**, pp. 79, and depositary notification C.N.29.1996.TREATIES-2 of 18 March 1996 (procès-verbal of rectification of the authentic Arabic text) [https://treaties.un.org/pages/ViewDetails.aspx?src=TREATY&mtdsg\\_no=XXVII-8&chapter=27](https://treaties.un.org/pages/ViewDetails.aspx?src=TREATY&mtdsg_no=XXVII-8&chapter=27)
- Dasti, A.A., Saima, S., Athar, M. & Attiq-ur-Rahman Malik, S.A. 2007. Botanical composition and multivariate analysis of vegetation on the Pothowar Plateau, Pakistan. *Journal of the Botanical Research Institute of Texas* **1**, pp. 557–568. <https://www.jstor.org/stable/41971453>
- Dawkins, R. 1978. *The Selfish Gene*. Oxford University Press, 224 pp.
- Dutra, R.C., Campos, M.M., Santos, A.R. & Calixto, J.B. 2016. Medicinal plants in Brazil: Pharmacological studies, drug discovery, challenges and perspectives. *Pharmacol Res.* **112**, 4–29. doi: 10.1016/j.phrs.2016.01.021
- Flora of the Tajik SSR. V. **10**. 1991. ed. by M.R. Rasulova. L., Science, 568 pp.
- Gailis, J., Turka, I. & Ausmane, M. 2017. Soil tillage and crop rotation differently affect biodiversity and species assemblage of ground beetles inhabiting winter wheat fields. *Agronomy Research* **15**(1), 094–111.
- Geist, H. 2005. *Our earth's changing land: An encyclopedia of land-use and land-cover change*. Greenwood Publishing Group.
- Golinska, P., Wypij, M., Agarkar, G., Rathod, D., Dahm, H. & Rai, M. 2015. Endophytic actinobacteria of medicinal plants: diversity and bioactivity. *Antonie Van Leeuwenhoek* **108**(2), 267–289. doi: 10.1007/s10482-015-0502-7
- Iacona, G.D., Sutherland, W.J., Mappin, B., Adams, V.M., Armsworth, P.R., Coleshaw, T., Cook, C., Craigie, I., Dicks, L.V., Fitzsimons, J.A., McGowan, J., Plumpton, A.J., Polak, T., Pullin, A.S., Ringma, J., Rushworth, I., Santangeli, A., Stewart, A., Tulloch, A., Walsh, J.C. & Possingham, H.P. 2018. Standardized reporting of the costs of management interventions for biodiversity conservation. *Conserv Biol.* **32**(5), 979–988. doi: 10.1111/cobi.13195
- Imeri, R., Kullaj, E., Duhani, E. & Millaku, L. 2019. Impact of rootstock on heavy metal bioaccumulation in apple plant grown near an industrial source in Obiliq, Kosovo. *Agronomy Research* **17**(1), 100–110. <https://doi.org/10.15159/AR.19.012>
- Karomatov, I.D. 2013. Using licorice in medicine. *Actual problems of the humanities and natural sciences*, **11** (2), 230–235.

- Karomatov, I.D., Badritdinova, M.N. & Yazmuradov, F.A. 2018. Chamomile as a well-known pharmaceutical drug. *Biology and Integrative Medicine* **7**(24), 4–26.
- Karomatov, I.D. & Davlatova, M.S. 2018. Medicinal properties of dandelion. *Biology and Integrative Medicine* **9**(26), 145–164.
- Karomatov, I.D. & Kakhkhorova, S.I.K. 2018. Wormwood: chemical composition and medicinal properties. *Biology and Integrative Medicine* **9**(26), 84–101.
- Karlsons, A. & Osvalde, A. 2019. Effect of foliar fertilization of microelements on highbush blueberry (*Vaccinium corumbosum* L.) nutrient status and yield components in cutover peatlands. *Agronomy Research* **17**(1), 133–143. <https://doi.org/10.15159/AR.19.028>
- Khan, S.M., Page, S.E., Ahmad, H. & Harper, D.M. 2013. Sustainable utilization and conservation of plant biodiversity in mountain ecosystems: western Himalayas as a case study **112**(3), 479–501. doi: 10.1093/aob/mct125
- Khodzhimatov, M. 1989. Wild medicinal plants of Tajikistan. Dushanbe: Ch. scientific ed. of Tajik Encyclopedias, 368 pp.
- Korepanov, S.V. & Openko, T.G. 2012. Using medicinal plants with immunomodulating properties in oncology. *Russian Biotherapeutic Journal* **11**(4), 15–20.
- Madaminov, A.A. 2010. Productivity of high-mountain pastures of Gissar Range. *News of the AC of the TR. Dept. of Biol. and Medical Sciences* **3**(172), 47–54.
- Markov, A. 2010. The birth of complexity. Evolutionary biology today: unexpected discoveries and new questions. Moscow: ACT CORPUS Publ, 528 pp. (in Russian).
- Markov, A. & Naimark, E. 2015. Evolution. Classical ideas in the light of new discoveries. Moscow, ACT CORPUS Publ. (in Russian)
- May, R.M. 1973. *Stability and Complexity in Model Ecosystems*. Princeton: Univ. Press, 304 pp.
- Moiseev, O.N. 2009. A drug for preventing the development and for management of inflammatory processes in animals. Patent for invention RU 2388480 C1, 05/10/2010. Application No. 2009102216/15 as of 01/23/2009
- Moelling, K. 2016. *Viruses: More Friends Than Foes*. Singapore: World Scientific Publishing. doi: 10.1142/10230
- Navaneethan, P., Nautiyal, S., Kalaivani, T. & Rajasekaran, C. 2011. Cross-cultural ethnobotany and conservation of medicinal and aromatic plants in the Nilgiris, Western Ghats, A case study. *Medicinal Plants* **3**(1), 27–45. doi: 10.5958/j.0975-4261.3.1.004
- Nautiyal, S., Katari Bhaskar, K. & Imran Khan, Y.D. 2015. Biodiversity of Semi-arid Landscape. Springer International Publishing Switzerland and ISBN: 978-3-319-15463-3
- Online plant guide [Electronic resource] – Access mode: [www.plantarium.ru](http://www.plantarium.ru)
- Ozyigit, I.I., Yalcin, B., Turan, S., Saracoglu, I.A., Karadeniz, S., Yalcin, I.E. & Demir, G. 2018. Investigation of Heavy Metal Level and Mineral Nutrient Status in Widely Used Medicinal Plants' Leaves in Turkey: Insights into Health Implications. *Biol Trace Elem Res.* **182**(2), 387–406. doi: 10.1007/s12011-017-1070-7
- Que, L., Chi, X.L., Zang, C.X., Zhang, Y., Chen, M., Yang, G. & Jin, A.Q. 2018. Species diversity of ex-situ cultivated Chinese medicinal plants. *Zhongguo Zhong Yao Za Zhi.* **43**(5), 1071–1076. doi: 10.19540/j.cnki.cjcm.20180109.003 (in Chinese).
- Rakhimov, S. 2010. The number and age composition of coenopopulations of *Thermopsis dolichocarpa* in the conditions of Vakhsh and Gissar Ranges. *Proceedings of AC TR. Dept. of Biol. and Medical Sciences* **3**(172), 32–39.
- Rosenberg, G.S. & Zinchenko, T.D. 2014. Sustainability of hydroecosystems: a review of the problem. *Arid Ecosystems* **20**(4–61), 11–23.
- Safarov, N.M. 2013. Species composition of the flora of the Central Pamir-Alai. Bulletin of Ayni Tajik Pedagogical University. **5–3**(54), 9–74.
- Safarov, N.M. 2013a. Geographic analysis of the flora of the Central Pamir-Alai. *Proceedings of the Academy of Sciences of the Republic of Tajikistan* **56**(7), 569–573.

- Sakovich, G.V., Zharkov, A.S., Pyankov, S.A. & Misovets, A.N. “Healing gift of Altai” bioactive drug. Russian patent of 1997 acc.to IPC A23L1/29 A61K35/78
- Salama, E.S., Roh, H.S., Dev, S., Khan, M.A., Abou-Shanab, R.A.I., Chang, S.W. & Jeon, B.H. 2019. Algae as a green technology for heavy metals removal from various wastewater. *World J Microbiol Biotechnol* **35**(5), 75. doi: 10.1007/s11274-019-2648-3
- Sattarov, D.S. & Karimov, Kh.S. 2017. Resources of wild medicinal plants of Gashne gorge (Gissar Range, Tajikistan). *Bulletin of Tajik National University*. 1/1, 258–262.
- Sattarov, D.S. & Karimov, Kh.S. 2018. Influence of temperature and rainfall on the seed productivity of *Origanum tyttanthum* (Lamiaceae) (Gissar Range, Tajikistan). *Plant Resources* **54**(3), 367–374.
- Sattarov, D.S. & Vishegurov, S.Kh. 2018a. Bioresources of wild medicinal plants in Gulobod and Saphedchashma canyons (Gissar ridge, Tajikistan). *International Journal of Engineering & Technology* **7**(4.38), 434–438.
- Sofowora, A., Ogunbodede, E. & Onayade, A. 2013. The Role and Place of Medicinal Plants in the Strategies for Disease Prevention. *Afr J Tradit Complement Altern Med*. **10**(5), 210–229. doi: 10.4314/ajtcam.v10i5.2
- Sukhanov, A.I. 2000. Gastrointestinal herbal tea. Patent for an invention. RU 2157228 C1.
- Takhtadzhyan, A.L. 1987. *Magnoliophyte system*. L., Science, 439 pp.
- Landscape Indicators. 2011. Assessing and Monitoring Landscape Quality. Editors: C. Cassatella, A. Peano. Springer Publ., Netherlands. doi: 10.1007/978-94-007-0366-7
- Wangchuk, P., Namgay, K., Gayleg, K. & Dorji, Y. 2016. Medicinal plants of Dagala region in Bhutan: their diversity, distribution, uses and economic potential. *J. Ethnobiol. Ethnomed*. **12**(1), 28. doi: 10.1186/s13002-016-0098-7

## **A food-grade antioxidant production using industrial potato peel by-products**

I. Sepelevs\*, J. Zagorska and R. Galoburda

Latvia University of Life Sciences and Technologies, Department of Food Technology, 22 Rigas street, LV–3004 Jelgava, Latvia

\*Correspondence: igor\_shepelev@inbox.lv

**Abstract.** Currently, industrial potato processing waste recycling and re-use is an important topic in the food industry, but no actual processing facilities could be found at the moment of this study. The main aim of present research was to develop a method that could, potentially, be practically applicable for industrial potato peel waste recycling into encapsulated phenolic compounds (fine powder), with a further approbation as an antioxidant for ground pork meat. Potato peel wastes were collected from the local potato processing facility, homogenized in the solvent media, and two accelerated extraction technologies (microwave assisted (MAE) and ultrasound accelerated extractions) were applied for the extraction of biologically active compounds and encapsulation wall material. Produced extracts were concentrated (recovered solvent had been collected and reused) and directed for spray-drying. In general, MAE alone showed higher extraction yields than in combinations with ultrasound treatment. Extracts reached maximal biologically active compound concentrations (and were possessing highest radical scavenging activities) after 10 min of MAE treatment. Produced capsules (food grade antioxidant) inhibited ground pork meat lipid oxidation during the storage study at accelerated oxidation conditions. Acquired results form a basis for development of a potato peel industrial scale processing technology.

**Key words:** extraction, encapsulation, oxidation inhibition, potato peel recycling.

### **INTRODUCTION**

According to FOASTAT (2018), the potato production reached 475.9 million tonnes worldwide in 2016. In general, potato consumption vary highly between countries with different cultures and income levels. In lower income countries potatoes are mostly sold raw, while in the First world countries up to 70% of all produced potatoes can be utilized for industrial processing (Parr et al., 2018). In combination with the fact, that up to 40% of total potato mass that enters the production facility can exit it in a form of waste (Schieber et al., 2001) and that the most international waste regulations are commanding to reduce the amount of generated wastes and maximise the recycling and re-use, lately, potato by-product recycling has become a very important topic in the food industry.

As an inexpensive by-product, potato peels contain extractable biologically valuable compounds that can be applied in food and pharmaceutical industries (Al-Weshahy & Rao, 2012; Friedman et al., 2017) and, upon consumption, are able to

provide beneficial effect on the human health (Samarin et al., 2012; Hsieh et al., 2016). Additionally, a potato peel extract can be applied as an antioxidant for various food products prolonging the shelf-life (Habebullah et al., 2010; Mohdaly et al., 2010; Farvin et al., 2012; Samarin et al., 2012). Although, biologically active compound extracts are usually unstable due to their reactivity and require an additional protection/stabilization. One of the possible protection technologies is encapsulation – a method of entrapping targeted compounds in the protective shell or matrix.

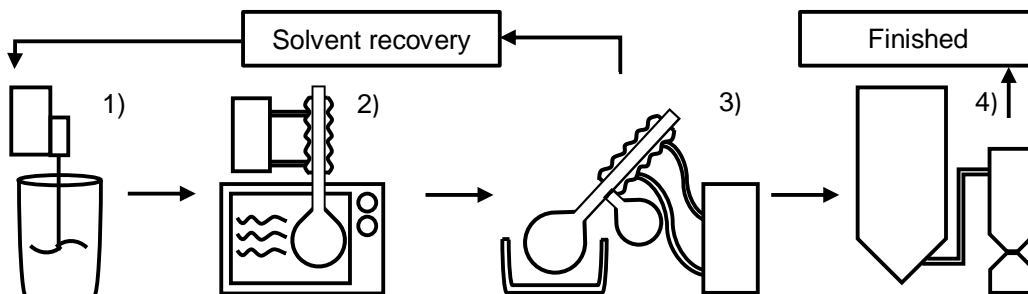
The main aim of present research was to combine both extraction and encapsulation technologies to develop a compact method for encapsulated phenolic compound production (fine powder) from actual industrial potato peel wastes, that, potentially, could be applicable on potato processing sites.

## MATERIALS AND METHODS

### Potato peel waste processing schematics

Industrial potato peel wastes were processed into a food grade antioxidant (fine powder) through following steps (Fig. 1):

- 1) potato peel homogenization in the solvent media;
- 2) valuable compound extraction through microwave assisted extraction and ultrasound treatment;
- 3) solvent evaporation and extract concentration;
- 4) encapsulation of extracted compounds via spray-drying.



**Figure 1.** Steps for the simultaneous phenolic compound extraction and encapsulation. Where, 1) – homogenisation; 2) – microwave assisted extraction; 3) – vacuum evaporation (concentration); 4) – encapsulation through spray-drying.

All steps are described in detail in further sections.

### Chemicals and materials

All reagents and standards (96% ethanol, Folin–Ciocalteu reagent, sodium carbonate, ethyl ether, gallic acid, hexane, isopropanol, isooctane, acetic acid, trolox, 2,2–diphenyl–1–picrylhydrazyl radical (DPPH<sup>•</sup>)) were purchased from the Merck KGaA (previous Sigma–Aldrich).

Industrial potato peel samples (brown skin,  $3 \pm 2$  cm) were acquired from the Paplata Nr. 1, Ltd. (Raubeni, Latvia). Freshly prepared ground pork meat was purchased

form the local market chain Maxima Group (Jelgava, Latvia) and was used on the same day, within two hours after the purchase.

### **Sample preparation**

Industrial potato peel by-products were collected directly from the potato processing lines into the plastic bags. Within an hour, peels were rapidly frozen in the laboratory scale plate freezer FT34–MKII (Armfield, United Kingdom) and stored at  $-20\text{ }^{\circ}\text{C}$  for further analyses.

For extraction purposes, frozen potato peels (25 g) were homogenised in the 60% ethanol (v/v; 250 mL) with a kitchen type blender RHB450–S–W (Rotex, China) for  $30 \pm 1$  s. Acquired samples were evenly divided between three 300 mL Erlenmeyer flasks and used for the further extraction purposes.

### **Simultaneous phenolic compound and carbohydrate extraction**

Microwave EMS 2840 (Electrolux, Sweden) had been used to conduct the microwave assisted extraction (MAE) and three extraction methods had been applied:

- 1) MAE only;
- 2) MAE with following 5 min ultrasound treatment (UST) in the laboratory scale ultrasonic bath YJ5120–1 (Zhengzhou Henan, China);
- 3) 5 min UST with following MAE.

For all three methods, four MAE regimes were applied: 5, 10, 15, and 20 min at the power level of 180 W. This power level had been chosen based on Singh et al. (2011) work reporting that lower power levels result in the higher bioactive compound yield from potato peels.

### **Concentration of extracts**

After the initial extraction, still hot (to minimize sedimentation of dissolved carbohydrates) supernatant had been collected and centrifuged at  $2,500 \times g$  for residue separation in the CM–6MT (Elmi, Latvia) centrifuge. Resulting mixture of phenolic compounds and soluble carbohydrates (with possible impurities of soluble fibre, free amino acids, etc.) was collected and concentrated under the vacuum at  $40\text{ }^{\circ}\text{C}$ . Recovered ethanol was collected and its concentration was adjusted to 60% (based on density) and reused for the further extractions.

### **Encapsulation via spray-drying**

After the concentration, phenolic extract had been directly fed into the bench top type spray-drier B–290 (Buchi, Switzerland) that was operating at the following conditions: inlet and outlet air temperatures were maintained at  $170 \pm 2\text{ }^{\circ}\text{C}$  and  $70 \pm 2\text{ }^{\circ}\text{C}$ ; feed rate:  $15\text{ mL min}^{-1}$ ; spray gas flow:  $667\text{ L h}^{-1}$ . Collected samples were transferred into the glass jar, that was additionally sealed with a paraffin paper and stored in the plastic bag at  $-20\text{ }^{\circ}\text{C}$  till the further application.

### **Determination of moisture content**

Moisture content had been determined by a gravimetric method by the oven drying at  $105\text{ }^{\circ}\text{C}$  to a constant weight, ISO 1442:1997 (iso.org).



### **Determination of the total phenolic compound content in the produced capsules**

Produced capsules were divided in two batches:

1. For the total phenolic compound analysis: 0.1 g of capsules was dissolved in the 2 mL of water and 40 mL of ethanol had been added for carbohydrate sedimentation and phenolic compound dilution. Mixture was placed in the ultrasonic bath for 10 min, centrifuged for 5 min at  $2,500 \times g$  and filtered.

2. For the phenolic compound content analysis on the capsule surface. 0.1 g of capsules were washed with 10 mL of ethanol, centrifuged for 5 min at  $2,500 \times g$  and filtered.

All filtrates were collected for the further analyses.

Jung et al. (2011) method with slight modifications had been applied for the phenolic compound analysis. Briefly, 200  $\mu\text{L}$  of the phenolic extract was mixed with 1 mL of distilled water and 100  $\mu\text{L}$  of Folin–Ciocalteu phenol reagent (precisely diluted with distilled water 1:1, v/v). After 5 min incubation, 2 mL of the 10% sodium carbonate solution was added and mixture was allowed to stand at room temperature for 60 min, and then centrifuged at  $2,500 \times g$  for 10 min. The absorbance was measured at 725 nm by a laboratory spectrophotometer Jenway 6300 (Stone, United Kingdom). Results were recalculated per dry matter and expressed as a gallic acid equivalent (GAE).

### **Determination of the free radical scavenging activity**

DPPH<sup>•</sup> was used for *in vitro* determination of free radical scavenging activity (Yu et al., 2003). Briefly, 0.5 mL of extract was mixed with 0.004% DPPH<sup>•</sup> ethanol solution, and mixture was allowed to stand for 30 min in the dark at room temperature. The absorbance was measured at 517 nm. Data had been expressed as a trolox equivalents per 100 g of sample ( $\text{mg } 100 \text{ g}^{-1} \text{ TE}$ ).

### **Determination of the total lipid content**

The total lipid content was determined by the Soxhlet extraction method AOAC 920.39 Fat (Crude) or Ether Extract in Animal Feed.

### **Ground meat treatment with encapsulated phenolic compounds**

Produced capsules (4.6 g) were added to the ground pork meat (500 g) in proportion 2 g of phenolic compounds per 1 kg of pork fat. Acquired meat mass was homogenized in the kitchen type blender for 30 s and stored at the accelerated oxidation conditions ( $+30 \pm 1 \text{ }^\circ\text{C}$ ), with daily sampling. All experiment had been conducted in triplicate.

### **Lipid extraction from the pork meat mass**

Lipid extraction had been conducted according to the Hara & Radin (1978) method, with modifications. Briefly, meat sample (ca. 15 g) had been mixed with the extraction solution (hexane–isopropanol, 3:2 v/v) in proportion 1 : 6 (w/v). Extraction had been conducted for 30 min under the constant energetic shaking. Supernatant was removed by filtration, and evaporated under the vacuum at  $40 \text{ }^\circ\text{C}$ . Collected condensed solvent was re-used for the extraction of the same sample two more times. Extracted lipids were kept under the vacuum till further analysis.

### **Determination of lipid oxidation ratios**

An active oxygen value was determined according to the International Fragrance Association Analytical Method: Determination of the Peroxide Value (from October 17<sup>th</sup>, 2011) (IFRA, 2011), that is based on the ISO-Standard 3960 third edition 2001, AOCS CD 8b-90, European Pharmacopeia, and Leatherhead Food RA second edition.

### **Microscopic analysis**

Microscope Leica DM300 LED (Leica Microsystems, Germany) had been used for the microscopic analysis. Photos were taken with camera Leica DFC 290 HD and analysed using software Leica Application Systems (LAS) V4.2.

### **Statistical analysis**

Data statistical analysis was conducted in the MS Excel 2016 software. One-way ANOVA ( $P \leq 0.05$ ) and Tukey's test were applied for the statistical analysis of all suitable data clusters. Where applicable, data is shown as a mean value with a standard deviation.

## **RESULTS AND DISCUSSION**

In the present research, a new potato peel (an industrial potato processing by-product) recycling method had been developed. It is scalable and, potentially, practically applicable and consists of several stages (Fig. 1) that include: collected peel homogenisation in the solvent media, initial phenolic compound and carbohydrate extraction, concentration of acquired extracts (recovery of the solvent for further reuse), and following encapsulation through spray-drying. The proposed method offers a basis for actual industrial scale technology development.

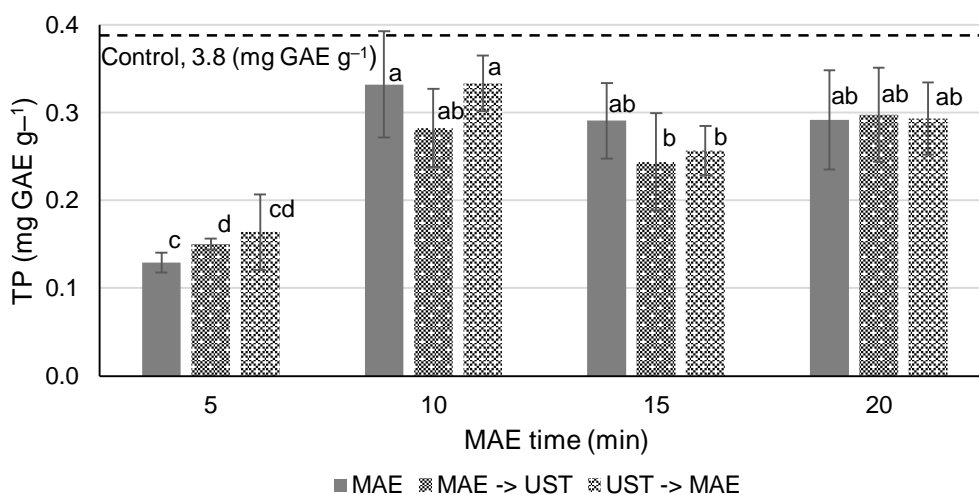
The first step (peel homogenisation) included also the first initial phenolic compound extraction – a conventional extraction, when phenolic compounds (a result of cell disruption and diffusion processes) are released into the solvent. Additionally, in the case of present research (when applied samples were previously frozen) peel samples were defrosted during the homogenisation process. On the industrial production scale, depending on the available machinery and amounts of reprocessible material, it could be necessary to increase homogenisation times in order to achieve complete cell disruption and to rise phenolic compound extraction yields. Our previous research (Shepelev et al., 2016) showed that, for the biologically active compound extraction purposes, abrasion peeled industrial potato peels can be stored for up to two days at ambient conditions (as it is on the actual potato processing plants). In addition, it had been emphasized that it is critical to reprocess only peels with remaining whole cells, but completely shredded peels are not suitable for extraction purposes even directly after the peeling.

The second processing stage included the main extraction step. To achieve shorter extraction times and, at the same time, maximize phenolic compound yields at minimal energy consumption, two accelerated extraction technologies were applied (microwave assisted and ultrasound accelerated extractions) in different combinations. Results show (Fig. 2) that MAE without any additional ultrasound treatment is a method of choice for phenolic compound extraction from ground potato peels. In case of the present research, maximal phenolic compound yield had been achieved after the 10 min long extraction,

and the prolongation of extraction time did not show a statistically significant increase in phenolic compound concentrations in acquired extracts. As had been stated previously, parameters could vary depending on the applied equipment and simultaneously processed amount of peels.

The extraction time of 5 min gave the lowest phenolic compound yield in final extracts. Samples extracted at 15 showed lower results comparing to 10 min, but higher than samples extracted during the 5 min period. The incorporation of ultrasound treatment gave a positive result only in 5 min samples. It can be concluded that MAE allow to achieve maximal molecule agitation and diffusion during the extraction process that makes ultrasound treatment unnecessary. In opposite case, when MAE treatment is at too low rates, ultrasound treatment can increase biologically active compound extraction yields till some extent.

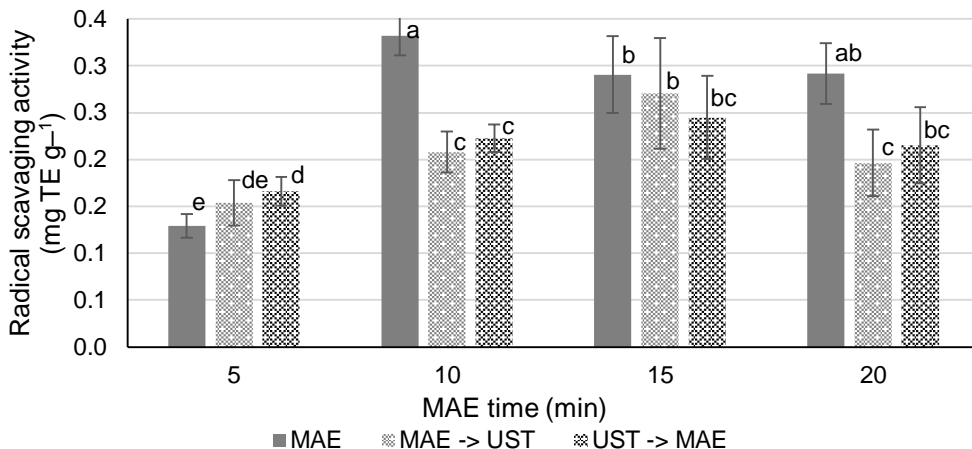
It is known that concentrated ethanol solutions exhibit great antimicrobial activity (Oh & Marshall, 1993). Taking in consideration the applied MAE, it can be concluded that potato peels will undergo complete sterilization during the manufacturing time and a possible microbial contamination during peel storage should not cause problems or trigger necessity of implying additional critical control points. Although, it is advised to minimize or prevent unnecessary pathogenic microflora development as it can result in the presence of stable toxins in produced extracts.



**Figure 2.** Total phenolic (TP) compound extraction yield depending on the extraction method (n = 9), similar lowercase letters indicate no significant difference among samples of the same fraction ( $P \leq 0.05$ ). Where, TP – total phenolics; GAE – gallic acid equivalent; MAE – microwave assisted extraction; MAE -> UST – microwave assisted extracting with following 5 min of ultrasound treatment; UST -> MAE – 5 min of ultrasound treatment with the following microwave-assisted extraction.

Similar results were acquired during free radical scavenging activity analyses (Fig. 3). But in this case, free radical scavenging activity of samples that were extracted for 10 min (and 20 min) dropped significantly with the incorporation of ultrasound treatment. This fact could suggest that completely extracted phenolic compounds could

undergo degradation, as ultrasound treatment was combined with higher temperatures (a result of MAE). An advanced research on different extraction method combinations should be performed to give a more precise conclusion. For the purposes of present research, 10 min MAE had been chosen as an optimal method based on the ratio between the phenolic compound yield and energy consumption.



**Figure 3.** Free radical scavenging activity of produced extracts depending on the extraction method ( $n = 9$ ), similar lowercase letters indicate no significant difference among samples of the same fraction ( $P \leq 0.05$ ). Where, TE – Trolox equivalent; MAE – microwave assisted extraction; MAE → UST – microwave assisted extracting followed by 5 min of ultrasound treatment; UST → MAE – 5 min of ultrasound treatment followed by microwave–assisted extraction.

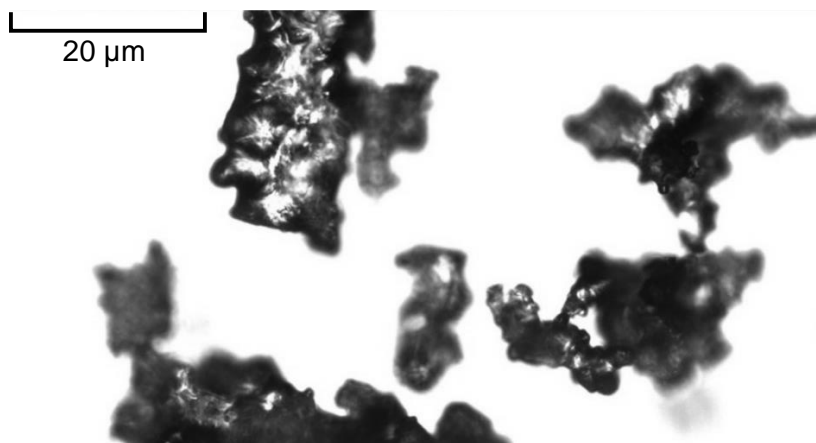
The third processing stage consisted of the concentration of produced extracts. It had been designed to achieve two main goals: 1) to recover the solvent for repeated extraction (the concentration of ethanol had been adjusted based on density), and 2) to decrease the volume of samples to minimize energy and time consumption for the next stage – encapsulation via spray–drying.

Additional energy savings were achieved by the transfer of hot extracts (directly after MAE) into the vacuum evaporator (at the average extract temperature of  $79.0 \pm 2.8$  °C, upon leaving the MAE chamber). This allowed to achieve a rapid solvent evaporation mostly without additional thermal treatment in the warm water bath. To minimize the possible oxidation, after the concentration, extracts were kept under the constant vacuum until they had been fed into the spray–dryer. It had been previously reported that phenolic extracts can undergo also polymerisation processes resulting in the extract colour change from lighter to darker (Vámos-Vigyázó, 1981).

The final fifth processing stage included the encapsulation of extracted phenolic compounds by using carbohydrate compounds that should be dissolved in the same extract. The comparison of total phenolic compound concentrations and gravimetric data on dry weight of extracts (data is not shown) shows that carbohydrate–to–phenolic mass ratios were ca. 11 : 1 (w/w), which was sufficient for encapsulation purposes.

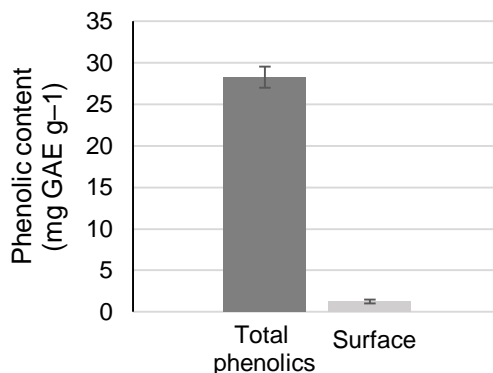
It had been planned that multiple types of encapsulation could take place during the capsule formation. First of all, formation of the matrix type capsule should occur, as both core and wall materials are water soluble and should form homogeneous structures. Low molecular weight sugars should form a solid shell wall that should prevent oxygen diffusion inside the capsule and active compound oxidation. Secondly, it had been reported that amylose can encapsulate small guest molecules by forming inclusion complexes (Cohen et al., 2008; Putseys et al., 2010; Gökmen et al., 2011; Kong & Ziegler, 2014).

While it was possible to dry all extracts, unfortunately, particles of the dried powder coagulated in the collection chamber, resulting in uneven capsule shapes (Fig. 4). Visual inspection of the transparent collection chamber during the spray-drying process showed that capsules were in the powdered form, and were moving around the chamber due to the strong aeration (construction flaw/compromise of the small laboratory scale benchtop dryer). This fact indicates that the same air that had been used for moisture evaporation and transfer is coming into contact with the dry product in cooled conditions of the collection chamber. As a result, it is possible that moisture could condensate on the particle surface, causing the coagulation. Additionally, active aeration could accelerate encapsulated compound oxidation (Anantharamkrishnan & Reineccius, 2017). Taking in consideration that carbohydrate content in the extract should consist mostly of short chain carbohydrates (as applied 60% ethanol solution as a solvent for phenolic compound extraction should result in the high molecular weight carbohydrate sedimentation), it is possible that temperature in the collection chamber exceeded the glass transition temperature of capsule matrix carbohydrates and resulted in the carbohydrate transition into rubbery state forming the sticky surface. Increased surface area of produced particles (in comparison to a theoretically possible spherical shape capsules) could provide a practical benefit in a way of faster capsule dissolution in target media and more rapid release of encapsulated compounds. Additional trials are necessary in spray-dryers of advanced construction or industrial scale spray-dryers.



**Figure 4.** Irregular shape of produced capsules under the optical microscope.

Based on the phenolic compound distribution between capsule surface and total phenolic content (Fig. 5), encapsulation efficiency of produced capsules (the ration between surface and bound compounds) reached  $95.5 \pm 0.9\%$ . This value should be considered as too big, because capsule had been formed of the same polarity substances. As a result, homogenous matrix should be formed and encapsulation efficiency should be a function of surface-to-volume ratio, and surface area should be increased together with the decrease of capsule size. As an example, in our previous study on gallic acid encapsulation in low dextrose equivalent starch showed encapsulation efficiency of  $77 \pm 7\%$  for spray dried samples (Sepelevs et al., 2018). There could be couple of reasons for a such high number. First of all, phenolic compounds could be mechanically separated from the surface during the encapsulation process in the cyclone and withdrawn from the dryer together with the airflow. On the opposite side, as it had been discussed previously, carbohydrates could undergo the glass transition state and (forming sticky rubbery capsule surface) entrap phenolic compounds strong enough preventing their extraction with a pure ethanol (as it was performed in present study, as carbohydrates are not dissolvable in it). Deeper study of the capsule surface is necessary for more precise conclusions.



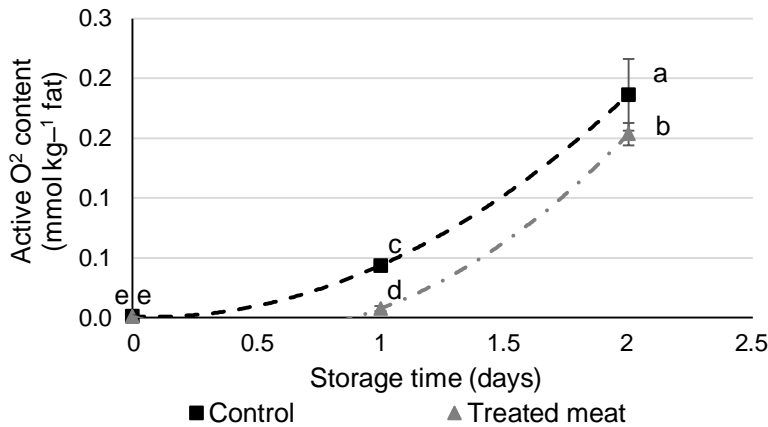
**Figure 5.** Total and surface phenolic contents of produced capsules (n = 3).

There are several approaches that could be implemented to improve upon the current product. First of all, assuming that there is a large proportion of low molecular weight carbohydrates in sample extracts, a low dextrose equivalent (4–10) maltodextrin could be added to the concentrated extract before feeding it into the spray-dryer in order to increase the average dextrose equivalent and thus rise the glass transition temperature. Secondly, different extraction solvent combinations with lower ethanol contents could be used to increase solubility of longer chain dextrans. But it is important to take into the consideration that decreased ethanol concentrations could negatively influence phenolic compound extraction yields (Wu et al., 2012).

All five stages of the developed method took a half of a day in laboratory conditions, with most of the time spent on the solvent evaporation and recovery. It had been planned that on the production scale all process should take approximately one work day, based on the available concentration technology. Due to the chosen MAE and concentration stages, the present method is suitable for the production process that consists of separate batches. This is a great choice for small scale production lines that could be used in Latvia, due to the relatively small annual potato processing amounts countrywide.

The functionality of produced encapsulated phenolic compounds as a food grade antioxidant had been tested during the ground pork meat storage at accelerated oxidation conditions (Fig. 6). It can be seen that after one day of storage at 30 °C, meat mass with added encapsulated phenolic compounds shows ca. five times lower oxidation rates in

comparison to control (active oxygen contents of 0.08 mmol kg<sup>-1</sup> for treated meat samples versus 0.44 mmol kg<sup>-1</sup> for control samples, respectively). Unfortunately, on the second day of storage oxidation rates of both samples were significantly increased. On the third day of the storage, microbial degradation of meat samples did not allow quantitative determination of active oxygen. The rapid ground pork meat spoilage had been anticipated but a decision had been made against application of additional preservatives as they could interfere with oxidation processes. Results can be evaluated as a positive as present research part had been conducted at increased temperatures.



**Figure 6.** Changes in the active oxygen content in the ground pork meat lipid fraction during the storage at accelerated oxidation conditions (n = 3), similar lowercase letters indicate no significant difference among samples of the same fraction ( $P \leq 0.05$ ).

Number of studies reported a successful application of herbal extract as natural antioxidants in meat and meat products (Nissen et al., 2004; Devatkal et al., 2012; Mathenjwa et al., 2012; Ozvural & Vural, 2012; Sánchez-Muniz et al., 2012; Cao et al., 2013; Reddy et al., 2013; Naveena et al., 2013; Grāmatiņa et al., 2017). Although, in majority of those cases, investigators chose raw materials with high phenolic compound contents, as grape skin, green tea leaves, red peony, etc. And only couple of investigators were using actual potato peel extracts, but prepared from potatoes that were peeled in laboratory conditions (Mansour & Khalil, 2000; Kanatt et al., 2005; Farvin et al., 2012). One of the major differences between potato peel samples acquired in laboratory conditions and acquired from the actual potato processing facility is that on the production sites peel by-products usually are being collected with an assistance of water, and, as had been stated previously, water is a second food-grade solvent for phenolic compound extraction after ethanol. Of course, an additional assistance (mechanical, ultrasound, microwave, etc.) should be applied for better phenolic compound diffusion from cells into water, but still some phenolic compound losses should be present. This means that previously reported data is not fully scalable for industrial application, as water and ethanol extracts results in the different phenolic profiles and different antioxidant properties (Farvin et al., 2012).

Theoretically, there could be additional applications of recovered and encapsulated phenolic compounds – introduction of produced capsules as a separate specialized wall material for another valuable compound encapsulation, to ensure the protection of encapsulated materials against oxidation. For example, it could be used for unsaturated oil encapsulation where (incorporated in the modified starch shell wall material) phenolic compounds could serve as an additional oxygen barrier. Additionally, it had been reported that some of water soluble polysaccharides (no specification reported) from potato peels have good water holding abilities, fat binding capacity, foaming properties (due to the presence of some protein remains), emulsification stability, and possess a natural antioxidant abilities (Jeddou et al., 2016). As a result, it can be concluded that the produced mixture of simultaneously extracted phenolic compounds and carbohydrates have a potential to serve as a wall material, for example, for the pharmacological use where active compound preservation plays a critical role and application of more expensive wall materials (and technologies) is a common practice.

## CONCLUSION

A practically applicable method for the industrial potato peel waste processing and powdered encapsulated phenolic compound production had been developed, using the industrial potato peel by-products as the only source material. It consists of four subsequent steps: peel homogenisation in the solvent media, phenolic compound and carbohydrate extraction, produced extract concentration, and encapsulation via spray-drying. Microwave assisted extraction alone showed higher extraction yields than in combinations with ultrasound treatment. Produced capsules showed a positive result during the ground pork meat accelerated storage study during the first two days of the storage at accelerated oxidation conditions. The developed method does not produce chemical wastes that could be toxic for the environment. Acquired results form a basis for development of a potato peel industrial processing technology.

**ACKNOWLEDGEMENTS.** The present study was supported by the Latvian State Research program ‘Agricultural Resources for Sustainable Production of Qualitative and Healthy Foods in Latvia’ (AgroBioRes) (2014–2017). Project No. 4 ‘Sustainable use of local agricultural resources for qualitative and healthy food product development’ (FOOD). Research material was kindly donated by the local potato processing enterprise Papatle Nr 1, Ltd, Raubeni, Latvia.

## BIBLIOGRAPHY

- Al-Weshahy, A. & Rao, V.A. 2012. Potato Peel as a Source of Important Phytochemical Antioxidant Nutraceuticals and Their Role in Human Health–A Review. In V. Rao (Ed.), *Phytochemicals as Nutraceuticals - Global Approaches to Their Role in Nutrition and Health* (pp. 207–224).
- Cao, Y., Gu, W., Zhang, J., Chu, Y., Ye, X., Hu, Y. & Chen, J. 2013. Effects of chitosan, aqueous extract of ginger, onion and garlic on quality and shelf life of stewed-pork during refrigerated storage. *Food Chemistry* **141**, 1655–1660.
- Cohen, R., Orlova, Y., Kovalev, M., Ungar, Y. & Shimoni, E. 2008. Structural and functional properties of amylose complexes with genistein. *Journal of Agricultural and Food Chemistry* **56**, 4212–4218.



- Devatkal, S.K., Thorat, P. & Manjunatha, M. 2012. Effect of vacuum packaging and pomegranate peel extract on quality aspects of ground goat meat and nuggets. *Journal of Food Science and Technology* **51**(10), 2685–2691.
- Farvin, S.K.H., Grejsen, H.D., Jacobsen, C., Sabeena Farvin, K.H., Grejsen, H.D., Jacobsen, C., Farvin, S.K.H., Grejsen, H.D. & Jacobsen, C. 2012. Potato peel extract as a natural antioxidant in chilled storage of minced horse mackerel (*Trachurus trachurus*): Effect on lipid and protein oxidation. *Food Chemistry* **131**(3), 843–851.
- FOASTAT. 2018. Crops, Worldwide, Production Quantity, Potatoes, 2016. Available at <http://www.fao.org/faostat/en/#data/QC>
- Friedman, M., Kozukue, N., Kim, H.-J.J., Choi, S.-H.H. & Mizuno, M. 2017. Glycoalkaloid, phenolic, and flavonoid content and antioxidative activities of conventional nonorganic and organic potato peel powders from commercial gold, red, and Russet potatoes. *Journal of Food Composition and Analysis* **62**(March), 69–75.
- Gökmen, V., Mogol, B.A., Lumaga, R.B., Fogliano, V., Kaplun, Z. & Shimoni, E. 2011. Development of functional bread containing nanoencapsulated omega-3 fatty acids. *Journal of Food Engineering* **105**, 585–591.
- Grāmatīņa, I., Sazonova, S., Krūma, Z., Skudra, L. & Prieciņa, L. 2017. Herbal Extracts for Ensuring Pork Meat Quality during Cold Storage. *Proceedings of the Latvian Academy of Sciences. Section B. Natural, Exact, and Applied Sciences* **71**(6), pp. 453–460.
- Habeebullah, S.F.K., Nielsen, N.S. & Jacobsen, C. 2010. Antioxidant activity of potato peel extracts in a fish-rape seed oil mixture and in oil-in-water emulsions. *JAOCS, Journal of the American Oil Chemists' Society*, **87**(11), 1319–1332.
- Hara, A. & Radin, N.S. 1978. Lipid extraction of tissues with a low toxicity solvent. *Analytical Biochemistry* **90**(1), 420–426.
- Hsieh, Y.-L., Yeh, Y.-H., Lee, Y.-T. & Huang, C.-Y. 2016. Dietary potato peel extract reduces the toxicity of cholesterol oxidation products in rats. *Journal of Functional Foods* **27**, 461–471.
- IFRA. 2011. 22291 Analytical Guidelines 2011-10-17 IFRA Analytical Method – Determination of the Peroxide Value. Available at: <https://www.scribd.com/document/277150250/22291-Analytical-Guidelines-2011-10-17-IFRA-Analytical-Method-Determination-of-the-Peroxide-Value>
- iso.org. 1997. ISO 1442:1997 Meat and meat products – Determination of moisture content (reference method). Available at: <https://www.iso.org/standard/6037.html>
- Jeddou, K. Ben, Chaari, F., Maktouf, S., Nouri-Ellouz, O., Helbert, C.B. & Ghorbel, R.E. 2016. Structural, functional, and antioxidant properties of water-soluble polysaccharides from potatoes peels. *Food Chemistry* **205**, 97–105.
- Jung, J.K., Lee, S.U., Kozukue, N., Levin, C.E. & Friedman, M. 2011. Distribution of phenolic compounds and antioxidative activities in parts of sweet potato (*Ipomoea batata* L.) plants and in home processed roots. *Journal of Food Composition and Analysis* **24**(1), 29–37.
- Kanatt, S.R., Chander, R., Radhakrishna, P. & Sharma, A. 2005. Potato peel extract - a natural antioxidant for retarding lipid peroxidation in radiation processed lamb meat. *Journal of Agricultural and Food Chemistry* **53**(5), 1499–1504.
- Kong, L. & Ziegler, G.R. 2014. Formation of starch-guest inclusion complexes in electrospun starch fibers. *Food Hydrocolloids* **38**, 211–219.
- Mansour, E.H. & Khalil, A.H. 2000. Evaluation of antioxidant activity of some plant extracts and their application to ground beef patties. *Food Chemistry* **69**(2), 135–141.
- Mathenjwa, S.A., Hugo, C.J., Bothma, C. & Hugo, A. 2012. Effect of alternative preservatives on the microbial quality, lipid stability and sensory evaluation of boerewors. *Meat Science* **91**, 165–172.
- Mohdaly, A.A.A., Sarhan, M.A., Smetanska, I. & Mahmoud, A. 2010. Antioxidant properties of various solvent extracts of potato peel, sugar beet pulp and sesame cake. *Journal of the Science of Food and Agriculture* **90**(2), 218–226.

- Naveena, B.M., Vaithiyanathan, S., Muthukumar, M., Sen, A.R., Kumar, Y.P., Kiran, M., Shaju, V.A. & Chandran, K.M. 2013. Relationship between the solubility, dosage and antioxidant capacity of carnosic acid in raw and cooked ground buffalomeat patties and chicken patties. *Meat Science* **95**, 195–202.
- Nissen, L.R., Byrne, D.V., Bertelsen, G. & Skibsted, L.H. 2004. The antioxidative activity of plant extracts in cooked pork patties as evaluated by descriptive sensory profiling and chemical analysis. *Meat Science* **68**, 485–495.
- Oh, D.-H. & Marshall, D. 1993. Antimicrobial activity of ethanol, glycerol monolaurate or lactic acid against *Listeria monocytogenes*. *International Journal of Food Microbiology* **20**(4), 239–246.
- Ozvural, E.B. & Vural, H. 2012. The effects of grape seed extract on quality characteristics of frankfurters. *Journal of Food Processing and Preservation* **36**, 291–297.
- Parr, B., Bond, K.J. & minor, T. 2018. Vegetables and Pulses Yearbook Data. Economic Research Service. Available at [http://usda.mannlib.cornell.edu/usda/ers/VEGANPULSESEYEARBOOK/2018/Vegetables\\_and\\_Pulses\\_Yearbook\\_2018.pdf](http://usda.mannlib.cornell.edu/usda/ers/VEGANPULSESEYEARBOOK/2018/Vegetables_and_Pulses_Yearbook_2018.pdf)
- Putseys, J.A., Lamberts, L. & Delcour, J.A. 2010. Amylose-inclusion complexes: Formation, identity and physico-chemical properties. *Journal of Cereal Science* **51**, 238–247.
- Reddy, G.V.B., Sen, A.R., Nair, P.N., Reddy, K.S., Reddy, K.K. & Kondaiah, N. 2013. Effects of grape seed extract on the oxidative and microbial stability of restructured mutton slices. *Meat Science* **95**, 288–294.
- Samarin, A.M., Poorazarang, H., Hematyar, N. & Elhamirad, A. 2012. Phenolics in potato peels: Extraction and utilization as natural antioxidants. *World Applied Sciences Journal* **18**(2), 191–195.
- Sánchez-Muniz, F.J., Olivero-David, R., Triki, M., Salcedo, L., González-Muñoz, M.J., Cofrades, S., Ruiz-Capillas, C., Jiménez-Colmenero, F. & Benedi, J. 2012. Antioxidant activity of *Hypericum perforatum* L. extract in enriched n-3 PUFA pork meat systems during chilled storage. *Food Research International* **48**, 909–915.
- Schieber, A., Stintzing, F.C. & Carle, R. 2001. By-products of plant food processing as a source of functional compounds — recent developments. *Trends in Food Science & Technology* **12**(11), 401–413.
- Sepelevs, I., Stepanova, V. & Galoburda, R. 2018. Encapsulation of Gallic Acid with Acid-Modified Low Dextrose Equivalent Potato Starch Using Spray-and Freeze-Drying Techniques. *Polish Journal of Food and Nutrition Sciences* **68**(3), 273–280.
- Shepelev, I., Galoburda, R. & Rakcejeva, T. 2016. Changes in the total phenol content in the industrial potato peel wastes during the storage. *Agronomy Research* **14**(S2), 1442–1450.
- Singh, A., Sabally, K., Kubow, S., Donnelly, D.J., Garipey, Y., Orsat, V.V.V. & Raghavan, G.S.V. 2011. Microwave-assisted extraction of phenolic antioxidants from potato peels. *Molecules* **16**(3), 2218–2232.
- Vámos-Vigyázó, L. 1981. Polyphenol oxidases and peroxidases in fruits and vegetables. *CRC Critical Reviews in Food Science and Nutrition* **15**(1), 49–127.
- Wu, T., Yan, J., Liu, R., Marcone, M.F., Akber, H. & Tsao, R. 2012. Optimization of microwave-assisted extraction of phenolics from potato and its downstream waste using orthogonal array design. *Food Chemistry* **133**(4), 1292–1298.
- Yu, L., Haley, S., Perret, J., Harris, M., Wilson, J. & Haley, S. 2003. Antioxidant properties of bran extracts from Akron wheat grown at different locations. *Journal of Agriculture and Food Chemistry* **51**, 1566–1570.

## **The effects of irrigation on root density profiles of potato, celery, and wheat**

P. Svoboda<sup>1</sup>, I. Raimanová<sup>1</sup>, R. Duffková<sup>2</sup>, P. Fučík<sup>2</sup>, G. Kurešová<sup>1</sup> and J. Haberle<sup>1,\*</sup>

<sup>1</sup>Crop Research Institute, v.v.i, Drnovská 507, CZ161 06 Praha 6, Czech Republic

<sup>2</sup>Research Institute for Soil and Water Conservation, v.v.i., Žabovřeská 250, CZ15600 Praha 5 - Zbraslav, Czech Republic

\*Correspondence: haberle@vurv.cz

**Abstract.** Irrigation rate should correspond to the effective root depth, however, crop root growth is influenced by a number of factors, and little data is available on the impact of irrigation. This contribution presents the results of several experiments in which the influence of sprinkler or drip irrigations on root density distribution of shallow, medium and deep rooted crops within the soil profile were studied. Irrigation significantly increased the root density of potato, celery, and wheat in the topsoil zone. On the contrary, at most cases there was only a slightly reduced root density in the subsoil layers. Total root length, to maximum root depth, only increased significantly with drip irrigation in potato. The root depths of these crops were not significantly modified by irrigation. The results suggest that the use of a constant value for the calculation of maximum irrigation depth in a specific crop may not correspond to the variability of root depth nor the distribution in different years or fields.

**Key words:** drought, root distribution, root length, water depletion.

### **INTRODUCTION**

In recent years drought has caused farmers in the Czech Republic (as well as in many other countries) losses of hundreds of millions of euros. Agro-climate models agree that water deficit, due to high evapotranspiration and uneven rainfall distribution throughout the year, will become increasingly common in Central Europe and elsewhere with impacts on yields (Středová et al., 2013; Spitz & Hemerka, 2014; Trnka et al., 2019).

At present in the Czech Republic, primarily vegetables and early potato are irrigated, as well as (to a different extent) fruit orchards, hops gardens, and vineyards (Agriculture and Horticulture Czech Republic, 2019). Most irrigation water is applied to field crops and vegetables by sprinkling; however, drip irrigation that is mainly applied in orchards and vineyards is more effective. The study of Duffková et al. (2019) showed that over 80% of spring crop regions in the Czech Republic were threatened with medium to severe water scarcity. The growing trend for the occurrence of dry periods, will lead to the expansion of irrigated fields. There is concern whether there will be enough water for irrigation in dry years. In addition, water is increasingly discharged

from the landscape; and the water supply within both underground and surface resources (and often additionally its quality) has been declining.

This implies the need to improve the use of water in agriculture. The efficiency of irrigation water application depends on correctly determining both the current and estimated future water needs of plants, as well as the available water supply in the root zone. This subject matter has been described in a number of papers (Ahmadi et al., 2011, 2017; Haberle & Svoboda, 2015; Kirnak et al., 2017; Elzner et al., 2018; Assouline, 2019). If the irrigation dose is excessive, water can be lost by percolation below the root zones of the crops; while too low a dose increases the need for repeated application of water, thus increasing evaporation losses. Thus, actual crop root depth determines the maximum irrigation depths, and the volume of soil with the relevant water capacity. It is an especially important factor with shallow rooted potato, vegetables such as lettuce and radish, which are also often grown on shallow light soils.

In the Czech Republic, the calculation of the irrigation dose is determined by Czech national standard (ČSN 750434, 2017). The standard defines the maximum irrigation depth corresponding to the root depth for field crops, vegetables, and fruit trees. However, the root extent is only described in general terms; the effective root depth (for example, according to limit root density) not being defined. Based on this standard, the IRRIPROG expert system (Spitz et al., 2011) was created to calculate the terms and rates of irrigation. The calculation is based on: the FAO 56 evapotranspiration water balance methodology (Allen et al., 1998), infiltrating proportion of rainfall and irrigation water, decrease in available water supply in the root zone below the specified level, available soil water capacity, and possible water leakage below the root zone. Again, the maximum root zone depth of crops is fixed as an average value for a given species.

Root growth is influenced by a number of factors, and the question is whether the root depth under farm conditions does not significantly deviate from the table values of maximum irrigation depth (Spitz et al., 2011; ČSN 750434, 2017). In addition to the expected impacts of soil site conditions, agronomic measures, or cultivar differences, there is concern that high soil moisture, due to irrigation or excessive fertilization (mainly nitrogen), could reduce root depth or density (Svoboda & Haberle, 2006). In such a case, too high an irrigation rate, calculated for an expected deeper root zone, might result in a percolation loss of irrigation water outside of the root zone. Potato and most vegetables have a high demand for nitrogen, but shallow roots and show a low efficiency of N utilization from fertilizers and a high risk of nitrate leaching into the groundwater (Haberle et al., 2018; Svoboda et al., 2018). It is especially important in regions also used for the accumulation of drinking water. These are often situated in areas with light soils near rivers where early potato and vegetables are produced. The on-farm experiments with potato and celery presented here were carried out in the lower Jizera river aquifer, source of 25% of the drinking water for Prague. Due to increasing nitrate concentrations in drainage waters the concerns about optimal irrigation are more pressing (Bruthans et al., 2019). To some extent the activities of these farms are regulated, but the growing of irrigated vegetables and potatoes is not prevented.

Optimal or supra optimum soil resource availability generally reduce plant investment in the root system, but there is little data on the effects of irrigation upon root depth. Tracking roots to the maximum root depth is difficult, so there is little relevant data to be found in the literature. We decided to determine the root density and depth in early potato and celery on farms in order to obtain data relevant for the conditions found

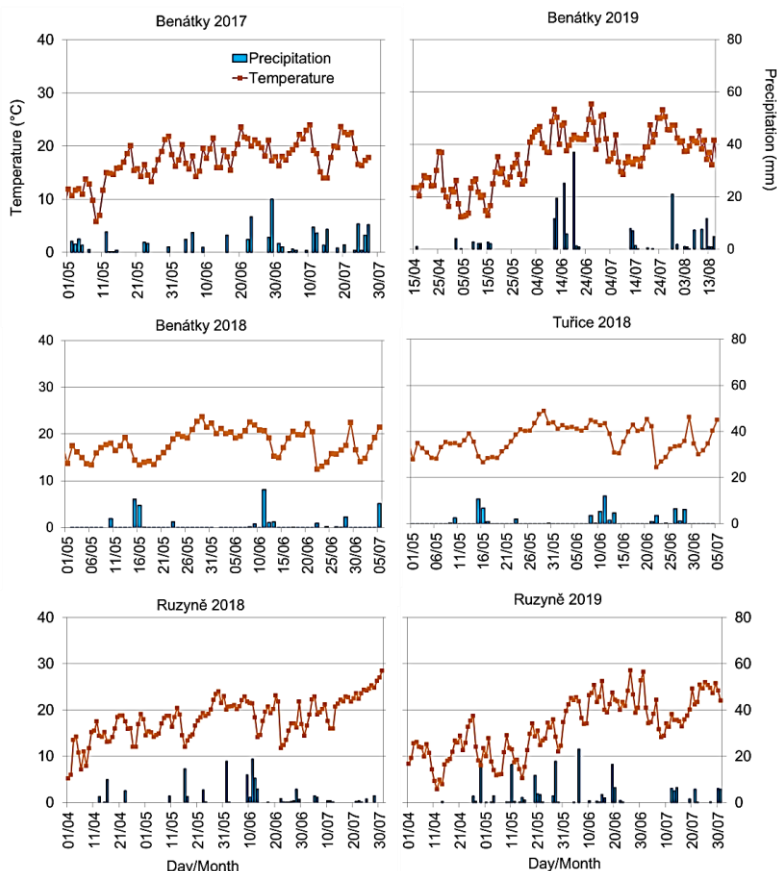
in the area. This data should verify the recommended maximum irrigation depths for selected crops and to support the decisions of the farmers.

The aim of this research was to determine the effects of irrigation on the root density distribution of potato and celery (crops with shallow and medium deep root systems, respectively), and winter wheat (characterized by a large and deep root system).

## MATERIALS AND METHODS

### Site conditions

The basic descriptions of the crops studied, treatments, soils, irrigation systems, and total amount of irrigation water (mm) are shown in Table 1. The potato and celery roots were sampled at the farms, while the wheat was studied in a plot trial. Daily precipitation sums and average temperatures at the experimental sites and years are shown in Fig. 1. Soil moisture during the potato and celery experiments were monitored with EC10 (Decagon, USA) and CS616 (Campbell Scientific, USA) sensors. In wheat, the amount of water in the 0–90 cm zone was calculated from water balance data, corrected according to a standard determination of soil moisture (Raimanová et al., 2016).



**Figure 1.** Temperature and precipitation in the experimental years and sites.

## Treatments

Potato (*Solanum tuberosum* L.) was studied during years 2017–2019, celery (*Apium graveolens* L.) in 2018, and winter wheat (*Triticum aestivum* L.) during 2018–2019.

In 2017, the growth of roots of potato (cv. Impala), irrigated conventionally according to the estimated water need by sprinkling (wheel sprinkler irrigation), was compared with the control of a non-irrigated (rain-fed) potato crop at Benátky n. Jizerou. Irrigation increased the water supply in 2017 by 250 mm compared to the non-irrigated control. Due to technical problems, only the sums of irrigation water were recorded in potato (2017 and 2019), and not the individual water doses.

In 2018, on another part of the same field, the growth of potato roots (cv. Adéla) was monitored in two irrigation variants: the conventional empirical irrigation applied to this farm and the irrigation operated by calculation from the IRRIPROG program (Spitz et al., 2011) with the aim to save irrigation water use. Optimized irrigation in 2018 reduced the volume of water supplied to potato by 40 mm compared to the standard control (Table 1).

**Table 1.** Summary of experiments with observations of the effects of irrigation on crops root systems

Crop Year Irrigation system	Site Coordinates	Soil topsoil Subsoil	Treatments	Total amount of irrigation water (mm) [Precipitation (mm)] <sup>4</sup>
Potato 2017 Wheel <sup>1</sup>	Benátky n. Jizerou 50.2800797N 14.8443431E	sandy loam loamy sand	Without Irrigation Irrigated conventionally	nil 250 mm [151.4 mm]
Potato 2018 Wheel <sup>1</sup>	Benátky n. Jizerou 50.2829208N 14.8390903E	sandy loam loamy sand	Irrigated according IRRIPROG calculation Irrigated conventionally	195 mm 235 mm [80.0 mm]
Potato 2019 Drip <sup>3</sup>	Benátky n. Jizerou 50.2781683N 14.8378714E	loam loamy sand	Irrigation stopped at butonization phase Irrigated according IRRIPROG calculation	120 mm 270 mm [155.8 mm]
Celery 2018 Sprinkler <sup>2</sup>	Tuřice 50.2450472N 14.7544764E	loam sandy loam	Irrigated conventionally Irrigated according IRRIPROG calculation	150 mm 120 mm [68.9 mm]
Winter wheat 2018 Drip <sup>3</sup>	Ruzyně 50.0845428N 14.2994058E	silt loam clay loam	Stressed from heading Irrigated after heading	nil [31.7 mm] 230 mm [129.7 mm]
Winter wheat 2019 Drip <sup>3</sup>	Ruzyně 50.0845428N 14.2994058E	silt loam clay loam	Stressed from heading Irrigated after heading	nil [64.5 mm] 220 mm [141.4 mm]

<sup>1</sup>Wheel sprinkler irrigation, <sup>2</sup>Micro sprinkler irrigation, <sup>3</sup>Drip irrigation, <sup>4</sup>Precipitation was summed from start of April to harvest (celery), desiccation (potato) or to maturity (wheat).

In 2019, potato root distribution (cv. Antonia) was observed on the adjacent field with drip irrigation (driplines placed under a thin layer of soil). The drip irrigation was

terminated at the start of butonization (BBCH 53–55, at visible bud inflorescence, 5th June) at two portions of the field, with the reduction in the amount of water compared to the irrigated crop being 155 mm of water.

For celery (cv. Asterix) in 2018 in Tuřice (micro sprinkler irrigation), the treatment with conventional irrigation was compared with the variant where the irrigation was adjusted by the IRRIPROG program's calculations.

The study of winter wheat was carried out in a field trial at Ruzyně in 2018 and 2019 as a part of experiments related to irrigation and the induction of water shortage during grain growth (e.g., Haberle & Svoboda, 2014; Raimanová et al., 2016). The growth of roots from drip irrigated and drought-stressed plants was studied; the lack of water was induced from heading (BBCH 58–60) with the help of a mobile cover (Table 1).

Commercial compost (ORGANIC, 2.8–3.2% N dry matter) was applied during autumn soil tillage for both potato and celery at the rate of 5–10 t per hectare. Nitrogen fertilizers in the form of ammonium nitrate were applied before potato planting. In total, from 135 kg to 175 kg N ha<sup>-1</sup> was applied in organic and mineral fertilizers. For celery, 180 kg ha<sup>-1</sup> of nitrogen in the form of ammonium nitrate and calcium nitrate was applied together with complex fertilizers with micronutrients in several doses during growth. For wheat, 150 kg of nitrogen per hectare in the form of nitrate ammonium with limestone was divided into a regenerative early spring dose of 35 kg ha<sup>-1</sup>, and a production dose of 115 N ha<sup>-1</sup> at the start of stem elongation (BBCH 31–33).

## RESULTS AND DISCUSSION

### Root study

Soil samples were taken using a hand sampler with a diameter of 36 mm, in 10 cm increments, with at least in six replicates, down to the root-free depth. The roots were separated with water on sieves, cleaned, and their total length determined according to Tennant (1975), after which the root density was calculated (in cm per cm<sup>-3</sup> of soil). The density distribution of the roots in potato was determined before desiccation of the plants (BBCH 85-91); and for celery before the harvest, when the target size of the bulbs had been reached. The roots of wheat were sampled during the grain filling period (BBCH 78-83). For potato and celery, soil with roots were taken on the ridge, row of plants, and between the ridge and furrow. For wheat, the soil was sampled on and between plant rows.

Statistical data evaluation was performed by the analysis of variance (ANOVA) and by the Tukey's HSD test (significance level  $P < 0.05$ ). Statistica 13 (Stat-Soft Inc., Tulsa, USA) software was used.

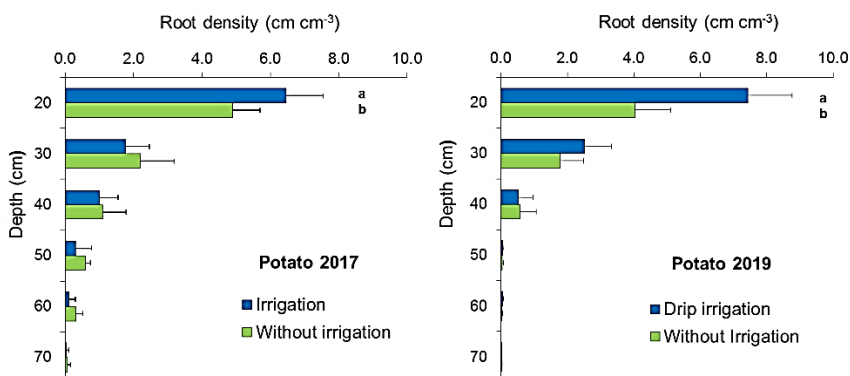
### The impact of irrigation upon yields

The weather during the experimental years were among the hottest of the last several decades in the Czech Republic. The precipitation was mostly low (Fig. 1), water shortage created conditions for a positive effect of irrigation on yields. In 2017, the irrigation of potato, compared to the non-irrigated control increased the yield by 10.8 t ha<sup>-1</sup> (50.4 t ha<sup>-1</sup> against 39.6 t ha<sup>-1</sup>), while the impact on the roots was weak. Also, in 2019, drip irrigation greatly increased tuber yield (from 10.7 kg per ten plants in the non-irrigated treatment, to 18.3 kg per ten plants); in agreement with the strong impact

of drought on canopy and reduction of the root density in the stressed plants. The positive effect of irrigation on potato yields has not only been reported in drier areas, but also in areas with higher rainfall, where potato is grown on lighter soils (e.g., Elzer et al., 2018). The irrigation increased yields in wheat by 50.7% and 49.8% in comparison with stressed crop (3.81 t and 3.66 t ha<sup>-1</sup>) in the experimental years 2018 and 2019, respectively. On the contrary, the effects of a relatively small reduction in supplemental irrigation on potato in 2018 (34.3 t ha<sup>-1</sup> and 34.7 t ha<sup>-1</sup>), as well as on the celery yields (average weight of bulb with tops 0.85 kg and 0.91 kg) were not significant.

### The effect of irrigation on total root length and root distribution

In spite of different experimental conditions, the root distributions of the experimental crops showed similar trends. However, the differences of the root density between variants were not significant, in some cases, due variability in root density.

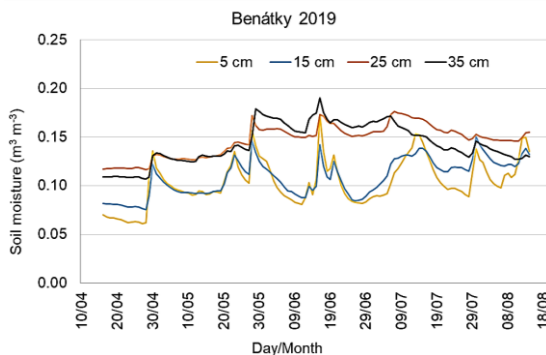


**Figure 2.** Root density of potato without irrigation and with irrigation (Benátky and Jizerou - 2017) or with drip irrigation (Benátky n. Jizerou - 2019). Here and further, the effect of irrigation is significant ( $p < 0.05$ ) at layers with different letters.

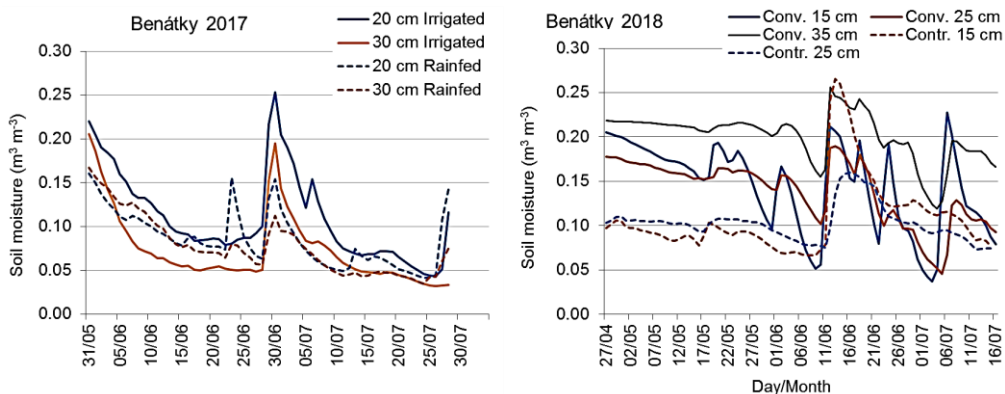
Irrigation significantly increased the total root length to the maximum depth (TRL) of potato only in 2019 (10.53 km m<sup>-2</sup> under irrigation, vs. 6.42 km m<sup>-2</sup> for the non-irrigated crop) thanks to great root proliferation in the topsoil (Fig. 2). We have not found similar results in the literature, and these observations should be verified with further experiments. The strong effect was probably the result of frequent drip irrigation, with relatively small amounts of water (about 5 mm every day) in contrast to the strong stress due to low precipitation in the phase of the greatest need for assimilates for tuber growth in the not irrigated treatment. Potatoes, due to their origin, have a dense shallow root system aimed at the quick utilization of rainwater. Due to frequent small daily doses by drip irrigation, water was quickly evapotranspired at high temperatures. The moisture content was low in the top soil layers, except for periods with higher precipitation. (Fig. 3); however, the demand for water was satisfied. Soil moisture was only monitored in the irrigated treatment, but it can be deduced that the soil moisture was depleted to low levels in the treatment without irrigation, resulting in both low yield and reduced root growth in the top soil. The comparison of root distributions in years 2017 and 2019 shows significant year and site variability and it suggests difficulty in determining constant effective depths.



In 2017, the increase of TRL due to irrigation in potato was not significant ( $9.72 \text{ km m}^{-2}$  and  $9.20 \text{ km m}^{-2}$ ). Irrigation only significantly increased the root density of potato in the topsoil; and it slightly (but insignificantly) reduced the density in layers below a depth of 20 cm (Fig. 2). It was seemingly not fully consistent with the impact of the water shortage on potato roots in 2019, but in 2017 irrigation was not applied from the beginning of growth, and the potato plants probably adapted to the lower water content. The soil moisture data (Fig. 4) suggest lower water consumption of stressed plants in 2017. In 2019, irrigation was stopped at butonization when the canopy was fully developed, LAI was high, and the plants were accustomed to a regular supply of water from the drip irrigation. Shallow roots in 2019 (Fig. 2) could not compensate for the water input reduction.



**Figure 3.** Soil moisture in irrigated potato (Benátky - 2019).

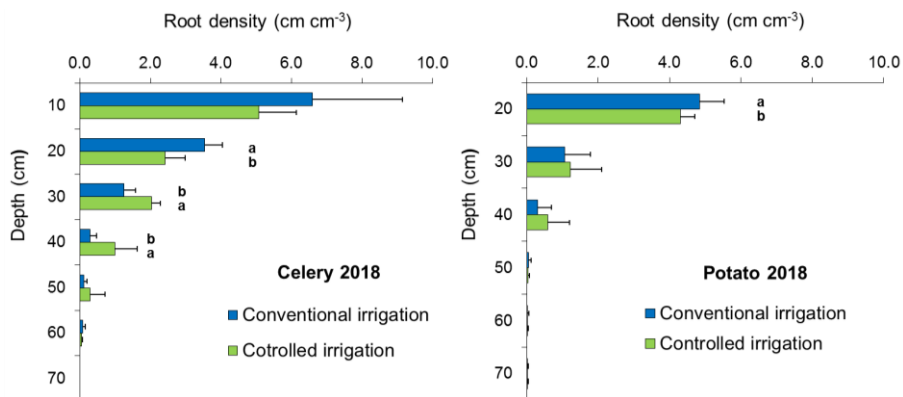


**Figure 4.** Soil moisture in potato (Benátky 2017 and 2018). Conventional (Conv.) and controlled (Contr.) irrigation in 2018.

In 2018, the increase of TRL due to the slightly higher conventional irrigation in potato was not significant ( $6.29 \text{ km m}^{-2}$  and  $6.18 \text{ km m}^{-2}$ ), in agreement with the similar amounts of water applied in both treatments (Table 1). Conventional irrigation of potato, compared to lower irrigation (according to calculations) significantly increased root density in the top layers, and insignificantly reduced root density under 20 cm (Fig. 5). The soil moisture (Fig. 4) suggests periods of both low and high water supply that complicates the interpretation of small differences in root growth.

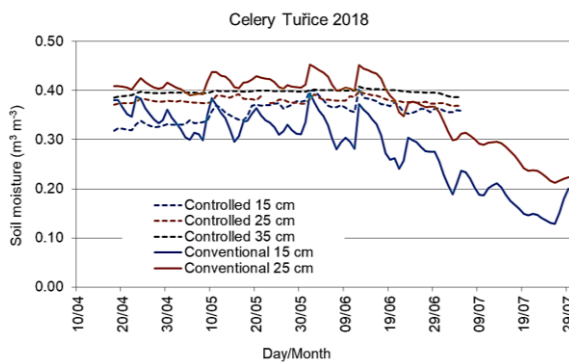
The exact calculation of effective depths, where the density drops (for example under  $1 \text{ cm cm}^{-3}$ ) would demand interpolation of the root density curve in ten-centimetre segments. A simple comparison of potato root densities at these depths shows that the

effective root depth was different in the experimental years (Figs 2 and 5). This suggests that the application of constant maximum irrigation depth for a species may cause irrigation doses that are either too low or too high.



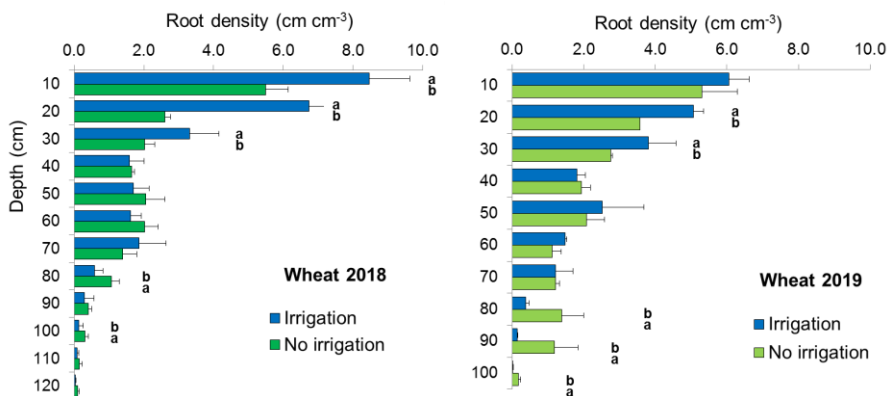
**Figure 5.** Root density of potato (Benátky nad Jizerou - 2018) and celery (Tuřice - 2018) with conventional empirical irrigation and with irrigation according to sensors and calculation with the IRRIPROG program.

Similar to potato in 2017 and 2018, TRL was (not significantly) greater at a greater water irrigation dose (with conventional irrigation) in celery (11.9 km m<sup>-2</sup> compared to 10.9 km m<sup>-2</sup>); however, the effect on root distribution and root length in both the top and subsoil layers was significant (Fig. 5). The soil moisture was slightly lower at the 15 cm depth, and slightly higher at the 25 cm in the conventional treatment in comparison with controlled irrigation; however, two different types of sensors were used (Fig. 6).

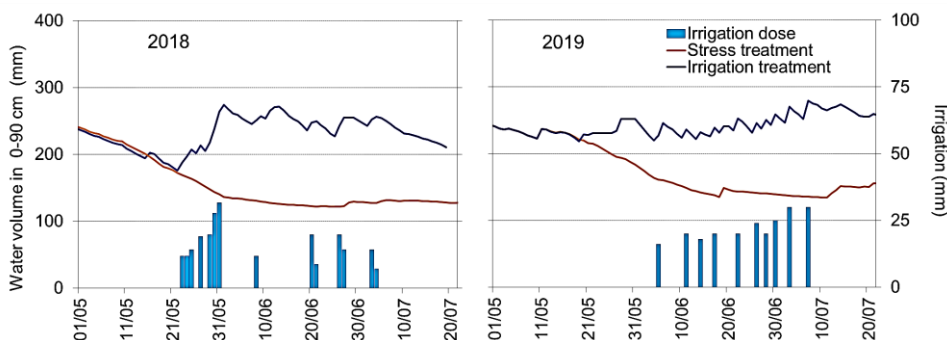


**Figure 6.** The soil moisture in celery (Tuřice - 2018). The data from controlled irrigation treatment (EC 10 sensors) are incomplete because the station with the sensors was stolen. Data from the conventional treatment were recorded with CS616 sensors.

The TRL of irrigated wheat was (marginally) significantly greater (22.51 km m<sup>-2</sup>) than in stressed plants (20.70 km m<sup>-2</sup>) thanks to significantly greater root length in the arable layer (Fig. 7) in 2018 (an extremely dry year), while in 2019, the effect of irrigation at the grain growth stage was practically nil (11.21 km m<sup>-2</sup> and 11.16 km m<sup>-2</sup>). Plants in the stressed treatment were strongly affected by a decrease of soil water content near the wilting point level (Fig. 8), as was also shown by the low yields in comparison with the irrigated treatment.



**Figure 7.** Root density of winter wheat with drip irrigation and stressed after heading (Ruzyně - 2018 and 2019).



**Figure 8.** Soil water content in stressed and irrigation treatments in the 0–90 cm zone in wheat (Ruzyně - 2018 and 2019).

Despite different crops and locations, and great differences in the water supply, the results suggest a similar effect of irrigation on root distribution. An interpretation of the results is difficult. In the potato trials in 2017 and 2019, as well as in the wheat, the water deficit was much higher than in both potato and celery in 2018 (Table 1). There is very little literature data about the effects of irrigation on potato and celery root growth. Published results come mostly from different soil-climate conditions or pot experiments; thus, the described effects often differ. Ahmadi et al. (2017) observed greater total root length under a partial root drying irrigation regime when compared with full irrigation and deficit irrigation. On the other hand, Boguszevska-Mańkowska et al. (2019) found the root dry mass decreased in response to drought, but that the more drought-tolerant cultivars developed elongated roots. Zarzyńska et al. (2017) in a container experiment found that the greater the length and weight of potato cultivars' roots in the deeper layer (60–80 cm), the lesser was the decrease in yield due to (short term) drought. Further, in most experiments, root size was only determined during one term during growth. Generally, maximum root size in annual crops is attained after flowering and during seed

development. We decided to sample the celery roots before harvest, upon attaining their target, retail, size of the bulbs; however, further root growth cannot be excluded.

### **The importance of root modification for effective irrigation**

Generally, plants adapt to water and nutrient scarcity by investing more in underground organs, increasing root density, and/or growing roots at depth - making it possible to exploit the water reserve in the deeper subsoil layers. In our experiments, the effect of the variants on the observed maximum root depth was both small (in the scale of 10 cm layer) and inconsistent among crops and variants. A possible reason may be that in spring, during the period of maximum root growth to depth, crops grow under a more-or-less sufficient water supply accumulated from winter precipitation, while in the latter period (when water shortage occurred) assimilates are preferentially used for seed and storage organs.

The root density in the deepest layers (mostly formed by individual unbranched root axes) is far below the levels considered effective (1.0–2.0 cm cm<sup>-3</sup>) (Haberle & Svoboda, 2014; Haberle & Svoboda, 2015); therefore, the importance for water uptake is probably low. However, not only in wheat, but also in shallow and medium rooted crops, such as potato, varieties with deeper roots that are expected to be more resistant to drought (Ahmadi et al., 2017; Zarzyńska et al., 2017). Deep rooted crops, such as winter wheat or sunflower, adapt to resources shortage by extracting water (and nitrate nitrogen and other ions) from deep subsoil reserves (Haberle et al., 2006; Kautz et al., 2013; Haberle & Svoboda, 2014). The plant's demand for water is shifted downwards; a low root density in the deep layers may to some extent be compensated by an enhanced uptake per root unit. However, with irrigation depleted water is replenished in the densely rooted topsoil; therefore, small changes of root depth and density in the deep subsoil layers will probably not affect the water uptake and balance. The correct determination of the maximum depth of irrigation is a key input value for any calculation for both the optimum rates and timing of irrigation water. The possible reduction of the root depth of potatoes and vegetables, with both shallow and medium deep root systems, is more important than a lesser root density in the deeper subsoil zones. Soil compaction, impermeable layers of clay / pebbles, even a high ground water level are known factors limiting root penetration and the depletion of water and nutrients (e.g., Johansen et al., 2014). According to the monitoring of fields in the lower Jizera region, the soils are often highly variable due to their origins (Bruthans et al., 2019). In our experiment, potato root distribution and maximum depths were influenced by soil conditions in an interaction with the irrigation method. In those cases where fine tuning of the irrigation doses and its timing are priority due to water quality concerns, farmers should check for the possible reduction of root growth and accordingly adjust the maximum irrigation depth. However, farmers lack a simple method for the calculation or estimation of the effective root depth.

The lateral distribution of roots is another factor complicating standardization of input value of effective root zone for maximum depth of irrigation. The root density of wide-row crops varies according to the distance from the plant and the row. This aspect should be taken into account under irrigation conditions. For example, Ahmadi et al. (2011) found twice the amount of potato roots below furrows when compared with the corresponding layers below ridges. We observed a lower density between rows with potato, celery, lettuce, and other vegetables, as well as sunflower, or maize (not

published). This means that for wide-row crops it is not possible to determine any one generally valid (effective) root depth to be used in standards and irrigation models. The uptake and use of water from the entire soil volume will depend upon the density and physiological properties of the roots at varying distances from the plant, with the soil properties affecting the movement of water to the roots and the crop's water demand. With drip irrigation the use of one constant effective root zone seems even more dubious. Our data did not support the idea about the local proliferation of roots only in the vicinity of a dripping hose; however, this subject needs more experimental data.

## CONCLUSIONS

Irrigation stimulated root growth in the topsoil, while reduced irrigation or non-irrigation slightly enhanced growth in the deeper layer. The observed modifications of root depth and distribution in subsoil seem too small to affect the effectiveness of irrigation water utilization. These results suggest that the use of a constant value for the calculation of maximum irrigation depth of a specific crop may not correspond to the variability of root depth and distribution. When irrigation doses and timing are the priority due to water supply shortage and water quality concerns, farmers should check for any possible reduction of root growth and adjust the maximum irrigation depth accordingly. This is especially important with shallow rooted vegetables and soil limitations. However, a definition of effective depth has not yet been standardized.

ACKNOWLEDGEMENTS. This contribution was supported by Projects # QK1720285 and RO0418 of the Ministry of Agriculture of the Czech Republic.

## REFERENCES

- Agriculture and Horticulture Czech Republic 2019. <https://www.climatechangepost.com/czech-republic/agriculture-and-horticulture>. Accessed 13.1.2020.
- Ahmadi, S.H., Plauborg, F., Andersen, M.N., Sepaskhah, A.R., Jensen, C.R. & Hansen, S. 2011. Effects of irrigation strategies and soils on field grown potatoes: Root distribution. *Agricultural Water Management* **98**, 1280–1290.
- Ahmadi, S.H., Agharezaee, C.M., Kamgar-Haghighi, A.A. & Sepaskhah, A.R. 2017. Compatibility of root growth and tuber production of potato cultivars with dynamic and static water saving irrigation managements. *Soil Use and Management* **33**, 106–119.
- Allen, R.G., Pereira, L.S., Raes, D. & Smith, M. 1998. Crop evapotranspiration: Guidelines for computing crop water requirements. *FAO Irrigation and Drainage Paper*, No. 56. Food and Agriculture Organisation of the United Nations, Rome, 300 pp. Available at: <http://www.fao.org/docrep/X0490E/X0490E00.htm>. Accessed 13.1.2020.
- Assouline, Shmuel 2019. A simple method to design irrigation rate and duration and improve water use efficiency. *Water Resources Research* **55**, 6295–6301.
- Boguszewska-Mańkowska, D., Zarzyńska, K. & Nosalewicz, A. 2019. Drought differentially affects root system size and architecture of potato cultivars with differing drought tolerance. *American Journal of Potato Research* **97**, 54–62.
- Bruthans, J., Kůrková, I. & Kadlecová, R. 2019. Factors controlling nitrate concentration in space and time in wells distributed along an aquifer/river interface (Káraný, Czechia). *Hydrogeology Journal* **27**, 195–210.
- ČSN 750434. 2017. 'Ammelioration – Water demand for additional irrigation'. Czech state norm (in Czech with English abstract).

- Duffková, R., Holub, J., Fučík, P., Rožnovský, J. & Novotný, I. 2019. Long-term water balance of selected field crops in different agricultural regions of the Czech Republic using FAO-56 and soil hydrological approaches. *Sustainability* **11**, No. 5243.
- Elzner, P., Jůzl, M. & Kasal, P. 2018. Effect of different drip irrigation regimes on tuber and starch yield of potatoes. *Plant, Soil & Environment* **64**, 546–550.
- Haberle, J., Svoboda, P. & Krejčová, J. 2006. Uptake of mineral nitrogen from subsoil by winter wheat. *Plant, Soil & Environment* **52**, 377–384.
- Haberle, J. & Svoboda, P. 2014. Impacts of use of observed and exponential functions of root distribution in soil on water utilization and yield of wheat, simulated with a crop model. *Archives of Agronomy and Soil Science* **60**, 1533–1542.
- Haberle, J. & Svoboda, P. 2015. Calculation of available water supply in crop root zone and water balance of crops. *Contributions to Geophysics and Geodesy* **45**, 285–298.
- Haberle, J., Svoboda, P., Šimon, T., Kurešová, G., Henzlová, B. & Klír, J. 2018. Distribution of mineral nitrogen in soil in relation to risk of nitrate leaching in farms with irrigated vegetables and early potatoes. *Journal of Horticultural Research* **26**, 47–54.
- Johansen, T.J., Thomsen, M.G., Løes, A-K. & Riley, H. 2014. Root development in potato and carrot crops – influences of soil compaction. *Acta Agriculturae Scandinavica, Section B – Soil & Plant Science*, doi: 10.1080/09064710.2014.977942
- Kautz, T., Amelung, W., Ewert, F., Gaiser, T., Horn, R., Jahn, R., Javaux, M., Kemna, A., Kuzyakov, Y., Munch, J. .... & Köpke, U. 2013. Nutrient acquisition from arable subsoils in temperate climates: A review. *Soil Biology and Biochemistry* **57**, 1003–1022.
- Kirnak, H., Varol, I.S., Irik, H.A & Ozaktan, H. 2017. Effects of irrigation applied at different growth stages on chickpea yield. *Agronomy Research* **15**, 1928–1933. <https://doi.org/10.15159/AR.17.046>
- Raimanová, I., Svoboda, P., Kurešová, G. & Haberle, J. 2016. The effect of different post-anthesis water supply on the carbon isotope discrimination of winter wheat grain. *Plant, Soil & Environment* **62**, 329–334.
- Spitz, P., Zavadil, J., Duffková, R., Korsuň, S., Nechvátal, M. & Hemerka, I. 2011. Methods of management of crops irrigation regimes of crops with calculation programme IRRIPROG. Certified methods. VÚMOP, v.v.i., 41 pp. (in Czech with English abstract). Available at: [https://docplayer.cz/107704357-Metodika-rizeni-zavlahoveho-rezimu-plodin-vypocetnim-programem-irriprog-s-prilohami-a-b-c-na-cd-rom.html#show\\_full\\_text](https://docplayer.cz/107704357-Metodika-rizeni-zavlahoveho-rezimu-plodin-vypocetnim-programem-irriprog-s-prilohami-a-b-c-na-cd-rom.html#show_full_text). Accessed 13.1.2020.
- Spitz, P. & Hemerka, I. 2014. The development of the irrigation requirement in the dry regions of the Czech Republic with reference to possible climatic change. *Acta Universitatis Agriculturae et Silviculturae Mendelianae Brunensis* **54**, 171–180.
- Středová, H., Rožnovský, J. & Středa, T. 2013. Predisposition of drought occurrence in selected arid areas of the Czech Republic. *Contributions to Geophysics and Geodesy* **43**, 237–252.
- Svoboda, P. & Haberle, J. 2006. The effect of nitrogen fertilization on root distribution of winter wheat. *Plant, Soil & Environment* **52**, 308–313.
- Svoboda, P., Kurešová, G., Raimanová, I. & Haberle, J. 2018. Root depth of field crops and vegetables in the Czech Republic. In: *15th ESA Congress*, August 2018, Geneve, 2 pp.
- Tennant, D. 1975. A test of a modified line intersect method of estimating root length, *Journal of Ecology* **63**, 995–1001.
- Trnka, M., Feng, S., Semenov, M.A., Olesen, J.E., Kersebaum, K.C., Rötter, R.P., Semerádová, D., Klem, K., Huang, W., Ruiz-Ramos, M. .... & Buntgen, U. 2019. Mitigation efforts will not fully alleviate the increase in water scarcity occurrence probability in wheat-producing areas. *Science Advances* **5**, eaau2406. <https://doi.org/10.1126/sciadv.aau2406>
- Zarzyńska, K., Boguszewska-Mańkowska, D. & Nosalewicz, A. 2017. Differences in size and architecture of the potato cultivars root system and their tolerance to drought stress. *Plant, Soil & Environment* **63**, 159–164.

## **Modelling the effect of sowing date on the emergence, silking and yield of maize (*Zea mays* L.) in a moderately warm and dry production area**

A. Széles<sup>1,\*</sup> and L. Huzsvai<sup>2</sup>

<sup>1</sup>University of Debrecen, Faculty of Agricultural and Food Sciences and Environmental Management, Institute for Land Utilisation, Regional Development and Technology, Böszörményi út 138, H-4032 Debrecen, Hungary

<sup>2</sup>University of Debrecen, Faculty of Economics and Business, Institute of Statistics and Methodology, Böszörményi str. 138, H-4032 Debrecen, Hungary

\*Correspondence: szelesa@agr.unideb.hu

**Abstract.** This research focused on accurately modelling emergence ( $VE_{\text{Emergence}}$ ) and silking (R1) dates using 5 cm deep soil temperature (ST) and how sowing date (SD) affects  $VE_{\text{Emergence}}$  and R1 date of different maturity hybrids and which is the optimum sowing date in the changed climate. Three sowing dates were used between 4th April and 10th May. The same maize hybrids (FAO 290, FAO 350, FAO 420) were involved in the experiment between 2011–2013. The 5 cm deep soil temperature could be used for simulating the date of  $VE_{\text{Emergence}}$  and R1 and the Percentage of Predicted Deviation (PD) was below 10%. When calculating the effective heat units (HU) at 5 cm depth, setting 6 °C as base temperature leads to better modelling. SD did not clearly affect yield since due to the influence of genotype and crop years. The FAO 290 hybrid had the lowest yield (11.534 t ha<sup>-1</sup>) and it responded sensitively to sowing date. Its highest yield (12.788 t ha<sup>-1</sup>;  $P < 0.05$ ) could be obtained with SD3. FAO 350 and FAO 420 hybrids provided stable yields without any significant effect of SD. The highest yield was provided by the FAO 420 hybrid (13.494 t ha<sup>-1</sup>) with a wide SD interval (4th April – 10th May). The obtained findings help farmers in making grounded decisions to obtain high and stable yield under the changed climatic circumstances. The obtained findings help farmers in making grounded decisions to obtain high and stable yield under the changed climatic circumstances.

**Key words:** climate change, air temperature, CERES-Maize model, computer simulation.

### **INTRODUCTION**

Over the past fifty years, world maize production has increased fivefold, partly due to an increase in average yields and an increase in cultivated areas. On a global level, there is a potential for increasing production (Schils et al., 2018), which is in great need of food safety (Ort & Long, 2014).

– However, climate change – increasing air temperature and decreasing precipitation – has a negative impact on agriculture (Pielke et al., 2007; Rosenzweig et al., 2008; Lobell et al., 2011; Ványiné Széles & Nagy, 2012; Bassu et al., 2014; IPCC, 2014). The global average above-ground temperature increased by about 0.89 °C

(0.69–1.08) over the period between 1901–2012 (IPCC, 2013) and forecasts suggest a temperature increase of 1.5 °C by 2030 (IPCC, 2018). The temperature rise pushes the production zones 150 to 250 km towards the poles (Harnos, 2008). It is expected that precipitation will also change and will show even greater regional variation (FAO, 2001), especially in southern parts of Europe, with more frequent and prolonged dry seasons (Trnka et al., 2014).

– Several studies have shown that the most important factor in the growth and development of maize is the temperature that affects germination, water and nutrient uptake (Hunter et al., 1977; Nerson, 2007; Siebert et al., 2014). At 25 to 30 °C, uniform emergence occurs after 4–7 days. Lower and higher temperatures slow down the germination process (Silva-Neta et al., 2015). Low temperature causes early deformation of the leaves (Santos et al., 2019) at an early stage of the plant, high temperatures accelerate the rate of development, resulting in shorter vegetative and reproductive phases (Hatfield et al., 2011; Lizaso et al., 2018) and it may change the metabolic processes, especially photosynthesis (Xu et al., 2011; Ványiné Széles et al., 2012; Song et al., 2014). Furthermore, the vitality of the pollen decreases and the number of grains on the ear is reduced, resulting in yield loss (Hatfield et al., 2011; Lizaso et al., 2018). Lobell & Field (2007) showed an 8.3% yield decrease.

– Climate change has an impact on the soil, soil temperature increases and it has a stronger tendency than that of air temperature (Zhang et al., 2001; Qian et al., 2011; Yeşilirmak, 2014). At the time of sowing, seedbed temperature and humidity can stimulate or prolong maize emergence in the top 5cm layer of the soil (Kaspar et al., 1990). Germination can start at a low soil temperature of 6 °C, but the process is very slow and the germination force is greatly reduced (Miedema, 1982; Nagy, 2008). If the soil temperature is below 10 °C, the germinated seed is viable for 14 hours, while it is viable for 5 hours at -2 °C and for 4 hours at -4 °C (Modi & Asanzi, 2008). The 1 °C change in soil temperature has a major impact on crop development (Barlow et al., 1977; Stone et al., 1999). The low temperature of the root zone (9 °C) stops maize growth (Mozafar et al., 1993), inhibits leaf growth (Thiagarajah & Hunt, 1982), silking (Cutforth & Shaykewich, 1989; Hayhoe & Dwyer, 1990; Hayhoe et al., 1996) and physiological maturity (Daynard, 1972; Afuakwa et al., 1984; Cutforth & Shaykewich, 1990; Akman, 2009).

Determining the sowing date for maize is a key element of production technology and the change of sowing date is necessary in order to adapt to changes (Wang et al., 2016). However, when determining the optimal sowing date, different conclusions were reached by researchers, as agronomic experiments carried out in different regions cannot be reproduced in space and time, as climatic and soil factors differ (Sorensen et al., 2000). The use of simulation crop production models is of great importance for environmental stress effects (high temperature, drought stress) in determining the sowing date of maize, as well as in accurately assessing its growth and development (Wilkens & Singh, 2001; Huzsvai & Rajkai, 2009; Tao & Zhang, 2010; Fodor, 2012; Wang et al., 2018).

– Aims of the examination: (1) How exactly can the date of emergence be modelled with the temperature of the 5 cm deep soil layer? (2) How does sowing date affect the emergence and silking dates of different maturity maize hybrids? (3) How does the date of sowing affect the yield of different maturity maize hybrids? (4) What is the optimal sowing date in the changed climate?



## MATERIALS AND METHODS

### Site description

The examinations presented in this study were performed at the Experiment Site of the University of Debrecen in Hungary (47° 33' N, 21° 26' E, 111 m asl), in a moderately warm and dry production area on calcareous chernozem soil with deep humus layers formed on loess (Mollisol-Calciustoll or Vermustoll, clayey loam; USDA) in a small plot long-term polyfactorial field experiment with four replications and a randomised block design in three years (2011, 2012 and 2013). Plot size was 15 m<sup>2</sup>.

### Weather data

The data collected by the weather station installed on the experiment site were continuously logged. The obtained values were compared to the means of the 30-year-long period (1981–2010) (Nagy, 2019).

The effective heat units (HU) were calculated for the entire growing season based on the following formula:

$$\text{Heat Unit} = (T_{max} + T_{min})/2 - T_{basis}, \quad (1)$$

where  $T_{max}$  = daily maximum temperature,  $T_{min}$  = minimum daily temperature and  $T_{basis}$  = temperature threshold value needed for development.

In the case of maize, this value is 10 °C (Davidson & Campbell, 1983; Nielsen, 2010).

In order to estimate the potential evapotranspiration (PET), we used the Szász (1977) PET estimation algorithm calibrated for Hungarian conditions.

$$\text{PET} = \beta[0.0095(T - 21)^2(1 - R)^{2/3}f(v)], \quad (2)$$

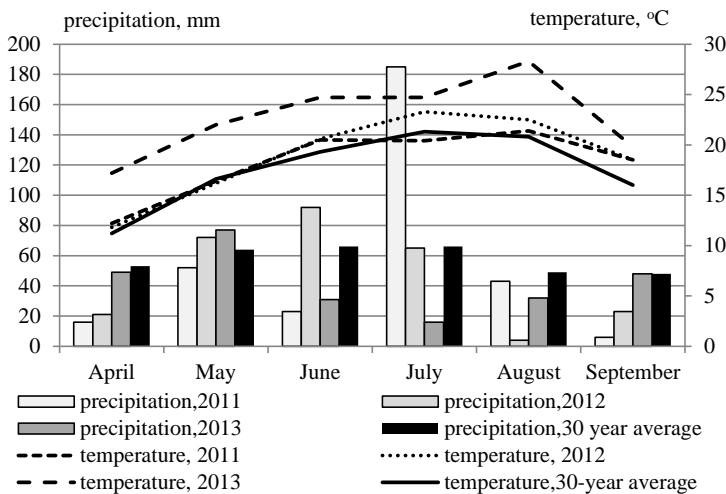
where PET = potential evapotranspiration [mm day<sup>-1</sup>],  $T$  = daily mean temperature [°C],  $R$  = relative humidity,  $f(v)$  = effect function of wind speed,  $\beta$  = factor for expressing oasis effect.

The growing season of the experimental period (2011–2013) was characterized by variable weather conditions (Fig. 1). In 2011, the distribution of precipitation was very uneven; precipitation in July was the most pronounced (185 mm), which was nearly three times higher than the average (66 mm) of 30 years (1981–2010). Each month was significantly above the average with the exception of July (-0.9 °C), thus the average temperature during the growing season was 0.7 °C higher.

In the 2012 growing season, there was 277 mm of precipitation, which was 20% below the average. The period between May and July provided sufficient amount of precipitation. However, during the grain-filling period (August), there was only 4 mm of precipitation, which was accompanied by high temperatures, 1.7 °C above average. The average temperature of the growing season was 1.3 °C higher than the 30-year average.

Precipitation sum of the 2013 growing season was 253 mm, which was 74% of the 30-year average and its distribution was disproportionate. Precipitation was sufficient from sowing to emergence, but for the remainder of the growing season, water deficiency was significant. The most critical period was silking, when the difference was 50 mm from the average. The growing season ended with a significant lack of precipitation (-93 mm) and was 5.3 °C warmer than the average (17.5 °C). The largest difference was in August (+7.5 °C).

While precipitation decreased during the growing season, temperature increased relative to the 30-year average, in the case of all three years. HU values varied between 1,390 and 1,410 °C, which exceeded both the site-specific and the FAO 300 (1,140 °C) and FAO 400 (1,250 °C) values (Menyhért, 1985). The growing season of all three years was characterized by potential water scarcity (375 mm in 2011, 433 mm in 2012 and 434 mm in 2013).



**Figure 1.** Precipitation and air temperature changes of the experimental space in the growing period (Debrecen, 2011–2013).

### Soil data

The average  $\text{pH}_{\text{KCl}}$  of the soil is 6.6 (slightly acidic). In the upper (20 cm) layer of the soil, the Arany's plasticity index is 39, the total amount of water-soluble salts (anions and cations) is 0.04%, i.e. salt deficient. The calcareous chalk content is around 0% in the upper 80 cm of the soil (i.e. chalk deficient), but it is 12% from 100 cm down (moderately calcareous). The organic matter content in the upper 20 cm layer of the soil does not exceed 2.3%, while it does not exceed 1.00% at 120 cm depth. The potassium supply of the soil is appropriate, and its P supply is moderate.

### Experimental details

Three sowing dates (SD1, SD2, SD3) were used in the field experiment in the three examined years. After harvesting the previous crop (winter wheat), 150 kg of  $\text{N ha}^{-1}$ , 65 kg of  $\text{P}_2\text{O}_4 \text{ ha}^{-1}$  and 130 kg of  $\text{K}_2\text{O ha}^{-1}$  fertiliser was applied. 50% of the 34% ammonium nitrate was applied in the autumn and the other 50% was applied in the spring before seedbed preparation. 100% of phosphorus and potassium were incorporated into the at a depth of 27 cm with autumn ploughing. Sowing depth was 5 cm. The plant number was set to 73,000 plants  $\text{ha}^{-1}$ . The same very early- (FAO 290; Mv 255), early- (FAO 350; Mv 350) and mid-ripening (FAO 420; Mv Koppány) domestic hybrid maize hybrids were included in the analysis. The harvested grain yield was corrected to a moisture content of 14%.

Treatment	2011	2012	2013
SD1	6th April	6th April	4th April
SD2	27th April	19th April	15th April
SD3	10th May	7th May	6th May
Harvesting	26th September	18th September	20th October

## Applied analytical methods

### *Computerised simulation model*

A computer simulation model was used to analyse the phenophases of maize. As a result of a previous university cooperation, we have the source code of the CERES Maize program (Ritchie et al., 1994). The program – originally written in FORTRAN – was rewritten into R-language for faster and more flexible running (Huzsvai & Szőke, 2014). The CERES Maize program simulates emergence as a function of sowing depth. Furthermore, it assumes that there is so much moisture in the top layer of the soil after sowing that germination starts the subsequent day. The model determines the heat time required for emergence using the following formula:

$$DD = 15 + 6 \times SD \text{ (cm)}, \quad (3)$$

where  $DD$  = Degree Days and  $SD$  = Sowing Depth (cm).

### *Statistical analysis*

To model the 5cm soil temperature, real non-linear regression analysis was used. When selecting the best fitting sinusoidal model, the difference was minimised by a square sum. The overall form of the sinusoidal model was the following:

$$ST = a + b \times \sin\left(\frac{2\pi \times (Jday - c)}{365}\right), \quad (4)$$

where  $Jday$  = Julian day, and  $a$ ,  $b$ ,  $c$  = regression parameters.

The goodness of fit was characterised by the size of the residual standard error.

The effects of treatments on yield were analysed using a general linear model (GLM) (Huzsvai & Vincze, 2013). Within the GLM, the evaluation was based on the Repeated Measurement Model, and the year was taken into account as a repeated factor. Fixed factors were sowing date and genotype. The significance level was chosen to be 5%. Comparison of treatment mean values was performed with Duncan's test (Mendiburu, 2017) to avoid the accumulation of alpha error. Within the homogeneous group, the obtained yields did not differ from the 5% significance level. Evaluation was performed with the latest version of R (R Core Team, 2018).

## RESULTS AND DISCUSSION

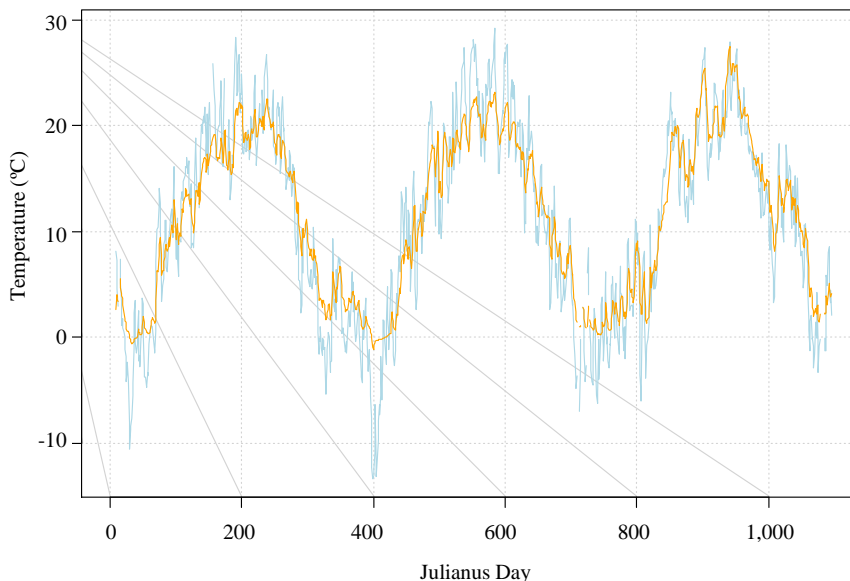
### **Evaluation of soil and air temperature, 2011–2013**

The days of the 2011–2013 period were converted to Julian for days for a subsequent clear analysis. The first day was January 1, 2011 and the last day was December 31, 2013, totalling 1,096 days.

The fluctuation of the soil temperature measured at a depth of 5cm is much smaller than the air temperature measured at 2 m above the surface (Fig. 2). However, according to the law of energy conservation, the average of the two temperatures must be the same in the long run. In addition, this does not preclude a significant difference in between

surface and air temperature at a given time. Average temperatures for the three years were the following:

	Average	Minimum	Maximum
soil temperature at 5 cm depth, °C	11.49	10.49	12.58
air temperature at 2 m above the ground, °C	11.11	5.85	16.31



**Figure 2.** Three-year average of daily soil temperature ( $ST_{\text{mean}}$ ) and air temperature ( $AT_{\text{mean}}$ ) on the experiment site, 2011–2013.

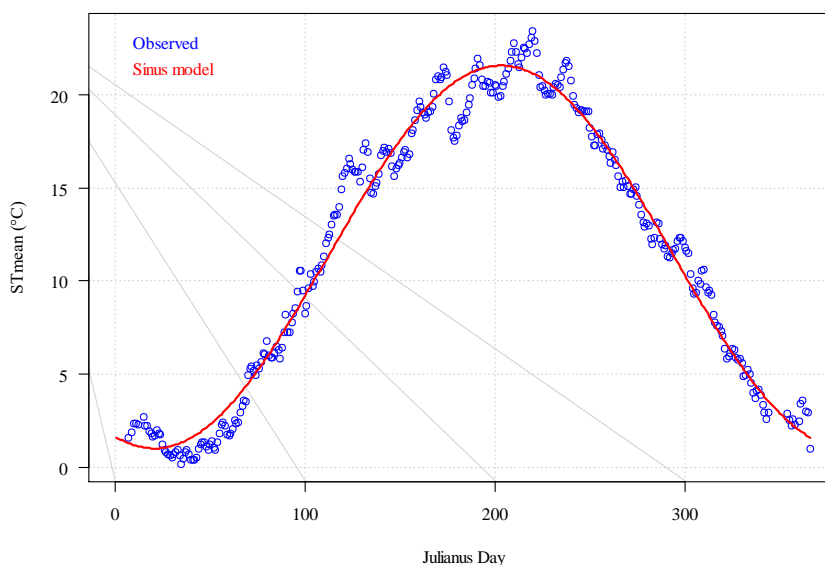
The difference between the average air and soil temperature is only 0.38 °C. The difference can also be caused by the accuracy of thermometers. Air decreases by an average of 0.65 °C every 100 meters above the ground (Bartholy et al., 2013), which means that there is a 0.013 °C difference at a distance of 2 meters. This method also helps in comparing the accuracy of thermometers. If the thermometers at different depths detect the same average temperature in the long run, their measurement accuracy can be considered adequate.

A sinusoidal model was fitted with a real nonlinear regression analysis in order to examine the 5cm deep soil temperature during the examined period (2011–2013).

$$ST = 11.3 + 10.3 \times \sin\left(\frac{2\pi \times (JDay - 112)}{365}\right), \quad (5)$$

where  $ST$  = soil temperature,  $Jday$  = Julian day,  $a$ ,  $b$ ,  $c$  = regression parameters.

The sinusoidal model accurately modelled the soil temperature (Fig. 3) and the residual standard error was 1.067. With this model, the soil temperature and the useful temperature for the Ceres Maize emergence algorithm can be produced even if no measured temperature data is available. Our algorithm can be used between latitudes  $\pm 23.45$  and  $\pm 65.5$ . Parameters  $a$ ,  $b$ ,  $c$  must be determined by taking into account the values of the given location.



**Figure 3.** Modeled values of daily soil temperature ( $ST_{\text{mean}}$ ) based on three-year-long (2011–2013) data.

### Results of the computer simulation

The original model uses air temperature 2 m above the ground as input data and a base temperature of 10 °C. Since soil temperature affects emergence must stronger, the value measured at 5 cm depth was used during the simulation. At a depth of 5 cm, the soil shows a lower average temperature fluctuation and is cooler than the air temperature at 2 m height during the growing season; therefore, the best result was obtained with a base temperature of 6 °C when calculating the useful soil temperature. This temperature corresponded to a base temperature of 10 °C air temperature.

The goodness of the simulation was evaluated using the Percentage of Predicted Deviation (%) (PD) index (Table 1). According to Jamieson et al. (1991), based on the PD value, the result of the simulation is outstanding if  $PD < 10\%$ , good if PD is between 10–20%, fair if PD is between 20–30% and poor if  $PD > 30\%$ .

$$PD = (p - o)/o \times 100, \quad (6)$$

where  $PD$  = Percentage of Predicted Deviation (%),  $p$  = predicted value and  $o$  = observed value.

The measured and simulated days of emergence were close to each other in the case of early sowing (SD1). However, in the case of late sowing (SD2, SD3), we experienced a significant difference between 2012 and 2013. The reason for this difference is germination. The optimal relative humidity of the soil is 70–80%, which is necessary for germination (Liu et al., 2010). If this value is less or more, germination does not start and the emergence is delayed (Ma et al., 2012). The original computer model does not take this factor into account. The solution may be to start the simulation from the actual time of emergence or to run a high-resolution soil moisture model. However, these models have little accuracy in the sowing depth.

In practice, sowing is performed at a depth of 6–7 cm in dry soil to make sure that the seed is planted in a wet layer to facilitate germination. In the Maize model, each cm

depth increases the time of emergence by 6 DD. As a result, this period is increased by one day in the case of early sowing and half day in the case of late sowing (Table 1).

**Table 1.** Observed and simulated values of the number of days between sowing and emergence (VE) in the case of different sowing dates, experiment site, 2011–2013

	SD1			SD2			SD3		
	O	P	PD (%)	O	P	PD (%)	O	P	PD (%)
2011									
FAO 290	12.5	13,0	4.0	11.25	10.0	-11.1	8.75	8.0	-8.6
FAO 350	12.5	13,0	4.0	12.00	10.0	-16.7	8.50	8.0	-5.9
FAO 420	14.0	13,0	-7.1	12.50	10.0	-20.0	9.25	8.0	-13.5
2012									
FAO 290	12.0	14.0	16.7	12.25	9.0	-26.5	12.0	6.0	-50.0
FAO 350	14.0	14.0	0.0	12.00	9.0	-25.0	12.0	6.0	-50.0
FAO 420	14.0	14.0	0.0	12.50	9.0	-28.0	13.0	6.0	-53.8
2013									
FAO 290	9.0	9.0	0.0	9.00	5.0	-44.4	6.50	6.0	-7.7
FAO 350	11.0	9.0	-18.2	9.25	5.0	-45.9	6.50	6.0	-7.7
FAO 420	10.0	9.0	-10.0	10.50	5.0	-52.4	7.25	6.0	-17.2

Note. O: Observed value; P: Predicted value; PD: Percentage of Predicted Deviation (%).

To determine the date of R1, the CERES Maize model also uses genetic parameters in addition to temperature and day length. The latest model uses a trial method to determine genetic parameters (Table 2). The best results were obtained with the following values.

FAO 290, very early ripening,  $P1: 175, P2: 0.7$

FAO 350, early ripening,  $P1: 190, P2: 0.5$

FAO 420, mid-ripening,  $P1: 240, P2: 0.1$

where  $P$  = heat sum needed for the juvenile phase,  $P2$  = photoperiod sensitivity (0.00–1.00).

**Table 2.** Observed and simulated values of the number of days between sowing (SD) and silking (R1) in the case of different sowing dates, experiment site, 2011–2013

	SD1			SD2			SD3		
	O	P	PD (%)	O	P	PD (%)	O	P	PD (%)
2011									
FAO 290	80.50	79.0	-1.9	72.25	73.0	1.0	63.5	68.0	7.1
FAO 350	82.50	82.0	-0.6	73.50	75.0	2.0	64.0	68.0	6.3
FAO 420	89.75	88.0	-1.9	75.25	77.0	2.3	65.0	72.0	10.8
2012									
FAO 290	82.75	75.0	-9.4	72.00	66.0	-8.3	60.00	63.0	5.0
FAO 350	83.00	75.0	-9.6	71.75	66.0	-8.0	63.50	63.0	-0.8
FAO 420	87.50	80.0	-8.6	75.75	72.0	-5.0	66.25	65.0	-1.9
2013									
FAO 290	69.5	65.0	-6.5	63.50	57.0	-10.2	56.50	61.0	8.0
FAO 350	74.0	65.0	-12.2	64.00	57.0	-10.9	57.25	61.0	6.6
FAO 420	76.0	67.0	-11.8	66.75	63.0	-5.6	59.75	64.0	7.1

Note. O: Observed value; P: Predicted value; PD: Percentage of Predicted Deviation (%).

The date of the R1 phase was perfectly predicted by the model. PD values, with some exceptions, were below 10%. The number of under- and overestimations was

roughly the same. In 2012, the late emergence in the case of SD2 and SD3 did not appear in the silking period. A similar pattern was observed in 2013 in the case of SD2, although the silking of maize occurred 10% later than the model predicted. The difference between the hybrids in terms of ripening can be well observed during the silking period. In the case of early sowing (SD1), the difference is more pronounced, while it is more moderate in the case of late sowing (SD2, SD3) decreases. The reason for this phenomenon is the heat time calculated in degree days, which accumulates faster in the case late sowing due to higher temperatures. Differences in ripening period can be detected at low temperatures.

### The effect of sowing date on yield and determining the optimal sowing date

Based on the results of the variance analysis, years ( $P < 0.001$ ) and genotype ( $P < 0.001$ ) had a significant effect on yield, averaged over the three examined years.

Among the examined factors, year had the most significant modifying effect based on the MS value. Environmental factors affected the yield of all three FAO hybrids to a 0.1% extent, while sowing date only modified the yield of the FAO 290 hybrid ( $P < 0.001$ ), while there was no significant effect in the case of the FAO 350 and FAO 420 hybrids (Table 3). There was a significant difference between yields quantified for each crop year, averaged over the different treatments. The yield difference in all three years was significant at the level of 0.1%. The biggest difference was observed between 2011 and 2013 ( $2.537 \text{ t ha}^{-1}$ ).

The average yield of hybrids in 2011 proved to be successful at the SD3 sowing date ( $12.837 \text{ t ha}^{-1}$ ), from which the SD2 was not significantly different with its  $502 \text{ kg ha}^{-1}$  lower yield. In this year, we could not verify Kucharik's (2008) conclusion that early sowing contributes to higher yields, as the yield of SD1 was significantly less than that of SD2 ( $10.209 \text{ t ha}^{-1}$ ;  $P < 0.05$ ) and SD3 ( $12.837 \text{ t ha}^{-1}$ ;  $P < 0.001$ ). The examined hybrids achieved their highest average performance ( $13.335 \text{ t ha}^{-1}$ ) with the sowing date of SD1 in 2012, with a yield surplus of  $1.002 \text{ t ha}^{-1}$  ( $P < 0.05$ ) compared to SD2 and  $1.048 \text{ t ha}^{-1}$  ( $P < 0.05$ ) compared to SD3. In accordance with the findings of Long et al. (2017), delayed sowing resulted in decreased yield. There was no significant difference between the yields of the two late sowing dates (SD2 and SD3). In 2013, the different sowing dates did not affect average yield (Table 4).

The yield of maize hybrids was not significantly altered by the sowing date in every year. In 2011, there was a clear difference in the case of SD1 ( $9.185 \text{ t ha}^{-1}$ ) and SD3 ( $11.7454 \text{ t ha}^{-1}$ ) concerning the FAO 290 maize hybrid. In 2012, SD1 resulted in a 9% yield increase compared to SD2 ( $P < 0.05$ ) and SD3 ( $P < 0.05$ ). The difference between

**Table 3.** Analysis of variance of maize sowing date (SD), ripening period (FAO number) and the years of experiment (Y), 2011–2013

ANOVA	Hybrid			Average
	FAO 290	FAO 350	FAO 420	
Year (Y)	***	***	***	***
Sowing date (SD)	***	ns	ns	
Y x SD	***	**	***	
Year				
	2011	2012	2013	Average
Year (Y)				***
Sowing date (SD)	***	***	ns	ns
Genotype (G)	***	***	***	***
Y x SD				***
Y x G				***
SD x G	ns	ns	***	***
Y x SD x G				***

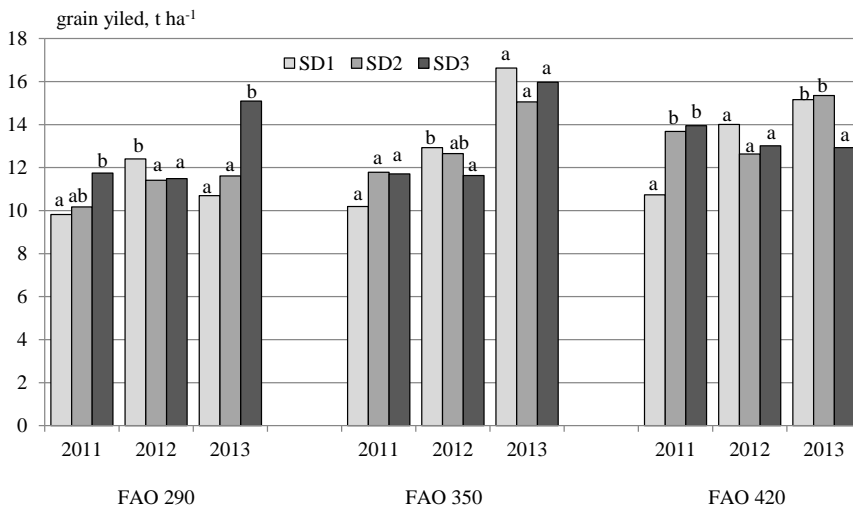
Note: \*\*\* $P = 0.001\%$ ; \*\* $P = 0.01\%$ ; ns = not significant.

the yield of SD2 and SD3 is not significant. The higher yield of 2013 can be linked to SD3 (15.095 t ha<sup>-1</sup>). The rate of yield increase was 41% ( $P < 0.05$ ) for SD1 and 30% ( $P < 0.05$ ) for SD2. In 2011 and 2013, the FAO 350 hybrid showed no significant difference between the yields of the three sowing dates. In 2012, SD1 proved to be the best (12.928 t ha<sup>-1</sup>), resulting in an 11.1% increase in yield compared to SD3 (1.293 t ha<sup>-1</sup>;  $P < 0.05$ ). In the case of the FAO 420 hybrid, the delay in sowing increased the yield in 2011 ( $P < 0.05$ ), but there was no significant difference between SD2 and SD3. In 2012, the yield of SD1 (14.005 t ha<sup>-1</sup>) was the most successful, with no significant decrease in in the case of SD2 and SD3. In 2013, the highest yield was achieved as a result of SD1 (15.160 t ha<sup>-1</sup>) and subsequent sowing dates resulted in a decreasing trend. However, the only significant difference was the 17% decrease between SD1 and SD3 ( $P < 0.05$ ) (Fig. 4).

**Table 4.** The effect of sowing date (SD) on the yield of maize hybrids on the experiment site between 2011 and 2013

Sowing date	Grain yield (t ha <sup>-1</sup> )		
	2011	2012	2013
SD1	10.209a	13.335c	14.409a
SD2	12.331b	12.333b	14.346a
SD3	12.837b	12.287a	14.231a

Note: Based on the Duncan's test, yields indicated with different letter significantly differ from each other at the significance level of  $P \leq 0.05$ .



**Figure 4.** The effect of sowing date (SD) and the years of experiment on the yield of maize hybrids of different FAO numbers on the experiment site between 2011–2013.

Legend: Data marked with the same letter do not significantly differ from each other on the basis of the Duncan's test.

In 2011, SD1 caused no significant difference between the yields of different genotypes. In the case of SD2, there was a significant difference between FAO 420 and FAO 290 hybrids ( $P < 0.01$ ), and the FAO 420 hybrid had a 34% higher yield. In the case of SD3, the FAO 420 hybrid was more favourable resulting in 2.204 t ha<sup>-1</sup> ( $P < 0.001$ ) higher yield compared to the FAO 290 hybrid and 2.444 t ha<sup>-1</sup> ( $P < 0.001$ ) higher yield than that of the FAO 350 hybrid. There was no significant difference in the yield of the FAO 290 and FAO 350 hybrids.



In 2012, there was a significant difference in the case of SD1 ( $P < 0.05$ ) and SD3 ( $P < 0.05$ ) between the FAO 420 and FAO 290 hybrids, and in the case of SD2 between FAO 350 and FAO 290 hybrids ( $P < 0.05$ ).

In 2013, there was a significant yield difference between FAO 290 and FAO 350 in the case of SD1 ( $P < 0.001$ ) and SD2 ( $P < 0.01$ ). FAO 290 and FAO 420 hybrids differed from each other by 0.1% in the case of all three sowing dates. In the case of SD3, the FAO 420 hybrid had a significant yield surplus of 2.166 t ha<sup>-1</sup> ( $P < 0.001$ ) compared to the FAO 290 hybrid, and 3.044 t ha<sup>-1</sup> ( $P < 0.001$ ) compared to the FAO 350 hybrid.

## DISCUSSION

Due to the thermal insulation of the soil, the temperature at 5 cm depth is always colder during the growing season than the surface or air temperature. Computer simulation models, such as the CERES Maize model, take into account the temperature of the air measured at a height of 2 m above the surface and provide the base temperature in relation to the air temperature. In the case of maize, this value is 8–10 °C. At the time of germination and emergence, computer simulation models use higher base temperatures. After emergence, lower base temperatures are used. When calibrating the model - based on our measurement results -, if the useful temperature is calculated based on the temperature measured at a depth of 5 cm, then the resulting base temperature is 6 °C. This method resulted in the most accurate estimate of the  $VE_{\text{Emergence}}$  date. If we the sowing depth temperature is known, maize emergence can be perfectly modelled, as long as the base temperature is reduced to 6 °C.

In the CERES Maize model, the heat time required for emergence is independent of the ripening period of the given hybrid and its other genetic characteristics. The amount of heat required for the sprout to appear on the surface of the soil depends solely on the depth of sowing. Our experimental data confirmed this concept, and, regardless of the examined hybrid,  $VE_{\text{Emergence}}$  values were the same. The wrong estimation of the simulation model, when the PD value increased to around 50%, was caused by prolonged germination.

With today's modern computer models, the date of the R1 phase can be precisely predicted and, according to our data, apart from some cases, the PD values are below 10%. However, it should be noted that, as a result of determining the value of PD, the obtained percentages may even be a bit misleading as a seven-day delay results in a PD of 10% at the time of silking, while the same value results in a PD of 50% at the time of emergence.

According to the results of the repeated measures ANOVA, averaged over the three examined years, the years and genotype main effect was significant in relation to yield. Of these factors, the effect of year on yield was the most significant based on the MS value. Sowing date did not give a clear result. Several authors (Russelle et al., 1987; Berzsenyi & Lap, 2008; Shrestha et al., 2016) achieved high yields with early sowing (first decade of April), while others reported outstanding yields with sowing taking place in the third decade of April (Johnson & Mulvaney, 1980; Berzsenyi & Lap, 2001; Videnović et al., 2011), and Futó & Sárvári, (2003), El Hallof & Sárvári (2004) obtained higher yields with late sowing (first and second decades of May). Based on the obtained results, neither of these findings can be confirmed, but it can be concluded with the authors (Bruns, 2003; Futó & Sárvári, 2003; Berzsenyi & Lap, 2008) that the climatic

changes of the examined years have a great influence on determining the proper sowing date. Based on the sowing date\*genotype interaction, sowing date had a significant effect only on the very early ripening hybrid (FAO 290). In the case of this hybrid, late sowing resulted in higher yields. As regards the FAO 350 and FAO 420 hybrids, sowing date had no clear effect on yield, as they produced high yields in the case of all three SDs.

In conformity with the conclusions of Nagy (2012), Pepó (2012) and Széles et al. (2018), the climatic conditions of the different years affected yield to varying degrees. The biggest difference was observed between 2011 and 2013 (2.537 t ha<sup>-1</sup>).

In the three examined years, SD affected maize yield differently. In 2011, SD2 and SD3 resulted in higher yields. In 2012, SD1 resulted in the highest yield, while in there was no difference in 2013.

In all three years, the very early ripening hybrid (FAO 290) had the lowest yield. In 2011 and 2012, the highest yield was provided by the mid-ripening hybrid (FAO 420). In 2013, the early ripening hybrid (FAO 350) resulted in the highest yield. The length of the ripening period clearly bears the potential for higher yields.

During the examined period, the smallest yield fluctuation was observed in the case of the mid-ripening hybrid (FAO 420), CV = 6.5%. However, the highest yield fluctuations were shown by the early ripening hybrid (FAO 350), CV = 18.4%. The yield fluctuation of the very early ripening hybrid (FAO 290) could be place between the two other hybrids, CV = 9.3%. According to the obtained findings, growing mid-ripening hybrids reduces the risk of production and these hybrids are not sensitive to sowing date either.

## CONCLUSIONS

If emergence is modelled with computer simulation and the 5 cm deep soil temperature is used, a base temperature of 6 °C should be used to calculate HU, which provides the best result.

The negative effect of delayed emergence was not detectable in crop yields. The very early ripening hybrid (FAO 290) had the lowest yield and it responded sensitively to sowing date and high yields were provided only in the case of late sowing. Yield fluctuation was also higher than that of early-ripening (FAO 350) and mid-ripening (FAO 420) hybrids.

Under the changed climatic conditions, the mid-ripening hybrid (FAO 420) provided the highest yield, the lowest yield fluctuation, and it was not sensitive to sowing date. When these hybrids are grown, one does not have to stick to a specific sowing date, but they can be sown from April 4th to May 10th. This is very advantageous in production, as there is enough time to wait for good soil moisture conditions and to ensure a quick and even emergence.

The obtained findings help farmers in making grounded decisions to obtain high and stable yield under the changed climatic circumstances.

**ACKNOWLEDGMENTS.** The research was financed by the Higher Education Institutional Excellence Programme (NKFIH-1150-6/2019) of the Ministry of Innovation and Technology in Hungary, within the framework of the 4<sup>th</sup> thematic programme of the University of Debrecen, and the project ‘EFOP-3.6.3-VEKOP-16-2017-00008’.

## REFERENCES

- Afuakwa, J.J, Crookston, R.K. & Jones, R.J. 1984. Effect of temperature and sucrose availability on kernel black layer development in maize. *Crop Science* **24**(2), 285–288.
- Akman, Z. 2009. Comparison of high temperature tolerance in maize, rice and sorghum seeds, by plant growth regulators. *Journal of Animal and Veterinary Advances* **8**(2), 358–361.
- Barlow, E.W.R., Boersma, L. & Young, J.L. 1977. Photosynthesis, transpiration, and leaf elongation in corn seedlings at suboptimal soil temperatures. *Agronomy Journal* **69**(1), 95–100.
- Bartholy, J., Mészáros, R., Geresdi, I., Matyasovszky, I., Pongrácz, R. & Weidinger, T. 2013. Meteorological basics. ELTE. [https://www.tankonyvtar.hu/hu/tartalom/tamop412A/2011-0073\\_meteorologia\\_alapismeretek/adatok.html](https://www.tankonyvtar.hu/hu/tartalom/tamop412A/2011-0073_meteorologia_alapismeretek/adatok.html)
- Bassu, S., Brisson, N., Durand, J.L., Boote, K., Lizaso, J., Jones, J.W., Rosenzweig, C., Ruane, A.C., Adam, M., Baron, C., Basso, B., Biernath, C., Boogaard, H., Conijn, S., Corbeels, M., Deryng, D., De Sanctis, G., Gayler, S., Grassini, P. & Waha, K. 2014. How do various maize crop models vary in their responses to climate change factors? *Global Change Biology* **20**(7), 2301–2320.
- Berzsenyi, Z. & Lap, D.Q. 2008. Effect of sowing date and N fertilisation on the yield and yield stability of maize (*Zea mays* L.) hybrids in a long-term experiment. *Acta Agronomica Hungarica* **56**(3), 247–264.
- Berzsenyi, Z. & Lap, D.Q. 2001. Effect of sowing time and N fertilisation on the yield and yield stability of maize (*Zea mays* L.) hybrids between 1991 and 2000. *Crops Production* **50**(2–3), 309–331.
- Bruns, H.A. 2003. Controlling aflatoxin and fumonisin in maize by crop management. *Journal of Toxicology: Toxin Reviews* **22**(2–3), 153–173.
- Cutforth, H.W. & Shaykewich, C.F. 1990. A temperature response function for corn development. *Agricultural and Forest Meteorology* **50**, 159–171.
- Cutforth, H.W. & Shaykewich, C.F. 1989. Relationship of development rates of corn from planting to silking to air and soil temperature and to accumulated thermal units in a prairie environment. *Canadian Journal of Plant Science* **69**(1), 121–132.
- Davidson, H.R. & Campbell, C.A. 1983. The effect of temperature, moisture and nitrogen on the rate of development of spring wheat as measured by degree days. *Canadian Journal of Plant Science* **63**(4), 833–846.
- Daynard, T.B. 1972. Relationships among black layer formation, grain moisture percentage, and heat unit accumulation in corn. *Agronomy Journal* **64**(4), 716–719.
- El-Halouf, N. & Sárvári, M. 2004. Effect of sowing time on the yield and the seed moisture content at harvest of maize. In: Sz. Hidvégi, Cs. Gyuricza (Eds.), *Proceedings of the III. Alps-Adria Scientific Workshop*, Dubrovnik, Croatia, pp. 427–431.
- FAO, 2001. Climate variability and change: a challenge for sustainable agricultural production. Document for the Committee on Agriculture, COAG/01/5. Rome
- Fodor, N. 2012. 4Mx Soil-Plant Model: Applications, opportunities and challenges. *Agricultural Informatics* **3**(2), 50–60.
- Futó, Z. & Sárvári, M. 2003. Effect of sowing date on the yield of maize (*Zea mays* L.) in different years. *Crop Production* **52**(5), 543–558.
- Harnos, Zs. 2008. Climate change and some impact on the environment and agriculture modelling case study. „*Klíma-21*” *Brochures* **55**, 5–23.
- Hatfield, J.L., Boote, K.J., Kimball, B.A., Ziska, L.H., Izaurralde, R.C., Ort, D., Thomson, A.M. & Wolfe, D.W. 2011. Climate impacts on agriculture: Implications for crop production. *Agronomy Journal* **103**(2), 351–370.
- Hayhoe, H.N. & Dwyer, L.M. 1990. Relationship between percentage emergence and growing degree days for corn. *Canadian Journal Soil Science* **70**, 493–497.

- Hayhoe, H.N., Dwyer, L.M., Stewart, D.W., White, R.P. & Culley, J.L.B. 1996. Tillage, hybrid and thermal factors in corn establishment in cool soils. *Soil and Tillage Research* **40**(1–2), 39–54.
- Hunter, R., Tollenaar, M. & Breuer, C. 1977. Effects of photoperiod and temperature on vegetative and reproductive growth of a maize (*Zea mays* L) hybrid. *Canadian Journal of Plant Science* **57**(4), 1127–1133.
- Huzsvai, L. & Szöke, Sz. 2014. Modeling Soil Heat Flux in R. *Journal of Agricultural Informatics* **5**(1), 37–45.
- Huzsvai, L. & Rajkai, K. 2009. Modeling of plant adaptation to climatic drought induced water deficit. *Biologia* **64**(3), 536–540.
- Huzsvai, L. & Vincze, Sz. 2013. SPSS-Books. Debrecen, Hungary, 325 pp.
- IPCC, 2013. Climate Change 2013: The Physical Science Basis. Contribution of Working Group I to the Fifth Assessment Report of the Intergovernmental Panel on Climate Change, T.F. Stocker, D. Qin, G.-K. Plattner, M. Tignor, S.K. Allen, J. Boschung, A. Nauels, Y. Xia, V. Bex and P.M. Midgley (Eds.), Cambridge University Press, Cambridge, United Kingdom and New York, NY, USA, 1535.
- IPCC, 2014. Impacts, Adaptation, and Vulnerability. Part A: Global and Sectoral Aspects. Contribution of Working Group II to the Fifth Assessment Report of the Intergovernmental Panel on Climate Change, C.B. Field, V.R. Barros, D.J. Dokken, K.J. Mach, M.D. Mastrandrea, T.E. Bilir, M. Chatterjee, K.L. Ebi, Y.O. Estrada, R.C. Genova, B. Girma, E.S. Kissel, A.N. Levy, S. MacCracken, P.R. Mastrandrea, and L.L. White (Eds.). Cambridge University Press, Cambridge, United Kingdom and New York, NY, USA, [https://ipcc-wg2.gov/AR5/images/uploads/WGIAR5-PartA\\_FINAL.pdf](https://ipcc-wg2.gov/AR5/images/uploads/WGIAR5-PartA_FINAL.pdf)
- IPCC, 2018. Summary for Policymakers of IPCC Special Report on Global Warming of 1.5°C approved by governments, <https://www.ipcc.ch/2018/10/08/summary-for-policymakers-of-ipcc-special-report-on-global-warming-of-1-5c-approved-by-overnments/>
- Jamieson, P.D., Porter, J.R. & Wilson, D.R. 1991. A test of the computer simulation model ARC-WHEAT1 on wheat crops grown in New Zealand. *Field Crops Research* **27**(4), 337–350.
- Johnson, R.R. & Mulvaney, D.L. 1980. Development of a model for use maize replant decisions. *Agronomy Journal* **72**(3), 459–464.
- Kaspar, T.C., Erbach, D.C. & Cruse, R.M. 1990. Corn response to seed-row residue removal. *Soil Science Society of America Journal* **54**(4), 1112–1117.
- Kucharik, C.J. 2008. Contribution of planting date trends to increased maize yields in the central United States. *Agronomy Journal* **100**(2), 328–336.
- Liu, Y., Wang, E.L., Yang, X.G. & Wang, J. 2010. Contributions of climatic and crop varietal changes to crop production in the North China Plain, since 1980s. *Global Change Biology* **16**(8), 2287–2299.
- Lizaso, J.I., uiz-Ramos, M., Rodríguez, L., Gabaldon-Leal, C., Oliveira, J.A., Lorite, I.J., Sánchez, D., García, E. & Rodríguez, A. 2018. Impact of high temperatures in maize: Phenology and yield components. *Field Crops Research* **216**, 129–140.
- Lobell, D.B., Bänziger, M., Magorokosho, C. & Vivek, B. 2011. Nonlinear heat effects on African maize as evidenced by historical yield trials. *Nature Climate Change* **1**(1), 42–45.
- Lobell, D.B. & Field, C.B. 2007. Global scale climate-crop yield relationships and the impacts of recent warming. *Environment Research Letters* **2**(1), 014002.
- Long, N.V., Assefa, Y., Schwalbert, R. & Ciampitti, I.A. 2017. Maize yield and planting date relationship: A synthesis-analysis for US high-yielding contest-winner and field research data. *Frontiers in Plant Science* **8**, 2106.
- Ma, S.Q., Wang, Q., Lu, H.Q., Xu, L.P., Yu, H. & Zhang, T.L. 2012. Impact of water and temperature on spring maize emergence speed and emergence rate. *Acta Ecologica Sinica* **32**(11), 3378–3385.
- Mendiburu, F. 2017. Agricolae: Statistical procedures for agricultural research, R package version 1. 2–8. <https://CRAN.R-project.org/package=agricolae>

- Menyhét, Z. 1985. Handbook on maize production. Mezőgazda Kiadó, Budapest, 560 pp.
- Miedema, P. 1982. The effects of low temperature on *Zea mays*. *Advances in Agronomy* **35**, 93–128.
- Modi, A.T. & Asanzi, N.M. 2008. Seed performance of maize in response to phosphorus application and growth temperature is related to phytate-phosphorus occurrence. *Crop Science* **48**, 286–297.
- Mozafar, A., Schreiber, P. & Oertli, J.J. 1993. Photoperiod and root-zone temperature: interacting effects on growth and mineral nutrients of maize. *Plant and Soil* **153**(1), 71–78.
- Nagy, J. 2008. *Maize production: Food, bioenergy, forage*. Akadémiai Kiadó, Budapest, Hungary, 391 pp.
- Nagy, J. 2012. The effect of fertilization and precipitation on the yield of maize (*Zea mays* L.) in a long-term experiment. *Quarterly Journal of the Hungarian Meteorological Service* **116**(1), 39–52.
- Nagy, J. 2019. Complex long-term experiments *Crop Production* **68**(3), 5–28.
- Nerson, H. 2007. Seed Production and Germinability of Cucurbit Crops. *Seed Science Biotechnology* **1**, 1–10.
- Nielsen, R.L. 2010. Heat unit concepts related to corn development, Corny news network, purdue extension. <http://www.kingcorn.org/news/timeless/HeatUnits.html>
- Ort, D.R. & Long, S.P. 2014. Botany. Limits on yields in the corn belt. *Science* **344**(6183), 484–485.
- Pepó, P. 2012. Effect of crop year and some agrotechnical factors in rainfed and irrigated maize (*Zea mays* L.) production. *Crop Production* **61**, 77–80.
- Pielke, R.A., Prins, G., Rayner, S. & Sarewitz, D. 2007. Lifting the taboo on adaptation. *Nature* **445**(7128), 597–598.
- Qian, B., Gregorich, E.G., Gameda, S., Hopkins, D.W. & Wang, X.L. 2011. Observed soil temperature trends associated with climate change in Canada. *Journal of Geophysical Research* **116**(D2), 1–16.
- R Core Team. 2018. R: A language and environment for statistical computing, R Foundation for Statistical Computing, Vienna, Austria, <https://www.R-project.org>.
- Ritchie, J.T., Singh, U., Godwin, D.C. & Humphries, J. 1994. Ceres Cereal Generic Model Fortran source code, Michigan State University, East-Lansing, MI, 28–42.
- Rosenzweig, C., Karoly, D., Vicarelli, M., Neofotis, P., Wu, Q., Casassa, G., Menzel, A., Root, T.L., Estrella, N. & Seguin, B. 2008. Attributing physical and biological impacts to anthropogenic climate change. *Nature* **453**(7193), 353–358.
- Russelle, M.P., Olson, R.A. & Hauck, R.D. 1987. Planting date and nitrogen management interactions in irrigated maize. *Field Crops Research* **16**(4), 349–362.
- Santos, H.O., Vasconcellos, R.C.C., Pauli, B., Pires, R.M.O., Pereira, E.M., Tirelli, G.V. & Pinho, É.V.R.V. 2019. Effect of soil temperature in the emergence of maize seeds. *Journal of Agricultural Science* **11**(1), 479–484.
- Schils, R., Olesen, J.E., Kersebaum, K.Ch., Rijk, B., Oberforster, M., Kalyada, V., Khitrykau, M., Gobin, A., Kirchev, H., Manolova, V., Manolov, I., Trnka, M., Hlavinka, P., Palosuo, T., Peltonen-Sainio, P., Jauhiainen, L., Lorgeou, J., Marrou, H., Danalatos, N., Archontoulis, S., Fodor, N., Spink, J., Roggero, P.P., Bassu, S., Pulina, A., Seehusen, T., Kjersti Uhlen, A.K., Żyłowska, K., Nieróbca, A., Kozyra, J., Silva, J.V., Maçãs, B.M., Coutinho, J., Ion, V., Takáč, J., Mínguez, M.I., Eckersten, H., Levy, L., Herrera, J.M., Hiltbrunner, J., Kryvobok, O., Kryvoshein, O., Sylvester-Bradley, R., Kindred, D., Topp, C.F.E., Boogaard, H., Groot, H., Lesschen, J.P., Bussel, L., Wolf, J., Zijlstra, M., P. van Loon, M. & K. van Ittersum, M. 2018. Cereal yield gaps across Europe. *European Journal of Agronomy* **101**, 109–120.
- Shrestha, U., Amgain, L.P., Karki, T. & Shrestha, J. 2016. Effect of sowing dates and maize cultivars in growth and yield of maize along with their agro-climatic indices in Nawalparasi, Nepal. *Journal AgriSearch* **3**(1), 57–62.

- Siebert, S., Ewert, F., Rezaei, E.E., Kage, H. & Graß, R. 2014. Impact of heat stress on crop yield-on the importance of considering canopy temperature. *Environmental Research Letters* **9**(6), 044012.
- Silva-Neta, I.C., Pinho, E.V., Veiga, A.D., Pinho, R.G., Guimarães, R.M., Caixeta, F. & Marques, T.L. 2015. Expression of genes related to tolerance to low temperature for maize seed germination. *Genetics and Molecular Research* **14**(1), 2674–2690.
- Song, Y., Chen, Q., Ci, D., Shao, X. & Zhang, D. 2014. Effects of high temperature on photosynthesis and related gene expression in poplar. *BMC Plant Biology* **14**(1), 111.
- Sorensen, I., Stone, P. & Rogers, B. 2000. Effect of sowing time on yield of a short and a long season maize hybrid. *Proceedings of the Agronomy Society of New Zealand* **30**, 63–66.
- Stone, P.J., Sorensen, I.B. & Jamieson, P.D. 1999. Effect of soil temperature on phenology, canopy development, biomass and yield of maize in a cool-temperate climate. *Field Crops Research* **63**(2), 169–178.
- Szász, G. 1977. Formulae of calculating evapotranspiration and their application in the practice of Hungary, I.C.I.D., Internet round table conference, Evapotranspiration from Plant Communities. Budapest, Hungary, pp. 1–13.
- Széles, A., Harsányi, E., Kith, K. & Nagy, J. 2018. The effect of fertilisation and weather extremities caused by climate change on maize (*Zea mays* L.) yield in Hungary. *Journal of Agriculture Food and Development* **4**, 1–9.
- Tao, F. & Zhang, Z. 2010. Adaptation of maize production to climate change in North China Plain: quantify the relative contributions of adaptation options. *European Journal of Agronomy* **33**(2), 103–116.
- Thiagarajah, M.R. & Hunt, L.A. 1982. Effects of temperature on leaf growth in corn (*Zea mays* L.). *Canadian Journal of Botany* **60**(9), 1647–1652.
- Trnka, M., Rötter, R.P., Ruiz-Ramos, M., Kersebaum, K.C., Olesen, J.E., Žalud, Z. & Semenov, M.A. 2014. Adverse weather conditions for European wheat production will become more frequent with climate change. *Nature Climate Change* **4**(7), 637–643.
- Ványiné Széles, A., Megyes, A. & Nagy, J. 2012. Irrigation and nitrogen effects on the leaf chlorophyll content and grain yield of maize in different crop years. *Agricultural Water Management* **107**, 133–144.
- Ványiné Széles, A. & Nagy, J. 2012. Effect of nutrition and water supply on the yield and grain protein content of maize hybrids. *Australian Journal of Crop Science* **6**(3), 381–290.
- Videnović, Ž., Simić, M., Srdić, J., Dumanović, Z. & Pavlov, M. 2011. Effect of sowing time on yield of ZP maize hybrids. *Journal on Processing and Energy in Agriculture* **15**(1), 23–26.
- Wang, N., Wang, E., Wang, J., Zhang, J., Zheng, B., Huang, Y. & Tan, M. 2018. Modelling maize phenology, biomass growth and yield under contrasting temperature conditions. *Agr Forest Meteorol.* **250–251**, 319–329.
- Wang, Zh., Chen, J., Li, Y., Li, C., Zhang, L. & Chen, F. 2016. Effects of climate change and cultivar on summer maize phenology. *International Journal of Plant Production* **10**(4), 509–522.
- Wilkins, P. & Singh, U. 2001. A CODE-Level Analysis for Temperature Effects in the CERES Models, Resource Development Division, International Fertilizer Development Center (IFDC), Muscle Shoals, Alabama, USA, 1–7.
- Xu, Z., Zhou, G., Han, G. & Li, Y. 2011. Photosynthetic potential and its association with lipid peroxidation in response to high temperature at different leaf ages in maize. *Journal of Plant Growth Regulation* **30**(1), 41–50.
- Yeşilirmak, E. 2014. Soil temperature trends in Büyük Menderes Basin, Turkey. *Meteorological Applications* **21**(4), 859–866.
- Zhang, T., Barry, R.G., Gilichinsky, D., Bykhovets, S.S., Sorokovikov, V.A. & Ye, J. 2001. An amplified signal of climatic change in soil temperatures during the last century at Irkutsk, Russia. *Climate Change* **49**(1–2), 41–76.

## Weed management in soybean with a special focus on the control of purple nutsedge (*Cyperus rotundus*)

I. Travlos<sup>1,\*</sup>, A. Tataridas<sup>1</sup>, P. Kanatas<sup>2</sup>, I. Kakabouki<sup>1</sup> and P. Papastylianou<sup>1</sup>

<sup>1</sup>Agricultural University of Athens, Department of Crop Science, Laboratory of Agronomy, 75 Iera Odos str., Athens GR11855, Greece

<sup>2</sup>Agricultural Cooperative of Mesolonghi-Nafpaktia, Mesolonghi GR30200, Greece

\*Correspondence: travlos@aua.gr

**Abstract.** Purple nutsedge (*Cyperus rotundus* L.) is globally an important perennial weed. Infestations from this species lead to significant losses in yield and quality of crop production. A field study was conducted at Kopaida region in Greece, to evaluate the efficacy of different herbicides for the weed management in soybean. The evaluation of the herbicides was based on the efficacy against purple nutsedge and the effect on soybean biomass production and crop seed yield. Treatments included an untreated control, two pre-emergence applications (with S-metolachlor and pendimethalin), as well as three post-emergence applications (with trifloxysulfuron, bentazone and pyriithiobac sodium). A single application of S-metolachlor maintained the density of purple nutsedge at 15 plants per m<sup>2</sup> in soybean and allowed the crop to compete adequately with the weed. S-metolachlor also resulted in a seed yield of 3.26 tn ha<sup>-1</sup>, a value 52% higher than the untreated control and 38–45% higher than the other herbicides. The results from this study demonstrated that a combination of high seed density in soybean and effective application of herbicides like S-metolachlor can lead to economically acceptable yields.

**Key words:** field crops, weed management, purple nutsedge, herbicides, yield.

### INTRODUCTION

Substantial crop yield and economic losses can occur if weeds are not adequately controlled (Auškalnienė & Auškalnis, 2006; Pacanoski & Mehmeti, 2019). *Cyperus rotundus* (purple nutsedge) is a perennial, noxious weed worldwide which poses a major threat for many important crops (Lawal & Oyedeji, 2009; Singh et al., 2010). It is often referred as one of the worst and most problematic weeds globally (Brecke et al., 2005). The propagation and spreading of purple nutsedge is carried out mainly by tubers, while this species has an extended subterranean network of creeping rhizomes (Bryson et al., 2003; Webster et al., 2008). The underground propagules (tubers) have varying levels of dormancy and can resprout producing multiple plants even within the same cultivation period. This trait often makes this weed noxious and tolerant to several conventional control methods which mostly aim on aboveground biomass of purple nutsedge, such as chemical control and mechanical means (Tuor & Froud-Williams, 2002; Bryson et al., 2003; Iqbal et al., 2019; Travlos et al., 2009). Purple nutsedge can be acclimatized efficiently in a broad spectrum of environments and growing conditions showing

significant tolerance in high temperatures, drought and inadequate light exposure (Tuor & Froud-Williams, 2002; Brecke et al., 2005). It competes strongly with several cultivated crops, such as cotton, maize and soybean (Tuor & Froud-Williams, 2002; Das et al., 2014). This capability makes this species a serious threat for the crop yields, resulting to severe yield losses and increasing the production costs (Tuor & Froud-Williams, 2002; Iqbal et al., 2019).

Soybean (*Glycine max* (L.) Merr.), one of the most important legumes (Degola & Jonkus, 2018; Degola et al., 2019), is a species with a slow initial growth and relatively poor competition with weeds (Das et al., 2014; Datta et al., 2017). Especially in the first growth stages of soybean, the interference with weeds can result in great yield losses (Datta et al., 2017). The timing and the extent of the canopy coverage of the soybean is an important parameter for the interference with weeds, because extensive leaf surface of the canopy doesn't allow solar radiation to reach soil surface and be utilized by the quite competitive purple nutsedge (Tuor & Froud-Williams, 2002). The competition of purple nutsedge with soybean extends up to crop seed maturity and is usually associated with poor control achieved with conventional herbicide application (Das et al., 2014). By the use of practices like narrowed rows, the soybean gains advantage over annual and perennial weeds because the canopy formation is enhanced and leads to earlier canopy closure, reducing the light capturing ability of weeds (Norsworthy, 2004). This trait is often combined currently with an increase in plant density, which along with narrow row spacing improves crop competitiveness (Datta et al., 2017). Due to the fact that they are based on active ingredients with different MOAs than post-emergence herbicides, pre-emergent herbicides reduce selection pressure on subsequent post-emergent herbicide applications and remove much of the early season weed competition for crops (Travlos et al., 2014; Gage et al., 2019; Pacanoski & Mehmeti, 2019).

During the last years and especially since several herbicides are no longer registered in a EU level, there have been many reports that many weeds have become extremely difficult to control with several herbicides and often herbicide resistant (Travlos & Chachalis, 2010; 2012). In addition to this, there is a global lack of selective herbicides that control weeds like purple nutsedge (Kumar et al., 2012). Consequently, a limited number of active ingredients is used in many countries, leading often in overreliance to them and loss of efficacy (Burke et al., 2008). The soil applied herbicide S-metolachlor is a typical example which is used by farmers against nutsedges (Boyd & Dittmar, 2018). There are also some post emergence herbicides such as trifloxysulfuron and pyrithiobac sodium which are recommended against purple nutsedge (Gannon et al., 2012; Banerjee et al., 2018). The objectives of this study were to evaluate the efficacy of several pre- and post-emergence herbicides against purple nutsedge in a high infested field and their effect on the productivity of soybean in terms of biomass and seed yield.

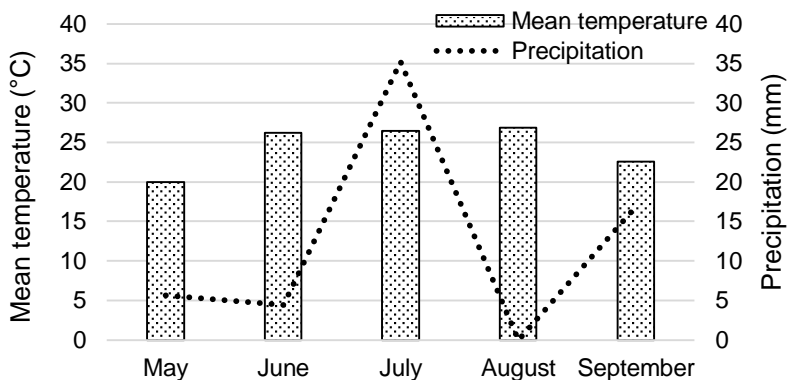
## MATERIAL AND METHODS

### Description of the Study Site

A field study was conducted in the experimental field of Agricultural University of Athens in Kopaida region in Greece (Latitude: 38°23'33.0 N, Longitude: 23°06'08.8 E, Altitude: 94 m above sea level) from May until September 2019. The soil was a clay loam with high organic matter. Weather data (mean monthly temperature and precipitation) during the growing period were obtained from the weather station of



National Observatory of Athens in Kopaida and can be shown in Fig. 1. This field had been cultivated for several years only with cotton with complete absence of rotation crops. Purple nutsedge densities in this field were usually high (over 40–50 plants m<sup>-2</sup>) indicating that it was a high infested area. The control of purple nutsedge and other perennial weeds, such as *Sorghum halepense* which also occurred in the experimental field during the previous years, was conducted traditionally with hand-weeding, a practice that is still followed.



**Figure 1.** Weather data (mean monthly temperature and total month precipitation) during the growing period in the experimental area.

### Treatments and Experimental Design

This study was carried out to evaluate different sole applications of chemical herbicides for the control of purple nutsedge in soybean. Soybean was seeded at 800,000 seed ha<sup>-1</sup>, in a row configuration of 25 cm with a desired plant density of around 60–70 plants m<sup>-2</sup>, with 5 cm distance between the seeds in the row and a 3-cm seed depth. The soil was tilled and harrowed prior soybean sowing, which was conducted on 19 May 2019. The experimental field was fertilized with a conventional 20-20-20 fertilizer the same day with the field cultivation. The plants were irrigated regularly almost every 2 weeks until 10 August, which was the last irrigation for soybean. After that, the plants followed the physiological maturity and the harvest conducted at 15 September.

The treatments included a) a non-treated control, two treatments with pre-emergence applications with b) S-metolachlor or c) pendimethalin, as well as three post-emergence applications with d) trifloxysulfuron, e) bentazone or f) pyriithiobac sodium. Trifloxysulfuron, bentazone and pyriithiobac sodium were applied at 26 days after sowing (DAS). The

**Table 1.** The treatments and application rates of the tested herbicides. PRE: Pre-emergence application, POST: Post-emergence application

Treatment	Active ingredient	Dose, g a.i. ha <sup>-1</sup>	Application
1	-	-	Untreated control
2	s-metolachlor	1,248	PRE
3	pendimethalin	1,980	PRE
4	trifloxysulfuron	15	POST
5	bentazone	1,440	POST
6	pyriithiobac sodium	68.9	POST

untreated control was left without any herbicide application throughout the entire growing season. The plots were sprayed using a custom-built, compressed-air, low-pressure flat-fan nozzle experimental sprayer, calibrated to deliver 300 L ha<sup>-1</sup> at 250 kPa. The treatments can be found in Table 1 and were replicated four times in a complete block design. The size of each plot was 1.25 m × 3.30 m. The plots were arranged in the field in a completely randomized block design.

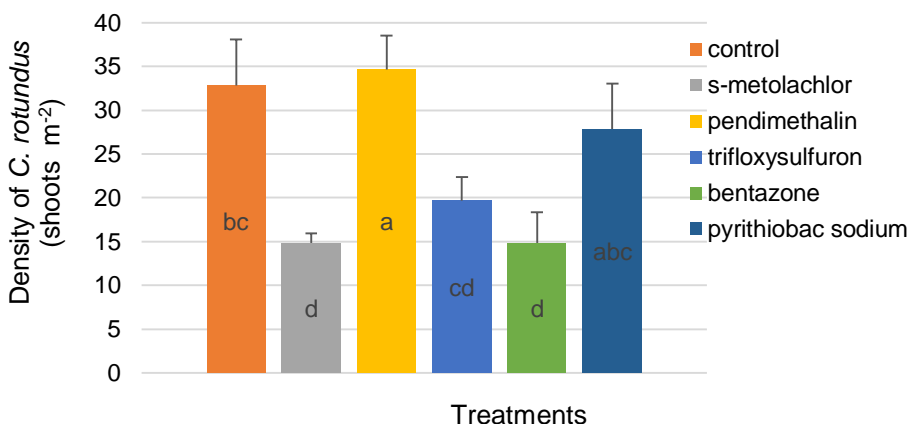
The measurements were carried out from 14 days after treatment (DAT) and at week intervals until harvest and included: (1) density of purple nutsedge, (2) dry weight of purple nutsedge and (3) dry weight of soybean. Soybean yield was also recorded at harvest, at 119 days after sowing (DAS). Concerning the plant density records, a custom-built quadrat of an area of 1 m<sup>2</sup> was used across the weekly measurements. The quadrat was deposited in specific area inside each plot and this process was repeated twice in each plot.

### Data Analysis

The experimental data were analysed using the STATGRAPHICS Centurion XVII Version statistical software (Statpoint Technologies Inc., The Plains, VA, USA). All data were subjected to multiple ANOVA. Treatment and replication effects were tested along with all possible interactions. Treatment means were separated using Fisher’s protected LSD test at  $P < 0.05$ .

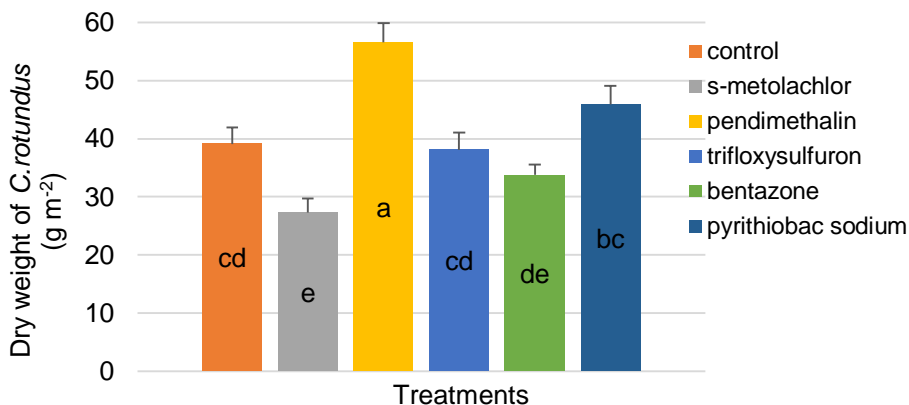
## RESULTS AND DISCUSSION

Our findings have shown that the application of herbicides like S-metolachlor and bentazone maintained an average density of about 15 plants m<sup>-2</sup> at 14 DAT (Fig. 2). This density is significantly lower ( $P < 0.05$ ) than the corresponding values for the untreated plots and the plots treated with pendimethalin.



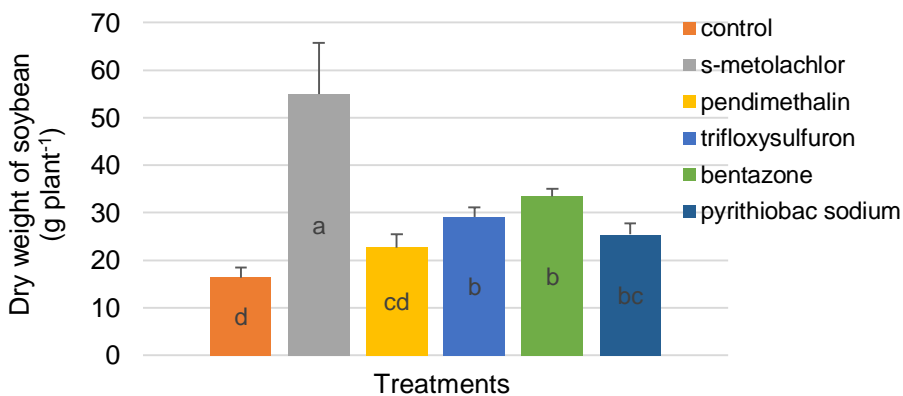
**Figure 2.** Purple nutsedge density two weeks after the post-emergence herbicide applications (14 DAT). Vertical bars denote the standard errors of the means.

The biomass of purple nutsedge also confirmed that the treatments with S-metolachlor was the most effective one for the control of this noxious weed (Fig. 3), partially due to the suppression of its regrowth and the lower density described above.



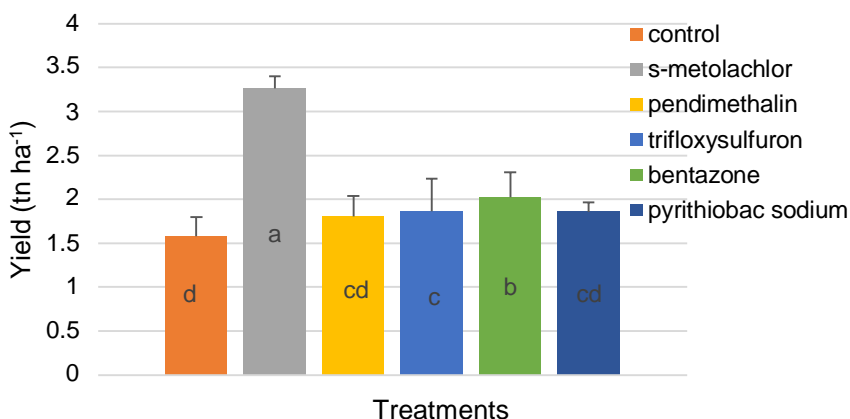
**Figure 3.** Purple nutsedge dry weight two weeks after the post-emergence herbicide applications (14 DAT). Vertical bars denote the standard errors of the means.

The dry weight measurements of soybean at 60 DAS (Fig. 4) showed that the growth was significantly higher in the treatment where S-metolachlor was applied ( $P < 0.05$ ). This pattern was repeated until harvest date (data not shown), showing 2-3-fold higher growth of S-metolachlor than the other treatments and a significantly lower productivity in the cases of untreated plots and the plots treated with pendimethalin.



**Figure 4.** Soybean biomass for the several treatments at 60 days after sowing (60 DAS) or 34 days after the post-emergence herbicide applications (34 DAT). Vertical bars denote the standard errors of the means.

In Fig. 5, it is shown that seed yield of soybean treated with S-metolachlor was 3.26 tn ha<sup>-1</sup>. This yield was 52% higher than the untreated plots and 38–45% higher than the other herbicides. This significantly higher yield can be attributed to the effective control of purple nutsedge observed during the growing period, which ensured a better soybean growth and a higher productivity. Our findings regarding the low yield in the untreated plots are in full agreement with Datta et al. (2017), who showed that weed competition especially in the first growth stages of soybean can result in great yield losses.



**Figure 5.** Soybean seed yield for the several treatments at harvest. Vertical bars denote the standard errors of the means.

S-metolachlor proved to be a very effective herbicide against purple nutsedge, a finding previously reported by Norsworthy (2004) and Brecke et al. (2005). A pre-emergent application with S-metolachlor at a rate of 1,248 g a.i. ha<sup>-1</sup> resulted in high soybean seed yield and provided a long-term control of purple nutsedge. The competition with nutsedge for water and nutrients was low in the crucial growth stages of flowering and pod-filling and consequently yield was high, in agreement with the findings of the study conducted by Wei et al. (2018). On the contrary, weed management programs in soybean which depend only on pendimethalin pre-emergence applications can't always eliminate the weed interference in crop, leading to low yields (Yadav et al., 2017). The same authors found that a single application of pendimethalin pre-emergence in soybean resulted in a seed yield of 1.7 tn ha<sup>-1</sup>, a value comparable with the one found in our study. Therefore, several researchers suggested the combination of pendimethalin with hand-weeding in order to achieve high soybean yield (Rajput & Kushwah, 2004). Furthermore, mixtures can also give a solution, with the application of pendimethalin in a mixture with imazethapyr resulting in soybean seed yield higher than 2.5 tn ha<sup>-1</sup> (Das & Das, 2018).

Our findings also revealed that the post-emergence herbicides trifloxysulfuron and pyrithiobac sodium were of intermediate efficacy when they were applied alone and didn't give a clear advantage to soybean. Kaur et al. (2019) stated that pyrithiobac sodium needs to be combined with other chemical or cultural methods in order to show significant results against purple nutsedge, which is in full agreement with our findings. Concerning trifloxysulfuron, this active ingredient acted better when it was tank-mixed with other herbicides against purple nutsedge (Gannon et al., 2012; Boyd & Dittmar, 2018). The integrated management of purple nutsedge should also focus on tuber viability (Brecke et al., 2005; Webster et al., 2008) and the regrowth. All the above show that competition among perennial weeds and cultivated plants should be assessed in a long-term basis and introduction of new active ingredients, novel tank mixes and adoption of integrated weed management approaches are of major importance.

## CONCLUSION

In summary, a single application of S-metolachlor resulted in soybean seed yield of 3.26 tn ha<sup>-1</sup>, a value significantly higher than the average yield in Greece (approximately 2.5 tn ha<sup>-1</sup>). The adequate control of purple nutsedge during the crucial first crop growth stages allowed a better growth of soybean and a canopy closure that also suppressed the weed and resulted in high biomass and seed production for the crop. In all cases, integrated weed management (IWM) strategies need to be adopted.

## REFERENCES

- Auškalnienė, O. & Auškalnis, A. 2006. Effects of sulfonylurea herbicides on weeds and maize. *Agronomy Research* **4**, 129–132.
- Banerjee, H., Das, T.K., Ray, K., Laha, A., Sarkar, S. & Pal, S. 2018. Herbicide ready-mixes effects on weed control efficacy, non-target and residual toxicities, productivity and profitability in sugarcane–green gram cropping system. *International Journal of Pest Management* **64**, 221–229.
- Boyd, N.S. & Dittmar, P. 2018. Evaluation of postemergence-directed herbicides for purple nutsedge (*Cyperus rotundus*) control in fresh-market tomato. *Weed Technology* **32**, 260–266.
- Brecke, B.J., Stephenson, D.O. & Unruh, J.B. 2005. Control of purple nutsedge (*Cyperus rotundus*) with herbicides and mowing. *Weed Technology* **19**, 809–814.
- Bryson, C.T., Reddy, K.N. & Molin, W.T. 2003. Purple nutsedge (*Cyperus rotundus*) population dynamics in narrow row transgenic cotton (*Gossypium hirsutum*) and soybean (*Glycine max*) rotation. *Weed Technology* **17**, 805–810.
- Burke, I.C., Troxler, S.C., Wilcut, J.W. & Smith, W.D. 2008. Purple and yellow nutsedge (*Cyperus rotundus* and *C. esculentus*) response to postemergence herbicides in cotton. *Weed Technology* **22**, 615–621.
- Das, T.K. & Das, D.K. 2018. Using chemical seed dormancy breakers with herbicides for weed management in soybean and wheat. *Weed Research* **58**, 188–199.
- Das, T.K., Paul, A.K. & Yaduraju, N.T. 2014. Density-effect and economic threshold of purple nutsedge (*Cyperus rotundus*) in soybean. *Journal of Pest Science* **87**, 211–220.
- Datta, A., Ullah, H., Tursun, N., Pornprom, T., Knezevic, S.Z. & Chauhan, B.S. 2017. Managing weeds using crop competition in soybean [*Glycine max* (L.) Merr.]. *Crop Protection* **95**, 60–68.
- Degola, L. & Jonkus, D. 2018. The influence of dietary inclusion of peas, faba bean and lupin as a replacement for soybean meal on pig performance and carcass traits. *Agronomy Research* **16**, 389–397.
- Degola, L., Sterna, V., Jansons, I. & Zute, S. 2019. The nutrition value of soybeans grown in Latvia for pig feeding. *Agronomy Research* **17**(5) 1874–1880. <https://doi.org/10.15159/AR.19.158>
- Gage, K.L., Krausz, R.F. & Walters, S.A. 2019. Emerging challenges for weed management in herbicide-resistant crops. *Agriculture* **9**, 180.
- Gannon, T.W., Yelverton, F.H. & Tredway, L.P. 2012. Selective exposure of yellow nutsedge (*Cyperus esculentus*), purple nutsedge (*Cyperus rotundus*), and false green kyllinga (*Kyllinga gracillima*) to postemergence herbicides. *Weed Technology* **26**, 294–299.
- Iqbal, N., Khaliq, A. & Cheema, Z.A. 2019. Weed control through allelopathic crop water extracts and S-metolachlor in cotton. *Information Processing in Agriculture*. <https://doi.org/10.1016/j.inpa.2019.03.006>

- Kaur, T., Bhullar, M.S. & Kaur, S. 2019. Weed control in Bt (*Bacillus thuringiensis*) cotton with pre mix of pyriithiobac sodium plus quizalofop ethyl in north-west India. *Crop Protection* **119**, 69–75.
- Kumar, M., Das, T.K. & Yaduraju, N.T. 2012. An integrated approach for management of *Cyperus rotundus* (purple nutsedge) in soybean–wheat cropping system. *Crop Protection* **33**, 74–81.
- Lawal, O. & Oyediji, A. 2009. Chemical composition of the essential oils of *Cyperus rotundus* L. from South Africa. *Molecules* **14**, 2909–2917.
- Norsworthy, J.K. 2004. Soil-applied herbicide use in wide-and narrow-row glyphosate-resistant soybean (*Glycine max*). *Crop Protection* **23**, 1237–1244.
- Pacanoski, Z. & Mehmeti, A. 2019. Pre-emergence grass weed control in winter wheat (*Triticum aestivum* L.) with soil applied premixed herbicides influenced by precipitations. *Agronomy Research* **17**(6) 2386–2398. <https://doi.org/10.15159/AR.19.198>
- Rajput, R.L. & Kushwah, S.S. 2004. Integrated weed management in soybean on farmers field. *Indian Journal of Weed Science* **36**, 210–212.
- Singh, S., Walia, U.S., Kaur, R. & Shergill, L.S. 2010. Chemical control of *Cyperus rotundus* in maize. *Indian Journal of Weed Science* **42**, 189–192.
- Travlos, I.S., Economou, G., Kotoulas, V., Kanatas, P. & Kontogeorgos, A. 2009. Potential effects of diurnally alternating temperatures and solarization on purple nutsedge (*Cyperus rotundus*) tuber sprouting. *Journal of Arid Environments* **73**, 22–25.
- Travlos, I.S., Kanatas, P., Tsioros, S., Papastylianou, P., Papatheohari, Y. & Bilalis, D. 2014. Effects of legume incorporation and pendimethalin application on oriental sun-cured tobacco. *Agronomy Journal* **106**, 1225–1230.
- Travlos, I.S. & Chachalis, D. 2010. Glyphosate-resistant hairy fleabane (*Conyza bonariensis*) is reported in Greece. *Weed Technology* **24**, 569–573.
- Travlos, I.S. & Chachalis, D. 2012. Relative competitiveness of glyphosate-resistant and glyphosate-susceptible populations of hairy fleabane (*Conyza bonariensis* L.). *Journal of Pest Science* **86**, 345–351.
- Tuor, F.A. & Froud-Williams, R.J. 2002. Interaction between purple nutsedge, maize and soybean. *International Journal of Pest Management* **48**, 65–71.
- Webster, T.M., Grey, T.L., Davis, J.W. & Culpepper, A.S. 2008. Glyphosate hinders purple nutsedge (*Cyperus rotundus*) and yellow nutsedge (*Cyperus esculentus*) tuber production. *Weed Science* **56**, 735–742.
- Wei, Y., Jin, J., Jiang, S., Ning, S. & Liu, L. 2018. Quantitative response of soybean development and yield to drought stress during different growth stages in the Huaibei Plain, China. *Agronomy* **8**, 97.
- Yadav, R., Bhullar, M.S., Kaur, S., Kaur, T. & Jhala, A.J. 2017. Weed control in conventional soybean with pendimethalin followed by imazethapyr+ imazamox/quizalofop-p-ethyl. *Canadian Journal of Plant Science* **97**, 654–664.

## ***In vitro* effects of regulators on growth and morphogenesis of *Ocimum basilicum* L. ‘Alfavaca Green’ stem apexes**

J.R. Trettel, M. D.S. Queiroz, M.M. Andrade and H.M. Magalhães\*

University Paranaense, Department of Biotechnology, Mascarenhas de Moraes Square, 4282, BR87502-210 Umuarama, Paraná, Brazil

\*Correspondence: [helidamara@prof.unipar.br](mailto:helidamara@prof.unipar.br)

**Abstract.** Large-scale cultivation of contamination free plants requires a good standardization protocol and production methods. Basil is widely used for cosmetics, food and pharmaceutical industries as it is rich in many bioactive compounds. This present study aimed to evaluate the growth and *in vitro* anatomical aspects of apical buds of basil grown under different concentrations rowth regulators like: NAA (Naphthalenoacetic Acid), BAP (6-benzylaminopurine), and KIN (Kinetin). The *in vitro* establishment was evaluated every 20 days to calculate the, the percentage of plants with calluses, appearance of the roots, any abnormal seedlings, any oxidized seedlings, and the number of sprouts per plant. Growth, physiological, and morpho-anatomical evaluations were performed at 80 days. Basal callogenesis was observed when cytokinin’s and auxins are used in combination. Auxin treatments caused hyperhydricity in the stems and leaves. Medium A2 (0.05 mg L<sup>-1</sup> of NAA and 0.1 mg L<sup>-1</sup> of BAP), and A3 (0.05 mg L<sup>-1</sup> of NAA and 0.1 mg L<sup>-1</sup> of KIN) resulted in the best development of basil plants, cultivar ‘Alfavaca Green’. The A2 produced plants with greater numbers of leaves, an average bud length of 59.81 mm, and the best root properties. A2 and A1 have a higher percentage of hyperhydricity (83 and 67%). The A3 resulted in an acceptable number of leaves (range: 21–39), and this treatment produced the best shoot properties as well as fewer plants with hyperhydricity. In addition, the A3 treatment produced plants with a shoot length, high shoot fresh and dry mass (2.82 and 0.23 g), high chlorophyll index and leaf anatomy that was similar to the control. Excluding the control, the other treatments presented more than 90% of the explants with calluses in their bases.

**Key words:** callus, hyperhydricity, Lamiaceae, morphological processes, leaf tissues.

### **INTRODUCTION**

The Lamiaceae family are valued for the pharmaceutical properties of their biologically active components and for their use as culinary seasonings (Makri & Kintzios, 2008; Carović-Stanko et al., 2010; Taie et al., 2010; Vieira et al., 2014). Basil (*Ocimum basilicum* L.) is a rich source of natural compounds such as monoterpenes, sesquiterpenes, phenylpropanoids, anthocyanins, and phenolic acids (Monfort et al., 2018; Trettel et al., 2018a).

The application of plant tissue culture techniques to medicinal plants improves phytopharmaceutical production and can increase plant biomass (Morais et al., 2012; Miralpeix, 2013). One of the advantages of *in vitro* culture is that growing conditions can be controlled (Vanisree et al., 2004). This enhances the predictability of production,

allows for rapid and efficient isolation of target compost, and improves the health and quality of the seedlings produced (Ahsan et al., 2013; Gonçalves & Romano, 2013). Thus, to establish a protocol, it is necessary to specify the basic requirements of the species or cultivar. In addition to the commonly used nutrients and sucrose in culture media, growth regulators are also essential for plant growth (George et al., 2008; Senhaji et al., 2019). Regulators are compounds similar to natural hormones that act on plant development through altering plant metabolism (Small & Degenhardt, 2018). The most commonly used regulators belong to the auxin and cytokine groups. Auxins mainly promote cell stretching and root formation (Perrot-Rechenmann 2010), whereas cytokines neutralize the auxins that cause apical dominance and promote cell multiplication and lateral growth of the plant (Perilli et al., 2010).

There is also a lack of information on how growth regulators influence the formation and differentiation of tissues in basil, especially leaf tissues (Trettel et al., 2019). The genus *Ocimum* is composed of 50–60 species (Makri & Kintzios, 2008) and has several cultivars, making it necessary to establish the concentrations and types of regulators needed for each cultivar (Monfort et al., 2018). Research has revealed that different regulators can impact organogenesis in various cultivars. For example, partial changes in leaf architecture and reductions in palisade and spongy parenchyma thickness were observed in *O. basilicum* ‘Genovese’ when 0.4 mg L<sup>-1</sup> of BAP and 0.2 mg L<sup>-1</sup> of NAA were applied simultaneously (Trettel et al., 2019).

Thus, it can be expected that combining growth regulators will influence the morphoanatomical characteristics of the leaves (Rout et al., 2000), and will particularly affect palisade and spongy parenchyma thickness (Stefanova et al., 2011). Thus, anatomical studies allow us to assess the normality of the tissues and to identify treatments with a higher likelihood of success, for example, treatments that produce plants with thicker cuticles, epidermises, and leaf limbs (Kumar & Rao, 2012). Given the above-mentioned facts, the present study aimed to evaluate the effects of different concentrations of auxin (naphthaleneacetic acid - NAA) and cytokine (6-benzylaminopurine - BAP, and kinetin - KIN) growth regulators on the *in vitro* establishment and leaf morphoanatomy of *Ocimum basilicum* L. ‘Alfavaca Green’.

## MATERIALS AND METHODS

### Obtention of propagative material

The research was carried out at the Laboratory of Plant Tissue Culture at the *Universidade Paranaense* - UNIPAR. Seeds were used as initial propagating material. The cultivar used in this study was ‘Alfavaca Green’ (Feltrin<sup>®</sup>, Farroupilha, Brazil), and the batch number was 0061401530016050. Before the start of the experiment, seeds were immersed in distilled water and were oxygenated for 2 hours before being disinfected in a laminar flow cabinet. Seeds were immersed in 70% ethyl alcohol for 2 minutes, then transferred to 2% sodium hypochlorite solution and stirred for 15 minutes. Subsequently, four successive washes were performed with deionized and autoclaved water.

After the disinfection process, groups of four seeds were inoculated into flasks containing 50 mL of culture medium. The MS medium (Murashige & Skoog, 1962) was used at its full strength, and was supplemented with 30 g L<sup>-1</sup> sucrose and 6.5 g L<sup>-1</sup> agar. The pH was adjusted to 5.8. After the medium was prepared, flasks were autoclaved for



20 minutes at 120 °C. After seeds were inoculated, the flasks were kept in a growth chamber at 25 ± 2 °C with a light intensity of 72.0 μmol m<sup>-2</sup> s<sup>-1</sup>, which was maintained using LED lamps (Blumenau® Porto Alegre, Brazil; LED T8 10W 6.000K, 100-240 V, -50/60 Hz, power factor: ≥ 0.92; High PF). The plants were kept in the growth chamber for 80 days under a 24 h d<sup>-1</sup> photoperiod.

### Implementation and establishment *in vitro*

Seedlings free of abnormalities and oxidation were selected, and stem apices of approximately 1.5 cm with two buds were obtained. The baseline medium used for all treatments consisted of full-strength MS medium supplemented with 30.0 g L<sup>-1</sup> sucrose and 6.5 g L<sup>-1</sup> agar; the pH of the medium was adjusted to 5.8. Combinations of NAA (Naphthaleneacetic Acid), BAP (6-benzylaminopurine), and KIN (Kinetin; Sigma Aldrich® Hamburg, Germany) growth regulators were added according to Table 1.

Regulator concentrations in the treatments were based on those suggested by Stefanova et al. (2011), in addition to on tests previously performed. Fifty milliliters of culture medium was added to each 350 mL flask. One apex was inoculated per flask; then flasks were kept in a growth chamber for 80 days under the conditions previously cited.

### Evaluation during *in vitro* establishment

Two evaluations were performed during *in vitro* cultivation. The first evaluation was performed 20 days after explant inoculation and the second at 40 days post-inoculation. In these evaluations, the percentage of plants with calluses, the appearance of the roots, and any abnormal or oxidized seedlings were recorded. Evaluations were performed in six replications, with five flasks per replication.

### Physiological and growth evaluation

Number of leaves (NL), sprout length (SPL), root length (RTL), sprout fresh mass (SFM), root fresh mass (RFM), callus fresh mass (CFM), sprout dry mass (SDM), root dry mass (RDM), callus dry mass (CDM), and chlorophyll index (CLI) were analyzed after 80 days. Any hyperhydricity or adventitious roots were also recorded. The measurements were obtained with a digital caliper, and the samples were kept in an oven at 65 °C for three days before being weighed on a precision scale to obtain the dry mass. Total chlorophyll index was determined based on the middle third of the plants, and a Chlorophyll meter ClorofiLOG® CFL 1030 was used to obtain these measurements, according to the manufacturer's instructions (Falker® Porto Alegre, Brazil).

**Table 1.** Treatments used to growth of *Ocimum basilicum* ‘Alfavaca Green’ with different growth regulators NAA (Naphthaleneacetic acid) BAP (6-benzylaminopurine) and KIN (Kinetin)

Treatments	NAA (mg L <sup>-1</sup> )	BAP	KIN
A1	0.0	0.0	0.0
A2	0.05	0.1	0.0
A3	0.05	0.0	0.1
A4	0.2	0.4	0.0
A5	0.2	0.0	0.4
A6	1.0	2.0	0.0
A7	1.0	0.0	2.0
A8	0.5	0.0	1.0
A9	0.2	5.0	0.0

### **Anatomical and morphometric evaluation of the leaves**

After 80 days, three replicates from each treatment were selected for anatomical evaluation. The leaves were fixed in formalin solution, acetic acid, and ethyl alcohol (FAA50) for 24 hours and were stored in 70% alcohol. They were subsequently dehydrated in succession with butyl (50%, 70%, 85%, 95%, and 100%) according to the methodology of Johansen (1940), and were then incorporated into paraplast (Kraus & Arduim, 1997).

The region from the petiole to the midpoint of the leaf limb was chosen for cutting. Cross-sections of 10  $\mu\text{m}$  in thickness were obtained using the Leica (RM2125 RT) hand rotating microtome (Biosystems<sup>®</sup> Wetzlar, Germany). Afterwards, sections were transferred to glass slides and were deparaffinized. They were then dehydrated in a decreasing ethanol series (90%, 80%, 70%, and 50%) before being stained in a mixture of astrablue and safranin (9:1 v/v) (Bukatsch, 1972) modified to a concentration of 0.5%, according to the methodology of Antoniazzi et al., (2016). Sections were then washed in water and were again passed through an increasing ethanol series (50%, 70%, 80%, and 90%). Glass varnish was used for coverslip fixation (Paiva, 2006).

Photographs were taken at 40 $\times$  magnification under a microscope (Olympus BX-60<sup>®</sup> Tokyo, Japan) with a camera attached. Motic Images Plus 3.0 software was used for anatomical evaluations (Motic, 2016). The measurements were taken from each photo: adaxial epidermis (AE), palisade parenchyma (PP), spongy parenchyma (SP), abaxial epidermis (XE), and the distance between the inferior and superior epidermis (EE). The thickness of these regions was obtained in three different images and from each tissue ten measurements were taken.

### **Experimental design and statistical analyses**

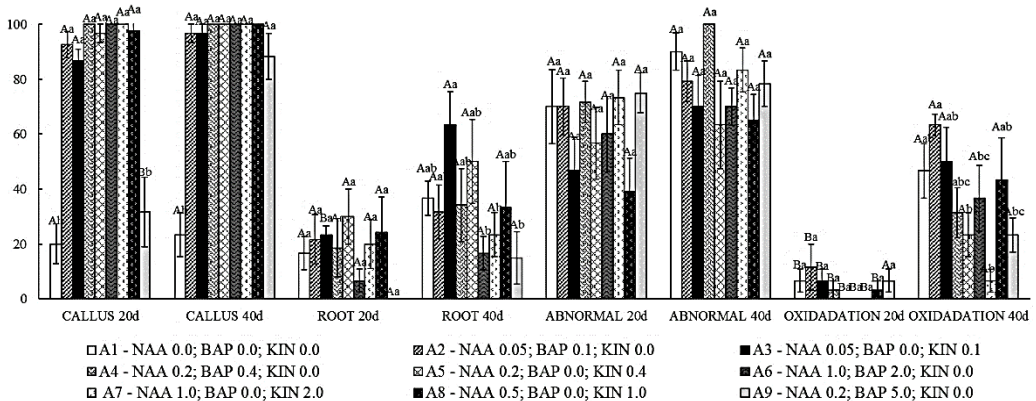
The experiment was carried out with a completely randomized design to produce nine treatments, six replications, and five flasks per replication containing one stem apex each. Callus formation, appearance of the roots, and any abnormal or oxidized seedlings were recorded at two evaluation times (at 20 and 40 days) in a 2 $\times$ 9 factorial scheme, and nine treatments were evaluated. Leaf growth, physiological data, and morphometric data obtained in the final evaluation were submitted to analysis of variance One-way ( $p \leq 0.05$ ) and were compared using Tukey tests ( $p \leq 0.05$ ) on Sisvar 5.6 software (Ferreira, 2011).

The data obtained for the presence and absence of hyperhydricity and adventitious roots were noted down as binary annotations. The number 1 signified the presence of the characteristic and 0 signified its absence. Data were converted to a dissimilarity index using the Jaccard Tanimoto formula, and data were transformed to  $d = (1-r) \times 100$  with 100 replicates using the <http://genomes.urv.cat/UPGMA/> platform. Data were exported to the Statistica 13.3 software (Statsoft, 2017), and the hierarchical clustering technique was used to interconnect the samples by associations. The software generated a dendrogram within which similar samples were grouped (Moita Neto & Moita 1998). Euclidean distance was used to measure the similarity between the centroids of each isolate, and Ward's method was adopted for grouping. The results of the analysis are presented in graphic form (dendrogram).

## RESULTS

### Evaluation during *in vitro* establishment

The control treatment had the lowest percentage of plants with calluses during the whole period of *in vitro* establishment. During the second evaluation period, plants subjected to experimental treatments showed callus formation, and the percentage of plants with calluses ranged from 96.67 to 100% (Fig. 1). Although calluses were present in all treatments, this did not limit seedling growth. Sprouting occurred first, and was then followed by root growth. Approximately 17.90% of cultivated seedlings took root within the first 20 days. Between the first and second evaluation periods, there was a 15.89% increase in seedling rooting (Fig. 1).

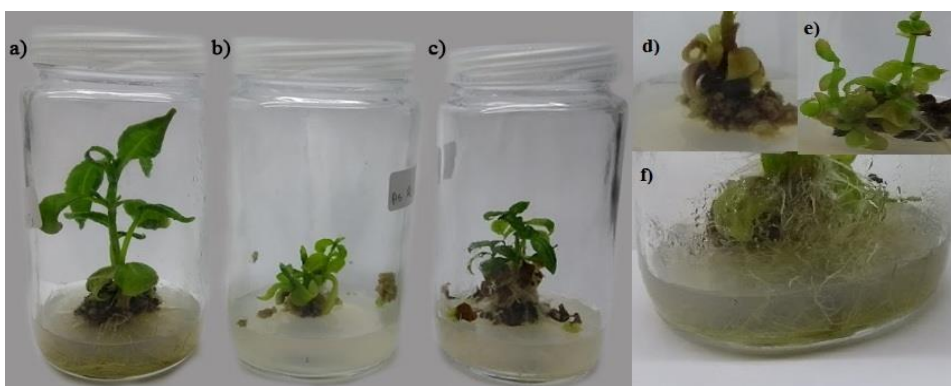


**Figure 1.** Percentage of abnormal and oxidized seedlings, and formation of callus and roots, at 20 and 40 days after *in vitro* establishment of the stem apices of *Ocimum basilicum* 'Alfavaca Green'.

\*Tukey test ( $p \leq 0.05$ ) Equal letters do not differ from each other. Uppercase letters compare the same treatment between evaluation times. Lowercase letters compare the different treatments within the same evaluation time.

Regarding the presence of abnormal plants, it was observed that 77.68% of the seedlings showed abnormalities at 40 days post-inoculation. There were no significant differences ( $p \leq 0.05$ ) in this trait among treatments or between the evaluation times. However, 90 and 100% of the seedlings were abnormal under the A1 and A4 treatments, respectively (Fig. 1). Among the visualized characteristics, the most common abnormalities were hyperhydricity, adventitious roots, and twisted sickle-shaped leaves (Fig. 2).

Oxidation was higher at 40 days than at 20 days post-inoculation; treatments A2 and A7 had the highest and lowest percentages of oxidation at 63.33% and 6.67%, respectively (Fig. 1). On average, the experimental treatments generated low shoot formation per seedling compared to the control, with an average of 0.61 shoots per plant at 20 days, and 0.84 shoots per plant at 40 days.



**Figure 2.** Abnormal seedlings of *Ocimum basilicum* ‘Alfavaca Green’ at 80 days after *in vitro* establishment of stem apices: a) seedling with twisted leaves; b) Seedling with hyperhydricity; c) Seedling with adventitious roots; d) callus; e) hyperhydricity symptoms; f) adventitious rooting.

### Evaluation of physiological and growth characteristics

After 80 days of cultivation, analysis of the physiological and growth characteristics was performed for all treatments (Table 2). Treatments A1, A2, and A3 produced plants with the highest numbers of leaves. Among them, the A2 treatment generated an average of 21.84 leaves per seedling, and this was followed by A3 and A1 (21.39 and 18.72 leaves per seedling, respectively). The highest results for SPL were observed under the A2 treatment (59.81 mm), followed by A3 (56.25 mm) and by A1 (48.35 mm). There were no significant differences among these results ( $p \leq 0.05$ ). The average shoot length of treatments A2, A3, and A1 was 55.69% higher than the average shoot length under the A7 treatment, which produced the smallest SPL (24.28 mm) (Table 2).

Regarding root system formation, it was observed that the A2 produced a higher average RTL (71.08 mm), which was 63.11 and 23.39% higher than the averages of treatments A6 and A9, with the lowest values of root length respectively. The fresh and dry masses of roots under the A2 were 3.24 g and 0.17 g, respectively, which represented 12 and 8.5 times greater fresh and dry masses of roots compared to the A4 (0.26 g and 0.02, respectively) (Table 2). In general, the A3 medium was better in terms of characteristics related to shoot biomass, with averages of 2.32 and 0.23 g for fresh and dry shoot mass, respectively. No callus formation was observed in the control treatment (A1). Treatments A2 and A3 had low fresh and dry masses of calluses (A2 = 1.79 and 0.12 g; A3 = 1.48 and 0.09 g, respectively). The A3 medium produced the highest average CLI (41.89), which was higher than the averages of A1 and A2 (21.43 and 21.39, respectively) (Table 2).

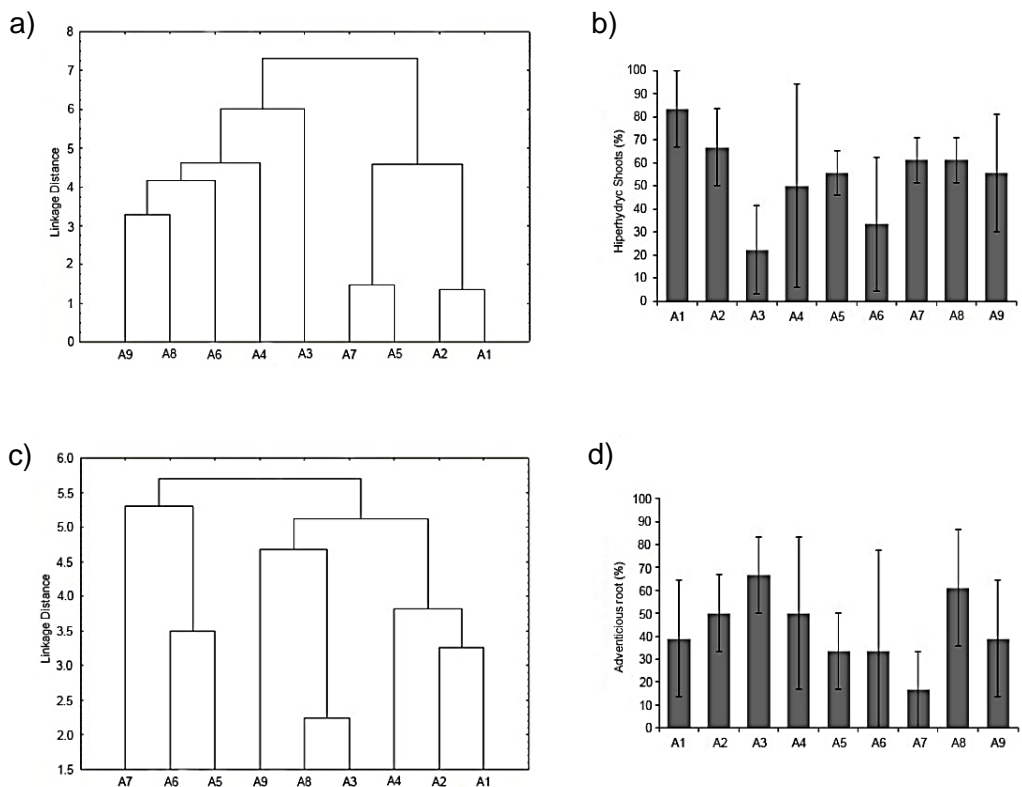
Some abnormalities were observed at the end of the experiment. Among them, the most recurrent were hyperhydricity and adventitious roots. The results of these analyses are shown in Fig. 3. In general, the first group (A9, A8, A6, A4, and A3 - Fig. 3, a) contained treatments with a higher concentration of the NAA regulator, except for treatment A3. When comparing the dendrogram with the percentage graph (Fig. 3, b), it can be observed that the treatments grouped at the left extremity, A9 and A8, are those with lower percentages of hyperhydricity (56 and 61% - Fig. 3, b) compared to the right extremity (A2 and A1), which had higher percentages of hyperhydricity (83 and 67% - Fig. 3, b).

**Table 2.** Number of leaves, sprout and root length, fresh and dry mass of sprout, root and callus, and chlorophyll index evaluated at 80 days after *in vitro* cultivation of *Ocimum basilicum* ‘Alfavaca Green’ stem apexes

Treat	NL	SPL (mm)	RTL (mm)	SFM (g)	RFM (g)	CFM (g)	SDM (g)	RDM (g)	CDM (g)	CLI
A1	18.72 ± 2.69 <sup>ab</sup>	48.35 ± 10.44 <sup>a</sup>	51.00 ± 19.21 <sup>ab</sup>	2.13 ± 0.56 <sup>abc</sup>	1.21 ± 1.05 <sup>ab</sup>	0.00 ± 0.00 <sup>d</sup>	0.16 ± 0.04 <sup>abc</sup>	0.06 ± 0.07 <sup>ab</sup>	0.00 ± 0.00 <sup>c</sup>	21.43 ± 13.30 <sup>ab</sup>
A2	21.84 ± 5.21 <sup>a</sup>	59.81 ± 10.43 <sup>a</sup>	71.08 ± 13.61 <sup>a</sup>	2.82 ± 0.77 <sup>ab</sup>	3.24 ± 2.20 <sup>a</sup>	1.79 ± 1.01 <sup>dc</sup>	0.19 ± 0.08 <sup>ab</sup>	0.17 ± 0.11 <sup>a</sup>	0.12 ± 0.06 <sup>edc</sup>	21.39 ± 7.61 <sup>ab</sup>
A3	21.39 ± 3.43 <sup>ab</sup>	56.25 ± 15.03 <sup>a</sup>	59.90 ± 15.32 <sup>ab</sup>	2.32 ± 0.79 <sup>abc</sup>	2.25 ± 1.43 <sup>ab</sup>	1.48 ± 0.86 <sup>d</sup>	0.23 ± 0.08 <sup>a</sup>	0.12 ± 0.07 <sup>ab</sup>	0.09 ± 0.05 <sup>edc</sup>	41.89 ± 9.11 <sup>a</sup>
A4	13.06 ± 3.40 <sup>c b</sup>	25.21 ± 9.85 <sup>c b</sup>	37.74 ± 18.45 <sup>ab</sup>	0.95 ± 0.30 <sup>c</sup>	0.26 ± 0.21 <sup>b</sup>	2.02 ± 1.41 <sup>dc</sup>	0.09 ± 0.03 <sup>cb</sup>	0.02 ± 0.02 <sup>b</sup>	0.33 ± 0.22 <sup>abc</sup>	9.64 ± 2.51 <sup>b</sup>
A5	14.78 ± 3.47 <sup>abc</sup>	42.58 ± 10.46 <sup>abc</sup>	71.58 ± 15.21 <sup>a</sup>	1.86 ± 0.81 <sup>abc</sup>	2.82 ± 1.49 <sup>ab</sup>	2.82 ± 0.85 <sup>dc</sup>	0.18 ± 0.09 <sup>abc</sup>	0.14 ± 0.08 <sup>ab</sup>	0.14 ± 0.09 <sup>edcb</sup>	25.46 ± 9.63 <sup>ab</sup>
A6	13.14 ± 5.66 <sup>c b</sup>	25.20 ± 12.84 <sup>c b</sup>	26.22 ± 26.84 <sup>b</sup>	1.43 ± 0.77 <sup>cb</sup>	0.92 ± 0.98 <sup>ab</sup>	9.95 ± 4.57 <sup>a</sup>	0.08 ± 0.04 <sup>cb</sup>	0.03 ± 0.05 <sup>ab</sup>	0.50 ± 0.31 <sup>a</sup>	13.47 ± 3.63 <sup>b</sup>
A7	9.67 ± 3.63 <sup>c</sup>	24.28 ± 11.19 <sup>c</sup>	72.11 ± 36.50 <sup>a</sup>	1.03 ± 0.44 <sup>cb</sup>	1.03 ± 0.98 <sup>ab</sup>	7.12 ± 1.01 <sup>ab</sup>	0.06 ± 0.02 <sup>c</sup>	0.03 ± 0.03 <sup>ab</sup>	0.41 ± 0.12 <sup>ab</sup>	12.09 ± 7.54 <sup>b</sup>
A8	15.31 ± 6.19 <sup>abc</sup>	46.21 ± 15.18 <sup>b a</sup>	63.71 ± 23.45 <sup>ab</sup>	3.25 ± 2.19 <sup>a</sup>	2.78 ± 3.05 <sup>ab</sup>	5.12 ± 1.57 <sup>cb</sup>	0.11 ± 0.09 <sup>cb</sup>	0.12 ± 0.13 <sup>ab</sup>	0.28 ± 0.06 <sup>dabc</sup>	17.60 ± 4.40 <sup>b</sup>
A9	18.56 ± 4.87 <sup>ab</sup>	25.16 ± 1.70 <sup>c b</sup>	26.02 ± 29.62 <sup>b</sup>	2.43 ± 0.78 <sup>abc</sup>	0.67 ± 0.75 <sup>ab</sup>	0.86 ± 1.01 <sup>d</sup>	0.15 ± 0.06 <sup>abc</sup>	0.04 ± 0.05 <sup>ab</sup>	0.05 ± 0.04 <sup>ed</sup>	19.22 ± 6.20 <sup>b</sup>

\*Tukey test ( $p \leq 0.05$ ). Equal letters do not differ from each other in the column. NL – number of leaves; SPL – sprout length; RTL – root length; SFM – sprout fresh mass; RFM – root fresh mass; CFM – callus fresh mass; SDM – sprout dry mass; RDM – root dry mass; CDM – callus dry mass; CLI – chlorophyll index. A1 (control) without growth regulators; A2 – 0.05, 0.1 and 0 mg L<sup>-1</sup>; A3 – 0.05.0 and 0.1 mg L<sup>-1</sup>; A4 – 0.2, 0.4 and 0.0 mg L<sup>-1</sup>; A5 – 0.2, 0.0 and 0.4 mg L<sup>-1</sup>; A6 – 1.0, 2.0 and 0.0 mg L<sup>-1</sup>; A7 – 1.0, 0.0 and 2.0 mg L<sup>-1</sup>; A8 – 0.5, 0.0 and 1.0 mg L<sup>-1</sup>; A9 – 0.2, 5.0 and 0.0 mg L<sup>-1</sup> of NAA, BAP and KIN, respectively.

The second group generally consisted of the treatments with lower concentrations of BAP and KIN. Thus, it was observed that the A3 treatment was situated between the two large groups. It can be inferred that the treatment A3 was associated with the first group due to the low percentage of hyperhydricity it produced, and with the second group due to the low concentration of NAA and KIN in its composition (Fig. 3, a).



**Figure 3.** Dendrogram and percentage of *Ocimum basilicum* ‘Alfavaca Green’ seedlings with hyperhydricity and adventitious roots grown at different concentrations of growth regulators. a) Dendrogram referring to hyperhydricity; b) Percentage of the presence of hyperhydricity; c) Dendrogram referring to the presence of adventitious roots; d) Percentage of presence of adventitious roots.

A1 (control) without growth regulators; A2 – 0.05, 0.1 and 0 mg L<sup>-1</sup>; A3 – 0.05.0 and 0.1 mg L<sup>-1</sup>; A4 – 0.2, 0.4 and 0.0 mg L<sup>-1</sup>; A5 – 0.2, 0.0 and 0.4 mg L<sup>-1</sup>; A6 – 1.0, 2.0 and 0.0 mg L<sup>-1</sup>; A7 – 1.0, 0.0 and 2.0 mg L<sup>-1</sup>; A8 – 0.5, 0.0 and 1.0 mg L<sup>-1</sup>; A9 – 0.2, 5.0 and 0.0 mg L<sup>-1</sup> of NAA, BAP and KIN, respectively.

The dendrogram of the presence of adventitious roots were grouped into two main clusters (Fig. 3, c). The first cluster contains treatments A6, A5, and A7, and the second cluster grouped the treatments into two subgroups containing A9, A8 and A3, and A4, A2, and A1, respectively. Treatments A9, A8, and A3 had the presence of KIN in common, and produced the highest percentages of adventitious roots (100, 61, and 67%, respectively) (Fig. 3, d). Both treatments A2 and A4 produced plants 50% of plants with adventitious roots (Fig. 3, d), and also contained intermediate concentrations of BAP.

### Anatomy and morphometry of basil leaves

Normal, twisted, and hyperhydric leaves were observed under the experimental treatments (Fig. 4). Leaf tissue morphometry differed among the treatments tested (Table 3). As shown in Table 3, the A2

medium presented the greatest average adaxial epidermis (AE) thickness, with 19.51  $\mu\text{m}$ , followed by A9, which produced an average AE thickness of 18.44  $\mu\text{m}$ . The A9 treatment produced the greatest abaxial epidermis (XE) thickness (18.08  $\mu\text{m}$ ). The thickness of the palisade parenchyma (PP) was greater under treatments A7 and A8; the average of both was 65% greater than that of A4, which had the lowest mean PP thickness (55  $\mu\text{m}$ ). Treatment A8 also produced the highest average spongy parenchyma (SP) thickness (492.68  $\mu\text{m}$ ), and this was 80.15 and 75.50% higher than the A1 and A3 treatments respectively, which had the lowest average PL thicknesses at 97.77 and 120.68  $\mu\text{m}$ , respectively. A8 also produced plants with the greatest

distance between the inferior and superior epidermis (DE), with an average of 659.45  $\mu\text{m}$ , which was 74.22 and 70.13% higher than the A1 and A4 treatments respectively.



**Figure 4.** Leaves of *Ocimum basilicum* 'Alfavaca Green' at 80 days of *in vitro* cultivation of stem apices at different concentrations of growth regulators: a) Normal leaves; b) twisted and sickle shaped leaves; c) leaves with hyperhydricity.

**Table 3.** Leaf morphometry of *Ocimum basilicum* 'Alfavaca Green' grown at different concentrations of regulators NAA, BAP, and KIN

TRAT	AE ( $\mu\text{m}$ )	XE ( $\mu\text{m}$ )	PP ( $\mu\text{m}$ )	SP ( $\mu\text{m}$ )	EE ( $\mu\text{m}$ )
A1	8.80 $\pm$ 3.79 <sup>b</sup>	9.65 $\pm$ 3.72 <sup>b</sup>	66.54 $\pm$ 37.64 <sup>bc</sup>	97.77 $\pm$ 31.76 <sup>d</sup>	160.95 $\pm$ 66.59 <sup>f</sup>
A2	19.51 $\pm$ 3.87 <sup>a</sup>	15.62 $\pm$ 3.83 <sup>ab</sup>	111.71 $\pm$ 23.23 <sup>abc</sup>	394.22 $\pm$ 4.56 <sup>b</sup>	520.73 $\pm$ 9.33 <sup>b</sup>
A3	14.13 $\pm$ 1.16 <sup>ab</sup>	12.35 $\pm$ 1.61 <sup>ab</sup>	74.85 $\pm$ 3.09 <sup>bc</sup>	120.68 $\pm$ 16.57 <sup>d</sup>	227.85 $\pm$ 35.55 <sup>ef</sup>
A4	9.72 $\pm$ 0.72 <sup>b</sup>	13.36 $\pm$ 4.04 <sup>ab</sup>	55.00 $\pm$ 9.03 <sup>c</sup>	130.03 $\pm$ 32.07 <sup>cd</sup>	196.92 $\pm$ 42.41 <sup>f</sup>
A5	8.33 $\pm$ 0.74 <sup>b</sup>	9.68 $\pm$ 1.30 <sup>b</sup>	78.67 $\pm$ 10.37 <sup>bc</sup>	185.93 $\pm$ 26.01 <sup>cd</sup>	277.98 $\pm$ 45.12 <sup>def</sup>
A6	11.01 $\pm$ 1.75 <sup>b</sup>	9.94 $\pm$ 0.90 <sup>b</sup>	124.38 $\pm$ 41.01 <sup>ab</sup>	187.93 $\pm$ 32.86 <sup>cd</sup>	396.14 $\pm$ 35.66 <sup>bcd</sup>
A7	11.46 $\pm$ 1.34 <sup>b</sup>	12.36 $\pm$ 3.11 <sup>ab</sup>	152.01 $\pm$ 8.65 <sup>a</sup>	323.20 $\pm$ 37.10 <sup>b</sup>	458.40 $\pm$ 44.95 <sup>bc</sup>
A8	13.65 $\pm$ 0.55 <sup>ab</sup>	15.59 $\pm$ 1.52 <sup>ab</sup>	166.31 $\pm$ 15.76 <sup>a</sup>	492.68 $\pm$ 61.75 <sup>a</sup>	659.45 $\pm$ 65.47 <sup>a</sup>
A9	18.44 $\pm$ 2.78 <sup>a</sup>	18.08 $\pm$ 0.57 <sup>a</sup>	115.14 $\pm$ 21.08 <sup>abc</sup>	221.90 $\pm$ 21.29 <sup>c</sup>	351.72 $\pm$ 38.32 <sup>cde</sup>

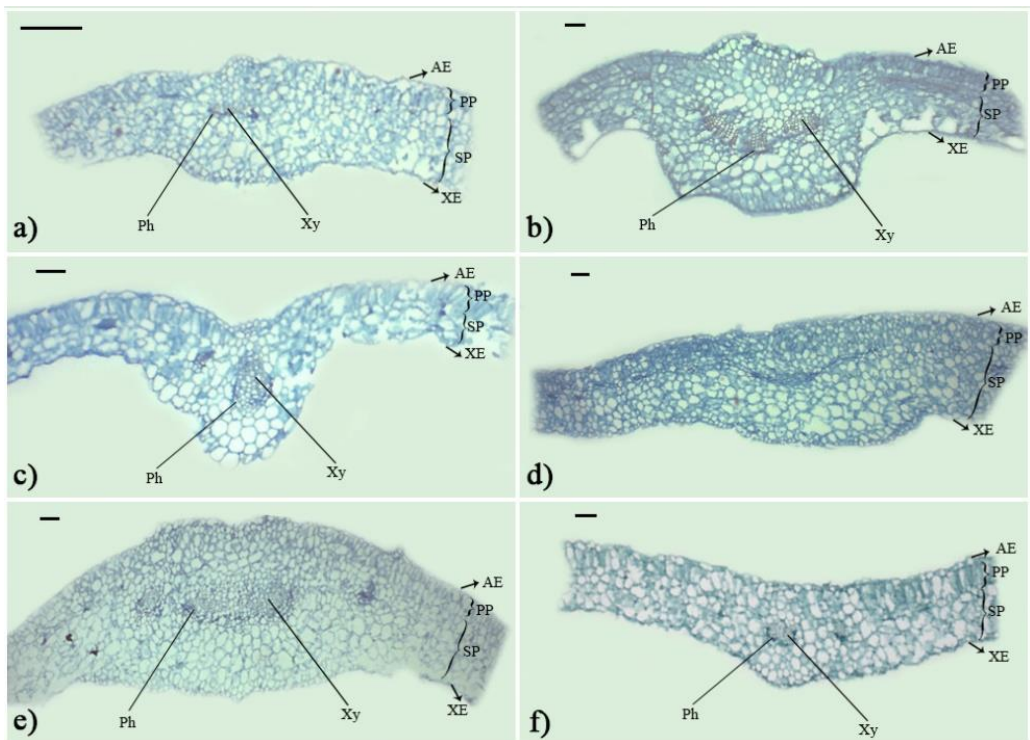
\*Tukey test ( $p \leq 0.05$ ). Equal letters do not differ from each other in the column.

AE – adaxial epidermis; XE – abaxial epidermis; PP – palisade parenchyma; SP – spongy parenchyma; DE – distance between the inferior and superior epidermis.

A1 (control) without growth regulators; A2 – 0.05, 0.1 and 0 mg L<sup>-1</sup>; A3 – 0.05.0 and 0.1 mg L<sup>-1</sup>; A4 – 0.2, 0.4 and 0.0 mg L<sup>-1</sup>; A5 – 0.2, 0.0 and 0.4 mg L<sup>-1</sup>; A6 – 1.0, 2.0 and 0.0 mg L<sup>-1</sup>; A7 – 1.0, 0.0 and 2.0 mg L<sup>-1</sup>; A8 – 0.5, 0.0 and 1.0 mg L<sup>-1</sup>; A9 – 0.2, 5.0 and 0.0 mg L<sup>-1</sup> of NAA, BAP and KIN, respectively.

Morphological observations showed that *O. basilicum* 'Alfavaca Green' leaves had an epidermis with rectangular and oval cells at the apexes and a thin cuticle layer (Fig. 5, a, b, f). Next, a layer of juxtaposed palisade parenchyma was observed, with few cell spaces present (Fig. 5, b). The spongy parenchyma occupied four layers of the leaf limb, with irregular to rounded cells that varied in size (Fig. 5, c). These cells were larger and had large spaces between them in the midrib. The conductive vessels were formed by metaxylem vessel elements that had a thicker rounded cell wall and formed layers of cells oriented towards the collateral bundle (Fig. 5, e).

Differences in the distribution of cells in the parenchyma were also observed between treatments. In treatment A1 (Fig. 5, a), palisade parenchyma (PP) with smaller cells distributed in two layers were observed, which also occurred under treatments A2, A7, and A8 (Fig. 5, b, c, d). The other treatments produced plants with PP in a single layer and with longer cells. In all treatments, the extension of the spongy parenchyma was formed in two or more layers and was greater than the extension of the PP.



**Figure 5.** Cross section of *Ocimum basilicum* 'Alfavaca Green' leaves at 80 days of *in vitro* cultivation of stem apexes at different concentrations of growth regulators.

A1 (control) without growth regulators; A2 – 0.05, 0.1 and 0 mg L<sup>-1</sup>; A3 – 0.05.0 and 0.1 mg L<sup>-1</sup>; A4 – 0.2, 0.4 and 0.0 mg L<sup>-1</sup>; A5 – 0.2, 0.0 and 0.4 mg L<sup>-1</sup>; A6 – 1.0, 2.0 and 0.0 mg L<sup>-1</sup>; A7 – 1.0, 0.0 and 2.0 mg L<sup>-1</sup>; A8 – 0.5, 0.0 and 1.0 mg L<sup>-1</sup>; A9 – 0.2, 5.0 and 0.0 mg L<sup>-1</sup> of NAA, BAP and KIN, respectively. AE – adaxial epidermis; PP – palisade parenchyma; SP – spongy parenchyma; XE abaxial epidermis; Xy – Xylem; Ph – Phloem (bar = 100µm).



## DISCUSSION

### **Evaluation during *in vitro* establishment**

Transformations during the organogenesis process of *in vitro* cultivated plants have been studied in many plants of commercial interest (George et al., 2008). For medicinal plants, there has been a lack of studies using this information to advance the technologies used in micropropagation (Alvarez, 2014). These plants, when subjected to *in vitro* conditions, have responded in numerous ways including adventitious root formation, hyperhydricity, callus formation, oxidation, and abnormal seedlings. These observations are variable throughout *in vitro* culture (Toma et al., 2004; Stefanova et al., 2011; Kosar & Mahmoud, 2012).

During the first evaluation period, the experimental treatments containing different concentrations of regulators produced plants with calluses at the base of the inoculated apex. In a study by Ikeuchi et al. (2013), some mechanisms behind the formation of these structures were clarified. Among the mechanisms mentioned, it was indicated that some hormones, mainly cytokines and auxins, signal and regulate the expression of transcription factors responsible for callus formation. Most studies involving micropropagation of *Ocimum* plants have shown that a small number of cytokines and auxins cause callus formation when used together (Gogoi & Kumaria, 2011; Asghari et al., 2012; Monfort et al., 2018). If regulators are excluded from the medium there is hardly any callus formation, highlighting their crucial role in this process. This sensitivity of *O. basilicum* to callus formation during *in vitro* culture has also been reported as common for other cultivars (Monfort et al., 2018), and can also be caused by other characteristics of the culture medium, such as medium concentration (Silva et al., 2017), antioxidants and sugars (Trettel et al., 2018b).

There was an increase in oxidation during the *in vitro* process, which may also be associated with callus formation. Only the treatments containing the highest concentrations of cytokines and the lowest concentrations of auxins had low percentages of oxidized plants, with the opposite being observed for the treatments containing the lowest concentrations of regulators. The most likely reason for this is that oxidation occurred due to compounds and free radicals being released by the calluses (Silva et al., 2017). Seedlings that grew under higher stress conditions (higher concentrations of regulators) may have increased their secondary compound production. In particular, plants may have increased their phenolic compound production (Monfort et al., 2018), which can neutralize free radicals and toxic compounds (Stashenko et al., 2004). Another hypothesis is that oxidation was caused by increases in antioxidant enzymes such as polyphenol oxidase, peroxidase, catalase, and superoxide dismutase (Stashenko et al., 2004). Although oxidation occurred in many plants, it was not severe enough to cause plant death, which reinforces the idea that the biochemical stress mechanisms of *O. basilicum* ‘Alfavaca Green’ seedlings combatted oxidative effects.

### **Evaluation of physiological and growth characteristics**

Growth regulator concentration strongly altered the developmental pattern and organogenesis of *O. basilicum* ‘Alfavaca Green’ seedlings, and this alteration has also been observed in other *O. basilicum* cultivars (Asghari et al., 2012; Manan et al., 2016; Monfort et al., 2018; Trettel et al., 2019). This demonstrates that the culture medium

with same formulation should only be used as a basis for initial studies of micropropagation protocols.

*O. basilicum* ‘Alfavaca Green’ seedlings that showed the best growth were those subjected to low concentrations of both auxin and cytokine regulators (A2 and A3 treatments), which demonstrates that, although necessary in higher concentrations, regulators promote seedling anomalies. The occurrence of abnormalities is closely linked to the amount of regulator that promotes signal cascades by binding to membrane receptors and to the amount of regulator that binds to intracellular factors such as enzymes, which clear excess regulators (Neelakandan & Wang, 2012). The types of auxin and cytokine used also influences the occurrence of abnormalities because, the particular types of these regulators seem to be standardized according to the plant genotype in the cell membrane (Zaidi et al., 2006; Perrot-Rechenmann, 2010). Therefore, the A2 and A3 experimental treatments resulted in greater numbers of leaves per plant, taller plants, and greater seedling biomass.

The best growth was observed in the treatments with low concentrations of NAA. Auxins are a group of growth hormones naturally present in plants, and they are mainly found in the apical meristem (Rademacher, 2015). However, the use of a cytokines was necessary to increase the number of leaves per plant and to improve biomass production, as in some cases the absence of this regulator resulted in no sprouts forming (Asghari et al., 2012). In this study, a concentration of 0.5 mg L<sup>-1</sup> BAP was ideal to optimize these characteristics. Other *O. basilicum* L. cultivars have been shown to limit their growth patterns, such as shoot, and root formation, in response to BAP concentrations above 2.0 mg L<sup>-1</sup>. For example, in *O. basilicum* ‘Maria Bonita’, the use of 2.0 mg L<sup>-1</sup> BAP and 0.5 mg L<sup>-1</sup> NAA resulted in lower leaf production, sprout production, and biomass (Monfort et al., 2018). In *O. basilicum* ‘Sweet Thai’, 1.0 mg L<sup>-1</sup> BAP improved all analyzed characteristics (Manan et al., 2016).

Abnormal characteristics were also observed. The most frequently observed of these characteristics were hyperhydricity, adventitious roots, and twisted leaves. Several factors can induce hyperhydricity including pH, explant type, culture medium composition, light intensity, humidity, and ventilation (Liu et al., 2017). Because of this, studies are needed to verify which of these factors are involved in the induction of hyperhydricity in the ‘Alfavaca Green’ basil cultivar. Toma et al., (2004), which examined the impact of cytokines and auxins on the growth of nodal segments in *Hyssopus officinalis*, also observed plants with a vitreous appearance. The authors demonstrated that, in addition to callus formation, the seedlings demonstrated different degrees of hyperhydricity in the stems and leaves. George et al. (2008) claimed that the occurrence of hyperhydricity can cause damage and make the acclimatization process more difficult for micro-propagated plants, and therefore should be avoided.

A study by Klerk (1996) showed that agreed that auxin application can cause adventitious root formation. As in the present experiment, the presence of KIN in the medium resulted in the highest percentage of adventitious roots. The high number of plants with twisted leaves may also be related to copper deficiency in the *in vitro* culture of *O. basilicum*. The same study showed that a lower number of abnormal seedlings occurred when 25 µM CuSO<sub>4</sub> was added to the culture medium (Trettel et al., 2018a). One of the symptoms of copper deficiency is the presence of twisted, wilted, sickle-shaped leaves (Stepien & Wojtkowiak, 2016). This metal induces the production of phenylpropanoids, which are precursors of lignin (Moura et al., 2010), and in some cases

it can act on the activity of the laccase enzyme which participates in lignin formation (Moura et al., 2010; Liu, 2012).

### **Evaluations of Leaf Anatomy**

Regulators impact cell structure through stretching, induction of cell division, and tissue maturation (Neelakandan & Wang, 2012). In cell stretching, the role of auxins is widely recognized, as they can act on nonpolar transport. In this way, auxins are transported from cell to cell via PIN proteins, as a function of the pH difference between the membranes and between the cell walls (Perrot-Rechenmann, 2010). The result is the activation of proteins called ‘expansins’, which loosen the cell wall and allow cell elongation. In *O. basilicum* ‘Alfavaca Green’, the A2 and A9 treatments produced plants with the thickest epidermises due to the low concentration of NAA and its action on cell elongation. Similar results were obtained by Trettel et al. (2019) in *O. basilicum* ‘Genovese’, and by Stefanova et al. (2011) in *Lamium album* L.

It is likely that the interaction between the highest concentration of NAA and the highest concentration of cytokine (BAP or KIN) caused increases in palisade and spongy parenchyma thickness. This may be due to the role that cytokines play in the cell multiplication process through the induction of cyclin-dependent kinase (CDK) transcription factors, which regulate the cell cycle (Neelakandan & Wang, 2012; Xie et al., 2018). This signaling process is a result of the interactions among regulator types, regulator doses, and regulator synergisms. In turn, these processes are closely linked to the plant genotype. The observed increases in tissue thickness are mirrored by those of Toma et al. (2004), in which *Hyssopus officinalis* L. seedlings cultivated with 0.5 mg L<sup>-1</sup> indole-3-acetic acid (IAA) and 1.0 mg L<sup>-1</sup> BAP displayed increased parenchymal thickness. Trettel et al. (2019) found that 0.1 mg L<sup>-1</sup> of BAP produced *O. basilicum* ‘Genovese’ plants with increased palisade and spongy parenchyma thickness.

The total leaf limb thickness impacts the structure of the leaf interior, which is formed by the palisade and spongy parenchyma (Trettel et al., 2019). The formation of spongy parenchyma may be due to the use of KIN in the medium. Additionally, the greater spongy parenchyma thickness observed may be related to the formation of leaves with hyperhydricity. Treatment A3 had intermediate morphometry, which was close to normality. These results are similar to those found by Toma et al. (2004) in *Hyssopus officinalis* L. when 1.0 mg L<sup>-1</sup> indole-3-butyric acid (IBA) was used as a source of auxin. The plants grown under the A3 treatment displayed a normal structure with a spongy parenchyma (SP) layer under the adaxial epidermis (AE), which suggests that this medium is most favorable to the development of basil.

## **CONCLUSIONS**

Thus, the A3 treatment (0.05 mg L<sup>-1</sup> NAA and 0.1 mg L<sup>-1</sup> KIN) containing low concentrations of NAA and KIN is best suited for *in vitro* cultivation of *O. basilicum* ‘Alfavaca Green’, due to the observed increases in number of leaves, height, and sprout and root biomass. Additionally, a fewer plants with hyperhydricity and calluses were observed under this treatment. Our initial hypothesis regarding the effects of regulators on leaf tissues was confirmed; the epidermis was elongated under low auxin concentrations, and at higher concentrations there was an increase in cell multiplication.

Hyperhydricity is very common in the Lamiaceae family, especially in the *Ocimum* genus. Future research must seek to identify additional factors that could be associated with this disorder in order to reduce the problem. This is important for both the production of seedlings from *in vitro* culture and for obtaining leaves as a raw material for oil extraction, because this disorder promotes considerable yield losses and increased costs.

ACKNOWLEDGMENTS. We would like to thank the *Coordenação de Aperfeiçoamento de Pessoal de Nível Superior* (CAPES) no.º001 and *Conselho Nacional de Desenvolvimento Científico e Tecnológico* (CNPq) for funding this work. And *Universidade Paranaense* (UNIPAR) for financial support.

## REFERENCES

- Ahsan, T., Amjad, N., Iqbal, A. & Javed, A. 2013. A review: tissue culturing of important medicinal plants. *Int. J. Water. Res Environ Eng.* **2**, 76–79.
- Alvarez, M.A. 2014. *Plant biotechnology for health: from secondary metabolites to molecular farming*. New York, Springer, 161 pp.
- Antoniazzi, D., Ferrari, M.P.S., Nascimento, A.B., Silveira, F.A., Pio, L.A.S., Pasqual, M. & Magalhães, H.M. 2016. Growth regulators, DNA content and anatomy *in vitro*-cultivated *Curcuma longa* plantlets. *Afr. J. Biotechnol.* **15**, 1711–1725.
- Asghari, F., Hossieni, B., Hassani, A. & Shirzad, H. 2012. Effect of explants source and different hormonal combinations on direct regeneration of basil plants (*Ocimum basilicum* L.). *Aust. J. Exp Agric.* **3**, 12–17.
- Bukatsch, F. 1972. Benerkemgemzeiddoppelfar being sastrablau-safranina. *Mikrokosmos* **61**, 255.
- Carović-Stanko, K., Liber, Z., Besendorfer, V., Javornik, B., Bohanec, B., Kolak, I. & Satovic, Z. 2010. Genetic relations among basil taxa (*Ocimum* L.) based on molecular markers, nuclear DNA content, and chromosome number. *Plant. Syst Evol.* **285**, 13–22.
- Ferreira, D.F. 2011. A computer statistical analysis system. *Ciência e Agrot.* **359**, 1039–1042.
- George, E.F., Hall, M.A. & Klerk, G. 2008. *Plant propagation by tissue culture: the background*. 3th ed. Dordrecht, Springer, 501 pp.
- Gogoi, K. & Kumaria, S. 2011. Callus-mediated plantlet regeneration of *Ocimum tenuiflorum* L. using axillary buds as explants. *Int. J. Plant. Sci.* **2**, 001–005.
- Gonçalves, S. & Romano, A. 2013. *In vitro* culture of lavenders (*Lavandula* spp.) and the production of secondary metabolites. *Biotechnol. Adv.* **31**, 166–174.
- Ikeuchi, M., Sugimoto, K. & Iwase, A. 2013. Plant callus: mechanisms of induction and repression. *The Plant Cell.* **25**, 3159–3173.
- Johansen, D.A. 1940. *Plant microtechnique*, 1th edn. New York, McGraw Hill, 523 pp.
- Klerk, G.J. 1996. Markers of adventitious root formation. *Agronomie.* **16**, 609–616.
- Kosar, M. & Mahmoud, O. 2012. Trichomes and regeneration by direct organogenesis of medicinal plant *Dracocephala lumkotschyi* L. using shoot tips (Lamiaceae). *J. Crop. Sci. Biotech.* **15**, 251–257.
- Kraus, J.E. & Arduim, M., 1997. *Manual básico de métodos em morfologia vegetal*. 1th ed. Seropédica, EDUR, 198 pp. (in Portuguese).
- Kumar, K. & Rao, I.U. 2012. Morpho physiological problems in acclimatization of micropropagated plants in: *ex vitro* conditions - a review. *J. Ornament. Horticult. Plants.* **2**, 271–283.
- Liu, C.J. 2012. Deciphering the enigma of lignification: precursor transport, oxidation, and the topochemistry of lignin assembly. *Mol. Plant.* **5**, 304–317.

- Liu, M., Jiang, F., Kong, X., Tian, J. & Wu, Z. 2017. Effects of multiple factors on hyperhydricity of *Allium sativum* L. *Sci Hort.* **217**, 285–296.
- Makri, O. & Kintzios, S. 2008. *Ocimum* sp. (basil): botany, cultivation, pharmaceutical properties, and biotechnology. *J. Herbs. Spices Med Plants.* **13**, 123–150.
- Manan, A.A., Taha, R.M., Mubarak, E.E. & Elias, H. 2016. *In vitro* flowering, glandular trichomes ultrastructure, and essential oil accumulation in micropropagated *Ocimum basilicum* L. *In Vitro Cell Dev. Biol. Plant.* **52**, 303–314.
- Miralpeix, B. 2013. Metabolic engineering of plant secondary products: which way forward? *Curr. Pharm Design.* **19**, 5622–5639.
- Moita Neto, J.M. & Moita, G.C. 1998. An introduction analysis exploratory multivariate data. *Quim Nova.* **21**, 467–469.
- Monfort, L.E.F., Bertolucci, S.K.V., Lima, A.F., Carvalho, A.A., Mohammed, A., Blank, A.F. & Pinto, J.E.B.P. 2018. Effects of plant growth regulators, different culture media and strength MS on production of volatile fraction composition in shoot cultures of *Ocimum basilicum*. *Ind. Crop. Prod.* **116**, 231–239.
- Morais, T.P., LUZ, J.M.Q., Silva, S.M., Resende, R.F. & Silva, A.S. 2012. Applications of tissue culture in medicinal plants. *Rev. Bras Plantas Med.* **14**, 110–121.
- Motic. 2016. Software Motic images Plus 3.0 (computer program manual). Available at [www.motic.com/As\\_Support\\_Download/](http://www.motic.com/As_Support_Download/)
- Moura, J.C.M.S., Bonine, C.A.V., Viana, J.O.F., Dornelas, M.C. & Mazzafera, P. 2010. Abiotic and biotic stresses and changes in the lignin content and composition in plants. *J. Integr. Plant Biol.* **52**, 360–376.
- Murashige, T. & Skoog, F. 1962. A revised medium for rapid growth and bio assays with tobacco tissue cultures. *Physiol. Plant.* **15**, 473–497.
- Neelakandan, A.K. & Wang, K. 2012. Recent progress in the understanding of tissue culture-induced genome level changes in plants and potential applications. *Plant Cell Reports.* **31**, 597–620.
- Paiva, J.G.A. 2006. Verniz vitral incolor 500®: a mounting medium alternative and economically viable. *Acta Bot. Bras.* **20**, 257–264.
- Perilli, S., Moubayidin, L. & Sabatini, S. 2010. The molecular basis of cytokinin function. *Curr Opin. Plant Biol.* **13**, 21–26.
- Perrot-Rechenmann, C. 2010. Cellular responses to auxin: division versus expansion. *Cold Spring Harb. Perspect Biol.* **2**, a001446.
- Rademacher, W. 2015. Plant growth regulators: backgrounds and uses in plant production. *J. Plant Growth Regul.* **34**, 845–872.
- Rout, G.R., Samantaray, S. & Das, P. 2000. *In vitro* manipulation and propagation of medicinal plants. *Biotechnol Adv.* **18**, 91–120.
- Senhaji, C., Gaboun, F., Abdelwahd, R., Udupa, S.M., Douira, A. & Iraq, D. 2019. Development of an efficient regeneration system for bombarded calli from immature embryos of Moroccan durum wheat varieties. *Agron. Res.* **17**, 1750–1760.
- Silva, F.J., Nascimento, A.B., Barbosa, L.N. & Magalhães, H.M. 2017. *In vitro* cultivation of purple basil *Ocimum basilicum* L. ‘redrubin’ at different levels of salts, charcoal, sucrose and potassium iodine. *Aust. J. Crop. Sci.* **11**, 1137–1445.
- Small, C.C. & Degenhardt, D. 2018. Plant growth regulators for enhancing vegetation success in reclamation: a review. *Ecol. Eng.* **118**, 43–51.
- Stashenko, E.E., Jaramillo, B.E. & Martínez, J.R. 2004. Comparison of different extraction methods for the analysis of volatile secondary metabolites of *Lippia alba* (Mill.) NE Brown, grown in Colombia, and evaluation of its *in vitro* antioxidant activity. *J. Chromat A.* **1025**, 93–103.
- Statsoft. 2017. Statistica for Windows (computer program manual). Available at <http://www.statsoft.com>.

- Stefanova, M.A., Koleva, D.P., Ganeva, T.G. & Dimitrova, M.A. 2011. Effect of plant growth regulators on the regeneration of *in vitro*-propagated *Lamium album* L. plants. *J. Pharm Res.* **4**, 1982–1985.
- Stepien, A. & Wojtkowiak, K. 2016. Effect of foliar application of Cu, Zn, and Mn on yield and quality indicators of winter wheat grain. *Chil. J. Agric. Res.* **76**, 220–227.
- Taie, H.A.A., Salama, Z.A.R. & Radwan, S. 2010. Potential activity of basil plants as a source of antioxidants and anticancer agents as affected by organic and bio-organic fertilization. *Not. Bot Horti.* **38**, 119–127.
- Toma, I., Toma, C. & Ghiorghita, G. 2004. Histo-anatomy and *in vitro* morphogenesis in *Hyssopus officinalis* L. (Lamiaceae). *Acta Bot. Croat.* **63**, 59–68.
- Trettel, J.R., Gazim, Z.C., Gonçalves, J.E., Stracieri, J. & Magalhães, H.M. 2018b. Effects of copper sulphate (CuSO<sub>4</sub>) elicitation on the chemical constitution of volatile compounds and the *in vitro* development of Basil. *Sci. Hort.* **234**, 19–26.
- Trettel, J.R., Nascimento, A.B., Barbosa, L.N. & Magalhães, H.M. 2018a. *In vitro* growth of genovese basil in response to different concentrations of salts and interaction of sucrose and activated carbon. *J. Agr. Sci.* **10**, 1–11.
- Trettel, J.R., Nascimento, A.B., Barbosa, L.N. & Magalhães, H.M. 2019. *In vitro* organogenesis and growth of *Ocimum basilicum* ‘Genovese’ (basil) cultivated with growth regulators. *Aust. J. Crop. Sci.* **13**, 1131–1140.
- Vanisree, M., Lee, C.Y., Lo, S.F., Nalawade, S.M., Lin, C.Y. & Tsay, H.S. 2004. Studies on the production of some important secondary metabolites from medicinal plants by tissue cultures. *Bot. Bull. Acad. Sinica.* **45**, 1–22.
- Vieira, P.R., Morais, S.M., Bezerra, F.H., Ferreira, PAT., Oliveira, Í.R. & Silva, M.G.V. 2014. Chemical composition and anti fungal activity of essential oils from *Ocimum* species. *Ind. Crop. Prod.* **55**, 267–271.
- Xie, M., Chen, H., Huang, L., O’neil, R.C., Shokhirev, M.N. & Ecker, J.R. 2018. A B-ARR-mediated cytokinin transcriptional network direct shormone cross-regulation and shoot development. *Nat. Commun.* **9**, 1604–1610.
- Zaidi, M.A., Narayanan, M., Sardana, R., Taga, I., Postel, S., Johns, R. & Altosaar, I. 2006. Optimizing tissue culture media for efficient transformation of different indica rice genotypes. *Agron. Res.* **4**, 563–575.

## **Growth and yield of spinach depending on absorbents' action**

O. Ulianych<sup>1</sup>, K. Kostetska<sup>2,\*</sup>, N. Vorobiova<sup>1</sup>, S. Shchetyna<sup>1</sup>, G. Slobodyanyk<sup>1</sup>  
and K. Shevchuk<sup>1</sup>

<sup>1</sup>Uman National University of Horticulture, Faculty of Horticulture, Ecology and Plants Protection Department of Vegetable Growing, Instytutska street, 1, UA20300 Uman, Ukraine

<sup>2</sup>Uman National University of Horticulture, Department of Technology of Storage and Processing of Grain, 1 Instytutska street, UA20305 Uman, Ukraine

\*Correspondence: kostetskakateryna@gmail.com

**Abstract.** The use of absorbents from Maximarin for growing spinach contributed to its faster germination, increased plant growth and development, and resulted in an increase in yields of commodity products by 2.0–6.1 t ha<sup>-1</sup> and an increase in chemical composition. The use of absorbents in open ground for spinach made it possible to obtain the highest amount of contingent net profit for making the drug Maximarin in the form of a gel and the company Eco – with small granules, and in the Krasen Polissia variety – 2,160 and 2,102 USD ha<sup>-1</sup>, in the Malakhit variety for introduction the drug Maximarin in the form of a gel 1,949 USD ha<sup>-1</sup> and the company Eco absorbent with potassium – 1,575 USD ha<sup>-1</sup>. Profitability for the Matador variety has reached 75%, Malakhit grade – 69–75%, Keb – 3.0–3.2. It was established that in the closed ground application of the drug Maximarin in the form of gel and granules for spinach made it possible to obtain the highest amount of contingent net profit, which was Matador 3,079 and 3,025 USD ha<sup>-1</sup>, in the Malakhit variety for the introduction of gel 4,304 USD ha<sup>-1</sup> and granules – 4,245 USD ha<sup>-1</sup>. Profitability for the use of drugs for the Krasen' Polissia variety reached 84–77%, Malakhit – 118–116 %, the bioenergy efficiency ratio – 3.0–3.3.

**Key words:** spinach, varietal, absorbent, commodity products, yield.

## **INTRODUCTION**

### **Setting of the problem**

Production of agricultural goods in our time is hardly possible without mineral fertilizers and means of regulating growth and development of plants (Kosterna & Zaniewicz-Bajkowska, 2012). High yield of spinach in arid conditions requires optimal growth conditions. In the scientific literature, it is recommended to use absorbents to promote growth in arid conditions. Absorbents are natural or synthetic compounds that are used to make soil in order to initiate changes in their vital processes to improve the quality of plant material, increase yields, facilitate harvesting and storage. The use of absorbents leads to changes in metabolism similar to those that occur under the influence of external conditions.

That is, absorbents are not nutrients, but factors for ensuring plant growth and development. Absorbents activate the basic life processes in plants. Under their action accelerates the growth of green mass and the root system, and therefore more actively used water and dissolved in it soil and mineral fertilizers, increase the protective properties of plants, their resistance to diseases, high and low temperatures, drought. Accordingly, the yield is increased and the quality of the vegetables is improved. The use of absorbents allows to realize more fully the potential of plants, laid by nature and breeding. The use of new generation suppliers to increase the yield of spinach is an important issue and needs detailed research.

### **Analysis of recent studies and publications**

The widespread introduction of vegetable spinach into agricultural production is hampered by the lack of sufficient variety of varieties and scientifically sound organic cultivation technology in the Right-Bank Forest Steppe of Ukraine. To this end, it is necessary to thoroughly study the agrobiological features of plants, to bring in new high-yielding varieties, to improve the organic technology of cultivation, to establish conditions for obtaining high productivity, prolongation of fresh consumption, since the existing intensive technology does not allow to obtain environmentally-friendly (Osadcuks & Pecka 2016; Kostetska et al., 2019).

The population has increased interest in consuming exclusively natural food as a way of improving the quality of life (Corbo et al., 2006; Osadcuks & Pecka, 2016). Now both professionals and consumers talk about natural products with special properties (Philipchuk, 2005; Kostetska et al., 2019).

In recent years, many scientists have dedicated their research to spinach. However, its widespread introduction into production is hampered by the lack of zonal science-based cultivation technology. The urgency of existing issues leads to the conduct and justification of directions of scientific search technology (Aworh et al., 1980; Guarrera & Savo, 2013; Ulianych & Alekseichuk, 2015; Ulianych et al., 2015; Vorobiova et al., 2018).

The properties of the product is vary considerably depending on weather conditions, growing technologies and features of varieties, it requires thorough study (Kostetska & Yevchuk, 2016). In a context characterized by a growing consumer's interest in locally produced foods, the safeguard of ancient fruit varieties appears relevant (Darby et al., 2008; Bartolini & Ducci, 2017; Kostetska et al., 2019).

## **MATERIALS AND METHODS**

**The purpose of the research** was to study the conditions for increasing the yield of spinach for the introduction of absorbents and to develop technological methods for improving productivity. The study of influence of hydrogel firms Maximarin used in the form of tablets, gel, granules). For spinach cultivation, preparations were used in the following forms: 'MaxiMarin' gel-like, 'MaxiMarin' tableted, 'MaxiMarin' granular on grow and yield of cultivars spinach: Krasen Polissia and Malakhit.

The research was carried out in 2015–2018 at the experimental field of the Department of Vegetable Growing of Uman National University of Horticulture in accordance with generally accepted methods (Dospekhov, 1985; Bondarenko & Yakovenko, 2001; Hrytsaienko et al., 2003; Ieshchenko et al., 2005; Volkodav, 2016).



The soil of the experimental field is black, puddle, heavy loam with a well developed humus horizon (about 2.9% of humus) in the deep of 40–45 cm. The breeding work was carried out in accordance with the methods of the Institute of Expertise of Plants Varieties and Institute of Vegetables and Melons of NAAS (Bondarenko & Yakovenko, 2001).

The precursor of spinach was white cabbage and other varieties of cabbage. The seeds were sown in the first decade of April. The care of plants consisted of systematic loosening of the soil, mounding of plants, removal of weeds and protection against pests and diseases. Irrigation was carried out by method of drip irrigation during the vegetation period of plants – 1–2 irrigations of 60–80 m<sup>3</sup> ha<sup>-1</sup>. After each irrigation loosening rows with simultaneous weeding was carried out.

According to Uman meteorological station the hydrometeorological conditions of 2017 were characterized by a slightly lower amount of precipitation relative to the average perennial indicator. The amount of precipitation for this period in 2018 was more relative to 2017, which is close to medium-long-term data, but the main number of them fell at the beginning and at the end of the vegetation which testifies to their lack of a phase of intensive growth and development of the plant, but it did not has a significant effect of precipitation, so the investigation was carried out under the drip irrigation (Novak, 2017; Novak & Novak, 2018; Ulianych et al., 2019).

The total area: for the experiment 500 m<sup>2</sup>, for plot 50 m<sup>2</sup>, for sampling – 5 m<sup>2</sup>. The plots were arranged in a systematic order with a four replication. To characterize the structure of the crop, the green samples taken from the plots were divided into fractions – standard and non-standard. There were determined the number of leaves and plant weight of each fraction. The tradability of the yield was determined by the mass of a plant and the total green mass collected from a plot.

The No. of leaves (per plant, pcs) was determined by the method of calculation, the area of the leaf blade by a calculated (linear) method, using the parameters of the length and width of the leaf by the formula 1:

$$S_n = 0.74 \times a \times b \quad (1)$$

where  $S_n$  – the area of one leaf, cm<sup>2</sup>;  $a$  – the largest leaf width, cm;  $b$  – leaf length, cm; 0.74 is the coefficient that reflects the configuration of the leaf.

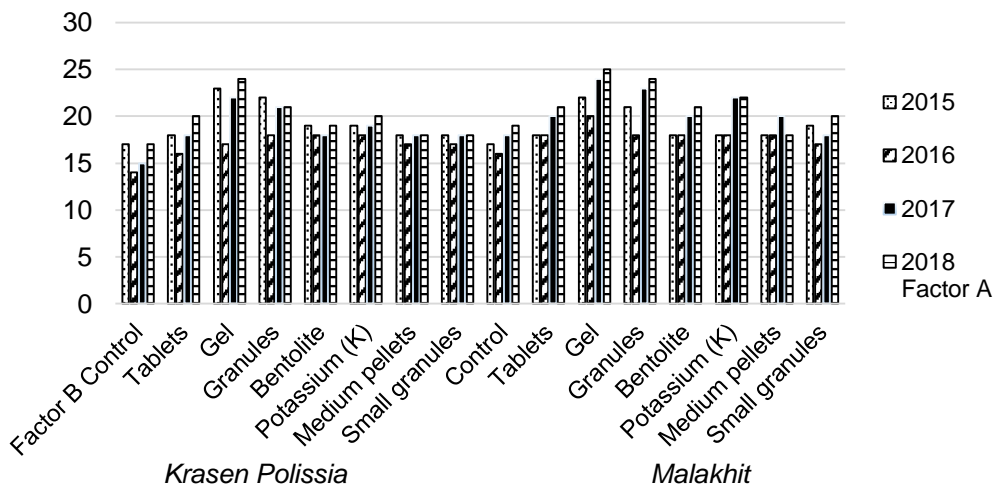
The data were statistically analyzed using Analysis of variance Microsoft Office Excel (Fisher, 2006).

## RESULTS AND DISCUSSION

Spinach leaf is the main product of consumption and is crucial for evaluating its quality, as for each green plant, which determines its edible properties during consumption. The number of leaves in the socket is important for spinach. The definition of this indicator in the experiment showed that in 2015, the number of leaves is in the range of 17–23 piece plant<sup>-1</sup> (Fig. 1).

The larger number of leaves was in plants that grew with the introduction of absorbents in the form of gel and granules – 22–23 pcs plant<sup>-1</sup>. In 2016, the number of leaves was lower due to the worse growing conditions and ranged from 14 to 20 pcs plant<sup>-1</sup>. In 2017 and 2018, a larger number of leaves were obtained for the

application of gel and granules – 21–25 pcs plant<sup>-1</sup>, which significantly exceeded the control by 6–9 pcs plant<sup>-1</sup>.



**Figure 1.** The number of leaves in spinach and in the phase of technical maturity, depending on the action of the absorbents, pcs plant<sup>-1</sup>.

During the years of research, the number of leaves in the Krasen Polissia variety without making absorbent (control) was 16 pcs plant<sup>-1</sup>. Growing spinach against the background of the use of various forms of absorbents contributed to the increase in the number of leaves. And for the introduction of tablets in the Krasen Polissia variety up to 18 pcs plant<sup>-1</sup>, in the Malakhit variety – 19 pcs plant<sup>-1</sup>, which was significantly higher than the control by 2–3 pcs plant<sup>-1</sup>. The application of the gel contributed to the increase in the number of leaves in the Krasen Polissia variety up to 22 pcs plant<sup>-1</sup>, in the Malakhit variety – up to 23 pcs plant<sup>-1</sup>, which also dominated the control by 6–7 pcs plant<sup>-1</sup>. The introduction of the pellets caused a slightly lower effect, but the advantage to control was quite high and was 5–6 pcs plant<sup>-1</sup>.

The use of Eco products of different size and composition showed that the number of leaves in the spinach garden variety Krasen Polissia in accordance with the form of the drug corresponded to different indicators. The introduction of pellets with potassium contributed to the receipt of more leaves against control – 19–20 pcs plant<sup>-1</sup>, which is higher than the control by 3–4 pcs plant<sup>-1</sup>.

Growing spinach against the background of the use of various forms of absorbents helped to increase the area of the leaf. For making tablets in the Krasen Polissia variety it was 108.9 cm<sup>2</sup>, in the Malakhit variety – 104.8 cm<sup>2</sup>. The introduction of the gel in the Krasen Polissia variety increased the leaf area up to 113.1 cm<sup>2</sup>, in the Malakhit variety – up to 112.5 cm<sup>2</sup>, which exceeded the control by 6.9–7.3 cm<sup>2</sup> was quite high and was 3.3–6.9 cm<sup>2</sup>.

The use of Eco products of different size and composition showed that the leaf area in Krasen Polissia varied according to the form of the preparation corresponded to different indicators and for the application of granules with potassium the leaf area was obtained 109.4–112.4 cm<sup>2</sup>, average granules – 110.8–108.5 cm<sup>2</sup>.

An important indicator of the growth of spinach plants, which determined its value as a green plant, was the total leaf area, the determination of which we carried out in the technical maturity phase of green (Table 1).

**Table 1.** The area of spinach leaves, depending on the absorbent, thousand m<sup>2</sup> ha<sup>-1</sup>

Variety (Factor A)	Absorbent (Factor B)	Year				Average per 2015–2018
		2015	2016	2017	2018	
Krasen	Without making absorbent	26.3	21.2	24.5	26.5	24.6
Polissia	Tablet	29.4	24.3	29.5	33.2	29.1
	Gel	39.4	27.3	37.6	40.1	36.1
	Granule	36.6	29.5	36.0	34.6	34.2
	Granule with Concrete	30.8	26.8	30.5	32.9	30.3
	Granule with Potassium	31.6	29.0	32.5	33.5	31.7
	Medium pellets	29.4	27.8	30.0	29.4	29.2
	Small granules	29.7	27.7	29.7	30.5	29.4
	Malakhit	Without making absorbent	27.8	23.6	29.2	29.4
Tablet		29.9	24.6	31.6	33.4	29.9
Gel		37.9	30.1	41.1	43.2	38.1
Granule		34.1	26.6	38.2	40.6	34.9
Granule with Concrete		27.5	26.8	32.1	33.4	30.0
Granule with Potassium		30.0	27.3	36.1	36.5	32.5
Medium pellets		29.5	29.0	32.2	28.2	29.8
Small granules		29.4	25.6	28.2	32.7	29.0

It is established that the area of spinach leaves in the variety Malakhit in the phase of technical maturity of the plant without the introduction of absorbent reached the level of 24.6 thousand m<sup>2</sup> ha<sup>-1</sup>. The variants with the introduction of gel and granules of the company Maximarin – 34.2–38.1 thousand m<sup>2</sup> ha<sup>-1</sup>, which exceeded the control by 9.6–13.5 thousand m<sup>2</sup> ha<sup>-1</sup>, were higher indicators. The introduction of potassium pellets and medium pellets of Eco produced a positive result and the leaf area corresponded to 29.2–32.5 thousand m<sup>2</sup> ha<sup>-1</sup>, which was higher than the control by 4.6–7.9 thousand m<sup>2</sup> ha<sup>-1</sup>.

Increasing the weight of spinach plants leads to an increase in yield, an indicator by which we determine the suitability of new elements of technology for growing crops. The above data showed that the use of tablets helped to increase the weight of spinach plants in the phase of technical maturity in the variety Krasen Polissia up to 132 g, in the variety Malakhit –158 g, which was significantly higher than the control by 60–72 g (*SSD*<sub>05</sub>, by Factor B = 17 g). Malakhit plants had a greater mass for the introduction of gel and pellets of the company ‘MaxiMarin’ – 171–178 g and granules with potassium of the company Eco – 150 g, which significantly outweighed the control by 42–70 g.

Improvement of conditions for growing spinach, even in less favourable climatic conditions, allowed to get more green mass. These green plants are characterized by the fact that they form a larger average mass than other green crops, such as dill, leaf lettuce, etc. The average weight of plants was counted each time the products were harvested, and the harvested green mass, which was cut in the form of sockets, was divided by its number (Table 2).

**Table 2.** Weight of spinach plant before harvest depending on absorbents' action, g

Variety (factor A)	Absorbent (factor B)	Year				Average per 2015–2018
		2015	2016	2017	2018	
Krasen	Without making absorbent	120	87	104	120	108
Polissia	Tablet	132	106	120	132	123
	Gel	180	167	174	180	175
	Granule	189	159	163	185	174
	Granule with Concrete	175	101	140	169	146
	Granule with Potassium	178	143	146	178	161
	Medium pellets	112	87	99	112	103
	Small granules	101	176	139	101	129
Malakhit	Without making absorbent	125	147	136	125	133
	Tablet	158	122	160	158	150
	Gel	192	153	173	192	178
	Granule	189	140	165	189	171
	Granule with Concrete	130	128	129	130	129
	Granule with Potassium	152	136	154	157	150
	Medium pellets	121	123	121	112	119
	Small granules	130	117	148	150	136
<i>SSD<sub>05</sub></i>	<i>Factor A</i>	<i>12</i>	<i>15</i>	<i>10</i>	<i>11</i>	
	<i>Factor B</i>	<i>17</i>	<i>20</i>	<i>23</i>	<i>25</i>	
	<i>Interaction AB</i>	<i>63</i>	<i>54</i>	<i>65</i>	<i>60</i>	

Increasing the weight of spinach leads to the increase in yield, an indicator by which we determine the suitability of new elements of technology for growing crops. The above data showed that in 2015 the use of absorbent in the form of tablets helped to increase the weight of spinach in the phase of technical maturity in the variety Krasen Polissia up to 132 g, in the variety Malachite – 158 g. Higher indicators were obtained for the fertilization of gel by the company ‘MaxiMarin’ and potassium granules by the company ‘Eco’ – 180–192 g, which was significantly higher than the control of 60–72 g (*SSD<sub>05</sub>*, by Factor B = 17 g).

Growing spinach varieties in 2016 showed that this indicator was less than last year, but compared to the control the above pattern was revealed. In 2017, the weight of spinach in technical maturity phase of Krasen Polissia and Malachite varieties with the use of absorbent in the form of tablets was significantly higher than the control (104 g) and reached the level of 120–160 g. There were higher indicators for plants fertilized by gel and granules of the company ‘MaxiMarin’ and potassium granules of the company ‘Eco’ – 146–173 g, which exceeded the control by 42–69 g (*SSD<sub>05</sub>*, by Factor B = 23 g). The plant weight in 2018 was higher than the control (120 g) for the use of the absorbent in the form of tablets and reached the level of 132–158 g. According to the previous years, higher indicators differ in those plants which were fertilized by gel and granules of the company ‘MaxiMarin’ and granules with potassium of the company ‘Eco’ – 178–192 g, which is above the control by 58–72 g (*SSD<sub>05</sub>*, by Factor B = 25 g).

The analysis of the data obtained during the years of research showed that at the beginning of a socket growth there was no significant difference between the variants and therefore this data is not presented in the paper. During the period of intensive growth of a socket and before harvest, the smallest amount of spinach was in the variety Krasen Polissia and Malachite without the fertilization, which was stated as 108 and

133 g in average during the years of research. Spinach of the variety Malachite had a greater mass for the fertilization of the granules and gel of the company ‘MaxiMarin’ and granules with potassium of the company ‘Eco’ – 171–178 g, which significantly outweighed the control by 63–70 g.

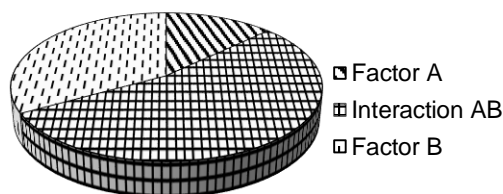
The yield of spinach varied according to the influence of weather conditions during the years of research and the preparations used (Table 3).

**Table 3.** The yield of spinach, depending on the absorbents, t ha<sup>-1</sup>

Variety (factor A)	Absorbent (factor B)	Year				Average per 2015–2018	± to Control
		2015	2016	2017	2018		
Krasen	Without making absorbent	17.1	12.9	15.4	16.8	15.6	0
Polissia	Tablet	19.0	15.8	17.7	19.6	18.0	+2.4
	Gel	26.0	24.9	25.8	25.7	25.6	+10.0
	Granule	25.1	16.2	21.0	24.9	21.8	+6.2
	Granule with Concrete	18.5	15.8	19.6	18.5	18.1	+2.5
	Granule with Potassium	26.4	15.0	20.7	26.4	22.1	+6.5
	Medium pellets	14.8	25.9	20.4	15.1	19.0	+3.4
	Small granules	27.6	20.8	24.4	28.1	25.3	+9.7
Malakhit	Without making absorbent	18.5	21.2	19.1	18.5	19.3	+3.7
	Tablet	20.5	18.0	19.3	20.5	19.6	+4.0
	Gel	28.5	21.9	30.2	28.5	27.3	+11.7
	Granule	22.4	23.9	24.7	26.4	24.4	+8.8
	Granule with Concrete	19.3	18.9	19.1	19.3	19.2	+3.6
	Granule with Potassium	22.6	21.7	24.7	23.6	23.2	+7.6
	Medium pellets	17.9	18.7	18.3	17.9	18.2	+2.6
	Small granules	16.3	16.4	21.4	22.3	19.1	+3.5
SSD <sub>05</sub>	Factor A	0.3	0.4	0.3	0.2		
	Factor B	0.7	0.9	0.8	0.7		
	Interaction AB	0.9	1.4	1.3	1.6		

A significant increase in the spinach crop was obtained from the application of the gel, where the yield of the Krasen Polissia variety was 25.6 t ha<sup>-1</sup>, and the Malakhit variety – 27.3 t ha<sup>-1</sup>, which was additionally 10–11.7 t ha<sup>-1</sup>. The introduction of ‘MaxiMarin’ pellets helped increase yields to 21.8–24.4 t ha<sup>-1</sup> and outperformed control by 6.2–8.8 t ha<sup>-1</sup>. The introduction of Eco potassium pellets resulted in a lower yield of 22.1–23.2 t ha<sup>-1</sup> and a control of 6.5–7.6 t ha<sup>-1</sup>. A positive result was obtained with the use of medium and small pellets for the varieties of sMalakhit and Krasny Polissia, and the yield increased by 2.6–9.7 t ha<sup>-1</sup>. The introduction of concrete pellets allowed additional 2.5–3.6 t ha<sup>-1</sup>.

The results of the variance analysis of the obtained data showed that factor B or absorbent and interaction of factors had the greatest influence on the spinach yield (Fig. 2).



**Figure 2.** Effect of factors on vegetable spinach yield depending on the absorbent input (average for 2015–2018), t ha<sup>-1</sup>.

Factor B or absorbent was affected the spinach yield by 33%, the interaction of factors A and B – 54% in the Malakhit variety being more influential.

The absorbents did not cause any negative changes in the plants and had a positive effect on the quality of the vegetable spinach crop and contributed to the increase of important chemical composition. Higher dry solids content in Krasen Polissia and Malakhit varieties was observed with the use of ‘MaxiMarin’ granules and gel absorbents – 8.1–8.9%.

The higher sugar content was different for plants grown using ‘MaxiMarin’ absorbents in the form of granules and gel – 2.6–2.9% and potassium granules of Eco – 2.7–2.8%. The content of vitamin C was dominated by plants grown with the use of MaxiMarin absorbents in the form of granules and gel – 56–62% and potassium granules of Eco – 58–64%.

## CONCLUSIONS

From the use of plant growth regulators during processing of spinach seeds, a higher profitability of the Malachit variety was obtained for the use of absorbents in the form of gel and granules – 83–102 %. The bioenergy efficiency ratio was more than unity, which indicates the efficiency of growing spinach 3.0–3.1). The use of absorbents from ‘MaxiMarin’ for growing spinach contributed to its faster germination, increased plant growth and development, and resulted in an increase in yields of commodity products by 2.0–6.1 t ha<sup>-1</sup>.

### Scientific novelty and practical significance of the obtained results

In the conditions of the Forest-Steppe of Ukraine, experimental researches were carried out, which allowed to solve particular questions of spinach growing technology and proved that the absorbents in arid conditions of the modern climate are effective for increasing the productivity of spinach, for which the quality of produce is not impaired. The influence of the variety on the weight and height of the plant, the area of the leaf blade and the total area of the leaves, correlation dependence between the indices of plant growth, yield depending on the developed elements of spinach growing technology.

Based on the conducted research, it is developed and recommended for agricultural producers of industrial, private and personal sector to grow domestic early ripening varieties of spinach of the city Krasen Polissia and Malakhit. Absorbents in arid conditions of modern climate contribute to increase of spinach of vegetable garden and reception of high quality of production.

## REFERENCES

- Aworh, O.C., Hicks, I.R., Minotti, P.L. & Loe, C.G. 1980. Effect of plant age and nitrogen fertilisation nitrite accumulation in fresh Spinach. *J. Amer. Soc. Hort Sci.* **105**(1), 18–20.
- Bartolini, S. & Ducci, E. 2017. Quality evaluation of local apple varieties: physicochemical and antioxidant proprieties at harvest and after cold storage. *Agronomy Research* **15**(5), 1866–1877. <https://doi.org/10.15159/AR.17.054>
- Bondarenko, H.L. & Yakovenko, K.I. 2001. *Methodology of experimental work in vegetable and melon*. Kharkiv. Osnova, 369 pp. (in Ukrainian).

- Corbo, M. R., Nobile, M.A.D. & Sinigaglia, M. 2006. A novel approach for calculation shelf life of minimally processed vegetables. *International Journal of Food Microbiology* **106**, 69–73.
- Darby, K., Batte, M.T., Ernst, S. & Roe, B. 2008. Decomposing local: A conjoint analysis of locally produced foods. *Am. J. Agr. Econ.* **90**(2), 476–486.
- Dospekhov, B. A. 1985. *Methods of field experience (with basics of statistical processing of research results)*. Moscow: Ahropromizdat, 351 pp. (in Russian).
- Fisher, R.A. 2006. *Statistical methods for research workers*. New Delhi: Cosmo Publications, 354 pp.
- Guarrera, P.M. & Savo, V. 2013. Perceived health properties of wild and cultivated food plants in local and popular traditions of Italy, A review. *J. Ethnopharmacol.* **146**, 659–680. URL: [https://www.researchgate.net/publication/235441085\\_Perceived\\_health\\_properties\\_of\\_wild\\_and\\_cultivated\\_food\\_plants\\_in\\_local\\_and\\_popular\\_traditions\\_of\\_Italy\\_A\\_review](https://www.researchgate.net/publication/235441085_Perceived_health_properties_of_wild_and_cultivated_food_plants_in_local_and_popular_traditions_of_Italy_A_review). doi: 10.1016/j.jep.2013.01.036
- Hrytsaienko, Z.M., Hrytsaienko, A.O. & Karpenko, V.P. 2003. *Methods of biological and agrochemical studies of plants and soils*. Kyiv: Nichlava, 320 pp. (in Ukrainian).
- Ieshchenko, V.O., Kopytko, P.H., Opryshko, V.P. & Kostohryz, P.V. 2005. *Fundamentals of scientific research in agronomy: Textbook*. Kyiv: Diia. 288 pp. (in Ukrainian).
- Kosterna, E. & Zaniewicz-Bajkowska, A. 2012. *The effect of AgroHydroGel and irrigation in celery yield and quality*. *Folia Horticulturae. Annalis*, 297 pp.
- Kostetska, K., Osokina, N., Gerasymchu, H. & Nakloka, O. 2019. Objective organoleptic, structural-and-mechanical parameters of vegetables depending on their degree of ripeness. *Agronomy Research* **17**(6), 2286–2294. <https://doi.org/10.15159/AR.19.203>
- Kostetska, K.V. & Yevchuk, Y.V. 2016. Physical and mechanical properties and quality indicator of wheat. *Carpathian journal of food science and technology* **8**(2), 187–192.
- Novak, A.V. 2017. Agrometeorological conditions of 2016–2017 agricultural year (according to Uman meteorological station). *Bulletin of the Uman National University of Horticulture* **11**(2), 57–59 (in Ukrainian).
- Novak, A.V. & Novak, V.G. 2018. Agrometeorological conditions of 2017-2018 agricultural year according to the data of the meteorological station Uman. *Bulletin of the Uman National University of Horticulture* **12**(2), 73–75. (in Ukrainian).
- Osadcuks, V. & Pecka, A. 2016. Electrical field based detection of fruits and vegetables for robotized horticulture. *Agronomy Research* **14**(S1), 1088–1098.
- Philipchuk, P. 2005. Honor and praise orange! *Ogorodnik* **3**, 12 (in Ukrainian).
- Ulianych, O.I., Alekseichuk, O.M., Prudkyi, R.Y. & Dydenko, Y.A. 2015. Use of biological products for ecologically safe production of garden spinach and celery spinach. *Scientific articles of the State Agrarian University of Moldova*. Chisinau, **42**, 225–227 (in Russian).
- Ulianych, O.I. & Alekseichuk, O.M. 2015. The use of natural products for the pre-sowing treatment of vegetable spinach seeds. *Electronic Collection of Scientific Reports of the National University of Life and Environmental Sciences of Ukraine* **5**(54), [http://nd.nubip.edu.ua/2015\\_5/index.html](http://nd.nubip.edu.ua/2015_5/index.html) (in Ukrainian).
- Ulianych, O., Yatsenko, V., Didenko, I., Vorobiova, N., Kuhnyuk, O., Lazariiev, O. & Tretyakova, S. 2019. Agrobiological evaluation of *Allium ampeloprasum* L. variety samples in comparison with *Allium sativum* L. cultivars. *Agronomy Research* **17**(4), 1779–1787. <https://doi.org/10.15159/AR.19.192>
- Volkodav, V.V. 2016. *Method of state sorting of agricultural crops (potatoes, vegetables and melons)*. Kyiv, 94 pp. (in Ukrainian).
- Vorobiova, N.V., Kukhniuk, O.V. & Prudkyi, R.I. 2018. Nanotechnology in vegetable growing in Ukraine. Science and education a new dimension. *Natural and Technical Sciences*. **VI**(21), 179. Budapest, 2018, 13–15 (<https://doi.org/10.31174/SEND-NT2018-179VI21-03>).

## Effect of sowing method and density on the physical properties of the seed bed and oilseed rape yield

E. Wilczewski\*, G. Harasimowicz-Hermann and G. Lemańczyk

UTP - University of Science and Technology, Al. prof. S. Kaliskiego 7, PL85-796 Bydgoszcz, Poland

\*Correspondence: [edward@utp.edu.pl](mailto:edward@utp.edu.pl)

**Abstract.** Oilseed rape (*Brassica napus* L. var. *napus*), as a plant requiring shallow sowing, is sensitive to water deficiency in the soil during germination. The lack of rainfall results in the delay of emergence and a reduction in plant density before winter. The aim of the present study was to assess the effect of various sowing methods (sowing with the furrow method – in furrows 6–8 cm deep; direct sowing into non-cultivated soil using disc coulters and conventional sowing) on the physical properties of the seed bed and winter oilseed rape yield depending on the sowing density (40, 60, 80, 100 and 120 seeds per m<sup>2</sup>). The field study was carried out in 2011–2014, in *Albic Luvisols* with fine sandy loam texture. Furrow sowing and direct sowing provided higher seed bed moisture than conventional sowing. The use of furrow sowing resulted in the formation of a greater number of siliques per plant than in other sowing methods. Furrow sowing made it possible to produce a higher seed yield than direct sowing, however the oilseed rape yield did not increase significantly in relation to conventional sowing. The winter rapeseed yield after sowing 80–120 seeds per m<sup>2</sup> was significantly higher than after sowing 40 and 60 seeds per m<sup>2</sup>. When using low sowing densities (40 seeds per m<sup>2</sup>), furrow sowing made it possible to produce a higher seed yield than conventional sowing. The possibility of improving oilseed rape yield by differentiating sowing methods at a density of 60–120 seeds per m<sup>2</sup> was not demonstrated.

**Key words:** direct sowing, furrow sowing, plant density, seed bed moisture, sowing method.

### INTRODUCTION

Oilseed rape is a plant of growing economic importance. It is now one of the most important oil crops in the World (Abbasian & Rad, 2011; Szczepaniak, 2014; Wollmer et al., 2018). This plant acts as profitable break crop in cereal crop rotations breaking the life-cycle of common cereal pathogens and pests and also improving the structural properties of the soil (Lääniste et al., 2016). In Poland, the area of oilseed rape cultivation has increased more than 3 times over the past 50 years, and the increase in seed yield has been on average 29 kg ha<sup>-1</sup> year<sup>-1</sup> (Central Statistical Office, 2003 & 2017; Zajac et al., 2016). One of the major problems in oilseed rape cultivation is a relatively high yield variability, resulting from the sensitivity of this plant to weather conditions (Dzieżyc et al., 2013; Mirzaei et al., 2013). Winter oilseed rape is sensitive to water deficiency in the soil during germination and emergence (Aboutalebian et al., 2012; Harker et al., 2012a), as well as during intensive plant growth in spring (Mirzaei et al., 2013). Plants underdeveloped before winter are not very resistant to low temperatures in winter



(Velička et al., 2010 and 2012; Waalen et al., 2013; Martinez-Feria, 2015). The high sensitivity of winter rape seeds to soil moisture during germination is associated with a large proportion of seed cover in relation to seed weight and their small size, forcing the use of shallow sowing, from 1 cm to 2 cm (Martinez-Feria, 2015). According to Harker et al. (2012a), seeding at a depth of 1 cm will not only improve winter oilseed rape emergence density, but will also decrease days to emergence, increase ground cover by plants, decrease days to flowering and days to maturity and tend to decrease green seed levels compared to sowing at a depth of 4 cm. On the other hand, droughts occurring in some years in Eastern Europe during the sowing period prevent the seeds from collecting water from such a shallow soil layer. As a result, plant emergence is delayed and uneven (Wilczewski et al., 2014). The improvement of germination conditions of plants can be achieved by the application of furrow sowing, according to Patent PL215714 B1 (Wilczewski & Harasimowicz-Hermann, 2014). Furrow sowing allows the seeds to be placed in a deeper, more humid soil layer, while maintaining their shallow cover. Also, the abandonment of pre-sow ploughing and the use of direct sowing ensures a higher moisture of the seed bed (Wilczewski et al., 2014). Ensuring higher moisture of the seed bed can be particularly important when using a low sowing density (40–80 seeds per m<sup>2</sup>), where incomplete germination results in too few plants being produced per area unit (Kazemeini et al., 2010; Balodis & Gaile, 2015).

The aim of this study was to assess the effect of different sowing methods (sowing with the furrow method - in furrows 6–8 cm deep, in accordance with Patent PL215714 B1; direct sowing into non-cultivated soil using disc coulters and conventional sowing) on the physical properties of the seed bed and the yield of winter oilseed rape depending on the sowing density (40, 60, 80, 100 and 120 seeds per m<sup>2</sup>).

## MATERIALS AND METHODS

### Experimental design and conditions

The field study was conducted in 2011–2014 at the Research Station in Mochełek (53°13' N; 17°52' E) near Bydgoszcz, Poland. Three sowing methods were tested (factor I): A – conventional row sowing (control), B – sowing in furrows 6–8 cm deep, using a row drill, according to patent PL215714 (Wilczewski & Harasimowicz-Hermann, 2014); C – furrow sowing directly in the stubble (using a drill with disc coulters). These methods were assessed in 5 variants of sowing density (factor II): 40, 60, 80, 100 and 120 seeds m<sup>2</sup>. The split-plot experimental design with four repetitions was used. Field experiments were performed on *Albic Luvisols* (*LVab*) with a fine sandy loam texture (WRB, 2014). Furrow sowing involves placing seeds in a seed bed at the bottom of a furrow formed to a depth of 6–8 cm from the flat surface of the field. For sowing, a seeder equipped with coulters which have a larger wing opening angle (10–20 degrees) is used. During operation, the coulter wings make a furrow 6–10 cm wide and 6–8 cm deep, depending on the coulter setting. Seeds falling from the seeder to the bottom of the furrows are covered by a 1 cm layer of soil sliding by gravity from the ridges.

The soil was characterized by a high content of available forms of phosphorus and potassium (70.6 and 194.2 mg of P and K in kg of dry soil, respectively), a very high magnesium concentration (98.7 mg of Mg in kg of dry soil) and a neutral (first and third year of the study) or slightly acidic reaction (second year of the study).

The total rainfall in August was high in the first year of the study and average in the second and third years of the study (Table 1). In the first year of the study, there were quite low precipitation totals in September and October, very low in November and in the March-May period, and excessively high in June and July, when they exceeded the long-term averages by 147.3 and 55.6% respectively. In the second year of the study, the precipitation totals occurring in autumn and spring were well matched to the needs of winter oilseed rape. The precipitation in May was higher than the average multi-year total for this month by as much as 107.9%. Only in April 2013 there was a shortage of precipitation (-50.0%, compared to average for 1949–2019). In the third year of the study, the precipitation total and distribution were the closest to the long-term averages for the study area.

**Table 1.** Weather conditions at the experiment site

Months	2011– 2012	2012– 2013	2013– 2014	1949– 2019	2011– 2012	2012– 2013	2013– 2014
Total precipitation (mm)					Deviations from the total precipitation of 1949–2019 (%)		
August	67.7	51.8	56.6	53.2	27.3	-2.6	6.4
September	37	25.1	64.1	42.1	-12.1	-40.4	52.3
October	13.2	40.3	18.6	34.3	-61.5	17.5	-45.8
November	9	53.7	28.5	33.1	-72.8	62.2	-13.9
December	46.2	27.2	19.1	32.6	41.7	-16.6	-41.4
January	62.9	44	23.5	25.6	145.7	71.9	-8.2
February	29.6	31.3	18	19.1	55.0	63.9	-5.8
March	15.4	14.7	49.7	24.7	-37.7	-40.5	101.2
April	26.5	13.6	40.7	27.2	-2.6	-50.0	49.6
May	25.4	91.7	65.7	44.1	-42.4	107.9	49.0
June	133.8	49.3	44.9	54.1	147.3	-8.9	-17.0
July	115.6	79	55.4	74.3	55.6	6.3	-25.4
August–July	582.3	521.7	484.8	464.4	25.4	12.3	4.4
Average air temperature (°C)					Deviations from the average air temperature of 1949–2019 (°C)		
August	17.7	17.6	18.1	17.6	0.1	0.0	0.5
September	14.3	13.3	10.7	13.3	1.0	0.0	-2.6
October	8.4	7.4	8.2	8.2	0.2	-0.8	0.0
November	2.7	4.5	4.9	3.3	-0.6	1.2	1.6
December	2.7	-2.5	1.8	-0.4	3.1	-2.1	2.2
January	-0.3	-3.5	-3.2	-2.2	1.9	-1.3	-1.0
February	-5.4	-0.9	2	-1.4	-4.0	0.5	3.4
March	4.6	-3	5.6	2	2.6	-5	3.6
April	8.4	7	9.9	7.6	0.8	-0.6	2.3
May	14.5	14.2	13.3	12.9	1.6	1.3	0.4
June	15.2	17.4	16	16.4	-1.2	1.0	-0.4
July	18.8	18.9	21.5	18.1	0.7	0.8	3.4
August–July	8.5	7.5	9.1	7.9	0.6	-0.4	1.2

The air temperature in autumn was relatively high in the first and second year of the study, which favoured the intensive development of plants and the formation of a thicker root neck than in the third year of the study, characterized by cool September,

when the temperature was lower by 2.6 °C compared to average for 1949–2019. Thermal conditions in winter were considerably different in individual years of the study. They were the most unfavourable for winter oilseed rape in the 2011–2012 season, in which the minimum temperature reaching -22 °C occurred on February 5, with not very thick snow cover. In the second and third years of the study, thermal conditions in winter were favourable for winter oilseed rape. Although the average temperatures in March 2013 were as much as 5°C lower than the long-term average, but they were not harmful to this plant.

### **Crop management**

Seeds of winter oilseed rape (*Brassica napus* L. var. *napus*) were sown after the harvest of winter wheat in the period of 25 August – 3 September. Open pollinated cultivar 'Californium' was used in the research. The weight of 1,000 seeds used for sowing was 4.25, 4.60 and 4.31 g, respectively, in 2011, 2012 and 2013. Fertilization of oilseed rape with phosphorus (70 kg ha<sup>-1</sup> P<sub>2</sub>O<sub>5</sub>) and potassium (140 kg ha<sup>-1</sup> K<sub>2</sub>O) was applied directly after the harvest of the previous crop (on stubble). Nitrogen (210 kg ha<sup>-1</sup> N) was applied at three rates. The first rate (40 kg ha<sup>-1</sup> N) was spread on stubble (together with phosphorus and potassium); the second rate (100 kg ha<sup>-1</sup> N) was spread in early spring (for starting growth). The last rate (70 kg ha<sup>-1</sup> N) was applied at BBCH 55–57 stage (Böttcher et al., 2016).

The control of dicot and monocot weeds was carried out immediately after sowing seeds with the preparation Butisan Star 416 SC (a.i. metazachlor + qinomerak) at a dose of 2.5 dm<sup>3</sup> ha<sup>-1</sup>. In addition, in the first and third years of the study, an additional treatment was applied to control monocot weeds. This treatment in the first year of the study was carried out at the stage of 4–6 oilseed rape leaves using Fusilade Forte 150 EC (a.i. fluazifop-P-butyl), at a dose of 1.5 dm<sup>3</sup> ha<sup>-1</sup>, and in the third year of the study in the early spring, at the stem formation stage, with Elegant 0.5 EC (a.i. qizalofop-P-ethyl) at a dose 1 dm<sup>3</sup> ha<sup>-1</sup>. The control of pests of winter oilseed rape was carried out by performing two or three chemical treatments in individual years of conducting the field study. The first treatment was performed using Proteus 110 OD (a.i. thiacloprid + deltamethrin) at a dose of 0.6 dm<sup>3</sup> ha<sup>-1</sup>, in the early spring, after observing the appearance of ceutorrhynchid beetles. The second treatment was carried out during the oilseed rape budding season, mainly to control rape blossom beetle. In the first year, Mospilan 20 SP (a.i. acetamiprid) was used for this purpose, in a dose of 0.1 kg ha<sup>-1</sup>, and in subsequent years, Fastac 100 EC (a.i. alpha-cypermethrin) in a dose 0.1 dm<sup>3</sup> ha<sup>-1</sup>. In the first year of the study, the treatment was also applied during the fall of flower petals with Fastac 100 EC (a.i. alpha-cypermethrin) in a dose of 0.1 dm<sup>3</sup> ha<sup>-1</sup>, in order to control the silique-damaging pests. To reduce seed shedding, Nu Film 96 EC (a.i. di-1-p-menthene) was used in a dose of 0.7 dm<sup>3</sup> ha<sup>-1</sup>, during the technical maturity stage. Plant harvesting was carried out within 23–30 July, in one step with a Wintersteiger plot combine, harvesting crops from an area of 26 m<sup>2</sup>. Seed moisture at harvest was 6.95, 10.69 and 7.31% in 2012, 2013 and 2014, respectively. Seed yield and 1,000 seed weight from individual plots have been calculated into 7% water content.

### **Measurements and observations made during oilseed rape growth**

In the period from rape sowing to emergence, measurements of soil moisture and temperature in the vicinity of sown seeds were carried out. The measurement was carried

out every second day with the TDR WET-2/d-02 probe, equipped with the HH2 reader. Based on the measurements made, the average moisture and temperature of the seed bed was calculated during oilseed rape germination and emergence. In the spring each year, the plant density was determined (No. m<sup>-2</sup>). On each plot, plants were counted on a randomly chosen row with a length of 5 meters. Prior to the harvest of winter oilseed rape, on each plot, the number of siliques per plant (on 20 randomly chosen plants) and the number of seeds per silique (on 20 randomly collected siliques) were determined. After the harvest of rapeseed, the seed crop from each plot was weighed and seed samples were collected in which the 1,000 seed weight was determined. The measurement was performed in the seed laboratory of the Department of Agronomy. 500 seeds were counted from each sample and weighed on the analytical balance to the nearest 0.01 g, and the results were multiplied by two.

### Statistical analysis

Statistical treatment of the data were performed using analyses of variance mixed model. When significant effects of the studied factor were found, Tukey’s test at the significance level  $P < 0.05$  was used to compare treatment means. Regression equations for the relationship between the sowing density and the seed yield for individual sowing methods were developed using the software *Statistica* for Windows.

## RESULTS

### The effect of a sowing method on winter oilseed rape yield and its structure

The sowing method significantly affected the moisture in the sowing bed space during plant germination and emergence (Table 2). It was the highest in treatments with direct sowing, significantly lower after the application of furrow sowing and the lowest in the vicinity of seeds sown with the conventional method. The soil surrounding seeds sown with the conventional method was characterized by a significantly higher temperature in this period than after the application of other methods of cultivation and sowing. A better moisture of the seed bed resulted in the acceleration of oilseed rape emergence, however, it did not affect the plant density after the end of emergence.

**Table 2.** Properties of the winter oilseed rape seed bed during germination and after emergence depending on the sowing method (means for 2012–2014)\*

Trait	Control	Furrow sowing	Direct sowing	Mean	HSD <sub>0.05</sub>
Moisture of the seed bed, %	6.33	8.97	10.85	8.72	1.06
Temperature of the seed bed, °C	21.63	21.17	21.07	21.29	0.23
Plant density in the autumn, No. m <sup>-2</sup>	62.3	62.5	61.8	62.2	ns

\* – the results presented in the table are averages of all sowing rates (40, 60, 80, 100 and 120 seeds per m<sup>2</sup>); ns – non-significant differences.

The number of plants in spring was on average by 14% smaller than in autumn. No significant effect of the sowing method on the winter oilseed rape plant density after winter was found (Table 3). Furrow sowing has contributed to formation of a significantly larger number of siliques per plant and per m<sup>2</sup> than in treatments with the conventional and direct sowings. However, no effect of this factor on the number of

seeds per silique and on the weight of 1,000 oilseed rape seeds was found. Oilseed rape yield was dependent on the sowing method. Furrow sowing resulted in a significantly higher seed yield than that obtained after direct sowing. The seed yield obtained after conventional sowing was not significantly different from that obtained in other treatments.

**Table 3.** Yielding and yield components of winter oilseed rape depending on the sowing method (means for 2012–2014)\*

Trait	Control	Furrow sowing	Direct sowing	Mean	HSD <sub>0.05</sub>
Plant density in the spring, No. m <sup>-2</sup>	53.2	53.5	54.1	53.6	ns
Number of siliques per plant	117	133	115	122	12.9
Number of siliques per m <sup>2</sup>	5711	6582	5829	6040	680
Number of seeds per silique	22.4	23.5	23.7	23.2	ns
1000 seeds weight, g	5.39	5.31	5.46	5.39	ns
Seed yield, Mg ha <sup>-1</sup>	3.42	3.58	3.34	3.45	0.213

\* – the results presented in the table are averages of all sowing rates (40, 60, 80, 100 and 120 seeds per m<sup>2</sup>); ns – non-significant differences.

#### The effect of sowing density on the winter oilseed rape yield and its structure

Most yield components were dependent on the sowing density (Table 4). Each increase in sowing density within the range of 40 to 120 seeds per m<sup>2</sup> resulted in a significant increase in the number of plants per m<sup>2</sup>. Along with increasing the sowing rate and thus significantly increasing the plant density, the number of siliques per plant decreased. It was the largest after sowing 40 seeds per m<sup>2</sup>, significantly smaller after sowing 60 or 80 seeds per m<sup>2</sup> and the smallest at the two highest sowing densities. The number of siliques per m<sup>2</sup> was the largest after sowing 80, 100 or 120, and the smallest after sowing 40 seeds per m<sup>2</sup>. In contrast to the plant density and the number of siliques per plant, the number of seeds per silique, although depending on the sowing density, was not subject to unidirectional changes. It was the largest after sowing 60 and the smallest after sowing 100 rape seeds per m<sup>2</sup>. There was no significant variation in this characteristic for other sowing densities. The weight of 1,000 rape seeds was an average of 5.39 g and it was not dependent on the sowing rate.

**Table 4.** Yield components of winter oilseed rape depending on the sowing density (means for 2012–2014)

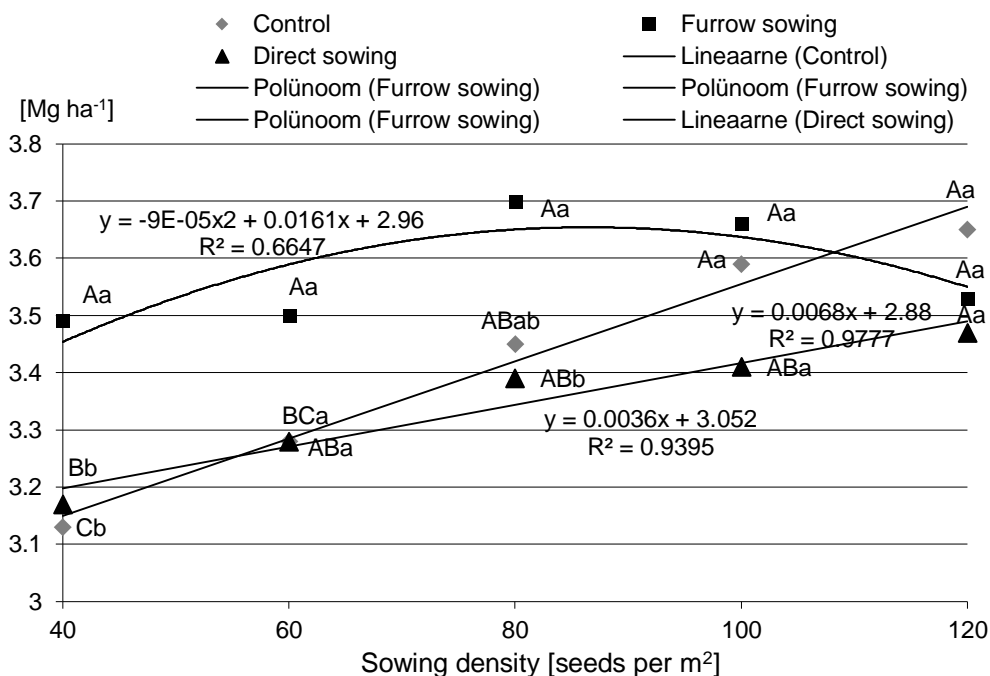
Trait	Sowing density (seeds m <sup>-2</sup> )					Mean	HSD <sub>0.05</sub>
	40	60	80	100	120		
Plant density in the autumn, No. m <sup>-2</sup>	35.0	49.4	63.8	75.2	87.6	62.2	3.46
Plant density in the spring, No. m <sup>-2</sup>	31.8	44.2	55.5	64.3	72.2	53.6	2.69
Number of siliques per plant	149	134	123	105	97	122	11.8
Number of siliques per m <sup>2</sup>	4554	5748	6628	6518	6756	6040	876
Number of seeds per silique	23.5	23.8	23.2	22.4	23.1	23.2	1.24
1000 seeds weight, g	5.53	5.43	5.29	5.38	5.30	5.39	ns
Seed yield, Mg ha <sup>-1</sup>	3.27	3.35	3.51	3.55	3.55	3.45	0.149

ns – non-significant differences.

The sowing density significantly influenced the size of the seed yield. It was significantly higher after sowing 80, 100 and 120 seeds per m<sup>2</sup> than after sowing 40 and 60 seeds per m<sup>2</sup> (Table 4).

### Interaction of the sowing method and sowing density in shaping winter oilseed rape yield and its structure

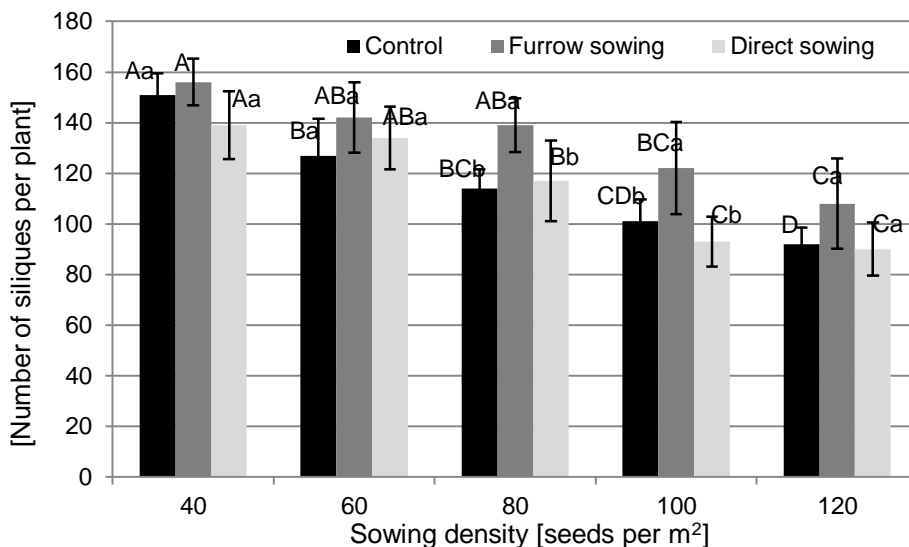
An interaction between the study factors in shaping the seed yield and the number of siliques per rapeseed plant has been demonstrated (Figs 1 and 2). After applying conventional sowing, increasing the sowing density from 40 to 80 and from 60 to 100 seeds per m<sup>2</sup> resulted in a significant increase in the seed yield (Fig. 1). Also, after direct sowing, an increase in seed yield was found as a result of the increased sowing rate from 40 to 120 seeds per m<sup>2</sup>. However, no significant effect of sowing density on the yield of oilseed rape seeds sown with the furrow method was found, for which a curvilinear relation was found between the sowing density and the rapeseed yield. There was a tendency to increase the yield as the sowing rate with the furrow method increased from 40 to 80 seeds per m<sup>2</sup>. After increasing the sowing density from 80 to 100 and 120 seeds per m<sup>2</sup> there was a tendency for the seed yield to decrease. In the case of conventional and direct sowings, this relationship was linear in the entire range of applied sowing densities.



Note. a, b, c – data marked with various small letters within particular sowing density differ significantly as a result of sowing method influence, at  $P < 0.05$ ; A, B, C – data marked with various capital letters within particular sowing method differ significantly as a result of sowing density influence, at  $P < 0.05$ .

**Figure 1.** Interaction of sowing method with the sowing density for the seed yield of winter oilseed rape (means for 2012–2014).

Regardless of the sowing method, increasing the sowing density resulted in a reduction in the number of siliques per plant (Fig. 2).



Note. a, b, c – data marked with various small letters within particular sowing density differ significantly as a result of sowing method influence, at  $P < 0.05$ ; A, B, C – data marked with various capital letters within particular sowing method differ significantly as a result of sowing density influence, at  $P < 0.05$ .

**Figure 2.** Interaction of sowing method with the sowing density for the number of siliques per plant of winter oilseed rape (means for 2012–2014).

The sowing method did not affect the number of siliques per plant of oilseed rape sown in the amount of 40, 60 and 120 seeds per m<sup>2</sup>. After applying 80 and 100 seeds per m<sup>2</sup>, the number of siliques per plant of oilseed rape sown with the furrow method was significantly higher than after using the conventional or direct sowings.

## DISCUSSION

Sowing technology is a factor of great importance in shaping the habit of plants and their yield (Jambor, 2007; Wielebski, 2007; Lääniste et al., 2008; Kazemeini et al., 2010; French et al., 2016; Harker et al., 2017). In the scientific literature, there are no results regarding the effect of furrow sowing on the yield of winter oilseed rape. Numerous studies have been conducted regarding the possibilities of using direct sowing in oilseed rape cultivation, which has been shown by Harker et al. (2012b) to provide better rainwater retention and availability for plants. The present study confirmed the beneficial effect of this sowing method on the seed bed moisture during the oilseed rape germination period. Despite this, the favourable effect of direct sowing on the plant density after emergence was not obtained. Also in the spring season, the density was not dependent on the sowing method, and the plants from direct sowing produced significantly smaller seed yields than after the application of furrow sowing. The

disadvantage of this method of cultivation and sowing is a large resistance to soil penetration (Celik, 2011; Oduma et al., 2017), which puts more resistance to the developing roots, which generally has a negative effect on plant yields (Chiriac et al., 2013). In our studies it has been found, that plants in furrow sowing were stronger before the winter, compared to direct sowing treatment. This was seen through greater number of leaves per plant and thicker root neck (Wilczewski et al., 2015). As a result, in spring the plants started growing faster and produced a greater number of siliques per plant (Table 3).

According to Wielebski (2007), the plant density prior to harvest should not be lower than 50 plants per m<sup>2</sup>, for which 80 seeds per m<sup>2</sup> should be sown. The author, conducting research in unfavourable moisture and thermal conditions (drought during sowing), did not show the relationship between the type of cultivar (composite hybrids, restored hybrids and open pollinated) and their reaction to the sowing density. The opposite results were obtained by Vujaković et al. (2014), who did not show the relationship between the oilseed rape seed yield and the plant density in the range of 20 to 80 seeds per m<sup>2</sup>. Also in the study by Jambor (2007) the amount of seeding rate in the range of 30 to 80 of germinable seeds per m<sup>2</sup>, had only a little influence on yield. The author stated significant interaction between seeding rate and variety in yield forming effect. For Artus variety 80 germinable seeds per m<sup>2</sup> gave best yield whereas for Fanal variety the lowest seeding rate used was the most favourable. According to French et al. (2016), the optimal oilseed rape plant density in low and medium rainfall zones is 30 plants per m<sup>2</sup> for hybrid cultivars and 75 plants per m<sup>2</sup> for population cultivars. The present study generally confirms the results presented by these authors. However, the optimal plant density for the studied population cultivar 'Californium' was dependent on the sowing method. After application of furrow sowing, the optimal sowing density was 80 seeds per m<sup>2</sup>, for which the spring oilseed rape density was 55 plants per m<sup>2</sup>. For the other sowing methods, a tendency to increase the yield was observed as the sowing density increased to 120 seeds per m<sup>2</sup>, with 72 plants per m<sup>2</sup> found in spring. In the study by Harker et al. (2017), the effect of increasing the sowing density (from 50 to 150 seeds per m<sup>2</sup>) on rapeseed yield was dependent on the size of seeds sown. After sowing small seeds (the weight of 1,000 seeds 3.32–3.44 g) the authors found that the seed yield increased as the sowing density increased, while no such an effect was found after sowing large seeds (the weight of 1,000 seeds 4.96–5.40 g). The seed material used in the present study was characterized by an average 1,000 seed weight (4.25–4.60 g), and the oilseed rape response to increasing the sowing density was similar to that for small seeds in the study by Harker et al. (2017), but only in the case of conventional and direct sowings. However, in the present study this tendency was only tested in the range of sowing density from 40 to 120 seeds per m<sup>2</sup>. According to Harker et al. (2017), increasing the sowing density increases the loss of plants during the growing season, especially when small seeds are used for sowing. In the present study, this relationship was confirmed. Plant loss in the autumn and winter period increased from 9.1% after applying the sowing density of 40 seeds per m<sup>2</sup> to 17.6% after sowing 120 seeds per m<sup>2</sup>.

The relationship between sowing density and winter rape seed yield depended on the method of sowing. For furrow sowing it was curvilinear, while for other sowing methods it was rectilinear within the tested sowing densities (Fig. 1). This variation in the relationship between the method of sowing and the sowing density in shaping the seed yield may be due to the fact that in the case of furrow sowing a relatively high yield



was found after applying 40 seeds per m<sup>2</sup>. In this variant it was significantly higher than in traditional or direct sowing. This was related to the positive effect of furrow sowing on the number of siliques per plant. However, increasing the sowing density to 100 and 120 seeds per m<sup>2</sup> in a furrow sowing method resulted in a tendency to reduce rapeseed yield. Meanwhile, in the treatment with traditional or direct sowing, none of the tested sowing densities were excessive and this relationship was straight-line.

## CONCLUSION

A significant effect of the studied factors on the yield of winter oilseed rape was demonstrated. The highest seed yields were harvested from oilseed rape sown using the furrow method, and significantly lower after direct sowing. When using a low sowing density (40 seeds per m<sup>2</sup>), furrow sowing allowed for a higher seed yield than conventional sowing. The sowing method has not been found to significantly affect the yield of winter oilseed rape sown in the amount of 60–120 seeds per m<sup>2</sup>. Increasing the sowing density from 40 to 80 seeds per m<sup>2</sup> most often led to an increase in yield of winter oilseed rape. There was no significant increase in seed yield as a result of increased sowing density in the range from 80 to 120 seeds per m<sup>2</sup>.

**ACKNOWLEDGEMENTS.** This scientific study was financed from the funds for science by the National Science Centre of Poland, in the years 2011–2014, as research project No. N N310 731040.

Weather data was developed in the Melioration and Agrometeorology Laboratory at the Faculty of Agriculture and Biotechnology, UTP in Bydgoszcz.

## REFERENCES

- Abbasian, A. & Rad, A.H.S. 2011. Investigation the response of rapeseed cultivars to moisture regimes in different growth stages. *Journal of Central European Agriculture* **12**(2), 353–366. <https://doi.org/10.5513/JCEA/12.2.923>
- Aboutalebian, M.A., Mohagheghi, A., Niaz, S.A. & Rouhi, H.R. 2012. Influence of hydropriming on seed germination behaviour of canola cultivars as affected by saline and drought stresses. *Annals of Biological Research* **3**(11), 5216–5222. <https://www.scholarsresearchlibrary.com>
- Balodis, O. & Gaile, Z. 2015. Changes of winter oilseed rape plant survival during vegetation. *Proceedings of the Latvia University of Agriculture* **33**(1), 35–45. <https://doi.org/10.1515/plua-2015-0005>
- Böttcher, U., Rampin, E., Hartmann, K., Zanetti, F., Flenet, F., Morison, M. & Kage, H. 2016. A phenological model of winter oilseed rape according to the BBCH scale. *Crop and Pasture Science* **67**(3-4), 345–358. <https://doi.org/10.1071/CP15321>
- Celik, I. 2011. Effects of tillage methods on penetration resistance, bulk density and saturated hydraulic conductivity in a clayey soil conditions. *Journal of Agricultural Sciences* **17**(2), 143–156. [https://doi.org/10.1501/Tarimbil\\_0000001166](https://doi.org/10.1501/Tarimbil_0000001166)
- Central Statistical Office 2003. Statistical yearbook of the Republik of Poland, Warsaw, pp. 362–392 (in Polish).
- Central Statistical Office 2017. Branch yearbooks. Statistical yearbook of agriculture. Warsaw, Poland, pp. 160–162 (in Polish).

- Chiriac, G., Raus, L., Coroi, I.G., Gales, D.C. & Jitareanu, G. 2013. Effect of tillage and cultivar on winter oilseed rape (*Brassica napus* L.) yield and economic efficiency in Suceava Plateau. *ProEnvironment* **6**, 130–135. <http://journals.usamvcluj.ro/index.php>
- Dziężyk, H., Chmura, K. & Piotrowski, M. 2013. Influence of meteorological conditions on the yield of winter oilseed rape in Lower Silesia. *Annals of Warsaw University of Life Sciences – SGGW, Land Reclamation* **45**(2), 235–242. [http://ann\\_landreclam.sggw.pl/Zeszyt452.html](http://ann_landreclam.sggw.pl/Zeszyt452.html)
- French, R.J., Seymour, M. & Malik, R.S. 2016. Plant density response and optimum crop densities for canola (*Brassica napus* L.) in Western Australia. *Crop and Pasture Science* **67**(3–4), 397–408. <https://doi.org/10.1071/CP15373>
- Harker, K.N., O'Donovan, J.T., Blackshaw, R.E., Johnson, E.N., Lafond, G.P. & May, W.E. 2012a. Seeding depth and seeding speed effects on no-till canola emergence, maturity, yield and seed quality. *Canadian Journal of Plant Science* **92**, 795–802. <https://doi.org/10.4141/cjps2011-189>
- Harker, K.N., O'Donovan, J.T., Turkington, T.K., Blackshaw, R.E., Lupwayi, N.Z., Smith, E.G., Klein-Gebbinck, H., Dossdall, L.M., Hall, L.M., Willenborg, C.J., Kutcher, H.R., Malhi, S.S., Vera, C.L., Gan, Y., Lafond, G.P., May, W.E., Grant, C.A. & McLaren, D.L. 2012b. High-yield no-till canola production on the Canadian prairies. *Canadian Journal of Plant Science* **92**, 221–233. <https://doi.org/10.4141/cjps2011-125>
- Harker, K.N., O'Donovan, J.T., Smith, E.G., Johnson, E.N., Peng, G., Willenborg, C.J., Gulden, R.H., Mohr, R.M., Gill, K.S., Weber, J.D. & Issah, G. 2017. Canola growth, production, and quality are influenced by seed size and seeding rate. *Canadian Journal of Plant Science* **97**(3), 438–448. <https://doi.org/10.1139/cjps-2016-0215>
- Jambor, M. 2007. Effect of seeding rate and seeding date on creation of yield of selected winter oilseed rape varieties and hybrids. *Agriculture (Polnohospodárstvo)* **53**(1), 49–57.
- Kazemeini, S.A., Edalat, M., Shekoofa, A. & Hamidi, R. 2010. Effects of nitrogen and plant density on rapeseed (*Brassica napus* L.) yield and yield components in Southern Iran. *Journal of Applied Sciences* **10**, 1461–1465. <https://doi.org/10.3923/jas.2010.1461.1465>
- Lääniste, P., Joudu, J., Ereemeev, V. & Mäeorg, E. 2008. Effect of sowing date and increasing sowing rates on plant density and yield of winter oilseed rape (*Brassica napus* L.) under Nordic climate conditions. *Acta Agriculturae Scandinavica, Section B – Soil and Plant Science* **58**, 330–335. <https://doi.org/10.1080/09064710701763821>
- Lääniste, P., Ereemeev, V., Mäeorg, E. & Jõudu, J. 2016. Effect of sowing date on oil, protein and glucosinolate concentration of winter oilseed rape (*Brassica napus* L.). *Agronomy Research* **14**(S2), 1384–1395.
- Martinez-Feria, R.A. 2015. Suitability of winter canola (*Brassica napus*) for enhancing summer annual crop rotations in Iowa. *Graduate Theses and Dissertations* **14637**, pp. 149 <https://lib.dr.iastate.edu/etd/14637>
- Mirzaei, A., Naseri, R., Moghadam, A. & Esmailpour-Jahromi, M. 2013. The effects of drought stress on seed yield and some agronomic traits of canola cultivars at different growth stages. *Bulletin of Environment, Pharmacology and Life Sciences* **2**(11), 115–121. [http://www.bepls.com/oct\\_2013](http://www.bepls.com/oct_2013)
- Oduma, O., Nnadi, D.C., Agu, C.S. & Igwe, J.E. 2017. Determination of the effect of tillage on soil resistance to penetration. A study of south-east agricultural soils. *American Journal of Engineering Research* **6**(7), 1–5. [http://www.ajer.org/v6\(07\).html](http://www.ajer.org/v6(07).html)
- Szczepaniak, W. 2014. A mineral profile of winter oilseed rape in critical stages of growth – nitrogen. *Journal of Elementology* **19**(3), 759–778. <https://doi.org/10.5601/jelem.2014.19.1.600>

- Velička, R., Anisimovienė, N., Pupalienė, R., Jankauskienė, J., Butkevičienė, L.M. & Kriauciūnienė, Z. 2010. Preparation of oilseed rape for over-wintering according to autumnal growth and cold acclimation period. *Žemdirbyste = Agriculture* **97**(3), 69–76.
- Velička, R., Pupalienė, R., Butkevičienė, L.M. & Kriauciūnienė, Z. 2012. Peculiarities of overwintering of hybrid and conventional cultivars of winter rapeseed depending on the sowing date. *Acta Scientiarum Polonorum, Agricultura* **11**(1), 53–66. <http://agricultura.acta.utp.edu.pl>
- Vujaković, M., Marjanović-Jeromela, A., Jovičić, D., Lečić, N., Marinković, R., Jakovljević, N. & Mehandžić-Stanišić, S. 2014. Effect of plant density on seed quality and yield of oilseed rape (*Brassica napus* L.). *Journal on Processing and Energy in Agriculture* **18**(2), 73–76. <http://scindeks.ceon.rs/issue.aspx?issue=11983&lang=en>
- Waalén, W., Øvergaard, S.I., Åssveen, M., Eltun, R. & Gusta, L.V. 2013. Winter survival of winter rapeseed and winter turnip rapeseed in field trials, as explained by PLS regression. *European Journal of Agronomy* **51**, 81–90. <http://dx.doi.org/10.1016/j.eja.2013.06.004>
- Wielebski, F. 2007. Response of different types of winter oilseed rape varieties to various plant density in the field. I. Seed yield and its components. *Rośliny Oleiste – Oilseed Crops*, **28**, 209–226 (in Polish). [http://biblioteka.ihar.edu.pl/oilseed\\_crops](http://biblioteka.ihar.edu.pl/oilseed_crops)
- Wilczewski, E. & Harasimowicz-Hermann, G. 2014. Patent No PL215714 B1. Furrow sowing of winter oilseed rape (in Polish).
- Wilczewski, E., Harasimowicz-Hermann, G. & Lemańczyk, G. 2015. Effect of sowing technology on winter oilseed rape density in autumn and plant overwintering. In: Emerging Innovations in Agriculture: From Theory to Practice. Rakshit, A. (ed.), Atiner, pp. 57–66.
- Wilczewski, E., Harasimowicz-Hermann, G., Szczepanek, M. & Kaszkowiak, J. 2014. Effect of sowing method on soil properties in the surroundings of seeds and emergence dynamics of winter oilseed rape. In Pepó, P. & Csajbók, J. (eds): *Proceedings of 13<sup>th</sup> Congress of the European Society for Agronomy*, Debrecen, Hungary, pp. 67–68.
- Wollmer, A.C., Pitann, B. & Mühling, K.H. 2018. Waterlogging events during stem elongation or flowering affect yield of oilseed rape (*Brassica napus* L.) but not seed quality. *Journal of Agronomy and Crop Sciences* **204**, 165–174. <https://doi.org/10.1111/jac.12244>
- WRB. 2015. World Reference Base for Soil Resources 2014, update 2015 International soil classification system for naming soils and creating legends for soil maps. *World Soil Resources Reports* No. 106. FAO, Rome.
- Zajac, T., Klimek-Kopyra, A., Oleksy, A., Lorenc-Kozik, A. & Ratajczak, K. 2016. Analysis of field and plant traits of oilseed rape (*Brassica napus* L.) cultivated in temperate region in light of the possibilities of sowing in arid areas. *Acta Agrobotanica* **69**(4), 1696–1708. <https://doi.org/10.5586/aa.1696>

## **The study of new feed additives in the ration in newly-calved high producing cows**

N.A. Yurina<sup>1,2,\*</sup>, D.V. Osepchuk<sup>1</sup>, M.P. Semenenko<sup>1</sup>, E.V. Kuzminova<sup>1</sup> and E.G. Chuprina<sup>1</sup>

<sup>1</sup>Krasnodar Research Center for Animal Husbandry and Veterinary Medicine, Pervomaiskaya street 4, RU350055 Krasnodar, Russia

<sup>2</sup>Kuban State Agrarian University named after I.T. Trubilin, 13, Kalinina street, RU350000 Krasnodar, Russia

\*Correspondence: naden8277@mail.ru

**Abstract.** The paper highlights the results of a study on the combined use of the CattlePro Effect amido-vitamin-and-mineral complex and PassPro Ballans feed product in the diets of newly-calved high producing cows. The studies were carried out in the conditions of the Bolshevik collective farm of the Kalacheevsky district of the Voronezh region (Russia) according to the method of A.I. Ovsyannikov (1976) for three months after a 21-day equalizing period. During the course of the experiment, it was determined that the introduction of new feed additives into the diet leads to an increase in the consumption of dry matter by lactating animals by 1.0–6.2%. The basic fat content and protein content of milk was increased by 11.6–19.1%, and when adjusting the milk yield for 4% milk – by 9.3–17.4%. The digested feed particles in the feces were closer to normal in the cows of the experimental groups, which indicates the beneficial effect of the feed additive on the digestive processes of animals. When applying the studied feed additive, there was a certain decrease in enterobacteria and staphylococci in the samples of the rumen fluid and at the same time there was an increase in lactic acid microorganisms 1.6–2.0 times.

**Key words:** amido-vitamin-and-mineral complex, milk yield, newly calved high producing cows, protected protein.

### **INTRODUCTION**

Animal productivity is increasing due to the transition of farms of all forms of ownership to intensive livestock production technologies. Therefore, it is especially important to develop the right feeding strategies so that the animal breeding system matches the available resources (Zenkin, et al., 2017).

The implementation of the program for the further development of animal husbandry is possible, first of all, on the basis of its intensification and the maintenance of high production performance of animals. Therefore, meeting the growing needs of the population for quality food remains the main concern of livestock production (Niu et al., 2016; McDonnell & Staines, 2017).

To date, the average productivity of cows has been increased to 7,000 tons of milk per year (Zhou et al., 2017; Weatherly et al., 2018).

Throughout life, the cow's body goes through a series of cyclical conditions. Especially vulnerable of them are the period before calving and the first three months of lactation. In the first month after calving, the highest requirements are made for feeding cows, since errors in the diet during this period will greatly affect the productivity and health of the animal. Practice has shown that even with careful organization of feeding, only about 60% of cows after calving are completely healthy. Right after calving, a number of diseases associated with metabolism may appear, since during the transition from pregnancy to the post-calving period, metabolism changes. In order to smooth out the negative impact of this period, special attention should be paid to feeding three weeks before calving and three weeks after (Kolesnik et al., 2018).

During this period, there are such phenomena as negative energy and protein balance – when the cow needs more energy and protein than it has with the feed. The physiological status in the postpartum period is extremely important for health and fertility, because if you do not fill the deficiency of energy and protein during milking, this can lead to a number of diseases, and, as a consequence, a decrease in productivity and reproductive performance. Therefore, knowing the risk of such a condition, it is necessary to make every effort to prevent it with the help of rational feeding. The postpartum feeding requirements of cows are highest, since the consequences of using unbalanced diets in the first three months of lactation can be very severe. Even with a high level of feeding, only 60% of the cows in the first period of lactation have a normal metabolism (Gaworski et al., 2018; Klebaniuk et al., 2019).

Feeding should be based on knowledge of the animal's need for basic nutrients, metabolism in the body through the inclusion of various feed products and ways to optimize nutrition by selecting and synergizing feed additives that show better efficacy (Aristov et al., 2018).

The cow has a very complex stomach, which is a biological fermenter in which a huge number of microorganisms and protozoa live. In turn, rumen bacteria use not only carbohydrates, but also nitrogen of amino acids, soluble fractions of feed protein. Therefore, the availability of amino acids for the body of cows should be ensured by the intake of at least 60% of the non-degradable protein in the rumen of cows. As far back as 20 years ago, it was believed that assimilation of microbial protein was sufficient for a cow, in addition to protein available from feed (Leso et al., 2019; Migulev et al., 2019).

For normal life, maintaining productivity and health in the body of a cow, especially in the first time of lactation, it is necessary to ensure the supply of a sufficient amount of protein. A protected protein is a protein that practically does not undergo cleavage in the rumen. It is very important when balancing the diet, because with insufficient intake of amino acids in the cow's body, metabolism is impaired, the protective functions of the body are reduced and the quality of milk is deteriorated (Velikanov et al., 2016; Zenkin et al., 2016).

With the transition to acidic conditions of the abomasum, the protected protein disintegrates and begins to unwind, allowing digestive enzymes to penetrate the molecule, breaking down the protein into its constituent abomasum material and is used for milk synthesis (Yadav & Chaudhary, 2010; Astashova et al., 2017).

With sufficient intake of protected protein, there is every chance to maintain health and extend the productive longevity of the cow by improving its biological status as a whole. Studies, evaluating the effect of protected methionine intake on milk production, have shown an increase in the percentage of protein in milk (Toledo et al., 2017).

Feeding Holstein cows a protein supplement with protected lysine and methionine in the postpartum period, slightly increases milk yield and its protein content (Carder & Weiss, 2017).

Previous studies on the use of PassPro Balance in the diet of Simmental cows in the fresh season showed an increase in the consumption of the feed mixture by 0.9% and dry matter by 5.4%, the average daily milk yield by 29.2% ( $p < 0.01$ ) and the profitability level of milk production – by 7.8%, and also reduces the service life by 5.0% and the consumption of concentrates for the production of 1 kg of basic fat milk by 22.8% (Yurina et al., 2019).

Vitamins and microelements in nutrition of cows, especially in the newly calved period, are important for metabolism and production. Moreover, the fact is known that proteins interact with minerals, producing complexes with a high biological role (Zang et al., 2019).

Copper is essential in the nutrition of newly calved cows and in its interaction with protein. Copper metabolism occurs mainly in the liver and hepatocytes are its main structures. The copper entering them initially binds to protein. Copper is involved in biochemical processes as a component of electron transfer proteins that oxidize organic substrates with molecular oxygen (Taov et al., 2019).

However, although the role of each trace element is important for the metabolism of the body, it is necessary to take into account the uniform intake (according to the standards) of each trace element separately, since minerals come into contact with each other. For example, cobalt has a positive effect on hematopoietic function with sufficient intake of copper and iron with feed, and copper, in turn, exhibits its properties better when magnesium is optimally absorbed into the body. Trace elements are involved in the metabolism, in the production of hormones, regulating the activity of enzymes, vitamins, and protein. Endogenous enzymes cannot be sufficiently active without an optimal amount of trace elements. Minerals are also involved in various mechanisms providing morphofunctional homeostasis in different animals, especially in the postpartum period, when the body needs to recover and gain strength for the next reproductive cycle. Cattle feeding is necessarily ensured by a complete, balanced diet for basic nutrients, and then for vitamins and minerals (Omur et al., 2016).

According to Taov et al. (2019), the intake of a sufficient amount of minerals increases milk yield by 0.95–1.45 kg. Calves from cows that received vitamin A and trivitamin develop better during the embryonic period, and their live weight at birth was 2.8–3.0 kg more compared to the control group.

The purpose and objectives of the researches. It was the purpose of the research to study the combined use of the CattlePro Effect amido-vitamin-and-mineral complex and PassPro Ballans feedstuff, which consists of protected soy and sunflower protein in the diets of newly-calved high producing cows.

To achieve the stated goal, the following tasks were set:

1) To develop the composition of compound feed and rations for newly-calved high producing cows, taking into account the determination of the dosage of the introduction of the studied feed.

2) To determine the effect of both separate and combined use of the CattlePro Effect amido-vitamin and-mineral complex and PassPro Ballans feedstuff, which consists of protected soy and sunflower protein in the diets of newly-calved high producing cows on milk productivity, milk quality.

3) To assess the digestion rate of the feed and analyze the microflora of the rumen fluid of the cows with separate and combined use of the CattlePro Effect amide-vitamin-mineral complex and PassPro Ballans feed product.

## MATERIALS AND METHODS

The scientific and production experiment was carried out in the conditions of the enterprise of the Bolshevik collective farm in the Kalacheevsky district of the Voronezh region (Russia) according to the method of A.I. Ovsyannikova (1976). Four groups of newly-calved Simmental cows were formed, selected according to the principle of analogue pairs with 8 animals each: by age in calving, calving period, live weight, with high productivity for past lactation, fat and protein content in milk. The experiment has been continued after an equalizing period for 3 months. Cows were fed according to the scheme presented below (Table 1).

**Table 1.** Experimental design (n = 8)

Group	Experimental design
1 – control	Basal diet (BD) + compound feed (CF) with substitution
2 – experimental	BD + CF with substitution 1 kg CattlePro Effect
3 – experimental	BD + CF with substitution 2 kg PassPro Ballans
4 – experimental	BD + CF with substitution 1kg CattlePro Effect and 2 kg PassPro Ballans

The preparatory period was carried out 10 days before the date of the proposed calving and after within 10 days. Animals of the control and experimental groups during this period received the same diet. The experimental period was carried out from the 11<sup>th</sup> day after calving.

Feeding, milking and keeping animals were according to the adopted on the farm regime. Every ten days, control milking of each cow was carried out to determine the average daily milk yield and gross milk yield, as well as the fat and protein content in milk.

To determine the amount of feed consumed, control feeding was carried out (within 3 adjacent days) by taking into account the given feed mixtures and weighing their residues. Expected nutrient costs per unit of production were counted.

According to zootechnic records, the indicators characterizing the reproductive function of high producing cows were determined: the duration of the service period and the insemination index.

Mass fraction of protein and fat in milk was determined on a Lactan device.

The amount of milk fat and protein: gross milk yield per period was multiplied by the mass fraction of fat or protein.

To compare milk productivity of cows in the experiment, the corrected milk yield with 4% fat was calculated according to the formula:

$$\text{FCMY (fat corrected milk yield) 4\%} = M \times (0.4 + F \times 0.15), \quad (1)$$

where M – the amount of milk received from cows in the experiment; F – the percentage of fat in cow's milk, actually obtained; 0.15 is a constant coefficient used for adjustment.

The calculation of the cow milk for delivery to the dairy was performed according to the following formula:

$$ABM = AF \times 0.4 + AP \times 0.6 / 3.16 \times M, \quad (2)$$

where ABM – the amount of milk of basic fat content and protein content, kg; AF – the percentage of fat in cow's milk, actually obtained; AP – the percentage of protein in cow's milk, actually obtained; 0.4 – fat value coefficient; 0.6 – protein value coefficient; 3.16 – the coefficient is calculated as follows:  $3.4 \times 0.4$  (fat value coefficient) +  $3.0 \times 0.6$  (protein value coefficient); 3.4 – the all-Russian basic standard of the mass fraction of fat in milk; 3.0 – the all-Russian basic standard of the mass fraction of protein in milk (Basonov & Muryanova, 2014).

The use of a feces separator makes it possible to relatively quickly get the first impression of providing animals with structural fiber. This is the first step in determining the effectiveness of the diet.

When evaluating feces, one can obtain information on how well the food is digested, whether the diet is correctly selected, whether the content of nutrients (proteins, fiber, carbohydrates) is balanced, whether the animal consumes enough water.

To analyze the assimilation of feed nutrients, a Nasco Pigestion Analyzer, a type feces separator (or Pennsylvania sieve) was used. It consists of 3 sieves with different hole diameters – wider in the upper sieve and narrow in the lower sieve. The feces was washed in a separator until clean water appeared, then it was removed from the sieves and weighed to calculate the percentage of the fractions being evaluated, the number of undigested grains was visually determined (Filinskaya & Kevorkyan, 2018).

Rumen fluid was taken with a rumen probe 3 hours after feeding. Microbiological values of the rumen fluid were evaluated in the Argus Testing Centre according to the guidelines 'Bacteriological diagnosis of dysbiosis' (Fedorov & Fedorova, 1989).

The research results were processed by the biometric method of variation statistics. Differences were considered statistically significant at \* –  $p < 0.05$ ; \*\* –  $p < 0.01$ ; \*\*\* –  $p < 0.001$  (Plokhinskiy, 1970). For analysis our data, we used the computer program Microsoft Excel.

Animal feeding diets were developed in according to NRC (2001) of modern detailed feeding standards for lactating cows, taking into account the actual productivity and physiological state (Table 2).

**Table 2.** Composition of diets for cows in the first phase of lactation

Component	1 group		2 group		3 group		4 group	
	DM	Fraction, kg	DM	Fraction, kg	DM	Fraction, kg	DM	Fraction, kg
Meadow hay	0.919	1.0	0.919	1.0	0.919	1.0	0.919	1.0
Corn silage	7.350	21.0	7.350	21.0	7.350	21.0	7.350	21.0
Grass-legume silage	3.840	8.0	3.840	8.0	3.840	8.0	3.840	8.0
Fresh beet pulp	1.200	6.0	1.200	6.0	1.200	6.0	1.200	6.0
Compound feed	7.139	8.0	6.247	7.0	5.355	6.0	4.462	5.0
CP Effect PMVC	–	–	0.929	1.0	–	–	0.929	2.0
PassPro Balance	–	–	–	–	1.863	2.0	1.863	1.0
Total	20.45	44.0	20.49	44.0	20.53	44.0	20.56	44.0



Nutritional value presented below (Table 3).

**Table 3.** Nutritional value

Nutrient index	1 group	2 group	3 group	4 group
Dry matter, g	20448	20485	20527	20563
Crude protein, g	2575.64	2922.08	3100.15	3446.59
Digestible protein, g	2834.32	2879.86	3181.32	3226.86
Crude fat, g	541.56	541.74	604.44	604.61
Starch, g	6463.4	5990.03	5517.71	5044.33
Sugar, g	702.69	758.6	816.86	872.77
Rumen UDP, %	22.94	23.04	31.57	30.79
Calcium, g	142.375	161.692	141.54	160.857
Phosphorus, g	82.21	80.823	82.526	81.14
Sodium, g	61.795	56.89	50.717	45.812
Magnesium, g	41.305	41.342	42.547	42.584
Crude fiber, g	4064.51	4136.12	4184.26	4255.87
Vitamin A, IU	94000	94000	94000	94000
Vitamin D, IU	9400	9400	9400	9400
Vitamin E, IU	320	320	320	320
Zinc, mg	752	752	752	752
Iron, mg	106.86	106.86	106.86	106.86
Manganese, mg	564	564	564	564
Copper, mg	188	188	188	188
Cobalt, mg	2.82	2.82	2.82	2.82
Iodine, mg	7.52	7.52	7.52	7.52
Selenium, mg	5.64	5.64	5.64	5.64

CattlePro Effect is an amido-vitamin-and-mineral complex in the form of grains. It contains feed urea, which is a source of readily available nitrogen. (Table 4). CattlePro effect contains 11.2 MJ of metabolic energy, 52.0% crude protein, 6.2% crude fat, and 6.5% crude ash. Also contains a probiotic complex.

The PassPro Balance feed stuff production technology (manufactured by Protectfeed LLC) is based on the extrusion of oilseeds, expansion, and then additional processing of the product under pressure and temperature to the required protection characteristics against the decay in the rumen of animals with a multi-chamber stomach. Processing modes are selected so that digestibility in the small intestine

remains at a high level. PassPro Balance contains (on absolutely dry matter basis): 42.0% crude protein, 8.5% crude fat, 13.2% crude fiber and 12.3 MJ of metabolic energy, ‘protected’ soy and sunflower proteins have a stable rate of protein protection (protein non-degradable in the rumen 65–70%) with digestibility up to 95–96%.

**Table 4.** The nutritional value of the studied feed additives

Nutrient index	CP Effect	PassPro Balance
Metabolic energy, MJ	11.2	12.3
Humidity, %	9.5	9.0
Crude protein, %	52.0	42.0
Crude fat, %	6.2	8.5
Crude ash, %	6.5	6.0
Crude fiber, %	12.0	13.2
Sugar, %	7.5	4.9
Starch, %	2.5	1.7
Calcium, %	2.7	0.7
Phosphorus, %	1.0	0.6

From the data of Table 2 it follows that the diet was completely balanced according to the requirements of the cows of the first phase of lactation.

## RESULTS AND DISCUSSION

After the control feeding, it was found that feeding the studied feed additive in the second experimental group made it possible to increase the dry matter intake by 1.0% relative to the control. In the third experimental group, the consumption was higher by 3.6%, and in the fourth experimental group by 6.2% dry matter ( $p < 0.01$ ).

When recalculating the milk yield taking into account the basic fat content and protein content of milk, a significant excess of the control value was found in the second and fourth experimental groups by 11.6 ( $p < 0.05$ ) and 19.1% ( $p < 0.01$ ). The third group showed an increase tendency by 12.3%. According to the correction of fat corrected milk (4% milk), in the second experimental group, the dynamics of increase by 9.3% is visible, and in the third and fourth experimental groups this indicator significantly exceeded the control by 12.8 ( $p < 0.05$ ) and 17.4% ( $p < 0.01$ ).

The data obtained are consistent with the results of studies by several authors (Niu, 2016; Carder & Weiss, 2017; Toledo et al., 2017).

The results of feces flushing on a Pennsylvanian sieve are shown in Table 5.

**Table 5.** Results of feces flushing on the Pennsylvanian Sieve, n = 3

Group	Sieve type		
	upper	lower	middle
1 (control)	55.1 ± 1.9	150.0 ± 3.7	360.0 ± 13.3
in %	9.8	26.5	63.7
2 (experiment)	45.6 ± 0.6**	109.8 ± 5.4***	402.2 ± 10.2
in %	8.2	19.7	72.1
3 (experiment)	51.1 ± 2.0	99.5 ± 4.2***	384.3 ± 14.2
in %	9.6	18.6	71.8
4 (experiment)	44.3 ± 1.5***	92.5 ± 5.6***	392.1 ± 9.2
in %	8.4	17.5	74.1
Norm, %	< 10	< 20	> 50

\* –  $p < 0.05$ ; \*\* –  $p < 0.01$ ; \*\*\* –  $p < 0.001$ .

It was found that closer to the norm, according to the size of the digested feed particles in the feces, were cows of the experimental groups, especially of the fourth group, which consumed the CattlePro Effect amido-vitamin-and-mineral complex and PassPro Ballans feedstuff in combination with the basal diet, which indicates better digestion of animals compared to the control.

When analyzing the rumen fluid of the cows, it was revealed that the number of enterobacteria - representatives of the normal microflora of the rumen – did not differ significantly in groups and amounted to  $1.4 \times 10^2$ ;  $2.0 \times 10^2$  and  $1.1 \times 10^2$  CFU g<sup>-1</sup> according to the experimental groups versus the control –  $1.0 \times 10^2$  CFU g<sup>-1</sup> (Table 6).

Clostridia, which break down simple fiber and other carbohydrates, are present in small quantities, namely in the form of one colony, in the fourth experimental group.

The content of lactic acid microorganisms practically does not differ in the experimental groups in comparison with the control, which suggests that the studied feed does not negatively affect the content of ‘useful’ microorganisms in the rumen of experimental cows.

**Table 6.** The composition of the microflora of rumen fluid in cows

Items	1 group (control)	2 group	3 group	4 group
Enterobacteria, CFU g <sup>-1</sup>	1.0×10 <sup>2</sup>	1.4×10 <sup>2</sup>	2.0×10 <sup>2</sup>	1.1×10 <sup>2</sup>
Clostridia, in 1 ml	Not detected	Not detected	Not detected	1.0
Lactic acid microorganisms, CFU g <sup>-1</sup>	2.0×10 <sup>5</sup>	8.0×10 <sup>4</sup>	1.0×10 <sup>5</sup>	5.0×10 <sup>4</sup>
Yeast, CFU g <sup>-1</sup>	3.0×10 <sup>6</sup>	5.0×10 <sup>4</sup>	3.0×10 <sup>6</sup>	3.0×10 <sup>6</sup>
Mold, CFU g <sup>-1</sup>	8.0×10 <sup>1</sup>	2.5×10 <sup>2</sup>	9.0×10 <sup>1</sup>	Not detected

The yeast in the rumen stimulates the growth of bacteria utilizing strong organic acids, which helps to maintain normal pH in the rumen. Thus, optimal digestion conditions are created, and acidosis is prevented. The number of yeast in the rumen of the cows of the first, third and fourth groups was 3.0×10<sup>6</sup> CFU g<sup>-1</sup>. In the second group, this indicator amounted to 5.0×10<sup>4</sup> CFU g<sup>-1</sup>.

It should be noted that when cows fed the CattlePro Effect amido-vitamin-and-mineral complex and PassPro Ballans feed stuff, molds are not found in the analysis of the rumen fluid, which indicates the effectiveness of the combined use of these feed products.

## CONCLUSIONS

The best use should be considered the combined use of the CattlePro Effect amido-vitamin-and-mineral complex and PassPro Ballans feed stuff in combination with the basal diet of newly-calved high producing Simmental cows from the 11<sup>th</sup> day after calving for three months (the rate of introduction of the fourth experimental group).

## REFERENCES

- Aristov, A.V., Esaulova, L.A. & Khromova, L.G. 2018. Foreign evaluation of fodders feeding power and ration for in milk cows under conditions of ZAO Manino of the Kalachevsky district of the Voronezh region. *Research Journal of Pharmaceutical, Biological and Chemical Sciences* **9**, 1428–1437.
- Astashova, E.A., Gavrilova, N.B. & Moliboga, E.A. 2017. Prospects of Import Substitution by Extending the Volume of Russian Dairy and Milk-Containing Production. *RevistaEspacios*. **38**(48), pp. 3.
- Basonov, O.A. & Muryanova, E.L. 2014. *Guidelines for conducting laboratory classes and performing independent work for students of the veterinary faculty on the topic "Accounting for milk productivity"* N. Novgorod, 2014, pp- 16.
- Fedorov, R.V. & Fedorova, E.R. 1989. *Bacteriological diagnosis of dysbiosis: Method, recommendations for cadets*. Kazan, 30 pp. (in Russian).
- Filinskaya, O.V. & Kevorkyan, S.A. 2018. Practical methods of monitoring the usefulness of feeding highly productive cows in a modern complex. *Herald of the AIC of the Upper Volga* **44**, 30–36 (in Russian).

- Carder, E.G. & Weiss, W.P. 2017. Short- and longer-term effects of feeding increased metabolizable protein with or without an altered amino acid profile to dairy cows immediately postpartum. *Journal of Dairy Science* **100**, 4528–4538. doi: 10.3168/jds
- Klebaniuk, R., Kochman, G., Kowalczyk-Vasilev, E., Grela, E.R., Bakowski, M. & Kowalczyk-Pecka, D. 2019. Dietary supplementation with glucogenic precursors and fatty acids improves performance and health of periparturient dairy cows. *Animal Production Science* **59**, 109–121. doi: 10.1071/AN16550
- Gaworski, M., Leola, A., Kiiman, H., Sada, O., Kic, P. & Priekulis, J. 2018. Assessment of dairy cow herd indices associated with different milking systems. *Agronomy Research* **16**(1), 83–93. doi: 10.15159/AR.17.075
- Kolesnik, Y.N., Yurina, N.A., Yurin, D.A., Danilova, A.A., Korotky, V.P., Ryzhov, V.A. & Zenkin, A.S. 2018. Development of biohacking elements drawn from the example of cows under stress conditions. *International Journal of Pharmaceutical Research*. **10**, 655–660.
- McDonnell, R.P. & Staines, M.V.H. 2017. Replacing wheat with canola meal and maize grain in the diet of lactating dairy cows: feed intake, milk production and cow condition responses. *Journal of Dairy Research*. **84**, 240–247.
- Migulev, P.I., Schukin, S.I. & Abylkasymov, D.A. 2019. Analysis and Operation Experience of Robotic Milking System. *International Journal of Recent Technology and Engineering (IJRTE)*. **8**, 2073–2076.
- Leso, L., Pellegrini, P. & Barbari, M. 2019. Effect of two housing systems on performance and longevity of dairy cows in Northern Italy *Agronomy Research*. **17**(2), 574–581. doi: 10.15159/AR.19.107
- Niu, M., Appuhamy, J.A.D.R.N., Kebreab, E., Leytem, A.B. & Dungan, R.S. 2016. Effect of dietary crude protein and forage contents on enteric methane emissions and nitrogen excretion from dairy cows simultaneously. *Animal Production Science* **56**, 312–321.
- Omur, A., Aksu, E., Ucar, O., Kirbas, A., Kandemir, F., Kaynar, O. & Dorman, E. 2016. Effects of antioxidant vitamins (A, D, E) and trace elements (Cu, Mn, Se, Zn) on some metabolic and reproductive profiles in dairy cows during transition period *Polish Journal of Veterinary Sciences* **19**, 697–706. doi: 10.1515/pjvs-2016-0088
- Ovsyannikov, A.I. 1976. *Fundamentals of experimental work in animal breeding*. Kolos, Moscow, 304 pp. (in Russian).
- Plokhinskiy, N.A. 1970. *Biometriya*. MSU Publishing House, Moscow, 367 pp. (in Russian).
- Taov, I.K., Kagermazov, Ts.B. & Khuranov, A.M. 2019. Ecological aspects of microelements' and vitamins' salts impact on dairy cows' productivity and reproductive function in mountain territories of KBR In: *International Scientific and Practical Conference AgroSMART – Smart Solutions for Agriculture*. KnE Life Sciences, pp. 362–368.
- Toledo, M.Z., Baez, G.M., Garcia-Guerra, A., Lobos, N.E., Guenther, J.N., Trevisol, E., Shaver, R.D., Wiltbank, M.C. & Luchini, D. 2017. Effect of feeding rumen-protected methionine on productive and reproductive performance of dairy cows. *PLoS ONE*. **12**, C. e0189117. doi: org/10.1371/journal.pone.0189117
- Velikanov, V.I., Klyapnev, A.V., Kharitonov, L.V., Zenkin, A.S. & Kalyazina, N.Y. 2016. The level of metabolic and immunological status of newborn calves under the action of timogen on the body of down-calving cows *Biosciences Biotechnology Research Asia*. **13**, 1247–1252. doi: 10.13005/bbra/2159
- Weatherly, M.E., Pate, R.T., Cardoso, F.C., Rottinghaus, G.E. & Roberti Filho, F.O. 2018. Physiological responses to a yeast and clay-based adsorbent during an aflatoxin challenge in holstein cows. *Animal Feed Science and Technology*. **235**, 147–157. doi: org/10.1016/j.anifeedsci.2017.11.019
- Yadav, C.M. & Chaudhary, J.L. 2010. Effect of feeding protected protein on growth performance and physiological reaction in crossbred heifers. *Indian Journal of Animal Nutrition* **27**(4), 397–403.

- Yurina, N.A., Semenenko, M.P., Kuzminova, E.V., Vlasov, A.B., Konik, N.V., Galicheva, M.S. & Chuprina, E.G. 2019. Increasing economic efficiency of cow milk production in the first phase of lactation. *International Journal of Innovative Technology and Exploring Engineering* **8**, 4072–4074. doi: 10.35940/ijitee.L3634.1081219
- Zang, Y., Silva, L.H.P., Ghelichkhan, M., Whitehouse, N.L., Brito, A.F., Chizzotti, M.L. & Miura, M. 2019. Incremental amounts of rumen-protected histidine increase plasma and muscle histidine concentrations and milk protein yield in dairy cows fed a metabolizable protein-deficient diet. *Journal of Dairy Science*. **102**, 4138–4154. doi: <https://doi.org/10.3168/jds.2018-15780>
- Zenkin, A.S., Kalyazina, N.Y., Eryashev, P.N., Pilgaev, F.P. & Switin, A.I. 2016. Scientific and experimental substantiation of possibility of application of the original drug bio-effective w in bovine leucosis. *Research Journal of Pharmaceutical, Biological and Chemical Sciences*. **7**(2), 1040–1045.
- Zenkin, A.S., Habeeb, D.S., Pilgaev, F.P., Korotky, V.P. & Ryzhov, V.A. 2017. Changes in the indicators of blood in cows during the last month of pregnancy when a phytobiotic preparation is used. *Ecology, Environment and Conservation* **23**(2), 1135–1140.
- Zhou, Z., Loor, J.J., Trevisi, E. & Luchini, D.N. 2017. Differences in liver functionality indexes in periparturient dairy cows fed rumen-protected methionine or choline are associated with performance, oxidative stress status, and plasma amino acid profiles. *Journal of Dairy Science* **100**, 6720–6732. doi: 10.3168/jds.2016-12299

## **Fertilisation with ash from wood and with sewage sludge versus contents of macro-and microelements in the soil following cultivation of *Helianthus tuberosus* L.**

A. Zapałowska<sup>1</sup>, Cz. Puchalski<sup>1</sup>, S. Stankowski<sup>2</sup> and M. Gibczyńska<sup>3,\*</sup>

<sup>1</sup>University of Rzeszow, Department of Bioenergetics, Food Analysis and Microbiology, Zelwerowicza 4, PL35-601 Rzeszów, Poland

<sup>2</sup>West Pomeranian University of Technology in Szczecin, Department of Agroengineering, Papieża Pawła VI 3, PL71-459 Szczecin, Poland

<sup>3</sup>West Pomeranian University of Technology in Szczecin, Department of Bioengineering, Słowackiego 17, PL71-434 Szczecin, Poland

\*Correspondence: [marzena.gibczynska@zut.edu.pl](mailto:marzena.gibczynska@zut.edu.pl)

**Abstract.** The present study investigated the effects produced in the soil by municipal sewage sludge and wood ash applied during the cultivation of Jerusalem artichoke. The impact of the presence of applied the fertilizer materials on changes in soil and a macro- and microelements contents were investigated. The comparative analyses took into account 3 factors; the first factor - 4 levels of wood ash – 0; I–4.28; II–8.57; III–12.85 t ha<sup>-1</sup>, the second factor – 2 levels of sewage sludge – 0; 1 – 30.3 t ha<sup>-1</sup>, the third factor – 2 varieties of Jerusalem artichoke (*Helianthus tuberosus* L.) – Gigant, Albik. Application of the fertilisers did not resulted in significant change in the total contents of phosphorus, potassium and magnesium in soil examined after Jerusalem artichoke was harvested. Application of ash from coniferous trees, with high levels of calcium, resulted in increased total contents of calcium in the soil. Fertilisation of the soil with ash from coniferous trees or with sewage sludge, as well as cultivation of two varieties of Jerusalem artichoke, resulted in a significant increase in the concentrations of cadmium and lead, and produced no effects in the levels of nickel, zinc and copper identified in soil. The above findings, and in particular the fact that the limit values were not exceeded, indicate the possibility of using both sludge and biomass ash for fertilizing Jerusalem artichoke.

**Key words:** wood ash, sewage sludge, macro- and microelements, soil, Jerusalem artichoke.

### **INTRODUCTION**

Owing to its composition, sewage sludge contributes to soil formation by introducing biogenic substances, into the soil. It also contains a variety of nutrients for plants, so it may be used in order to improve growing conditions before a plantation is established, and to increase the growth rate in short rotation plantations (Lazdina et al., 2011). Based on the related EU directive, the Waste Act defines detailed conditions to be followed while using municipal sewage sludge in agriculture (Official Journal L 181/6, 4.7.1986; Journal of Laws 2013 item 21; Journal of Laws 2019 item 1403). Sewage sludge may be used in the cultivation of plants, for compost production, and in

the farming of crops not intended as food, or for the production of animal feed, as well as for land remediation, including the restoration of agricultural land. One such plant is the Jerusalem artichoke (*Helianthus tuberosus* L.) which may be utilised in the production of biogas and ethanol. Due to the high yielding potential and versatile utility value of biomass, Jerusalem artichoke has a chance to become an alternative source of energy. Tubers can be used for the production of bioethanol or for methane fermentation; the aboveground part can be used for the production of biomethane, (Sawicka et al., 2020).

The presence of microelements (e.g., Cu, Fe, Zn), which function as catalysts in the physiological processes occurring in plants, is an important factor affecting the development and growth of crops. On the other hand, some of these elements, i.e. Hg, Pb occurring in a dissolved form in sewage sludge, co-precipitated with metal oxides and adsorbed or associated with biological residues, are hazardous toxic substances (De la Guardia & Morales-Rubio 1996; Milik et al., 2016). Furthermore, the application of wood ash from known sources must not increase the contents of heavy metals in the soil to levels exceeding the norms (Pitman 2006; Libiete et al., 2016)

Currently based on the Decision issued by the Commission of the European Communities, on 3 May 2000 regarding the waste catalogue, sludges from the treatment of urban waste water are marked with the code 19 08 05, (Official Journal L 226, 6.9.2000). As regards the agricultural use of municipal sewage sludge the main hazards are linked with the high quantities of heavy metals; their permissible concentrations are defined in the Ordinance of the Minister of Environment dated 6 July 2015 regarding municipal sewage sludge. According to the ordinance of the Minister of the Environment on municipal sewage sludge, according to which a single dose of sewage sludge, allowed once every three years for non-food crops, may not exceed 45 Mg per hectare every 3 years (Journal of Laws 2015 item 257).

Wood ash, as an alternative to calcium fertilisers, is characterised by an alkaline reaction and therefore treatments involving the use of wood ash significantly affect soil pH. Composition of wood is rather stable, with high concentrations of calcium and silicon, and lower contents of phosphorus and potassium (Čepauskienė et al., 2018). Spruce wood ash has been reported to contain: calcium carbonate ( $\text{CaCO}_3$ ), potassium sulphate(VI) ( $\text{K}_2\text{SO}_4$ ), magnesium potassium phosphate ( $\text{K}_2\text{Mg}(\text{PO}_3)_4$ ), manganese potassium phosphide (KMnP) and manganese sulphate(VI) ( $\text{MnSO}_4$ ). Wood ash applied as a fertiliser produces significant changes in the physical and chemical properties of the soil (Libiete et al., 2016). Saletnik & Puchalski (2019) reported that application of wood ash may positively affect the soil, particularly in areas requiring remediation.

The present study investigated the effects on soil by municipal sewage sludge and wood ash applied during the cultivation of Jerusalem artichoke. The impact of the presence of applied the fertilizer materials on changes in soil and a macro- and microelements contents was investigated.

## METHODOLOGY

### Characteristics of the experiment

The experiment was conducted in the village of Ujkowice (49.85° N, 22.72° E), located in the commune of Przemyśl in the Podkarpackie Region of Poland. It was carried out in a field lying fallow for 8 years. The size of the plots was 35 m<sup>2</sup> (7 m × 5 m)

at the start of the experiment, and for harvest were cut to 24 m<sup>2</sup> (6 m × 4 m). The comparative analyses took into account three factors; the first factor - 4 levels of fertiliser use with wood ash - 0; I – 4.28; II – 8.57; III – 12.85 t ha<sup>-1</sup>, the second factor – 2 levels of fertiliser use with sewage sludge – 0; 1 – 30.3 t ha<sup>-1</sup>, the third factor – 2 varieties of *Helianthus tuberosus* L. – Gigant, Albik. In English *Helianthus tuberosus* L. it is called Jerusalem artichoke.

The experiment was carried out in three replications, in accordance with a split plot – split block design.

The soil used in the experiment was classified as heavy loam, agronomic category – heavy soil (total fraction > 0.02 mm – 37.7%) and agricultural usefulness complex IV (USDA, 2006). The physicochemical and chemical parameters of the soil are shown in Table 1.

**Table 1.** Physicochemical and chemical parameters of the soil before the experiment

Parameter	Value	Regulation of the Minister of Environment dated September 1, 2016 on how to assess the pollution of the earth's surface, (Journal of Laws 2016 item 1395)
pH (pH <sub>H2O</sub> )	6.10	
pH (pH <sub>KCl</sub> )	5.58	
Soil salinity g NaCl kg <sup>-1</sup>	0.11	
Unit (mg kg <sup>-1</sup> )		
Available phosphorus	53.2	-
Available potassium	132.7	-
Exchangeable calcium	290.7	-
Available magnesium	124.0	-
Cd	1.30	2–15
Pb	21.5	100–600
Ni	15.4	100–500
Zn	51.9	300–2,000
Cu	14.7	100–600
Cr	22.0	150–1,000
Hg	0.0424	2–4

The soil was characterised by slightly acidic pH (ISO 10390:1997P). The contents of available phosphorus and potassium were at a medium level (Egner et al., 1960). Magnesium contents is classified as high (DIN-R-04020:1994+Azl:2004) (Table 1). The assessment of the total contents of metals in the soil showed that they did not exceed values described as medium. In the light of the applicable laws, the soil was suitable for the use of municipal sewage sludge as a fertiliser (Journal of Laws 2015 item 257). Sewage sludge obtained from the Municipal Treatment Plant in Przemyśl was subjected to fermentation, dehydration and hygienisation with lime. Metal concentrations in the sludge (Table 2) did not exceed the limits specified in the Ordinance of the Minister of Environment regarding municipal sewage sludge (Journal of Laws 2015 item 257). In terms of its chemical composition, the sewage sludge complied with the standard for organic fertilisers, as set forth in the Regulation of the Minister of Agriculture and Rural Development on the implementation of certain provisions of the act on fertilisers and fertilisation (Journal of Laws 2008 No. 119 item 765).

Ash from coniferous trees obtained from the Tartak Olczyk Sp. Z o.o. sawmill in Świdno near Krasocin, was produced from incinerated wood shavings and sawdust of coniferous trees: spruce, pine and larch. The ash was found to have an alkaline pH (9.5).



The tests took into account two varieties of Jerusalem artichoke (*Helianthus tuberosus* L.), Albik and Gigant, intended for the production of biomass for energy related purposes. Tubers of Albik Jerusalem artichoke were purchased in the Dolnośląskie Region, directly from the producer, Emilian Siemsa, and Jerusalem artichoke of the Gigant variety was acquired from Vreeken's Zaden, Voorstraat 448, 3311 CX Dordrecht (the Netherlands).

In the spring of 2013, before the seasonal works were started, and following the germination of Jerusalem artichoke, herbicidal treatments were performed with Roundup 360 SL, at the 3–4 leaf stage of couch grass, at a dose of 3 L ha<sup>-1</sup> + the adjuvant AS 500 SL 1–2 L ha<sup>-1</sup>, followed by Fusilade Super 125 EC (2 dm<sup>3</sup> ha<sup>-1</sup>).

In 2013, before planting, mineral and organic fertilisers were applied to the plot, taking into account the requirements of Jerusalem artichoke (N–100 kg ha<sup>-1</sup>, P–70 kg ha<sup>-1</sup>, K–100 kg ha<sup>-1</sup>). The doses of the respective fertilisers were determined based on the contents of nitrogen and phosphorus in the sewage sludge, the contents of calcium and potassium and the pH value in the wood ash, and the area of the relevant plots (35 m<sup>2</sup>). In order to balance out the dosage of sewage sludge with regard to nitrogen, 35 kg of fresh sludge was applied to the plot. The dose used once in the three years amounted to 105 kg per plot, i.e. 30 t ha<sup>-1</sup>. The dosage of wood ash was determined based on the potassium content in the ash. The following doses of wood ash were applied: 0; 4.28; 8.57 and 12.85 t ha<sup>-1</sup>. The potassium fertiliser, i.e. ash from wood biomass, was spread on the plots, and mixed with soil with the use of a tiller. The sewage sludge was spread into the soil in spring 2013, before the tubers of Jerusalem artichoke were planted. Only two of the above fertilizers were used in the experiment.

### Methodology of chemical analyses

Samples of the soil, acquired from each plot after harvest of the Jerusalem artichokes, were collected with Egner–Riehm's sampling stick at a depth of 0–20 cm in conformity with the applicable standard (DIN-R-04031:1997). The air-dry soil samples were analysed. Soil reaction (pH<sub>H2O</sub> and pH<sub>KCl</sub>) was determined with potentiometrically (ISO 10390/1997). Available phosphorus and potassium in the soil were identified using the Egner-Riehm method based on extraction of calcium lactate and lactic acid with buffer solution characterised by a pH value of 3.55 (Egner et al., 1960). The contents of available magnesium were measured using soil extraction with a solution of calcium chloride with a concentration of 0.0125 mol CaCl<sub>2</sub> dm<sup>-3</sup>, (DIN-R-04020:1994+Azl:2004).

**Table 2.** Physicochemical and chemical parameters of the municipal sewage sludge from the Municipal Treatment Plant in Przemysł, and ash from coniferous trees from the Tartak Olczyk Sp. Z o.o. Świdno sawmill

Parameter	Sewage sludge	Ash
pH (pH <sub>H2O</sub> )	7.4	9.5
Dry mass (%)	23.6	-
Unit (% d.m).		
Organic matter	52.8	
N	4.24	-
P	1.60	0.60
K	0.20	2.34
Ca	2.80	20.6
Mg	0.64	1.14
Unit (mg kg <sup>-1</sup> d.m)		
Cd	1.60	11.6
Pb	42.7	13.1
Ni	61.2	11.4
Zn	1053	280
Cu	171.5	134
Cr	61.2	125
Hg	1.33	0.013

The contents of exchangeable calcium in the soil were determined using soil extraction with barium chloride with pH = 8.1 (ISO 11260:2011). In order to measure the overall contents of elements, the soil was subjected to mineralisation in a mixture of nitric(V) acid (HNO<sub>3</sub>) and chloric(VII) acid (HClO<sub>4</sub>), subsequently a chemical assay was conducted using ICP-OES 6500 apparatus. The assessment applied Echelle-type optics with a semiconductor CID detector with a resolution of 200 nm, and an element spectrum in the range of 166–847 nm.

Statistical analysis of the findings was based on three-way analysis of variance, with a split-plot split-block design in 2013 and 2014; number of replications  $n = 3$ . Multiple comparison of the means was performed using Tukey's test, at a significance level  $\alpha = 0.05$ . The analyses were carried out using STATISTICA v.12 software.

### **Climatic conditions**

According to the data obtained from the Institute of Meteorology and Water Management in Warsaw, mean total precipitation in the Podkarpackie Region in 2013 was lower (580 mm) than the multiannual mean (610 mm), and in 2014 it was slightly higher (640 mm). The mean air temperature during the first and second vegetation season was similar (11.2 °C and 11.3 °C, respectively), and it was slightly higher than the multiannual mean (10.6 °C). During the initial vegetation period (April – May) as well as at its peak (June – August) the mean monthly air temperatures were similar to the multiannual mean values. In June 2013 and July 2014 there was heavy rainfall (140 mm and 120 mm). During the remaining months precipitation was significantly lower. The temperatures observed from October to December were higher than the multiannual mean, on average by 2 °C. In 2014 the mean air temperature of 11.3 °C exceeded the multiannual mean by 0.7 °C. The high temperature in November and December supported continued vegetation growth, and did not pose any significant hazard for the wintering plants. During the first decade of January the high temperature promoted continued vegetation growth of the plants. Later during the same month, the increased mean diurnal temperature of the air resulted in intensified physiological processes occurring in the plants. The mellow and sunny weather in March removed excess moisture from the fields and warmed up the soil. The weather conditions in April were also favourable for agriculture. Warm and sunny weather during the month promoted rapid growth of the plants. In May the agrometeorological conditions were differently. As a result of a cold spell, the pace of plant growth and maturation was slower. The frequent and heavy rainfall during the month led to excessive hydration of the soil. The warm days in the first and second decade of June promoted plant growth and a cold spell during the third decade resulted in transient slowing down of plant maturation. The rainfall observed throughout the month of July beneficially affected the level of moisture in the surface layer of the soil as well as the growth and development of root crops.

## **RESULTS AND DISCUSSION**

### **Macroelements in the soil**

Owing to the ten times higher concentrations of potassium and calcium in ash, compared to sewage sludge, the former may effectively be used as an additional source of these macroelements. In 2013 the soil from the experiment was analysed and shown

to have total contents of phosphorus amounting to 1 g P kg<sup>-1</sup> soil (Table 3, 4, 5). Application of sewage sludge and ash from coniferous trees did a change significantly contents of the element in the soil. As an exception, the soil in which the Albik Jerusalem artichoke was grown contained significantly more phosphorus compared to the soil in which the Gigant variety was cultivated. After the experiment ended, in 2014, more uniform results were observed as regards available phosphorus concentrations in the soil; the mean value amounted to 0.60 g P kg<sup>-1</sup> and no effects were produced by either of the fertilisers or the Jerusalem artichoke varieties.

**Table 3.** Effect of fertilisation with wood ash on the contents of total and available forms of macroelements in the soil

Year	Element	Ash doses (t ha <sup>-1</sup> )				LSD <sub>0.05</sub>
		0	4.3	8.6	12.8	
		Total form (g kg <sup>-1</sup> soil)				
2013	P	1.00 ± 0.095*	1.08 ± 0.089	1.22 ± 0.099	1.11 ± 0.092	n.s.
	K	2.91 ± 0.13	3.27 ± 0.14	3.17 ± 0.12	3.37 ± 0.15	n.s.
	Ca	3.01 ± 0.16	3.23 ± 0.17	4.030 ± .18	4.87 ± 0.19	1.052
	Mg	3.43 ± 0.13	3.67 ± 0.12	3.42 ± 0.13	3.57 ± 0.14	n.s.
2014	P	0.597 ± 0.076	0.658 ± 0.068	0.612 ± 0.059	0.543 ± 0.066	n.s.
	K	2.35 ± 0.12	2.24 ± 0.11	2.35 ± 0.11	2.29 ± 0.10	n.s.
	Ca	2.10 ± 0.067	2.35 ± 0.073	2.63 ± 0.069	3.04 ± 0.072	0.571
	Mg	2.47 ± 0.10	2.42 ± 0.11	2.60 ± 0.12	2.52 ± 0.11	n.s.
		Available form (mg kg <sup>-1</sup> soil)				
2014	P	33.7 ± 2.40	47.4 ± 2.60	64.3 ± 2.70	79.52.90	11.5
	K	115 ± 9.00	151 ± 9.20	178 ± 10.3	222 ± 11.0	21.4
	Mg	136 ± 6.70	149 ± 6.20	147 ± 6.50	161 ± 6.80	n.s.
pH (pH <sub>H2O</sub> )						
2014		5.58 ± 0.32	5.58 ± 0.34	5.90 ± 0.31	6.28 ± 0.36	n.s.

n.s. – no significant difference; \*Standard deviation.

Analysis of the effects produced by the fertilisers shows a notable impact of sewage sludge resulting in increased contents of total potassium in the soil treated with that material at the end of the first year. Like in the case of phosphorus, the soil in which the Albik variety of Jerusalem artichoke was grown had higher total contents of potassium, with a difference of 0.68 g K kg<sup>-1</sup> soil. At the end of the second year of the experiment there was no difference in the potassium contents in the soil in relation to the treatment with either sewage sludge or wood ash; the concentrations were in the range of 2.24–2.35 g K kg<sup>-1</sup> soil (Table 3, 4, 5).

Ash from the wood of coniferous trees contained far less magnesium (only 1.14%) than calcium, and incorporation of the material into the soil produced no significant effects on magnesium levels in the soil during the two years of the experiment (Table 3, 4). Like in the case of total phosphorus and potassium in 2013, the soil in which the Albik variety of Jerusalem artichoke was grown contained on average 4.0 g Mg kg<sup>-1</sup> soil, i.e. significantly more than the soil in which the Gigant variety was cultivated. The different levels of these macroelements in the soil, relative to the variety grown, can be explained by the higher yield of tubers in the case of the Gigant variety.

Application of the fertilisers essentially did not produce a change in the contents of the above macroelements in the soil as they were collected by the growing Jerusalem artichoke.

Owing to the 20% content of calcium in the wood ash, the soil was found with increased overall concentrations of calcium, which were maintained until the end of the experiment. In 2013 the mean concentration of calcium amounted to 3.78 g Ca kg<sup>-1</sup> of soil, which shows the soil was rich in calcium (Table 3).

It should be noted that a comparative analysis of the data from the two years outlining the concentration of phosphorus, potassium, calcium and magnesium in the soil shows lower levels of these elements in the second year, which would indicate a high uptake of these elements by cultivated Jerusalem artichoke.

Available forms of the macroelements more accurately reflect their availability to plants; therefore the related literature contains far more studies investigating the impact of soil enhancements on changes in soil fertility and the contents of these elements (Kulczycki 2012; Piekarczyk, 2013; Niu & Hao 2017; Stankowski 2018).

The soil from the experiment contained 53.2 mg P kg<sup>-1</sup> which means it had a moderate content of available phosphorus. The ash applied as a fertiliser contained 0.60% phosphorus, resulting in increase of the concentration of the available form of this macroelement in the soil after the experiment. Application at a dose of 12.8 t ha<sup>-1</sup> resulted in a content of 79.5 mg P kg<sup>-1</sup> soil, which represents a high concentration of available phosphorus in the soil (Egner et al., 1960). Cruz-Paredes et al., (2017) grew barley on loamy sand, obtained results showing that application of biomass ash as a fertiliser may be an appropriate strategy for retaining available phosphorus in agricultural soil.

Analysis of the changes in available potassium levels in the soil showed the effects of the ash from coniferous trees incorporated into the soil. At the start of the experiment the content of available potassium amounted to 133 mg K kg<sup>-1</sup> soil, and at the end the soil from the plots where ash was applied at a rate of 12.8 t ha<sup>-1</sup> was found with 222 mg K kg<sup>-1</sup> soil (Table 3). The fact, that the ash from coniferous trees contained 2.34% potassium, as a result of which the soil, initially with a high content of potassium, after the experiment could be classified as soil with a very high concentration of potassium (Egner et al., 1960). Piekarczyk et al. (2011) assessed soil treatment involving the use of ash from rapeseed straw and reported that the material was particularly useful as a potassium fertiliser. Likewise, Saletnik & Puchalski (2019) established that by using wood ash at an adequately selected dose, it is possible to enhance the chemical

**Table 4.** Effect of fertilisation with sewage sludge on the contents of total and available forms of macroelements in the soil

Year	Element	Sludge doses (t ha <sup>-1</sup> )		LSD <sub>0.05</sub>
		0	30.3	
Total form (g kg <sup>-1</sup> soil)				
2013	P	1.10 ± 0.096*	1.08 ± 0.092	n.s.
	K	2.98 ± 0.081	3.38 ± 0.090	0.127
	Ca	4.08 ± 0.17	3.49 ± 0.16	n.s.
	Mg	3.71 ± 0.12	3.33 ± 0.11	n.s.
2014	P	0.618 ± 0.72	0.587 ± 0.68	n.s.
	K	2.30 ± 0.11	2.31 ± 0.12	n.s.
	Ca	2.56 ± 0.078	2.50 ± 0.076	n.s.
	Mg	2.54 ± 0.11	2.46 ± 0.11	n.s.
Available form (mg kg <sup>-1</sup> soil)				
2014	P	49.6 ± 2.8	62.9 ± 2.6	n.s.
	K	160 ± 9.9	173 ± 10.2	n.s.
	Mg	147 ± 6.3	149 ± 6.2	n.s.
pH (pH <sub>H2O</sub> ) 6.2				
2014		5.83 ± 0.30	5.85 ± 0.31	n.s.

n.s. – no significant difference; \*Standard deviation.

characteristics of the soil, including its pH and the contents of available forms of macroelements.

Prior to the experiment, the soil was found to have available magnesium amounting to 124.0 mg Mg kg<sup>-1</sup> of soil. Despite the fact that the ash from coniferous trees contained 1.14% magnesium, after two years of the experiment no effect of the fertiliser was identified in the contents of the available form of this macroelement in the soil (Table 3).

No significant effects on soil pH or contents of available forms of the above macroelements in the soil were produced in the experiment by fertilisation with sewage sludge or by the variety of Jerusalem artichoke grown (Table 4, 5). The ash from coniferous trees applied in the experiment was characterised by a pH of 9.5. This resulted in alkalisation of the soil treated with ash, proportionate to the dose of ash applied; the effect was maintained after the experiment ended (Table 3). Using a dose of 12.8 t ha<sup>-1</sup> a soil pH of 6.28 was obtained, which classifies it as slightly acidic soil (ISO 10390: 1997P). The increase in soil richness in potassium and its alkalization as a result of using wood ash is a topic of research in many countries (Pels et al., 2005; Gibczyńska et al., 2007; Shen et al., 2008).

**Table 5.** Effect of Jerusalem artichoke cultivation on the contents of total and available forms of macroelements in the soil

Year	Element	Variety		LSD <sub>0.05</sub>
		Gigant	Albik	
Total form (g kg <sup>-1</sup> soil)				
2013	P	1.00 ± 0.078	1.18 ± 0.076	0.142
	K	2.84 ± 0.081	3.52 ± 0.093	0.408
	Ca	3.63 ± 0.17	3.94 ± 0.18	n.s.
	Mg	3.02 ± 0.11	4.02 ± 0.14	0.412
2014	P	0.618 ± 0.70	0.5880.64	n.s.
	K	2.27 ± 0.078	2.34 ± 0.068	n.s.
	Ca	2.54 ± 0.15	2.52 ± 0.13	n.s.
	Mg	2.48 ± 0.10	2.52 ± 0.11	n.s.
Available form (mg kg <sup>-1</sup> soil)				
2014	P	54.0 ± 3.0	58.4 ± 2.9	n.s.
	K	162 ± 8.1	172 ± 7.3	n.s.
	Mg	145 ± 6.3	151 ± 6.6	n.s.
Reaction (pH)				
2014		5.77 ± 0.32	5.91 ± 0.32	n.s.

n.s. – no significant difference; \*Standard deviation.

### Microelements in the soil

The Ordinance of the Minister of Environment on soil quality standards and land quality standards specifies limit values for the discussed five metals (Cd, Pb, Ni, Zn, Cu) (Journal of Laws 2002 no. 165 item 1359). Cadmium is not a biologically required element. The threshold value in the case of cadmium defined as 4 mg Cd kg<sup>-1</sup> of soil, (Journal of Laws 2002 nr 165 item 1359), is higher than the level of this element found in the soil at the start of the experiment. The relatively high content of cadmium (11.6 mg Cd kg<sup>-1</sup>) in the ash resulted in a significant increase in cadmium levels in the soil in the plots treated with ash at the highest dose; in the consecutive years the levels amounted to 1.85 and 0.480 mg Cd kg<sup>-1</sup> of soil (Table 6). Indeed, it has most frequently been reported that fertilisation with wood ash leads to an increase in cadmium concentrations in soil. Füzesi et al., (2015) investigated the combined effect of wood ash and ryegrass or mustard cultivation on soil composition and reported that cadmium was the only heavy metal whose concentrations were slightly increased. Faridullah et al., (2017), based on an experiment carried out in two types of soil, reported that charcoal introduced into the soil acted as an adsorbent and effectively reduced cadmium leachability in soil.

It is known that lead is easily absorbed by plants and accumulated in their tissues. The natural soil in which the experiment took place contained 21.5 mg Pb kg<sup>-1</sup> soil. The ash from coniferous trees and the sewage sludge applied in the experiment were found with lead contents of 13.1 and 42.7 mg Pb kg<sup>-1</sup>, respectively (Table 6). The findings of the experiment showed an increase in lead contents produced by all the three factors taken into account, but only in the first year of the experiment. However, the limit value defined as 100 mg Pb kg<sup>-1</sup> of soil (Journal of Laws 2002 no. 165 item 1359) was not exceeded. In the second year there was a decrease in the content of lead in the soil, compared to the initial value.

**Table 6.** Effect of fertilisation with biomass ash in the contents of microelements in the soil

Year	Element	Ash dosage (t ha <sup>-1</sup> )				LSD <sub>0.05</sub>
		0	4.3	8.6	12.8	
mg kg <sup>-1</sup> soil						
2013	Cd	1.29 ± 0.043*	1.35 ± 0.045	1.36 ± 0.046	1.85 ± 0.047	0.064
	Pb	19.1 ± 1.2	22.7 ± 1.3	21.0 ± 1.2	23.3 ± 1.2	1.069
	Ni	17.9 ± 0.82	18.7 ± 0.87	16.8 ± 0.78	17.5 ± 0.80	n.s.
	Zn	64.5 ± 3.3	67.7 ± 3.4	69.4 ± 3.3	58.0 ± 3.5	n.s.
	Cu	15.91.0	16.0 ± 1.1	15.9 ± 0.9	15.8 ± 1.1	n.s.
2014	Cd	0.411 ± 0.026	0.443 ± 0.028	0.462 ± 0.027	0.480 ± 0.021	0.039
	Pb	12.9 ± 1.2	13.7 ± 1.0	13.3 ± 1.2	12.9 ± 1.1	n.s.
	Ni	13.3 ± 0.72	13.3 ± 0.76	14.3 ± 0.81	14.3 ± 0.80	n.s.
	Zn	50.7 ± 3.5	50.4 ± 3.3	53.7 ± 3.2	49.8 ± 3.0	n.s.
	Cu	14.9 ± 1.1	15.0 ± 1.2	15.8 ± 1.1	15.4 ± 1.4	n.s.

n.s. – no significant difference; \*Standard deviation.

**Table 7.** Effects of fertilisation with sewage sludge and Jerusalem artichoke variety on the contents of general and available forms of microelements in the soil

Year	Element	Sludge dosage (t ha <sup>-1</sup> )			Varieties		LSD <sub>0.05</sub>
		0	30.3	LSD <sub>0.05</sub>	Gigant	Albik	
mg kg <sup>-1</sup> soil							
2013	Cd	1.28 ± 0.048*	1.59 ± 0.050	n.s.	1.47 ± 0.047	1.51 ± 0.05	n.s.
	Pb	20.0 ± 1.2	23.0 ± 1.2	1.32	20.5 ± 1.2	22.5 ± 1.2	0.24
	Ni	17.6 ± 0.78	17.9 ± 0.76	n.s.	15.8 ± 0.80	19.7 ± 0.78	1.64
	Zn	64.7 ± 3.4	65.2 ± 3.3	n.s.	64.1 ± 3.5	65.7 ± 3.5	n.s.
	Cu	16.1 ± 1.2	15.7 ± 1.3	n.s.	15.8 ± 1.3	16.0 ± 1.4	n.s.
2014	Cd	0.460 ± 0.26	0.439 ± 0.22	n.s.	0.450 ± 0.23	0.449 ± 0.2	n.s.
					1		
	Pb	13.2 ± 0.98	13.3 ± 0.96	n.s.	13.3 ± 0.90	13.1 ± 0.93	n.s.
	Ni	14.1 ± 0.76	13.5 ± 0.73	n.s.	13.7 ± 0.74	13.9 ± 0.72	n.s.
	Zn	51.4 ± 3.1	50.8 ± 3.0	n.s.	52.7 ± 3.1	49.6 ± 3.2	n.s.
	Cu	15.5 ± 1.1	15.0 ± 1.2	n.s.	15.2 ± 1.2	15.3 ± 1.1	n.s.

n.s. – no significant difference; \*Standard deviation.

Nickel plays an important role in regulating the processes in which free nitrogen is assimilated by soil bacteria. The maximum levels of nickel in the soil from the experiment amounted to 19.7 Ni mg kg<sup>-1</sup> soil in 2013, and to 14.7 mg Ni kg<sup>-1</sup> soil in 2014 (Table 6, 7). The permissible maximum content of nickel in heavy soils is defined as

100 mg Ni kg<sup>-1</sup> soil (Journal of Laws 2002 no. 165 item 1359), while the levels in the soil from the experiment were much lower.

Generally, zinc contents in heavy soils are in the range of 35–75 mg Zn kg<sup>-1</sup> soil (Kabata-Pendias 2011). In the experiment, the contents of zinc in the soil were in a narrower range, from 49.6 to 69.4 mg Zn kg<sup>-1</sup>, and did not exceed the values typically observed in soils in Poland (Table 6 and 7).

The permissible concentration of copper in heavy soils amounts to 150 mg Cu kg<sup>-1</sup> of soil (Journal of Laws 2002 no. 165 item 1359). Throughout the duration of the experiment, copper levels in the soil were ten times lower, amounting to 15 mg Cu kg<sup>-1</sup>.

While analysing the effects of the factors taken into account in the experiment it should be emphasised that the microelements were very stable in the soil. The three factors, i.e. fertilisation with ash from coniferous trees, or with sewage sludge, as well as the different varieties of Jerusalem artichoke grown in the experiment, did not produce a significant change in the concentrations of the three microelements: nickel, zinc and copper, in the soils. Besides the chemical contents of the fertilisers, the above analogy may be explained by the fact that these elements are located in the same period and they occur in the second oxidation state.

A comparison of the data collected during the two years, i.e. the levels of the five microelements in the soil, shows their lower concentrations in the second year, which may suggest that these elements are absorbed in large quantities by growing Jerusalem artichoke, and this is a similar trend to that observed in the case of the macroelements.

## CONCLUSIONS

1. Application of the fertilisers essentially did not produce a change in the total contents of phosphorus, potassium and magnesium in the soil examined after Jerusalem artichoke was harvested.

2. Application of ash from coniferous trees, with high levels of calcium, resulted in increased total contents of calcium in the soil. The soil can be classified as rich in this macroelement.

3. The lower contents of the relevant macroelements and microelements in the soil in the second year of the experiment may reflect the fact that growing Jerusalem artichoke absorbs these elements in large quantities.

4. Out of the three factors in question, only fertilisation with ash from coniferous trees produced a significant increase in the concentration of available phosphorus and potassium in the soil.

5. Fertilisation of the soil with ash from coniferous trees or with sewage sludge, as well as cultivation of different varieties of Jerusalem artichoke, resulted in a significant increase in the concentrations of cadmium and lead, and produced no effects in the levels of nickel, zinc and copper identified in the soil.

6. The above findings, and in particular the fact that the limit values were not exceeded, indicate the possibility of using both sludge and biomass ash for fertilizing Jerusalem artichoke.

**FUNDING.** This research was funded by Minister of Science and Higher Education ‘Regional Initiative of Excellence’ in the years 2019–2022, grant number 026/RID/ 2018/19, loan amount PLN 9,542,500.

## REFERENCES

- Čepauskienė, D., Pedišius, N. & Milčius, D. 2011. Chemical composition of agromass ash and its influence on ash melting characteristics. *Agronomy Research* **16**(2), 357–364. doi.org/10.15159/AR.18.078
- Cruz-Paredes, C. López-García, Á., Rubæk, G.H., Hovmand, M.F., Sørensen, P. & Kjøller, R. 2016. Risk assessment of replacing conventional P fertilizers with biomass ash: Residual effects on plant yield, nutrition, cadmium accumulation and mycorrhizal status. *Science of the Total Environment* **575**, 1168–1176. doi: 10.1016/j.scitotenv.2016.09.194. Epub 2016 Oct 4
- De la Guardia, M. & Morales-Rubio, A. 1996. Modern strategies for the rapid determination of metals in sewage sludge. *Trends in Analytical Chemistry* **15**(8), 311–318. doi.org/10.1016/0165-9936(96)00041-6
- DIN-R-04020:1994/Az1:2004 – Chemical-agricultural analysis of soil. Determination of available magnesium. Poland.
- DIN-R-04031:1997. – Agricultural chemical analysis of soil. Sampling. Poland.
- Egner, H., Riehm, H. & Domingo, W. 1960. Studies on chemical soil analysis as the basis for assessing the nutrient status of the soil. II. Chemical extraction methods for the determination of phosphorus and potassium. *Kungliga Lantbrukshögskolans Annaler* **26**, 199–215 (in German).
- Faridullah, Malik, N., Fareed, I. & Irshad, M. 2017. Reducing the leachability of nitrate, phosphorus and heavy metals from soil using waste material. *Brazilian Journal of Chemical Engineering* **34**(3), 715–726. doi.org/10.1590/0104-6632.20170343s20150617
- Füzesi, I., Heil, B. & Kovács 2015. Effects of Wood Ash on the Chemical Properties of Soil and Crop Vitality in Small Plot Experiments. *Acta Silvatica et Lignatica Hungarica* **11**(1), 55–64. doi.org/10.1515/aslh-2015-0004
- Gibczyńska, M., Meller, E. & Hury, G. 2007. Effect of brown coal ashes on physical properties of light soil. *Zeszyty Problemowe Postępu Nauk Rolniczych* **518**, 53–61 (in Polish).
- ISO 10390:1997P Soil quality – Determination of pH.
- ISO 11260:2011 - Soil quality – Determination of effective cation exchange capacity and base saturation level using barium chloride solution.
- Journal of Laws 2008 No. 119 item 765 – The Ordinance of the Minister of Agriculture and Rural Development on the implementation of certain provisions of the act on fertilizers and fertilizing.
- Journal of Laws 2013 item 21– Act on Waste of 14 December 2012
- Journal of Laws 2015 item 257 – The Ordinance of the Minister of Environment of 6 February 2015 on municipal sewage sludge.
- Journal of Laws 2016 item 1395 – Regulation of the Environment of the Minister of Environment dated September 1, 2016 on how to assess the pollution of the earth's surface.
- Journal of Laws 2019 item 1403 – Act of 4 July 2019 amending the waste act and certain other acts.
- Journal of Laws 2002 no. 165 item 1359 - Regulation of the Minister of Environment of 9 September 2002 on soil and earth quality standards.
- Kabata-Pendias, A. 2011. Trace Elements in Soils and Plants. *Taylor and Francis Group, LLC*, ed. 4, 505 pp.
- Kulczycki, G. 2012. The effect of phosphorus and potassium precision fertilization upon changes in the content of the soluble form of these elements in soil. *Fragmenta Agronomica* **29**(1), 70–82.
- Lazdina, D., Bardule, A., Lazdins, A. & Stola, J. 2011. Use of waste water sludge and wood ash as fertiliser for Salix cultivation in acid peat soils. *Agronomy Research* **9**(1, 2), 305–314.



- Libiete, Z., Bardule, A. & Lupikis, A. 2016. Long-term effect of spruce bark ash fertilization on soil properties and tree biomass increment in a mixed scots pine-Norway spruce stand on drained organic soil. *Agronomy Research* **14**(2), 495–512.
- Milik, J., Pasela, R., Szymczak, M. & Chalamoński, M. 2016. Evaluation of the Physico-chemical Composition of Sludge from Municipal Sewage Treatment Plant. *Annual Set the Environment Protection* **18**, 579–590.
- Niu, L.A. & Hao, J. 2017. Impacts of fertilizer application rates on phosphorus dynamics in salt-affected soil. *Plant Soil Environment* **63**(10), 468–474. doi.org/10.17221/580/2017-PSE
- Official Journal of the European Communities L 181/6, 4.7. 1986. COUNCIL DIRECTIVE of 12 June 1986 on the protection of the environment, and in particular of the soil, when sewage sludge is used in agriculture, 86/278/EEC
- Official Journal of the European Communities, L 226, 06/09/2000. COMMISSION DECISION of 3 May 2000 replacing Decision 94/3/EC establishing a list of wastes pursuant to Article 1(a) of Council Directive 75/442/EEC on waste and Council Decision 94/904/EC establishing a list of hazardous waste pursuant to Article 1(4) of Council Directive 91/689/EEC on hazardous waste. 2000/532/EC, 3–24.
- Pels, J.R., Nie, D.S. & Kiel, J.H.A. 2005. Utilization of ashes from biomass combustion and gasification. Published at *14th European Biomass Conference & Exhibition*, Paris, France, 17.21 October 2005, pp. 1–17.
- Piekarczyk, M., Kotwica, K. & Jaskulski, D. 2011. Effect of spring barley straw ash on the chemical properties of light soil. *Fragmenta Agronomica* **28**(3), 91–99.
- Piekarczyk, M. 2013. Effect of winter wheat straw ash on the some macro- and microelements available forms content in light soil. *Fragmenta Agronomica* **30**(1), 92–98.
- Pitman, R.M. 2006. Wood ash use in forestry – a review of the environmental impacts. *Forestry* **79**(5), 563–588.
- Saletnik, B. & Puchalski, Cz. 2019. Suitability of Biochar and Biomass Ash in Basket Willow (*Salix Viminalis* L.) Cultivation. *Agronomy* **9**(10), 577. doi.org/10.3390/agronomy9100577
- Sawicka, B., Skiba, D., Bienia, B., Kiełtyka-Dadasiewicz, A. & Danilcenko, H. 2020. Jerusalem artichoke (*Helianthus Tuberosus* L.) as energy raw material. In Raupelienė, A. (ed): *proceedings of the 9th International Scientific Conference Rural Development 2019*, pp. 336–342. http://doi.org/10.15544/RD.2019.042
- Shen, J., Zhou, X., Sun, D., Fang, J., Liu, Z. & Li, Z. 2008. Soil improvement with coal ash and sewage sludge: a field experiment. *Environmental Geology* **53**, 1777–1785.
- Stankowski, S., Sobolewska, M., Jaroszewska, A. & Gibczyńska, M. 2018. Influence of biomass ash, lime and gypsum fertilization on macro- and microelement contents in the soil and grains of spring wheat. *Soil Science Annual* **69**(3), 177–183. doi.org/10.2478/ssa-2018-0018
- USDA, 2006. Agriculture-Handbooks United States. *United States Department of Agriculture*, 690 pp.

## Study of correlation among ploidy level and steroid glycoalkaloids content in resistance in cultivated and uncultivated potato species from an *in vitro* genebank

D. Zeka<sup>1,\*</sup>, P. Sedlák<sup>2</sup>, V. Sedláková<sup>2</sup>, P. Vejl<sup>2</sup>, Sh. Fetahu<sup>1</sup>, I. Rusinovci<sup>1</sup> and S. Aliu<sup>1</sup>

<sup>1</sup> Department of Plan Production, Faculty of Agriculture and Veterinary, University of Prishtina, Bul. “Bill Clinton” XK10000 Prishtinë, Republic of Kosovo

<sup>2</sup> Department of Genetic and Breeding, Faculty of Agrobiolgy, Food and Natural Resources, Czech University of Life Sciences Prague, Kamýcká 129, Prague 6 – Suchbátov 21, Czech Republic

\*Correspondence: dukagjin.zeka@uni-pr.edu

**Abstract.** The present research was carried out with the aim to determine the correlation between ploidy level, steroid glycoalkaloids (SGAs) content and resistance against Late blight (*Phytophthora infestans* (Mont.) de Bary), and Colorado potato beetle (*Leptinotarsa decemlineata* (Say)) in cultivated and wild *Solanum* species preserved in the Potato Gene Bank of Czech Republic. In this study 27 species were included which consist of five cultivated and 22 wild species, with a total of 31 genotypes (four species represented by two accessions). In this study 70.97% of genotypes were evaluated as diploid, 3.23% were triploid, 19.35% tetraploid and 6.45% hexaploid as depicted from counting of chromosomes. The highest concentration, of foliage  $\alpha$ -solanine (5,450 mg kg<sup>-1</sup>) and  $\alpha$ -chaconine (9,420 mg kg<sup>-1</sup>) of dry matter was found in the specie *S. yungasense* 00070, whereas lowest 1.1 mg kg<sup>-1</sup> and 2.3 mg kg<sup>-1</sup> in *S. pinnatisectum* 00051, respectively, Tukey’s test of one way *anova* was performed for getting significance from the data obtained and found significant variation among species of steroid glycoalkaloids (SGA) content in dry weight at level of  $P \leq 0.01$ . Leaf damages by *Leptinotarsa decemlineata* under field experiment circumstances were also recorded. *In vitro* study, *S. bulbocastanum* PIS 06-17 and *S. bulbocastanum* 00240 shown resistant to *P. infestans* upon inoculation of aggressive isolates and strong resistance was observed in *S. stoloniferum* 00295, *S. sucrense* 0062 and *S. yungasense* 0070. Nevertheless, there was no correlation of ploidy level, SGA contents and resistance to the CPB ( $r = 0.00$ ) and late blight ( $r = 0.076$ ) found in the investigated *Solanum* species.

**Key words:** *Solanum* species, polyploidy,  $\alpha$ -chaconine,  $\alpha$ -solanine, resistance.

### INTRODUCTION

Genus *Solanum* is one of the largest genera in flowering plants. Ploidy level has been of great importance in the classification and identification of cultivated potatoes (Huamán & Spooner, 2002). Bukasov (1939) was the first who count chromosomes of

the cultivated potatoes and discovered diploids, triploids, tetraploids, and pentaploids and used these data to speculate on their hybrid origins. The evolutionary diversity of the wild species and the comparatively narrow genetic basis of the cultivated potato make *Solanum* species unique materials for breeding (Carputo et al., 2013; Zeka et al., 2015). The potato secondary gene pool consists of the broadest range of wild and primitively cultivated relative species compared to other crop plants (Pavek & Corsini, 2001; Zeka, et al., 2014). Species of the family *Solanaceae* produce a wide spectrum of steroid glycoalkaloids (SGAs). These are secondary metabolites characterized by a bitter taste and toxicity (Friedmann & McDonald, 1997). The two main potato steroid glycoalkaloids are  $\alpha$ -solanine and  $\alpha$ -chaconine, derived from solanidin, which represent approximately 90 - 95% of total glycoalkaloids. Nevertheless, SGAs are always present in potatoes, albeit in varying amounts, and form the plant's inbuilt protection against insects and disease. The influence of potato genotype on total glycoalkaloids (TGA) content in tubers was significant, but the impact of growing conditions or year are insignificant (Skrabule et al., 2010).

Jansky et al. (2009) found significant effect of ploidy in resistance to CPB; where diploid species were most resistant, followed by hexaploids and then tetraploids. Also she postulated that there was no significant difference among two Endosperm balance number (EBN) and four EBN from each other, but they were more susceptible than the one EBN species.

*Phytophthora infestans* is responsible for the late blight disease found in potatoes and tomatoes. *P. infestans* belongs to the oomycetes, a diverse group of deeply branching eukaryotic microorganisms (Kamoun, 2003). Due to their filamentous growth habit, oomycetes had been traditionally classified in the kingdom of fungi. Continuous pathogen population studies describing the contemporary *P. infestans* population are essential in order to advise potato breeders and growers accordingly (Runno-Paurson et al., 2016). Late blight has become a particularly devastating disease worldwide during the past few decades (Goodwin et al., 1994; Klarfeld et al., 2009) limiting potato production.

So far, 11 late blight resistance genes from the wild potato species *Solanum demissum* were introduced into cultivated potato (Gebhardt & Valkonen, 2001).

The aim of this research was to determine correlation between ploidy level, steroid glycoalkaloids content (SGAs), and resistance against Late blight (*Phytophthora infestans* (Mont.) de Bary) and Colorado potato beetle (*Leptinotarsa decemlineata* (Say)) in cultivated and uncultivated *Solanum* species preserved *in vitro* in Potato Gene Bank of Czech Republic. Moreover, use these plant genetic resources for potato breeding programs and developing new interspecific somatic hybrids highly resistant.

## MATERIAL AND METHODS

### Plant Material

Twenty-seven of cultivated and uncultivated botanical species of genus *Solanum* were used as biological material in the research. Origin, taxonomy, and genetic background of *Solanum* species are presented in Table 1. The biological material, single clone of 31 genotypes were obtained from *in vitro* preservation gene bank of Potato Research Institute in Havlíčkův Brod Ltd. than genotypes *in vitro* micropropagated and tested in Department of Genetics and Breeding, FAFNR-CULS.

Ploidy level, glycoalkaloid content and resistance to *P. infestans* was analyzed in three random plants with three replication of each genotype, whereas evaluation of resistance to the Colorado potato was done on five plants with three replications in two consecutive years field experiment.

### **Determination of the Ploidy**

The ploidy of all species was determined according to Zlesak et al. (2005) with minor changes in time procedures. Young long roots tips of 5–10 mm sizes were collected for ploidy determination from the greenhouse after four weeks of seedlings. The roots were carefully pre-washed using distilled water. The root tips were treated using 350  $\mu$ l colchicine 0.3% for 4 hours in room temperature. Fixation of cells was realized by mixture of ethanol 96% and ice acetic acid in ratio of 3:1 in refrigerator (5 °C) overnight and macerated using 1:1 mixture of concentrated HCl and ethanol. Colouring and pressure setting of karyotype was performed on microscopic glass slides as described by (Zlesak et al., 2005), Chromosomes were counted and karotypes documented by means of binocular microscope Olympus BX41TF (Olympus Corporation Tokyo, Japan).

### **Identification and Quantification of Steroid Glycoalkaloids**

The foliage samples were collected and freeze dried for identification and quantification of glycoalkaloids. Total 0.25 g of freeze-dried grinded foliages were used for separation of  $\alpha$ -chaconine and  $\alpha$ -solanine as described by (Crabbe & Fryer, 1980). Extract were purified on Solid Phase Extraction (SPE) column and analyzed by HPLC-MS/MS method as described by (Friedman & McDonald, 1997). Individual glycoalkaloids were identified by their molecular ions and product spectrum and further quantified using external calibration.

### **Resistance assessment**

Symptoms of potato late blight, and resistance to the Colorado potato beetle was recorded by estimating the percentage of damaged leaf from 3<sup>rd</sup> week of June month. The evaluation of symptoms was performed at each week interval.

Potato genotypes samples were grown in the CULS experimental field, plot size for each variety was 5 sqm. Plots were arranged three replications in a random design.

In vitro testing of the potato for partial resistance to *P. infestans* (Hodgson, 1961) was followed. *P. infestans* isolates for the reference were received from Department of Plant Protection and maintained as described by Vleeshouwers et al. (1999). Three highly aggressive isolates overcoming *Solanum demissum* genes R1, R2, R3, R4, R6, R7, R10, and R11 recorded from all the inoculums under study. These Isolates were collected from Valečov (Czech Republic) and labelled as 1/3, 2/1 and 4/1. Inoculation of virulent strains were performed in triplicate on 4 weeks old genotypes on the dorsal surface of leaf. Virulence was studied after 72 hours of inoculation under stereomicroscope. The resistant and partially resistant genotypes were again re-evaluated against other aggressive isolates 2/2, 4/2 and 5/3.

## Statistical Analyses

Mean results of the  $\alpha$ -chaconin,  $\alpha$ -salonine and SGA contents between the species were compared by Tukey's test one-way ANOVA at MINITAB 18, whereas analysis of correlation (r) coefficient of SGA and resistance is done using MINITAB 18 and Microsoft® Excel 2007 software's.

**Table 1.** Origin and taxonomy of *Solanum* species used in this research

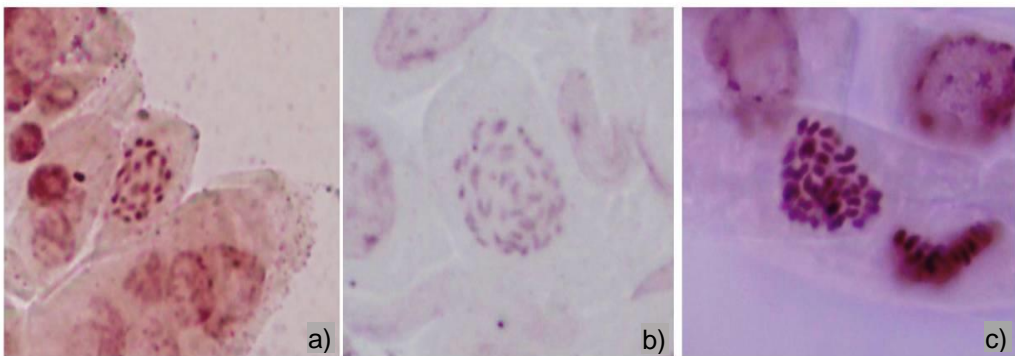
Subsections and series	<i>Solanum</i> species	2n	EBN <sup>4</sup>	Region of origin	Altitude range, m
<u>subsection</u>					
<u>Estolonifera</u>					
<i>Etuberosa</i>	<i>brevidens</i>	24	1	C-S.CHL, S.ARG	< 1,000
<u>subsection</u>					
<u>Potatoe</u>					
super series <i>Stellata</i>					
<i>Bulbocastana</i>	<i>bulbocastanum</i>	24	1	MEX	1,500–2,300
<i>Pinnatisecta</i>	<i>pinnatisectum</i>	24	1	C.MEX	1,800–2,100
<i>Polyadenia</i>	<i>polyadenium</i>	24	1	C.MEX	1,900–2,900
<i>Yungasensa</i>	<i>chacoense</i>	24	2	BOL, ARG, PRY, URY, PER	0–2,350
	<i>yungasense</i>	24	2	N.BOL-S.PER	1,100–1,900
super series <i>Rotata</i>					
<i>Tuberosa</i> (wild)	<i>berthaultii</i>	24	2	BOL	2,000–2,800
	<i>gourlai</i>	24	2	C.BOL-NW.ARG	2,100–3,400
	<i>incamayoense</i>	24	2	NW.ARG	2,100–2,800
	<i>leptophyes</i>	24	2	S.PER, N.BOL	2,500–4,000
	<i>microdontum</i>	24	2	ARG, BOL	1,800–3,100
	<i>mochiquense</i>	24	1	N.PER	250–1,750
	<i>sparsipilum</i>	24	2	C.PER-C.BOL	2,400–4,200
	<i>spgazzinii</i>	24	2	NW.ARG	1,900–3,100
	<i>sucrense</i>	48	4	C.BOL	2,500–4,000
	<i>vernei</i>	24	2	NW.ARG	2,200–2,800
	<i>verrucosum</i>	24	2	MEX	2,400–3,200
<i>Tuberosa</i> (cultivated)	<i>phureja</i>	24	2	VEN, COL, ECU, PER, BOL	1,600–2,800
	<i>goniocalyx</i>	24	2	N.PER-C.BOL	> 3,000
	<i>stenotomum</i>	24	2	C.BOL-C.PER	3,000–3,800
	<i>x chaucha</i>	36	2	PER, BOL, ARG	1,600–3,800
	<i>andigena</i>	48	4	Andes: ARG-MEX	2,000–3,000
<i>Acaulia</i>	<i>acaule</i>	48	2	PER, BOL, NW.ARG	2,600–4,650
<i>Longipedicellata</i>	<i>fendleri</i>	24	2	NW.MEX, SW.USA	1,600–2,800
	<i>polytrichon</i>	48	2	C-NW.MEX	1,800–2,500
	<i>stoloniferum</i>	48	2	C.MEX	1,800–3,000
<i>Demissa</i>	<i>guerreroense</i>	72	4	SW.MEX	2,600–3,000
	<i>demissum</i>	72	4	MEX, GTM	2,650–3,800

<sup>4</sup> (Source: Spooner & Castillo, 1997; Hijmans et al., 2007).

## RESULTS AND DISCUSSION

*Solanum* species shows ploidy from diploid ( $2n = 2x = 24$ ) to hexaploid ( $2n = 6x = 72$ ). Salaman (1926) published first ploidy determination of wild species *Solanum demissum* and *Solanum x edinense*. The diploid level in natural occurred (about 80%) wild *Solanum* species (Carputo & Barone, 2005). Hijmans et al. (2007) compiled a total of 5,447 reports of ploidy determination covering 185 of the 187 species.

Our results on investigated genotypes/species confirmed the expected ploidy level (Table 1). In this study 70.97% of genotypes were evaluated as diploid, 3.23% were triploid, 19.35% tetraploid and 6.45% hexaploid as depicted from counting of chromosomes (Fig. 1). We also obtained similar results with other researchers (Spooner & Castillo, 1997; Hijmans et al., 2007).



© Sedlak, P.

**Figure 1.** Chromosomes, a)  $2n$  *S. polyadenium* 00290; b)  $3n$  *S. x chaucha* 00134 and c)  $4n$  *S. stoloniferum* 00295.

In this study, the highest concentration, of foliage  $\alpha$ -solanine ( $5,450 \text{ mg kg}^{-1}$ ) and  $\alpha$ -chaconine ( $9,420 \text{ mg kg}^{-1}$ ) of dry matter was found in the specie *S. yungasense* 00070, whereas lowest  $1.1 \text{ mg kg}^{-1}$  and  $2.3 \text{ mg kg}^{-1}$  in *S. pinnatisectum* 00051, respectively, Tukey's test of one way *anova* was performed for getting significance from the data obtained and found significant variation among species of steroid glycoalkaloids (SGA) content in dry weight at level of  $P \leq 0.01$  (Table 2). *Solanum* glycoalkaloids are known as insect-deterrent activity, which may offer a valuable alternative to synthetic pesticides in providing natural defence against pests, especially CPB. However, in *S. tuberosum*  $\alpha$ -solanine and  $\alpha$ -chaconine are ineffective against CPB; whereas some accessions of *S. chacoense*, even their total glycoalkaloid content was almost same with other species, showed high resistance to CPB due to their high leptine content (Sinden, et al., 1986). Jansky et al. (2009) postulated that the best sources of CPB resistance seem to be the wild diploid *Solanum* species. Host plant resistance to the CPB has been reported in several other wild *Solanum* relatives (Flanders et al., 1998). Most reports indicated that resistance is due to glandular trichomes or high levels of glycoalkaloids (Jansky et al., 2009). Glandular trichomes provide effective resistance in *Solanum berthaultii* Hawkes (Dimock & Tingey, 1988) and *Solanum polyadenium* Greenm (Gibson, 1976).

**Table 2.** Average steroid glycoalkaloids (SGA) content in dry weight mg kg<sup>-1</sup>

Order	Species	EVIGEZ Code	Foliar glycoalkaloids content		
			$\alpha$ -chaconin	$\alpha$ -solanin	SGA
1	<i>S. acaule</i>	00030	7.3 <sup>J</sup>	4.6 <sup>M</sup>	11.9 <sup>K</sup>
2	<i>S. andigenum</i>	00108	413.0 <sup>I</sup>	152.5 <sup>JK</sup>	565.5 <sup>J</sup>
3	<i>S. berthaultii</i>	00260	19.3 <sup>J</sup>	8.9 <sup>M</sup>	28.2 <sup>K</sup>
4	<i>S. bulbocastanum</i>	00240	2.8 <sup>J</sup>	2.9 <sup>M</sup>	5.7 <sup>K</sup>
5	<i>S. bulbocastanum</i>	PIS06-17	35.5 <sup>J</sup>	23.8 <sup>KLM</sup>	59.3 <sup>K</sup>
6	<i>S. chacoense</i>	00037	4,555.0 <sup>E</sup>	3,220.0 <sup>C</sup>	7,775.0 <sup>E</sup>
7	<i>S. chacoense</i>	00230	6,220.0 <sup>CD</sup>	4,500.0 <sup>B</sup>	10,720.0 <sup>B</sup>
8	<i>S. demissum</i>	00250	7.7 <sup>J</sup>	30.9 <sup>KLM</sup>	38.6 <sup>K</sup>
9	<i>S. fendleri</i>	00275	56.4 <sup>J</sup>	13.2 <sup>LM</sup>	69.6 <sup>K</sup>
10	<i>S. goniocalyx</i>	00109	6,000.0 <sup>D</sup>	3,050.0 <sup>D</sup>	9,050.0 <sup>D</sup>
11	<i>S. gourlai</i>	00045	29.5 <sup>J</sup>	13.1 <sup>LM</sup>	42.6 <sup>K</sup>
12	<i>S. gourlai</i>	00043	7.9 <sup>J</sup>	10.5 <sup>LM</sup>	18.4 <sup>K</sup>
13	<i>S. guerreroense</i>	00280	76.1 <sup>J</sup>	15.0 <sup>LM</sup>	91.1 <sup>K</sup>
14	<i>S. incamayoense</i>	00047	1,595.0 <sup>F</sup>	1,195.0 <sup>G</sup>	2,790.0 <sup>G</sup>
15	<i>S. leptophyes</i>	00048	6,715.0 <sup>B</sup>	3,025.0 <sup>D</sup>	9,740.0 <sup>C</sup>
16	<i>S. microdontum</i>	00049	6,360.0 <sup>C</sup>	3,185.0 <sup>C</sup>	9,545.0 <sup>C</sup>
17	<i>S. mochiquense</i>	00050	695.0 <sup>H</sup>	477.5 <sup>I</sup>	1,172.5 <sup>I</sup>
18	<i>S. phureja</i>	00308	120.0 <sup>J</sup>	62.9 <sup>KLM</sup>	182.9 <sup>K</sup>
19	<i>S. pinnatisectum</i>	00051	2.3 <sup>J</sup>	1.1 <sup>M</sup>	3.4 <sup>K</sup>
20	<i>S. polyadenium</i>	00290	70.7 <sup>J</sup>	33.6 <sup>KLM</sup>	104.3 <sup>K</sup>
21	<i>S. polytrichon</i>	00053	4,595.0 <sup>E</sup>	2,210.0 <sup>E</sup>	6,805.0 <sup>F</sup>
22	<i>S. sparsipillum</i>	00071	4,570.0 <sup>E</sup>	1,955.0 <sup>F</sup>	6,525.0 <sup>F</sup>
23	<i>S. spgazzini</i>	00060	66.9 <sup>J</sup>	36.5 <sup>KLM</sup>	103.4 <sup>K</sup>
24	<i>S. stenotomum</i>	00212	643.5 <sup>HI</sup>	138.5 <sup>JKL</sup>	782.0 <sup>J</sup>
25	<i>S. stoloniferum</i>	00295	1,285.0 <sup>G</sup>	240.5 <sup>J</sup>	1,525.5 <sup>HI</sup>
26	<i>S. sucrense</i>	00062	1,071.5 <sup>G</sup>	777.0 <sup>HI</sup>	1,848.5 <sup>H</sup>
27	<i>S. vernei</i>	00069	18.1 <sup>J</sup>	10.2 <sup>LM</sup>	1,848.5 <sup>H</sup>
28	<i>S. vernei</i>	00234	5.4 <sup>J</sup>	2.4 <sup>M</sup>	7.8 <sup>K</sup>
29	<i>S. verrucosum</i>	00299	4,540.0 <sup>E</sup>	2,120.0 <sup>EF</sup>	6,660.0 <sup>F</sup>
30	<i>S. x chaucha</i>	00134	118.0 <sup>J</sup>	72.5 <sup>KLM</sup>	190.5 <sup>K</sup>
31	<i>S. yungasense</i>	00070	9,420.0 <sup>A</sup>	5,450.0 <sup>A</sup>	14,870.0 <sup>A</sup>
	Mean		1,913.61	1,034.78	2,948.39
	F		4,474.80**	5,763.39**	5,667.58**
	LSD <sub>0.05</sub>		113.53	56.33	156.85
	LSD <sub>0.01</sub>		149.19	74.03	206.15

\*Means that do not share a letter are significantly different according to Tukey's test ( $P \leq 0.01$ ).

Regarding to the *P. infestans* resistance, in field susceptibility was not recorded; however, under laboratory test *S. bulbocastanum* 00240 and *S. bulbocastanum* PIS 06-17 were fully resistant upon inoculation of aggressive isolates. Strong resistance observed also in *S. stoloniferum* 00295, *S. sucrense* 00062 and *S. yungasense* 00070. The isolates were fully virulent to most of tested species/genotypes and presented in Table 3, Fig. 2).

**Table 3.** *Solanum* genotypes evaluation of resistance to *Phytophthora infestans*

Order	Species	EVIGEZ Code	Isolates					
			1/3	2/1	4/1	2/2	4/2	5/3
1	<i>Solanum acaule</i>	00030	+	+	+	+	+	+
2	<i>S. andigenum</i>	00108	+	+	+	+	+	+
3	<i>S. berthaultii</i>	00260	+	+	+	+	+	+
4	<i>S. bulbocastanum</i>	00240	-	-	-	-	-	-
5	<i>S. bulbocastanum</i>	PIS 06-17	-	-	-	-	-	-
6	<i>S. chacoense</i>	00037	+	+	+	+	+	+
7	<i>S. chacoense</i>	00230	+	+	+	+	+	+
8	<i>S. demissum</i>	00250	+	+	+	+	+	+
9	<i>S. fendleri</i>	00275	+	+	+	+	+	+
10	<i>S. goniocalyx</i>	00109	+	+	+	+	+	+
11	<i>S. gourlai</i>	00045	+	+	+	+	+	+
12	<i>S. gourlai</i>	00043	+	+	+	+	+	+
13	<i>S. guerreroense</i>	00280	+	+	+	+	+	+
14	<i>S. incamayoense</i>	00047	+	+	+	+	+	+
15	<i>S. leptophyes</i>	00048	+	+	+	+	+	+
16	<i>S. microdontum</i>	00049	+	+	+	+	+	+
17	<i>S. mochiquense.</i>	00050	+	+	+	+	+	+
18	<i>S. phureja.</i>	00308	+	+	+	+	+	+
19	<i>S. pinnatisectum</i>	00051	+	+	+	+	+	+
20	<i>S. polyadenium</i>	00290	+	+	+	+	+	+
21	<i>S. polytrichon.</i>	00053	+	+	+	+	+	+
22	<i>S. sparsipillum</i>	00071	+	+	+	+	+	+
23	<i>S. spegazzini</i>	00060	+	+	+	+	+	+
24	<i>S. stenotomum.</i>	00212	+	+	+	+	+	+
25	<i>S. stoloniferum</i>	00295	-	+	-	-	-	-
26	<i>S. sucrense</i>	00062	-	-	+	-	-	-
27	<i>S. vernei</i>	00069	+	+	+	+	+	+
28	<i>S. vernei</i>	00234	+	+	+	+	+	+
29	<i>S. verrucosum.</i>	00299	+	+	+	+	+	+
30	<i>S. x chacha.</i>	00134	+	+	+	+	+	+
31	<i>S. yungasense</i>	00070	-	-	+	-	+	-

+ = virulent; - = resistant.

It is interesting to note that diploid genotypes *S. bulbocastanum* PIS 06-1 and *S. bulbocastanum* 00240 had low content of foliage SGA but were fully resistant to the late blight, whereas *S. yungasense* 0070 showed strong resistance and had very high level of foliage SGA. So, there was a very weak correlation ( $r = 0.076$ ) of foliage SGA contents and resistance to the *P. infestans* (Fig. 3) and less correlation was obtained regarding to the ploidy level and resistance ( $r = 0.014$ ).



© Zeka, D.

**Figure 2.** *Phytophthora infestans*; isolate 1/3 in *S. mochiquense* 00050.





- Gebhardt, C. & Valkonen, J. P. T. 2001. Organization of genes controlling disease resistance in the potato genome. *Annual Review of Phytopathology* **39**, 79–102.
- Gibson, R.W. 1976. Glandular hairs of *Solanum polyadenium* lessen damage by the Colorado potato beetle. *Annals of Applied Biology* **82**, 147–150.
- Goodwin, S.B., Cohen, B.A. & Fry, W.E. 1994. Panglobal distribution of a single clonal lineage of the Irish potato famine fungus. *Proceedings of the National Academy of Sciences of the USA* **91**, 11591–11595.
- Hijmans, R.J., Gavrilenko, T., Stephenson, S., Bamberg, J., Salas, A. & Spooner, D.M. 2007. Geographical and environmental range expansion through polyploidy in wild potatoes (*Solanum* section *Petota*). *Global Ecology and Biogeography* **16**, 485–495.
- Hodgson, W.A. 1961. Laboratory testing of the potato for partial resistance to *Phytophthora infestans*. *American Potato Journal* **38**, 259–264.
- Huamám, Z. & Spooner, D.M. 2002. Reclassification of landrace populations of cultivated potatoes (*Solanum* Sect. *Petota*). *American Journal of Botany* **89**, 947–965.
- Jansky, S.H., Simon, R. & Spooner, D.M. 2009. A Test of Taxonomic Predictivity: Resistance to the Colorado Potato Beetle in Wild Relatives of Cultivated Potato. *Journal of Economic Entomology* **102**, 422–431.
- Kamoun, S. 2003. Molecular genetics of pathogenic oomycetes. *Eukaryotic Cell* **2**, 191–199.
- Klarfeld, S., Rubin, A.E. & Cohen, Y. 2009. Pathogenic Fitness of Oosporic Progeny Isolates of *Phytophthora infestans* on Late-Blight-Resistant Tomato Lines. *Plant Disease* **93**, 947–953.
- Pavek, J.J. & Corsini, D.L. 2001. Utilization of Potato Genetic Resources in Variety Development. *American Journal of Potato Research* **78**, 433–441.
- Runno-Paurson, E., Kiiker, R., Aav, A., Hansen, M. & Williams, I.H. 2016. Distribution of mating types, metalaxyl sensitivity and virulence races of *Phytophthora infestans* in Estonia. *Agronomy Research* **14**, 220–227.
- Salaman, R.N. 1926. Potato varieties. In: Hijmans, R.J., Gavrilenko, T., Stephenson, S., Bamberg, J., Salas, A., Spooner, D.M. 2007. Geographical and environmental range expansion through polyploidy in wild potatoes (*Solanum* section *Petota*). *Global Ecology and Biogeography* **16**, 485–495.
- Sinden, S.L., Sanford, L.L., Cantelo, W.W. & Deahl, K.L. 1986. Leptine glycoalkaloids and resistance to the Colorado potato beetle (Coleoptera: Chrysomelidae) in *Solanum chacoense*. *Environmental Entomology* **15**, 1057–1062.
- Skrabule, I., Grauda, D., Mikelsone, A. & Vasariete, A. 2010. Adaptation of glycoalkaloids detection method for evaluation of Latvian potato genetic resources. *Agronomy Research* **8**, 705–710.
- Spooner, D.M. & Castillo, R.T. 1997. Reexamination of series relationships of South American wild potatoes (*Solanaceae*: *Solanum* sect. *Petota*): evidence from chloroplast DNA restriction site variation. *American Journal of Botany* **84**, 671–685.
- Vleeshouwers, V.G.A.A., van Doijeweert, W., Keizer, L.C.P., Sijpkens, L., Govers F. & Colon, L.T. 1999. A laboratory assay for *Phytophthora infestans* resistance in various *Solanum* species reflects the field situation. *European Journal of Plant Pathology* **105**, 241–250.
- Zeka, D., Sedlák, P., Sedláková, V., Sharma, K. & Vejl, P. 2015. Phenotype and molecular diversity evaluation of some wild 2n *Solanum* species (super series *Rotata*). *Chilean Journal of Agricultural Research* **75**, 147–151.
- Zeka, D., Sedlak, P., Sedlakova, V., Vasek, J., Domkarova, J. & Vejl, P. 2014. cpDNA SSR polymorphism in secondary germplasm of potato maintained in Czech gene bank. *Pakistan Journal of Agricultural Sciences* **51**, 745–750.
- Zlesak, D.C., Thill, C.A & Anderson, N.O. 2005. Trifluralin-mediated polyploidization of *Rosa chinensis minima* (Sims) Voss seedlings. *Euphytica* **141**, 281–290.

## INSTRUCTIONS TO AUTHORS

Papers must be in English (British spelling). English will be revised by a proofreader, but authors are strongly urged to have their manuscripts reviewed linguistically prior to submission. Contributions should be sent electronically. Papers are considered by referees before acceptance. The manuscript should follow the instructions below.

**Structure:** Title, Authors (initials & surname; an asterisk indicates the corresponding author), Authors' affiliation with postal address (each on a separate line) and e-mail of the corresponding author, Abstract (up to 250 words), Key words (not repeating words in the title), Introduction, Materials and methods, Results and discussion, Conclusions, Acknowledgements (optional), References.

### Layout, page size and font

- Use preferably the latest version of **Microsoft Word**, doc., docx. format.
- Set page size to **ISO B5 (17.6 x 25 cm)**, all **margins at 2 cm**. All text, tables, and figures must fit within the text margins.
- Use single line spacing and **justify the text**. Do not use page numbering. Use **indent 0.8 cm** (do not use tab or spaces instead).
- Use font Times New Roman, point size for the title of article **14 (Bold)**, author's names 12, core text 11; Abstract, Key words, Acknowledgements, References, tables, and figure captions 10.
- Use *italics* for Latin biological names, mathematical variables and statistical terms.
- Use single ('...') instead of double quotation marks ("...").

### Tables

- All tables must be referred to in the text (Table 1; Tables 1, 3; Tables 2–3).
- Use font Times New Roman, regular, 10 pt. Insert tables by Word's 'Insert' menu.
- Do not use vertical lines as dividers; only horizontal lines (1/2 pt) are allowed. Primary column and row headings should start with an initial capital.

### Figures

- All figures must be referred to in the text (Fig. 1; Fig. 1 A; Figs 1, 3; Figs 1–3). Use only black and white or greyscale for figures. Avoid 3D charts, background shading, gridlines and excessive symbols. Use font **Arial, 10 pt** within the figures. Make sure that thickness of the lines is greater than 0.3 pt.
- Do not put caption in the frame of the figure.
- The preferred graphic format is Excel object; for diagrams and charts EPS; for half-tones please use TIFF. MS Office files are also acceptable. Please include these files in your submission.
- Check and double-check spelling in figures and graphs. Proof-readers may not be able to change mistakes in a different program.

### References

- **Within the text**

In case of two authors, use '&', if more than two authors, provide first author 'et al.':  
Smith & Jones (1996); (Smith & Jones, 1996);

Brown et al. (1997); (Brown et al., 1997)

When referring to more than one publication, arrange them by following keys: 1. year of publication (ascending), 2. alphabetical order for the same year of publication:

(Smith & Jones, 1996; Brown et al., 1997; Adams, 1998; Smith, 1998)

- **For whole books**

Name(s) and initials of the author(s). Year of publication. *Title of the book (in italics)*. Publisher, place of publication, number of pages.

Shiyatov, S.G. 1986. *Dendrochronology of the upper timberline in the Urals*. Nauka, Moscow, 350 pp. (in Russian).

- **For articles in a journal**

Name(s) and initials of the author(s). Year of publication. Title of the article. *Abbreviated journal title (in italic)* volume (in bold), page numbers.

Titles of papers published in languages other than English, should be replaced by an English translation, with an explanatory note at the end, e.g., (in Russian, English abstr.).

Karube, I. & Tamiya, M.Y. 1987. Biosensors for environmental control. *Pure Appl. Chem.* **59**, 545–554.

Frey, R. 1958. Zur Kenntnis der Diptera brachycera p.p. der Kapverdischen Inseln. *Commentat.Biol.* **18**(4), 1–61.

Danielyan, S.G. & Nabaldiyan, K.M. 1971. The causal agents of meloids in bees. *Veterinariya* **8**, 64–65 (in Russian).

- **For articles in collections:**

Name(s) and initials of the author(s). Year of publication. Title of the article. Name(s) and initials of the editor(s) (preceded by In:) *Title of the collection (in italics)*, publisher, place of publication, page numbers.

Yurtsev, B.A., Tolmachev, A.I. & Rebristaya, O.V. 1978. The floristic delimitation and subdivisions of the Arctic. In: Yurtsev, B. A. (ed.) *The Arctic Floristic Region*. Nauka, Leningrad, pp. 9–104 (in Russian).

- **For conference proceedings:**

Name(s) and initials of the author(s). Year of publication. Name(s) and initials of the editor(s) (preceded by In:) *Proceedings name (in italics)*, publisher, place of publishing, page numbers.

Ritchie, M.E. & Olf, H. 1999. Herbivore diversity and plant dynamics: compensatory and additive effects. In: Olf, H., Brown, V.K. & Drent R.H. (eds) *Herbivores between plants and predators. Proc. Int. Conf. The 38<sup>th</sup> Symposium of the British Ecological Society*, Blackwell Science, Oxford, UK, pp. 175–204.

.....  
**Please note**

- Use ‘.’ (not ‘,’) for decimal point: 0.6 ± 0.2; Use ‘,’ for thousands – 1,230.4;
- Use ‘-’ (not ‘-’) and without space: pp. 27–36, 1998–2000, 4–6 min, 3–5 kg
- With spaces: 5 h, 5 kg, 5 m, 5 °C, C : D = 0.6 ± 0.2;  $p < 0.001$
- Without space: 55°, 5% (not 55 °, 5 %)
- Use ‘kg ha<sup>-1</sup>’ (not ‘kg/ha’);
- Use degree sign ‘°’ : 5 °C (not 5 °C).