

WHAT'S NEW



ATS 1/4" AIR HYDRAULIC RIVETER KIT



- Pulling Force 3,500 lbs (1,603 Kg)
- Rivet Capacity 1/4" aluminum or mild steel
- Stroke Length .55" (14 mm)
- Nosepieces: 3/32" (2.4 mm), 1/8" (3.2 mm), 5/32" (4.0 mm), 3/16" (4.8 mm), 1/4" (6.4 mm)
- Full 1-year warranty

The newest addition to our air riveter line delivers a massive 3,500 lbs of force to effortlessly pull up to 1/4" aluminum and steel rivets. It's made to the same quality standards as all of our other, aviation grade riveters and comes with a full 1 year warranty. The complete package contains the riveter, 2 jaw cases (light duty, and heavy duty), 4 nosepieces, a set of spanners, and a stem deflector for added safety. Great for pulling Cherry, Avdel, and Pop rivets.

ATS8808.....\$149.95

SPARK PLUG TERMINAL LEAD THREAD CHASER



When removing and reinstalling the spark plug, the terminal lead will leave bits of aluminum on the threads that builds up over time. This galling, and any other buildup, must be removed from the end of the spark plug to ensure optimum electrical connectivity. Just run the thread chaser over the threads a couple of times and they will be restored to like new condition. It will clean the threads of both 5/8-24 and 3/4-16 spark plug electrical leads. Made of high speed steel in the USA.

ATS484.....\$29.95

DIMPLE DIE KIT

A complete set of dimples & dies to work with Flush Rivets (AN426) in sizes: 3/32", 1/8", 5/32", and 3/16". Highly polished hardened steel faces are guaranteed not to mar the surface as they produce perfect 100 degree dimples. Includes polyethylene holder.



426DD-KIT\$65.95

ATS PNEUMATIC TANDEM "C" SQUEEZERS



ATS-214C-3



ATS-214CK

This kit features an ATS Tandem C-Squeezer, a 3" yoke, a Longeron yoke, plus a generous 17 piece assortment of dimple dies and squeezer sets (p/n SKT17). There is enough force within this squeezer to squeeze up to 3/16" solid aluminum, or mild steel rivets. The easy-to-use ATS-214C Tandem Squeezer incorporates two pistons to deliver twice the force of a standard squeezer at the same air pressure. It's lightweight, compact, and efficient design is modeled after the industry standard Chicago Pneumatic 0214-C squeezer, and will work with all yokes and accessories compatible with the 0214-C.

CAPACITY	YOKE REACH	YOKE GAP	CLOSED HEIGHT	MAX FORCE
3/16"	3"	1-1/4"	11/16"	6000 lbs

ATS-214CK.....(Complete Tandem Kit)\$769.95

ATS-214C.....(Squeezer Only with 1-1/2" Yoke)\$649.95

ATS-214C-3.....(Squeezer Only with 3" Yoke)\$659.95

ATS PNEUMATIC TANDEM ALLIGATOR SQUEEZERS



ATS-214AK



ATS-214A



A complete ready-to-use kit features the ATS Tandem Alligator Squeezer and our popular 17 piece dimple die and squeezer set assortment (p/n SKT17). The powerful ATS-214A Tandem Alligator Squeezer incorporates two pistons to deliver twice the force of a standard squeezer at the same air pressure. It's modeled after the industry standard Chicago Pneumatic 0214-A squeezer, and will work with all yokes and accessories compatible with it. With enough force to squeeze up to 3/16" solid aluminum, or mild steel rivets, this riveter will easily fit your riveting needs without breaking your budget.

CAPACITY	YOKE REACH	YOKE GAP	CLOSED HEIGHT	MAX FORCE
3/16"	1-1/2"	1-1/4"	11/16"	6000 lbs

ATS-214AK(Complete Kit with 1-1/2" Squeezer)\$769.95

ATS-214A(1-1/2" Alligator Squeezer Only)\$689.95

ATS-214A-3(3" Alligator Squeezer Only)\$735.95

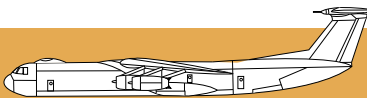

WHAT'S NEW

TITANIUM BONDED SNIP



A leader in the field due to its Titanium Bonding which provides a surface 3x harder than untreated steel. This allows the snip to stay sharper up to 3x longer. Precision ground edges on the blades ensure a tight grip on each cut for superior cutting quality. Corrosion and adhesive resistant. Cuts straight, notches and wide curves. For plumbing, heating, air conditioning and roofing trades. Non-slip cushion handles for comfort and control. Perfect for cutting low carbon cold rolled steel.

- 18476.....(7").....\$15.95
- 18477.....(10").....\$18.95
- 18578.....(12").....\$23.95

DZUS "SNOOPY" DRIVER



This classic tool is a favorite of A&P mechanics. It installs and removes the Dzus fasteners typically found in airplane and race car panels. The distinctive "snoopy" shape comes from the 3 different radii "coin" drives designed to match slots in various 1/4 turn fasteners. Solid wooden handle. Made in the USA by Avery Tools.

different radii "coin" drives designed to match slots in various 1/4 turn fasteners. Solid wooden handle. Made in the USA by Avery Tools.

- AE7810.....\$17.95

MULTI WEDGE INTERIOR AND EXTERIOR PANEL TOOL



Specially designed slim profile on these interior and exterior panel tools. Shaped for many different applications such as removing dashboards, air vents, door panels, door locks, electronic seal controls, seal levels, center consoles, gear shifter and more. High quality nylon material prevents scratches to painted surfaces and delicate panel surfaces.

- 15047.....(3 pc).....\$3.95
- 15048.....(6 pc).....\$8.95

TITANIUM BONDED AVIATION SNIP

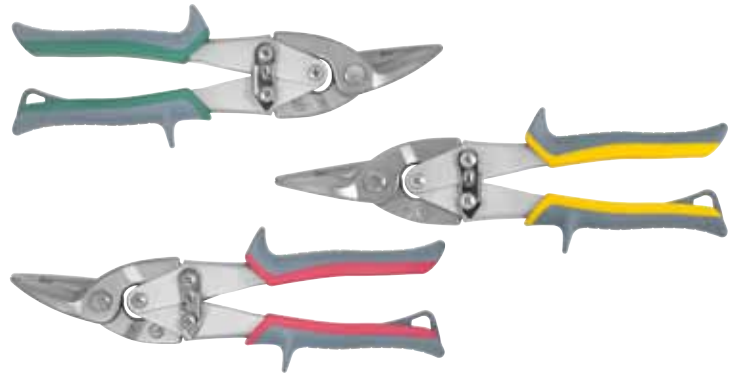

Titanium Bonded Aviation Snips will bite through sheet metal quickly and easily. The blades are 3x harder than untreated steel and will stay sharper longer. Resists corrosion and adhesives. Serrated blades prevent slip-out. Sturdy handles and pivot points. Color coded handles for easy identification of cut type. Heat-induced blades. Integrated steel curl design. Spring-loaded locking mechanism. Cuts sheet metal, Stainless and Aluminum.

- 18423.....(Left Cut)\$16.95
- 18430.....(Straight Cut)\$16.95
- 18421.....(Right Cut)\$16.95

TUNGSTEN BUCKING BARS

AE6001



5/8" long, 1" wide, 4" high. 1.6 lbs Tungsten steel

- AE6001.....\$149.95

AE6004



5/8" long, 1.5" wide, 2" high. 1.2 lbs Tungsten steel

- AE6004.....\$135.95

AE6005



3/4" long, 1.5" wide, 2.5" high. 1.6 lbs Tungsten steel

- AE6005.....\$175.95

AE6006



5/8" long, 5/8" wide, 2" high. 2 lbs Tungsten steel

- AE6006.....\$139.95

AE6007



5/8" long, 1" wide, 1/4" high. 1.3 lbs Tungsten steel

- AE6007.....\$149.95

AE6008



1" long, 1" wide, 2.25" high. 1.4 lbs Tungsten steel

- AE6008.....\$129.95



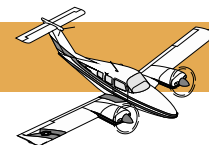

ATS VIDEOSCOPE (WITH RECORDER)



90° Tip Mirror

Magnet

Includes 90 degree mirror and magnet

- Records video and still images on Micro SD cards
- 3.5" high resolution full color LCD display (320x240)
- Takes pictures and videos at 640x480 resolution
- 5mm (0.20") diameter probe fits any access point
- 1 meter (39.4") semi-rigid, "obedient" flexible watertight shaft
- Sealed white LED illumination with intensity control
- Built-in rechargeable battery lasts up to 6 hours
- Includes 90° tip mirror for to extend field of view
- Includes magnetic, and hook tips to retrieve objects

Our new ATS-VS400 takes full advantage of modern videoscope technology to bring you an inspection tool of outstanding quality at a very affordable price. It's based on the popular Autel MV400 scope with adaptations for aviation use, such as a water-tight probe that only 5mm in diameter to get into the tightest confines. The probe is 1 meter long and resists water, fuels, and the solvent effects of brake fluids such as Skydrol and 5606. The camera and 4 bright-white LED lights are completely sealed and do not present any risk of spark when used for inspecting hazardous areas such as fuel tanks. Images and video are easily recorded onto micro SD cards with the push of a button.

The ATS-VS400 VideoScope's small size, coupled with its high resolution camera makes it well suited for any visual inspection task:

- Check out the carburetor without tearing it apart or removing it.
- Examine exhaust baffles for holes (go right up the exhaust pipe)
- Do a detailed inspection of the engine underside fins for cracks.
- Look behind instruments and electrical systems for shorts.
- Do fuselage or wing inspections from a couple of access points

ATS-VS400 (Complete Kit) \$249.95

ATS "INSPECTOR" VIDEO BORESCOPE (WITH RECORDER)



Includes 3 Tip mirrors for maximum view

5mm dia

70°

90°

110°

1m probe



Actual images of a spark plug inside a cylinder taken with the ATS-VS12

- Record and play back still images and video clips on SD cards
- 3.5 " high resolution full color LCD display (320x240)
- Wide camera angle for images with 640x480 resolution
- 5mm (0.20") diameter probe fits spark plug holes
- 1 meter (39.4") semi-rigid, gooseneck IP67 watertight shaft
- 4 bright pure white LEDs with intensity control
- Built-in rechargeable battery lasts up to 6 hours
- Includes 3 tip mirrors: 70° forward oblique, 90° right angle, 110° rear oblique for valve inspections

Thanks to the wonder of digital miniaturization, we now have pin-head-sized video cameras with resolutions over 5X better than the best fiberscopes of a few years ago. The new ATS-VS12 Inspector incorporates this technology to produce a videoscope of superior quality. The ATS-VS12 Inspector has been adapted for aviation use by incorporating a probe that resists not just water and fuels, but also the solvent effects of hydraulic fluids such as Skydrol and 5606. The probe is also shielded to avoid electrical interference with avionics. But the real power of the ATS-VS12 Inspector is its built-in digital recorder that writes video or still pictures directly to an SD card. You can record your inspections in the field and review them at your leisure. No more overlooking critical issues because you were pressed for time. Simply record and review, and you'll never miss spotting a corrosion point or a fracture line again.

ATS-VS12 (Complete Kit) \$599.95

WHAT'S NEW



OIL FILTER TOOL



The Oil Filter Tool was created to assist in removing a stuck filter, without resorting to the traditional hammer, punch, chisel, and or the huge pump plier's methods. Bogert Aviation wanted the tool to be safe in tight quarters and unable to slip, attempting to minimize damage to nearby components. This is still a messy process but this tool will always work to remove stuck filters without damaging anything else.

- BO-10M-OFT** (Up to 1200 in lbs) **\$23.95**
- BO-10M-TALON** (Up to 1500 in lbs) **\$34.95**

CONTROL LOCK



Gusty winds will cause unsecured control surfaces to flail about and control sticks to thrash around inside the cockpit and most certainly will cause damage to your airplane if measures aren't taken to secure them. That's why this lightweight, space-saving control lock is for you. It will quickly lock the control stick in place, thus keeping your ailerons and elevators in a safe and firm position. It's made of quality anodized aluminum and can be locked/unlocked in a few seconds. Installation only takes a few minutes, and complete instructions are included.

- DAS-CL110** (General Aviation) **\$52.95**
- DAS-CL100** (Piper Sport) **\$52.95**
- DAS-CL200** (RV, Cessna, and Cub) **\$52.95**
- DAS-CL212** (RV12) **\$52.95**

V-DRILL GUIDE



The Big Gator Tools V-Drill Guide is like a portable drill press for precision alignment! V-groove along the bottom of the guide allows for perpendicular alignment with all drill sizes on round parts and corners. Bottom surface is precision ground to assure stability and accurate perpendicular alignment on flat surfaces. Guides are made from special nickel alloyed steel that is heat treated for durability. Drill straight - every time!

PART	DESCRIPTION	PRICE
STD2000DGNP	Drill bit sizes: 3/8" to 1/2" 9 Drill sizes – 1/64" increments	\$29.95
STD1000DGNP	Drill bit sizes: 1/8" to 3/8" 17 drill sizes – 1/64" increments	\$24.95
MDG1000NP	Drill bit sizes: 3, 3.3, 3.5, 4, 4.2, 4.5, 5, 5.5, 6, 6.5, 6.8, 7, 7.5, 8, 8.5, 9, 9.5mm	\$24.95
STD500NP	7" Titanium Bonded Side Cut Wire Cutter	\$22.95
MTG500NP	13 Metric Ground Tap Sizes: 1.6, 2, 2.5, 3, 3.5, 4, 5, 6, 8, 10, 12, 14, 16mm	\$22.95
STI-UNC100SNP	10 Unified Coarse Thread sizes: 9/16-12, 1/2-13, 7/16-14, 3/8-16, 5/6-18, 1/4-20, 12/24, 10-24, 8-32, 6-32"	\$22.95
STI-UNF200SNP	9 Unified Fine Thread sizes: 5/8-18, 9/16-18, 1/2-20, 7/16-20, 3/8-24, 5/6-24, 1/4-28, 10-32, 8-36"	\$22.95

SCRAPER SET WITH NON-MARRING BLADES



Don't ever fear about scrapping off the next decal or sticky residue. With these new non-marring blades you can remove items from sheet metal without scratching the surface. 22 piece set.

- 17008** (Scraper Set) **\$12.95**
- 12038** (Non-Marring Blades) **\$3.95**



STINGER® CLASSIC LED HP W/ CHARGER



This compact and extremely powerful all-purpose flashlight is designed for the broadest range of lighting needs at the best value. The Stinger LED is a rechargeable flashlight with a super-bright C4 LED that triples the brightness of a regular LED. Durable and water-resistant materials, for use in extreme conditions, make the rugged Stinger LED flashlight ideal for use in law enforcement, outdoor use, security, fire and rescue, automotive, industrial, and more. The Stinger LED Flashlight also features a multi-function, easy access head mounted On/Off push-button switch with three lighting modes and strobe.

75663.....\$149.95

NIGHT COM® UV LED



Combination white LED/UV LED Multi-mode flashlight. Choose between far-reaching, bright, white light or ultraviolet light for detection of fraudulent documents, or detecting engine and HVAC leaks. Mode selection switch: C4 LED high, C4 LED low, UV LEDs, and Safety. Safety mode prevents the light from coming on when you don't want it to. IPX4 water resistant.

51046.....\$89.95

STRION® LED HL LED FLASHLIGHT



When you need maximum illumination with a wide beam to search a large area the Strion LED HL rechargeable, high lumen flashlight provides a blast of 500 lumens with 200 meters of beam distance. Three modes (high, medium, and low) and strobe. IPX4 water-resistant; 2 meter impact resistance tested.

74751.....\$137.95

PROTAC HL® 2



New technology allows us to put 1,100 lumens in the palm of your hands. The ProTac HL 3 provides extraordinary brightness in a wide beam pattern that lights your entire area. Three selectable programs; high, strobe, low. Durable anodized machined aircraft aluminum construction. Waterproof to 1 meter for 30 minutes.

88031.....\$85.95

STINGER® LED HP W/ CHARGER



This all purpose flashlight is designed for the broadest range of lighting needs at the best value. Multi-function On/Off push-button switch lets you choose three lighting modes and strobe; designed for extremely long life. IPX4 water resistant. Unbreakable poly carbonate lens with scratch-resistant coating. Assembled in the USA.

75711.....\$112.95

PROTAC HEADLAMP 3



Producing 540 lumens of light that reach 172 meters, this powerful device will surpass all others in your toolbox. With 90 degrees of tilting, your neck will not strain for the job required. Three lighting modes with a maximum of 36 hours of running time.

88047.....\$155.95





WHAT'S NEW

MINI ORBITAL DETAIL SANDER



- Free speed 7,500 rpm
- .3HP Air motor
- Pad size 1-1/4" (30 mm)
- Orbit dia .060" (1.5 mm)
- Weight 1.42 lbs (.66 kg)
- Length 6-5/8" (168 mm)

The perfect sander for targeted corrosion removal, spot repair of paint jobs, and general finesse sanding of small areas. Front exhaust allows continuous cooling of gear box which extends the life of the tool. Includes a 1-1/4" (30mm) diameter hook and loop vpad

ATS4115P..... \$59.95

HIGH SPEED PANEL SAW



- Free speed 12,000 rpm
- Weight 1.7 lbs (.77 kg)
- Length 6-7/8" (175 mm)

High speed saw designed to quickly cut through hard materials such as composites, fiberglass, and ceramics. Includes diamond cutting wheel.

ATS8512..... (Includes Diamond Cutting Wheel)..... \$139.95

DIGITAL TORQUE ADAPTER/CALIBRATOR



- 1/2" Drive
- Measures in: Kg-CM, Kg-M, in-lb, ft-lb, and N-m
- Range: 30-150 ft-lbs
- LED backlight
- Swivels 240 degrees
- Screen flips 180 degrees
- 10 Memory settings

This digital torque adaptor is a calibration device for torque wrenches. Use to verify the calibration of any type of torque wrench. Can also be used to convert any ratchet wrench into a digital torque wrench. Includes a calibrating block.

23154..... (1/2" Drive)..... \$57.95

ADJUSTABLE TORQUE SCREWDRIVER SET



Easily adjust torque with interchangeable blades with precision black tip. Features an ergonomic handle with advanced 2-component design. Precision release indicated by acoustic and mechanic signal. 12 piece set including a metal case. Lifetime warranty.

52039..... (5-13in/lbs)..... \$115.95

52041..... (13-26in/lbs)..... \$115.95

52043..... (26-47in/lbs)..... \$115.95

13" HEAVY DUTY HAND RIVETER



This hand riveter features a compound lever action that reduces operator fatigue. With a spent mandrel cup to keep your work area clean, and the ability to pull stainless steel rivets makes it a great addition to your toolbox. For rivets: 1/8, 5/32, 3/16, & 1/4"

15050..... \$44.95

MEGATESTER FLASHLIGHT



MegaTester is a powerful LED flashlight and an electrical continuity tester in one. Use it to light your way to the problem and then separate the removable pocket clip to convert it to a tester, which will locate open circuits, blown fuses, and a thousand other continuity-related electrical problems.

MEGATESTER \$39.95

RIVETING KITS



RANS S-19 KIT



QTY	PART	DESCRIPTION	QTY	PART	DESCRIPTION
1	2078218	NEEDLE NOSE PLIERS	1	BL70104H	DRILL LUBRICANT
1	6LN	NEEDLE NOSE VISE GRIP PLIERS	1	00047	10" FILE
1	E200-003	WIRE STRIPPERS	1	S475	SMALL FILES
1	MKR	SET OF AVIATION SNIPS	1	PRP-26A	CLOSE QUARTERS POP RIVETER
1	5B	ADJUSTABLE FLY CUTTER	1	7971	SOLDERING IRON
1	SP275A	SPEED DEBURRING TOOL	1	ATS8806	PNEUMATIC RIVETER
1	131	CLECO PLIERS	1	ATS6132	RIGHT ANGLE DRILL
1	FP10	FLUTING PLIERS	45	CL-3/16	3/16" CLECOS
1	2078308	SIDE CUTTERS	200	CL-3/32	3/32" CLECOS
6	24EL	SMALL SPRING CLAMPS	200	CL-1/8	1/8" CLECOS
1	HP-2	MARSON HAND RIVETER	20	CL-5/32	5/32" CLECOS
1	001A	CLICK PUNCH	1	UNIBIT-3	UNIBIT 3/4
4	7447	SCOTCH-BRITE PADS	1	UNIBIT-1	UNIBIT 1/2
1	012-50	50 COBALT DRILL BIT	1	013-30	30 6" LONG DRILL BIT
3	012-40	40 COBLAT DRILL BIT	1	013-40	40 6" LONG DRILL BIT
3	012-30	30 COBLAT DRILL BIT	1	014-40	40 12" LONG DRILL BIT
1	012-28	28 COBALT DRILL BIT	1	RMR-1/4	1/4" REAMER
1	012-21	21 COBALT DRILL BIT	1	RMR-3/16	3/16" REAMER
2	050-17	17 CARBIDE DRILL BIT	1	5000-40	40 RIGHT ANGLE COBALT THREADED DRILL BIT
3	012-11	11 CARBIDE DRILL BIT	1	5000-30	30 RIGHT ANGLE COBALT THREADED DRILL BIT
1	FT100	FLANGING TOOL	1	5000-11	11 RIGHT ANGLE COBALT THREADED DRILL BIT
1	21474H	FILE HANDLE	1	19000	TOOL BOX

The Rans-19 kit is so easy to assemble it requires virtually no sheet metal skills, and needs little more than a few hand tools. We've made your task even easier by bringing together all the tools you'll need into one kit, and priced it inside your budget.

RANS-19\$1,195.95



RIVETING KITS

ZODIAC KIT



QTY	PART	DESCRIPTION	QTY	PART	DESCRIPTION
1	012-3/16	3/16" COLBALT DRILL BIT	1	131	CLECO PLIERS
1	012-20	20 COLBALT DRILL BIT	200	CL-1/8	1/8" CLECOS
1	012-30	30 COLBALT DRILL BIT	200	CL-5/32	5/32" CLECOS
1	012-1/4	1/4" COLBALT DRILL BIT	20	CL-3/32	3/32" CLECOS
1	012-5/16	5/16" COLBALT DRILL BIT	1	863X4	LEFT METAL SNIPS
1	012-3/8	3/8" COLBALT DRILL BIT	1	864X4	RIGHT METAL SNIPS
1	ATS6104	REVERSIBLE 3/8" AIR DRILL	1	00024	8" FLAT FILE
1	ATS8806	AIR HYDRAULIC BLIND RIVETER	1	04896N	8" HALF ROUND FILE
1	36021	HAND RIVETER	1	11904	8" ROUND FILE
1	7210	TAPE MEASURE	1	FS01	RIVET FAN SPACING TOOL
1	EZ18	18" STEEL RULER	1	AE6352	EDGE DISTANCE MARKER BLOCK
4	165	WISE GRIP CLAMPS	4	59200	TOGGLE CLAMPS
3	21474H	FILE HANDLES	1	92346	SMART TOOL LEVEL
1	19000	TOOL BOX			

The Zodiac CH 601 (and the new CH 640) series of home-built airplanes from Zenith Aircraft (ZenAir) is a top choice among first-time home builders. It's an all-metal construction that requires few more than a pop riveter and a few alignment tools for the quick-build kits. The tools offered in this kit closely follows ZenAir's recommended tool list for their quick-build kits and gives you just what you need to get the job done.

ZODIAC\$785.95

RIVETING KITS

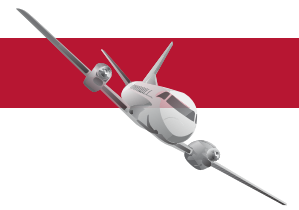

SONEX KIT



QTY	PART	DESCRIPTION	QTY	PART	DESCRIPTION
1	131	CLECO PLIERS	1	11904	ROUND FILE
200	CL-3/32	3/32" CLECOS	1	00024	FLAT FILE
200	CL-1/8	1/8" CLECOS	1	CP7AM	3M SCOTCH BRITE WHEEL
100	CL-5/32	5/32" CLECOS	2	165	C-CLAMP
10	CL-3/16	3/16" CLECOS	1	ATB8362	STANDARD AIRCRAFT HANDBOOK
1	2000-3/8x1/4	30 COUNTERSINK	24	012-40	40 DRILL BITS
1	5102D-1/8	1/8" POP DIMPLE DIE	24	012-30	30 DRILL BITS
1	5102D-3/32	3/32" POP DIMPLE DIE	4	012-21	21 DRILL BITS
1	S3	OFFSET HAND SEAMER	1	20547N	VIXEN FILE
1	863x4	LEFT HAND AVIATION SNIP	1	SP275A	SPEED DEBURRING TOOL
1	864x4	RIGHT HAND AVIATION SNIP	1	FP21	FLUTING PLIERS
1	M14	14" COMBO SNIP	1	ATS8805K	PNEUMATIC POP RIVETER
1	36021	HAND POP RIVETER	1	MARKERS	SHARPIE MARKERS
3	21474H	FILE HANDLES	1	19000	RED TOOLBOX
1	EZ24	24" RULER	1	SP201A	EDGE SCRAPER

This Sonex Kit features the essentials that you will need to build your new airplane. Buying these tools together will save you money and stress, let us get it right for you!

SONEX\$849.95

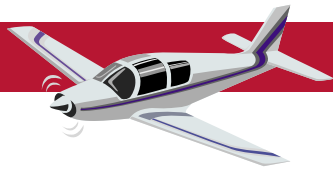

RIVETING KITS

RV BUILDER'S STARTER KIT



QTY	PART	DESCRIPTION	QTY	PART	DESCRIPTION	QTY	PART	DESCRIPTION
1	ATS-3X	ATS 3X PRO RIVET GUN	6	012-40	COBALT DRILL BITS (40)	1	4263DP-2	DIMPLE DIE SET (3/32)
1	113M	E-Z RETAINER SPRING	6	012-30	COBALT DRILL BITS (30)	2	4710-2	SQUEEZER SET FLUSH (1/2)
1	7922R	SWIVEL AIR REGULATOR	1	SP375A	SPEED DEBURRING TOOL	1	2470	BACK RIVET SET
1	181	SWIVEL FLUSH SET (1")	1	131	CLECO PLIERS	1	AE1065	BACK RIVET PLATE
1	470-3-1/8	RIVET SET (AN470, 1/8")	1	36021	SWIVEL POP RIVETER	1	06785	DIMPLE DIE ORGANIZER
1	148	BUCKING BAR (MINI)	1	MARKERS	PERMANENT MARKERS	1	ATB8362	STANDARD AIRCRAFT BOOK
1	133	MICROSTOP COUNTERSINK	30	CL-3/32	CLECOS (3/32)	1	SP2005K	CHIP CHASERS (4" & 8")
1	1000-100-40	PILOT CUTTER (3/32")	10	CL-1/8	CLECOS (1/8)	1	5022-3A	RIVET SQUEEZER
1	10L	WISS SNIP (LEFT & STR)	1	CP7AM	3M CUT & POLISH WHEEL 6"	1	204RV	C-FRAME RIVETING TOOL
1	10R	WISS SNIP (RIGHT & STR)	1	685-1	3M RIVETER'S TAPE	1	CH1	DEAD BLOW HAMMER
1	ATS6104	REVERSIBLE AIR DRILL	1	014-30	1/2" DRILL BIT 30	1	SVB-KIT	DEBURRING SET

This scaled down version of our RV Builder's Kit contains just the tools you need to get your feet wet with sheet metal construction. The kit closely follows the recommended tools list from Van's RV Training Project -1 and their Tool Box Kit projects. This kit is also the minimum recommended set of tools to build the empennage (tail) section of the RV3, RV4, RV7, RV8, RV9, and RV10 series of home built airplanes. Start out with this kit, and when you're ready to do more advanced work, get the upgrade package to take you all the way up to the full RV Builder's Tool Kit.

RVS-2602A.....	(With 2602A 3X Rivet Gun).....	\$749.95
RVS-2X.....	(With ATS Pro 2X Rivet Gun).....	\$769.95
RVS-3X.....	(With ATS Pro 3X Rivet Gun).....	\$775.95
RVK-UPG.....	(Upgrade Package).....	\$799.95

RIVETING KITS

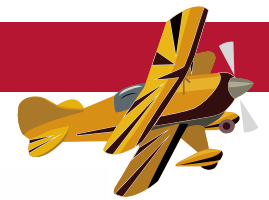

RV-12 QUICK BUILD KIT



QTY	PART	DESCRIPTION	QTY	PART	DESCRIPTION
10	407	"C" CLAMPS (2")	1	TAP-3/8-16	TAP (3/8-16)
4	3203HT	PONY CLAMPS (3")	1	TAP-3/8-24	TAP (3/8-24)
350	CL-1/8	1/8" CLECOS (COPPER)	1	TAP-6-32	TAP (6-32)
50	CL-3/32	3/32". CLECOS (SILVER)	1	12000-KIT	T-HANDLE TAP WRENCH KIT (0 - 1/2")
1	4263DP-2R	DIMPLE & DIE SET (3/32" REDUCED)	1	NB5470	DIGITAL FISH SCALE (0 - 150 LBS)
1	4704-4	SQUEEZER SET, 1/8" UNIVERSAL (1/2" THICK)	1	13807M	TRIANGULAR FILE (6")
1	4264DP-2	DIMPLE AND DIE SET (1/8")	1	09099	MILL FILE (8")
1	4508DP-2	DIMPLE AND DIE SET 8 AN SCREW	1	11904	ROUND FILE (8")
2	4710-2	SQUEEZER SET, FLUSH	1	04896N	HALF-ROUND FILE (8")
1	4710-4	SQUEEZER SET, FLUSH (1/2" THICK)	4	21474H	ERGONOMIC FILE HANDLES
1	012-3	COBALT DRILL BIT (3)	1	42030	JEWELER'S FILES (SET OF 6)
1	012-11	COBALT DRILL BIT (11)	1	PRP-26A	POP BRAND BLIND RIVETER
2	012-12	COBALT DRILL BIT (12)	1	ATSRS-3SD	STAINLESS STEEL 3" RIVET SQUEEZER
1	012-16	COBALT DRILL BIT (16)	1	FP21	FLUTING PLIERS
2	012-19	COBALT DRILL BIT (19)	1	131	CLECO PLIERS
1	012-27	COBALT DRILL BIT (27)	1	HS144	HAND SEAMER
3	012-30	COBALT DRILL BIT (30)	1	KDS85050	TORQUE WRENCH (30 - 200 in-lb)
1	014-30	12" AIRCRAFT EXTENSION DRILL BIT (30)	1	10L	WISS SNIPS (LEFT & STRAIGHT)
1	012-36	COBALT DRILL BIT (36)	1	10R	WISS SNIPS (RIGHT & STRAIGHT)
5	012-40	COBALT DRILL BIT (40)	1	CP-413G	WIRE CRIMPER/STRIPPER
1	012-52	COBALT DRILL BIT (52)	1	CH1	SOFT FACE DEADBLOW HAMMER
1	012-1/4	COBALT DRILL BIT (1/4")	1	212FB	AVIATION FLARING TOOL (37°)
1	012-5/16	COBALT DRILL BIT (5/16")	1	TC1050RH	TUBING CUTTER (RATCHETING)
1	012-11/32	COBALT DRILL BIT (Q-11/32")	1	470FH	TUBE BENDER (5-IN-1)
1	012-3/8	COBALT DRILL BIT (3/8")	1	SP375A	DEBURRING COUNTERSINK TOOL (DOGLEG)
1	UNIBIT-3	UNIBIT STEP DRILL (1/4" - 3/4" BY 1/16" STEP)	1	SVB-KIT	SHAVIV DEBURRING TOOL (ROYAL STYLE)
1	1000-100-27	PILOT CUTTER 100° (27)	1	7447RV	SCOTCH-BRITE PADS
1	1000-120-30	PILOT CUTTER 120° (30)	1	ATS8806	AIR HYDRAULIC BLIND RIVETER
1	1000-100-30	PILOT CUTTER 100° (30)	1	BL70104H	BOELUBE DRILL-LUBE
1	1000-100-40	PILOT CUTTER 100° (40)	1	5X605	SAFETY GLASSES
1	133	COUNTERSINK CAGE (MICROSTOP)	1	MARKERS	PERMANENT MARKERS
1	TAP-1/4-28	TAP (1/4-28)	1	KMC-1022	HEAVY DUTY 22" TOOL BOX

The new RV-12 is so easy to assemble it requires virtually no sheet metal skills, and needs little more than a few hand tools. We've made your task even easier by bringing together all the tools you'll need into one kit, and priced it to be easy on your wallet.

RV12-KIT\$1,295.95



RIVETING KITS

RV BUILDER'S KIT



Newly redone to conform to Van's newest listing

QTY	PART	DESCRIPTION	QTY	PART	DESCRIPTION	QTY	PART	DESCRIPTION
1	2602A	ATS ECONOMY RIVET GUN	1	O14-40	12" DRILL BIT (40)	1	FP21	FLUTING PLIERS
1	113M	E-Z RETAINER SPRING	1	O14-30	12" DRILL BIT (30)	1	130HD	RIVET CUTTER
1	7922R	SWIVEL AIR REGULATOR	1	SP375A	SPEED DEBURRING TOOL	1	MVL080	MARVEL AIR TOOL OIL
1	181	SWIVEL FLUSH SET (1")	1	131	CLECO PLIERS	1	21455	FILE CARD
1	470-3-3/32	RIVET SET (AN470, 3/32")	1	24EL	CLECO CLAMPS (1/2")	1	20547N	DUAL VIXEN FILE (10")
1	470-3-1/8	RIVET SET (AN470, 1/8")	4	26EL	CLECO CLAMPS (1")	1	204RV	C-FRAME RIVETING TOOL
1	470-3-3/16	RIVET SET (AN470, 3/16")	1	36021	SWIVEL POP RIVETER	1	DS-40	DRILL STOP (3/32)
1	1470-5-3/32	RIVET SET (DBL OFS 3/32")	2	OOP2	SCREWDRIVER BITS (2)	1	DS-30	DRILL STOP (1/8)
1	1470-5-1/8	RIVET SET (DBL OFS 1/8")	1	5022-3A	RIVET SQUEEZER (3")	1	DS-21	DRILL STOP (5/32)
1	1470-5-3/16	RIVET SET (DBL OFS 3/16")	1	RS-BK	SQUEEZER BENCH MOUNT	1	DS-12	DRILL STOP (3/16)
1	148	BUCKING BAR (MINI)	1	4704-2	SQUEEZER SET (1/8")	1	A601	ANGLE DRILL ATTACHMENT
1	149	BUCKING BAR (ANVIL)	1	4706-2	SQUEEZER SET (3/16")	1	PT-1136A	CORDLESS SCREWDRIVER
1	142	BUCKING BAR (FOOTED)	2	4710-2	SQUEEZER SET (FLUSH 1/2")	1	5000-40	THREADED DRILL BIT (40)
1	133	MICROSTOP COUNTERSINK	2	3710-2	SQUEEZER SET (FLUSH 3/8")	1	5000-30	THREADED DRILL BIT (30)
1	1000-100-40	PILOT CUTTER (3/32")	1	4263DP-2	DIMPLE DIE SET (3/32)	1	5000-21	THREADED DRILL BIT (21)
1	1000-100-30	PILOT CUTTER (1/8")	1	4264DP-2	DIMPLE DIE SET (1/8)	1	5000-12	THREADED DRILL BIT (12)
1	1000-100-28	PILOT CUTTER (6 SCREW)	1	4508DP-2	DIMPLE DIE SET (8 SCREW)	1	2470	BACK RIVET SET
1	1000-100-19	PILOT CUTTER (8 SCREW)	1	52-340-024	STAINLESS STEEL RULE 24"	1	AE1065	BACK RIVET PLATE
1	1000-100-12	PILOT CUTTER (10 SCREW)	1	UNIBIT-3	UNIBIT (1/4" - 3/4" BY 1/16")	1	O6785	DIMPLE DIE ORGANIZER
1	10L	WISS SNIP (LEFT & STR)	1	MARKERS	PERMANENT MARKERS	1	685-1	3M RIVETER'S TAPE
1	10R	WISS SNIP (RIGHT & STR)	1	CP7AM	3M CUT & POLISH WHEEL 6"	1	CH1	DEAD BLOW HAMMER
1	ATS6104	REVERSIBLE AIR DRILL	1	QM24	HEARING PROTECTOR	1	HS144	HAND SEAMER
6	012-40	COBALT DRILL BITS (40)	1	5X605	SAFETY GLASSES	1	ATB8362	STANDARD AIRCRAFT BOOK
6	012-30	COBALT DRILL BITS (30)	325	CL-3/32	CLECOS (3/32)	1	SP2005	8" CHIP CHASER
2	012-19	COBALT DRILL BITS (19)	175	CL-1/8	CLECOS (1/8)	1	SP2005S	4" CHIP CHASER
2	012-12	COBALT DRILL BITS (12)	1	SVB-KIT	DEBURRING SET	1	KMC-1022	HOMARK 22" TOOL BOX
2	012-21	COBALT DRILL BITS (21)	1	SP201A	EDGE SCRAPER			

Our RV Builder's Kit closely conforms to Van's recommended tool list for their very popular line of RV home-built airplanes. It contains all of the tools necessary to successfully assemble the RV3, RV4, RV7, RV8, RV9, and RV10 series of home built airplanes.

- RVK-2602A**.....(With 2602A Economy 3X Rivet Gun)**\$1,495.95**
- RVK-2X**.....(With ATS Pro 2X Rivet Gun)**\$1,525.95**
- RVK-3X**.....(With ATS Pro 3X Rivet Gun)**\$1,529.95**

RIVETING KITS



MUSTANG BUILDER'S KIT



QTY	PART	DESCRIPTION	QTY	PART	DESCRIPTION
1	ATS-3X	ATS PRO RIVET GUN	1	ATSR3-3SD	3" SUPER DUTY RIVET SQUEEZER
1	12A	FLUSH SET, RUBBERGUARD	1	3456-2	RIVET SQUEEZER SET (6 PCS)
1	470-3-3/32	RIVET SET	1	140	BUCKING BAR
1	470-3-1/8	RIVET SET	1	AE6007	TUNGSTEN BUCKING BAR
1	470-3-5/32	RIVET SET	1	181	SWIVEL FLUSH SET
1	1470-5-1/8	RIVET SET, 5" DOUBLE OFFSET	1	29W-1	FASTENER, CAM LEVER
1	13M	RIVET GUN RETAINER SPRING	1	64823	NIBBLER, HAND
1	130HD	HEAVY DUTY RIVET CUTTER	1	010-30	DRILL BIT, JOBBER
1	133	ADJUSTABLE STOP COUNTERSINK	4	010-3/32	DRILL BIT, JOBBER
1	1000-100-40	PILOT CUTTER 40	4	010-40	DRILL BIT, JOBBER
1	1000-100-30	PILOT CUTTER 30	4	010-1/8	DRILL BIT, JOBBER
1	1000-100-28	PILOT CUTTER 28	4	010-12	DRILL BIT, JOBBER
1	1000-100-19	PILOT CUTTER 19	2	010-3/16	DRILL BIT, JOBBER
1	FP10	PLIERS, FLUTING	2	014-40	1/2" AIRCRAFT EXTENSION DRILL BIT 40
100	CL-3/32	CLECO FASTENER	1	UNIBIT-1	UNIBIT STEP DRILL
130	CL-1/8	CLECO FASTENER	1	001A	CENTER PUNCH, SPRING LOADED
25	KHD-1/8	CLECO FASTENER	1	685-1	RIVETERS TAPE, (3/4" WIDE)
1	131	PLIERS, CLECO	1	4263DP-2	DIMPLE DIE SET
1	HS144	SEAMER, HAND	1	4264DP-2	DIMPLE DIE SET
1	5X640	PLIERS, DUCK BILL	1	7922R	SWIVEL CONNECTOR WITH AIR REGULATOR
1	SVB2	DEBURRING TOOL	1	19000	TOOL BOX
4	26EL	SIDE GRIP SPRING CLAMPS 1"			

This kit contains the majority of the tools needed in every phase of constructing the popular Kit Mustang. It's designed to provide only the tools you will need to get the job done quickly and professionally.

MUS-2602A	(With 2602A Economy 3X Rivet Gun)	\$749.95
MUS-2X	(With ATS Pro 2X Rivet Gun)	\$775.95
MUS-3X	(With ATS Pro 3X Rivet Gun)	\$779.95
MUS-4X	(With ATS Pro 4X Rivet Gun)	\$785.95

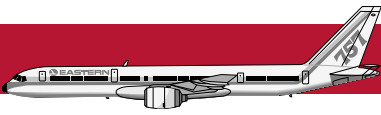

RIVETING KITS

MASTER BUILDER'S KIT

**SAVE OVER
30%
ON OUR
635 PIECE KIT**



QTY	PART	DESCRIPTION	QTY	PART	DESCRIPTION	QTY	PART	DESCRIPTION
1	KMC-1022	HOMARK 22" TOOL BOX	1	133	ADJUSTABLE MICROSTOP	1	C-1	CRIMPER
1	ATS-3X	ATS PRO RIVET GUN	1	1000-100-40	PILOT CUTTER (3/32)	1	ATS6104	REVERSIBLE AIR DRILL
1	1824	AIR REGULATOR	1	1000-100-30	PILOT CUTTER (1/8)	2	010-40	JOBBERS LENGTH DRILL BITS
1	470-3-3/32	RIVET SET (AN470, 3/32")	1	1000-100-21	PILOT CUTTER (5/32)	2	010-30	JOBBERS LENGTH DRILL BITS
1	470-3-1/8	RIVET SET (AN470, 1/8")	1	1000-100-12	PILOT CUTTER (3/16)	2	010-21	JOBBERS LENGTH DRILL BITS
1	470-3-5/32	RIVET SET (AN470, 5/32")	1	4187	DIMPLE DIE BLOCK SET	2	010-12	JOBBERS LENGTH DRILL BITS
1	470-3-3/16	RIVET SET (AN470, 3/16")	1	4263DP-2	DIMPLE DIE SET (3/32)	1	DS-40	DRILL STOP (3/32)
1	0470-3-3/32	OFFSET RIVET SET (3/32")	1	4264DP-2	DIMPLE DIE SET (1/8)	1	DS-30	DRILL STOP (1/8)
1	0470-3-1/8	OFFSET RIVET SET (1/8")	1	4265DP-2	DIMPLE DIE SET (5/32")	1	DS-21	DRILL STOP (5/32")
1	0470-3-5/32	OFFSET RIVET SET (5/32")	1	4266DP-2	DIMPLE DIE SET (3/16")	1	DS-12	DRILL STOP (3/16)
1	0470-3-3/16	OFFSET RIVET SET (3/16")	1	4703-2	SQUEEZER SET (3/32")	1	013-40	EXTENSION DRILL BIT (6")
1	750	FLUSH RIVET SET	1	4704-2	SQUEEZER SET (1/8")	1	013-30	EXTENSION DRILL BIT (6")
1	12A	RUBBERGUARD SET (1")	1	4705-2	SQUEEZER SET (5/32")	1	013-21	EXTENSION DRILL BIT (6")
1	12C	RUBBERGUARD SET (1-1/2")	1	4706-2	SQUEEZER SET (3/16")	1	013-12	EXTENSION DRILL BIT (6")
1	140	BUCKING BAR	2	4710-2	SQUEEZER SET (FLUSH 1/2")	1	61	STRAP DUPLICATOR (3/32)
1	141	BUCKING BAR	2	3710-2	SQUEEZER SET (FLUSH 3/8")	1	62	STRAP DUPLICATOR (1/8)
1	142	BUCKING BAR	1	06785	DIMPLE DIE ORGANIZER	1	63	STRAP DUPLICATOR (5/32")
1	147	BUCKING BAR	1	5022-3A	HAND RIVET SQUEEZER (3")	1	65	STRAP DUPLICATOR (3/16)
1	148	BUCKING BAR	1	RS1004A	LONGERON YOKE	1	001A	AUTOMATIC CENTER PUNCH
1	149	BUCKING BAR	1	RS1005A	4" YOKE	1	ATB8362	STANDARD AIRCRAFT BOOK
120	CL-3/32	CLECOS (3/32")	1	RS1006A	CLOSE QUARTERS YOKE	1	1341A	RIVET REMOVAL TOOL
120	CL-1/8	CLECOS (1/8")	1	RS-BK	BENCH MOUNT	1	A601	ANGLE DRILL ATTACHMENT
120	CL-5/32	CLECOS (5/32")	1	HS144	HAND SEAMER	2	5000-40	THREADED DRILL BIT (40)
120	CL-3/16	CLECOS (3/16")	1	FT100	HOLE FLANGING TOOL	2	5000-30	THREADED DRILL BIT (30)
4	26EL	SIDE GRIP FASTENER	1	302-32	SAFETY WIRE (.032)	2	5000-21	THREADED DRILL BIT (21)
4	542	SPRING TENSION CLAMPS	1	515A	BURNISHING TOOL	2	5000-12	THREADED DRILL BIT (12)
10	KWN-3/32	WINGNUT FASTENER (3/32")	1	FP10	FLUTING PLIERS	1	10L	OFFSET SNIP (LEFT CUT)
10	KWN-1/8	WINGNUT FASTENER (1/8")	1	5B	CIRCLE (FLY) CUTTER	1	10R	OFFSET SNIP (RIGHT CUT)
10	KWN-5/32	WINGNUT FASTENER (5/32")	1	HC1	ADJUSTABLE HOLE CUTTER	1	144ST	BENDER BRAKE (18")
10	KWN-3/16	WINGNUT FASTENER (3/16")	1	SP375A	SPEED DEBURRING TOOL	1	6WR	6" REV. WIRE TWISTER
1	131	CLECO PLIERS	1	64823	HAND NIBBLER	2	3202HT	CLAMPS
1	130HD	RIVET CUTTER	1	SP2005K	CHIP CHASERS (4" & 8")			

This comprehensive riveting kit contains the tooling needed to build some of the most popular aluminum airplanes, including the RV series, and the Midget Mustang. It's also very popular with mechanics needing an all-in-one riveting kit

- MBK-2602A**..... (With 2602A Economy 3X Rivet Gun)..... **\$1,549.95**
- MBK-2X**..... (With ATS Pro 2X Rivet Gun) **\$1,575.95**
- MBK-3X**..... (With ATS Pro 3X Rivet Gun) **\$1,579.95**
- MBK-4X**..... (With ATS Pro 4X Rivet Gun) **\$1,585.95**

RIVETING KITS



DELUXE RIVETING KIT

We added \$100 more value to our popular 150 piece kit, and lowered the price to give you even more savings!



**SAVE OVER
20%**

QTY	PART	DESCRIPTION	QTY	PART	DESCRIPTION	QTY	PART	DESCRIPTION
1	KMC-1022	HOMARK 22" TOOLBOX	1	ATS6104	REV. AIR DRILL (3/8" CHUCK)	1	ATSRS-3SD	HAND RIVET SQUEEZER
1	140	BUCKING BAR	1	DS-12	DRILL STOP (3/16)	1	4263DP-2	DIMPLE DIE SET (3/32)
1	141	BUCKING BAR	1	DS-21	DRILL STOP (5/32)	1	4264DP-2	DIMPLE DIE SET (1/8)
1	142	BUCKING BAR	1	DS-30	DRILL STOP (1/8)	1	4265DP-2	DIMPLE DIE SET (5/32")
1	147	BUCKING BAR	1	DS-40	DRILL STOP (3/32)	1	4244DP-2	DIMPLE DIE SET (3/16")
1	148	BUCKING BAR	1	A601	ANGLE DRILL ATTACHMENT	1	4703-2	SQUEEZER SET (3/32")
20	CL-3/32	CLECOS (SILVER)	1	1824	AIR REGULATOR	1	4704-2	SQUEEZER SET (1/8")
20	CL-1/8	CLECOS (COPPER)	1	130	RIVET CUTTER	1	4705-2	SQUEEZER SET (5/32")
20	CL-5/32	CLECOS (BLACK)	1	64823	HAND NIBBLER	1	4706-2	SQUEEZER SET (3/16")
20	CL-3/16	CLECOS (GOLD)	1	ATSRS-1SDY	1 1/2" YOKE	1	4710-2	SQUEEZER SET (FLUSH 1/2")
1	131	CLECO PLIERS	1	61	STRAP DUPLICATOR (3/32)	1	3710-2	SQUEEZER SET (FLUSH 3/8")
1	470-3-3/32	RIVET SET (AN470, 3/32")	1	62	STRAP DUPLICATOR (1/8)	1	06785	DIMPLE DIE ORGANIZER
1	470-3-1/8	RIVET SET (AN470, 1/8")	1	63	STRAP DUPLICATOR (5/32)	1	133	STOP COUNTERSINK
1	470-3-5/32	RIVET SET (AN470, 5/32")	1	65	STRAP DUPLICATOR (3/16)	1	1000-100-40	PILOTED CUTTER (3/32)
1	470-3-3/16	RIVET SET (AN470, 3/16")	1	FP10	FLUTING PLIERS	1	1000-100-30	PILOTED CUTTER (1/8)
1	0470-3-3/32	OFFSET RIVET SET (3/32")	1	SP2005	CHIP CHASER	1	1000-100-21	PILOTED CUTTER (5/32)
1	0470-3-1/8	OFFSET RIVET SET (1/8")	1	ATB8362	STANDARD AIRCRAFT BOOK	1	1000-100-12	PILOTED CUTTER (3/16)
1	0470-3-5/32	OFFSET RIVET SET (5/32")	1	5000-40	THREADED DRILL BIT (3/32)	1	ATS-3X	ATS PRO RIVET GUN
1	0470-3-3/16	OFFSET RIVET SET (3/16")	1	5000-30	THREADED DRILL BIT (1/8)	1	4187	DIMPLE DIE BLOCK
1	750	FLUSH RIVET SET	1	5000-21	THREADED DRILL BIT (5/32)	1	12A	RUBBERGUARD FLUSH SET
1	10L	OFFSET SNIP (LEFT CUT)	1	5000-12	THREADED DRILL BIT (3/16)			
1	10R	OFFSET SNIP (RIGHT CUT)						

Our Deluxe Riveting Kit contains everything needed to build and maintain an all metal aircraft. This kit is highly recommended for the professional mechanic or the experienced home builder.

135-2602AKT	(With 2602A Economy 3X Rivet Gun).....	\$949.95
135-2XKT	(With ATS Pro 2X Rivet Gun)	\$975.95
135-3XKT	(With ATS Pro 3X Rivet Gun)	\$979.95
135-4XKT	(With ATS Pro 4X Rivet Gun)	\$985.95



RIVETING KITS

UNIVERSITY STUDENTS RIVETING KIT



QTY	PART	DESCRIPTION
1	ATS-3X	ATS 3X PRO RIVETING GUN
1	1824	AIR TOOL REGULATOR
1	120	5 PIECE STRAIGHT RIVET SET MIX
1	142	BUCKING BAR
1	130	RIVET CUTTER
12	CL-3/32	CLECOS (SILVER)
12	CL-1/8	CLECOS (COPPER)
8	CL-5/32	CLECOS (BLACK)
8	CL-3/16	CLECOS (GOLD)
1	131	CLECO PLIERS
1	ATS6104	REVERSIBLE AIR DRILL
2	010-40	DRILL BITS
2	010-30	DRILL BITS
1	010-21	DRILL BIT
1	010-12	DRILL BIT
1	DS-40	DRILL STOP
1	DS-30	DRILL STOP
1	DS-21	DRILL STOP
1	DS-12	DRILL STOP
1	19000	TOOL BOX

This kit is specifically designed for the Airframe student. It's equipped with all of the essential tools needed to work on sheet metal. This kit is currently being used by students in schools such as Vincennes University and others.

- 2602ASTUD (With 2602A Economy 3X Gun) \$265.95
- 2XSTUD (With ATS Pro 2X Gun)..... \$295.95
- 3XSTUD (With ATS Pro 3X Gun)..... \$299.95
- 4XSTUD (With ATS Pro 4X Gun)..... \$305.95

AIRCRAFT MECHANIC'S RIVETING KIT



QTY	PART	DESCRIPTION
1	ATS-3X	ATS 3X PRO RIVETING GUN
1	1824	AIR TOOL REGULATOR
1	140	BUCKING BAR
1	142	BUCKING BAR
1	147	BUCKING BAR
1	148	BUCKING BAR
1	120	5 PIECE STRAIGHT RIVET SET MIX
1	121	4 PIECE OFFSET RIVET SET MIX
5	CL-3/32	CLECOS (SILVER)
5	CL-1/8	CLECOS (COPPER)
5	CL-5/32	CLECOS (BLACK)
5	CL-3/16	CLECOS (GOLD)
1	131	CLECO PLIERS
1	19000	TOOL BOX

A perfect starter kit for the A&P mechanic, the KT series of kits contains just the essentials needed for riveting. This kit is most commonly used as a starting point for mechanics wishing to make their own customized kits.

- 2602AKT (With 2602A Economy 3X Gun) \$239.95
- 2XKT (With ATS Pro 2X Gun)..... \$269.95
- 3XKT (With ATS Pro 3X Gun)..... \$275.95
- 4XKT (With ATS Pro 4X Gun)..... \$279.95

Didn't find the kit you were looking for?...Why not build your own!

Fax us at 1-989-739-1448 with the tool list of your dream kit and we'll price it for you. Better yet, send us your list via e-mail to quotes@aircraft-tool.com to receive an immediate quotation. And be sure to include your delivery address and preferred method of shipment if you would like us to also quote shipping charges.

RIVET GUNS



ATS PRO REDBOX RIVETING KIT



The latest addition to our line of Professional Riveting Kits is modeled after the popular "redbox" kit that was used extensively by fabricators and mechanics in the production of the Boeing 737. It contains our new ATS Pro E-Series Rivet Gun, two of the most commonly used Bucking Bars (142 and 148), and an assortment of rivet sets for Universal Head (AN470) and Flush (AN426) rivets in sizes 3/32" to 3/16". There is also an Air Regulator, a set of Mechaidd and Beehive springs, and a bottle of Marvel Mystery Air Tool Oil.

- ATS-E2XRK..... (E2X Gun)..... \$219.95
- ATS-E3XRK..... (E3X Gun)..... \$225.95
- ATS-E4XRK..... (E4X Gun)..... \$229.95
- ATS-RKU..... (No Gun) \$79.95

RETAINER SPRINGS



113B

113M

Fits all Rivet Guns and Air Hammers with a .401" shank.

- 113M..... (Quick Connect Mechaidd Retainer) \$4.95
- 113B..... (Beehive Retainer)..... \$4.95
- 113B-1/4..... (Beehive Retainer for 1/4" Rivet Sets) \$5.95
- 13M..... (Rivet Gun Spring Retainer)..... \$7.95

ATS PRO MINI RIVETING KIT



The ATS Mini Riveting Kit is a smaller version of the popular "redbox" kit. You'll get five (5) straight sets for Universal Head (AN470) and Flush (AN426) rivets in sizes 3/32" to 3/16". There is also an Air Regulator, a set of Mechaidd and Beehive springs, and a bottle of Marvel Mystery Air Tool Oil.

- ATS-E2XMK..... (E2X Gun) \$195.95
- ATS-E3XMK..... (E3X Gun) \$199.95
- ATS-E4XMK..... (E4X Gun) \$205.95
- ATS-MKU..... (No Gun)..... \$49.95

ATS PRO E-SERIES RIVET GUNS



Includes air regulator, beehive & mechaidd springs, plus a FREE bottle of ATS Tool Oil

Our new E-Series rivet guns feature the same quality and power as our Pro-X series with an even more delicate feathering trigger to control the rivet setting process. A new valve and shuttle mechanism also makes it more reliable, and less likely to choke and jam up. This new style is based on the latest Chicago Pneumatic design. Accepts all .401 shank rivet sets and attachments. Includes both a mechaidd & beehive spring, an air regulator, and a bottle of ATS tool oil.

PART	BPM	CAP.	STROKE	PRICE
ATS-E2X	2580	1/8"	2-1/4"	\$165.95
ATS-E3X	2160	3/16"	2-7/8"	\$169.95
ATS-E4X	1740	1/4"	3-1/16"	\$175.95

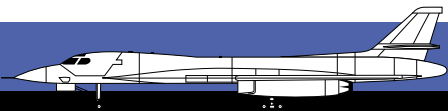

RIVET GUNS



Express your individuality with our Designer Pro Rivet Gun. You get the same rugged durability, reliability, and power of our Pro Series Rivet gun in an array of brilliant new colors that will set you apart from the ordinary. Everything about this gun, from its rich vibrant color to the laser-etched ATS Pro logo on the side, reflects the outstanding quality you've come to expect from ATS. And, of course, it's all backed by our industry leading unconditional ATS-Pro Lifetime Warranty.

PART	BPM	CAP.	STROKE	PRICE
ATS-2X-(color)	2580	1/8"	2-1/4"	\$179.95
ATS-3X-(color)	2160	3/16"	2-7/8"	\$185.95
ATS-4X-(color)	1740	1/4"	3-1/16"	\$189.95

COLOR	DESCRIPTION
RED	SUNSET RED
BLUE	CARIBBEAN BLUE
YELLOW	YELLOW
GREEN	LIME GREEN
BLACK	STARLIGHT BLACK

Ordering Instructions: When ordering, please specify the size of the rivet gun, as well as the color desired. Example: to order a RED 2X gun, use part number ATS-2X-RED.

ATS PRO RIVET GUN KITS



This is the ultimate Riveting Kit. Included in the kit is our ATS Pro-X Rivet Gun (accepts all .401" shank rivet sets and attachments), a 4-piece set of Bucking Bars (141, 142, 148 & 149), ATS Air Tool Oil (ATSOIL), 5-piece Standard Rivet Set (120), 4-piece Offset Rivet Set (121), 1-Rubber Guard Flush Rivet Set (12A) & 1- Professional Air Regulator (1824)..

Note: If you already own an ATS Rivet Gun, you can upgrade to the full kit by purchasing the upgrade package which contains everything except the Rivet Gun.

ATS-2602PK..... (Economy Gun Kit).....	\$229.95
ATS-2XPK..... (2X Gun Kit)	\$275.95
ATS-3XPK..... (3X Gun Kit)	\$279.95
ATS-4XPK..... (4X Gun Kit)	\$284.95
ATS-PKU.....(Upgrade Kit - No Gun)	\$159.95

ATS PRO X-SERIES RIVET GUNS



Includes beehive & mechaid springs plus a FREE bottle of ATS Tool Oil

Introducing the ATS Pro Series X-Guns. The standard tool used in aircraft manufacturing plants! We've retooled our popular X-Guns to make them smoother and more powerful, while still keeping them completely interchangeable with Chicago Pneumatic guns. They are slow hitting with excellent finger tip control. Accepts all .401 shank rivet sets and attachments.

PART	BPM	CAP.	STROKE	PRICE
ATS-2X	2580	1/8"	2-1/4"	\$155.95
ATS-3X	2160	3/16"	2-7/8"	\$159.95
ATS-4X	1740	1/4"	3-1/16"	\$165.95

RIVET GUNS



ATS PRO JIFFY-STYLE RIVETING KIT



This Jiffy-Style Professional Riveting Kit is compact enough to get into impossibly tight riveting areas, while still delivering the full power of a 3X riveting gun. It features our ATS-200B Jiffy-Style Riveting Gun with a fully variable teasing trigger to properly "set" the rivet prior to bucking it. It also includes a full complement of rivet sets (snaps) to cover 3/32", 1/8", 5/32", and 3/32" Universal Head (AN470), Modified Brazier (AN456), and Flush Head (AN426) rivets. We've also included two of our most popular Bucking Bars to help you get started right away. Completing this great package is a durable military-style canvas bag with ample space for your kit.

- ATS-200BK..... (Without Bucking Bars)..... **\$225.95**
- ATS-200BK2..... (With Bucking Bars) **\$239.95**
- ATS-200B..... (Gun Only)..... **\$179.95**

JIFFY GUN STUBBY RIVET SETS



These rivet sets are designed to work with our new ATS Pro 200B Rivet gun. They will also work with any Jiffy 100 or 200 rivet guns.

STRAIGHT RIVET SETS					
PART	SIZE	PRICE	PART	SIZE	PRICE
J510-4703	3/32"	\$10.95	J510-4706	3/16"	\$9.95
J510-4704	1/8"	\$10.95	J502	Flush	\$10.95
J510-4705	5/32"	\$10.95			
J510-SET	5 Piece Set (4 AN470 Sets & 1 Flush Set)				\$49.95
10 DEGREE OFFSET RIVET SETS					
J520-4703	3/32"	\$11.95	J520-4705	5/32"	\$11.95
J520-4704	1/8"	\$11.95	J520-4706	3/16"	\$11.95
J520-SET	4 Piece Set (AN470 Offset Sets)				\$41.95

SHOCK REDUCED RIVET GUN



Low Shock 3X Rivet Gun has same power of a standard gun, but at a much lower level of vibration. If you are at risk for the harmful effects of vibration shock, then this gun will allow you to work longer without suffering its numbing effects. Performance is similar to a standard rivet gun, but this unit is slightly heavier and a bit longer than a standard gun.

Specifications: 3/16" Aluminum (Dural) capacity; 2160 BPM; 9.5" Overall Length; 3.52 Lbs; .401" Shank fits standard rivet sets; Vibration 10 m/s²; Noise: 105 dBA 90 psi operation; 8.8 cfm air consumption.

- ATS-2XVR(2X) **\$175.95**
- ATS-3XVR(3X) **\$179.95**
- ATS-4XVR(4X) **\$185.95**

RIVET GUN AIR REGULATORS



Precision, quality built regulators, accurately control airflow at up to 150 psi. 1/4" NPT thread size.

- 7922R.....(360 Degree Swivel Regulator)..... **\$12.95**
- 1824.....(Positive Lock Regulator) **\$14.95**
- 5401.....(Low-Profile Regulator)..... **\$7.95**





RIVET GUNS

ATS ECONOMY AIRCRAFT RIVET GUN



Includes beehive & mechaid springs plus a FREE bottle of ATS Tool Oil

The next generation of our best-selling 2602 Economy Rivet Gun is 6 ounces lighter, better balanced, and now features the same feather-light throttle as many of the more expensive X-Guns. We've engineered the new 2602A with your safety in mind by adding an ergonomic, vibration-reducing rubber grip that significantly reduces the hand-numbing effects of vibration shock. The 2602A has been recommended for use in many kits by their manufacturers such as the RV's, Thorp T-18, and the Midget Mustang. 0-2160 BPM, weight 3.2 lbs., 3CFM at 90 psi, .401 shank.

2602A\$129.95

ATS PRO .498" LARGE BORE RIVET GUNS



Our large bore rivet guns are heavy hitting to handle those larger riveting jobs that are beyond the capacity of smaller .401" shank rivet guns. Excellent for driving rivets of 1/4" diameter rivets or larger. Completely interchangeable with Chicago Pneumatic guns, and they have excellent finger tip control. Accepts .498" shank rivet sets and attachments, but we've also included at no extra cost a .401" shank adapter (p/n SR498401) that allows you to use .401" tooling.

PART	BPM	CAP.	STROKE	WGT	PRICE
ATS-5X	1560	1/4"	2-11/16"	4.84 lbs	\$295.95
ATS-7X	900	3/8"	5-13/16"	5.94 lbs	\$345.95

SIoux™ RIVET GUN



The new Sioux "A" series rivet guns are the next evolutionary step in their exceptional line of rivet guns. They feature a new metering trigger that gives you total control from starting tap to full-on drive. The comfortable, ergonomic handle is a welcomed addition for anyone who pound rivets all day for a living. Accepts all sets and accessories with a .401" shank. Operates at 90 psi (6.2 bar) and consumes 8.0 cfm (3.8 l/s).

PART	BPM	CAP.	STROKE	WGT	PRICE
270A-2	2500	5/32"	2"	3.0lbs	\$369.95
270A	2000	3/16"	3"	3.2lbs	\$369.95
270A-4	1700	1/4"	4"	3.5lbs	\$421.95

CHICAGO PNEUMATIC OYR STYLE RIVET GUN



The Chicago Pneumatic OYR Rivet Gun is designed to reach into tight areas. It's a very compact unit that measures only 4" from the back of the handle to the nose, but still packs enough power to drive 1/8" aluminum rivets. Accepts all .401" shank rivet sets. Teasing trigger for better control. 2800 BPM. Weighs 2.3 lbs.

OYR (Rebuilt)\$249.95

RIVETS

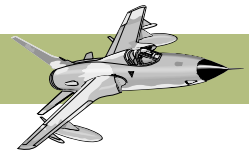

SIZE	GRIP LENGTH	CHERRYMAX® FLUSH HEAD				CHERRYMAX® UNIVERSAL HEAD			
		NOMINAL (CR3212)		OVERSIZE (CR3242)		NOMINAL (CR3213)		OVERSIZE (CR3243)	
		50 PCS	100 PCS	50 PCS	100 PCS	50 PCS	100 PCS	50 PCS	100 PCS
4-1	VARIABLE	N/A	N/A	31.95	28.75	31.95	28.75	33.95	30.55
4-2	.063-.125	26.95	24.25	29.95	26.95	27.95	25.15	27.95	25.15
4-3	.126-.187	27.95	25.25	29.95	26.95	28.95	26.05	27.95	25.15
4-4	.188-.250	28.95	26.25	31.95	28.75	30.95	27.85	29.95	26.95
4-5	.251-.312	30.95	27.85	37.95	34.15	36.95	33.25	33.95	30.55
4-6	.313-.375	41.95	37.85	43.95	39.55	41.95	37.75	43.95	39.55
4-7	.376-.437	45.95	41.35	50.95	45.85	52.95	47.65	48.95	44.05
4-8	.438-.500	58.95	53.25	56.95	51.25	97.95	88.15	64.95	58.45
5-1	.031-.062	N/A	N/A	N/A	N/A	41.95	37.75	45.95	41.35
5-2	.063-.125	31.95	28.75	34.95	31.45	30.95	27.85	35.95	32.35
5-3	.126-.187	30.95	27.85	34.95	31.45	30.95	27.85	33.95	30.55
5-4	.188-.250	31.95	28.85	34.95	31.45	31.95	28.75	32.95	29.65
5-5	.251-.312	34.95	31.45	38.95	35.05	34.95	31.45	35.95	32.35
5-6	.313-.375	41.95	37.75	41.95	37.75	43.95	39.55	41.95	37.75
5-7	.376-.437	56.95	51.25	49.95	44.95	49.95	44.95	46.95	42.95
5-8	.438-.500	63.95	57.55	52.95	47.65	62.95	56.65	54.95	49.45
6-1	.037-.062	N/A	N/A	N/A	N/A	58.95	53.05	52.95	47.65
6-2	.063-.125	38.95	35.25	43.95	39.55	37.95	34.15	41.95	37.75
6-3	.126-.187	38.95	35.25	41.95	37.75	37.95	34.15	41.95	37.75
6-4	.188-.250	38.95	35.25	43.95	39.55	38.95	35.05	43.95	39.55
6-5	.251-.312	43.95	39.55	52.95	47.65	43.95	39.55	48.95	44.05
6-6	.313-.375	57.95	52.15	53.95	48.55	54.95	49.55	54.95	49.45
6-7	.376-.437	62.95	56.65	60.95	54.85	61.95	55.75	56.95	51.25
6-8	.438-.500	77.95	70.15	77.95	70.15	72.95	65.65	73.95	66.55

CHERRYMAX RIVET ASSORTMENT

An assortment of 125 rivets consisting of 25 each of the 5 most popular sizes: CR3243-4-1, CR3243-4-2, CR3243-4-3, CR3242-4-2, and CR3242-4-3.

CM25\$79.95



RIVET TRIMMER



Ground flush for close trimming of Cherrymax rivets.

HT2\$14.95

CHERRYMAX GRIP GAUGE



Used to determine the proper grip length of Cherrymax® rivets. Easy to use: just insert the gauge into the prepared hole, draw the gauge back until the hook contacts the backside of the structure, then take your reading directly from the gauge.

269C3\$12.95





RIVETS

2117-T4 (AD) SOLID ALUMINUM RIVETS



MS20426



MS20470

SIZE	1/4LB	1/2LB	3/4LB	1LB
3-3	10.95	18.32	27.48	36.64
3-4	9.95	16.32	24.48	32.64
3-5	9.95	16.32	24.48	32.64
3-6	9.95	16.32	24.48	32.64
3-7	9.95	16.32	24.48	32.64
3-8	9.95	16.32	24.48	32.64
4-3	8.95	12.95	20.95	26.95
4-4	7.95	10.95	16.95	22.95
4-5	7.95	10.95	16.95	22.95
4-6	7.95	10.95	16.95	22.95
4-7	7.95	10.95	16.95	22.95
4-8	7.95	10.95	16.95	22.95
5-3	8.95	12.76	19.14	25.52
5-4	8.95	12.76	19.14	25.52
5-5	8.95	12.76	19.14	25.52
5-6	8.95	12.76	19.14	25.52
5-7	8.95	12.76	19.14	25.52
5-8	8.95	12.76	19.14	25.52
6-3	7.95	10.95	16.95	22.95
6-4	7.95	10.95	16.95	22.95
6-5	7.95	10.95	16.95	22.95
6-6	7.95	10.95	16.95	22.95
6-7	7.95	10.95	16.95	22.95
6-8	7.95	10.95	16.95	22.95

Notes:

- All solid rivets are sold in 1/4lb increments. Discount prices apply to 1/2lb or more of the same size only.
- When ordering rivets, please specify the type of rivet as well as the size: i.e. MS20426-4-3.

SOLID RIVET ASSORTMENT

An assortment of solid rivets in the most popular sizes. The 3lb pack contains 1/4lb each of MS20470 (universal) and MS20426 (flush) series rivets in the following sizes: 3-4, 4-4, 4-6, 5-4, 5-6 & 6-6. The 6lb pack also includes sizes: 3-5, 3-6, 4-5, 5-5, 6-4 & 6-5.



- MS20KIT-3.....(3lb Pack).....\$74.95
- MS20KIT-6.....(6lb Pack).....\$149.95

ATS RIVET REMOVAL TOOLS



See drill bit section for replacement "L" series threaded drill bits.

Our new Blind Rivet Removal Tool is designed to remove those stubborn Pop, Avdel, Cherry-Qt, and other blind rivets. The serrated end cups over any button head, round head, or universal head rivet and locks in place to keep it from spinning as it's being drilled out. It will also remove solid rivets. Includes adapters to remove 3/32", 1/8", 5/32", and 3/16" rivets. Not for use with steel-stemmed blind rivets.

- Serrated nosepieces
- Drill depth control
- Knurled comfort grip
- Works with any drill

- 1341S.....(Blind Rivet Removal Tool).....\$75.95
- 1341A.....(Standard Rivet Removal Tool).....\$59.95

ATS RIVET CUTTERS



130HD



130

Cuts from 3/32" to 1/4" diameter. Cuts same length every time with use of Rivet leaf spacers.

- 130.....(Standard).....\$18.95
- 130HD.....(Heavy Duty).....\$39.95

BENCH MOUNTED RIVET CUTTER

This heavy-duty rivet cutter by Lancaster Pumps is designed to mount onto a workbench (or held in vise), and will cut five different diameter rivets, wire, and screws to any of seven different lengths. It is made of hardened steel and the cutting surfaces are ground to exacting tolerances for consistently clean, distortion-free cuts. Accepts diameters: 1/16", 3/32", 1/8", 5/32", and 3/16". Cuts lengths: 5/32", 7/32", 9/32", 11/32", 13/32", 15/32", and 17/32". Cuts stainless steel rivets.



- RC-1.....\$128.95

BUCKING BARS

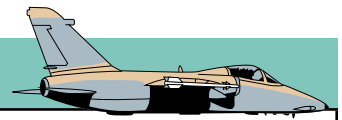

<p>140</p>  <p>5-1/8" long, 3" wide, 1-5/8" high. 2 lbs cast steel</p> <p>140..... \$18.95</p>	<p>141</p>  <p>10-3/8" long, 1" wide, 2" high. 3 lbs cast steel</p> <p>141..... \$18.95</p>	<p>142</p>  <p>6-3/8" long, 1" wide, 2-1/4" high. 2 lbs cast steel</p> <p>142..... \$18.95</p>	<p>147</p>  <p>5-1/4" long, 2" wide, 1" high. 1.5 lbs cast steel.</p> <p>147..... \$18.95</p>
<p>148</p>  <p>3-3/4" long, 2" wide, 1" high. 1.5 lbs cast steel</p> <p>148..... \$18.95</p>	<p>149</p>  <p>5-1/2" long, 1-1/2" wide, 2" high. 3" lbs cast steel</p> <p>149..... \$18.95</p>	<p>150</p>  <p>6" long, 1" wide, 1-3/4" high. 1.5 lbs machined steel</p> <p>150..... \$19.95</p>	<p>153</p>  <p>2-1/2" long, 2" wide, 1-1/2" high. 1 lb machined steel</p> <p>153..... \$19.95</p>
<p>154</p>  <p>6" long, 1-1/2" wide, 1-1/2" high. 1.75 lbs machined steel.</p> <p>154..... \$19.95</p>	<p>161</p>  <p>4" long, 1" wide, 2" high. 1.75 lbs machined steel</p> <p>161..... \$19.95</p>	<p>AT601SP</p>  <p>6-3/8" long, 2" small x 2-3/4" large dia. 4 lbs machined steel.</p> <p>AT601SP..... \$39.95</p>	<p>AT605SP</p>  <p>3-1/2" long, 2" wide, 1" high. 1.5 lbs machined steel.</p> <p>AT605SP..... \$21.95</p>
<p>AT624</p>  <p>8" long, 1/2" wide, 1" high. 1 lb machined steel.</p> <p>AT624 \$29.95</p>	<p>AT646</p>  <p>12" long, 1/2" wide, 2" high. 2.25 lbs machined steel</p> <p>AT646 \$35.95</p>	<p>AT659</p>  <p>6" long, 1" wide, 2" high. 1-1/2" 1.5 lbs machined steel.</p> <p>AT659 \$35.95</p>	<p>AT715</p>  <p>5-1/4" long, 1/2" wide, 6" high. 2 lbs machined steel.</p> <p>AT715 \$35.95</p>
<p>AT750P</p>  <p>5-1/2" long, 1-1/2" wide, 2-3/8" high. 3 lbs machined steel.</p> <p>AT750P \$35.95</p>	<p>AT750-23</p>  <p>8" long, 3" wide, 1-1/2" high. 1.5 lbs machined steel.</p> <p>AT750-23 \$29.95</p>	<p>SAVE ON BUCKING BAR SETS!</p> <p>Our 4 piece set comes with the following: 141, 142, 148, and 149</p> <p>4PC..... \$74.95</p> <p>The 6 piece package has the following bucking bars: 140, 141, 142, 147, 148, and 149</p> <p>6PC..... \$109.95</p> <p>The 10 piece package consists of each of the following: 140, 141, 142, 147, 148, 149, 150, 153, 154 and 161.</p> <p>10PC..... \$185.95</p>	



RIVETING EQUIPMENT

STANDARD .401" RIVET SETS

STRAIGHT .401" SHANK RIVET SETS

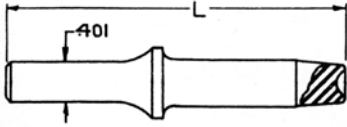

*Note: To order, please specify the part number and the diameter.
Example: to order a 3-1/2" long 1/8" diameter Universal Head set, the number would be 470-3-1/8.*

PART	LEN (L)	DIAMETERS AVAILABLE	PRICE
UNIVERSAL HEAD (AN470)			
470-2	2-1/2"	3/32, 1/8, 5/32, 3/16, 1/4	\$7.95
470-3	3-1/2"	3/32, 1/8, 5/32, 3/16, 7/32, 1/4"	\$6.95
470-5	5-1/2"	3/32, 1/8, 5/32, 3/16, 1/4	\$7.95
470-7	7-1/2"	3/32, 1/8, 5/32, 3/16, 1/4	\$8.95
470-10	10-1/2"	3/32, 1/8, 5/32, 3/16, 1/4	\$12.95
MODIFIED BRAZIER (AN456)			
456-2	2-1/2"	3/32, 1/8, 5/32, 3/16, 1/4	\$7.95
456-3	3-1/2"	3/32, 1/8, 5/32, 3/16, 1/4	\$8.95
456-5	5-1/2"	3/32, 1/8, 5/32, 3/16, 1/4	\$8.95
456-7	7-1/2"	3/32, 1/8, 5/32, 3/16, 1/4	\$10.95
456-10	10-1/2"	3/32, 1/8, 5/32, 3/16, 1/4	\$12.95
BRAZIER HEAD (AN455)			
455-2	2-1/2"	3/32, 1/8, 5/32, 3/16, 1/4	\$7.95
455-3	3-1/2"	3/32, 1/8, 5/32, 3/16, 1/4	\$8.95
455-5	5-1/2"	3/32, 1/8, 5/32, 3/16, 1/4	\$8.95
455-7	7-1/2"	3/32, 1/8, 5/32, 3/16, 1/4	\$10.95
455-10	10-1/2"	3/32, 1/8, 5/32, 3/16, 1/4	\$12.95
FLAT HEAD (AN442)			
442-2	2-1/2"	3/32, 1/8, 5/32, 3/16, 1/4	\$7.95
442-3	3-1/2"	3/32, 1/8, 5/32, 3/16, 1/4	\$8.95
442-5	5-1/2"	3/32, 1/8, 5/32, 3/16, 1/4	\$8.95
442-7	7-1/2"	3/32, 1/8, 5/32, 3/16, 1/4	\$10.95
442-10	10-1/2"	3/32, 1/8, 5/32, 3/16, 1/4	\$12.95
BUTTON HEAD (AN435)			
435-2	2-1/2"	3/32, 1/8, 5/32, 3/16, 1/4	\$7.95
435-3	3-1/2"	3/32, 1/8, 5/32, 3/16, 1/4	\$8.95
435-5	5-1/2"	3/32, 1/8, 5/32, 3/16, 1/4	\$8.95
435-7	7-1/2"	3/32, 1/8, 5/32, 3/16, 1/4	\$10.95
435-10	10-1/2"	3/32, 1/8, 5/32, 3/16, 1/4	\$12.95
ROUND HEAD (AN430)			
430-2	2-1/2"	3/32, 1/8, 5/32, 3/16, 1/4	\$7.95
430-3	3-1/2"	3/32, 1/8, 5/32, 3/16, 1/4	\$8.95
430-5	5-1/2"	3/32, 1/8, 5/32, 3/16, 1/4	\$8.95
430-7	7-1/2"	3/32, 1/8, 5/32, 3/16, 1/4	\$10.95
430-10	10-1/2"	3/32, 1/8, 5/32, 3/16, 1/4	\$12.95

10° OFFSET .401" SHANK RIVET SETS

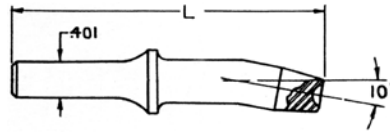

PART	LEN (L)	DIAMETERS AVAILABLE	PRICE
UNIVERSAL HEAD (AN470)			
0470-3	3-1/2"	3/32, 1/8, 5/32, 3/16, 1/4"	\$6.95
0470-5	5-1/2"	3/32, 1/8, 5/32, 3/16, 1/4	\$7.95
0470-7	7-1/2"	3/32, 1/8, 5/32, 3/16, 1/4	\$8.95
0470-10	10-1/2"	3/32, 1/8, 5/32, 3/16, 1/4	\$12.95
MODIFIED BRAZIER (AN456)			
0456-3	3-1/2"	3/32, 1/8, 5/32, 3/16, 1/4	\$9.95
0456-5	5-1/2"	3/32, 1/8, 5/32, 3/16, 1/4	\$9.95
0456-7	7-1/2"	3/32, 1/8, 5/32, 3/16, 1/4	\$10.95
0456-10	10-1/2"	3/32, 1/8, 5/32, 3/16, 1/4	\$12.95
BRAZIER HEAD (AN455)			
0455-3	3-1/2"	3/32, 1/8, 5/32, 3/16, 1/4	\$9.95
0455-5	5-1/2"	3/32, 1/8, 5/32, 3/16, 1/4	\$9.95
0455-7	7-1/2"	3/32, 1/8, 5/32, 3/16, 1/4	\$10.95
0455-10	10-1/2"	3/32, 1/8, 5/32, 3/16, 1/4	\$12.95
FLAT HEAD (AN442)			
0442-3	3-1/2"	3/32, 1/8, 5/32, 3/16, 1/4	\$9.95
0442-5	5-1/2"	3/32, 1/8, 5/32, 3/16, 1/4	\$9.95
0442-7	7-1/2"	3/32, 1/8, 5/32, 3/16, 1/4	\$10.95
0442-10	10-1/2"	3/32, 1/8, 5/32, 3/16, 1/4	\$12.95
BUTTON HEAD (AN435)			
0435-3	3-1/2"	3/32, 1/8, 5/32, 3/16, 1/4	\$9.95
0435-5	5-1/2"	3/32, 1/8, 5/32, 3/16, 1/4	\$9.95
0435-7	7-1/2"	3/32, 1/8, 5/32, 3/16, 1/4	\$10.95
0435-10	10-1/2"	3/32, 1/8, 5/32, 3/16, 1/4	\$12.95
ROUND HEAD (AN430)			
0430-3	3-1/2"	3/32, 1/8, 5/32, 3/16, 1/4	\$9.95
0430-5	5-1/2"	3/32, 1/8, 5/32, 3/16, 1/4	\$9.95
0430-7	7-1/2"	3/32, 1/8, 5/32, 3/16, 1/4	\$10.95
0430-10	10-1/2"	3/32, 1/8, 5/32, 3/16, 1/4	\$12.95

FLUSH .401" SHANK RIVET SETS

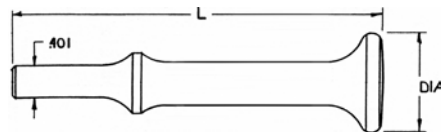

PART	LENGTH	DIAMETER	PRICE
90	3-1/2"	1" Dia	\$12.95
94	3-1/2"	1-1/4" Dia	\$14.95
95	5-1/2"	1-1/4" Dia	\$19.95
094	3-1/2"	1-1/4" Dia 10° offset	\$16.95
095	5-1/2"	1-1/4" Dia 10° offset	\$19.95

RIVETING EQUIPMENT

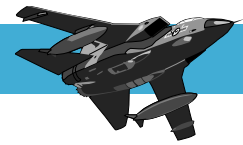

DOUBLE OFFSET .401" SHANK RIVET SETS

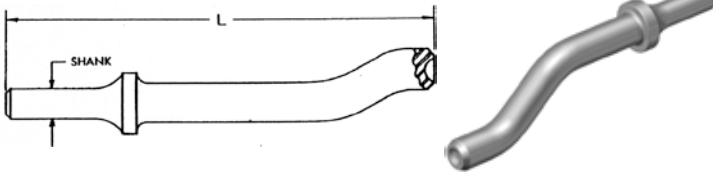

Note: To order, please specify the part number and the diameter. Example: to order a 7-1/2" long 1/4" diameter Flat Head set, the number would be 1442-7-1/4.

PART	LEN (L)	DIAMETERS AVAILABLE	PRICE
UNIVERSAL HEAD (AN470)			
1470-5	5-1/2"	3/32, 1/8, 5/32, 3/16, 1/4	\$7.95
1470-7	7-1/2"	3/32, 1/8, 5/32, 3/16, 1/4	\$8.95
1470-10	10-1/2"	3/32, 1/8, 5/32, 3/16, 1/4	\$12.95
MODIFIED BRAZIER (AN456)			
1456-5	5-1/2"	3/32, 1/8, 5/32, 3/16, 1/4	\$14.95
1456-7	7-1/2"	3/32, 1/8, 5/32, 3/16, 1/4	\$15.95
BRAZIER HEAD (AN455)			
1455-5	5-1/2"	3/32, 1/8, 5/32, 3/16	\$14.95
1455-7	7-1/2"	3/32, 1/8, 5/32, 3/16	\$15.95
FLAT HEAD (AN442)			
1442-5	5-1/2"	3/32, 1/8, 5/32, 3/16, 1/4	\$14.95
1442-7	7-1/2"	3/32, 1/8, 5/32, 3/16, 1/4	\$15.95
BUTTON HEAD (AN435)			
1435-5	5-1/2"	3/32, 1/8, 5/32, 3/16, 1/4	\$14.95
1435-7	7-1/2"	3/32, 1/8, 5/32, 3/16, 1/4	\$15.95
ROUND HEAD (AN430)			
1430-5	5-1/2"	3/32, 1/8, 5/32, 3/16, 1/4	\$14.95
1430-7	7-1/2"	3/32, 1/8, 5/32, 3/16, 1/4	\$15.95

GOOSENECK .401" SHANK RIVET SETS

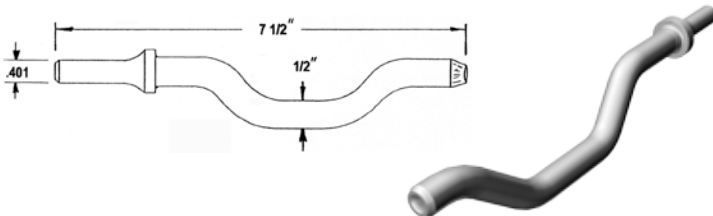

PART	CUPPING	DIAMETERS	PRICE
5470	AN470	3/32, 1/8, 5/32, 3/16	\$29.95
5456	AN456	3/32, 1/8, 5/32, 3/16	\$59.95
5455	AN455	3/32, 1/8, 5/32, 3/16	\$59.95
5442	AN442	3/32, 1/8, 5/32, 3/16	\$59.95
5435	AN435	3/32, 1/8, 5/32, 3/16	\$59.95
5430	AN430	3/32, 1/8, 5/32, 3/16	\$59.95

STANDARD RIVET SET MIX



The 5 piece mix contains the following sizes Universal Head (AN470) rivet sets: 3/32", 1/8", 5/32", 3/16" and 1 flush set. Each rivet set is 3-1/2" long.

- 120..... (Standard) \$29.95
- 120A (Heavy Duty) \$31.95

10 DEGREE OFFSET MIX



The offset mix contains the following sizes Universal Head (AN470) rivet sets: 3/32", 1/8", 5/32", and 3/16". Each rivet set is 3-1/2" long.

- 121..... \$29.95

EXTRA LONG RIVET SET MIX

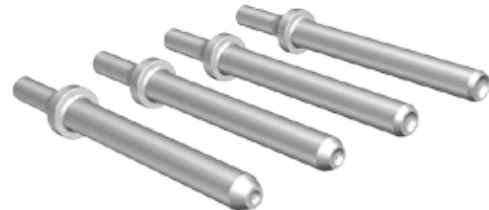

The extra long mix contains the following 4 sizes Universal Head (AN470) rivet sets: 3/32", 1/8", 5/32", and 3/16". Each long rivet set is 5-1/2" long.

- 125..... \$29.95

RIVET EDGE GAUGE

Maintenance standards require that all rivet be no less than 2 diameters (2D) and no more than 4 diameters (4D) from the edge of the sheet, with the optimum distance being 2.5 diameters (2.5D). This tool will accurately gauge the distance of rivet holes from the edge of the sheet to verify that they are within these standards. Simply slide the tool against the edge of the sheet and verify that it aligns with the center line of the rivet holes. You can also use it to establish the ideal center line by the same technique. One side gauges distances for 1/8" (-4) and 5/32" (-5) rivets, and the other is for 3/16" (-6) rivets.



- MJ520 \$9.95



RIVETING EQUIPMENT

SWIVEL DIMPLE DIES AND HOLDERS

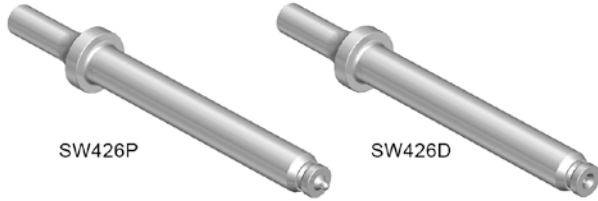

Designed to dimple AN426 series rivets. Each set comes complete with swivel set and dimple die block holder. .401" shank.

PART	SIZE	SWIVEL	PRICE
SW426P-3/32	3/32	MALE	\$35.95
SW426P-1/8	1/8	MALE	\$35.95
SW426D-3/32	3/32	FEMALE	\$35.95
SW426D-1/8	1/8	FEMALE	\$35.95

RIVET SET EXTENSION

Standard .401 shank. Insert standard rivet sets for added reach. Accepts .401 shank sets. 9" overall length.



128A \$24.95

HIGH SHEAR AND HUCK COLLAR SPLITTERS

Designed to remove the locking collars around High Shear and Huck rivets. 5-1/2" long with .401 shank.



PART	SIZE	PRICE	PART	SIZE	PRICE
HS-1/8	1/8"	\$22.95	HS-1/4	1/4"	\$19.95
HS-5/32	5/32"	\$20.95	HS-5/16	5/16"	\$19.95
HS-3/16	3/16"	\$23.95	HS-3/8	3/8"	\$21.95

HIGH SHEAR RIVET PUNCH

Uses a standard .401 rivet gun to remove High Shear and Huck rivets. Each punch is 3-3/8" long.



PART	SIZE	PRICE	PART	SIZE	PRICE
RP-1/8	1/8"	\$14.95	RP-1/4	1/4"	\$16.95
RP-5/32	5/32"	\$14.95	RP-5/16	5/16"	\$16.95
RP-3/16	3/16"	\$14.95	RP-3/8	3/8"	\$15.95

SWIVEL FLUSH RIVET SET



The swiveling face of this rivet set will keep it flush against the head of the rivet even if you are a little off angle. This means that there is much less of a chance of "smiling" the sheet metal or mis-setting the rivet. The 1-1/4" face is highly polished and slightly mushroomed to keep it against the head of the rivet and off the sheet metal. Fits into any .401 shank rivet gun.

181 \$18.95

RUBBER GUARD FLUSH RIVET SET



Flush rivet set with a rubber boot to prevent damage to metal surfaces while riveting. Fits any .401 rivet gun.

12A (3/4" Dia.) \$14.95
 12C (1-1/2" Dia.) \$21.95

BACK RIVET SET



Superior for back riveting flush rivets without damage to the skin surface. Spring loaded plastic guard holds down skin while riveting. Can also be used for "straight" riveting.

2470 \$21.95

EXTENDED BACK RIVET SETS

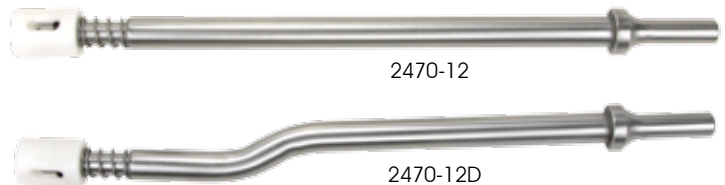

These extended versions of our 2470 Back Rivet Sets are great to get into confined areas, They are especially useful to RV-10 builders who must back rivet some areas of the fuselage. 12" long, .401 shank.

2470-12 (12" Straight) \$27.95
 2470-12D (12" Double Offset) \$29.95

RIVETING EQUIPMENT

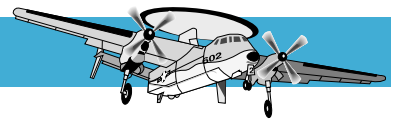

STRAIGHT .401" HUCK LOCKBOLT SET

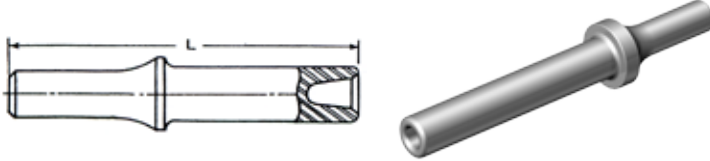

Note: To order, please specify the part number and the diameter.
Example: to order a 5-1/2" long, 1/4" diameter set, the number would be HLB10-5-1/4.

PART	LEN (L)	DIAMETERS	PRICE
HLB10-3	3-1/2"	1/8, 5/32, 3/16, 1/4, 5/16, 3/8	\$24.95
HLB10-5	5-1/2"	1/8, 5/32, 3/16, 1/4, 5/16, 3/8	\$27.95
HLB10-7	7-1/2"	1/8, 5/32, 3/16, 1/4, 5/16, 3/8	\$31.95

10° OFFSET .401" HUCK LOCKBOLT SET

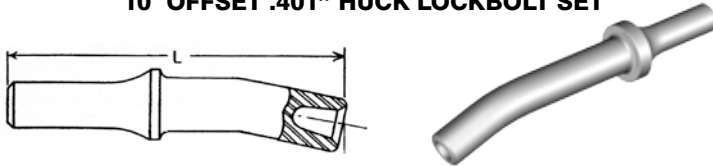

PART	LEN (L)	DIAMETERS	PRICE
HLB20-3	3-1/2"	1/8, 5/32, 3/16, 1/4, 5/16, 3/8	\$21.95
HLB20-5	5-1/2"	1/8, 5/32, 3/16, 1/4, 5/16, 3/8	\$24.95
HLB20-7	7-1/2"	1/8, 5/32, 3/16, 1/4, 5/16, 3/8	\$27.95

STRAIGHT .401" HIGH-SHEAR SET

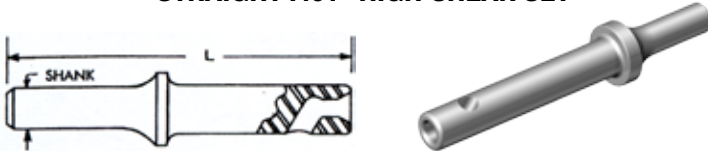

Note: To order, please specify the part number and the diameter.
Example: to order a 3-1/2" long, 5/32" diameter set, the number would be HSR10-3-5/32.

PART	LEN (L)	DIAMETERS	PRICE
HSR10-3	3-1/2"	1/8, 5/32, 3/16, 1/4	\$14.95
HSR10-5	5-1/2"	1/8, 5/32, 3/16, 1/4	\$16.95
HSR10-7	7-1/2"	1/8, 5/32, 3/16, 1/4	\$18.95

10° OFFSET HIGH-SHEAR SET

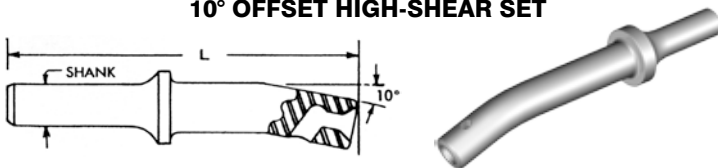

PART	LEN (L)	DIAMETERS	PRICE
HSR20-3	3-1/2"	1/8, 5/32, 3/16, 1/4, 5/16, 3/8	\$15.95
HSR20-5	5-1/2"	1/8, 5/32, 3/16, 1/4, 5/16, 3/8	\$17.95
HSR20-7	7-1/2"	1/8, 5/32, 3/16, 1/4, 5/16, 3/8	\$19.95

.498" SHANK RIVET SETS

5 - STRAIGHT .498" SHANK RIVET SETS (3-1/2")

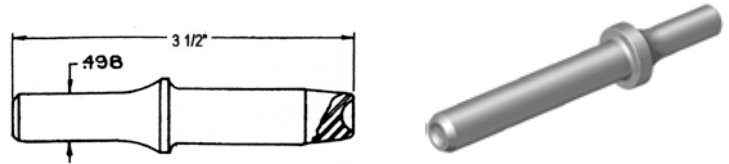

Note: To order, please specify the part number and the diameter.
Example: to order a 1/8" diameter Universal Head set, the number would be K470-3-1/8.

PART	CUPPING	DIAMETERS	PRICE
K470-3	AN470	3/32, 1/8, 5/32, 3/16, 1/4	\$9.95
K456-3	AN456	3/32, 1/8, 5/32, 3/16, 1/4	\$9.95
K455-3	AN455	3/32, 1/8, 5/32, 3/16, 1/4	\$9.95
K442-3	AN442	3/32, 1/8, 5/32, 3/16, 1/4	\$9.95
K435-3	AN435	3/32, 1/8, 5/32, 3/16, 1/4	\$9.95
K430-3	AN430	3/32, 1/8, 5/32, 3/16, 1/4	\$9.95

10° OFFSET .498" SHANK RIVET SETS (3-1/2")

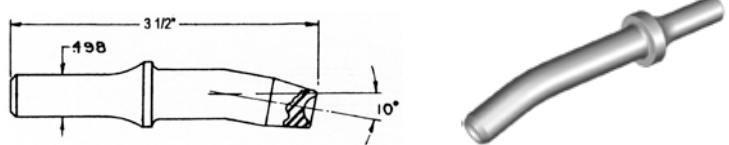

PART	CUPPING	DIAMETERS	PRICE
K0470-3	AN470	3/32, 1/8, 5/32, 3/16, 1/4	\$12.95
K0456-3	AN456	3/32, 1/8, 5/32, 3/16, 1/4	\$12.95
K0455-3	AN455	3/32, 1/8, 5/32, 3/16, 1/4	\$12.95
K0442-3	AN442	3/32, 1/8, 5/32, 3/16, 1/4	\$12.95
K0435-3	AN435	3/32, 1/8, 5/32, 3/16, 1/4	\$12.95
K0430-3	AN430	3/32, 1/8, 5/32, 3/16, 1/4	\$12.95

FLUSH .498" SHANK RIVET SETS

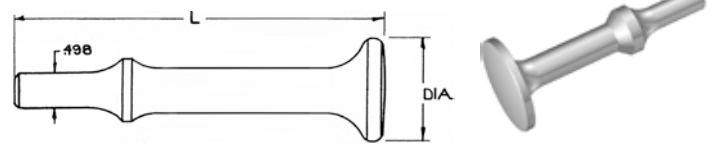

PART	LENGTH	DIAMETER	PRICE
K90	3-1/2"	1" Dia	\$16.95
K94	3-1/2"	1-1/4" Dia	\$16.95
K095	5-1/2"	1-1/4" Dia 10° offset	\$22.95

RIVET GUN SHANK ADAPTER (.498 TO .401)

This adapter reduces the shank bore of .498 rivet guns (5X and higher) so that you can use standard .401" tooling with them. Hardened tool steel construction. Precisely ground. Remember to use a regulator when using .401 tools with a large bore gun.



SR498401 \$14.95



RIVETING EQUIPMENT

SWIVEL RUBBER GUARD FLUSH RIVET SET



Safety flush rivet set makes it virtually impossible to damage or "smile" the skin while flush riveting. Rubber outer guard cushions the outer edge of the set while limiting recoil. Swivel head will move through 20 degrees to keep the face of the set flush against the head of the rivet which minimizes mis-setting the rivet. Finally, the safety spring keeps the set securely attached to the rivet gun to prevent accidental "bullets".

AT106A \$52.95

ERGODYNE PROFLEX® ANTI-VIBRATION GLOVES



The Visco and Elastic gel in the palm protects against shock, impact and vibration. Four way stretch spandex moves with the hand for full range of movement. They are abrasion resistant PVC reinforcement zones add life and grip and strength. Ideal for use with rivet guns, percussion drills, air chisels, or any other power tools.

ERG9002M (Medium) \$49.95

ERG9002L (Large) \$49.95

ERG9002XL (Extra Large) \$49.95

TOOL OIL

Marvel is the industry standard tool oil used to keep rivet guns and other air operated tools performing at peak capacity. The regular application of a few drops of Marvel Air Tool Oil will keep your tools lubricated and rust-free. 4 oz.



MVL080



ATSOIL

MVL080 \$3.95

ATSOIL \$3.95

BRASS, ALUMINUM & NYLON RIVETING PEENS



Peens are great for driving pins, knocking out old rivets, removing dents, nudging things into place, and shaping sheet metal. Select a peen head with a material that is softer than the object you intend to drive to prevent marring. Screw-in heads are made of solid brass, aluminum, or nylon and are interchangeable between body lengths. 1-1/4" diameter. Fits .401" rivet guns and air hammers.

PART	PEEN MATERIAL	LENGTH	PRICE
ATS107A-3B	Brass	3"	\$19.95
ATS107A-5B	Brass	5"	\$21.95
ATS107A-7B	Brass	7"	\$25.95
ATS107A-3A	Aluminum	3"	\$19.95
ATS107A-5A	Aluminum	5"	\$21.95
ATS107A-7A	Aluminum	7"	\$25.95
ATS107A-3N	Nylon	3"	\$19.95
ATS107A-5N	Nylon	5"	\$21.95
ATS107A-7N	Nylon	7"	\$25.95
ATS107-B	Replacement Brass Head		\$9.95
ATS107-N	Replacement Nylon Head		\$9.95
ATS107-A	Replacement Aluminum Head		\$9.95

ECONOMY BRASS PEEN

A great tool for driving pins or removing small dents. Solid brass head will not damage steel surfaces. 3" long by 3/4" diameter. Head is non-removable.



BP03 \$8.95

BACK RIVETING PLATE



Back riveting requires a hard flat surface to act as a bucking bar while you set the shop head of the rivet. This low carbon steel plate has flat ground surfaces to help you accomplish the task with minimal effort. 3/8" thick X 4" wide X 15" long.

AE1065 \$67.95



BENCH MOUNTED DIMPLING/RIVETING TOOL

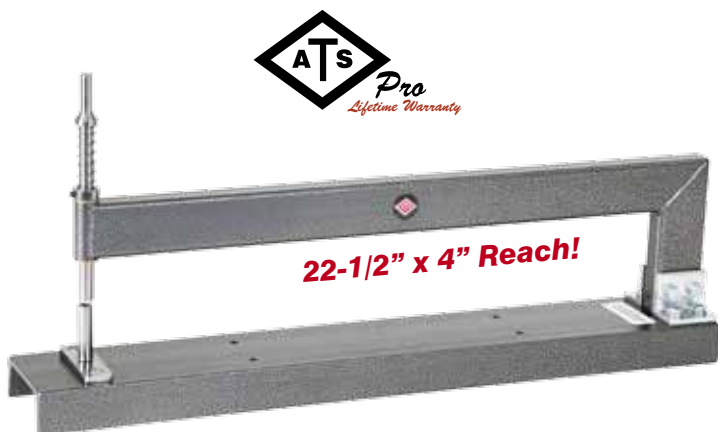

The deep 22-1/2" reach and 4" clearance height of this tool makes it a favorite of home builders and repair specialists. It's manufactured from heavy duty steel and finished with a rock hard powder-coated enamel for durability and great looks. The precision ground rivet shaft and fitted bronze bushing guarantees silky smooth operation. And the automatic spring-return feature will make your work easier. Uses dimple & die or rivet sets with a .187" shank. Comes complete with extension shaft and die holder block. New design extends throat to a **22-1/2" reach for RV and other kit builders.**

204RV.....\$179.95

DIMPLE DIE BLOCK SETS



Set accepts any dimple die or rivet squeezer sets with a .187 shank. Shank portion can be used in a standard rivet gun or struck with a hammer.

4187.....\$18.95
6187.....(Corner Block Unit).....\$18.95

DIMPLE DIE & SQUEEZER SET HOLDER



Designer to securely hold up to 20 dimple dies and rivet squeezer sets. Made of high impact plastic. Size is 4" x 4" x 5/8" 25 holes.

3456-B.....(6 Holes).....\$3.95
06785D.....(8 Holes).....\$4.95
06785.....(20 Holes).....\$11.95

C-RIVET SET KIT



Designed to work like the industry standard "gooseneck" style rivet sets, this is a much more versatile solution in that it allows you to instantly work with any size rivet without having to carry around a set of goosenecks. It uses standard .187" shank rivet

squeezers (and dimple dies) to do the work. Complete kit comes with C-SET rivet set, plus an assortment of squeezer sets in sizes: 3/32", 1/8", 5/32", 3/16", and flush.

CSET-KIT.....(Complete Kit).....\$41.95
CSET.....(C-SET Only).....\$24.95

60 DEGREE C-RIVET SET



The "C" shape is designed to reach around obstructions, while the polished wedge shaped "toe" can slip into the tightest areas to install a rivet. It can also be used as a driver to install and remove pins and bolts. Made of 4160 tool steel and hard-

ened to Rockwell 48.

CSET60.....\$29.95

RIVET FAN SPACING TOOL



This tool is just what you need for lining up those rivet holes. The clever accordion action of the fan spacer allows you to set up rivet holes with deadly

accuracy. Simply expand or contract the tool to get the spacing you're looking for and start laying out your holes. It just doesn't get any easier than this.

FS01.....(Standard Spacer).....\$35.95
FS02.....(Mini Spacer).....\$29.95

DIMPLE DIE SETS - 100°



Something new for dimpling 3/32" - 1/8" holes with any "pop" riveter.

5102D-3/32.....\$8.95
5102D-1/8.....\$8.95

3M RIVETERS TAPE



Riveters tape saves you time when doing those large riveting jobs by securely holding each rivet in place until you are ready to buck it. Rivets are fully visible through the transparent center window. Leaves no residue upon separation.

685-1.....(3/4" Wide x 36 Yards).....\$12.95
685-2.....(1" Wide x 36 Yards).....\$13.95

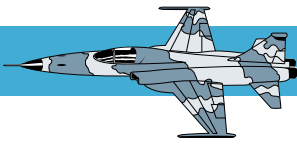

RIVETING EQUIPMENT

SPRING BACK DIMPLE DIE SETS



Spring back dimple dies are precision CNC machined from aircraft quality heat treatable stainless steel & heat treated to Rockwell C42/46. Spring back angles on both dies make a superior dimple. Working surfaces are polished to a satin finish & sharp edges are radii. Manufactured by Avery Tools

- AE6DDS(#6 AN Screw)\$38.95
- AE8DDS(#8 AN Screw)\$38.95
- AE10DDS(#10 AN Screw)\$38.95
- AEDDS-3/32(3/32 Rivet).....\$38.95
- AEDDS-1/8(1/8 Rivet)\$38.95
- AEDDS-5/32(5/32 Rivet).....\$38.95

FUEL TANK DIMPLE DIE SET 3/32



Use this dimple die set on fuel tanks. 3/32" dimple dies.

- AE14875.....\$38.95

DIE SETS FOR SETTING BRAKE RIVETS



Use your hand or pneumatic squeezer to set Cleveland brake rivets when re-lining your brake pads. Includes (2) sets with .187" dia. shank. All you need is a 3/16" drill bit, a small socket, a small pin punch and a hammer. Can also be used to install 1/8" countersunk tubular rivets.

- AE4625.....\$33.95

SCREW DIMPLERS



A dimpling tool similar to our pop rivet dimplers, but these use an allen screw to apply the dimpling force. Each size comes with a male & female die, allen screws & nuts and an allen wrench.

PART	SCREW SIZE	PRICE
AE1025	6 Screw	\$25.95
AE1026	8 Screw	\$25.95
AE1027	10 Screw	\$25.95

WISE GRIP DIMPLER



Made for dimpling in restricted and hard to reach places where regular dimple dies won't fit. Made in our shop with 7" Vise Grip plier. Machined tool steel dimple dies are T.I.G. welded to the Vise Grip jaws then polished. Manufactured by Avery Tools.

- AE550.....(3/32")\$45.95
- AE552.....(1/8")\$45.95

HAND DIMPLING PLIERS



Our dimpling pliers are produced from sturdy Vise Grip® Pliers which allow you to clamp down with over 3,500 lbs. of force! This unit sports a 1" reach and uses any standard dimple die with a .187 shank. Just order one pair of pliers and three additional sets of dies and you will have four tools in one!

PART	SIZE	PRICE	PART	SIZE	PRICE
7073	3/32"	\$35.95	707AN6	AN6 Screw	\$35.95
7074	1/8"	\$35.95	707AN8	AN8 Screw	\$35.95
7075	5/32"	\$35.95	707AN10	AN10 Screw	\$35.95
7076	3/16"	\$35.95			

SHOP HEAD RIVET GAUGE



Set of four gauges for -3, -4, -5, & -6 rivets. Each gauge measures MINIMUM height and MINIMUM diameter of shop heads AFTER setting. Works for measuring both universal head and flush rivets.

- AE1007(Avery Brand, USA).....\$21.95
- RG031(Economy).....\$9.95

RIVET LENGTH GAUGE



One gauge measures -3, -4, -5 & -6 rivets. Used to check length of rivets BEFORE setting. Works with universal and flush head rivets.

- AE1008(Avery Brand, USA).....\$10.95
- RG032(Economy).....\$5.95

RIVETING EQUIPMENT



SPRING BACK DIMPLE DIES



The unique shape of a spring back dimple die's face pushes the metal up slightly before the dimple is made, resulting in a cleaner, more precise 100° dimple. All dies are 1/2" in diameter and 1/4" long with a .187" shank.

PART	SIZE	PRICE	PART	SIZE	PRICE
SB4263	3/32"	\$25.95	SB6	AN6 Screw	\$29.95
SB4264	1/8"	\$25.95	SB8	AN8 Screw	\$29.95
SB4265	5/32"	\$25.95	SB10	AN10 Screw	\$29.95

DIMPLE DIES AND PUNCHES

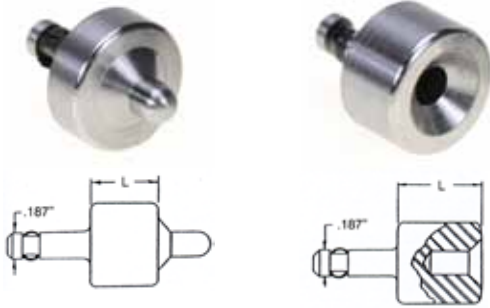

426XP Punch (Male)

426XD Die (Female)

Standard .187 shank. For AN426 series rivets (100 degrees countersink).

PART	SIZE	M/F	BODY LENGTH (L)				PRICE
			1/8"	1/4"	3/8"	1/2"	
4263P	3/32	M	-1	-2	-3	-4	\$12.95
4264P	1/8	M	-1	-2	-3	-4	\$12.95
4265P	5/32	M	-1	-2	-3	-4	\$12.95
4266P	3/16	M	-1	-2	-3	-4	\$12.95
4506P	6 Screw	M		-2	-3		\$12.95
4508P	8 Screw	M		-2	-3		\$12.95
4510P	10 Screw	M		-2	-3		\$12.95
4263D	3/32	F		-2	-3	-4	\$11.95
4264D	1/8	F		-2	-3	-4	\$11.95
4265D	5/32	F			-3	-4	\$11.95
4266D	3/16	F			-3	-4	\$11.95
4506D	6 Screw	F			-3		\$11.95
4508D	8 Screw	F			-3		\$11.95
4510D	10 Screw	F			-3		\$11.95
4263DP	3/32	M&F	-1*	-2	-3	-4	\$22.95
4264DP	1/8	M&F	-1*	-2	-3	-4	\$22.95
4265DP	5/32	M&F	-1*	-2**	-3	-4	\$22.95
4266DP	3/16	M&F	-1*	-2**	-3	-4	\$22.95
4506DP	6 Screw	M&F		-2	-3		\$22.95
4508DP	8 Screw	M&F		-2	-3		\$22.95
4510DP	10 Screw	M&F		-2	-3		\$22.95

*Note: these sets consist of a -2 die (F) and a -1 punch (M). **Note: these sets consist of a -3 die (F) and a -2 punch (M).

RIVET SQUEEZER/DIMPLE DIE MIX



A complete set of rivet squeezers and dimple dies for AN470 and Flush riveting. 17 piece set.

PART	DESCRIPTION	QTY	PART	DESCRIPTION	QTY
4703-2	3/32" Squeezer Set	1	4263DP-2	3/32" Dimple Die	1
4704-2	1/8" Squeezer Set	1	4264DP-2	1/8" Dimple Die	1
4705-2	5/32" Squeezer Set	1	4265DP-2	5/32" Dimple Die	1
4706-2	3/16" Squeezer Set	1	4266DP-2	3/16" Dimple Die	1
4710-2	Flush Set (1/2")	2	06785	Set Holder	1
3710-2	Flush Set (3/8")	2			

SKT17 \$119.95

RIVET SQUEEZER SETS



470X Series

4710 Series

200-X Series

200-450X Series

3456-x

UNIVERSAL RIVETS (AN470) STANDARD .187 SHANK							
PART	DIA (D)	RIVET SIZE	BODY LENGTH (L)				PRICE
			1/8"	1/4"	3/8"	1/2"	
4703	1/2"	3/32	-1	-2	-3	-4	\$6.95
4704	1/2"	1/8	-1	-2	-3	-4	\$6.95
4705	1/2"	5/32	-1	-2	-3	-4	\$6.95
4706	1/2"	3/16	-1	-2	-3	-4	\$6.95
4710	1/2"	Flush	-1	-2	-3	-4	\$6.95
3456	1/2"	6 piece set: 3/32 to 3/16 plus 2 flush	-1	-2	-3	-4	\$29.95
3710	3/8"	Flush	-1	-2	-3	-4	\$5.95
SEMI-TUBULAR RIVETS (AN450) STANDARD .187 SHANK							
OVAL			FLARE				
PART	SIZE	PRICE	PART	SIZE	PRICE		
200-2	1/16"	\$16.95	200-4502	1/16"	\$16.95		
200-3	3/32"	\$16.95	200-4503	3/32"	\$16.95		
200-4	1/8"	\$16.95	200-4504	1/8"	\$16.95		
200-5	5/32"	\$16.95	200-4505	5/32"	\$16.95		
200-6	3/16	\$16.95	200-4506	3/16"	\$16.95		
200-8	1/4"	\$16.95	200-4508	1/4"	\$16.95		



RIVET SQUEEZERS

"C" SQUEEZER YOKES

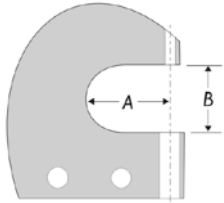

A = 2.5", B = 1.25"
14-10 \$99.95



A = 1.0", B = 1.0"
14-1 \$68.95



A = 1.19", B = 1.25"
14-2 \$69.95



A = 3.875", B = 1.25"
14-8 \$145.95



A = 2.75", B = 1.25"
14-6 \$125.95



A = 3.0", B = 1.375"
14-7 \$135.95



A = 1.5", B = 1.25"
14-3 \$69.95



A = 5.625", B = 1.250"
14-9 \$155.95



A = 2.5", B = 1.375"
14-5 \$125.95



A = 2", B = 1.25"
14-4 \$105.95

PNEUMATIC ALLIGATOR COMPRESSION RIVETERS

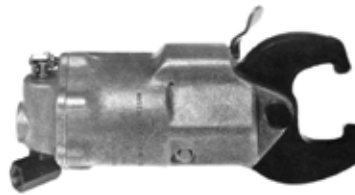

A214-30 Series

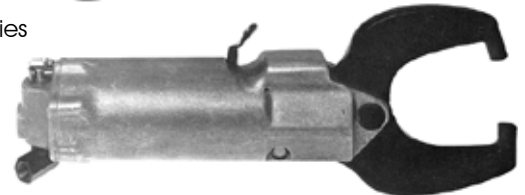

A214-60 Series

Alligator "A" Riveters are designed to be used in areas not accessible by other riveting methods. Our riveters are completely interchangeable with Chicago Pneumatic Squeezers. All Riveters will accept any Squeezer Set with .187" shank.

PART	FORCE (LBS)	CAPACITY	REACH	PRICE
A214-30-A15	3000	1/8"	1-1/2"	\$729.95
A214-30-A22	2400	1/8"	2-1/4"	\$769.95
A214-30-A30	1800	3/32"	3"	\$789.95
A214-60-A15	6000	3/16"	1-1/2"	\$781.95
A214-60-A22	4600	5/32"	2-1/4"	\$820.95
A214-60-A30	3400	1/8"	3"	\$842.95
A214-90-A15	9000	1/4"	1-1/2"	\$1,695.95
A214-90-A22	7000	3/16"	2-1/4"	\$1,849.95
A214-90-A30	5200	3/16"	3"	\$1,899.95

PNEUMATIC "C" COMPRESSION RIVETERS



0214-30 Series



0214-60 Series

All parts are interchangeable with Chicago Pneumatic Squeezers. Tandem Squeezers use a double piston action to double the force of a single piston squeezer. They will accept any Squeezer Set with a .187" shank.

PNEUMATIC BENCH MODEL RIVET SQUEEZERS



All units come equipped with an adjustable lower set holder, bench mounting brackets, hoses and foot control. Accepts all squeezer sets with a .187" shank. Available in a variety of yokes and power units. Made in U.S.A.

PART	RIVET CAPACITY	YOKE REACH	YOKE GAP	PRICE
0214-30C-C60B	1/8"	6"	3-1/2"	\$1627.95
0214-30C-C120B	1/8"	12"	4"	\$3097.95
0214-60C-C60B	3/16"	6"	3-1/2"	\$2199.95
0214-60C-90B	3/16"	9"	3-1/2"	\$2695.95

PART	TYPE	FORCE (LBS)	CAPACITY	PRICE
0214-30C	Single	3000	1/8"	\$556.95
0214-60C	Tandem	6000	3/16"	\$898.95

Note: "C" Riveters are sold without yokes. See our selection of yokes for compression riveters.

RIVET SQUEEZERS



ATS PNEUMATIC "C" SQUEEZER



ATS-114C



ATS-114CK

The "C" squeezer is by far the most popular pneumatic type riveter. They are also the most versatile. With a wide array of yokes to choose from, there is practically no riveting job they cannot take on. That's why we decided to create our own version of this popular squeezer. Our new ATS "C" Squeezer is lightweight and has the same power as the Chicago Pneumatic 0214-C squeezer on which it is based. It accepts the same yokes and attachments as the 214C squeezer, and is powerful enough to squeeze up to 1/8" solid aluminum, or 3/32" solid steel rivets. And we've combined our new riveter with a Longeron yoke, and our best-selling 17-piece squeezer/dimpler set to provide you with a value package that's hard to beat.

CAPACITY	YOKE REACH	YOKE GAP	CLOSED HEIGHT	MAX FORCE
1/8" aluminum	1-1/2"	1-1/4"	11/16"	3000 lbs

No. ATS-114CK (Complete kit) **\$599.95**
 No. ATS-114C ("C" Riveter with 1-1/2" yoke)..... **\$499.95**

ATS PNEUMATIC ALLIGATOR SQUEEZER



ATS-114A



ATS-114AK



The new ATS Alligator Squeezer is a lightweight, compact, and powerful riveter modeled after the industry standard Chicago Pneumatic 0214-A squeezer. Its completely interchangeable with the 0214-A squeezer, and will accept any jaws designed for that unit. It delivers a consistent 3,000 lbs of force to squeeze up to 1/8" solid aluminum, or 3/32" solid steel rivets. This is a riveter that will easily fit most of your riveting needs without breaking your budget. Want even more savings? Get the complete riveting kit, which contains the alligator squeezer, plus our 17-piece squeezer/dimpler set.

CAPACITY	YOKE REACH	YOKE GAP	CLOSED HEIGHT	MAX FORCE
1/8"	1-1/2"	1-5/8"	7/8"	3000 lbs

No. ATS-114AK (Complete kit) **\$569.95**
 No. ATS-114A (Alligator Squeezer Only) **\$479.95**

RIVET SQUEEZER BENCH MOUNT



Adapt your pneumatic "C" rivet squeezers for bench use. Machined steel bracket mounts to your bench permanently while allowing you to easily install or remove the riveter. The unique design clamps any yoke in any position from straight to tilted back 90 degrees. Works with all (9/16" thick) pneumatic squeezer yokes.

AE7698 **\$67.95**

ADJUSTABLE SET HOLDER FOR PNEUMATIC SQUEEZER



This adjustable set holder will eliminate the need to shim the dies and sets with shim washers. Adjustments are faster & easier. Note: Only for yokes with 1" thick base or less. Does not work for tandem units.

AE274 **\$79.95**

RIVET SPACER SHIM KIT



Spacer shims are used with Compression Riveters to produce a precise rivet gap spacing. This kit contains 2 each of the following shim sizes: 1/64", 1/32", and 1/16". With it you will be able to make 1/64" adjustments in a range of 1/64" to 7/32".

SMS-012K **\$5.95**



RIVET SQUEEZERS

ATS SUPER DUTY RIVET SQUEEZER KIT



This addition to our ATS Pro Rivet Squeezer line is built from solid Stainless Steel for hard use. Our new money-saving kit contains everything you'll need to tackle any riveting job. You get our popular ATSRs-3SD 3" Rivet Squeezer, an extra 1.5" yoke, our 17 Piece Dimple Die & Squeezer Set, a Rivet Length Gauge, and a Shop Head Rivet Gauge to help you get the job done right. Our new ATS Rivet Squeezer will easily squeeze rivets up to 5/32" diameter. Adjustable ram eliminates the need for shims.

SDRS-KIT.....\$269.95

ATS SUPER DUTY RIVET SQUEEZER

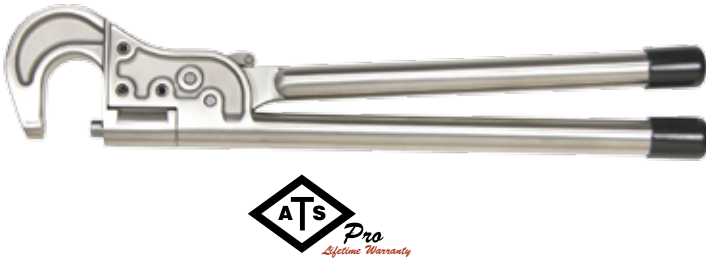

The addition to our ATS Pro Rivet Squeezer Line is built for hard use, but we must admit it's also one of the best looking squeezers we've ever seen. It's an all **stainless steel** design that's constructed to last a lifetime. The unique unibody styling is drop forged for extra strength and CNC machined to tight tolerances. The yoke (also stainless steel) is engineered to be half the weight of other yokes, yet retains its full strength. Finally, the whole thing is beautifully finished in a brush satin look and highly polished surfaces. It has a very solid feel, and a professional look that will complement anyone's toolbox. Squeezes up to 5/32" aluminum (1/8" steel) rivets. Works with any rivet sets, or dimple dies having a 3/16" (.187") shank. Adjustable ram does not need shims.

ATSRs-1SD..... (1.5" Rivet Squeezer)\$105.95
ATSRs-3SD..... (3" Rivet Squeezer).....\$115.95
ATSRs-1SDY..... (1.5" Yoke)\$39.95
ATSRs-3SDY..... (3" Yoke).....\$49.95
ATSRs-B2SDY..... (Box Head Longeron Yoke).....\$54.95
3456-2..... (Squeezer Sets, Set of 6).....\$29.95

ATS ECONOMY RIVET SQUEEZER KIT



Our Rivet Squeezer Kit contains everything you'll ever need to tackle any riveting job. You get our popular ATSRs Rivet Squeezer, plus three yokes in sizes 1", 2" and 3". We've also thrown in our 6 Piece Squeezer Set, and a set of Rivet Gauges to help you get the job done right. Our ATS Rivet Squeezer will easily squeeze rivets up to 5/32" diameter. The yokes are made of tool steel and hardened to resist flex. Adjustable ram eliminates the need for shims.

ATSRs-KIT.....\$179.95

ATS ECONOMY RIVET SQUEEZER



Our ATS Series Rivet Squeezer will safely squeeze aluminum rivets up to 5/32" in diameter (up to 1/8" steel rivets). The unibody handles are forged from a single billet of steel and precisely machined. This makes them extremely strong and resistant to breakage. The yoke is made of the highest quality tool steel and hardened to resist flex under stress. An adjustable ram eliminates the need for shims.

ATSRs-1..... (1" Rivet Squeezer).....\$85.95
ATSRs-3..... (3" Rivet Squeezer).....\$95.95
ATSRs-1Y..... (1" Yoke)\$29.95
ATSRs-2Y..... (2" Yoke)\$35.95
ATSRs-3Y..... (3" Yoke)\$39.95
3456-2..... (Rivet Squeezer Sets, Set of 6)\$29.95

ROPER WHITNEY® COMPOUND HAND RIVET SQUEEZER



Compound leverage develops 3,500 lbs. of force and can easily squeeze 3/32", 1/8", 5/32", and 3/16" rivets. Also can be used with dimple dies (see our Dimple Die section). Adjustable ram. Yoke swivels 360° and can be locked in any position. Overall length is 19".

PART	REACH	GAP HEIGHT	PRICE
DA-2	2-1/2"	1-5/8"	\$499.95
DA-5	6"	1-5/8"	\$405.95

RIVET SQUEEZERS



DELUXE HAND/BENCH RIVET SQUEEZER KIT



The ATS Hand/Bench Rivet Squeezer Kit gives you the best of both worlds. It's a hand squeezer that converts to a free-standing bench squeezer in under 10 seconds! To make sure you can handle any riveting job we included a 3" yoke in addition to our 1 1/2" squeezer. You'll also get the bench mounting kit and our 17 piece squeezer and dimple die assortment set (SKT17).

5022-DX.....\$349.95

ATS PROFESSIONAL SWIVEL HAND RIVET SQUEEZER



This squeezer has a 360° swivel head for greater versatility. Featuring a 5/8" adjustable ram eliminates the need for shims. With longer handles to give you the leverage you need to squeeze a 3/16" rivet and an interchangeable yoke, this makes it one of the best squeezers on the market.

5011-1A (Squeezer with 1-1/2" Yoke) \$135.95

5022-3A (Squeezer with 3" Yoke) \$145.95

RS1009A-1 (Replacement 1-1/2" Yoke) \$65.95

RS1008A-3 (Replacement 3" Yoke) \$75.95

ATS PROFESSIONAL HAND/ BENCH RIVET SQUEEZER



The newly redesigned ATS Hand/Bench Rivet Squeezer is a hand squeezer that quickly converts to a bench riveter. Just pin it into its cradle and you have a solid bench riveter; and when you need to use it as a hand squeezer, simply unpin it. The ATS Hand/Bench Rivet Squeezer has the same design features as our popular 5022 squeezer, including a 360° swivel head, and an adjustable ram. It uses all of the same yokes and accessories as the 5022, and will squeeze up to 3/16" aluminum, or 5/32" steel rivets.

5011-1B..... (1-1/2" Reach) \$185.95

5022-3B..... (3" Reach) \$195.95

RS-BK (Bench Mount Only) \$55.95

SPECIALTY YOKES



Our new specialty yokes adds even more versatility to our popular 5022-DX, 5022, and 5011 Rivet Squeezers. Each yoke is heat treated and precision CNC machined.

PART	DESCRIPTION	REACH	GAP HGHT	PRICE
RS1004A	Longeron Yoke	2-1/2"	1-1/4"	\$95.95
RS1005A	Deep Reach Yoke	4"	1-1/4"	\$99.95
RS1006A	Close Quarters Yoke	1-1/2"	1-1/4"	\$75.95
RS1007A	Close Quarters Yoke	3"	1-1/4"	\$79.95

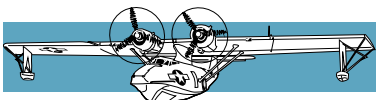

POWER RIVETERS

GBP 704 CHERRYMAX POWER RIVETER

This pneumatic-hydraulic tool designed specifically for the efficient installation of Cherrymax®, as well as a wide range of blind rivets. The GBP704 riveter operates on a wide range of air pressure, with 90 to 100 psi providing the maximum efficiency, at 90 psi of air pressure. **Recommended Nosepieces:** H701B-456 Straight, H753-456 Right Angle, and H781-456 Offset for CherryMAX®. *Nosepieces sold separately.*



GBP704F.....\$865.95

GBP 744 CHERRYMAX POWER RIVETER

The GBP744 is a pneumatic-hydraulic tool designed specifically for the efficient installation of 1/8" thru 1/4" Cherrymax® and High-Clinch rivets, as well as a wide range of blind rivets. It has a .590" rivet setting stroke and a rated pull load of 3,800 pounds on 90 psi air pressure at the air inlet. **Recommended Nosepieces:** 456MAX744-20 Straight, and 08MAX744-20 Straight CherryMAX®. *Nosepieces sold separately.*



GBP744E.....\$2,779.95

GBP 784 CHERRYLOCK POWER RIVETER

The GBP784 is a pneumatic-hydraulic tool designed specifically for the efficient installation of 2000 series Cherrylock®, or other aerospace blind rivets meeting NAS1398, NAS1399, NAS1798, and NAS1799. It has a .938" rivet setting stroke and a rated pull load of 2,650 pounds. **Recommended Nosepieces:** H681-3C, -4C, -5C, and -6C for CherryLOCK®; *Nosepieces sold separately.*



GBP784B.....\$2,936.95

GBP 703 COMMERCIAL POWER RIVETER

The GBP703 will efficiently install a wide range of commercial (nail-type) blind rivets. With the proper nosepieces, it will also pull Cherry Avex®, Monobolt®, KampTite®, Nutplate®, Plastic Split Rivets, T-Rivets, and TLR Rivets. Ready to operate, including nose assembly.



GBP703E.....\$850.95

GBP 704 CHERRYMAX RIVETING KIT



GAGE BILT offers a complete tool kit for installing Huck and Cherry blind rivets per NAS9301-NAS9312, M7885, BACR15FP/FR and BACR15GF/GK. The basic kit, GBP704RK, contains a straight nose to install -4, -5 and -6 diameter, bleeder bottle, pintail catcher bag and a grip selector gage. The dash one kit also contains a right angle and an offset nose, must items for re-work operations. All these items are stored in an easy access carrying case with a manual, data sheets, powermax tools manual and pocket card.

GBP704RK-1\$2,399.95

GBP 784 CHERRYLOCK RIVETING KIT



A complete tool kit for installing CherryLock®, and other aerospace blind rivets meeting NAS1400; NAS1740 standards. The complete kit contains the GBP 784 Riveter; bleeder bottle; stroke setting gage; and straight noses to install -4 (1/8"), -5 (5/32"), and -6 (3/16") diameter rivets. All these items are stored in an easy access carrying case with a manual and data sheet.

GBP784RK\$4,332.95

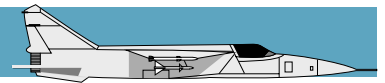

CHERRY® POWER RIVETERS

Note: Pulling heads are not furnished with Riveters and must be purchased separately.

G704B CHERRYMAX® POWER RIVETER



This tool utilizes straight, offset and right-angle pulling heads, all of which can install -4, -5, and -6 diameter CherryMAX® rivets in all head styles, materials and grip lengths. Specifications: 90 to 110 PSI (6.2 to 7.6 bar) operating pressure; 3100 lbs (13.79 kN) pulling force at 90 psi (6.2 bar); .510" (12.954mm) stroke length; 4.25 lbs (1.93 kg) weight.

See the Power Riveter section of this catalog for the following recommended Nosepieces: H701B-456 Straight, H753-456 Right Angle, and H781-456 Offset for CherryMAX®.

G704B (NSN 5130-01-044-7207) \$1,029.95

G784 CHERRYLOCK® HYDRO-SHIFT RIVETER



It will install nearly all diameters of CherryLOCK® Rivets up to a half-inch grip. It can be operated in any position with one hand. With proper adapters and pulling heads, this tool will install other types of rivets including CherryMAX® Rivets. Specifications: 90 to 110 PSI (6.2 to 7.6 bar) operating pressure; 2600 lbs (11.57 kN) pulling force at 90 psi (6.2 bar); .875" (22.2mm) stroke length; 8 lbs (3.63 kg) weight.

See the Power Riveter section of this catalog for the following recommended Nosepieces: H681-3C, -4C, -5C, and -6C for CherryLOCK®; H680B200A & 744-300 adapter for CherryMAX®.

G784 (NSN 5130-00-935-4681) \$3,995.95

G747 CHERRYMAX® POWER RIVETER



This tool utilizes straight, offset and right-angle pulling heads, all of which can install -4, -5, and -6 diameter CherryMAX® bulb type rivets in all head styles, materials and grip lengths. Specifications: 90 to 110 PSI (6.2 to 7.6 bar) operating pressure; 2100 lbs (9.34 kN) pulling force at 90 psi (6.2 bar); .437" (11.1 mm) stroke length; 3.5 lbs (1.59 kg) weight.

See the Power Riveter section of this catalog for the following recommended Nosepieces: H701B-456 Straight, H753-456 Right Angle, and H781-456 Offset for CherryMAX®.

G747 \$1,101.95

G83 CHERRY LOCKBOLT POWER RIVETER



This a heavy duty production tool designed for high speed, reliable installation of the most popular sizes of aircraft lockbolts. It can be operated in any position with one hand. This tool can also be used to install blind bolts and blind rivets. Specifications: 90 to 110 PSI (6.2 to 7.6 bar) operating pressure; 3750 lbs (16.7 kN) pulling force at 90 psi (6.2 bar), 800 lbs (3.56 kN) on return stroke; .438" (11.1mm) stroke length; 4.95 lbs (2.25 kg) weight.

See the Power Riveter section of this catalog for the following recommended Nosepieces: H701B-456 for CherryMAX®.

G83 (NSN 5130-01-435-3507) \$1,785.95

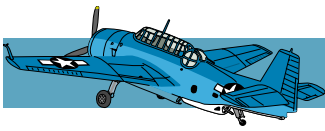

POWER RIVETERS

BLIND BOLT PULLING HEADS



These pulling heads will fit Cherry G83 and G84 Riveters and allow you to pull Cherry MaxiBolt®, Huck A286, MS90353, MS90354, MS21140, and MS21141 Blind Bolts. The Cherry® and Huck® Pulling Heads shown below are compatible for a given size, and may be used interchangeably with corresponding Huck or Cherry Riveters.

PART	SIZE	DESCRIPTION	MFG	PRICE
H83B-5MB 99-2701	-5	5/32" Pulling Head	Cherry Huck	\$598.95 \$475.95
H83B-6MB 99-2707	-6	3/16" Pulling Head	Cherry Huck	\$597.95 \$495.95
H84B-8MB 99-2713	-8	1/4" Pulling Head	Cherry Huck	\$653.95 \$486.95

CHERRYLOCK PULLING HEADS



The H681 series pulling heads are used to install 2000 series Cherrylock® rivets. A separate pulling head is required for each diameter and type of rivet. Fits GBP models GBP700 and GBP784, and Cherry Textron models G700 and G784 riveters.

PART	SIZE	PRICE
H681-3C	3/32"	\$499.95
H681-4C	1/8"	\$435.95
H681-5C	5/32"	\$435.95
H681-6C	3/16"	\$435.95

OFFSET CHERRYMAX PULLING HEAD



Offset nosepieces are used to clear obstructions that are in line with the normal pulling axis of the riveter. This pulling head provides an offset of 1-15/32". Overall length is 4-3/8". Pulls all nominal and oversize Cherrymax® rivets from 1/8" (-4) to 3/16" (-6). Works with the following riveters: GBP model GBP704, Cherry Textron models G701A, G704B, G749A and G845A.

H781-456 \$449.95

RIGHT ANGLE CHERRYMAX PULLING HEAD



A right angle nosepiece pulls at 90° to the normal pulling axis of the riveter. They are used in restricted areas, or when pulling from around a corner. The H753-456 has a head clearance of 2-1/4", and an overall length of 5-7/16". Pulls all nominal and oversize Cherrymax® rivets from 1/8" (-4) to 3/16" (-6). Works with the following riveters: GBP model GBP704, Cherry Textron models G701A, G704B, G739A and G845A.

H753-456 \$612.95

STRAIGHT CHERRYMAX PULLING HEADS



Figure a



Figure b

A straight nosepiece is the preferred way to install Cherrymax® rivets if circumstances permit. Each nosepiece listed in the chart below will pull all nominal and oversize Cherrymax® rivets from 1/8" (-4) to 3/16" (-6).

PART	FIG	FITS RIVETER		PRICE
		GBP MODEL	CHERRY MODEL	
H701B-456	a	GBP704	G701A,	\$125.95
H680B200A	b	GBP700,	G704B	\$475.95
456MAX744-20	b	GBP784	G700, G784	\$346.95

STRAIGHT CHERRYMAX PULLING HEAD



A straight nosepiece is the preferred way to install Cherrymax rivets if circumstances permit. Pulls all nominal and oversize Cherrymax rivets from 1/8" (-4) to 3/16" (-6). Fits GPB744; Cherry G744 riveters.

08MAX744-20 \$192.95

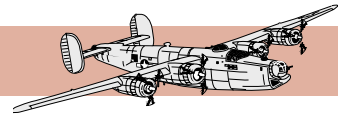

ATS AIR HYDRAULIC RIVETER

Our new riveter is compact and lightweight yet delivers a whopping 2,300 lbs of pulling force to effortlessly pull up to 3/16" (4.8mm) steel rivets. Comes complete with nosepieces for 1/8", 5/32", and 3/16" rivets. Includes stem deflector for added safety. Will not pull Cherrymax.



- Pulling Force 2,300 lbs (1,045 Kg)
- Rivet Capacity 3/16" aluminum or mild steel
- Stroke Length .63" (16 mm)
- Nosepieces: 3/32" (2.4 mm), 1/8" (3.2 mm), 5/32" (4.0 mm), 3/16" (4.8 mm)
- Weight 3.26 lbs (1.48 kg)

ATS8806.....(Heavy Duty Riveter) \$95.95
 3047RP.....(Replacement Jaws) \$13.95

ATS AIR HYDRAULIC RIVETER KIT

Our newest riveting kit features our ATS8805 riveter plus an assortment of tools to keep it in peak operating condition, all in a molded high impact case.



- Pulls 3/32", 1/8", 5/32", and 3/16" rivets.
- Includes Stem Catcher
- 2300 lbs pulling force
- .63" Stroke length.

Accessory Kit Contains: An assortment of 40 pop rivets in sizes 3/32", 1/8", 5/32", and 3/16"; 1 set replacement o-rings and seals (1 t); Oil Bottle; replacement spring set (3); replacement valve pushed; replacement jaws and jaw case; wrench set; high impact molded case.

ATS8805K..... \$105.95

ATS HEAVY DUTY RIVETER WITH COLLECTOR

A powerful riveter with a built in vacuum collection system to store stems.



- Pulling Force 2400 lbs (1090 Kg)
- Rivet Capacity 3/16" aluminum or mild steel
- Stroke Length .768" (19 mm)
- Built-in vacuum collection system
- Nosepieces: 3/32" (2.4 mm), 1/8" (3.2 mm), 5/32" (4.0 mm)
- Weight 4.11 lbs (1.87 kg)

ATS8821V..... \$170.95

ATS EXTENDED REACH RIVETER W/ COLLECTOR



This specialty riveter is for reaching into those really deep areas. Vacuum collection system keeps stems safely stowed in collector.

- Pulling Force 1,300 lbs (600 Kg)
- Rivet Capacity 5/32" aluminum or mild steel
- Stroke Length .63" (16 mm)
- Extended nose dimensions: 8.00" long x .635" diameter
- Nosepieces: 3/32" (2.4 mm), 1/8" (3.2 mm), 5/32" (4.0 mm)
- Built-in vacuum collection system
- Weight 2.7 lbs (1.2 kg)

ATS8814VE..... \$229.95

ATS8814VE-3.....(3PC Replacement Jaws)..... \$25.95

ATS INLINE RIVETER WITH COLLECTOR

This riveter gets you into some very tight spaces. It's unique in line configuration allows you to use it to do construction or repairs through openings such as inspection holes or wheel wells.



- Pulling Force 2400 lbs (1090 Kg)
- Rivet Capacity 3/16" aluminum or mild steel
- Stroke Length .768" (19 mm)
- Built-in vacuum collection system
- Nosepieces: 3/32" (2.4 mm), 1/8" (3.2 mm), 5/32" (4.0 mm)
- Weight 4.11 lbs (1.87 kg)

ATS8802V..... \$199.95

ATS MONOBOLT RIVETER

With a heavy duty jaws and a pulling force of nearly 4,000 lbs, the new ATS Monobolt Riveter will easily draw 3/16" and 1/4" diameter rivets. Suitable for use with Avdel Monobolts® (27xx series), and Huck Magna-Loks® (MGL and UMGL series).



- Pulling Force 3,841 lbs (1,745 Kg)
- Rivet Capacity 1/4" aluminum or mild steel
- Heavy Duty Jaws
- Nosepieces: 3/16" (4.8 mm), 1/4" (6.4 mm)
- Weight 3.85 lbs (1.75 kg)

ATS8813..... \$345.95



BLIND RIVETERS

TAYLOR PNEUMATIC BLIND RIVETER



A quality Pneumatic riveter designed to rivet 3/32" through 3/16" aluminum and steel blind rivets. Comes with 1/8", 5/32" and 3/16" nosepieces. Very compact design. Weighs 3.5 lbs. Operates on 80 to 100 psi air pressure at 4.2 CFM.

- 3047.....\$116.95
- 3047RP.....(Replacement Jaws)\$13.95

SWIVEL BLIND RIVETER



This riveter has a swivel head which rotates a full 360° for versatility. This riveter will double as a 90° offset riveter, or a straight (in line) puller just by rotating the head. Pulls up to 3/16" Cherrymax® and many other blind rivets without any additional attachments.

- 36021.....\$29.95

CLOSE QUARTERS POP RIVETER



Close quarters POP® brand riveter features an offset nosepiece for easy access to corners and close to wall applications. Sets rivets from 3/32" to 5/32" (2.4 - 4.0 mm) diameter. Includes nosepiece to set 1/8" (3.2 mm) rivets.

- PRP-26A.....\$179.95

HUCK® AIR POWERED RIVETER



The AK175A is the air powered counterpart to the HK150A. It is the most compact air-reciprocating hydraulic riveter on the market. It will pull Cherrymax® rivets in 5/32" and 3/16" sizes. It will also pull Pop® and Monobolt® rivets (Monobolt nosepieces are sold separately).

- AK175A\$379.95
- 202159.....(1/8" Nominal Cherrymax Nosepiece).....\$20.95
- 202168.....(3/16" Monobolt Nosepiece).....\$20.95
- 202169.....(1/4" Monobolt Nosepiece).....\$20.95
- 3047RP.....(Replacement 2-Piece Jaw Set).....\$13.95
- 202929.....(Replacement 3-Piece Jaws Set).....\$25.95
- HKRN205(Rivnut Conversion Kit).....\$142.95

HUCK® HAND HYDRAULIC RIVETER



The HK150A features a moveable jaw design which allows it to pull 1/8", 5/32", and 3/16" Cherrymax® rivets without any additional attachments. It will also pull many other types of blind rivets ranging from simple Pop® rivets to sophisticated Monobolts® in sizes ranging up to 1/4" steel rivets.

- HK150A\$259.95
- 202159.....(1/8" Nominal Cherrymax Nosepiece).....\$20.95
- 202929.....(Replacement 3-Piece Jaws).....\$25.95
- HKRN205(Rivnut Conversion Kit).....\$142.95

BLIND RIVETERS

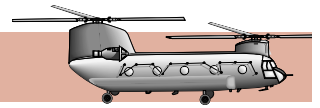

CHERRY TEXTRON™ BLIND RIVETER



Cherry Textron hand riveter is ideally suited for installing Cherry-Q, Pop Rivets, or Avex Rivets in sizes 1/8" through 3/16" aluminum or up to 1/8" steel rivets. Includes nose pieces for 1/8", 3/16", and 5/32" rivets. Length: 9-1/4".

G28.....\$141.95

MARSON® HEAVY-DUTY RIVNUT INSTALLER KIT



Industrial strength Rivnut tool is made from forged steel to withstand hard use. Unique design allows mandrels to be replaced quickly and easily. Kit includes mandrels and an assortment of Rivnuts for the following sizes: 6-32, 8-32, 10-32, 10-24, 1/4-20, 5/16-18, and 3/8-16.

- 39213**..... \$94.95
- 39254**..... (Replacement 6-32 Mandrel) \$15.95
- 39255**..... (Replacement 8-32 Mandrel) \$15.95
- 39257**..... (Replacement 10-32 Mandrel) \$15.95
- 39271**..... (1/4-28 Mandrel) \$17.95

MARSON® DELUXE POP RIVETER KIT



The deluxe hand riveter kit includes the Marson HP-2 riveter, tool, wrench, removable nosepieces for 3/32", 1/8", 5/32" and 3/16" riveting, plus and assortment of over 200 assorted Alcoa Klik-Fast rivets: 40 each SB4-2, SB4-4, AB4-2A; 25 each SC4-4, AB6-2. Also includes a molded plastic case.

200KT\$57.95

RIVNUT INSTALLER KIT



Complete kit includes tool, nosepiece, and mandrels in sizes 6-32, 8-32, 10-32, and 1/4-20, plus an assortment of Rivnuts.

- 20RNK** \$59.95
- 20RNK-6-32** (Replacement 6-32 Mandrel) \$11.95
- 20RNK-8-32** (Replacement 8-32 Mandrel) \$11.95
- 20RNK-10-32** (Replacement 10-32 Mandrel) \$11.95

MARSON® HP-2 HAND RIVETER



The Marson HP-2 is the number one selling hand rivet tool in the industry. Known and trusted for durability, quality and performance, the HP-2 is often copied but never duplicated. The HP-2 sets up to 3/16" steel rivets and comes with four mounted nosepieces (3/32", 1/8", 5/32" and 3/16") and a service wrench.

HP-2.....\$35.95





BLIND RIVETERS

SIoux CLINCH NUT INSTALLER



Sioux Tool's new Signature Series Clinch Nut Tools are designed to quickly and efficiently install clinch nuts (also known as Rivnuts, rivet nuts, or captive nuts). Rapid reverse button allows fast release from the clinch nut after installation. Grease fitting in head enables easy lubrication of thrust bearing for reduced wear and extended life. Signature Series housing features the latest in ergonomics - providing maximum operator comfort and superb balance.

Note: Units are sold without nosepiece assemblies which must be purchased separately.

PART	FREE SPEED	MAX TORQUE		PRICE
	RPM	IN LB	NM	
SCN3R	300	400	45.2	\$709.95
SCN5R	500	325	36.7	\$709.95
SCN7R	700	220	24.8	\$709.95
NOSEPIECE ASSEMBLIES				
SCN-440S	Installs 4-40 Rive-Nuts			\$114.95
SCN-632S	Installs 6-32 Rive-Nuts			\$114.95
SCN-832S	Installs 8-32 Rive-Nuts			\$114.95
SCN-1032S	Installs 10-32 Rive-Nuts			\$114.95
SCN-420S	Installs 1/4-20 Rive Nuts			\$114.95

SPEED DRIVER RIVNUT INSTALLER



Fast economical hand tool for installing aluminum or steel Rivnuts or thread-serts. Conversion kits are also available that allow you to change the tool size.

INSTALLATION TOOL		CONVERSION KIT		REPL. MANDREL	
PART	PRICE	PART	PRICE	PART	PRICE
C50-6000-4x40	161.95	C50-4x40	62.95	C5000-4x40	35.95
C50-6000-6x32	159.95	C50-6x32	45.95	C5000-6x32	17.95
C50-6000-8x32	141.95	C50-8x32	45.95	C5000-8x32	17.95
C50-6000-10x32	159.95	C50-10x32	45.95	C5000-10x32	17.95
C50-6000-10x24	141.95	C50-10x24	41.95	C5000-10x24	17.95

HAND RIVNUT INSTALLER

Unit is simple to use and allows an inexpensive, efficient means for installing Rivnuts.



- RN190-6-32.....(Installs 6-32 Rive-Nuts).....\$25.95
- RN190-8-32.....(Installs 8-32 Rive-Nuts).....\$25.95
- RN190-10-32.....(Installs 10-32 Rive-Nuts).....\$25.95

RIVNUT TOOL



The Rivnut Tool is an inexpensive alternative to industrial drivers. It's design enables the rivet nuts to be seated tighter than with conventional tools. Compact design takes up less room in your tool box. Complete kit contains driver, plus mandrels for 6-32, 8-32, and 10-32 Rivnuts.

- RNT01.....\$26.95

POP RIVNUT INSTALLER



Convert your conventional hand pop riveter into an economical Rive-Nut installer tool.

- R290-6-32.....(Installs 6-32 Rive-Nuts).....\$11.95
- R290-8-32.....(Installs 8-32 Rive-Nuts).....\$11.95
- R290-10-32.....(Installs 10-32 Rive-Nuts).....\$11.95

RIVNUTS



Aluminum "notchless" threaded nut. Grip length of .010 to .075 inches. Sold in packages of 10 pieces.

- RIVNUT-6.....(6-32).....\$2.95
- RIVNUT-8.....(8-32).....\$3.25
- RIVNUT-10.....(10-32).....\$3.45
- RIVNUT-1/4-20.....(1/4-20).....\$3.75

SHEET METAL FASTENERS



CLECO KIT



An assortment of clecos (0 to .25" grip range) plus a pair of cushioned cleco pliers packaged in a convenient storage case. The 50 piece kit contains 13 ea. of the 3/32" (silver), & K-1/8 (copper) clecos; plus 12 ea of the 5/32" (black), & 3/16" (gold) clecos. The 100 piece kit contains 25 each of the 3/32", 1/8", 5/32", and 3/16" clecos.

CL50K..... (50 Piece Kit) \$28.95

CL100K..... (100 Piece Kit) \$52.95

SPRING TENSION CLAMPS



These clamps can be applied in a fraction of the time required for ordinary screw clamps by eliminating hand tightening. Provides 70 lbs. of clamping pressure. Uses standard Cleco Pliers.

PART	REACH	CAPACITY	PRICE
24EL	1/2"	0-3/4"	\$2.25
26EL	1"	0-3/4"	\$2.25
542	2"	0-1/2"	\$5.95
543	3"	1/4"-15/32"	\$7.95

CLECO FASTENERS



Used to temporarily hold panels and fixtures in place prior to riveting. Standard size (2"x 3/8"). 70 lbs pulling force.

PART	SIZE	GRIP	PRICE	1000+	5000+
CL-3/32	3/32"	0-1/4"	.45	.41	.38
CL-1/8	1/8"	0-1/4"	.45	.41	.38
CL-5/32	5/32"	0-1/4"	.45	.41	.38
CL-3/16	3/16"	0-1/4"	.45	.41	.38
CL-1/4	1/4"	0-1/4"	1.10	.99	.94
EXTRA LONG SERIES					
KHD-3/32	3/32"	0-1/2"	.77	.69	.65
KHD-1/8	1/8"	0-1/2"	.77	.69	.65
KHD-5/32	5/32"	0-1/2"	.77	.69	.65
KHD-3/16	3/16"	0-1/2"	.77	.69	.65

CLECO FASTENERS "SPECIAL"

Order pre-packaged clecos for additional savings. Each package contains 25 pieces of our standard clecos.

25CL-3/32(25 Pieces CL-3/32 Clecos) \$11.95

25CL-1/8(25 Pieces CL-1/8 Clecos) \$11.95

25CL-5/32(25 Pieces CL-5/32 Clecos) \$11.95

25CL-3/16(25 Pieces CL-3/16 Clecos) \$11.95

CLECO CAPS



Vinyl cleco cap slips over the end of standard spring-loaded (K, KHD, or KK series) clecos and prevents damage to the skin. Can be reused many times over and cleans off easily with soap and water.

Note: Does not include clecos.

SIZE	COLOR	10-PACKS	
		PART	PRICE
3/32"	Gray	10KSCAP-3/32	\$2.95
1/8"	Orange	10KSCAP-1/8	\$2.95
5/32"	Black	10KSCAP-5/32	\$2.95
3/16"	Blue	10KSCAP-3/16	\$2.95

CLECO PLIERS



For use with clecos and spring loaded fasteners.

131..... \$5.95

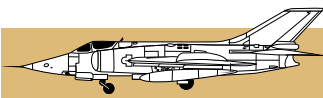

SHEET METAL FASTENERS

WING NUT FASTENERS



For applications requiring a high-clamping force. These fasteners can be adjusted to deliver from zero to 300 lbs. Perfect for all types of metallic and composite materials.

PART	SIZE	GRIP	PRICE
KWN-3/32	3/32"	0 -1/2"	\$2.95
KWN-1/8	1/8"	0 -1/2"	\$2.95
KWN-5/32	5/32"	0 -1/2"	\$2.95
KWN-3/16	3/16"	0 -1/2"	\$2.95
KWN-7/32	7/32"	0 -1/2"	\$3.95
KWN-1/4	1/4"	0 -1/2"	\$3.95
EXTRA LONG SERIES			
KWNL-3/32	3/32"	0 -1"	\$3.95
KWNL-1/8	1/8"	0 -1"	\$3.95
KWNL-5/32	5/32"	0 -1"	\$3.95
KWNL-3/16	3/16"	0 -1"	\$3.95

HEX NUT FASTENERS



They provide high clamping force with the ability to be quickly installed and removed with a Hex Nut Runner. Delivers from zero to 300 lbs. of clamping force.

PART	SERIES	HEAD	PRICE
HNX-3/32	3/32"	0 -1/2"	\$3.95
HNX-1/8	1/8"	0 -1/2"	\$3.95
HNX-5/32	5/32"	0 -1/2"	\$3.95
HNX-3/16	3/16"	0 -1/2"	\$3.95
HNX-7/32	7/32"	0 -1/2"	\$3.95
HNX-1/4	1/4"	0 -1/2"	\$3.95
EXTRA LONG SERIES			
HNXL-3/32	3/32"	0 -1"	\$3.95
HNXL-1/8	1/8"	0 -1"	\$3.95
HNXL-5/32	5/32"	0 -1"	\$3.95
HNXL-3/16	3/16"	0 -1"	\$3.95

WING NUT/HEX NUT DRIVE ADAPTER



Works with any drill chuck, or any 1/4" hex screwdriver. Drives all styles of wing nuts and hex nuts with a 5/16" nut.

MJ350	(USA Made)	\$25.95
WHD01	(Economy)	\$12.95
MJ375	(Hand Driver)	\$22.95

DZUS® GROMMET FLARING TOOLS



Oval

Flush

Clamping Tool

These tools are designed to flare the stud grommet when installing Dzus® (Z-SPEC and ZLOC™) fasteners. The #5 tool has been specifically designed to replace grommets in Beech Bonanza cowlings without having to remove the cowling brackets. Complete instructions and diagrams included.

Note: Every installation set requires the use of a clamping tool (not included). However you need only one, as each set will fit the same clamp.

PART	SET DESCRIPTION	PRICE
MS-A3C	#3 Round (Oval) Head	\$39.95
MS-A4C	#4 Round (Oval) Head	\$39.95
MS-A5C	#5 Round (Oval) Head	\$39.95
MS-A6.5C	#6.5 Round(Oval) Head	\$39.95
MS-F4C	#4 Flush Head	\$39.95
MS-F5C	#5 Flush Head	\$39.95
MS-F6.5C	#6.5 Flush Head	\$39.95
MS-ZC	Clamping Tool: required for use of the above sets	\$24.95

DZUS® FLUSH HEAD STUD DIMPLER



This tool dimples sheet metal panels with the exact countersink angle for Dzus® (Z-Lock) FN and FR series flush head studs. Made from heat treated steel and zinc plated for long life. A grade 8 bolt and nut complete the assembly. Fits 5, 6, and 6.5 series.

MS-DT1 \$28.95

DZUS® "S" WIRE BENDING JIG



This tool bends Dzus® (Z-Lock) "S" wire receptacles quick and easy. Adjust more than 1/2" by pulling on the spring. Special legs eliminates the risk of pull through. Fits all 5 and 6 series springs. Complete instructions included.

MS-7301 \$39.95

ATS DZUS DRIVER



The ideal tool for locking and unlocking Dzus® (Z-Lock) type fasteners. Contoured handle provides maximum grip without slipping. Fits 5, 6 and 6.5 series studs.

DZS1 \$14.95

SHEET METAL FASTENERS

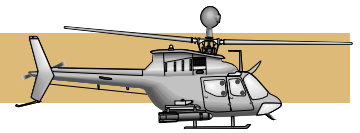

AIRLOC® GROMMET INSTALLATION TOOLS



Flush

Round (Oval)

Airloc® (also branded as A-SPEC™ and ALOC™) fasteners are very common to BeechCraft airplanes and Piper cowlings. This specialty tool is required to flare the stud grommets when installing these type of fasteners. Select the tool corresponding to the series (2 or 5) and style head (flush or round).

PART	DESCRIPTION	PRICE
MS-AL2R	#2 Round (Oval) Head	\$27.95
MS-AL2F	#2 Flush Head	\$27.95
MS-AL5R	#5 Round (Oval) Head	\$27.95
MS-AL5F	#5 Flush Head	\$27.95

AIRLOC® CROSSPIN REMOVAL & INSTALLATION TOOL



The most difficult part of installing or replacing Airloc® (A-SPEC™ and ALOC™) fasteners is the removal and replacement of the cross pin which serves to lock the stud in place. This tool makes the task easy. It will efficiently remove and reinstall the cross pin for both #2 and #5 studs.

MS-ALPT \$49.95

CAMLOC® GROMMET FLARING TOOL



Used for installing the flare type Camloc (C-Spec) grommets. This simple tool consists of two blocks that are precision machined with the correct contours to make a perfect flare every time.

MS-40GFT \$27.95

CAMLOC® DRILLING TEMPLATES



MS-DT2

MS-DT4

MS-DT4B

Provides proper hole spacing for Camloc receptacles.

MS-DT2 (2600/2700 series) \$2.95

MS-DT4 (4000 series) \$2.95

MS-DT4B (4000 series hole enlarger) \$2.95



ATS CAMLOC® PLIERS

Used to depress Camloc® studs so they can be properly installed. Manufactured from drop forged steel with polished surfaces. Grips are rubber cushioned for extra comfort and to reduce slipping.

CLP1 \$16.95

CAMLOC® SNAP RING INSTALLATION TOOLS



Installs Camloc® 2600 and 2700 series fasteners. Quickly installs 2600-LW, 2600-SW and 27S5-1 stud retainers. The rubber tip provides a comfortable grip to prevent fatigue when installing large quantities.

MS-T98 (2600/2700 Series) \$26.95

MS-T26 (4000 Series) \$22.95

CAMLOC® RECEPTACLE DRILL JIG



This drill Jig provides the proper hole spacing for Camloc® (C-Lock) fasteners so that rivet and center holes are drilled accurately and easily. One end of the T16 jig has 3/4" spacing for the 2600 and 2700 series fasteners. The other end has 1" spacing for the 4000 series fasteners. The body is made of light weight aluminum. Drill bushings are made from tool steel for excellent wear resistance.

MS-T16 \$34.95

CAMLOC® SHEET METAL DIMPLING TOOL



MS-27DT

MS-40DT

Used for dimpling thin sheet metal panels to accept Camloc Fasteners. It can also be used to dimple panels to accept FJ4 Series Flush-Head Dzus (Z-Spec) Fasteners.

MS-27DT (2600/2700 Series) \$20.95

MS-40DT (4000 Series) \$20.95

CAMLOC® RECEPTACLE PICK



Used to disengage the locking-clip on the MS213 & MS245 Adjustable-Depth Camloc Receptacles, for depth-setting adjustments.

MS-PK \$6.95



HI-LOK® TOOLING

HI-LOK INSTALLATION WRENCH



These clutch driven installation wrenches are designed for smooth, positive engagement in limited access areas. There's no lost motion when you ratchet assemblies. Tested to 220 inch pounds.

PART	DESCRIPTION	DRIVE	PRICE
3539	3/8" dia by 3" long	1/4"	\$59.95
3539L	3/8" dia by 6" long	1/4"	\$69.95

ROLLER-CLUTCH HI-LOK® INSTALLATION WRENCH



Designed for installing Frangible Collar (Hi-Lok®) fasteners in limited access areas. Toothless bearing clutch provides smooth precise movement with no lost motion. Thru-hole permits the use of allen wrench when installing non-interference fit fasteners. Reversible.

PART	DESCRIPTION	DRIVE	PRICE
BT2303	3" long	1/4"	\$45.95
BT2606	6" long	1/4"	\$45.95

HI-LOK HEX DRIVERS



Use these drivers to "keep" Hi-Lok type fasteners when installing with hand wrenches. Hex tip can be replaced as needed. Comes complete with tip and installation wrench.

HLK-5/64 (5/64") \$6.95
HLK-3/32 (3/32") \$6.95
HLK-1/8 (1/8") \$6.95

HI-LOK® GRIP GAUGE



A convenient tool to determine the correct length and diameter Hi-Lok to use. Just hook it in the hole and read the scale. Graduated in inches on one side, and millimeters on the other.

2-612 \$8.95
-------	--------------

THE "LIBERATOR" HI-LOK INSTALLATION SYSTEM

The 13 piece kit contains two "roller clutch" ratchet heads which are torque rated up to 80 in-lbs; two 1/4" drive studs for use with any brand of 1/4" drive socket, as well as a variety of straight and 90 degree handles. The entire system is interchangeable and will lock into an *unlimited* range of straight and offset configurations! The ratchet heads feature the unique ability to be "indexed" in any position by a full 360 degrees. Includes molded plastic case.



LIBK-13 \$109.95
---------	----------------

HI-LOK INSTALLATION/REMOVAL KIT (15 PIECES)

This remarkably versatile 15 piece Hi-Lok® tool kit combines in over 256 ways to give you access to just about any confined space. The complete kit consists of 2 - 1/4" drive clutch heads (clockwise and counterclockwise); 2 - straight arms in lengths 2" and 2.5"; 3 - bent arms in 20, 45, and 90 degrees; 1 - female to female coupler; 2 - mating studs; 2 - end caps; and 2 - locknuts.



HILOK-15 \$99.95
----------	---------------

HI-LOK REMOVAL PLIERS

The diamond cut jaws of these Hi-Lok® Removal Pliers will grip the fastener from the top or bottom of the offset head.



3579 \$35.95
------	---------------

HI-LOK REMOVAL SOCKETS

These specialized sockets are the ultimate for removing stubborn Hi-Lok® fasteners. Hardened chromium-alloy left-handed taper threads bite into and firmly grips the fastener for easy removal.



PART	HI-LOK SIZE	SOCKET	LENGTH	PRICE
3581-6	3/16" & 5/32"	3/8"	1"	\$20.95
3581-8	1/4"	7/16"	1.06"	\$20.95
3581-10	5/16"	7/16"	1.21"	\$25.95
3581-12	3/8"	1/2"	1.3"	\$29.95

CUTTERS

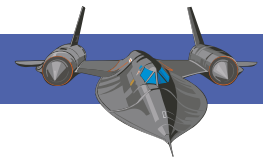

SIoux RIVET SHAVER & COUNTERSINK CUTTER



Designed so that the skirt face is parallel to the rivet shaver bit or piloted cutter (for countersink cutting), and the spring loaded stabilizer feet permit the operator to feed the cutter to the work piece. Accommodates up to 1/2" cutters. Easily adjustable in increments of 0.001 inches, 21,000 RPM speed at 0.75 hp. Accepts cutters with a 1/4-28 male thread (See our 3000 series rivet shaver cutters in this catalog).

SRS10P21-8 \$543.95

HEAVY DUTY MICROSTOP COUNTERSINK



Our heavy duty microstop uses ball bearings for ultra smooth operation. The ball bearing design also makes it run much cooler than a standard microstop. Depth adjustable in 0.001" increments with positive locking collar. Shaft travel is 9/32". Attaches to any drill having a 1/4" chuck. Uses standard 1/4-28 threaded cutters up to 1/2" in diameter. Rated at 10,000 RPM.

133-HD \$39.95

MICROSTOP COUNTERSINK



Fits any air or electric drill with a 1/4" chuck. The 1/4-28 female threaded end will accept any cutter having a male 1/4-28 thread and a diameter of up to 1/2".

133 \$25.95

133F (No-Mar Screw on Foot) \$6.95

NARROW EXTENDED MICROSTOP COUNTERSINK



This microstop reaches into very confined areas and the extended reach is great for getting down into narrow channels such as seat tracks. Uses 1/4-28 threaded cutters up to 3/8" diameter. Shaft travel is 1/4". Rated at 3000 RPM. **Note: Requires 3/8" dia. cutters.**

133-NX \$39.95

SLIM MICROSTOP COUNTERSINK



Packs all the features of a standard microstop in a slim design that's only 1 1/16" in diameter. It's ideal for those narrow areas that can't be reached with a standard microstop. Features bronze bearings. Depth adjustable in 0.001" increments with positive locking collar. Shaft travel is 9/32". Attaches to any drill having a 1/4" chuck. Uses standard 1/4-28 threaded cutters up to 1/2" in diameter, Rated at 3000 RPM.

133-SLIM \$29.95

MINI MICROSTOP COUNTERSINK



Use this microstop in those tight areas that can't be reached by a standard cage. It's only 1-3/8" long, and threads onto any drill with a 1/4-28 threaded shaft. Features bronze bearings. Positive locking collar is adjustable in 0.003" increments with positive locking collar. Uses 1/4-28 threaded cutters up to 5/8" diameter. Shaft travel is 3/32". Rated at 3000 RPM.

133-MINI \$20.95

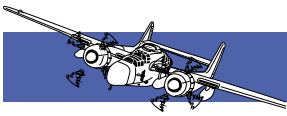

CUTTERS

PILOT CUTTERS

- High Speed Steel
- Precision ground diameter
- 1/4 x 28 male thread
- 3 cutting flute



PART	PILOT	USE	PRICE
100° - 1/2" DIA (for use in standard microstops)			
1000-100-40	40	3/32" rivet	\$8.95
1000-100-30	30	1/8" rivet	\$8.95
1000-100-21	21	5/32" rivet	\$8.95
1000-100-12	12	3/16" rivet	\$8.95
1000-100-33	33	4 AN Screw	\$10.95
1000-100-28	28	6 AN Screw	\$10.95
1000-100-19	19	8 AN Screw	\$10.95
1000-100-12	12	10 AN Screw	\$8.95
120° - 1/2" DIA (for use in standard microstops)			
1000-120-40	40	3/32" rivet	\$10.95
1000-120-30	30	1/8" rivet	\$12.95
100° - 3/8" DIA (for use in slim microstops)			
1038-100-40	40	3/32" rivet	\$7.95
1038-100-30	30	1/8" rivet	\$7.95
1038-100-21	21	5/32" rivet	\$7.95
1038-100-12	12	3/16" rivet	\$7.95

CARBIDE TIPPED CUTTER

- Solid carbide tip
- 1/2" diameter
- 1/4 x 28 male thread
- 100° x 2 cutting flutes



These cutters work exceptionally well on highly abrasive materials such as Kevlar® and other "difficult to machine" materials.

PART	PILOT	USE	PRICE
3100-40	40	3/32" rivet	\$35.95
3100-30	30	1/8" rivet	\$35.95
3100-21	21	5/32" rivet	\$35.95
3100-12	12	3/16" rivet	\$35.95

RIVET SHAVER BIT

- Solid carbide tip
- 1/4 x 28 male thread
- 2 flat cutting flutes



PART	DIAMETER	PRICE
3000-5/16	.313	\$38.95
3000-3/8	.375	\$38.95
3000-7/16	.438	\$38.95
3000-1/2	.500	\$38.95
3000-9/16	.593	\$38.95
3000-5/8	.625	\$38.95

ZERO FLUTE PILOT CUTTER

- High Speed Steel
- 1/2" diameter
- 1/4 x 28 male thread
- 100° x high-hook flute



The unique "high-hook" design of zero flute countersinks allow them to cut with virtually no chatter. Fits into any standard microstop.

PART	PILOT	USE	PRICE
4100-40	40	3/32" rivet	\$25.95
4100-30	30	1/8" rivet	\$25.95
4100-21	21	5/32" rivet	\$25.95
4100-12	12	3/16" rivet	\$25.95

ZERO FLUTE COUNTERSINK

- High Speed Steel
- 100° x high-hook flute



The "high-hook" design is a single hole drilled through the head of the cutter, which makes it virtually chatter-free. And since it has no flutes to shift inside the hole, the cutter always stays on center. Fits any drill with a 1/4" chuck.

ZFC01.....(3/32" to 1/4" Diameter) \$9.95
 ZFC02.....(1/8" to 27/64" Diameter) \$11.95

CARBIDE TIPPED REMOVABLE PILOT CUTTER

- Carbide tipped for durability
- 1/2" diameter
- 1/4 x 28 male thread
- 100° x 3 cutting flutes
- Requires 1500P pilot (shown below)



1500-1/2 \$39.95

REMOVABLE PILOTS



These pilots are used exclusively with the 1500-1/2 cutters (above).

PART	SIZE	PRICE	PART	SIZE	PRICE
1500P-40	40	\$6.95	1500P-16	16	\$6.95
1500P-30	30	\$6.95	1500P-12	12	\$6.95
1500P-27	27	\$6.95	1500P-10	10	\$6.95
1500P-21	21	\$6.95	1500P-3/16	3/16"	\$6.95
1500P-18	18	\$6.95	1500P-1/4	1/4"	\$6.95

CUTTERS

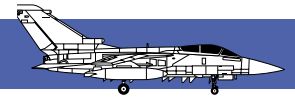

AIRCRAFT COUNTERBORES



Made of High Speed Steel. Requires pilot (see chart below).

PART	DIA.	LENGTH	PILOT SHANK	PRICE
4000-1016	1/4"	2-3/8"	3/32"	\$19.95
4000-1018	9/32"	2-3/8"	3/32"	\$17.95
4000-1020	5/16"	2-3/8"	3/32"	\$17.95
4000-1022	11/32"	2-3/8"	3/32"	\$18.95
4000-1024	3/8"	2-3/8"	3/32"	\$18.95
4000-1026	13/32"	2-3/4"	1/8"	\$17.95
4000-1028	7/16"	2-3/4"	1/8"	\$18.95
4000-1030	15/32"	2-3/4"	1/8"	\$21.95
4000-1032	1/2"	2-3/4"	1/8"	\$21.95
4000-1034	17/32"	2-3/4"	1/8"	\$24.95
4000-1036	9/16"	2-3/4"	1/8"	\$24.95
4000-1038	19/32"	2-3/4"	1/8"	\$29.95
4000-1040	5/8"	2-3/4"	1/8"	\$25.95
4000-1042	21/32"	2-3/4"	3/16"	\$31.95
4000-1044	11/16"	2-3/4"	3/16"	\$39.95

COUNTERBORE PILOTS

For use with 4000 series counterbores (above.)



PART	PILOT	SHANK	PRICE
1400P-1A	3/32"	3/32"	\$5.95
1400P-2A	40	3/32"	\$5.95
1400P-3A	1/8"	3/32"	\$5.95
1400P-3B	1/8"	1/8"	\$5.95
1400P-4A	30	3/32"	\$5.95
1400P-4B	30	1/8"	\$5.95
1400P-5A	5/32"	3/32"	\$5.95
1400P-5B	5/32"	1/8"	\$5.95
1400P-6A	21	3/32"	\$5.95
1400P-6B	21	1/8"	\$5.95
1400P-7A	3/16"	3/32"	\$5.95
1400P-7B	3/16"	1/8"	\$5.95
1400P-8A	10	3/32"	\$5.95
1400P-8B	10	1/8"	\$5.95
1400P-9A	7/32"	3/32"	\$4.95
1400P-9B	7/32"	1/8"	\$4.95
1400P-10A	1/4"	3/32"	\$5.95
1400P-10B	1/4"	1/8"	\$5.95
1400P-11B	9/32"	1/8"	\$5.95
1400P-11C	9/32"	3/16"	\$4.95
1400P-12B	5/16"	1/8"	\$5.95
1400P-12C	5/16"	3/16"	\$4.95
1400P-13B	3/8"	1/8"	\$5.95
1400P-13C	3/8"	3/16"	\$4.95
1400P-14B	13/32"	1/8"	\$4.95
1400P-14C	13/32"	3/16"	\$4.95
1400P-15B	7/16"	1/8"	\$5.95
1400P-15C	7/16"	3/16"	\$4.95
1400P-16B	15/32"	1/8"	\$4.95
1400P-16C	15/32"	3/16"	\$4.95
1400P-17C	1/2"	3/16"	\$4.95

BAYONET SPOTFACE & COUNTERSINK CUTTERS



AT402 Series (100°)

AT403 Series (Flat)

Made of High Speed Steel. Requires pilot (see chart below).

PART		CUTTER DIA.	PILOT SIZE	PRICE
100°	FLAT			
AT402-1	AT403-1	1/4"	3/32"	\$18.95
AT402-1B	AT403-1B	1/4"	1/8"	\$22.95
AT402-2	AT403-2	5/16"	1/8"	\$18.95
AT402-2B	AT403-2B	5/16"	5/32"	\$22.95
AT402-3	AT403-3	3/8"	1/8"	\$18.95
AT402-3B	AT403-3B	3/8"	5/32"	\$23.95
AT402-3C	AT403-3C	3/8"	3/16"	\$23.95
AT402-4	AT403-4	7/16"	5/32"	\$19.95
AT402-4B	AT403-4B	7/16"	3/16"	\$23.95
AT402-5	AT403-5	1/2"	3/16"	\$24.95
AT402-5B	AT403-5B	1/2"	1/4"	\$24.95
AT402-6	AT403-6	9/16"	3/16"	\$23.95
AT402-6B	AT403-6B	9/16"	1/4"	\$25.95
AT402-7	AT403-7	5/8"	1/4"	\$20.95
AT402-7B	AT403-7B	5/8"	5/16"	\$22.95
AT402-8	AT403-8	3/4"	1/4"	\$41.95
AT402-8B	AT403-8B	3/4"	5/16"	\$30.95
AT402-9	AT403-9	7/8"	3/8"	\$51.95
AT402-10	AT403-10	1"	3/8"	\$53.95

BACK CUTTER PILOTS



For use with AT402 and AT403 series cutters (above).

PART	SIZE	PRICE	PART	SIZE	PRICE
AT404-3/32	3/32"	\$9.95	AT404-1/4	1/4"	\$9.95
AT404-1/8	1/8"	\$9.95	AT404-5/16	5/16"	\$9.95
AT404-5/32	5/32"	\$9.95	AT404-3/8	3/8"	\$9.95
AT404-3/16	3/16"	\$9.95			

100° COUNTERSINKS



Three flute design. Made of High Speed Steel.

PART	DIA.	SHANK	PRICE
2000-1/4x3/16	.250	3/16"	\$12.95
2000-3/8x1/4	.375	1/4"	\$13.95
2000-1/2x3/8	.500	3/8"	\$11.95
2000-5/8x3/8	.625	3/8"	\$14.95
2000-3/4x3/8	.725	3/8"	\$27.95



DRILLING EQUIPMENT

ATS PRO REVERSIBLE PALM DRILL



This is one of the smallest reversible drill on the market that features a full feathering trigger. It's just over 7" long and delivers .5HP of power to drill through even the toughest materials. The fully variable trigger gives you total control over the speed all the way from 0 to 2000 RPM. Very smooth running and quiet operation.

- 1/2HP at operating speed
- 90 psi operating pressure
- Positive reverse mechanism
- 1/4" Jacobs Chuck
- True variable speed trigger
- Rubber grip handle

ATS61100R.....(2000 RPM).....\$135.95

ATS PRO PALM DRILL



Our new Pro Palm Drill is only 7" long yet has all of the features of a full sized drill. It delivers up to .5HP of power, and the trigger is fully feathered allowing for very precise speed control. It runs smoothly and quietly even when operating at top speed. Carries a full 1 year warranty.

- 1/2HP at operating speed
- 90 psi operating pressure
- True variable speed trigger
- 1/4" Jacobs Chuck

ATS61100.....(2600 RPM).....\$119.95
ATS61101.....(4000 RPM).....\$129.95

ATS HEAVY DUTY AIR DRILL



With a speed of 2600 RPM and .67 hp of power, our new heavy-duty drill can take on any job. The high quality full cage gear design ensures that this drill keeps running smoothly even under hard abuse. A solid performer that will get the job done every time.

- 3/8" (9.5 mm) Jacobs® Chuck
- Full Cage Gear
- Variable speed control
- 2,600 RPM
- Ergonomic Design
- 67 hp (.5 kw)
- 7-1/2" (190 mm) OAL
- 2.07 lbs (.94 kg)

ATS6101.....\$65.95
ATS6104.....(2400 RPM Reversible Model)\$75.95

ATS HIGH SPEED AVIATION AIR DRILL



A very nice palm-sized precision air drill that runs at 5000 RPM. It's ideal for applications requiring extra-high speed such as drilling fiberglass, composites, or tough metals. It cuts cleanly through aluminum, composites, and even tough metals such as Titanium. Planetary gears for smooth operation. 1/4" chuck. Only 6" long. 90 psi pressure.

- 1/4" (6.4 mm) Jacobs® Chuck
- 2-Speed (Low/High) Control
- Ergonomic design
- 4,500 RPM
- 9-3/4" (248 mm) OAL
- 1.25 lbs (.5 kg)

ATS6100B.....\$119.95

ATS REVERSIBLE PALM DRILL



This palm drill is only 6" long and is fully reversible. Runs very smoothly at 2200 thanks to its planetary gear system. Features comfort grip cushion handle. 1/4" chuck. 90 psi operating pressure.

ATS6100F.....\$99.95

ATS PALM DRILL

This is the drill I wish I had when I was still out there hauling a toolbox. It has everything a proper drill should have: speed, durability, and flexibility. And the nice part is that this feather-light gem is small enough to literally fit into your shirt pocket. A real work of art!



- 1/4" (6.4 mm) Jacobs® Chuck
- Two-stage (Low/High) Control Trigger
- 5-7/8" (150 mm) Overall Length
- 1.54 lbs (.7 kg)
- 2,800 RPM Free Speed

ATS6100.....\$99.95



ATS COMPACT ANGLE AIR DRILL (WITH JIFFY® HEAD)



With a head height of only .937" (23.8mm) and .625" (15.8mm) in diameter, our new Compact Angle Drill will get into those extremely close-quarter areas other drills simply can't. It's solidly engineered with top quality parts such a Jiffy® angle head, and a powerful compact air motor designed to our specifications. Operates at 3500 RPM and delivers .33 hp using 90 psi of air. Teasing throttle and needle bearing construction for smooth operation and longer tool life. Accepts 1/4 x 28 threaded drill bits and attachments (1/4" max drill capacity). Overall length of 9". Weighs only 1.08 lbs.

- 775..... (90° Drill with Jiffy® Head) \$349.95
- 77545..... (45° Drill with Jiffy® Head) \$339.95
- 775A (90° Drill with Pan American Nova® Head) \$295.95

ATS ANGLE AIR DRILLS



This is the drill you need to get into those tight spaces. It has a head height of just over an inch, and produces enough torque at 2800 RPM to drill through steel. Excellent speed control, and has a solid, well-balanced feel.

- Spindle 1/4"-28 Thread
 - 2,800 RPM
 - 33 hp (.25 kw)
 - Variable speed control
 - Head Length 1.08" (27 mm)
 - Head Width .65" (16 mm)
 - 10" (254 mm) Overall Length
 - 1.6 lbs (.73 kg)
- ATS6131..... (45° Angle Drill) \$259.95
 - ATS6132..... (90° Angle Drill) \$259.95

CLOSE-QUARTER AIR DRILL



Special head design allows you to drill in areas that were inaccessible before. Features a 1 year warranty, accepts 1/4 x 28 threaded drill bits. Heat treated gears with re-greasing capabilities for longer life. 1/4" capacity.

1750..... \$495.95

PAN AMERICAN NOVA® ANGLE AIR DRILLS



This 90° air drill packs a lot of power into a very compact form. It delivers enough speed and torque to drill into most materials with ease. One year warranty.

- Uses 1/4 x 28 Threaded Bits
 - Head rotates 360°
 - Speed: 3000 RPM
 - Weight: 1.2 lbs.
 - Head size is 1" Long x 5/8" Dia.
 - Smooth Quiet Operation
 - Capacity: 1/4"
 - Air Inlet: 1/4 x 28 NPT
- PA60-051..... \$298.95

ATS HEAVY DUTY STRAIGHT AIR DRILL



The in line configuration of a straight drill lets you reach into tight areas and drill without having to worry about your hand or the drill's handle getting in the way.

- 3/8" (9.5 mm) Jacobs® Chuck
 - 2,400 RPM
 - .5 hp (.37 kw)
 - Planetary Gear
 - 7-7/8" (200 mm) Overall Lg.
 - 2.86 lbs (1.3 kg)
- ATS6110..... \$65.95





DRILLING EQUIPMENT



SIoux™ AIR DRILLS

SIoux SIGNATURE SERIES AIR DRILLS



The new Sioux Signature Series drills feature new ergonomically designed housings, and a teasing throttle for excellent speed control, full ball and needle bearing construction for quiet operation (less than 80 dB) and long life. These drills are well designed and will withstand heavy use with very little maintenance. Overall length of each drill is 7".

PART	CHUCK SIZE	RPM	HP	STYLE	PRICE
SDR6P26N2	1/4"	2600	0.6	non-reversible	\$239.95
SDR10P26N3	3/8"	2600	1.0	non-reversible	\$261.95
SDR6P40N2	1/4"	4000	0.6	non-reversible	\$239.95
SDR10P40N3	3/8"	4000	1.0	non-reversible	\$261.95
SDR6P60N2	1/4"	6000	0.6	non-reversible	\$243.95
SDR10P60N3	3/8"	6000	1.0	non-reversible	\$261.95
SDR10P25R2	1/4"	2500	1.0	reversible	\$295.95
SDR10P25R3	3/8"	2500	1.0	reversible	\$299.95

SIoux PALM AIR DRILLS



The Sioux line of miniature drills are only 6-1/4" long and weigh just a little over a pound! Yet they have the same power (.33 hp) and speed of their larger counterparts. They are available in both reversible and non-reversible styles.

PART	CHUCK SIZE	RPM	HP	STYLE	PRICE
1410	1/4"	2600	.33	non-reversible	\$289.95
1412	1/4"	3600	.33	non-reversible	\$319.95
1410R	1/4"	2000	.20	reversible	\$361.95
1412R	1/4"	2600	.20	reversible	\$361.95

SIoux 90° ANGLE AIR DRILLS



Top of the line Sioux Close Quarter Angle Drills with built-in speed control. Accepts all 1/4 x 28 threaded accessories. Head height is 1-5/16".

PART	RPM	LENGTH	HP	PRICE
1AM1551	2800	9.7"	.33	\$571.95

SIoux 45° ANGLE AIR DRILLS



The same Sioux quality and design as their 90° counterparts, with a 45° angle. Accepts all 1/4 x 28 threaded accessories. Head height is 1-5/16".

PART	RPM	LENGTH	HP	PRICE
1AM1541	2800	10.2"	.33	\$553.95
2A1410-45	5800	12.0"	.75	\$629.95

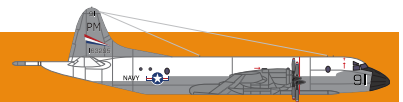

90° SNAKE DRILL ATTACHMENT



Our 602 snake attachment consists of the A601 angle drill attachment, a 30" snake cable, and an adapter. The snake is removable to permit the use of the angle drill portion. Drill capacity is 1/4".

602.....\$206.95

90° HEAVY-DUTY SNAKE DRILL ATTACHMENT



Designed with a heavy-duty flexible casing and core assembly for longevity. Fits any air or electric drill. Accepts 1/4" x 28 threaded drill bits and other accessories for close quarter drilling. Dimensions are 30" snake length, 1-1/4" head height, and 3/8" side to center. Drill capacity is 1/4".

N63\$165.95

ANGLED DRILL ATTACHMENTS



345



A601

Fits any air or electric drill. Accepts 1/4" x 28 threaded drill bits and other accessories for close quarter drilling. Dimensions are 7-1/2" long, 1-3/16" head height 3/8" side to center. Drill capacity is 1/4".

345.....(45°).....\$152.95

A601(90°).....\$99.95

90° ANGLE DRILL KIT



One of the most versatile tools on the market today.

Complete kit consists of:

- Tool Case
- 4 Drill Bits, 40, 30, 21, 12
- 90° Angle Drill (A601)
- 4 Collets, 40, 30, 21, and 12
- 24" Flexible Attachment
- Collet Adapter
- Straight Drill Attachment
- Complete Instructions

6012KT\$329.95

360° HEAVY-DUTY SNAKE DRILL ATTACHMENT



Ideal for drilling in areas inaccessible to regular 90° angle tools. Made of heavy-duty flexible casing and core assembly. Swivels 360° and can be locked into eight different positions. Accepts 1/4" x 28 threaded drill bits and accessories for close quarter drilling. Dimensions are 30" snake length, 1-1/4" head height 1-7/16" offset distance, 3/8" side to center. Drill capacity is 1/4".

N634\$385.95

FLAT OFFSET DRILL ATTACHMENT

One of a kind drill attachment. Designed with a head thickness of only 7/16" for drilling in areas as close as 1". Fits any air or electric drill. Accepts 1/4 x 28 threaded drill bits and accessories for close quarter drilling. Dimensions are 6-5/8" long, 7/16" head thickness, 2-5/16" offset distance, 7/16" side to center. Drill capacity is 1/4".



T235\$219.95



DRILLING EQUIPMENT

DUPLICATING/TRANSFER PUNCH



Used to mark holes in overlapping sheets. Overall length of 3-1/2".

PART	SIZE	PRICE	P/N	SIZE	PRICE
TP-40	40	\$7.95	TP-21	21	\$7.95
TP-30	30	\$7.95	TP-10	10	\$7.95

DRILL EXTENSION



Used to extend drill bits, pilot cutters, etc. Has a 1/4" shank on one end to fit into a chuck, and a 1/4" x 28 internal thread at the other.

382.....	(2" Long)	\$3.95
384.....	(4" Long)	\$5.95
387.....	(7" Long)	\$6.95
3810.....	(10" Long)	\$7.95

DUAL THREADED DRILL EXTENSION



Used to extend drill bits, pilot cutters, etc. Has a 1/4" x 28 external (male) thread on the shank end, and a 1/4" x 28 internal (female) thread at the other.

T382.....	(2" OAL)	\$5.95
T384.....	(4" OAL)	\$6.95
T387.....	(7" OAL)	\$7.95
T3810.....	(10" OAL)	\$8.95

HEX POWER DRIVER DRILL EXTENSION



Used to extend drill bits, pilot cutters, etc. Has a 1/4" Hex Drive on the shank end, and a 1/4" x 28 internal (female) thread at the other.

H382.....	(2" OAL)	\$6.95
H384.....	(4" OAL)	\$7.95
H387.....	(7" OAL)	\$8.95
H3810.....	(10" OAL)	\$9.95

MINIATURE JACOBS DRILL CHUCK

This chuck is only 1 inch long with a capacity of 0 to 5/32 inches. It includes a 1/4" x 28 adapter so that you can attach it to most angle drills.



C4-05..... \$94.95

CLOSE QUARTER CONE CHUCK

Attaches to all angle drills with 1/4" x 28 thread. Ideal for getting into tight areas.



A604..... \$25.95

JACOBS™ KEYLESS DRILL CHUCK

This patented design allows it to grip securely in either forward or reverse, and the more torque you apply to it, the tighter it will grip. Fits any drill with a 3/8" x 24 thread.



30353..... \$16.95

PROFESSIONAL AUTOMATIC CENTER PUNCH



The General Automatic Center Punch is the standard in automatic center punches. It is tough enough to mark hard metals, yet not overbearing when working with aluminum skin, or thin-walled tubing. Replaceable steel point.

GT79.....	(Professional)	\$27.95
GT79P.....	(Replacement Point)	\$3.95
GT89.....	(Stainless Steel)	\$15.95
001A.....	(Economy)	\$8.95

NOXON® HAMMERLESS PUNCH



It's a brilliant idea: connect a prick punch and a center punch to each end of a powerful spring to produce the ultimate punch. Just place the working end on any surface, pull the striking end straight back and release. The prick punch marks lightly, while the center punch creates a deeper indentation for drill starts.

32R00-1..... \$11.95

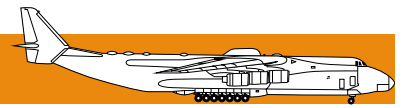

BOELUBE®



Boelube® is a specially formulated lubricant patented by Boeing Aerospace. Use it on drill bits, reamers, saw blades, taps & dies, boring tools, and any other application where smooth cutting action is required. The application of a small amount of Boelube, which is consumed in the metalworking process, will greatly improve tool life, surface finish, and hole quality. Recommended for use on aluminum, titanium, inconel, stainless steel,

graphite, composites, Kevlar, and wood. Can also be used with other ferrous and non-ferrous metals.

- BL70200-13** (1.6oz Stick) **\$2.45**
- BL90** (4oz Liquid) **\$8.95**
- BL70104H** (Drill Lube) **\$7.95**
- BL70307L** (4oz Paste) **\$8.95**

DRILL HOUSING AND BUSHINGS



A hand held guide to keep drills and taps 90° to flat or curved surfaces. The guide assembly is a transparent plastic housing that allows you to view your work as you drill. And the hardened steel bushing (must be ordered separately) securely guides the bit as you drill. The bushings can be interchanged in one housing.

- DH01** (Drill Housing Only) **\$9.95**
- DB-40** (40 Drill Bushing) **\$7.95**
- DB-30** (30 Drill Bushing) **\$7.95**
- DB-21** (21 Drill Bushing) **\$7.95**
- DB-10** (10 Drill Bushing) **\$7.95**
- DB-1/4** (1/4" Drill Bushing) **\$7.95**
- DH01-KIT** (Drill Housing & 40, 30, 21, 10 Bushings) **\$39.95**

DRILL COLLETS (SHANK GRIP)



Adapts standard drill bits for use with 1/4-28 threaded drills. Includes both collet and collet adapter. Overall of length of 1.125".

PART	SIZE	PRICE	P/N	SIZE	PRICE
503C-40	40	\$6.95	503C-21	21	\$6.95
503C-30	30	\$6.95	503C-10	10	\$6.95

STRAP DUPLICATORS

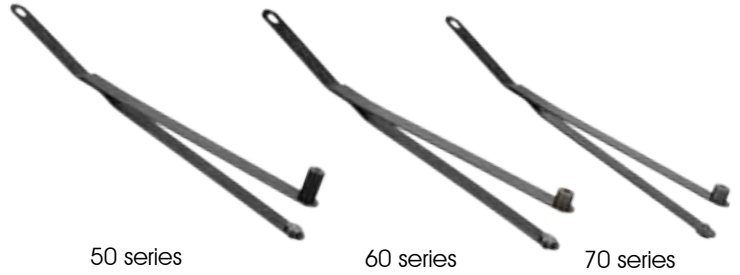

SIZE	TYPE	6" CAPACITY		12" CAPACITY		18" CAPACITY	
		P/N	PRICE	P/N	PRICE	P/N	PRICE
40	punch	51	\$14.95	51-12	\$18.95	51-18	\$29.95
30	punch	52	\$14.95	52-12	\$18.95	52-18	\$29.95
21	punch	53	\$14.95	53-12	\$18.95	53-18	\$29.95
12	punch	55	\$10.95	55-12	\$18.95	55-18	\$29.95
40	drill	61	\$10.95	61-12	\$14.95	61-18	\$24.95
30	drill	62	\$10.95	62-12	\$14.95	62-18	\$24.95
21	drill	63	\$10.95	63-12	\$14.95	63-18	\$24.95
12	drill	65	\$10.95	65-12	\$14.95	65-18	\$24.95
40	inverted	71	\$10.95	71-12	\$14.95	71-18	\$24.95
30	inverted	72	\$10.95	72-12	\$14.95	72-18	\$24.95
21	inverted	73	\$10.95	73-12	\$14.95	73-18	\$24.95
12	inverted	75	\$10.95	75-12	\$14.95	75-18	\$24.95

DRILL STOPS



Used to stop the drill bit after reaching a preset depth. Overall length of 1-5/15"

PART	SIZE	PRICE	P/N	SIZE	PRICE
DS-40	40	\$1.95	DS-21	21	\$1.95
DS-30	30	\$1.95	DS-12	12	\$1.95
DS-1/4	1/4"	\$4.95	DS-5/16	5/16"	\$4.95

HOLE TRANSFER PINS



Great for aligning overlapping holes. Just place the pin in the hole of the lower sheet with the point facing up, then place the overlapping sheet in place and tap lightly. Leaves a clear

prick point for drilling. Sold in packs of 5.

- BHP-1/8** (1/8", 5 pcs) **\$4.95**
- BHP-5/32** (5/32", 5 pcs) **\$4.95**
- BHP-3/16** (3/16", 5 pcs) **\$4.95**
- BHP-1/4"** (1/4", 5 pcs) **\$4.95**



DRILLING EQUIPMENT

TWO-WAY DEBURRING TOOL



Deburrs the front, back or both sides of a hole in one pass. Works with any drill. Adjusts easily to control the depth of cut.

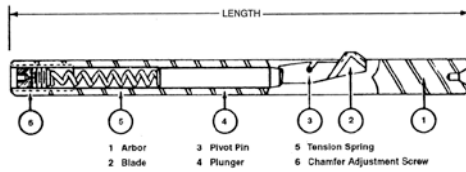

PART	HOLE SIZE	LENGTH	PRICE
TD001	3/32"	3-3/8"	\$113.95
TD002	1/8"	3-3/8"	\$100.95
TD003	5/32"	3-3/8"	\$92.95
TD004	3/16"	3-3/8"	\$99.95

PLASTIC CUTTERS



These cutters are used to score acrylic and Plexiglas sheets so that they can be broken cleanly without any cracks or chips.

- CPC01.....(Economy Cutter)\$5.95
- CPC02.....(Heavy Duty Cutter)\$8.95

PLASTIC EDGE SCRAPER



This unique tool has four features in one. Not only will it remove saw marks from flat edges, it also bevels thick and thin material, and will radius the edge quickly and evenly.

- CES01.....\$8.95

SPEED DEBURRING & COUNTERSINK TOOL

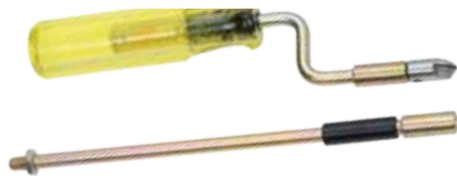

Swivel action - makes deburring & countersink holes fast & easy. Molded handle with 2" long plated steel shaft with 1/4"-28 threaded holder. Includes (1) 3/8" X 100° 3-flute burring cutter and 8" extension shaft for deburring the inside of flanges & other areas.

- AE1046.....\$32.95
- AE1050.....(3 Flute Burring Cutter).....\$16.95

SHAVIV™ HEAVY DUTY DEBURRING TOOL



All aluminum handle and solid steel construction makes the Shaviv HD Deburring Tool the standard in the Tool & Die industry. Sharp deburring blades cleanly removes burrs from aluminum, steel, and plastics. Includes B10 & B20 blades.

- SVBHD.....(Deburring Tool with B10 & B20 Blades).....\$13.95
- SV-B10.....(Standard Blade).....\$1.65
- SV-B20.....(Heavy Duty Version of B10).....\$1.75
- SV-B11.....(Small Hole Deburring Blade).....\$2.05
- SV-B30.....(Two-Way Internal/External Blade).....\$1.85
- SV-B70.....(Carbide Sheet Metal Edge Scraper).....\$5.95

STUBBY DEBURRING TOOL



Compact stubby deburring tool easily reaches tight areas. Sharp cutting head removes burrs from cut pipe with up to

a 3/4" inner diameter, as well as drilled holes in sheet metal up to 1/2" diameter.

- GT196.....\$11.95

ATS SPEED DEBURRING TOOL



Debur holes fast and easy with speed handle.

- SP275A.....(8" OAL "Stubby").....\$17.95
- SP375A.....(10" OAL New Design).....\$17.95
- SP375-1.....(Replacement Tips).....\$8.95

CHIP CHASER



All steel construction for long dependable life. Ideal for removing chips from between metal after drilling rivet holes.

- SP2005S.....(4" Stubby).....\$3.95
- SP2005.....(6" Standard).....\$4.95
- SP2005K.....(6" & 4").....\$7.95

SHAVIV™ ECONOMY DEBURRING TOOL



Get the same Shaviv quality in a handy tool that clips to your pocket. Includes B10 blade in a

convenient throwaway design.

- SVB2.....\$4.95



PLATE NUT DRILL JIGS

TWO LUG - DOUBLE WING

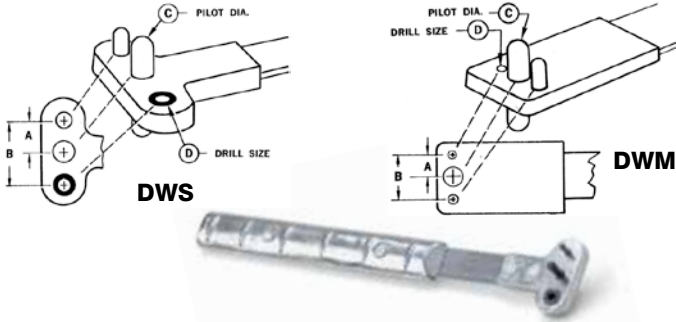

PART	SCREW SIZE	A SPACING	B SPACING	C PILOT DIA.	D DRILL SIZE	PRICE
STANDARD (DWS)						
518A	6	.344	.688	.139	40	\$35.95
518B	8	.344	.688	.164	40	\$35.95
518C	10	.344	.688	.191	40	\$35.95
518D	1/4	.500	1.000	.248	40	\$35.95
MINIATURE (DWM)						
518NB	6	.218	.436	.139	40	\$39.95
518NC	8	.234	.468	.164	40	\$39.95
518ND	10	.250	.500	.191	40	\$39.95
518NE	1/4	.281	.562	.248	40	\$39.95

CORNER WING

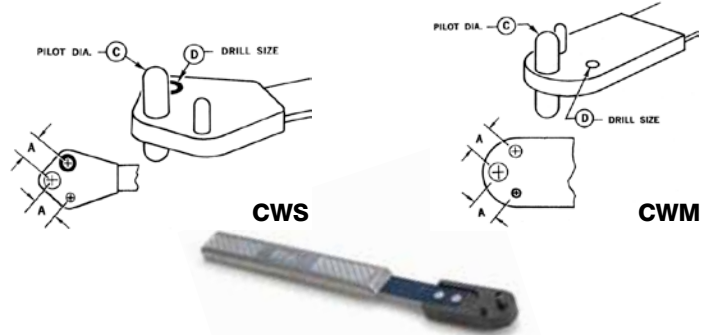

PART	SCREW SIZE	A SPACING	C PILOT DIA.	D DRILL SIZE	PRICE
STANDARD (CWS)					
518R	6	.344	.139	40	\$39.95
518S	8	.344	.164	40	\$39.95
518T	10	.344	.191	40	\$39.95
518U	1/4	.500	.248	40	\$39.95
MINIATURE (CWM)					
518SB	6	.218	.139	40	\$45.95
518SC	8	.234	.164	40	\$45.95
518SD	10	.250	.191	40	\$45.95
518SE	1/4	.281	.248	40	\$45.95

EASTERN DRILL RITE™ PRECISION DRILL GUIDE

The Drill Rite precision drill guide is an easy, accurate way to drill any curved surface or tubing from 1/2" to 2-1/2" in diameter. Light and portable, it produces straight and true holes every time. Includes super hardened drill bushings for popular 3/16" and 1/4" holes for rivets and aircraft hardware. Made in U.S.A. from aircraft grade aluminum.



EDF1 \$59.95

ONE LUG - SINGLE WING

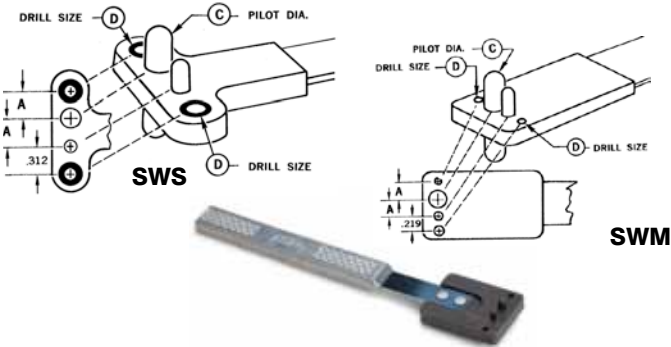

PART	SCREW SIZE	A SPACING	C PILOT DIA.	D DRILL SIZE	PRICE
STANDARD (SWS)					
518G	6	.344	.139	40	\$35.95
518H	8	.344	.164	40	\$35.95
518J	10	.344	.191	40	\$35.95
518K	1/4	.344	.248	40	\$35.95
MINIATURE (SWM)					
518PB	6	.218	.139	40	\$39.95
518PC	8	.234	.164	40	\$39.95
518PD	10	.250	.191	40	\$39.95
518PE	1/4	.281	.248	40	\$39.95

CENTER-IT V-BLOCK DRILL GUIDE

Drilling through the center of round stock can be a daunting task without the right tool. Center-It makes easy work of it by securely holding the stock in its cradle as you drill. It's 4"W x 5"L, and extruded from 6065-T3 Aluminum for years of use.



CIT01 \$15.95

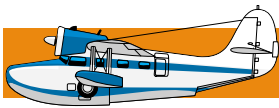

DRILLING EQUIPMENT

HIGH SPEED STEEL JOBBER LENGTH BITS



Heavy duty drill bits are suitable for drilling 6061 aluminum and high tensile strength steels. 135° split point is self-centering, and reduces "walking". Black oxide finish.

PART	SIZE	DEC	PRICE	PART	SIZE	DEC	PRICE	PART	SIZE	DEC	PRICE
010-55	55	.0520	1.95	010-21	21	.1590	1.95	010-M	M	.2950	3.95
010-54	54	.0550	1.95	010-20	20	.1610	1.95	010-19/64	19/64	.2969	2.95
010-53	53	.0595	1.95	010-19	19	.1660	1.95	010-N	N	.3020	3.95
010-1/16	1/16	.0625	0.95	010-18	18	.1695	1.95	010-5/16	5/16	.3125	2.95
010-52	52	.0635	1.95	010-11/64	11/64	.1719	1.95	010-O	O	.3160	3.95
010-51	51	.0670	1.95	010-17	17	.1730	1.95	010-P	P	.3230	3.95
010-50	50	.0700	1.95	010-16	16	.1770	1.95	010-21/64	21/64	.3281	3.95
010-49	49	.0730	1.95	010-15	15	.1800	1.95	010-Q	Q	.3320	4.95
010-48	48	.0760	1.95	010-14	14	.1820	1.95	010-R	R	.3390	4.95
010-5/64	5/64	.0781	0.95	010-13	13	.1850	1.95	010-11/32	11/32	.3438	3.95
010-47	47	.0785	1.95	010-3/16	3/16	.1875	1.95	010-S	S	.3480	4.95
010-46	46	.0810	1.95	010-12	12	.1890	1.95	010-T	T	.3580	4.95
010-45	45	.0820	1.95	010-11	11	.1910	1.95	010-23/64	23/64	.3594	3.95
010-44	44	.0860	1.95	010-10	10	.1935	1.95	010-U	U	.3680	4.95
010-43	43	.0890	1.95	010-9	9	.1960	2.95	010-3/8	3/8	.3750	4.95
010-42	42	.0935	1.95	010-8	8	.1990	2.95	010-V	V	.3770	5.95
010-3/32	3/32	.0938	0.95	010-7	7	.2010	2.95	010-W	W	.3860	5.95
010-41	41	.0960	1.95	010-13/64	13/64	.2031	1.95	010-25/64	25/64	.3906	4.95
010-40	40	.0980	1.95	010-6	6	.2040	2.95	010-X	X	.3970	6.95
010-39	39	.0995	1.95	010-5	5	.2055	2.95	010-Y	Y	.4040	7.95
010-38	38	.1015	1.95	010-4	4	.2090	2.95	010-13/32	13/32	.4063	4.95
010-37	37	.1040	1.95	010-3	3	.2130	2.95	010-Z	Z	.4130	7.95
010-36	36	.1065	1.95	010-7/32	7/32	.2188	1.95	010-27/64	27/64	.4219	5.95
010-7/64	7/64	.1094	1.95	010-2	2	.2210	2.95	010-7/16	7/16	.4375	5.95
010-35	35	.1100	1.95	010-1	1	.2280	2.95	010-29/64	29/64	.4531	6.95
010-34	34	.1110	1.95	010-A	A	.2340	2.95	010-15/32	15/32	.4688	7.95
010-33	33	.1130	1.95	010-15/64	15/64	.2344	1.95	010-31/64	31/64	.4844	7.95
010-32	32	.1160	1.95	010-B	B	.2380	2.95	010-1/2	1/2	.5000	7.95
010-31	31	.1200	1.95	010-C	C	.2420	2.95	010-33/64	33/64	.5156	15.95
010-1/8	1/8	.1250	1.95	010-D	D	.2460	2.95	010-17/32	17/32	.5313	16.95
010-30	30	.1285	1.95	010-E	E	.2500	2.95	010-35/64	35/64	.5469	17.95
010-29	29	.1360	1.95	010-1/4	1/4	.2500	1.95	010-9/16	9/16	.5625	18.95
010-28	28	.1405	1.95	010-F	F	.2570	2.95	010-37/64	37/64	.5781	18.95
010-9/64	9/64	.1406	1.95	010-G	G	.2610	2.95	010-19/32	19/32	.5938	18.95
010-27	27	.1440	1.95	010-17/64	17/64	.2656	2.95	010-39/64	39/64	.6094	19.95
010-26	26	.1470	1.95	010-H	H	.2660	2.95	010-5/8	5/8	.6250	19.95
010-25	25	.1495	1.95	010-I	I	.2720	2.95	010-41/64	41/64	.6406	22.95
010-24	24	.1520	1.95	010-J	J	.2770	3.95	010-21/32	21/32	.6563	22.95
010-23	23	.1540	1.95	010-K	K	.2810	3.95	010-43/64	43/64	.6719	25.95
010-5/32	5/32	.1563	1.95	010-9/32	9/32	.2813	2.95	010-11/16	11/16	.6875	25.95
010-22	22	.1570	1.95	010-L	L	.2900	3.95	010-23/32	23/32	.7188	32.95

DRILLING EQUIPMENT



COBALT JOBBER LENGTH BITS



Cobalt jobber drill bits are used for drilling in tough materials like stainless steel, titanium, and inconel. They are made to NAS907 Type J specifications and have a 135° split point flute. Bright finish.

PART	SIZE	DEC	PRICE	PART	SIZE	DEC	PRICE	PART	SIZE	DEC	PRICE
012-55	55	.0520	1.95	012-21	21	.1590	2.95	012-M	M	.2950	5.95
012-54	54	.0550	1.95	012-20	20	.1610	2.95	012-19/64	19/64	.2969	5.95
012-53	53	.0595	1.95	012-19	19	.1660	2.95	012-N	N	.3020	5.95
012-1/16	1/16	.0625	1.95	012-18	18	.1695	2.95	012-5/16	5/16	.3125	5.95
012-52	52	.0635	1.95	012-11/64	11/64	.1719	2.95	012-O	O	.3160	6.95
012-51	51	.0670	1.95	012-17	17	.1730	2.95	012-P	P	.3230	6.95
012-50	50	.0700	1.95	012-16	16	.1770	2.95	012-21/64	21/64	.3281	6.95
012-49	49	.0730	1.95	012-15	15	.1800	2.95	012-Q	Q	.3320	7.95
012-48	48	.0760	1.95	012-14	14	.1820	2.95	012-R	R	.3390	7.95
012-5/64	5/64	.0781	1.95	012-13	13	.1850	2.95	012-11/32	11/32	.3438	7.95
012-47	47	.0785	1.95	012-3/16	3/16	.1875	2.95	012-S	S	.3480	8.95
012-46	46	.0810	1.95	012-12	12	.1890	2.95	012-T	T	.3580	8.95
012-45	45	.0820	1.95	012-11	11	.1910	2.95	012-23/64	23/64	.3594	7.95
012-44	44	.0860	1.95	012-10	10	.1935	2.95	012-U	U	.3680	8.95
012-43	43	.0890	1.95	012-9	9	.1960	2.95	012-3/8	3/8	.3750	7.95
012-42	42	.0935	1.95	012-8	8	.1990	2.95	012-V	V	.3770	9.95
012-3/32	3/32	.0938	1.95	012-7	7	.2010	2.95	012-W	W	.3860	9.95
012-41	41	.0960	1.95	012-13/64	13/64	.2031	2.95	012-25/64	25/64	.3906	8.95
012-40	40	.0980	1.95	012-6	6	.2040	3.95	012-X	X	.3970	9.95
012-39	39	.0995	1.95	012-5	5	.2055	3.95	012-Y	Y	.4040	10.95
012-38	38	.1015	1.95	012-4	4	.2090	3.95	012-13/32	13/32	.4063	9.95
012-37	37	.1040	1.95	012-3	3	.2130	3.95	012-Z	Z	.4130	11.95
012-36	36	.1065	1.95	012-7/32	7/32	.2188	3.95	012-27/64	27/64	.4219	10.95
012-7/64	7/64	.1094	1.95	012-2	2	.2210	3.95	012-7/16	7/16	.4375	10.95
012-35	35	.1100	1.95	012-1	1	.2280	3.95	012-29/64	29/64	.4531	12.95
012-34	34	.1110	1.95	012-A	A	.2340	3.95	012-15/32	15/32	.4688	12.95
012-33	33	.1130	1.95	012-15/64	15/64	.2344	3.95	012-31/64	31/64	.4844	13.95
012-32	32	.1160	1.95	012-B	B	.2380	4.95	012-1/2	1/2	.5000	13.95
012-31	31	.1200	1.95	012-C	C	.2420	4.95				
012-1/8	1/8	.1250	1.95	012-D	D	.2460	4.95				
012-30	30	.1285	1.95	012-1/4	1/4	.2500	3.95				
012-29	29	.1360	2.95	012-E	E	.2500	3.95				
012-28	28	.1405	2.95	012-F	F	.2570	4.95				
012-9/64	9/64	.1406	1.95	012-G	G	.2610	4.95				
012-27	27	.1440	2.95	012-17/64	17/64	.2656	4.95				
012-26	26	.1470	2.95	012-H	H	.2660	4.95				
012-25	25	.1495	2.95	012-I	I	.2720	4.95				
012-24	24	.1520	2.95	012-J	J	.2770	4.95				
012-23	23	.1540	2.95	012-K	K	.2810	4.95				
012-5/32	5/32	.1563	2.95	012-9/32	9/32	.2813	4.95				
012-22	22	.1570	2.95	012-L	L	.2900	5.95				

COBALT DRILL INDEX



Complete drill indexes with storage case. M35 Cobalt steel with a 135 degree split point. Bright finish.

012-C60N (#1-60 wire size)..... \$42.95
012-C29F ... (1/16-1/2" fractional) ... \$42.95
012-C26A..... (A-Z letter sizes)..... \$42.95





DRILLING EQUIPMENT

SOLID CARBIDE JOBBER LENGTH BITS

Exceptionally hard and hold their edge longer than any other bits. Ideal for high speed (2000-6000 rpm) drilling of aluminum. Excellent abrasion resistance also makes them suited for drilling composites and fiberglass without dulling. Not recommended for use on steel.



PART	SIZE	DEC	PRICE	PART	SIZE	DEC	PRICE	PART	SIZE	DEC	PRICE
050-55	55	.0520	8.95	050-21	21	.1590	16.95	050-M	M	.2950	47.95
050-54	54	.0550	9.95	050-20	20	.1610	16.95	050-19/64	19/64	.2969	47.95
050-53	53	.0595	8.95	050-19	19	.1660	19.95	050-N	N	.3020	48.95
050-1/16	1/16	.0625	8.95	050-18	18	.1695	19.95	050-5/16	5/16	.3125	47.95
050-52	52	.0635	8.95	050-11/64	11/64	.1719	17.95	050-O	O	.3160	48.95
050-51	51	.0670	8.95	050-17	17	.1730	19.95	050-P	P	.3230	48.95
050-50	50	.0700	8.95	050-16	16	.1770	20.95	050-21/64	21/64	.3281	53.95
050-49	49	.0730	8.95	050-15	15	.1800	20.95	050-Q	Q	.3320	55.95
050-48	48	.0760	9.95	050-14	14	.1820	20.95	050-R	R	.3390	55.95
050-5/64	5/64	.0781	9.95	050-13	13	.1850	20.95	050-11/32	11/32	.3438	44.95
050-47	47	.0785	9.95	050-3/16	3/16	.1875	20.95	050-S	S	.3480	55.95
050-46	46	.0810	9.95	050-12	12	.1890	20.95	050-T	T	.3580	65.95
050-45	45	.0820	9.95	050-11	11	.1910	20.95	050-23/64	23/64	.3594	64.95
050-44	44	.0860	9.95	050-10	10	.1935	20.95	050-U	U	.3680	70.95
050-43	43	.0890	10.95	050-9	9	.1960	23.95	050-3/8	3/8	.3750	68.95
050-42	42	.0935	10.95	050-8	8	.1990	23.95	050-V	V	.3770	70.95
050-3/32	3/32	.0938	9.95	050-7	7	.2010	23.95	050-W	W	.3860	89.95
050-41	41	.0960	10.95	050-13/64	13/64	.2031	24.95	050-25/64	25/64	.3906	83.95
050-40	40	.0980	10.95	050-6	6	.2040	24.95	050-X	X	.3970	91.95
050-39	39	.0995	10.95	050-5	5	.2055	24.95	050-Y	Y	.4040	91.95
050-38	38	.1015	10.95	050-4	4	.2090	24.95	050-13/32	13/32	.4063	85.95
050-37	37	.1040	10.95	050-3	3	.2130	24.95	050-Z	Z	.4130	95.95
050-36	36	.1065	11.95	050-7/32	7/32	.2188	24.95	050-27/64	27/64	.4219	87.95
050-7/64	7/64	.1094	10.95	050-2	2	.2210	24.95	050-7/16	7/16	.4375	91.95
050-35	35	.1100	11.95	050-1	1	.2280	24.95	050-29/64	29/64	.4531	117.95
050-34	34	.1110	11.95	050-A	A	.2340	30.95	050-15/32	15/32	.4688	119.95
050-33	33	.1130	12.95	050-15/64	15/64	.2344	28.95	050-31/64	31/64	.4844	120.95
050-32	32	.1160	12.95	050-B	B	.2380	32.95	050-1/2	1/2	.5000	107.95
050-31	31	.1200	12.95	050-C	C	.2420	32.95				
050-1/8	1/8	.1250	12.95	050-D	D	.2460	32.95				
050-30	30	.1285	13.95	050-E	E	.2500	32.95				
050-29	29	.1360	14.95	050-1/4	1/4	.2500	25.95				
050-28	28	.1405	14.95	050-F	F	.2570	32.95				
050-9/64	9/64	.1406	15.95	050-G	G	.2610	38.95				
050-27	27	.1440	14.95	050-17/64	17/64	.2656	38.95				
050-26	26	.1470	14.95	050-H	H	.2660	39.95				
050-25	25	.1495	14.95	050-I	I	.2720	39.95				
050-24	24	.1520	15.95	050-J	J	.2770	39.95				
050-23	23	.1540	16.95	050-K	K	.2810	39.95				
050-5/32	5/32	.1563	16.95	050-9/32	9/32	.2813	39.95				
050-22	22	.1570	16.95	050-L	L	.2900	39.95				

DRILL LUBE

This hand held Drill Cleaner/Lubricator is designed for use with drill bits, taps, and reamers. The application of a small amount of Boelube, which is consumed in the metalworking process, will greatly improve tool life, surface finish, and hole quality.



BL70104H \$7.95



6" AIRCRAFT EXTENSION DRILL BITS



Aircraft extension drill bits are designed to resist bending and buckling under torsional loads, which makes them perfect for unsupported drilling into deep areas. They are manufactured to NAS 907 Type B and type J specifications. Great for drilling aluminum and mild steel. Constructed of M-2 high speed steel for the best combination of strength, heat resistance, and wear resistance. Black oxide coating resists corrosion. 135 degree split point ensures a true start and eliminates bit walking.

PART	SIZE	DEC	PRICE	PART	SIZE	DEC	PRICE	PART	SIZE	DEC	PRICE
013-55	55	.0520	4.95	013-24	24	.1520	2.95	013-G	G	.2610	7.95
013-54	54	.0550	4.95	013-23	23	.1540	2.95	013-17/64	17/64	.2656	5.95
013-53	53	.0595	4.95	013-5/32	5/32	.1563	2.95	013-H	H	.2660	7.95
013-1/16	1/16	.0625	2.95	013-22	22	.1570	2.95	013-I	I	.2720	7.95
013-52	52	.0635	2.95	013-21	21	.1590	2.50	013-J	J	.2770	7.95
013-51	51	.0670	2.95	013-20	20	.1610	2.95	013-K	K	.2810	7.95
013-50	50	.0700	2.95	013-19	19	.1660	3.25	013-9/32	9/32	.2813	6.95
013-49	49	.0730	2.95	013-18	18	.1695	3.25	013-L	L	.2900	8.95
013-48	48	.0760	2.95	013-11/64	11/64	.1719	3.25	013-M	M	.2950	8.95
013-5/64	5/64	.0781	2.95	013-17	17	.1730	3.25	013-19/64	19/64	.2969	7.95
013-47	47	.0785	2.95	013-16	16	.1770	3.25	013-N	N	.3020	9.95
013-46	46	.0810	2.95	013-15	15	.1800	3.25	013-5/16	5/16	.3125	7.95
013-45	45	.0820	2.95	013-14	14	.1820	3.25	013-O	O	.3160	10.95
013-44	44	.0860	2.95	013-13	13	.1850	3.25	013-P	P	.3230	10.95
013-43	43	.0890	2.95	013-3/16	3/16	.1875	3.50	013-21/64	21/64	.3281	8.95
013-42	42	.0935	2.95	013-12	12	.1890	2.95	013-Q	Q	.3320	10.95
013-3/32	3/32	.0938	2.95	013-11	11	.1910	3.50	013-R	R	.3390	10.95
013-41	41	.0960	2.95	013-10	10	.1935	3.50	013-11/32	11/32	.3438	8.95
013-40	40	.0980	2.25	013-9	9	.1960	3.50	013-S	S	.3480	11.95
013-39	39	.0995	2.95	013-8	8	.1990	3.50	013-T	T	.3580	11.95
013-38	38	.1015	2.95	013-7	7	.2010	3.50	013-23/64	23/64	.3594	8.95
013-37	37	.1040	2.95	013-13/64	13/64	.2031	3.50	013-U	U	.3680	11.95
013-36	36	.1065	2.95	013-6	6	.2040	3.50	013-3/8	3/8	.3750	10.95
013-7/64	7/64	.1094	2.95	013-5	5	.2055	3.50	013-V	V	.3770	12.95
013-35	35	.1100	2.95	013-4	4	.2090	3.50	013-W	W	.3860	12.95
013-34	34	.1110	2.95	013-3	3	.2130	3.50	013-25/64	25/64	.3906	12.95
013-33	33	.1130	2.95	013-7/32	7/32	.2188	3.50	013-X	X	.3970	10.95
013-32	32	.1160	2.95	013-2	2	.2210	3.50	013-Y	Y	.4040	12.95
013-31	31	.1200	2.95	013-1	1	.2280	3.50	013-13/32	13/32	.4063	9.95
013-1/8	1/8	.1250	2.95	013-A	A	.2340	3.95	013-Z	Z	.4130	13.95
013-30	30	.1285	2.25	013-15/64	15/64	.2344	2.95	013-27/64	27/64	.4219	5.95
013-29	29	.1360	2.95	013-B	B	.2380	3.95	013-7/16	7/16	.4375	11.95
013-28	28	.1405	2.95	013-C	C	.2420	3.95	013-29/64	29/64	.4531	12.95
013-9/64	9/64	.1406	2.95	013-D	D	.2460	3.95	013-15/32	15/32	.4688	13.95
013-27	27	.1440	2.95	013-1/4	1/4	.2500	3.95	013-31/64	31/64	.4844	11.95
013-26	26	.1470	2.95	013-E	E	.2500	3.95	013-1/2	1/2	.5000	14.95
013-25	25	.1495	2.95	013-F	F	.2570	4.95				



DRILLING EQUIPMENT

12" AIRCRAFT EXTENSION DRILL BITS



Aircraft extension drill bits are designed to resist bending and buckling under torsional loads, which makes them perfect for unsupported drilling into deep areas. They are manufactured to NAS 907 Type B and type J specifications. Great for drilling aluminum and mild steel. Constructed of M-2 high speed steel for the best combination of strength, heat resistance, and wear resistance. Black oxide coating resists corrosion. 135 degree split point ensures a true start and eliminates bit walking.

PART	SIZE	DEC	PRICE	PART	SIZE	DEC	PRICE	PART	SIZE	DEC	PRICE
014-55	55	.0520	8.05	014-24	24	.1520	3.95	014-G	G	.2610	5.95
014-54	54	.0550	7.95	014-23	23	.1540	3.95	014-17/64	17/64	.2656	7.95
014-53	53	.0595	7.95	014-5/32	5/32	.1563	3.95	014-H	H	.2660	9.95
014-1/16	1/16	.0625	5.95	014-22	22	.1570	3.95	014-I	I	.2720	9.95
014-52	52	.0635	7.95	014-21	21	.1590	2.95	014-J	J	.2770	9.95
014-51	51	.0670	7.95	014-20	20	.1610	3.95	014-K	K	.2810	9.95
014-50	50	.0700	3.95	014-19	19	.1660	3.95	014-9/32	9/32	.2813	7.95
014-49	49	.0730	3.95	014-18	18	.1695	3.95	014-L	L	.2900	9.95
014-48	48	.0760	3.95	014-11/64	11/64	.1719	3.95	014-M	M	.2950	9.95
014-5/64	5/64	.0781	3.95	014-17	17	.1730	3.95	014-19/64	19/64	.2969	8.95
014-47	47	.0785	3.95	014-16	16	.1770	3.95	014-N	N	.3020	10.95
014-46	46	.0810	3.95	014-15	15	.1800	3.95	014-5/16	5/16	.3125	9.95
014-45	45	.0820	3.95	014-14	14	.1820	3.95	014-O	O	.3160	11.95
014-44	44	.0860	3.95	014-13	13	.1850	3.95	014-P	P	.3230	11.95
014-43	43	.0890	3.95	014-3/16	3/16	.1875	4.25	014-21/64	21/64	.3281	10.95
014-42	42	.0935	3.95	014-12	12	.1890	3.25	014-Q	Q	.3320	11.95
014-3/32	3/32	.0938	3.95	014-11	11	.1910	4.25	014-R	R	.3390	12.95
014-41	41	.0960	3.95	014-10	10	.1935	4.25	014-11/32	11/32	.3438	10.95
014-40	40	.0980	2.95	014-9	9	.1960	4.25	014-S	S	.3480	13.95
014-39	39	.0995	3.95	014-8	8	.1990	4.25	014-T	T	.3580	13.95
014-38	38	.1015	3.95	014-7	7	.2010	4.25	014-23/64	23/64	.3594	11.95
014-37	37	.1040	3.95	014-13/64	13/64	.2031	4.25	014-U	U	.3680	13.95
014-36	36	.1065	3.95	014-6	6	.2040	4.25	014-3/8	3/8	.3750	11.95
014-7/64	7/64	.1094	3.95	014-5	5	.2055	4.25	014-V	V	.3770	13.95
014-35	35	.1100	3.95	014-4	4	.2090	4.25	014-W	W	.3860	13.95
014-34	34	.1110	3.95	014-3	3	.2130	4.50	014-25/64	25/64	.3906	12.95
014-33	33	.1130	3.95	014-7/32	7/32	.2188	4.50	014-X	X	.3970	14.95
014-32	32	.1160	3.95	014-2	2	.2210	4.50	014-Y	Y	.4040	14.95
014-31	31	.1200	3.95	014-1	1	.2280	4.50	014-13/32	13/32	.4063	12.95
014-1/8	1/8	.1250	3.95	014-A	A	.2340	4.50	014-Z	Z	.4130	15.95
014-30	30	.1285	2.95	014-15/64	15/64	.2344	4.50	014-27/64	27/64	.4219	13.95
014-29	29	.1360	3.95	014-B	B	.2380	4.75	014-7/16	7/16	.4375	14.95
014-28	28	.1405	3.95	014-C	C	.2420	4.75	014-29/64	29/64	.4531	14.95
014-9/64	9/64	.1406	3.95	014-D	D	.2460	4.75	014-15/32	15/32	.4688	16.95
014-27	27	.1440	3.95	014-1/4	1/4	.2500	4.95	014-31/64	31/64	.4844	16.95
014-26	26	.1470	3.95	014-E	E	.2500	4.95	014-1/2	1/2	.5000	16.95
014-25	25	.1495	3.95	014-F	F	.2570	5.50				



COBALT THREADED DRILL BITS



1/4-28 threaded shank.
Cobalt-M35 with black oxide finish. 135° Split point. NAS965 Type D standards.

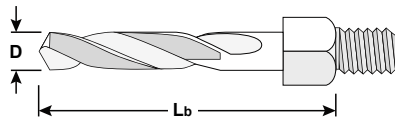

SHORT (Lb = 1-1/4")			
PART	SIZE (D)	DEC	PRICE
5000-3/32	3/32	.0938	2.25
5000-40	40	.0980	1.75
5000-39	39	.0995	2.25
5000-38	38	.1015	2.25
5000-37	37	.1040	2.25
5000-36	36	.1065	2.25
5000-34	34	.1110	2.25
5000-33	33	.1130	2.25
5000-32	32	.1160	2.25
5000-1/8	1/8	.1250	2.25
5000-30	30	.1285	1.75
5000-29	29	.1360	2.25
5000-27	27	.1440	2.25
5000-26	26	.1470	2.30
5000-25	25	.1495	2.30
5000-24	24	.1520	2.30
5000-5/32	5/32	.1563	2.30
5000-22	22	.1570	2.30
5000-21	21	.1590	1.85
5000-20	20	.1610	2.30
5000-19	19	.1660	2.30
5000-18	18	.1695	2.35
5000-16	16	.1770	2.35
5000-13	13	.1850	2.35
5000-3/16	3/16	.1875	2.35
5000-12	12	.1890	1.95
5000-11	11	.1910	2.35
5000-10	10	.1935	2.45
5000-9	9	.1960	2.45
5000-8	8	.1990	2.45
5000-7	7	.2010	2.45
5000-6	6	.2040	2.45
5000-5	5	.2055	2.55
5000-7/32	7/32	.2188	2.55
5000-1	1	.2280	2.55
5000-D	D	.2460	2.55
5000-1/4	1/4	.2500	2.95

STUBBY (Lb = 5/8")			
PART	SIZE (D)	DEC	PRICE
5000-3/32S	3/32	.0938	2.75
5000-40S	40	.0980	2.75
5000-30S	30	.1285	2.75
5000-29S	29	.1360	2.75
5000-27S	27	.1440	2.75
5000-21S	21	.1590	2.75
5000-19S	19	.1660	2.75
5000-13S	13	.1850	2.95
5000-3/16S	3/16	.1875	2.95
5000-12S	12	.1890	2.95
5000-10S	10	.1935	2.95
5000-1/4S	1/4	.2500	3.25

SUPER STUBBY (Lb = 3/8")			
PART	SIZE (D)	DEC	PRICE
5000-40SS	40	.0980	3.95
5000-30SS	30	.1285	3.95

LONG (Lb = 2-1/8")			
PART	SIZE (D)	DEC	PRICE
5000-3/32L	3/32	.0938	2.75
5000-40L*	40	.0980	2.25
5000-1/8L	1/8	.1250	2.75
5000-30L*	30	.1285	2.25
5000-29L	29	.1360	2.75
5000-27L	27	.1440	2.75
5000-5/32L	5/32	.1563	2.75
5000-21L*	21	.1590	2.75
5000-19L	19	.1660	2.75
5000-3/16L	3/16	.1875	2.95
5000-12L	12	.1890	2.50
5000-11L	11	.1910	2.95
5000-10L*	10	.1935	2.95
5000-7/32L	7/32	.2188	2.95
5000-1/4L	1/4	.2500	2.95

*Replacement bits for our 1341A and 1341S rivet removal tools.

EXTRA LONG (Lb = 2-5/8")			
PART	SIZE (D)	DEC	PRICE
5000-1/8XL	1/8	.1250	1.25
5000-30XL	30	.1285	3.95
5000-21XL	21	.1590	3.95
5000-40XL	40	.0980	3.95
5000-10XL	10	.1935	3.95

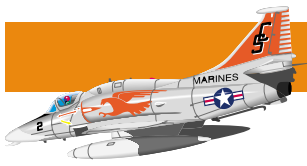

DRILLING EQUIPMENT

CHUCKING REAMERS



High speed steel straight flute chucking reamers are made with a diameter tolerance of: +.0002 -.0000

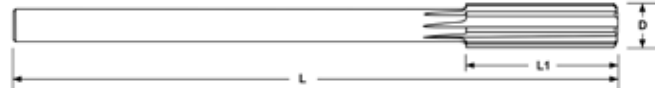

PART	SIZE (D)	DEC	FLUTE (L1)	OAL (L)	PRICE	PART	SIZE (D)	DEC	FLUTE (L1)	OAL (L)	PRICE
RMR-3/32	3/32	.0938	7/8	3-1/2	9.95	RMR-9	9	.1960	1-1/4	5	10.25
RMR-40	40	.0980	7/8	3-1/2	9.95	RMR-8	8	.1990	1-1/4	5	10.25
RMR-39	39	.0995	7/8	3-1/2	9.95	RMR-7	7	.2010	1-1/4	5	10.25
RMR-38	38	.1015	7/8	3-1/2	9.95	RMR-13/64	13/64	.2031	1-1/4	5	10.25
RMR-37	37	.1040	7/8	3-1/2	9.95	RMR-6	6	.2040	1-1/4	5	10.25
RMR-36	36	.1065	7/8	3-1/2	9.95	RMR-5	5	.2055	1-1/4	5	10.25
RMR-7/64	7/64	.1094	7/8	3-1/2	9.95	RMR-4	4	.2090	1-1/4	5	10.25
RMR-35	35	.1100	7/8	3-1/2	9.95	RMR-3	3	.2130	1-1/4	5	10.25
RMR-34	34	.1110	7/8	3-1/2	9.95	RMR-7/32	7/32	.2188	1-1/4	5	10.25
RMR-33	33	.1130	7/8	3-1/2	9.95	RMR-2	2	.2210	1-1/4	5	10.25
RMR-32	32	.1160	7/8	3-1/2	9.95	RMR-1	1	.2280	1-1/2	6	10.25
RMR-31	31	.1200	7/8	3-1/2	9.95	RMR-15/64	15/64	.2344	1-1/2	6	10.25
RMR-1/8	1/8	.1250	7/8	3-1/2	9.95	RMR-1/4	1/4	.2500	1-1/2	6	10.25
RMR-30	30	.1285	7/8	3-1/2	9.95	RMR-17/64	17/64	.2656	1-1/2	6	10.25
RMR-29	29	.1360	1	4	9.95	RMR-9/32	9/32	.2813	1-1/2	6	10.25
RMR-28	28	.1405	1	4	9.95	RMR-19/64	19/64	.2969	1-1/2	6	10.25
RMR-9/64	9/64	.1406	1	4	9.95	RMR-5/16	5/16	.3125	1-1/2	6	10.50
RMR-27	27	.1440	1	4	9.95	RMR-21/64	21/64	.3281	1-1/2	6	10.50
RMR-26	26	.1470	1	4	9.95	RMR-11/32	11/32	.3438	1-1/2	6	10.75
RMR-25	25	.1495	1	4	9.95	RMR-23/64	23/64	.3594	1-3/4	7	10.75
RMR-24	24	.1520	1	4	9.95	RMR-3/8	3/8	.3750	1-3/4	7	10.95
RMR-23	23	.1540	1	4	9.95	RMR-25/64	25/64	.3906	1-3/4	7	10.95
RMR-5/32	5/32	.1563	1	4	9.95	RMR-13/32	13/32	.4063	1-3/4	7	10.95
RMR-22	22	.1570	1	4	9.95	RMR-27/64	27/64	.4219	1-3/4	7	11.50
RMR-21	21	.1590	1-1/8	4-1/2	9.95	RMR-7/16	7/16	.4375	1-3/4	7	11.50
RMR-20	20	.1610	1-1/8	4-1/2	9.95	RMR-29/64	29/64	.4531	1-3/4	7	12.25
RMR-19	19	.1660	1-1/8	4-1/2	9.95	RMR-15/32	15/32	.4687	1-3/4	7	12.25
RMR-18	18	.1695	1-1/8	4-1/2	9.95	RMR-31/64	31/64	.4844	2	8	12.50
RMR-11/64	11/64	.1719	1-1/8	4-1/2	9.95	RMR-1/2	1/2	.5000	2	8	12.50
RMR-17	17	.1730	1-1/8	4-1/2	9.95						
RMR-16	16	.1770	1-1/8	4-1/2	9.95						
RMR-15	15	.1800	1-1/8	4-1/2	9.95						
RMR-14	14	.1820	1-1/8	4-1/2	9.95						
RMR-13	13	.1850	1-1/8	4-1/2	9.95						
RMR-3/16	3/16	.1875	1-1/8	4-1/2	10.25						
RMR-12	12	.1890	1-1/4	5	10.25						
RMR-11	11	.1910	1-1/4	5	10.25						
RMR-10	10	.1935	1-1/4	5	10.25						

PILOTED REAMERS



High Speed Piloted Reamers for all uses; Valve Guides, Valve Guide Boss, Rocker Arm & Shaft Bushings; and Rocker Shaft Support Base. You specify size. Available from .375 thru .751".

PROI \$75.95

Note: Please specify reamer size & pilot size when ordering.

DRILLING EQUIPMENT

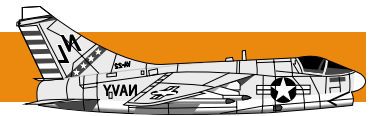

UNIBIT DRILL BITS

Unibit.



These amazing drill bits will make sheet metal work a snap! One Unibit will drill many different size holes. Each step will drill through material up to 1/8" thick.

PART	HOLES	RANGE	SHANK	PRICE
UNIBIT-1	13	1/8"-1/2"	1/4"	\$20.95
UNIBIT-3	9	1/4"-3/4"	3/8"	\$37.95
UNIBIT-20	8	9/16"-1.0"	1/2"	\$45.95
UNIBIT-21	10	13/16"-1-3/8"	1/2"	\$95.95
UNIBIT-4	12	3/16 - 7/8"	3/8"	\$59.95
UNIBIT-5	10	1/4-1-3/8	1/2"	\$95.95

AIRCRAFT TAPERED ROUTER BITS



Used for cutting, trimming and routing. 1/4" per foot taper.

PART	SHANK DIAMETER (IN.)	LENGTH	PRICE
910-1	.081-.098	2"	\$4.95
910-2	.110-.128	2-1/4"	\$5.95
910-3	.165-.1875	2-1/2"	\$7.95
910-4	.224-.250	2-3/4"	\$9.95

TI-COATED STEP DRILL SET



These TiN (Titanium Nitrate) coated stepped drill bit sets make it easy to drill 28 hole sizes. Constructed from high-speed steel, they feature clearly marked hole sizes and have a titanium finish for long bit life. Includes 13-Step bit ranging from 1/8 in. to 1/2 in., 6-Step bit ranging from 3/16 in. to 1/2 in., and a 9-Step bit ranging from 1/4 in. to 3/4 in.

16503..... \$16.95
 16504.....(1/4"-3/4" Only) \$10.95

UNIBIT® TITANIUM STEP DRILL



Ideal for drilling holes into thin materials such as stainless steel, copper, brass, aluminum, plastic and laminates.

Single-flute cutting edge for greater control through steps.

3 flatted shank prevents slipping in drill chuck.

New Speedpoint™ tip penetrates faster and prevents walking.

PART	DESC	HOLE SIZE	STEPS	INC	PRICE
15221	#21	13/16"-1-3/8"	10	Enlarging	\$131.95
15200	#20	9/16"-1"	8	Enlarging	\$61.95
15104	#4	3/16"-7/8"	12	1/16"	\$69.95
15103ZR	#3	3/16"-7/8"	9	1/16"	\$57.95
15101ZR	#1	1/8"-1/2"	13	1/32"	\$39.95

UNIBIT® COBALT STEP DRILL



These Cobalt Step Drill Unibit lasts 6X longer than most. M35 grade Cobalt HSS. Radial concave flute. Speedpoint™ tip. Laser marked sizes.

PART	DESC	HOLE SIZE	STEPS	INC	PRICE
10231CB	#1	1/8"-1/2"	13	1/32"	\$33.95
10233CB	#3	1/4"-3/4"	9	1/16"	\$59.95
10234CB	#4	3/16"-3/4"	12	1/16"	\$89.95
10239CB	#9	7/8"&1-1/8"	2	1/2" & 3/4"	\$95.95
10220CB	#20	9/16"-1"	8 steps	1/16"	\$69.95

HAND TAPERED REAMERS



Tapered reamers are great for hole enlarging, or deburring. Cuts steel, brass, aluminum, plastic, and wood.

GT130(T-Handle) \$11.95
 GT131(Straight Handle) \$14.95

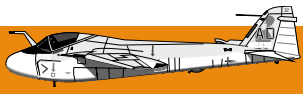

DRILLING EQUIPMENT

DIAMOND DUST PLASTIC DRILL BIT



Diamond Dust Coated plastic drill bits provide superior cutting action in Plexiglas, polycarbonates, and acrylics. They have a 60 degree point and a 0 degree rake that prevents the drill from walking or "breaking out" as with ordinary drill bits. They will not chip, crack, or gum up the material. Use to drill stacks or singles, with or without masking. Ideal for drilling mounting holes, or crack stopping holes in windshields and canopies.

- DDPD-1/8 (1/8") **\$2.25**
- DDPD-3/16 (3/16") **\$2.95**
- DDPD-1/4 (1/4") **\$3.95**

PLEXIGLAS DRILL BITS



Made of high-speed steel. 90° point, 0° rake. Jobbers length. Slow spiral makes it ideal for drilling Plexiglas, acrylic, & polycarbonate.

PART	DIAMETER	DEC.	FLUTE	PRICE
AC55-1/8	1/8"	0.1250	1-5/8"	\$3.95
AC55-5/32	5/32"	0.1562	2"	\$4.95
AC55-3/16	3/16"	0.1875	2-5/16"	\$4.95
AC55-1/4	1/4"	0.2500	2-3/4"	\$4.95
AC55-5/16	5/16"	0.3125	3-1/8"	\$6.95
AC55-3/8	3/8"	0.3750	3-5/8"	\$8.95
AC55-7/16	7/16"	0.4375	4-1/16"	\$12.95
AC55-1/2	1/2"	0.5000	4-1/2"	\$14.95

DRILL GAUGES

- Top quality drill gauges are used to quickly identify drill sizes.
- Made of heavy-gauge heat treated steel, machined to close tolerances.
- Hole sizes and decimal equivalents are permanently etched into the metal.

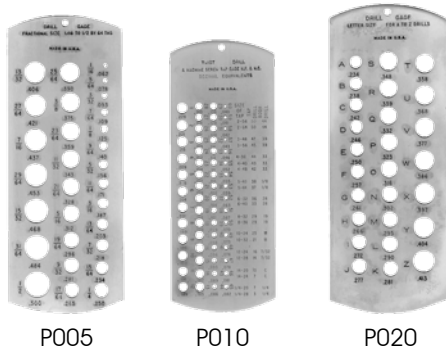

PART	TYPE	HOLES	PRICE
P005	Fractional	29	\$11.95
P010	Number	60	\$11.95
P020	Letter	20	\$12.95

DRILL INDEXES



- Made from high-speed steel
- Name-brand manufacturer
- Jobbers length
- 118° point

PART	PIECES	TYPE	RANGE	PRICE
P108	13	Fractional	1/16"-1/4"	\$9.95
P129	29	Fractional	1/16"-1/2"	\$39.95
P60	60	Wire Size	1-60	\$39.95
P24	26	Letter Size	A-Z	\$39.95
L13	13	Left Fraction	1/16"-1/4"	\$40.95

HAND EXPANSION REAMERS



High Speed Straight Flutes. Expansion Limits: +/- 0.006".

PART	DIA (IN.)	OF FLUTES	FLUTE LEN.	OVERALL LEN (IN.)	PRICE
016AR	1/4	6	1-7/16	3-7/8	\$75.95
020AR	5/16	6	1-3/4	4	\$57.95
024AR	3/8	6	1-3/4	4-1/4	\$57.95
028AR	7/16	6	1-3/4	4-1/2	\$59.95
032AR	1/2	6	1-13/16	5	\$59.95
036AR	9/16	8	2-1/8	5-1/2	\$59.95
040AR	5/8	8	2-1/2	6	\$65.95

BROWN & SHARPE TAPERED PIN REAMERS



Used to size AN385 and AN386 taper pin holes

PART	DIAMETER OF REAMER		FLUTE LENGTH	O.A.L.	PRICE
	LARGE END	SMALL END			
BSR-1	.3176	.1974	2-7/8"	4-3/4"	\$29.95
BSR-2	.3781	.2474	3-1/8"	5-1/8"	\$34.95
BSR-3	.4510	.3099	3-3/8"	5-1/2"	\$34.95
BSR-4	.5017	.3474	3-11/16"	5-7/8"	\$38.95
BSR-5	.6145	.4474	4"	6-3/8"	\$43.95
BSR-6	.6808	.4974	4-3/8"	6-7/8"	\$48.95
BSR-7	.8011	.5974	4-7/8"	7-1/2"	\$48.95
BSR-8	.9770	.7474	5-1/2"	8-1/8"	\$59.95
BSR-9	1.1530	.8974	6-1/8"	8-7/8"	\$74.95
BSR-10	1.3370	1.0420	6-7/8"	9-3/4"	\$99.95



ATS MINI BELT SANDER



Removing old paint and corrosion from channels, tracks, and other tight areas is always a challenge. But this sander will make your life easier. It's narrow enough to get into hard-to-reach areas, and powerful enough to make short work of it. Ideal for use on all composite type aircraft projects or contouring and finishing molds and jigs.

- 360° Head Rotation
- Uses 3/8" x 13" (10 x 330 mm) Belts
- 16,000 RPM
- 11-3/16" (284 mm) Overall Length
- Built-in Regulator
- 1.76 lbs (.8 kg)

ATS4501A\$95.95

87885..... *Belts (3/8" x13") 60 Grit\$15.95

87886..... *Belts (3/8" x13") 80 Grit\$15.95

87887..... *Belts (3/8" x13") 100 Grit ...\$15.95

*Belts are in packages of 5.

ATS HEAVY DUTY JITTERBUG SANDER



Our new jitterbug sander provides the ultimate balance of power and controllability. Ideally suited for paint removal and surface preparation work.

- Free Speed 8,000 osc/min
- 6-11/16" (170mm) Overall Length
- Pad Size 3-3/4" x 9" (93 x 228mm)
- 4.33 lbs (1.97kg) weight

ATS4211.....\$65.95

ATS COMPACT FINGER SANDER



This tool is great for removing paint and corrosion in narrow, confined areas such as seat tracks, or guide rails. High speed orbital action quickly removes material while giving you total control. Uses standard adhesive-backed sandpaper.

- 15,000 RPM Free Speed
- 2.375" x .825"(60x21mm) pad size
- Orbital diameter 3mm
- Heavy duty orbital head
- 9-7/16" (240 mm) Overall Length
- 2.2 lbs (1 kg)

ATS4103A\$189.95

ATS HD RANDOM ORBITAL SANDER WITH VACUUM COLLECTOR



Excellent high speed finishing sander cuts very quickly and features an internal self-generated vacuum system to remove debris as you sand.

- Free Speed 10,000 RPM
- Head Length 1.08" (2.7 mm)
- 5" or 6" (127 or 150mm) Disc Size
- 2.4 lbs (1.1 kg)
- 4-25/32" (121mm) Overall Length
- Includes vacuum hose and bag

ATS4201V..... (6")\$145.95

ATS50VE.....(5" Heavy Duty)\$189.95

5" COMPACT ORBITAL SANDER



Compact orbital sander produces uniform sanding pattern for even material removal, or for finishing work. It features an internal regulator that allows you to control the speed for different sanding needs. Completely sealed and water resistant so it will work as both a wet and dry sander.

- 5" (127mm) Vinyl or Hook & Loop pad
- Orbit Diameter 3/16" (4.7 mm)
- Built-in air regulator
- 6-1/2" (165mm) Overall Length
- Free Speed 10,000 RPM

ATS4019.....(Hook & Loop)\$79.95

ATS4021.....(Vinyl Pad)\$79.95

ATS 6" HEAVY DUTY DUAL-ACTION SANDER



The smooth strength and power of our Dual-Action Sander quickly removes heavy material on large, flat surfaces while leaving a clean swirl-free finish. Pad motion resists loading for better finishes and less heat build-up.

- 10,000 RPM Free Speed
- Balanced ball bearing construction
- 6" (150mm) Disc Size (PSA)
- Head Width .65" (1.6 mm)
- 10" (254 mm) Overall Length
- 4.25 lbs (1.93 kg)

ATS4205.....\$75.95



DIE GRINDERS & SANDERS

ATS REAR EXHAUST EXTENDED DIE GRINDERS



Combines all the features of a well engineered die grinder with the extra reach needed to get into tight areas. Full ball bearing construction for exceptionally smooth running action. Rear exhaust system vents air away from the work area and prevents contamination from blowing debris.

- 25,000 RPM Free Speed
- Rear Exhaust
- 1/4" (6.4 mm) Collet Size
- .3 HP (.22 kw)

ATS253E..... (3" Die Grinder) **\$135.95**
ATS255E..... (5" Die Grinder) **\$155.95**

ATS MINI DIE GRINDERS



At only 6" long, our new Mini Die Grinders are small enough to fit comfortably in your hand, yet has all of the speed and power of the bigger models. Manufactured from top quality parts and features full ball bearing supports. Use it with rotary files, or Scotch-Brite Roloc discs to shape and polish your work.

- 1/4" (6.4 mm) Collet size
- 2hp (.15 kw) horsepower
- Front exhaust cleans work area
- Full 1 year warranty

PART	STYLE	RPM	WEIGHT	PRICE
ATS5101	Straight	26,000	.79 lbs (.36 kg)	\$59.95
ATS5105	Angle	20,000	1.1 lbs (.5 kg)	\$65.95
ATS5107	115 Degree	20,000	1.1 lbs (.5 kg)	\$75.95

ATS 17 PIECE MICRO DIE GRINDER KIT



A complete rear exhaust micro die grinder kit featuring a powerful die grinder and a collection of stones in various shapes and sizes. Also included in the kit are:

- 1 - Mini Oiler
- 1 - Set of spanners
- 10 - Grinding Stones
- 1 - 1/4" Air Connector

Micro Die Grinder Specifications: 54,000 RPM Free Speed, 1/8" (3mm) Collet Size, 5-3/8" (137mm) overall length, .44 lbs (.2 kg) weight, rear exhaust.

ATS5001K..... **\$95.95**

ATS HIGH SPEED MICRO DIE GRINDER



The very high speed and pencil-thin form factor makes this die grinder the perfect tool to do detailed grinding, polishing, or drilling in all types of metals and composites. Ball bearing construction gives it a remarkably smooth and quiet operation.

- 1/8" (3 mm) Collet Size
- 60,000 RPM Free Speed
- 5.86" (149 mm) OAL
- Rear Exhaust
- Very light weight .48 lbs (.22 kg)
- Full 1 year warranty

ATS5023..... **\$95.95**

Need more information about a product?

Visit our website at www.aircraft-tool.com to find out more about our products. There you'll find complete descriptions, plus additional pictures and videos of our products. You may also call us at 1-800-248-0638 to speak to one of our representatives if you require more specific help.

DIE GRINDERS & SANDERS



CYLINDER SHAPE CARBIDE BURRS (TYPE SA)

SIZE	SINGLE CUT		DOUBLE CUT	
	PART	PRICE	PART	PRICE
1/4 x 5/8	SA-S1	\$5.95	SA-D1	\$5.95
3/8 x 3/4	SA-S3	\$7.95	SA-D3	\$7.95
1/2 x 1	SA-S5	\$11.95	SA-D5	\$11.95
5/8 x 1	SA-S6	\$17.95	SA-D6	\$17.95
3/4 x 1	SA-S7	\$26.95	SA-D7	\$26.95

TREE SHAPE POINTED CARBIDE BURRS (TYPE SG)

SIZE	SINGLE CUT		DOUBLE CUT	
	PART	PRICE	PART	PRICE
1/4 x 5/8	SG-S1	\$6.95	SG-D1	\$6.95
3/8 x 3/4	SG-S3	\$7.95	SG-D3	\$7.95
1/2 x 1	SG-S5	\$11.95	SG-D5	\$11.95
5/8 x 1	SG-S6	\$16.95	SG-D6	\$16.95
3/4 x 1	SG-S7	\$21.95	SG-D7	\$21.95

CYLINDRICAL RADIUS END CARBIDE BURRS (TYPE SC)

SIZE	SINGLE CUT		DOUBLE CUT	
	PART	PRICE	PART	PRICE
1/4 x 5/8	SC-S1	\$6.95	SC-D1	\$6.95
3/8 x 3/4	SC-S3	\$7.95	SC-D3	\$7.95
1/2 x 1	SC-S5	\$12.95	SC-D5	\$12.95
5/8 x 1	SC-S6	\$17.95	SC-D6	\$17.95
3/4 x 1	SC-S7	\$27.95	SC-D7	\$27.95

FLAME SHAPE CARBIDE BURRS (TYPE SH)

SIZE	SINGLE CUT		DOUBLE CUT	
	PART	PRICE	PART	PRICE
1/4 x 5/8	SH-S1	\$6.95	SH-D1	\$6.95
5/16 x 3/4	SH-S2	\$7.95	SH-D2	\$7.95
1/2 x 1-1/4	SH-S5	\$12.95	SH-D5	\$12.95
5/8 x 1-7/16	SH-S6	\$27.95	SH-D6	\$27.95
3/4 x 1-5/8	SH-S7	\$35.95	SH-D7	\$35.95

BALL SHAPE CARBIDE BURRS (TYPE SD)

SIZE	SINGLE CUT		DOUBLE CUT	
	PART	PRICE	PART	PRICE
1/8	SD-S11	\$5.95	SD-D11	\$5.95
1/4	SD-S1	\$6.95	SD-D1	\$6.95
3/8	SD-S3	\$6.95	SD-D3	\$6.95
1/2	SD-S5	\$7.95	SD-D5	\$7.95
5/8	SD-S6	\$14.95	SD-D6	\$14.95

90° TAPER SHAPE CARBIDE BURRS (TYPE SK)

SIZE	SINGLE CUT		DOUBLE CUT	
	PART	PRICE	PART	PRICE
1/4 x 1/8	SK-S1	\$6.95	SK-D1	\$6.95
3/8 x 3/16	SK-S3	\$8.95	SK-D3	\$8.95
1/2 x 1/4	SK-S5	\$8.95	SK-D5	\$8.95
5/8 x 5/16	SK-S6	\$13.95	SK-D6	\$13.95
3/4 x 3/8	SK-S7	\$19.95	SK-D7	\$19.95

OVAL SHAPE CARBIDE BURRS (TYPE SE)

SIZE	SINGLE CUT		DOUBLE CUT	
	PART	PRICE	PART	PRICE
1/4 x 3/8	SE-S1	\$6.95	SE-D1	\$6.95
3/8 x 5/8	SE-S3	\$8.95	SE-D3	\$8.95
1/2 x 7/8	SE-S5	\$11.95	SE-D5	\$11.95
5/8 x 1	SE-S6	\$16.95	SE-D6	\$16.95
3/4 x 1	SE-S7	\$26.95	SE-D7	\$24.95

CONE SHAPE CARBIDE BURRS (TYPE SM)

SIZE	SINGLE CUT		DOUBLE CUT	
	PART	PRICE	PART	PRICE
1/4 x 1/2	SM-S1	\$6.95	SM-D1	\$6.95
1/4 x 3/4	SM-S2	\$7.95	SM-D2	\$7.95
1/4 x 1	SM-S3	\$8.95	SM-D3	\$8.95
1/2 x 7/8	SM-S5	\$11.95	SM-D5	\$11.95
5/8 x 1	SM-S6	\$19.95	SM-D6	\$19.95

TREE SHAPE RADIUS CARBIDE BURRS (TYPE SF)

SIZE	SINGLE CUT		DOUBLE CUT	
	PART	PRICE	PART	PRICE
1/4 x 3/4	SF-S1	\$6.95	SF-D1	\$6.95
3/8 x 3/4	SF-S3	\$7.95	SF-D3	\$7.95
1/2 x 1	SF-S5	\$11.95	SF-D5	\$11.95
5/8 x 1	SF-S6	\$16.95	SF-D6	\$16.95
3/4 x 1	SF-S7	\$24.95	SF-D7	\$24.95

INVERTED CONE SHAPE CARBIDE BURRS (TYPE SN)

SIZE	SINGLE CUT		DOUBLE CUT	
	PART	PRICE	PART	PRICE
1/4 x 5/16	SN-S1	\$6.95	SN-D1	\$6.95
3/8 x 3/8	SN-S2	\$7.95	SN-D2	\$7.95
1/2 x 1/2	SN-S4	\$11.95	SN-D4	\$11.95
5/8 x 3/4	SN-S6	\$21.95	SN-D6	\$21.95
3/4 x 5/8	SN-S7	\$45.95	SN-D7	\$45.95



DIE GRINDERS & SANDERS

SOLID CARBIDE ROTARY BURR SET

Complete set of 1/4" shank rotary burrs designed to shape and trim steel, cast iron, and other ferrous metals. Also ideal for use with composite materials. Can be used with any die grinder or high speed drill. Each set contains a selection of nine cylindrical (Type-SA) and tree shaped (Type-SF) carbide burrs suitable for most applications. Comes complete with case. Not recommended for use on aluminum.



PRO-R110.....(9pcs - 1/4" Shank).....\$165.95

CARBIDE BURR SET FOR ALUMINUM

This set of 1/4" shank carbide burrs is specifically designed to cut aluminum and other non-ferrous metals without galling or loading up. Includes one each: SA-3NF & SA-5NF cylindrical, SC-3NF & SC-5NF radiused cylindrical, SD-5NF ball, SF-5NF tree taper, and SL-3NF tapered. Comes in fitted blow molded case.



WT1109-0060..... (8pcs - 1/4" Shank).....\$99.95

1/8" SHANK CARBIDE BURR SET

A complete set of 12 carbide burrs for use in 1/8" pencil die grinders. Double cut edges removes material efficiently while leaving a smooth finish. Includes one each: SA-51, SA-53 & SB-51 cylindrical, SC-51 & SC-53 radiused cylindrical, SD-51 ball, SE-51 oval, SF-51 & SF-53 tree taper, SM-51 conical, and SN-51 inverted cone. Comes in fitted blow molded case.



WT1134-0080.....(12pcs - 1/8" Shank).....\$49.95

1/8" SHANK 50 PCS DIAMOND GRINDING BITS

Diamond bits are ideally suited for hard materials such as glass, ceramics, and carbon composites. Contains a variety of the most popular sizes and shapes, such as: ball, cylinder, taper, inverted cone, radius end, discs, and more. Includes a blow molded plastic case.



WT4999-9915..... (50pcs - 1/8" Shank).....\$29.95

DIAMOND MOUNTED POINT SETS

Mounted diamond point sets range in diameter from 1/16" to 5/16" in an assortment of shapes. Useful for trimming, hole resizing, precision fitting, etching, etc. Works best with hard materials such as glass, ceramics, and carbon composites.



WT4999-9910.....(10pcs - 1/4" Shank).....\$5.95

WT4999-9900.....(20pcs - 1/8" Shank).....\$8.95

ATS HIGH SPEED CUT-OFF TOOL



Perfect for cutting and trimming studs & bolts. Features a safety hood to protect against flying debris. 3" (75 mm) disc capacity, 3/8" (15 mm) mount. Free speed 20,000 RPM. Weight 1.74 lbs (.79 kg).

ATS8502.....\$39.95

CUT-OFF WHEEL ARBOR



Allows you to use any type of cutoff wheel with your 1/14" collet die grinder. The complete arbor set includes the shank and two screw mandrels for 1/4" and 3/8" hole sizes. Supports cut-off wheels up to 4" in diameter. *Always use an approved face shield when using a die grinder with any type of cut-off wheels.*

16413..... (1/4" & 3/8" Holes).....\$5.95

REINFORCED CUT-OFF WHEELS

Premium quality cut-off wheels has high cut rates and long life. Provides top level grinding for fiberglass, stainless steel, mild steel, and alloys. 25,000 maximum RPM. Type-1 Grade 60 Aluminum Oxide suitable for all metals except Titanium. *Always use an approved face shield when using any type of cut-off wheels.*



PART	QTY	SIZE	PRICE
MG90-3-2	5	2"x1/32"x3/8"	\$6.95
MG90-3-3	5	3"x1/32"x3/8"	\$6.95
MG90-3-4	5	4"x1/32"x3/8"	\$7.95



ATS SURFACE CONDITIONING KIT



A complete sanding and finishing kit that contains a high speed angle sander plus an assortment of 3" sanding discs and surface preparation pads. Includes the following:

- 1 - Coarse Surface Prep Disc
- 1 - Medium Surface Prep Disc
- 1 - Fine Surface Prep Disc
- 10 - 80 Grit Sanding Discs
- 10 - 100 Grit Sanding Discs
- 10 - 120 Grit Sanding Discs

Sander Specifications: 18,000 RPM Free Speed, 3" (76mm) Pad Size, 4-23/32" (120mm) overall length, 1.49 lbs (.68 kg) weight.

ATS4106K.....\$135.95

SCOTCH-BRITE™ HAND PADS



Available in various grades to cover all jobs ranging from light deburring to fine polishing. Each pack consists of either 10 or 20 pads. Pad size is 6" x 9".

PART	DESCRIPTION	PKG. QTY.	COLOR	PRICE
6444	Extra Duty	20	Brown	\$27.95
6448	Light Duty	20	Dark Gray	\$28.95
7440	Heavy Duty	10	Tan	\$35.95
7445	Light Duty Cleansing	20	White	\$27.95
7446	Blending	10	Gray	\$24.95
7447	General Purpose	20	Maroon	\$26.95
7448	Ultra-Fine	20	Light Gray	\$25.95
961H	Twist-Lok Pad Holder			\$6.95

ATS RIVET SPOT SAND BLASTER



This self-contained sand blaster gets down to the bare metal. Ideal for sand-blasting rivets to remove corrosion and oxidation or other spotted areas. The abrasive is recirculated, no mess to clean up. Contains 4 rubber nozzles for flat surfaces, panel edges, and inside and outside corners. Operates on 60 PSI.

ATS201.....\$39.95

SCOTCH-BRITE™ ROLOC SURFACE CONDITIONING KIT



This 20 piece sampler kit includes an assortment of 2" and 3" Scotch-Brite™ surface conditioning discs plus all necessary mandrels for immediate use. Ideal for light deburring and polishing work. The 3M ROLOC™ locking system is superior to all other methods: there is virtually no chance of discs flying off at high

speeds. Kit includes:

- 2 each of 2" Dia. discs in S SFN, A VFN, A MED, and A CRS grades
- 2 each of 3" Dia. discs in S SFN, A VFN, A MED, and A CRS grades
- 1 each of 2" Roloc Disc Pad - Medium
- 1 each of 3" Roloc Disc Pad - Medium
- 2 each of 1/4" threaded shaft for Roloc Pad

985S.....\$64.95

SCOTCH-BRITE™ HAND PAD TRIAL PACK



A convenient pack of assorted 6"x 9" hand pads lets you decide which product is right for your application. Each pack contains one of the following:

- Scrubbing Sponge.
- Light duty pad (6448)
- Cleansing pad (7445)
- General purpose pad (7447)
- TWIST-LOK pad holder (961)
- Extra duty pad (6444)
- Heavy duty pad (7440)
- Blending Pad (7446)
- Ultra fine pad (7448)

961S.....\$23.95

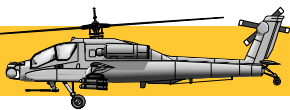

SURFACE PREP TOOLS

PINSTRIP REMOVAL KIT



High speed graphics removal tool quickly and cleanly removes tail numbers, decals, signage, tapes, and any other type of graphics without doing damage to the underlying finish. The Smart Eraser wheel acts to gently "erase" the graphic by using the mild friction. It requires no chemicals or solvents, and there's no residue to clean up afterwards. Runs at 4000 RPM and requires 90psi at 4cfm. Overall length is 7.75" (97mm). Uses 4" Smart Eraser, or 3M 7498 graphics removal wheels.

ATS8701K.....\$49.95

3M EXL ROLOC UNITIZED WHEELS



EXL unitized wheels are great for edge deburring, blending, and finishing. They leave a very high luster satin finish that's ready for painting or fine polishing.

PART	GRADE	DIAMETER	PRICE
EXL17194	A CRS	2"	\$5.95
EXL17195	A CRS	3"	\$9.95
EXL17192	8A MED	2"	\$5.95
EXL17193	8A MED	3"	\$9.95
EXL17187	6S FIN	2"	\$5.95
EXL17189	6S FIN	3"	\$8.95

3M™ STRIPE-OFF GRAPHICS REMOVAL WHEEL



The new 3M Stripe-Off Graphics Removal Wheel is great for removing stripes, decals, or tail numbers from airplanes without damaging the paint finish. Comes ready to use in any air or electric drill. Includes complete instructions. 4" dia x 5/8" wide.

3M7498.....\$35.95

3M ROLOC™ DISC PADS



For use with 3M Roloc™ discs. The pads are made of medium grade rubber and has a female thread to accept any standard 1/4" x 20 threaded shaft.

RLP2 (2" Pad and Shaft)..... \$19.95
RLP3 (3" Pad and Shaft)..... \$22.95
RLTS(Threaded Shaft) \$3.15

SANDING DETAILER KIT



Ideal for finishing those hard to reach areas. The spring loaded to put tensions on the abrasive belt. Included in this standard kit is one each of four various grits.

12301..... (Standard Kit - Coarser Grits)..... \$19.95
12302..... (Finishing Kit - Finer Grits)..... \$19.95

PLASTIC CHISEL SCRAPER SET



Set of three plastic chisels for removing emblems and adhesive backed trim without damage. The one-piece, high-impact plastic chisels can also be used to remove stick-on weights from aluminum wheels and gaskets from aluminum surfaces, without marring. Blades can be sharpened. Includes 3/4", 1", 1-1/2" blade widths.

81200.....\$19.95

FLEXIBLE SANDER



Flexible design allows for optimal sanding of flat and curved surfaces. Ergonomic dual handle design for comfort and maximum control.

15078.....\$5.95

SURFACE PREP TOOLS



3M COMBI WHEELS

Alternate flaps of coated abrasive and finishing web makes these wheels perfect for blending and finishing work. Requires 1 Roloc holder.

PART	SIZE	GRADE	PRICE
CW80	2-1/4" X 1-1/4"	80	\$25.95
CW120	2-1/4" X 1-1/4"	120	\$29.95
CW180	2-1/4" X 1-1/4"	180	\$29.95



3M CUT AND POLISH DISC

Made of five discs of tough cutting polishing web ganged together on a shaft. Use for satin finishing or for light to medium duty cleaning applications. Requires 2 Roloc Holder.

PART	SIZE	GRADE	PRICE
CPD3	3" x 1-1/4"	MEDIUM	\$13.95
CPD4	4" X 1-1/4"	MEDIUM	\$24.95



3M CUT AND POLISH FLAP BRUSH

Flaps of heavy duty cutting and polishing web will leave a uniform finish while removing surface imperfections. Medium grade finish. 3" Dia. x 1-3/8" wide. Designed for long-life. Requires 2 Roloc Holder.

CPFB.....\$20.95

3M GRAPHICS REMOVAL DISC

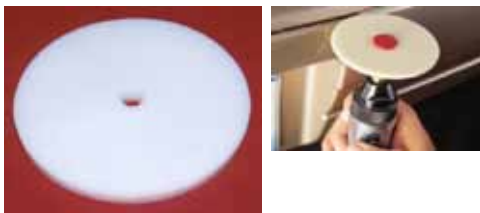

Graphics removal discs provide the best way to remove vinyl decals, graphics, tapes, films and adhesives. Their unique construction assures a long life and allows easy conforming to contours. Because the discs are flexible and have no sharp edges, they will not damage underlying paint. 4" Dia. x 3/8" wide. Requires 1 Roloc Holder.

GRD1.....\$25.95



3M SCOTCH-BRITE™ ROLOC DISCS

Scotch-Brite™ discs are excellent for general purpose surface finishing. They provide a burr-free surface suitable for painting or fine polishing. Use them to remove light corrosion, oxides, and coatings. Sold in packs of five discs.

PART	GRADE	DIA.	PRICE (5 PCS)
SBD05528	A CRS	2"	\$6.95
SBD05532	A CRS	3"	\$10.95
SBD05527	A MED	2"	\$7.95
SBD05531	A MED	3"	\$13.95
SBD05523	A VFN	2"	\$6.95
SBD05530	A VFN	3"	\$11.95
SBD05522	S SFN	2"	\$6.95
SBD05529	S SFN	3"	\$12.95

3M SCOTCH-BRITE™ "SE" ROLOC DISCS



SE discs are the choice of professionals when it comes to removing heavy corrosion or surface irregularities. It's very aggressive, open web makes it ideally suited for heavy deburring, cleaning, and finishing applications.

PART	GRADE	DIA.	PRICE
SE18081	A CRS	2"	\$2.05
SE18082	A CRS	3"	\$3.15
SE18471	A MED	2"	\$2.05
SE18472	A MED	3"	\$3.15

3M 6" CUT & POLISH WHEEL

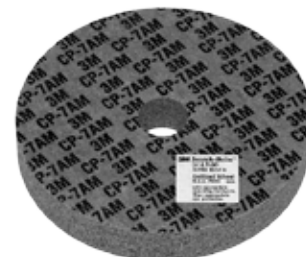

3M Cut & Polish wheel, Medium Grade, 6" Diameter x 1" wide x 1/2" arbor hole. Perfect for deburring and blending aluminum.

CP7AM.....\$81.95

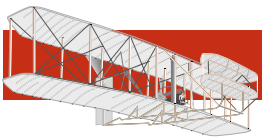

CLEANING & POLISHING

ATS DELUXE VERTICAL POLISHER KIT



A superior quality polisher kit features a high speed ball-bearing vertical polisher for smooth, quiet operation. Includes a complete collection of pads and holders for any polishing, blending, or buffing job.

- 1 - 3" Eva Pad
- 1 - 3" Hook & Loop Holder
- 1 - 3" Wool Buffing Pad
- 1 - 3" Wool Polishing Pad

Polisher Specifications: 2,500 RPM Free Speed, 3" (76mm) Pad Size, 6-5/16" (160mm) overall length, 1.78 lbs (.81 kg) weight.

ATS4601K.....\$199.95

ATS 7 PIECE MINI POLISHER KIT



This is a great all-a-round polishing kit that's well suited for blending, and buffing out blemishes, as well as bringing out a mirrorlike shine to any surface. Includes everything needed to get started except buffing compounds and polishes:

- 1 - 3" Hard Compounding Pad
- 1 - 3" Soft Compounding Pad
- 1 - 3-1/2" Wool Bonnet
- 1 - 3" Hook & Loop Backing

Polisher Specifications: 2,000 RPM Free Speed, 3" (76mm) Pad Size, 4-7/16" (138mm) overall length, 1.6 lbs (.75 kg) weight.

ATS4600K.....\$135.95

ATS 5" PALM POLISHER



A powerful compact polisher that's perfect for doing detail polishing in tight areas having complex surfaces such as wing roots, cowlings, or control surface areas.

- 3,000 RPM Free Speed
- 5" (125mm) Pad Size
- 6-1/2" (165 mm) OAL
- Orbit 3/16" (5mm)
- 1/4 hp
- 2.2 lbs (1.0 kg)

ATS4602.....\$145.95

ATS 7" VERTICAL POLISHER



This powerful polisher makes short work of any buffing job. Heavy duty motor will not bog down under heavy loading, and dual-handle design gives you total control. This is the tool you need to bring out a glass like finish to your airplane's paint job.

- 2,000 RPM Free Speed
- 7-1/2" (190 mm) Overall Length
- 7" (178 mm) Pad Size
- 2.2 lbs (1.0 kg)

ATS4603.....\$99.95

ATS 7" ANGLE POLISHER



An angle polisher is ideally suited for polishing relatively flat areas very quickly. It's the perfect tool to polish fuselage and wing areas.

- 2,500 RPM Free Speed
- 14-1/2" (370 mm) OAL
- 7" (178 mm) Pad Size
- 5.3 lbs (2.4 kg)

ATS4605.....\$95.95

CLEANING & POLISHING



CYCLO FOAM BONNETS AND PADS



The Cyclo Wonder Orbital Polisher was developed for the aircraft industry to polish aircraft, supersonic jets, and missiles the exacting standards required for government approval. It is used by most major airlines and aircraft manufacturers to polish without gouging, marring or burning, as a rotary polisher may do. It leaves no swirl marks and gives a beautifully polished finish. Even a beginner can do a professional job quickly, easily and safely. This versatile durable tool can be used for cutting, compounding, waxing, scrubbing, and cleaning.

CYCLO5.....(For use with Bonnet heads).....\$319.95
CYCLO-RPH.....(For use with Velcro heads)\$331.95

CYCLO FOAM BONNETS AND VELCRO PADS



Foam pads are ideal for applying polishes, sealants, and buffing compounds. They are also superb for fine polishing.

PART	COLOR	DESCRIPTION	PRICE
Bonnet (for use with CYCLO5)			
CY71-110	White	Super Fine Finishing Pad (x2)	\$14.95
CY71-120	Green	Buffing Pad (x2)	\$14.95
CY71-135	Yellow	Blending/Polishing (x2)	\$15.95
CY71-145	Orange	Scratch Removal/Blending (x2)	\$15.95
Velcro (For use with CYCLO5-RPH)			
CY72-110	White	Super Fine Finishing Pad (x4)	\$16.95
CY72-115	Blue	Extra Fine Buffing/Finishing Pad (x4)	\$16.95
CY72-120	Green	Buffing Pad (x4)	\$16.95
CY72-135	Yellow	Blending/Polishing (x4)	\$19.95
CY72-145	Orange	Scratch Removal/Blending (x4)	\$19.95

CYCLO FASTCUT DISC

This coarse nylon pad is strong, durable, and specifically designed to remove bug stains and light corrosion on unpainted aircraft surfaces. 6,000 grit. 10 discs per package. Use with Velcro (RPH) models only.



CY74-660.....\$12.95

CYCLO MICROFIBER PAD COVER (SUEDE)

An ultra-soft cover used for final touches. It effectively removes all surface residue without leaving any swirls or streaks. Excellent for cleanup after waxing. Can be used with any Cyclo Polisher configuration. 4 covers per package.



CY73-515.....\$16.95

CYCLO MICROFIBER PAD COVER (TERRY CLOTH)

Terry cloth is the preferred cover for applying polish and buffing wax. Its hooked fibers remove surface residue effectively while leaving a high-gloss finish. Can be used with any Cyclo Polisher configuration. 4 covers per package.



CY73-530.....\$16.95

CYCLO WOOL BONNETS AND PADS



Wool pads are typically used to apply polish and blend out scratches and marks before finishing.

PART	COLOR	DESCRIPTION	PRICE
Bonnet (for use with CYCLO5)			
CY71-455	White	Removes Swirls and Scratches (x2)	\$15.95
Velcro (For use with CYCLO5-RPH)			
CY72-435	Yellow	Removes Pits & Scratches (x4)	\$35.95
CY72-455	White	Removes Swirls and Scratches (x4)	\$21.95

CYCLO PROSHINE ABRASIVE PADS

A resilient cushioned abrasive disk that is excellent for the removal of scratches fogging, and crazing in aircraft windows. Use with Velcro (RPH) models only. 4 pads per package.

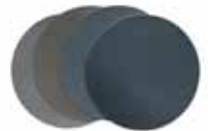

PART	GRIT	DESCRIPTION	PRICE
CY72-702	2400	Pit & Scratch Removal	\$12.95
CY72-704	4000	Heavy Blending & Smoothing	\$12.95
CY72-706	6000	Light Scratch Removal	\$12.95
CY72-708	8000	Restore Luster and Shine	\$12.95
CY72-712	12,000	Restore Optical Clarity	\$12.95



CLEANING & POLISHING

CYCLO DELUXE AVIATION POLISHING KIT



With this kit you will be able to polish your aircraft with professional quality results quickly, easily, and safely - even if you've never polished before. The complete kit includes the Cyclo-RPH Hook & Loop Polisher, a set of green pads to quickly remove dirt and oxidation, a set of wool polishing pads, and a 16 ounce can of MET-ALL polish. Includes everything needed to bring out a mirror-like shine in aluminum and painted surfaces.

CYCLO-DELUXE \$405.95

CYCLO AVIATION POLISHING KIT



With this kit you will be able to polish your aircraft with professional quality results quickly, easily, and safely - even if you've never polished before. The complete kit includes the Cyclo-RPH Hook & Loop Polisher, a set of green pads to quickly remove dirt and oxidation, a set of wool polishing pads, and a 16 ounce can of MET-ALL polish. Includes everything needed to bring out a mirror-like shine in aluminum and painted surfaces.

CYCLO-RPH-KIT \$339.95



CYCLO CLEANING BRUSHES



Brushes allows you to use your Cyclo as a cleaning and scrubbing tool. Attaches directly to any Cyclo Polisher unit. 2 brushes per package.

PART	COLOR	DESCRIPTION	PRICE
CY76-810	Gray	Ultra Soft Upholstery Brush	\$45.95
CY76-830	Aqua	Shampoo Brush	\$41.95
CY76-840	White	Carpet Brush	\$41.95
CY76-870	Black	Scrubbing Brush	\$41.95

CYCLO CLEANER, POLISHER, AND SEALANT COMPOUNDS



CY84-392

CY84-176

CY84-246

CY84-346

Painted or unpainted, Aluminum & Stainless Steel polish keeps your aluminum and steel surfaces shining bright. Special protective agents remove and prevent oxidation. It's non-abrasive, environmentally safe formula guards against water spots and maintains luster. Non-toxic and non-flammable. Effective in removing accumulated surface dirt and stains from anodized aluminum.

CY84-176(Light Compounding Liquid)..... \$10.95

CY84-246(Cleaner, Polisher, Sealant)..... \$15.95

CY84-346(Free Flite Protective Sealant)..... \$10.95

CY84-392(Metal Polish/Free Flite Sealant)..... \$24.95



MET-ALL® DETAILING POLISHING KIT



MET-ALL's Detail Polishing Kit will produce a show room finish on bare metal, painted surfaces and fiberglass using a variety of Met-All polishes and premium bonnets. Each bonnet features a recessed loop back so the edge of the pad, as well as its face, can be used effectively with less concern for scuffing or marring the finish.

MDPKIT\$35.95

MET-ALL® PREP AND ULTRA POLISH



MA-P37

MA-P100

A complete two-stage solution to the perfect finish. First, use the Prep Polish to remove roughness. It's thorough cutting action clears away years of oxidation and readies the surface for finish polishing. Next, buff to a mirror-like finish with super-smooth Ultra Polish. Ultra Polish also restores optical clarity to acrylics, as well as removes fine scratches in painted surfaces.

MA-P37.....(16 oz Prep Polish)\$12.95
MA-P100.....(16 oz Ultra Polish)\$18.95
MA-UPC(16 oz Prep & Ultra Polish Combo).....\$29.95

MET-ALL® ALUMINUM & STAINLESS STEEL POLISH

Painted or unpainted, MET-ALL's Aluminum & Stainless Steel polish keeps your aluminum and steel surfaces shining bright. Special protective agents remove and prevent oxidation. It's non-abrasive, environmentally safe formula guards against water spots and maintains luster. Non-toxic and non-flammable. Effective in removing accumulated surface dirt and stains from anodized aluminum.



MA-BP2.....(2.5 oz Tube)\$3.95
MA-TC10.....(16 oz Can)\$10.95
MA-TC20.....(32 oz Can)\$19.95

EXTREME SIMPLE GREEN

Extreme Simple Green's aircraft cleaning product, cuts through tough, built up grease, oil, dirt, pollution, insect residue and impact soils. Simple Green will cause no harm to aircraft structural metals, plastics, paints, or coatings.

ESGAC32.....\$13.95



WINBRIGHT WINDSHIELD CLEANER

WinBright is specially formulated for aircraft transparencies. This professional strength spray with Micro-Brighteners leaves surfaces sparkling clear and clean. Removes dust, dirt, stains, smudges, and finger prints. Contains no wax, solvents or ammonia and leaves no residue or build-up. 8 oz.

3MWIN008.....\$10.95



ALL KLEER WINDSHIELD CLEANER & POLISH

All Kleer is different than most windshield products as it not only cleans, but leaves a very fine, slick finish, which helps to repel those same dirt and bug stains. It will also inhibit fogging and static. All Kleer contains no wax, ammonia, or abrasives and does not require the use of any water.

AK8.....\$7.95



BUG BLASTER

For use on aircraft, autos, RVs, boats, and motorcycles. Quickly removes bugs without leaving a residue. Just spray, wait and wipe. Bug Blaster instantly attacks bug proteins and acids. Safe on all exterior surfaces including: Plexiglas, acrylic, glass, clear coat or polyurethane paints, etc. Bug Blaster is completely biodegradable. 8 oz.

3MBB1008\$6.95



MICRO-MESH™ AIRCRAFT WINDOW RESTORATION KIT



The cushioned backed abrasives which minimizes the deep, random scratching and unnecessary steps, unavoidable with conventional abrasives. Micro-Mesh™ has been used extensively in military and commercial applications to restore damaged windows and canopies.

KR-70.....(Restores up to 30 Sq. Ft.)\$25.95
HP-100.....(Restores up to 60 Sq. Ft.)\$45.95
3MG8.....(Polish & Scratch Remover 8oz)\$9.95

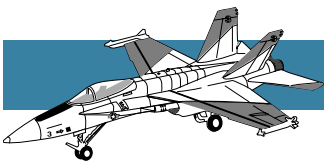

FABRIC TOOLS

MAULE FABRIC TESTER



Test fabric on your airplane for minimum FAA requirements without removing or punching holes in the fabric. Accurately calibrated in pounds (ranges from 25 to 80 pounds). Stainless steel construction. Comes in protective case.

315.....\$347.95

FLORIAN ROTARY PINKER™



The Florian Rotary Pinker™ has been proven since the mid-1930's. Makes one continuous pinked edge with comfortable right or left hand use. Easily pinks the most intricate patterns with a light and compact touch. One year warranty.

FL12\$77.95

TITANIUM BONDED ROTARY CUTTER



Titanium bonded rotary cutter smoothly cuts multiple layers of fabric, photos, fleece, felt and more. This 45mm rotary cutter features a titanium bonded blade which means it will stay sharper longer and will have increased resistance to adhesives. Blades are available in straight or pinking. Ambidextrous use.

18503.....(Cutter)\$19.95
 18505.....(Blades 2pk).....\$9.95
 18548.....(Pinking Blade).....\$8.95

UTILITY GROMMET KITS

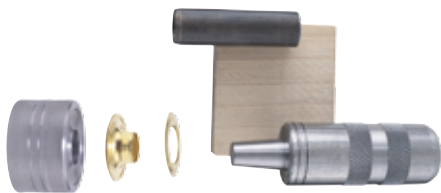

Each easy-to-use set includes a hardened steel hole cutter, a matched mandrel/anvil pair, a hardwood backer block and an assortment of grommets. We offer three kit sizes (1/4", 1/2" and 3/8") as well as the option to purchase additional grommets.

GT71260 (1/4")\$7.95
 GT71262 (3/8")\$8.95
 GT71264 (1/2")\$8.95
 GT1261-0(24 Refill 1/4" Grommets).....\$1.95
 GT1261-2(12 Refill 3/8" Grommets).....\$2.95
 GT1261-4(12 Refill 1/2" Grommets).....\$4.95

TITANIUM NON-STICK SCISSORS



Precision

Straight

Bent Shears

PART	DESCRIPTION	PRICE
18540	4" Titanium Non-Stick Precision Scissors	\$5.95
18541	5" Titanium Non-Stick Precision Scissors	\$8.95
18542	7" Titanium Non-Stick Straight Scissors	\$11.95
18543	8" Titanium Non-Stick Straight Scissors	\$14.95
18544	8" Titanium Non-Stick Bent Shears	\$14.95
18545	9" Titanium Non-Stick Bent Shears	\$16.95

BENT KEVELAR SHEARS



Specially designed to cut Kevlar® materials. Also excellent for cutting plastic, canvas, upholstery and more. Micro-serrated blades for true grip & cut performance. Bent. High carbon alloy steel. Molybdenum and Vanadium blades for industrial strength.

18425.....(8").....\$34.95

BENT EXTREME EDGE TITANIUM BONDED SHEARS



Extreme Edge Titanium Bonded Bent Shear with Knife Edges Titanium Bonded blades are 3x harder than Stainless Steel so they stay sharper longer. Blades will resist corrosion & adhesives. Bent, ergonomic glass-filled nylon handles. Cuts multiple layers of material. Includes Hex Key tool for adjusting tension depending on the type of material you need to cut. Industrial strength shear, constructed for durability.

18523.....(8").....\$15.95
 18524.....(9").....\$17.95
 18527.....(11").....\$19.95



PANEL BEATER AND DOLLY KIT



The most widely used selection of panel beaters and dollies for most metal shaping needs, professional grade tools in a molded plastic box. Each hammer is color-coded for either shrinking (blue) or stretching (red) forming tasks. The three panel beaters included are the dinging, shallow-domed face, and pick hammer combo. The dollies

included are the thin toe, utility, curved, and heel shapes, providing the user with the best combination kit on the market.

DTCP07K.....\$159.95

EXTENDED REACH SHRINKER/STRETCHER



The new Dagger Tools shrinker/stretcher features a deep 8" working depth, and a 6" working height for unmatched versatility. Work all metals from straight sheets up to and including 2" wide angles. The heavy duty frame is cast from ductile iron and fitted with high carbon jaws to easily form 14 gauge aluminum or 16 gauge mild steel. Each unit comes complete with one

set of shrinking jaws, and one set of stretching jaws. Can be bench mounted or individual stand mounted.

DTSH-02.....\$858.95

HARDWOOD SLAPPERS



Leather covered wooden slappers are perfect for quick metal shaping without marring the surface. Use it with a leather shot bag to rough form shapes prior to finishing.

PART	SHAPE STYLE	FACE LENGTH	FACE WIDTH	PRICE
DTSLP1	Gentle	8-1/2"	2-1/4"	\$67.95
DTSLP2	Medium	8-1/2"	2-1/4"	\$69.95
DTSLP3	Flat	8"	2-1/4"	\$67.95

BOSSING MALLETS



High quality bossing mallets are lightweight, resistant to wear, and feature non-marring polyethylene heads. When used with a shot bag, the simplest to very complex shapes can be roughed out and finished with either a planishing hammer or english wheel.

PART	SMALL RADIUS	LARGE RADIUS	HEAD DIA.	PRICE
DTSBM11	7/16"	1"	2"	\$28.95
DTSBM12	1/2"	1-1/4"	2-1/2"	\$33.95
DTSBM13	1/2"	1-1/2"	3"	\$39.95

SHEET METAL HAMMERS



Heat-treated, dropped forged steel dollies and hammers. Fiberglass hammer handles with non-slip grip. Includes: bumping hammer, pick and finish hammer, reverse curve hammer, utility dolly, double end dolly, shrinking dolly, curve dolly, blow mold case.

PART	DESCRIPTION	PRICE
15084	7pc Sheet Metal Hammer Set	\$41.95
15079	Straight Finishing Hammer	\$6.95
15080	Shrinking Hammer	\$6.95
15081	Pick Finishing Hammer	\$6.95
15082	8oz Rubber Mallet	\$3.95
15085	Heel Dolly	\$6.95
15086	Wedge Dolly	\$7.95
15087	General Purpose Dolly	\$7.95

SHOT BAGS



Heavy duty shot bags are made from .070"/.090" top grain cowhide for extended life, and to produce a blemish-free metal surface. Approximately 1-1/2" to 2" when filled.

DTSB8 (8" Diameter).....\$25.95
 DTSB12 (12" Diameter).....\$39.95
 DTSB-STAND (12" Diameter Shot Bag Stand).....\$125.95

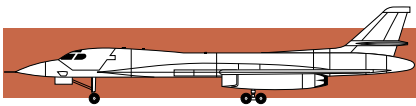

SHEET METAL TOOLS

SHORT FINISHING HAMMER

For close work. 1-1/4" dia. head; 1-1/8" square head; flat faces; 4" long; Wt. 14 oz.

55301.....\$35.95



SHRINKING HAMMER

For all-around work and fast finishing; does not stretch the metal, 1-1/4" round serrated head, 1-1/8" square flat head; 4" long; Wt. 14 oz.

55302.....\$47.95



BENT SKIN HAMMER

Long shaft and small paddle, folds flanges on skins. 6-1/2" long, Wt. 17 oz.

55356.....\$37.95



DINGING HAMMER

Perfectly balanced, for light dinging. 6-1/4" long. 1-1/4" round head; 1-3/16" square head; flat surfaces. Wt. 12 oz.

55358.....\$39.95



CURVED FINISHING HAMMER

Chisel end is 3-1/2" long; Round head, flat face. 6-1/4" long; Wt. 11 oz.

55368.....\$29.95



SHOT BAG

Heavy-duty leather bag filled with 2-1/2 lbs. of shot. Used to stretch and form metal without nicks or gouges. 4" wide by 6" long.

55115.....\$44.95



GENERAL PURPOSE RAIL DOLLY

For bumping, dinging, and finishing. Also has 3 beading and flanging lips. 3"L x 3"W x 2-3/8"H. Wt. 3 lbs.

55105.....\$38.95



LARGE TOE DOLLY

Flat and low-crown curved faces for dinging flat surfaces. 7"L x 2-3/8"W x 2"H. Wt. 2 lbs.

55108.....\$38.95



LARGE HEEL DOLLY

Used in sharp corners and wide radii areas. 3"L x 2-1/2"W x 1-1/2"H. Wt. 2-1/2 lbs.

55107.....\$38.95



LARGE COMMA DOLLY

Use behind brackets, braces, and other reinforcements. 6"L x 2-5/8"W x 2"H. Wt. 3-3/4 lbs.

55112.....\$48.95



LOW CROWN DOLLY

Has low crown and wide radius for general purpose contouring. 3-1/4"L x 2-3/4"W x 2"H. Wt. 3 lbs.

55135.....\$55.95



ROLLED EDGES DOLLY

Has high crown, radii and contours. 4"L x 3-1/4"W x 2"H. Wt. 3lbs.

55145.....\$72.95



SPOON DOLLY

For use in hard to reach places. 14"L x 2-1/2"W x 1"H. Wt. 4-3/4 lbs.

55150.....\$50.95



SLAPPING SPOON

The large polished surface provides a broad face to quickly and evenly work the metal. 4" x 2", Wt. 3/4 lbs.

55501.....\$23.95



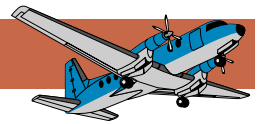

ROPER WHITNEY HAND PUNCH



Punches up to 1/4" hole through 16 ga. metal. Sold either as an individual tool or as a complete kit in a case with 7 punches and dies for 3/32" to 9/32" holes. NOTE: New style inverted handle allows operation close to work without injury to your hand. Made in U.S.A.

45.....\$95.95

INSTRUMENT HOLE PUNCH



Reversible cutter for both 2-1/4" and 3-1/8" instrument panel holes. Easy to use even with instrument panel installed in aircraft. Allows for close work with other instruments already installed.

123C.....\$135.95

T123C.....(Instrument Hole Drill Template).....\$19.95

MALCO REDLINE® HAND CRIMPER



New 5 blade style crimps more evenly. Has 1-1/4" jaw depth. Full 20 gauge capacity. 9" Overall length.

C5R.....(5 Blade Double Crimper).....\$26.95

SC-1.....(3 Blade Single Crimper).....\$21.95

ECONOMY THROATLESS SHEAR



Throatless shears are ideal all purpose metal cutting tools because they permit any desired cut in heavy gauge material, yet handle lighter materials without distortion. Unique shoulder design allows work to be turned in any position during the cut. Geared rack and pinion makes heavy metal cutting easy. Upper and lower blades are positioned to provide a clean, knurl - free cut, regardless of material. Features an 18" handle to give you plenty of leverage for cutting anything from aluminum to stainless steel. Replaceable 4" hardened alloy steel cutting blades. Overall dimensions: 8-1/4"L x 7"W x 27-1/4"H (with handle) 3 holes for mounting. Weight: 16.4 lbs.

HF3841.....\$209.95

ADJUSTABLE HOLE CUTTER



Cuts perfect holes from 2" to 12" diameter in 16 ga. metal and wood up to 1" thick. Ideal for cutting out inspection and instrument holes. Uses any air or electric drill.

HC1.....\$59.95

CB.....(Replacement Cutter Bit).....\$10.95

CIRCLE CUTTER



This tool, also known as a "Fly Cutter", uses a flying cutting bit to cleanly cut holes in metal, wood, plastic, and hardwoods from 1" to 5-1/2" diameter. The included 1/4" drill bit automatically forms its own pilot hole prior to cutting. The drill shank is 5/16". We strongly recommend

a drill-press and safety gear when using this tool.

5B.....\$15.95

555.....(Replacement Cutter Blade).....\$4.95

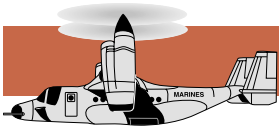

SHEET METAL TOOLS

ANDY SNIPS®



Superior quality, heavy-duty snips are only 1/3 the weight of steel types, and give many more years of service. Comfortable, sleek contour aluminum handles have reinforcing ribs to duplicate the strength of steel. Handles will not spring when cutting heavy gauges of sheet metal. Inlaid blades are supreme cutlery grade moly steel, electronically heat treated and tempered for continuous use. Precision ground, beveled cutting edges stay sharp longer and make pattern cutting, even circle cuts an easy job. Blades are able to be sharpened and also easily replaced when necessary.

- M12.....(12" Long, 3" Cut) \$30.95
- M14.....(14" Long, 3-1/2" Cut) \$35.95

WISS METALMASTER® AVIATION SNIPS



Wiss Metalmaster® snips were originally developed for cutting extremely tough alloys used in the aircraft industry. The jaws are made of durable and wear-resistant molybdenum steel.

- Ideal for cutting tight curves or intricate patterns in sheet metal
- Fine serrated jaws require very little (if any) cleanup after cutting
- Cuts up to 18ga (.049") aluminum or steel

- M1R..... Cuts Left and Straight (Red)..... \$19.95
- M2R..... Cuts Right and Straight (Green)..... \$19.95
- M3R..... Cuts Straight (Yellow) \$19.95
- MKR..... (Set of All 3) \$49.95

WISS METALMASTER® OFFSET SNIPS



Wiss Metalmaster® snips are advanced metal cutting tools originally developed for cutting extremely tough alloys used in the aircraft industry. The jaws are made of durable and wear-resistant molybdenum steel.

- Offset blades keep hands clear of metal
- Fine serrated jaws require very little (if any) cleanup after cutting
- Cuts up to 18ga (.049") aluminum or steel

- M6R..... Cuts Left and Straight (Red)..... \$22.95
- M7R..... Cuts Right and Straight (Green)..... \$22.95

IRWIN® ERGONOMIC OFFSET SNIPS



Irwin has once again set the standard for quality snips. Their new Offset Snips feature cold-formed blades that are stronger and sharper than any other brand. The serrated offset jaws are designed to make straight or tight circular cuts with equal ease while keeping your hand safely away from the work. And Irwin's exclusive new Pro-Touch™ ergonomic grips maximize comfort while increasing leverage, creating a snip you can trust every time.

- 20SL(Left and Straight) \$16.95
- 20SR (Right and Straight) \$16.95

OFFSET CUTTING SNIPS

Offset blades allow cut material to flow unobstructed past blades and your hand. Excellent for notching, long cuts, circles, etc. 18 gauge capacity.



- 10L(Left and Straight) \$19.95
- 10R (Right and Straight) \$19.95

TINNER SNIPS

Maneuvers and cuts easily to very tip of blade. Cuts aluminum, plastics and other thin materials without tearing or catching. Hot drop forged from the finest quality high carbon tool steel. Comfortable vinyl coated handles.



PART	LENGTH OF CUT	OVERALL LENGTH	WEIGHT	PRICE
MD10	2-1/2"	10"	10 oz.	\$19.95
MD12	3"	12-1/2"	24 oz.	\$24.95

SHEET METAL TOOLS



JILSON SUPERSNIP® SHEARS

The SuperSnip cuts cleanly and accurately without damage to painted, plated, or polished surfaces! As it cuts, the SuperSnip conveniently snips off the waste curl so that it does not build up and interfere with your progress; and a built-in guard prevents the cut-off waste from flying up and into the eyes. The SuperSnip makes straight or curved cuts in up to 16 gauge aluminum or 18 gauge steel. Interior cuts can be made by first drilling a 1/4" hole.



J1451 \$45.95
JS1251RB.....(Replacement Blade) \$8.95

JILSON MONODEX® SHEARS

The Monodex® shears will accurately cut aluminum up to 16 gauge, and mild steel up to 18 gauge without distorting, blurring or curling the edges of the cut. Interior cuts can easily be made by first drilling a 1/4" starter hole to accommodate the blade. The handle is made of a tough, durable plastic, which makes it extremely lightweight.



JS12 \$29.95
JS1251RB.....(Replacement Blade) \$8.95

HAND NOTCHER

Notches a neat and uniform 31 degree "V" every time. The throat depth is 3/4".



N1 \$42.95

AN BOLT GAUGE

All metal gauge designed to accurately determine the sizes and lengths of AN bolts up to 5/8" diameter. Self-explanatory, easy to use instructions are written directly on the gauge.



AN7 \$11.95

LAP JOINT JOGGLE TOOL



Use for lap joint and inspection hole joggles in aluminum skins up to .032" thick. Steel handle with adjustment slots and precision ball bearing rollers. Adjustable for set back (width of joggle) and for different material thickness.

AE465 \$56.95

EDGE MARKER BLOCK



This handy device holds a making pen and has an adjustable guide that runs along the edge of a part. The guide allows variable edge distance for rivet layout. One thumb screw holds the pen and the other screw holds the adjustable stop. Comes ready to use with one Pilot marking pen.

AE6352 \$20.95

EDGE ROLLING TOOL



For pre-bending skin edges on lap joints and butt joints before riveting. "Edge rolling" will prevent skin edges from curling up during riveting. Machined round body made from 2024 aluminum. Black anodized finish for wear resistance. Ball bearing style nylon rollers and a spare set of rollers included.

AE1042 \$22.95
AE1040.....(Spare Rollers-2)..... \$2.95

HOLE FLANGING TOOL



Excellent for flanging lightening holes or overlapping sheets. Won't mar material. Flanges straight or curved edges up to 1" deep.

FT100 \$14.95



SHEET METAL TOOLS

HEAVY DUTY HAND SEAMER



The extra wide 3-3/8" jaw face is machined smooth and aligned to be exactly parallel along the edges. The 6" handle is covered in a thick vinyl for maximum leverage without any discomfort.

- HS144..... (ATS Brand)..... \$24.95
- A44 (Roper Whitney Brand)..... \$56.95

ECONOMY HAND SEAMER



Locks to work with powerful non-slip grip. Eliminates tiresome hand gripping. Ideal for holding templates or riveting work, welding, etc. Throat depth 1-3/4".

- AE575..... (Avery Tools)..... \$45.95
- S7 (Irwin)..... \$25.95

OFFSET HAND SEAMER



Bends and flattens metal easily, overhead or in confined areas. Makes permanent, tight fitting seams. Scaled depth marks on jaws are in 1/4" increments. Jaws are made of drop forged high impact steel and are nickel plated.

- S3 \$53.95

SKIN WEDGE



A skin wedge is the tool to use (instead of a screwdriver) whenever you need to pry and jog sheet metal skins. Just slip the thin curved blade into the gap and slide it along the edge to gently separate the edges without gouging the skin. Can also be used as a jogging tool to align new skin. 7" long by 1" wide.

- SWG7 \$9.95

BURNISHING TOOL



Designed to remove surface blemishes in aircraft sheet metal. Comfort grip handle.

- 515A \$11.95

ATS DELUXE FLUTING PLIERS

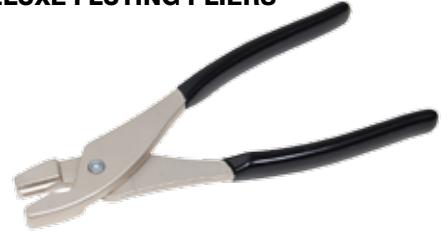

Narrow fluting pliers are used for straightening out or coxing sheet metal into the correct shape. Great for working on spars, ribs, and bulkheads. Smooth polished faces produce very clean flutes without any marring. 3/16" fluting faces.

- FP21 \$19.95

WISE GRIP FLUTING PLIERS

Make narrow & precise flutes for straightening ribs and bulkheads easier & better than pliers with molded jaws. Jaws are 3/16" diameter.



- AE500..... (Avery Tools)..... \$45.95
- 7070..... (ATS Brand)..... \$39.95

FLUTING PLIERS

Special coating on jaws allows work on aircraft components without marring the surface. Has a 1" reach and will produce a 3/8" flute.



- FP10 \$19.95

EDGE SCRAPER

Ideal for deburring sheet metal edges. Special guard protects users hand.



- SP201A \$11.95

DOUBLE DEBURRING TOOL

Fast, efficient deburring tool designed specifically for sheet metal and composite materials. Replaceable hardened twin cutting wheels deburr sheet metal up to 3/8" thick. Overall length is 7-3/4".



- G480 \$19.95
- G480-RB (Replacement Cutting Wheel)..... \$3.95

SHEET METAL TOOLS

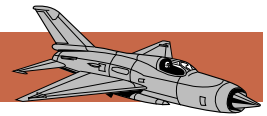

PRECISION SCREW & BOLT SHEAR



This is a precision cutting device to cleanly cut screws and bolts without damaging the threads. Simply insert the screw or bolt into the proper size threaded opening, set the length required, and strike the cutting blade with a hammer to cleave the bolt. It cuts threaded products in sizes of 4-40, 6-32, 8-32, 10-32, 10-24, 1/4-20, and 1/4-28. It will cut steel, stainless steel, aluminum, brass, and even hardened bolts. Comes in a protective pouch and includes complete instructions.

SBS1\$109.95

PILOTED BONDING BRUSH



Stainless steel brush used to clean away corrosion and paint buildup. 1/4" shank.

PART	PILOT	PRICE	P/N	PILOT	PRICE
06721	3/32"	\$17.95	06781	3/16"	\$17.95
06741	1/8"	\$17.95	06801	1/4"	\$19.95
06761	5/32"	\$17.95			

C-CLAMPS

Made of cast steel and plated to prevent rust.



PART	OPENING	DEPTH	PRICE
144C	1"	1-1/8"	\$4.95
407	2"	1"	\$5.95
409	3"	1-1/2"	\$7.95

PONY® SPRING CLAMP



Poly-vinyl jaw-tips protect work area. Spring action allows instant opening and closing.

PART	OPENING	REACH	PRICE
32005	3/4"	3/4"	(4 PCS) \$1.95
3201HT	1"	1-1/4"	\$2.95
3202HT	2"	2"	\$4.95
3203HT	3"	3"	\$10.95
3204HT	4"	4"	\$18.95

SCRIBES & AWLS



Special heat-treated for long, dependable service.

PART	DESCRIPTION	PRICE
GT818	Scratch Awl	\$6.95
627	Hook & Scribe	\$4.95
GT85	Single Point Scribe	\$2.95
GT83	Pocket Scribe with Replaceable Tip	\$4.95
GT83P	Replacement Tip for GT83	\$1.95

CAM LEVER CLAMPS



Locking cam keeps work securely held. Rubber jaws prevent marring.

29W-1 (1" Reach)\$4.95
 29W-2 (2" Reach)\$5.95

HAND TOGGLE CLAMPS



Toggle clamp has a jaw capacity of 1 in. and jaw depth is 1-1/8 in.

145\$19.95

LOCKING C-CLAMPS



Wide-opening jaws provide great versatility in clamping a variety of shapes. The plastic c-clamps are made from high-tech resin while the metal c-clamps are made from high-grade treated alloy steel for maximum toughness and durability.

59100 (Plastic) 1-1/2"\$3.95
 59200 (Plastic) 2"\$8.95
 59400 (Plastic) 4"\$9.95
 31 (Metal) 9"\$17.95
 18 (Metal) 8"\$15.95

SHEET METAL TOOLS



ATS PUNCH & FLANGING TOOL



When overlapping two pieces of sheet metal, you must "jog" the edge of one sheet so that they will join together without seams- and that's just what this tool does. The jogging die places a nice 1/2" jogging flange on the edge of sheet metal up to 16ga. While the other end of the die contains a hole punch that will make a clean 3/16" hole. This tool is a real time-saver if you do a lot of sheet metal work.

- Cap 16ga (.060"/15mm) steel.
- Flange width 1/2" (12 mm)
- 9-3/4" (248 mm) OAL
- Punch Dia 3/16" (5 mm)
- Rubber comfort grip
- 2.75 lbs (1.25 kg)

ATS8400\$75.95

ATS 2" AIR CIRCULAR SAW



Designed to make precise, controlled cuts in aluminum panels up to 1/4" thick. Leaves a high-luster, burr-free edge that does not require any additional filing or cleanup. Great for cutting out access panels. Excellent balance and smooth operation

- Uses 2" (51 mm) saw blades
- .080" (2 mm) steel capacity
- .290" (7.5 mm) capacity
- 620 RPM
- Weight 2.42 lbs (1.1 kg)
- Length 6-7/8" (175 mm)

ATS8510.....\$155.95

ATS8510-RB.....(Replacement Blade)\$25.95

ATS HIGH SPEED RECIPROCATING SAW KIT



Heavy duty saw features safety guards and a locking throttle to prevent accidental starts. At 10,000 strokes per minute, this saw will cut through steel or aluminum just as fast and easily as cutting through wood. Complete kit includes the high speed saw, two sets of blades, mini oiler, a swivel connector, accessory tooling, and a blow molded case.

- Cuts up to 16 ga (.060" / 15 mm) steel or aluminum
- .063" (16, mm) Stroke Length
- 10,000 Strokes Per Minute (SPM)
- Weight 2.1 lbs (1.35 kg.)

ATS8202K.....\$99.95

ATS526.....(Replacement Blades, 18TPI, pkg. of 5).....\$5.95

ATS527.....(Replacement Blades, 24TPI, pkg. of 5)\$5.95

ATS528.....(Replacement Blades, 32TPI, pkg. of 5).....\$5.95

VIBRATION REDUCED SAW KIT



Very low vibration saw is designed to reduce the effects of vibration shock injuries. Cuts at 5000 strokes/min. Operates at 90 psi.

Complete kit includes:

- Saw
- 5 24T Blades
- Air Swivel
- 5 32T Blades
- 5 18T Blades
- Molded Case

ATS8229K.....\$139.95

ATS526.....(18 Teeth Blade 5 Pieces)\$5.95

ATS527.....(24 Teeth Blade 5 Pieces)\$5.95

ATS528.....(32 Teeth Blade 5 Pieces)\$5.95

SHEET METAL TOOLS

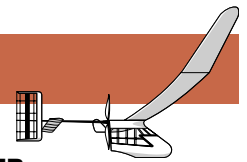

ATS HIGH SPEED AIR SHEARS



The powerful jaws breeze through 16ga sheet metal at over 50 feet/min. Great for rough cutting, or finish trimming. Triple blade (2 stationary, 1 moveable) design cuts without leaving any edge burrs or distortions.

- Cuts up to 16 ga (.060" / 15 mm) steel or aluminum
- Replaceable blades may be sharpened for extended use
- Weight 3 lbs (1.35 kg.)

ATS8500.....(Pistol Grip Handle)\$75.95
ATS8501..... (Straight Handle)\$85.95

HAND NIBBLER



Improved nibbler design provides maximum comfort and ease of use. The extra long handles (7") delivers enough force to easily cut through 18 ga. (.046") aluminum, steel, or plastic. The punch action of the nibbler makes it flexible enough to cut any shape ranging from a straight line down to a 5/16" radius circle.

64823.....\$16.95
64823BIT(Replacement Bit)\$9.95

SHEET METAL JOGGING TOOL



Fits any rivet gun with a .401 shank and forms a perfect 90 degree jog approximately 1/2 inch wide. Ideal for forming sheet metal repair patches or to flush mount full sheets.

91625.....\$50.95

RTN TUBING NOTCHER



The RTN100 (Ol' Joint Jigger) is a bench-mounted tubing notcher designed to make precision angular cuts in both round and rectangular tubing. By using inexpensive BIMETAL hole saws (not included), you can easily and economically notch all types of tubing ranging from mild aluminum to stainless steel.

- Easily adjusts in one degree increments to 45 degree notches.
- Notch any round tubing up to 2" OD in less than 30 seconds.
- Automatically centers and aligns round tubes.
- Can be used vertically or horizontally.
- Includes adjusting wrench and arbor locking pin.

RTN100.....\$175.95
RTN100B.....(Base Adapter).....\$36.95

HOLE SAW KIT



A set of 5 high-carbon hole saws in sizes: 3/4", 7/8", 1", 1-1/8" and 1-1/4" that ideally suited for tube cutting using a jig such as the RTN Tubing Notcher. Includes arbor and carrying case

K1090.....(Complete Kit).....\$109.95

ATS AIR NIBBLER



Cuts beautiful, burr-free edges in aluminum and steel sheets up to 16ga (.060") thick. Features push-type action to give you a better view of you cutting path.

- Cuts up to 16 ga (.060" / 15 mm) steel or aluminum
- Easily replaceable punch and die
- Weight 1.74 lbs (.79 kg)

ATS8300.....\$99.95
ATS8300-RP..... (Replacement Punch)\$10.95

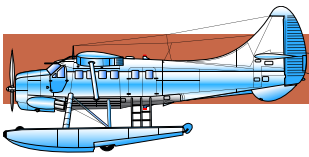

SHEET METAL TOOLS

IMPERIAL FLOOR ENGLISH WHEELS



The Model 26F is Imperial Wheeling's most popular machine. It's a floor model with a 26" throat allowing you to form up to a 52" panel. This is a superb machine that is very stable and solid. It will shape 14 gauge steel with ease. The front and rear legs bolt on and make a stable tripod mount on any firm surface. Custom lower tool arms can be fabricated to allow you to wheel shapes that would otherwise hit the stock tool arm. The 26F comes with an 8"x2" heat treated upper wheel (Rockwell 51c) and six 3"x2" anvils.

Note: 26F features 26" throat, 8"x 2" upper wheel, 6-3"x 2" anvils. CROWN36 features 36" throat 4"x 9" upper wheel 6-3"x 3" anvils. Both are built to order and ships directly from the factory via motor freight within est. 2 weeks.

- IWM-26F \$3,240.95
- IWM-CROWN36 \$3,948.95

ATS BENCH BENDER BRAKE



Bends and forms up to 90° in metals up to 18 gauge thickness. Provides flanged edges up to 1" in height. Adjustments for stock thickness, sharpness of bends are easy to make. Includes two "C" clamps.

PART	CAPACITY	BENDING LENGTH	PRICE
144ST	18 ga.	18"	\$39.95
244ST	18 ga.	24"	\$55.95
364ST	18 ga.	36"	\$79.95

IMPERIAL BENCH MOUNTED ENGLISH WHEELS



Built from 2x5" tubing for exceptional stiffness. Features a stub axle, instead of a yoke, to work very small pieces without pinching your fingers. The lower yoke adjusts side to side and fore and aft easily for alignment for specialized needs. The welded tripod legs will securely bolt to your workbench for maximum stability. It's also designed to hang over the bench edge so you don't have to twist your body to operate it.

Note: Custom built to order with 16" throat, 5-1/2" x 2" upper wheel, 6-2"x2" anvils and ships directly from the factory via motor freight within est. 2 weeks.

- IWM-16S \$1,695.95

LANCASTER PUMPS® METAL SHRINKER/ STRETCHER



Shrinks and stretches metals, Shrinks metal down to a 2" or 3" radius. Works and forms metal up to, and including, 16 gauge. Mounts easily in a bench vise. Jaws are reversible to increase usage.

PART	DESCRIPTION	PRICE
4135	Metal Shrinker	\$191.95
4136	Metal Stretcher	\$191.95
4135/4136	Set of Both Units (4135 & 4136)	\$382.95
523	Replacement Shrinker Jaws	\$102.95
524	Replacement Stretcher Jaws	\$102.95
4135-524	Shrinker Stretcher Combo Unit 1 Metal Shrinker & 1 Stretcher Jaw	\$293.95



TENNSMITH BENDER BRAKES 4', 6', 8' & 10'



Tennsmith brakes are the industry standard. Their rugged construction and precise control makes them the most sought after tool on the market. Their ease of operation causes less fatigue and boost operations efficiency. FOB shipping point.

PART	WIDTH IN.	WEIGHT (LBS)	FIN- GERS	CAPACITY	PRICE
S48-22	48	220	None	22ga. (.030)	\$695.95
HBS48-16	48	460	None	16ga.(.060)	\$1,295.95
HB97-18*	97	1385	None	18ga.(.040)	\$3,789.95
HB121-18*	121	2350	None	18ga.(.040)	\$5,459.95
U48-22	48	280	2",3",4"	22ga. (.030)	\$895.95
HBU48-16	48	495	2",3",4"	16ga.(.060)	\$1,465.95
HBU72-16*	72	1700	2",3",4"	16ga.(.060)	\$4,459.95
B48	Optional Stand (for use with S48, U48, & HBU48)				\$235.95

*Free-standing floor models

TENNSMITH INDUSTRIAL SHEARS



Unit is available in 36" or 52" length and comfortably handles up to 16 Ga. mild steel. Comes complete with protractor gauges, slide gauges. FOB shipping point.

PART	WIDTH	WEIGHT	PRICE
S-36	36"	700 lbs.	\$2,149.95
S-52	52"	950 lbs.	\$2,859.95

TENNSMITH COMBINATION ROTARY MACHINE



This versatile machine with interchangeable rolls (see chart) has many exclusive features to insure fast precise performances. Also will reverse the direction of the arbors. Comes complete with rolls and gauges and table stand. Maximum capacity is 22ga mild steel. Throat width is 7", and shaft roll diameter is 2". Shipping weight is 67 lbs.

R22.....\$919.95

TENNSMITH SLIP ROLLERS 24", 36", & 42"



Exceptional features including rolls, accurate circle setting and wire grooves. Ideal for tool rooms, sheet metal shops, FBOs, and schools. Simple to adjust and operate for faster set up. Minimum roll radius is 1". FOB shipping point.

PART	ROLL DIA.	CAPACITY	WIDTH	PRICE
SR24	2"	20 Ga.	24"	\$779.95
SR36	2"	22 Ga.	36"	\$899.95
SR42	2"	22 Ga.	42"	\$995.95
Optional Floor Stands				
SR24-STAND	Optional Stand for use with the SR24			\$275.95
SR36-STAND	Optional Stand for use with the SR36			\$315.95
SR42-STAND	Optional Stand for use with the SR42			\$369.95

TENNSMITH METAL NOTCHER



Notcher has a size 6" x 6" cutting area and will notch up to 16 gauge (.060") metal with ease. It is mounted on a 17-1/2" x 12" work table that comes as standard equipment. Angles of more than 90° can be done in two operations. Front gauges are standard. Optional tab-notching blades are available. Shipping Weight is 170 lbs. FOB shipping point.

16-18\$895.95

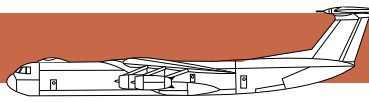

SHEET METAL TOOLS

JET™ COMBINATION SHEAR, BRAKE & ROLL



This tool combines the functions of a shear, bender brake, and a slip roller in one compact unit. The Shear can be used with mild steel, aluminum, soft metals, and plastics. The Brake has removable fingers that permit angle, channel, box and other complex bending operations. The Slip Rolls are precision turned and ground with wire grooves.

PART	WIDTH IN.	WGT. (LBS)	MIN. ROLL DIA (INCHES)	CAPACITY	PRICE
SBR-30N	30	320	1-1/2	22ga. (.030)	\$1107.95
SBR-40N	40	575	2	22ga.(.030)	\$1,859.95
SRS-30N	Optional 30" Floor Stand for SBR-30N				\$209.95
SRS-40N	Optional 40" Floor Stand for SBR-40N				\$297.95

JET™ THROATLESS SLITTING SHEARS



Capable of shearing aluminum and steel sheets, bars and rods, plus many non-metallic materials. Replaceable high quality stainless steel blades are hardened and tempered for maximum service life. An adjustable hold down clamp aids in securing material. Compound leverage allows the operator to easily perform work within the shear's rated capacity. Includes 35-1/2" handle.

- SS-8N.....(8" Blade, 3/16" Capacity)\$265.95
- SS-12N.....(12" Blade, 1/8" Capacity)\$365.95

JET™ HAND BENDER BRAKES



Jet Hand Brakes are constructed to last. All body sections are welded steel plate with heavy truss rods and braces for greater strength. And precise bed and beam alignment ensures accuracy. The HB-1648N features a removable apron nose extension.

PART	WIDTH IN.	WGT. (LBS)	FINGERS	CAPACITY	PRICE
HB-2248N	48	210	None	22ga. (.030)	\$942.95
HB-1648N	48	430	None	16ga.(.060)	\$1,895.95
S-48N	Optional Floor Stand				\$344.95

JET™ BOX AND PAN BENDER BRAKES



Jet Box & Pan Brakes have removable fingers sections to allow the creation of special shapes, such as boxes, pans, channels, or other items requiring complex bends.

PART	WIDTH IN.	WGT. (LBS)	FINGERS	CAPACITY	PRICE
BP-2248N	48	260	2",3",4"	22ga. (.030)	\$1049.95
S-48N	Optional Floor Stand (for 48" units only)				\$344.95

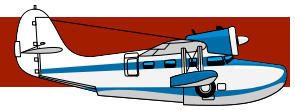

ATS REVERSIBLE SAFETY WIRE TWISTER



Reversible Safety Wire Pliers switches from right-handed (clockwise) to left-handed (counterclockwise) twisting at the flick of a switch. This allows you to change directions on the fly without having to resort to a second tool. Excellent for series wiring where you must switch directions with each bolt. Features a smooth spring-loaded automatic return with a rugged reversing mechanism that resists dirt and contaminants, with a positive locking collar that will not pop back during use. It also has a tapered nose, and built in wire cutters. These are the twisters I want in my tool box!

- 6WR.....(6").....\$69.95
- 9WR.....(9").....\$69.95

REVERSIBLE SAFETY WIRE PLIERS



The innovative, patent-pending, design of the new BSI Safety Wire Pliers allows you to switch from right-handed (clockwise) to left-handed (counterclockwise) twisting at the flick of a switch. This effectively gives you the utility of both a right-handed and a left-handed twister in one tool. It's an absolute time-saver when doing series wiring, as you don't have to stop to change tools as you alternate between bolts. Simply flick the direction switch and keep going. The locking mechanism is also a big improvement over older designs in that it won't accidentally unlock during twisting. Very versatile, and a huge time-saver.

- TH3602-BS(6").....\$89.95
- TH3902-BS(9").....\$89.95

SAFETY WIRE TWISTERS



6" Automatic Return, .041 Wire Capacity. Serrated jaws.

- 6WA.....(6" with Automatic Return).....\$25.95
- 1WA.....(10" with Automatic Return).....\$25.95

TURNBUCKLE RIGGING KITS



TB12K
(TB01 & TB02)

TBR-KIT
(ADE4U & TB02)

Adjusting cable turnbuckles no longer has to be a dreaded ordeal, and you won't need three hands to do it. With our new Turnbuckle Rigging Kit you'll get a complete solution that consists of our Turnbuckle Rigging Tool (p/n ADE4U) to hold the terminal ends of the turnbuckle in place and keep the cable from twisting as you turn the barrel. And you also get our new Turnbuckle Wrench (p/n TB02) to make turning the barrel a piece of cake. The wrench clamps around the barrel (MS21251 style) and gives you the leverage to effortlessly turn it. This kit is a real time saver that will let you adjust turnbuckles through inspection holes quickly and with minimum effort.

- TBR-KIT (Rigging Kit)\$45.95
- TB12K (Close Quarters Rigging Kit).....\$49.95
- ADE4U (Rigging Tool Only)\$18.95
- TB01(Close Quarters Rigging Tool Only)\$24.95
- TB02 (Turnbuckle Wrench Only)\$29.95

ATS EZ-TWIST SAFETY WIRE BIT



The new EZ-TWIST safety wire twisting bit is another ATS exclusive product. It quickly snaps into any 1/4" bit holder (or chuck) for instant use. Simply string the safety wire through the bolt or nut to be wired and run the wire ends into the EZ-TWIST. Then, set your drill to forward (or reverse for left-handed twists), and twist away... EZ-TWIST is available in a 3" length for tight spaces, or in a deep-reaching 6" length.

- EZT3.....(3").....\$7.95
- EZT6.....(6").....\$8.95

SAFETY WIRE

Stainless steel annealed, used to secure bolts, nuts or hardware subject to vibration. Comes in no waste 1 lb. dispenser cans. Type 302. MS-20995C; MIL-W-6713.



PART	DIAMETER	PRICE
302-21	.021	\$11.95
302-25	.025	\$11.95
302-32	.032	\$11.95
302-41	.041	\$11.95



CABLE & WIRE

MILBAR PROFESSIONAL SAFETY WIRE KIT

This versatile safety wiring kit belongs in every professional's tool kit. It includes three Safetytwist® wire twisters that will cover any application. The kit includes a 6" Mini Twister with tapered nose, a 9" Spring Return Twister, and the 13W specialty twister that is adjustable from 9" to 12". Also included are three 1/4 lb. spools of annealed stainless steel wire (.020", .032", .041"). It's all packed in a durable plastic carrying case. (NSN 5180-90-986-8939).



105W.....\$209.95

MILBAR REVERSIBLE SAFETY WIRE TWISTER



Milbar's safety wire twister pliers can twist safety wire in either direction with a simple turn of a sleeve - a second tool is not needed for left handed twisting. The jaw design holds the wire firmly without nicks or scrapes. It also features a spring-loaded return for easy operation in tight areas. Lifetime warranty. Made in the U.S.A.

25W.....(6").....\$95.95
26W.....(9").....\$95.95

MILBAR SAFETY WIRE TWISTER



The Milbar right-hand safety wire twister has a diagonal nose for easier use in tight areas, and features an automatic spring return for faster operation. They are used throughout the aerospace industry as well as in the military. Lifetime warranty, made in the U.S.A.

11WS.....(6" Right Hand)\$79.95
1W393.....(9" Right Hand)\$79.95
5W4.....(9" Left Hand).....\$81.95

MILBAR SAFETY WIRE SPECIALTY TWISTER



The Milbar Specialty Twister is ideal for difficult access situations. Its deep, slender reach will take it into areas that just cannot be reached with ordinary safety wire pliers. Adjustable 9" to 12", right hand twist with manual return.

13W.....\$55.95

ATS SAFETY WIRE DRILL JIG



This tool provides a fast and simple way to drill safety wire holes in the HEAD as well as the BODY of AN bolts, and studs. Works with all Hex Head, Allen Head, and Cap Head bolts from size 3/16" to 5/8." Includes holder, drill bushing (2), and 1/16" drill bits (2). Made from anodized 6061-T6 Aluminum for durability.

6061B.....\$59.95

NUT SAFTBLOCK



Special design enables you to drill safety wire holes through the head of bolts or through nuts, across the diagonal. Accepts up to 3/4 inch diameter nuts and bolts. Easy to use, just place the bolt head into the "V" groove, tighten the holding screw, drill and deburr.

MT002\$29.95

AERO SAFTBLOCK



Designed to let you safely drill wire holes in bolts on center without damage to the bolt or drill. Just thread the bolt to the required depth and drill through the pilot hole. Creates a perfect hole every time. Accepts sizes 8-32, 10-32, 1/4x20, 1/4x28 and 5/16x24.

MT001\$26.95

HAND SAFETY WIRE TWISTER



The hand twister is a convenient way of twisting safety wire in very confined areas. The narrow shaft reaches into areas that are inaccessible to other safety wire tools.

134.....(8").....\$8.95
134L.....(12").....\$9.95

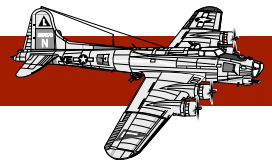

PRECISION CABLE TENSIO METER



The T60 is an industrial & military grade tensiometer accurate to within 5%. Simple, comfortable lever grip permits one hand operation without operator fatigue. A positive 3-point cable grip system prevents dislodgement when the instrument is hanging free on control cable. The accurate built-in gage eliminates guess work. It requires no risers for the various size cables. The gauge also has a "read hold" feature which allows you to take a reading in confined areas. Includes certificate of calibration conformance.

RANGE IN LBS.	CABLE SIZES	UNIT USED	ACCURACY
10-200	1/16", 3/32", 1/8"	C8	5%
30-200	5/32", 3/16"	C8 or C9	5%
80-200	7/32", 1/4"	C8 or C9	5%

T60-1001-C8 (10-200 lbs) \$961.95
 T60-1001-C9 (150-450 lbs) \$974.95

COMPACT CABLE TENSIO METER



The extremely small size of this tensiometer permits entry through small openings, and permits accurate readings on cables located in confined areas. Each instrument is calibrated at the factory and is provided with its own calibration chart for the simple conversion of readings into pounds of tension. The chart also indicates the risers that must be used to accommodate various sizes and tensions. This tool is so easy to use that the entire testing operation can be done with one hand in a matter of seconds.

RANGE IN LBS.	CABLE SIZES	RISER USED	ACCURACY
10-100	1/16", 3/32", 1/8"	Number 1	5%
15-150	5/32", 3/16"	Number 2C	5%
25-150	7/32", 1/4"	Number 3	5%

MC257(Model Type T5-2002-101-00) \$895.95

FLYING WIRE TENSIO METER



A simple, elegant, and extremely accurate flying wire tensiometer that's designed to be used in conjunction with a standard dial or beam type torque wrench. This tool is used for setting the tension on flying wires from 1/4 - 1/2 inch, and tension ranges from 200 lbs to 2400 lbs. Can also be used for setting drag, anti-drag wire tension. Ideal for use on Stearmans, Wacos, and Pitts, etc. To use this tool you'll need a torque wrench with a 1/2" drive. Please note that a flying wire's size is measured at the round, threaded end of the wire, not across the flat. Tie wires are also measured by the thread size and pitch.

HWT-1(Tensiometer Only)..... \$269.95
 HWT-1KIT(Tensiometer & Dial Torque Wrench) \$558.95

ECONOMY CABLE TENSIO METERS



3375D



KM8159

This tool combines low cost with high quality and accuracy. It's a direct reading tensiometer that's compact enough to fit through inspection holes.

PART	RANGE IN LBS.	CABLE SIZES	PRICE
3375D	15-70	1/16", 3/32", 1/8"	\$199.95
3375G	50-350	5/32", 3/16"	\$199.95
3375H	50-350	1/4"	\$189.95
KM8159	Set of 3 Tensiometers plus storage case		\$629.95

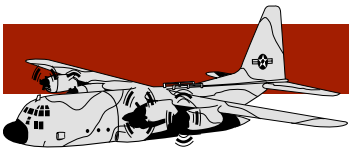

CABLE & WIRE

LOOS & CO. CABLE PRODUCTS

LOCOLOC® KEARNEY CABLE SWAGING MACHINE



This portable, hand operated roll type swaging machine will swage MS and AN type terminals onto galvanized and stainless steel cables from 1/16" diameter up to and including 3/16" diameter. You may purchase the tool only and get only the dies you need, or you can purchase the complete kit. The kit includes the machine, a full set of roll dies, terminal gauges, feed guide adapters, and a steel carrying and storage case.

PART	DESCRIPTION	PRICE
M1-K	Complete kit which includes all of the items listed below. Shipping weight 64 lbs.	\$8,060.95
M1	Swaging machine only with case, Feed Guide Assembly, & Feed Guide Adapters	\$3,221.95
M1-B2	1/16" Ball Terminal Die	\$709.95
M1-B3	3/32" Ball Terminal Die	\$709.95
M1-B4	1/8" Ball Terminal Die	\$709.95
GAB24	Ball Terminal Gauge (1/16"-1/8" cable)	\$165.95
M1-S2	1/16" Straight Terminal Die	\$595.95
M1-S3	3/32" Straight Terminal Die	\$595.95
M1-S4	1/8" Straight Terminal Die	\$595.95
M1-S5	5/32" Straight Terminal Die	\$595.95
M1-S6	3/16" Straight Terminal Die	\$595.95
GAS26	Straight Terminal Gauge (1/16"-3/16" cable)	\$165.95

CABLE DIAMETER GAUGE

Quickly and accurately measures standard cable diameters. Measures sizes: 1/16", 3/32", 1/8", 5/32", 3/16", 7/32", 1/4", 9/32", 5/16", 3/8".



GAP4 \$6.95

LOCOLOC® CABLE SWAGER KIT



This kit contains everything you need to swag cable sizes from 1/16" up to 3/16". It has an assortment of oval and stop sleeves, AN steel thimbles, compression gauge, steel tool box, plus the 1 swager, and the C-7 cable cutter.

CSS-1 \$1,119.95

HAND SWAGER



Multi-compression hand swager with cable cutter. Swages 1/16", 3/32", 1/8", 5/32", and 3/16" oval and stop sleeves, plus 7/32" stop sleeves, total of 11 sizes plus the ability to cut up to 7/32" diameter aircraft quality steel cable (1SC only). A tool with a dozen functions! Only 26" long. Shipping weight 6.5 lbs.

1SC(LOOS & CO. LOCOLOC® Model)..... \$319.95

BENCH SWAGER



For in-shop one location jobs. Multi compression jaws swag 1/16", 3/32", 1/8", 5/32" and 3/16" oval and stop sleeves plus 7/32" stop sleeves. 22.5" long, 6.25" high. Shipping weight 6.6 lbs.

1BSC.....(LOOS & CO. LOCOLOC® Model)..... \$469.95

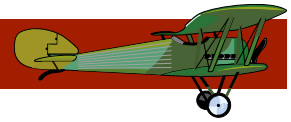

CABLE SWAGERS



Compound action swagers doubles the force so that you can make perfect swages with less effort. Each swagger features a built-in cable cutter that will cut up to 1/4" cables. Swages standard AN copper, zinc, and steel oval and stop sleeves. Not for stainless steel sleeves.

PART	CABLE SIZES	WGT	LEN	PRICE
JPS14	1/16", 3/32", 1/8"	3 lbs	14"	\$49.95
JPS24	1/16", 3/32", 1/8", 5/32", 3/16"	6 lbs	24"	\$69.95

FELCO® DELUXE CABLE CUTTERS



Swiss made cutters feature a unique triangular jaw that cuts cleanly and never frays the end. New handle design allows you to cut with less effort. 3/16" capacity. Unique triangular cutting jaws never leave a frayed end on cut cables

- C7**(Felco® Brand) **\$69.95**
0690TN.....(Cooper Tools® Brand) **\$37.95**

AN100 THIMBLES, OVAL & STOP SLEEVES

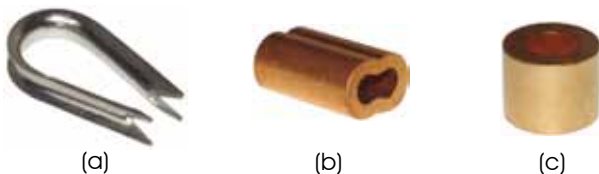

Thimbles are made of stainless steel. Oval and Stop sleeves are made of copper. Note: The C4 is used for both 3/32" & 1/8" cables.

THIMBLES (A)			OVAL SLEEVES (B)			STOP SLEEVES (C)		
PART	SIZE	PRICE	PART	SIZE	PRICE	PART	SIZE	PRICE
C3	1/16	.50	SL-2	1/16	.35	ST-2	1/16	.50
*C4	3/32	.60	SL-3	3/32	.43	ST-3	3/32	.60
*C4	1/8	.75	SL-4	1/8	.74	ST-4	1/8	.60
C5	5/32	.66	SL-5	5/32	.99	ST-5	5/32	.75
C6	3/16	.85	SL-6	3/16	2.25	ST-6	3/16	.85

GBG HAND AND BENCH SWAGERS



GBG brand cable swagers are manufactured in the USA and feature a compound leverage action to deliver twice the force. Works on 1/16", 3/32", 1/8", 5/32" and 3/16" oval and stop sleeves plus 7/32" stop sleeves..

- 64CGMP**..... (Hand Model) **\$249.95**
B64-CGMP.....(Bench Model) **\$399.95**

HAND SWAGER



Ideal for quick swaging of nicopress sleeves onto cables. The 2 swagger will do 1/16", 3/32", and 1/8" cables. The #3 swager is for 1/8", 5/32", 3/16" and 1/4" cables. A Go-No-Go Gauge is included with both the 2SKT and the #2 swager.

- 2SKT** (Complete Kit with thimbles and Sleeves)..... **\$26.95**
2.....(For 1/16", 3/32" & 1/8" Cable) **\$17.95**
3..... (For 1/8", 5/32", 3/16" & 1/4" Cable) **\$45.95**
54-11 (Go-No-Go Gage)..... **\$5.95**

SWAGER GAUGE

Checks your cable swages to see if they meet acceptable standards. Measures sizes: 1/32", 3/64", 1/16", 3/32", 1/8", 5/32" and 3/16".



- GAI1P** **\$15.95**



PRECISION MEASURING

FOWLER® CALIPERS

VERNIER CALIPERS



- Fine quality vernier calipers are constructed of stainless steel.
- 52-057-004 offers 3-way measurement to .001" accuracy.
- 52-058-XXX series offers 4-way measurement in both inch and metric.

PART	RANGE	GRAD	FEATURE	PRICE
52-057-004	0-4"	.001"	Pocket caliper	\$45.95
52-058-008	0-8"	.001"/.02mm	Fine adjusting	\$65.95
52-058-012	0-12"	.001"/.02mm	Fine adjusting	\$105.95

ELECTRONIC CALIPERS



- Patented ceramic capacitive sensor
- Large easy-to-read LCD display
- Resolution to .0005"/01mm
- 4" model includes leatherette case
- Direct inch/metric conversions
- 6" & 8" models includes case

PART	RANGE	ACCURACY	PRICE
54-100-004	0-4"/100mm	.001"/.02mm	\$91.95
54-100-006	0-6"/150mm	.001"/.02mm	\$169.95
54-100-008	0-8"/200mm	.0015"/.03mm	\$129.95

SHOCKPROOF DIAL CALIPERS WITH THUMBROLL!



- 100" range per revolution
- Stainless steel construction
- Silky smooth movement
- Resolution to .001"
- 4-way measuring jaws
- Supplied in molded case

PART	RANGE	GRAD	DIAL FACE	PRICE
52-008-706	0-6"	.001"	White	\$69.95
52-008-707	0-6"	.001"	Black	\$69.95
52-008-708	0-8"	.001"	White	\$85.95
52-008-709	0-150mm	.02mm	Yellow (Metric)	\$69.95
52-008-712	0-12"	.001"	White	\$115.95

EURO-CAL IV® ELECTRONIC CALIPERS with "Sylvac Capacitive Measuring System"



- Repeatability: .0005"/.01mm
- Direct RS232 Output
- Direct inch/metric conversion
- 4-Way Measurement
- Large easy-to-read LCD display
- Resolution: .0005"/.01mm
- Includes molded case

PART	RANGE	ACCURACY	PRICE
54-100-330	0-6"/150mm	.001"/.02mm	\$109.95
54-100-340	0-8"/200mm	.001"/.02mm	\$263.95
54-100-400	0-12"/300mm	.001"/.02mm	\$551.95

SNAP-CAL® ELECTRONIC CALIPER



Fowler's new Snap-Cal is a compact (only 4" long), spring-loaded caliper that allows you to take accurate one-handed measurements to an accuracy of .001" (.02mm).

- Range: 1.25" (31.5mm)
- Spring loaded travel
- Resolution: .0005"(.01mm)
- Direct inch/metric conversion
- .001"(.02mm) accuracy
- Large easy-to-read LCD display

54-550-300 \$96.95

6" DIAL CALIPER



The rugged, 6" Dial Caliper is made from hardened stainless steel for the utmost in accuracy and durability. The large, clear dial accurately reads to .001 and has an adjustable bevel for zero setting. The body of the caliper features a satin chrome scale with etched graduations, and a covered rack prevents dirt and chips from entering the gear mechanism. There is also an adjustable stop rod for taking depth measurements.

GT107 \$47.95

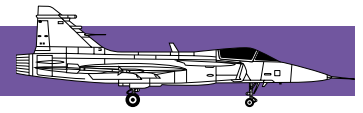

FOWLER® MICROMETERS & MEASURING SETS

ECONOMY OUTSIDE MICROMETERS

- .0001" reading
- Carbide tipped anvils
- Ratchet thimble and locking nut
- Microfine graduations
- Includes standards on sets and sizes over 1"
- Also includes wrench and fitted case



PART	RANGE	GRAD	PRICE
52-229-201	0-1"	.0001"	\$37.95
52-229-202	1-2"	.0001"	\$45.95
52-229-203	2-3"	.0001"	\$55.95
52-229-213	0-3" set of 3 micrometers plus case		\$129.95

DIGITAL OUTSIDE MICROMETERS

- Digital counter
- Resolution: .0001" (using vernier)
- Microfine graduations on satin chrome
- Carbide tipped measuring faces
- Positive locking nut on spindle
- Sizes over 1" supplied with standards



PART	RANGE	GRAD	PRICE
52-224-001	0-1"	.0001"	\$85.95
52-224-002	1-2"	.0001"	\$89.95
52-224-003	2-3"	.0001"	\$99.95
52-224-103	0-3" set of 3 micrometers plus case		\$265.95

IP54 ELECTRONIC MICROMETERS



- Resolution: .00005"/.001mm
- Automatic switch off
- Direct RS232 output
- Carbide measuring faces
- Includes case and wrench
- Oil & fluid resistant to IP54
- Standards included with set & sizes over 1"
- Complete in fitted case



PART	RANGE	GRAD	PRICE
54-860-001	0-1"	.0001"	\$105.95
54-860-002	1-2"	.0001"	\$121.95
54-860-003	2-3"	.0001"	\$130.95
54-860-103	0-3" set of 3 micrometers plus case		\$349.95

WATER RESISTANT ELECTRONIC MEASURING SET



Caliper protected to IP65 and Micrometer protected to IP54 standards. 0-6"/150mm Ultra-Cal IV Caliper - .0005"/.01mm resolution. Direct RS232 output and direct inch/metric conversion. 4R steel rule.

54-004-854 \$299.95

ELECTRONIC CALIPER & MICROMETER SET



6" Electronic caliper - .0005"/.01mm resolution w/ patented ceramic chip. Direct inch/metric conversion.

54-004-850 \$185.95

TOOLMAKER UNIVERSAL MEASURING SET



Set includes: 6" dial caliper - .001" graduations; 0-1" outside micrometer - .0001" graduations; and a 6" flexible rule with 32nds, 64ths, 10ths, & 100ths graduations. All contained in a fitted, shop-hardened case.

52-095-007 \$135.95



PRECISION MEASURING

FOWLER® DEPTH & BORE GAUGES

ECONOMY DEPTH MICROMETERS

- Satin chrome finish
- .001" Graduations
- 4" wide base
- Base surface hardened, ground and lapped
- Ratchet thimble
- Locking clamp
- Includes wooden case.

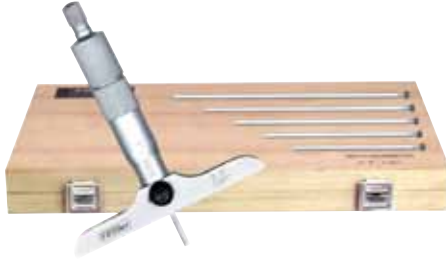

PART	RANGE	GRAD	PRICE
52-225-114	0-4"	.001"	\$115.95
52-225-116	0-6"	.001"	\$139.95

IP54 ELECTRONIC DEPTH MICROMETER

- Resolution: .00005"/.001mm
- Range: 0-6"/150mm
- Precision ground and microlapped 4" base
- Protected to IP54 standards
- Direct RS232 output
- Automatic switch off
- Large LCD display



54-225-456\$195.95

DIAL DEPTH GAUGE

- 0-1" travel with 8mm stem
- .001" Graduations
- Rods connect together for full 22" capacity
- Satin chrome finish
- Base size: 3.5"
- Includes fitted wooden case

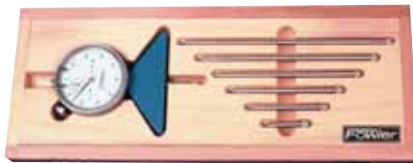

52-125-006\$165.95

COMBINATION SQUARES

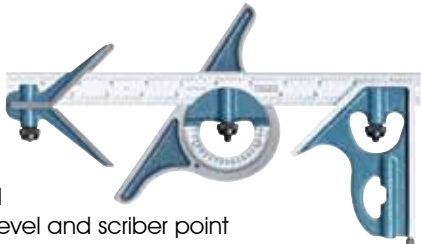

- Protractor has level
- Square head has level and scribe point
- Includes square head, center head and protractor
- Double-indexed protractor is graduated 180 degrees in both directions

PART	SIZE	GRADS	PRICE
52-375-012	12"	32nd, 64th, 50th, 100th	\$159.95
52-375-018	18"	32nd, 64th, 50th, 100th	\$165.95

DIAL BORE GAUGE SETS



- Carbide anvils
- Easy-to-read
- Includes extension holder & case
- Chrome plated handle
- Insulated grip
- Economical

PART	RANGE	GRAD	PRICE
52-646-300	2-6"	.0005"	\$114.95
52-646-400	1.4"-6"	.0005"	\$165.95

DIAL INDICATORS



P52-520-110



P52-520-109



P52-520-129

- 1" Travel
- Continuous reading: 0-100
- AGD group II 2-1/4" dial diameter
- Revolution counter
- Tolerance markers
- Lug back mount

PART	READING	DIAL FACE	PRICE
P52-520-110	.001"	White	\$79.95
P52-520-109	.001"	Black	\$59.95
P52-520-129	.0005"	White	\$99.95
52-585-005	Magnetic Base		\$41.95

PLUNGER DIAL INDICATOR

Plunger Dial Indicators offer a myriad of uses in your machine shop, from setting up milling machines and lathes to checking the accuracy of a work piece. The highly sensitive plunger detects small imperfections in your stock or machine with accuracy to .001. The 2-1/2 diameter face can be rotated for setting at any point, and includes adjustable limit indicators for marking important readings. There is also a lug mount on the back of the Dial for mounting to a magnetic base.



MG1780 (Pro)\$82.95
 GT109 (Economy)\$25.95

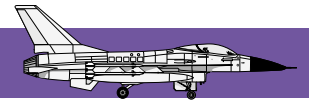

TELESCOPING GAUGES

Double action (self-centering) contact point ends are made of hardened tool steel and precision ground on a radius of the smallest hole the gauge will enter.



PART	SIZE	PRICE
001	5/16" - 1/2"	\$13.95
002	1/2" - 3/4"	\$15.95
003	3/4" - 1-1/4"	\$17.95
004	1-1/4" - 2-1/8"	\$18.95
005	2-1/8" - 3-1/2"	\$19.95
006	3-1/2" - 6"	\$20.95
903	Set of all 6	\$93.95

FULL BALL HOLE GAUGES

Ball hole gauges are used to determine the diameter of small holes. They will measure inside diameters of holes and grooves ranging from 1/8" to 1/2". Makes an ideal companion for our telescoping gauges.



PART	RANGE	PRICE
97A	.125" - .200"	\$17.95
97B	.200" - .300"	\$14.95
97C	.300" - .400"	\$17.95
97D	.400" - .500"	\$15.95
97S	Set of all 4 sizes	\$59.95

CALIPERS AND DIVIDERS

These spring-joint calipers and dividers are fully hardened and heat treated. Brushed finish.



PART	SIZE	PRICE
3304	4"	\$11.95
3314	4"	\$10.95
3324	4"	\$10.95

FRACTION+ DIGITAL CALIPER



This 6" stainless steel digital caliper measures in decimal, millimeters, and *fractions* with guaranteed accuracy to 0.001". Rugged metallic display housing superior to plastic digital display cases. Resolution 0.0005" (0.01mm). Accuracy 0.001" (0.02mm). Auto on/off feature.

GT1433(3").....	\$19.95
GT146(6").....	\$39.95
GT1478(8").....	\$59.95

DIGITAL ANGLE FINDER

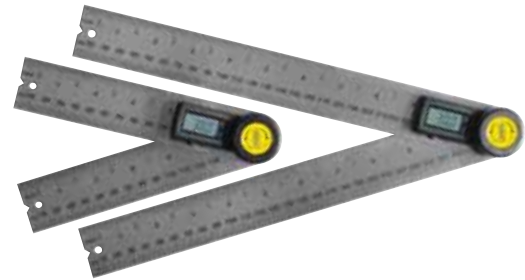

These new angle finders combine the ruggedness of analog rulers (standard and metric) together with the digital technology needed for complete accuracy when measuring inside, outside and reverse angles. One button activates the reverse angle function, a hold button digitally saves the measurement and the large ergonomic locking knob saves the angle manually. A big LCD readout makes measurements extremely easy to read while an innovative center check notch enables exact ruler placement marking.

GT822(5").....	\$29.95
GT823(10").....	\$39.95

UTILITY MICROMETER



The satin chrome barrel and thimble offer easy to read etched black graduations, and the spindle is equipped with a lock for taking repetitive measurements.

GT102	\$23.95
-------	-------	---------



PRECISION MEASURING

STEEL PROTRACTORS

The 6" adjustable arm is ideal for setting bevels, taking measurements and transferring angles. Ultra-fine etched graduations read from 0 to 180 degrees in forward and reverse directions, and will not wear or rub off. Made of ground stainless steel for precision and durability.



- GT17 (Mechanical) \$16.95
- GT1702 (Electronic) \$29.95
- GT19 (Protractor / Depth Gage) \$21.95

DEPTH/ANGLE GAUGE



The easy-to-use Depth and Angle Gage allows you to accurately measure and mark the outside, inside and sloped angles of a surface. The hardened steel base is grooved on both sides to deliver accurate setting of the ruler at 30, 45 and 60 degree angles. The rule can also be used as a depth gage for measuring small holes and slots.

- GT444 \$21.95

10' DECIMAL & METRIC TAPE MEASURE

For ultra precise measurements in both decimal reading and metric. The decimal scale is graduated in 50th (.02) of a foot for the first foot and 10th of an inch for rest of the tape. Metric graduated in millimeters throughout the blade.



- 7210 \$16.95

CONTOUR GAUGES



Contour gauges are designed for precise surface duplication in sheet metal work. The 35 ultra-thin pins per inch assure that you are getting an exact replication of your copied shape. Capable of duplicating surfaces up to 3-1/2" deep.

- GT837 (6") \$10.95
- GT833 (10") \$21.95

EZ READ RULES



The combination of a black chrome finish and precisely etched white graduations make these rules very easy on the eyes. Manufactured from a hardened steel for flexibility and durability.

PART	LEN	WID	GRAD	PRICE
EZ6	6"	1/2"	10th, 100th, 32nd, 64th	\$8.95
EZ12	12"	1/2"	10th, 100th, 32nd, 64th	\$13.95
EZ18	18"	3/4"	10th, 100th, 32nd, 64th	\$24.95
EZ24	24"	3/4"	10th, 100th, 32nd, 64th	\$30.95

SATIN CHROME STEEL RULES



PART	LEN	WID	GRAD	PRICE
52-340-006	6"	3/4"	32nd, 64th, 10th, 100th	\$8.95
52-340-012	12"	1-1/8"	32nd, 64th, 10th, 100th	\$14.95
52-340-018	18"	1-1/8"	32nd, 64th, 10th, 100th	\$25.95
52-340-024	24"	1-1/8"	32nd, 64th, 10th, 100th	\$39.95

CENTER FINDING RULE



Ideal for laying out equally spaced holes or finding the center between two points. The zero mark is in the middle of the rule and is graduated equally to either side of the center. One side is graduated in 8th, 16th, 32nd, and 64th inches. 1" width and length is 12".

- 1210CF \$9.95

AGD INDICATOR & FINE ADJUST MAGNETIC BASE



- **Indicator Features:**
- 1" travel
- AGD group 2
- 2-1/4" dial diameter
- Reading: .001"
- Continuous reading 0-100

- **Magnetic Base Features:**
- 85 lb. pull
- Fine adjustment
- V-bottom base

- 52-585-110 (Fowler) \$49.95





SCREW PITCH GAUGES

Set of 51 screw pitches combines all sizes from 4 to 84, including 11-1/2 and 27 pipe thread sizes. Knurled thumb nuts lock the case in an open or closed position.



GT251 \$55.95

RADIUS GAUGES

Precision ground gauges are used to check layouts and radii. Each has a concave and a convex radius. Stamped radius size on each lead. All gauges have a locking device.



PART	SIZE	GRAD	PRICE
52-470-100	1/32"-1/4"	64th	\$25.95
52-470-102	17/64"-1/2"	64th	\$35.95
52-470-120	1/32"-17/64"	64th	\$28.95
52-470-121	9/32"-33/64"	64th	\$29.95

FEELER GAUGE

Feeler Gages are used for adjusting and gauging spark plugs, distributor points and valve clearances, or any other instance of measuring the space between two parts. Precision Series Gages are made of high-grade precision steel with etched numbering for easy identification.



GT226 (.0015" to .025") \$25.95
GT226T (.0015 to .025 .)..... \$26.95
68050..... (11 Offset Blades, 1/2" x 4")..... \$5.95
68100..... (31 Blades .0015" to .035") \$8.95

SHEET METAL & WIRE GAUGES

Gauge numbers are U.S. standard 0 to 36. Decimal equivalents are stamped on reverse side.



21..... (Sheet Metal Gauge)..... \$19.95
20..... (Wire Gauge)..... \$19.95

SMARTTOOL™ TORPEDO MODULE



The SmartTool™ Torpedo Module packs the features of the larger units in a compact 7" unit. Read a full 360° range (0-90°

in 4 quadrants). Large LCD digital display shows readings in either degree, percent slope, and pitch with an accuracy of 1/10 degree. Beeper sounds when level and/or plumb. Impact and water resistant.

92346..... \$122.95
92395..... (Magnetic Mounting Bracket) \$12.95

SMARTTOOL™



The SmartTool™ digital electronic level delivers precise angular readings. Digital display reads in degrees, % slope, pitch. Up to 1/10 degree accuracy. "Beeps" at level and plumb. Easy push button calibration. Dirt and water resistant.

92288..... (24" Unit) \$142.95
92296..... (48" Unit) \$152.95

4-INCH SLIDE CALIPERS



The rugged, stainless steel construction, coupled with a compact design makes these calipers a great addition. This item provides

inside and outside readings in both 1/16" and 1/32" graduations. There is a decimal equivalents chart on the caliper's back side for help in making measurement calculations.

GT729 \$13.95
GT132ME..... (Pocket Caliper)..... \$9.95

ANGLE PROTRACTOR



A practical tool for measuring and duplicating difficult angles where a standard protractor cannot fit. Measure and mark the degrees of an angle on outside, inside and sloped angles. Fine black graduations from 0° to 165° in opposite directions.

GT29 \$5.95



ELECTRICAL



LUG TERMINAL CRIMPER



All metal tool, for crimping terminals to heavy gauge wires from size AWG8 to 250MCM. Adjustable depth knob controls the amount of crimping. Includes built-in go-no-go gauge. 22" Overall length.

E300-107 \$129.95

CLOSED BARREL D-SUB CRIMPER



Ratcheting, 4-indent, spring-loaded crimper used to install machined terminal pins in D-Subminiature connectors. Installs to AWG 20-26 wires. Standard plugs 6 & 8 position.

E300-015 \$32.95

PRECISION TWEEZERS



Surgical stainless steel. Ideal for picking up and holding small parts.

E900-204 (Set of 4) \$9.95

INSULATED FORCEPS

- Hemostat locking design
- Surgical Stainless Steel
- Insulated handles
- Serrated jaws
- 6" OAL



E900-181 (Straight) \$8.95

E900-222 (Curved) \$8.95

D-SUB INSERTION/EXTRACTION TOOL



Handy tool for installing and removing pins from D-Subminiature housings. Simply place over pin press lightly and pull pin out.

E900-065 \$3.95

PRECISION ELECTRICAL PLIERS



Excellent quality pliers for delicate work on electronic circuits and wiring. Drop forged from high grade steel with mirror polished surface, oil hardened and tempered. Easy open double leaf springs.

PART	FIG.	SIZE	TYPE	PRICE
E100-012	a	6"	Slim needle-nose	\$14.95
E100-013	a	5.5"	Needle nose	\$14.95
E100-015	b	5.5"	Flat nose	\$14.95
E100-016	c	5.5"	Round nose	\$14.95
E100-014	d	5.5"	Bent nose	\$14.95

PRECISION ELECTRICAL CUTTERS



Manufactured from high grade steel with mirror polished surface, induction hardened cutting edges with hot-formed box joints.

PART	FIG.	SIZE	TYPE	PRICE
E200-057	a	4.5"	Full-flush diag cutters	\$16.95
E200-058	b	4.5"	Slim full-flush cutters	\$16.95
E200-059	c	5"	Full-flush side cutters	\$16.95
E200-060	d	5"	Oblique end nippers	\$16.95

ELECTRONIC MAINTENANCE FIELD KIT

A complete field maintenance kit for on the spot electrical repairs.



- 7 Pc Hex Key Set
- 5" Side Cutters
- 6" Combination Pliers
- 6" Long nose Pliers
- Desoldering Pump
- Soldering Iron, Stand & Solder
- PVC Electrician's Tape
- Digital Multimeter
- 8 Pc Screwdriver Set
- (3 Phillips, 3 Flat, 2 Nutdrivers)
- Zippered carrying case



E500-032 \$99.95

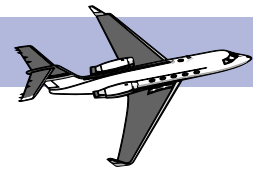

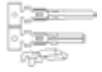

TYPE	DESCRIPTION	FIG
A	Insulated Terminals & Splices: 22-10 AWG red, blue and yellow terminals and splices.	
B	Coax Terminals: BNC, TNC, Mini-UHF, RG-58, 141, 142, 303, 400, 59, 62, 210, RG6, 212, 222, 304, Belden 8279, 8281, 9231, 9141.	
C	Open Barrel Contacts: 30-20 AWG pins and sockets found in most AMP, MOLEX, ITT, Cannon, and other connector plugs.	

TERMINAL CRIMPER DIES

These replacement dies will fit into the Professional Ergonomic Crimpers (E902 series), as well as the Economy Ratchet Crimpers (E300 series). Each die is drop forged from tool steel and hardened.



- E300-058.....\$12.95
- E300-038.....\$12.95
- E300-039.....\$12.95

ECONOMY RATCHET CRIMPERS



Powerful full-ratcheting crimper with safety release and adjustable crimp pressure. Very comfortable rubber handles and ergonomic design makes it easy to install multiple terminals without fatigue.

- E300-002.....Insulated Terminals (Type A)\$35.95
- E300-003.....BNC Terminals (Type B)\$35.95
- E300-005.....Open Barrel Terminals (Type C).....\$35.95
- E300-054.....(Frame Only)\$27.95

PROFESSIONAL ERGONOMIC CRIMPER



Full-ratcheting crimper with an ergonomic angled shape that reduces the exertion required to crimp terminals by as much as 60%. Adjustable crimp pressure control wheel with safety release. Comfortable rubber handles will not slip or stress your hand.

- E902-152.....Insulated Terminals (Type A)\$39.95
- E902-137.....BNC Terminals (Type B)\$39.95
- E902-138.....Open Barrel Terminals (Type C).....\$39.95
- E902-085.....(Frame Only)\$29.95

MULTI-FUNCTION WIRE STRIPPER/CRIMPER



Self-adjusting wire stripper safely removes insulation from AWG 24 to 10 wires. Crimper section installs insulated and non-insulated terminals from AWG 22 to 10 Steel construction.

- E200-070.....\$21.95

AUTOMATIC WIRE STRIPPER

Classic style wire stripper cleanly removes insulation from wires in sizes AWG-22, 16, 14, 12, 10 and 8. Constructed of Die Cast Aluminum for durability.



- E200-003.....\$16.95

ELECTRICAL TERMINAL CRIMP KIT



- Heavy duty ratcheting crimper with rubber handles (E300-002)
- 30 Butt splices 22-16 AWG
- 15 Butt splices 12-10 AWG
- 50 Ring insulated 16-14 AWG
- 20 Butt splices 16-14 AWG
- 50 Ring terminals 22-16 AWG
- 20 Ring terminals 12-10 AWG

An economical electrical terminal kit that includes a heavy-duty ratcheting crimper (Type A) with rubber comfort grips, plus an assortment of insulated terminals and splices. Crimper features an adjusting wheel to control pressure, plus a safety release mechanism.

- E500-037.....\$57.95



ELECTRICAL

HEAVY GAUGE RATCHETING CRIMPER



Powerful ratcheting crimper makes short work of attaching terminals to heavy gauge wires and cables in sizes AWG 12-10, 8, 6, and 4. Features new generation of energy saving crimper designed and high leverage handles to provide superior mechanical advantage.

CP-351B \$47.95

XCELITE® CRIMPERS



U.S. made Xcelite crimpers are used throughout the aviation industry to install terminals and splices of all types. Features full-cycle ratchet to ensure a complete crimp every time. Meets or exceeds UL® standards for terminals from Molex, AMP, ITT, 3M, T&B, and others.

MAC2210 Insulated Terminals (Type A) \$127.95

MIC3020BL Open Barrel Terminals (Type C) \$137.95

COAX CABLE STRIPPER



Twin blade design safely removes the outer and inner insulation from coaxial cables. Just clip it onto the cable, and give it a couple of spins to prepare the coax for a BNC connector. Works with RG-58/59/62 and 6 cables.

E200-004 \$12.95

BNC CONNECTION/REMOVAL TOOL

Use this tool to get at BNC connectors in tight areas. Securely holds the BNC terminal an allows you to tighten or loosen from up to 12" away.



E800-050 \$15.95

3PC MINI ELECTRICAL TOOL SET

Set includes a cutter, stripper, and crimper. Overall length of tools is 5-1/2". For hard to reach applications. Spring loaded to reduce fatigue.



11476 \$41.95

MILBAR® MULTI-PURPOSE ELECTRICAL CRIMPER



The Multi-Purpose Crimper will crimp open barrel, closed barrel, or flag terminals. It also has a bolt cutter section to cut bolt sizes: 4-40, 6-32, 8-32, 10-32 & 10-24.

25E (Milbar) \$48.95

CP-413G (Eclipse Stripper/Crimper) \$9.95

WIRE STRIPPER/CUTTER

At only 6" long, this wire stripper/cutter fits the hand very comfortably. The cutting jaws easily cut up to 14 AWG copper wire. At the other end is an automatic stripper that cuts and removes insulation from 26 AWG to 14 AWG wire.



ELB250 \$8.95

PORTASOL® SOLDERING KIT

Portable Butane soldering iron kit with 1001 uses. Great multi-purpose tool.

- Push button piezo ignition
- 25 to 75 watts in 45 seconds
- Up to 1 hour use per charge
- Includes mini blow torch tip, hot knife tip, hot air tip & deflector, sponge, tray, tool holder, & case.



P2KC \$68.95

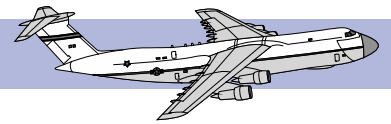

WELLER® SOLDERING STATION

- Variable power 5-40 watts
- Lightweight pencil iron
- Cushioned foam grip with replaceable heating element
- Replaceable tip



WLC100..... \$58.95

WELLER® PROFESSIONAL SOLDERING GUN KIT

- Professional dual heat gun produces 260 or 200 watts
- Fingertip trigger selects high or low
- Ready to use in 6 seconds
- Twin lights illuminate work
- Heavy duty plated copper tip
- Includes 1 soldering tip, 1 smoothing tip, 1 cutting tip, flux brush, soldering aid tool, and a roll of lead-free solder
- 7 year warranty



D550PK..... \$64.95

QUICK CHARGE CORDLESS SOLDERING IRON KIT

The Quick Charge Soldering Iron is a rechargeable soldering iron kit. It's ideal for the shop or field mechanic who needs a reliable and consistent soldering tool when making critical electrical repairs. It has a power rating of 25 watts and reaches 900°F in less than ten seconds. The complete kit includes: rechargeable soldering iron, charging stand, a fine tip, a heavy-duty tip, battery and instructions.



7700..... \$49.95

SILVER BEARING SOLDER PASTE

Provides strength without distortion. Superior electrical conductivity and is resistant to stress and vibration. Disposable 7.1 gram syringe makes it convenient and easy to apply. Works with a match, lighter, soldering iron or torch.



7459..... \$4.95

ESD SAFE SOLDERING STATION

The stabilized precise temperature control of this station makes it ideal for use with delicate circuitry without danger of overheating. It is also ESD (Electro-Static Discharge) certified, which means that it will protect sensitive circuits from static discharge (the leading cause of bench-level circuit failure) while you're working on the part.



SS-207E (Digital Display) \$99.95

SS-206E (Analog Display) \$75.95

BUTANE SOLDERING IRON

The world's most popular pocket-sized butane soldering iron specifically designed for the hobby/DIY enthusiast. Features include: soldering temperature of 410-750°F, torch temperature 2400°F, 5.5" OAL and ready to use 20 seconds after ignition. Kit includes: Soldering Iron, conical tip 7992, protective cap with igniter instructions. Does not include butane fuel.



7971..... \$25.95

WELLER® PRO CORDLESS SOLDERING IRON

Portable battery operated soldering iron is perfect for field maintenance work.

- 950 °F heat in under 15 seconds
- 150 solder joints per battery set
- White LED illumination light
- Includes batteries, lead free solder, 2 tips, and wrench
- 7 year warranty



BP860MP (Soldering Iron) \$22.95

BP10 (Replacement Tip) \$9.95

DESOLDERING TOOL

Great for electrical repair work where wires or components must be removed and resoldered. One-shot vacuum action cleanly removes excess solder from the work area.



E900-001N \$5.95

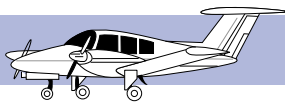

ELECTRICAL

DIGITAL MULTIMETER



This rugged multimeter is designed to give reliable, accurate readings under the most extreme conditions. Measures voltage, amperage, resistance, continuity, capacitance, temperature, frequency, and diode checks. Positive stop rotary switch selects any of over 40 different functions. 1 year warranty.

- MT-1280(Heavy Duty) \$39.95
- MT-1232 (Economy)..... \$39.95

DIGITAL MULTIMETER



A digital multimeter that measures AC/DC voltage, DC current. This product checks resistance, continuity, and diode integrity. Auto ranging with a auto power off. Low battery indicator. Fast sampling rate.

- DMM333 (Credit Card Style)..... \$39.95
- DMM45 (Auto Ranging w/ Backlight)..... \$29.95
- DMM20UL (UL Listed)..... \$16.95

ANALOG MULTIMETER



Analog multi-meters may not be as accurate as their digital counterparts, but you can't beat them for giving you instant visual cues about what's going on in a bad circuit. Just watching that needle can tell you if you've got an intermittent short, an oscillating power supply, or any of the hundreds of other "analog" conditions that you just can't easily see by watching the numbers of a digital multi-meter. 1 year warranty

- AM35UL \$12.95

CANNON PLUG PLIERS



Designed to safely install and remove Cannon plug collars. Incorporates removable plastic inserts which will grip on smooth, oily or serrated surfaces. Adjustable from 3/4" to 2-1/2" grip diameter.

- AT508K (ATI Brand) \$29.95
- 52910N (Crescent® Brand)..... \$27.95

WIRE CATCHING NIPPERS

Heavy duty nippers with wire catching clip to trap snipped wire ends before they can fly off and cause damage.



- 2178M..... (Xcelite® Brand, USA) \$13.95
- E200-082..... (Heavy Duty ESD Safe) \$9.95

OVERHEAD LIGHT REMOVAL TOOL (WEMAC)

A great tool to quickly and safely remove WEMAC overhead (eyeball) cabin light & air vent housings for servicing.

- Works on Beechcraft, Cessna, Embraer, Sino Swearingen, and more
 - No more damage to the housing when removing
 - Manufactured with high friction elastomer tip for maximum grip
 - 3-5/8" (9.2cm) high by 2-1/8" (5.4cm) diameter
- WEMAC-1 \$29.95



3M WIRE MARKER TAPE WITH DISPENSER



A convenient method for marking wire, cable, and terminals. Tape has numbers from 0 thru 9. Self adhesive, oil and solvent resistant.

- 233A2 \$46.95

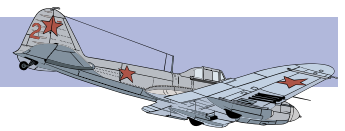

BATTERYMINDER® AVIATION BATTERY CHARGER/MAINTAINERS



12248/24041

24041-AA-S3

The Aviation BatteryMinder was rated 1 by Aviation Consumer! They are designed exclusively for use with FAA and/or PMA approved batteries manufactured by Concorde, Gill and EnerSys.

- Fully automatic 3 stage charging
- Patented random sweep desulphation
- Polarity reversal indicator
- Short circuit and reverse polarity
- Auto-reset thermal breaker
- Rejects damaged battery
- Spark-proof
- Optima/AGM/Lower Temp. Mode
- Built-in battery condition indicators
- Automatic temp compensation

PART	VOLT	AMPS	DESCRIPTION	PRICE
12248-AA-S2	12	8	For use with Gill/non-LT/7000 series	\$180.95
24041-AA-S2	24	4		\$179.95
12248-AA-S3	12	8	Gil LT/7000 series, Odyssey, and Hawker	\$189.95
24041-AA-S3	24	4		\$179.95
12248-AA-S5	12	8	ALL Concorde 12V Aviation AGM (Absorbed Glass Mat) batteries	\$199.95
24041-AA-S5	24	4		\$199.95

SCHAUER® AVIATION BATTERY CHARGERS



JAC0512/JAC0524

JAC0212/JAC224

Schauer's intelligent charger design follows the battery impedance to the end of the charge cycle for all battery types, thus ensuring a full charge with virtually no danger of overcharging or cooking the battery.

- Charge control: constant current charge to a constant voltage, then float standby.
- Fully automatic 3 stage charger can be left on the battery in maintaining mode.
- For any type lead-acid battery, including conventional, maintenance free, deep cycle, gelled-type, valve regulated batteries.
- Finishing voltage: 2.28V per cell float; 2.4V per cell finishing.
- Will start charging a deeply discharged battery with less than 4 volts.
- Current limiting, and short circuit proof
- Reverse polarity protection (except 2 amp models).

PART	AMPS	VOLTS	FEATURES	PRICE
JAC0212	2	12	With Battery Clips	\$29.95
JAC0512	5	12	With Ring Terminals	\$79.95
JAC0224	2	24	With Battery Clips	\$29.95
JAC0524	5	24	With Ring Terminals	\$79.95

QUICK CHARGE AIRCRAFT AUXILIARY POWER UNIT/BATTERY CHARGER



Designed to supply filtered DC bus power through standard APU receptacle in private and commercial aircraft. Up to 25 or 50 amp is available for operating avionics and flight control systems when the master switch is activated. Can also charge the battery

through the plug at a 10 amp rate. Output is current and voltage limited for added safety. DC current and voltage are displayed on panel meters.

PART	DC AMPS	DC VOLTS	AC POWER	PRICE
APU14V/25A	25	12	117V 60HZ 3 AMPS	\$645.95
APU28V/25A	25	24	117V 60HZ 6 AMPS	\$695.95
APU28V/50A	50	24	117V 60HZ 12 AMPS	\$875.95

DELTRAN BATTERY TENDER (12V)



The Deltran Battery Tender is designed to fully charge your battery and maintain it at proper storage voltage without producing any of the damaging effects caused by

trickle chargers. Its microprocessor constantly monitors your battery's state and controls the charging so that it does not overcharge your battery. Two year warranty.

Note: The manufacturer cautions that while Battery Tender will work perfectly for AGM and/or flooded batteries, it does not work with gel type batteries such as Gil. Please check your battery type before ordering.

021-0128(12V) \$49.95



ELECTRICAL

SCHAUER® AVIATION BATTERY CHARGER/GROUND POWER UNITS

JAC2512-3

JAC2024H-1



Schauer's new battery charger/GPU features computer-controlled battery charging, plus enough cranking amps to start the airplane if the battery is completely dead.

- Charge control: constant current charge to a constant voltage, then float standby.
- Fully automatic 3 stage charger can be left on the battery in maintaining mode.
- Can be set for any type lead acid battery, including conventional, maintenance free, deep cycle, gelled-type, valve regulated batteries.
- Cyclic voltage: FLOODED 2.5 volts/cell; GEL & AGM 2.4 volts/cell. 2.6 volts/cell for 36 & 48 volt batteries. May be preset to customer's specification for battery type.
- Will start charging a deeply discharged battery with less than 4 volts.
- Current limiting, Reverse polarity, and short circuit proof.

PART	VOLT	AMPS	DESCRIPTION	PRICE
JAC2512-1	12	25	Charger/GPU with Single Pin	\$219.95
JAC2024H-1	24	20		\$269.95
JAC2512-3	12	25	Charger/GPU with 3-Pin	\$236.95
JAC2024H-3	24	20		\$339.95

BATTERYMINDER CHARGER AND MAINTAINER



This BatteryMinder battery charger and maintainer supplies up to 25 amps of ground power from 1000-240 VAC, as far as 300 feet from the source. Approved by major aircraft battery manufacturers in the U.S., it safely charges both sealed and wet cell 24 volt LA aviation batteries in as little as one hour. LCD panel shows battery voltage, amperage, temperature, time and amp hour acceptance. Maintain up to 50 batteries at a time.

28252-AA **\$795.95**

BATTERY CARRIER



Sturdy steel jaws securely hold batteries. Spring-action handle turns lifting power into battery gripping pressure. Form-fitting handle provides a solid gripping surface for your hand. Carrier works on nearly all batteries, from motorcycles to boats. Saw-tooth jaw tips provide no-slip battery gripping power. Carrier grips the battery just below the top lip for good balance. A heavy-duty tool that is built to last. Opens up to 10".

57850 **\$12.95**

BATTERY TERMINAL SOCKET

Patented socket removes and installs battery terminals without damage to the nuts or posts. Unique torque-limiting feature makes it less likely to strip the nut or snap the stud.



AGE01 **\$13.95**

BATTERY BRUSH



Cleans dirt and corrosion from battery terminals and cable clamps. The external brush cleans cable clamps and internal brush cleans terminal posts. Case is made of high impact plastic that will not weaken in cleaning solutions.

11120 **\$7.95**

IMPERIAL® BATTERY CABLE CUTTER

A powerful set of cutters specifically designed to cut through copper battery cables. Easily cuts through cables as thick as 2/0 gauge. Cushioned grips for comfort. Not for use on steel cables.



BS103 **\$17.95**





LENOX AUTOSCOPE



Since its introduction in the mid 80's, the Autoscope has been the choice borescope inspection tool of aircraft engine manufacturers Teledyne Continental and Textron-Lycoming. It's an easy to use, portable, inexpensive, battery powered side viewing borescope that is optimized for viewing cylinder walls, and engine valve areas. The complete Autoscope kit includes the borescope, a heavy-duty battery handle with a 6 foot cord, and a plastic case. The Autoscope is recommended by Continental to perform the borescope inspection phase of their SB03-3 Service Bulletin.

- 6600K-900.....(9" Kit) \$1,275.95
- 6600K-1500.....(15" Kit) \$1,925.95
- 501-0167(Replacement Halogen Bulb) \$56.95

PORTABLE ARTICULATING VIDEO BORESCOPE (WITH VIDEO RECORDER)



This Borescope is a compact, palm-sized unit that includes a super-white LED light source, a TFT (Thin film transistor) display, video camera, and recorder. Take still photos and video in real time. The removable SD memory card allows you to record and save inspection sessions for later review on either a TV monitor, or a computer.

A fully articulating tip and extra wide viewing angles make it possible to perform a comprehensive inspection of any area.

- 2-Way Articulation sweep 0 to $\pm 120^\circ$
- .216" (5.5mm) external diameter
- 39.4" (1m) soft metal probe
- 4 super-strength white light LED's
- Oil and scratch resistant (IPX7)
- Adjustable illumination intensity
- 3.5" (89mm) extra-wide TFT monitor
- TV monitor and USB interfaces
- 67° Field of view (FOV)
- Includes instrument case

- DCS1600-ART (Full 2-Way Articulation) \$1,999.95
- DCS1600 (Non-Articulating Model) \$995.95

REMOTE ARTICULATING VIDEOSCOPE (WITH RECORDER)



- 2-Way Articulation 0 to $\pm 120^\circ$
- .216" (5.5mm) external diameter
- Wireless image and video transfer
- Transmits up to 150 feet (46 m)
- 39.4" (1m) soft metal probe
- 4 super-strength white light LED's
- Oil and scratch resistant
- adjustable illumination intensity
- 3.5" (89mm) TFT monitor
- 640x480 video resolution
- 67° Field of view (FOV)
- Includes instrument case

This wireless borescope comes as a two-part remote camera system. The compact probe section fits in the palm of your hand and is 1 meter long x 5.5 mm diameter. Information is transmitted wirelessly to the camera section which can be located up to 150 feet (46 meters) away. This makes it ideal for "crawl in" inspections where it's just not possible to have a bulky camera inside the inspection area. It's also perfect for training students in inspection procedures, where the instructor can stand outside and observe the student's progress.

- DCS1800-ART (Full 2-Way Articulation) \$2,495.95
- DCS1800 (Non-Articulating Model) \$1,295.95

HAWKEYE® PRECISION BORESCOPE KITS



The **CLASSIC MODEL** comes with powerful Mini-Maglight® source, while the **NOVA MODEL** features the 10X intensity superNOVA Rechargeable Light. The **PRO MODEL** also comes with the superNOVA light, and also features an independent focusing ring, making it more suitable for use with a digital camera or video.

- SideWays® 90° Tip Mirror Tube included
- 0.04" (1mm) to infinity focal range
- 55° Field of View
- Includes Aluminum Carrying Case

PART	MODEL	LENGTH	DIAMETER	PRICE
HH12-AF-KIT	Classic	12" (305 mm)	.313" (8 mm)	\$1,141.95
HH12-AF-NVK	Classic Nova	12" (305 mm)	.313" (8 mm)	\$1,371.95
PH12-NVK	Pro Nova	12" (305 mm)	.313" (8 mm)	\$1,495.95

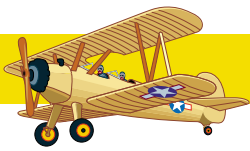

TEST & INSPECTION

INSPECTION MIRRORS



All angle ball joint. Insulated vinyl grip.

PART	FACE	DESCRIPTION	PRICE
S22	3-1/2"x2"	16" Telescoping	\$10.95
E22	2-1/4" dia.	14" Telescoping	\$7.95
C22	1-1/4" dia.	8-1/2" long with clip	\$7.95
B22	1"x2"	8-1/2" long with clip	\$7.95

3X POWER MAGNIFYING TELESCOPING MIRROR



Use the Telescoping Magnifying Mirror to inspect small objects in areas that are out of reach or obstructed. The 3x glass magnifying mirror can be helpful when checking the bottom end of a motor for leaks, etc. The stainless steel telescoping wand extends from 8-1/2" to 29" in length.

- 316M.....(2-1/2" x 3" Rectangle).....\$14.95
- GT759563(2-1/2" Diameter Round).....\$14.95

TELESCOPING LIGHTED MAGNET & MIRROR SET



The pickup wand features a bright white LED light at the end of the chrome plated shaft that telescopes to 26". The magnet lifts up to 5lbs, and shielded so it won't attract peripheral objects. The 2-1/4" diameter oversized mirror is mounted on a universal joint that adjusts to any angle, and the chrome plated shaft telescopes to 36". Both the pickup and mirror feature foam covered handles for comfort. Complete set includes carrying case.

- ELB910.....\$19.95

STEELMAN LIGHTED INSPECTION MIRROR



The Steelman Inspector aids inspection and more importantly saves time! Inspector is a one-hand tool that comes with a very bright light that illuminates the total inspection area. Easy to operate thumb knob mirror angle from 0 to 90 degrees. The inspection mirror is 1" x 2". 4X magnifying mirror.

- 50101.....\$28.95

STEELMAN BEND-A-LIGHT



Bend-A-Light is a flexible high intensity light that bends to any configuration and illuminates hard-to-reach areas where conventional lighting cannot go. High intensity halogen bulb provides ample illumination for any type of inspection task.

- 16102..... (11" Mini-Pro).....\$20.95
- 10150A (16" Bend-A-Light).....\$27.95

TELESCOPING LIGHTED INSPECTION MIRROR



Our Lighted Telescoping Inspection Mirror allows you to peer into the dark crevices of your work space in search of leaks, breaks or lost tools. The telescoping shaft extends and the shatter-resistant mirror sits on a 360 degree swivel head for accurate positioning.

- GT80560 (Rectangle).....\$16.95
- GT80557 (Circle).....\$16.95

LIGHTED MAGNIFIER



Featuring a 3-1/2" diameter lens with 3x magnification, the LumiLens offers both a contoured handle and integrated stand for hand-held or hands-free applications. A 6" inset lens offers high quality magnification for hobbyists, collectors and craftsmen. And of course, the integrated LED light is perfect for working in confined or dimly lit areas.

- GT800543\$19.95



TELESCOPING MAGNETS

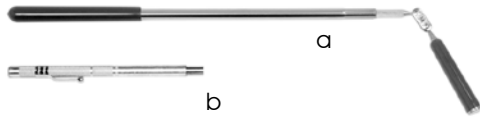

Use to pick up ferrous metal parts and tools. Lifts up to 1 lb.

PART	ITEM	MAXIMUM LENGTH	PRICE
01	(a)	27"	\$9.95
02	(b)	18"	\$5.95
03	(b)	8" with pocket clip	\$6.95

FLEXIBLE PICKUP TOOLS



Excellent tool for picking up parts in hard-to-reach areas.

395.....(20" Magnetic Pickup).....\$7.95
 396.....(18" Claw Pickup)\$7.95

LIGHTED MECHANICAL PICK-UPS



A built-in, bright white light-emitting diode (LED) to directly illuminate an area. The flex-shaft allows you to maneuver through cramped engine compartments, or cabin areas to retrieve fallen items.

GT70396(24").....\$12.95
 GT70399(36").....\$13.95

TELESCOPING MINI-LITE WITH MAGNETIC PICK-UP



The Telescoping Mini Light & Magnetic Pick-Up is a great combination tool for retrieving lost items from confined areas. Equipped with a powerful LED light and a 2 lb. magnet.

GT582\$18.95

BINOCULAR MAGNIFIER



The Binocular Magnifiers offer powerful, crisp magnification of your detailed projects while simultaneously leaving both of your hands free to work. The ground and polished optical lens is mounted to a tilt-up frame, allowing you to disengage the magnifier without removing the entire assembly from your head.

GT950-5\$34.95

BRIGHTYES PRO

The perfect solution when you need a flashlight, but you need both hands free. It places two high-intensity beams wherever you look and allows both hands free to work. Batteries included.



80205.....\$14.95

TELESCOPING FLASHLIGHT WITH MAGNET



Here's an LED flashlight with a new twist -- it telescopes to 20" and has a powerful magnet at the end to make it the ultimate magnetic pickup tool. Simply extend the shaft, light up, and go!

DA75570\$14.95

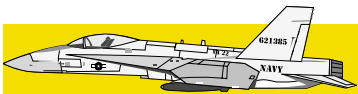

O-BEAM FLASHLIGHT



You must see this flashlight to believe its power! With 1200 lumens of intensity, 4x adjustable zoom, an aluminum water-resistant body, this is a true professional's flashlight! The O2-Beam flashlight comes in an incredibly hard case with foam padding. You will not be let down with this product.

NB6000 **\$99.95**

NEBO REDLINE® COMPACT FLASHLIGHT



The REDLINE® has been called the most powerful compact flashlight ever made. It delivers an amazing 220 lumens of pure white light in a flashlight that measures just a little under 5". Also features S.O.S. mode, and an emergency strobe mode. It's made from aircraft-grade aluminum and anodized for heavy-duty use. It's also sealed to resist water and other liquids. Batteries included. 4X adjustable beam.

NB5599 (220 Lumens / Silver)..... **\$29.95**
NB5610 (220 Lumens / Black) **\$29.95**
NB5615 (SE Model 250 Lumens) **\$34.95**

CSI EDGE™ FLASHLIGHT



Constructed of anodized aircraft grade aluminum, the EDGE™ emits 50 lumens with 1 powerful LED. The water-resistant body also features a steel clip to keep this flashlight handy, or gives you the ability to use as a cap-light for convenient hands-free lighting. The glow-in-the-dark button is positioned in the back so that you can keep constant control of the flashlight while activating the button.

NB5519 **\$9.95**

US ARMY HP-35 CAP-LIGHT



The HP-35 is a high-powered 35 lumen LED Cap-Light with 4 color-changing LEDs. It features a magnetic and a claw clip to attach to anything. 6 lighting modes. The head rotates 90° and turns 360° for lighting in any direction. Water-resistant and shock-proof.

NB5588 **\$14.95**

TRI-EYE LED/UV HEADLIGHT



TRI-EYE is a 35 lumen head lamp powerful enough to fully illuminate areas up to 80 yards away. The push button On/Off switch allows you to choose between the bright white LED light, or 2 auxiliary UV LEDs. Batteries included.

NB5482 **\$12.95**

US ARMY TAC-110Z TACTICAL FLASHLIGHT



The TAC-110Z offers 3 essential light colors in one compact flashlight. All-aluminum body is sealed to resist water and other liquids. Batteries included.

NB5586 (Army TAC-110Z)..... **\$44.95**
NB5463 (Nebo Chameleon) **\$39.95**

BATTERYLESS KINETIC FLASHLIGHT



One of the brightest batteryless flashlights tested. It uses 3 LEDs and its optical lens system to produce a truly brilliant light that lasts over 15 minutes for each 30 second shake. Made from anodized aluminum instead of plastic. It's water and shock resistant, and carries a lifetime warranty. Overall size is 8-1/2" long x 1-1/2" dia

RC6000 **\$15.95**



TRUTACH II DIGITAL PROPELLER TACHOMETER



The new all digital TruTach II measures propeller RPM to a remarkable accuracy of 1 RPM. It features a digital signal filter that eliminates noise and gives solid readings. TruTach II works on single or multi-engine propeller aircraft with 2, 3, 4, or 5 blades, and it never needs adjustment. Easily check calibration anytime with a standard light. RPM Range 240 - 7000 RPM. Uses a standard 9 Volt battery (included). Compact 3.8 x 2.4 x 1.5 inches and weighs just 4 Ounces. Includes impact resistant carrying case. 5 Year Warranty. Designed by Pilots for Pilots.

TRUTACH2 \$215.95

360° DIGITAL PROTRACTOR (PRO360)



This precision instrument is engineered to be accurate to within 1 degree of level and plumb, it provides a full 360 degree reading so that the unit may be used accurately, even upside-down. Reading hold feature lets you take a reading in any situation. Extra large LCD readout for easy viewing. Machined aluminum frame will take just about any punishment. Batteries are included. 1-year warranty.

PRO360 (PRO360 Model) \$249.95
DP82201B (Economy Model) \$129.95

PROPELLER PROTRACTOR



The Warp Drive Protractor is an economical device that accurately sets the pitch of your propeller blades to within 1/4 degree. It can also be used for a variety of other applications such as wing surfaces, flaps, tail sections or anything needing to be measured in degrees. The Warp Drive Protractor makes it easy to prepare the propeller for adjustment by: (1) setting the blades to horizontal, (2) set the hub to vertical, (3) and finally measure the blade pitch. And with the protractor locked in place on the blade, you can adjust the pitch to required standards.

WD-PP1 \$42.95

1400°F ULTRA WIDE-RANGE INFRARED THERMOMETER



30:1 high performance infrared thermometer, -26° to 1400° f. High precision and high performance unit, can be used in most industrial applications, including furnaces and heat exchangers.

IRT670 \$249.95

INFRARED THERMOMETERS



Ideal for most applications in HVAC/R, plumbing and heating, electrical, automotive and other industrial jobs. Printed in USA IRT206SS 2.5M 6/1 1 The IRT206 Heat Seeker is a precision measuring device used for obtaining accurate temperatures without having to contact the object being measured. It works by capturing and measuring the invisible infrared energy naturally emitted by all objects. It offers an easy and safe way to measure surface temperatures of objects which are difficult or unsafe to contact. The Heat Seeker has a rugged, ergonomic design and features a backlit LCD display with built-in laser sighting. The IRT206 has a measurement range of -4° to 604°F (-20° to 320°C) and utilizes a switchable on/off laser pointer for target location. The practical distance-to-spot ratio of 8:1 is suitable for most consumer and commercial applications.

IRT206 (604°F) \$55.95
IRT657 (1076°F) \$49.95

482°F POCKET INFRARED THERMOMETER



Ideal for spot-checking the temperature of substances and surfaces from a distance. The IRT105's measurement range of -40° to 482°F (-40° to 250°C) along with its premium features and specs make it suitable for applications in electrical troubleshooting, aviation maintenance and automotive.

IRT105 \$39.95

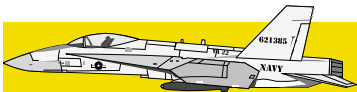

TEST & INSPECTION



MAGNAFLUX® ZYGLO™ PENETRANT TEST KIT



Under the high-intensity Zyglo Black Light you see cracks and defects as glowing signals - even ones you'd miss entirely by any other penetrant test method. The Portable 100-watt Black Light, supplied with the kit, is unique in its high-intensity black light output -- much higher than standard lights. With this intense black light and the strongly fluorescent Zyglo penetrants, defects glow brilliantly in normally lighted area. With Zyglo you get increased inspection efficiency and accuracy at a remarkably low cost. Kit consists of 1 can ZL-27A Penetrant, 1 can ZP-9F Developer, 2 cans SKC-S Cleaner/Remover, and the portable 100-watt Black Light (115 AC., 60Hz). Comes complete with instructions, cleanup scrubs, and cloth. Meets MIL-I-25135 Rev. E specifications (Non-Halogenated).

- ZA70..... (Complete Kit).....\$995.95
- ZP-9F.....(Developer, 12 oz. Aerosol Can)\$20.95
- ZL-27A..... (Penetrant, 12 oz. Aerosol Can).....\$21.95
- SKC-S.....(Cleaner/Remover, 12 oz. Aerosol Can).....\$16.95
- ZB-23A.....(100 Watt Black Light)\$749.95
- 507320.....(Replacement Bulb for ZB-23A)\$74.95

MAGNETIC FIELD INDICATOR



Can be used with Magnaflux to detect magnetic field, also current indicator. Extremely sensitive. Measures from -10 to +10 Gauss in 1 Gauss increments.

- 7308.....\$59.95

MAGNAFLUX® SPOTCHECK DYE PENETRANT TEST KIT



The General Purpose Dye Penetrant inspection kit is used throughout the industry for the detection of surface defects. Suitable for the inspection of most solids, Spotcheck Dye Penetrants give clear, vivid indications of surface flaws, for just pennies a check. The compact carrying case permits this complete, lightweight kit to be taken anywhere. Kit consists of 2 cans Spotcheck SP1 Penetrant, 4 cans SKC-S Cleaner/Remover, and 2 cans SKD-S2 Developer. Includes brush, cloth and instructions. 12 oz. aerosol cans.

- SK816..... (Complete Kit).....\$169.95
- SKL-SP1..... (Penetrant, 12 oz. Aerosol Can).....\$19.95
- SKD-S2.....(Developer, 12 oz. Aerosol Can)\$18.95
- SKC-S..... (Cleaner/Remover, 12 oz. Aerosol Can).....\$16.95

MAGNAFLUX® PORTABLE SPOTCHECK KIT



An undetected crack can be deadly! Critical aircraft areas, especially around stud mounts, can and do crack. And sometimes the flaw is too small to be noticed with the naked eye. That's why you need the new Magnaflux Spotcheck Portable Kit. It's a complete dye penetrant test kit containing everything you'll need to find surface defects in welds, castings, and forgings. The Spotcheck Portable Kit comes in a rugged plastic case and includes complete instructions.

- 2 cans of SKC-S Cleaner/Remover
- 1 can of SKD-S2 Developer
- 1 can of SKL-SP1 Penetrant
- Carrier/Dispenser Pack
- Marking Pen
- Packet of SCRUBS™ Hand Cleaner
- Wiping Cloth
- Complete Instructions

- SK416.....\$95.95



HEAVY DUTY OIL FILTER CUTTER



Heavy duty oil filter cutter opens any spin-on type oil filter quickly and efficiently, including the new Champion dash 1 series with the heavier base. This is a complete tool with no parts or adapters to change. It centers around the filter

quickly, with no parts to change, and cuts in either direction. Cuts all Champion 3.7 Inch diameter filters. Also cuts the new Champion RBC308 filter used on the Rotax 912 and 914 engines.

- FC-2000 (For Filters up to 3.7" Diameter)..... \$85.95
- FC-3000 (For Filters from 3.7" to 4.7" Diameter) \$99.95
- CT470-4 (Replacement Cutter Wheel)..... \$13.95

OILEASY OIL FILTER WRENCH



The "Oil Easy Wrench" is specifically designed to remove the oil filter on any aircraft using the Continental IO-520, or IO-550 engine. It's the only

wrench that can get between the top of the oil filter and the pressure pump and still provide enough leverage to remove the old (usually stuck) oil filter by hand.

- OILEASY1 \$43.95

SWIVEL-GRIPPER "NO-SLIP" OIL FILTER WRENCH



Tough, stainless steel band with permanently bonded textured coating for superior gripping power...won't slip. Handle swivels more than 180° with adjustable tension. Tension adjusting nut allows swivel pressure to be regulated...no more floppy filter wrenches. Specially designed tab

keeps grip from sliding off the handle.

- 57010..... (2.375"-2.625" ROTAX)..... \$10.95
- 57030.....(3.5"-3.875") \$10.95

TOM'S OIL FILTER CUTTER



Tom's Oil Filter Cutter offers a new approach to essential task of opening your oil filter for inspection. This product cuts the filter easily in one pass. Includes adapter to work with any type of Lycoming or Continental filter. May also be used

on smaller filters such as found on Rotax or automotive engines.

- 154701 \$55.95

OIL FILTER MEDIA CUTTER



This innovative new Oil Filter Media Cutter allows the filter media to be cut, removed and analyzed in a very neat and orderly fashion. It's design greatly reduces the chance of accidentally injuring yourself. A pivoting knife with a retractable safety blade is brought into position to make a clean, consistent cut of the filter media. And once cut, the media can be removed for inspection and evaluation. Other benefits are timesaving and a filter sample with no contamination compared with other cutting methods. Works with all Champion filters, and can be adapted for use with Kelly and Tempest Filters.

- FMC-2010(Portable Unit) \$185.95
- FMC-2000(Bench Unit with Stand) \$285.95
- FMC-2000K(Kelly Aerospace Adapter Kit) \$98.95
- FMC-2000T(Tempest Adapter Kit) \$98.95
- FMC-2000BL (Replacement Cutting Blade) \$13.95

OIL FILTER CAN HOLDER



Cutting open an oil filter can be a messy process, but this oil filter can holder makes easy work of it by containing spills that might occur during the cutting process. It's made from solid CNC machined aluminum to hold up to heavy use. And it features three locking pins to puncture and securely hold the can in place prior to cutting. The holder also reduces side loads on the cutter blade (from the FC2000), allowing for a more precise cut with less can deformation. It's simple to use and easily locks into any machine vise. It's a great accessory to the FC2000 Oil Filter Cutter.

- FH-2000..... \$85.95

ENGINE EQUIPMENT



OIL FILTER CUTTER



Works on all oil filters. Cuts open oil filter for inspection without introducing chips.

- 1154**.....\$122.95
- 1154-1** (Replacement Cutter)\$16.95

OIL NUT WRENCH



This wrench is specially designed to comply with CESSNA AD 96-12-22

The Oil Nut Wrench allows you to reach the adapter nut, which must be torqued to a value of 50 to 60 foot pounds in accordance with

the CESSNA AD. Its use is required every time the oil filter is removed to prevent the possible loss of engine oil caused by loose or separated adapters. This tool is absolutely essential for anyone working on any of the following aircraft: All Cessna Models 100, 200, 300, and 400 series; Meyers 200; Twin Commander 500A and 685; Beech 33, 35, 36 and 55 series; Piper PA 46; Navion Rangemaster 17 series; Wren Model 460; Bellanca 200 and 300 series.

- TG961222**\$65.95

AVERY TOOLS OIL FILTER CUTTER



This tool allows you to easily cut open your oil filter to inspect the paper filter element for contaminants and to detect problems inside your engine before they become major and expensive issues. This oil filter cutter will work with both styles of aircraft oil filters -- those that have female threads and those that have male threads. This tool will cut filters from 3" diameter up to 4-3/4" diameter. Some of the newer aircraft filters have a thicker steel base plate. This newly designed filter cutter has the cutting wheel height and guide bearings located higher so the cutting wheel cuts above the thicker base plates (there is no need to remove the rubber filter gasket as other filter cutters instruct you to do).

- AE81031**\$89.95
- AE12027**(Replacement Blade)\$8.95

AIRWOLF OIL FILTER CUTTER



The Airwolf Oil Filter Cutter's unique design makes it a snap to cut through any type of oil filter. It's machined from solid 6061-T6 Aircraft-Grade Aluminum and fitted with stainless steel rollers for smooth cutting. The high carbon steel cutting blade is hardened to 60 Rockwell and honed to razor sharpness to produce clean, consistent cuts. Every mechanic knows that an oil filter cutter is an essential tool; and if you demand the best, then the Airwolf is for you.

- AFC470**\$89.95
- AFC470-RB**(Replacement Blade)\$8.95

KLUHSMAN OIL FILTER CUTTER



This economical cutter quickly opens any size oil filter canisters for filter inspection. Simply place the filter in a vise, attach the tool to the top, and rotate about 4 to 6 turns to cleanly cut open the canister. It's made of high quality 6061 aluminum with an attractive purple anodized finish. The cutting wheel stays sharp for up to 45 applications, and is easily replaced when it becomes dull.

- FC01**\$61.95
- FCW**(Replacement Cutting Wheel).....\$8.95

AVIATION LABORATORIES ENGINE OIL ANALYSIS KIT



Aviation Laboratories' test kit determines the condition of oil wetted engine parts even on the first sample. Metal Check Oil Analysis Kit includes 1 test kit, all lab work and pre-paid FedEx SmartPost Shipping back to the lab for each kit. This oil analysis kit is used for determination of the condition of oil wetted engine parts, even on

the first sample. Aviation Laboratories will analyze 12 wear metal elements for piston and turbine engines, and post the results online for your private review. The analysis is usually completed within 24 hours, and if they detect an abnormal condition, they will contact you immediately to alert you to potential engine problems. Complete kit includes sample bottle, siphon hose, and full instructions.

- AVL-GA001**\$17.95



AIRCRAFT ENGINE TIMING KIT



Mag-Rite's cone uses 6 hooks to securely attach to any propeller blade combination. It uses a digital indicator to measure angles to within .1 degrees. The Fly-Rite Digital Protractor also comes with the kit and it utilizes the same precision digital indicator mounted into a high-impact ABS frame. Use it to quickly and accurately set the proper deflection angle of flight control surfaces and propeller pitch angles.

RSK-BASIC (Without LED52 Mag Timer) **\$109.95**

RSK-DX..... (With LED52 Mag Timer)..... **\$149.95**

EXHAUST STUD DRILL GUIDE

For drilling out broken exhaust studs without damaging the cylinder head. For 470 and 520 series engines. Case hardened steel.



8067..... **\$55.95**

NUT SPLITTER



Compact tool features an angled head to fit into tight spaces and a 3/4" driving hex head for use with a wrench or socket. The Nut Splitter easily breaks up to 1/2" nuts and can be a real time saver.

GT175 **\$31.95**

TEMPORARY ASSEMBLY PINS



Fitting of control surfaces requires numerous installations & removals of the parts to fit and adjust everything. These temporary assembly pins make the task quicker and easier. Pins are 3/16" diameter with tapered points and angle bends for easy installation.

AE445..... **\$16.95**

HIGH RESOLUTION DIGITAL MANOMETER



This manometer has a digital display of gauge or differential pressure in the palm of your hands. Five display unit options of psi, inH2O, mmH2O, bar and mbar. Range from 0 to 2 psi. Data hold and record. Simple fittings for hose connection on the unit. Includes a connection hose, hard case, and battery.

DM8252RS **\$249.95**

EXHAUST STUD REPLACER KIT



A precision tool that will allow you to remove broken studs, retap, and replace them accurately to the original dimensions. This can be accomplished in most cases without removing the cylinder; even Number One in a Bonanza, Works on all Continental 470, 540, 550, and 520 series engines. The kit includes the following:

- One steel jig bored, locating plate
- Three knurled retaining nuts to secure the locating plate
- Four hardened and ground drill bushings
- Three drill extensions: 6", 9", and 12"
- One 3/8" drill chuck

HE01 **\$249.95**

PLUG AND JUMP GROUND POWER PLUG



11808

11807

The Plug & Jump is a very light weight portable unit. It can be used to start your aircraft using standard jumper cables and a car. The Plug and Jump comes in two models; The Universal Model for Cessna, Beechcraft, etc. (3 pin plug) and the single pin model for the Piper. It is not a battery in itself, but a simple conduit of power from any external power source to the aircraft. The Plug & Jump can be used for either 28 or 14 V systems.

11807..... (3 Pin Unit - Cessna)..... **\$79.95**

11808..... (Single Pin Unit - Piper)..... **\$85.95**

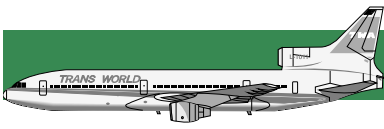

ENGINE EQUIPMENT

MAGNETO E-GAP TIMING KIT



The Magneto Internal Timing Kit is used to set the "E" Gap on Bendix S-20, S-200, S-400, S-500, and S-1200 series aircraft and industrial magnetos. Complete kit with instructions included.

11-8150\$91.95

ENGINE MOUNT INSTALLATION ALIGNMENT PINS



Alignment pins for use in installation of engine mounts on aircraft engines. Pins go in the holes ahead of bolts to help align everything without damaging the bolts. Pins are 7/16" diameter steel, and machined with a taper to a bullet nose on the smaller end.

AE282.....\$17.95

MAGNETO TIMER



This tool simplifies magneto timing on TCM (Continental) series 470, 520, and 550 engines. No protractor on the spinner required, or other complicated tooling. Simply place it over the prop nuts and sight down the casing split to set the timing. That's all there is to it. It's foolproof. Comes with instructions right on the tool for easy reference.

CCMT-01\$39.95

ENGINE TEST KIT



The new ATS engine test kit has all the test equipment needed to check engine compression, synchronize magnetos, time aircraft engines, and test the aircraft ignition leads in one tool box. The kit contains: 2E (or 2EM) pressure tester; 8" extension tube; LED52 magneto synchronizer; Eastern E25 timing indicator; Eastern E5 cable tester; and a tool box. Wt. 16 lbs.

EK5(With 2E)..... \$309.95
 EK5EM(With 2EM & Master Orifice)..... \$319.95
 EK5T(2E W/ US Industrial Cable Tester)..... \$279.95
 EK5EMT.....(2EM W/ US Industrial Cable Tester) \$289.95

ELECTRONIC MAGNETO SYNCHRONIZER

Revolutionary new design uses a high frequency electronic signal instead of high voltages to determine when the points of the magneto break. It will reliably indicate breaks so that you can accurately adjust the magneto's internal timing, or synchronize it to the aircraft's engine. Completely safe and foolproof. Dimensions are 3"x5"x2-5/8".



LED52.....(Deluxe Dual Mag, with Tone)..... \$49.95
 LED52N.....(Standard Dual Mag, no Tone)..... \$45.95
 LED51.....(Deluxe Single Mag, with Tone)..... \$42.95
 LED51N.....(Standard Single Mag, no Tone)..... \$36.95

SLICK® MAGNETO LOCKING PIN



Use this pin to lock the gears of Slick™ magnetos and maintain the correct timing position prior to removal or installation of the magneto.

T118\$4.95

MAGNETO LOCK TOOL



This Bendix Mag-Lock tool is both simple and fast to use.

ML20\$6.95



ENGINE EQUIPMENT

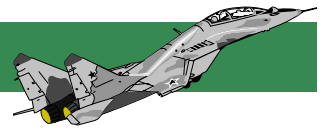

ATS PRO DIFFERENTIAL PRESSURE TESTER KIT



BENDIX MAGNETO P-LEAD ADAPTER



This unique design of the P-lead Adapter allows you to connect to the timer leads of Bendix magnetos with an immediate and positive connection. It provides secure and stable alignment, and includes a post that prevents the timer leads from falling off.

PART	WORKS WITH BENDIX	PRICE
8765	Early S4, S6 & S20 mags (3/8" p-lead)	\$35.95
8766	All other S series mags (1/4" p-lead)	\$35.95
8767	D2000 & D3000 series mags	\$35.95
8768	Set of all 3 adapters	\$95.95

I don't have to tell you how aggravating it can be to reach down into the cowling to get to those spark plug holes for a quick leakdown check. It's a real pain to get the hose to reach the spark plug hole without contorting your arm into pretzels. Well, we feel your pain... You don't have time to waste fighting your tools, so we paired up our top of the line ATS 2EM Differential Pressure Tester (with Master Orifice) along with our new Spark Plug Port Extension Tool to make your life a whole lot easier. Order this kit now and you'll never dread doing a leakdown test again.

- 2EM-KIT.....(With 2EM).....\$119.95
- 18MM-XT (18MM For ATS Compression Testers).....\$29.95
- 14MM-XT (14MM For ATS Compression Testers).....\$29.95
- 12MM-XT (12MM For ATS Compression Testers).....\$29.95
- E18MM-XT..... (18MM For EASTERN Compression Testers).....\$39.95
- E14MM-XT..... (14MM For EASTERN Compression Testers).....\$39.95

MASTER ORIFICE TOOL



The Master Orifice Tool is required by Continental's SB03-3 Service Bulletin. Use it with Eastern's E2, or our own 2E Differential Pressure tester to determine your calibrated leakage reading prior to engine testing. It is available in either plated steel (SPX), or non-sparking brass (ATS). **Note: This tool is not needed by our (ATS) 2EM or Eastern's E2M, as they already have a built-in master orifice.**

- 646953A (SPX Model) \$89.95
- 6469..... (ATS Model)..... \$75.95

DIFFERENTIAL PRESSURE TESTER



DIFFERENTIAL PRESSURE TESTER W/ MASTER ORIFICE



Our own make comes with on-off safety valve to eliminate hose pressure when disconnecting from the cylinder. Use it to check valves, cracked or worn rings, defective cylinders, worn bushings, etc. Includes hose, plug adapter, and complete instructions.

- 2E.....(For Up to 5" Bores).....\$79.95
- 2E-14.....(W/14mm Adpt).....\$79.95
- 2E-60..... (For Over 5" Bores).....\$79.95

The Model 2EM Differential Cylinder Pressure Tester combines the features of our popular 2E tester, and a Master Orifice into one tool. Check your engine's leakdown rate against a calibrated standard in accordance with Continental's Service Bulletin SB03-3.

- 2EM.....(For Up to 5" Bores).....\$99.95
- 2EM-14.....(W/14mm Adpt).....\$99.95
- 2EM-60..... (For Over 5" Bores).....\$99.95

DIFFERENTIAL PRESSURE TESTER PLUG ADAPTER



- 18MM.....(18mm Plug Adapt) \$8.95
- 14MM.....(14mm Plug Adapt) \$8.95
- 12MM.....(12mm Plug Adapt) \$8.95
- 10MM.....(10mm Plug Adapt) \$8.95



ENGINE EQUIPMENT

SLICK® MAGNETO OVERHAUL TOOL KIT



Slick magnetos must be overhauled every time you perform an engine overhaul. Additionally, they must be overhauled whenever there is a lightning strike, or sudden engine stoppage. This kit contains all of the tools you will need to perform a complete magneto overhaul in accordance with Unison Industries L-1037 and L-1363B Service manuals. The complete kit contains: Bearing Assembling Plug, Rotor & Frame Assembling Plug, Puller, Base Adapter Plate, Timing Pin, Adapter Plate Bushing, Bearing Puller, Wedge Extractor, Timing Plug, Assembly Fixture, "E" Gap Gauge, Cam and Rotor Set, Spacer, Alternate Cam and Rotor Set, Spacer. **Note: This kit does not include magneto replacement parts.**

T100\$599.95

SLICK® IGNITION HARNESS ASSEMBLY KIT



The Slick® Assembly Tool Kit is required to install all Slick Ignition Harness Leads on all magneto harness caps and spark plug termination ends. The complete kit includes: Pressing Tool, 72 Drill Bit, Pin Vise, Stripping Tool, Spring Assembly Tool,

and Shield Stripper. Complete instructions for the use of this kit can be found in the Unison Industries L-1178 Service Manual.

T200\$249.95

EASTERN MAGNETO SYNCHRONIZER



The Eastern "buzz-box" magneto synchronizer is perhaps the most well known of its type. Its simple design makes it absolutely foolproof. Just attach the leads to the magneto, and adjust until you see the lights and hear the buzz!

E50\$115.95

DIFFERENTIAL PRESSURE TESTER



The Model E2A Tester quickly locates worn and cracked rings, defective intake and exhaust valves, scored and cracked cylinders, leaky head gaskets, and worn and stripped spark plug bushings; virtually every potential cause of pressure loss. The E2A Tester also features Eastern's new

Slow Fill Valve™ technology. Includes hose and plug adapter.

E2A.....(For Cylinder Bores up to & Including 5")..... \$105.95

E2A-1000..... (For Cylinder Bores Over 5")..... \$115.95

DIFFERENTIAL PRESSURE TESTER WITH MASTER ORIFICE



The Eastern E2M has all of the features of the Model E2A plus the added benefit of a built-in master orifice. The master orifice is used to quickly and effectively calibrate your tester in the field prior to using it; allowing you to make accurate and reliable assessments of engine leakage. Includes hose and plug adapter.

E2M..... (For Cylinder Bores up to & Including 5")..... \$139.95

E2M-1000..... (For Cylinder Bores Over 5")..... \$149.95

HIGH VOLTAGE CABLE TESTER



Designed to give you a fast accurate test of Hi-Voltage aircraft ignition cables. Simply connect three wires, push the test button and the test is completed. The E5 will instantly indicate in its test window both good and defective cables. There is no waiting for any indication to appear.

- Fail-safe circuitry
 - Compact 3" x 5" x 2-5/8"
 - Unbreakable case
 - Heavy-duty lead wires
- E5\$115.95**

AIRCRAFT TIMING INDICATOR



This all aluminum unit is designed to improve and speed up the process of timing magnetos to the engine. It easily attaches to the propeller spinner, and has an accuracy of 1/2 degree. The easy to read dial can be viewed from any angle. Comes with top dead center locator and mounting bands.

E25\$72.95





HELL-COIL® SPARK PLUG REPAIR KIT (NON-SERRATED)



These repair kits contains everything you'll need to make on-the-spot engine repairs. Includes piloted tap, and installation tool, and 24 inserts.

Note: Use of non-aviation Heli-coil inserts may not be approved for your engine. Check with the manufacturer before using.

PART	DESCRIPTION	PRICE
5523-18	18mm Spark Plug Repair Kit	\$171.95
514-6	individual insert 18mm x 1/2", each	\$5.95
5523-14	14mm Spark Plug Repair Kit	\$171.95
513-13	individual insert 14mm x 1/2", each	\$5.95

HELL-COIL® MASTER REPAIR KIT



Kit includes taps, inserts, drill specifications and instructions for repairing a wide range of the most commonly experienced coarse thread repair problems. Includes inserts in the following sizes (and quantity): 1/4x20 (12), 5/16x18 (12), 3/8x16 (12), 7/16x14 (6), 1/2x13 (6), 5/8x11 (6). Custom molded case also included.

4934.....\$392.95

HELL-COIL® INDIVIDUAL REPAIR PACKS



Each pack includes inserts, insertion tool, and tap.

PART	SIZE	PRICE	PART	SIZE	PRICE
5401-04	4-40	\$54.95	5402-06	6-40	\$83.95
5401-05	5-40	\$83.95	5402-2	8-36	\$83.95
5401-06	6-32	\$75.95	5402-3	10-32	\$65.95
5401-1	12-24	\$54.95	5402-4	1/4-28	\$72.95
5401-2	8-32	\$54.95	5402-5	5/16-24	\$72.95
5401-3	10-24	\$54.95	5402-6	3/8-24	\$72.95
5401-4	1/4-20	\$65.95	5402-7	7/16-20	\$72.95
5401-5	5/16-18	\$72.95	5402-8	1/2-20	\$92.95
5401-6	3/8-16	\$69.95	5402-9	9/16-18	\$127.95
5401-7	7/16-14	\$69.95	5402-10	5/8-18	\$134.95
5401-8	1/2-13	\$92.95	5402-12	3/4-16	\$146.95



HELL-COIL® AVIATION SPARK PLUG THREAD REPAIR KITS



Using Heli-Coil® serrated aviation inserts is the only FAA approved method of repairing damaged spark plug threads. It is also the only method certified by engine manufacturers such as Teledyne-Continental and Textron-Lycoming. Serrated inserts, unlike regular inserts, require special tools to insert, expand and stake them in place. These kits contain everything you will need including: piloted tap, insertion tool, offset and staking tool, expanding tool, 20 serrated inserts (10 each 1/2" and 13/16" long inserts for the 18mm kit and 10 each 3/8" and 1/2" long inserts for the 14mm kit), and complete instructions.

PART	DESCRIPTION	PRICE
4260-18	18mm Aviation Spark Plug Repair Kit	\$1,280.95
2-50	individual insert 18mm x 13/16", each	\$8.95
2-52	individual insert 18mm x 1/2", each	\$8.95
4260-14	14mm Aviation Spark Plug Repair Kit	\$1,095.95
137-43	individual insert 14mm x 3/8", each	\$8.95
137-22	individual insert 14mm x 1/2", each	\$8.95

PERMA-COIL SPARK PLUG THREAD REPAIR KIT



Perma-Coil kits are designed to repair stripped spark plug port threads to like new or better than original condition. By following the detailed instructions enclosed in every kit, even an inexperienced mechanic can repair stripped threads, permanently. Perma-Coil inserts meet all applicable industrial and military specifications.

They may be used on all military and government airplanes and other vehicles covered by MS21208, MS21209, and NAS1222. Includes Tap, Installation Tool, and 6 18MM x.5" inserts.

1218-500 (Complete Kit) \$69.95
 418-500 (Pack of 6 Inserts) \$6.95

ENGINE EQUIPMENT

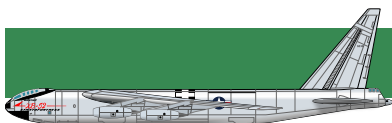

HEAVY DUTY SPARK PLUG GAPPER KIT



A complete spark plug gapping solution for field or bench use. Includes our ATS420 Heavy Duty Spark Plug Gapping Tool to accurately set your spark plug gaps to within 0.001". You also get a set of wire feeler gauges (p/n ATS450) to verify gap size. If you should happen to accidentally over-gap the plug, then the included Gap Expansion Tool (p/n ATS483) will get you back on track. And finally, we've included an Electrode Erosion Gauge (p/n ATS482) to make sure that your gapped plugs are still in serviceable condition.

ATS420DX	(Complete Kit)	\$59.95
ATS420	(Gapper Only)	\$34.95
ATS420K	(Gapper & Gauge)	\$39.95
ATS483	(Expansion Tool)	\$16.95
ATS482	(Erosion Gauge)	\$6.95

ATS SPARK PLUG GAPPER KIT



This economy gapping kit features the Sure-Gap gapping tool, which works with all 18mm massive electrode aircraft spark plugs and eliminates guessing of plug gap. The kit also includes our ATS450 retractable gap gauge. Wire gauges are made of stainless steel wire and are accurate to .0005". Gauge sizes are: .015", .018", .019", and .022". Wires can also be replaced when worn out.

116K	(Complete Kit)	\$22.95
116	(Gapping Tool Only)	\$9.95
ATS450	(Wire Gauge Only)	\$19.95
ATS450-WG	(Replacement Wire)	\$8.95

SPARK PLUG CLEANER



Cleans any size plug without changing grommet. Has 2-way valve (blast or air) and comes complete with abrasive powder. Ready to use.

12	(Complete Unit)	\$25.95
78B	(Replacement Powder)	\$3.15
C12B	(Replacement Canvas Bag)	\$3.95
12GN	(Replacement Grommet)	\$3.15

ATS SPARK PLUG GAPPER



A low-cost efficient gap setting tool for closing gaps on massive electrode-type aviation spark plugs. Can be hand held, bench mounted, or held in a vise. Complete with one adapter for 18mm spark plugs, and one for REM37BY plugs. Also includes the ATS450 retractable gap gauge.

ATS415K	\$59.95
---------	---------

SPARK PLUG VIBRATOR CLEANER



This tool will do the same job as the more expensive vibrator cleaners at a fraction of the cost. It removes heavy deposits in and around the electrodes with absolutely no risk of damage to the plug.

PA01	\$39.95
PA01-1	(Replacement Blade) \$2.95
PA01-21T	(Tip Assembly) \$29.95

SPARK PLUG CONTINUITY TESTER



Before installing or re-installing a spark plug its internal resistor should be checked to be between about 500 and 5,000 Ohms. Spark-On will perform these checks quickly and easily for years to come. Tests all 14mm-18mm shielded plugs. Approximately 50,000 checks during its lifetime. A good test yields a green light, while a bad yields a red light.

SPARKON	\$49.95
---------	---------

ATS SPARK PLUG THREAD LUBRICANT



A high-temperature, graphite lubricant that is applied to spark plug threads prior to installation to prevent galling and seizure. One 4oz. bottle provides enough lubricant for up to 200 applications. Non-hazardous compound.

ATS2612	\$6.95
---------	--------

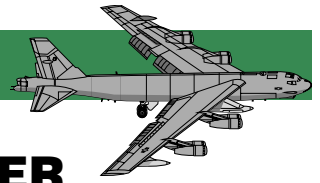

ATS SPARK PLUG CLEANER & TESTER

The #1 selling tester in the aviation industry



Buy spark plugs for \$60 a piece, or... Clean them for LESS THAN \$.02 cents a piece..

BEFORE

AFTER



The latest model of our popular Spark Plug Cleaner & Tester now operates on 120V as well as 220V without the need for converters. It also features advanced protection circuitry to prevent the unit from overheating during prolonged use. It has the same dependability and ease-of-use that's made our SPCT100 the 1 selling cleaner-tester in the industry, and carries a full 1-year warranty. It's still the best choice for anyone who needs to reliably and accurately check the quality of used spark plugs. The cleaner section uses a powerful blast of air and abrasive to thoroughly remove carbon deposits from plugs. The recessed observation mirror is perfectly angled to display the electrodes of the spark plug so that you can clearly judge the quality of the spark as the plug is being tested. It is manufactured to the rigorous ISO 9002 standard. Includes adapters for 12mm, 14mm, and 18mm spark plugs. Works with Aviation and Automotive plugs. Features a motorized turntable for automatic, "hands-off" cleaning of plugs. Test plugs at 24,000 volts and up to 150 psi to simulate engine conditions.

Note: The SPCT100A will not remove lead deposits from spark plugs. The proper way to remove lead deposits is by using either the Champion Vibrator Cleaner (p/n 2600A) or the Aircraft Tool Supply Vibrator Cleaner (p/n PA01).

Specifications:

- Operating voltage: 115V or 220V AC Single-phase 50/60Hz
- Recommended air pressure: 100 to 140 psi (7 to 10kg/cm²)
- Cleaner section abrasive capacity: 1 lb. (900g)
- High-voltage output when spark testing : 24,000V
- Dimensions: 19.3" (49cm) x 11" (28cm) x 10.4" (26cm)
- Weight: 20.5 lbs (9.3kg)
- Accessories included: 12mm, 14mm and 18mm spark plug adapters (2pcs each); 12mm, 14mm and 18mm cleaner gaskets (1 each); Adapter case (1pcs); Aviation Massive Electrode adapter plug (1pcs), Abrasive 1 lb. (900g)

SPCT100-COVER



SPCT100A	(120/220 Volts)	\$579.95
SPCT100-COVER		\$29.95

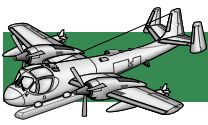

ENGINE EQUIPMENT

DELUXE SPARK PLUG KIT



Our new Deluxe Spark Plug Cleaner Kit is perfect for aviation shops, or for the do-it-yourselfer who wants to do more hands-on maintenance to save some money. It includes our ATS415K Bench Gapping Tool with Gap Gauge; the 12 Spark Plug Cleaner; the PA01 Spark Plug Vibrator Cleaner to remove lead deposits; a Spark Plug Tray; a 10X Inspection Magnifier; a 4oz Bottle of Anti-Seize Lubricant; a box of 100 Copper Gaskets; a Thread Chaser; plus our new ATS950 Magnetic Spark Plug Socket. And rounding out this winning kit is our best-selling SPECT100A Spark Plug Cleaner Tester Unit that will check plugs under simulated high-voltage/high-pressure conditions for spark quality and leakage.

SPK-DX..... (120/220 Volts)..... **\$699.95**

SPARK PLUG FIELD KIT



Keep your airplane running smoothly and sputter-free with our new Spark Plug Field Kit. It contains our 12 Spark Plug Cleaner to remove carbon buildup, and a set of Dental Picks to handle more stubborn lead deposits. After cleaning your plugs, inspect them for pitting and cracks with the included 10X Inspection Magnifier. Finally, keep them firing at peak efficiency with our 116 Spark Plug Gapper and ATS450 Gap Gauge. You'll also receive a Thread Chaser to remove buildup from port threads, a 4oz bottle of Anti-Seize Lubricant, 8 copper gaskets, a Champion Spark Plug Tray, and our new ATS950 Magnetic Spark Plug Socket. It all comes in a durable military-style canvas bag to keep things well organized.

SPK001 **\$159.95**

ATS MAGNETIC SPARK PLUG SOCKET



Specially designed to accept longer aircraft massive electrode spark plugs. 3-1/2" overall length. 7/8" hex socket with 3/8" drive.

ATS950..... **\$29.95**

SPARK PLUG THREAD CHASER



Cleans threads in spark plug hole of dirt, carbon build-up, and metal particles. Double ended for both 14mm and 18mm threads. Neoprene band on hex drive holds tool securely in any 13/16" deep-well spark plug socket.

20200..... **\$7.95**

SPARK PLUG TRAY



Holds up to 12 spark plugs and is marked with the cylinder numbers (1-6).

FAP-12 **\$27.95**

SPARK PLUG WIRE TESTER



Now you can check spark plug wires without piercing the wires. Light flashes indicating sound wire.

26900..... **\$7.95**

10X ILLUMINATED SPARK PLUG INSPECTOR



This 10X illuminated magnifier will clearly reveal even the smallest defect in spark plugs. Use it to check for cracked insulation, pitted electrodes, and foreign deposits that can lead to engine failure.

DV980-10 (Donagan) **\$25.95**

52-660-050 (Fowler Brand) **\$35.95**

ENGINE EQUIPMENT

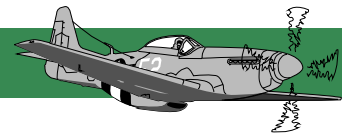

CHAMPION MASSIVE ELECTRODE SPARK PLUGS

Champion Spark Plugs are used in more airplanes than any other brand. Note: All spark plugs are shipped in a factory sealed case - opened cases are non-refundable.

REB37E	\$28.95
REM37BY	\$28.95
REM38E	\$28.95
REM40E	\$28.95
RHB32E	\$29.95
RHB37E	\$29.95
RHM38E	\$29.95
RHM40E	\$29.95



ENGINE MODEL	5/8"-24 SHIELD	3/4"-20 SHIELD	ENGINE MODEL	5/8"-24 SHIELD	3/4"-20 SHIELD
ALLISON			FRANKLIN ENGINE CO. (continued)		
V-1710	REB37E	RHB37E	6AS-335-A, B; 6AS-350-A, A1; 6V335-A1A, A1B	REB37E	RHB32E RHB37E
TELEDYNE-CONTINENTAL			6VS-335-A, B	REB37E REB32E	RHB37E RHB32E
A-65, A-75, C-75, C-85, C-90, C-115, C-125	REM37BY* REM40E	RHM40E	6A-350-C1, C1A, C2, C2A, D, D1; 6V-350-A, -B		RHB32E
E-165, E-185, E-225	REM40E	RHM40E	GYPSY MAJOR (all types)		
O-200-A, -B, -C	REM37BY* REM40E	RHM40E	JACOBS		
IO-240	REM38E	RHM38E	L-4, L-5, & L-6 series R-755	REM40E	RHM40E
GO-300-A, B, C, D, E, F O-300-A, B, C, D, E, C-145	REM37BY* REM40E REM38E	RHM40R RHM38E	R755S, R-755SM	REM38E	
IO-346-A, -B	REM40E REM38E	RHM40E RHM38E	KENROYCE-REARWIN (all types)		
IO-360-A, AB, C, CB, D, E, G, GB, H, HB, J, JB, K, KB; T5IO-360-A, AB, B, C, CB, D, DB, E, EB, F, FB, G, GB, H, HB, JG, K, KB, LB, MB; LT5IO-360-E, EB, K, KB	REM38E	RHM38E	TEXTRON-LYCOMING		
IO-360-B	REM40E	RHM40E	O-235-C, E, H O-235-K, L, M, N, P; O-290 series	REM40E REM38E REM37BY*	RHM40E
O-470-2	REM38E	RHM38E	O-320-A, C, E; O-320-B, D, H AIO-320; LIO-320-B; IO-320-B, C, D AEO-320-A, B, C, D	REM37BY* REM40E REM38E	RHM40E
O-470-4, 11, 13, 13A, 15, O-470-A, E, J, K, L, R, S	REM40E	RHM40E	IO-320-A, D, E	REM37BY* REM40E	RHM38E
O-470-B, G, H, M, N, P	REM40E REM38E	RHM40E RHM38E	AEIO-320-E IO-320-C, F; LIO-320-C (Long Reach)	REM37BY* REB37E	RHM40E RHM37E
O-470-T, U		RHB32E	O-340-A	REM40E REM38E	RHM40E RHM38E
IO-470-C, G, P, R, T	REM40E REM38E	RHM40E RHM38E	O-340-B	REM40E	RHM40E
IO-470-J, K	REM40E	RHM40E	O-360-A, C, E, F IO-360-B, E, F, H, L AEO-360-B, C, H; HO-360-A	REM38E REM37BY*	RHM40E RHM38E
IO-470-D, E, F, H, L, M, N, S, U, V, VO, LO; GIO-470-A		RHB32E	O-360-B, D	REM40E REM37BY*	RHM40E
LIO-470-A	REM40E REM38E	RHM40E RHM38E	IO-360-A, C, D, J; LIO-360-E	REM38E REM37BY*	RHM38E
TSIO-470-B, C, D		RHB32E	LO-360-A1G6D; O-360-E1A6D LO-360-E1A6D LO-360-C	REM40E REM38E REM37BY*	RHM40E RHM38E
IO-520-A, B, BA, BB, C, CB, D, E, F, J, K, L, M, MB, N, NB		RHB32E	IO-360-A, IO-360-C1F IO-360-F (Long Reach) IVO-360	REB37E	RHB37E
TSIO-520-A, B, BB, CE, CE, D, DB, E, EB, F, G, H, J, JB, K, KB, L, M, N, NB, P, R, T, U, UB, V, VB, WB, AE, AF; LT5IO-520-AE		RHB32E	AIO-360-A LIO-360-C; AEO-360-A	REM38E REM37BY*	RHM38E
GT5IO-520-C, D, E, F, G, H, K, L, M, N		RHB32E	HIO-360-A, D	REM38E	RHM38E
TSIO-550-A, B, C; IO-550-A, B, C, D, E, F, G, L, N, P, R		RHB32E	HO-360-B; HIO-360-A, B	REM40E REM38E	RHM40E RHM38E
W-670	REM40E	RHM40E	TIO-360-A, B; AEO-360-A (Long Reach)	REB37E	RHB37E
R9A	REB37E	RHB37E	HIO-360-E1AD, E1BD, F1AD LHIO-360-F1AD; IVO-360-A	REB32E	RHB32E
FRANKLIN ENGINE CO.			TO-360-A1A6D, C1A6D, E, F1A6D LIO-360-A1A6D, E	REB37E	RHB37E RHB32E
2A4 Series	REJ38		VO-360-A, B	REM40E REM38E	RHM40E RHM38E
2A-120-A, B		RHB32E	O-435-A, C O-435-K, K1	REM40E REM38E	RHM40E
4A4 Series, 4AC Series	REJ38		GO-435-C, D Series VO-435-A; TVO-435-A (Short Reach)	REM38E	RHM38E
4A-235-B, B3, Sport 4, 4A, 4A1, 4B, 4R		RHB32E			
6AC, 6AL, 6AG, 6AA, 6V4 Series	REJ38				
6A4-200, 6V4-200, 6V6-245	REL37B				
6A8-215	REJ38				
6A-335-A, B, 6V335-A, -B	REL37B				

ENGINE MODEL	5/8"-24 SHIELD	3/4"-20 SHIELD
TEXTRON-LYCOMING		
VO-435-A, B (Long Reach) TVO-435-A, B, C, D, E, F, G (Long Reach) O-435-23-25	REB37E REB32E	RHB37E RHB32E
GO-480-B, D, F	REM40E REM38E	RHM40E RHM38E
GO-480-C, G (Short Reach)	REM38E	RHM38E
GO-480-G1, G2 (Long Reach)	REB37E	RHB37E RHB32E
GSO-480-A, B (Short Reach)	REM38E	RHM38E
GSO-480-A, B (Long Reach)	REB37E	RHB37E
IGSO-480-A (Short Reach)	REB38E	RHM38E
IGSO-480-A (Long Reach) IGO-480-A; O-480-1-3	REB37E REB32E	RHB37E RHB32E
O-540-A, D, E, F, G, H, J, J3A5; O-540-B; IO-540-A, B, E, G, K, L, M, P, S, U (Short Reach), IO-540-C, D, J, N, T, V; AEO-540-D, L	REM40E REM38E	RHM40E RHM38E
IO-540-AA, E, G, J, K, M, P, R, S, U; O-540-L3C5D, M1B5D (Long Reach)	REB37E REB32E	RHB37E RHB32E
VO-540-A, B, C (Short Reach)	REM38E	RHM38E
O-540-9, VO-540-Series IVO-540 Series (Long Reach)	REB37E	RHB37E
IGO-540-A, -B (Short Reach)	REM38E	RHM38E
IGO-540-A, -B (Long Reach) TIO-540-A, C, E, F, G, H, J, K, N, R, S, T,	REB37E	RHB37E
TVO-540-A	REB32E	RHB32E
IGSO-540-B (Short Reach)	REM38E	RHM38E
IGO-540-A, B	REB37E	RHB37E
IGSO-540-A, B (Long Reach)	REB32E	RHB32E
LTO-540-F, J, N, R TIO-541-A, E TIGO-541-A, E	REB37E REB32E	RHB37E RHB32E
IO-580-A		RHB37E
R-680	REM40E	RHM40E
IO-720-A, B, C, D (Short Reach)	REM38E	RHM38E
IO-720-A, B, C, D (Long Reach)	REB37E REB32E	RHB37E RHB32E
PRAATT & WHITNEY		
R-985 (Wasp Jr.), R-1340 (Wasp)	REM37BY* REM40E	RHM40E
R-1830 (Twin Wasp C)	REB37E	RHB37E
R-2000 (Twin Wasp D)	REB37E	RHB37E
R-2800 (Double Wasp), R-2800-97, C3, CA5, CA15, CA17, CA18, CA19	REB37E REB32E	RHB37E RHB32E
R-4360 (Wasp Major)	REB37E	RHB37E
RANGER (all 18MM Short Reach)		
	REM40E	RHM40E
WARNER (all types)		
	REM40E	RHM40E
WRIGHT AERONAUTICAL		
R-540 Whitwind R-760, R-975 (1/2" Rch.) Cyclone 9N with 1/2" insert (R-1820)	REM40E	RHM40E
Whitwind R-760, R-975 (18mm 13/16") Cyclone R-1300 Cyclone R-1820 Series (Except F & HE) Cyclone R-2600 Series	REB37E	RHB37E
Cyclone R-1820-84 (C9HE Series)		RHB32E
Cyclone R-3350, C18BA, C18BD	REB37E	RHB37E
Cyclone R-3350-C18CB1 Cyclone R-3350-DA1, 2, 3, 4, EA1, 2, 3 Cyclone R-3350-EA4, 5, 6		RHB29E

Not a complete list. Visit our website at www.aircraft-tool.com for complete listing

* Use REM37BY when encountering lead fouling



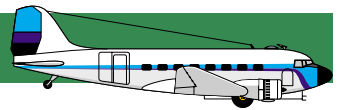

SPARK PLUG TRAY

A sturdy steel tray that holds up to 12 aviation spark plugs. Speeds handling of used or new plugs. Holes are numbered to correspond with engine cylinders. Protects against shielding barrel contamination.



- CT446**..... (12 Plug Tray)..... **\$50.95**
CT446-18 (18 Plug Tray)..... **\$150.95**

LEAD-MASTER WRENCH

Lead-Master wrenches reduce time to remove and install spark plug ignition leads, also permits short arc turning due to 12-point grip head.



- CT913**..... **\$130.95**

RETRACTABLE GAP GAUGE

Gap gauge with 4 sets of accurate retractable go and no-go wire gauges for massive electrode aviation spark plugs. Wire sizes .015, .019, .018, and .022.



- CT450**..... **\$33.95**
CT450-WG(Replacement Wire Pack) **\$19.95**

SPARK PLUG THREAD LUBRICANT

A high-temperature, graphite lubricant that is applied to spark plug threads prior to installation to prevent galling and seizure. The special compound will remain stable at very high temperatures. 4 fl oz.



- 2612**..... **\$7.95**

“T” HANDLE LEAD WRENCH

Special “T” handle designed open box wrench 7/8”.



- CT912**..... **\$130.95**

SPARK PLUG GASKETS

Use these copper gasket rings when replacing spark plugs to ensure a secure seal.



- M674K**.....(Set of 8) **\$5.95**
M674HD (Pack of 100)..... **\$69.95**

OIL NUT WRENCH

Designed for easy removal of Cessna oil filter adapters from 150 Series thru 300 Series aircraft. Manufactured from tool quality steel, features both 3/8” and 1/2” drives, as well as “flip over” reversability. This is the wrench to use when complying with Cessna AD 96-12-22.



- CT709**..... **\$115.95**

OIL FILTER CUTTER

The new improved CT923 Cutter is designed to cut open any spin-on type oil filter quickly and efficiently. This is a complete tool with no parts or adapters to change. It centers around the filter quickly, with no parts to change, and cuts in either direction. The cutter



blades are the same blades that are used in the now discontinued CT470 Oil Filter Cutter. Cuts all Champion 3.7 Inch diameter filters. The CT923 also cuts the new Champion RBC308 filter used on the Rotax 912 and 914 engines.

- CT923**..... **\$269.95**
CT470-4(Replacement Cutter Wheel)..... **\$13.95**

SPARK PLUG GAP SETTING TOOL

A low-cost efficient gap setting tool for closing gaps on massive electrode-type aviation spark plugs. Can be hand held, bench mounted, or held in a vise. Complete with one adapter for 18mm spark plugs, and one adapter for REM37BY plugs. Also includes a CT450 retractable gap gauge.



- CT415AV**..... **\$249.95**

OIL FILTER TORQUE WRENCH



A Professional Quality, Heavy Duty wrench with a built in ratcheting mechanism and a pre-set torque arm. The tool fits all standard general aviation aircraft oil filters and has a solid lever-arm with a knurled grip to make oil filter removal a snap! The wrench is compact for areas of limited access and easily fits filters in tightly cowled aircraft. Once the new filter is ready for installation, reverse the wrench and ratchet the filter securely back into place. When the pre-set torque limit of 17 ft/lbs is reached, the user will feel a slight “break” or “click” in the handle. No other torque tools are required.

- KS5639**(Kell-Strom) **\$49.95**

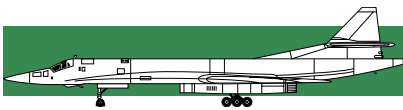

ENGINE EQUIPMENT

AVIATION PISTON RING COMPRESSOR



Our new Aviation Piston Ring Compressor features a quick-change design to speed up piston ring installation. It includes the famous Hastings Ring-O-Matic® pliers and bands that operate in all positions: not just vertically or horizontally.

PART	DESCRIPTION	PRICE
1670A	Ring-O-Matic Pliers	\$35.95
1670F	Band 3-7/8" to 4-1/8"	\$19.95
1670G	Band 4-1/8" to 4-3/8"	\$19.95
1670H	Band 4-1/2" to 4-3/4"	\$21.95
1670I	Band 4-3/4" to 5"	\$21.95
1670J	Band 5" to 5-1/4"	\$21.95
1670L	Band 5-1/2" to 5-3/4"	\$29.95
7500	Complete kit with pliers and all 6 bands	\$149.95

SMALL BORE PISTON RING COMPRESSOR KIT



This kit is designed to accommodate engines with smaller cylinder bores. It features the same Hastings Ring-O-Matic® pliers as the Aviation Kit, so you can easily purchase additional bands as needed. The kit includes pliers and 6 bands in the following sizes: 2-7/8 to 3-1/8", 3-1/8" to 3-3/8", 3-3/8" to 3-5/8", 3-5/8" to 3-7/8", 3-7/8" to 4-1/8", and 4-1/8" to 4-3/8".

1670.....\$89.95

WRINKLE BAND PISTON RING COMPRESSOR



An economical alternative to standard pliers and bands, this tool will do a great job of installing piston rings of any diameter up to and including 5".

- Wrinkle band cuts friction in half. Ring slides in easily.
- Wrinkle Band can't slip down into cylinder.
- Set adjustment screw just once for the entire set of pistons.
- Faster! Insert a full set of piston rings in half the time with half the work!
- Installs rings from 3" (76.2mm) to 5" (127mm).

21700.....\$12.95

PISTON RING EXPANDER



A unique tool that will speed the removal and installation of piston rings with minimum ring distortion. The use of a ring expander will greatly reduce ring point misalignment which can be detrimental to good piston ring sealing and engine performance. Made of steel and requires no adjustments.

1941..... (For Rings 2-3/4" to 4-1/2" Diameter).....\$19.95

1936..... (For Rings 4-1/4" to 7" Diameter).....\$19.95

PISTON RING INSTALLER AND EXPANDER



This important tool is inexpensive and easy to use. Just insert the ring ends in wedge jaws and expand the ring gently and slip into groove. Also ideal for removing rings easily without damage. Handles piston rings from 3/64" to 1/4" wide.

1723.....\$10.95

PISTON RING GROOVE CLEANER



Cleans carbon from piston ring grooves. Easily adjustable. Blades included for five most popular piston groove sizes: 5/64", 3/32", 1/8", 5/32", 3/16". Adjustable ratchet action holds piston in position during cleaning. Revolve tool around piston to clean. Spring release for quick removal of piston.

2477.....\$20.95

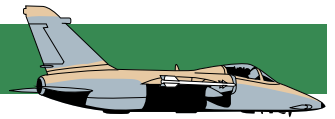

HARTZELL PROPELLER WRENCH



Made from heat treated 4130 steel and laser cut to fit 3/4" nuts and 1/2" drive torque wrench. For use on Hartzell props on Lycoming O360 engines.

AE3528.....\$67.95

PROPELLER SHAFT OIL SEAL INSTALLER



For all flange shafts per Continental Bulletin M-70-2. Also fits Lycoming. For installing one piece stretch seals easily and efficiently without damaging the seal or crankshaft.

5209.....\$89.95

STAINLESS STEEL CLEANING PICKS



A set of four picks that are great for removing lead deposits from spark plugs. Contains 1 straight, 1 curved, and 2 hooked tips.

E900-205.....\$8.95

HEAT RESISTANT ARM GLOVES



The heat resistant Kevlar® material protects hands and arms from hot surfaces. This enables work on hot engines and exhaust systems without waiting. Works on both right and left hands. The glove portion is coated with a vinyl tread for greater gripping power. Extends to 24". Washable.

21260..... (Arm Glove)\$19.95

18700..... (Hot Sleeve)\$13.95

MITYVAC SILVERLINE® VACUUM TESTER KIT

This is the original Mityvac hand vacuum pump kit used by service professionals worldwide for performing hundreds of automotive diagnostic and mechanical tests and for one-person brake bleeding. The complete kit includes: the Silverline vacuum pump, reservoir jar and transfer lid, storage lid, brake bleeding adapter package, test adapter package, 1-1/4" rubber cup adapter, two 24" lengths of 1/4" tubing, carrying case with removable lid, and a 100 page manual.



4000.....\$79.95

VACUUM PUMP

Pump is made of one-piece zinc die cast material for durability and improved performance. Order 75400 repair kit to replace worn out o-rings, seals and valves.



75000.....\$68.95

75400..... (Repair Kit)\$6.95

VACUUM & FUEL PUMP TESTER

Easy reading gauge assures accurate vacuum and pressure check. Has both English and Metric scales and measures vacuum from 0 to 30. The pressure gauge reads from 0 to 15 psi in increments of 1 psi.



20300.....\$25.95

RAPCO VACUUM PUMP WRENCH

This wrench is the tool of choice to remove and replace vacuum pump flange nuts. The shank is bent at the perfect angles to provide easy access to those tight areas between the pump and the accessories nearby. The open end head is precision laser cut to provide a close tolerance fit on the nut.



RA716.....\$29.95



ENGINE EQUIPMENT

TOPCAP ENGINE PROTECTOR

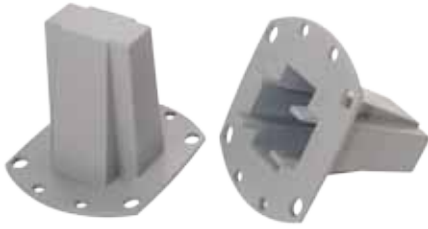

The Topcap engine protector is made to fit over the cylinder studs and shield the inside of your engine while maintenance is being performed. Topcap engine protectors are used by leading mechanics everywhere.

- Fits most engines including Lycoming Wide Deck 320, 360, 540, 720, and Continental 470, 520, and 550 series engines.
- Allows for full crankshaft rotation.
- Made of fuel and solvent resistant polymer.

TC320..... (1 Pair)..... \$29.95

GASKET PUNCH SET



Punches holes in gasket material, leather, vinyl or soft material. Set of ten punches 1/4", 5/16", 3/8", 7/16", 1/2", 9/16", 5/8", 3/4", 7/8", and 1" with driving mandrel and molded plastic case.

S1270..... \$35.95

LOCTITE® AVIATION GASKET SEALANT



A reliable liquid gasket sealant, dressing and coating compound. It brushes on very thinly and forms seals that resists temperatures of -65° to 400°F (-54°C to 204°C). It's resistant to gasoline, oils, and other solvents and is inert so that it will not interact with other chemicals. It dries to full strength in just under 12 hours. 1 pint container.

3051..... \$14.95

SEAL DRIVER KIT



Quickly drives seals without damage to the surrounding fixture. Comes complete with 16 adapters for seals up to 3-3/8" diameter. Includes a special adapter for "shielded" seals.

24800..... \$32.95

UNIVERSAL BEARING PACKER



Fast, efficient, thorough. Simply place the bearing between the plastic cones, tighten, and apply grease through the fitting on the end of the threaded shaft. Forces out old grease and evenly injects fresh grease into the bearing. Cone diameter is 5".

65250..... \$9.95

HANDY PACKER® BEARING PACKER



The Handy Packer works on bearings up to 3 1/2" O.D. The grease stays in the tool cavity, not on your hands. To pack a bearing, place the bearing on the piston. Press down on the cap until the old grease is forced out and the new grease shows on top of the bearing.

34550..... \$18.95

ADJUSTABLE SEAL PULLER



Two hook sizes easily remove most oil and grease seals. Where clearance is a problem, remove the pin to reposition the head. The adjustable head works great in tight areas.

56650..... \$15.95

SEAL PULLER



Removes Oil and Grease Seals. Simply insert the tip of the tool behind the oil or grease seal, press and pull. Leverage works for you. Two size tips reach in and fits nearly all seal applications.

56750..... \$8.95



VALVE SPRING COMPRESSOR



For all Continental and Lycoming engines. Adjustable type to work on all series engines. Ring installs on rockers and "C" collar compressor spring to allow keeper removal.

3602.....\$179.95

PUSH ROD FLARING TOOL



Expansion type flaring tool produces a perfect housing flare every time. Balls rotate inside the push rod housing tube, and snugly expands it into the boss.

4915A\$99.95

VALVE GUIDE FLEX-HONES



Flex-Hone allows you to precision fit valve stems to proper guide tolerances. Flex-Hone is self aligning to the guide bore and self compensating for hone wear. Provides a plateau finish, which creates proper lubrication to prevent sticking and permits a closer stem to guide clearance. Hones are 240 S/C grit.

PART	SIZE	PRICE	PART	SIZE	PRICE
GB9	.354"	\$14.95	GBI2	.472"	\$14.95
GB95	.375"	\$14.95	GB125	.500"	\$14.95
GB10	.395"	\$16.95	GB58	.625"	\$16.95
GB11	.433"	\$16.95	GB34	.750"	\$16.95

CYLINDER FLEX-HONE

For cylinder bore reconditioning. 120 grit silicon carbide provides proper finish for cylinder wall breaking without expensive fixtures.



PART	SIZE	PRICE
102	3-1/2" to 4"	\$79.95
202	3-3/4" to 4-1/4"	\$85.95
305	4" to 4-1/2"	\$85.95
405	4-1/2" to 5"	\$89.95
505	5" to 5-1/2"	\$95.95
605	5-1/2" to 6"	\$104.95

PUSH ROD SPRING COMPRESSOR



For compressing and holding push rod springs on all engines with spring loaded tubes. Compresses the spring, which can then be removed with the clips furnished. Eliminates wiring springs together. To install, simply insert spring, then pull off the clip. Instructions included.

68-3\$245.95

VALVE TAPPET CLEARANCE GAUGE



These tools do the same job as the comparable Lycoming or Continental product which sells for well over \$150. The blades are ground and polished to precisely .080" and .028" respectively for Lycoming, and .060_ and .200" for Continental.

T23S (Lycoming).....\$65.95

T35S (Continental).....\$79.95

VALVE LAPPERS



Excellent tool for restoring a valve's surface finish. Hand operated action allows you to remove metal in precise amounts. Each lapping tool comes with cups for two different valve sizes. Get both tools and you will be able to handle just about any type of engine.

21100..... (Sizes: 1-1/8" and 1-3/8").....\$8.95

21200..... (Sizes: 5/8" and 13/16").....\$8.95

VALVE LAPPING COMPOUND

Clover lapping compound is the choice of leading mechanics whenever they need to size valve stems and seats to exact tolerances, while producing an exceptionally smooth finish. Grease type mix retains its texture and lubrication properties during extended lapping or grinding and leaves a rust preventing film. 1lb. can.



A51803\$36.95



In Aviation Timing is Everything



ATS is the proud manufacturer of the Time-Rite since acquiring all rights in 1985. Each unit is precisely assembled by hand and tested to the strictest standards at our plant to preserve the original craftsmanship that has made it so famous. From its polished Bakelite cap tight down to its signature double-chrome finish, no detail was overlooked!



What makes the Time-Rite so effective is its simplicity. By using specialized arms and calibrated scales, the Time-Rite accurately locates Top Dead Center and then enables you to set the timing angle with dead-on accuracy.

ENGINE EQUIPMENT



TIME-RITE®

No other instrument besides the Time-Rite has come close to matching the versatility, simplicity, and accuracy of the Time-Rite. The Time-Rite uses specialized arms and calibrated scales to accurately display piston and angular displacement to 1°.

The basic Time-Rite unit (I200B18 & I200B14) does not include any arms or scales. You must purchase these separately for the specific type of engine you intend to service. The complete Time-Rite kits (I200B18K & I200B14K) include the basic unit plus the complete set of Arms and Scales.



PART	DESCRIPTION	PRICE
I200B18K	Complete 18mm Time-Rite Kit	\$549.95
I200B14K	Complete 14mm Time-Rite Kit	\$439.95
I200BCK	Combo 14 & 18mm Time-Rite Kit	\$619.95

ENGINE MAKE	ENGINE MODEL	TIME RITE	SCALE	ARM	U/D
ALLISON	V-1710-143, -145	B18	12	H	Dn.
CONTINENTAL	A SERIES	B18	5B	D	Up
	C-75, C-85, C-115, C-125	B18	5A	C	Up
	C-90, C-145, O-300-A thru D, O-200 A thru F	B18	10B	C	Up
	E-165, E-185, 1, 3, 8, 9, 11; E-225-4, 8 (with 532452 Cylinders); IO-470-J, 0470-A, E, J, 11 15 (with 532452 Cylinders)	B18	10A	D	Up
	E-165, E-185, 1, 3, 8, 9, 11, E-225-4, 8; O-470-A, E, J, 11, 15 (with 536727, 538348, 528610 Cylinders)	B18	13A	E	Dn.
	FSO-526-A (ATC), GSO-526-A (ATC)	B18	20A	X	
	G10-300, GO-300-A, B, C, E	B18	21A	U	Up
	GSO-526-A (BTC)	B18	20B	A	Dn.
	IO-470-C, G; O-470-B, G, H, M, N, P, 2, 13	B18	13B	E	Dn.
	IO-470-D, E, F, H, K, L, M, N, R, I520	B18	17	S	Up
	O-470-G, H	B18	21B	T	Up
	O-470-K, L, R, S	B18	17A	S	Up
	R-9A, R-760, R-975.-C1, C2, C3	B18	4A	C	Dn.
	W670	B18	4B	C	Dn.
FRANKLIN	4A4; 6A4-150, 165; 64-178; O-335-3, 4	B14	7B	A	Dn.
	6A8-125	B14	7A	E	Dn.
	6A4-200, 6V4-200, O-335-2, 5, 5A, 5B, 6, 6B, VO-335-5	B14	8B	G	Dn.
	6A6-245, 6A8, 6V6-245, O-425-1, 5, 9	B14	8A	R	Dn.
JACOBS	L4, R755A, R755B2	B18	6B	C	Dn.
LYCOMING	D2, O-145-B, C	B18	9A	C	Up
	O-235, O-290-11, O-320, A, C, E, O435-17, 23, O-480-1, A1, A6, GO-435, VO-435, GO-480-A1, A6, B, B6, D, F, F6, GO-580, GSO-480-A1A6, B1A6, B1B6, GSO-580, IGSO-480-A, A1, A6, B6, IO-320A TVO-435, TVO-435-B1A	B18	9B	E	Dn.
	O-340-A, O-290-D2B, O-290-D2C	B18	18B	V	Dn.
	GO-480C, C1B6, C2D6; G2D6; GO-480-C1D6; GO-480-C2C6	B18	19	E	Dn.
	IMO-360-A, O-360A, A1A, VO-360, MO-360, IGO-540, O540-A, A1A; VO-540, IGSO-540, HIO-360B, O-340-A1A	B18	18A	D	Dn.
	R-680 (5.5:1)	B18	3A	C	Dn.
IO540	B18	9A	T	Up	

PART	DESCRIPTION	PRICE
I200B18	Basic 18mm Time-Rite Unit	\$305.95
I200B14	Basic 14mm Time-Rite Unit	\$289.95
I209-X	Engine Scale: specify the desired scale when ordering e.g. I209-5A	\$16.95
I205-X	Engine Arm: specify the desired arm when ordering e.g. I205-D	\$20.95

ENGINE MAKE	ENGINE MODEL	TIME RITE	SCALE	ARM	U/D
LYCOMING	IMO-360-B	B18	19	E	Up
	IO-320-B1A, B, C; O-320-B, D; GO-480-B1B; B1DB, D1A; O-235-C1, GO-435-C2A, C2B, D1; GSO-590C, GSO-580D, O-540-B2B5	B18	9A	E	Dn.
	O-360A1D, O-360C, O-540D, O-540E, IO-540-D4A5, O-540F, IO-360A, IO-360B, IO-360-A1B6	B18	29A	U	Up
	VO-360A, VO-360B, IVO-360A, HO-360A, HO-360B, IO-540C, IO-540D, IO-540J, HO-360, IGSO-540-A1A	B18	18A	D	Up
	IO-720, IO-360-A1A	B18	18A	V	Up
	HIO-360B, O-340-A1A	B18	18A	D	Dn.
	O-360B, O-540B	B18	19	R	Up
	O-290-D2	B18	18A	E	Dn.
	O-290D, O-435A	B18	13A	V	Dn.
	PRATT & WHITNEY	R-985, R-1830	B18	24A	A
R-2000 R-2800		B18	24B	A	Up
R-1340-H1, R-2180		B18	23A	A	Dn.
R-4360		B18	23B	A	Up
RANGER	6-440-C	B18	3B	A	Dn.
ROLLS-ROYCE	V-1650, 23, 25	B14	15	J	Dn.
	GIPSY QUEEN 30MK.2 & 70 MK.2	B14	25A	C	Dn.
	GIPSY MAJOR 140	B14	28A	D	Up
	GIPSY MAJOR 10MK.2	B14	25B	R	Dn.
WARNER	125, 145, 165, 185	B18	6A	C	Dn.
WRIGHT	R-1300-1A, 2A, 3, 4, C7BA (805941)	B18	11A	K	Up
	R-3350-75 (80594) 749C188D1 (805941)	B18	11B	G	Up
	R-1820-54, 72 WA, 60, 62, 62A, 74W, 76, 76A, 76B, 76C, 76D, 80, 80A, 82, 82A, 84, 84A, 84C, 84D, 86, 86A, 97, 101, 103, 103A, C9GC, C9HD, C9HE (805940)	B18	2B	B	Up
	R-2600-8, 13, 20, 29, C148B, R-3350-8, 13, 23A, 24W, 24WA, 35, 35A, 57M, 57AM, 83; 745C18BA-3 (805940)	B18	2A	B	Up
	R-3350-26W, 26WA, 26WB, 30W, 30WA, 30WB, 32W, 34, 77, 85, 89, 91 (805942), 861C18CA-2, 956C18CA, 927TC18DA-1, 2, 3, 4; 975C18CB-1, 988IC18EA-1, 2, 3	B18	14B	M	Up
	R-760, R-975	B18	4A	C	Dn.
	R-3350TC18	B18	14A	MA	Dn.



ENGINE EQUIPMENT

ATS AIRCRAFT ENGINE STAND KIT (WITH LOCKING CASTERS)



- Bolts together in minutes using just a 1/2" wrench.
- No Welding necessary.
- Supports over 1,200 lbs.
- Ships as a regular sized package, not over-sized or dim weight.

Our new breakdown Engine Stand Kit comes to you unassembled to save you **BIG** on shipping costs, but goes together in just a few minutes with only a couple of wrenches. Other engine stands are pre-welded and shipping via UPS or FEDEX can be very expensive because of their size and shape. In fact, it's not unusual for us to see shipping costs as high as \$375 to places in Alaska! Some of our competitors try to get around this by selling their engine stands in kit form, which solves the shipping problem. But you still have to weld it together yourself! So if you don't have welding equipment, or your welding skills are rusty, then you're out of luck. Our new engine stand requires ABSOLUTELY NO WELDING. We ship it in a compact box to minimize shipping costs, and provide everything you need to get going. All you need to supply are a couple of 1/2" wrenches and a little elbow grease.

65530CX (Complete Kit) **\$249.95**
W670985-20 (Optional 20 Spline Adapter) **\$149.95**

CONTINENTAL 470/520 MOUNT AREA WRENCHES



The special configuration of these wrenches permits access to the 470 and 520 engine mount areas. The 5203A wrench is specially designed for the 520 D&H engine's 3 and 6 cylinders.

PART	DESCRIPTION	SIZE	PRICE
5203	Left mount area wrench	5/8"	\$472.95
5204	Right mount area wrench	5/8"	\$459.95
5203A	520D&H 3 & 4 cyl. wrench	9/16"	\$478.95

CONTINENTAL/LYCOMING CYLINDER BASE WRENCHES



Superior quality wrenches come individually or as a set. Drive end is 1/2" and overall length is 13-1/2".

PART	SIZE	PRICE
2882-9/16	9/16"	\$19.95
2882-1/2	1/2"	\$19.95
2882-5/8	5/8"	\$19.95
2882-3/4	3/4"	\$19.95
2882-5	Set of all 4 sizes	\$75.95

LYCOMING CYLINDER BASE WRENCHES



Superior quality wrench is specifically used with internal hex nuts on Lycoming engines. Drive end is 1/2".

PART	SIZE	PRICE
6494-2	1/2"	\$39.95
6494-3	3/8"	\$39.95
6494-SET	Set of both sizes	\$69.95

CONTINENTAL 550 CYLINDER BASE WRENCH



This 9/16" wrench is designed for easy access to nuts on the 550 series engines. Standard 1/2" square drive. 13" overall length. This wrench is also used on the 7th order stud of the GTSIO520BA.

8158A **\$298.95**



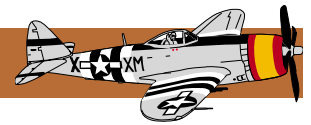

DELUXE BRAKE BLEEDER TANK



Our new Deluxe Brake Bleeder Tank has been completely redesigned to resist the solvent effects of most types of aviation brake fluids. The high-impact plastic reservoir and specialized seals are compatible with 5606 and Skydrol. The hand operated pressurizing pump has also been totally re-engineered to deliver more pressure with fewer strokes. You will get everything needed to fit most brake receptacles.

- 225DX(W/Both Adapters)\$89.95
- A255(Universal Adapter)\$8.95
- 1246.....(Cleveland Adapter).....\$29.95

DESSER® AIRCRAFT TIRE & WHEEL BALANCER



The Desser Wheel & Tire Balancer does what the Goodyear tire balancer does at a fraction of the cost. It will work with any assembly with at least a 1" axel up to 35" diameter tire.

- AS01\$399.95
- AS01-5W..... (5 zoz Wgts- 5 pcs)\$8.95

TIRE BEAD BREAKER



Break tire beads safely, with little effort!

Originally built to work on dragster tires, this Tire Bead Breaker is capable of working on very small to very large tires. It's extremely adjustable! The Tire Bead Breaker is used to break the bead or bond between the tire and wheel with little effort and without doing damage to the expensive cast wheels.

If you are a repair station, shop, school, or owner that wants to do your own maintenance then this tool is a must!

- BO-13M-TBB.....(18"x16" base).....\$159.95
- BO-13M-TBB2.....\$194.95

BRAKE BLEEDER EXTENSION HOSE



With this 15 foot hose you will be able to control the flow, while also monitor the master cylinder, thus reducing the recharge process from a two man process to a one man. Hook the hose to your 225DX Pro Brake Bleeder Tank (not included) and you will be able to take the tank to the cockpit and control the refill process from there while you monitor the master cylinder.

- 225DX-15H\$59.95

MEYER® TIRE BEAD BREAKER



Easily adjusts for a wide range of aircraft tires up to 14" inches in diameter. Quality construction for dependable service.

- AB-1\$177.95

WHEEL BALANCER



McFarlane's new wheel balancer uses the same static balancing method that is used to balance helicopter rotors. This design features a pivot point that is easily adjustable on-the-fly for maximum sensitivity, and includes bushings to accommodate both 1 1/4" and 1 1/2" axle sizes. The design is more precise than other static balancing methods, and allows the wheel to be balanced while the bearings and seals are installed. Due to the horizontal balancing and orientation, test weights can be temporarily set in place and easily adjusted while balancing. This eliminates the need to tape the test weights. This is a lifetime tool that fits almost all light aircraft wheel/tire assemblies.

- MA108.....\$220.95

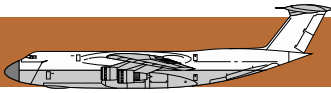

SERVICE & SUPPORT

MEYER HYDRAULICS® AIRCRAFT JACKS



AJS UNIVERSAL AIRCRAFT JACK SETS

A complete lifting system to handle most light aircraft. Includes two (2) A422 jacks; (2) A434 jacks; (2 sets) AJL extension legs; (2) AT42228 slide tubes; (2) AT42234 slide tubes; (2) AT43454 slide tubes; (2) ATC-4 extension caps; (2) ATC-8 extension caps; and (1) ATS tail stand. The AJS2 Deluxe Jack Set includes an extra A422 jack; (1) AT42228 slide tube, and (1) ATC-4 cap to support ALL retractable gear aircraft up to 8,000 pounds. The AJS3 Premium Set adds (2) extra A427 jacks.

- AJS** (Standard Set) **\$3,363.95**
AJS2 (Deluxe Set) **\$4,015.95**
AJS3 (Premium Set) **\$4,472.95**

AIRCRAFT JACKS				
PART	OLD	RANGE	CAPACITY	PRICE
A322B	A-10	22"-36"	16000 LBS	\$1,195.95
A325B	A-2516	25"-42"	16,000 LBS	\$1,225.95
A328B	A-9	28"-48"	16,000 LBS	\$1,255.95
A330B	A-11	30"-50"	16,000 LBS	\$1,259.95
A334B	A-17	34"-60"	16,000 LBS	\$1,275.95
A334C	-	34"-60"	24,000 LBS	\$1,425.95
A340C	A-15	40"-71"	24,000 LBS	\$1,465.95
A342B	A-13	42"-75"	16,000 LBS	\$1,355.95
A342C	A-1324	42"-75"	24,000 LBS	\$1,479.95
A355C	A-5524	55"-95"	24,000 LBS	\$1,835.95
A360A	A-60	60"-100"	10,000 LBS	\$1,479.95
A419	-	19"-34"	6,000 LBS	\$679.95
A421	-	21"-38"	6,000 LBS	\$689.95
A422	A-5	22"-36"	6,000 LBS	\$579.95
A427	-	27" - 46"	6,000 LBS	\$619.95
A434	A-6	34"-58"	6,000 LBS	\$679.95

ACCESSORIES			
PART	OLD	DESCRIPTION	PRICE
AJL	-	EXT LEGS (4), 10", FOR A434	\$69.95
AT-EC01	-	SLIDE TUBE, 28"-47", FOR A427	\$89.95
AT42222	AT-1	SLIDE TUBE, 22"-36", FOR A422	\$47.95
AT42225	-	SLIDE TUBE, 35"-39", FOR A422	\$67.95
AT42228	AT-28	SLIDE TUBE, 28"-42" FOR A422	\$51.95
AT42234	AT-3	SLIDE TUBE, 34"-48", FOR A422	\$55.95
AT42727	-	SLIDE TUBE, 27"-46", FOR A427	\$52.95
AT42734	-	SLIDE TUBE, 34"-53", FOR A427	\$57.95
AT43434	AT-2	SLIDE TUBE, 34"-58", FOR A434	\$59.95
AT43454	AT-4	SLIDE TUBE, 54"-78", FOR A434	\$75.95
ATC-4	-	TUBE CAP, 1" TO 4" EXTENSION	\$51.95
ATC-8	-	TUBE CAP, 1" TO 8" EXTENSION	\$61.95
ATS	-	TAIL STAND, 30" TO 51-1/2"	\$155.95
ATS-AA72	-	SLIDE TUBE, 51"/72" FOR ATS	\$65.95

Meyer Hydraulics Aircraft Jacks have served as the general aviation industry standard for over 45 years. Professional mechanics and service technicians all over the world rely on Meyer Jacks to confidently lift propeller, and jet aircraft with the security and features one should demand in aircraft jacks.

AIRCRAFT JACK SELECTION GUIDE				
AIRCRAFT	JACKS	TUBES	LEGS	STAND
AERO COMMANDER	(2) A434	(2) AT43454	(2) AJL	(1) ATS
BEECH: 91, 1900, KING AIR SUPER 200	(3) A334B			
BEECH: MODEL 50, QUEEN AIR	(2) A434 (1) A422	(1) AT42234		
BEECH: BARON, BONANZA, DEBONAIR, TRAVELAIRE	(2) A422			(1) ATS
CESSNA CARAVAN 208	(2) A328B (1) A427			
CESSNA CARDINAL RG	(2) A434	(2) AT43454 (2) ATC-8		(1) ATS
CESSNA CITATION I, II, & V	(2) A325B (1) A322B			
CESSNA CITATION III, VI, VII	(2) A334B (1) A325B			
CESSNA CITATION X	(2) A342C (1) A334B			
CESSNA: ALL HIGH WING (EXCEPT CARDINAL)	(2) A434	(2) AT43454 (2) ATC-8	(2) AJL	(1) ATS
CESSNA 300 & 400 SERIES	(3) A427			
CESSNA MUSTANG (VLJ)	(3) A421			
ECLIPSE 500 (VLJ)	(2) A419 (1) A427	AT-EC01		
FALCON 10	(3) A328B			
FALCON 20	(3) A334C			
FALCON 50	(3) A340C			
GULFSTREAM (GRUMMAN)	(2) A342B (1) A334B			
LEAR JET	(2) A330B (1) A322B			
LOCKHEED JETSTAR	(3) A334B			
MERLIN II, III, & IV	(3) A342B			
MITSUBISHI MU-2	(2) A360A CALL FOR NOSE			
MOONEY: ALL MODELS	(2) A422			(1) ATS
NAVION	(2) A427			(1) ATS
PIPER CHEYENNE	(2) A334B	(1) ATS-AA72		(1) ATS
PIPER: ALL MODELS (EXCEPT NAVAJO & AEROSTAR)	(2) A422			(1) ATS
PIPER NAVAJO & AERO-STAR	(2) A434			(1) ATS
SABERLINER	(3) A328B			
TURBO COMMANDER	A360A			
WESTWIND	(2) A334B			

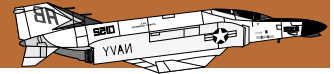

ALPHA AVIATION AIRCRAFT JACKS

For over 12 years, family owned and operated Alpha Aviation has been making high quality aircraft jacks with the kind of craftsmanship and attention to detail that you just don't see in mass-market types. Each jack is hand fabricated, assembled, and thoroughly inspected to ensure that you will consistently receive the finest aircraft jack for your money. And with over 4,000 units in service since 1995, Alpha Aviation Jacks are field-proven to provide safe, rock-steady support for your airplane.

Find your jack: There are 5 models to cover just about every light aircraft. Locate your airplane in the chart below and select the appropriate jacks. Or if it's not listed, measure the height from the ground to your airplane's jack point and select jacks that are shorter, but with enough range and load capacity to safely lift your airplane. Need more details? Visit www.aircraft-tool.com and search for keyword "Alpha Aviation."

Alpha

aviation inc.

AIRCRAFT BUILDER	AIRCRAFT MODELS	JACK MODEL* (*Any of the indicated models will work)	REQ	TAIL STAND
AERO COMMANDER	Commander 112/114/115	326, 332, 838, 868	3	No
BEECH AIRCRAFT	Baron	326, 332, 838, 868	2	Yes
	Duke	324	3	No
	Bonanza BE33/35/36	324, 326, 332, 838, 868	2	Yes
	Debonair BE333	326, 332, 838, 868	2	Yes
	Duchess BE76	326, 332, 838, 868	2	Yes
	Musketeer BE23	326, 332, 838, 868	2	Yes
	Sierra BE23	332, 838, 868	2	Yes
	Sundowner BE23	326, 332	2	Yes
Travel Air BE95	326, 332, 838, 868	2	Yes	
BELLANCA	All Low Wing, including SUPER VIKING	324	2	Yes
CESSNA	Cessna 172/177/182/210	868, 868HLW	2	Yes
	Cessna 310/320	332, 838, 868, 838HLW	3-4	No
	Cessna 337 Skymaster	868, 838HLW	2	Yes
	Cessna 340/400 series	838, 868, 838HLW	3-4	No
GRUMMAN	Cheetah, Tiger	326, 332, 838, 868	2	Yes
MOONEY	Ovation, Acclaim	324, 326, 332, 838, 868	2	Yes
PIPER	Apache PA23	326, 332, 838, 868	2	Yes
	Arrow PA28R	326, 332, 838, 868	2	Yes
	Aztec PA23	838, 868	2	Yes
	Brave PA25	326, 332, 838, 868	2	Yes
	Cherokee PA28/PA32	326, 332, 838, 868	2	Yes
	Comanche PA24	324, 326, 332, 838, 868	2	Yes
	Lance PA32	326, 332, 838, 868	2	Yes
	Saratoga PA32	326, 332, 838, 868	2	Yes
	Seminole PA44	326, 332, 838, 868	2	Yes
	Seneca 1/11/111	326, 332, 838, 868	2	Yes
	Twin Comanche PA30/39	324, 326, 332, 838, 868	2	Yes
PART	DESCRIPTION	CAPACITY	RANGE	PRICE
AAJ-324	Low Wing Jack	3 Ton (6,000lbs)	24"-40"	\$249.95
AAJ-326	Low Wing Single & Light Twin Jack	3 Ton (6,000lbs)	26"-43"	\$249.95
AAJ-332	Low Wing Single & Light Twin Jack	3 Ton (6,000lbs)	26"-49"	\$289.95
AAJ-838HLW	High Lift Cylinder	8 Ton (16,000lbs)	32"-63"	\$429.95
AAJ-838W	Universal Jack	8 Ton (16,000lbs)	26"-55"	\$389.95
AAJ-868HLW	High Lift Cylinder	8 Ton (16,000lbs)	32"-93"	\$549.95
AAJ-868W	High Wing Universal Jack	8 Ton (16,000lbs)	26"-87"	\$509.95
AAJ-375	Tail Weight	----	17"-39"	\$199.95
AAJ-375EX	Tail Weight Extension	----	16"	\$27.95
AAJ-K1	All-in-one Kit will raise all of the airplanes listed above (except Bellancas and Beech Duke). Contains (2) AA-838 and (2) AA-868 Universal jacks, plus (1) AA-375 Tail Weight. This is your best value if you need to raise more than one type of airplane.			\$1,999.95



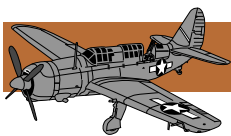

SERVICE & SUPPORT

SLIDE-DOWN AIRCRAFT TIE-DOWNS



The SlideDown aircraft tiedown secures your aircraft to the ground anchors. The set of three Slidedowns includes one for each wing and a tail. The 7/16" kernmantle braided rope is super strong, the powder coated slide is made from aircraft grade aluminum and then precision drilled allowing for easy sliding but also a tight hold.

- SD-BLK (Black) \$69.95
- SD-BLU (Blue) \$69.95
- SD-ORG (Orange) \$69.95
- SD-RED (Red) \$69.95
- SD-YEL (Yellow) \$69.95
- SD-BLUWHT (Blue w/White Stripes) \$69.95
- SD-GRNBLU (Green w/Blue Stripes) \$69.95
- SD-ORGBLU (Orange w/Blue Stripes) \$69.95
- SD-REDWHT (Red w/White Stripes) \$69.95
- SD-WHTBLU (White w/Blue Stripes) \$69.95
- SD-WHTRED (White w/Red Stripes) \$69.95

THE CLAW TIE-DOWN



Unique airplane tie-down holds the biggest kites. Unless you have sand handy, there hasn't been a way to tie down hard pulling kites without the use of heavy objects. The Claw has 1,200 lbs of holding power. Easy to install with a hammer, it works in anything but sand or loose dirt. The aluminum frame folds to 12" and weighs less than 3-lbs, including the corrosion-resistant spikes. Nylon pouch included.

- C-100 \$99.95

REMOVE BEFORE FLIGHT BANNER



A "remove before flight" streamer hangs off the cover as a prominent pre-flight reminder to pilots.

- PTC-34 (Large 3/4") \$9.95
- PTC-58 (Small 5/8") \$9.95
- PTC-B (Blade) \$9.95
- ASA-RBF \$7.95

BROWNELL JACK STANDS



Safe, reliable and easy to use. These Brownell Jack Stands range from 25"- 84" (64cm-213cm) in height. Built with precision acme threads for a smooth adjustment. The small footprint of the base and top pad allow for easy access. Each stand stacks neatly when not in use to free up valuable space. TPE surface resists slipping and scratching.

PART	DESCRIPTION	CAPACITY	RANGE	PRICE
AS3	Jack Stand	10 Ton (20,000lbs)	25"-38"	\$120.95
AS2	Jack Stand	10 Ton (20,000lbs)	29"-46"	\$127.95
AS1	Jack Stand	10 Ton (20,000lbs)	33"-50"	\$134.95
AS0	Jack Stand	10 Ton (20,000lbs)	41"-58"	\$148.95
ASOX	Jack Stand	10 Ton (20,000lbs)	52"-72"	\$170.95
AS0XX	Jack Stand	10 Ton (20,000lbs)	67"-84"	\$184.95
TS1	Tail Stand	10 Ton (20,000lbs)	30"-52"	\$169.95
AD1	Fuselage Dollies: Innovative design to easily and securely move aircraft on the hangar or shop floor. Allows maximum utilization of space. Disassembles for compact storage. Phenolic wheels with brakes. Width 28"-84", Length 32"-148", Height 34"-51", Weight capacity 10,000lbs/4,535kgs			\$2,795.95

AVIAITON JACK



BO-30M-LL

BO-30M-TJ

Low profile and lightweight, these are the perfect aviation jacks for LSA Bush planes, Cubs, Husky, SWP, and small, lightweight aircraft. It can be used on main gear, nose gear, and tail wheel in aviation.

- BO-30M-LL (9.5 Lift Height) \$159.95
- BO-30M-LL2 (13.5 Lift Height) \$183.95
- BO-30M-LL3 (19.5 Lift Height) \$194.95
- BO-30M-TJ \$239.95



ATS AIRCRAFT STRUT PUMP



- Made from 6061-T6 Aluminum for lightweight durability
- Operates on 50 to 150 psi air pressure (100 psi recommended)
- Enhanced high pressure valve system rated at over 3,000 psi
- True 10X boost produces over 1,500 psi from 150 psi source
- Also works with Nitrogen delivery systems
- Safety "one-shot" system delivers pressure in controlled bursts
- 24" High Pressure Delivery Hose

Delivers up to 1,500 PSI of pressure to raise struts without the need for jacks. Safety one-shot air delivery system gives you maximum control over the entire process -- each stroke of the delivery valve injects a small shot of pressurized air into the strut so that you can raise it in controlled increments. Virtually zero chance of accidentally over-pressurizing and possibly damaging your struts.

675A **\$249.95**

DUAL RANGE TIRE PRESSURE GAUGE



Accurately measures tire pressure up to 200 psi in 5 psi increments. Dual calibrations; psi in black and kg/cm² in red. Accurate to within 5%.

980400 **\$45.95**

LEXEIT SEALANT SCRAPER KIT



This innovative new kit is the brainchild of an aircraft mechanic who needed a way to effectively remove sealants and residue from fuel tanks and other areas without doing damage to expensive airplane finishes. The kit consists of a handle and 7 interchangeable Lexan tips. The scraping tips will not scratch or mar painted and polished surfaces. This kit is a brilliant idea and is a must-have for any mechanic needing to clean away sealants and adhesives.

LX001 **\$49.95**

STRUT SERVICING EQUIPMENT



Our kit contains all of the hardware you'll need to deliver nitrogen to tires and struts from a nitrogen bottle. It includes a regulator, gauges (input & delivery), shut off valve, 12' hose, and a strut coupler. There are two types to choose from: Low pressure for nose struts and high pressure for main struts. Bottle (input) pressure gauge ranges 0-4000 psi. Delivery pressure gauge ranges 0-500 psi for the low pressure model, and 0-2500 psi for the high pressure model. Does not include nitrogen bottle.

606.....(0-500 psi Delivery Pressure) **\$385.95**

607.....(0-2500 psi Delivery Pressure) **\$675.95**

SCHRADER HIGH PRESSURE STRUT COUPLER



The Schrader Tee-coupler attaches directly to the strut valve to inflate or deflate the strut via the built-in core depressor pin. It attaches to the valve threads (.305-32 thread size) and forms a perfect seal at up to 3000 psi. The air line connector is a 1/8" NPT male thread.

556..... **\$25.95**

SCHRADER STRUT COUPLER



The Schrader "gooseneck" coupler is used to connect to the inflation valves of most types of aircraft struts. One end fits directly to the strut and the other has a 1/8" NPT thread.

SK2043C **\$14.95**



SERVICE & SUPPORT

SEAT ROLLER HOUSING GAUGE



The McFarlane seat roller housing gauge is designed to facilitate inspection of seat roller housings for wear in Cessna aircraft as required by mandatory FAA AD 2011-10-09. This gauge simplifies determining whether the housing is in or out of tolerance by allowing the areas of concern to be gauged as opposed to measuring each individual attribute on each seat roller housing with calipers.

MA110.....\$120.95

PIPER TAPER PIN REMOVAL TOOL



Piper AD 2010-15-10 requires inspection of the connection between the control yoke universal joint and the shaft on the forward end of the joint. This taper pin removal tool makes this job easy and safe even with the most stubborn taper pins. Simply position the tool on the u-joint and tighten the bolts until the pin breaks free.

MA107.....\$82.95

HINGE BEARING TOOL KIT



Makes pressing bearings in or out easy! This unique tool is specifically designed to prevent damage when installing or removing sintered bronze elevator and rudder hinge bearings in Cessna aircraft.

- Seven piece kit for common bearing sizes
- Heat treated stainless steel will last a lifetime
- Kit comes in a convenient storage pouch

MA990.....\$71.95

CESSNA FLAP TRACK GAUGE/ INSTALLATION TOOL

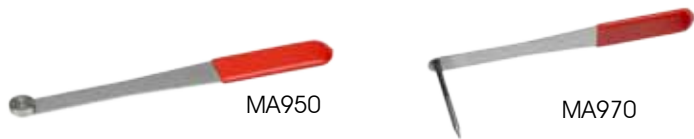

MA950

MA970

Use the flap track gauge to quickly determine if your aircraft track guides are within tolerance. The installation tool holds parts in alignment while inserting the bolt for Cessna 150 thru 210.

MA950.....\$40.95

MA970.....\$40.95

WHEEL CHOCKS



These tire stops keep the aircraft securely parked. A pair of black molded plastic wheel stops are connected with a 22" bright yellow and black braided nylon rope that won't rot or retain water. The bottom cleats keep aircraft securely parked, and the concave design fits any aircraft tire. One pair is needed for each wheel.

ASA-COCKS.....\$29.95

WEAR GAUGES



Airworthiness Directive AD2011-10-09 requires the inspection of the rollers, roller housings, seat rails, engagement pin and attaching hardware. In all, there are five measurements that are required for the pilot and copilot seat assemblies. These two tools will shorten the time to make these five compliance measurements to only two minutes! TOOL-A measures the pin engagement, roller tang width, and roller tang thickness, and TOOL-B measures the seat rail hole wear, and the opening of the roller housing tangs.

AD2011-10-09.....\$39.95

SEAT RAIL WEAR GAUGE



For checking seat rail wear limits as per FAA Airworthiness Directive 2011-10-09, Effective 06/17/2011 Seat Rail Directive and its predecessor A.D. The gauge is used for inspection of seat rail wear in Cessna aircraft. It's designed to measure the actual radius wear near the seat stop holes. The size applies to the .42 diameter limits referred to by the A.D. The .020 upper surface wear allowance allowed by the A.D. is designed into the gauge.

SR1.....\$43.95



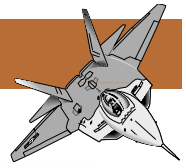

TORQUE SEAL™



Torque Seal is used to detect warranty tampering; and vibration loosening. Used in production on compression fittings, studs, nuts, parts, and assemblies after they are in proper torque or position. Inspectors can visually detect any movement or tampering.

F900-R.....	(Red)	\$3.95
F900-Y.....	(Yellow)	\$3.95
F900-O.....	(Orange)	\$3.95
F900-YO.....	(Yellow-Orange)	\$3.95
F900-G.....	(Green)	\$3.95
F900-P.....	(Pink)	\$3.95
F925-Y.....	(Skydrol Resistant Yellow)	\$4.95
F925-P.....	(Skydrol Resistant Pink)	\$4.95

CARBON MONOXIDE DETECTOR



Carbon Monoxide (CO) is a toxic, odorless, and tasteless gas produced by the incomplete combustion of fossil fuels, and dangerous levels of CO can be produced by engines. Exposure to CO may cause sickness, headaches, or even death. This Carbon Monoxide Detector can save a pilot's life, especially when flying with the heater on, by warning of the presence of CO in the cockpit—the spot will turn gray/black when CO is in the air. The spot on the detector returns to normal color after it is exposed to fresh air. Useful life is 90 days once opened. Not for use with Diesel engines.

ASA-CO-D.....	\$4.95
---------------	-------	--------

FUEL TESTER



Protect yourself from fuel contamination by visually checking the fuel for water and debris. Fits all quick-drain valves and has an adapter for recessed drains. The transparent cylinder is 6" or 4" long with octane color-coding molded in the side. Also includes a screwdriver blade with both Phillips and slotted heads.

AFT-1.....	(6")	\$6.95
AFT-SHORT.....	(4")	\$6.95
AFT-C.....	(Cup)	\$5.95

PRECISION BRASS SCALE



Compact general purpose weight and force measurement instrument. 50 lbs. capacity in 8 oz. increments. Non-corrosive brass with numeral and gradations deeply embossed in black. Precision springs calibrated by certified weights for accuracy to within one graduation. Knurled knob for tare and zero adjustment. Dual graduations - English and metric. Can be used vertically or horizontally.

5A354.....	\$104.95
------------	-------	----------

DIGITAL FISH SCALE



A fish scale is used to measure aircraft weights and forces such as control stick force, landing gear forces, and tail weight. This portable scale precisely measures weights to within .5 lbs (.2 kg) to a limit of 150 lbs (68 kg). The scale has a digital readout that measures in pounds, kilograms and ounces. Also measures temperature in both Fahrenheit and Celsius. Uses two AAA batteries (included).

NB5470.....	\$19.95
-------------	-------	---------

BRAKE RELINING TOOLS



W403

W404

Our new W404 brake relining tool makes it virtually impossible to botch a brake relining job. The threaded screw action of the rivet insertion tool insures a perfect roll on brake rivets every time without damaging the liner. Machined steel, not cast.

W404.....	(Threaded Model)	\$25.95
W403.....	(Impact Model)	\$19.95
4-4.....	(Brake Relining Rivets)	\$6.95



SERVICE & SUPPORT

PAINT CUTTERS



PA36-5XX

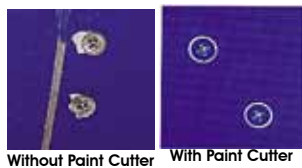

Without Paint Cutter With Paint Cutter



PA36-666

You know how frustrating it can be to remove a painted over screw only to wind up chipping up the paint job. But you wouldn't have that problem if you had a set of these innovative paint cutters. They work by slicing through the paint around the head of the screw so you can remove it without chipping the paint. They have a 1/4 x 28 thread to fit into any angle drill, or you can get the optional arbor for use in a drill chuck.

PART	DESCRIPTION	PRICE
PA36-511	4 Screw Paint Cutter	\$25.95
PA36-512	6 Screw Paint Cutter	\$25.95
PA36-513	8 Screw Paint Cutter	\$25.95
PA36-514	10 Screw Paint Cutter	\$25.95
PA36-517	1/4" Screw Paint Cutter	\$25.95
PA36-666	Optional Paint Cutter Arbor	\$6.95
PA36-SET	Set of all 5 cutters & Arbor	\$125.95

MINI-MIXER SEMKIT PACKAGE MIXER



MMX01 \$21.95

The mini-mixer conveniently fits onto any air or electric drill with a 3/8" chuck and will work with both injection and barrier style packages. Use the mini-mixer to reduce fatigue and provide a more uniform mix than is possible by hand. The mini-mixer is tiny enough to fit into your shirt pocket, yet it will perform the same job as the larger industrial mixers.

ADEL CLAMP INSTALLER



SMA-101 \$37.95

These pliers make cushion clamp installation so easy that you will no longer dread the installation process. This tool securely and simply clamps the entire assembly together and leaves the hardware holes lined up. The mechanic is free to use both hands to fit the hardware.

HOSE ASSEMBLY TOOL



For use in assembling AN and STRATOFLEX® 300 series hose fittings.

PART	HOSE SIZE	FITTING NUMBER	THREAD SIZE	PRICE
2701-3	-3	300-3	3/8-24	\$18.95
2701-4	-4	300-4	7/16-20	\$14.95
2701-5	-5	300-5	1/2-20	\$14.95
2701-6	-6	300-6	9/16-18	\$19.95
2701-8	-8	300-8	3/4-16	\$21.95
2701-10	-10	300-10	7/8-14	\$29.95
2701-12	-12	300-12	1-1/16-12	\$37.95
2701-KIT	All mandrels listed above plus case			\$155.95

EXTEND-A-LUBE™

Finally, an aerosol focusing tube long enough to access those hard-to-reach places and the right product to keep you from losing it! The 16" chemical resistant tube is compatible with virtually all aerosol nozzles and ensures you will never drop your straw again!



EXAL-1 \$5.95

FORM-A-FUNNEL

Shape, drain, pour, store. Its that easy with the new Form-A-Funnel Flexible Draining Tool. It guides oil around skid plates and cross members right into your oil drain for easy, no-mess oil changes! This tool quickly bends, molds and holds any shape, so you can customize the perfect channel to drain liquids without making a mess.



- 18509.....(9"L x 4.75"W Rotax)..... \$9.95
- 18609.....(14.5"L x 6.5"W Automotive) \$19.95
- 18611.....(29"L x 5"W Aviation) \$34.95
- 18714.....(22"L x 8.62"W Heavy Equipment)..... \$34.95



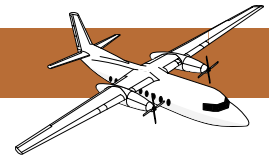

CAULK MASTER® AEROSPACE SEALANT GUN (SEMCO TYPE)



The patented Valox® grip trigger mechanism gives you the exact amount of caulk, sealant, or adhesive you need, so you can dispense material at a smooth steady pace. This gun will dispense all Semco (PRC DeSoto) type cartridges containing sealant or adhesives. Comes with a 3 foot air hose and standard 1/4" NPT fitting.

- PG10260 (Complete Gun w/ 6oz Retainer) \$129.95
- 102025 (2.5oz Retainer) \$67.95
- 102060 (6.0oz Retainer) \$67.95
- 102120 (12oz Retainer) \$99.95

SEMCO® AIR SEALANT GUN



The Semco air sealant gun is designed for the quiet, pneumatic application of sealants, adhesives, potting compounds, and other materials packaged in PRC® disposable cartridges. The gun is made of metal and plastic and is engineered to withstand the rigors of the production work place. The handle can be removed to allow more clearance and better manipulation in confined areas. Note: The air hoses required to operate Semco air sealant guns are sold separately.

PART	DESCRIPTION	PRICE
250A-2	Pistol grip gun with 2.5 oz. Metal retainer	\$356.95
250A-6	Pistol grip gun with 6 oz. Metal retainer	\$369.95
250-2R	2.5oz. metal retainer for 250 series dispensers	\$69.95
250-6R	6oz metal retainer for 250 series dispensers	\$72.95

SEMCO® HOSE ASSEMBLY



All hose assemblies come with a B-nut fitting to attach to the Semco gun and the specified quick connect attachment. Each hose is 5 ft (1.5m) long.

- PRC-5A (With ARO Quick-Connect Fitting) \$57.95
- PRC-5H (With HANSEN Quick-Connect Fitting) \$60.95
- PRC-5S (With SCHRADER Quick-Connect Fitting) \$57.95

PRC® DISPOSABLE CARTRIDGES & NOZZLES



Semco disposable cartridges are molded from high density polyethylene, which makes them capable of handling a wide variety of chemical fluids for storage and application. Use them to load your own adhesives, sealants, lubricants, or other media.

PART	DESCRIPTION	PRICE
PRC-2PW	2.5 oz. Disposable cartridge	\$1.95
PRC-6PW	6 oz. Disposable cartridge	\$3.15
PRC-255N	2" nozzle, no orifice	\$1.95
PRC-415N	3-1/2" nozzle, no orifice	\$1.95
PRC-420N	3-1/2" nozzle with 1/16" orifice	\$1.95
PRC-440N	3-1/2" nozzle with 1/8" orifice	\$1.95

SEMCO and SEMKIT are registered trademarks of PRC DeSoto International

SEMCO® MANUAL SEALANT GUN



The Semco model 850 gun is a hand-operated, high quality dispensing gun designed to accept Semco disposable cartridges or Semkit packages. It is excellent for the "in-field" application of sealants, adhesives, and other materials. A threaded retainer provides a tight fit into the ratchet handle, permitting uninterrupted operation.

PART	DESCRIPTION	PRICE
850-2	Manual Gun with 2.5 oz. Metal retainer	\$119.95
850-6	Manual Gun with 6 oz. Metal retainer	\$132.95
850-2R	2.5oz. metal retainer for 850 series dispensers	\$41.95
850-6R	6oz metal retainer for 850 series dispensers	\$48.95

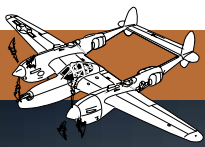

SERVICE & SUPPORT

ATS PRO TUBE BEADING KIT

The finest beading tool money can buy. We Guarantee it!



AP145

\$419⁹⁵

*Makes perfect beads
from 1/4" to 1"*

*Meets MILSPEC MS33660D and SAE
AS5131 standards*



Looking for a tube beading kit that will last a lifetime? Yes, a lifetime! The Pro Tube Beading Kit carries the ATS Pro lifetime warranty guarantee. It is a kit that has been the number one choice of mechanics for making clamping beads in metal tubes.

For years, Aircraft Tool Supply was the sole supplier of these tools as a surplus product. Eventually supply exhausted, however customers insisted that they take the necessary steps to bring them back in stock.

In the process of recreating this classic tool, Aircraft Tool Supply added a few enhancements to further elevate this kit. The new improvements include ground, hardened, and polished surfaces for mar-free beads in aluminum, copper, brass, and mild steel tubes ranging from 1/4" to 1" in diameter.

Also available are our ATS Pro Mini Beading Kits (p/n TB145A series). They use the same components and have the same exceptional quality as the Pro Beading Kit. Each kit is designed to cover a set of commonly used sizes, and can be easily upgraded by adding more dies and frames as needed.

Here's my personal guarantee to you: Try our ATS Pro Beading Kit for 30 days and if you're not 100% satisfied, call me toll free at 1-800-248-0638 and I will personally make sure that you get a full refund including your shipping costs. No questions asked.

-- Des Lynch, Owner

PART	TUBE SIZES	PRICE
TB145A-1	1/4"	\$155.95
TB145A-2	3/8", 1/2", & 5/8"	\$179.95
TB145A-3	3/4", 1"	\$179.95
AP145	ATS Pro Beading Kit all sizes 1/4" to 1"	\$419.95

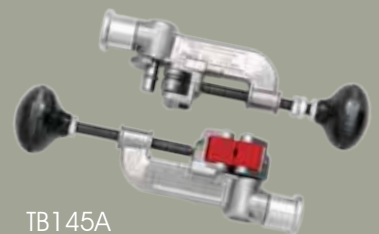

TB145A



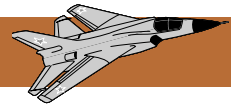

IMPERIAL® TRIPLE HEAD BENDER



For making 45°, 90° and offset bends in tubing. Bends aluminum, copper, steel and other metal tubing.

367FH.....(Bends 1/8", 3/16" & 1/4") \$32.95
 368FH.....(Bends 3/16", 1/4", 5/16" & 3/8") \$39.95

ROL-AIR® 37° FLARING TOOL



Flares rolled out above die by smooth faceted cone. Makes stronger flares.

The industry standard Rol-Air® is the choice of professionals. Flares soft copper, aluminum and brass tubing. The faceted hard chrome coated cone rolls out perfect 37° flares above the die block, and then automatically burinishes the flare face while maintaining the original

wall thickness at the base of flare. New slip-on yoke permits use in tight quarters. Satin chrome and black finish. Able to flare 3/16" 1/4" 5/16" 3/8" 1/2" and 5/8" O.D. tubing. *Not recommended for stainless steel.*

507FB \$89.95

IMPERIAL® HEAVY DUTY ROTO-LOK™ 180° TUBE BENDER



- Imperial's redesigned heavy duty tube benders now feature their patented Roto-Lok™ quick-action indexing lever which allows you to make up to 180° bends in any type of metal (including stainless steel) accurately and with minimal effort.
- Rollers in bending handle reduce friction and eliminates scoring of tubing.
- Works with copper, aluminum, brass, thin wall steel, and thin wall stainless.
- Calibrated markings for making accurate left-hand, right-hand offset bends.

PART	TUBE DIA.	BEND RADIUS	WEIGHT (LBS)	PRICE
464FH-04	1/4"	3/4"	1.2	\$59.95
464FH-06	3/8"	1-1/8"	3.7	\$69.95

IMPERIAL® 37° HEAVY-DUTY FLARING TOOL



Flares 1/8" stainless steel primer lines!

Forms 37° flares in annealed stainless steel (MIL-T-6345 or AMS5566), cold drawn stainless steel, copper, aluminum, brass, and other soft metals. Ball thrust bearing mechanism reduces the effort required to produce perfect 37° flares, even in stainless steel. Made of hardened tool

steel, and features a non-slip grip which securely holds tubing, even after repetitive flaring. Extension on bar can be clamped in a vise for extra support. Able to flare 1/8" 3/16" 1/4" 5/16" 3/8" and 1/2" O.D. tubing.

447F \$355.95

ROL-AIR® 37° AVIATION FLARING TOOL



Flares T6845 aviation grade stainless steel!

Forms 37° flares in aircraft grade stainless steel (MIL-T-6845), titanium, and other metal tubing, both soft and hard. Positive stop gauge assures correct size of flare. The three rollers in the flaring cone roll out 37° flares above the die block while burnishing the flare face to a smooth finish. A built in

extension on the yoke can be clamped in a vise for extra support. Satin chrome and black nickel finish. **Note: Use of the optional 401FA Reamer Yoke is recommended when flaring aviation grade stainless steel tubing.**

400F.....(3/16", 1/4", 5/16", 3/8", 1/2", & 5/8" Tubing).... \$343.95
 401FA.....(Optional Reaming Yoke for Stainless Steel)..... \$59.95
 402FA.....(Kit Consisting of 400F & 401FA)..... \$395.95

IMPERIAL® ROTO-LOK™ TRIPLE HEAD 180° TUBE BENDER



This new improvement the old "Imp" 3-in-1 bender (368FH), features Imperial's patented Roto-Lok™ quick-action indexing lever. It's a two-stage handle that automatically repositions itself midway through bend to allow easy fabrication of bends up to 180° with reduced effort, better control and no crossing of handles

Up to 180 degree bends in sizes: 3/16", 1/4", 5/16", and 3/8" O.D. tubing.

- Bend radii are: 7/16", 9/16", 11/16", and 15/16" respectively.
 - Works with copper, aluminum, brass, thin wall steel, and thin wall stainless.
- 470FH.....(Bends 1/8", 3/16", 1/4", 5/16" & 3/8" O.D.)..... \$39.95
 370FH.....(Bends 1/4", 3/8" & 1/2" O.D.) \$51.95



SERVICE & SUPPORT

TUBE BENDER



Special nylon forms prevents kinking or flattening. Easy to use with one end of the tube connected, or the unit can be mounted in a vice. For 3/16", 1/4", 5/16", and 3/8" O.D. tubing. Not recommended for 3/8 steel.

44000.....\$14.95

TUBING BENDING PLIERS

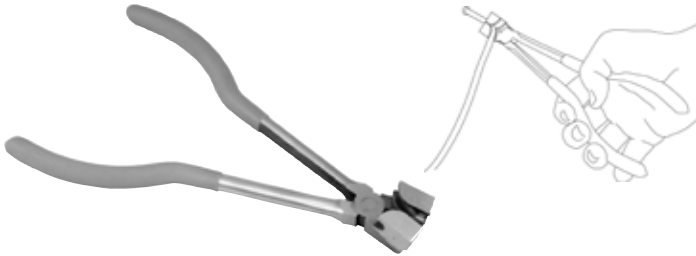

Bends all types of 1/4OD tubing. Unique head design bends tubing without collapsing the tube. Won't mark tube surface. Handles are more than 3-1/4" apart and unique head design keeps handles in line with the tubing for proper leverage even when bending steel tubing.

44070..... (1/4")\$30.95
44150..... (3/16")\$26.95

LEVER TYPE TUBE BENDERS



Each tool only bends one size. Open side type which slips over tube at any point. Makes smooth short radius bends up to 180°.

PART	TUBE DIA.	BEND RADIUS	WEIGHT (LBS)	PRICE
4-2829	1/4"	9/16"	1	\$49.95
5-2829	5/16"	11/16"	1	\$59.95
6-2829	3/8"	15/16"	2	\$59.95
8-2829	1/2"	1-1/2"	3	\$117.95
10-2829	5/8"	3"	6	\$145.95
12-2829	3/4"	3"	7	\$215.95

PARKER 37° FLARING TOOL

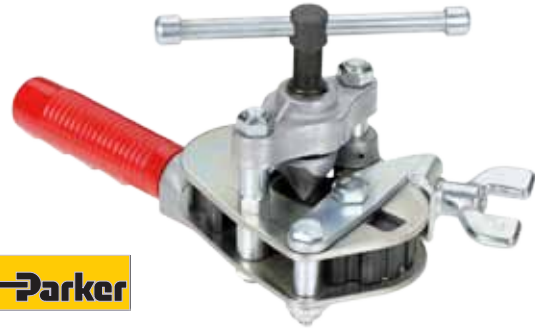

The heavy duty Parker Hannifin flaring tool is designed to make perfect 37° flares in aluminum, copper, brass, and mild steel tubing. The hardened tri-fluted cone burnishes the tubing as it creates the flare without scoring the surface. A built-in stop positions the tube prior to flaring so that your flares are always perfect. 1 year limited warranty. Tube Sizes 1/8", 3/16", 1/4", 5/16", 3/8", 7/16", 1/2", 5/8", 3/4".

212FB\$89.95

INNER-OUTER REAMING & DEBURRING TOOL

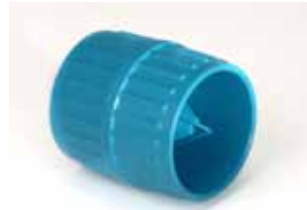

Reams both the inside and outside edges of 3/16" to 1-1/2" diameter tubes with the aid of three hollow ground cutters. Fluted body fits comfortably in the palm of your hands.

208F..... (Copper, Alum., & Soft Metals).....\$22.95
GT134 (Copper, Alum., & Soft Metals).....\$12.95
208SS (All metals).....\$59.95

IMPERIAL® 8 PIECE TUBE BENDER KIT



The patented spring coil design of these tube benders allows you to bend aluminum and copper tubing in to complex shapes without crushing or creasing the tube. Simply slip the belled end of the bender over the tubing and slide to the point to be bent. Complete kit contains eight (8) benders for tube sizes: 1/4", 5/16", 3/8", 7/16", 1/2", 5/8", 3/4", and 7/8" OD.

201-F.....\$25.95

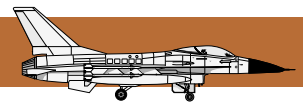

MALCO® RATCHET TUBE CUTTER

Malco® Ratchet Action tube cutter makes it easy to make clean cuts in tight spaces. Simply insert the tube into the self-ratcheting throat, tighten the cutting wheel, and cut through the tube using a back and forth ratcheting motion. Use it to make fast, clean cuts in copper, brass, aluminum, and mild steel. Includes spare cutting wheel, and built-in reamer.



- RTC623**..... (Small: Sizes 1/4" to 7/8")..... **\$30.95**
RTC829..... (Large: Sizes 5/16" to 1-1/8")..... **\$35.95**

IMPERIAL® RATCHETING TUBE CUTTER

Award winning 2-in-1 design features a mini-tube cutter mounted in a ratcheting handle to quickly cut through copper, aluminum, brass, steel, stainless steel, monel, titanium, and other tubing. Cuts from 1/8" to 7/8" O.D. tubing. Mini tube cutter can be removed from handle and used to cut tubing in tight areas (requires only 1-1/4" clearance). The ratcheting handle is made of a tough polymer to resist breaking and features a curved ergonomic design with non-slip padding. Guaranteed spiral-free cutting.



- TC1050RH** **\$21.95**

MINI TUBING CUTTER

The Mini Tubing Cutter performs where conventional tubing cutters simply cannot fit. With a 1-1/2" swing radius, the Mini Cutter is ideal for limited-space applications. The adjustable jaws accept tubing sizes from 1/8" to 7/8" in diameter and up to 1/8" in wall thickness. Gold Standard, tempered cutting wheels are capable of cutting through copper, aluminum, brass and thin-wall stainless steel.



- GT129X** **\$9.95**

THE TUBECUTTER™ HOSE CUTTER

The TubeCutter™ is guaranteed to produce a clean, square cut every time. It cuts through Aeroquip lines, rubber tubing, plastic tubing, hydraulic hoses, and pneumatic lines. It's so strong, it'll even cut through Kevlar reinforced hoses! Manufactured from drop forged steel and chrome plated for durability.



- UG1234** **\$35.95**
UG1234-B..... (Replacement Blade) **\$9.95**

EZ RATCHET TUBE AND PIPE CUTTER



Cuts PVC, Stainless Steel, Copper, Brass and Aluminum 5 degrees of ratcheting = 360 degrees of cutting. Great for use in tight spaces and on installed pipes. One-hand operation Cutting capacity 1/8" to 1-1/8" tubing Durable and lightweight 360 degrees of cutting action Ideal for thin-wall tubing and conduit.

- GT135** **\$32.95**

TUBE CUTTERS



374FC



127FB

Heavy-duty cutter makes clean, right angle cuts with absolutely no burrs. Kit includes roller, spare cutting wheel and foldaway reamer. Cuts or constricts tubes from 1/4" to 1-5/8" (6-413mm). Hardened roller and cutter for long working life.

- 374FC**(Deluxe Tube Cutter) **\$17.95**
127FB(Mini Tube Cutter) **\$7.95**

PHENOLIC SCRAPERS



Phenolic scrapers are perfect for safely removing sealants, adhesives, stickers, labels, grime, and more. They are extremely durable and will easily slice through sealants, but will not damage the underlying structure.

PART	FIG	TYPE	SIZE	PRICE
PH01	a	Hand	3/4" x 8"	\$4.95
PH02	a	Hand	1" x 8"	\$4.95
PH03	a	Hand	1-1/2" x 8"	\$5.95
PH04	a	Hand	2" x 8"	\$7.95
PHRG01	b	Air Gun	2" x 9"	\$32.95
PHRG02	b	Air Gun	2" x 3-3/4"	\$29.95
PH-SET		Set of all 6 scrapers		\$59.95



SERVICE & SUPPORT

RECOIL AIR HOSE



PART	FITTING	LENGTH	PRICE
425	1/4" NPT	25'	\$13.95

INDUSTRIAL AIR HOSE WITH FITTINGS



PART	ID	MAX. PSI	FITTING	LG	PRICE
610	3/8"	200	1/4" NPT	25'	\$24.95
611	3/8"	200	1/4" NPT	50'	\$32.95

BLOW GUN



Meets OSHA standards as to maximum PSI and noise level.

D420\$4.95

AIR HOSE COUPLERS



D340



P341

"Quick connect" style plugs and sockets will attach to any 1/4" air line. 1/4" pipe thread fittings.

D340 (Female Socket)\$4.95

P341 (Male Plug)\$2.05

SWIVEL CONNECTOR



Eliminates twisted air hoses forever. This connector swivels 360° and keeps your air hose straight no matter how your tool is held. Screws into any 1/4" NPT air tool. It can be used with quick disconnect couplers.

2563.....\$13.95

AIR REGULATOR



Proper air pressure and air flow are a must when operating air tools and when painting. Screws into any 1/4" NPT fitting. 160 PSI gauge.

1370.....\$11.95

AIR REGULATOR



Fits any tool with 1/4" thread.

5401.....\$7.95

SWIVEL CONNECTOR AND REGULATOR



This unit combines a swivel connector and a precision air regulator all in one. The swivel section rotates a full 360° to keep the hose out of your way, while the regulator will accurately control airflow at up to 150 psi. 1/4" NPT thread size.

7922R.....\$12.95

THREE IN ONE AIR LINE MANIFOLD



Supply three air tools from one source! Use on air hose end or as permanently fixed bench outlet. No need to disconnect/connect to use different tools. Three 1/4" NPT outlets and a single 1/4" NPT inlet makes this a useful shop accessory.

3404\$9.95

AIR TOOL OIL



A special oil developed for proper lubrication of air tools, Sold in 1 quart (32 fl. oz.) containers.

X-300QT\$9.95

INLINE AIR OILER



Automatically feeds your air tools with the proper amount of oil for longer tool life. 1/4" NPT thread.

5830.....\$11.95

PROFESSIONAL AIR REGULATOR



Positive adjustment for accurate air regulating. 1/4" thread.

1824.....\$14.95





BRANSON ULTRASONIC CLEANERS

BRANSONIC MODEL 1800



TANK SIZE (LX-WXD)	CAP. (QT)	OVERALL SIZE (LX-WXH)	WGT. (LBS)
6" x 5.5" x 4"	2	10" x 12" x 11.5"	7

- B1800-MT(Mechanical Timer, Unheated) \$435.95
- B1800-MTH(Mechanical Timer & Heater)..... \$475.95
- B1800-DT (Digital Timer, Unheated)..... \$505.95
- B1800-DTH..... (Digital Timer & Heater) \$565.95

BRANSONIC MODEL 2800



TANK SIZE (LX-WXD)	CAP. (QT)	OVERALL SIZE (LXWXH)	WGT. (LBS)
9.5" x 5.5" x 4"	3	13.5" x 12" x 11.5"	9

- B2800-MT(Mechanical Timer, Unheated) \$573.95
- B2800-MTH(Mechanical Timer & Heater)..... \$638.95
- B2800-DT (Digital Timer, Unheated)..... \$685.95
- B2800-DTH..... (Digital Timer & Heater) \$745.95

BRANSONIC MODEL 3800



TANK SIZE (LXWXD)	CAP. (QT)	OVERALL SIZE (LXWXH)	WGT. (LBS)
11.5" x 6" x 6"	6	16" x 12" x 14.5"	12

- B3800-MT(Mechanical Timer, Unheated) \$881.95
- B3800-MTH(Mechanical Timer & Heater)..... \$992.95
- B3800-DT (Digital Timer, Unheated)..... \$1,095.95
- B3800-DTH..... (Digital Timer & Heater) \$1,140.95

Bransonic Ultrasonic Cleaners are faster, more consistent and safer than many other methods. They are powerful enough to remove grease, and heavy oils; yet completely safe for delicate items such as electronic components and fuel injectors. All Bransonic cleaners now include the same high power, rugged transducers fitted on industrial systems. That coupled with a new sweep frequency technology provides the best cleaning every time. **Mechanical Timer (MT)** units have a timer switch, which can be set for up to 60 minutes and has a setting for continuous cleaning. **Mechanical Timer and Heater (MTH)** units, in addition to having the mechanical timer, also have a safety-protected heater. **Digital Timer and Heater (DTH)** models are the top-of-the line and has a digital timer switch, degassing facility, and a heater with safety cut-off. The keyboard is used to set the cleaning time and temperature. The microprocessor remembers the last settings, so the timer does not have to be reset for repetitive cleaning.

BRANSONIC MODEL B200



The popular B200 is a compact and stylish unit intended for cleaning smaller, more delicate components such as injector nozzles. It includes a cover, and parts basket.

TANK SIZE (LXWXD)	CAP. (QT)	OVERALL SIZE (LX-WXH)	WGT. (LBS)
6.5" x 3.5" x 2.5"	1	8.75" x 4.5" x 5"	3

- B200 \$131.95

BRANSONIC MODEL 5800



TANK SIZE (LXWXD)	CAP. (QT)	OVERALL SIZE (LXWXH)	WGT. (LBS)
11.5" x 9.5" x 6"	10	16" x 15.5" x 14.5"	14

- B5800-MT(Mechanical Timer, Unheated) \$1,313.95
- B5800-MTH(Mechanical Timer & Heater)..... \$1,393.95
- B5800-DT (Digital Timer, Unheated)..... \$1,355.95
- B5800-DTH..... (Digital Timer & Heater) \$1,459.95

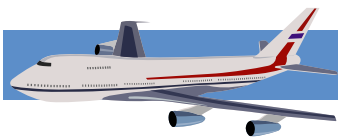

SHOP EQUIPMENT

BRANSON ULTRASONIC CLEANER ACCESSORIES

Brasonic accessories turn your Brasonic ultrasonic cleaner into a powerful multi-purpose cleaning machine. Choose from solid insert trays, perforated insert trays, or mesh baskets. Parts should not be allowed to rest on the tank bottom



BRANSONIC SOLID TRAYS

Solid trays are used for general purpose cleaning of small parts.

PART	FITS SERIES	ID SIZE (LXWXH)	PRICE
B100-410-170	B1800	5.5" x 6" x 4"	\$47.95
B100-410-172	B2800	9.5" x 5.5" x 4"	\$59.95
B100-410-174	B3800	11.5" x 6" x 6"	\$76.95
B100-410-176	B5800	11.5" x 9.5" x 6"	\$97.95



BRANSONIC PERFORATED TRAYS

Perforated trays are more effective than solid trays, and are useful for larger parts.

PART	FITS SERIES	ID SIZE (LXWXH)	PRICE
B100-410-160	B1800	5.5" x 6" x 4"	\$66.95
B100-410-162	B2800	9.5" x 5.5" x 4"	\$70.95
B100-410-164	B3800	11.5" x 6" x 6"	\$79.95
B100-410-166	B5800	11.5" x 9.5" x 6"	\$108.95



BRANSONIC ULTRASONIC CLEANING SOLUTIONS

Pour on the cleaning power with Branson cleaning solutions! 32 oz bottle.

PART	DESCRIPTION	PRICE
BRANSON-JC	Jewelry cleaner for very delicate parts	\$13.95
BRANSON-IS	Industrial Strength maximum cleaning	\$13.95
BRANSON-MC3	Metal Cleaner safe for alum. & titanium	\$13.95



BRANSONIC MESH BASKETS

Mesh baskets offer superior cleaning power for all types of parts.

PART	FITS SERIES	ID SIZE (LXWXH)	PRICE
B100-916-333	B1800	5.5" x 6" x 4"	\$50.95
B100-916-334	B2800	9.5" x 5.5" x 4"	\$69.95
B100-916-335	B3800	11.5" x 6" x 6"	\$81.95

DIGITAL ULTRASONIC CLEANER



An exceptionally effective cleaner that removes dirt and oil from metals, plastics, glass, and any other type of hard material. High energy transducer cleans quickly and thoroughly. Large basket will hold fuel injector nozzles for thorough cleaning.

- Full digital timer shuts unit off after preset time period.
 - See-through lid also acts as a sound barrier to keep noise to a minimum
 - High capacity 750ml cleaning tank (6" long x 4" wide x 2.5" deep)
 - Includes basket for holding small parts
 - Includes holder for disc objects such as CDs or DVDs
 - Excellent for cleaning fuel injectors and other small parts
- E902-187(110V) \$99.95**



BRANSONIC SUPPORT RACKS

Use a support rack to clean very large, or heavy parts.

PART	FITS SERIES	ID SIZE (LXW)	PRICE
BCPN-916-039	B1800	5.5" x 6"	\$58.95
BCPN-916-040	B2800	9.5" x 5.5"	\$64.95
BCPN-916-041	B3800	11.5" x 6"	\$82.95
BCPN-916-042	B5800	11.5" x 9.5"	\$91.95

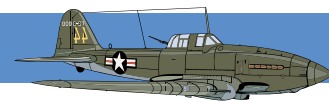

PRIMER PISTOL™



Primer Pistol™ is the simple and cost effective way to apply small amounts of primer paint and liquid with minimal cleanup time. It's a very handy tool that uses disposable 35mm film canisters as the delivery jar so that you'll use that expensive primer in stingy amounts. It also makes cleanup a snap -- just throw away the jar and the pickup tube and you're done. A great toolbox item for touch-up work.

- SA-PP01 (Primer Pistol) \$30.95
- SA-PP01H.... (Replacement Siphon Tubes-Pack of 10) \$1.95
- 161931..... (Canisters) \$0.59

GREASE JOINT REJUVENATOR



The Grease Joint Rejuvenator opens clogged grease joints and fittings effortlessly in less than a minute. Loosens dried grease in joints with just a tap. Also comes with a flexible shaft.

- 7862.....(Professional Model) \$49.95
- 7864.....(Pocket Model)..... \$29.95

PRECISION OILER



A Precision Oiler is a highly accurate lubrication tool intended for anyone working with small mechanical parts. The needlepoint tip allows for the precise placement of oil in confined areas. The smooth thumb actuator lets you control the release of lubricant from the reservoir in small droplets. The Precision Oiler includes a screw-on cover and pocket clip for use on the go.

- GT589 \$10.95

HEAVY DUTY PRODUCTION PAINT GUNS



Designed for day in and day out professional use. Non-bleeder, siphon feed with external mix. Operates on 40 to 85 psi at 5 to 12 CFM. Includes 1 quart cup.

- 36622..... \$55.95

SIPHON FEED PRODUCTION SPRAY GUN



Fully adjustable spray pattern with a 1.8MM needle and nozzle set for heavier materials. This 1 Liter spray gun is a non-bleeder type and siphon feed. Made from spun aluminum.

- 19418..... \$26.95

SPRAY WAND ENGINE CLEANER



Connect to any air source. Sprays solvents or any cleaning solution. Complete with siphon hose.

- 37CB \$20.95

SPOT SPRAY NON-AEROSOL SPRAYER



These eco-friendly sprayers are refillable and eliminate dangerous, harmful propellants. 80-150 psi operating pressure. Refillable and not for use with paint products. Eliminates dangerous, harmful propellants. Maximum capacity 32 oz.

- 19419.....(Red) \$24.95
- 19421..... (Red & Blue)..... \$54.95

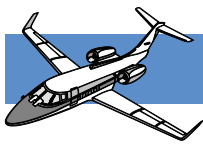

SHOP EQUIPMENT

SAND BLASTER & FINISHER



Comes complete with 100CFM dust collector, 24" rubber gloves, light, trigger nozzle and wide view window. 60" overall height. Requires 80 PSI. Motor Freight Shipment.

PART	WORK AREA (WXHXD)	DOOR (LXW)		PRICE
		TOP	SIDE	
40400	36"x24"x24"	13"x35"	N/A	\$1,345.95
40402	36"x24"x24"	13"x35"	11"x17"	\$1,565.95
40408	48"x24"x24"	13"x47"	N/A	\$1,632.95
40410	48"x24"x24"	13"x47"	11"x17"	\$1,842.95

FLAMELESS HEAT GUNS

All models are 115VAC with a three-position switch. Can be used as a hand held unit or mounted to a bench for continuous use on production lines.



PART	TEMP (°F)	VOL. (CFM)	PRICE
045Z2	500 - 700	35	\$89.95
046Z2	750 - 1000	35	\$179.95

HEAT GUN

This is a high performance, hot air source that delivers concentrated, heated air to the job. Has two heat selections: 750°F and 1,000°F. Only weighs 1/2 pound. Operates on 120 volts, 10 amps, 1,200 watts. Contains no asbestos. UL listed. Three special nozzles available for easy attachments included in the accessory kit.



- 87250..... (Heat Gun)..... \$39.95
- 75212..... (Accessory Kit)..... \$13.95
- 22400..... (Economy)..... \$16.95

PORTABLE SAND BLASTER



Unit cleans and removes rust scale, paint or dirt. Use with sand, abrasive powder, water or other cleaning liquids. Holds 55 lbs. Operates at 40 PSI and 3.5 CFM.

67624.....\$169.95

SWIVEL VACUUM VISE



The popular Swivel Vacuum Vise gives you the same great features as a standard bench vise, but in a design that is collapsible and easily transportable. The mobile vacuum base adheres powerfully to any flat, smooth surface, making this Vise an ideal choice for those frequently changing job locations. Equipped with hardened-steel jaws, the Swivel Vacuum Vise also features a universal ball joint neck which can be rotated 360 degrees and tilted 90 degrees in any direction. The entire unit folds for compact storage.

GT1850 \$83.95



ATS PRO MINI VACUUM



We've redesigned our popular Mini Vacuum Cleaner to provide even more quality and value for your money. The vacuum housing section is now manufactured from cast aluminum, and the valves are made from marine-grade brass.

ATSMV01.....\$25.95

WONDER GUN AIR VACUUM



A two-in-one tool that's both an air operated vacuum cleaner, as well as a blow gun. Use it as a vacuum cleaner to pick up metal shavings, liquids, and small parts. As a blow gun, it can be used to clear debris from work areas, clean up machines, etc. 1 year warranty.

WG01.....\$35.95

WG01-RB..... (Replacement Bag).....\$14.95

MINI FLUORESCENT LIGHT



A compact (6"), high-intensity, 115V fluorescent light that fits very nicely in any toolbox. The bulb is sealed in a high impact plastic housing to protect it against dust and chemicals. 25 ft. cord.

PL25.....\$25.95

SL-103.....(Replacement Lamp).....\$6.95

FLUORESCENT WORK LIGHTS



Cool, comfortable lights are safe and gives a glare-free light.

PART	VOLTS	O.A.L.	WATTS	PRICE
506S	110	26"	15	\$49.95
506M	110	20"	8	\$54.95

HIP ROOF TOOLBOX



General purpose, sturdy co-polymer construction, large partitioned tote tray. Large nickel-plated steel draw-bolts. Lockable padlock eye. 19"W x 9-1/4"H x 10"D.

19000.....\$25.95

MILITARY "G.I." CANVAS TOOL BAG



This heavy duty canvas bag is perfect for toting your tools around in the field. It contains ample space for a rivet gun and bucking bars, plus plenty of pouch space for accessories. Opens easily with sturdy brass zipper.

CB21-11.....(11").....\$16.95

CB21-17.....(17").....\$24.95

COLLAPSIBLE RUBBER MAGNETIC PARTS TRAY



Perfect for holding small parts, hardware and fasteners in place. Sticks to any ferrous metal surface. Rubber covered prevents scratching.

21266.....\$6.95

DOUBLE MAGNETIC PARTS TRAY



Rectangular Magnetic Parts Tray perfect for holding parts, hardware and fasteners in place. Sticks to any ferrous metal surface - even works upside-down. Non-marring vinyl magnetic base 5-3/8" x 9-3/8" stainless steel dish.

21265.....\$6.95



SHOP EQUIPMENT

PROFESSIONAL WIRELESS WEATHER STATION



Wireless monitoring of weather condition: indoor/outdoor temperature, humidity, rainfall, wind speed, barometric pressure and many more.

WS821 \$199.95

WIRELESS DATA LOGGING WEATHER STATION



Wireless transmission of outdoor temperature, humidity, quantity of rainfall, wind velocity and direction from the exterior sensors to the display station (433 MHz). Long-distance range up to (100 m) free field.

WS831DL \$249.95

DELUXE LIGHTNING DETECTOR



This portable/ground-based unit comes in a rugged, weather-resistant plastic case and is more powerful than the personal unit and will detect storms within 40 miles but will start detecting thunderstorms up to 70 miles away. It will identify severe thunderstorms as well as storms that can produce dangerous winds, heavy rains or tornadoes. It is battery operated and can be handheld or table/wall mountable. The LEDs indicate ranges from 0-3 miles, 3-8 miles, 8-20 miles and 20-40 miles and the number of alarm beeps will indicate the proximity of lightning.

LD50 \$299.95

LIGHTNING SEEKER PERSONAL LIGHTNING DETECTOR



This personal lightning detector is ideal for early storm warnings, storm directions and protection for any outdoor activity.

LD7 \$79.95

MAGNETIC SOCKET RAILS



Magnetic rails offer organization in your toolbox.

32097 (1/2" Drive SAE) \$22.95
38097 (3/8" Drive SAE) \$19.95
36097 (1/4" Drive SAE) \$11.95

REFERENCE TABLE

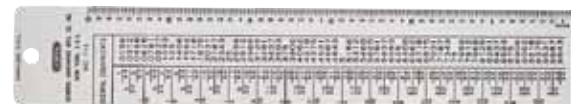

Our Tap Drill Reference Table is a must have for any toolmaker, machinist or mechanic. The double-sided guide features a Tap Drill Depth Chart, decimal conversions from 1/6" to 6" and a ruler graduated in 6ths. The Tap Drill Reference Table works with National Fine, National Course, American Standard Pipe and Metric threads.

GT715 \$7.95

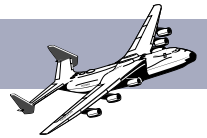

ATS 3/8" MICRO AIR RATCHET



Mighty-mite air ratchet only 4-1/2" small, but delivers up to 20 ft-lb (27 Nm) of torque to handle even the most stubborn nut or screw. 3/8" driver features a built-in 1/4" hex receptacle so you can use it as a ratchet wrench, or as a screwdriver. Great dual-purpose tool. 260 rpm, Handle exhaust, 1/4" NPT air inlet, 90 psi max.

ATS3031 \$65.95

ATS STUBBY RATCHET



New stubby air ratchet is only 6" long, but delivers enough torque to tighten or loosen the toughest bolts and nuts. Ergonomic design makes it very comfortable in the hand.

- 240 RPM Free Speed
- 30 ft-lb (40 Nm) torque
- 6-1/2" long
- Front exhaust

ATS3003..... (1/4" Drive)..... \$65.95

ATS3004..... (3/8" Drive)..... \$65.95

ATS HIGH SPEED CUT-OFF TOOL



Perfect for cutting and trimming studs & bolts. Features a safety hood to protect against flying debris. 3" (75 mm) disc capacity, 3/8" (15 mm) mount. Free speed 20,000 RPM. Weight 1.74 lbs (.79 kg).

ATS8502..... \$39.95

ATS ADJUSTABLE CLUTCH AIR SCREWDRIVER

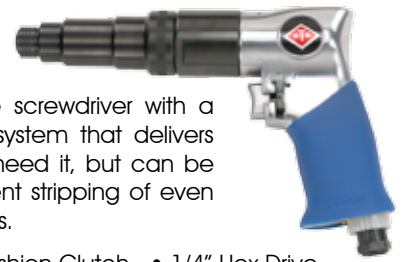

A powerful, direct drive screwdriver with a positive control clutch system that delivers high torque when you need it, but can be adjusted down to prevent stripping of even the smallest screw heads.

- Internal Adjustable Cushion Clutch
- 1/4" Hex Drive
- 8-1/2" (216 mm) Overall Length
- 800 RPM
- 45-115 in-lb (5-16 Nm) Torque
- 2.64 lbs (1.2 kg) Weight

ATS6203..... \$95.95

ATS STRAIGHT AIR SCREWDRIVER



Has all the same features as our ATS6203 Pistol Grip Screwdriver in a straight form that allows you to use it in tight areas that would otherwise be unreachable.

- Internal Adjustable Clutch
- 1/4" Hex Drive
- 10-3/8" (265 mm) OAL
- 1,800 RPM
- 45-115 in-lb (5-13 Nm) Torque
- 2.55 lbs (1.16 kg) Weight

ATS6212..... \$125.95

ATS AIR FILE



If you do a lot of filing, then this is the tool for you. It takes the pain and drudgery out of filing by putting air power to work for you.

- Uses 1/4" (6 mm) shank files
- Comes with a set of 4 files
- 3,700 Strokes Per Minute (SPM)
- 9-3/16" (234 mm) Length
- Built-in Silencer
- 2.42 lbs (1.1 kg)

ATS5095..... \$95.95

SWIVEL BIT HOLDER



1/4" hex shank. 30 degree swiveling head. Locks into stationary position as desired.

16227..... \$9.95



HAND TOOLS

CRESCENT® "FORD" WRENCH



The original Crescent Wrench (aka Monkey Wrench, Ford Wrench, Spud Wrench). Tool of choice for removing and installing "B" nuts. Smooth jaws.

C79H.....	(9").....	\$31.95
C711H.....	(11").....	\$36.95
C715.....	(15").....	\$57.95
C718.....	(18").....	\$79.95

ALDEN GRABIT-PRO® BROKEN BOLT & DAMAGED SCREW REMOVER



Works on damaged screws and broken bolts from as small as 4 screw to as large as a 3/8" bolt. It easily removes most damaged screw types such as Hex, Phillips, Torx, and Square Drive from wood, plastic or metal up to 3 inches in length. Two-step drill bit and extractor in one tool extracts broken bolts and damaged screws fast; use in reverse only when drilling and extracting with reversible hand held power drill.

PART	QTY	REMOVES SIZES			PRICE
		AN SCREW	AN/SAE BOLT	METRIC BOLT	
8401P	1 ea.	4 - 7	10	M5	\$8.95
8402P	1 ea.	6 - 10	1/4"	M6	\$8.95
8403P	1 ea.	12 - 14	5/16"	M8	\$8.95
8404P	1 ea.	16 - 24	3/8"	M10	\$9.95
8440P	4pc Kit	4 - 24	10 - 3/8"	M5 - M10	\$24.95
8430P	3pc Kit	4 - 14	10 - 5/16"	M5 - M8	\$18.95
8420P	2pc Kit	4 - 10	10 - 1/4"	M5 - M6	\$14.95

ALDEN DRILL-OUT® BROKEN BOLT EXTRACTOR



Drill-out is a drill-bit and extractor in one tool. It drills into broken bolts on center and extracts them cleanly using the power of the drill. Simply chuck the self-centering bit, set your drill to reverse, and drill at medium speed to extract the bolt. Drills up to grade 8 and 10.9 class fasteners with no pilot hole required. Made from M2 HSS in the USA.

PART	QTY	REMOVES SIZES		PRICE
		AN/SAE BOLT	METRIC BOLT	
4017P	4pc Kit	1/4" - 1/2"	M6 - M12	\$34.95
7017P	7pc Kit	5 - 1/2"	M3 - M12	\$57.95

FELO ERGONIC TOOL SET

Felo's Ergonic ratcheting handle provides extreme comfort and extra torque. These tool sets include a storage case that is labeled inside for organization in the shop. Keep everything together and ready to go with any of Felo's kits.



62053

62053.....	(36pc Ratchet, Sockets, and Adapters).....	\$128.95
62055.....	(19pc Socket Set w/ Ratchet).....	\$82.95
61545.....	(33pc Bit Set w/ Ratchet).....	\$57.95

LOW-PROFILE SOCKET SETS



Low profile sockets and ratchets provide at least an additional 3/4" of clearance.

PART	DESCRIPTION				PRICE
68003	22pc 3/8" Drive Fractional/Metric				
	SAE	1/4, 5/16, 3/8, 7/16, 1/2, 9/16, 5/8, 11/16 & 3/4"	Metric	8, 9, 10, 11, 12, 13, 14, 15, 16, 17, 18 & 19mm	\$71.95
63003	23pc 1/4" Drive Fractional/Metric				
	SAE	5/32, 3/16, 7/32, 1/4, 9/32, 5/16, 11/32, 3/8, 7/16, 1/2 & 9/16"	Metric	4, 5, 6, 7, 8, 9, 10, 11, 12, 13 & 14mm	\$49.95

21PC EXO-DRIVE™ SOCKET SET



This socket set features a slim design ratchet handle with 5 degree sweep and a 72 tooth ratchet mechanism. The slim head ratchet handle allows for more room in those tight spaces. Included in the set is a 3" EXO-Drive Extension and 1/4" and 3/8" drive quick-release conventional adaptors. Finished with chrome vanadium steel, fully polished and chrome plated.

17400.....	\$40.95
------------	---------



CROWSFOOT WRENCH SET



A set of 3/8" drive wrenches commonly used with torque wrenches. Sizes: 3/8", 7/16", 1/2", 9/16", 5/8", 11/16", 3/4", 13/16" and 7/8". Drop forged. Full polish, high chrome finish.

81908.....\$65.95

GEARWRENCH® STUBBY FLEX COMBO RATCHET SET



Small enough to fit in the palm of your hand, but provides enough leverage to tighten or loosen even the most stubborn nut. Features a ratcheting box end with a flex head to ensure access with tight areas. 7 piece set in sizes: 3/8, 7/16, 1/2, 9/16, 5/8, 11/16, and 3/4.

9507.....\$81.95

SAE X-BEAM FLEX HEAD COMBINATION RATCHETING WRENCH SET



GearWrench 9-Piece XL X-beam flex ratcheting wrench set consists of one each: 5/16-Inch, 11/32-Inch, 3/8-Inch, 7/16-Inch, 1/2-Inch, 9/16-Inch, 5/8-Inch, 11/16-Inch, and a 3/4-Inch wrenches. Ratcheting box end needs as little as 5 degrees to move a fastener vs 30 degrees for standard box end wrenches. Surface drive design reduces fastener rounding. Flexible head on box end of wrench provides for multiple angles for better clearances in tight spaces. Open end of wrench features gear wrench surface drive, which reduces rounding of fasteners and delivers 25 Percent more torque. Long pattern X-beam design provides for greatly increased torque and reduced hand fatigue. High polish nickel chrome finish and blow molded tray for storage.

85298.....\$179.95
85398.....(Reversible)\$165.95

PASS-THRU® RATCHET SET



The Pass-Thru® ratchet system is the perfect tool to get to nuts in difficult to reach areas. Pass-Thru design works better than a deep-well socket when trying to access nuts mounted to studs. Contains both SAE & metric sizes. Lifetime Warranty.

1/4" KIT (27 PCS)	3/8" KIT (23 PCS)	1/2" KIT (25 PCS)
SAE sockets (inches) 5/32, 3/16, 7/32, 1/4, 9/32, 5/16, 3/8, 7/16, 1/2, 9/16	SAE sockets (inches) 3/8, 7/16, 1/2, 9/16, 5/8, 11/16, 3/4, 13/16, 7/8	SAE sockets (inches) 5/8, 11/16, 3/4, 13/16, 7/8, 15/16, 1, 1-1/16, 1-1/8, 1-1/4
Metric sockets (mm) 4, 4.5, 5, 5.5, 6, 7, 8, 9, 10, 11, 12, 13	Metric sockets (mm) 10, 11, 12, 13, 14, 15, 16, 17, 18, 19	Metric sockets (mm) 15, 16, 17, 18, 19, 20, 21, 22, 24, 27, 30, 32
Tools Flex GearRatchet® Handle, 3" & 6" extensions.	Tools Flex GearRatchet® Handle, 3" & 6" extensions, 3/8" drive adapter.	Tools Flex GearRatchet® Handle, 1/2" drive adapter.
891427.....\$67.95	893823.....\$85.95	891226.....\$168.95

REVERSIBLE RATCHETING SET



12 point ratcheting set. Opening Sizes include: 5/16 in, 11/32 in, 3/8 in, 7/16 in, 1/2 in, 9/16 in, 5/8 in, 11/16 in, 3/4 in, 13/16 in, 7/8 in, 15/16 in, 1 in. Made from forged alloy steel. Flat handle type.

9567.....(7 Piece Set).....\$105.95
9509.....(13 Piece Set).....\$259.95





HAND TOOLS



GEARWRENCH® OPEN END RATCHETING WRENCH

Ratcheting head



The open end actually ratchets! No need to reposition with every stroke, both box end and open end are ratcheting. 7 piece set in sizes: 5/16, 3/8, 7/16, 1/2, 9/16, 5/8, 11/16, and 3/4.

85599.....\$69.95

INDEXING COMBO WRENCH SET



GearWrench combination indexing ratcheting wrenches need as little as 5-Degree to move the fastener as opposed to 30-Degree for standard box end wrenches. Just a push of the indexing button allows you to select 13 different angles. The box end features improved strength from GearWrench surface drive technology and at the same time, reduces fastener rounding. These ratcheting

wrenches are made from premium alloy steel for a precision, long lasting tool.

85498.....\$156.95

HALF MOON REVERSIBLE RATCHET SET



Reversible levers on both ends to allow direction change from either side. No need to remove the wrench from the fastener to tighten or loosen. Includes: two double reversing 5 degree ratcheting heads This 4 piece set includes 3/8-Inch x 7/16-Inch; 1/2-Inch x 9/16-Inch ; 5/8-Inch x 11/16-Inch ; 3/4-Inch x 7/8-Inch.

85399.....\$173.95

HALF MOON REVERSIBLE RATCHET SET



Eliminates the problem of reaching around obstructions. Features 2 double reversing 5 ratcheting heads. Each box end features a reversing lever on both sides of the wrench that allows direction changes from either side. Allows the fastener to be moved as little as 5 in both directions without removing the wrench. Sizes include: 3/8"x7/16", 1/2"x9/16", 5/8"x11/16" and 3/4"x7/8".

9840.....\$167.95

GEARWRENCH® AVIATION TOOLKIT

GearWrench specifically designed this kit with the A&P student in mind. It's part of their Technical Education Program (TEP) series aimed at making top quality GearWrench tools affordable for students. The kit contains the basic hand tools required by most curriculums and is, in fact, the recommended kit of many A&P schools across the country. All tools are of the highest quality, and backed by the GearWrench Lifetime Warranty.



1/4" DRIVE TOOLS	3/8" DRIVE TOOLS	SCREWDRIVERS & PLIERS
10 piece 12-point Set 3/16, 7/32, 1/4, 9/32, 5/16, 11/32, 3/8, 7/16, 1/2, 9/16 10 piece 12-point deep Set 3/16, 7/32, 1/4, 9/32, 5/16, 11/32, 3/8, 7/16, 1/2, 9/16 1/4" Drivers Full Polish Teardrop Ratchet, 3" extension, 6" Extension, Universal Joint	13 piece 12-pt set 1/4, 5/16, 3/8, 7/16, 1/2, 9/16, 5/8, 11/16, 3/4, 13/16, 7/8, 15/16, 1 11 piece 12-pt deep set 1/4, 5/16, 3/8, 7/16, 1/2, 9/16, 5/8, 11/16, 3/4, 13/16, 7/8 3/8" Drivers Full Polish Teardrop Ratchet, 6" Extension, Speed Handle, Universal Joint	6 Pc. Screwdriver Set 1/8x3" Slotted, 1/4 x 4" Slotted, 5/16" x 6 Slotted, 3/8" x 8" Slotted, 1 x 3" Phillips, 2 x 4" Phillips 4 Pc Mixed Pliers Set 9.5" Tongue & Groove, 7" Diagonal Cutters, 8" Long Nose, 8" Slip Joint
COMBINATION WRENCHES	GENERAL PURPOSE TOOLS	SPECIALTY TOOLS
15 pc Long Combination Set 1/4, 9/32, 5/16, 11/32, 3/8, 7/16, 1/2, 9/16, 5/8, 11/16, 3/4, 13/16, 7/8, 15/16, 1	Safety Goggles, Hearing Protection	23" Pickup Tool, Telescoping Mirror, Telescoping Magnet, Screw Starters, 1-1/4" Putty Knife, Scribe, Crimper, Tool Box

83080.....(Complete Kit)\$595.95



DOUBLE X PLIERS SET



Designed with a compound joint that allows access with minimal handle movement. Features flush rivet for strength and is made of corrosion resistant alloy steel. Includes dual dipped grips for comfort and aligned serrated tips for precision gripping.

- 82106.....(2 Piece Set - Straight and Needle Nose)..... \$61.95
- 82005.....(Straight Needle Nose)..... \$32.95
- 82006..... (45° Needle Nose) \$32.95
- 82007..... (Duck Bill)..... \$32.95
- 82107.... (3 Piece Set - Straight, Needle Nose, Duck Bill) ... \$91.95

DOUBLE X SNAP RING PLIERS SET



Provides removal and installation of hard to reach snap rings where side to side access is restricted. Interchangeable tips sizes include .038 to .070 straight and 45 degree.

- 82110..... \$57.95

DOUBLE HEMOSTAT SET



Jaws open greater distance than handle for added reach in tight locations. Increases access by up to 50 percent. Variable locking positions. Set includes straight and 45 degree pliers.

- 82111..... \$51.95

3/8" DR. & 1/2" DR. HEX BIT SOCKET



PART	CONTAINS	PRICE
80579	(7) 3/8 in. Dr. Hex Bit Sockets 1/8 - 3/8 in, (3) 1/2 Dr. Hex Bit Sockets 1/2 - 5/8 in Measuring System: SAE	\$69.95
80581	Hex Bit Socket Set includes: 1/16" thru 3/8" 3/8" Drive only	\$69.95

*See full product descriptions online.

3/8" DRIVE SOCKET SET



The Gearwrench Polished Ratchet features a low profile head which allows for greater comfort and access while the flush mounted reversing lever allows for greater access while the 60 Tooth Gear System allows for greater access. Sockets have serration depth as deep as the fastener and are large hard stamped for easy identification.

PART	CONTAINS	PRICE
80551	1/4" - 1" 12 Pt. Std. SAE Sockets 1/4" - 7/8" 12 Pt. Deep SAE Sockets 6 - 19 mm 12 Pt. Deep Metric Sockets 6 - 19 mm 12 Pt. Deep Metric Sockets	\$162.95
80566	3/8" drive 3/8", 7/16", 1/2", 9/16", 5/8", 11/16", 3/4", 13/16" and 7/8" 12 point standard SAE sockets	\$114.95
80561	1/4", 5/16", 3/8", 7/16", 1/2", 9/16", 5/8", 11/16", 3/4", 13/16", 7/8", 15/16", and 1"	\$49.95
80563	1/4", 5/16", 3/8", 7/16", 1/2", 9/16", 5/8", 11/16", 3/4", 13/16", 7/8"	\$59.95

*See full product descriptions online.

1/4" DRIVE SOCKET SET



The Gearwrench Polished Ratchet features a low profile head which allows for greater comfort and access while the flush mounted reversing lever allows for greater access while the 60 Tooth Gear System allows for greater access. Sockets have serration depth as deep as the fastener and are large hard stamped for easy identification.

PART	CONTAINS	PRICE
80301	3/16", 7/32", 1/4", 9/32", 5/16", 11/32", 3/8", 7/16", 1/2", 9/16", 4mm, 5mm, 5.5mm, 6mm, 7mm, 8mm, 9mm, 10mm, 11mm, 12mm, 13mm, 14mm, 15mm - 12 point deep sockets sizes: 3/16", 7/32", 1/4", 9/32", 5/16", 11/32", 3/8", 7/16", 1/2", 9/16", 4mm, 5mm, 5.5mm, 6mm, 7mm, 8mm, 9mm, 10mm, 11mm, 12mm, 13mm, 14mm, 15mm	\$139.95
80313	5/32", 3/16", 7/32", 1/4", 9/32", 5/16", 11/32", 3/8", 7/16", 1/2", 9/16", 3/16", 7/32", 1/4", 9/32", 5/16", 11/32", 3/8", 7/16", 1/2", 9/16" 12 Pt. Deep SAE Socket 1/4" Dr.	\$65.95

*See full product descriptions online.



HAND TOOLS

PRECISION DIAL TORQUE WRENCHES



Sturdy body construction ensures maximum durability with easy to read laser marked single scale. Large, easy to read dial is shock resistant and protected by a tough metal guard. The memory needle retains highest torque reading applied. Calibrated in both CW and CCW directions, with accuracy +/- 2%, from 2-100% of full scale. Individually serialized with matching certificate of calibration traceable to N.I.S.T.

PART	RANGE	DRIVE	GRAD	PRICE
KL45-751	0-75 in-lb	1/4"	1 in-lb	\$221.95
KL45-3002	0-300 In-Lb	3/8"	5 in-lb	\$228.95
KL45-502	0-50 ft-lb	3/8"	1 ft-lb	\$241.95
KL45-1003	0-100 ft-lb	1/2"	2 ft-lb	\$289.95
KL45-2503	0-250 ft-lb	1/2"	5 ft-lb	\$289.95

REVERSIBLE TORQUE WRENCH



This torque wrench features a reversible head design that allows you to accurately torque both left and right hand fasteners. This wrench has an easy-to-read analog scale window for setting torque values in ft-lbs and Newton-meters. With a fully heat-treated handle this is one tough and durable wrench and it meets ANSI specifications.

- 23149**..... (3/8" 20-80 ft lbs)..... **\$63.95**
- 23150**..... (1/2" 20-150 ft lbs)..... **\$75.95**
- 23151**..... (1/2" 50-250 ft lbs)..... **\$85.95**

TORQUE SCREWDRIVER



This torque screwdrivers is lightweight and durable. With an easy-to-read scale and accurate to +/- 3 percent. This torque screwdrivers has a comfortable rubber handle for ease of operation allowing you to easily torque on both right and left-had threads. It also locks in calibrating position for untimely setting changes. 3-15 in-lbs. Range.

- 23156**..... (1/4" Hex)..... **\$115.95**
- 23157**..... (1/4" Square)..... **\$115.95**

GEARWRENCH® ELECTRONIC TORQUE WRENCH



Digital precision guarantees exact torque settings by beeping when the desired torque (or angle) is reached. Accurate to +/- 2% CW and 3% CCW from 20% to Full Scale. Also measures angular torque to an accuracy of +/- 1%. Thin profile head features backlit LCD display that can be clearly read, even in poor lighting.

PART	RANGE	DRIVE	HEAD	PRICE
85070	10-100 ft-Lbs	3/8"	Straight	\$260.95
85071	25-250 ft-lb	1/2"	Straight	\$290.95
85072	12-120 in-lb	1/4"	Flex	\$144.95
85073	10-100 in-lb	3/8"	Flex	\$289.95
85074	25-250 in-lb	1/2"	Flex	\$329.95

MICROMETER TORQUE WRENCH



Precision torque wrenches are accurate to within +/- 2%. The drive head is a sealed teardrop design that provide ease of access, strength, and keeps out contaminants. The drive reverses direction at the flick of a level, and the micrometer twist lock securely holds your torque settings even under heavy use.

PART	RANGE	GRAD	DRIVE	PRICE
KDS85050	30-200 in-Lbs	1 in-lb	1/4"	\$135.95
KDS85051	50-240 in-lb	1 in-lb	3/8"	\$129.95
KDS85052	10-100 ft-lb	0.5 ft-lb	3/8"	\$135.95
KDS85054	30-250 ft-Lbs	1 ft-lb	1/2"	\$148.95

PRECISION TORQUE SCREWDRIVERS



Positive locking pull down adjustment knob with automatic lock in counterclockwise direction. 1/4" hex bit holder with a cam-over torque limiting clutch. The easy to read window scale is accurate to +/- 6% clockwise direction and from 20-100% of full scale.

PART	RANGE	GRAD	PRICE
KL45-61SM	20-100 in-oz	1 in-oz	\$230.95
KL45-151SM	3-15 in-Lbs	.2 in-lbs	\$236.95
KL45-401SM	5-40 In-lbs	.5 in-lbs	\$309.95



HAND TOOLS

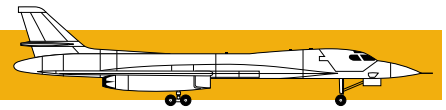

COMBINATION DUAL-HEAD OFFSET RATCHETS



Flex Head

This 72 tooth ratchet mechanism engages with just 5 degrees of sweep for work in the tightest places. Contoured cushion with a grip handle for comfort and strength.

12052.....	(1/4 & 3/8")	\$14.95
12053.....	(3/8 & 1/2")	\$15.95
12357.....	(1/4" & 3/8" Flex Head)	\$14.95
12358.....	(3/8" & 1/2" Flex Head)	\$16.95
11050.....	(1/4" & 3/8" Stubby Flex Head)	\$13.95
12051.....	(3/8" & 1/2" Stubby Flex Head)	\$18.95

ROUND SWIVEL-HEAD RATCHETS

270° Swivel



Unique swivel head design for confined areas. 72 tooth ratchet mechanism. Chrome moly steel construction.

11066.....	(1/4" Drive 5-1/2")	\$16.95
11067.....	(3/8" Drive 5-3/4")	\$17.95
11076.....	(3/8" Drive 8-3/4")	\$29.95

EXTENDABLE RATCHET



This ratchet is more versatile than most. It has the ability to telescope in 5 increments (8-1/2" to 12-1/2"), push button quick release, and extendable quick release. Chrome vanadium steel and contoured handle.

12075.....	(1/4")	\$16.95
12070.....	(3/8")	\$19.95
12074.....	(1/2" w/ 17.5" Reach)	\$30.95
12073.....	(1/2")	\$35.95
12072.....	(3/4")	\$95.95

4PC LONG DUAL MATERIAL SCREWDRIVER



Designed tri-lobe ergonomic dual material handle for comfort and optimal balance of performance. Features handle with speed zone for faster turning in lox back torque applications.

80059.....	\$59.95
------------	---------

GEARWRENCH® ROTO RATCHET SET



Head rotates 180 Degrees

The ratchet head rotates and operates a full 180° to work in confined areas. 72 teeth ratchet requires less than 5° to actuate. Set of 1/4" and 3/8" drives.

81223.....	(Set of 1/4" and 3/8" Drivers)	\$60.95
------------	--------------------------------	---------

QUADBOX™ BOX END RATCHETING WRENCH SET



The QuadBox features a reversible ratchet at each box end to give you the ultimate ratcheting tool. 3 piece set in sizes: 5/16, 3/8, 7/16, 1/2, 9/16, 5/8, 11/16, 3/4, 13/16, 7/8, 15/16, 1.

85204.....	\$99.95
------------	---------

RATCHETING BREAKER BAR



This heavy duty breaker bar has a 3-way ratchet mechanism, chrome plated bar, black-oxide head, chrome vanadium steel construction, and a maximum torque of 148 ft/lbs (20 kg/m).

12015.....	(3/8" Drive x 15" Long)	\$29.95
12018.....	(1/2" Drive x 18" Long)	\$30.95
12019T.....	(3/8" Drive x 18" Long)	\$18.95
12024.....	(1/2" Drive x 24" Long)	\$32.95
12047.....	(1/2" Drive x 30" Long)	\$25.95
12048.....	(3/4" Drive x 40" Long)	\$68.95
12049.....	(1" Drive x 40" Long)	\$78.95

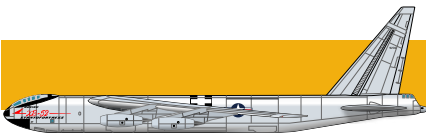

HAND TOOLS

3" MINI RATCHET AND BIT HOLDER



A two-in-one ratchet featuring one side that holds hex bits is a perfect addition to your toolbox. The compact handle is ideal for confined areas. Chrome vanadium steel finish.

- 12101..... (1/4") \$11.95
- 12102..... (3/8") \$12.95
- 12103..... (1/2") \$13.95

MINI RATCHET HANDLE 1/4" HEX



Mini ratchet handle with 1/4" hex bit. Bit holding mini-ratchet features a fine tooth mechanism requiring only 6 degrees of movement yet is capable of 575 lb/in (65 Nm). The handle is angled upwards 15 degrees for fingertip clearance.

- 61569..... \$20.95

FINGER RATCHETS



Buy them individually or in a set, these finger ratchets have a contoured grip for comfort and power during every job. They offer a reversible ratchet mechanism. Designed specifically to reach confined spaces.

- 12090..... (1/4") \$6.95
- 12091..... (3/8") \$7.95
- 12092..... (1/2") \$7.95
- 12093..... (1/4" and 3/8" 2 pc set) \$11.95

3/8" DR. BALL END HEX BIT SOCKET SET



8 pc SAE 3/8" drive metric ball tip hex bit socket set. S2 Alloy bits with Chrome Vanadium sockets. Ball tips allow access to fasteners in confined areas.

- 16117..... \$12.95

QUAD RATIO DRIVER (4:1 RATIO)



If you spend a lot of time installing and removing screws then the Ratio Driver will speed up your work by a factor of four. The geared drive mechanism ratchets the nosepiece 4 times for each turn of the handle; and the ratchet direction can be reversed with a quick flick of a switch. It accepts any 1/4" drive bits and includes an assortment of 8 bits in the handle compartment. The included bits are: Hex 3/32", 1/8", 5/32", 3/16"; Torx 15, 20, 25, 30; Phillips 0, 1, 2, 3; Slot 1/4", 3/16"; Roberts (square) 2, 3. Lifetime warranty.

- SAB710..... \$21.95

IMPACT DRIVER



3/8" drive kit includes reversing driver and 4 insert bits. Metal case included.

- 650-S..... \$13.95

JEWELER'S SCREWDRIVER



Nickel plated body with screw chuck. Kit contains three size flat blades, one Phillips blade and one scratch awl. Comes in a fitted vinyl case.

- SPC606..... \$6.95

TITANIUM HAND TOOLS

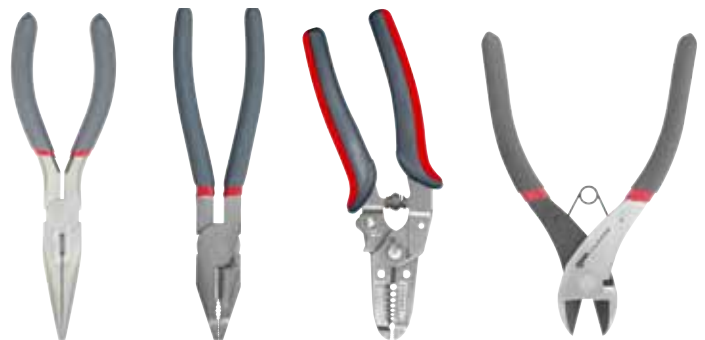

18431 18627 18651 18429

PART	DESCRIPTION	PRICE
18651	7.75" Titanium Bonded Wire Striper	\$14.95
18431	8" Titanium Bonded Needle Nose Pliers	\$17.95
18627	8.25" Titanium Bonded Linesman Pliers	\$24.95
18429	7" Titanium Bonded Side Cut Wire Cutter	\$19.95

HAND TOOLS

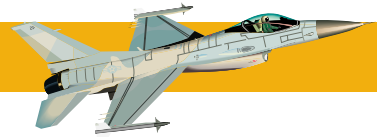

BONDHUS BALL END L-WRENCH SET



74937

16537

10999

37937

PART	DESCRIPTION	PRICE
74937	Pro-Hold 13pc 0.050"-3/8"	\$25.95
74999	Pro-Hold 9pc 1.5-10mm	\$21.95
20499	Pro-Hold 22pc Complete Set	\$49.95
16537	Stubby 13pc 0.050"-3/8"	\$21.95
16599	Stubby 9pc 1.5-10mm	\$17.95
20599	Stubby 22pc Complete Set	\$39.95
10937	Economy 13pc 0.050"-3/8"	\$17.95
10999	Economy 9pc 1.5-10mm	\$14.95
20199	Economy 22pc Complete Set	\$29.95
38099	Gold Finish 9pc 1.5-10mm	\$19.95
37937	Gold Finish 13pc 0.050" - 3/8"	\$24.95
20899	Gold Finish 22pc Complete Set	\$42.95

HEX GORILLAGRIP FOLD UP SET



12589

12592

12634

The greatest advantage of a fold up is the convenience of range of blade sizes in one package. It's also easily and conveniently carried in a pocket. The GorillaGrip® fold up handle is 40% stronger than steel, and will not rust or corrode.

12589.....	(9pc 5/64"-1/4").....	\$6.95
12592.....	(7pc 1.5-6mm)	\$5.95
12634.....	(8pc T-9-T-40).....	\$13.95

HEX PRO PIVOT HEAD WRENCH SET

00022

Fits Inch and Metric screws. Heat treated high quality industrial tool steel. Long handles for extra reach. Matte chrome finish to prevent corrosion. Heavy duty folding canvas pouch/holder (included with sets).



00017.....	(8pc 3/16"-3/8").....	\$71.95
00018.....	(5pc T40-T55).....	\$59.95
00010.....	(6pc 3-10mm).....	\$59.95
00019.....	(5pc T15-T30).....	\$55.95
00009.....	(5pc 1/8"-3/8").....	\$58.95
00022.....	(10pc T15-T55).....	\$109.95

ALLEN® HEX WRENCH SET

Genuine Allen brand wrench in sizes:

- .050", 1/16" (p/n 56030 only)
- 5/64", 3/32", 1/8", 5/32", 3/16", 7/32", 1/4" (p/n 56030, 56034 & 56110)
- 5/16", and 3/8" (p/n 56030 & 56034)



56030.....	(11 pcs, 4" Short Arm)	\$7.95
56034.....	(9 pcs, 6" Long Arm)	\$17.95
56110.....	(7 pcs, 12" Long Arm)	\$24.95

T-HANDLE HEX WRENCH SET

Contains sizes 3/32, 7/64, 1/8, 9/64, 5/32, 3/16, 7/32, 1/4, 5/16, 3/8. 6" long.



307X6.....	\$35.95
------------	-------	---------

THREE PIECE OFFSET SCREWDRIVER SET

The perfect screwdriver for those really tight areas. Each set includes 3 Phillips x 5/16" slotted; 2 Phillips x 1/4" slotted; 1 Phillips x 3/16" slotted.



OSD3.....	\$6.95
-----------	-------	--------



HAND TOOLS

E-Z SCREWDRIVER



Quick and easy way of installing or removing screws. Offset designed handle allows "speed" driving of screws. Ideal for removing and installing inspection plates, cowling screws, etc.

- SP496A (New Design) \$14.95
- SP495-1 (2 Phillips Replacement Bit) \$4.95

THREADED SCREWDRIVER BITS



Slotted

Phillips

They have 1/4-28 threads for use in our SP496A, or any threaded tooling.

PART	DESCRIPTION	PRICE
B00141	1 Phillips Bit	\$1.75
B00142	2 Phillips Bit	\$1.85
B00147	3-4 Slotted Bit	\$1.85
B00149	6-8 Slotted Bit	\$1.75
B00145	Set of 4 bits	\$6.95

THREADED HEX BIT ADAPTER

The Nova Threaded Bit Adapter lets you use your hex shank insert bits with any 1/4-28 threaded tool. Perfect for close quarters applications.

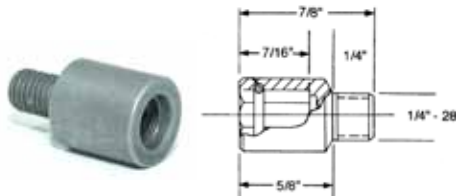

- PA28-450 \$3.15

SCREW & NUT STARTERS



For starting screws and nuts in inaccessible areas.

PART	DESCRIPTION	PRICE
8081	Nut Starter	\$8.95
8082	Slotted screw starter 3/64" - 7/6" screws	\$9.95
8083	Phillips screw starter 6 - 1/4" screws	\$8.95

APEX BIT HOLDERS

Heavy duty drop forged bit holders will not break under heavy driving force. Works with all types of Flat, Phillips, Tri-Wing, and Torq insert bits.



- 93813 (1/4" Hex Holder x 3/8" Drive) \$6.95
- 93815 (5/16" Hex Holder x 3/8" Drive) \$6.95
- 93817 (5/16" Hex Holder x 1/2" Drive) \$6.95

PHILLIPS® AVIATION APEX BITS

Genuine Phillips Tri-Wing® and Torq-Set® bits are hot formed for optimum toughness and resistance to wear. Each bit is 1" long and has a 1/4" hex shank.



TRI-WING



TORQ-SET

POINT SIZE	TRI-WING®		TORQ-SET®	
	PART	PRICE	PART	PRICE
0	-	-	TQ0	\$1.85
1	TW1	\$3.15	TQ1	\$1.85
2	TW2	\$3.15	TQ2	\$1.85
3	TW3	\$3.15	TQ3	\$1.85
4	TW4	\$3.15	TQ4	\$1.85
5	TW5	\$3.15	TQ5	\$1.85
6	TW6	\$3.15	TQ6	\$1.85
7	TW7	\$3.15	-	-
8	-	-	TQ8	\$1.85
10	-	-	TQ10	\$1.85

TORQ-SET HEX POWER BIT



TORQ-SET

Common fastener type in aviation and electronics industry.

PART	DESC	OAL	PRICE
TH0	#0	1-1/4"	\$1.95
TH1	#1	1-1/4"	\$1.95
TH2	#2	1-1/4"	\$1.95
TH3	#3	1-1/4"	\$1.95
TH4	#4	1-1/4"	\$1.95
TH5	#5	1-1/4"	\$1.95
TH6	#6	1-1/4"	\$1.95
TH8	#8	1-1/4"	\$1.95
TH10	#10	1-1/4"	\$1.95



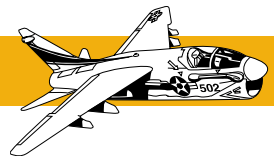

SCREW AND BOLT REMOVER



Fits all rivet guns with a .401 Parker Taper shank and is held with a retaining spring. 3/8" square drive end. Used to remove screws, bolts, nuts, etc. that are corroded or cannot be loosened by conventional methods.

- AT540A (10" Standard) \$19.95
- AT540B (6" Stubby) \$19.95

SCREW ADAPTER KIT



Specifically designed to work with our AT540 Screw Bolt Remover. This kit contains an assortment of various hardened screwdriver bits (Phillips and Common) that will withstand the driving force of the removal tool. Also includes a 1/4" adapter.

- AT54K \$11.95

SCREW EXTRACTOR SET



Five piece extractor set designed to remove broken screws and bolts. Easy to use, just drill a pilot hole, insert the extractor and twist out the screw. Set includes sizes: 1 for sizes 3/32" - 5/32", 2 for sizes 5/32" - 7/32", 3 for sizes 7/32" - 9/32", 4 for sizes 9/32" - 3/8", 5 for sizes 3/8" - 5/8".

- S35P \$11.95

STUCK BOLT, NUT, AND STUD REMOVER SET



The 6 piece set removes standard and metric bolts, nuts and studs from 1/4" to 9/16" (6mm to 14mm).

Drive the proper size remover over the bolt head, nut or stud. The remover spline cuts into the bolt head or threads for a sure grip.

- 19250 \$35.95

ARMSTRONG® SPEED HANDLE



Full polish. Chrome Vanadium steel.

- 10-935 (1/4" Drive) \$22.95
- 11-935 (3/8" Drive) \$22.95
- 12-935 (1/2" Drive) \$38.95

FLEXIBLE EXTENSION BIT HOLDER



Flexible Extension Bit Holder with locking, magnetic, and quick release. Designed to flex and hold at various angle. 12x stronger magnet than standard bit holder. For use with hand or power tool driver.

- 16004 \$19.95

BOLT GRIP



This tool lightly grips the heads of bolts and screws for easier insertion into tight or blind spots. No more dropped or lost parts. Double ended -- one end for -3 (3/16") fastener and one end for -4 (1/4") fastener. Bolt Grips are made from flexible stainless steel with an Overall Length of 12".

- AE5866 \$21.95

SCREW-GRAB®



Just a drop of Screw Grab® placed onto the head of a stripped screw or rounded bolt will increase the torque by up to 400% and allow you to easily tighten or remove them. The special emulsion will not stain or react chemically.

- SG94 \$6.95

MAGNETIZER/DEMAGNETIZER

A handy device that magnetizes and demagnetizes screwdrivers, wrenches, and other small tools. Can also be used to remove unwanted magnetism from small tools.



- 40010 \$11.95



HAND TOOLS

PRECISION TAP AND DIE SETS



24606

24614

Precision machined to exacting standards, then Tempered-Tuff to assure clean accurate threading. 24 piece set handles 1/4" to 1/2" sizes. 41 piece set handles 1/4" to 1/2" along with 4 through 12 machine screw sizes.

PART	PCS.	RANGE	PRICE
24614	24	1/4" to 1/2"	\$99.95
24606	41	1/4" to 1/2", plus 4 to 12	\$139.95

DRIVE PIN PUNCHES



A set of 8 hardened pin punches uniformly heat treated and centerless ground to withstand the hardest use. The end of each punch is ground square for accurate pin driving. Each set contains one of each of the following diameter punches: 1/16", 3/32", 1/8", 5/32", 3/16", 7/32", 1/4", and 5/16". Overall length of each punch is 4".

- SPC75.....(8pc Set) \$29.95
- SPC76.....(Extra Long 8" 5pc Set) \$25.95

REVOLVING PUNCH PLIERS



A convenient spring tension, self opening tool for punching round holes in leather, plastic, rubber, canvas and similar materials. Punches holes: 5/64", 3/32", 7/64", 1/8", 5/32", & 3/16".

- 722..... \$9.95

WASHER WRENCH SET



Slip washers in place with ease. Precision cut from 301 full hard stainless steel .042" thick. Fits most commonly used aircraft size washers.

- AE23800..... \$39.95

FASTENER HOLDER



This tool lightly grips fasteners for easier insertion into tight or blind spots. No more dropped or lost parts.

- AE5015..... \$8.95

WISE-GRIP® PLIERS



Genuine Vise-Grip pliers can be used for everyday jobs.

PART	SIZE	TYPE	PRICE
7R	7"	Standard	\$12.95
6LN	6"	Long Nose	\$14.95
9LN	9"	Long Nose	\$25.95

CABLE TIE GUN



The tension is factory pre-set to apply the right amount of pressure when tightening nylon ties. A built in break-away spring mechanism automatically flush cuts the tie at the correct tension. Works with any length tie up to 1/4" wide.

- TY3(Deluxe Tie Gun) \$49.95
- E900-005.....(Economy Tie Gun) \$27.95
- ELB721.....(Mini Tie Gun)..... \$5.95

NYLON TIE STRAPS



Use nylon tie straps to secure cables, hoses and other fixtures. Tensile strength of 50 lbs. Comes in packages of 100.

- NT1..... (3/4" Max. Diameter, 4-1/2" Long) \$7.95
- NT2.....(2" Max. Diameter, 7-1/2" Long) \$7.95

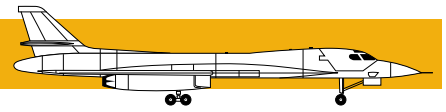

COTTER PIN PULLER



General's Cotter Pin Puller helps you to easily and safely remove steel cotter pins from confined areas. The compound bend design facilitates use of the tool with either a pull or a twist motion. In addition, the heavy duty screwdriver handle provides a familiar, comfortable grip.

GT64 \$8.95

RAWHIDE HAMMERS

Rawhide hammers have good control and deliver a solid impact.



M0 (1") \$16.95

M2 (1-1/2") \$20.95

M4 (2") \$29.95

BRASS HAMMERS

Non-sparking brass hammers are perfect for working in volatile spaces.



B2 (1 lb) \$33.95

B4 (2 lbs) \$47.95

DEAD BLOW HAMMERS

Soft-faced dead blow hammers deliver a solid blow without recoil or excessive shock. Great for hard pounding.



CH1 (1-1/2") \$17.95

CH3 (2") \$25.95

CH5 (2-1/2") \$35.95

FILE CARD

Used to clean and remove buildup from files.



21455 \$7.95

UNIVERSAL SNAP RING PLIER SET



This cleverly designed combination snap ring pliers works to install and remove both internal and external snap rings. It includes 3 interchangeable heads that can be configured as either internal or external. In all, you effectively have 6 snap ring pliers in one tool kit.

E100-022 \$13.95

INSIDE/OUTSIDE SNAP RING PLIERS



Dual action Snap Ring Pliers quickly converts to install both internal and external snap rings. Includes a set of 4 tips: .045" straight, .060" straight, .045" at 45 degrees, .035" at 90 degrees.

46000 \$13.95

COMPASS SCREWDRIVER



These compass screwdrivers are totally non-magnetic. Strictly designed to adjust magnetic compasses or great for other applications where you need a small blade screwdriver.

906 (ATS Brass) \$9.95

AE8505 (Avery Stainless Steel) \$9.95

WIRE BRUSHES



Used to remove rust scale, paint, solder, clean threads, files, metal parts and castings. Wood handles with high carbon steel wire.

PART	FIG.	SIZE	PRICE
6X877	a	5 x 5/8"	\$5.95
6X878	b	5 x 1"	\$6.95



HAND TOOLS

STAINLESS STEEL PROBE, POSITIONING & SPRING HOOK SET



The probe, positing and spring hook set includes 10 unique blades for use in a wide array of electrical and mechanical applications. The positioning blades can be used for separating and installing wires, while the probes are great for cleaning, picking or marking small work surfaces. Also included is a 5" extension for reaching wires up to 10" away.

- GT707865(Complete Set) \$27.95
- GT707862(4pc Probe Set w/o Case) \$12.95

4-IN-1 PIN VISE SET



This 6" Piece Set includes our 4-In-1 Pin Vise and 5 drill bits. The 4-In-1 Pin Vise is larger and more robust than our miniature version, highlighted by two double-ended collets for holding tools of varying sizes. Equipped

with a rotating cap, the 4-In-1 Pin Vise is ideal for precision drilling, tapping and scribing. There is also a storage area beneath the handle cap for the extra collet and drill bits.

- GT175806 \$21.95

PRECISION SCREWDRIVER SET



A set of quality precision screwdrivers perfect for working on radios, electrical circuits, and other delicate instruments. They have a patented, ergonomic handle for greater comfort, and a swivel head offers rapid rotation. The set includes each of the following screwdrivers: 00-CP, 0-CP, 1-CP, 3/32"-Flat, and 1/8"-Flat.

- 700..... \$15.95

POWER PRECISION ENGRAVER



This tool enables precision cordless engraving anywhere by anyone from professional technicians and mechanics to homeowners and DIYers. The engravers powerful 20,000 RPM motor is powered by just two AAA batteries and enables engraving in glass, metal, ceramic and plastic. An aluminum body offers superior durability.

- GT505 \$19.95

SMART BELT POUCH SET



This 9 piece multi-tool set with interchangeable blades replaces 32 single tools! The handle with anti-roll shape is T-shape and screwdriver handle in one. 1/4" blades made from high-quality bit-steel, exceeding industry standards by up to 100% with black tip for precision and fit. The blades included in the set are the following: 1 Blade-2 Tamper-Resistant Torx Heads, and 3 Blades-6 Phillips heads, 4 Blades-8 Torx heads.

- 50624..... \$61.95

SMART TORCH TITAN



The Smart Torch Titan, with its fully adjustable 2400°F precision flame, has enough intensity to wow even the most discerning gadget enthusiast. Its ignition system is both wind-resistant and completely water-proof. And just for fun, the Smart Torch Titan's transparent fuel tank glows neon

blue when in use – which is truly even more entertaining than it sounds.

- 9004-NB \$9.95

SEAL & O-RING REMOVER SET



These rounded tips allows for easy removal of seals and o-rings without damaging the seal or the finished surface. Set includes (2) Contoured Tips and (2) Spoon Tips. Lengths are 5-1/2" and 8-1/2"

- 17004..... \$13.95

SWISS PATTERN NEEDLE FILE SET



Our Swiss Pattern Needle File Sets have been designed to meet the needs of hobbyists, craftsmen, tool makers and jewelers. Every file is made from alloy steel and machined into distinctive shapes for various small scale and finishing applications. 12 piece set.

- GT707475 \$23.95



NICHOLSON® DUAL “VIXEN” FILE



Fast cutting “curved tooth” file cuts through aluminum, brass, steel, plastics, fiberglass, and composites without loading up. Features a coarse cutting surface on one side (10 TPI) for quick removal and a smooth cut on the other side (16 TPI) for finishing.

20547N (12”)..... \$34.95

NICHOLSON® MAGICUT™ PLASTIC FILES



Magicut files feature a pattern of narrow chip breakers created by steep and angled serrations for rapid removal of material with virtually no loading, even when working with soft plastics. Perfect for fiberglass, lexan, plexiglass, composites, and soft metals.

PART	DESCRIPTION	PRICE
07894	8" Flat	\$8.95
07917	10" Flat	\$11.95
07941	12" Flat	\$14.95

NICHOLSON® ALUMINUM FILES



Special double-cut teeth is designed specifically to quickly remove aluminum without clogging. Can also be used for smoothing.

PART	DESCRIPTION	PRICE
00024	8" Flat	\$11.95
00047	10" Flat	\$13.95
00070	12" Flat	\$17.95

MINI FILE SET



Included in this mini set are 12 high strength carbon steel files with an ergonomic interchangeable handle with quick release. Comes in a durable nylon pouch. In this set are flat, triangle, flat-point, knife-type, square, barette files. 13 Piece set.

17067..... \$36.95

NICHOLSON® GENERAL PURPOSE FILES

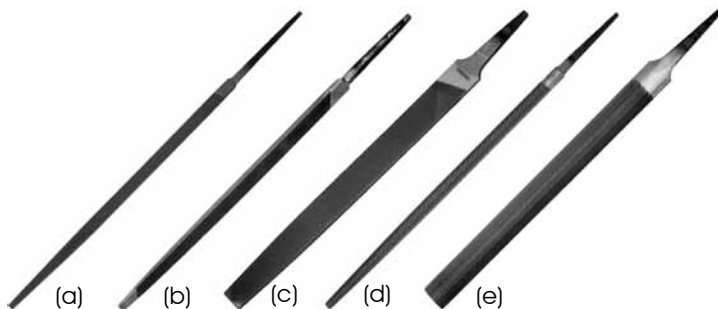

PART	FIG	DESCRIPTION	PRICE
13081		8" Square Bastard	\$8.95
13196	a	10" Square Bastard	\$11.95
13310		12" Square Bastard	\$16.95
13807M	b	6" Regular Triangular Bastard	\$5.95
13875M		8" Regular Triangular Bastard	\$7.95
14224M	b	6" Slim Triangular Bastard	\$4.95
14290M		8" Slim Triangular Bastard	\$6.95
14665M	b	6" X-Slim Triangular Bastard	\$3.95
14729N		8" X-Slim Triangular Bastard	\$5.95
09099		8" Mill Bastard	\$7.95
09179	c	10" Mill Bastard	\$9.95
09227		12" Mill Bastard	\$11.95
11904		8" Round Bastard	\$5.95
12019	d	10" Round Bastard	\$9.95
12134		12" Round Bastard	\$10.95
04896N		8" Half Round Bastard	\$11.95
04995N	e	10" Half Round Bastard	\$13.95
05094N		12" Half Round Bastard	\$17.95

NICHOLSON® FILE HANDLES



21528N

21474H

Designed to fit most popular files. Tapered to enhance push force.

21474H (Ergonomic)..... \$3.95

21528N (Wooden)..... \$2.95

NICHOLSON® NEEDLE FILE SET

A set of 6 precision files made to meet the exacting standards of die makers, instrument makers, jewelers, watchmakers, and other craftspeople. Each set contains 1 each of: Equaling, Half Round, Flat, Round, Square, and Three Square (Triangular) Swiss Pattern Files. Comes packed in a durable vinyl case. Overall length of each file is 5-1/2".



42030..... (Nicholson 6 pcs)..... \$29.95

5475..... (Economy 12 pcs)..... \$20.95



BOOKS AND SOFTWARE

FAA AC43.13 ACCEPTABLE METHODS, TECHNIQUES, & PRACTICES

The FAA's AC43.13 provides a wealth of information pertaining to the inspection and general maintenance of airplanes. In it, you'll find charts and tables, identification and marking conventions; and maintenance standards. Compliance with the standards set forth in AC43.13 is not optional - it's mandatory.

AC4313\$26.95



SKY RANCH ENGINEERING MANUAL

John Schwaner authors one of the most definitive manuals on aircraft engine maintenance we've ever seen. His book takes you from the basics up to the arcane art of engine diagnostics. He covers factors such as lubrication, electrical issues, mechanical alignment, heat related problems, vibration and balance, etc. The chapter on troubleshooting alone is worth it's weight in gold.

SREM1\$21.95

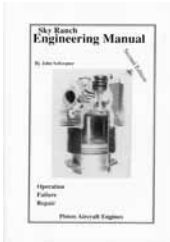

DICTIONARY OF AERONAUTICAL TERMS

Aviation is full of terms, acronyms and technical language. This book helps users understand all the words, abbreviations, and phrases of aviation. The most complete collection available, Explains and defines more than 10,000 terms and includes nearly 500 illustrations.

ASA-DAT-4\$19.95



AIRCRAFT WEIGHT AND BALANCE

This book explains in detail the process to determine the weight and balance of any aircraft. This new edition has been updated to include information on new Light Sport Aircraft (LSA) and Very Light Jet (VLJ) categories. Applicable to both airplanes and helicopters. This book is a primary reference for all FAA Knowledge Exams for both pilots and mechanics.

FAA-H-8083-1A\$9.95



AVIATION MECHANIC HANDBOOK

Dale Crane's handbook has been considered "The Aviation Standard" for many years. A core reference manual for mechanics, aircraft owners, and pilots, it compiles specs from reference books and government pubs into a handy guide. Your single source for: conversions, formulas, aircraft nomenclature, material/tool identifications, hardware sizes/equivalents, and much more.

ASA-MHB-6\$16.95



ESSENTIALS OF ADVANCED COMPOSITE FABRICATION & REPAIR

An excellent resource for beginners and professionals alike. It teaches concepts and methods in a direct manner for a wide array of composites including fiber and matrix selection, curing and achieving desired properties, testing and inspection, with step-by-step instructions and troubleshooting.

ASA-COMPOSITE\$79.95



POCKET REFERENCE

- Do you stay up at night pondering what kind of electrical plugs they use in Western Ethiopia?
- Are your semaphore skills a little rusty?
- And just how the heck do you tie a Crabber's Eye Knot, anyway?

If these and other such questions occupy your waking thoughts, then this is the book for you. The Pocket Reference is packed full of remarkably useful information. Inside you'll find tables for every conversion imaginable; US and international standards; weights & properties of materials, and much more. Get a copy of this book and you'll never lack the answer to life's nagging questions again.

POCKETREF \$10.95



STANDARD AVIATION MAINTENANCE HANDBOOK

Hundreds of the most commonly used charts, diagrams, scales and measurements for aviation maintenance, plus a tool box-sized, spiral bound, up-to-date reference guide.

EA-282-0\$20.95



AIRCRAFT INSPECTION & MAINTENANCE RECORDS

Describes the many types of inspections required and how to properly enter them into the maintenance records. A real aid to the A&P.

EA-IAR\$24.95



AIRCRAFT GAS TURBINE POWERPLANTS

The most up-to-date information on aircraft gas turbine powerplants available. New edition features over 450 pages and 500 illustrations.

EA-TEP-2\$59.95

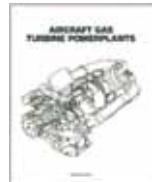

HELICOPTER MAINTENANCE

Written in concise, simple language and packed with photos and illustrations, this text explains the eight major helicopter types and how their systems operate. Combined with its companion study guide, this text provides "rotary-wing" excellence.

EA-HF-2 (Textbook)\$29.95

EA-HF-SG (Workbook)\$21.95

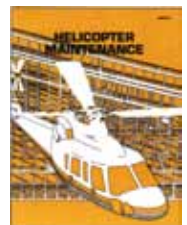

AIRFRAME SECTION TEXTBOOK

Airframe maintenance begins with a good understanding of aircraft systems. This book not only explains the systems, but allows you to understand them. Starting with the basics, components are added until complete, aircraft systems are presented in a clear, concise format.

EA-ITP-AB\$72.95



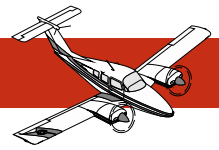

FAR/AIM FOR AVIATION MAINTENANCE TECHNICIANS

Contains Titles 14 and 49 of the Code of Federal Regulations (14 and 49 CFR) pertinent to General Aviation, Sport Pilots and Flight Instructors, combined with the Aeronautical Information Manual (AIM) (includes Change 3, effective 8/25/2011).

FAR-AIM\$16.95



AVIATION MAINTENANCE TECHNICIAN SERIES: POWERPLANT (3RD ED)

The third book of Dale Crane's AMT Series, Details the technical maintenance of turbine and reciprocating engines, covering the final section of the FAA's required curriculum.

AMT-P3\$59.95



AVIATION MAINTENANCE TECHNICIAN SERIES: GENERAL

The first book of Dale Crane's AMT Series, Covers the first section of the FAA's required curriculum, an introduction to aviation along with basic lessons on mathematics, physics, and electricity. Also addressed are regulations, mechanic privileges, forms, aircraft hardware and tools.

AMT-G3H\$59.95



AVIATION MAINTENANCE TECHNICIAN SERIES: GENERAL

Covers the first section of the FAA's required curriculum, an introduction to aviation along with basic lessons on mathematics, physics, and electricity. Also addressed are regulations, mechanic privileges, forms, aircraft hardware and tools.

AC4313-1B2B\$24.95



NONDESTRUCTIVE & ULTRASONIC TESTING FOR AIRCRAFT

Preparation, procedures, inspections, applications, and testing methods are discussed in this reprint of two FAA Advisory Circulars.

AC43-3-7\$12.95



AVIATION MAINTENANCE TECHNICIAN SERIES: STRUCTURES (3RD ED)

This is the second book of Dale Crane's AMT Series, the first of two volumes. Covers aircraft structures including aerodynamics, and hydraulics and pneumatic systems as they relate to the landing gear.

AMT-STRUC-3H\$49.95



AVIATION MAINTENANCE TECHNICIAN SERIES: GENERAL

Covers the first section of the FAA's required curriculum, an introduction to aviation along with basic lessons on mathematics, physics, and electricity. Also addressed are regulations, mechanic privileges, forms, aircraft hardware and tools.

ASA-8083-30\$39.95



KITLOG PRO (SOFTWARE)



Kitlog Pro is a comprehensive four part software design that allows the builder/pilot to create, archive, maintain and display the entire building process of their aircraft.

KITLOG (Windows 98, 2000, XP or Vista).....\$50.95

ORAL & PRACTICAL EXAM GUIDE

Written by industry expert Dale Crane, this book prepares students for the general, airframe, and powerplant oral and practical exams with information on the certification process, typical projects and required skill levels, practical knowledge requirements in a Q&A format, and reference materials.

ASA-OEG-AMT2\$12.95



MECHANIC'S TOOLBOX (SOFTWARE)



Windows based software for the aviation mechanic. The Mechanics Tool Box features over 30 different programs with hints, tips and suggestions on how to troubleshoot and make repairs easier and less costly.

TLBXC1 (Window XP, Vista, 7, or MAC).....\$39.95

AMT PRACTICAL TEST STANDARDS

This new PTS guide for mechanics includes all three current standards in one book for the General (8081-26—through Change 3), Airframe (8081-27—through Change 3), and Powerplant (8081-28—through Change 2) sections of the Oral & Practical exams. The standards presented in these guides are essential for study, and eventually passing the tests to become FAA-certified aviation mechanics.

FAA-S-8081\$9.95



This program makes managing your airplane projects a breeze. It keeps track of every detail of the construction and development process, especially those required by the FAA in order to get an Airworthiness Certificate. Requires Windows XP (SP2), or Windows Vista.

RC-MKA (Windows Software)\$68.95

ORDERING INSTRUCTIONS

PRICING

We strive for total accuracy in the pricing and presentation of our products, however we have been known to make a mistake every now and then. Therefore, we reserve the right to make corrective changes to pricing and product descriptions without notice.

NO MINIMUM ORDER

No minimum order is required.

CUSTOMER INFORMATION

To help us process your order quickly, please verify that both your shipping and mailing addresses are correct. Also please be sure to give us your complete shipping address including street name and number, post office box (if any), postal or zip code, and country (if other than the United States). This will ensure that your order will be delivered without delay.

SHIPPING METHOD

Please indicate your preferred method of shipment and we will try our best to accommodate your request. Note however, that it may not be possible to deliver your package via the method you've specified if your chosen carrier does not deliver to your area. In such cases, we will send your order either via UPS or Mail depending on which carrier services your area.

If you choose to have your package delivered via UPS, then you must give us a physical street address. UPS cannot deliver to a post office box, or to an FPO/APO address.

Unless you request a different service, domestic orders are shipped by UPS ground and international orders are shipped via UPS Worldwide. Priority delivery is also available. Please see our order form for options.

However you choose to send your order, we will usually process it and send it out the same day if we receive it before 4 p.m. (EST) -- and if there are no backorders. If your order contains backordered items, we will send you a partial shipment, or hold your order until it's complete if the backordered items are expected to arrive shortly.

ORDER LINE ITEMS

Please give us the part number, description, and quantity of the items you would like to purchase. And note that some items such as piloted reamers will require that you specify a size in addition to the part number. Use the description area to specify sizes whenever it's needed; and please feel free to continue your order on a blank sheet of paper if there isn't enough space on the order form.

Use the Special Instructions area to provide additional instructions regarding your order.

Michigan residents please remember to add 6% sales tax if you are an end-user. If you are a Michigan business with a valid tax ID number, then please include it so that we can exempt your order from sales tax.

PAYMENT METHOD

You may pay for your order with a Visa, MasterCard, Discover/Novus or American Express credit card by writing the card number, its expiration date, and your signature in the space provided on the order form.

You may also make payment by sending us a check or money order with your order. However, please note that we reserve the right to hold personal checks until they are cleared by the bank, which might take up to 5 business days.

If you are purchasing for a government organization, a school, or a company that has an open account with us, you may execute the order by writing your purchase order number in the space provided on the order form. We will then process your order and send you a copy of the invoice for payment. Our payment terms for all accounts is net 30 days.

SENDING YOUR ORDER

Please take a moment to review your order before sending it. In particular, verify that your shipping and mailing addresses are correct, and that you've entered your payment information correctly. Also, don't forget to include a telephone number where you can be reached during business hours so that

we may contact you if there is a problem with your order.

- The fastest way of placing your order is by calling our order desk at **1-800-248-0638** (United States and Canada only) and one of our sales clerks will gladly take your order. International customers may reach our order desk by calling **USA+989-739-1447**.
- Placing your order from our online e-commerce site is also extremely fast and efficient. It's located at **www.aircraft-tool.com** and there you'll find a complete shopping system that lets you order with ease at anytime, and from anywhere. You can also order by e-mailing **orders@aircraft-tool.com**, and it will be processed as soon as we receive it. When e-mailing, please remember to include a return e-mail address so that we can contact you.
- The fax number to our order desk is **1-989-739-1448**, and it's available 24 hours a day.
- And finally, you can mail your order to us at:

Aircraft Tool Supply Company
P.O. Box 370
Oscoda, Michigan 48750

CUSTOMER SERVICE

Our customer service representative is there to help you with your service needs. If you have a problem with your order or tools, please feel free to give our representative a call. We are always pleased to quote price and availability on any item we sell. You may be assured of prompt and individual attention.

RETURNING MERCHANDISE

You may return any unused item within **30 days** for a full refund or exchange. A 20% restocking fee will be charged for special order items. When returning an item, please use the return form provided with your invoice, or send a copy of your invoice and state the nature of the problem (defective, ordered in error, etc) and what you would like us to do to resolve it. Return items properly packaged and **PREPAY** shipping charges. Do not return your merchandise COD, our receiving department cannot accept these shipments.

REPAIR SERVICE

Items requiring repair and no longer covered by our warranty may be returned to our repair department. Please include your complete address and a telephone number at which you may be reached during the daytime. State the nature of the problem clearly. Please indicate if you require an estimate before repair. Enclose payment information to cover the cost.

WARRANTY

Aircraft Tool Supply (ATS) warrants the original purchaser or, for products purchased from a Reseller, to the original end-user that ATS branded products will be free from defects in materials and workmanship from the date of shipment for 1 year from the date of shipment or invoice, or in the case of ATS PRO branded products, the serviceable lifetime of the product. During the warranty period, ATS will, at its option: (1) provide replacement parts necessary to repair the product, (2) replace the product with a comparable product, (3) refund the amount you paid for the product, LESS DEPRECIATION, upon its return. ATS will provide labor to resolve warranty issues. To obtain service under this limited warranty, you must follow our warranty procedures. If we ask you to return a defective product or part, you must do so within 7 days after you receive the replacement part or product. ATS will charge you for replacement parts or products if you fail to do so. If you are domestic U.S. customer who purchased a product directly from ATS, we will arrange to ship replacement parts or products to and from you, and will pay the return shipping costs. If you live outside the United States, then you must pay shipping and applicable duty costs from and to your destination.

THIS LIMITED WARRANTY COVERS NORMAL USE. ATS DOES NOT WARRANT AND IS NOT RESPONSIBLE FOR DAMAGES CAUSED BY MISUSE, ABUSE, ACCIDENTS, UNAUTHORIZED SERVICE OR PARTS, OR THE COMBINATION OF ATS BRANDED PRODUCTS WITH OTHER PRODUCTS. THIS LIMITED WARRANTY DOES NOT COVER RECALIBRATIONS OR REGULAR MAINTENANCE. THIS LIMITED WARRANTY DOES NOT COVER NON-ATS BRANDED PRODUCTS. ANY WARRANTY APPLICABLE TO NON-ATS BRANDED PRODUCTS IS PROVIDED BY THE ORIGINAL MANUFACTURER.

Index

A

Adel Clamp Installer 142
 Air Couplers 148
 Aircraft Jacks 136, 137, 138
 Aircraft Tie-Down
 Slide-Down 138
 Wheel Chocks 140
 Aircraft Tie-Downs 138
 Air Drills 50, 51, 52
 Air Hose 148
 Air Line Connectors 148
 Airtoc Installation Tools 45
 Air Oiler 148
 Air Ratchet 155
 Air Regulators 19, 148
 Alignment Pins, Engine Mount 118
 Allen Wrenches. *See* Hex Wrenches
 Analog Multimeter 106
 Anti-Vibration Gloves 28
 Apex Bit Holders 164
 Auxillary Power Unit (APU) 107

B

Back Rivet Plate 28
 Battery Chargers 107, 108
 Battery Terminal Socket 108
 Beading Kit 144
 Bearing Packer 130
 Bender Brakes 88, 89, 90
 Blind Riveters 37, 39, 40, 41, 42
 Blow Gun 148
 Boelube® 55, 60
 Bolt Cutter 85
 Bolt Gauge 83
 Bolt Grip 165
 Bonding Brush 85
 Books 170, 171
 Borescopes 3, 109. *See also* Fiberscopes
 Bossing Mallets 79
 Brake Bleeder Adapters 135
 Brake Bleeder Tank 135
 Brake Relining Tools 30, 141
 Branson Ultrasonic Cleaners 149
 Brass Peen 28
 Breaker Bar 161
 Brushes, Wire 167
 Bucking Bars 23
 Bug Remover 77
 Burnishing Tool 84
 Burrs, Carbide 69, 70

C

Cable Cutter 95
 Cable Gauges 94, 95
 Cable Swager 94, 95
 Cable Tensiometer 93
 Cable Tester, Ignition 120
 Cable Thimbles & Sleeves 95
 Cable & Wire Tools 92, 93, 94, 95
 Caliper, Precision 96, 101
 Calipers & Dividers 99
 Calipers, Precision 96, 99

Camloc Installation Tools 45
 Camloc Pliers 45
 Cannon Plug Pliers 106
 Carbide Burrs 69, 70
 Carbon Monoxide Detector 141
 Center Finding Rule 100
 Center-It Drill Guide 57
 Center Punch 54
 Cherrymax® Rivets 21
 Cherry® Riveters 37, 41
 Chip Chaser 56
 Clamps, Sheet Metal 43, 85
 Cleco Caps 43
 Cleco Fasteners 43
 Cleco Pliers 43
 Combination Squares 98
 Compression Riveters 1, 32, 33
 Cotter Pin Puller 167
 Counterbores, Aircraft 49
 Countersinks & Counterbores 47, 48, 49
 Crescent® Wrench 156
 Crimpers
 Electrical Terminal 102, 103, 104
 Sheet Metal 81
 C-Squeezer Yokes 32
 Cable & Wire Tools 91
 Cable Tie Gun 166
 Computer Software. *See* Software
 Countersinks & Counterbores. *See* Pilot Cutters
 Cut-Off Tool, Air 70, 155
 Cut-Off Wheels & Arbors 70
 Cutters, Electrical 102, 106
 Cyclo Polisher & Accessories 75, 76
 Cylinder Base Wrenches 134
 Cylinder Bore Gauge 98

D

Dagger Tools Sheet Metal Products 79
 Deburring Tools 56, 84, 146
 Dental Picks 129
 Depth Gauges 98
 Dial Indicators 98, 100
 Diamond Points & Cutters 70
 Die Grinders 68
 Differential Pressure Testers 119, 120
 Dimple Die Block Set 29
 Dimple Dies 1, 26, 29, 30, 31
 Dimple Die & Squeezer Set Holder 29
 Dimpling Pliers 30
 Dolly, Sheet Metal 80
 Drill Attachments 53
 Drill Bits 58, 59, 60, 61, 62, 63, 65, 66
 Drill Chuck 54
 Drill Collets 55
 Drill Extension 54
 Drill Gauges 66
 Drill Guides
 Plate Nut 57
 Safety Wire 92
 Tube 57
 Drill Guides
 Tube 4
 Drill Housing & Bushings 55
 Drilling Equipment 50, 51, 52, 53, 54, 55, 56,
 57, 58, 59, 60, 61, 62, 63, 64, 65, 66
 Drills, Air 50, 52
 Drill Stops 55
 Duplicating/Transfer Punch 54

Dzus Installation Tools 2, 44

E

Edge Marker 83
 Edge Rolling Tool 83
 E-Gap Timing Kit. *See* Magneto E-Gap Timing Kit
 Electronic Tool Kit. *See* Tool Kit, Electronic
 Engine Equipment 115, 116, 117, 118, 119,
 120, 122, 123, 124, 127, 128, 129, 130, 131,
 132, 133, 134
 Engine Protector, TopCap 130
 Engine Stand 134
 Engine Test Kit 117, 118
 English Wheel
 Imperial 88
 Exhaust Stud Drill Guide 117
 Extend-A-Lube 142
 Extension Hose, Brake Bleeder 135

F

Fabric Tester, Maule 78
 Fabric Tools 78
 Fiberscopes. *See also* Borescopes
 File, Air 155
 File Card 167
 File Handles 169
 Files 168, 169
 Flanging Tool
 Air 86
 Hole 83
 Flaring Tools
 Push Rod 131
 Tube 145, 146
 Flashlights 5, 6, 111, 112
 Flex Hone 131
 Fluorescent Lights 153
 Fluting Pliers 84
 Fly Cutter 81
 Flying Wire Tensiometer 93
 Ford Wrench. *See* Crescent® Wrench
 Form-A-Funnel 142
 Fuel Tester 141

G

Gage Built Riveters (GBP). *See* Power Riveters
 Gasket Punch 130
 Gauges
 Ball Hole 99
 Contour 100
 Depth 100
 Feeler 101
 Radius 101
 Screw 101
 Sheet Metal & Wire 101
 Telescoping 99
 Gloves, Anti-Vibration 28
 Graphics Removal 72
 Grease Joint Rejuvenator 151
 Ground Power Plugs 117

H

Hammerless Punch 54
 Hammers
 Brass 167
 Dead Blow 167

Rawhide 167
 Sheet Metal 79, 80
 Hand Tools 156, 157, 158, 159, 160, 161, 162, 163, 164, 165, 166, 167, 168, 169
 Heat Gun 152
 Heli-Coil® 121
 Hex Bit Adapter, Threaded 164
 Hexnut Driver. *See* Wingnut/Hexnut Driver
 Hex Nut Fastener 44
 Hex Wrenches 163
 High Voltage Cable Tester 120
 Hi-Lok® Tools 46
 Hinge Bearing Kit 140
 Hi-Shear Tools 26
 Hole Cutter 81
 Hole Duplicators 55
 Hole Saw 87
 Hole Spotters 55
 Hose Assembly Tool 142
 Huck® Riveters 40

I

Ignition Harness Tool Kit, Slick 120
 Impact Driver 162

J

Jacks, Aircraft. *See* Aircraft Jacks
 Jet™ Sheet Metal Brakes & Shears 90
 Jilson Shears 83
 Jogging Tool, Sheet Metal 83

K

KitLog Pro Software 171

L

Lapping Compound 131
 Lead Thread Chaser 1
 Light
 Fluorescent 153
 Inspection 89, 110, 111
 Light Remover (WEMAC) 106

M

Magnaflux® 114
 Magnetic Field Indicator 114
 Magneto E-Gap Timing Kit 118
 Magneto Locks 118
 Magneto Overhaul Tool Kit 120
 Magneto Synchronizers 118, 120
 Magnets 110, 111, 165
 Manuals, Reference. *See* Books
 Master Orifice Tool 119
 Mechanical Pick-Ups Lighted 111
 Meyer Hydraulics® Aircraft Jacks. *See* Aircraft Jacks
 Micro-Mesh™ 77
 Micrometers 97, 98, 99
 Microstop Countersink 47
 Mini-Mixer 142
 Mirrors, Inspection 110
 Monkey Wrench. *See* Crescent® Wrench
 Multimeter 106

N

Nibbler, Sheet Metal 87
 Nippers, Electrical. *See* Cutters, Electrical

Nosepieces, Power Riveter. *See* Pulling Head, Riveter
 Notcher
 Sheet Metal 83, 89
 Tubing 87
 Nut Splitter 117

O

Oil, Air Tool 28, 148
 Oil Analysis Kit 116
 Oil Filter Cutter 115, 116, 127
 Oil Filter Media Cutter 115
 Oil Filters 126
 Oil Filter Wrench 4, 115, 127
 Oil Nut Wrench, Cessna 116
 Oil Seal Installer 129

P

Paint Cutters 142
 Panel Beater & Dolly Kit 79
 Perma-Coil 121
 Pilot Cutters 48
 Pin Insertion/Extraction Tool 102
 Pin Punches 166
 Piper Taper Pin Removal 140
 Piston Ring Compressor 128
 Piston Ring Expander 128
 Piston Ring Groove Cleaner 128
 Piston Ring Installer 128
 Plastic Cutters 56
 Plastic Edge Scraper 56
 Plate Nut Drill Jigs 57
 P-Lead Adapter, Magneto 119
 Plastic Cleaner. *See also* Window Cleaner
 Plexiglas® Drill Bits. *See* Plastic Drill Bits
 Pliers
 Cannon Plug 106
 Cleco 43
 Dimpling 30
 Electrical 102
 Fluting 84
 Snap Ring 167
 Vise-Grip® 166
 Point Sets
 Diamond 70
 Polish
 Aircraft 76, 77
 Windshield & Plastic 77
 Polisher 74
 Power Riveters 40
 Cherry Textron® 37
 Gage Built® 36
 Power Tools 155
 Precision Measuring Tools 96, 97, 98, 99, 100, 101
 Pressure Gauge, Tire 139
 Probe Set 168
 Production Guns
 Paint 151
 Sprayers 151
 PROGRABIT® 156
 Propeller Tachometer 113
 Protractor
 Digital 113
 Measuring 100, 101
 Propeller 113
 Pulling Head, Riveter 38

Punch
 Air 86
 Hand 81, 166
 Pin. *See* Pin Punches
 Push Rod Flaring Tool 131
 Push Rod Spring Compressor 131

R

Rapco Vacuum Pump Wrench 129
 Ratchets 158, 161, 162
 Ratio Driver 162
 Reamers 64, 65
 Expansion 66
 Piloted 64
 Tapered Pin 66
 Retainer Springs, Rivet Gun 17
 Rivenut Installers 41, 42
 Rivenuts 42
 Rivet Cutters 22
 Riveters
 Blind 1, 6, 39, 40
 Cherry® 37
 Huck® 40
 Monobolt 39
 Riveters Tape 29
 Rivet Gauge 30
 Rivet Guns 17, 18, 19, 20
 Rivet Gun Shank Reducer 27
 Riveting Equipment 24, 25, 26, 27, 28, 29, 30, 31
 Riveting Kits 7, 8, 9, 10, 11, 12, 13, 14, 15, 16, 17, 18, 19
 Rivet Puller 40, 41
 Rivet Puller, Pneumatic. *See* Power Riveters
 Rivet Removal Tools 22
 Rivets
 Brake Relining 141
 Cherrymax® 21
 Solid AD 22
 Rivet Set Extension 26
 Rivet Sets 19, 24, 26, 27, 28
 Rivet Shaver 47, 48
 Rivet Spacing Tool 29
 Rivet Squeezer
 Hand Squeezers 34, 35
 Pneumatic Squeezers. *See* Compression Riveters
 Rivet Squeezer Accessories 33
 Rivet Squeezer Dies 31
 Rivet Squeezer Kits 34, 35
 Rivet Squeezer Yokes 35
 Rivet Trimmer 21
 Rotary Machine, Sheet Metal 89
 Router Bits
 Aircraft 65
 Rules, Measuring 100
 Angle 99

S

Safety Wire 91
 Safety Wire Twisters 91, 92
 Sand Blaster 71, 152
 Sanders 67, 72
 Saws, Air 86
 Scale, Straight 141
 Scotch-Brite™ 71, 73

Scrapers 84, 147
 Non-Marring 2, 4, 72, 139
 Screw & Bolt Remover 165
 Screwdriver
 Hand 162, 163, 168
 Torque 160
 Screwdriver Bits, Threaded 164
 Screw Extractors 156, 165
 Screw-Grab® 165
 Screwdriver
 Air 155
 Brass Compass 167
 Hand 164
 Screw Starters 164
 Scribe 85
 Sealant, Aviation Gasket 130
 Sealant Gun, Caulk Master® 143
 Sealant Gun, Semco® 143
 Seal Driver 130
 Seal Installer 129
 Seal Puller 130
 Seamer-Hand, Sheet Metal 84
 Semco® Sealant Products 143
 Service & Support Equipment 135, 136, 137, 138, 139, 140, 141, 142, 143, 146, 147, 148
 Shears
 Fabric 78
 Sheet Metal 78, 81, 83, 87, 89, 90
 Sheet Metal Fasteners 43, 44, 45
 Sheet Metal Tools 79, 80, 81, 82, 83, 84, 85, 86, 87, 88, 89, 90
 Shop Equipment 149, 150, 151, 152, 153, 154
 Shot Bags 79, 80
 Shrinker/Stretcher, Sheet Metal 79, 88
 Simple Green 77
 Sioux Air Drills 52
 Skin Wedge 84
 Slappers, Hardwood 79
 Slapping Spoon 80
 Slick® Magneto Tools 120
 Slip Rollers, Sheet Metal 89
 SmartTool™ 101
 Snake Drill Attachment 53
 Snap Ring Pliers 159. *See* Pliers, Snap Ring
 Snips, Sheet Metal 82
 Socket Set 156, 157, 159, 162
 Software
 KitLog Pro 171
 Mechanic's Toolbox 171
 My Kit Airplane 171
 Soldering Iron 104, 105
 Soldering Paste 105
 Soldering Station 105
 Soldering Tools 105
 Spark Plug Cleaner 122
 Spark Plug Cleaner & Tester 123, 124
 Spark Plug Gap Gauge 127
 Spark Plug Gapper 122, 127
 Spark Plug Gaskets 127
 Spark Plug Inspection Magnifier 124
 Spark Plug Lead Wrench 127
 Spark Plugs 125
 Spark Plug Socket 124
 Spark Plug Thread Chaser 124
 Spark Plug Thread Lubricant 122, 127
 Spark Plug Tray 122, 124, 127
 Spark Plug Vibrator Cleaner 122

Speeder Handle 165
 Spotcheck, Magnaflux® 114
 Spray Wand Cleaner 151
 Squeezer Sets. *See* Rivet Squeezer Dies
 Squeezer Yokes 32
 Strap Duplicators 55
 Strut Coupler 139
 Strut Pump 139
 Swagers 94, 95
 Swaging Machines 94

T

Tachometer, Propeller. *See* Propeller Tachometer
 Tap & Die Sets 166
 Tape Measure 100
 Tennsmith™ Brakes & Shears 89
 Tensiometer
 Cable 93
 Flying Wire 93
 Terminal Crimpers. *See* Crimpers, Electrical
 Terminal
 Test & Inspection Equipment 109, 110, 111, 112, 113, 114, 121
 Thermometer, Infrared 113
 Thimbles, Oval & Stop Sleeves 95
 3M Products 71, 72, 73
 Throatless Shears 81
 Tie Strap Gun. *See* Cable Tie Gun
 Tie Straps 166
 Time-Rite® 133
 Timing Indicator 120
 Tire Bead Breaker 135
 Tire Pressure Gauge 139
 Tire & Wheel Balancer 135
 Titanium Snips & Cutters 2, 78, 162
 Toolboxes & Toolbags 153
 Tool Kit 158
 Tool Kit, Electronic 102
 Torch 168
 Torq-Set® Bits 164
 Torque Screwdriver 6, 160
 Torque Seal 141
 Torque Wrenches 127, 160
 Transfer Pins 55
 Transfer Punch 54
 Tri-Wing® Bits 164
 Trutach Digital Prop Tach 113
 Tube Beading Kit 144
 Tube Benders 145, 146
 Tube Cutters 147
 Tube Notchers 87
 Tungsten Bucking Bars 2
 Turnbuckle Tool 91

U

Ultrasonic Cleaners 149, 150
 Unibit 65

V

Vacuum Cleaner, Air 153
 Vacuum Gauge 129
 Vacuum Pump Wrench 129
 Vacuum Test Kit 129
 Valve Guide Flex Hones 131
 Valve Lappers 131

Valve Spring Compressor 131
 Valve Tappet Gauge 131
 Video Inspection Scope 3, 109
 Video Tapes & DVDs. *See* DVD & Video Tapes
 Vixen File. *See* Files

W

Wear Gauge
 Engine 140
 Flap Track 140
 Seat Housing 140
 Seat Rail 140
 Weather Station 154
 Window Cleaner 77
 Wingnut Fastener 44
 Wingnut/Hexnut Driver 44
 Wire Brushes 167
 Wire Crimpers. *See* Crimpers, Electrical
 Terminal
 Wire Marker 106
 Wire Stripper 103, 104
 Wire Twister 92
 Wrench
 Cessna Oil Nut 116
 Combination/Box End 157, 158, 161
 Crowsfoot 157
 Cylinder Base 134
 Ford 156
 Hex. *See* Hex Wrenches
 Propeller 129
 Ratchet 157, 158, 159, 161
 Set 158, 163, 166
 Vacuum Pump 129

Y

Yokes, Rivet Squeezer. *See* Rivet Squeezer
 Yokes

Z

Zyglo™ Test Kit, Magnaflux 114