

**PHILIPS**

Temmuz 2018

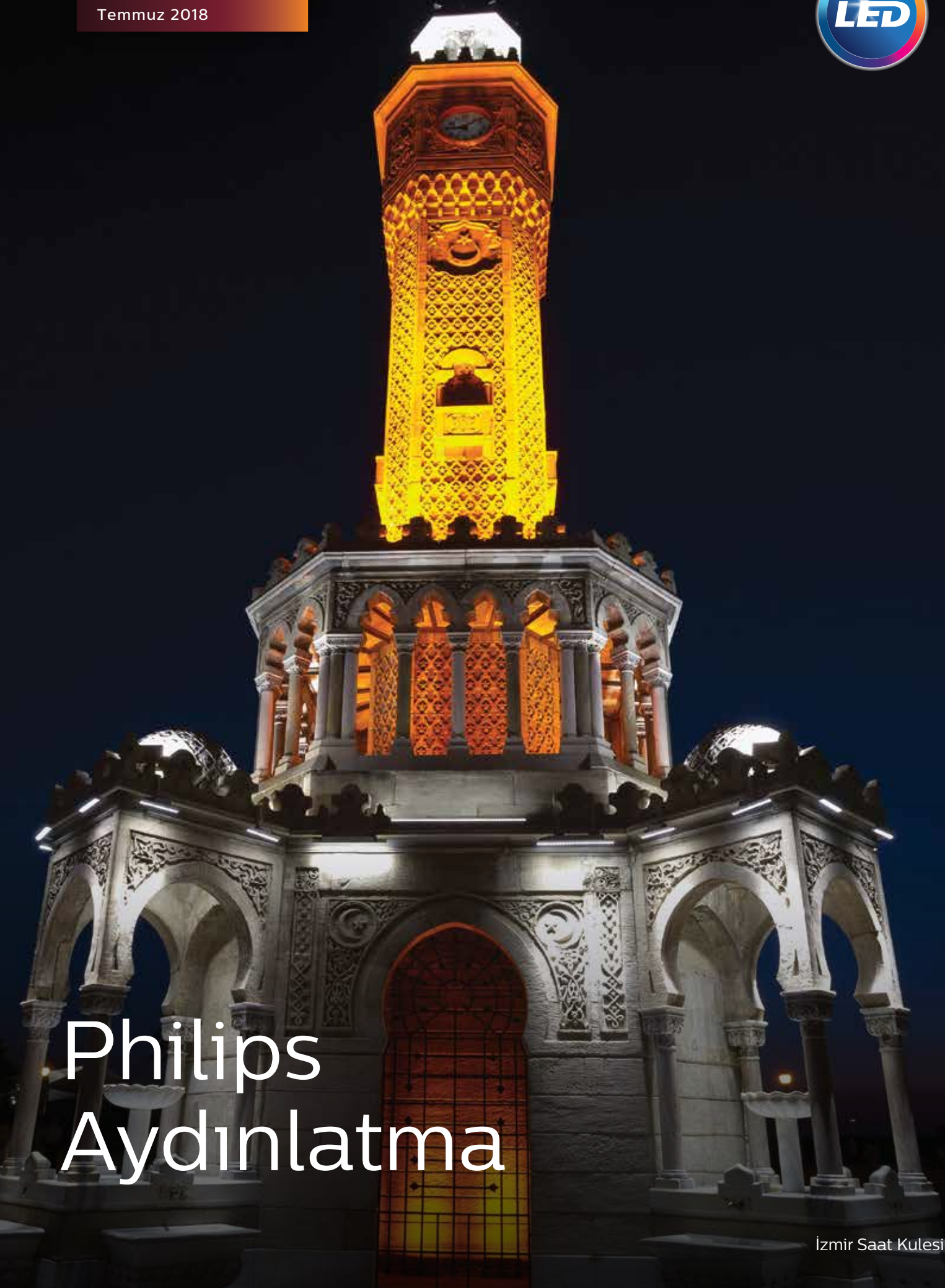

# Philips Aydınlatma

Izmir Saat Kulesi

**PHILIPS**

Essential LED Ampul



Philips Essential **LED** Ampul **9 Watt** ile  
**Essential ailesi**  
**tam kadro!**



Uzun kullanım ömrü:  
10.000 saat



Yüksek enerji  
tasarrufu



Mükemmel  
verim



Essential  
LED Ampul 9 Watt

# İçindekiler

## LAMBALAR

LED Lambalar	6
Enerji Tasarruflu Lambalar	30
Floresan Lambalar	33
Gaz Deşarjlı Lambalar	36
Gaz Deşarjlı Lambalar - Kompakt	38
Halojen Lambalar	40

## TÜKETİCİ ARMATÜRLERİ

LED Gömme Spot	42
LED Plafonyer - LED Şerit	45
LED LINEA	46

## BALASTLAR

Floresan Lamba Balastları	50
Gaz Deşarjlı Lamba Balastları	52
Ateşleyiciler, Halojen Transformatörler	55

## ARMATÜRLER

İç Mekan Armatürler	58
Dış Mekan Armatürler	81



DecoClassic Filament



CorePro LED Bulb



Master LEDtube





# LAMBALAR

LED Lambalar

Enerji Tasarruflu Lambalar

Floresan Lambalar

Gaz Deşarjlı Lambalar

Gaz Deşarjlı Lambalar - Kompakt

Enkandesan Lambalar

Halojen Lambalar

# LED LAMBALAR

LEDbulb



## Essential LEDbulb



2700/6500



E 27



Dim Edilmez



10000 Saat



EEL



12 Adet



%85

Ürün	12 NC	Gerilim (V)	Güç (W)	Eşdeğer Güç (W)	Duy	Işık Akısı (lm)	Renk Sıcaklığı (K)	Renk Geriverim (Ra)	Maks. Uzunluk (mm)	Çap (mm)	Kutu Adedi	Fiyat (€)
ESS LEDBulb 6-40W E27 2700K 230V TR	929001252187	220-240	6	40	E27	470	2700	80	108	60	12	2.70
ESS LEDBulb 5.5-40W E27 6500K 230V TR	929001365083	220-240	5.5	40	E27	470	6500	80	112	60	12	2.70
ESS LEDBulb 8.5-60W E27 2700K 230V TR	929001313587	220-240	8.5	60	E27	806	2700	80	112	60	12	3.15
ESS LEDBulb 8.5-60W E27 6500K 230V TR	929001365383	220-240	8.5	60	E27	806	6500	80	112	60	12	3.15
ESS LEDBulb 10.5-70W E27 2700K 230V TR	929001365587	220-240	10.5	70	E27	1055	2700	80	120	60	12	3.45
ESS LEDBulb 9-70W E27 6500K 230V A60 TR	929001379383	220-240	9	70	E27	950	6500	80	104	58	12	3.45
ESS LEDBulb 14-100W E27 2700K 230V TR	929001252987	220-240	14	100	E27	1521	2700	80	120	65	12	6.25
ESS LEDBulb 14-100W E27 6500K 230V TR	929001359283	220-240	14	100	E27	1521	6500	80	120	67	12	6.25



## CorePro LEDbulb



2700/3000/4000/6500



E 27



Dim Edilmez



15000 Saat



EEL



10 Adet



%85

Ürün	12 NC	Gerilim (V)	Güç (W)	Eşdeğer Güç (W)	Duy	Işık Akısı (lm)	Renk Sıcaklığı (K)	Renk Geriverim (Ra)	Maks. Uzunluk (mm)	Çap (mm)	Kutu Adedi	Fiyat (€)
CorePro LEDbulb ND 5.5-40W A60 E27 827	929001234202	220-240	5.5	40	E27	470	2700	80	110	60	10	3.45
CorePro LED bulb 5-40W A60 E27 830	929001304532	220-240	5	40	E27	470	3000	80	110	60	10	3.45
CorePro LEDbulb ND 5-40W A60 E27 840	929001234602	220-240	5	40	E27	470	4000	80	110	60	10	3.45
CorePro LED bulb ND 5-40W A60 E27 865	929001304632	220-240	5	40	E27	470	6500	80	110	60	10	3.45
CorePro LEDbulb ND 8-60W A60 E27 827	929001234302	220-240	8	60	E27	806	2700	80	110	60	10	3.95
CorePro LED bulb 7.5-60W A60 E27 830	929001304732	220-240	7.5	60	E27	806	3000	80	110	60	10	3.95
CorePro LEDbulb ND 7.5-60W A60 E27 840	929001234702	220-240	7.5	60	E27	806	4000	80	110	60	10	3.95
CorePro LED bulb ND 7.5-60W A60 E27 865	929001304832	220-240	7.5	60	E27	806	6500	80	110	60	10	3.95
CorePro LEDbulb ND 11-75W A60 E27 827	929001234402	220-240	11	75	E27	1055	2700	80	110	60	10	5.15
CorePro LEDbulb ND 10.5-75W A60 E27 830	929001162332	220-240	10.5	75	E27	1055	3000	80	110	60	10	5.15
CorePro LEDbulb ND 10-75W A60 E27 840	929001234802	220-240	10	75	E27	1055	4000	80	110	60	10	5.15
CorePro LEDbulb ND 10-75W A60 E27 865	929001163832	220-240	10	75	E27	1055	6500	80	110	60	10	5.15
CorePro LEDbulb ND 13-100W A60 E27 827	929001234502	220-240	13	100	E27	1521	2700	80	110	60	10	7.30
CorePro LEDbulb ND 13-100W A60 E27 830	929001235002	220-240	13	100	E27	1521	3000	80	110	60	10	7.30
CorePro LED bulb 12.5-100W A60 E27 840	929001312402	220-240	12.5	100	E27	1521	4000	80	110	60	10	7.30
CorePro LED bulb 12.5-100W A60 E27 865	929001312502	220-240	12.5	100	E27	1521	6500	80	110	60	10	7.30



## CorePro LEDbulb



Ürün	12 NC	Gerilim (V)	Güç (W)	Eşdeğer Güç (W)	Duy	Işık Akısı (lm)	Renk Sıcaklığı (K)	Renk Geriverim (Ra)	Maks. Uzunluk (mm)	Çap (mm)	Kutu Adedi	Fiyat (€)
CorePro LEDbulb ND 18.5-120W E27 827 A67	929001313202	220-240	18.5	120	E27	2000	2700	80	132	69	10	13.00
CorePro LEDbulb ND 18-120W E27 840 A67	929001313302	220-240	18	120	E27	2000	4000	80	132	69	10	13.00
CorePro LEDbulb ND 18-120W A67 865 E27	929001313402	220-240	18	120	E27	2000	6500	80	132	69	10	13.00
CorePro LED bulb ND 19.5-150W A67E27 827	929001892402	220-240	19.5	150	E27	2500	2700	80	132	69	6	21.65
CorePro LED bulb ND 17.5-150W A67E27 840	929001892502	220-240	17.5	150	E27	2500	4000	80	132	69	6	21.65
CorePro LED bulb ND 17.5-150W A67E27 865	929001892602	220-240	17.5	150	E27	2500	6500	80	132	69	6	21.65



## CorePro LEDbulb (Dim edilir)



Ürün	12 NC	Gerilim (V)	Güç (W)	Eşdeğer Güç (W)	Duy	Işık Akısı (lm)	Renk Sıcaklığı (K)	Renk Geriverim (Ra)	Maks. Uzunluk (mm)	Çap (mm)	Kutu Adedi	Fiyat (€)
CorePro LEDbulb D 5.5-40W A60 E27 827	929001352402	220-240	5.5	40	E27	470	2700	80	110	60	10	7.40
CorePro LEDbulb D 8.5-60W A60 E27 827	929001352502	220-240	8.5	60	E27	806	2700	80	110	60	10	8.85
CorePro LEDbulb D 11-75W A60 E27 827	929001352702	220-240	11	75	E27	1055	2700	80	110	60	10	9.55
CorePro LEDbulb D 13.5-100W A67 E27 827	929001352802	220-240	13.5	100	E27	1521	2700	80	137	70	10	14.20



## Classic Filament LEDbulb



Ürün	12 NC	Gerilim (V)	Güç (W)	Eşdeğer Güç (W)	Duy	Işık Akısı (lm)	Renk Sıcaklığı (K)	Renk Geriverim (Ra)	Maks. Uzunluk (mm)	Çap (mm)	Kutu Adedi	Fiyat (€)
CLA LEDBulb ND 4-40W A60 E27 827 CL	929001237102	220-240	4	40	E27	470	2700	80	104	60	10	5.80
CLA LEDBulb ND 4-40W A60 E27 840 CL	929001814902	220-240	4	40	E27	540	4000	80	106	60	10	5.80
CLA LEDBulb ND 4-40W A60 E27 865 CL	929001815102	220-240	4	40	E27	540	6500	80	106	60	10	5.80
CLA LEDBulb ND 7-60W E27 WW A60 CL	929001387302	220-240	7	60	E27	806	2700	80	104	60	10	6.90
CLA LEDBulb ND 7-60W A60 E27 840 CL	929001815002	220-240	7	60	E27	850	4000	80	106	60	10	6.90
CLA LEDBulb ND 7-60W A60 E27 865 CL	929001815202	220-240	7	60	E27	850	6500	80	106	60	10	6.90
CLA LEDBulb ND 8-75W E27 WW A60 CL	929001384002	220-240	8	75	E27	1055	2700	80	104	60	10	10.60
CLA LEDBulb ND 8-75W E27 CW A60 CL	929001384102	220-240	8	75	E27	1055	4000	80	104	60	10	10.60
CLA LEDBulb ND 8-75W A60 E27 865 CL	929001815302	220-240	8	75	E27	1055	6500	80	106	60	10	10.60
CLA LEDBulb ND 11-100W E27 WW A67 CL	929001384402	220-240	11	100	E27	1521	2700	80	124	70	10	20.00
CLA LEDBulb ND 11-100W E27 CW A67 CL	929001384502	220-240	11	100	E27	1521	4000	80	124	70	10	20.00
CLA LEDBulb ND 10-100W A67 E27 865 CL	929001815402	220-240	10	100	E27	1521	6500	80	128	70	10	20.00

# LED LAMBALAR

LEDbulb



## Classic Filament LEDbulb



2700



E 27



Dim Edilmez



15000 Saat



EEL



6-10 Adet



%88

Ürün	12 NC	Gerilim (V)	Güç (W)	Eşdeğer Güç (W)	Duy	Işık Akısı (lm)	Renk Sıcaklığı (K)	Renk Geriverim (Ra)	Maks. Uzunluk (mm)	Çap (mm)	Kutu Adedi	Fiyat (€)
CLA LEDBulb ND 7-60W E27 WW G93 CL	929001387902	220-240	7	60	E27	806	2700	80	140	95	6	8.85
CLA LEDBulb ND 4-40W ST64 E27 827 CL	929001237302	220-240	4	40	E27	470	2700	80	140	64	10	6.90
CLA LEDBulb ND 7-60W E27 WW ST64 CL	929001387602	220-240	7	60	E27	806	2700	80	140	64	10	7.50



## Classic Filament LEDbulb (Dim edilir)



2700



E 27



Dim Edilir



15000 Saat



EEL



6-10 Adet



%87

Ürün	12 NC	Gerilim (V)	Güç (W)	Eşdeğer Güç (W)	Duy	Işık Akısı (lm)	Renk Sıcaklığı (K)	Renk Geriverim (Ra)	Maks. Uzunluk (mm)	Çap (mm)	Kutu Adedi	Fiyat (€)
CLA LEDBulb D 5.5-40W A60 E27 827 CL	929001331002	220-240	5.5	40	E27	470	2700	80	104	60	10	7.75
CLA LEDBulb D 8-60W A60 E27 827 CL	929001331202	220-240	8	60	E27	806	2700	80	104	60	10	9.55
CLA LEDGlobe D 7-60W G93 E27 827 CL	929001229002	220-240	7	60	E27	806	2700	80	150	95	6	16.10
CLA LEDBulb D 7-60W ST64 E27 827 CL	929001228602	220-240	7	60	E27	806	2700	80	148	64	6	14.65



## Classic Filament LEDbulb (DimTone)



2200-2700



E 27



DimTone



15000 Saat



EEL



10 Adet



%86

Ürün	12 NC	Gerilim (V)	Güç (W)	Eşdeğer Güç (W)	Duy	Işık Akısı (lm)	Renk Sıcaklığı (K)	Renk Geriverim (Ra)	Maks. Uzunluk (mm)	Çap (mm)	Kutu Adedi	Fiyat (€)
CLA LEDBulb DT 5.5-40W A60 E27 CL	929001333602	220-240	5.5	40	E27	470	2200-2700	80	104	60	10	9.55
CLA LEDBulb DT 8-60W A60 E27 CL	929001333802	220-240	8	60	E27	806	2200-2700	80	104	60	10	12.30
CLA LEDBulb DT 8-60W ST64 E27 CL	929001334002	220-240	8	60	E27	806	2200-2700	80	140	64	10	15.50



## Gold Filament LEDbulb (Spiral Filament)



2000



E 27



Dim Edilmez



15000 Saat



EEL



6-10 Adet



%80

Ürün	12 NC	Gerilim (V)	Güç (W)	Eşdeğer Güç (W)	Duy	Işık Akısı (lm)	Renk Sıcaklığı (K)	Renk Geriverim (Ra)	Maks. Uzunluk (mm)	Çap (mm)	Kutu Adedi	Fiyat (€)
CLA LEDBulb SP ND 2.3-14W E27 GOLD A60CL	929001391902	220-240	2.3	14	E27	125	2000	80	106	60	10	17.15
CLA LEDBulb SP ND 5-25W E27 GOLD ST64 CL	929001392002	220-240	5	25	E27	250	2000	80	143	64	10	25.15
CLA LEDBulb SP ND 5-25W E27 GOLD G93 CL	929001392102	220-240	5	25	E27	250	2000	80	142	95	6	27.05





## Gold Filament LEDbulb (Spiral Filament)



2000



E 27



Dim Edilmez



15000 Saat



EEL



2 Adet



%80

Ürün	12 NC	Gerilim (V)	Güç (W)	Eşdeğer Güç (W)	Duy	Işık Akısı (lm)	Renk Sıcaklığı (K)	Renk Geriverim (Ra)	Maks. Uzunluk (mm)	Çap (mm)	Kutu Adedi	Fiyat (€)
CLA LEDBulb ND 5-25W E27 2000K G200 GOLD	929001817202	220-240	5	25	E27	300	2000	80	286	200	2	76.20
CLA LEDBulb ND 5-25W E27 2000K A160 GOLD	929001817102	220-240	5	25	E27	300	2000	80	293	160	2	66.70



## Gold Filament LEDbulb (Dim ediliyor)



2000/2500



E 27



Dim Edilir



15000 Saat



EEL



6-10 Adet



%84

Ürün	12 NC	Gerilim (V)	Güç (W)	Eşdeğer Güç (W)	Duy	Işık Akısı (lm)	Renk Sıcaklığı (K)	Renk Geriverim (Ra)	Maks. Uzunluk (mm)	Çap (mm)	Kutu Adedi	Fiyat (€)
CLA LEDBulb D 7.5-48W A60 E27 820 GOLD	929001332902	220-240	7.5	48	E27	610	2000	80	104	60	10	12.75
CLA LEDGlobe D 7-50W G120 E27 820 GOLD	929001229102	220-240	7	50	E27	630	2000	80	188	125	6	18.15
CLA LEDBulb D 7-50W ST64 E27 820 GOLD	929001228902	220-240	7	50	E27	630	2000	80	148	64	6	15.60
CLA LEDBulb D 7-55W ST64 E27 825 GOLD	929001228502	220-240	7	55	E27	720	2500	80	148	64	6	15.60



## MASTER LEDbulb (DimTone)



2200-2700



E 27



DimTone



25000 Saat



EEL



6-10 Adet



%85

Ürün	12 NC	Gerilim (V)	Güç (W)	Eşdeğer Güç (W)	Duy	Işık Akısı (lm)	Renk Sıcaklığı (K)	Renk Geriverim (Ra)	Maks. Uzunluk (mm)	Çap (mm)	Kutu Adedi	Fiyat (€)
MAS LED bulb DT 5-40WE27 927-922 A60FR	929001351302	220-240	5.5	40	E27	470	2200-2700	90	110	60	10	8.35
MAS LED bulb DT 9-60W E27 927-922 A60 FR	929001351402	220-240	9	60	E27	806	2200-2700	90	110	60	10	10.75
MAS LEDbulb DT 11-75W A67 E27 827 FR	929001200502	220-240	11	75	E27	1055	2200-2700	80	137.2	70.6	6	20.35
MAS LEDbulb DT 15-100W A67 E27 827 FR	929001184402	220-240	15	100	E27	1521	2200-2700	80	137.2	70.6	6	23.85
MAS LEDbulb DT 6-40W E27 A60 CL	929001150802	220-240	6	40	E27	470	2200-2700	80	110	60	10	8.35
MAS LEDbulb DT 8.5-60W E27 A60 CL	929001150932	220-240	8.5	60	E27	806	2200-2700	80	110	60	10	10.75



Şeffaf

Şeffaf

# LED LAMBALAR

## LEDcandle & LEDluster



### Essential LEDcandle



2700/4000



E14



Dim Edilmez



10000 Saat



EEL



12 Adet



%84

Ürün	12 NC	Gerilim (V)	Güç (W)	Eşdeğer Güç (W)	Duy	Işık Akısı (lm)	Renk Sıcaklığı (K)	Renk Geriverim (Ra)	Maks. Uzunluk (mm)	Çap (mm)	Kutu Adedi	Fiyat (€)
<b>MUM TİPİ</b>												
ESS LEDCandle 25W B35 E14 WW FR ND TRK	929001157483	220-240	4	25	E14	250	2700	80	106	35	12	3.45
ESS LEDCandle 40W B35 E14 WW FR ND TRK	929001157783	220-240	5.5	40	E14	470	2700	80	106	35	12	3.80
<b>MİNİ TOP TİPİ</b>												
ESS LEDcandle 40W P45 E14 WW FR ND TRK	929001157883	220-240	5.5	40	E14	470	2700	80	88	45	12	3.80
ESS LEDcandle 40W P45 E14 CW FR ND TRK	929001205983	220-240	5.5	40	E14	520	4000	80	88	45	12	3.80



### CorePro LEDcandle



2700/4000/6500



E14/E27



Dim Edilmez



15000 Saat



EEL



10 Adet



%84

Ürün	12 NC	Gerilim (V)	Güç (W)	Eşdeğer Güç (W)	Duy	Işık Akısı (lm)	Renk Sıcaklığı (K)	Renk Geriverim (Ra)	Maks. Uzunluk (mm)	Çap (mm)	Kutu Adedi	Fiyat (€)
CorePro candle ND 4-25W E14 827 B35 FR	929001157402	220-240	4	25	E14	250	2700	80	106	35	10	3.95
CorePro candle ND 3.5-25W E14 840 B35 FR	929001205602	220-240	3.5	25	E14	290	4000	80	106	35	10	3.95
CorePro candle ND 5.5-40W E14 827 B35 FR	929001157702	220-240	5.5	40	E14	470	2700	80	106	35	10	4.40
CorePro candle ND 5.5-40W E14 840 B35 FR	929001205802	220-240	5.5	40	E14	520	4000	80	106	35	10	4.40
CorePro candle ND 5.5-40W E14 865 B35 FR	929001394502	220-240	5.5	40	E14	520	6500	80	106	35	10	4.40
CorePro candle ND 7-60W E14 827 B38 FR	929001325102	220-240	7	60	E14	806	2700	80	114	38	10	8.25
CorePro candle ND 7-60W E14 840 B38 FR	929001325402	220-240	7	60	E14	830	4000	80	114	38	10	8.25
CorePro candle ND 7-60W E14 865 B38 FR	929001394702	220-240	7	60	E14	830	6500	80	114	38	10	8.25
Şeffaf Corepro Candle ND 4-25W E14 827 B35 CL	929001142202	220-240	4	25	E14	250	2700	80	106	35	10	3.95
Şeffaf Corepro candle ND 5.5-40W E14 827 B35 CL	929001142502	220-240	5.5	40	E14	470	2700	80	106	35	10	4.40
Şeffaf Corepro candle ND 5.5-40W E14 840 B35 CL	929001206002	220-240	5.5	40	E14	520	4000	80	106	35	10	4.40
Şeffaf Corepro candle ND 5.5-40W E27 827 B35 CL	929001324702	220-240	5.5	40	E27	470	2700	80	104	35	10	4.40



## CorePro LEDlustre



2700/4000/6500



E14/E27



Dim Edilmez



15000 Saat



EEL



10 Adet



%84

Ürün	12 NC	Gerilim (V)	Güç (W)	Eşdeğer Güç (W)	Duy	Işık Akısı (lm)	Renk Sıcaklığı (K)	Renk Geriverim (Ra)	Maks. Uzunluk (mm)	Çap (mm)	Kutu Adedi	Fiyat (€)
CorePro lustre ND 4-25W E14 827 P45 FR	929001157502	220-240	4	25	E14	250	2700	80	88	45	10	3.95
CorePro lustre ND 3.5-25W E14 840 P45 FR	929001205702	220-240	3.5	25	E14	290	4000	80	88	45	10	3.95
CorePro lustre ND 5.5-40W E14 827 P45 FR	929001157802	220-240	5.5	40	E14	470	2700	80	88	45	10	4.40
CorePro lustre ND 5.5-40W E14 840 P45 FR	929001205902	220-240	5.5	40	E14	520	4000	80	88	45	10	4.40
CorePro lustre ND 5.5-40W E14 865 P45 FR	929001394602	220-240	5.5	40	E14	520	6500	80	88	45	10	4.40
CorePro lustre ND 7-60W E14 827 P48 FR	929001325202	220-240	7	60	E14	806	2700	80	95	48	10	8.25
CorePro lustre ND 7-60W E14 840 P48 FR	929001325502	220-240	7	60	E14	830	4000	80	95	48	10	8.25
CorePro lustre ND 7-60W E14 865 P48 FR	929001394802	220-240	7	60	E14	830	6500	80	95	48	10	8.25
CorePro lustre ND 4-25W E27 827 P45 FR	929001157602	220-240	4	25	E27	250	2700	80	87	45	10	3.95
Corepro Lustre ND 5.5-40W E27 827 P45 FR	929001175402	220-240	5.5	40	E27	470	2700	80	87	45	10	4.40
CorePro lustre ND 7-60W E27 827 P48 FR	929001325302	220-240	7	60	E27	806	2700	80	93	48	10	8.25
CorePro lustre ND 7-60W E27 840 P48 FR	929001325602	220-240	7	60	E27	830	4000	80	93	48	10	8.25



## CorePro LEDlustre (Şeffaf)



2700/4000



E14/E27



Dim Edilmez



15000 Saat



EEL



10 Adet



%84

Ürün	12 NC	Gerilim (V)	Güç (W)	Eşdeğer Güç (W)	Duy	Işık Akısı (lm)	Renk Sıcaklığı (K)	Renk Geriverim (Ra)	Maks. Uzunluk (mm)	Çap (mm)	Kutu Adedi	Fiyat (€)
Corepro Lustre ND 4-25W E14 827 P45 CL	929001142302	220-240	4	25	E14	250	2700	80	88	45	10	3.95
Corepro lustre ND 5.5-40W E14 827 P45 CL	929001142602	220-240	5.5	40	E14	470	2700	80	88	45	10	4.40
Corepro lustre ND 5.5-40W E14 840 P45 CL	929001206102	220-240	5.5	40	E14	520	4000	80	88	45	10	4.40
Corepro Lustre ND 4-25W E27 827 P45 CL	929001142402	220-240	4	25	E27	250	2700	80	87	45	10	3.95
Corepro Lustre ND 5.5-40W E27 827 P45 CL	929001175302	220-240	5.5	40	E27	470	2700	80	87	45	10	4.40

ŞEFFAF

# LED LAMBALAR

## LEDcandle & LEDluster



### Classic Filament LEDcandle



2700



E14



Dim Edilmez



15000 Saat



EEL



10 Adet



%90

Ürün	12 NC	Gerilim (V)	Güç (W)	Eşdeğer Güç (W)	Duy	Işık Akısı (lm)	Renk Sıcaklığı (K)	Renk Geriverim (Ra)	Maks. Uzunluk (mm)	Çap (mm)	Kutu Adedi	Fiyat (€)
<b>MUM TIPI</b>												
CLA LEDCandle ND 2-25W B35 E14 827 CL	929001238302	220-240	2	25	E14	250	2700	80	97	35	10	5.40
CLA LEDCandle ND 4-40W B35 E14 827 CL	929001258002	220-240	4	40	E14	470	2700	80	97	35	10	6.65
<b>KUĞU MUM TIPI</b>												
CLA LEDCandle ND 2-25W BA35 E14 827 CL	929001238402	220-240	2	25	E14	250	2700	80	123	35	10	5.40
<b>BURGU MUM TIPI</b>												
CLA LEDCandle ND 2-25W ST35 E14 827 CL	929001238502	220-240	2	25	E14	250	2700	80	97	35	10	5.40



### Classic Filament LEDcandle (Dim edilir)



2700



E14



Dim Edilir



15000 Saat



EEL



10 Adet



%87

Ürün	12 NC	Gerilim (V)	Güç (W)	Eşdeğer Güç (W)	Duy	Işık Akısı (lm)	Renk Sıcaklığı (K)	Renk Geriverim (Ra)	Maks. Uzunluk (mm)	Çap (mm)	Kutu Adedi	Fiyat (€)
<b>MUM TIPI</b>												
CLA LEDCandle D 2.7-25W B35 E14 827 CL	929001332002	220-240	2.7	25	E14	250	2700	80	103	35	10	8.25
CLA LEDCandle D 5-40W B35 E14 827 CL	929001332102	220-240	5	40	E14	470	2700	80	103	35	10	8.95
<b>KUĞU MUM TIPI</b>												
CLA LEDCandle D 5-40W BA35 E14 827 CL	929001332802	220-240	5	40	E14	470	2700	80	129	35	10	8.95



### Classic Filament LEDluster



2700



E14/E27



Dim Edilmez



15000 Saat



EEL



10 Adet



%90

Ürün	12 NC	Gerilim (V)	Güç (W)	Eşdeğer Güç (W)	Duy	Işık Akısı (lm)	Renk Sıcaklığı (K)	Renk Geriverim (Ra)	Maks. Uzunluk (mm)	Çap (mm)	Kutu Adedi	Fiyat (€)
CLA LEDLuster ND 2-25W P45 E14 827 CL	929001238602	220-240	2	25	E14	250	2700	80	80	45	10	5.15
CLA LEDLuster ND 4-40W P45 E14 827 CL	929001258102	220-240	4	40	E14	470	2700	80	80	45	10	6.35
CLA LEDLuster ND 2-25W P45 E27 827 CL	929001238702	220-240	2	25	E27	250	2700	80	78	45	10	5.15
CLA LEDLuster ND 4-40W P45 E27 827 CL	929001258202	220-240	4	40	E27	470	2700	80	78	45	10	6.35





## Classic Filament LEDluster (Dim edilir)



2700



E14/E27



Dim Edilir



15000 Saat



EEL



10 Adet



%87

Ürün	12 NC	Gerilim (V)	Güç (W)	Eşdeğer Güç (W)	Duy	Işık Akısı (lm)	Renk Sıcaklığı (K)	Renk Geriverim (Ra)	Maks. Uzunluk (mm)	Çap (mm)	Kutu Adedi	Fiyat (€)
CLA LEDLuster D 2.7-25W P45 E14 827 CL	929001332302	220-240	2.7	25	E14	250	2700	80	85	45	10	8.25
CLA LEDLuster D 5-40W P45 E14 827 CL	929001332502	220-240	5	40	E14	470	2700	80	85	45	10	8.95
CLA LEDLuster D 2.7-25W P45 E27 827 CL	929001332402	220-240	2.7	25	E27	250	2700	80	80	45	10	8.25
CLA LEDLuster D 5-40W P45 E27 827 CL	929001332602	220-240	5	40	E27	470	2700	80	80	45	10	8.95



## CLA LEDcandle (Buzlu Cam)



2700



E14



Dim Edilmez



15000 Saat



EEL



10 Adet



%89

Ürün	12 NC	Gerilim (V)	Güç (W)	Eşdeğer Güç (W)	Duy	Işık Akısı (lm)	Renk Sıcaklığı (K)	Renk Geriverim (Ra)	Maks. Uzunluk (mm)	Çap (mm)	Kutu Adedi	Fiyat (€)
<b>MUM TİPİ</b>												
CLA LEDCandle ND 2.2-25W B35 E14 FR	929001345202	220-240	2.2	25	E14	250	2700	80	97	35	10	5.15
CLA LEDCandle ND 4.3-40W B35 E14 FR	929001345302	220-240	4.3	40	E14	470	2700	80	97	35	10	6.35
<b>KUĞU MUM TİPİ</b>												
CLA LEDCandle ND 2.2-25W BA35 E14 FR	929001345802	220-240	2.2	25	E14	250	2700	80	123	35	10	5.15



## CLA LEDluster (Buzlu Cam)



2700



E14/E27



Dim Edilmez



15000 Saat



EEL



10 Adet



%89

Ürün	12 NC	Gerilim (V)	Güç (W)	Eşdeğer Güç (W)	Duy	Işık Akısı (lm)	Renk Sıcaklığı (K)	Renk Geriverim (Ra)	Maks. Uzunluk (mm)	Çap (mm)	Kutu Adedi	Fiyat (€)
CLA LEDLuster ND 2.2-25W P45 E14 FR	929001345402	220-240	2.2	25	E14	250	2700	80	80	45	10	5.15
CLA LEDLuster ND 4.3-40W P45 E14 FR	929001345502	220-240	4.3	40	E14	470	2700	80	80	45	10	6.35
CLA LEDLuster ND 2.2-25W P45 E27 FR	929001345602	220-240	2.2	25	E27	250	2700	80	78	45	10	5.15
CLA LEDLuster ND 4.3-40W P45 E27 FR	929001345702	220-240	4.3	40	E27	470	2700	80	78	45	10	6.35

# LED LAMBALAR

## LEDcandle & LEDluster



### Gold Filament LEDcandle



2000/2500



E14



Dim Edilir



Dim Edilmez



15000 Saat



EEL



10 Adet



%83

Ürün	12 NC	Gerilim (V)	Güç (W)	Eşdeğer Güç (W)	Duy	Işık Akısı (lm)	Renk Sıcaklığı (K)	Renk Geriverim (Ra)	Maks. Uzunluk (mm)	Çap (mm)	Kutu Adedi	Fiyat (€)
<b>SPIRAL FILAMENT</b>												
CLA LEDCandle ND 2.3-14W B35 E14 SP GOLD	929001814502	220-240	2.3	14	E14	125	2000	80	99	35	10	17.15
<b>MUM TIPI (Dim Edilir)</b>												
CLA LEDCandle D 5-35W E14 GOLD B35 CL	929001395202	220-240	5	35	E14	410	2500	80	102	35	10	10.50
<b>KUĞU MUM TIPI (Dim Edilir)</b>												
CLA LEDBulb D 5-35W E14 GOLD BA35 CL	929001395402	220-240	5	35	E14	410	2500	80	129	35	10	10.50



### Gold Filament LEDluster (Dim edilir)



2500



E14/E27



Dim Edilir



15000 Saat



EEL



10 Adet



%85

Ürün	12 NC	Gerilim (V)	Güç (W)	Eşdeğer Güç (W)	Duy	Işık Akısı (lm)	Renk Sıcaklığı (K)	Renk Geriverim (Ra)	Maks. Uzunluk (mm)	Çap (mm)	Kutu Adedi	Fiyat (€)
CLA LEDLuster D 5-35W E14 GOLD P45 CL	929001395302	220-240	5	35	E14	410	2500	80	92	45	10	10.50
CLA LEDLuster D 5-35W E27 GOLD P45 CL	929001395502	220-240	5	35	E27	410	2500	80	80	45	10	10.50



### MASTER LEDcandle (DimTone)



2200/2700



E14/E27



DimTone



25000 Saat



EEL



10 Adet



%84

Ürün	12 NC	Gerilim (V)	Güç (W)	Eşdeğer Güç (W)	Duy	Işık Akısı (lm)	Renk Sıcaklığı (K)	Renk Geriverim (Ra)	Maks. Uzunluk (mm)	Çap (mm)	Kutu Adedi	Fiyat (€)
<b>MUM TIPI</b>												
MAS LEDcandle DT 4-25W E14 B38 CL	929001139802	220-240	4	25	E14	250	2200-2700	80	113	38	10	6.70
MAS LEDcandle DT 6-40W E14 B38 CL	929001140402	220-240	6	40	E14	470	2200-2700	80	113	38	10	7.65
MAS LEDcandle DT 8-60W B40 E14 827 CL	929001211702	220-240	8	60	E14	806	2200-2700	80	127	40	10	10.95
MAS LEDcandle DT 6-40W E27 B38 CL	929001157902	220-240	6	40	E27	470	2200-2700	80	112	38	10	7.65
<b>KUĞU MUM TIPI</b>												
MAS LEDcandle DT 4-25W E14 BA38 CL	929001139902	220-240	4	25	E14	250	2200-2700	80	129	38	10	6.70
MAS LEDcandle DT 6-40W E14 BA38 CL	929001140502	220-240	6	40	E14	470	2200-2700	80	129	38	10	7.65



### MASTER LEDlustre (DimTone)



2200/2700



E14/E27



DimTone



25000 Saat



EEL



10 Adet



%84



Ürün	12 NC	Gerilim (V)	Güç (W)	Eşdeğer Güç (W)	Duy	Işık Akısı (lm)	Renk Sıcaklığı (K)	Renk Geriverim (Ra)	Maks. Uzunluk (mm)	Çap (mm)	Kutu Adedi	Fiyat (€)
MAS LEDlustre DT 4-25W E14 P48 CL	929001140002	220-240	4	25	E14	250	2200-2700	80	95	48	10	6.70
MAS LEDlustre DT 6-40W E14 P48 CL	929001140602	220-240	6	40	E14	470	2200-2700	80	95	48	10	7.65
MAS LEDlustre DT 8-60W P50 E14 827 CL	929001211902	220-240	8	60	E14	806	2200-2700	80	111	50	10	10.95
MAS LEDlustre DT 4-25W E27 P48 CL	929001140102	220-240	4	25	E27	250	2200-2700	80	93	48	10	6.70
MAS LEDlustre DT 6-40W E27 P48 CL	929001140702	220-240	6	40	E27	470	2200-2700	80	93	48	10	7.65

## Benzersiz dim deneyimi: DimTone

Işık, dim edildiğinde sıcak tonlara yaklaşır.  
(2200K - 2700K arası)

DimTone özelliği ile LED lambaların dim edilme özelliği yeni bir seviyeye ulaşıyor. Bu özellik sayesinde hem ışığın parlaklığını hem de ışık rengini ayarlayabilirsiniz. 2700K sarı renk sıcaklığını 2200K "gün batımı" renk sıcaklığına kadar kısararak, sıcak ambiyanslar yakalayabilirsiniz.



2200 K

2700 K



### Essential LEDspot MV



Ürün	12 NC	Gerilim (V)	Güç (W)	Eşdeğer Güç (W)	Duy	Işık Akısı (lm)	Renk Sıcaklığı (K)	Renk Geriverim (Ra)	Maks. Uzunluk (mm)	Çap (mm)	Kutu Adedi	Fiyat (€)
ESS LEDspots 50W GU10 WW 36D ND TR	929001250487	220-240	4.7	50	GU10	380	2700	80	54	50	10	3.25
ESS LEDspots 50W GU10 CW 36D ND TR	929001247087	220-240	4.7	50	GU10	420	4000	80	54	50	10	3.25



### CorePro LEDspot MV



Ürün	12 NC	Gerilim (V)	Güç (W)	Eşdeğer Güç (W)	Duy	Işık Akısı (lm)	Renk Sıcaklığı (K)	Renk Geriverim (Ra)	Maks. Uzunluk (mm)	Çap (mm)	Kutu Adedi	Fiyat (€)
CorePro LEDspot 31-25W GU10 827 36D	929001217532	220-240	3.1	25	GU10	215	2700	80	54	50	10	3.85
CorePro LEDspot 31-25W GU10 830 36D	929001217602	220-240	2	25	GU10	190	3000	80	54	50	10	3.85
CorePro LEDspot 31-25W GU10 840 36D	929001217702	220-240	2	25	GU10	205	4000	80	54	50	10	3.85
CorePro LEDspot 3.5-35W GU10 827 36D	929001217862	220-240	3.5	35	GU10	255	2700	80	54	50	10	3.85
CorePro LEDspot 3.5-35W GU10 830 36D	929001217902	220-240	3.5	35	GU10	275	3000	80	54	50	10	3.85
CorePro LEDspot 3.5-35W GU10 840 36D	929001218002	220-240	3.5	35	GU10	300	4000	80	54	50	10	3.85
CorePro LEDspot 4.6-50W GU10 827 36D	929001215232	220-240	4.6	50	GU10	355	2700	80	54	50	10	4.05
CorePro LEDspot 4.6-50W GU10 830 36D	929001218102	220-240	5	50	GU10	385	3000	80	54	50	10	4.05
CorePro LEDspot 4.6-50W GU10 840 36D	929001218202	220-240	4.6	50	GU10	390	4000	80	54	50	10	4.05
CorePro LEDspot 5-65W GU10 830 36D ND	929001381202	220-240	5	65	GU10	520	3000	80	54	50	10	5.15
CorePro LEDspot 5-65W GU10 840 36D ND	929001381302	220-240	5	65	GU10	540	4000	80	54	50	10	5.15
CorePro LEDspot 550lm GU10 830 120D	929001297232	220-240	5		GU10	550	3000	80	54	50	10	5.15
CorePro LEDspot 550lm GU10 840 120D	929001297332	220-240	5		GU10	550	4000	80	54	50	10	5.15
CorePro LEDspot 550lm GU10 865 120D	929001297432	220-240	5		GU10	550	6500	80	54	50	10	5.15
<b>DİM EDİLİR</b>												
CorePro LEDspot 4-35W GU10 827 36D DIM	929001218632	220-240	4	35	GU10	280	2700	80	54	50	10	5.35
CorePro LEDspot 4-35W GU10 830 36D DIM	929001363902	220-240	4	35	GU10	290	3000	80	54	50	10	5.35
CorePro LEDspot 4-35W GU10 840 36D DIM	929001364002	220-240	4	35	GU10	305	4000	80	54	50	10	5.35
CorePro LEDspot 5-50W GU10 827 36D DIM	929001218832	220-240	5	50	GU10	395	2700	80	54	50	10	5.95
CorePro LEDspot 5-50W GU10 830 36D DIM	929001364202	220-240	5	50	GU10	405	3000	80	54	50	10	5.95
CorePro LEDspot 5-50W GU10 840 36D DIM	929001364302	220-240	5	50	GU10	425	4000	80	54	50	10	5.95





# LED LAMBALAR

## LEDspot



### CorePro LEDspot LV



2700/3000/4000



GU5.3



Dim Edilmez



15000 Saat



EEL



10 Adet



Huzme Açısı



%84

Ürün	12 NC	Gerilim (V)	Güç (W)	Esdeğer Güç (W)	Duy	Işık Akısı (lm)	Renk Sıcaklığı (K)	Renk Geriverim (Ra)	Maks. Uzunluk (mm)	Çap (mm)	Kutu Adedi	Fiyat (€)
CorePro LED spot ND 3-20W MR16 827 36D	929001344002	12	3	20	GU5.3	230	2700	80	46	51	10	5.50
CorePro LED spot ND 5-35W MR16 827 36D	929001344302	12	5	35	GU5.3	345	2700	80	46	51	10	6.45
CorePro LED spot ND 5-35W MR16 840 36D	929001344502	12	5	35	GU5.3	390	4000	80	46	51	10	6.45
CorePro LED spot ND 8-50W MR16 827 36D	929001344902	12	8	50	GU5.3	621	2700	80	50	51	10	12.65
CorePro LED spot ND 8-50W MR16 830 36D	929001345002	12	8	50	GU5.3	621	3000	80	50	51	10	12.65
CorePro LED spot ND 8-50W MR16 840 36D	929001345102	12	8	50	GU5.3	630	4000	80	50	51	10	12.65



### CorePro LEDspot LV MR11



2700



GU4



Dim Edilmez



15000 Saat



EEL



12 Adet



%85

Ürün	12 NC	Gerilim (V)	Güç (W)	Esdeğer Güç (W)	Duy	Işık Akısı (lm)	Renk Sıcaklığı (K)	Renk Geriverim (Ra)	Maks. Uzunluk (mm)	Çap (mm)	Kutu Adedi	Fiyat (€)
CorePro LED spot 2.6-20W 827 MR11 36D	929001339202	12	2.6	20	GU4	190	2700	80	37.5	35	12	9.55

## Tasarım odaklı LED spot aydınlatma

Zarif tasarımlı yeni Philips MASTER LEDSpot LV AR111; mağaza, galeri, restoran, otel ve müze aydınlatma uygulamaları için idealdir. CRI 90 renksel geriverim indeksine sahip bu lambalar sayesinde renkler daha canlı ve parlak görünür. Yenilenen reflektör tasarımı, ışığı tek noktada toplayarak gölgelenme riskini azaltır. Kamaşma önleyici "anti-glare" özelliği ise artırılmış kullanıcı konforu sunar.





### CorePro LEDcapsule G4



Ürün	12 NC	Gerilim (V)	Güç (W)	Eşdeğer Güç (W)	Duy	Işık Akısı (lm)	Renk Sıcaklığı (K)	Renk Geriverim (Ra)	Maks. Uzunluk (mm)	Çap (mm)	Kutu Adedi	Fiyat (€)
CorePro LEDcapsuleLV 1.2-10W G4 827	929001244302	12	1.2	10	G4	120	2700	80	39.2	14.3	12	5.15
CorePro LEDcapsuleLV 1.2-10W 830 G4	929001118702	12	1.2	10	G4	105	3000	80	39.2	14.3	12	5.15
CorePro LEDcapsuleLV 2-20W G4 827	929001244402	12	2	20	G4	200	2700	80	45	14.3	12	6.80
CorePro LEDcapsuleLV 2-20W 830 G4	929001131802	12	2	20	G4	200	3000	80	45	14.3	12	6.80
Dim edilir CorePro LEDcapsuleLV 2-20W G4 827 D	929001235302	12	2	20	G4	200	2700	80	48	17	12	8.25



### CorePro LEDcapsule G9

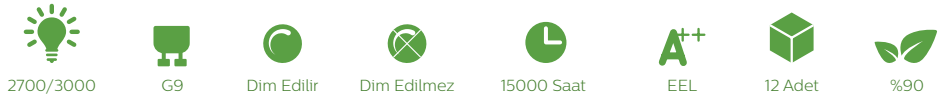

Ürün	12 NC	Gerilim (V)	Güç (W)	Eşdeğer Güç (W)	Duy	Işık Akısı (lm)	Renk Sıcaklığı (K)	Renk Geriverim (Ra)	Maks. Uzunluk (mm)	Çap (mm)	Kutu Adedi	Fiyat (€)
CorePro LEDcapsule ND 1.9-25W G9 827	929001323802	220-240	1.9	25	G9	204	2700	80	48	16.5	12	7.95
CorePro LEDcapsule ND 1.9-25W G9 830	929001364702	220-240	1.9	25	G9	210	3000	80	48	16.5	12	7.95
CorePro LEDcapsule ND 2.8-35W G9 827	929001357702	220-240	2.8	35	G9	315	2700	80	49	16	12	11.35
CorePro LEDcapsule ND 2.8-35W G9 830	929001357802	220-240	2.8	35	G9	315	3000	80	49	16	12	11.35
Dim edilir CorePro LEDcapsuleMV 2.3-25W G9 827 D	929001232002	220-240	2.3	25	G9	215	2700	80	51	23	12	10.15



### Corepro LEDspot R



Ürün	12 NC	Gerilim (V)	Güç (W)	Eşdeğer Güç (W)	Duy	Işık Akısı (lm)	Renk Sıcaklığı (K)	Renk Geriverim (Ra)	Maks. Uzunluk (mm)	Çap (mm)	Kutu Adedi	Fiyat (€)
CorePro LEDspotMV ND 2.2-30W 827 R39 36D	929001235502	220-240	2.2	28	E14	150	2700	80	66	39	6	5.15
CorePro LEDspotMV ND 1.7-25W 827 R50 36D	929001235802	220-240	1.7	25	E14	135	2700	80	81	51	6	5.85
CorePro LEDspotMV ND 2.9-40W 827 R50 36D	929001235902	220-240	2.9	40	E14	230	2700	80	81	51	6	6.70
CorePro LEDspotMV ND 2.7-40W 827 R63 36D	929001233602	220-240	2.7	40	E27	210	2700	80	102	63	6	11.35
CorePro LEDspotMV ND 3.7-60W 827 R80 40D	929001235602	220-240	3.7	60	E27	370	2700	80	113	80	6	8.60
CorePro LEDspotMV ND 7-100W 827 R80 40D	929001235702	220-240	7	100	E27	667	2700	80	113	80	6	10.60



### Corepro LEDspot R (Dim edilir)



Ürün	12 NC	Gerilim (V)	Güç (W)	Eşdeğer Güç (W)	Duy	Işık Akısı (lm)	Renk Sıcaklığı (K)	Renk Geriverim (Ra)	Maks. Uzunluk (mm)	Çap (mm)	Kutu Adedi	Fiyat (€)
CorePro LEDspotMV D 5-60W 827 R50 36D	929001236002	220-240	5	60	E14	320	2700	80	81	51	6	8.10
CorePro LEDspotMV D 5.7-60W 827 R63 36D	929001114402	220-240	5.7	60	E27	345	2700	80	102	63	6	15.75



## CorePro R7s



3000/4000



R7s



Dim Editir



Dim Edilmez



15000 Saat



EEL



10 Adet



%86

Ürün	12 NC	Gerilim (V)	Güç (W)	Eşdeğer Güç (W)	Duy	Işık Akısı (lm)	Renk Sıcaklığı (K)	Renk Geriverim (Ra)	Maks. Uzunluk (mm)	Çap (mm)	Kutu Adedi	Fiyat (€)
CorePro LEDlinear ND 7.5-60W R7S 78mm830	929001339002	220-240	7.5	60	R7S	950	3000	80	78	29	10	24.40
CorePro LEDlinear ND 7.5-60W R7S 78mm840	929001339102	220-240	7.5	60	R7S	1000	4000	80	78	29	10	24.40
CorePro R7S 118mm 6.5-60W 830	929001186102	220-240	6.5	60	R7S	806	3000	80	118	22.5	10	15.75
<b>DİM EDİLİR</b>												
CorePro R7S 118mm 14-100W 830 D	929001243702	220-240	14	100	R7S	1600	3000	80	118	29	10	30.95
CorePro R7S 118mm 14-100W 840 D	929001243802	220-240	14	100	R7S	1800	4000	80	118	29	10	30.95
CorePro LED linear D 14-120W R7S 118 830	929001353602	220-240	14	120	R7S	2000	3000	80	118	29	10	38.10
CorePro LED linear D 14-120W R7S 118 840	929001353702	220-240	14	120	R7S	2000	4000	80	118	29	10	38.10



## MASTER Value LEDspot MV

2200/2700/  
3000/4000/6500

GU10



Dim Editir



DimTone



25000 Saat



EEL



10 Adet



%86

Ürün	12 NC	Gerilim (V)	Güç (W)	Eşdeğer Güç (W)	Duy	Işık Akısı (lm)	Renk Sıcaklığı (K)	Renk Geriverim (Ra)	Maks. Uzunluk (mm)	Çap (mm)	Kutu Adedi	Fiyat (€)
MAS LEDspotMV VLE D 3.5-25W GU10 827 40D	929001215402	220-240	3.5	25	GU10	230	2700	80	56	50	10	6.00
MAS LED spot VLE D 3.7-35W GU10 927 36D	929001348202	220-240	3.7	35	GU10	260	2700	90	54	50	10	6.80
MAS LED spot VLE D 3.7-35W GU10 927 60D	929001348502	220-240	3.7	35	GU10	260	2700	90	54	50	10	6.80
MAS LED spot VLE D 3.7-35W GU10 930 36D	929001348302	220-240	3.7	35	GU10	270	3000	90	54	50	10	6.80
MAS LED spot VLE D 3.7-35W GU10 930 60D	929001348602	220-240	3.7	35	GU10	270	3000	90	54	50	10	6.80
MAS LED spot VLE D 3.7-35W GU10 940 36D	929001348402	220-240	3.7	35	GU10	285	4000	90	54	50	10	6.80
MAS LED spot VLE D 3.7-35W GU10 940 60D	929001348702	220-240	3.7	35	GU10	285	4000	90	54	50	10	6.80
MAS LED spot VLE D 4.9-50W GU10 927 36D	929001348802	220-240	4.9	50	GU10	355	2700	90	54	50	10	7.75
MAS LED spot VLE D 4.9-50W GU10 927 60D	929001349102	220-240	4.9	50	GU10	355	2700	90	54	50	10	7.75
MAS LED spot VLE D 4.9-50W GU10 930 36D	929001348902	220-240	4.9	50	GU10	365	3000	90	54	50	10	7.75
MAS LED spot VLE D 4.9-50W GU10 930 60D	929001349202	220-240	4.9	50	GU10	365	3000	90	54	50	10	7.75
MAS LED spot VLE D 4.9-50W GU10 940 36D	929001349002	220-240	4.9	50	GU10	380	4000	90	54	50	10	7.75
MAS LED spot VLE D 4.9-50W GU10 940 60D	929001349302	220-240	4.9	50	GU10	380	4000	90	54	50	10	7.75
MAS LED spot VLE D 7-80W GU10 830 36D	929001349402	220-240	7	80	GU10	590	3000	80	54	50	10	10.60
MAS LED spot VLE D 7-80W GU10 840 36D	929001349502	220-240	7	80	GU10	610	4000	80	54	50	10	10.60
MAS LED spot VLE D 7-80W GU10 865 36D	929001349602	220-240	7	80	GU10	610	6500	80	54	50	10	10.60
MAS LED spot VLE D 650lm GU10 830 120D	929001349702	220-240	7		GU10	650	3000	80	54	50	10	10.60
MAS LED spot VLE D 680lm GU10 840 120D	929001349802	220-240	7		GU10	680	4000	80	54	50	10	10.60
MAS LED spot VLE D 680lm GU10 865 120D	929001349902	220-240	7		GU10	680	6500	80	54	50	10	10.60
<b>DIMTONE</b>												
MAS LED spot VLE DT 3.7-35W GU10 927 36D	929001350002	220-240	3.7	35	GU10	290	2200-2700	90	54	50	10	8.25
MAS LED spot VLE DT 4.9-50W GU10 927 36D	929001350302	220-240	4.9	50	GU10	395	2200-2700	90	54	50	10	9.40





### MASTER Value LEDspot LV



2700/3000/4000



GU5.3



Dim Edilir



25000 Saat



EEL



10 Adet



Huzme Açısı



%84

Ürün	12 NC	Gerilim (V)	Güç (W)	Eşdeğer Güç (W)	Duy	Işık Akısı (lm)	Renk Sıcaklığı (K)	Renk Geriverim (Ra)	Maks. Uzunluk (mm)	Çap (mm)	Kutu Adedi	Fiyat (€)
MAS LED spot VLE D 5.5-35W MR16 827 36D	929001325902	12	5.5	35	GU5.3	450	2700	80	45	50.5	10	12.50
MAS LED spot VLE D 5.5-35W MR16 827 60D	929001326202	12	5.5	35	GU5.3	450	2700	80	45	50.5	10	12.50
MAS LED spot VLE D 5.5-35W MR16 830 36D	929001326002	12	5.5	35	GU5.3	460	3000	80	45	50.5	10	12.50
MAS LED spot VLE D 5.5-35W MR16 830 60D	929001326302	12	5.5	35	GU5.3	460	3000	80	45	50.5	10	12.50
MAS LED spot VLE D 5.5-35W MR16 840 36D	929001326102	12	5.5	35	GU5.3	490	4000	80	45	50.5	10	12.50
MAS LED spot VLE D 5.5-35W MR16 840 60D	929001326402	12	5.5	35	GU5.3	490	4000	80	45	50.5	10	12.50
MAS LED SPOT VLE D 7-50W MR16 827 36D	929001326502	12	7	50	GU5.3	621	2700	80	49.5	50.5	10	16.70
MAS LED SPOT VLE D 7-50W MR16 827 60D	929001326802	12	7	50	GU5.3	621	2700	80	49.5	50.5	10	16.70
MAS LED SPOT VLE D 7-50W MR16 830 36D	929001326602	12	7	50	GU5.3	630	3000	80	49.5	50.5	10	16.70
MAS LED SPOT VLE D 7-50W MR16 830 60D	929001326902	12	7	50	GU5.3	630	3000	80	49.5	50.5	10	16.70
MAS LED SPOT VLE D 7-50W MR16 840 36D	929001326702	12	7	50	GU5.3	660	4000	80	49.5	50.5	10	16.70
MAS LED SPOT VLE D 7-50W MR16 840 60D	929001327002	12	7	50	GU5.3	660	4000	80	49.5	50.5	10	16.70

### MASTER LEDspot ExpertColor MV



2700/3000/4000



GU10



Dim Edilir



40000 Saat



EEL



10 Adet



Huzme Açısı



%88

Ürün	12 NC	Gerilim (V)	Güç (W)	Eşdeğer Güç (W)	Duy	Işık Akısı (lm)	Renk Sıcaklığı (K)	Renk Geriverim (Ra)	Maks. Uzunluk (mm)	Çap (mm)	Kutu Adedi	Fiyat (€)
MAS LED ExpertColor 3.9-35W GU10 927 25D	929001346402	220-240	3.9	35	GU10	265	2700	97	54	50	10	13.70
MAS LED ExpertColor 3.9-35W GU10 927 36D	929001346702	220-240	3.9	35	GU10	265	2700	97	54	50	10	13.70
MAS LED ExpertColor 3.9-35W GU10 930 25D	929001346502	220-240	3.9	35	GU10	280	3000	97	54	50	10	13.70
MAS LED ExpertColor 3.9-35W GU10 930 36D	929001346802	220-240	3.9	35	GU10	280	3000	97	54	50	10	13.70
MAS LED ExpertColor 3.9-35W GU10 940 25D	929001346602	220-240	3.9	35	GU10	300	4000	97	54	50	10	13.70
MAS LED ExpertColor 3.9-35W GU10 940 36D	929001346902	220-240	3.9	35	GU10	300	4000	97	54	50	10	13.70
MAS LED ExpertColor 5.5-50W GU10 927 25D	929001347002	220-240	5.5	50	GU10	355	2700	97	54	50	10	15.50
MAS LED ExpertColor 5.5-50W GU10 927 36D	929001347302	220-240	5.5	50	GU10	355	2700	97	54	50	10	15.50
MAS LED ExpertColor 5.5-50W GU10 930 25D	929001347102	220-240	5.5	50	GU10	375	3000	97	54	50	10	15.50
MAS LED ExpertColor 5.5-50W GU10 930 36D	929001347402	220-240	5.5	50	GU10	375	3000	97	54	50	10	15.50
MAS LED ExpertColor 5.5-50W GU10 940 25D	929001347202	220-240	5.5	50	GU10	400	4000	97	54	50	10	15.50
MAS LED ExpertColor 5.5-50W GU10 940 36D	929001347502	220-240	5.5	50	GU10	400	4000	97	54	50	10	15.50





## MASTER LEDspot ExpertColor LV



2700/3000/4000



GU5.3



Dim Edilir

15000 Saat  
25000 Saat

EEL



10 Adet



10°



24°



36°



60°



%81



%81

Ürün	12 NC	Gerilim (V)	Güç (W)	Eşdeğer Güç (W)	Duy	Işık Akısı (lm)	Renk Sıcaklığı (K)	Renk Geriverim (Ra)	Maks. Uzunluk (mm)	Çap (mm)	Kutu Adedi	Fiyat (€)
MAS LED ExpertColor 6.5-35W MR16 927 10D	929001341702	12	6.5	35	GU5.3	450	2700	97	46	50.5	10	25.60
MAS LED ExpertColor 6.5-35W MR16 927 24D	929001342002	12	6.5	35	GU5.3	450	2700	97	46	50.5	10	25.60
MAS LED ExpertColor 6.5-35W MR16 927 36D	929001342302	12	6.5	35	GU5.3	450	2700	97	46	50.5	10	25.60
MAS LED ExpertColor 6.5-35W MR16 927 60D	929001341402	12	6.5	35	GU5.3	430	2700	97	46	50.5	10	25.60
MAS LED ExpertColor 6.5-35W MR16 930 10D	929001341802	12	6.5	35	GU5.3	470	3000	97	46	50.5	10	25.60
MAS LED ExpertColor 6.5-35W MR16 930 24D	929001342102	12	6.5	35	GU5.3	470	3000	97	46	50.5	10	25.60
MAS LED ExpertColor 6.5-35W MR16 930 36D	929001342402	12	6.5	35	GU5.3	470	3000	97	46	50.5	10	25.60
MAS LED ExpertColor 6.5-35W MR16 930 60D	929001341502	12	6.5	35	GU5.3	480	3000	97	46	50.5	10	25.60
MAS LED ExpertColor 6.5-35W MR16 940 10D	929001341902	12	6.5	35	GU5.3	490	4000	97	46	50.5	10	25.60
MAS LED ExpertColor 6.5-35W MR16 940 24D	929001342202	12	6.5	35	GU5.3	490	4000	97	46	50.5	10	25.60
MAS LED ExpertColor 6.5-35W MR16 940 36D	929001342502	12	6.5	35	GU5.3	490	4000	97	46	50.5	10	25.60
MAS LED ExpertColor 6.5-35W MR16 940 60D	929001341602	12	6.5	35	GU5.3	480	4000	97	46	50.5	10	25.60
MAS LED ExpertColor 7.5-43W MR16 927 24D	929001386002	12	7.5	43	GU5.3	520	2700	92	46	50.5	10	26.80
MAS LED ExpertColor 7.5-43W MR16 927 36D	929001386302	12	7.5	43	GU5.3	520	2700	92	46	50.5	10	26.80
MAS LED ExpertColor 7.5-43W MR16 930 24D	929001386102	12	7.5	43	GU5.3	530	3000	92	46	50.5	10	26.80
MAS LED ExpertColor 7.5-43W MR16 930 36D	929001386402	12	7.5	43	GU5.3	530	3000	92	46	50.5	10	26.80
MAS LED ExpertColor 7.5-43W MR16 940 24D	929001386202	12	7.5	43	GU5.3	560	4000	92	46	50.5	10	26.80
MAS LED ExpertColor 7.5-43W MR16 940 36D	929001386502	12	7.5	43	GU5.3	560	4000	92	46	50.5	10	26.80



## MASTER LEDspot MV PAR



2700/3000/4000



E27



Dim Edilir



Dim Edilmez

15000 Saat  
25000 Saat

EEL



10 Adet



25°



40°



%85



%85

Ürün	12 NC	Gerilim (V)	Güç (W)	Eşdeğer Güç (W)	Duy	Işık Akısı (lm)	Renk Sıcaklığı (K)	Renk Geriverim (Ra)	Maks. Uzunluk (mm)	Çap (mm)	Kutu Adedi	Fiyat (€)
MAS LEDspot CLA ND 9-60W 827 PAR38 25D	929001322702	220-240	9	60	E27	850	2700	80	134	122	6	22.05
<b>DİM EDİLİR</b>												
MAS LEDspot CLA D 6-50W 827 PAR20 25D	929001317402	220-240	6	50	E27	520	2700	80	85	64	6	16.70
MAS LEDspot CLA D 6-50W 827 PAR20 40D	929001317702	220-240	6	50	E27	520	2700	80	85	64	6	16.70
MAS LEDspot CLA D 6-50W 830 PAR20 25D	929001317502	220-240	6	50	E27	535	3000	80	85	64	6	16.70
MAS LEDspot CLA D 6-50W 830 PAR20 40D	929001317802	220-240	6	50	E27	535	3000	80	85	64	6	16.70
MAS LEDspot CLA D 6-50W 840 PAR20 25D	929001317602	220-240	6	50	E27	555	4000	80	85	64	6	16.70
MAS LEDspot CLA D 6-50W 840 PAR20 40D	929001317902	220-240	6	50	E27	555	4000	80	85	64	6	16.70
MAS LEDspot CLA D 9.5-75W 827 PAR30S 25D	929001322902	220-240	9.5	75	E27	790	2700	80	86	95	6	23.25
MAS LEDspot CLA D 9.5-75W 830 PAR30S 25D	929001342902	220-240	9.5	75	E27	810	3000	80	86	95	6	23.25
MAS LEDspot CLA D 9.5-75W 840 PAR30S 25D	929001323002	220-240	9.5	75	E27	880	4000	80	86	95	6	23.25
MAS LEDspot CLA D 13-100W 827 PAR38 25D	929001322502	220-240	13	100	E27	1000	2700	80	134	122	6	29.80



### MASTER LEDspot LV



Ürün	12 NC	Gerilim (V)	Güç (W)	Eşdeğer Güç (W)	Duy	Işık Akısı (lm)	Renk Sıcaklığı (K)	Renk Geriverim (Ra)	Maks. Uzunluk (mm)	Çap (mm)	Kutu Adedi	Fiyat (€)
MAS LEDspotLV D 8.0-50W 827 MR16 24D	929001149802	12	8	50	GU5.3	635	2700	80	55	51	10	24.40
MAS LEDspotLV D 8.0-50W 827 MR16 36D	929001150102	12	8	50	GU5.3	635	2700	80	55	51	10	24.40
MAS LEDspotLV D 8.0-50W 830 MR16 24D	929001149902	12	8	50	GU5.3	660	3000	80	55	51	10	24.40
MAS LEDspotLV D 8.0-50W 830 MR16 36D	929001150202	12	8	50	GU5.3	660	3000	80	55	51	10	24.40
MAS LEDspotLV D 8-50W 840 MR16 24D	929001150002	12	8	50	GU5.3	670	4000	80	55	51	10	24.40
MAS LEDspotLV D 8-50W 840 MR16 36D	929001150302	12	8	50	GU5.3	670	4000	80	55	51	10	24.40
MAS LEDspotLV DimTone 6.5-35W MR16 24D	929001127802	12	6.5	35	GU5.3	410	2700	80	50	51	10	15.85
MAS LEDspotLV DimTone 6.5-35W MR16 36D	929001127902	12	6.5	35	GU5.3	410	2700	80	50	51	10	15.85

### MASTER LEDspot LV MR11



Ürün	12 NC	Gerilim (V)	Güç (W)	Eşdeğer Güç (W)	Duy	Işık Akısı (lm)	Renk Sıcaklığı (K)	Renk Geriverim (Ra)	Maks. Uzunluk (mm)	Çap (mm)	Kutu Adedi	Fiyat (€)
MAS LEDspotLV 3.5-20W 827 MR11 24D	929001123802	12	3.5	20	GU4	210	2700	80	40	35	12	14.30

### MASTER LEDspot LV AR111



Ürün	12 NC	Gerilim (V)	Güç (W)	Eşdeğer Güç (W)	Duy	Işık Akısı (lm)	Renk Sıcaklığı (K)	Renk Geriverim (Ra)	Maks. Uzunluk (mm)	Çap (mm)	Kutu Adedi	Fiyat (€)
MAS LEDspotLV D 11-50W 927 AR111 8D	929001243902	12	11	50	G53	560	2700	90	62	111	6	33.70
MAS LEDspotLV D 11-50W 927 AR111 24D	929001169802	12	11	50	G53	620	2700	90	62	111	6	33.70
MAS LEDspotLV D 11-50W 927 AR111 40D	929001170002	12	11	50	G53	620	2700	90	62	111	6	33.70
MAS LEDspotLV D 11-50W 930 AR111 8D	929001244002	12	11	50	G53	580	3000	90	62	111	6	33.70
MAS LEDspotLV D 11-50W 930 AR111 24D	929001169902	12	11	50	G53	640	3000	90	62	111	6	33.70
MAS LEDspotLV D 11-50W 930 AR111 40D	929001170102	12	11	50	G53	640	3000	90	62	111	6	33.70
MAS LEDspotLV D 15-75W 927 AR111 24D	929001170202	12	15	75	G53	800	2700	90	62	111	6	36.55
MAS LEDspotLV D 15-75W 927 AR111 40D	929001170402	12	15	75	G53	800	2700	90	62	111	6	36.55
MAS LEDspotLV D 15-75W 930 AR111 24D	929001170302	12	15	75	G53	810	3000	90	62	111	6	36.55
MAS LEDspotLV D 15-75W 930 AR111 40D	929001170502	12	15	75	G53	810	3000	90	62	111	6	36.55
MAS LEDspotLV D 15-75W 940 AR111 24D	929001329702	12	15	75	G53	830	4000	90	62	111	6	36.55
MAS LEDspotLV D 15-75W 940 AR111 40D	929001330002	12	15	75	G53	830	4000	90	62	111	6	36.55
MAS LEDspotLV D 20-100W 827 AR111 24D	929001170802	12	20	100	G53	1300	2700	80	62	111	6	44.65
MAS LEDspotLV D 20-100W 827 AR111 40D	929001171102	12	20	100	G53	1160	2700	80	62	111	6	44.65
MAS LEDspotLV D 20-100W 830 AR111 24D	929001170902	12	20	100	G53	1200	3000	80	62	111	6	44.65
MAS LEDspotLV D 20-100W 830 AR111 40D	929001171202	12	20	100	G53	1180	3000	80	62	111	6	44.65
MAS LEDspotLV D 20-100W 840 AR111 24D	929001171002	12	20	100	G53	1250	4000	80	62	111	6	44.65
MAS LEDspotLV D 20-100W 840 AR111 40D	929001171302	12	20	100	G53	1250	4000	80	62	111	6	44.65

# PHILIPS

LEDtube

## Her defasında dođru LEDtube

Aydınlatma ihtiyacınız ne olursa olsun, Philips MASTER LEDtube portföyünde mutlaka ona uygun ideal bir çözüm vardır. Lambalarımızı her uygulama için dođru LEDtube çözümünü bulmanızı kolaylaştırabilmek için **Standart**, **Yüksek ve Ultra** şeklinde üç yeni ışık çıkışı kategorisine göre etiketleyerek yeniden düzenledik. En iyi enerji verimliliğinden en iyi ışık çıkışına kadar her adım için.

Bu basit geçiş, Philips LEDtube'ün dönebilen başlık özelliğinin yanı sıra üç farklı uzunluk ve renk sıcaklığı seçenekleriyle sağlanabilir. Sonuç olarak Philips ile her defasında dođru LEDtube çözümünü sunmak mümkün.



# LED LAMBALAR

LEDtube



## LEDtube T8



4000/6500



G13



Dim Edilmez



15000 Saat



EEL



10 Adet



%55



Ürün	12 NC	Gerilim (V)	Güç (W)	Eşdeğer Güç (W)	Duy	Işık Akısı (lm)	Renk Sıcaklığı (K)	Renk Geriverim (Ra)	Maks. Uzunluk (mm)	Çap (mm)	Kutu Adedi	Fiyat (€)
LEDtube T8 600mm 800lm 8W840 G13	929001276231	220-240	8	18	G13	800	4000	80	602.5	27.8	10	6.45
LEDtube T8 600mm 800lm 8W865 G13	929001276331	220-240	8	18	G13	800	6500	80	602.5	27.8	10	6.45
LEDtube T8 1200mm 1600lm 16W840 G13	929001276031	220-240	16	36	G13	1600	4000	80	1212	27.8	10	8.50
LEDtube T8 1200mm 1600lm 16W865 G13	929001276131	220-240	16	36	G13	1600	6500	80	1212	27.8	10	8.50
LEDtube T8 1500mm 2000lm 20W840 G13	929001338131	220-240	20	54	G13	2000	4000	80	1514.2	27.8	10	12.85
LEDtube T8 1500mm 2000lm 20W865 G13	929001338231	220-240	20	54	G13	2000	6500	80	1514.2	27.8	10	12.85

## CorePro LEDtube T8 EM/Mains



4000/6500



G13



Dim Edilmez



30000 Saat



EEL



10 Adet



%55



Ürün	12 NC	Gerilim (V)	Güç (W)	Eşdeğer Güç (W)	Duy	Işık Akısı (lm)	Renk Sıcaklığı (K)	Renk Geriverim (Ra)	Maks. Uzunluk (mm)	Çap (mm)	Kutu Adedi	Fiyat (€)
CorePro LEDtube 600mm 8W840	929001338602	220-240	8	18	G13	800	4000	80	604	27.8	10	Lütfen fiyat sorunuz.
CorePro LEDtube 600mm 8W865	929001338702	220-240	8	18	G13	800	6500	80	604	27.8	10	
CorePro LEDtube 1200mm 14.5W840	929001338802	220-240	14.5	36	G13	1600	4000	80	1213.6	27.8	10	
CorePro LEDtube 1200mm 14.5W865	929001338902	220-240	14.5	36	G13	1600	6500	80	1213.6	27.8	10	
CorePro LEDtube 1500mm 20W 840	929001337902	220-240	20	58	G13	2200	4000	80	1514.2	27.8	10	
CorePro LEDtube 1500mm 20W 865	929001338002	220-240	20	58	G13	2200	6500	80	1514.2	27.8	10	

## CorePro LEDtube T8 InstantFit HF



4000/6500



G13



Dim Edilmez



30000 Saat



EEL



10 Adet



%40



Ürün	12 NC	Gerilim (V)	Güç (W)	Eşdeğer Güç (W)	Duy	Işık Akısı (lm)	Renk Sıcaklığı (K)	Renk Geriverim (Ra)	Maks. Uzunluk (mm)	Çap (mm)	Kutu Adedi	Fiyat (€)
CorePro LEDtube HF 600mm 9W840 T8 G	929001249502	30-80	9	18	G13	800	4000	83	604	27.9	10	Lütfen fiyat sorunuz.
CorePro LEDtube HF 600mm 9W865 T8 G	929001249602	30-80	9	18	G13	800	6500	83	604	27.9	10	
CorePro LEDtube HF 1200mm 15W840 T8 G	929001249902	30-80	15	36	G13	1600	4000	83	1213.6	27.9	10	
CorePro LEDtube HF 1200mm 15W865 T8 G	929001136502	30-80	15	36	G13	1600	6500	83	1213.6	27.9	10	
CorePro LEDtube HF 1500mm 20W840 T8 G	929001249702	30-80	20	58	G13	2000	4000	83	1514.2	27.9	10	
CorePro LEDtube HF 1500mm 20W865 T8 G	929001249802	30-80	20	58	G13	2000	6500	83	1514.2	27.9	10	

Özel proje fiyatlandırması için lütfen satış temsilcilerimize danışın.





## MASTER LEDtube EM/Mains T8

3000/3300/  
4000/6500

G13



Dim Edilmez



50000 Saat



EEL



10 Adet



%55

RoHS  
Compliant

KEMA

Ürün	12 NC	Gerilim (V)	Güç (W)	Eşdeğer Güç (W)	Duy	Işık Akısı (lm)	Renk Sıcaklığı (K)	Renk Geriverim (Ra)	Maks. Uzunluk (mm)	Çap (mm)	Kutu Adedi	Fiyat (€)
<b>YÜKSEK ÇIKIŞ</b>												
MAS LEDtube 600mm HO 8W830 T8	929001307002	220-240	8	18	G13	1000	3000	83	600	28	10	
MAS LEDtube 600mm HO 8W840 T8	929001307102	220-240	8	18	G13	1050	4000	83	600	28	10	
MAS LEDtube 600mm HO 8W865 T8	929001307202	220-240	8	18	G13	1050	6500	83	600	28	10	
MAS LEDtube 900mm HO 12W840 T8	929001298402	220-240	12	30	G13	1575	4000	83	900	28	10	
MAS LEDtube 900mm HO 12W865 T8	929001298502	220-240	12	30	G13	1575	6500	83	900	28	10	
MAS LEDtube 1200mm HO 14W830 T8	929001298902	220-240	14	36	G13	2000	3000	83	1200	28	10	
MAS LEDtube 1200mm HO 14W840 T8	929001299002	220-240	14	36	G13	2100	4000	83	1200	28	10	
MAS LEDtube 1200mm HO 14W865 T8	929001299102	220-240	14	36	G13	2100	6500	83	1200	28	10	
MAS LEDtube 1500mm HO 20W830 T8	929001298602	220-240	20	58	G13	2900	3000	83	1500	28	10	
MAS LEDtube 1500mm HO 20W840 T8	929001298702	220-240	20	58	G13	3100	4000	83	1500	28	10	
MAS LEDtube 1500mm HO 20W865 T8	929001298802	220-240	20	58	G13	3100	6500	83	1500	28	10	
<b>ULTRA ÇIKIŞ</b>												
MAS LEDtube 1200mm UO 16W 830 T8	929001297802	220-240	16	36	G13	2300	3000	83	1200	28	10	
MAS LEDtube 1200mm UO 16W 840 T8	929001297902	220-240	16	36	G13	2500	4000	83	1200	28	10	
MAS LEDtube 1200mm UO 16W 865 T8	929001298002	220-240	16	36	G13	2500	6500	83	1200	28	10	
MAS LEDtube 1500mm UO 24W 830 T8	929001298102	220-240	24	58	G13	3400	3000	83	1500	28	10	
MAS LEDtube 1500mm UO 24W 840 T8	929001298202	220-240	24	58	G13	3700	4000	83	1500	28	10	
MAS LEDtube 1500mm UO 24W 865 T8	929001298302	220-240	24	58	G13	3700	6500	83	1500	28	10	
<b>YÜKSEK VERİMLİ</b>												
MAS LEDtube 1200mm UE 14.5W 840 T8	929001376802	220-240	14.5	36	G13	2500	4000	83	1213.6	28	10	
MAS LEDtube 1200mm UE 14.5W 865 T8	929001376902	220-240	14.5	36	G13	2500	6500	83	1213.6	28	10	
MAS LEDtube 1500mm UE 21.5W 840 T8	929001377002	220-240	21.5	58	G13	3700	4000	83	1514.2	28	10	
MAS LEDtube 1500mm UE 21.5W 865 T8	929001377102	220-240	21.5	58	G13	3700	6500	83	1514.2	28	10	
<b>FOOD</b>												
MAS LEDtube 900mm 8.5W833 T8 FOOD	929001812102	220-240	8.5	30	G13	750	3300	83	907.5	28	10	
MAS LEDtube 1200mm 12W833 T8 FOOD	929001812202	220-240	12	36	G13	1000	3300	83	1213.6	28	10	
MAS LEDtube 1500mm 20W833 T8 FOOD	929001812302	220-240	20	58	G13	1680	3300	83	1514	28	10	

Lütfen  
fiyat  
sorunuz.



3000/4000/6500



G13



Dim Edilir



Dim Edilmez



50000 Saat



EEL



10 Adet



%45

RoHS  
Compliant

KEMA

## MASTER LEDtube InstantFit HF T8

Ürün	12 NC	Gerilim (V)	Güç (W)	Eşdeğer Güç (W)	Duy	Işık Akısı (lm)	Renk Sıcaklığı (K)	Renk Geriverim (Ra)	Maks. Uzunluk (mm)	Çap (mm)	Kutu Adedi	Fiyat (€)
MAS LEDtube HF 600mm HO 8W830 T8	929001393102	20-50	8	18	G13	1000	3000	83	602.8	27.8	10	Lütfen fiyat sorunuz.
MAS LEDtube HF 600mm HO 8W840 T8	929001393202	20-50	8	18	G13	1050	4000	83	602.8	27.8	10	
MAS LEDtube HF 600mm HO 8W865 T8	929001393302	20-50	8	18	G13	1050	6500	83	602.8	27.8	10	
<b>YÜKSEK ÇIKIŞ (Dim edilir)</b>												
MAS LEDtube HF 1200mm HO 14W830 T8	929001284302	30-80	14	36	G13	2000	3000	83	1200	28	10	
MAS LEDtube HF 1200mm HO 14W840 T8	929001284102	30-80	14	36	G13	2100	4000	83	1200	28	10	
MAS LEDtube HF 1200mm HO 14W865 T8	929001284202	30-80	14	36	G13	2100	6500	83	1200	28	10	
MAS LEDtube HF 1500mm HO 20W830 T8	929001284602	30-80	20	58	G13	2900	3000	83	1500	28	10	
MAS LEDtube HF 1500mm HO 20W840 T8	929001284402	30-80	20	58	G13	3100	4000	83	1500	28	10	
MAS LEDtube HF 1500mm HO 20W865 T8	929001284502	30-80	20	58	G13	3100	6500	83	1500	28	10	
<b>ULTRA ÇIKIŞ (Dim edilir)</b>												
MAS LEDtube HF 1200mm UO 16W830 T8	929001300202	30-80	16	36	G13	2350	3000	83	1200	28	10	
MAS LEDtube HF 1200mm UO 16W840 T8	929001300002	30-80	16	36	G13	2500	4000	83	1200	28	10	
MAS LEDtube HF 1200mm UO 16W865 T8	929001300102	30-80	16	36	G13	2500	6500	83	1200	28	10	
MAS LEDtube HF 1500mm UO 24W830 T8	929001300502	30-80	24	58	G13	3500	3000	83	1500	28	10	
MAS LEDtube HF 1500mm UO 24W840 T8	929001300302	30-80	24	58	G13	3700	4000	83	1500	28	10	
MAS LEDtube HF 1500mm UO 24W865 T8	929001300402	30-80	24	58	G13	3700	6500	83	1500	28	10	

## MASTER LEDtube Universal T8 (Ultra Çıkış)



3000/4000/6500



G13



Dim Edilmez



50000 Saat



EEL



10 Adet



%56

RoHS  
Compliant

KEMA

Ürün	12 NC	Gerilim (V)	Güç (W)	Eşdeğer Güç (W)	Duy	Işık Akısı (lm)	Renk Sıcaklığı (K)	Renk Geriverim (Ra)	Maks. Uzunluk (mm)	Çap (mm)	Kutu Adedi	Fiyat (€)
MAS LEDtube UN 1200mm UO 16W830 T8	929001336002	220-240	16	36	G13	2300	3000	83	1200	28	10	Lütfen fiyat sorunuz.
MAS LEDtube UN 1200mm UO 16W840 T8	929001336102	220-240	16	36	G13	2500	4000	83	1200	28	10	
MAS LEDtube UN 1200mm UO 16W865 T8	929001336202	220-240	16	36	G13	2500	6500	83	1200	28	10	
MAS LEDtube UN 1500mm UO 24W830 T8	929001336302	220-240	24	58	G13	3400	3000	83	1500	28	10	
MAS LEDtube UN 1500mm UO 24W840 T8	929001336402	220-240	24	58	G13	3700	4000	83	1500	28	10	
MAS LEDtube UN 1500mm UO 24W865 T8	929001336502	220-240	24	58	G13	3700	6500	83	1500	28	10	

Özel proje fiyatlandırması için lütfen satış temsilcilerimize danışın.





## MASTER LEDtube InstantFit HF T5



3000/4000/6500



G5



Dim Edilmez



50000 Saat



EEL



10 Adet



%41

RoHS  
Compliant

KEMA

Ürün	12 NC	Gerilim (V)	Güç (W)	Eşdeğer Güç (W)	Duy	Işık Akısı (lm)	Renk Sıcaklığı (K)	Renk Geriverim (Ra)	Maks. Uzunluk (mm)	Çap (mm)	Kutu Adedi	Fiyat (€)	
<b>YÜKSEK ÇIKIŞ</b>													
MAS LEDtube HF 1200mm HO 26W 830 T5	929001338302	50-60	26	54	G5	3700	3000	83	1200	21	10	Lütfen fiyat sorunuz.	
MAS LEDtube HF 1200mm HO 26W 840 T5	929001338402	50-60	26	54	G5	3900	4000	83	1200	21	10		
MAS LEDtube HF 1200mm HO 26W 865 T5	929001338502	50-60	26	54	G5	3900	6500	83	1200	21	10		
MAS LEDtube HF 1500mm HO 26W 830 T5	929001296102	100-135	26	49	G5	3700	3000	83	1500	21	10		
MAS LEDtube HF 1500mm HO 26W 840 T5	929001296202	100-135	26	49	G5	3900	4000	83	1500	21	10		
MAS LEDtube HF 1500mm HO 26W 865 T5	929001296302	100-135	26	49	G5	3900	6500	83	1500	21	10		
<b>ULTRA ÇIKIŞ</b>													
MAS LEDtube HF 1500mm UO 36W 830 T5	929001346102	65-75	36	80	G5	5200	3000	83	1500	21	10		
MAS LEDtube HF 1500mm UO 36W 840 T5	929001346202	65-75	36	80	G5	5600	4000	83	1500	21	10		
MAS LEDtube HF 1500mm UO 36W 865 T5	929001346302	65-75	36	80	G5	5600	6500	83	1500	21	10		
<b>YÜKSEK VERİMLİ</b>													
MAS LEDtube HF 600mm HE 8W 830 T5	929001390702	40-60	8	14	G5	1000	3000	83	600	18.8	10		
MAS LEDtube HF 600mm HE 8W 840 T5	929001390802	40-60	8	14	G5	1050	4000	83	600	18.8	10		
MAS LEDtube HF 600mm HE 8W 865 T5	929001390902	40-60	8	14	G5	1050	6500	83	600	18.8	10		
MAS LEDtube HF 1200mm HE 16.5W 830 T5	929001391002	90-130	16.5	28	G5	2300	3000	83	1200	18.8	10		
MAS LEDtube HF 1200mm HE 16.5W 840 T5	929001391102	90-130	16.5	28	G5	2500	4000	83	1200	18.8	10		
MAS LEDtube HF 1200mm HE 16.5W 865 T5	929001391202	90-130	16.5	28	G5	2500	6500	83	1200	18.8	10		
MAS LEDtube HF 1500mm HE 20W 830 T5	929001391302	120-160	20	35	G5	2800	3000	83	1500	18.8	10		
MAS LEDtube HF 1500mm HE 20W 840 T5	929001391402	120-160	20	35	G5	3000	4000	83	1500	18.8	10		
MAS LEDtube HF 1500mm HE 20W 865 T5	929001391502	120-160	20	35	G5	3000	6500	83	1500	18.8	10		



## CorePro LED PLC



3000/4000



G24



Dim Edilmez



30000 Saat



EEL



10 Adet

RoHS  
Compliant

KEMA

Ürün	12 NC	Gerilim (V)	Güç (W)	Eşdeğer Güç (W)	Duy	Işık Akısı (lm)	Renk Sıcaklığı (K)	Renk Geriverim (Ra)	Maks. Uzunluk (mm)	Çap (mm)	Kutu Adedi	Fiyat (€)
CorePro LED PLC 6.5W 830 2P G24d-2	929001201402	220-240	6.5		G24D-2	600	3000	83	147.1	33.4	10	13.60
CorePro LED PLC 6.5W 840 2P G24d-2	929001201502	220-240	6.5		G24D-2	650	4000	83	147.1	33.4	10	13.60
CorePro LED PLC 8.5W 830 2P G24d-3	929001201202	220-240	8.5		G24D-3	900	3000	83	170.1	33.4	10	14.80
CorePro LED PLC 8.5W 840 2P G24d-3	929001201302	220-240	8.5		G24D-3	950	4000	83	170.1	33.4	10	14.80
CorePro LED PLC 6.5W 830 4P G24q-2	929001201002	20-50	6.5		G24Q-2	600	3000	83	140.1	33.4	10	16.20
CorePro LED PLC 6.5W 840 4P G24q-2	929001201102	20-50	6.5		G24Q-2	650	4000	83	140.1	33.4	10	16.20
CorePro LED PLC 9W 830 4P G24q-3	929001200802	20-50	9		G24Q-3	900	3000	83	163.1	33.4	10	19.05
CorePro LED PLC 9W 840 4P G24q-3	929001200902	20-50	9		G24Q-3	950	4000	83	163.1	33.4	10	19.05

# LED LAMBALAR

LEDtube / HID LED



## CorePro LED PLL



Ürün	12 NC	Gerilim (V)	Güç (W)	Eşdeğer Güç (W)	Duy	Işık Akısı (lm)	Renk Sıcaklığı (K)	Renk Geriverim (Ra)	Maks. Uzunluk (mm)	Çap (mm)	Kutu Adedi	Fiyat (€)
CorePro LED PLL HF 16.5W 830 4P 2G11	929001381502	53-77	16.5	36	2G11	2000	3000	83	411.6	37.6/17	10	29.75
CorePro LED PLL HF 16.5W 840 4P 2G11	929001381602	53-77	16.5	36	2G11	2100	4000	83	411.6	37.6/17	10	29.75
CorePro LED PLL HF 16.5W 865 4P 2G11	929001381702	53-77	16.5	36	2G11	2100	6500	83	411.6	37.6/17	10	29.75

## HID LED



## TrueForce LED HPL (Park & Bahçe)



Ürün	12 NC	Gerilim (V)	Güç (W)	Eşdeğer Güç (W)	Duy	Işık Akısı (lm)	Renk Sıcaklığı (K)	Renk Geriverim (Ra)	Maks. Uzunluk (mm)	Çap (mm)	Kutu Adedi	Fiyat (€)
TForce LED HPL ND 28-25W E27 730 FR	929001898102	220-240	25	80	E27	2800	3000	70	178	84	6	Lütfen fiyat sorunuz.
TForce LED HPL ND 31-25W E27 730 CL	929001898002	220-240	25	80	E27	3100	3000	70	178	84	6	
TForce LED HPL ND 29-25W E27 740 FR	929001898302	220-240	25	80	E27	2900	4000	70	178	84	6	
TForce LED HPL ND 32-25W E27 740 CL	929001898202	220-240	25	80	E27	3200	4000	70	178	84	6	
TForce LED HPL ND 42-33W E27 730 FR	929001897702	220-240	33	125	E27	4200	3000	70	178	84	6	
TForce LED HPL ND 46-33W E27 730 CL	929001897602	220-240	33	125	E27	4600	3000	70	178	84	6	
TForce LED HPL ND 44-33W E27 740 FR	929001897902	220-240	33	125	E27	4400	4000	70	178	84	6	
TForce LED HPL ND 48-33W E27 740 CL	929001897802	220-240	33	125	E27	4800	4000	70	178	84	6	



## TrueForce Core LED HPL (Park & Bahçe)



Ürün	12 NC	Gerilim (V)	Güç (W)	Eşdeğer Güç (W)	Duy	Işık Akısı (lm)	Renk Sıcaklığı (K)	Renk Geriverim (Ra)	Maks. Uzunluk (mm)	Çap (mm)	Kutu Adedi	Fiyat (€)
TForce Core LED PT 30-27W E27 830 FR	929001925308	220-240	27	80	E27	3000	3000	80	228	96	4	25.00
TForce Core LED PT 30-27W E27 840 FR	929001925408	220-240	27	80	E27	3000	4000	80	228	96	4	25.00
TForce Core LED PT 30-27W E27 865 FR	929001925508	220-240	27	80	E27	3000	6500	80	228	96	4	25.00
TForce Core LED PT 50-42W E27 830 FR	929001925008	220-240	42	125	E27	5000	3000	80	265	108	4	40.00
TForce Core LED PT 50-42W E27 840 FR	929001925108	220-240	42	125	E27	5000	4000	80	265	108	4	40.00
TForce Core LED PT 50-42W E27 865 FR	929001925208	220-240	42	125	E27	5000	6500	80	265	108	4	40.00



## TrueForce LED HPI (Yüksek Tavan) Retrofit



4000



E40



50000 Saat



Dim Edilmez



EEL



2 Adet



Huzme Açısı



%63

Ürün	12 NC	Gerilim (V)	Güç (W)	Eşdeğer Güç (W)	Duy	Işık Akısı (lm)	Renk Sıcaklığı (K)	Renk Geriverim (Ra)	Maks. Uzunluk (mm)	Çap (mm)	Kutu Adedi	Fiyat (€)
TForce LED HPI ND 110-88W E40 840 60D	929001356802	100-145	88	250	E40	11000	4000	80	250	210	2	Lütfen fiyat sorunuz.
TForce LED HPI ND 110-88W E40 840 120D	929001356902	100-145	88	250	E40	11000	4000	80	250	210	2	
TForce LED HPI ND 200-145W E40 840 60D	929001357002	100-145	145	400	E40	20000	4000	80	250	210	2	
TForce LED HPI ND 200-145W E40 840 120D	929001357102	100-145	145	400	E40	20000	4000	80	250	210	2	



## TrueForce LED HPI (Yüksek Tavan)



4000/6500



E40



25000 Saat



Dim Edilmez



EEL



2-4 Adet



Huzme Açısı



%60

Ürün	12 NC	Gerilim (V)	Güç (W)	Eşdeğer Güç (W)	Duy	Işık Akısı (lm)	Renk Sıcaklığı (K)	Renk Geriverim (Ra)	Maks. Uzunluk (mm)	Çap (mm)	Kutu Adedi	Fiyat (€)
TForce HB 100-85W E40 840 120D GM	929001875708	110-277	85	250	E40	10000	4000	80	270	190	4	Lütfen fiyat sorunuz.
TForce HB 100-85W E40 865 120D GM	929001875908	110-277	85	250	E40	10000	6500	80	270	190	4	
TForce Core HB 200-160W E40 840 NB GM	929001812408	110-277	160	400	E40	20000	4000	80	252	211	2	
TForce Core HB 200-160W E40 840 WB GM	929001812508	110-277	160	400	E40	20000	4000	80	252	211	2	
TForce Core HB 200-160W E40 865 NB GM	929001812608	110-277	160	400	E40	20000	6500	80	252	211	2	
TForce Core HB 200-160W E40 865 WB GM	929001812708	110-277	160	400	E40	20000	6500	80	252	211	2	



## TrueForce Core LED HPI (Yüksek Tavan)



3000/4000/6500



E27/E40



20000 - 25000 Saat



Dim Edilmez



EEL



6 Adet



Huzme Açısı

Ürün	12 NC	Gerilim (V)	Güç (W)	Eşdeğer Güç (W)	Duy	Işık Akısı (lm)	Renk Sıcaklığı (K)	Renk Geriverim (Ra)	Maks. Uzunluk (mm)	Çap (mm)	Kutu Adedi	Fiyat (€)
TForce Core HB MV ND 26-24W E27 830	929001937602	220-240	24	/	E27	2600	3000	80	190	105	6	18.45
TForce Core HB MV ND 28-24W E27 840	929001937702	220-240	24	/	E27	2800	4000	80	190	105	6	18.45
TForce Core HB MV ND 37-35W E27 830	929001937902	220-240	35	/	E27	3700	3000	80	190	105	6	25.55
TForce Core HB MV ND 40-35W E27 840	929001938002	220-240	35	/	E27	4000	4000	80	190	105	6	25.55
TForce Core HB MV ND 48-42W E27 830	929001938202	220-240	42	/	E27	4800	3000	80	225	123	6	32.70
TForce Core HB MV ND 50-42W E27 840	929001938302	220-240	42	/	E27	5000	4000	80	225	123	6	32.70
TForce Core HB 70-65W E40 840	929001938908	220-240	65	/	E40	7200	4000	80	280	145	4	60.00
TForce Core HB 70-65W E40 865	929001939008	220-240	65	/	E40	7200	6500	80	280	145	4	60.00
TForce Core HB 90-80W E40 840	929001939208	220-240	80	/	E40	9000	4000	80	280	145	4	73.80
TForce Core HB 90-80W E40 865	929001939308	220-240	80	/	E40	9000	6500	80	280	145	4	73.80



## TrueForce Road (SON-T LED)



3000/4000



E27



50000 Saat



Dim Edilmez



EEL



6 Adet

Ürün	12 NC	Gerilim (V)	Güç (W)	Eşdeğer Güç (W)	Duy	Işık Akısı (lm)	Renk Sıcaklığı (K)	Renk Geriverim (Ra)	Maks. Uzunluk (mm)	Çap (mm)	Kutu Adedi	Fiyat (€)
TForce LED Road 58-35W E27 730	929001898402	70-80	35	70	E27	5500	3000	70	200	61	6	Lütfen fiyat sorunuz.
TForce LED Road 60-35W E27 740	929001898502	70-80	35	70	E27	6000	4000	70	200	61	6	

# LAMBALAR

Enerji Tasarruflu Lambalar  
Normal Duyulu



## ECONOMY TWISTER



≤ 2.5



CRI 81



6000

Açma-Kapama



5-40 sn



0,3 sn



Dim Edilmez



EEL



6000 Saat

Ürün	12 NC	Gerilim (V)	Güç (W)	Eşdeğer Güç (W)	Duy	Işık Akısı (lm)	Renk Sıcaklığı (K)	Renk Geriverim (Ra)	Maks. Uzunluk (mm)	Çap (mm)	Kutu Adedi	Fiyat (€)
EconomyTwister 8W CDL E27 220-240V 1PF/6	929689218401	220-240	8	40	E27	475	6500	80	86,5	47,5	6	2.55
EconomyTwister 8W WW E27 220-240V 1PF/6	929689218302	220-240	8	45	E27	500	2700	81	86,5	47,5	6	2.55
EconomyTwister 12W CDL E27 220-240V 1PF/6	929689218601	220-240	12	58	E27	700	6500	80	94,0	47,5	6	2.55
EconomyTwister 12W WW E27 220-240V 1PF/6	929689218501	220-240	12	60	E27	741	2700	81	94,0	47,5	6	2.55
EconomyTwister 15W CDL E27 220-240V 1PF/6	929689218801	220-240	15	70	E27	900	6500	80	107,5	51,5	6	2.55
EconomyTwister 15W WW E27 220-240V 1PF/6	929689218701	220-240	15	75	E27	970	2700	81	107,5	51,5	6	2.55
EconomyTwister 20W CDL E27 220-240V 1PF/6	929689219001	220-240	20	88	E27	1.200	6500	80	113	55	6	2.55
EconomyTwister 20W WW E27 220-240V 1PF/6	929689218901	220-240	20	91	E27	1.250	2700	81	113	55	6	2.55
EconomyTwister 23W CDL E27 220-240V 1PF/6	929689258201	220-240	23	103	E27	1.450	6500	80	115	60	6	2.55
EconomyTwister 23W WW E27 220-240V 1PF/6	929689258101	220-240	23	110	E27	1.570	2700	81	115	60	6	2.55
EconomyTwister 8W CDL E14 220-240V 1PF/6	929689238401	220-240	8	40	E14	475	6500	80	96,5	47,5	6	2.55
EconomyTwister 8W WW E14 220-240V 1PF/6	929689238302	220-240	8	45	E14	500	2700	81	90	46	6	2.55
EconomyTwister 12W CDL E14 220-240V 1PF/6	929689238602	220-240	12	58	E14	700	6500	80	104,0	47,5	6	2.55
EconomyTwister 12W WW E14 220-240V 1PF/6	929689238501	220-240	12	60	E14	741	2700	81	102	46	6	2.55



## TORNADO YÜKSEK LÜMEN



≤ 5.0



CRI 80



10000

Açma-Kapama



10-100 sn



2,0 sn



Dim Edilmez



EEL



10000 Saat

Ürün	12 NC	Gerilim (V)	Güç (W)	Eşdeğer Güç (W)	Duy	Işık Akısı (lm)	Renk Sıcaklığı (K)	Renk Geriverim (Ra)	Maks. Uzunluk (mm)	Çap (mm)	Kutu Adedi	Fiyat (€)
Tornado High Lumen 45W CDL E27 1CT/6	929676005901	220-240 V	45	198	E27   E27	3080	6500	80	207	98	6	22.75
Tornado High Lumen 45W WW E27 1CT/6	929676005701	220-240 V	45	198	E27   E27	3080	2700	80	207	98	6	21.65
Tornado High Lumen 60W CDL E27 1CT/6	929676006201	220-240 V	60	270	E27   E27	4300	6500	80	223	98	6	22.75
Tornado High Lumen 60W WW E27 1CT/6	929676006001	220-240 V	60	270	E27   E27	4300	2700	80	223	98	6	21.65
Tornado T3 32W CDL E27 220-240V 1PF/6	929689301404	220-240 V	32	145	E27   E27	2160	6500	80	149	70	6	9.10
Tornado T3 32W WW E27 220-240V 1PF/6	929689301301	220-240 V	32	150	E27   E27	2255	2700	80	149	70	6	9.10
Tornado High Lumen 75W CDL E40 1CT/6	929676006501	220-240 V	75	340	E40   E40	5550	6500	80	264	104	6	22.75
Tornado High Lumen 75W WW E40 1CT/6	929676006301	220-240 V	75	340	E40   E40	5550	2700	80	264	104	6	22.75



## CIRCULAR



≤ 5.0



CRI 81



6000

Açma-Kapama



5-40 sn



0,3 sn



Dim Edilmez



EEL



6000 Saat

Ürün	12 NC	Gerilim (V)	Güç (W)	Eşdeğer Güç (W)	Duy	Işık Akısı (lm)	Renk Sıcaklığı (K)	Renk Geriverim (Ra)	Maks. Uzunluk (mm)	Çap (mm)	Kutu Adedi	Fiyat (€)
Circular ES 24W CDL E27 220-240V 1CT/6	929689187201	220-240	24	118	E27	1.700	6500	80	77,5	17,5	6	11.10
Circular ES 24W WW E27 220-240V 1CT/6	929689187101	220-240	24	118	E27	1.700	2700	82	77,5	17,5	6	11.10



## MASTER PL-C



≤ 1.4



CRI 82+



Dim Edilmez



10000 Saat

Ürün	12 NC	Gerilim (V)	Güç (W)	Duy	Işık Akısı (lm)	Renk Sıcaklığı (K)	Renk Geriverim (Ra)	Maks. Uzunluk (mm)	Çap (mm)	Kutu Adedi	Fiyat (€)
MASTER PL-C 10W/827/2P	927903882740	63	10	G24d-1	600	2700	82	117,4	27,1	5x10	2.65
MASTER PL-C 10W/830/2P	927903883040	63	10	G24d-1	600	3000	82	117,4	27,1	5x10	2.65
MASTER PL-C 10W/830/4P	927907083040	63	10	G24d-1	600	3000	82	108,9	27,1	5x10	2.65
MASTER PL-C 10W/840/2P	927903884040	63	10	G24d-1	600	4000	82	117,4	27,1	5x10	2.65
MASTER PL-C 10W/840/4P	927907084040	63	10	G24d-1	600	4000	82	108,9	27,1	5x10	2.65
MASTER PL-C 13W/827/2P	927904882740	95	13	G24d-1	900	2700	82	139,4	27,1	5x10	2.65
MASTER PL-C 13W/827/4P	927907182740	77	13	G24q-1	900	2700	82	131,9	27,1	5x10	2.65
MASTER PL-C 13W/830/2P	927904883040	95	13	G24d-1	900	3000	82	139,4	27,1	5x10	2.65
MASTER PL-C 13W/830/4P	927907183040	77	13	G24q-1	900	3000	82	131,9	27,1	5x10	2.65
MASTER PL-C 13W/840/2P	927904884040	95	13	G24d-1	900	4000	82	139,4	27,1	5x10	2.65
MASTER PL-C 13W/840/4P	927907184040	77	13	G24q-1	900	4000	82	131,9	27,1	5x10	2.65
MASTER PL-C 13W/865/2P	927904886540	95	13	G24d-1	840	6500	82	139,4	27,1	5x10	2.65
MASTER PL-C 18W/827/2P	927905782740	100	18	G24d-2	1.200	2700	82	151,4	27,1	5x10	2.65
MASTER PL-C 18W/827/4P	927907282740	95	18	G24q-2	1.200	2700	82	143,9	27,1	5x10	2.65
MASTER PL-C 18W/830/2P	927905783040	100	18	G24d-2	1.200	3000	82	151,4	27,1	5x10	2.65
MASTER PL-C 18W/830/4P	927907283040	95	18	G24q-2	1.200	3000	82	143,9	27,1	5x10	2.65
MASTER PL-C 18W/840/2P	927905784040	100	18	G24d-2	1.200	4000	82	151,4	27,1	5x10	2.65
MASTER PL-C 18W/840/4P	927907284040	95	18	G24q-2	1.200	4000	82	143,9	27,1	5x10	2.65
MASTER PL-C 18W/865/2P	927905786540	100	18	G24d-2	1.120	6500	82	151,4	27,1	5x10	2.65
MASTER PL-C 26W/827/2P	927906182740	105	26	G24d-3	1.800	2700	82	172,4	27,1	5x10	2.65
MASTER PL-C 26W/827/4P	927907382740	100	26	G24q-3	1.800	2700	82	164,9	27,1	5x10	2.65
MASTER PL-C 26W/830/2P	927906183040	105	26	G24d-3	1.800	3000	82	172,4	27,1	5x10	2.65
MASTER PL-C 26W/830/4P	927907383040	100	26	G24q-3	1.800	3000	82	164,9	27,1	5x10	2.65
MASTER PL-C 26W/840/2P	927906184040	105	26	G24d-3	1.800	4000	82	172,4	27,1	5x10	2.65
MASTER PL-C 26W/840/4P	927907384040	100	26	G24q-3	1.800	4000	82	164,9	27,1	5x10	2.65
MASTER PL-C 26W/865/2P	927906186540	105	26	G24d-3	1.740	6500	82	172,4	27,1	5x10	2.65

## MASTER PL-L



2.0



CRI 80+



Dim Edilir %10



20000 Saat



EEL

Ürün	12 NC	Gerilim (V)	Güç (W)	Duy	Işık Akısı (lm)	Renk Sıcaklığı (K)	Renk Geriverim (Ra)	Maks. Uzunluk (mm)	Çap (mm)	Kutu Adedi	Fiyat (€)
MASTER PL-L 18W/827/4P	927903008270	58	18	2G11	1.200	2700	82	226,6	39,0	25	3.45
MASTER PL-L 18W/830/4P	927903008370	58	18	2G11	1.200	3000	>80	226,6	39,0	25	3.65
MASTER PL-L 18W/840/4P	927903008470	58	18	2G11	1.200	4000	82	226,6	39,0	25	3.65
MASTER PL-L 24W/827/4P	927903208270	87	24	2G11	1.800	2700	82	321,6	39,0	25	3.65
MASTER PL-L 24W/830/4P	927903208370	87	24	2G11	1.800	3000	>80	321,6	39,0	25	3.65
MASTER PL-L 24W/840/4P	927903208470	87	24	2G11	1.800	4000	82	321,6	39,0	25	3.65
MASTER PL-L 36W/827/4P	927903408270	106	36	2G11	2.900	2700	82	416,6	39,0	25	3.45
MASTER PL-L 36W/830/4P	927903408370	106	36	2G11	2.900	3000	>80	416,6	39,0	25	3.65
MASTER PL-L 36W/840/4P	927903408470	106	36	2G11	2.900	4000	82	416,6	39,0	25	3.65
MASTER PL-L 36W/865/4P	927903486570	106	36	2G11	2.900	6500	80	416,6	39,0	25	3.65
MASTER PL-L 40W/830/4P	927908208370	126	40	2G11	3.500	3000	>80	541,6	39,0	25	4.15
MASTER PL-L 40W/840/4P	927908208470	126	40	2G11	3.500	4000	82	541,6	39,0	25	4.15
MASTER PL-L 55W/830/4P	927908708370	105	55	2G11	4.800	3000	>80	541,6	39,0	25	4.15
MASTER PL-L 55W/840/4P	927908708470	105	55	2G11	4.800	4000	82	541,6	39,0	25	4.15
MASTER PL-L 55W/865/4P	927908786570	105	55	2G11	4.800	6500	80	541,6	39,0	25	4.15

# LAMBALAR

Enerji Tasarruflu Lambalar  
Soket Duylu



## MASTER PL-S

Hg

<2.0

CRI 80+

Dim Edilir  
%10

L

10000 Saat

Ürün	12 NC	Gerilim (V)	Güç (W)	Duy	Işık Akısı (lm)	Renk Sıcaklığı (K)	Renk Geriverim (Ra)	Maks. Uzunluk (mm)	Çap (mm)	Kutu Adedi	Fiyat (€)
MASTER PL-S 7W/827/2P	927935682711	46	7	G23	400	2700	82	135	28,0	5x10	2.65
MASTER PL-S 7W/840/2P	927935684011	46	7	G23	400	4000	82	135	28,0	5x10	2.65
MASTER PL-S 9W/827/2P	927936082711	60	9	G23	600	2700	82	167	28,0	5x10	2.65
MASTER PL-S 9W/830/2P	927936083011	60	9	G23	600	3000	82	167	28,0	5x10	2.65
MASTER PL-S 9W/840/2P	927936084011	60	9	G23	600	4000	82	167	28,0	5x10	2.65
MASTER PL-S 11W/827/2P	927936482711	91	11	G23	900	2700	82	235,8	28,0	5x10	2.65
MASTER PL-S 11W/830/2P	927936483011	91	11	G23	900	3000	82	235,8	28,0	5x10	2.65
MASTER PL-S 11W/840/2P	927936484011	91	11	G23	900	4000	82	235,8	28,0	5x10	2.65
MASTER PL-S 5W/827/4P	927935482711	35	5	2G7	259	2700	82	89,1	28,0	5x10	2.65
MASTER PL-S 7W/840/4P	927935884011	46	7	2G7	405	4000	82	119,1	28,0	5x10	2.65
MASTER PL-S 9W/840/4P	927936284011	60	9	2G7	583	4000	82	151,1	28,0	5x10	2.65
MASTER PL-S 11W/827/4P	927936682711	89	11	2G7	900	2700	82	219,9	28,0	5x10	2.65
MASTER PL-S 11W/840/4P	927936684011	89	11	2G7	900	4000	82	219,9	28,0	5x10	2.65





## Floresan Lambalar

## MASTER TL-D ECO



Hg

2.0



CRI 80+



Dim Edilir



20000 Saat



EEL

Ürün	12 NC	Gerilim (V)	Güç (W)	Duy	Işık Akısı (lm)	Renk Sıcaklığı (K)	Renk Geriverim (Ra)	Maks. Uzunluk (mm)	Çap (mm)	Kutu Adedi	Fiyat (€)
MASTER TL-D Eco 16W/840	927922884015	51	16	G13	1.175	4000	>80	604	28	25	3.70
MASTER TL-D Eco 16W/865	927922886515	51	16	G13	1.125	6500	>80	604	28	25	3.70
MASTER TL-D Eco 32W/830	927921183023	92	32	G13	2.650	3000	>80	1.514,2	28	25	4.45
MASTER TL-D Eco 32W/840	927921184023	92	32	G13	2.650	4000	>80	1.213,6	28	25	4.45
MASTER TL-D Eco 32W/865	927921186523	92	32	G13	2.550	6500	>80	1.213,6	28	25	4.45
MASTER TL-D Eco 51W/840	927922184023	95	51	G13	4.550	4000	>80	1.514,2	28	25	5.15
MASTER TL-D Eco 51W/865	927922186523	95	51	G13	4.300	6500	>80	1.514,2	28	25	5.15

## MASTER TL-D Super 80



Hg

&lt;2.0



CRI &gt;80



Dim Edilir



20000 Saat



EEL

Ürün	12 NC	Gerilim (V)	Güç (W)	Duy	Işık Akısı (lm)	Renk Sıcaklığı (K)	Renk Geriverim (Ra)	Maks. Uzunluk (mm)	Çap (mm)	Kutu Adedi	Fiyat (€)
MASTER TLD Super 80 18W/827	927920082723	59	18	G13	1.350	2700	>80	604	28	25	1.85
MASTER TLD Super 80 18W/830	927920083023	59	18	G13	1.350	3000	>80	604	28	25	1.85
MASTER TLD Super 80 18W/840	927920084023	59	18	G13	1.350	4000	>80	604	28	25	1.85
MASTER TLD Super 80 18W/865	927920086544	59	18	G13	1.300	6500	>80	604	28	25	1.85
MASTER TLD Super 80 36W/827	927921082723	103	36	G13	3.350	2700	>80	1.213,6	28	25	1.95
MASTER TLD Super 80 36W/830	927921083023	103	36	G13	3.350	3000	>80	1.213,6	28	25	1.95
MASTER TLD Super 80 36W/840	927921084023	103	36	G13	3.350	4000	>80	1.213,6	28	25	1.95
MASTER TLD Super 80 36W/865	927921086544	103	36	G13	3.250	6500	>80	1.213,6	28	25	1.95
MASTER TLD Super 80 58W/827	927922082723	111	58	G13	5.240	2700	>80	1.514,2	28	25	2.40
MASTER TLD Super 80 58W/830	927922083023	111	58	G13	5.240	3000	>80	1.514,2	28	25	2.40
MASTER TLD Super 80 58W/840	927922084023	111	58	G13	5.240	4000	>80	1.514,2	28	25	2.40
MASTER TLD Super 80 58W/865	927922086544	111	58	G13	5.000	6500	>80	1.514,2	28	25	2.40

## TL-D Standart Snow White



G13



CRI 78



20000 Saat

Ürün	12 NC	Gerilim (V)	Güç (W)	Duy	Işık Akısı (lm)	Renk Sıcaklığı (K)	Renk Geriverim (Ra)	Maks. Uzunluk (mm)	Çap (mm)	Kutu Adedi	Fiyat (€)
TL-D 18W Snow White TR 15L/25	928048045019	59	18	G13	1.050	12.000	78	604	28	25	1.15
TL-D 36W Snow White TR 15L/25	928048545019	103	36	G13	2.500	12.000	78	1.213,6	28	25	1.20
TL-D 58W Snow White TR 15L/25	928049045019	111	58	G13	4.000	12.000	78	1.514,2	28	25	1.60

# LAMBALAR

## Floresan Lambalar

### MASTER TL-D 90 de Luxe



<3.0



CRI 91+



Dim Edilir



20000 Saat



EEL

Ürün	12 NC	Gerilim (V)	Güç (W)	Duy	Işık Akısı (lm)	Renk Sıcaklığı (K)	Renk Geriverim (Ra)	Maks. Uzunluk (mm)	Çap (mm)	Kutu Adedi	Fiyat (€)
TL-D 90 De Luxe 18W/950	928043595081	59	18	G13	1.150	5300	92	604	28	10	6.50
TL-D 90 De Luxe 18W/965	928043596581	59	18	G13	1.150	6500	93	604	28	10	6.50
TL-D 90 De Luxe 36W/950	928044595081	103	36	G13	2.800	5300	92	1.213,6	28	10	6.50
TL-D 90 De Luxe 36W/965	928044596581	103	36	G13	2.800	6500	93	1.213,6	28	10	6.50
TL-D 90 De Luxe 58W/950	928045095081	111	58	G13	4.550	5300	92	1.514,2	28	10	8.15
TL-D 90 De Luxe 58W/965	928045096581	111	58	G13	4.550	6500	93	1.514,2	28	10	8.15

### MASTER TL-D 90 Graphica



<3.0



CRI 97+



Dim Edilir



20000 Saat



EEL

Ürün	12 NC	Gerilim (V)	Güç (W)	Duy	Işık Akısı (lm)	Renk Sıcaklığı (K)	Renk Geriverim (Ra)	Maks. Uzunluk (mm)	Çap (mm)	Kutu Adedi	Fiyat (€)
TL-D 90 Graphica 36W/950	928044795081	103	36	G13	2.340	5300	97	1.213,6	28	10	8.70
TL-D 90 Graphica 36W/965	928044796581	103	36	G13	2.100	6500	98	1.213,6	28	10	8.70
TL-D 90 Graphica 58W/950	928045295081	111	58	G13	3.670	5300	97	1.514,2	28	10	10.15
TL-D 90 Graphica 58W/965	928045296581	111	58	G13	3.350	6500	98	1.514,2	28	10	10.15

### MASTER TL5 HE



≤ 1.4



CRI 80+



Dim Edilir



24000 Saat



EEL

Ürün	12 NC	Gerilim (V)	Güç (W)	Duy	Işık Akısı (lm)	Renk Sıcaklığı (K)	Renk Geriverim (Ra)	Maks. Uzunluk (mm)	Çap (mm)	Kutu Adedi	Fiyat (€)
MASTER TL5 HE 14W/827 SLV/40	927926082755	86	14	G5	1.350	2700	>80	563,2	17	40	2.45
MASTER TL5 HE 14W/830 SLV/40	927926083055	86	14	G5	1.350	3000	>80	563,2	17	40	2.45
MASTER TL5 HE 14W/840 SLV/40	927926084055	86	14	G5	1.350	4000	>80	563,2	17	40	2.45
MASTER TL5 HE 14W/865 SLV/40	927926086555	86	14	G5	1.250	6500	>80	563,2	17	40	2.45
MASTER TL5 HE 21W/827 SLV/40	927926282755	126	21	G5	2.100	2700	>80	863,2	17	40	2.45
MASTER TL5 HE 21W/830 SLV/40	927926283055	126	21	G5	2.100	3000	>80	863,2	17	40	2.45
MASTER TL5 HE 21W/840 SLV/40	927926284055	126	21	G5	2.100	4000	>80	863,2	17	40	2.45
MASTER TL5 HE 21W/865 SLV/40	927926286555	126	21	G5	1.950	6500	>80	863,2	17	40	2.45
MASTER TL5 HE 28W/827 SLV/40	927926582755	166	28	G5	2.900	2700	>80	1.163,2	17	40	2.55
MASTER TL5 HE 28W/830 SLV/40	927926583055	166	28	G5	2.900	3000	>80	1.163,2	17	40	2.55
MASTER TL5 HE 28W/840 SLV/40	927926584055	166	28	G5	2.900	4000	>80	1.163,2	17	40	2.55
MASTER TL5 HE 28W/865 SLV/40	927926586555	166	28	G5	2.700	6500	>80	1.163,2	17	40	2.55
MASTER TL5 HE 35W/827 SLV/40	927927082755	205	35	G5	3.650	2700	>80	1.463,2	17	40	2.55
MASTER TL5 HE 35W/830 SLV/40	927927083055	205	35	G5	3.650	3000	>80	1.463,2	17	40	2.55
MASTER TL5 HE 35W/840 SLV/40	927927084055	205	35	G5	3.650	4000	>80	1.463,2	17	40	2.55
MASTER TL5 HE 35W/865 SLV/40	927927086555	205	35	G5	3.400	6500	>80	1.463,2	17	40	2.55



## MASTER TL5 HO



Hg

1.4



CRI 80+



Dim Edilir



30000 Saat



EEL



%10

Ürün	12 NC	Gerilim (V)	Güç (W)	Duy	Işık Akısı (lm)	Renk Sıcaklığı (K)	Renk Geriverim (Ra)	Maks. Uzunluk (mm)	Çap (mm)	Kutu Adedi	Fiyat (€)
MASTER TL5 HO 24W/830 SLV/40	927928083055	77	24	G5	1.950	3000	85	563,2	17	40	2.55
MASTER TL5 HO 24W/840 SLV/40	927928084055	77	24	G5	1.950	4000	85	563,2	17	40	2.55
MASTER TL5 HO 24W/865 SLV/40	927928086555	77	24	G5	1.825	6500	85	563,2	17	40	2.55
MASTER TL5 HO 39W/830 SLV/40	927928583055	118	39	G5	3.500	3000	85	863,2	17	40	2.55
MASTER TL5 HO 39W/840 SLV/40	927928584055	118	39	G5	3.500	4000	85	863,2	17	40	2.55
MASTER TL5 HO 39W/865 SLV/40	927928586555	118	39	G5	3.250	6500	85	863,2	17	40	2.55
MASTER TL5 HO 49W/830 SLV/40	927927583055	195	49	G5	4.900	3000	85	1.463,2	17	40	2.80
MASTER TL5 HO 49W/840 SLV/40	927927584055	195	49	G5	4.900	4000	85	1.463,2	17	40	2.80
MASTER TL5 HO 49W/865 SLV/40	927927586555	195	49	G5	4.550	6500	85	1.463,2	17	40	2.80
MASTER TL5 HO 54W/830 SLV/40	927929083055	120	54	G5	5.000	3000	85	1.163,2	17	40	2.80
MASTER TL5 HO 54W/840 SLV/40	927929084055	120	54	G5	5.000	4000	85	1.163,2	17	40	2.80
MASTER TL5 HO 54W/865 SLV/40	927929086555	120	54	G5	4.800	6500	85	1.163,2	17	40	2.80
MASTER TL5 HO 80W/830 SLV/40	927929583057	152	80	G5	7.000	3000	85	1.463,2	17	40	2.80
MASTER TL5 HO 80W/840 SLV/40	927929584057	152	80	G5	7.000	4000	85	1.463,2	17	40	2.80
MASTER TL5 HO 80W/865 SLV/40	927929586557	152	80	G5	6.650	6500	85	1.463,2	17	40	2.80



## Starter

Ürün	12 NC	Gerilim (V)	Güç (W)	Duy	Işık Akısı (lm)	Renk Sıcaklığı (K)	Renk Geriverim (Ra)	Maks. Uzunluk (mm)	Çap (mm)	Kutu Adedi	Fiyat (€)
S2 4-22W SER 220-240V BL LIS/12X25CT	928390610114	230	4-22	-	-	-	-	-	-	12x25	0.55
S10 4-65W SIN 220-240V BL LIS/12X25	928392110114	230	4-65	-	-	-	-	-	-	12x25	0.55

# LAMBALAR

Gaz Deşarjlı Metal Halide -  
Quartz Lambalar



## MASTER HPI-T PLUS - Quartz



CRI 65+



Dim Edilmez



20000 Saat



EEL

Ürün	12 NC	Gerilim (V)	Güç (W)	Duy	Işık Akısı (lm)	Renk Sıcaklığı (K)	Renk Geriverim (Ra)	Maks. Uzunluk (mm)	Çap (mm)	Civa (mg)	Kutu Adedi	Fiyat (€)
<b>MASTER HPI-T Plus 450W/645 E40 1SL/12</b>	928481600097	125	445	E40	41.000	4000	65	286	47	30	12	18.75



## HPI-T SPORTS



CRI 57+



Dim Edilmez



12000 Saat



EEL

Ürün	12 NC	Gerilim (V)	Güç (W)	Duy	Işık Akısı (lm)	Renk Sıcaklığı (K)	Renk Geriverim (Ra)	Maks. Uzunluk (mm)	Çap (mm)	Civa (mg)	Kutu Adedi	Fiyat (€)
<b>HPI-T 1000W/543 E40 1SL/4</b>	928482600096	220	1000	E40	85.000	4300	57	382	66	86	4	107.14
<b>HPI-T 2000W/646 E40 220V CRP/4</b>	928073609231	220	2000	E40	189.000	3800	63	430	101,5	155,0	4	170.50
<b>HPI-T 2000W/542 E40 380V 1SL/4</b>	928074209228	380	2000	E40	210.000	3800	63	430	101,5	256,0	4	170.50



## MHN SPORTS



CRI 60+



Dim Edilmez



EEL

Ürün	12 NC	Gerilim (V)	Güç (W)	Duy	Işık Akısı (lm)	Renk Sıcaklığı (K)	Renk Geriverim (Ra)	Maks. Uzunluk (mm)	Çap (mm)	Civa (mg)	Kutu Adedi	Fiyat (€)
<b>MASTER MHN-LA 1000W/842 230V XWH</b>	928073005130	230	1000	X528	95.800	4200	70	294	40	112	1	333.33
<b>MASTER MHN-LA 1000W/956 230V XWH</b>	928072205130	230	1000	X528	87.000	5600	80	294	40	95	1	333.33
<b>MASTER MHN-LA 2000W/842 400V XWH</b>	928071305130	400	2000	X528	220.000	4200	72	364	40	185	1	380.95
<b>MASTER MHN-SA 2000W/956 400V XW HO</b>	928195105129	400	2000	X830R	226.000	5600	81	369	34,3	215	1	380.95
<b>MASTER MHN-SE 2000W/956 GX22 400V HO</b>	928196905130	400	2000	GX22	227.000	5600	84	196	39	215	1	464.29



Sodyum Buharlı - Yüksek Basınç

MASTER SON PIA PLUS



30000 Saat



Dim Edilir



EEL

Ürün	12 NC	Gerilim (V)	Güç (W)	Duy	Işık Akısı (lm)	Renk Sıcaklığı (K)	Renk Geriverim (Ra)	Maks. Uzunluk (mm)	Çap (mm)	Civa (mg)	Kutu Adedi	Fiyat (€)
MASTER SON PIA Plus 70W/220 I E27 1CT/24	928150008835	92	70	E27	5.900	1900	25	156	71	16	24	10.60
MASTER SON PIA Plus 150W/220 E40 1SL/12	928151409827	100	150	E40	16.100	2000	25	227	91	15	12	18.15
MASTER SON PIA Plus 250W/220 E40 1SL/12	928153309830	100	250	E40	30.900	2000	25	227	91	15	12	20.05
MASTER SON PIA Plus 400W/220 E40 1SL/12	928153409830	105	400	E40	55.400	2000	25	290	122	20	12	26.25
MST SON-T PIA Plus 50W/220 E27 1SL/12	928151900028	91	50	E27	4.400	2000	25	156	36	12	12	9.20
MST SON-TPIA Plus 70W E27 1CT/12 (Çin)	928483200094	93	70	E27	6.600	2000	25	156	36	12.2	12	7.85
MST SON-T PIA Plus 70W/220 E27 1SL/12	928152700028	90	70	E27	6.600	2000	25	156	36	12	12	8.95
MST SON-T PIA Plus 100W E40 1SL/12 (Çin)	928483300095	100	100	E40	10.700	2000	25	209	47	14	12	8.95
MST SON-T PIA Plus 100W/220 E40 1SL/12	928151709230	90	100	E40	10.700	2000	25	209	47	16	12	11.10
MST SON-T PIA Plus 150W E40 1SL/12 (Çin)	928483400095	100	150	E40	10.800	2000	25	209	47	15	12	8.95
MST SON-T PIA Plus 150W/220 E40 - 1SL/12	928150909230	100	150	E40	17.700	2000	25	209	47	15	12	11.65
MST SON-T PIA Plus 250W E40 1SL/12	928144709293	100	250	E40	33.000	2000	25	257	48	15	12	11.10
MST SON-T PIA Plus 400W E40 1SL/12	928144809293	100	400	E40	55.800	2000	25	283	48	20	12	12.45
MST SON-T PIA Plus 600W/220 E40 1SL/12	928158409227	110	600	E40	86.500	2000	25	283	47	24	12	22.20
SON-T 1000W/220 E40 1SL/4	928154509228	100	1000	E40	130.000	2000	25	390	66	38	4	39.55

# LAMBALAR

Gaz Deşarjlı Kompakt  
Metal Halide - Seramik



## CDM Elite



CRI 85+



Dim Edilmez



15000 Saat



A+  
EEL

Ürün	12 NC	Gerilim (V)	Güç (W)	Duy	Işık Akısı (lm)	Renk Sıcaklığı (K)	Renk Geriverim (Ra)	Maks. Uzunluk (mm)	Çap (mm)	Civa (mg)	Kutu Adedi	Fiyat (€)
MASTERCour CDM-T Elite 35W/930	928185205131	85	35	G12	4.050	3000	90	103	20	4,7	12	25.45
MASTERCour CDM-TC Elite 70W/930	928189505131	84	70	G8.5	7.800	3000	90	85	15	6,6	12	25.45
MASTERCour CDM-TC Elite 50W/930	928191805131	90	50	G8.5	5.400	3000	90	85	15	6,4	12	25.45



## CDM-T, CDM-TC, CDM-TD



CRI 81+



Dim Edilmez



12000 Saat



A  
EEL

Ürün	12 NC	Gerilim (V)	Güç (W)	Duy	Işık Akısı (lm)	Renk Sıcaklığı (K)	Renk Geriverim (Ra)	Maks. Uzunluk (mm)	Çap (mm)	Civa (mg)	Kutu Adedi	Fiyat (€)
MASTERC CDM-T 35W/830 G12 1CT/12	928083105125	88	35	G12	3.000	3000	81	103	20	3,1	12	23.55
MASTERC CDM-T 35W/842 G12 1CT/12	928094305125	85	35	G12	3.100	4200	84	103	20	2,7	12	23.55
MASTERC CDM-T 70W/830 G12 1CT/12	928082305125	88	70	G12	6.400	3000	84	103	20	4,5	12	23.55
MASTERC CDM-T 70W/942 G12 1CT/12	928084505131	88	70	G12	6.300	4200	92	103	20	6	12	23.55
MASTERC CDM-T 150W/830 G12 1CT	928083705125	96	150	G12	13.300	3000	88	110	20	14	12	23.55
MASTERC CDM-T 150W/942 G12 1CT	928084605131	90	150	G12	12.400	4200	96	110	20	10	12	23.55
MASTERC CDM-T 250W/830 G12 1CT/12	928089805131	95	250	G12	27.540	3000	85	135	25	27	12	86.60
MASTERC CDM-T 250W/942 G12 1CT/12	928094205131	93	250	G12	26.000	4200	91	135	25	19	12	86.60
MASTERC CDM-TC 35W/830 G8.5 1CT/12	928085205125	84	35	G8.5	3.000	3000	81	85	15	3	12	25.20
MASTERC CDM-TC 70W/830 G8.5 1CT/12	928086505131	83	70	G8.5	6.400	3000	83	85	15	5	12	25.20
MASTERC CDM-TC 70W/842 G8.5 1CT/12	928094605131	88	70	G8.5	5.800	4200	89	85	15	7	12	25.20
MASTERC CDM-TD 70W/830 RX7s 1CT/12	928082205125	94	70	RX7s	6.000	3000	80	119,63	22	3	12	25.75
MASTERC CDM-TD 150W/830 RX7s 1CT	928083605133	98	150	RX7s	13.250	3000	88	137,43	25	10	12	25.75
MASTERC CDM-TD 150W/942 RX7s 1CT	928084805133	103	150	RX7s	13.750	4200	96	137,43	25	8	12	25.75



## CDM-R Elite



CRI 90+



Dim Edilmez



15000 Saat



A  
EEL

Ürün	12 NC	Gerilim (V)	Güç (W)	Duy	Işık Şiddeti (cd)	Renk Sıcaklığı (K)	Renk Geriverim (Ra)	Maks. Uzunluk (mm)	Çap (mm)	Civa (mg)	Kutu Adedi	Fiyat (€)
MC CDM-R Elite 35W/930 E27 PAR20 10D	928050200630	88	35	E27	23.000	3000	91	95	65	4,7	12	42.75
MC CDM-R Elite 35W/930 E27 PAR20 30D	928050300630	88	35	E27	6.500	3000	91	95	65	4,7	12	42.75
MC CDM-R Elite 70W/930 E27 PAR30L 10D	928109300630	86	70	E27	61.000	3000	92	123	97	6,6	12	42.75
MC CDM-R Elite 70W/930 E27 PAR30L 30D	928109400630	86	70	E27	14.000	3000	92	123	97	6,6	12	42.75
MC CDM-R Elite 70W/930 E27 PAR30L 40D	928109500630	86	70	E27	10.300	3000	92	123	97	6,6	12	42.75



# LAMBALAR

Gaz Deşarjlı Kompakt  
Metal Halide - Seramik



## CDM-R 111 Elite



CRI 90+



Dim Edilmez



10500+ Saat



EEL

Ürün	12 NC	Gerilim (V)	Güç (W)	Duy	Işık Şiddeti (cd)	Renk Sıcaklığı (K)	Renk Geriverim (Ra)	Maks. Uzunluk (mm)	Çap (mm)	Civa (mg)	Kutu Adedi	Fiyat (€)
MASTERC CDM-R111 Elite 35W/930 GX8.5 40D	928195505330	89	35	GX8.5	4.500	3000	90	95	111	4,7	6	51.95
MASTERC CDM-R111 Elite 70W/930 GX8.5 24D	928195705330	89	70	GX8.5	16.000	3000	92	95	111	6,6	6	51.95
MASTERC CDM-R111 Elite 70W/930 GX8.5 40D	928195805330	89	70	GX8.5	8.500	3000	92	95	111	6,6	6	51.95

Metal halide - Quartz, Düşük Güç

## MHN-TD & MHN-TD Basic



CRI 70+



Dim Edilmez



9000+ Saat



EEL

Ürün	12 NC	Gerilim (V)	Güç (W)	Duy	Işık Akısı (lm)	Renk Sıcaklığı (K)	Renk Geriverim (Ra)	Maks. Uzunluk (mm)	Çap (mm)	Civa (mg)	Kutu Adedi	Fiyat (€)
MHN-TD 70W/730 RX7s 1CT/12	928482400092	90	70	RX7s	6.000	3000	70	117,6	19,5	13,4	12	12.80
MHN-TD 70W/842 RX7s 1CT/12	928070205190	90	70	RX7s	5.700	4200	80	117,6	19,5	11,0	12	12.80
MHN-TD 150W/730 RX7s 1CT/12	928482500092	96	150	RX7s	13.800	3000	70	135,4	24	12,4	12	12.80
MHN-TD 150W/842 RX7s 1CT/12	928076505190	98	150	RX7s	12.900	4200	85	135,4	24	13,0	12	12.80

# ENKANDESAN LAMBALAR



## PARTY (GECE LAMBASI)



Dim Edilir



1000 Saat

Ürün	12 NC	Gerilim (V)	Güç (W)	Eşdeğer Güç (W)	Duy	Işık Akısı (lm)	Renk Sıcaklığı (K)	Renk Geriverim (Ra)	Maks. Uzunluk (mm)	Çap (mm)	Kutu Adedi	Fiyat (€)
Party 15W E27 220-240V P45 BL MAVİ	921587543326	220-240	15	-	E27	2	2700	100	74	45	20	0.65
Party 15W E27 220-240V P45 GR YEŞİL	921587743329	220-240	15	-	E27	5	2700	100	74	45	20	0.65
Party 15W E27 220-240V P45 RE KIRMIZI	921587843326	220-240	15	-	E27	8	2700	100	74	45	20	0.65
Party 15W E27 220-240V P45 OR TURUNCU	921587943326	220-240	15	-	E27	25	2700	100	74	45	20	0.65
Party 15W E27 220-240V P45 YE SARI	921587643329	220-240	15	-	E27	100	2700	100	74	45	20	0.65

# LAMBALAR

## Halojen Lambalar



### HAL-DICH (EcoHalo Capsule MV yerine gelen ürünler)

YENİ

Ürün	12 NC	Gerilim (V)	Güç (W)	Eşdeğer Güç (W)	Duy	Işık Akısı (lm)	Renk Sıcaklığı (K)	Renk Geriverim (Ra)	Maks. Uzunluk (mm)	Çap (mm)	Kutu Adedi	Fiyat (€)
Hal-Dich 4y 20W GU4 12V 30D 2BC/10	925721617101	12	20		GU5.3	205	3000	100	40	35	10	1.70
Hal-Dich 4y 20W GU5.3 12V 36D 2BC/10	926000850064	12	20		GU5.3	205	3000	100	46	51	10	1.70
Hal-Dich 4y 35W GU4 12V 30D 2BC/10	925721517101	12	35		GU5.3	430	3000	100	40	35	10	1.70
Hal-Dich 4y 35W GU5.3 12V 36D 2BC/10	926000850066	12	35		GU5.3	430	3000	100	46	51	10	1.75
Hal-Dich 4y 50W GU5.3 12V 36D 2BC/10	926000850067	12	50		GU5.3	680	3000	100	46	51	10	1.75

### PLUSLINE COMPACT ÇUBUK HALOJEN



2900



CRI 100



8000  
Açma-Kapama



Anında  
Yanar



0.0 sn



Dim Edilir



2000 Saat

Ürün	12 NC	Gerilim (V)	Güç (W)	Eşdeğer Güç (W)	Duy	Işık Akısı (lm)	Renk Sıcaklığı (K)	Renk Geriverim (Ra)	Maks. Uzunluk (mm)	Çap (mm)	Kutu Adedi	Fiyat (€)
Plusline ES 78mm 2y 48W R7s 230V 1BB	924587044210	230	48	60	R7s	780	2900	100	78	11	100	3.95
Plusline ES 78mm 2y 80W R7s 230V 1BB	924587144210	230	80	100	R7s	1.415	2900	100	78	11	100	4.15
Plusline ES 78mm 2y 120W R7s 230V 1BB	924587244210	230	120	150	R7s	2.220	2900	100	78	11	100	4.15

### PLUSLINE SMALL ÇUBUK HALOJEN



2900



CRI 100



8000  
Açma-Kapama



Anında  
Yanar



0.0 sn



Dim Edilir



2000 Saat

Ürün	12 NC	Gerilim (V)	Güç (W)	Eşdeğer Güç (W)	Duy	Işık Akısı (lm)	Renk Sıcaklığı (K)	Renk Geriverim (Ra)	Maks. Uzunluk (mm)	Çap (mm)	Kutu Adedi	Fiyat (€)
Plusline ES 118mm 2y 120W R7s 230V 1BB	924587444210	230	120	150	R7s	2.220	2900	100	118	11	100	4.15
Plusline ES 118mm 2y 160W R7s 230V 1BB	924587544210	230	160	200	R7s	3.100	2900	100	118	11	100	4.15
Plusline ES 118mm 2y 240W R7s 230V 1BB	924572044210	230	240	300	R7s	4.900	2900	100	118	11	100	4.15
Plusline ES 118mm 2y 400W R7s 230V 1BB	924572144210	230	400	500	R7s	8.600	2900	100	118	11	100	4.15

# PHILIPS

Meson Essential



# Doğru ışık her şeydir! Ne diyorsak o!

Belirttiğimiz lümen ve watt değerleri ile yüksek ışık teknolojisini sizlere sunuyoruz.

	10W
900 lumen	
940 lumen	
940 lumen	



Meson Essential  
Downlight

# TÜKETİCİ ARMATÜRLERİ

LED Gömme Spot



## Meson Essential LED Gömme Spot



3000/4000/6500



Anında Yanar



CRI 80



15000 Saat



12 Adet

IP20

Sentetik

Ürün	12 NC	Gerilim (V)	Güç (W)	Etkinlik Faktörü (lm/W)	Işık Akısı (lm)	Renk Sıcaklığı (K)	Delik Çapı (mm)	Boyut (mm)	Yükseklik (mm)	Min. Sipariş Adedi	Kutu Adedi	Fiyat (€)
59200 MESON 2.5" 3.5W 30K LED gömme spot	915005362301	220-240	3,5	86	300	3000	Ø: 80	95	46	504	12	5.84
59200 MESON 2.5" 3.5W 40K LED gömme spot	915005362401	220-240	3,5	91	320	4000	Ø: 80	95	46	504	12	5.84
59200 MESON 2.5" 3.5W 65K LED gömme spot	915005362501	220-240	3,5	91	320	6500	Ø: 80	95	46	504	12	5.84
59201 MESON 3" 5.5W 30K LED gömme spot	915005362601	220-240	5,5	82	450	3000	Ø: 90	105	46	504	12	6.94
59201 MESON 3" 5.5W 40K LED gömme spot	915005362701	220-240	5,5	84	460	4000	Ø: 90	105	46	504	12	6.94
59201 MESON 3" 5.5W 65K LED gömme spot	915005362801	220-240	5,5	84	460	6500	Ø: 90	105	46	504	12	6.94
59202 MESON 3.5" 7W 30K LED gömme spot	915005362901	220-240	7	86	600	3000	Ø: 105	120	47	504	12	8.40
59202 MESON 3.5" 7W 40K LED gömme spot	915005363001	220-240	7	89	620	4000	Ø: 105	120	47	504	12	8.40
59202 MESON 3.5" 7W 65K LED gömme spot	915005363101	220-240	7	89	620	6500	Ø: 105	120	47	504	12	8.40
59203 MESON 4" 10W 30K LED gömme spot	915005363201	220-240	10	90	900	3000	Ø: 125	140	47	504	12	9.97
59203 MESON 4" 10W 40K LED gömme spot	915005363401	220-240	10	94	940	4000	Ø: 125	140	47	504	12	9.97
59203 MESON 4" 10W 65K LED gömme spot	915005363301	220-240	10	94	940	6500	Ø: 125	140	47	504	12	9.97
59204 MESON 6" 10W 30K LED gömme spot	915005501501	220-240	10	90	900	3000	Ø: 150	165	47	504	12	9.97
59204 MESON 6" 10W 40K LED gömme spot	915005501401	220-241	10	90	900	4000	Ø: 150	165	47	504	12	9.97
59204 MESON 6" 10W 65K LED gömme spot	915005501601	220-242	10	90	900	6500	Ø: 150	165	47	504	12	9.97



## Ürün Özellikleri

- Enerji tasarrufu kategorisinde A<sup>+</sup>
- Renksel geriverim >80

Çok çeşitli  
ışık rengi

3000K  
4000K  
6500K

**İnce tasarım**  
Alçak tavan uygulamaları için ideal



**Yüksek lümen**  
Tüm uygulamalar için

**Vida gerekmez**  
Tak çalıştır



**Düzgün yayılan ışık**  
Ekstra geniş difüzör

**Entegre sürücü**  
Kolay montaj

**Dayanıklı metal klips**  
Plastik kaplama ile rahatça takın

- Yüksek lümen, yüksek verim
- İndirgenmiş ürün yüksekliği, asma tavan için uygun daha ince tasarım
- Kurulumu kolaylaştıran daha hafif tasarım
- Backlight teknolojisi sayesinde homojen ışık

# TÜKETİCİ ARMATÜRLERİ

LED Gömme Spot



## Marcasite LED Gömme Spot



  
3000/4000/6500

  
Anında Yanar

  
CRI 80

  
15000 Saat

  
12 Adet

  
IP20

  
Sentetik

Ürün	12 NC	Gerilim (V)	Güç (W)	Etkinlik Faktörü (lm/W)	Işık Akısı (lm)	Renk Sıcaklığı (K)	Delik Çapı (mm)	Boyut (mm)	Yükseklik (mm)	Min. Sipariş Adedi	Kutu Adedi	Fiyat (€)
59536 MCSSLITE 175 13W 30K WH LED Gömme Spot	915005578501	220-240	13,0	77	1000	3000	Ø: 80	95	46	504	12	9.97
59536 MCSSLITE 175 13W 40K WH LED Gömme Spot	915005578601	220-240	13,0	81	1050	4000	Ø: 80	95	46	504	12	9.97
59536 MCSSLITE 175 13W 65K WH LED Gömme Spot	915005578701	220-240	13,0	81	1050	6500	Ø: 80	95	46	504	12	9.97
59537 MCSSLITE 200 15W 30K WH LED Gömme Spot	915005578801	220-240	15,0	73	1100	3000	Ø: 90	105	46	504	12	11.40
59537 MCSSLITE 200 15W 40K WH LED Gömme Spot	915005578901	220-240	15,0	77	1150	4000	Ø: 90	105	46	504	12	11.40
59537 MCSSLITE 200 15W 65K WH LED Gömme Spot	915005579001	220-240	15,0	77	1150	6500	Ø: 90	105	46	504	12	11.40

## Evinizde eşit aydınlatılmış ve sıcak bir ortam yaratan alanların keyfini çıkarın

**Gelişmiş yan-aydınlatma teknolojisi**, ışığın yüksek kaliteli dağıtıcı ile dağıtılmasını sağlar. Yayılan ışık düşük parlamayla eşit olarak dağıtılır, gözleriniz için rahatlatıcı ideal ev aydınlatması yaratır. Philips Marcasite LED Gömme Spot, yüksek renksel geriverim ile renkleri en doğal halleriyle ortaya çıkarır, aydınlatılmış objeler üzerinde gelişmiş renk ayrımları sağlar.

LED kaynağı ile güçlendirilmiş, en iyi parlaklığı ve enerji tasarrufunu sunan aydınlatmanın keyfini çıkarın.

## İnce ve kompakt gömme spot

Philips Marcasite LED Gömme Spot ile evinizde sıcak ve rahat bir aydınlatma deneyimi yaratın. Kompakt tasarımı, 27/30 mm ince boyutu ve entegre sürücüsüyle gömme spot düşük asma tavanlı ev sahipleri için geliştirildi. Philips Marcasite LED Gömme Spot, eviniz için uzun süre kullanım ömrüyle en iyi aydınlatma kalitesini sunar.

### Gelişmiş yan-aydınlatma teknolojisi

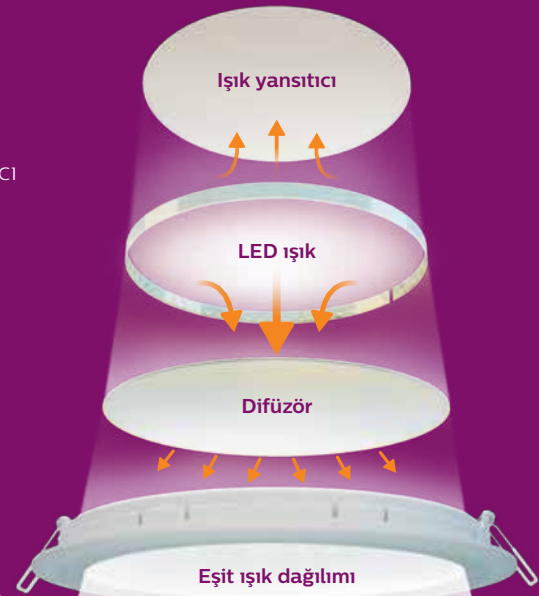

### Philips Marcasite LED Gömme Spot özelliklerine kısa bir bakış:



İnce tasarım



Eşit ışık dağılımı



Kolay kurulum



Doğal renksel geriverim (CRI)



Enerji tasarrufu



Uzun ömür

# TÜKETİCİ ARMATÜRLERİ

LED Gömme Spot



## Pomeron Essential Metal Spot



2700/4000



Anında Yanar



CRI 80



15000 Saat



12 Adet

IP 20

Ürün	12 NC	Gerilim (V)	Güç (W)	Etkinlik Faktörü (lm/W)	Işık Akısı (lm)	Renk Sıcaklığı (K)	Delik Çapı (mm)	Boyut (mm)	Yükseklik (mm)	Min. Sipariş Adedi	Kutu Adedi	Fiyat (€)
59774 POMERON 070 3W 27K SI LED Gömme Spot	915005445301	220-240	3,0	63	190	2700	Ø: 70	90	62	504	12	8.92
59774 POMERON 070 3W 40K SI LED Gömme Spot	915005445401	220-240	3,0	67	200	4000	Ø: 70	90	62	504	12	8.92
59775 POMERON 070 5W 27K SI recessed LED	915005445501	220-240	5,0	58	290	2700	Ø: 70	90	62	504	12	9.97
59775 POMERON 070 5W 40K SILED Gömme Spot	915005445601	220-240	5,0	60	300	4000	Ø: 70	90	62	504	12	9.97
59776 POMERON 070 7W 27K SI LED Gömme Spot	915005445701	220-240	7,0	56	390	2700	Ø: 70	90	71	504	12	10.53
59776 POMERON 070 7W 40K SI LED Gömme Spot	915005445801	220-240	7,0	57	400	4000	Ø: 70	90	71	504	12	10.53



## Kyanite Essential Synthetic Spot



2700/4000



Anında Yanar



CRI 80



15000 Saat



12 Adet

IP 20

Ürün	12 NC	Gerilim (V)	Güç (W)	Etkinlik Faktörü (lm/W)	Işık Akısı (lm)	Renk Sıcaklığı (K)	Delik Çapı (mm)	Boyut (mm)	Yükseklik (mm)	Min. Sipariş Adedi	Kutu Adedi	Fiyat (€)
59751 KYANITE 070 3W 27K WH LED Gömme Spot	915005443901	220-240	3,0	63	190	2700	70	82	62	504	12	6.54
59751 KYANITE 070 3W 40K WH LED Gömme Spot	915005444001	220-240	3,0	67	200	4000	70	82	62	504	12	6.54
59752 KYANITE 070 5W 27K WH LED Gömme Spot	915005444101	220-240	5,0	58	290	2700	70	82	62	504	12	7.49
59752 KYANITE 070 5W 40K WH LED Gömme Spot	915005444201	220-240	5,0	60	300	4000	70	82	62	504	12	7.49



# TÜKETİCİ ARMATÜRLERİ

LED Plafonyer & LED Şerit



## Essential LED Şerit



3000



Anında Yanar



CRI 80



20000 Saat



12 Adet



IP 20



Sentetik

Ürün	12 NC	Gerilim (V)	Güç (W)	Etkinlik Faktörü (lm/W)	Işık Akısı (lm)	Renk Sıcaklığı (K)	Boyut (mm)	Yükseklik (mm)	Min. Sipariş Adedi	Kutu Adedi	Fiyat (€)
30924 LED şerit güç bağlantı kablosu	915004923601	110-240	-	-	-	-	21x13x5	79	600	-	0.80
30925 şerit LED bağlantı aparatı	915004923701	110-240	-	-	-	-	16x13x5	79	600	-	0.75
DLI 31058 LED tape 3000K 18W 5m P	915004923501	220-240	18,0	105	1890	3000	5000	82	1000	12	25.61
DLI 31059 LED tape 3000K 18W 5m	915004923801	220-240	18,0	105	1890	3000	5000	82	1000	12	43.53



## 3336 LED Plafonyer



2700/6500



Anında Yanar



CRI 80



20000 Saat



IP 20



Sentetik

Ürün	12 NC	Gerilim (V)	Güç (W)	Etkinlik Faktörü (lm/W)	Işık Akısı (lm)	Renk Sıcaklığı (K)	Boyut (mm)	Yükseklik (mm)	Min. Sipariş Adedi	Kutu Adedi	Fiyat (€)
33362 Moire 27K 16W LED plafonyer beyaz	915004478301	220-240	16,0	69	1100	2700	320	79	300	6	27.64
33362 Moire 65K 16W LED plafonyer beyaz	915004478401	220-240	16,0	69	1100	6500	320	79	300	6	27.64
33361 Moire 27K 6W LED plafonyer beyaz	915004478501	220-240	6,0	80	480	2700	225	70	300	20	13.96
33361 Moire 65K 6WLED plafonyer beyaz	915004478601	220-240	6,0	80	480	6500	225	70	300	20	13.96



## Sensörlü LED Plafonyer



2700/6500



Anında Yanar



CRI 80



20000 Saat



20 Adet



IP 20



Sentetik

Ürün	12 NC	Gerilim (V)	Güç (W)	Etkinlik Faktörü (lm/W)	Işık Akısı (lm)	Renk Sıcaklığı (K)	Boyut (mm)	Yükseklik (mm)	Min. Sipariş Adedi	Kutu Adedi	Fiyat (€)
62233 Danta 65K 6W sensörlü LED plafonyer	915005216201	220-240	6,0	80	480	6500	254	79	160	20	23.56
62233 Danta 27K 6W sensörlü LED plafonyer	915005216301	220-240	6,0	80	480	2700	254	79	160	20	23.56
62234 Danta 65K 16W sensörlü LED plafonyer	915005216401	220-240	16,0	69	1100	6500	320	82	120	6	32.01
62234 Danta 27K 16W sensörlü LED plafonyer	915005216501	220-240	16,0	69	1100	2700	320	82	120	6	32.01

# TÜKETİCİ ARMATÜRLERİ

LED Linea



## myLiving LED Linea



3000/4000/6500



Anında Yanar



CRI 80



15000 Saat



20 Adet



IP 20

Sentetik

Ürün	12 NC	Gerilim (V)	Güç (W)	Etkinlik Faktörü (lm/W)	Işık Akısı (lm)	Renk Sıcaklığı (K)	Boyut (mm)	Min. Sipariş Adedi	Kutu Adedi	Fiyat (€)
31091 TrunkLinea 13W 3000K LED	915004985801	220-240	13	77	1.000	3000	1.170x22x36	1.000	20	11.05
31085 TrunkLinea 9W 3000K LED	915005196001	220-240	9	83	750	3000	870x22x36	1.000	20	9.45
31092 TrunkLinea 7W 3000K LED	915004985901	220-240	7	71	500	3000	570x22x36	1.000	20	7.40
31093 TrunkLinea 4W 3000K LED	915004986001	220-240	4	63	250	3000	310x22x36	1.000	20	5.65
31094 TrunkLinea 13W 4000K LED	915004986101	220-240	13	77	1.000	4000	1.170x22x36	1.000	20	11.05
31085 TrunkLinea 9W 4000K LED	915005196001	220-240	9	83	750	4000	870x22x36	1.000	20	9.45
31095 TrunkLinea 7W 4000K LED	915004986201	220-240	7	71	500	4000	570x22x36	1.000	20	7.40
31096 TrunkLinea 4W 4000K LED	915004986301	220-240	4	63	250	4000	310x22x36	1.000	20	5.65
31097 TrunkLinea 13W 6500K LED	915004986401	220-240	13	77	1.000	6500	1.170x22x36	1.000	20	11.05
31085 TrunkLinea 9W 6500K LED	915005196003	220-240	9	83	750	6500	870x22x36	1.000	20	9.45
31098 TrunkLinea 7W 6500K LED	915004986501	220-240	7	71	500	6500	570x22x36	1.000	20	7.40
31099 TrunkLinea 4W 6500K LED	915004986601	220-240	4	63	250	6500	310x22x36	1.000	20	5.65

\*Güç kablosunun ayrıca satın alınması gerekmektedir.

## myLiving LED Linea Aksesuarları



Anında Yanar



20 Adet

IP 20

Sentetik

Ürün	12 NC	Gerilim (V)	Boyut (mm)	Min. Sipariş Adedi	Kutu Adedi	Fiyat (€)
31090 TrunkLinea esnek bağlantı kablosu	915004986701	220-240	235x14x8	1.000	20	1.43
31089 TrunkLinea güç kablosu	915004986801	220-240	235x14x8	1.000	20	0.80



## Uygulama

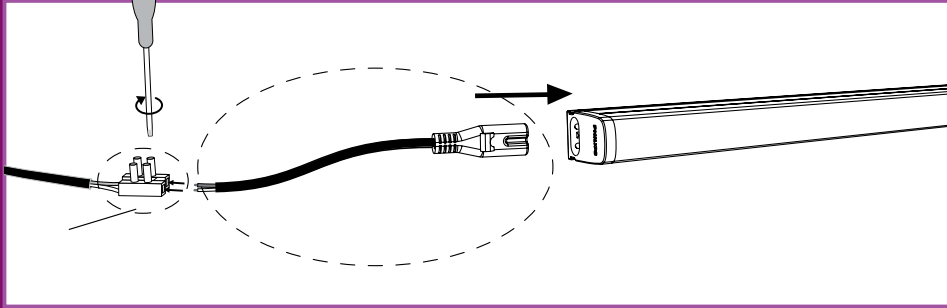

31089  
Güç bağlantı  
kablosu

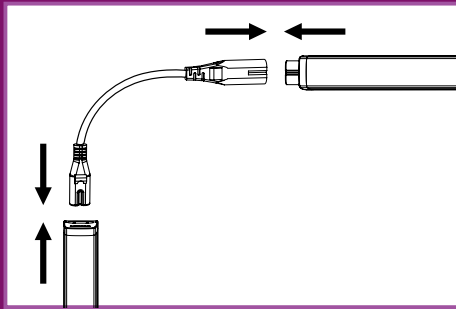

31090  
Esnek bağlantı  
kablosu

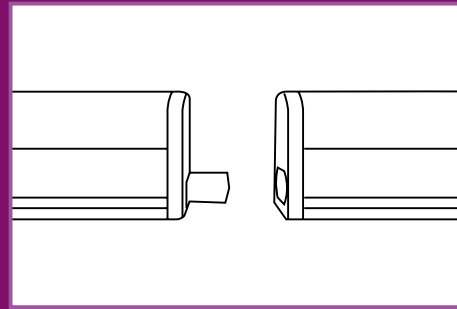

Ürünleri birbirine  
bağlamak için ayrıca  
bir kabloya gerek  
yoktur. 12 adede  
kadar TrunkLinea  
ucuca eklenebilir.

Elektronik Floresan  
Balastlar



Elektronik Floresan  
Balastlar



Elektronik Balastlar



# BALASTLAR

Floresan Lamba  
Balastları

Gaz Deşarjlı Lamba  
Balastları

Ateşleyiciler

Halojen  
Transformatörler

# FLORESAN LAMBA BALASTLARI

Elektronik, Sabit Çıkışlı  
Floresan Balastlar



## HF-Performer III



100000 Saat



50000+  
Açma-Kapama



< 0.5 sn



< %10

**A2BAT\***

EEL

Ürün	12 NC	Lamba Grubu	Lamba (W)	Kutu Adedi	Fiyat (€)
HF-P 1 14-35 TL5 HE III 220-240V	913713031066	TL5	1 x TL5 14-35	12	14.25
HF-P 1 24/39 TL5 III 220-240V 50/60Hz	913713034066		1 x TL5 24-39	12	13.55
HF-P 149 TL5 HO III 220-240V 50/60Hz IDC	913713028066		1 x TL5 49	12	13.55
HF-P 2 14-35 TL5 HE III 220-240V	913713031166		2 x TL5 14-35	12	15.65
HF-P 249 TL5 HO III 220-240V 50/60Hz IDC	913713028166		2 x TL5 49	12	14.90
HF-P 254/255 TL5 HO/PLL III 220-240V IDC	913713028366		2 x TL5 54, 2 x PL-L 55	12	15.65
HF-P 180 TL5 III 220-240V 50/60Hz	913713034266		1 x TL5 80	12	18.15
HF-P 280 TL5/PL-L III 220-240V 50/60Hz	913713034366		2 x TL5 80	12	25.75
HF-P 136 TL-D III 220-240V 50/60Hz IDC	913713031566	TL-D	1 x TL-D 36, 1 x PL-L 36	12	16.25
HF-P 158 TL-D III 220-240V 50/60Hz IDC	913713031866		1 x TL-D 58, 1 x PL-L 55	12	17.05
HF-P 258 TL-D III 220-240V 50/60Hz IDC	913713031966		2 x TL-D 58, 2 x PL-L 55	12	17.05

\*BAT: Best Available Technology



## HF-Selectalume II



85000 Saat



50000+  
Açma-Kapama



< 1.6 sn



< %10

**A2**

EEL

Ürün	12 NC	Lamba Grubu	Lamba (W)	Kutu Adedi	Fiyat (€)	
HF-S 1 14-35 TL5 HE II 220-240V	913713042066	TL5	1 x TL5 14-35	12	12.75	
HF-S 149 TL5 II 220-240V 50/60Hz	913713033466		1 x TL5 49	12	12.75	
HF-S 154 TL5 II 220-240V 50/60Hz	913713033666		1 x TL5 54	12	12.75	
HF-S 2 14-35 TL5 HE II 220-240V	913713042166		2 x TL5 14-21	12	16.50	
HF-S 254 TL5 II 220-240V 50/60Hz	913713033766		2 x TL5 54	12	14.25	
HF-S 3/414 TL5 II 220-240V 50/60Hz	913713033066		3/4 x TL5 14	12	13.55	
HF-S 3/424 TL5 II 220-240V 50/60Hz	913713034666		3/4 x TL5 24	12	16.50	
HF-S 180 TL5 II 220-240V 50/60Hz	913713042266		1 x TL5 80	12	14.25	
HF-S 280 TL5/PL-L II 220-240V 50/60Hz	913713042366	2 x TL5 80, 2 x PL-L 80	12	21.60		
HF-S 136 TL-D II 220-240V 50/60Hz	913713032166	TL-D	1 x TL-D 18 -36	12	13.55	
HF-S 158 TL-D II 220-240V 50/60Hz	913713032266		1 x TL-D 58	12	12.75	
HF-S 236 TL-D II 220-240V 50/60Hz	913713032466		2 x TL-D 36	12	13.40	
HF-S 258 TL-D II 220-240V 50/60Hz	913713032566		2 x TL-D 58	12	13.40	
HF-S 3/4 18 TL-D II 220-240V 50/60Hz	913713032666		3/4 x TL-D 18	12	14.25	
HF-S 218 PL-T/C II SR 220-240V 50/60Hz	913713035866		PL-T/C/L	1/2 x PL-T/C 18	12	16.50





### HF-Essential



45000 Saat



6000  
Açma-Kapama

## A2

EEL

**YENİ**

Ürün	12 NC	Lamba Grubu	Lamba (W)	Kutu Adedi	Fiyat (€)
HF-E 118 TL-D 220-240 50/60Hz	913713038766	TL-D	1 x TLD 18	20	6.40
HF-E 136 TL-D 220-240 50/60Hz	913713038866		1 x TLD 36	20	6.40
HF-E 236 TL-D 220-240 50/60Hz	913713039166		2 x TL-D 18 - 1 x TL-D 36	20	7.40
HF-E 418 TL-D 220-240 50/60Hz	913713039266		4 x TL-D 18	20	7.80



### HF-Essential II



45000 Saat



25000+  
Açma-Kapama



< 1.4 sn



THD  
< %15

## A2

EEL

Ürün	12 NC	Lamba Grubu	Lamba (W)	Kutu Adedi	Fiyat (€)
HF-E 1/2 28-35 TL5 II 220-240 50/60Hz	913713042866	TL5	1/2 x TL5 28 - 35	20	11.65
HF-E 3/4 14 TL5 II 220-240V 50/60Hz	913713041366		3/4 x TL5 14	20	11.65
HF-E 1/2 49 TL5 II 220-240V 50/60Hz	913713040766		1/2 TL5 49	20	12.50
HF-E 1/2 54 TL5 II 220-240V 50/60Hz	913713040866	TL-D	1/2 TL5 54 - 1/2 TL-D 58 - 1/2 PL-L 55	20	12.50
HF-E 136 TL-D II 220-240V 50/60Hz	913713041066		2 x TL-D 18 - 1 x TL-D 36	20	10.55
HF-E 236 TL-D II 220-240V 50/60Hz	913713041166		2 x TL-D 36	20	11.10
HF-E 418 TL-D II 220-240V 50/60Hz	913713041266		4 x TL-D 18	20	11.65
HF-E 1/2 58 TL-D II 220-240V 50/60Hz	913713040966		1/2 TL-D 58 - 1/2 PL-L 55	20	11.65

# GAZ DEŞARJLI LAMBA BALASTLARI

## Elektronik Balastlar



### PrimaVision



Ürün	12 NC	Lamba Grubu	Lamba (W)	Kutu Adedi	Fiyat (€)
HID-PV C 35/S CDM 220-240V 50/60Hz	913700652766	CDM	1 x CDM 35	12	34.10
HID-PV C 35/I CDM 220-240V 50/60Hz	913700653166		1 x CDM 35	12	32.50
HID-PV C 50 /S CDM 220-240V 50/60Hz	913700664966		1 x CDM 50	12	32.50
HID-PV C 70/S CDM 220-240V 50/60Hz	913700652966		1 x CDM 70	12	34.10
HID-PV C 70 /I CDM 220-240V 50/60Hz	913700653266		1 x CDM 70	12	32.50
HID-PV C 150 /S CDM 220-240V 50/60Hz	913700614066		1 x CDM 150	12	73.90

### Teknik Özellikler

#### HID İç Mekan Aydınlatmalar için



##### Soft Start Özelliği

Sınırlanmış ani akım sayesinde azalan kurulum maliyetleri, tek bir MCB'de daha fazla balast çalışmasına olanak tanır.



##### Gelişmiş Termal Performans

Bu balast, benzer koşullardaki standart balastlarla karşılaştırıldığında, 40.000 saate varan daha uzun kullanım ömrüne sahiptir.



##### Plug-and-Power (Tak ve Aç) Özelliği

Hatalı kablolamayı ortadan kaldırır ve montaj hızını artırır. Balastların kablolarla ve konnektörlerle bağlantısı önceden yapılmıştır veya balastlarda konnektör vardır.



##### Voltaj Düşüşü Algılama

Voltaj düşüşünün ana akımdaki bir düşüşten mi, yoksa lambanın ömrü sona erdiği için mi olduğunu algılayarak lambanın gerektiğinde yeniden yanmasını sağlar.



##### Kablo Aktarma Özelliği

Bir balasttan gelen şebeke girişini, splitter'e gerek kalmadan bir sonraki balasta bağlayarak montajın düşük maliyetli, hızlı ve kolay olmasını sağlar. (Yalnızca bağımsız modelde mevcuttur.)



##### Düşük Elektromanyetik Girişim

Düşük Elektromanyetik Girişim özelliğiyle, 10dB düzeyinde normal bir alt sınır mümkündür. Böylece EMI'nin önemli olduğu aydınlatma armatürleri için uygun hale gelir.



##### DALI Arabirimi

DALI, balastların alan dışındaki ışık noktalarını kontrol etmesine, ışık sensörlerine ve kızılötesi kontrollere doğrudan bağlanmasına ve bazı durumlarda dim edilebilmesine olanak tanır.

# PHILIPS

Elektronik balastlar

## Elektronik balastlar

HID iç mekan aydınlatması için

HID lambalar için Philips'in akıllı elektronik balast ürün grubu, en uygun ışık performansını sağlayacak biçimde ayarlanmıştır. Kompakt ve hafif olan bu balastlar, kesintileri azaltmak ve montaj maliyetlerinden tasarruf sağlamak için hızlı ve kolay monte edilebilecek şekilde tasarlanmıştır. Dahası, uzun ve enerji verimli bir kullanım ömrü sayesinde az bakım gerektirirler.

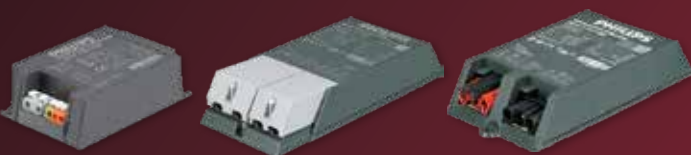

# GAZ DEŐARJLI LAMBA BALASTLARI

## Manyetik Balastlar



### BHL Metal Halide Balastı

Ürün	12 NC	Ateőleyici	Lamba (W)	Kutu Adedi	Fiyat (€)
BHL 250 K202 230V 50Hz BC2-126	913700283226	SI51	HPL / HPI / SON-H 250	6	31.85
BHL 400 K202 230V 50Hz BC2-151	913700284626	SI51	HPL / HPI / SON-H 400	6	42.65
BHL 1000 L02 220V 50Hz HP-207	913700218403	SI52	HPI-T 1000	1	193.20
BHL 2000 L76 380/400/415V 50Hz HP-317	913700217903	SI54	HPI-T 2000	1	278.45



### BHLE Alüminyum Sargılı Metal Halide Balastı

Ürün	12 NC	Ateőleyici	Lamba (W)	Kutu Adedi	Fiyat (€)
BHL E 250 L200 TS	913713017242	SI51	HPL / HPI / SON-H 250	60	18.75
BHL E 400 L200 TS	913713017342	SI51	HPL / HPI / SON-H 400	60	26.75



### BSN Sodyum Balastı

Ürün	12 NC	Ateőleyici	Lamba (W)	Kutu Adedi	Fiyat (€)
BSN 70 K302-A2-ITS 230V 50 Hz	913700752126	SK578	SON / CDO 70	6	25.75
BSN 150 K302-A2-ITS 230V 50Hz	913700752626	SK578	SON / CDO 150	6	37.35
BSN 250 K302-A2-ITS 230V 50Hz	913700752926	SKD578	SON / MH / CDM / CDO	6	53.85
BSN 400 K407-ITS 230/240V 50Hz BC3-166	913700277826	SK578	SON 400	2	64.95
BSN 1000 L78-A2 230/240V 50Hz HP-257	913700217503	SN59	SON 1000	1	232.70



### BSX Düşük Basınç Sodyum Balastı

Ürün	12 NC	Ateőleyici	Lamba (W)	Kutu Adedi	Fiyat (€)
BSX 35/55 L82 240V 50Hz BCO-196	913700200926	SX72	SOX 35-55	6	27.10
BSX 90 L40 230V 50Hz HD1-118	913650080426	SX76	SOX 90	6	43.30



## Ateşleyiciler

Ürün	12 NC	Lamba	Kutu Adedi	Fiyat (€)
SKD 578 220-240V 50/60Hz	913700655366	SON 50-70-100-400	48	14.50
SND 57 220-240V 50/60Hz	913700184966	SON / CDO 50-70	48	18.95
SND 58 220-240V 50/60Hz	913700185166	SON/CDO 100-150-250-400	48	18.95
SN 59 220-240V 50/60Hz	913619659966	SON1000	20	21.65
SI 51 220-240V 50/60Hz	913619519966	HPI(T)250-400	48	9.95
SI 52 220-240V 50/60Hz	913619529966	HPI(T)1000-2000	48	9.95
SI 54 380-415V 50/60Hz	913619149966	HPI(T)2000 (380V)	20	22.75
SX 76 220-240V 50/60Hz	913650050566	SOX90	20	31.25

## HALOJEN TRANSFORMATÖRLER



## Halojen Transformatörler

 20000 Saat
  < 0.8 sn

Ürün	12 NC	Lamba Grubu	Güç (W)	Kutu Adedi	Fiyat (€)
CERTALINE 60W 230-240V 50/60HZ	913700633891	Halojen	60	1	8.85
CERTALINE 105W 230-240V 50/60HZ	913700633991		105	1	11.40
ET-E 60 230-240V 50/60Hz	913710031101		60	1	6.25

GentleSpace Gen2



Pacific LED Gen4



SmartBright Essential  
LED Floodlight





# ARMATÜRLER

İç Mekan LED Aydınlatma Armatürleri

Dış Mekan LED Aydınlatma Armatürleri

# ARMATÜRLER

İç Mekan LED  
Yüksek Tavan



Yüksek tavan uygulamalarında, 250W & 400W HPI ve MH 150W lambalı armatürlerin birebir değişiminde kullanılan Coreline Highbay Yüksek Tavan Armatürü; HPI-P lambalı armatürlere göre %60 enerj tasarrufu ve en iyi lm/€ değeri sayesinde müşterilerine en uygun ilk yatırım maliyetini sunmaktadır.

## Coreline Highbay



Ürün	12 NC	Faydalı Ömür (L70B50) Saat	Güç Tüketimi (W)	Işık Akısı (lm)	Sürücü / Balast Tipi	Boyut (mm)	Fiyat (€)
BY121P G3 LED205S/840 PSD WB GR	911401505631	50.000	155	20.500	DALI Dimmer	Ø: 454	501.25
BY121P G3 LED205S/840 PSU WB GR	911401505431	50.000	155	20.500	Sabit Sürücü	Ø: 454	401.00
BY120P G3 LED105S/840 PSD WB GR	911401505531	50.000	85	10.500	DALI Dimmer	Ø: 382	375.94
BY120P G3 LED105S/840 PSU WB GR	911401505331	50.000	85	10.500	Sabit Sürücü	Ø: 382	300.75
BY121Z G3 MB - Sıva Üstü Ayak (Opsiyonel)	911401505831	-	-	-	-	-	28.00
BY120Z G3 MB - Sıva Üstü Ayak (Opsiyonel)	911401505731	-	-	-	-	-	25.00



## GreenPerform Highbay Gen 3



Ürün	12 NC	Faydalı Ömür (L70B50) Saat	Güç Tüketimi (W)	Işık Akısı (lm)	Sürücü / Balast Tipi	Boyut (mm)	Fiyat (€)
<b>Standart Model</b>							Lütfen fiyat sorunuz.
BY698P LED300/NW PSU ENB EN	911401864299	50.000	225	29.000	Sabit Sürücü	Ø: 530	
BY698P LED300/NW PSD NB EN	911401864599	50.000	225	29.000	DALI Sürücü	Ø: 530	
BY698P LED200/NW PSU NB EN	911401843599	50.000	155	20.000	Sabit Sürücü	Ø: 452	
BY698P LED200/NW PSD WB EN	911401843899	50.000	155	20.000	DALI Sürücü	Ø: 452	
BY698P LED160/NW PSU NB EN	911401843999	50.000	120	16.000	Sabit Sürücü	Ø: 417	
BY698P LED160/CW PSD WB L3000 EN	911401846199	50.000	120	16.000	DALI Sürücü	Ø: 417	
BY698P LED110/NW PSU NB EN	911401844399	50.000	85	11.000	Sabit Sürücü	Ø: 379	
BY698P LED110/CW PSD NB L3000 EN	911401846799	50.000	85	11.000	DALI Sürücü	Ø: 379	
<b>Intelligent Model</b>							
BY698X LED300/NW NB ACW 4 EN	911401827497	50.000	225	29.000	ACW Sürücü	Ø: 530	
BY698X LED200/NW WB ACW 4 EN	911401826397	50.000	155	20.000	ACW Sürücü	Ø: 452	
BY698X LED160/CW NB ACW 4 L3000 EN	911401827197	50.000	120	16.000	ACW Sürücü	Ø: 417	
BY698X LED110/CW WB ACW 4 L3000 EN	911401825997	50.000	85	11.000	ACW Sürücü	Ø: 379	



GentleSpace LED armatürün piyasaya çıkışıyla birlikte Philips; enerji tasarrufu, uzun kullanım ömrü ve yenilikçi tasarımı buluşturarak yüksek tavan armatürlerinde çığır açmıştır. Şimdi ise, GentleSpace yeni jenerasyon ile, Philips daha fazla enerji tasarrufu ve sıcak ortamlarda dahi daha uzun kullanım ömrüyle çitayı çok daha yükseğe çıkarıyor.



## GentleSpace Gen2

IP 65

IK07

CRI 80

HACCP

ENEC

CE

VDE

ATEX

30°C min

60°C+ max

Ürün	12 NC	Faydalı Omür (L70B50) Saat	Güç Tüketimi (W)	Işık Akısı (lm)	Sürücü / Balast Tipi	Boyut (mm)	Fiyat (€)	
<b>ECO Model</b>								
BY471P ECO320S/840 PSD WB GC SI	910925863385	60.000	218	32.000	DALI Dimmer	600x450x150	Lütfen fiyat sorunuz.	
BY471P ECO250S/840 PSD MB GC SI	910925863381	60.000	174	25.000	DALI Dimmer	600x450x150		
BY470P ECO170S/840 PSD WB GC SI	910925863383	60.000	120	17.000	DALI Dimmer	450x350x130		
<b>GREEN Model</b>								
BY471P GRN250S/840 PSD HRO GC SI	910930205961	70.000	164	25.000	DALI Dimmer	600x450x150		
BY471P GRN250S/840 PSD WB BR SI SWP	910930205966	70.000	164	25.000	DALI Dimmer	600x450x150		
BY471P GRN170S/840 PSD MB GC BR SI	910930205953	70.000	110	17.000	DALI Dimmer	600x450x150		
BY471P GRN170S/840 PSD A50 G MBW WH	910925863184	70.000	110	17.000	DALI Dimmer	600x450x150		
BY470P GRN130S/840 PSD NB GC SI	910930205941	70.000	87	13.000	DALI Dimmer	450x350x130		
BY470P GRN130S/840 PSD WB BR SI SWP	910930205946	70.000	87	13.000	DALI Dimmer	450x350x130		
<b>XTREME Model</b>								
BY471P PRO250S/840 PSD NB GC SI XT	910925863423	100.000	204	25.000	DALI Dimmer	600x450x150		
BY471P PRO250S/840 PSD VNB GC SI XT	910925863424	100.000	204	25.000	DALI Dimmer	600x450x150		
BY471P PRO170S/840 PSD WB GC SI XT	910925863417	100.000	138	17.000	DALI Dimmer	600x450x150		
BY471P PRO170S/840 PSD MB GC SI XT	910925863418	100.000	138	17.000	DALI Dimmer	600x450x150		
<b>ATEX Model</b>								
BY473P GRN250S/840 PSD WB G BR SI	910925863443	70.000	164	25.000	DALI Dimmer	600x450x150		
BY473P GRN170S/840 PSD WB G SI	910925863437	70.000	110	17.000	DALI Dimmer	600x450x150		
BY472P GRN130S/840 PSD MB G SI	910925863434	70.000	87	13.000	DALI Dimmer	450x350x130		

\*Sadece Xtreme model için geçerlidir. Standart modellerde +45°C'dir.



**PHILIPS**

İç mekan LED

# Akıllı depo aydınlatması

Enerji tasarrufunun esnek ve akıllı yolu





SmartBright Waterproof ailesi geleneksel floresanlı veya LED tube içeren armatürlerin birebir değişiminde kullanılan; enerji ve bakım maliyetlerini yüksek ışık kalitesi ile birlikte sunan entegre LED etanj çözümüdür. Armatürün tüm ekipmanları iç mekan ve yarı dış mekan (UV korumalı polikarbon muhafaza ve difüzör) uygulamalarında kullanılmak üzere tasarlanmıştır.



### SmartBrightWaterproof G2



**YENİ**

Ürün	12 NC	Faydalı Omür (L70B50) Saat	Güç Tüketimi (W)	Işık Akısı (lm)	Sürücü / Balast Tipi	Boyut (mm)	Fiyat (€)
WT066C NW LED45 L1500 PSU TB	911401823497	25.000	49	4.500	Sabit Sürücü	L: 1500	61.72
WT066C CW LED45 L1500 PSU TB	911401823397	25.000	49	4.500	Sabit Sürücü	L: 1500	61.72
WT066C NW LED36 L1200 PSU TB	911401823297	25.000	40	3.600	Sabit Sürücü	L: 1200	48.80
WT066C CW LED36 L1200 PSU TB	911401823197	25.000	40	3.600	Sabit Sürücü	L: 1200	48.80
WT066C NW LED18 L600 PSU TB	911401822897	25.000	19	1.800	Sabit Sürücü	L: 600	35.89
WT066C CW LED18 L600 PSU TB	911401822797	25.000	19	1.800	Sabit Sürücü	L: 600	35.89



Floresan lambalı etanj armatürlerin birebir değişiminde en uygun çözümü sunan Essential LED Waterproof Armatürler; yüksek verim, enerji tasarrufu ve mükemmel ısı yönetimi sağlayan şık tasarımı ile ilk yatırım maliyetlerini minimuma indiriyor. Essential LED Waterproof, profesyonel optik tasarım ve Philips LED modül ve sürücü sayesinde; konforlu aydınlatma ve mükemmel renksel geriverim sunmaktadır.

### Essential LED Waterproof



**TÜRKİYE'DE ÜRETİLMİŞTİR**

Ürün	12 NC	Faydalı Omür (L70B50) Saat	Güç Tüketimi (W)	Işık Akısı (lm)	Sürücü / Balast Tipi	Boyut (mm)	Fiyat (€)
WT061C LED36S/840 PSU L1200	919033020690	25.000	35	3.600	Sabit Sürücü	L: 1.200	67.67
WT061C LED36S/865 PSU L1200	919033020790	25.000	35	3.600	Sabit Sürücü	L: 1.200	67.67

# ARMATÜRLER

İç Mekan LED

Etanj



İster yeni bir binada ister mevcut yapıların yenilenmesinde olsun, müşterilerimiz her zaman enerji ve bakım masraflarından tasarruf ederek yüksek ışık kalitesi almak isterler. Yeni CoreLine LED Etanj Armatürler, floresan lambalı geleneksel çözümlerin LED'e dönüşümü için idealdir.

## CoreLine Waterproof



IP 65

IK08

CRI 80

CE

-20°C min

35°C max

Ürün	12 NC	Faydalı Ömür (L70B50) Saat	Güç Tüketimi (W)	Işık Akısı (lm)	Sürücü / Balast Tipi	Boyut (mm)	Fiyat (€)
WT120C LED60S/840 PSU L1500	910500453339	50.000	57	6.000	Sabit Sürücü	L: 1.500	Lütfen fiyat sorunuz.
WT120C LED60S/840 PSD L1500	910500458247	50.000	57	6.000	DALI Dimmer	L: 1.500	
WT120C LED34S/840 PSU L1500	910500453337	50.000	29	3.400	Sabit Sürücü	L: 1.500	
WT120C LED34S/840 PSD L1500	910500458245	50.000	29	3.400	DALI Dimmer	L: 1.500	
WT120C LED40S/840 PSU L1200	910500453338	50.000	38	4.000	Sabit Sürücü	L: 1.200	
WT120C LED40S/840 PSD L1200	910500458246	50.000	38	4.000	DALI Dimmer	L: 1.200	
WT120C LED22S/840 PSU L1200	910500453336	50.000	20	2.200	Sabit Sürücü	L: 1.200	
WT120C LED22S/840 PSD L1200	910500458244	50.000	20	2.200	DALI Dimmer	L: 1.200	
WT120C LED18S/840 PSU L600	910500453335	50.000	17	1.800	Sabit Sürücü	L: 600	
WT120C LED18S/840 PSD L600	910500458243	50.000	17	1.800	DALI Dimmer	L: 600	



## Pacific LED Gen4

IP 66

IK08

CRI 80

ENEC

CE

-30°C min

45°C max

Ürün	12 NC	Faydalı Ömür (L70B50) Saat	Güç Tüketimi (W)	Işık Akısı (lm)	Sürücü / Balast Tipi	Boyut (mm)	Fiyat (€)	
<b>Standart Model</b>								
WT470C LED80S/840 PSD O L1600	910925863878	70.000	58	7.600	DALI Dimmer	L: 1.600	Lütfen fiyat sorunuz.	
WT470C LED80S/865 PSU WB L1600	910925863873	70.000	58	8.000	Sabit Sürücü	L: 1.600		
WT470C LED64S/840 PSD VWB L1600	910925863862	70.000	47	6.400	DALI Dimmer	L: 1.600		
WT470C LED64S/840 PSU WB L1600	910925863832	70.000	47	6.400	Sabit Sürücü	L: 1.600		
WT470C LED35S/840 PSD WB TC5 L1600	910925863817	70.000	25	3.500	DALI Dimmer	L: 1.600		
WT470C LED35S/840 PSU WB L1600	910925863806	70.000	25	3.500	Sabit Sürücü	L: 1.600		
WT470C LED42S/840 PSD WB TW1 L1300	910925863828	70.000	31	4.200	DALI Dimmer	L: 1.300		
WT470C LED42S/840 PSU WB TW3 L1300	910925863820	70.000	31	4.200	Sabit Sürücü	L: 1.300		
WT470C LED23S/840 PSD WB L1300	910925863801	70.000	16	2.300	DALI Dimmer	L: 1.300		
WT470C LED23S/840 PSU VWB TC L1300	910925863795	70.000	16	2.300	Sabit Sürücü	L: 1.300		
WT470C LED23S/840 PSD VWB L700	910925863804	70.000	16	2.300	DALI Dimmer	L: 700		
WT470C LED23S/840 PSU WB TC L700	910925863798	70.000	16	2.300	Sabit Sürücü	L: 700		
<b>Kimyasal Korunmalı Model</b>								
WT471C LED80S/840 PSU WB L1600	910925863891	70.000	58	8.000	Sabit Sürücü	L: 1.600		
WT471C LED64S/840 PSD-CLO WB TW3 L1600	910925863890	70.000	47	6.400	DALI Dimmer	L: 1.600		
WT471C LED42S/840 PSU WB L1300	910925863881	70.000	31	4.200	Sabit Sürücü	L: 1.300		
WT471C LED23S/840 PSD VWB L1300	910925863880	70.000	16	2.300	DALI Dimmer	L: 1.300		
<b>CEC (Circular Economy) Model</b>								
WT480C LED80S/865 PSD WB TC5 T-30 L1600	910925863903	100.000	58	8.000	DALI Dimmer	L: 1.600		
WT481C LED64S/840 PSD WB L1600	910925863904	100.000	47	6.400	DALI Dimmer	L: 1.600		
<b>GreenParking Uyumlu Model</b>								
WT470X LED64S/840 WB ACWH TW1 L1600	910925863927	70.000	47	6.400	ACW Sürücü	L: 1.600		
WT480X LED64S/840 WB ACWH TW3 L1600	910925863930	70.000	47	6.400	ACW Sürücü	L: 1.600		
WT470X LED35S/840 VWB ACWH TW1 L1600	910925863919	70.000	25	3.500	ACW Sürücü	L: 1.600		





Yeni CoreLine Duvar Montaj LED Armatürleri kompakt floresan lambalı armatürlerin birebir değişiminde kullanılabilir.



### CoreLine Wall Mount Gen2



Ürün	12 NC	Faydalı Ömür (L70B50) Saat	Güç Tüketimi (W)	Işık Akısı (lm)	Sürücü / Balast Tipi	Boyut (mm)	Fiyat (€)
WL131V LED34S/830 PSU WH	912401483188	50.000	33	2.800	Sabit Sürücü	Ø: 450	Lütfen fiyat sorunuz.
WL131V LED34S/840 PSR MDU WH	912401483195	50.000	33	2.800	Faz Kesici Dimmer	Ø: 450	
WL130V LED20S/840 PSED WH	912401483199	50.000	21	1.800	DALI Dimmer	Ø: 350	
WL130V LED20S/840 PSU WH	912401483185	50.000	21	1.800	Sabit Sürücü	Ø: 350	
WL131V LED12S/830 PSR MDU WH	912401483190	50.000	12	1.000	Faz Kesici Dimmer	Ø: 350	
WL130V LED12S/830 PSU WH	912401483182	50.000	12	1.000	Sabit Sürücü	Ø: 350	



Geleneksel TL-D lambalı armatürler ile birebir değişim imkanı sayesinde; %40'a varan enerji tasarrufu, daha uzun ömür ve kolay kurulum sağlayan SmartBright LED Bant Tipi Armatürler mükemmel performans ve yüksek ışık kalitesi sunar.



### SmartBright LED Batten G2



Ürün	12 NC	Faydalı Ömür (L70B50) Saat	Güç Tüketimi (W)	Işık Akısı (lm)	Sürücü / Balast Tipi	Boyut (mm)	Fiyat (€)
<b>Standart Model</b>							
BN012C LED20/NW L1200 G2	911401806797	25.000	20	2.000	Sabit Sürücü	L: 1.200	14.84
BN012C LED20/CW L1200 G2	911401806897	25.000	20	2.000	Sabit Sürücü	L: 1.200	14.84
BN012C LED20/WW L1200 G2	911401806697	25.000	20	2.000	Sabit Sürücü	L: 1.200	14.84
BN012C LED10/NW L600 G2	911401807097	25.000	10	1.000	Sabit Sürücü	L: 600	10.25
BN012C LED10/CW L600 G2	911401807197	25.000	10	1.000	Sabit Sürücü	L: 600	10.25
BN012C LED10/WW L600 G2	911401806997	25.000	10	1.000	Sabit Sürücü	L: 600	10.25
<b>Trunkable Model</b>							
BN013C LED20/NW L1200 G2	911401808597	25.000	20	2.000	Sabit Sürücü	L: 1.200	15.59
BN013C LED20/CW L1200 G2	911401808697	25.000	20	2.000	Sabit Sürücü	L: 1.200	15.59
BN013C LED20/WW L1200 G2	911401808497	25.000	20	2.000	Sabit Sürücü	L: 1.200	15.59
BN013C LED10/NW L600 G2	911401808897	25.000	10	1.000	Sabit Sürücü	L: 600	10.40
BN013C LED10/CW L600 G2	911401808997	25.000	10	1.000	Sabit Sürücü	L: 600	10.40
BN013C LED10/WW L600 G2	911401808797	25.000	10	1.000	Sabit Sürücü	L: 600	10.40
ZCH086 C-2 - Trunkable İçin Güç Kablosu	911401591201	-	-	-	-	-	2.00

# ARMATÜRLER

İç Mekan LED

Doğrusal Sıralı (Trunking)



İster yeni bir binada ister mevcut yapıların yenilenmesinde olsun, müşterilerimiz her zaman enerji ve bakım masraflarından tasarruf ederek yüksek ışık kalitesi almak isterler. Yeni CoreLine LED Doğrusal Sıralı Armatürler, mevcut genel aydınlatma armatürlerinin birebir değişimi için idealdir.

## CoreLine Trunking



Ürün	12 NC	Faydalı Ömür (L70B50) Saat	Güç Tüketimi (W)	Işık Akısı (lm)	Sürücü / Balast Tipi	Boyut (mm)	Fiyat (€)
LL120X LED160S/840 2x PSD A 9 WH	910925864044	70.000	108	16.000	DALI Dimmer	L: 3.450	Lütfen fiyat sorunuz.
LL120X LED160S/840 2x PSU VWB 5 WH	910925863996	70.000	108	16.000	Sabit Sürücü	L: 3.450	
LL120X LED90S/840 PSD MB 9 WH	910925683019	70.000	63	9.000	DALI Dimmer	L: 3.450	
LL120X LED90S/840 PSU MB 5 WH	910925682915	70.000	63	9.000	Sabit Sürücü	L: 3.450	
LL121X LED80S/840 1x PSD A 7 WH	910925864035	70.000	54	8.000	DALI Dimmer	L: 1.725	
LL121X LED80S/840 1x PSU VWB 5 WH	910925864002	70.000	54	8.000	Sabit Sürücü	L: 1.725	
LL121X LED45S/840 PSD MB 9 WH	910925683013	70.000	32	4.500	DALI Dimmer	L: 1.725	
LL121X LED45S/840 PSU VWB 5 WH	910925682964	70.000	32	4.500	Sabit Sürücü	L: 1.725	

Aksesuarlar için lütfen satış ekibi ile görüşün.



Geleneksel aydınlatma sistemlerine göre daha az enerji tüketip, daha verimli çözümler sunarken; endüstriyel alanlarda da kullanıma uygun, güvenli, dayanıklı ve yüksek ışık kalitesine sahip armatürler sunan Maxos fusion trunking armatürler, perakende ve endüstri uygulamaları için üst düzey yatırım olanağı sunmaktadır.

## Maxos Fusion



Ürün	12 NC	Faydalı Ömür (L70B50) Saat	Güç Tüketimi (W)	Işık Akısı (lm)	Sürücü / Balast Tipi	Boyut (mm)	Fiyat (€)
<b>IP20 Model</b>							Lütfen fiyat sorunuz.
LL523X LED123S/840 PSD WB 7 BK	910925864359	70.000	89	12.300	DALI Dimmer	L: 2.300	
LL523X LED100S/840 PSD PCO 7 WH	910925864297	70.000	69	10.000	DALI Dimmer	L: 2.300	
LL523X LED62S/840 PSD DA35W 7 WH	910925864327	70.000	41	6.200	DALI Dimmer	L: 2.300	
LL512X LED61S/840 PSD WB 7 BK	910925864356	70.000	45	6.150	DALI Dimmer	L: 1.150	
LL512X LED50S/840 PSED PCO 7 WH	910925864301	70.000	36	5.000	DALI Dimmer	L: 1.150	
LL512X LED31S/840 PSD MB 7 WH	910925864312	70.000	21	3.100	DALI Dimmer	L: 1.150	
<b>IP54 Model</b>							
LL623X LED123S/840 PSD NB 7 WH	910925864382	70.000	89	12.300	DALI Dimmer	L: 2.300	
LL612X LED61S/840 PSD WB 7 WH	910925864377	70.000	45	6.150	DALI Dimmer	L: 1.150	

Aksesuarlar için lütfen satış ekibi ile görüşün.

# PHILIPS

İç mekan LED



# Işığınız yardımcınız!

- İnce ve şık tasarım
- Sararmayan ışık kılavuzu / Gerçek 25.000 saat!
- Yüksek renksel geriverim
- Farklı montaj seçenekleri
- **Süper fiyat!**

SmartBright  
Slim Panel  
RC091V

IP20

IK02

CRI  
80

CE

-10°C  
min

35°C  
max

12 NC	Ürün Açıklaması	Faydalı Ömür (L70B50) Saat	Güç Tüketimi (W)	Işık Akısı (lm)	Liste Fiyatı (€)
919033021990	RC091V LED36S/865 PSU W60L60 GM	25.000	40	3.600	49.99
919033022090	RC091V LED36S/840 PSU W60L60 GM	25.000	40	3.600	49.99



# ARMATÜRLER

İç Mekan LED

Sıvaaltı



Ofislerde, perakende mağazalarında ve sağlık hizmeti veren binalarda; insanların gözünü yormayan, rahatlatıcı, güven duygusu veren enerjik atmosferler oluşturmak çok önemlidir. Ledinaire Panel, homojen ışık yüzeyi sağlayan tasarımı sayesinde; farklı ebat, renk sıcaklığı ve montaj seçenekleri ile projeleriniz için verimli bir LED panel çözümü sunmaktadır.

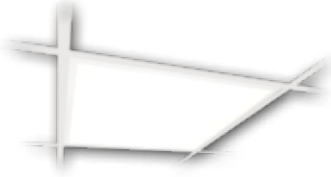

## Ledinaire Panel RC065B



Ürün	12 NC	Faydalı Ömür (L70B50) Saat	Güç Tüketimi (W)	Işık Akısı (lm)	Sürücü / Balast Tipi	Boyut (mm)	Fiyat (€)
RC065B LED325/840 PSU W60L60 NOC	910503910199	30.000	42	3.200	Sabit Sürücü	597x597x44	69.00
RC065B LED325/865 PSU W60L60 NOC	910503910316	30.000	42	3.200	Sabit Sürücü	597x597x44	69.00



CoreLine LED Panel; yüksek ışık kalitesi, homojen aydınlatma düzeyi, düşük enerji tüketimi ve sıfır bakım masrafı sayesinde, mevcut 4x14W T5 ve 4x18W T8 lambalı aydınlatma armatürlerinin LED dönüşümü için en ideal çözümdür.



## CoreLine Panel



Ürün	12 NC	Faydalı Ömür (L70B50) Saat	Güç Tüketimi (W)	Işık Akısı (lm)	Sürücü / Balast Tipi	Boyut (mm)	Fiyat (€)
RC127V LED365/840 PSD W60L60 OC	910503910323	50.000	36	3.600	DALI Dimmer	597x597x46	Lütfen fiyat sorunuz.
RC127V LED345/830 PSD W60L60 OC	910503910324	50.000	36	3.400	DALI Dimmer	597x597x46	
RC125B LED365/840 PSU W60L60 NOC	910503910255	50.000	36	3.600	Sabit Sürücü	597x597x46	



Yeni CoreLine LED Sıvaaltı Armatürler, mevcut geleneksel 4x14W T5 ve 4x18W T8 lambalı aydınlatma armatürlerinin birebir değişimi için idealdir.



### CoreLine Recessed



Ürün	12 NC	Faydalı Ömür (L70B50) Saat	Güç Tüketimi (W)	Işık Akısı (lm)	Sürücü / Balast Tipi	Boyut (mm)	Fiyat (€)
RC134B LED37S/840 PSU W60L60 NOC	910925864775	50.000	34	3.700	Sabit Sürücü	597x597x31	Lütfen fiyat sorunuz.
RC134B LED37S/840 PSD W30L120 NOC	910925864757	50.000	35.5	3.700	DALI Dimmer	1197x297x32	
RC134B LED37S/840 PSD W60L60 ELB3 NOC	910925864778	50.000	39	3.700	DALI Dimmer	597x597x31	
RC134B LED27S/840 PSU W60L60 NOC	910925864781	50.000	27	2.700	Sabit Sürücü	597x597x31	
RC134B LED27S/840 PSD W30L120 NOC	910925864784	50.000	26.5	2.700	DALI Dimmer	1197x297x32	
RC134B LED27S/840 PSD W60L60 ELB3 NOC	910925864786	50.000	30.5	2.700	DALI Dimmer	597x597x31	



Ofis alanlarının aydınlatmasında ana hedef, yapılan yatırımın geri kazanımını sağlayan sürdürülebilir çözümlerdir. Aynı zamanda, kurulan sistem konforlu bir çalışma ortamından ödün vermeden, ofis aydınlatması düzenlemelerine de uyumlu olmalıdır. PowerBalance Sıvaaltı, Philips'in ofis aydınlatması düzenlemelerine uygun, enerji verimliliği en yüksek armatürüdür.



### PowerBalance Gen3



Ürün	12 NC	Faydalı Ömür (L70B50) Saat	Güç Tüketimi (W)	Işık Akısı (lm)	Sürücü / Balast Tipi	Boyut (mm)	Fiyat (€)
RC600B LED40S/865 PSD W60L60 GM	911401898999	50.000	32	4.000	DALI Dimmer	597x597x70	Lütfen fiyat sorunuz.
RC600B LED40S/840 PSU W30L120 GM	911401898599	50.000	32	4.000	Sabit Sürücü	297x1197x70	
RC600B LED30S/840 PSU W60L60 GM	911401897499	50.000	25	3.100	Sabit Sürücü	597x597x70	

# ARMATÜRLER

İç Mekan LED  
Sivaaltı & Sivaüstü



SmartBalance LED Sivaaltı Armatürler, yüksek sistem verimi, estetik tasarım ve geleneksel optik teknolojisine göre çok daha verimli olan "mikro lens optik" çözümü sayesinde ofis ortamlarının kalitesini artıran bir aydınlatma çözümü sunmaktadır.

## SmartBalance Recessed



IP 20

IK02

CRI 80

ENEC

CE

10°C min

40°C max

Ürün	12 NC	Faydalı Ömür (L70B50) Saat	Güç Tüketimi (W)	Işık Akısı (lm)	Sürücü / Balast Tipi	Boyut (mm)	Fiyat (€)
RC480B LED35S/840 PSD W60L60 VPC W	910502022803	70.000	28.5	3.500	DALI Dimmer	597x597x76	Lütfen fiyat sorunuz.
RC480B LED35S/840 PSD W60L60 VPC PIP	910502022903	70.000	28.5	3.500	DALI Dimmer	597x597x76	
RC480B LED35S/840 PSD W30L120 VPC MK PIP	910502023403	70.000	34.5	3.500	DALI Dimmer	1197x297x76	



Yeni CoreLine LED Sivaüstü Armatürler, mevcut geleneksel 4x14W T5 ve 4x18W T8 lambalı aydınlatma armatürlerinin birebir değişimi için idealdir.

## CoreLine Surface Mounted



IP 20

IK02

CRI 80

ENEC

CE

10°C min

40°C max

Ürün	12 NC	Faydalı Ömür (L70B50) Saat	Güç Tüketimi (W)	Işık Akısı (lm)	Sürücü / Balast Tipi	Boyut (mm)	Fiyat (€)
SM134V LED375/840 PSU W60L60 NOC	910925864828	50.000	34	3.700	Sabit Sürücü	597x597x61	Lütfen fiyat sorunuz.
SM134V LED375/840 PSD W20L120 NOC	910925864815	50.000	35.5	3.700	DALI Dimmer	1197x197x61	
SM134V LED275/840 PSU W60L60 NOC	910925864834	50.000	27	2.700	Sabit Sürücü	597x597x61	
SM134V LED275/840 PSD W20L120 NOC	910925864837	50.000	26.5	2.700	DALI Dimmer	1197x197x61	





Ofis alanlarının aydınlatmasında ana hedef, yapılan yatırımın geri kazanımını sağlayan sürdürülebilir çözümlerdir. Aynı zamanda, kurulan sistem konforlu bir çalışma ortamından ödün vermeden ofis aydınlatması düzenlemelerine de uyumlu olmalıdır. PowerBalance Sıvaüstü, Philips'in ofis aydınlatması düzenlemelerine uygun, enerji verimliliği en yüksek armatürüdür.

### Powerbalance, Surface Mounted



Ürün	12 NC	Faydalı Ömür (L70B50) Saat	Güç Tüketimi (W)	Işık Akısı (lm)	Sürücü / Balast Tipi	Boyut (mm)	Fiyat (€)
SM461V LED40S/840 PSD W17L169	910504091203	70.000	30	4.000	DALI Dimmer	1685x171x81	Lütfen fiyat sorunuz.
SM461V LED40S/840 PSD W57L57 ACL	910504092003	70.000	29.5	4.000	ACW Sürücü	570x570x81	
SM461V LED34S/840 PSD W57L57	910504091403	70.000	24	3.400	DALI Dimmer	570x570x81	
SM461V LED28S/840 PSD W17L169 ACL	910504092303	70.000	22	2.800	ACW Sürücü	1685x171x81	
SM461Z SME-W57-5 - Sarkıtma Seti	910403218803	-	-	-	-	-	
SM461Z SME-W17-5 - Sarkıtma Seti	910403218903	-	-	-	-	-	



Pek çok durumda fonksiyonel aydınlatma performansı kilit öneme sahip olsa da, müşterilerimiz ilgi çekici ve göze hoş gelen armatürler kullanmak isterler. Yüksek enerji verimliliğinin yanı sıra gözü rahatsız etmeyen ve görsel çekiciliğe sahip SmartBalance Sıvaüstü Armatürler, yüksek teknik taleplere uygun en akılcı ve kesin ofis armatürü çözümdür.



### SmartBalance, Surface Mounted



Ürün	12 NC	Faydalı Ömür (L70B50) Saat	Güç Tüketimi (W)	Işık Akısı (lm)	Sürücü / Balast Tipi	Boyut (mm)	Fiyat (€)
SM480C LED35S/830 PSD ACC-MLO	910504084603	70.000	32	3.500	DALI Dimmer	1340x240x52	Lütfen fiyat sorunuz.
SM480C LED35S/840 PSD ACC-MLO	910504083603	70.000	30	3.500	DALI Dimmer	1340x240x52	



Pek çok durumda fonksiyonel aydınlatma performansı kilit öneme sahip olsa da, müşterilerimiz ilgi çekici ve göze hoş gelen armatürler kullanmak isterler. Yüksek enerji verimliliğinin yanı sıra, gözü rahatsız etmeyen ve görsel çekiciliğe sahip SmartBalance Sarkıt Armatürler, yüksek teknik taleplere uygun en akılcı ve kesin ofis armatürü çözümdür.

### SmartBalance Suspended



Ürün	12 NC	Faydalı Ömür (L70B50) Saat	Güç Tüketimi (W)	Işık Akısı (lm)	Sürücü / Balast Tipi	Boyut (mm)	Fiyat (€)
SP482P LED40S/830 PSD ACC-MLO SM2	910504085603	70.000	35	4.100	DALI Dimmer	1340x240x50	Lütfen fiyat sorunuz.
SP480P LED35S/830 PSD ACC-MLO SM2	910504085203	70.000	32	3.500	DALI Dimmer	1340x240x50	
SP480P LED35S/840 PSD ACC-MLO SM2	910504083703	70.000	30	3.500	DALI Dimmer	1340x240x50	



Mimarlar, çalıştıkları projenin iç mimarisi ile eşleşen aydınlatma çözümüne ihtiyaç duyarlar. Yüksek aydınlık düzeyi ve şık tasarımlı ışık hattı isterler. Proje firmaları; aydınlatma standartlarıyla uyumlu, enerji tasarrufu sağlarken doğru ışık seviyesini de verebilen armatürelere ihtiyaç duyarlar. TrueLine, tüm bu ihtiyaçlara cevap veren, sarkıt armatür çözümdür.

### TrueLine Suspended



Ürün	12 NC	Faydalı Ömür (L70B50) Saat	Güç Tüketimi (W)	Işık Akısı (lm)	Sürücü / Balast Tipi	Boyut (mm)	Fiyat (€)	
<b>Bağımsız / Direkt &amp; Endirekt Model</b>								
SP532P LED77S/840 PSD PI5 SM2 L1410 ALU	910504100503	70.000	60	7.700	DALI Dimmer	1409x55x88	Lütfen fiyat sorunuz.	
SP532P LED66S/830 PSD PI5 SM2 L1410 ALU	910504100403	70.000	53	6.600	DALI Dimmer	1409x55x88		
SP532P LED58S/840 PSD PI5 SM2 L1130 ALU	910504097503	70.000	42.5	5.850	DALI Dimmer	1130x55x88		
SP532P LED49S/830 PSD PI5 SM2 L1130 ALU	910504098203	70.000	37.5	4.950	DALI Dimmer	1130x55x88		
SP533P LED54S/840 PSD PI5 SM2 L1410 ALU	910504101003	70.000	51	5.400	DALI Dimmer	1409x55x88		
SP533P LED41S/840 PSD PI5 SM2 L1130 ALU	910504097703	70.000	36	4.100	DALI Dimmer	1130x55x88		
SP533P LED33S/830 PSD PI5 SM2 L1410 ALU	910504101103	70.000	31	3.300	DALI Dimmer	1409x55x88		
<b>Bağımsız Model / Direkt Model</b>								
SP530P LED50S/840 PSD ACL SM2 L1450 ALU	910504100103	70.000	39.5	5.000	ACW Sürücü	1449x55x88		
SP530P LED43S/840 PSD PI5 SM2 L1410 ALU	910504099903	70.000	32	4.300	DALI Dimmer	1409x55x88		
SP530P LED34S/840 PSD SM1 L1130 ALU PI5	910504097203	70.000	24	3.400	DALI Dimmer	1130x55x88		
SP531P LED15S/840 PSD PI5 SM2 L1130 ALU	910504097603	70.000	14.6	1.500	DALI Dimmer	1130x55x88		
SP531P LED19S/840 PSD PI5 SM2 L1410 ALU	910504100203	70.000	17.8	1.900	DALI Dimmer	1409x55x88		
<b>Lineer Model</b>								
SP532P LED47S/840 PSD LE1 PI5 SM2 L141	910504100703	70.000	34	4.750	DALI Dimmer	1408x55x88		
SP532P LED47S/840 PSD LF1 PI5 SMTT L1410	910504100803	70.000	34	4.750	DALI Dimmer	1408x55x88		
SP532P LED47S/840 PSD LF1 PI5 SW2 L1410	910504100903	70.000	34	4.750	DALI Dimmer	1408x55x88		
SP532P LED36S/840 PSD LE1 PI7 SM2 L1130	910504098003	70.000	25.5	3.600	DALI Dimmer	1130x55x88		
SP532P LED36S/840 PSD LF1 PI7 SMTT L1130	910504098103	70.000	25.5	3.600	DALI Dimmer	1130x55x88		



SlimBalance, müşterilerin farklı ve çekici alanlar oluşturmalarına yardım eden şık ve zarif tasarıma sahip geniş bir ürün ailesidir. 600, 1200 ve 1500 mm uzunluk seçenekleri; kare veya yuvarlak forma sahip sonlandırma kapağı seçenekleri ve direkt/endirekt ışık dağılımı ile ofis uygulamalarınız için kaliteli aydınlatma çözümleri sunar.

### SlimBalance



IP 20

IK02

CRI 80

CE

-20°C min

40°C max

YENİ

Ürün	12 NC	Faydalı Ömür (L70B50) Saat	Güç Tüketimi (W)	Işık Akısı (lm)	Sürücü / Balast Tipi	Boyut (mm)	Fiyat (€)	
<b>Sıva Altı</b>								
RC550B LED40S 840 L120 PSD SD GM	911401523341	50.000	41	4.000	DALI Dimmer	1230x70x105	Lütfen fiyat sorunuz.	
RC550B LED40S 840 L120 PSU SD GM	911401523141	50.000	41	4.000	Sabit Sürücü	1230x70x105		
RC550B LED40S 865 L120 PSD SD GM	911401523441	50.000	41	4.000	DALI Dimmer	1230x70x105		
RC550B LED40S 865 L120 PSU SD GM	911401523241	50.000	41	4.000	Sabit Sürücü	1230x70x105		
RC550B LED20S 840 L60 PSU SD GM	911401522941	50.000	22	2.000	Sabit Sürücü	630x70x105		
RC550B LED20S 865 L60 PSU SD GM	911401523041	50.000	22	2.000	Sabit Sürücü	630x70x105		
<b>Sıva Üstü</b>								
SM550C LED40S 840 L120 PSD SD GM	911401525541	50.000	41	4.000	DALI Dimmer	1230x70x105		
SM550C LED40S 840 L120 PSD SD GM SQ	911401532941	50.000	41	4.000	DALI Dimmer	1230x70x105		
SM551C LED40S 840 L120 PSD SD GM	911401522841	50.000	41	4.000	DALI Dimmer	1230x70x105		
SM551C LED40S 840 L120 PSD SD GM SQ	911401532841	50.000	41	4.000	DALI Dimmer	1230x70x105		
<b>Sarkıt</b>								
SP551P LED45S 840 L120 PSD SI GM SQ	911401530841	50.000	36	4.500	DALI Dimmer	1230x70x105		
SP551P LED45S 840 L120 PSU SI GM SQ	911401531241	50.000	36	4.500	Sabit Sürücü	1230x70x105		
SP550P LED40S 840 L150 PSD SD GM SQ	911401530741	50.000	41	4.000	DALI Dimmer	1555x70x105		
SP550P LED40S 840 L150 PSU SD GM SQ	911401531041	50.000	40	4.000	Sabit Sürücü	1555x70x105		
SP550P LED40S 840 L120 PSU SD GM SQ	911401530241	50.000	41	4.000	Sabit Sürücü	1230x70x105		
SP550P LED40S 865 L120 PSU SD GM SQ	911401530641	50.000	41	4.000	Sabit Sürücü	1230x70x105		
SP550P LED20S 840 L60 PSU SD GM SQ	911401530141	50.000	22	2.000	Sabit Sürücü	630x70x105		
SP550P LED20S 865 L60 PSU SD GM SQ	911401530441	50.000	22	2.000	Sabit Sürücü	630x70x105		

### PlainView



IP 20

IK02

CRI 80

CE

10°C min

40°C max

YENİ

Ürün	12 NC	Faydalı Ömür (L70B50) Saat	Güç Tüketimi (W)	Işık Akısı (lm)	Sürücü / Balast Tipi	Boyut (mm)	Fiyat (€)	
<b>Sıva Altı</b>								
RC140B LED48S/840 PSD PCV P15 L1430	912401483013	50.000	50	4.800	DALI Dimmer	1430x60x80	Lütfen fiyat sorunuz.	
RC140B LED48S/840 PSU PCV P13 L1430	912401483014	50.000	50	4.800	Sabit Sürücü	1430x60x80		
RC140B LED38S/840 PSD PCV P15 L1150	912401483009	50.000	40	3.800	DALI Dimmer	1150x60x80		
RC140B LED38S/840 PSU PCV P13 L1150	912401483010	50.000	40	3.800	Sabit Sürücü	1150x60x80		
<b>Sarkıt</b>								
SPI40P LED48S/840 PSD P15 SM2 L1415	912401483011	50.000	50	4.800	DALI Dimmer	1420x60x80		
SPI40P LED48S/840 PSU P13 SM2 L1415	912401483012	50.000	50	4.800	Sabit Sürücü	1420x60x80		
SPI40P LED38S/840 PSD P15 SM2 L1135	912401483007	50.000	40	3.800	DALI Dimmer	1140x60x80		
SPI40P LED38S/840 PSU P13 SM2 L1135	912401483008	50.000	40	3.800	Sabit Sürücü	1140x60x80		

# ARMATÜRLER

İç Mekan LED

Spot



Clear Accent; parlaklık, enerji tasarrufu ve minimum bakım maliyetlerinden taviz vermeden yatırımcılar için ideal geri dönüş süreleri sunmaktadır.



## Clear Accent

IP 20

IK02

CRI 80

CE

0°C min

40°C max

Dim Edilir

Ürün	12 NC	Faydalı Ömür (L70B50) Saat	Güç Tüketimi (W)	Işık Akısı (lm)	Sürücü / Balast Tipi	Boyut (mm)	Fiyat (€)
RS060B LED5-36-/830 PSR II WH	910503910182	25.000	6	500	Faz Kesici Dimmer	Ø: 75	Lütfen fiyat sorunuz.
RS060B LED5-36-/840 PSR II WH	910503910183	25.000	6	500	Faz Kesici Dimmer	Ø: 75	
RS061B LED5-36-/830 PSR II WH	910503910184	25.000	6	500	Faz Kesici Dimmer	Ø: 80	
RS061B LED5-36-/840 PSR II WH	910503910185	25.000	6	500	Faz Kesici Dimmer	Ø: 80	

Belirtilen boyut armatür dış çapına aittir.



Coreline Recessed Spot ürün ailesi, geleneksel halojen lambalı armatürlerin değişimi için ideal çözüm sunan ekonomik sıvaaltı ayarlanabilir spot armatür ailesindedir. Halojen lambalı geleneksel armatürlere göre daha uzun ve verimli spot çözümü olan Coreline Recessed spotlar genel aydınlatma ve vurgu aydınlatma ihtiyaçlarına cevap vermektedir.



## CoreLine Recessed Spot

IP 65

IP 44

IK02

CRI 80

CE

20°C min

35°C max

Dim Edilir

Ürün	12 NC	Faydalı Ömür (L70B50) Saat	Güç Tüketimi (W)	Işık Akısı (lm)	Sürücü / Balast Tipi	Boyut (mm)	Fiyat (€)
RS141B LED12-36-/840 PSR PI6 WH	912401483042	50.000	16	1.200	Faz Kesici Dimmer	Ø: 95	Lütfen fiyat sorunuz.
RS140B LED12-36-/830 PSR PI6 ALU	912401483053	50.000	16	1.200	Faz Kesici Dimmer	Ø: 95	
RS141B LED9-32-/840 PSR PI6 WH	912401483038	50.000	11	900	Faz Kesici Dimmer	Ø: 95	
RS140B LED9-32-/830 PSR PI6 WH	912401483039	50.000	11	900	Faz Kesici Dimmer	Ø: 95	
RS141B LED6-32-/830 PSR PI6 ALU	912401483049	50.000	8	650	Faz Kesici Dimmer	Ø: 95	
RS140B LED6-32-/827 PSR PI6 WH	912401483031	50.000	8	650	Faz Kesici Dimmer	Ø: 95	

Belirtilen boyut armatür dış çapına aittir.



İster yeni bir binada ister mevcut yapıların yenilenmesinde olsun, müşterilerimiz her zaman enerji ve bakım masraflarından tasarruf ederek yüksek ışık kalitesi almak isterler. Yeni CoreLine LED Downlight Armatürler, mevcuttaki geleneksel PL-C/PL-T lambalı aydınlatma armatürlerinin yenilenmesi için idealdir.

### CoreLine Slim Downlight



IP 44

IP 20

IK02

CRI  
80

CE

0°C  
min

35°C  
max

Ürün	12 NC	Faydalı Ömür (L70B50) Saat	Güç Tüketimi (W)	Işık Akısı (lm)	Sürücü / Balast Tipi	Boyut (mm)	Fiyat (€)
DN135B LED20S/830 PSU II WH	910503910112	50.000	28	2.000	Sabit Sürücü	Ø: 215	Lütfen fiyat sorunuz.
DN135B LED10S/840 PSU II WH	910503910111	50.000	13	1.000	Sabit Sürücü	Ø: 165	
DN135C LED20S/830 PSU II WH	910503910116	50.000	28	2.000	Sabit Sürücü	Ø: 219	
DN135C LED10S/830 PSU II WH	910503910114	50.000	13	1.000	Sabit Sürücü	Ø: 169	
DN135B LED6S/830 PSR-E II WH	910503910317	50.000	9	650	Sabit Sürücü	Ø: 84	
DN135B LED6S/840 PSR-E II WH	910503910318	50.000	9	650	Sabit Sürücü	Ø: 84	

Belirtilen boyut armatür dış çapına aittir.

### CoreLine Downlight



IP 44

IP 20

IK02

CRI  
80

CE

10°C  
min

40°C  
max

Ürün	12 NC	Faydalı Ömür (L70B50) Saat	Güç Tüketimi (W)	Işık Akısı (lm)	Sürücü / Balast Tipi	Boyut (mm)	Fiyat (€)
DN130B LED20S/830 PSED-E II WH	910500457703	50.000	22	2.100	DALI Dimmer	Ø: 234	Lütfen fiyat sorunuz.
DN131B LED20S/840 PSU PI6 ALU	910500457730	50.000	22	2.100	Sabit Sürücü	Ø: 234	
DN130B LED10S/840 PSED-E II WH	910500457725	50.000	11	1.100	DALI Dimmer	Ø: 187	
DN131B LED10S/830 PSU PI6 ALU	910500457704	50.000	11	1.100	Sabit Sürücü	Ø: 187	

Belirtilen boyut armatür dış çapına aittir.



# ARMATÜRLER

## İç Mekan LED Downlight



Müşterilerimiz, armatürün ömrü boyunca başlangıç yatırımları ile kurulum maliyetleri arasındaki dengeyi kurmak isterler. GreenSpace, geleneksel aydınlatma armatürlerinin yerine kullanılabilir düşük maliyetli ve verimli downlight armatürüdür. Düşük enerji tüketimi, kaliteli ışık çıkışı, stabil renk performansı ve yüksek renksel geriverim sağlayan en son LED teknolojisine sahiptir.

### GreenSpace



IP 44

IP 20

IK02

CRI 80

ENEC

CE

10°C min

40°C max

Ürün	12 NC	Faydalı Ömür (L70B50) Saat	Güç Tüketimi (W)	Işık Akısı (lm)	Sürücü / Balast Tipi	Boyut (mm)	Fiyat (€)
DN470B LED20S/840 PSE-E WH	910500454965	70.000	18	2.200	Sabit Sürücü	Ø: 216	Lütfen fiyat sorunuz.
DN470B LED20S/840 PSE-E EL3 WH	910500454967	70.000	18	2.200	Sabit Sürücü	Ø: 216	
DN470B LED20S/840 PSED-E PGO IP44 WH	910500456270	70.000	18	1.850	DALI Dimmer	Ø: 216	
DN460B LED11S/840 PSE-E WH	910500454945	70.000	11	1.200	Sabit Sürücü	Ø: 166	
DN460B LED11S/840 PSE-E EL3 WH	910500454947	70.000	11	1.200	Sabit Sürücü	Ø: 166	
DN460B LED11S/840 PSED-E PGO IP44 WH	910500456226	70.000	11	1.100	DALI Dimmer	Ø: 166	

Belirtilen boyut armatür dış çapına aittir.



GreenSpace Surface Mounted LED Downlight ailesi, birbir değişim yapıldığında, geleneksel aydınlatma çözümlerine göre %60'ın üzerinde enerji verimi sunmaktadır. Uygulandığı alandaki mimari ile kusursuz uyum sağlayan GreenSpace Surface Mounted LED Downlight ailesi, geleneksel armatürlerin tasarımından esinlenirken, enerji ve bakım maliyetleri açısından ciddi tasarruf sağlıyor.

### GreenSpace Surface Mount



IP 65

IP 20

IK02

CRI 80

CE

-20°C min

40°C max

Ürün	12 NC	Faydalı Ömür (L70B50) Saat	Güç Tüketimi (W)	Işık Akısı (lm)	Sürücü / Balast Tipi	Boyut (mm)	Fiyat (€)
SM295C LED70/865 PSU WP WH GM	911401848099	50.000	66	6.600	Sabit Sürücü	Ø: 200	Lütfen fiyat sorunuz.
SM294C LED40/840 PSU WP WH GM	911401847999	50.000	38	3.800	Sabit Sürücü	Ø: 200	
SM293C LED20/830 PSU WH GM	911401847499	50.000	20	2.000	Sabit Sürücü	Ø: 160	
SM291C LED10/840 PSU WH GM	911401847299	50.000	10	1.000	Sabit Sürücü	Ø: 160	

Belirtilen boyut armatür dış çapına aittir.





Yüksek enerji verimliliğine sahip LuxSpace, Philips'in ışık kalitesinden ödün vermeden düşük enerji tüketimi sağlayan, yüksek ışık çıkışına sahip downlight armatürüdür. Farklı uygulama alanlarına hitap edebilmek üzere tasarlanan LuxSpace Downlight Armatürleri; EN60598 normuna uyumlu, IP54 koruma sınıfına, UGR 19 değerine ve en iyi sonucu garanti etmek için geniş aksesuar yelpazesine sahiptir.

## LuxSpace



IP 54

IP 20

IK02

CRI 80

ENEC

CE

10°C min

40°C max

Ürün	12 NC	Faydalı Omür (L70B50) Saat	Güç Tüketimi (W)	Işık Akısı (lm)	Sürücü / Balast Tipi	Boyut (mm)	Fiyat (€)	
<b>YÜKSEK LÜMEN ÇIKIŞI</b>								
DN570B LED40S/830 PSE-E C WH	910503706635	70.000	34	4.200	Sabit Sürücü	Ø: 214	Lütfen fiyat sorunuz.	
DN570B LED40S/840 PSED-E C WH	910503706638	70.000	32	4.200	DALI Dimmer	Ø: 214		
<b>SIVAALTI</b>								
DN570B LED24S/840 PSE-E C WH	910503590515	70.000	21	2.600	Sabit Sürücü	Ø: 214		
DN570B LED20S/840 PSED-E F WH	910503588315	70.000	18	2.200	DALI Dimmer	Ø: 214		
DN570B LED12S/840 PSE-E C WH	910503586515	70.000	11	1.350	Sabit Sürücü	Ø: 214		
DN560B LED12S/840 PSE-E C WH	910503586405	70.000	12	1.200	Sabit Sürücü	Ø: 164		
DN560B LED8S/840 PSED-E F WH	910503706513	70.000	8	820	DALI Dimmer	Ø: 164		
<b>KARE</b>								
DN572B LED24S/840 PSED-E C WH	910503706621	70.000	22	2.500	DALI Dimmer	214x214		
DN572B LED12S/840 PSE-E C WH	910503706582	70.000	11	1.250	Sabit Sürücü	214x214		
<b>AKSESUAR</b>								
DN570Z PG - Koruma Camı	910503586401	-	-	-	-	-		
DN570Z PGO - Opal Koruma Camı	910503586402	-	-	-	-	-		
DN570Z CFRM-RML - Çerçevesiz Tavan Aparatı	910503586403	-	-	-	-	-		

Belirtilen boyut armatür dış çapına aittir.

# ARMATÜRLER

İç Mekan LED  
Vurgu - Sıvaaltı



Müşterilerimiz, armatürün ömrü boyunca başlangıç yatırımları ile kurulum maliyetleri arasındaki dengeyi kurmak isterler. GreenSpace Accent & LuxSpace Accent, geleneksel CDM lambalı aydınlatma armatürlerinin yerine kullanılacak düşük maliyetli, verimli ve sürdürülebilir bir sıvaaltı vurgu armatürüdür. Düşük enerji tüketimi, yüksek ışık çıkışı, stabil renk performansı ve yüksek renksel geriverim ile ideal bir çözümdür.



## GreenSpace Accent



Ürün	12 NC	Faydalı Ömür (L70B50) Saat	Güç Tüketimi (W)	Işık Akısı (lm)	Sürücü / Balast Tipi	Boyut (mm)	Fiyat (€)
RS342B LED35S/830 PSU-E MB II BK	910500456536	70.000	33	3.500	Sabit Sürücü	Ø: 193	Lütfen fiyat sorunuz.
RS342B LED27S/840 PSU-E WB II SI	910500456535	70.000	24	2.700	Sabit Sürücü	Ø: 193	
RS342B LED17S/830 PSU-E MB II WH	910500456516	70.000	15	1.700	Sabit Sürücü	Ø: 193	
RS343B LED39S/827 PSU-E WB II WH	910500459516	70.000	33	3.900	Sabit Sürücü	Ø: 193	
RS343B LED27S/830 PSED-E MB II WH CW3	910500459518	70.000	27	2.800	DALI Dimmer	Ø: 193	
RS343B LED17S/840 PSU-E WB II WH	910500459499	70.000	12	1.700	Sabit Sürücü	Ø: 193	

Belirtilen boyut armatür dış çapına aittir.



## LuxSpace Accent



Ürün	12 NC	Faydalı Ömür (L70B50) Saat	Güç Tüketimi (W)	Işık Akısı (lm)	Sürücü / Balast Tipi	Boyut (mm)	Fiyat (€)	
<b>PERFORMANS</b>								
RS752B LED49S/830 PSE-E WB WH	910500459440	70.000	40	4.700	Sabit Sürücü	Ø: 168	Lütfen fiyat sorunuz.	
RS752B LED39S/830 PSE-E WB WH	910500457313	70.000	31	3.800	Sabit Sürücü	Ø: 168		
RS752B LED27S/CRW PSE-E MB WH	910500459423	70.000	31	2.600	Sabit Sürücü	Ø: 168		
RS751B LED49S/830 PSE-E WB WH	910500459431	70.000	42	4.700	Sabit Sürücü	Ø: 168		
RS751B LED39S/827 PSE-E MB WH	910500457302	70.000	32	3.500	Sabit Sürücü	Ø: 168		
RS750B LED39S/830 PSE-E MB BK	910500457268	70.000	31	4.000	Sabit Sürücü	Ø: 168		
<b>KOMPAKT</b>								
RS741B LED39S/827 PSE-E WB WH LIN	910500457299	70.000	33	3.800	Sabit Sürücü	Ø: 130		
RS741B LED27S/830 PSE-E WB WH	910500457335	70.000	23	2.700	Sabit Sürücü	Ø: 130		
RS741B LED19S/FMT PSED-E MB BK CW3	910500457282	70.000	27	1.850	DALI Dimmer	Ø: 130		
RS740B LED39S/827 PSE-E MB BK	910500457438	70.000	33	3.900	Sabit Sürücü	Ø: 106		
RS740B LED27S/830 PSED-E WB WH	910500457890	70.000	23	2.700	DALI Dimmer	Ø: 106		
<b>Mini</b>								
RS731B LED12S/840 PSE-E WB WH	910500457293	70.000	9	1.100	Sabit Sürücü	Ø: 106		
RS730B LED14S/CRW PSED-E NB BK	910500457190	70.000	24	1.400	DALI Dimmer	Ø: 94		
RS730B LED12S/840 PSED-E WB WH	910500457292	70.000	9	1.100	DALI Dimmer	Ø: 94		

Belirtilen boyut armatür dış çapına aittir.



GreenSpace Accent ailesi, mağaza işletmecilerinin ve sahiplerinin aydınlatmalarının CDM'den LED'e dönüşümünü hızlandırmayı hedefler. Philips'in PerfectAccent ışık kalitesine sahip çözümlerinin keyfini çıkarmanızı sağlarken, fark edilir düzeyde enerji tasarrufu da yapabilirler. Tüm bu avantajları makul bir yatırım geri dönüşüm süresi ile taçlandırmak GreenSpace Accent Grid Ailesi ile artık çok kolay olacaktır.



### GreenSpace Accent Gridlight

IP 20

IK02

CRI 80

ENEC

CE

10°C min

40°C max

Ürün	12 NC	Faydalı Ömür (L70B50) Saat	Güç Tüketimi (W)	Işık Akısı (lm)	Sürücü / Balast Tipi	Boyut (mm)	Fiyat (€)
GD302B LED35S/830 PSED-E MB-MB WH	910500459241	70.000	64	7.000	DALI Dimmer	366x194x133	Lütfen fiyat sorunuz.
GD302B LED27S/PW9 PSE-E MB-MB WH	910500458769	70.000	60	5.400	Sabit Sürücü	366x194x133	
GD302B LED17S/830 PSE-E MB-MB I WH	910500458764	70.000	30	3.500	Sabit Sürücü	366x194x133	
GD301B LED27S/830 PSU-E NB WH CW	910500459234	70.000	27	2.700	Sabit Sürücü	194x194	
GD301B LED17S/830 PSU-E MB I WH	910500459232	70.000	16	1.750	Sabit Sürücü	194x194	



Yüksek lümen paketlerine sahip, birden çok LED ışık kaynağının aynı armatürde bir araya getirilmesi ile oluşan StoreFlux, CDM armatürlere göre düşük bakım maliyeti ve yüksek enerji verimliliği sağlar. Renk ve gölge iyileştirmesi, derinlik, özel ışınlar ve yüksek ışık kalitesi sayesinde; moda ürünlerinin doku, kumaş ve dokuma özelliklerini öne çıkararak daha özel ve arzulanır görünmesini sağlar.



### StoreFlux

IP 20

IK02

CRI 80

ENEC

CE

10°C min

40°C max

Ürün	12 NC	Faydalı Ömür (L70B50) Saat	Güç Tüketimi (W)	Işık Akısı (lm)	Sürücü / Balast Tipi	Boyut (mm)	Fiyat (€)
GD615B LED27S/830 PSU-E MB WH-WH	910500458467	70.000	100	10.800	Sabit Sürücü	294x294	Lütfen fiyat sorunuz.
GD614B LED20S/830 PSU-E NB WH-WH	910500458432	70.000	108	8.000	Sabit Sürücü	578x147x165	
GD613B LED17S/830 PSU-E MB WH-WH	910500458457	70.000	48	3.400	Sabit Sürücü	441x147x165	
GD612B LED12S/830 PSU-E MB WH-WH	910500458452	70.000	26	2.400	Sabit Sürücü	294x147x165	
GD611B LED12S/830 PSU-E MB WH-WH	910500458447	70.000	13	1.200	Sabit Sürücü	147x147	
GD605B LED27S/830 PSU-E MB WH-WH	910500458308	70.000	100	10.800	Sabit Sürücü	326x326	
GD604B LED20S/830 PSU-E NB WH-WH	910500458303	70.000	108	8.000	Sabit Sürücü	620x147x165	
GD603B LED39S/830 PSU-E MB WH-WH	910500458299	70.000	117	11.700	Sabit Sürücü	473x147x165	
GD602B LED27S/830 PSU-E MB WH-WH	910500458194	70.000	50	5.400	Sabit Sürücü	326x147x165	
GD601B LED20S/830 PSU-E NB WH-WH	910500458292	70.000	27	2.000	Sabit Sürücü	179x179	

GD61XB çerçevesiz versiyonlar için GD51XZ montaj çerçevesi ayrıca sipariş edilmelidir.

# ARMATÜRLER

İç Mekan LED  
Vurgu - Ray Spot



GreenSpace Accent ailesi, mağaza işletmecilerinin ve sahiplerinin aydınlatmalarının CDM'den LED'e dönüşümünü hızlandırmayı hedefler. Philips'in PerfectAccent ışık kalitesine sahip çözümlerinin keyfini çıkarmanızı sağlarken, aynı zamanda fark edilir düzeyde enerji tasarrufu da yapabilirler. Tüm bu avantajları makul bir yatırım geri dönüşüm süresi ile taçlandırmak GreenSpace Accent Projector Ailesi ile artık çok kolay olacaktır.



## GreenSpace Accent Projector



Ürün	12 NC	Faydalı Omür (L70B50) Saat	Güç Tüketimi (W)	Işık Akısı (lm)	Sürücü / Balast Tipi	Boyut (mm)	Fiyat (€)
ST320T LED39S/840 PSU VWB WH	910500459394	70.000	33	3.900	Sabit Sürücü	Ø: 114	Lütfen fiyat sorunuz.
ST320T LED39S/830 PSD WB WH	910500459788	70.000	33	3.900	DALI Dimmer	Ø: 114	
ST320T LED27S/840 PSD WB WH	910500459785	70.000	23	2.800	DALI Dimmer	Ø: 114	
ST320T LED27S/PW9 PSU MB WH	910500459368	70.000	27	2.600	Sabit Sürücü	Ø: 114	
ST320T LED17S/CRW PSU MB WH	910500459373	70.000	22	1.700	Sabit Sürücü	Ø: 114	



## StyliD



Ürün	12 NC	Faydalı Omür (L70B50) Saat	Güç Tüketimi (W)	Işık Akısı (lm)	Sürücü / Balast Tipi	Boyut (mm)	Fiyat (€)	
<b>YÜZEY MONTAJ</b>								
ST750C LED49S/840 PSE MB BK	910500457487	70.000	42	4.900	Sabit Sürücü	Ø: 119	Lütfen fiyat sorunuz.	
ST750C LED39S/930 PSE MB BK	910500457480	70.000	39	4.000	Sabit Sürücü	Ø: 119		
ST740C LED39S/830 PSE WB WH	910500457370	70.000	32	3.900	Sabit Sürücü	Ø: 89		
ST740C LED27S/830 PSE WB WH	910500457360	70.000	23	2.700	Sabit Sürücü	Ø: 89		
ST730C LED12S/830 PSED WB WH	910500457350	70.000	10	1.200	DALI Dimmer	Ø: 89		
<b>RAY MONTAJ</b>								
ST750T LED49S/840 PSED VWB WH	910500457389	70.000	42	5.200	DALI Dimmer	Ø: 119		
ST750T LED39S/840 PSED VWB WH	910500457380	70.000	31	4.100	DALI Dimmer	Ø: 119		
ST740T LED27S/830 PSED WB BK	910500457361	70.000	23	2.700	DALI Dimmer	Ø: 89		
ST740T LED17S/930 PSE MB BK	910500457356	70.000	16	1.650	Sabit Sürücü	Ø: 89		
ST730T LED12S/840 PSE WB WH	910500457353	70.000	10	1.250	Sabit Sürücü	Ø: 73		
ST730T LED11S/930 PSE NB BK	910500457341	70.000	13	1.200	Sabit Sürücü	Ø: 73		
<b>RAYLAR</b>								
RCS750 3C L1000 WH	910500188815	-	-	-	-	L: 1.000		
RCS750 3C L2000 ALU	910500188515	-	-	-	-	L: 2.000		
RCS750 3C L3000 BK	910930013418	-	-	-	-	L: 3.000		





TrueFashion, moda mağazalarının belirli ihtiyaçlarını karşılayan özel bir LED spot ailesidir. Şık ve ince tasarımıyla TrueFashion minyatür spotlar, çağdaş bir görünüm sunar ve mağazanın iç dekorasyonu kusursuz bir şekilde bütünlüştür. Mağaza içindeki kontrastları ideal hale getirmek için yenilikçi lensler kullanarak en iyi ışık kalitesini sunar. Renkleri ve görsel nitelikleri artırmak için özel olarak geliştirilmiş Philips moda ışığı çeşitleri sayesinde, TrueFashion üstün bir ışık deneyimini garanti eder.



## TrueFashion



YENİ

Ürün	12 NC	Faydalı Ömür (L70B50) Saat	Güç Tüketimi (W)	Işık Akısı (lm)	Sürücü / Balast Tipi	Boyut (mm)	Fiyat (€)
ST710T LED27S/PW9-3500 PSU FR24 WH	910500465140	70.000	28	2.700	Sabit Sürücü	Ø: 80	Lütfen fiyat sorunuz.
ST710T LED27S/PW9-3000 PSU FR60 WH	910500465157	70.000	30	2.600	Sabit Sürücü	Ø: 80	
ST700T LED17S/PW9-3000 PSU CLM30 SI	910500465148	70.000	24	1.700	Sabit Sürücü	Ø: 66	
ST700T LED17S/CRW PSU CLM18 WH	910500465221	70.000	25	1.400	Sabit Sürücü	Ø: 66	
ST720T LED-XNB/PW9-3000 PSD CLM6 BK	910500465165	70.000	19	1.150	DALI Dimmer	Ø: 118	



StyliD PerfectBeam müze uygulamaları için özel olarak geliştirilmiştir. Sürekli değişen sergi koleksiyonları, düşük bakım ve enerji verimliliği gerekliliği arasında, sanat eseri sunumu ile eseri koruma arasındaki mükemmel dengeyi tam anlamıyla sağlar. Zararlı UV veya IR ışınımı yaymayan LED aydınlatmasıyla StyliD PerfectBeam sanat eserlerini kendi gerçek renklerinde sunarak, izleyicinin dikkatini çeker ve görmeyi kolaylaştırarak sanat eserlerini en ince detayına kadar yorumlama ve takdir etme olanağı sunar.



## Perfect Beam



YENİ

Ürün	12 NC	Faydalı Ömür (L70B50) Saat	Güç Tüketimi (W)	Işık Akısı (lm)	Sürücü / Balast Tipi	Boyut (mm)	Fiyat (€)
ST741T LED5S/930 PSR 7-43 BK	910504801184	70.000	21	430 - 684	Dimlenebilir	Ø: 91	Lütfen fiyat sorunuz.
ST742T LED5S/927 PSR 30 WH	910504801185	70.000	21	254	Dimlenebilir	Ø: 91	

# ARMATÜRLER

İç Mekan LED  
Temiz Oda



Hastaneler ve gıda üretim tesisleri gibi hijyenin çok önemli olduğu uygulamalarda, müşteriler kullanımı güvenli ve çekici bir fiyata sahip, kalitesi ispatlanmış IP65 ve IP54 uyumlu aydınlatma armatürü istiyor. Philips LED platformu güvenilir ve yüksek kaliteli ışık sağlar; esnek montaj olanakları da bu ürün ailesinin geniş bir uygulama yelpazesinde kullanılabilmesi anlamına gelir. Armatürler de ilgili tüm standartlarla (CE, EMC, RoHS) uyumludur.

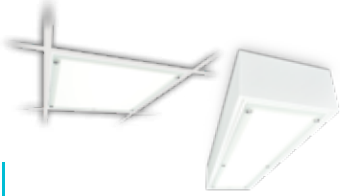

## Cleanroom LED CR250B

IP 65

IP 54

IK07

CRI 80

CE

-20°C min

40°C max

YENİ

Ürün	12 NC	Faydalı Omür (L70B50) Saat	Güç Tüketimi (W)	Işık Akısı (lm)	Sürücü / Balast Tipi	Boyut (mm)	Fiyat (€)
CR250B LED55S/840 PSD W30L120 IP65	910503910174	50.000	63	5.500	DALI Dimmer	1195x295x135	Lütfen fiyat sorunuz.
CR250B LED55S/840 PSU W60L60 IP65	910503910169	50.000	63	5.500	Sabit Sürücü	595x595x135	
CR150B LED35S/840 PSU W30L120 IP54	910503910177	50.000	40	3.500	Sabit Sürücü	1195x295x97	
CR150B LED35S/840 PSD W60L60 IP54	910503910176	50.000	40	3.500	DALI Dimmer	595x595x97	



Yeditepe Üniversitesi İhtisas Hastanesi Onkoloji Bölümü HealWell Aydınlatma Uygulaması

**PHILIPS**

Projektörler



# Tempo'lu dev kadro!



IP 65

IK 07



-40°C  
min



45°C  
max

## Essential SmartBright G2 (BVP13x)

- 10W, 20W, 30W, 50W, 70W
- 85 lm/W
- IP65
- 1/2kV parafudr

## SmartBright LED Floodlight (BVP17x)

- 100W, 150W, 200W
- 100 lm/W
- IP65
- 6kV parafudr

BVP13X

BVP17X



# ARMATÜRLER

## Dış Mekan LED Projektörler



Philips Essential SmartBright G2 LED Floodlight geleneksel halojen projektörler ile birebir değişim yapılabilecek 10W, 20W, 30W, 50W ve 70W olmak üzere üç farklı versiyonu ile halojen projektörlere oranla %90'a varan enerji tasarrufu sağlayan ince yapılı ve uzun ömürlü bir LED projektördür.

### Essential SmartBright G2 LED Floodlight



YENİ

Ürün	12 NC	Faydalı Ömür (L80F10) Saat	Güç Tüketimi (W)	Işık Akısı (lm)	Sürücü / Balast Tipi	Boyut (mm)	Fiyat (€)
BVP131 LED8/CW 10W 220-240V WB	911401858998	15.000	10	800	Sabit Sürücülü	117x109x27	20.00
BVP132 LED16/CW 20W 220-240V WB	911401859298	15.000	20	1.600	Sabit Sürücülü	134x130x28	27.00
BVP133 LED24/CW 30W 220-240V WB	911401859598	15.000	30	2.400	Sabit Sürücülü	167x170x36	41.00
BVP135 LED40/CW 50W 220-240V WB	911401859898	15.000	50	4.000	Sabit Sürücülü	222x240x38	65.00
BVP137 LED56/CW 70W 220-240V WB	911401860198	15.000	70	5.600	Sabit Sürücülü	222x240x38	91.00



### SmartBright LED Floodlight



YENİ

Ürün	12 NC	Faydalı Ömür (L70B50) Saat	Güç Tüketimi (W)	Işık Akısı (lm)	Sürücü / Balast Tipi	Boyut (mm)	Fiyat (€)
BVP174 LED90/CW 100W WB GREY CE	911401689704	30.000	100	9.500	Sabit Sürücülü	356x235x53	176.00
BVP175 LED142/CW 150W WB GREY CE	911401695104	30.000	150	14.250	Sabit Sürücülü	375x310x65	329.00
BVP176 LED190/CW 200W WB GREY CE	911401629604	30.000	200	19.000	Sabit Sürücülü	390x355x65	375.00



### SmartBright LED Security Light



YENİ

Ürün	12 NC	Faydalı Ömür (L70B50) Saat	Güç Tüketimi (W)	Işık Akısı (lm)	Sürücü / Balast Tipi	Boyut (mm)	Fiyat (€)
BWS220 LED20/CW PSU 100-240V	911401712692	30.000	30	2.200	Hassasiyet ayarlı hareket sensörü ve fotosel (on-off)	242x171x168mm	123.00



Tango G3 LED projektör; alan aydınlatması, billboard'lar, endüstriyel alan aydınlatması, amatör spor alanları aydınlatması gibi çok çeşitli aydınlatma uygulamaları için uygun çok amaçlı bir LED projektördür. DALI ve 1-10V dimleme uyumlu modelleri vardır.



### Tango G3 LED Projector



Ürün	12 NC	Faydalı Ömür (L70B50) Saat	Güç Tüketimi (W)	Işık Akısı (lm)	Sürücü / Balast Tipi	Boyut (mm)	Fiyat (€)
BVP381 LED55/WW 50W 220-240V SWB GM	911401845398	50.000	50	5.500	Sabit Sürücü	500 x 300 x 56	Lütfen fiyat sorunuz.
BVP381 LED84/CW 70W 220-240V SWB GM	911401841698	50.000	70	8.400	Sabit Sürücü	500 x 300 x 56	
BVP381 LED120/NW 100W 220-240V AMB GM	911401844098	50.000	100	12.000	Sabit Sürücü	500 x 300 x 56	
BVP382 LED144/NW 120W 220-240V SMB GM	911401844298	50.000	120	14.400	Sabit Sürücü	500 x 448 x 56	
BVP382 LED180/NW 150W 220-240V AMB GM	911401844698	50.000	150	18.000	Sabit Sürücü	500 x 448 x 56	
BVP382 LED240/NW 200W 220-240V AMB GM	911401845198	50.000	200	24.000	Sabit Sürücü	500 x 448 x 56	
BVP383 LED270/NW 240W 220-240V NB GM	911401696003	50.000	240	27.000	Sabit Sürücü	591x561x64	
BVP383 LED360/NW 320W 220-240V AMB GM	911401695903	50.000	320	36.000	Sabit Sürücü	591x561x64	
BVP383 LED405/NW 360W 220-240V SWB GM	911401695803	50.000	360	40.500	Sabit Sürücü	591x561x64	
BVP383 LED450/NW 400W 220-240V AWB GM	911401697303	50.000	400	45.000	Sabit Sürücü	591x561x64	



### ClearFlood



Ürün	12 NC	Faydalı Ömür (L80F10) Saat	Güç Tüketimi (W)	Işık Akısı (lm)	Sürücü / Balast Tipi	Boyut (mm)	Fiyat (€)
BVP650 LED80-4S/740 PSU S ALU	912300023506	100.000	52	7.199	Sabit Sürücü	503 x 524 x 95	Lütfen fiyat sorunuz.
BVP650 LED100-4S/740 PSU S ALU	912300023507	100.000	64	8.996	Sabit Sürücü	503 x 524 x 95	
BVP650 LED120-4S/740 PSU S ALU	912300023508	100.000	78	10.745	Sabit Sürücü	503 x 524 x 95	
BVP650 LED140-4S/740 PSU S ALU	912300023509	100.000	93	12.520	Sabit Sürücü	503 x 524 x 95	
BVP650 LED160-4S/740 PSU S ALU	912300023510	100.000	107	14.263	Sabit Sürücü	503 x 524 x 95	
BVP650 LED180-4S/740 PSU S ALU	912300023511	100.000	122	15.975	Sabit Sürücü	503 x 524 x 95	
BVP650 LED200-4S/740 PSU OFA52 ALU	912300023527	100.000	138	17.429	Sabit Sürücü	503 x 524 x 95	
BVP650 LED220-4S/740 PSU OFA52 ALU	912300023528	100.000	154	19.089	Sabit Sürücü	503 x 524 x 95	
BVP650 LED240-4S/740 PSU OFA52 ALU	912300023529	100.000	159	20.810	Sabit Sürücü	503 x 524 x 95	
BVP650 LED260-4S/740 PSU OFA52 ALU	912300023530	100.000	174	22.435	Sabit Sürücü	503 x 524 x 95	
BVP650 LED280-4S/740 PSU OFA52 ALU	912300023531	100.000	190	24.086	Sabit Sürücü	503 x 524 x 95	
BVP650 LED300-4S/740 PSU OFA52 ALU	912300023532	100.000	206	25.682	Sabit Sürücü	503 x 524 x 95	
BVP650 LED320-4S/740 PSU OFA52 ALU	912300023533	100.000	222	27.258	Sabit Sürücü	503 x 524 x 95	
BVP650 LED340-4S/740 PSU OFA52 ALU	912300023534	100.000	239	28.807	Sabit Sürücü	503 x 524 x 95	
BVP650 LED400-4S/740 OFA52 ALU PSU	912300023689	100.000	257	30.294	Sabit Sürücü	503 x 524 x 95	

YENİ

# ARMATÜRLER

## Dış Mekan LED Projektörler



ClearFlood LED Projektörler; özel tasarımı, yüksek verimli LED'leri ve optik seçenekleri ile sodyum ve metal halide 50-400 W aralığındaki projektörlerle birebir değişimle %75'e varan enerji verimliliği sağlamak üzere tasarlanmıştır. ClearFlood ürün ailesinde farklı uygulamalar için uygun, 8.000 ile 40.000 lümen aralığında paketler mevcuttur. ClearFlood LED Projektörler; meydan, alt geçit, kısa tüneller, alan aydınlatması gibi pek çok alanda kullanılabilir.



### ClearFlood Large

IP 66

IK08

CE

ENEC

-40°C  
min

45°C  
max

YENİ

Ürün	12 NC	Faydalı Omür (L80F10) Saat	Güç Tüketimi (W)	Işık Akısı (lm)	Sürücü / Balast Tipi	Boyut (mm)	Fiyat (€)
BVP651 LED450-4S/740 S ALU PSU	912300023731	100.000	286	39.600	Sabit Sürücü	522 x 817 x 80	Lütfen fiyat sorunuz.
BVP651 LED450-4S/740 OFA52 ALU PSU	912300023732	100.000	286	38.890	Sabit Sürücü	522 x 817 x 80	
BVP651 LED500-4S/740 S ALU PSU	912300023738	100.000	323	43.800	Sabit Sürücü	522 x 817 x 80	
BVP651 LED500-4S/740 OFA52 ALU PSU	912300023739	100.000	323	43.120	Sabit Sürücü	522 x 817 x 80	
BVP651 LED550-4S/740 S ALU PSU	912300023745	100.000	362	47.860	Sabit Sürücü	522 x 817 x 80	
BVP651 LED550-4S/740 OFA52 ALU PSU	912300023746	100.000	362	47.120	Sabit Sürücü	522 x 817 x 80	
BVP651 LED600-4S/740 S ALU PSU	912300023752	100.000	403	51.880	Sabit Sürücü	522 x 817 x 80	
BVP651 LED600-4S/740 OFA52 ALU PSU	912300023753	100.000	403	51.070	Sabit Sürücü	522 x 817 x 80	
BVP651 LED650-4S/740 S ALU PSU	912300023759	100.000	441	55.830	Sabit Sürücü	522 x 817 x 80	
BVP651 LED650-4S/740 OFA52 ALU PSU	912300023760	100.000	441	54.960	Sabit Sürücü	522 x 817 x 80	
BVP651 LED700-4S/740 S ALU PSU	912300023766	100.000	486	59.680	Sabit Sürücü	522 x 817 x 80	
BVP651 LED700-4S/740 OFA52 ALU PSU	912300023767	100.000	486	58.760	Sabit Sürücü	522 x 817 x 80	
BVP651 LED750-4S/740 S ALU PSU	912300023793	100.000	520	65.050	Sabit Sürücü	522 x 817 x 80	
BVP651 LED750-4S/740 OFA52 ALU PSU	912300023794	100.000	520	64.080	Sabit Sürücü	522 x 817 x 80	
BVP650 LED400-4S/740 OFA52 ALU PSU	912300023689	100.000	257	30.294	Sabit Sürücü	503 x 524 x 95	



### SportsStar

IP 66

IK08

CE

-40°C  
min

45°C  
max

YENİ

Ürün	12 NC	Faydalı Omür (L80F10) Saat	Güç Tüketimi (W)	Işık Akısı (lm)	Sürücü / Balast Tipi	Boyut (mm)	Fiyat (€)
BVP621 LED504/NW 480W 220-240V SWB GM	911401825998	50.000	480	50.400	Sabit Sürücü	680 x 520 x 307	Lütfen fiyat sorunuz.
BVP621 LED504/NW 480W 220-240V AWB GM	911401825298	50.000	480	50.400	Sabit Sürücü	680 x 520 x 307	
BVP621 LED504/NW 480W 220-240V SMB GM	911401826498	50.000	480	50.400	Sabit Sürücü	680 x 520 x 307	
BVP621 LED504/NW 480W 220-240V NB GM	911401825598	50.000	480	50.400	Sabit Sürücü	680 x 520 x 307	
BVP621 LED672/NW 640W 220-240V AWB GM	911401825098	50.000	640	67.200	Sabit Sürücü	680 x 610 x 307	
BVP621 LED840/NW 800W 220-240V AWB GM	911401825398	50.000	800	84.000	Sabit Sürücü	680 x 740 x 307	
BVP621 LED840/NW 800W 220-240V NB GM	911401825798	50.000	800	84.000	Sabit Sürücü	680 x 740 x 307	
BVP621 LED1008/NW 960W 220-240V NB GM	911401825698	50.000	960	100.800	Sabit Sürücü	680 x 740 x 307	
BVP621 LED1008/NW 960W 220-240V AWB GM	911401825898	50.000	960	100.800	Sabit Sürücü	680 x 740 x 307	
BVP621 LED1008/NW 960W 220-240V SMB GM	911401826398	50.000	960	100.800	Sabit Sürücü	680 x 740 x 307	



Smart Post Top Gen3, tüm cıva bazlı armatürleri LED'li sistemlerle tek seferde değiştirerek düşük ilk yatırım maliyetiyle yerel yönetimlere çözüm sağlayan, yüksek kaliteli dekoratif bir LED aydınlatma çözümüdür.



### Smart Post Top Gen3



Ürün	12 NC	Faydalı Omür (L80F10) Saat	Sürücü / Balast Tipi	Güç Tüketimi (W)	Işık Akısı (lm)	Ağırlık (kg)	Fiyat (€)
BGP161 LED2300/WW PSU 220-240V 9006 GM	911401834598	50.000	Sabit Sürücü	27	2.300	4,5	Lütfen fiyat sorunuz.
BGP161 LED2300/WW PSU 220-240V 7043 GM	911401834698	50.000	Sabit Sürücü	27	2.300	4,5	
BGP161 LED2500/NW PSU 220-240V 9006 GM	911401834798	50.000	Sabit Sürücü	27	2.500	4,5	
BGP161 LED2500/NW PSU 220-240V 7043 GM	911401834898	50.000	Sabit Sürücü	27	2.500	4,5	



TownGuide ailesi, Flat Cone ve Bowl olmak üzere iki adet dikkat çekici ve modern tasarıma sahip, dekoratif şehir içi park-bahçe-sokak aydınlatma armatürüdür. Her iki şekilde saydam ve buzlu optik seçeneğine sahiptir. Geniş bir lümen paketi yelpazesi ve renk sıcaklığı seçeneği sunan ve aynı zamanda uzun kullanım ömrü ve görece düşük güç tüketim vadeden TownGuide eşsiz bir seçenektir.



### TownGuide



Ürün	12 NC	Faydalı Omür (L80F10) Saat	Sürücü / Balast Tipi	Güç Tüketimi (W)	Işık Akısı (lm)	Ağırlık (kg)	Fiyat (€)
BDP001 ECO30-/840 DRW PCC GR 76P	910500991001	70.000	Sabit Sürücü	29	2.414	8,4	Lütfen fiyat sorunuz.
BDP002 ECO40-/830 II DRW PCC GR 62P	910500991006	70.000	Sabit Sürücü	39	3.284	8,4	
BDP100 GRN50-/830 II DS PCF SI CLO-LS-6	910500991011	100.000	LumiStep	43	2.893	8,4	
BDP101 GRN60-/830 II DM PCC SI CLO-DDF2	910500991014	100.000	Dynadimmer	48	4.898	8,4	
BDP102 GRN40-/830 II DRW PCC SI CLO-DDF1	910500991021	100.000	Dynadimmer	35	3.297	8,4	
BDP103 ECO60-/840 DM PCF ALU CLO 62P	910770200982	100.000	Programlanabilir	51	3.090	8,4	
BDP104 GRN30-/840 II DM PCC SI CLO-LS-8	910500991024	100.000	LumiStep	24	2.384	8,4	



# ARMATÜRLER

## Dış Mekan LED

Dekoratif Park-Bahçe Aydınlatma



19. yüzyıl ikonik fener tasarımını LED teknolojisi ile birleştiren ClassicStreet, hem tarihi hem de modern alanlarda şık tasarımı ile şehirlere estetik bir dokunuş katmaktadır. Geniş optik lens seçenekleri ile esnek bir tasarım fırsatı sunarken, yüksek verimi ile enerji tasarrufu sağlar.

### ClassicStreet

IP66

IK08

CE

ENEC

-20°C  
min

35°C  
max

Ürün	12 NC	Faydalı Ömür (L80F10) Saat	Güç Tüketimi (W)	Işık Akısı (lm)	Sürücü / Balast Tipi	Ağırlık (kg)	Fiyat (€)
BDP794 LED26-4S/740 II DM50 FG BK D9 CE	912300023853	100.000	DALI	18	1.800	11,4	Lütfen fiyat sorunuz.
BDP794 LED26-4S/830 DM50 FG BK CLO D9 CE	912300023854	100.000	DALI	21	1.800	11,4	
BDP794 LED42-4S/740 II DW10 FG BK CLO DD	912300023858	100.000	DALI	29	3.100	11,4	
BDP794 LED52-4S/830 II DS50 GF BK 60P	912300023850	100.000	DALI	43	3.200	11,4	
BDP794 LED53-4S/740 II DW10 FG BK CLO DD	912300023859	100.000	DALI	36	3.800	11,4	
BDP794 LED65-4S/740 II DW10 FG BK CLO DD	912300023860	100.000	DALI	44	4.500	11,4	



UrbanStar meşale şeklindeki tasarımı ile park bahçe aydınlatma projelerinde oldukça şık bir ambiyans yaratmanızı sağlar. Yenilenen LED platformu sayesinde yüksek verim değerlerine ulaşırken, LED'ine optimized platformundaki optik seçenekler ile konut alanlarında konforlu bir aydınlatma sunar.

### UrbanStar

IP66

IK08

CE

ENEC

-20°C  
min

35°C  
max

Ürün	12 NC	Faydalı Ömür (L80F10) Saat	Güç Tüketimi (W)	Işık Akısı (lm)	Sürücü / Balast Tipi	Ağırlık (kg)	Fiyat (€)
BDS100 LED12/830 I DX10 DGR CLO-LS-8 50%	912300023989	100.000	Lumistep	11	1.230		Lütfen fiyat sorunuz.
BDS100 LED14/740 I DS50 DGR CLO-LS-8 50	912300023990	100.000	Lumistep	10	1.230		
BDS100 LED22/740 I DGR DM50 CLO CSK	912300023988	100.000	DALI	15	1.930		
BDS100 LED23/830 II DM12 SGR C1K	912300023987	100.000	DALI	15	1.900		
BDS100 LED43/740 I DW50 DGR D9 C1K	912300023991	100.000	DALI	28	3.740		



Philips StreetStar LED yol aydınlatma armatürü, yol ve konut aydınlatma projelerinde kaliteli ışığıyla güvenli alanlar sağlıyor. Optimize edilmiş, uzun ömürlü, güven veren ve işletme-bakım masraflarında maksimum tasarruf sunan StreetStar LED armatürler, performans ve teknolojinin mükemmel sinerjisi ile yolunuzu aydınlatacak.

### StreetStar



IP 66

IK08

CE

-40°C  
min

55°C  
max

Ürün	12 NC	Faydalı Ömür (L70B50) Saat	Sürücü / Balast Tipi	Güç Tüketimi (W)	Işık Akısı (lm)	Ağırlık (kg)	Fiyat (€)
BRP210 LED35/NW 27W 220-240V DW3 MP1	911401833698	50.000	Sabit Sürücü	27	3500	1,1	Lütfen fiyat sorunuz.

### SmartBright Essential Road



IP 66

IK08

CE

-40°C  
min

50°C  
max

Ürün	12 NC	Faydalı Ömür (L70F10) Saat	Sürücü / Balast Tipi	Güç Tüketimi (W)	Işık Akısı (lm)	Ağırlık (kg)	Fiyat (€)
BRP130 LED70/NW 70W 220-240V DM GM	911401635404	30.000	Sabit Sürücü	70	7000	2,6	214,00
BRP131 LED100/NW 100W 220-240V DM GM	911401697404	30.000	Sabit Sürücü	100	10000	4,2	299,00
BRP132 LED140/NW 140W 220-240V DM GM	911401636104	30.000	Sabit Sürücü	140	14000	4,2	351,00

YENİ

### LumiStreet



IP 66

IK08

ENEC

CE

-30°C  
min

35°C  
max

Ürün	12 NC	Faydalı Ömür (L70F10) Saat	Sürücü / Balast Tipi	Güç Tüketimi (W)	Işık Akısı (lm)	Ağırlık (kg)	Fiyat (€)
BGP212 LED39-4S/740 II DM50 48/60A	910770204451	100.000	1-10V	27,5	3314	4,2	Lütfen fiyat sorunuz.
BGP212 LED44-4S/740 II DM50 D9 48/60A	910925864731	100.000	DALI	31	3726	4,2	
BGP212 LED49-4S/740 II DM50 D9 48/60A	910925864729	100.000	DALI	35	4137	4,2	
BGP212 LED56-4S/740 II DM50 D9 48/60A	910925864733	100.000	DALI	37	4695	4,2	
BGP253 LED74-4S/740 II DM50 D9 48/60A	910925864926	100.000	DALI	46,6	6400	6	
BGP253 LED84-4S/740 II DM50 D9 48/60A	910925864927	100.000	DALI	53	7200	6	
BGP253 LED94-4S/740 II DM50 D9 48/60A	910925864928	100.000	DALI	59,6	8200	6	
BGP253 LED109-4S/740 II DM50 D9 48/60A	910925864929	100.000	DALI	70,8	9400	6	
BGP253 LED120-4S/740 II DM50 D9 48/60A	910925864930	100.000	DALI	90,6	10500	6	
BGP214 LED109-4S/740 II DM50 D9 48/60A	910925863477	100.000	DALI	76	9483	8,5	
BGP214 LED139-4S/740 II DM50 D9 48/60A	910925863479	100.000	DALI	90	11917	8,5	
BGP214 LED149-4S/740 II DM50 D9 48/60A	910925863481	100.000	DALI	98	12816	8,5	

YENİ



# ARMATÜRLER

Dış Mekan LED  
Yol Aydınlatma



ClearWay Gen2 M3'ten M6'ya kadar olan yol sınıfları için uygun LED'li bir yol armatürüdür. Armatürler DALI dimlemeye uygun sürücüyü sahiptir.

## ClearWay Gen2

IP 66

IK08

ENEC

CE

-30°C  
min

35°C  
max

Ürün	12 NC	Faydalı Ömür (L70F10) Saat	Sürücü / Balast Tipi	Güç Tüketimi (W)	Işık Akısı (lm)	Ağırlık (kg)	Fiyat (€)
BGP307 LED45-4S/740 II DM50 48/60A	910925864601	100.000	1-10V	30	3.960	7	Lütfen fiyat sorunuz.
BGP307 LED54-4S/740 II DM50 48/60A	910925864602	100.000	1-10V	37	4.750	7	
BGP307 LED69-4S/740 II DM50 48/60A	910925864603	100.000	1-10V	43	5.980	7	
BGP307 LED84-4S/740 II DM50 48/60A	910925864604	100.000	1-10V	53	7.390	7	
BGP307 LED99-4S/740 II DM50 48/60A	910925864605	100.000	1-10V	63	8.700	7	
BGP307 LED109-4S/740 II DM11 CLO-DDF1 D1	910925865248	100.000	DALI	69	9.460	7	
BGP307 LED120-4S/740 II DM11 CLO-DDF1 D1	910925865249	100.000	DALI	78	10.320	7	



GreenVision Xceed M1'den M6'ya kadar tüm yol sınıflarına uygun çözümler sunabilen LED'li bir armatürdür. DALI, 1-10V ve Dynadimmer dimlemeye uygun modelleri vardır.

## GreenVision Xceed

IP 66

IK08

CE

-40°C  
min

55°C  
max

Ürün	12 NC	Faydalı Ömür (L70F10) Saat	Sürücü / Balast Tipi	Güç Tüketimi (W)	Işık Akısı (lm)	Ağırlık (kg)	Fiyat (€)
BRP371 LED42/NW 37W 220-240V DM MP1	911401833398	50.000	Sabit Sürücülü	37	4.200	7	Lütfen fiyat sorunuz.
BRP371 LED63/NW 55W 220-240V DM MP1	911401833998	50.000	Sabit Sürücülü	55	6.300	7	
BRP371 LED86/NW 75W 220-240V DM MP1	911401831998	50.000	Sabit Sürücülü	75	8.600	7	
BRP371 LED103/NW 90W 220-240V DM MP1	911401832098	50.000	Sabit Sürücülü	90	10.300	7	
BRP371 LED126/NW 110W 220-240V DM MP1	911401832198	50.000	Sabit Sürücülü	110	12.600	8	
BRP372 LED150/NW 125W 220-240V DM MP1	911401832298	50.000	Sabit Sürücülü	125	15.000	8	
BRP372 LED174/NW 145W 220-240V DM MP1	911401832398	50.000	Sabit Sürücülü	145	17.400	8	
BRP372 LED180/NW 150W 220-240V DM MP1	911401832498	50.000	Sabit Sürücülü	150	18.000	14	
BRP373 LED212/NW 185W 220-240V DM MP1	911401832598	50.000	Sabit Sürücülü	185	21.200	14	
BRP373 LED230/NW 200W 220-240V DM MP1	911401832698	50.000	Sabit Sürücülü	200	23.000	14	
BRP373 LED253/NW 220W 220-240V DM MP1	911401832798	50.000	Sabit Sürücülü	220	25.300	14	
BRP373 LED276/NW 240W 220-240V DM MP1	911401832898	50.000	Sabit Sürücülü	240	27.600	14	
BRP373 LED293/NW 255W 220-240V DM MP1	911401833098	50.000	Sabit Sürücülü	255	29.300	14	
BRP373 LED324/NW 270W 220-240V DM MP1	911401833198	50.000	Sabit Sürücülü	270	32.400	14	
BRP373 LED348/NW 290W 220-240V DM MP1	911401832998	50.000	Sabit Sürücülü	290	34.800	14	



RoadFlair, 3 farklı kasa boyutu ve 38.400 lümene kadar ışık akısı ile tüm yol sınıfları için çözüm sunar. 120lm/W tipik sistem verimi ve düşük ilk yatırım maliyeti ile LED yol ve sokak aydınlatma projelerinizde hızlı geri dönüş sağlar. Polikarbon optik kapağı sayesinde hafif bir gövdeye sahip olup, küçük ve orta kasada sürücü ve parafudur'a, büyük kasa versiyonunda ise parafudur'a kolay erişim sayesinde bakım ve işletme kolaylığı sağlar. Otonom kontrol sistemlerine ek olarak, akıllı aydınlatma sistemlerine uyumlu yapısı sayesinde enerji tasarrufunu maksimize eder.

### RoadFlair



IP 66

IK08

CE

-40°C  
min

50°C  
max

YENİ

Ürün	12 NC	Faydalı Omür (L70B50) Saat	Sürücü / Balast Tipi	Güç Tüketimi (W)	Işık Akısı (lm)	Ağırlık (kg)
BRP391 LED48/NW 40W 220-240V DM	911401815898	50.000	Sabit Sürücülü	40	4.800	5
BRP391 LED60/NW 50W 220-240V DM	911401815998	50.000	Sabit Sürücülü	50	6.000	5
BRP391 LED72/NW 60W 220-240V DM	911401816098	50.000	Sabit Sürücülü	60	7.200	5
BRP391 LED84/NW 70W 220-240V DM	911401816198	50.000	Sabit Sürücülü	70	8.400	5
BRP391 LED96/NW 80W 220-240V DM	911401815798	50.000	Sabit Sürücülü	80	9.600	5
BRP392 LED108/NW 90W 220-240V DM	911401816298	50.000	Sabit Sürücülü	90	10.800	7
BRP392 LED120/NW 100W 220-240V DM	911401815698	50.000	Sabit Sürücülü	100	12.000	7
BRP392 LED132/NW 110W 220-240V DM	911401816398	50.000	Sabit Sürücülü	110	13.200	7
BRP392 LED144/NW 120W 220-240V DM	911401816498	50.000	Sabit Sürücülü	120	14.400	7
BRP392 LED156/NW 130W 220-240V DM	911401815598	50.000	Sabit Sürücülü	130	15.600	7
BRP392 LED168/NW 140W 220-240V DM	911401816598	50.000	Sabit Sürücülü	140	16.800	7
BRP392 LED180/NW 150W 220-240V DM	911401816698	50.000	Sabit Sürücülü	150	18.000	7
BRP392 LED192/NW 160W 220-240V DM	911401816798	50.000	Sabit Sürücülü	160	19.200	7
BRP394 LED204/NW 170W 220-240V DM	911401816898	50.000	Sabit Sürücülü	170	20.400	10
BRP394 LED216/NW 180W 220-240V DM	911401816998	50.000	Sabit Sürücülü	180	21.600	10
BRP394 LED228/NW 190W 220-240V DM	911401815498	50.000	Sabit Sürücülü	190	22.800	10
BRP394 LED240/NW 200W 220-240V DM	911401815398	50.000	Sabit Sürücülü	200	24.000	10
BRP394 LED252/NW 210W 220-240V DM	911401815298	50.000	Sabit Sürücülü	210	25.200	10
BRP394 LED264/NW 220W 220-240V DM	911401817098	50.000	Sabit Sürücülü	220	26.400	10
BRP394 LED276/NW 230W 220-240V DM	911401815198	50.000	Sabit Sürücülü	230	27.600	10
BRP394 LED288/NW 240W 220-240V DM	911401815098	50.000	Sabit Sürücülü	240	28.800	10
BRP394 LED300/NW 250W 220-240V DM	911401814898	50.000	Sabit Sürücülü	250	30.000	10
BRP394 LED312/NW 260W 220-240V DM	911401814998	50.000	Sabit Sürücülü	260	31.200	10
BRP394 LED324/NW 270W 220-240V DM	911401817198	50.000	Sabit Sürücülü	270	32.400	10
BRP394 LED336/NW 280W 220-240V DM	911401817298	50.000	Sabit Sürücülü	280	33.600	10
BRP394 LED348/NW 290W 220-240V DM	911401814798	50.000	Sabit Sürücülü	290	34.800	10
BRP394 LED360/NW 300W 220-240V DM	911401817398	50.000	Sabit Sürücülü	300	36.000	10
BRP394 LED372/NW 310W 220-240V DM	911401817498	50.000	Sabit Sürücülü	310	37.200	10
BRP394 LED384/NW 320W 220-240V DM	911401817598	50.000	Sabit Sürücülü	320	38.400	10

Lütfen fiyat sorunuz.

# ARMATÜRLER

Dış Mekan LED  
Yol Aydınlatma



Philips DigiStreet aydınlatma armatürleri, yenilikçi ve modern tasarımı, yüksek verimi ve akıllı aydınlatma sistemleri ile uyumlu teknolojisi sayesinde, kent sakinlerinin yaşam kalitesini artırmanın yanı sıra şehirlere kimlik kazandırarak insanlar ile şehirler arasında bağ oluşmasına katkıda bulunur.

## DigiStreet



IP 66

IK08

ENEC+

CE

-30°C  
min

35°C  
max

YENİ

Ürün	12 NC	Faydalı Omür (L70B50) Saat	Sürücü / Balast Tipi	Güç Tüketimi (W)	Işık Akısı (lm)	Ağırlık (kg)	
BGP760 LED44-/740 I DW50 DGR 32-48	910925863566	100.000	Sabit Sürücü	31	3.726	6	
BGP761 LED50-/830 II DM11 DGR D9 62	910925863569	100.000	DALI	44	4.415	8	
BGP761 LED59-/830 II DN11 DGR D11 62	910925863571	100.000	LineSwitch	53	5.178	8	
BGP761 LED69-/830 II DM31 DGR D24 62	910925863573	100.000	Dynadimmer	60	6.063	8	
BGP761 LED79-/830 II DM70 DGR DDF27 D18	910925863575	100.000	Dynadimmer	69	6.893	8	
BGP761 LED90-/740 II DW10 DGR 62	910925863577	100.000	Sabit Sürücü	62	7.885	8	
BGP762 LED100-4S/830 II DM11 62 DGR D9	910925863702	100.000	DALI	87	8.908	9	
BGP762 LED110-4S/740 I DN10 32-48 DGR	910925863703	100.000	Sabit Sürücü	75	9.855	9	Lütfen fiyat sorunuz.
BGP762 LED129-4S/740 I DM30 32-48 DGR	910925863705	100.000	Sabit Sürücü	88	11.729	9	
BGP762 LED149-4S/740 I DM50 32-48 DGR	910925863707	100.000	Sabit Sürücü	101	13.206	9	
BGP762 LED170-4S/830 II DW10 76 DGR2	910925863710	100.000	Sabit Sürücü	149	14.922	9	
BGP762 LED180-4S/740 I DX10 32-48 DGR2	910925863711	100.000	Sabit Sürücü	122	15.338	9	
BGP762 LED200-4S/740 I DW50 62 DGR	910925863713	100.000	Sabit Sürücü	137	16.950	9	
BGP762 LED220-4S/740 II DW12 62 DGR SRG1	910925863715	100.000	Sabit Sürücü	153	18.500	9	
BGP763 LED320-4S/740 II DX70 76 DGR	910925863720	100.000	Sabit Sürücü	182	21.820	13	
BGP763 LED340-4S/740 II DW12 62 DGR SRG1	910925863721	100.000	Sabit Sürücü	188	17.754	13	



**PHILIPS**

TownGuide

# TownGuide ile şehirlerin ruhunu yaşat!

4 farklı  
dekoratif kapak  
ve 3 farklı optik  
açı seçeneği

109 Lm/W'a  
kadar  
sistem  
verimliliği

3000K sıcak beyaz  
4000K doğal beyaz  
5000K soğuk beyaz  
renk sıcaklığı seçenekleri

Farklı aydınlatma seviyesi  
ihtiyacına uygun  
1200-12000 Lm aralığında  
lümen paketleri

TownGuide Dekoratif Şehir Aydınlatma Armatürü, özel tasarımıyla hem gündüz hem de gece şehirlerin kimliğine katkıda bulunur. TownGuide; park, bahçe, sokak gibi şehir içinde pek çok alanda kullanıma uygun olarak tasarlanmıştır. Çok sayıda farklı lümen paketi, yüksek verimliliği ve özel optik seçenekleri ile optimum fiyat-kalite performansı sunar.



L80F10;  
70.000 saat  
lümen ömrü

TownGuide  
Dekoratif Şehir  
Aydınlatma  
Armatürü



Vaya Lineer, duvar boyama ve yüzeyel aydınlatma uygulamaları için tasarlanmış, DMX512 kontrol tabanlı, IP65, doğrusal LED armatürdür. Optimum ilk yatırım maliyeti, farklı optik aç seçenekleri ve düşük enerji tüketimiyle mimari aydınlatma uygulamaları için idealdir. RGB armatürler için data kablosu ayrıca çekilmelidir.



### Vaya Linear LP

IP 66

IK07

CE

-20°C  
min

40°C  
max

Ürün	12 NC	Faydalı Omür (L70F10) Saat	Sürücü / Balast Tipi	Güç Tüketimi (W)	Işık Akısı (lm)	Renk	Fiyat (€)	
BCP421 120 RGB L610 CE	910503704421	50.000	DMX	14	300	610	Lütfen fiyat sorunuz.	
BCP421 28x84 RGB L1200 CE	910503704424	50.000	DMX	28	600	1200		
BCP422 G2 120 2700 L610 CE CQC PSE	912400136134	50.000	Sabit Sürücü	9	740	610		
BCP422 G2 28x84 2700 L1200 CE CQC PSE	912400136137	50.000	Sabit Sürücü	18	1.700	1200		
BCP422 G2 120 3000 L610 CE CQC PSE	912400136118	50.000	Sabit Sürücü	9	740	610		
BCP422 G2 28x84 3000 L1200 CE CQC PSE	912400136121	50.000	Sabit Sürücü	17	1.700	1200		
BCP422 G2 28x84 4000 L610 CE CQC PSE	912400136123	50.000	Sabit Sürücü	9	880	610		
BCP422 G2 120 4000 L1200 CE CQC PSE	912400136124	50.000	Sabit Sürücü	17	1.490	1200		
BCP422 G2 28x84 5000 L610 CE CQC PSE	912400136143	50.000	Sabit Sürücü	9	880	610		
BCP422 G2 120 5000 L1200 CE CQC PSE	912400136144	50.000	Sabit Sürücü	17	1.490	1200		
BCP423 28x84 AM L610 CE	910503704494	50.000	Sabit Sürücü	10	600	610		
BCP423 120 AM L1200 CE	910503704495	50.000	Sabit Sürücü	20	1.200	1200		
ZCP425 C15000 BK CE LEADER CABLE	912400130044			Lider kablo				
ZCP425 C1500 BK CE JUMPER CABLE	912400130046			Jumper kablo				



### Vaya Linear MP

IP 66

IK06

CE

-40°C  
min

40°C  
max

Ürün	12 NC	Faydalı Omür (L70F10) Saat	Sürücü / Balast Tipi	Güç Tüketimi (W)	Işık Akısı (lm)	Renk	Fiyat (€)	
BCP424 10x50 RGB L310 CE	912400130057	50.000	DMX	18	450	310	Lütfen fiyat sorunuz.	
BCP424 50 RGB L1210 CE	912400130058	50.000	DMX	60	1.800	1210		
BCP425 50 2700 L310 CE	912400130141	50.000	Sabit Sürücü	18	840	310		
BCP425 10x50 2700 L1210 CE	912400130144	50.000	Sabit Sürücü	60	3.360	1210		
BCP425 50 3000 L310 CE	912400130117	50.000	Sabit Sürücü	18	840	310		
BCP425 10x50 3000 L1210 CE	912400130120	50.000	Sabit Sürücü	60	3.360	1210		
BCP425 50 4000 L310 CE	912400130121	50.000	Sabit Sürücü	18	840	310		
BCP425 10x50 4000 L1210 CE	912400130124	50.000	Sabit Sürücü	60	3.360	1210		
BCP425 50 5000 L310 CE	912400130153	50.000	Sabit Sürücü	18	840	310		
BCP425 10x50 5000 L1210 CE	912400130156	50.000	Sabit Sürücü	60	3.360	1210		
BCP426 50 AM L310 CE	912400130080	50.000	Sabit Sürücü	18	840	310		
BCP426 10x50 AM L1210 CE	912400130083	50.000	Sabit Sürücü	60	3.360	1210		
ZCP425 C15000 BK CE LEADER CABLE	912400130044			Lider kablo				
ZCP425 C1500 BK CE JUMPER CABLE	912400130046			Jumper kablo				



# ARMATÜRLER

Dış Mekan LED

Mimari Aydınlatma



Vaya Cove iç mekanlarda gizli aydınlatma uygulamalarında kullanılır. Armatürler lider kablo ile birlikte sipariş edilmelidir. 24VDC harici sürücü ile belenmelidir.



## Vaya Cove LP G2

IP20

IK08

CE

-20°C  
min

40°C  
max

Ürün	12 NC	Faydalı Ömür (L50F10) Saat	Sürücü / Balast Tipi	Güç Tüketimi (W)	Işık Akısı (lm)	Renk	Fiyat (€)
SM452L 3000 24V L300 CE UL	912400135341	50.000	24V DC harici	3	250	2700	Lütfen fiyat sorunuz.
SM452L 3000 24V L1200 CE UL	912400135343	50.000	24V DC harici	12	1.000	2700	
SM452L 4000 24V L300 CE UL	912400135344	50.000	24V DC harici	3	250	2700	
SM452L 4000 24V L1200 CE UL	912400135346	50.000	24V DC harici	12	1.000	4000	



## Vaya Flood LP G2

IP66

IK06

CE

-40°C  
min

40°C  
max

Ürün	12 NC	Faydalı Ömür (L70F10) Saat	Sürücü / Balast Tipi	Güç Tüketimi (W)	Işık Akısı (lm)	Renk	Fiyat (€)
BCP432 4000 100-240 20 CE CQC PSE	912400133934	50.000	Sabit Sürücü	45	3.380	4000	Lütfen fiyat sorunuz.
BCP432 4000 100-240 40 CE CQC PSE	912400133937	50.000	Sabit Sürücü	45	3.380	4000	
BCP433 RD 100-240 20 CE CQC PSE	912400133906	50.000	Sabit Sürücü	47	2.025	Red	
BCP433 GN 100-240 20 CE CQC PSE	912400133914	50.000	Sabit Sürücü	47	2.025	Green	
BCP433 BL 100-240 40 CE CQC PSE	912400133910	50.000	Sabit Sürücü	47	2.025	Green	
BCP431 RGB 100-240 20 CE CQC PSE	912400133973	50.000	DMX	45	1.380	RGB	
BCP431 RGB 100-240 40 CE CQC PSE	912400133975	50.000	DMX	45	1.380	RGB	



# ARMATÜRLER

Dış Mekan LED  
Mimari Aydınlatma



Vaya Flood MP RGB, duvar boyamayı renk değiştirme efektleri ile birleştiren, kurulumu kolay, yüksek performanslı LED armatürdür. DMX512 kontrol tabanlı, IP66 koruma sınıfındaki bu projektör, optimum ilk yatırım maliyeti, farklı optik açı seçenekleri ve düşük enerji tüketimiyle hem iç hem de dış mekan mimari aydınlatma uygulamaları için idealdir. RGB armatürler için data kablosu ayrıca çekilmelidir.



## Vaya Flood MP G2



Ürün	12 NC	Faydalı Ömür (L70F10) Saat	Sürücü / Balast Tipi	Güç Tüketimi (W)	Işık Akısı (lm)	Renk	Fiyat (€)
BCP435 3000 220-240 20 CE CQC	912400134021	50.000	Sabit Sürücü	68	5656	3.000K	Lütfen fiyat sorunuz.
BCP435 3000 220-240 40 CE CQC	912400134022	50.000	Sabit Sürücü	68	5656	3.000K	
BCP435 4000 220-240 20 CE CQC	912400134024	50.000	Sabit Sürücü	68	5656	4.000K	
BCP435 4000 220-240 40 CE CQC	912400134025	50.000	Sabit Sürücü	68	5656	4.000K	
BCP434 RGB 100-240 20 CE CQC PSE	912400133978	50.000	DMX	72	2480	RGB	
BCP434 RGB 100-240 40 CE CQC PSE	912400133979	50.000	DMX	72	2480	RGB	



## Vaya Flood HP



Ürün	12 NC	Faydalı Ömür (L70F10) Saat	Sürücü / Balast Tipi	Güç Tüketimi (W)	Işık Akısı (lm)	Renk	Fiyat (€)
VAYA FLOOD HP RGB 10 DEGREE CQC/CE/PSE	910503702884	50.000	DMX	105	3.500	RGB	Lütfen fiyat sorunuz.
VAYA FLOOD HP RGB 20 DEGREE CQC/CE/PSE	910503702885	50.000	DMX	105	3.500	RGB	
VAYA FLOOD HP RGB 40 DEGREE CQC/CE/PSE	910503702886	50.000	DMX	105	3.500	RGB	
VAYA FLOOD HP 2700K 10 DEGREE CQC/CE	912400130401	50.000	Sabit Sürücü	100	9.700	2700K	
VAYA FLOOD HP 2700K 20 DEGREE CQC/CE	912400130402	50.000	Sabit Sürücü	100	9.700	2700K	
VAYA FLOOD HP 2700K 40 DEGREE CQC/CE	912400130403	50.000	Sabit Sürücü	100	9.700	2700K	
VAYA FLOOD HP 3000K 10 DEGREE CQC/CE	910503703119	50.000	Sabit Sürücü	100	9.700	3000K	
VAYA FLOOD HP 3000K 20 DEGREE CQC/CE	910503703120	50.000	Sabit Sürücü	100	9.700	3000K	
VAYA FLOOD HP 3000K 40 DEGREE CQC/CE	910503703121	50.000	Sabit Sürücü	100	9.700	3000K	
VAYA FLOOD HP 4000K 10 DEGREE CQC/CE	910503703123	50.000	Sabit Sürücü	100	9.700	4000K	
VAYA FLOOD HP 4000K 20 DEGREE CQC/CE	910503703124	50.000	Sabit Sürücü	100	9.700	4000K	
VAYA FLOOD HP 4000K 40 DEGREE CQC/CE	910503703125	50.000	Sabit Sürücü	100	9.700	4000K	
VAYA FLOOD HP 5000K 10 DEGREE CQC/CE	912400130405	50.000	Sabit Sürücü	100	9.700	5000K	
VAYA FLOOD HP 5000K 20 DEGREE CQC/CE	912400130406	50.000	Sabit Sürücü	100	9.700	5000K	
VAYA FLOOD HP 5000K 40 DEGREE CQC/CE	912400130407	50.000	Sabit Sürücü	100	9.700	5000K	



Vaya Uplight HP gömme kasa vurgu aydınlatma armatürleri konvansiyonel CDM-T 70W gömme armatürler ile birebir değişim yapılarak %50 enerji tasarrufu sağlamaktadır. Ayrıca sahada -15 derece ile +15 derece arasında ayarlanabilir yapısı sayesinde uygulamada büyük esneklik sağlamaktadır.



### Vaya Uplight HP

IP 67

IK10

CE

-40°C  
min

50°C  
max

Ürün	12 NC	Faydalı Ömür (L70F10) Saat	Sürücü / Balast Tipi	Güç Tüketimi (W)	Işık Akısı (lm)	Renk	Fiyat (€)
BBP331 21xLED-HP/NW 220-240V 25	911401603303	50000	Sabit Sürücü	35	3.400	4000K	Lütfen fiyat sorunuz.
BBP331 21xLED-HP/NW 220-240V 55 L	911401603403	50000	Sabit Sürücü	35	3.400	4000K	
BBP331 21xLED-HP/WW 220-240V 15	911401603503	50000	Sabit Sürücü	35	3.100	3000K	
BBP331 21xLED-HP/WW 220-240V 25	911401603603	50000	Sabit Sürücü	35	3.100	3000K	
BBP331 21xLED-HP/WW 220-240V 55 L	911401603703	50000	Sabit Sürücü	35	3.100	3000K	
BBP331 15xLED-HP/NW 220-240V 15	911401697702	50000	Sabit Sürücü	15	2.200	4000K	
BBP331 15xLED-HP/NW 220-240V 25	911401697802	50000	Sabit Sürücü	15	2.400	4000K	
BBP331 15xLED-HP/GN 220-240V 15	911401697902	50000	Sabit Sürücü	15	1.200	Green	
BBP331 15xLED-HP/WW 220-240V 25	911401698002	50000	Sabit Sürücü	15	2.200	3000K	
BBP331 15xLED-HP/WW 220-240V 55 L	911401698102	50000	Sabit Sürücü	15	2.200	3000K	
BBP331 15xLED-HP/NW 220-240V 55 L	911401698202	50000	Sabit Sürücü	15	2.400	4000K	
BBP331 15xLED-HP/WW 220-240V 15	911401698302	50000	Sabit Sürücü	15	2.200	3000K	
BBP331 15xLED-HP/GN 220-240V 25	911401698402	50000	Sabit Sürücü	15	1.200	Green	
BBP331 15xLED-HP/GN 220-240V 55 L	911401698502	50000	Sabit Sürücü	15	1.200	Green	
BBP331 emdedded housing	911401699502	Gömme Kasa	-	-	-	-	
BBP331 T30 wrench	911401600503	Montaj Alyanı	-	-	-	-	

# ARMATÜRLER

Dış Mekan LED  
Mimari Aydınlatma



Vaya FreeForm esnek ve ince yapısı ile gizli aydınlatma uygulamaları ve bina cepheleri üzerindeki kontür aydınlatma uygulamalarında kullanılmakta olup; kısa karışma mesafesi ve özel konnektörleri ile bağlantı noktalarında ışık kaybı olmaması ile ön plana çıkıyor.

## Vaya FreeForm



YENİ

Ürün	12 NC	Faydalı Ömür (L80F10) Saat	Sürücü / Balast Tipi	Güç Tüketimi (W)	Işık Akısı (lm)	Renk	Fiyat (€)
BGC452 3000 IP66 L1000 W/LEADER	912400136470	50000	Harici	35	800	4000K	Lütfen fiyat sorunuz.
BGC452 3000 IP66 L5000 W/LEADER	912400136471	50000	Harici	35	4.000	4000K	
BGC452 3000 IP66 L10000 W/LEADER	912400136472	50000	Harici	35	8.000	3000K	
BGC452 4000 IP66 L1000 W/LEADER	912400136473	50000	Harici	35	800	3000K	
BGC452 4000 IP66 L5000 W/LEADER	912400136474	50000	Harici	35	4.000	3000K	
BGC452 4000 IP66 L10000 W/LEADER	912400136475	50000	Harici	15	8.000	4000K	



UniStrip LP ince tasarımı sayesinde kısıtlı yere sahip olan cephe aydınlatma projelerinde elinizi güçlendirir. Duvar sıyırma uygulamaları için özel olarak geliştirilmiş olan optiği sayesinde 2-3 metre duvar yüksekliğine sahip uygulamalar için çok uygundur.



## UniStrip LP



YENİ

Ürün	12 NC	Faydalı Ömür (L80F10) Saat	Sürücü / Balast Tipi	Güç Tüketimi (W)	Işık Akısı (lm)	Renk	Fiyat (€)
BCP270 G2 12xLED/3000 24V L300 A	911401658803	50000	Sabit Sürücü	4	330	3000K	Lütfen fiyat sorunuz.
BCP270 G2 48xLED/3000 24V L1200 A	911401659503	50000	Sabit Sürücü	16	1320	3000K	
BCP270 G2 12xLED/4000 24V L300 A	911401658903	50000	Sabit Sürücü	4	330	4000K	
BCP270 G2 48xLED/4000 24V L1200 A	911401659203	50000	Sabit Sürücü	16	1320	4000K	
BCP270 G2 12xLED/5000 24V L300 A	911401664003	50000	Sabit Sürücü	4	330	5000K	
BCP270 G2 48xLED/5000 24V L1200 A	911401659603	50000	Sabit Sürücü	16	1320	5000K	
BCP270 G2 18xLED/RGB 24V L300 A DMX	911401659003	50000	DMX	4	120	RGB	
BCP270 G2 72xLED/RGB 24V L1200 A DMX	911401659403	50000	DMX	15	480	RGB	



UniStrip Compact ince tasarımı sayesinde kısıtlı yere sahip olan cephe aydınlatma projelerinde elinizi güçlendirir. Duvar sıyırma uygulamaları için özel olarak geliştirilmiş olan optiği sayesinde 2-3 metre duvar yüksekliğine sahip uygulamalar için çok uygundur.

## UniStrip Compact



YENİ

Ürün	12 NC	Lamba Tipi	Güç Tüketimi (W)	Sürücü / Balast Tipi	Işık Akısı (lm)	Duy	Fiyat (€)
BCP290 LED-MP RGB 24V MB L1200 DMX	911401663603	50000	Harici	19	600	RGB	Lütfen fiyat sorunuz.
BCP290 LED-MP RGB 24V MB L300 DMX	911401663803	50000	Harici	5	150	RGB	
BCP290 LED-MP/WW-3000 24V MB L1200 onoff	911401640203	50000	Harici	19	2000	3000K	
BCP290 LED-MP/WW-3000 24V MB L300 onoff	911401639603	50000	Harici	5	850	3000K	
BCP290 LED-MP/NW-4000 24V MB L1200 onoff	911401639903	50000	Harici	19	2000	4000K	
BCP290 LED-MP/NW-4000 24V MB L300 onoff	911401639403	50000	Harici	5	850	4000K	
BCP290 LED-MP/CW-5000 24V MB L1200 onoff	911401640503	50000	Harici	19	2000	5000K	
BCP290 LED-MP/CW-5000 24V MB L300 on/off	911401639203	50000	Harici	5	850	5000K	
ZCP290 C2000-3x1-F LEAD CABLE 24V	911401641203	On-off versiyonlar için power-supply'dan armatüre giden lider kablo					
ZCP290 C2000-3x1-M&F LEAD CABLE	911401640903	DMX versiyonlar için data adaptöründen armatüre giden lider kablo					
ZCP290 C2000-3x1-F LEAD CABLE DMX	911401641803	DMX versiyonlar için kontrol cihazından data adaptörüne giden kablo					
ZCP290 SIGNAL ADAPTER	911401646403	Data adaptörü					



UniFlood HP 150W, dış mekan mimari aydınlatma uygulamalarında geniş yüzeylerde duvar boyama uygulamalarında kullanılmaktadır. Tek renk, RGB yada 4 kanallı RGBW uygulamalarda geniş bir renk skalasına sahip olup büyük bir tasarım esnekliği sağlamaktadır. Yüksek ışık akısı ve optik seçenekleri sayesinde yüksek yüzeylerde bile homojen bir aydınlatma sağlar.

## UniFlood HP 150W



YENİ

Ürün	12 NC	Lamba Tipi	Güç Tüketimi (W)	Sürücü / Balast Tipi	Işık Akısı (lm)	Duy	Fiyat (€)
BVP315 60XLED-HP/3000 220-240 NB	911401675703	50000	Sabit Sürücü	150	13500	3000K	Lütfen fiyat sorunuz.
BVP315 60XLED-HP/3000 220-240 MB	911401675803	50000	Sabit Sürücü	150	13500	3000K	
BVP315 60XLED-HP/4000 220-240 NB	911401675903	50000	Sabit Sürücü	150	13500	4000K	
BVP315 60XLED-HP/4000 220-240 MB	911401676203	50000	Sabit Sürücü	150	13500	4000K	
BVP315 60XLED-HP/RGB 220-240 NB	911401675203	50000	DMX	150	4500	RGB	
BVP315 60XLED-HP/RGB 220-240 MB	911401676003	50000	DMX	150	4500	RGB	
BVP315 60XLED-HP/RGBW 220-240 NB	911401675603	50000	DMX	150	5300	RGBW	
BVP315 60XLED-HP/RGBW 220-240 MB	911401676103	50000	DMX	150	5300	RGBW	



# ARMATÜRLER

Dış Mekan LED  
Mimari Aydınlatma



UniPoint ürün ailesi dış cephe ve iç mekan mimari aydınlatma uygulamalarında vurgu aydınlatmasında, özellikle kompakt boyutları ve şık tasarımı ile öne çıkmaktadır.



## UniPoint

24V  
DC

IP66

IK06

CE

-40°C  
min

45°C  
max

YENİ

Ürün	12 NC	Faydalı Ömür (L80F10) Saat	Sürücü / Balast Tipi	Güç Tüketimi (W)	Işık Akısı (lm)	Renk	Fiyat (€)
BGP312 1LED 2700K NB GG	911401711442	50000	Harici	3	110	2700K	Lütfen fiyat sorunuz.
BGP312 1LED 3000K MB GG	911401711482	50000	Harici	3	120	3000K	
BGP312 1LED 4000K WB GG	911401711522	50000	Harici	3	129	4000K	
BGP312 3LED 2700K MB GG	911401711542	50000	Harici	6	320	2700K	
BGP312 3LED 3000K WB GG	911401711582	50000	Harici	6	330	3000K	
BGP312 3LED 4000K NB GG	911401711592	50000	Harici	6	350	4000K	
BGP312 5LED 2700K WB GG	911401711642	50000	Harici	10	565	2700K	
BGP312 5LED 3000K MB GG	911401711662	50000	Harici	10	595	3000K	
BGP312 5LED 4000K NB GG	911401711682	50000	Harici	10	620	4000K	



UniDot üç farklı boya sahip dairesel direk görüntü armatürüdür. Dinamik renkli dış cephe aydınlatma projelerinde çeşitli senaryolar ile cephelere çekici bir görünüm kazandırmak için tasarlanmıştır.

## UniDot

24V  
DC

IP66

IK07

CE

-20°C  
min

50°C  
max

YENİ

Ürün	12 NC	Faydalı Ömür (L80F10) Saat	Sürücü / Balast Tipi	Güç Tüketimi (W)	Işık Akısı (lm)	Renk	Fiyat (€)
BGS301 18xLED-HB-RGB 24V D90	911401612103	50000	Harici	5	109	RGB	Lütfen fiyat sorunuz.
BGS301 18xLED-HB-3000 24V D90	911401612203	50000	Harici	3	217	3000K	
BGS301 18xLED-HB-5000 24V D90	911401612403	50000	Harici	3	217	5000K	
BGS302 42xLED-HB-RGB 24V D140	911401612503	50000	Harici	11	257	RGB	
BGS302 42xLED-HB-3000 24V D140	911401612603	50000	Harici	7	506	3000K	
BGS302 42xLED-HB-5000 24V D140	911401612803	50000	Harici	7	506	5000K	



**PHILIPS**

SmartBright Essential Road



# Her anı güzel ve güvenli şehirler

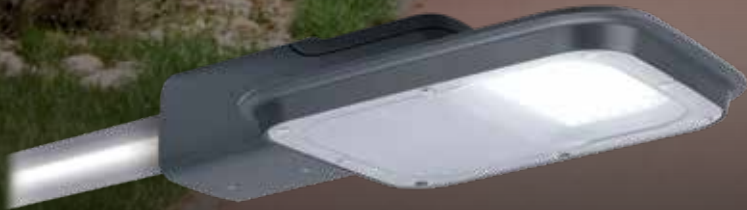

SmartBright  
Essential Road

- 7000 lm, 10.000 lm, 14.000 lm
- 100 lm/W
- %50'ye varan enerji tasarrufu
- 30.000 saat L70B50@35C
- Değişirilebilir 10kV parafudr
- IP66, IK08

IP66

IK08

SPD  
10KV

2,6-4  
KG

-40°C  
min

50°C  
max

# İKON AÇIKLAMALARI

IP20	12.5 mm'den büyük katı cisimlere karşı korumalı
IP40	1 mm'den büyük katı cisimlere karşı korumalı
IP43	1 mm'den büyük katı cisimlere karşı korumalı, 60 dereceye kadar dikey olarak damlayan suya karşı korumalı
IP44	1 mm'den büyük katı cisimlere karşı korumalı, her yönden sıçrayan suya karşı korumalı
IP54	Toza karşı korumalı, her yönden sıçrayan suya karşı korumalı
IP65	Toz geçirmez, her yönden püskürtülen su jetine karşı korumalı
IP66	Toz geçirmez, her yönden püskürtülen şiddetli su jetine karşı korumalı
IP67	15 cm ile 1 metre arasında yere gömme uygulamalarda kullanıma uygundur.
IK02	200 g ağırlığında bir cismin 10 cm yüksekliğinden düşmeye karşı korumalı
IK05	200 g ağırlığında bir cismin 55 cm yüksekliğinden düşmeye karşı korumalı
IK06	500 g ağırlığında bir cismin 20 cm yüksekliğinden düşmeye karşı korumalı
IK07	500 g ağırlığında bir cismin 40 cm yüksekliğinden düşmeye karşı korumalı
IK08	1,7 kg ağırlığında bir cismin 29,5 cm yüksekliğinden düşmeye karşı korumalı
IK09	5 kg ağırlığında bir cismin 20 cm yüksekliğinden düşmeye karşı korumalı
IK10	5 kg ağırlığında bir cismin 40 cm yüksekliğinden düşmeye karşı korumalı
CRI 80	Renksel Geriverim İndeksi %80
CRI 90	Renksel Geriverim İndeksi %90
CE	CE işareti; Avrupa Birliğinin (AB), teknik mevzuat uyumu çerçevesinde malların serbest dolaşımının tam anlamıyla sağlanması amacıyla, ürünlerin teknik yapılarına ilişkin mevzuatı daha basit ve genel hale getirmek için, 1985 yılında benimsediği Yeni Yaklaşım Politikası kapsamında hazırlanan Yeni Yaklaşım Direktifleri kapsamına giren ürünlerin bu direktiflere uygun olduğunu ve gerekli bütün uygunluk değerlendirme faaliyetlerinden geçtiğini sağlık, güvenlik ve tüketicinin ve çevrenin korunması gerekliliklerine uygunluğunu gösteren ve Conformité Européenne kelimelerinin baş harflerinden oluşan bir birlik işareti
ENEC	Avrupa Elektrik Normları Belgelendirme kısaltmasıdır. Elektrik ve elektronik ürünlerde güvenlik işaretidir. ENEC işareti Avrupa Ulusal Belgelendirme Kuruluşları tarafından onaylı olduğunun işareti
XX°C min	Minimum ortam sıcaklığı
XX°C max	Maksimum ortam sıcaklığı
VDE	VDE onaylı ball-proof sertifikası
HACCP	HACCP, gıda işletmelerinde, sağlıklı gıda üretimi için gerekli olan hijyen şartlarının (personel hijyeni, ekipman hijyeni, hammadde hijyeni, ortam hijyeni, vb.) belirlenerek bu şartların sağlanması, üretim ve servis aşamasında tüketici açısından sağlık riski oluşturabilecek nedenlerin belirlenmesi ve bu nedenlerin ortadan kaldırılması temeline dayanan bir ürün güvenilirliği sistemidir. HACCP, İngilizce Hazard Analysis and Critical Control Point - Tehlike Analizi ve Kritik Kontrol Noktaları ifadesinin kısaltması
ACTILUME	Philips'in armatüre entegre sensör teknolojisi
MLO	Mikro Lens Optik
Dim edilir	Dim edilir
BIR	Ball Impact Resistant (Top çarpmasına karşı dayanıklı)
Sentetik	Sentetik malzemeden üretilmiştir.



# TransforMax (Philips patentli)

Philips düşük gerilimli LEDspot LED lambalar içinde yer alan akıllı sürücü teknolojisi sayesinde halojen transformatörler ile birebir uyum.

Philips mevcut elektronik ve elektromanyetik halojen transformatörlerle uyumu sağlayan düşük gerilimli (12 V) LED lambalar için eşsiz (patentle korunan) akıllı sürücü teknolojisini geliştirdi. Bu teknolojisini sayesinde Philips, düşük gerilimli (12 V) LED lambaların birebir transformatör uyumunu sağlayarak, 12 V halojen spot lambaların yerini alır. TransforMax teknolojisi lambaların pek çok prizle uyumlu çalışmasına imkan tanır, "tak-çalıştır" kolay bir retrofit çözümü sunar.

## Dimmer anahtar olmadan

## Dimmer anahtar ile birlikte

Dim edilebilir düşük gerilimli LED lambaların dimmer anahtara bağlanması gerektiği durumlarda, aşağıdaki yaklaşım izlenecektir:

- 1) Hem transformatörün/transformatörlerin hem de dimmer anahtarın maksimum yüklemesini belirleyin: Watt (W) olarak.
- 2) 'Sistem Maks.' ve 'Devre Maks.' değerlerini belirlemek için aşağıdaki oranları kullanın.
- 3) 'Sistem Maks.' ile kurulumunu yapabileceğiniz toplam lamba sayısını sınırlandırın.
- 4) Transformatör toplam yükünün her bir 'Devre' için yeterli olduğundan emin olun.

%20 transformatör oranı  
(%20 x 150 W = 30 W)

LED Watt Gücü (7 W)

=

Devre Maks. (4.3)

Transformatör başına 4 adet lamba

Transformatör  
(150 W)

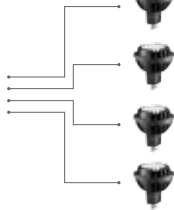

Dimmer Oranı  
(300 W)

Transformatör Watt Gücü (150 W)

=

Sistem Maks. (2)

Dimmer başına 2 adet transformatör



%20 transformatör oranı  
(%20 x 150 W = 30 W)

LED Watt Gücü (7 W)

=

Devre Maks. (4.3)

Transformatör başına 4 adet lamba

Transformatör  
(150 W)

Transformatör  
(150 W)

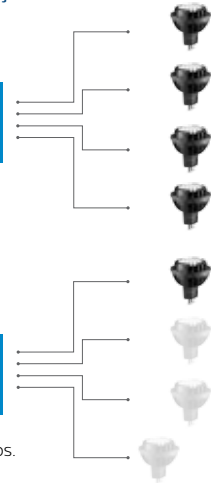

İlave MR16 LEDspot eklenmesi devrede izin verilen maksimum lamba sayısını aşmaz ancak sistemin toplam izin verilen lamba sayısını aşacaktır.

**Not:** Yük kuralını karşılamayan Elektronik Dimmer anahtarlar için lütfen ekli sayfayı ziyaret ediniz: [www.philips.com/masterledlamps](http://www.philips.com/masterledlamps).



Philips LEDspot LV LED lambalar ile uyumlu transformatör listesi için lütfen [www.philips.com/masterledlamps](http://www.philips.com/masterledlamps) adresini ziyaret ediniz.

## Güç Tüketimi ve Işık Akısı Karşılaştırma Tablosu

Enkandesan Lambalar	LED Lambalar (CorePro)	Enerji Tasarruflu Lambalar (Econ Twister)	Enerji Tasarruflu Lambalar (Genie)	Halojen Lambalar (EcoClassic)
25 W 220 lm*	3 W** 250 lm* (25 W)	5 W 270 lm* (28 W)	5 W 250 lm* (27 W)	18 W 204 lm* (23 W)
40 W 415 lm*	7 W 600 lm* (48 W)	8 W 505 lm* (45 W)	8 W 425 lm* (40 W)	28 W 370 lm* (35 W)
60 W 710 lm*	9,5 W 806 lm* (60 W)	12 W 741 lm* (60 W)	14 W 810 lm* (65 W)	42 W 630 lm* (55 W)
75 W 930 lm*	11 W 1055 lm* (75 W)	15 W 970 lm* (75 W)	18 W 1100 lm* (83 W)	53 W 850 lm* (70 W)

\* Geleneksel ampullerin lümen değerleri, alternatif teknolojilerin ürün kutusu üzerinde belirtilen eşdeğer güç tüketimi karşılığında ortalama kullanım ömrü üzerinden karşılanan asgari değerlerdir.

\*\* Lamba kullanım ömrü boyunca gerçekleşen parlaklık kaybı üretim teknolojisine bağlıdır. Lambalar arası ışık akısı karşılaştırması yapılırken, LED lambalar ve enerji tasarruflu lambalar gibi uzun ömürlü teknolojiler için lümen değerlerinin yüksek olduğu göz önünde bulundurulmalıdır.





# PHILIPS

Essential LED Ampul



Essential  
LED Waterproof



Meson Essential  
LED Gömme Spot

# Biz

# Ne Diyorsak O!

Philips Aydınlatma olarak, ürün kutularımızın üzerinde ve teknik raporlarımızda belirttiğimiz lümen, watt, kullanım ömrü ve renksel geriverim gibi tüm beyan değerlerinin %100 gerçeği yansıttığını garanti ederiz. Ürünlerimizi sizin güvenle kullanmanız için özel olarak tasarlıyoruz.



SmartBright LED  
Floodlight



SmartBright Slim Panel  
RC091V



0850 390 19 22

Hafta içi: 9:00 - 19:00