

Overview

HP StorageWorks DAT drives are based on the Digital Data Storage (DDS) format. In fact, DAT is the most successful tape backup technology of all time with more than 17 million DAT drives shipped since its introduction in 1989, and with a current world-wide installed base of over 9 million drives. A number of vendors manufacture DDS format DAT drives, but HP has long been the market leader in DAT technology.

This remarkable tape technology continues to flourish because of its ability to meet the needs of the Small and Medium Business (SMB) market for reliable, cost-effective backup better than any other technology available.

The HP StorageWorks family of DAT drives is the first choice for data protection for many small and medium businesses with low-end and mid-range servers and workstations. HP StorageWorks DAT drives are also frequently used for operating system backup and software loading on mission-critical servers in many large enterprises.

HP StorageWorks DAT drives are available with a range of capacities (from 40 GB to 72 GB) and a choice of interfaces. Customers can benefit from native USB 2.0 for plug-and-play installation: from out of the box to backup in less than 60 seconds. SCSI interfaces are also available for servers requiring SCSI connectivity.

Each member of the HP StorageWorks DAT family offers a complete backup solution including HP's unique One-Button-Disaster-Recovery (OBDR) feature providing customers with the ability to restore their systems quickly and effortlessly with the touch of a single button. HP's unique Library and Tape Tools (L&TT) utilities provide HP StorageWorks DAT customers with a comprehensive suite of tape drive management utilities and HP's extensive testing program ensures that customers benefit from the broadest connectivity and compatibility with HP and third-party servers, operating systems and software in the industry.

Also includes HP StorageWorks Data Protector Express Single Server Edition software and its Bare Metal Disaster Recovery option, providing a backup application to protect a single Windows, Linux or NetWare server.

What's New

HP StorageWorks DAT 40 SCSI Tape Drive

- Now 100% ROHS compliant (meets 2006 European legislation for removal of hazardous substances)
- Now carbonite colored enclosure
- Features a new enclosure design

HP StorageWorks DAT 40 SCSI Tape Drive

The HP StorageWorks DAT 40 SCSI Tape Drive is a dependable entry-level backup solution for smaller servers and workstations. This DDS-4 tape drive stores 40 GB of compressed data on a single cartridge at a rate of 23 GB/hr (assuming 2:1 data compression), providing an ideal balance between capacity and performance.

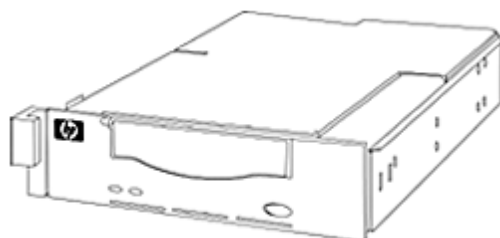

DAT 40 SCSI Array Module

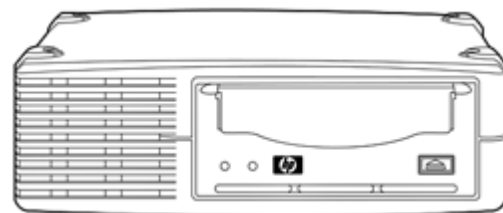

DAT 40 SCSI External Tape Drive

Overview

HP StorageWorks DAT 40 USB Tape Drive

The HP StorageWorks DAT 40 USB Tape Drive is a dependable entry-level backup solution for smaller servers and workstations. This DDS-4 tape drive stores 40 GB of compressed data on a single cartridge at a rate of 23 GB/hr (assuming 2:1 data compression), providing an ideal balance between capacity and performance. The USB 2.0 interface provides plug-and-play connectivity, enabling backup to be initiated from straight out of the box in less than 60 seconds.

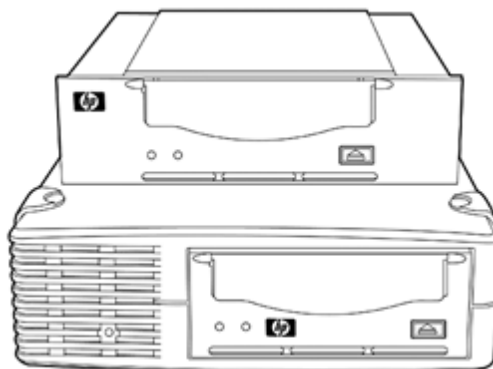

DAT 40 USB Internal Tape Drive
DAT 40 USB External Tape Drive

HP StorageWorks DAT 72 SCSI Tape Drive

- The industry leading HP StorageWorks DAT 72 SCSI tape drive provides an optimum balance of dependable backup capacity and low cost of ownership for small and medium businesses, remote offices, and workgroups. The DAT 72 delivers a capacity of 72 GB on a single data cartridge and a transfer rate of 23 GB/hr (assuming a 2:1 compression ratio).
- Now 100% ROHS compliant (meets 2006 European legislation for removal of hazardous substances) and available with SCSI-3 Ultra 160 interface.

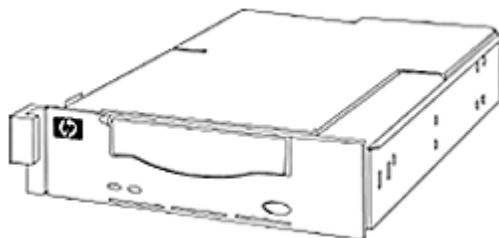

DAT 72 SCSI Array Module and
DAT 72 SCSI External Tape Drive

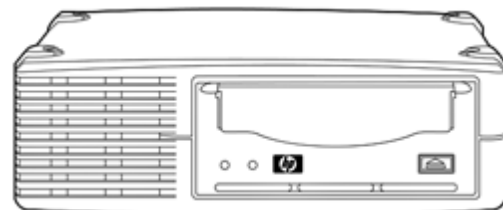

DAT 72 SCSI Internal Tape Drive
DAT 72 SCSI External Tape Drive

Overview

HP StorageWorks DAT 72 USB Tape Drive

The HP StorageWorks DAT 72 USB tape drive provides an optimum balance of dependable backup capacity and low cost of ownership for small and medium businesses, remote offices, and workgroups. The DAT 72 delivers a capacity of 72 GB on a single data cartridge and a transfer rate of 23 GB/hr (assuming a 2:1 compression ratio) and the USB 2.0 interface provides plug-and-play connectivity, enabling backup to be initiated from straight out-of-the-box in less than 60 seconds.

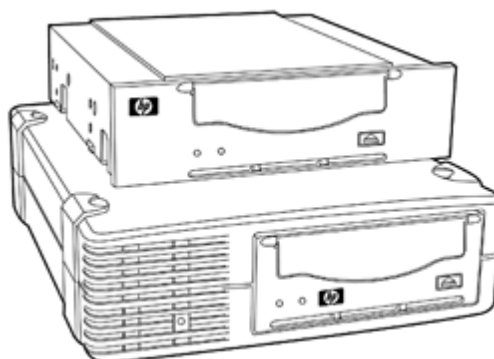

DAT 72 USB Internal Tape Drive
DAT 72 USB External Tape Drive

Models

DAT 40 SCSI Tape Drive	DAT 40 SCSI Internal Tape Drive	C5686C
	NOTE: OD1 will appear after this part number on your sales order if factory integration is indicated.	
	DAT 40 SCSI External Tape Drive	C5687D
DAT 40 USB Tape Drive	DAT 40 SCSI Array Module	C7497C
	NOTE: DAT 40 array modules fit into the HP Tape Array 5300 (C7508A).	
	NOTE: OD1 will appear after this part number on your sales order if factory integration is indicated.	
DAT 40 USB Tape Drive	DAT 40 USB Internal Tape Drive (Carbonite)	DW022A
	NOTE: OD1 will appear after this part number on your sales order if factory integration is indicated.	
DAT 72 SCSI Tape Drive	DAT 40 USB External Tape Drive (Carbonite)	DW023A
	DAT 72 SCSI Internal Tape Drive	Q1522B
	NOTE: OD1 will appear after this part number on your sales order if factory integration is indicated.	
DAT 72 USB Tape Drive	DAT 72 SCSI External Tape Drive	Q1523B
	DAT 72 SCSI Array Module Field-integrated	Q1524C
	NOTE: DAT 72 array modules fit into the HP Tape Array 5300 (C7508A).	
	NOTE: OD1 will appear after this part number on your sales order if factory integration is indicated.	
DAT 72 USB Tape Drive	DAT 72 USB Internal Tape Drive	DW026A
	NOTE: OD1 will appear after this part number on your sales order if factory integration is indicated.	
	DAT 72 USB External Tape Drive	DW027A

Overview

Key Features

- Based on industry-standard DDS technology -- the most popular server backup technology of all time, providing customers will all the benefits of an open standard including better pricing, wider availability and faster development cycles
- Proven reliability -- HP has increased reliability specifications for HP DAT drives based on real field data. Mean-Time-Between-Failure rates (MTBF) are now more than 1 million hours at a typical duty cycle of 12%
- Low-cost of ownership - Lowest media price (in \$/GB) of any tape backup technology
- Up to 36 GB native capacity on a single tape -- 72 GB at 2:1 compression -- with DAT 72 tape drive
- Up to 3.2 MB/s* native data transfer rate -- 6.4 MB/s* with 2:1 compression -- with DAT 40 and 72 tape drives * **Where 1KB = 1,000 Bytes**
- Plug and play -- USB 2.0 interface available for on all drives provides universal native plug-and-play capability and enabling customers to be ready for backup in less than 60 seconds straight out of the box
- SCSI interface also available to enable SCSI system connectivity if required
- Flexibility of solutions through a wide choice of models - internal, external, USB, offline hot-swap array module, and rack-mount configurations
- Small size drives and media for easy physical storage -- small, half-height 3.5-inch form-factor
- Low ongoing maintenance -- automatic head cleaning minimizes the need for cleaning. Intelligent cleaning monitors the performance of the drive and cleans accordingly when a cleaning tape is loaded
- Dependable disaster recovery -- HP StorageWorks One-Button Disaster Recovery (OBDR) restores your entire system at the touch of a button
- Supporting tools -- HP StorageWorks Library and Tape Tools included with the drive to make installation, performance tuning and trouble-shooting even easier
- Broad compatibility with a wide range of servers, operating systems, and backup software
- Includes HP StorageWorks Data Protector Express Single Server Edition software and its Bare Metal Disaster Recovery option.

Customer Benefits

- **Dependable:** a long track record of proven reliability
- **Easy:** supports One-Button Disaster Recovery, simply the easiest way to restore data in the event of a disaster
- **Affordable:** inexpensive media contributes to an exceptionally low cost of ownership
- **Manageable:** includes superior management capabilities that makes it easy to install, use and support
- **Low-maintenance:** automatic head cleaning system reduces the need for cleaning
- **Well-connected:** compatible with leading operating systems, backup software and servers
- **Future-proof:** the tape technology with an illustrious past also has a solid roadmap for the future
- **Complete:** comes with an easy-to-use backup solution that includes disaster recovery capabilities

Product Highlights

DDS Technology

Within the tape market there is a wide range of tape technologies, the question for SMB customers is which one to choose. The answer is clear - DDS/DAT continues to be the unit volume leader in the tape drive market for small and medium businesses with a current installed base of over 9 million and over 17 million DAT drives shipped since its introduction in 1989. This remarkable tape technology continues to flourish because it meets the needs of the SMB market for cost-effective, reliable backup better than any other technology available. Of the 3.5 million backup tape drives shipped in 2003, Gartner Dataquest estimates that approximately 50% were DAT drives.

Unlike AIT, VXA, ADR, SLR, DLT and SDLT, DDS/DAT is based on an open standard format for data interchange. The influential DAT manufacturers group presides over this open standard with verification processes that ensure compliance. With multiple manufacturers developing and shipping DDS/DAT products, customers benefit from increased competition, which leads to better prices, faster development and more choice.

DDS format for DAT is a helical scan format where data is written diagonally across the width of the tape. The advantage is that, by allowing subsequent tracks to have different writing angles and to overlap, a much greater capacity can be achieved for a given length of tape because no guard bands are necessary. The data format also allows for fast location of tracks and data. To achieve this, the rotating drum is tilted at a slight angle (6°) from the vertical. The drum has four heads (two write heads and two read heads), located at 90° intervals. For each rotation of the drum, two tracks are written. The read heads verify the data that has been written (recorded) and the drive rewrites if necessary. The straightness with which the track is written to tape is referred to as the linearity of the track and is critical in ensuring the data is always recoverable.

HP has been involved in the design and development of DDS drives since the beginning and applies these many years of experience to its current line of DDS products. Not only does an investment in DDS technology provide the security of a format with a history of outstanding reliability, the legacy of backward compatibility also provides the potential for future expansion without compromising your investment in the technology.

The target market for DDS/DAT continues to be direct-attach backup. In small and medium sized businesses cost of ownership, ease of use and a proven history (i.e. low risk) are paramount. DDS technology provides the capacity and performance needed in a tape backup solution for workstations and entry-level servers.

Product Highlights

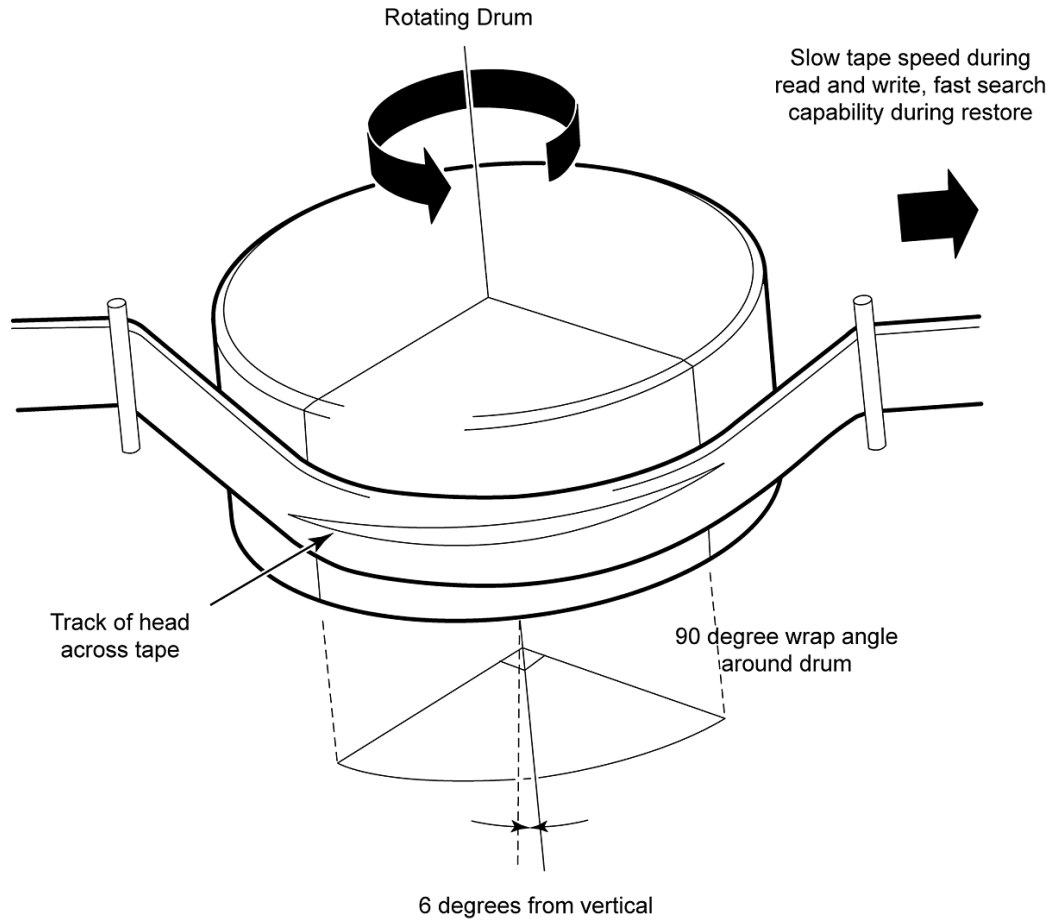

Backwards Compatibility HP DAT tape drives are backward read-write compatible with two previous generations, thus:

- DAT 72 also reads and writes DDS-4 and DDS-3
- DAT 40 also reads and writes DDS-3 and DDS-2

Product Highlights

Proven Reliability

HP DDS drives have proven to be exceptionally reliable backup devices. Hardware reliability is typically measured by MTBF (mean time between failures) quoted in a number of hours at a particular duty cycle. Duty cycle is a measure of average usage per day. For example, a 12% duty cycle means the device is used an average of 3 hours per day, whereas a 100% duty cycle means that it is used 24 hours per day. A drive's predicted MTBF is calculated from a series of tests done on a large population of drives both before and after product launch.

HP's ongoing reliability improvements have recently resulted in an increase in reliability specifications for HP DAT drives based on real field data. By completing an analysis of actual MTBF using the years of data captured about HP DAT products, HP discovered that our DDS-4 and DAT 72 tape drives deliver even better reliability than was initially predicted and documented in our specifications.

The DAT QuickSpecs have now been revised to reflect the new figures:

- The old specifications were:
 - MTBF: 400,000 hours at a 12% duty cycle
 - Unrecoverable error rate: 1 bit in 10^{-15}
- The new specifications are:
 - MTBF: 125,000 hours at a 100% duty cycle or 1 million hours at a 12% duty cycle
 - Unrecoverable error rate: 1 bit in 10^{-17}

DAT's MTBF is now typically expressed with a 100% duty cycle to make it simpler to compare to other tape formats; for example, HP's enterprise-level LTO Ultrium drives have an MTBF of 250,000 hours at a 100% duty cycle. In practice, however, unlike Ultrium drives (used 24x7 as the most popular choice for large tape libraries), few DAT drives would ever be used 24 hours a day. Using a 12% duty cycle that we believe is more typical for a DAT drive, the figure becomes an impressive 1 million hours at a 12% duty cycle.

Automated Head Cleaning/Intelligent cleaning

HP DDS drives benefit from an automatic head cleaning "sweeper" that can be used during the write or read recovery procedure to dislodge debris from the tape path and recording heads and drive. This feature reduces the need to use a DDS cleaning cartridge for manual cleaning.

Intelligent cleaning determines the cleaning provided by a cleaning cartridge when loaded by monitoring the drive performance when in use. If the drive is performing well, a routine maintenance clean is performed. If the drive has degraded performance the cleaning is automatically made more robust to recover the drive to optimum performance.

Product Highlights

USB 2.0 Interface

HP DAT drives are available with a choice of interfaces: the standard SCSI interface where SCSI connectivity is required and the newly introduced USB 2.0 interface.

The USB (Universal Systems Bus) interface was conceived out of a need to simplify computer peripheral device connection. It has been so successful that the majority of computer systems and servers shipped today offer multiple native USB 2.0 ports.

HP is the first company to develop a native USB DDS/DAT tape drive. Where other "USB tape drives" rely on a USB converter, HP's USB interface is fully integrated with the drive and uses the SCSI command set within the USB payload. The benefit of this implementation is that it gives the drive full SCSI functionality and the flexibility of USB without the additional cost of a converter.

By offering native USB 2.0 DAT drives, HP aims to provide customers with a number of benefits:

- Greater usability
 - Plug-and-play connectivity- the system automatically detects and configures the tape drive.
 - The DAT drive is installed and ready to backup in less than 60 seconds.
 - Microsoft fully supports USB devices natively in their operating systems providing robust, secure configuration and installation wizards.
 - Cables are easily identifiable, easy to attach without the need for thumb-screw and robust enough to ensure reliable retention.
- Resource abundance
 - Native USB ports are universally available in systems and servers
 - Multiple ports ensure that port resources are widely available, reducing the conflict between devices over scarce connectors.
 - Port expansion is easy, USB hubs can be installed to add additional ports supporting up to 127 devices on a system
- Low cost, reliable connectivity
 - By providing native USB DDS/DAT drives there is no need for customers to purchase additional host-bus adapters
 - HP's USB 2.0 implementation benefits from the built-in reliability and failure recovery inherent in the underlying SCSI protocol
 - USB 2.0 has multiple levels of physical error detection and recovery which ensure reliability on a par with SCSI and Fibre-channel interfaces.
 - USB 2.0 compliance certification provides thorough, ongoing reliability and quality control. A well implemented USB network should use only USB 2.0 compliant components, including USB 2.0 certified cables.
- Sustainable performance
 - In HP tests it has been shown that USB 2.0 can sustain the performance of an HP DDS/DAT drive at around 30MB/sec, a bandwidth that would sustain the HP DAT 72 drive operating with a compression ratio of 9:1!
 - USB 2.0 performance provides sufficient bandwidth to support all future generations of DDS/DAT drives specified on the DAT Manufacturers Group Roadmap

Compression

DDS uses built-in hardware compression using the 'DCLZ' data compression algorithm. Data compression is host-selectable with the default that compression is turned on. Typical data compression is 2:1, but actual compression depends on the type of data being compressed and can be more or less than 2:1.

Product Highlights

SCSI Offline Hot-Swap Technology

NOTE: this feature is available for SCSI products. USB variants of HP DAT drives already benefit from hot-plug capability through the USB 2.0 interface.

The HP StorageWorks DAT SCSI drives come in a form that increase your uptime: offline hot-swap. With this configuration, you never have to take down your system to replace a failed or non-responding tape device.

The HP StorageWorks Tape Array 5300 supports "offline hot-swap" (sometimes referred to as "warm-swap") array modules, including DAT drives. This means the drives can be removed and replaced with the power on and the SCSI cables attached to the server. Because the array's SCSI buses are not buffered, however, drive replacement should only take place while the SCSI bus is quiescent (no SCSI activity from the tape drive or any other device on the same bus).

With the HP StorageWorks DAT or array modules, the server does not need to be taken offline to install the tape drive. Simply insert the tape drive into the server's Tape Array 5300's drive bay and install or configure the backup software.

Rack-Mount Tape Options

HP DAT SCSI drives are supported on the HP StorageWorks 1U and 3U Rack-Mount Kits and the HP StorageWorks Tape Array 5300. The 3U Rack-Mount Kit and the Tape Array 5300 allow up to four internal DAT drives to be installed in 3U of rack space, while the 1U Rack-Mount Kit holds two DAT drives in 1U of space. Both the 1U and 3U rack-mount kits use standard internal DAT SCSI drives for a low-cost solution, while the Tape Array 5300 uses DAT array modules that provide offline hot-swap capabilities and redundant components for high-availability environments.

Either of these rack enclosures can be configured with separate SCSI buses (channels) for each drive or two or more drives per bus using the optional cable kits.

NOTE: Please refer to the QuickSpecs for HP StorageWorks Rack-Mount Kits at http://h18000.www1.hp.com/products/quickspecs/10854_div/10854_div.html or the HP StorageWorks Tape Array 5300 web page at <http://www.hp.com/products1/storage/products/tapebackup/tapearrays/tapearray5300/index.html> for further information.

HP StorageWorks OBDR (One-Button Disaster Recovery)

With HP One-Button Disaster Recovery, you can quickly, reliably and simply restore your entire system just by inserting the most recent backup tape and pushing one button on the tape drive. Your HP StorageWorks DAT drive will restore your operating system, configuration, applications, drivers and data files. There's no longer a need to search for software disks and manuals. And with downtime reduced, the costs of recovery are minimized too. There's no need to make a new set of disaster recovery disks each time the network configuration is altered or a peripheral is added. Recovering from a disaster manually at a stressful time makes for an error-prone process. The sheer simplicity of HP One-Button Disaster Recovery means less human error. Backup and disaster recovery preparation -- previously two separate tasks -- become one process. OBDR is simply the best disaster recovery product for small to medium systems. For a current list of servers, workstations, and software that support OBDR, check the tape backup compatibility pages at: <http://www.hp.com/go/connect>

Product Highlights

Software in the Box

The HP StorageWorks DDS/DAT tape drives include HP StorageWorks Data Protector Express Single Server Edition backup/recovery software and the HP StorageWorks Data Protector Express Bare Metal Disaster Recovery option. Data Protector Express Single Server Edition is an easy-to-use backup application to protect a single Windows, Linux or NetWare server. The Data Protector Express Bare Metal Disaster Recovery (BMDR) option provides automated system recovery of that server following a major hardware or software failure. The fastest method to recover the server is to use the Data Protector Express BMDR option and the One Button Disaster Recovery feature of the HP StorageWorks DDS/DAT tape drives.

As well as getting the Data Protector Express Single Server Edition software as part of the HP StorageWorks DDS/DAT tape drives solution, purchasers can also upgrade to the class-leading Data Protector Express backup/recovery software. This is a special SKU, only available for new customers of HP StorageWorks tape products that gives a significant discount off Data Protector Express to recognize the value of the in-box software. Upgrading to Data Protector Express allows network backup of servers and Windows desktops, extends the disk-to-disk backup capacity and capability and permits the additions of agents and extensions to increase scale and performance of the backup infrastructure. For more information about the in-box software please visit

<http://www.hp.com/go/dataprotectorexpress/sse>.

If the HP StorageWorks DDS/DAT tape drive is for a large environment that requires UNIX support and/or enterprise class application and feature support then HP OpenView Storage Data protector is the recommended backup/recovery software. For more information and evaluation software please visit

<http://www.hp.com/go/dataprotector>.

HP StorageWorks Library and Tape Tools (L&TT)

HP StorageWorks DAT drives are supported on HP's industry-leading diagnostic tool -- HP StorageWorks Library and Tape Tools (L&TT). L&TT is a single, convenient program that's a snap to install and simple to operate. L&TT's intuitive user interface eliminates the need for training and deploys in less than five minutes. This robust diagnostic tool is designed for both the experienced professional and the untrained administrator. It ensures product integrity through self-diagnostics and fast resolution to device concerns. Additional information on L&TT plus download information can be found at:

<http://www.hp.com/support/tapetools>

HP DDS Media

HP's test program for HP DAT media is probably the most thorough and comprehensive in the industry. HP data cartridges must satisfy an exhaustive battery of additional tests that relate directly to real life situations, where real data and real businesses are at stake. Over 1 million test hours on media and drives per year ensure that HP data cartridges will always offer maximum reliability even in the most extreme conditions. HP recommends that customers always use HP branded media to ensure stress-free backup and complete peace of mind.

Compatibility

HP's extensive compatibility testing program assures that HP StorageWorks DAT drives work with leading servers, operating systems, and backup applications -- and not just those sold by HP. HP DAT drives work seamlessly in many environments, making them especially suitable if you have a mixed system environment. For the latest list of servers, workstations, operating systems, and backup software that support HP DAT drives, check the tape backup compatibility pages at: <http://www.hp.com/go/connect>.

HP Server and Workstation Compatibility with SCSI drives HP StorageWorks DAT SCSI drives are compatible with HP ProLiant servers, HP 9000 servers, Integrity Servers, AlphaServers and HP Workstations, as well as many third-party servers. HP StorageWorks DAT drives are supported on the following classes of HP systems:

- HP ProLiant DL servers
- HP ProLiant ML servers
- HP AlphaServers
- HP 9000 servers
- HP Integrity servers
- HP Personal and RISC Workstations

For details of which tape drive models work with which systems, including third-party systems, visit <http://www.hp.com/go/connect> for the latest hardware compatibility information.

HP Server Compatibility with USB drives HP StorageWorks DAT USB drives are compatible with HP ProLiant servers and HP workstations, as well as many third-party servers. HP StorageWorks DAT drives are supported on the following classes of HP systems:

- HP ProLiant DL servers
- HP ProLiant ML servers
- HP Personal Workstations

For details of which tape drive models work with which systems, including third-party systems, visit <http://www.hp.com/go/connect> for the latest hardware compatibility information.

NOTE: HP recommends that no more than one DAT USB tape drive be connected to a system at a time.

OS Support for SCSI DAT drives Microsoft® Windows®, Novell NetWare, HP-UX, Linux (various distributions), HP Tru64, HP OVMS, IBM AIX, Sun Solaris, and other operating systems

NOTE: Please visit <http://www.hp.com/go/connect> for the latest compatibility information.

OS Support for USB DAT drives Microsoft Windows, Linux (various distributions)

NOTE: Please visit <http://www.hp.com/go/connect> for the latest compatibility information.

Backup Software Support for SCSI drives HP OpenView Storage Data Protector, HP StorageWorks Data Protector Express, VERITAS Backup Exec, Veritas Netbackup BrightStor ARCserve Backup, Yosemite Technologies TapeWare, Legato Networker, Dantz Retrospect, Tivoli Storage Manager, NovaBackup, and other backup applications

NOTE: Please visit <http://www.hp.com/go/connect> for the latest compatibility information.

Backup Software Support for USB drives HP StorageWorks Data Protector Express, Yosemite Technologies TapeWare, VERITAS Backup Exec
Additional third party backup software support will be available in 2006

NOTE: Please visit <http://www.hp.com/go/connect> for the latest compatibility information.

Service and Support, HP Care Pack, and Warranty Information

HP Care Pack Information HP Care Pack Services offer upgraded service levels to extend and expand your standard product warranty with easy to buy, easy to use support packages that help you make the most of your hardware and software investments. They let you choose the support levels that meet your business requirements, from basic to mission-critical. They help you contain total cost of ownership.

HP Care Pack warranty extensions can be purchased along with HP products to cost-effectively upgrade or extend your warranty. For many products, post-warranty HP Care Pack Services are available when your original warranty has expired.

Why purchase an HP Care Pack service?

Your standard warranty protects against product defects. HP Care Pack Services help you guard against unplanned downtime, which can reduce your productivity and profitability. These convenient service packages:

- Protect your investment in HP products
- Provide consistent, predictable levels of support across your entire department or business
- Ease budget planning with fixed-cost support that includes parts and labor
- Give you direct access to proven technical and problem-solving expertise
- Offer a choice of response-time and repair-time commitments
- Deliver prompt, measurable results
- Are available whenever and wherever you do business

HP Care Pack availability may vary by country and product.

Supporting your Adaptive Enterprise journey

HP Services helps you make the Adaptive Enterprise real for your organization. The breadth, depth, and quality of HP hardware and software support services can help you improve the performance of your IT support processes and resolve the complex software and hardware problems that tax user productivity. HP Care Pack services help you increase IT environment stability, efficiency, and agility from the desktop to the data center, and improve the productivity of your employees.

Warranty and Services Included with the HP StorageWorks DAT Products

Hewlett-Packard provides a 3-year, next-day, parts exchange, limited warranty, for all other StorageWorks DAT Tape Drives, plus 9x5 phone--support for the duration of the warranty.

For more information about HP's Global Limited Warranty and Technical Support, visit: ftp://ftp.compaq.com/pub/products/storageworks/warranty/EN_321708-008.pdf

Service and Support, HP Care Pack, and Warranty Information

Recommended Services

In order to maximize ROI and product uptime, and minimize the cost of ownership, Hewlett Packard recommends:

3 years 24 x 7 Hardware Support

- Guards against downtime, which reduces productivity and profitability
- Eases budget planning with fixed-cost support that includes parts and labor
- Direct access to proven technical and problem-solving expertise

3 years 24 x 7 Software Support

- Improve the productivity of system managers and operators
- Improve system performance and reduce downtime due to software defects
- Expedite problem resolution through expert-level technical resources
- Enjoy consistent service coverage across geographically dispersed sites
- Update HP and selected third-party software at a predictable cost
- Take advantage of subscription savings on software updates
- Keep your license compliancy up-to-date

Available HP Care Pack Services Extend your product warranty with a wide choice of cost-saving support packages.

HP Care Pack services are sold by HP and HP authorized enterprise and commercial resellers. Services for customers purchasing via direct and enterprise resellers are quoted using HP order configuration tools. Additional information about HP Care Pack service features and benefits is available at <http://www.hp.com/hps/carepack/services/>.

Key for HP Care Pack service availability in the table below:

E = Service available for customers purchasing direct and via enterprise resellers

C = Service available for customers purchasing via commercial resellers

N/A = Service not applicable

HP Care Pack Services Deployment and Per Event Services	Service Available
HP Installation	E/C
HP Installation & Startup	N/A
HP Implementation	N/A

For more information about deployment and per event services for HP storage products, visit <http://www.hp.com/hps/storage/>.

Service and Support, HP Care Pack, and Warranty Information

HP Care Pack Services Availability Services	1 yr	3 yr	4 yr	5 yr
HP Next Day Hardware Support	E/C	E/C	C	C
HP 4 Hr, 9x5 Hardware Support	E/C	E/C	C	C
HP 4 Hr, 13x5 Hardware Support	E/C	E/C	C	C
HP 4 Hr, 24x7 Hardware Support	E/C	E/C	C	C
HP 6 HR Call-to-Repair Hardware Support	E/C	E/C	C	C
HP Software Support	E/C	E/C	C	C
HP Software Support 24x7	E/C	E/C	C	C
HP Support Plus	E/C	E/C	C	C
HP Support Plus 24	E/C	E/C	E/C	E/C
HP Proactive Essentials 9x5, 10 Software Incidents	NA	NA	NA	NA
HP Proactive Essentials 9x5, 25 Software Incidents	NA	NA	NA	NA
HP Proactive Essentials 9x5 Unlimited	NA	NA	NA	NA
HP Proactive Essentials 24x7, 25 Software Incidents	NA	NA	NA	NA
HP Proactive Essentials 24x7, 50 Software Incidents	NA	NA	NA	NA
HP Proactive Essentials 24x7 Unlimited	NA	NA	NA	NA
HP Proactive 24 Service*	E/C	E/C	NA	NA
HP Critical Service*	E/C	E/C	NA	NA

***NOTE:** Both Proactive 24 & Critical Service only relate to 'reactive elements'. 'Proactive elements' are available on time & materials basis. (SW is supported separately per package).

Important Notice for Tape Drives Installed in a 1U or 3U Rack Mount Kit **NOTE:** These Care Packs do not apply to Tape Drives mounted in a 1U or 3U Rack Mount Kit. The HP Rack Mount Kit Care Pack covers the all possible configurations of Tape Drives. Hence the Care Packs for 1U & 3U Rack Mount Kit covers all encumberant drives.

Please follow the following url for the correct Care Pack Services and descriptions.

http://h18000.www1.hp.com/products/quickspecs/10854_div/10854_div.PDF

Important Notice for Internal Tape Drives Installed in an HP Server **NOTE:** These Care Packs do not apply to Internal Tape Drives because they do not have Care Packs associated with them if they are mounted in an HP Server. Hence the Care Packs for the HP Server covers all encumberant drives.

Please follow the following url for the correct Care Pack Services and descriptions.

For Proliant use: <http://h18000.www1.hp.com/products/quickspecs/ProductBulletin.html>

For BCS use: <http://h18000.www1.hp.com/products/quickspecs/ProductBulletin.html>

Important Notice for Tape Drive Modules Installed in an HP Tape Array **NOTE:** These Care Packs do not apply to Tape Drives mounted in an HP Tape Array because they do not have Care Packs associated with them. Hence the Care Packs for the HP Tape Array covers all encumberant drives.

Please follow the following url for the correct Care Pack Services and descriptions.

http://h18000.www1.hp.com/products/quickspecs/11878_div/11878_div.PDF

Service and Support, HP Care Pack, and Warranty Information

HP Care Pack Service Product Numbers

Enterprise & Commercial Purchased Care Packs (‘A’ stands for physical Care Pack, ‘E’ for electronic Care Pack)

For DAT 40 USB, DAT 40 SCSI, DAT 72 USB and DAT 72 SCSI

Product Number	Product Description
U2090A/E	Tape Installation Hardware Installation Only
H3155A/E	Hardware, "3-year", "Next Business Day", "9x5", "on-site"*
H4616A/E	Hardware, "3-year", "4-hour", "13x5", "on-site"
U2068A/E	Hardware, "3-year", "4-hour", "24x7", "on-site"
U6358A/E	Hardware, "3-year", "6hr Call-to-Repair", "24x7", "on-site"
U9338A/E	Hardware, "4-year", "4-hour", "13x5", "on-site"
U9339A/E	Hardware, "4-year", "4-hour", "24x7", "on-site"
U9340A/E	Hardware, "5-year", "4-hour", "13x5", "on-site"
U9341A/E	Hardware, "5-year", "4-hour", "24x7", "on-site"
UA450PE	Hardware, "1-year", "Next Business Day", "9x5", "on-site", "Post Warranty"
UA451PE	Hardware, "1-year", "4-hour", "13x5", "on-site", "Post Warranty"
UA452PE	Hardware, "1-year", "4-hour", "24x7", "on-site", "Post Warranty"
UA453PE	Hardware, "1-year", "6hr Call-to-Repair", "24x7", "on-site", "Post Warranty"

Enterprise Purchased Care Packs

For DAT 40 USB, DAT 40 SCSI, DAT 72 USB and DAT 72 SCSI

Product Number	Product Description	Drive Band	Install Band
HA113A1	Tape Installation Hardware Installation Only	N/A	596
HA101A3	Hardware, "3-year", "next-day", "13x5", "on-site"	455	N/A
HA103A3	Hardware, "3-year", "4-hour", "13x5", "on-site"	455	N/A
HA104A3	Hardware, "3-year", "4-hour", "24x7", "on-site"	455	N/A
HA105A3	Hardware, "3-year", "6hr Call-to-Repair", "24x7", "on-site"*	455	N/A
HA106A3	SW, "3-year", "Phone-in", "9x5"	N/A	N/A
HA107A3	SW, "3-year", "Phone-in", "24x7"	N/A	N/A
HA109A3	Hardware Only, Support Plus, "3-year", "13x5"	455	N/A
HA110A3	Hardware Only, Support Plus 24, "3-year", "24x7"	455	N/A
HA111A3	Hardware Only, Proactive 24, "3-year", "24x7"*	455	N/A
HA112A3	Hardware Only, Critical Service, "3-year", "24x7"*	455	N/A

Service and Support, HP Care Pack, and Warranty Information

eSupport

HP eSupport is a portfolio of technology-based services that assist you with managing your business environment - from the desktop to the data center.

Support Portal

The HP support portal provides one-stop access to the information, tools and services you need to manage the daily operations of your IT environment.

Features include:

- Access to self-solve tools (including search technical knowledge base)
- Efficient logging and tracking of support cases
- Collaboration with other business and IT professionals
- Download of patches and drivers
- Access to diagnostic tools
- Proactive notification of relevant information

Access to certain features of the support portal requires an HP service agreement. To access the support portal, visit <http://www.hp.com/support>.

HP Education Services

For more information about HP Education Services for Storage and SAN, visit <http://education.hp.com/curr-storsan.html>

Additional Services Information

For more information about Deployment, Per Event, Consulting and Education services for HP Storage, visit: <http://www.hp.com/hps/storage/>

For more information about HP Care Pack services for storage products, visit: http://www.hp.com/hps/carepack/storage/cp_networked.html

For more information about HP storage software, services and updates, visit: <http://h18006.www1.hp.com/storage/software.html>

If you have specific questions, contact your local HP representative. Contact information for a representative in your area can be found at "Contact HP" <http://www.hp.com/>

Kit Contents

HP StorageWorks DAT 40 Tape Drives

Model	Description	Part Number
DAT 40 SCSI Internal	DAT 40 SCSI Internal Tape Drive, installation guide, HP StorageWorks CD (containing electronic user's guide, drivers, and HP Library and Tape Tools software diagnostics), HP StorageWorks Data Protector Express Single Server Edition software and its Bare Metal Disaster Recovery option, SCSI ribbon cable, power extender cable, screws, HP DDS-4 data cartridge, HP DDS cleaning cartridge. NOTE: 0D1 will appear after this part number on your sales order if factory integration is indicated.	C5686C
DAT 40 SCSI External	DAT 40 SCSI External Tape Drive, installation guide, HP StorageWorks CD (containing electronic user's guide, drivers, and HP Library and Tape Tools software diagnostics), HP StorageWorks Data Protector Express Single Server Edition software and its Bare Metal Disaster Recovery option, SCSI cable (68-pin HD to 68-pin VHD, LVD/SE Ultra2, 2.5m), LVD/SE SCSI multi-mode terminator, power cord, HP DDS-4 data cartridge, HP DDS cleaning cartridge.	C5687D
DAT 40 Array Module for Tape Array 5300	DAT 40 SCSI Array Module, installation guide, HP StorageWorks CD (containing electronic user's guide, drivers, and HP Library and Tape Tools software diagnostics), HP StorageWorks Data Protector Express Single Server Edition software and its Bare Metal Disaster Recovery option, HP DDS-4 data cartridge, HP DDS cleaning cartridge. NOTE: 0D1 will appear after this part number on your sales order if factory integration is indicated.	C7497C
DAT 40 USB Internal	DAT 40 USB Internal Tape Drive, installation poster, HP StorageWorks CD (containing electronic user's guide, drivers, and HP Library and Tape Tools software diagnostics), HP StorageWorks Data Protector Express Single Server Edition software and its Bare Metal Disaster Recovery option, standard USB cable, USB cable for internal ProLiant connect, cable routing kit (for connection to external USB 2.0 ports), screws, HP DDS-4 data cartridge, HP DDS cleaning cartridge. NOTE: 0D1 will appear after this part number on your sales order if factory integration is indicated.	DW022A
DAT 40 USB External	DAT 40 USB External Tape Drive, installation poster, HP StorageWorks CD (containing electronic user's guide, drivers, and HP Library and Tape Tools software diagnostics), HP StorageWorks Data Protector Express Single Server Edition software and its Bare Metal Disaster Recovery option, integral USB cable, power cord, HP DDS-4 data cartridge, HP DDS cleaning cartridge.	DW023A

Kit Contents

HP StorageWorks DAT 72 Tape Drives

Model	Description	Part Number
DAT 72 SCSI Internal	DAT 72 SCSI Internal 100% ROHS Compliant Tape Drive, installation poster, HP StorageWorks CD (containing electronic user's guide, drivers, and HP Library and Tape Tools software diagnostics), HP StorageWorks Data Protector Express Single Server Edition software and its Bare Metal Disaster Recovery option, SCSI ribbon cable (68-pin wide HD LVD), HP DAT 72 data cartridge, HP DDS cleaning cartridge. NOTE: 0D1 will appear after this part number on your sales order if factory integration is indicated.	Q1522B
DAT 72 SCSI External	DAT 72 SCSI External 100 % ROHS Compliant Tape Drive, installation poster, HP StorageWorks CD (containing electronic user's guide, drivers, and HP Library and Tape Tools software diagnostics), HP StorageWorks Data Protector Express Single Server Edition software and its Bare Metal Disaster Recovery option, SCSI cable (68-pin Wide VHD-HD LVD), LVD/SE SCSI multi-mode terminator, power cord, HP DAT 72 data cartridge, HP DDS cleaning cartridge.	Q1523B
DAT 72 SCSI Array Module for Tape Array 5300	DAT 72 SCSI 100% ROHS Compliant Array Module, installation poster, HP StorageWorks CD (containing electronic user's guide, drivers, and HP Library and Tape Tools software diagnostics), HP StorageWorks Data Protector Express Single Server Edition software and its Bare Metal Disaster Recovery option, HP DAT 72 data cartridge, HP DDS cleaning cartridge. NOTE: 0D1 will appear after this part number on your sales order if factory integration is indicated.	Q1524C
DAT 72 USB Internal	DAT 72 USB Internal Tape Drive, installation poster, HP StorageWorks CD (containing electronic user's guide, drivers, and HP Library and Tape Tools software diagnostics), HP StorageWorks Data Protector Express Single Server Edition software and its Bare Metal Disaster Recovery option, standard USB cable, USB cable for internal ProLiant connect, cable routing kit (for connection to external USB 2.0 ports), screws, HP DAT 72 data cartridge, HP DDS cleaning cartridge. NOTE: 0D1 will appear after this part number on your sales order if factory integration is indicated.	DW026A
DAT 72 USB External	DAT 72 USB External Tape Drive, installation poster, HP StorageWorks CD (containing electronic user's guide, drivers, and HP Library and Tape Tools software diagnostics), HP StorageWorks Data Protector Express Single Server Edition software and its Bare Metal Disaster Recovery option, integral USB cable, power cord, HP DAT 72 data cartridge, HP DDS cleaning cartridge.	DW027A

Options

NOTE: This is a list of related options. Some may be discontinued.

Host Bus Adapters and Controllers for ProLiant Servers	64-Bit/133-MHz Single-Channel Ultra320 SCSI Adapter	374654-B21
	64-Bit/66-MHz Dual-Channel Wide Ultra3 SCSI Adapter, Alternate OS	284688-B21
	Single-channel Ultra320 SCSI Adapter	365289-B21
	Smart Array 532 Controller	225338-B21
	NOTE: Supports hot-plug tape drives only.	
	Smart Array 532 Controller (Japan)	225338-291
	NOTE: Supports hot-plug tape drives only.	
	Smart Array 5302/128 Controller	283552-B21
	NOTE: Supports hot-plug tape drives only.	
	Smart Array 5304/256 Controller	283551-B21
	NOTE: Supports hot-plug tape drives only.	
	Smart Array 641 Controller	291966-B21
	NOTE: Supports hot-plug tape drives only.	

Host Bus Adapters and Controllers for AlphaServers	32-bit Single Channel Ultra Wide HBA	KZPBA-CA
	NOTE: Not supported with hot-plug.	
	NOTE: Supported with DAT 40 models only.	
	Combo SCSI/Ethernet Dual Channel	KZPCM-DA
	NOTE: Not supported with hot-plug.	
	32-bit to LVD Single-Channel SCSI	3X-KZPCA-AA
	PCI Combo Ultra2 LVD SCSI Adapter	3X-DEPVZ-AA
	64-bit Dual-Channel Ultra 3 LVD SCSI Adapter	3X-KZPEA-DB

Controllers for Third-Party Servers	64-Bit/133-MHz Dual-Channel Ultra320 SCSI Adapter	268351-B21
	64-Bit/133-MHz Single-Channel Ultra320 SCSI Adapter	374654-B21

Media	HP DDS-2 Data Cartridge, 8 GB	C5707A
	HP DDS-3 Data Cartridge, 24 GB	C5708A
	HP DDS-4 Data Cartridge, 40 GB	C5718A
	HP DAT 72 Data Cartridge, 72 GB	C8010A
	HP DDS Cleaning Cartridge	C5709A

Options

Rack-Mount Options	<p>1U Rack-Mount Kit A7445B NOTE: 1U Rack-Mount Kit holds up to two internal DAT drives (and other tape technologies). NOTE: Please refer to the following web page for further information: http://h18006.www1.hp.com/products/storageworks/1urackmount/index.html</p>
	<p>1U USB Cable Option Kit 396114-B21 NOTE: This cable kit can be purchased to convert a 1U SCSI rack-mount kit to a USB interface to support the DAT USB drives. It includes 1 - 5 meter USB cable, 1- plastic grommet, 1- metallic panel, and documentation. All pieces are pre-assembled for easy implementation.</p>
	<p>3U Rack-Mount Kit 274338-B22 NOTE: 3U Rack-Mount Kit holds up to four internal DAT drives (and other tape technologies). NOTE: Please refer to the following web page for further information: http://h18006.www1.hp.com/products/storageworks/3urackmount/index.html</p>
	<p>Tape Array 5300 C7508B NOTE: Tape Array 5300 holds up to four offline hot-swap DAT array modules (and other tape technologies). NOTE: Please refer to the following web page for further information: http://www.hp.com/products1/storage/products/tapebackup/tapearrays/tapearray5300/index.html</p>

Cable Kits	<p>68-pin HD to 68-pin VHDCI, 12ft 341177-B21 NOTE: For SE and LVD SCSI tape devices.</p>
	<p>External SCSI Cable, 68-pin HD/68-pin VHDCI, 12ft/3.66m 341177-B21</p>
	<p>External SCSI Cable, 68-pin HD/68-Pin HD, 16.4ft/5m 328215-001</p>
	<p>External SCSI Cable, 68-pin HD/68-Pin HD, 32.8ft/10m 328215-002</p>

Technical Specifications

Dimensions

	DAT 40	DAT 72
Form Factor	Half-height, 5¼ inches (internal and array module)	Half-height, 5¼ inches (internal and array module)
Physical (HxWxD) SCSI Internal	1.6 x 5.7 x 6.1 in (4.0 x 14.5 x 15.5 cm)	1.6 x 5.7 x 6.1 in (4.0 x 14.5 x 15.5 cm)
Physical (HxWxD) USB Internal	1.6 x 5.7 x 6.1 in (4.0 x 14.5 x 15.5 cm)	1.6 x 5.7 x 6.1 in (4.0 x 14.5 x 15.5 cm)
Physical (HxWxD) SCSI External	1.8 x 7.1 x 8.7 in (4.5 x 18.1 x 22.2 cm)	1.8 x 7.1 x 8.7 in (4.5 x 18.1 x 22.2 cm)
Physical (HxWxD) USB External	1.8 x 7.1 x 8.7 in (4.5 x 18.1 x 22.2 cm)	1.8 x 7.1 x 8.7 in (4.5 x 18.1 x 22.2 cm)
Physical (HxWxD) Array Module	1.6 x 6.3 x 11.2 in (4.0 x 16.0 x 28.5 cm)	1.6 x 6.3 x 11.2 in (4.0 x 16.0 x 28.5 cm)
Shipping (HxWxD) SCSI Internal	9.5 x 9.25 x 9.5 in (24.0 x 23.5 x 24.0 cm)	9.5 x 9.25 x 9.5 in (24.0 x 23.5 x 24.0 cm)
Shipping (HxWxD) USB Internal	9.5 x 9.25 x 9.5 in (24.0 x 23.5 x 24.0 cm)	9.5 x 9.25 x 9.5 in (24.0 x 23.5 x 24.0 cm)
Shipping (HxWxD) SCSI External	11.8 x 11.02 x 12.6 in (30.0 x 28.0 x 32.0 cm)	11.8 x 11.02 x 12.6 in (30.0 x 28.0 x 32.0 cm)
Shipping (HxWxD) USB External	11.8 x 11.02 x 12.6 in (30.0 x 28.0 x 32.0 cm)	11.8 x 11.02 x 12.6 in (30.0 x 28.0 x 32.0 cm)
Shipping (HxWxD) Array Module	11.4 x 17.7 x 12.2 in (29.0 x 45.0 x 31.0 cm)	11.4 x 17.7 x 12.2 in (29.0 x 45.0 x 31.0 cm)

Weight

	DAT 40	DAT 72
Out of box SCSI Internal	2.1 lb (.95 kg)	2.1 lb (.95 kg)
Out of box USB Internal	2.1 lb (.95 kg)	2.1 lb (.95 kg)
Out of box SCSI External	4.2 lb (1.90 kg)	4.2 lb (1.90 kg)
Out of box USB External	4.2 lb (1.90 kg)	4.2 lb (1.90 kg)
Out of box Array Module	3.2 lb (1.45 kg)	3.1 lb (1.40 kg)
Shipping SCSI Internal	3.2 lb (1.44 kg)	3.2 lb (1.44 kg)
Shipping USB Internal	3.2 lb (1.44 kg)	3.2 lb (1.44 kg)
Shipping SCSI External	6.4 lb (2.9 kg)	6.4 lb (2.9 kg)
Shipping USB External	6.4 lb (2.9 kg)	6.4 lb (2.9 kg)
Shipping Array Module	7.9 lb (3.6 kg)	7.9 lb (3.6 kg)

Technical Specifications

Capacity		DAT 40	DAT 72
	Native	20 GB	36 GB
	Compressed (assumes 2:1 data compression)	40 GB	72GB
	Buffer Size (SCSI)	8 MB	8 MB
	Buffer Size	8MB	8MB
Performance		DAT 40	DAT 72
	Sustained Transfer Rate (native) Where 1KB = 1,000 Bytes	3.2 MB/s*	3.2 MB/s*
	Sustained Transfer Rate (with 2:1 data compression) Where 1KB = 1,000 Bytes	6.4 MB/s*	6.4 MB/s*
	Burst Transfer Rate (SCSI interface) Where 1KB = 1,000 Bytes	6.4 MB/s (asynchronous) 160 MB/s (synchronous)	6.4 MB/s (asynchronous) 160 MB/s (synchronous)
	Burst Transfer Rate (USB interface)Where 1KB = 1,000 Bytes	6.4MB/s (asynchronous) 40 MB/s (synchronous)	6.4 MB/s (asynchronous) 40 MB/s (synchronous)
	Data Access Time	50 s	68 s
	Average Load Time	15 s	15 s
	Average Unload Time	15 s	15 s
	Rewind Time	110 s (end to end)	120 s (end to end)
	Rewind Tape Speed	1.41 m/s	1.41 m/s
Reliability		DAT 40	DAT 72
	MTBF	125,000 hours at 100% duty cycle	125,000 hours at 100% duty cycle
	Uncorrected Error Rate	1x10 ⁻¹⁷ bits read	1x10 ⁻¹⁷ bits read
Media		DAT 40	DAT 72
	Recommended media	DDS-4 (155m)	DAT 72 (170m)
	Backward read-write compatibility (SCSI)	DDS-3 (125m) DDS-2 (120m)	DDS-4 (155m) DDS-3 (125m)
	Backward read-write compatibility (USB)	DDS-3 (125m) DDS-2 (120m)	DDS-4 (155m) DDS-3 (125m)

Technical Specifications

Tape Format

	DAT 40	DAT 72
Recording Method	4 mm helical scan	4 mm helical scan
Recording Format	DDS-4, DDS-3, and DDS-2 (ANSI/ISO/ECMA)	DAT 72, DDS-4, DDS-3 (ANSI/ISO/ECMA)
Data Compression	Lempel-Ziv (DCLZ)	Lempel-Ziv (DCLZ)
Error Detection/Correction	Reed-Solomon	Reed-Solomon
Data Encoding Method	Partial Response Maximum Likelihood (PRML)	Partial Response Maximum Likelihood (PRML)

Interface

	DAT 40	DAT 72
SCSI Interface	SCSI-3 Ultra 160 LVD	SCSI-3 Ultra 160 LVD
SCSI Connector	Internal: 68-pin wide HD LVD External: 68-pin wide HDLVD, thumbscrew Hot-plug: 80-pin SCA-2 (SCSI and power) Array module: 80-pin EBBI	Internal: 68-pin wide HD LVD External: 68-pin wide LVDS, thumbscrew Hot-plug: 80-pin SCA-2 (SCSI and power) Array module: 80-pin EBBI
USB Interface	USB 2.0	USB 2.0
USB Connector	USB standard series B receptacle	USB standard series B receptacle
Termination - is only required for the SCSI product	No terminator is required for internal model (assumes use of terminated cable). External model requires termination with multimode terminator (included with product). SCSI Array module requires termination with multimode terminator (ordered separately - p/n C2364A).	

Power Specifications

	DAT 40	DAT 72
Power Requirements (SCSI-2 internal, hot-plug, and array module)	+5V \pm 5% (100mV Max ripple) @0.6A +12V \pm 10% (150mV Max ripple) @1.2A	+5V \pm 5% (100mV Max ripple) @0.6A +12V \pm 10% (150mV Max ripple) @1.2A
Power Requirements (USB and SCSI-3 internal, and array module)	+5V \pm 5% (100mV Max ripple) @0.8A +12V \pm 10% (150mV Max ripple) @0.3A	+5V \pm 5% (100mV Max ripple) @0.8A +12V \pm 10% (150mV Max ripple) @0.3A
Power Requirements (external)	100 to 240 VAC, 50-60 Hz, auto-ranging	100 to 240 VAC, 50-60 Hz, auto-ranging
Power consumption (SCSI) (average)	7.3 Watts	7.1 Watts
Power consumption (USB) (average)	7.3 Watts	7.1 Watts

Technical Specifications

Environmental Specifications (all models)	Relative Humidity	Storage	5% to 95%
		Operating	20% to 80%
	Temperature Range	Storage	-40° to 158° F/(-40° to 70° C)
		Operating	41° to 104° F/(5° to 40° C)

Standards Compliance cCSAus Certification to C22.2, No. 60950, TÜV EN60950 (IEC 60950), FCC and CE Declaration of Conformity, C-TICK Approved (AS/NZS CISPR22), VCCI Approved, RRL Approved, BSMI Approved, GOSH Approved

Drive LED Indicators	Tape LED	Clean LED	Meaning
Tape Ready Signal	On steady	Off	The data cartridge is loaded and the drive is ready.
Tape Loading Signal	Flashing slowly	Off	The cartridge is loading or unloading, or power-on self-test is in progress
Tape Activity Signal	Flashing rapidly	Off	The cartridge is loaded, activity is occurring.
Media Caution Signal	Off or flashing	Flashing slowly	<p>If the media caution signal is displayed:</p> <ul style="list-style-type: none"> • Wait for the current operation to finish, then insert a different tape and repeat the operation that was being performed. • If the media caution signal does not show this time, it indicates that the original cartridge was nearing the end of its useful life. Copy any data you want to keep from the original tape onto a new tape if possible, and then discard the old tape. • If the media caution signal appears again with the second tape, the tape heads need cleaning. • If the media caution signal appears after using a cleaning cartridge, the cleaning cartridge has probably expired and should be discarded.
Error Condition Signal	Off	On steady	HP DAT drives perform a comprehensive self-test during power-up. If a hard error causes the self-test to fail, the clean light changes to steady amber. Run HP Library & Tape Tools to help diagnose the problem.
OBDR Signal	Both flashing slowly in an alternating pattern		The tape drive is in disaster recovery mode, restoring the operating system.

Technical Specifications

© Copyright 2007 Hewlett-Packard Development Company, L.P.

The information contained herein is subject to change without notice.

Microsoft and Windows are US registered trademarks of Microsoft Corporation. Intel is a US registered trademark of Intel Corporation. Unix is a registered trademark of The Open Group.

The only warranties for HP products and services are set forth in the express warranty statements accompanying such products and services. Nothing herein should be construed as constituting an additional warranty. HP shall not be liable for technical or editorial errors or omissions contained herein.