



Accurate
Manufactured
Products
Group

SEX BOLTS & MATING FASTENERS

A USA Manufacturer
of Specialty Fastener
and Industrial Products



8090 Woodland Drive • Indianapolis, IN 46278 • Tel: 317-472-9000 • Fax: 317-472-9010
Email: sales@ampg.com • Website: www.ampg.com



Introduction to Sex Bolts & Mating Fasteners

What They Are...

Sex Bolts are mating fasteners—a barrel with an internal thread, and a male screw. They were originally designed to clamp material between the head of the barrel and the head of the screw, or to bridge the gap between 2 parts, like going through a hollow door.

Common Names For Mating Fasteners...

Sex Bolts—Architectural Bolts—Chicago Screws—Binding Posts—Post & Screw—Internal Thread Mating Fastener—Threaded Rivets

Uses For Sex Bolts...

- Acrylic fastening
- Air Hoods
- Aquariums
- Automotive aftermarket
- Awnings
- Bathroom Partitions
- Belts
- Bindery—Publishing
- Bleachers
- Boats
- Body Armor
- Bullet Proof Glass—joins the panels
- Buses
- Cabinetry
- Construction
- Display Fixtures
- Doors
- Exhibits
- Fence Systems
- Furniture
- Gates
- Glass Fastening
- Hand Rails
- Helmets
- Hinge Pins
- Hurricane Protection
- HVAC
- Kayaks
- Knives
- Lock Sets
- Lockers
- Museum Exhibits
- Orthopedic Braces
- Panic Bars
- Playground Equipment
- Plexiglass Fastening
- Plumbing
- Power Tool Manufacturing
- Railings for buildings
- Range Hoods
- RV Manufacturing
- Saddlebags on Motorcycles
- Seating
- Sheet Metal fastening
- Shutters
- Signs
- Spear Guns
- Stage Production and Lighting
- Stadiums
- Store Fixtures
- Taxidermy
- Trains
- Water Fountains
- Windshields
- & Many More

Variations...

Accurate has 15 years of experience in manufacturing these mating parts. We can make all sizes and head styles in house. We work in most materials available in bar form. Our specialized machinery and processes allow us to produce small quantity and production quantity runs.



**SPECIAL ORDERS
AVAILABLE—
Small Quantities
to Large Volume**

*See page A7 for help in
ordering your custom part,
and use one of our new
SPECIAL SEX BOLT ORDER FORMS
on pages A8-A13.*





Pictorial Guide to Sex Bolts



Architectural Style
Smooth Head
Brass, Stainless, Aluminum, Steel
Pages A14-17



Combo Head Style
Slotted/Phillips Head
Steel Zinc & Stainless
Pages A18-23



Tamperproof Security Style
6 Lobe Drive with Security Pin
Stainless Steel
Pages A24-27



One-Way Tamperproof Style
Stainless Steel
Pages A28-29



Button Head Socket Drive Style
Stainless Steel
Page A30-31



Flat Head Socket Drive Style
Stainless Steel
Page A32-33



Low Profile Socket Drive Style
Stainless Steel
Pages A34-35



Binding Posts — Chicago Screws
Aluminum, Stainless Steel, Brass,
Copper, Plastic
Pages A36-45



Slotted Truss Head Style
Brass, Stainless Steel, Aluminum
Page A46



Slotted Flat Head Style
82 Degree Countersunk Head
Steel, Stainless Steel, Brass
Page A47



**Slotted Oval Head &
Grommet Nuts**
Steel & Stainless Steel
Page A47



Phillips Oversize Truss Head Style
Serrated under head
Stainless Steel & Steel
Page A48



Hex Head Sex Bolts
Stainless Steel
Page A48



T Head Binding Posts
Aluminum
Page A48



Connector Nuts & Bolts
Steel, Brass, Aluminum
Page A49

**SPECIAL ORDERS
AVAILABLE—
Small Quantities
to Large Volume**





Technical Guide to Sex Bolts

The most important criteria are:

1. BARREL DIAMETER—These bolts often are going through pre-drilled holes, and need to be able to fit. The barrel diameter should be slightly less than the hole diameter.

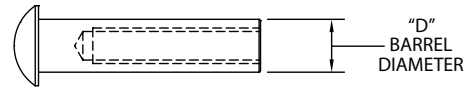

2. BARREL LENGTH—This is the length measured from underneath the head to the end of the barrel.
Normally the length of the barrel is shorter than the thickness of the material you are going through.

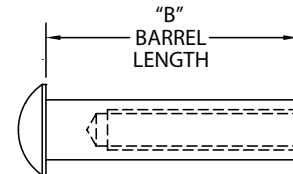

3. THREAD SIZE—What size threads are in the barrel, and how much depth is required. The more thread depth, the more difficult these parts are to manufacture, and the more expensive.

The "grip range", is the maximum thickness of the material that may be clamped between the male screw and the female sex bolt. Use a shorter male screw to avoid going too deep into the threads in the female barrel.

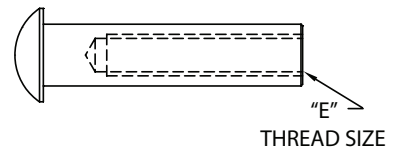

4. HEAD TYPE & DRIVE—Most common is a "truss" style head. Other common drive styles are; none, slotted, socket and combo drive.



5. MATERIAL & FINISH—We manufacture Sex Bolts in Steel, Aluminum, Brass, Copper and 18-8 and Type 316 Stainless Steel, available in several platings.



Architectural Series Sex Bolts—Pages A14-17

This is our most popular line of Sex Bolts, and are used mainly to set up door hardware (kickplates, panics bars, door closers, hinges) to doors.

Sex Bolts with a smooth head (and no drive) are knurled under the head, which prevents the female barrel from turning when the screw is tightened from the other side.

Bolts for the three most common door sizes are:

- 1-3/8" Thick Door Use 1-3/16" length Sex Bolt
- 1-3/4" Thick Door Use 1-9/16" length Sex Bolt
- 2-1/4" Thick Door Use 2-1/16" length Sex Bolt



**SPECIAL ORDERS
AVAILABLE—
Small Quantities
to Large Volume**





Technical Guide to Sex Bolts

Combo Head Style Sex Bolts—Pages A18-23

The most economical solution for mating fasteners.

Available from stock in 6-32 thru 5/16-18 sizes, in steel zinc and stainless steel materials. Female Barrels and Male screws and shoulder bolts are sold separately. Our male screws are manufactured to match the female barrels, and our male shoulder screws also match both the barrel and head dimensions. To properly identify the part we need the barrel diameter and length of the barrel from underneath the head.



Tamperproof Security Sex Bolts—Pages A24-27

Available from our stock in 10-24 and 1/4-20 sizes - 1/4" and 5/16" barrels. Our 6 Lobe with security pin drive allows for more secure and powerful driving without any cam out or head distortion. Female barrels are sold separately, and we also stock matching shoulder bolts and machine screws with matching dimensions.



One Way Partition Sex Bolts—Pages A28-29

These are the standard sex bolts used for bathroom partitions.

Manufactured in Stainless Steel, and with standard one way tamperproof drives. Both the male and female sides have matching shoulders, and these are usually specified with a shoulder length for both male and female portions.



Socket Drive Barrel Bolts—Pages A30-35

82 Degree Flat Head Barrel Bolts can be flush mounted for a finished appearance. Button Head have an industrial finished appearance. The socket drive in both styles allows for quick and efficient tightening with standard Hex Keys.



Binding Posts—Pages A36-45

These are the standard sex bolts developed originally for the printing industry, and used to bind catalogs together. Standard size is the 8-32 with .203" diameter barrel. We also stock the non-standard Stainless Steel, Brass and Copper items, for when increased strength or a different look is needed.



Slotted Truss Head Sex Bolts—Pages A46

Steel, Brass, Stainless Steel, and Aluminum are the materials we stock for these. Screw driver slot allows quick installation. Large heads have a finished appearance.



**SPECIAL ORDERS
AVAILABLE—**

**Small Quantities
to Large Volume**





Technical Guide to Sex Bolts

Slotted Flat Head Sex Bolts—Pages A47

82 Degree Slotted Flat Head Barrel Bolts can be flush mounted for a finished appearance. The screw driver slot allows for quick tightening. Stocked in Steel, Brass and Stainless materials.



Slotted Oval Head Sex Bolts—Pages A47

82 Degree Slotted Oval Head Barrel Bolts are mounted in countersunk holes for a finished decorative appearance. The screw driver slot allows for quick tightening. Stocked in Steel, and Brass materials.



Grommet Nuts—Pages A47

Originally designed for hinges (Full surface, Half surface, and Half mortise) they are also commonly used in the Display and Fixture industry. Slotted head is for quick and easy installation. The no slot (no drive) head is for tamperproof and secure applications, and the open head allows for infinite adjustment of the male mating screw.



Phillips Oversize Truss Head Sex Bolts—Pages A48

Oversize heads come with a Phillips drive. Serrations under the head aid in preventing turning and loosening from vibration. Stainless Steel and Steel with Chrome plating available.



Hex Head Sex Bolts—Pages A48

One of our strongest styles. Manufactured in 18-8 Stainless Steel for maximum corrosion resistance. Hex head allows for wrench tightening, and presents a substantial industrial look. Excellent strength characteristics.



T Head Binding Posts—Pages A48

Specially designed for use in slotted materials. Insert the thin end and then rotate for placement. Used in display fixtures and other commercial applications.



Connector Nuts & Bolts—Pages A49

The most commonly used nut in the furniture industry. Manufactured in steel, with the following finishes: plain, black, bronze, nickel, brass, and silver.



**SPECIAL ORDERS
AVAILABLE—
Small Quantities
to Large Volume**





Ordering Special Sex Bolts

Accurate specializes in manufacturing small quantities of special sex bolts with a quick turn-around. We also make it as simple as possible for you to place an order or get a custom item quoted quickly— To order or request a quote for a special order, fill out one of the special order forms on pages vi–xi, then cut it out and **Fax to 317-472-9010**. (Don't forget to make a copy of the blank form, for future use, before filling it out)

<u>Custom Bolt Type</u>	<u>Order Form</u>
 Architectural Series Sex Bolt.....	Form SB-1
 Combo Head Sex Bolt.....	Form SB-2
 Tamper Proof Sex Bolt.....	Form SB-2
 Socket Drive Sex Bolt (Button Head).....	Form SB-2
 Slotted Truss Head Sex Bolts.....	Form SB-2
 Phillips Truss Head Sex Bolts.....	Form SB-2
 Grommet Nuts.....	Form SB-2
 Socket Drive Sex Bolt (Flat Head).....	Form SB-3
 Slotted Flat Head Sex Bolts.....	Form SB-3
 Binding Post.....	Form SB-4
 Slotted Oval Head Sex Bolts.....	Form SB-5
 Hex Head Sex Bolts.....	Form SB-6

If, while filling in the order form, you have dimensions that are not critical, just write "standard" rather than a size. For example, if you need a sex bolt with a 1/2" Barrel Diameter, but the Head Diameter is not critical and does not need to be any special size, write "standard" for Head Diameter and we'll use the standard head size that would normally correspond to a 1/2" Barrel Diameter.

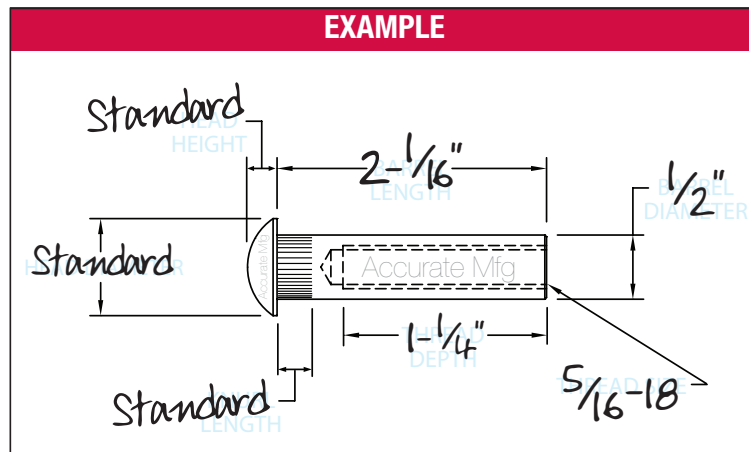

**SPECIAL ORDERS
AVAILABLE—
Small Quantities
to Large Volume**





Special Sex Bolt Order Form SB-1



ARCHITECTURAL STYLE SEX BOLT

QUOTE FOR: Name: _____

ORDER FOR: Company: _____

Address: _____

QUANTITY: _____ City: _____ State: _____ Zip: _____

Phone #: _____ Email Address: _____

FILL IN YOUR DIMENSIONS—write directly over light blue type*—write clearly and legibly

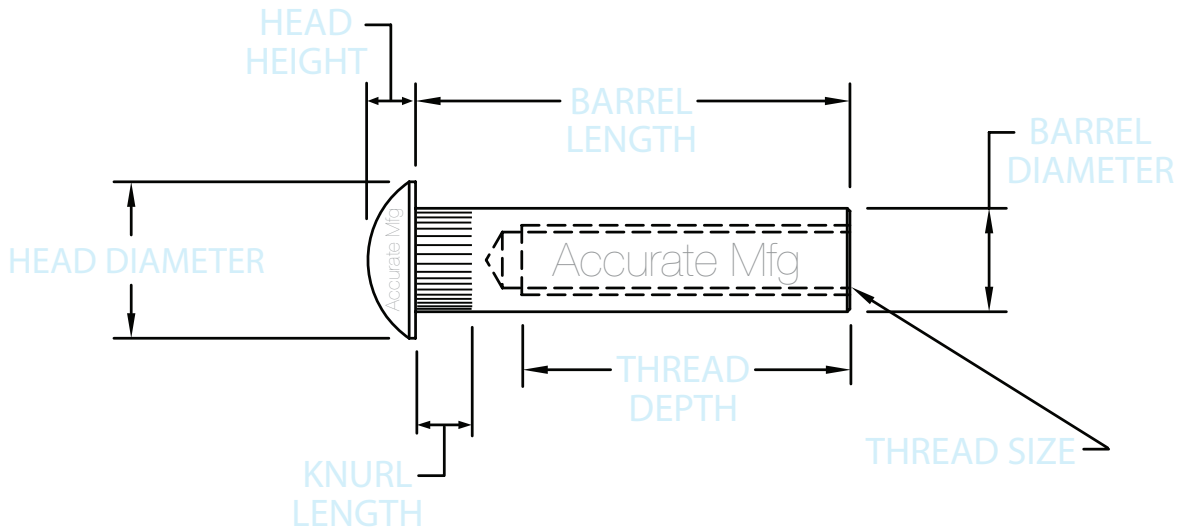

* Light Blue Type will not appear once form is faxed.

Materials

- 12L14 Low Carbon Steel
- 300 Series Stainless Steel
- 18-8 Stainless Steel
- Type 316 Stainless Steel
- Commercial Brass
- Other _____

Platings

- Chrome Plated
- Dark Bronze
- Zinc Plating
- Passivation
- Other _____

Knurling

- None
- Under Head

NOTES _____

FAX TO: 317-472-9010





Special Sex Bolt Order Form SB-2

TRUSS HEAD SEX BOLTS

QUOTE FOR: Name: _____

ORDER FOR: Company: _____

Address: _____

QUANTITY: _____ City: _____ State: _____ Zip: _____

Phone #: _____ Email Address: _____

FILL IN YOUR DIMENSIONS—write directly over light blue type*—write clearly and legibly

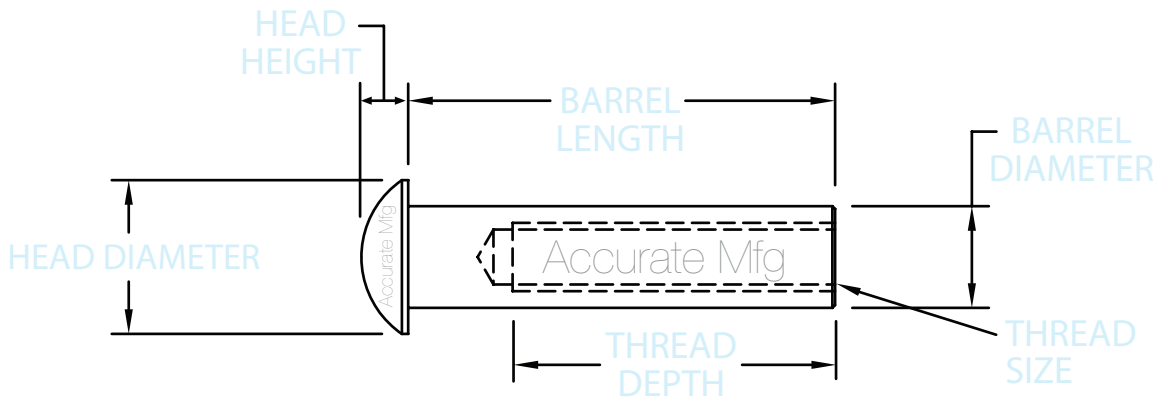

DRIVE STYLE:

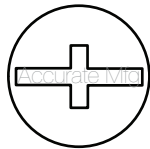

COMBO HEAD

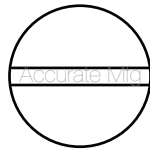

SLOTTED HEAD

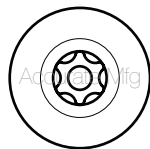

6-LOBE w/PIN (Tamperproof)

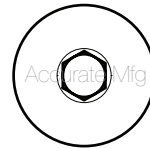

SOCKET DRIVE

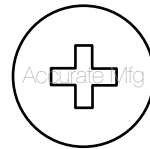

PHILLIPS HEAD

* Light Blue Type will not appear once form is faxed.

Materials

- 12L14 Low Carbon Steel
- 300 Series Stainless Steel
- 18-8 Stainless Steel
- Type 316 Stainless Steel
- Commercial Brass
- Other _____

Platings

- Chrome Plated
- Dark Bronze
- Zinc Plating
- Passivation
- Other _____

NOTES

FAX TO: 317-472-9010



Accurate
Manufactured
Products
Group

Phone: 317-472-9000 • FAX: 317-472-9010 • email: sales@ampg.com • www.ampg.com



Special Sex Bolt Order Form SB-3



FLAT HEAD SEX BOLTS

QUOTE FOR: Name: _____

ORDER FOR: Company: _____

Address: _____

QUANTITY: _____ City: _____ State: _____ Zip: _____

Phone #: _____ Email Address: _____

FILL IN YOUR DIMENSIONS—write directly over light blue type*—write clearly and legibly

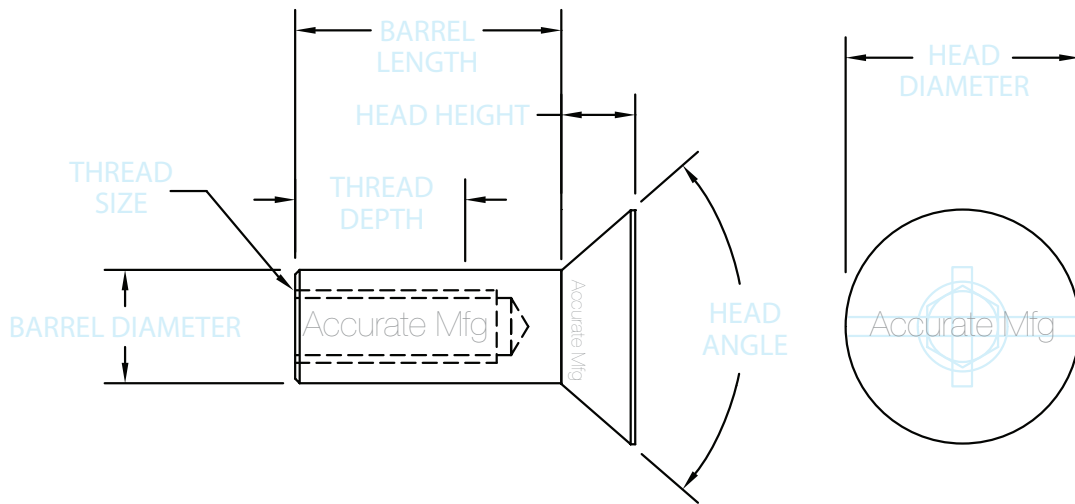

DRIVE STYLE:

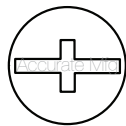

COMBO HEAD

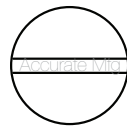

SLOTTED HEAD

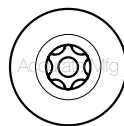

6-LOBE w/PIN (Tamperproof)

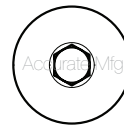

SOCKET DRIVE



PHILLIPS HEAD

* Light Blue Type will not appear once form is faxed.

Materials

- 12L14 Low Carbon Steel
- 300 Series Stainless Steel
- 18-8 Stainless Steel
- Type 316 Stainless Steel
- Commercial Brass
- Other _____

Platings

- Chrome Plated
- Dark Bronze
- Zinc Plating
- Passivation
- Other _____

NOTES

FAX TO: 317-472-9010





Special Sex Bolt Order Form SB-4

BINDING POSTS

QUOTE FOR: Name: _____

ORDER FOR: Company: _____

Address: _____

QUANTITY: _____ City: _____ State: _____ Zip: _____

Phone #: _____ Email Address: _____

FILL IN YOUR DIMENSIONS—write directly over light blue type*—write clearly and legibly

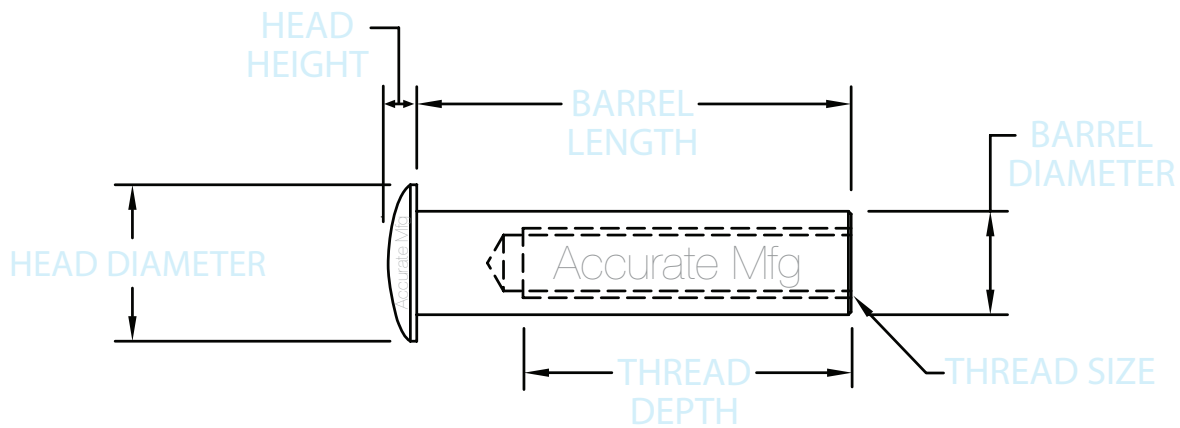

HEAD STYLE:

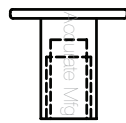

RIVET HEAD

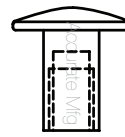

TRUSS HEAD

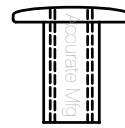

TAPPED THRU HEAD

* Light Blue Type will not appear once form is faxed.

Materials

- 12L14 Low Carbon Steel
- 300 Series Stainless Steel
- 18-8 Stainless Steel
- Type 316 Stainless Steel
- Commercial Brass
- Black Plastic
- White Plastic
- Other _____

Platings

- Chrome Plated
- Dark Bronze
- Zinc Plating
- Passivation
- Other _____

NOTES

FAX TO: 317-472-9010



Accurate
Manufactured
Products
Group

Phone: 317-472-9000 • FAX: 317-472-9010 • email: sales@ampg.com • www.ampg.com



Special Sex Bolt Order Form SB-5



OVAL HEAD SEX BOLTS

QUOTE FOR: Name: _____

ORDER FOR: Company: _____

Address: _____

QUANTITY: _____ City: _____ State: _____ Zip: _____

Phone #: _____ Email Address: _____

FILL IN YOUR DIMENSIONS—write directly over light blue type*—write clearly and legibly

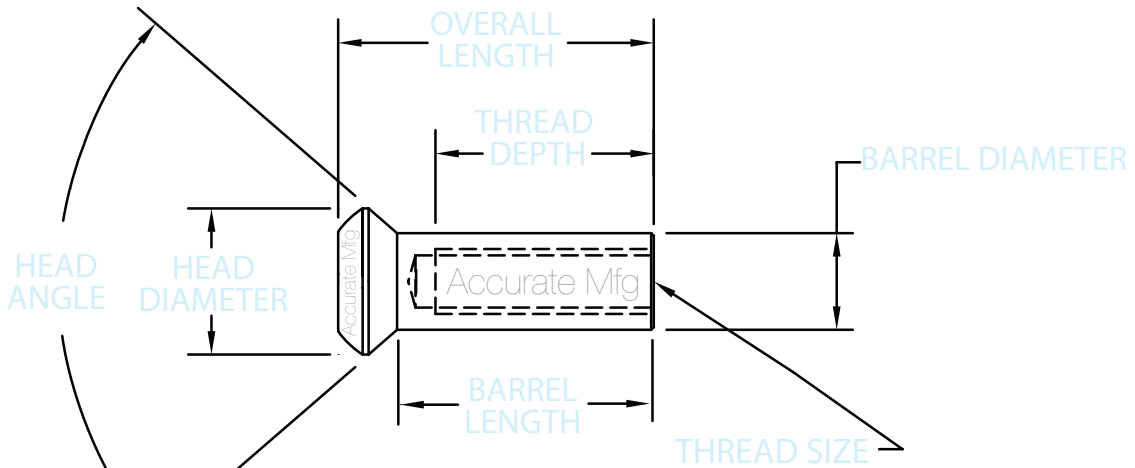

DRIVE STYLE:



COMBO HEAD

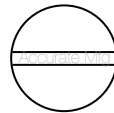

SLOTTED HEAD

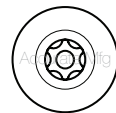

6-LOBE w/PIN (Tamperproof)



SOCKET DRIVE



PHILLIPS HEAD

* Light Blue Type will not appear once form is faxed.

Materials

- 12L14 Low Carbon Steel
- 300 Series Stainless Steel
- 18-8 Stainless Steel
- Type 316 Stainless Steel
- Commercial Brass
- Other _____

Platings

- Chrome Plated
- Dark Bronze
- Zinc Plating
- Passivation
- Other _____

NOTES

FAX TO: 317-472-9010





Special Sex Bolt Order Form SB-6

HEX HEAD SEX BOLTS

QUOTE FOR: Name: _____

ORDER FOR: Company: _____

Address: _____

QUANTITY: _____ City: _____ State: _____ Zip: _____

Phone #: _____ Email Address: _____

FILL IN YOUR DIMENSIONS—write directly over light blue type*—write clearly and legibly

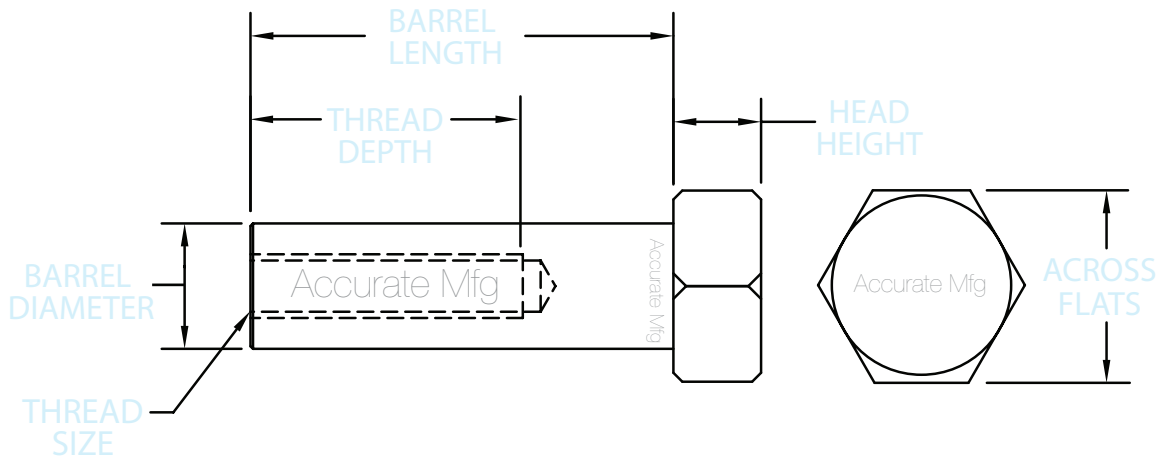

DRIVE STYLE:

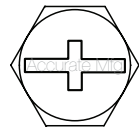

COMBO HEAD

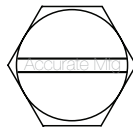

SLOTTED HEAD

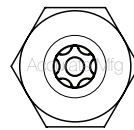

6-LOBE w/PIN (Tamperproof)

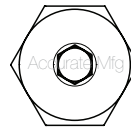

SOCKET DRIVE



PHILLIPS HEAD

* Light Blue Type will not appear once form is faxed.

Materials

- 12L14 Low Carbon Steel
- 300 Series Stainless Steel
- 18-8 Stainless Steel
- Type 316 Stainless Steel
- Commercial Brass
- Other _____

Platings

- Chrome Plated
- Dark Bronze
- Zinc Plating
- Passivation
- Other _____

NOTES _____

FAX TO: 317-472-9010



Accurate
Manufactured
Products
Group

Phone: 317-472-9000 • FAX: 317-472-9010 • email: sales@ampg.com • www.ampg.com

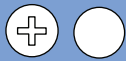

Architectural Series Sex Bolts



See chart on facing page for available sizes and order numbers



Architectural Sex Bolts have smooth Truss Heads—no drive. The knurled barrel keeps the sex bolt from spinning while the flat head screw is tightened from the other side. These parts are secure as there is no way to turn the sex bolt without a drive in the head.

Architectural Sex Bolts are available in a variety of materials and finishes. Materials include Brass, Steel, Aluminum, 18-8 Stainless Steel, & Type 316 Stainless Steel. Available platings include Chrome, Brass, Dark Bronze, & Zinc.

Mating screw is Phillips flat head, steel, and plated to match the finish on the sex bolt. Stainless Sex Bolts have Stainless screws.

Priced by the set—(1) female sex bolt and (1) male Phillips flat head screw—or you can order only the female bolt.

Architectural Sex Bolts have many applications, but are most often used to attach door hardware (kickplates, panics bars, door closers, hinges) to doors. When used in a hollow door they provide strength, security, and easy assembly from the other side.

Some uses are:

- Door and Lock Accessory mounts
- Hurricane Protection Shutters
- Elevator Protection Gates
- Architectural products – Railings, Cabinetry, Shutters, Seats, and more.

HVAC ventilation installations are also good uses for Sex Bolts. They provide a strong, secure, easy to assemble, and good looking solution for many sheet metal anchoring applications.

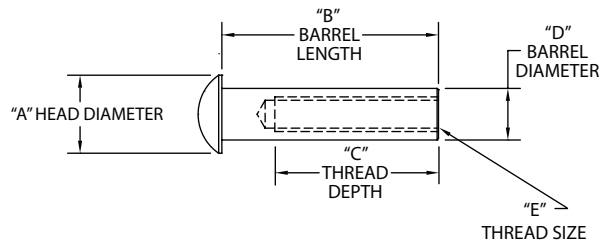
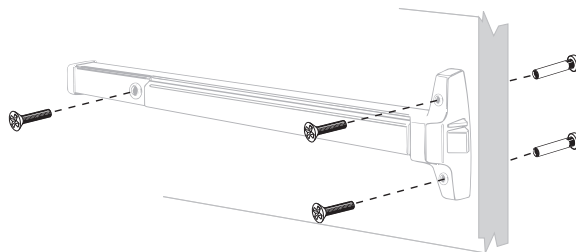
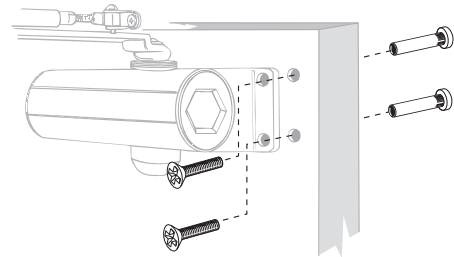

SPECIAL ORDERS AVAILABLE—
Small Quantities to Large Volume



Architectural Series Sex Bolts

USA  **MADE**



Architectural Series Sex Bolts						BRASS MATERIAL				
D Barrel Diameter	B Barrel Length	C Thread Depth	A Head Diameter	F Head Height	E Thread Size	Plating	Mating Screw	Set Order Number	Female Bolt Only	
1/4	1-3/16"	5/8"	1/2"	1/8"	8-32	Chrome	8-32 x 1"	Z4870	Z4870-1E	
	1-3/16"	5/8"	1/2"	1/8"	8-32	Brass	8-32 x 1"	Z4872	Z4870-1A	
	1-3/16"	5/8"	1/2"	1/8"	8-32	Dark Bronze	8-32 x 1"	Z4874	Z4874-1E	
	1-9/16	5/8	1/2	1/8	8-32	Chrome	8-32 x 1"	Z4880	Z4880-1E	
	1-9/16	5/8	1/2	1/8	8-32	Brass	8-32 x 1"	Z4882	Z4880-1A	
	1-9/16	5/8	1/2	1/8	8-32	Dark Bronze	8-32 x 1"	Z4884	Z4884-1E	
	2	5/8	1/2	1/8	8-32	Chrome	8-32 x 1"	Z4887	Z4887-1E	
	2	5/8	1/2	1/8	8-32	Brass	8-32 x 1"	Z4891	Z4887-1A	
	3	5/8	1/2	1/8	8-32	Chrome	8-32 x 1"	Z4888	Z4888-1E	
	3	5/8	1/2	1/8	8-32	Brass	8-32 x 1"	Z4892	Z4888-1A	
D Barrel Diameter	B Barrel Length	C Thread Depth	A Head Diameter	F Head Height	E Thread Size	Plating	Mating Screw	Set Order Number	Female Bolt Only	
5/16	1-3/16	3/4	1/2	1/8	10-32	Chrome	10-32 x 1	Z5000	Z5000-1E	
	1-3/16	3/4	1/2	1/8	10-32	Brass	10-32 x 1	Z5005	Z5000-1A	
	1-3/16	3/4	1/2	1/8	10-32	Dark Bronze	10-32 x 1	Z5010	Z5010-1E	
	1-9/16	3/4	1/2	1/8	10-32	Chrome	10-32 x 1	Z5100	Z5100-1E	
	1-9/16	3/4	1/2	1/8	10-32	Brass	10-32 x 1	Z5105	Z5100-1A	
	1-9/16	3/4	1/2	1/8	10-32	Dark Bronze	10-32 x 1	Z5110	Z5110-1E	
	2	3/4	1/2	1/8	10-32	Chrome	10-32 x 1	Z5102	Z5102-1E	
	2	3/4	1/2	1/8	10-32	Brass	10-32 x 1	Z5101	Z5105-1A	
	3	3/4	1/2	1/8	10-32	Chrome	10-32 x 1	Z5103	Z5103-1E	
	3	3/4	1/2	1/8	10-32	Brass	10-32 x 1	Z5104	Z5103-1A	
	1-3/16	3/4	1/2	1/8	12-24	Chrome	12-24 x 1	Z5115	Z5115-1E	
	1-3/16	3/4	1/2	1/8	12-24	Brass	12-24 x 1	Z5116	Z5115-1A	
	1-3/16	3/4	1/2	1/8	12-24	Dark Bronze	12-24 x 1	Z5117	Z5117-1E	
	1-9/16	3/4	1/2	1/8	12-24	Chrome	12-24 x 1	Z5120	Z5120-1E	
	1-9/16	3/4	1/2	1/8	12-24	Brass	12-24 x 1	Z5121	Z5120-1A	
	1-9/16	3/4	1/2	1/8	12-24	Dark Bronze	12-24 x 1	Z5122	Z5122-1E	
	2-1/16	3/4	1/2	1/8	12-24	Chrome	12-24 x 1	Z5315	Z5315-1E	
	2-1/16	3/4	1/2	1/8	12-24	Brass	12-24 x 1	Z5316	Z5315-1A	
2-1/16	3/4	1/2	1/8	12-24	Dark Bronze	12-24 x 1	Z5317	Z5317-1E		
D Barrel Diameter	B Barrel Length	C Thread Depth	A Head Diameter	F Head Height	E Thread Size	Plating	Mating Screw	Set Order Number	Female Bolt Only	
3/8	3/4	1/2	9/16	5/32	1/4-20	Chrome	1/4-20 x 1/2"	Z5150	—	
	3/4	1/2	9/16	5/32	1/4-20	Brass	1/4-20 x 1/2"	Z5155	—	
	1	5/8	9/16	5/32	1/4-20	Chrome	1/4-20 x 1/2"	Z5151	—	
	1	5/8	9/16	5/32	1/4-20	Brass	1/4-20 x 1/2"	Z5156	—	
	1-3/16	3/4	9/16	5/32	1/4-20	Chrome	1/4-20 x 1-1/2"	Z5152	—	
	1-3/16	3/4	9/16	5/32	1/4-20	Brass	1/4-20 x 1-1/2"	Z5157	—	
	1-9/16	1-1/4	9/16	5/32"	1/4-20	Chrome	1/4-20 x 1-1/2"	Z5200	Z5200-1E	
	1-9/16	1-1/4	9/16	5/32	1/4-20	Brass	1/4-20 x 1-1/2"	Z5205	Z5200-1A	
	1-9/16	1-1/4	9/16	5/32	1/4-20	Dark Bronze	1/4-20 x 1-1/2"	Z5210	Z5210-1E	
	2-1/16	1-1/4	9/16	5/32	1/4-20	Chrome	1/4-20 x 1-1/2"	Z5300	Z5300-1E	
	2-1/16	1-1/4	9/16	5/32	1/4-20	Brass	1/4-20 x 1-1/2"	Z5305	Z5300-1A	
	2-1/16	1-1/4	9/16	5/32	1/4-20	Dark Bronze	1/4-20 x 1-1/2"	Z5310	Z5310-1E	
	3	3/4	9/16	5/32	1/4-20	Chrome	1/4-20 x 1-1/2"	Z5301	Z5301-1E	
	3	3/4	9/16	5/32	1/4-20	Brass	1/4-20 x 1-1/2"	Z5302	Z5301-1A	
D Barrel Diameter	B Barrel Length	C Thread Depth	A Head Diameter	F Head Height	E Thread Size	Plating	Mating Screw	Set Order Number	Female Bolt Only	
1/2	2-1/16	1-1/4	3/4	3/16	5/16-18	Chrome	5/16-18 x 1-1/2"	Z5400	Z5400-1E	
	2-1/16	1-1/4	3/4	3/16	5/16-18	Brass	5/16-18 x 1-1/2"	Z5405	Z5400-1A	
	2-1/16	1-1/4	3/4	3/16	5/16-18	Dark Bronze	5/16-18 x 1-1/2"	Z5410	Z5410-1E	
	3	3/4	3/4	3/16	5/16-18	Chrome	5/16-18 x 1-1/2"	Z5401	Z5401-1E	
	3	3/4	3/4	3/16	5/16-18	Brass	5/16-18 x 1-1/2"	Z5402	Z5401-1A	



**THESE
SEX BOLTS
ARE ALL
MADE IN
USA**



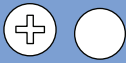

Architectural Series Sex Bolts

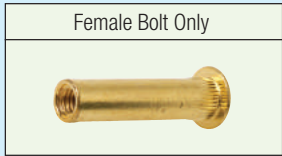

When joining two pieces of material together, Sex Bolts provide a versatile and stable fastener. The domed side is used in security applications, as there is no way to turn the smooth head of the Sex Bolt. A hole drilled thru the 2 materials being fastened is a safe and convenient method of joining. Our large selection of head styles, sizes, and materials makes for a custom look at an in-stock price and delivery.

This example shows a bulletproof glass installation at a bank. The sex bolts present a beautiful and finished look with a strong mechanical joint. The all metal joint protects the glass.

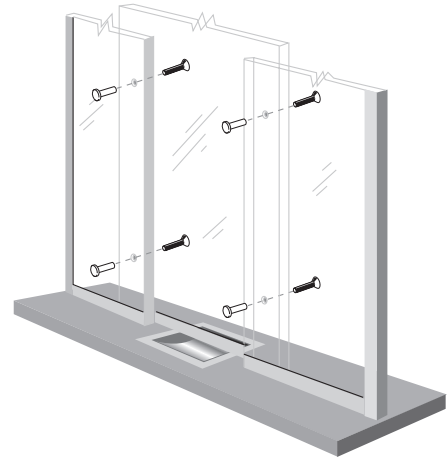

See chart on facing page for available sizes and order numbers

Marine applications are a common use for our 18-8 and Type 316 Stainless Steel Sex Bolts. Docks and construction projects in both fresh and salt water areas use these. Many boat manufacturers use these for attaching accessories both above and below the water line. Sex Bolts are particularly useful in fiberglass marine applications, as they take much of the stress away from the fiberglass.

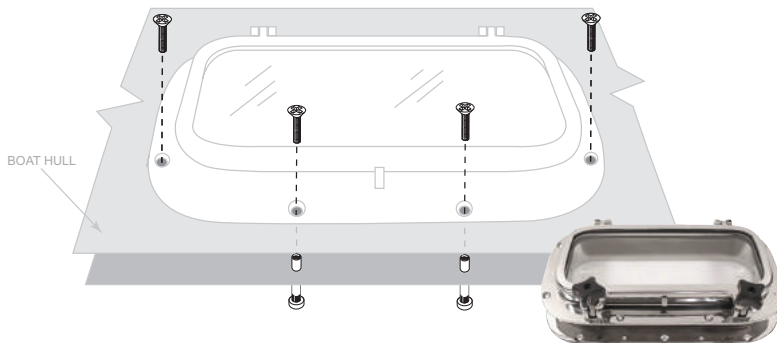
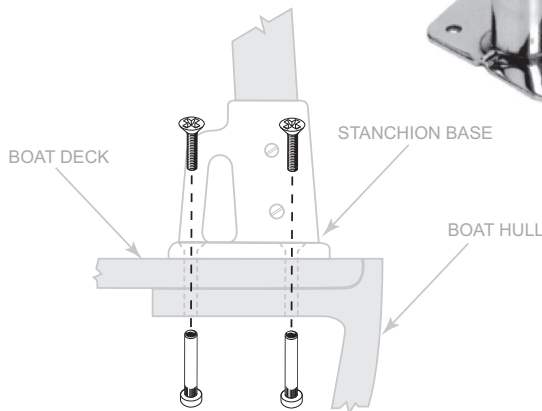

SPECIAL ORDERS AVAILABLE—
Small Quantities to Large Volume





Architectural Series Sex Bolts

USA MADE

Architectural Series Sex Bolts						STEEL MATERIAL			
D Barrel Diameter	B Barrel Length	C Thread Depth	A Head Diameter	F Head Height	E Thread Size	Plating	Mating Screw	Set Order Number	Female Bolt Only
3/8	1-3/16"	3/4"	9/16"	5/32"	1/4-20	None	None	—	Z5214
	1-7/8	3/4	9/16	5/32	1/4-20	Zinc	None	—	Z5201
	1-9/16	1	9/16	5/32	1/4-20	Zinc	1/4-20 x 1"	Z5215	Z5215-1E
	1-9/16	1	9/16	5/32	1/4-20	Chrome	1/4-20 x 1-1/2	Z5216	Z5216-1E
	1-9/16	1	9/16	5/32	1/4-20	Brass	1/4-20 x 1-1/2	Z5217	Z5217-1E
Architectural Series Sex Bolts						18-8 STAINLESS STEEL			
D Barrel Diameter	B Barrel Length	C Thread Depth	A Head Diameter	F Head Height	E Thread Size	Plating	Mating Screw	Set Order Number	Female Bolt Only
1/4	1-3/16"	5/8"	1/2"	1/8"	8-32	None	8-32 x 7/8"	Z4876	Z4876-1
	1-9/16	5/8	1/2	1/8	8-32	None	8-32 x 7/8	Z4886	Z4886-1
	2	5/8	1/2	1/8	8-32	None	8-32 x 7/8	Z4889	Z4889-1
	3	5/8	1/2	1/8	8-32	None	8-32 x 7/8	Z4890	Z4890-1
5/16	1-3/16	3/4	1/2	1/8	10-32	None	10-32 x 1	Z5025	Z5025-1
	1-9/16	3/4	1/2	1/8	10-32	None	10-32 x 1	Z5125	Z5125-1
	2	3/4	1/2	1/8	10-32	None	10-32 x 1	Z5126	Z5126-1
	3	3/4	1/2	1/8	10-32	None	10-32 x 1	Z5127	Z5127-1
3/8	1-3/16	3/4	1/2	1/8	12-24	None	12-24 x 1	Z5128	Z5128-1
	1-9/16	3/4	1/2	1/8	12-24	None	12-24 x 1	Z5129	Z5129-1
	2-1/16	3/4	1/2	1/8	12-24	None	12-24 x 1	Z5130	Z5130-1
	3/4"	1/2"	9/16"	5/32"	1/4-20	None	1/4-20 x 1	Z5140	Z5220-1
1/2	1	5/8	9/16	5/32	1/4-20	None	1/4-20 x 7/8	Z5221	Z5221-1
	1-3/16	3/4	9/16	5/32	1/4-20	None	1/4-20 x 1	Z5142	Z5222
	1-9/16	3/4	9/16	5/32	1/4-20	None	1/4-20 x 1	Z5225	Z5225-1
	2-1/16	3/4	9/16	5/32	1/4-20	None	1/4-20 x 1	Z5325	Z5325-1
3/8	3	3/4	9/16	5/32	1/4-20	None	1/4-20 x 1-1/2	Z5326	Z5326-1
	4	3/4	9/16	5/32	1/4-20	None	1/4-20 x 1-1/2	Z5327	Z5327-1
	1-9/16	3/4	3/4	3/16	5/16-18	None	5/16-18 x 1	Z5234	Z5234-1
	1-3/4	3/4	3/4	3/16	3/8-16	None	3/8-16 x 1	Z5235	Z5235-1
1/2	2-1/16	3/4	3/4	3/16	5/16-18	None	5/16-18 x 1-1/2	Z5425	Z5425-1
	3	3/4	3/4	3/16	5/16-18	None	5/16-18 x 1-1/2	Z5426	Z5426-1
Architectural Series Sex Bolts						316 STAINLESS STEEL			
D Barrel Diameter	B Barrel Length	C Thread Depth	A Head Diameter	F Head Height	E Thread Size	Plating	Mating Screw	Set Order Number	Female Bolt Only
1/4	1-3/16"	5/8"	1/2"	1/8"	8-32	None	8-32 x 3/4"	Z5180	Z4877
	1-9/16	5/8	1/2	1/8	8-32	None	8-32 x 3/4	Z5181	Z4885
	2	5/8	1/2	1/8	8-32	None	8-32 x 3/4	Z5182	Z4893
	3	5/8	1/2	1/8	8-32	None	8-32 x 3/4	Z5183	Z4894
5/16	1-3/16	3/4	1/2	1/8	10-32	None	10-32 x 1	Z5190	Z5024
	1-9/16	3/4	1/2	1/8	10-32	None	10-32 x 1	Z5191	Z5124
	2	3/4	1/2	1/8	10-32	None	10-32 x 1	Z5192	Z5131
	3	3/4	1/2	1/8	10-32	None	10-32 x 1	Z5193	Z5132
3/8	3/4	1/2	9/16	5/32	1/4-20	None	1/4-20 x 1/2	Z5194	Z5219
	1	5/8	9/16	5/32	1/4-20	None	1/4-20 x 1/2	Z5195	Z5223
	1-3/16	3/4	9/16	5/32	1/4-20	None	1/4-20 x 1-1/2	Z5196	Z5224
	1-9/16	3/4	9/16	5/32	1/4-20	None	1/4-20 x 1-1/2	Z5197	Z5197-1
	2-1/16	3/4	9/16	5/32	1/4-20	None	1/4-20 x 1-1/2	Z5198	Z5198-1
1/2	3	3/4	9/16	5/32	1/4-20	None	1/4-20 x 1-1/2	Z5199	Z5199-1
	2-1/16	3/4	3/4	3/16	5/16-18	None	5/16-18 x 1	Z5206	Z5206-1
1/2	3	3/4	3/4	3/16	5/16-18	None	5/16-18 x 1	Z5207	Z5207-1
	5/8	3	1	1	1/4	1/2-13	None	1/2-13 x 1	—
Architectural Series Sex Bolts						ALUMINUM MATERIAL			
D Barrel Diameter	B Barrel Length	C Thread Depth	A Head Diameter	F Head Height	E Thread Size	Plating	Mating Screw	Set Order Number	Female Bolt Only
3/8	1-9/16	1	9/16	1/8	1/4-20	None	1/4-20 x 1	Z5218	Z5218-1A
	1-11/16	3/4	9/16	1/8	1/4-20	None	1/4-20 x 3/4	Z5250	Z5250-1



THESE SEX BOLTS ARE ALL MADE IN USA

*Mating Screws are Phillips Flat Head Machine Screws, 18-8 Stainless Steel

New Items in Red



Mating Screws are Phillips Flat Head Machine Screws, Type 316 Stainless Steel





Combo Head Sex Bolts



THE LARGEST SELECTION IN THE WORLD!! The Accurate Combo Head System—“There is a difference”

Our engineers have developed a complete system and a set of standards for “off the shelf” Sex Bolts and Mating Parts. We stock a complete range of female barrels, which can be coupled with either our Shoulder Screws or machine screws.

Benefits:

- Truss Head, combination slotted/Phillips drive
- All components are matched. Heads on both male and female parts are identical.
- Shoulder Screws and Female Barrels allow different grip lengths to be achieved.
- Machine Screws present a finished set appearance.
- Heads manufactured in accordance with IFI Standards.



Store Fixtures use Sex Bolts everywhere. The finished appearance combined with secure joints and ease of installation make them very popular. Sex Bolts are especially useful and secure for metal tube applications, either round or square, as shown in these illustrations.

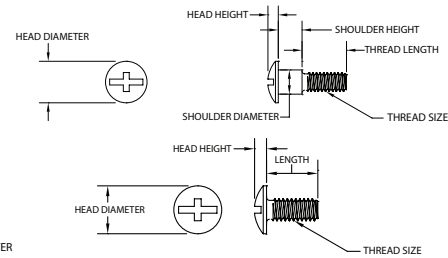
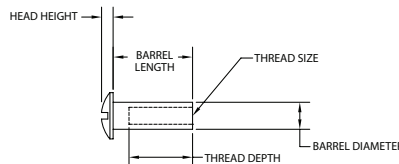
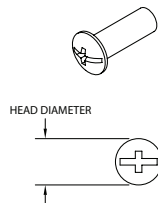
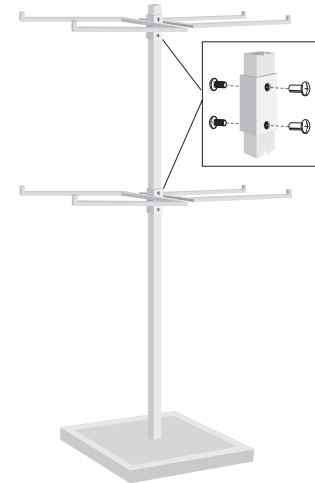

Combo Drive Truss-Head Barrel & Screw SETS—Zinc-Plated Steel

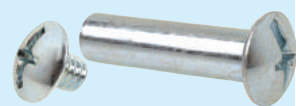

SPECIAL ORDERS AVAILABLE—
Small Quantities to Large Volume



Combo Drive Truss-Head Barrel & Screw Sets						ZINC-PLATED STEEL			
Barrel Diameter	For Material Thickness (Grip Range)		Female Barrel Length	Male Screw Thread Size	Male Screw Thread Length	Replacement Female Barrel Order Number	Replacement Male Screw Order Number	Quantity of Each Part	SET ORDER NUMBER
	Minimum	Maximum							
13/64"	3/8	1/2	3/8	8-32	5/16	Z4437	Z4075	1	Z4437PAK
	1/2	5/8	1/2	8-32	5/16	Z4438	Z4075	1	Z4438PAK
	3/4	7/8	3/4	8-32	5/16	Z4440	Z4075	1	Z4440PAK
1/4"	1/4	3/8	1/4	10-24	5/16	Z4404	Z4085	10	Z4404PAK *
	3/8	1/2	3/8	10-24	5/16	Z4406	Z4085	10	Z4406PAK
	1/2	5/8	1/2	10-24	5/16	Z4408	Z4085	10	Z4408PAK
	5/8	3/4	5/8	10-24	5/16	Z4410	Z4085	10	Z4410PAK
	3/4	7/8	3/4	10-24	5/16	Z4412	Z4085	10	Z4412PAK
	1	1-1/8	1	10-24	5/16	Z4416	Z4085	10	Z4416PAK
	1-1/4	1-3/8	1-1/4	10-24	5/16	Z4420	Z4085	10	Z4420PAK
	1-1/2	1-5/8	1-1/2	10-24	5/16	Z4424	Z4085	10	Z4424PAK
2	2-1/8	2	10-24	5/16	Z4432	Z4085	10	Z4432PAK	
5/16"	3/8	1/2	3/8	1/4-20	5/16	Z4445	Z4095	10	Z4445PAK
	1/2	5/8	1/2	1/4-20	5/16	Z4443	Z4095	10	Z4443PAK
	5/8	3/4	1/2	1/4-20	5/16	Z4443	Z4050	10	Z4447PAK
	3/4	7/8	3/4	1/4-20	5/16	Z4444	Z4095	10	Z4444PAK
	7/8	1	3/4	1/4-20	5/16	Z4444	Z4051	10	Z4449PAK
	1	1-1/8	1	1/4-20	5/16	Z4446	Z4095	10	Z4446PAK
	1-1/4	1-3/8	1-1/4	1/4-20	5/16	Z4448	Z4095	10	Z4448PAK
	1-1/2	1-5/8	1-1/2	1/4-20	5/16	Z4450	Z4095	10	Z4450PAK
3/8"	1/2	5/8	1/2	5/16-18	5/16	Z4146	Z4096	1	Z4146PAK





Combo Head Sex Bolts

Combo Truss Head FEMALE BARRELS—Zinc-Plated Steel

Combo Head Female Barrels					ZINC-PLATED STEEL		
Barrel Diameter	Barrel Length	Thread Size	Thread Depth	Drive	Head Diameter	Head Height	Order Number
3/16	3/8"	6-32	15/64"	Combo	5/16"	5/64"	Z4105
	1/2	6-32	3/8	Combo	5/16	5/64	Z4106
	5/8	6-32	3/8	Combo	5/16	5/64	Z4107
	3/4	6-32	3/8	Combo	5/16	5/64	Z4108
	7/8	6-32	3/8	Combo	5/16	5/64	Z4109
	1"	6-32	3/8	Combo	5/16	5/64	Z4110
13/64	1/4	8-32	Thru	Slot	3/8	3/32	Z4435
	3/8	8-32	15/64"	Combo	3/8	3/32	Z4437
	1/2	8-32	3/8	Combo	3/8	3/32	Z4438
	5/8	8-32	3/8	Combo	3/8	3/32	Z4439
	3/4	8-32	3/8	Combo	3/8	3/32	Z4440
	1	8-32	3/8	Combo	3/8	3/32	Z4442
1/4	1/4	10-24	Thru	Slot	7/16	1/8	Z4404
	5/16	10-32	Thru	Slot	3/8	1/8	Z4840
	3/8	10-24	5/16	Combo	7/16	1/8	Z4406
	1/2	10-24	3/8	Combo	7/16	1/8	Z4408
	5/8	10-24	3/8	Combo	7/16	1/8	Z4410
	3/4	10-24	3/8	Combo	7/16	1/8	Z4412
	1	10-24	3/8	Combo	7/16	1/8	Z4416
	1-1/4	10-24	3/8	Combo	7/16	1/8	Z4420
1-1/2	10-24	3/8	Combo	7/16	1/8	Z4424	
	2	10-24	3/8	Combo	7/16	1/8	Z4432
5/16	3/8"	1/4-20	3/16	Combo	9/16	5/32	Z4445
	1/2	1/4-20	3/8	Combo	9/16	5/32	Z4443
	3/4	1/4-20	3/8	Combo	9/16	5/32	Z4444
	1	1/4-20	3/8	Combo	9/16	5/32	Z4446
	1-1/4	1/4-20	1/2	Combo	9/16	5/32	Z4448
	1-1/2	1/4-20	1/2	Combo	9/16	5/32	Z4450
3/8	3/8	5/16-18	3/8	Combo	11/16	11/64	Z4145
	1/2	5/16-18	3/8	Combo	11/16	11/64	Z4146
	3/4	5/16-18	1/2	Combo	11/16	11/64	Z4148
	1	5/16-18	1/2	Combo	11/16	11/64	Z4150



Tapped-Thru Slotted Head

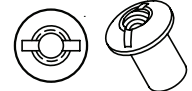

Shorter lengths, where the tap comes thru the head, are slotted drive only.

Combo Truss Head Machine Screws—Zinc-Plated Steel

Manufactured to match our Combo Head Sex Bolts for a finished appearance. Heads are the same dimensions as our Combo Head Sex Bolts series.

Combo Head Mating Screws		ZINC-PLATED STEEL		
Size	Head Diameter	Head Height	Order Number	
6-32 X 5/16 Steel Zinc	5/16"	5/64"	Z4074	
8-32 X 5/16 Steel Zinc	3/8	1/8	Z4075	
10-24 X 5/16 Steel Zinc	7/16	1/8	Z4085	
1/4-20 X 5/16 Steel Zinc	9/16	5/32	Z4095	
5/16-18 X 5/16 Steel Zinc	11/16	11/64	Z4096	



Combo Head Shoulder Mating Screws—Zinc-Plated Steel

Combo Head Shoulder Mating Screws		ZINC-PLATED STEEL					
For Female Barrel Diameters	Shoulder Diameter	Shoulder Length	Thread Size	Thread Length	Overall Length	Drive	Order Number
13/64 Diameter	13/64"	1/4"	8-32	5/16"	9/16"	Combo	Z4000
1/4" Diameter	1/4	1/4	10-24	5/16	9/16	Combo	Z4025
5/16" Diameter	5/16	1/8	1/4-20	5/16	7/16	Combo	Z4051
5/16" Diameter	5/16	1/4	1/4-20	5/16	9/16	Combo	Z4050



Accurate
Manufactured
Products
Group

Phone: 317-472-9000 • FAX: 317-472-9010 • email: sales@ampg.com • www.ampg.com





Combo Head Sex Bolts



Benefits:

- Truss Head, combination slotted/Phillips drive
- All components are matched. Heads on both male and female parts are identical.
- Shoulder Screws and Female Barrels allow different grip lengths to be achieved.
- Machine Screws present a finished set appearance.
- Heads manufactured in accordance with IFI Standards.



Type 303 (18-8) stainless steel offers excellent corrosion resistance. The most widely used stainless steel used in chemical and food processing equipment.



Combo Truss Head Barrel & Screw SETS—18-8 Stainless Steel

Combo Drive Truss-Head Barrel & Screw Sets					18-8 STAINLESS STEEL				
Barrel Diameter	For Material Thickness (Grip Range)		Female Barrel Length	Male Thread Size	Male Screw Thread Length	Replacement Female Barrel Order Number	Replacement Male Screw Order Number	Quantity of Each Part	SET ORDER NUMBER
	Minimum	Maximum							
3/16"	3/8"	1/2"	3/8"	6-32	5/16"	Z4105SS	Z4074SS	1	Z4105SSPAK
13/64"	3/8	1/2	3/8	8-32	5/16	Z4125SS	Z4075SS	1	Z4125SSPAK
	3/4	7/8	3/4	8-32	5/16	Z4128SS	Z4075SS	1	Z4128SSPAK
1/4"	1/4	3/8	1/4	10-24	5/16	Z4404SS	Z4085SS	1	Z4404SSPAK *
	3/8	1/2	3/8	10-24	5/16	Z4406SS	Z4085SS	1	Z4406SSPAK
	1/2	5/8	1/2	10-24	5/16	Z4408SS	Z4085SS	1	Z4408SSPAK
	5/8	3/4	5/8	10-24	5/16	Z4410SS	Z4085SS	1	Z4410SSPAK
	3/4	7/8	3/4	10-24	5/16	Z4412SS	Z4085SS	1	Z4412SSPAK
	1	1-1/8	1	10-24	5/16	Z4416SS	Z4085SS	1	Z4416SSPAK
	1-1/4	1-3/8	1-1/4	10-24	5/16	Z4420SS	Z4085SS	1	Z4420SSPAK
	1-1/2	1-5/8	1-1/2	10-24	5/16	Z4424SS	Z4085SS	1	Z4424SSPAK
	2	2-1/8	2	10-24	5/16	Z4432SS	Z4085SS	1	Z4432SSPAK
5/16"	3/8	1/2	3/8	1/4-20	5/16	Z4135SS	Z4095SS	1	Z4135SSPAK
	1/2	5/8	1/2	1/4-20	5/16	Z4443SS	Z4095SS	1	Z4443SSPAK
	5/8	3/4	5/8	1/4-20	5/16	Z4137SS	Z4095SS	1	Z4137SSPAK
	3/4	7/8	3/4	1/4-20	5/16	Z4444SS	Z4095SS	1	Z4444SSPAK
	7/8	1	7/8	1/4-20	5/16	Z4139SS	Z4095SS	1	Z4139SSPAK
	1	1-1/8	1	1/4-20	5/16	Z4446SS	Z4095SS	1	Z4446SSPAK
	1-1/4	1-3/8	1-1/4	1/4-20	5/16	Z4448SS	Z4095SS	1	Z4448SSPAK
	1-1/2	1-5/8	1-1/2	1/4-20	5/16	Z4449SS	Z4095SS	1	Z4449SSPAK
3/8"	1/2	5/8	1/2	5/16-18	5/16	Z4146SS	Z4096SS	1	Z4146SSPAK

* Slotted Drive Only

SPECIAL ORDERS AVAILABLE—
Small Quantities to Large Volume





Combo Head Sex Bolts

Combo Truss Head FEMALE BARRELS 18-8 Stainless Steel

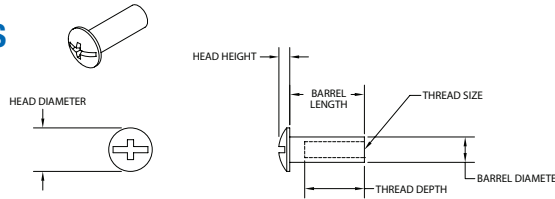

Combo Head Female Barrels					18-8 STAINLESS STEEL		
Barrel Diameter	Barrel Length	Thread Size	Thread Depth	Drive	Head Diameter	Head Height	18-8 SS Order Number
3/16"	3/8"	6-32	19/64"	Combo	5/16"	5/64"	Z4105SS
	1/2	6-32	3/8	Combo	5/16	5/64	Z4106SS
	5/8	6-32	3/8	Combo	5/16	5/64	Z4107SS
	3/4	6-32	3/8	Combo	5/16	5/64	Z4108SS
	7/8	6-32	3/8	Combo	5/16	5/64	Z4109SS
	1"	6-32	3/8	Combo	5/16	5/64	Z4110SS
13/64"	1/4	8-32	Thru	Slot	3/8	3/32	Z4124SS
	3/8	8-32	19/64	Combo	3/8	3/32	Z4125SS
	1/2	8-32	3/8	Combo	3/8	3/32	Z4126SS
	5/8	8-32	3/8	Combo	3/8	3/32	Z4127SS
	3/4	8-32	3/8	Combo	3/8	3/32	Z4128SS
	7/8	8-32	3/8	Combo	3/8	3/32	Z4129SS
1/4"	1/4	10-24	Thru	Slot	7/16	1/8	Z4404SS
	3/8	10-24	5/16	Combo	7/16	1/8	Z4406SS
	1/2	10-24	3/8	Combo	7/16	1/8	Z4408SS
	5/8	10-24	3/8	Combo	7/16	1/8	Z4410SS
	3/4	10-24	3/8	Combo	7/16	1/8	Z4412SS
	1	10-24	3/8	Combo	7/16	1/8	Z4416SS
	1-1/4	10-24	3/8	Combo	7/16	1/8	Z4420SS
	1-1/2	10-24	3/8	Combo	7/16	1/8	Z4424SS
5/16"	3/8	1/4-20	19/64	Combo	9/16	5/32	Z4135SS
	1/2	1/4-20	3/8	Combo	9/16	5/32	Z4443SS
	5/8	1/4-20	3/8	Combo	9/16	5/32	Z4137SS
	3/4	1/4-20	3/8	Combo	9/16	5/32	Z4444SS
	7/8	1/4-20	3/8	Combo	9/16	5/32	Z4139SS
	1	1/4-20	3/8	Combo	9/16	5/32	Z4446SS
	1-1/4	1/4-20	3/8	Combo	9/16	5/32	Z4448SS
3/8"	3/8	5/16-18	3/8	Combo	11/16	11/64	Z4145SS
	1/2	5/16-18	3/8	Combo	11/16	11/64	Z4146SS
	5/8	5/16-18	3/8	Combo	11/16	11/64	Z4147SS
	3/4	5/16-18	1/2	Combo	11/16	11/64	Z4148SS
	7/8	5/16-18	1/2	Combo	11/16	11/64	Z4149SS
	1	5/16-18	1/2	Combo	11/16	11/64	Z4150SS

Tapped-Thru Slotted Head

Shorter lengths, where the tap comes thru the head, are slotted drive only.

Combo Truss Head Machine Screws 18-8 Stainless Steel

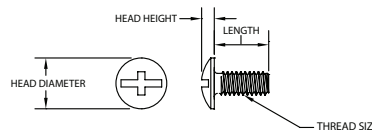

Combo Truss Head Machine Screws			18-8 STAINLESS STEEL
Size	Head Diameter	Head Height	18-8 St/St Order Number
6-32 X 5/16	5/16"	5/64"	Z4074SS
8-32 X 5/16	3/8	1/8	Z4075SS
10-24 X 5/16	7/16	1/8	Z4085SS
1/4-20 X 5/16	9/16	5/32	Z4095SS
5/16-18 X 5/16	11/16	11/64	Z4096SS





Combo Head Sex Bolts



Benefits:

- Truss Head, combination slotted/Phillips drive
- All components are matched. Heads on both male and female parts are identical.
- Shoulder Screws and Female Barrels allow different grip lengths to be achieved.
- Machine Screws present a finished set appearance.
- Heads manufactured in accordance with IFI Standards.



Type 316 stainless steel offers more corrosion resistance than 18-8 stainless steel. Widely used in chemical processing as well as marine environments, as the molybdenum in 316 stainless steel has higher resistance to chlorides.

Combo Truss Head Barrel & Screw SETS—Type 316 Stainless Steel

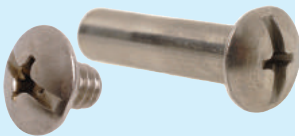

Combo Drive Truss-Head Barrel & Screw Sets					TYPE 316 STAINLESS STEEL				
Barrel Diameter	For Material Thickness (Grip Range)		Female Barrel Length	Thread Size	Male Screw Thread Length	Replacement Female Barrel Order Number	Replacement Male Screw Order Number	Quantity of Each Part	SET ORDER NUMBER
	Minimum	Maximum							
3/16"	3/8"	1/2"	3/8"	6-32	5/16"	Z4105-316SS	Z4074-316SS	1	Z4105-316SS-PAK
13/64"	3/8	1/2	3/8	8-32	5/16	Z4125-316SS	Z4075-316SS	1	Z4125-316SS-PAK
	3/4	7/8	3/4	8-32	5/16	Z4128-316SS	Z4075-316SS	1	Z4128-316SS-PAK
1/4"	1/4	3/8	1/4	10-24	5/16	Z4404-316SS	Z4085-316SS	1	Z4404-316SS-PAK *
	3/8	1/2	3/8	10-24	5/16	Z4406-316SS	Z4085-316SS	1	Z4406-316SS-PAK
	1/2	5/8	1/2	10-24	5/16	Z4408-316SS	Z4085-316SS	1	Z4408-316SS-PAK
	5/8	3/4	5/8	10-24	5/16	Z4410-316SS	Z4085-316SS	1	Z4410-316SS-PAK
	3/4	7/8	3/4	10-24	5/16	Z4412-316SS	Z4085-316SS	1	Z4412-316SS-PAK
	1	1-1/8	1	10-24	5/16	Z4416-316SS	Z4085-316SS	1	Z4416-316SS-PAK
	1-1/4	1-3/8	1-1/4	10-24	5/16	Z4420-316SS	Z4085-316SS	1	Z4420-316SS-PAK
	1-1/2	1-5/8	1-1/2	10-24	5/16	Z4424-316SS	Z4085-316SS	1	Z4424-316SS-PAK
2	2-1/8	2	10-24	5/16	Z4432-316SS	Z4085-316SS	1	Z4432-316SS-PAK	
5/16"	3/8	1/2	3/8	1/4-20	5/16	Z4135-316SS	Z4095-316SS	1	Z4135-316SS-PAK
	1/2	5/8	1/2	1/4-20	5/16	Z4443-316SS	Z4095-316SS	1	Z4443-316SS-PAK
	5/8	3/4	5/8	1/4-20	5/16	Z4137-316SS	Z4095-316SS	1	Z4137-316SS-PAK
	3/4	7/8	3/4	1/4-20	5/16	Z4444-316SS	Z4095-316SS	1	Z4444-316SS-PAK
	7/8	1	7/8	1/4-20	5/16	Z4139-316SS	Z4095-316SS	1	Z4139-316SS-PAK
	1	1-1/8	1	1/4-20	5/16	Z4446-316SS	Z4095-316SS	1	Z4446-316SS-PAK
	1-1/4	1-3/8	1-1/4	1/4-20	5/16	Z4448-316SS	Z4095-316SS	1	Z4448-316SS-PAK
	1-1/2	1-5/8	1-1/2	1/4-20	5/16	Z4449-316SS	Z4095-316SS	1	Z4449-316SS-PAK
3/8"	1/2	5/8	1/2	5/16-18	5/16	Z4146-316SS	Z4096-316SS	1	Z4146-316SS-PAK

SPECIAL ORDERS AVAILABLE—
Small Quantities to Large Volume





Combo Head Sex Bolts



Combo Truss Head FEMALE BARRELS Type 316 Stainless Steel

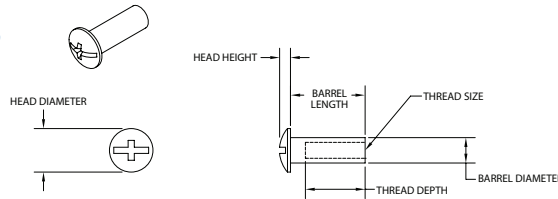

**New!
Expanded
Range!
Type 316
St/St**

Combo Head Female Barrels					TYPE 316 STAINLESS STEEL		
Barrel Diameter	Barrel Length	Thread Size	Thread Depth	Drive	Head Diameter	Head Height	18-8 SS Order Number
3/16"	3/8"	6-32	19/64"	Combo	5/16"	5/64"	Z4105-316SS
	1/2	6-32	3/8	Combo	5/16	5/64	Z4106-316SS
	5/8	6-32	3/8	Combo	5/16	5/64	Z4107-316SS
	3/4	6-32	3/8	Combo	5/16	5/64	Z4108-316SS
	7/8	6-32	3/8	Combo	5/16	5/64	Z4109-316SS
	1"	6-32	3/8	Combo	5/16	5/64	Z4110-316SS
13/64"	1/4	8-32	Thru	Slot	3/8	3/32	Z4124-316SS
	3/8	8-32	19/64	Combo	3/8	3/32	Z4125-316SS
	1/2	8-32	3/8	Combo	3/8	3/32	Z4126-316SS
	5/8	8-32	3/8	Combo	3/8	3/32	Z4127-316SS
	3/4	8-32	3/8	Combo	3/8	3/32	Z4128-316SS
	7/8	8-32	3/8	Combo	3/8	3/32	Z4129-316SS
1/4"	1	8-32	3/8	Combo	3/8	3/32	Z4130-316SS
	1/4	10-24	Thru	Slot	7/16	1/8	Z4404-316SS
	3/8	10-24	5/16	Combo	7/16	1/8	Z4406-316SS
	1/2	10-24	3/8	Combo	7/16	1/8	Z4408-316SS
	5/8	10-24	3/8	Combo	7/16	1/8	Z4410-316SS
	3/4	10-24	3/8	Combo	7/16	1/8	Z4412-316SS
	1	10-24	3/8	Combo	7/16	1/8	Z4416-316SS
	1-1/4	10-24	3/8	Combo	7/16	1/8	Z4420-316SS
5/16"	1-1/2	10-24	3/8	Combo	7/16	1/8	Z4424-316SS
	2	10-24	3/8	Combo	7/16	1/8	Z4432-316SS
	3/8	1/4-20	19/64	Combo	9/16	5/32	Z4135-316SS
	1/2	1/4-20	3/8	Combo	9/16	5/32	Z4443-316SS
	5/8	1/4-20	3/8	Combo	9/16	5/32	Z4137-316SS
	3/4	1/4-20	3/8	Combo	9/16	5/32	Z4444-316SS
	7/8	1/4-20	3/8	Combo	9/16	5/32	Z4139-316SS
3/8"	1	1/4-20	3/8	Combo	9/16	5/32	Z4446-316SS
	1-1/4	1/4-20	3/8	Combo	9/16	5/32	Z4448-316SS
	1-1/2	1/4-20	3/8	Combo	9/16	5/32	Z4449-316SS
	3/8	5/16-18	3/8	Combo	11/16	11/64	Z4145-316SS
	1/2	5/16-18	3/8	Combo	11/16	11/64	Z4146-316SS
3/8"	5/8	5/16-18	3/8	Combo	11/16	11/64	—
	3/4	5/16-18	1/2	Combo	11/16	11/64	Z4148-316SS
	7/8	5/16-18	1/2	Combo	11/16	11/64	—
	1	5/16-18	1/2	Combo	11/16	11/64	Z4150-316SS

Tapped-Thru Slotted Head

Shorter lengths, where the tap comes thru the head, are slotted drive only.

Combo Truss Head Machine Screws Type 316 Stainless Steel

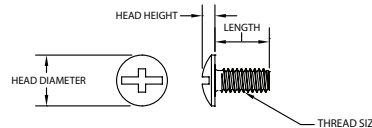

Combo Truss Head Machine Screws			316 STAINLESS STEEL
Size	Head Diameter	Head Height	Type 316 St/St Order Number
6-32 X 5/16	5/16"	5/64"	Z4074-316SS
8-32 X 5/16	3/8	1/8	Z4075-316SS
10-24 X 5/16	7/16	1/8	Z4085-316SS
1/4-20 X 5/16	9/16	5/32	Z4095-316SS
5/16-18 X 5/16	11/16	11/64	Z4096-316SS





Tamperproof Sex Bolts

6 Lobe with Pin Security Sex Bolts—The Complete System

A solution that replaces the traditional partition sex bolts, with superior drive characteristics, and a wider range of sizes. (See chart on facing page for available sizes and order numbers)

- Male screws available with or without shoulders.
- All parts are matched for a finished appearance.
- Both female and male bolts feature the 6-Lobe with Pin Security Drive.
- 6-Lobe drive has many advantages—
 - No cam out during installation
 - No head distortion during driving,
 - No special tooling required for both installation and removal.
- Head dimensions for both male and female parts are matched, per IFI standards.

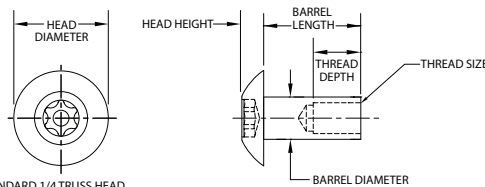

STANDARD 1/4 TRUSS HEAD
TAMPER RESISTANT 6-LOBE T27 DRIVE
GO GAGE PENETRATION: .070 MIN.



See chart on facing page for available sizes and order numbers

Truss Head 6 Lobe with Pin Security Screws

18-8 Stainless Steel

- Male screws available with or without shoulders.
- 6-Lobe drive has many advantages—
 - No cam out during installation
 - No head distortion during driving,
 - No special tooling required for both installation and removal.

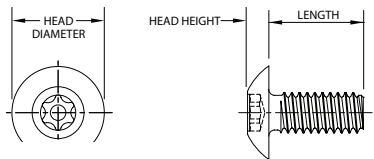

Truss Head 6 Lobe with Pin *SHOULDER* Security Screws

18-8 Stainless Steel

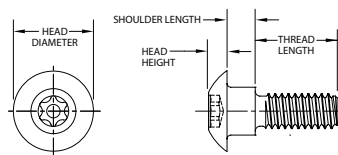

SPECIAL ORDERS AVAILABLE—
Small Quantities to Large Volume



Tamperproof Sex Bolts

IMPORT & USA MADE

Female Truss Head Sex Bolts — 6 Lobe with Pin Security Drive

Female Sex Bolts and Male Tamperproof Truss Head Screws are sold separately

6 Lobe Tamperproof Security—Female Barrels						18-8 ST/ST	
Barrel Diameter	Barrel Length	Thread Size	Thread Depth	Head Diameter	Head Height	Drive Size	Order Number
1/4	3/8"	10-24	1/4"	7/16"	7/64"	T 20	Z4406T6S
	1/2	10-24	1/4	7/16	7/64	T 20	Z4408T6S
	5/8	10-24	1/4	7/16	7/64	T 20	Z4410T6S
	3/4	10-24	3/8	7/16	7/64	T 20	Z4412T6S
	1	10-24	3/8	7/16	7/64	T 20	Z4416T6S
	1-1/4	10-24	3/8	7/16	7/64	T 20	Z4420T6S
	1-1/2	10-24	3/8	7/16	7/64	T 20	Z4424T6S
5/16	1/2	1/4-20	1/4	9/16	9/64	T 27	Z4443T6S
	3/4	1/4-20	3/8	9/16	9/64	T 27	Z4444T6S
	1	1/4-20	3/8	9/16	9/64	T 27	Z4446T6S
	1-1/4	1/4-20	3/8	9/16	9/64	T 27	Z4448T6S
	1-1/2	1/4-20	3/8	9/16	9/64	T 27	Z4449T6S



6 Lobe with Pin Truss Head Security Screws			18-8 STAINLESS STEEL	
Size	Head Diameter	Head Height	Drive	Order Number
10-24 X 1/4"	7/16"	7/64"	T 20	Z4580SS
10-24 X 1/2	7/16	7/64	T 20	Z4582SS
10-24 X 1	7/16	7/64	T 20	Z4588SS
1/4-20 X 1/4	9/16	9/64	T 27	Z4591SS
1/4-20 X 3/8	9/16	9/64	T 27	Z4590SS
1/4-20 X 1/2	9/16	9/64	T 27	Z4592SS



6 Lobe with Pin Truss Head Security Screws WITH SHOULDER							18-8 STAINLESS STEEL	
Size	Shoulder Diameter	Total Length Under Head	Shoulder Length	Thread Length	Head Diameter	Head Height	Drive	Order Number
10-24 X 1/4"	1/4"	3/8"	1/8"	1/4"	7/16"	7/64"	T20	Z4581SS
10-24 X 1/4	1/4	1/2	1/4	1/4	7/16	7/64	T20	Z4583SS
10-24 X 3/8	1/4	5/8	1/4	3/8	7/16	7/64	T20	Z4584SS
10-24 X 5/8	1/4	7/8	1/4	5/8	7/16	7/64	T20	Z4585SS
10-24 X 7/8	1/4	1-1/8	1/4	7/8	7/16	7/64	T20	Z4586SS
1/4-20 X 1/4	5/16	1/2	1/4	1/4	9/16	9/64	T27	Z4593SS
1/4-20 X 3/8	5/16	1/2	1/8	3/8	9/16	9/64	T27	Z4597SS
1/4-20 X 3/8	5/16	5/8	1/4	3/8	9/16	9/64	T27	Z4594SS
1/4-20 X 5/8	5/16	7/8	1/4	5/8	9/16	9/64	T27	Z4595SS
1/4-20 X 7/8	5/16	1-1/8	1/4	7/8	9/16	9/64	T27	Z4596SS



Tamperproof Security Tools

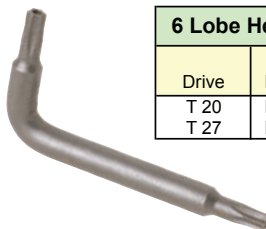

6 Lobe Hex Key	
Drive	Order Number
T 20	KEYT20
T 27	KEYT27

6 Lobe with Pin Bit		
Size	Hex Size	Order Number
T 20	1/4"	BITT20
T 27	1/4"	BITT27



Accurate
Manufactured
Products
Group

Phone: 317-472-9000 • FAX: 317-472-9010 • email: sales@ampg.com • www.ampg.com





Tamperproof Sex Bolts

ALL-NEW EXTRA LARGE Tamperproof Sex Bolts

A solution for playground equipment, exercise equipment, detention centers, hospitals, or any other public spaces that need security hardware.

- Male screws available with or without shoulders.
- All parts are matched for a finished appearance.
- Both female and male bolts feature the 6-Lobe with Pin Security Drive.
- 6-Lobe drive has many advantages—
No cam out during installation
No head distortion during driving,
No special tooling required for both installation and removal.
- Head dimensions for both male and female parts are matched, per IFI standards.



See chart on facing page for available sizes and order numbers

ALL-NEW EXTRA LARGE Security Screws —18-8 Stainless Steel

Female Sex Bolts and Male Tamperproof Truss Head Screws are sold separately

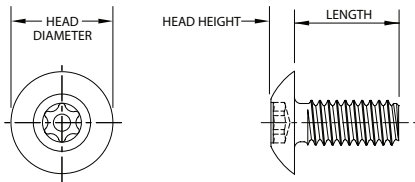
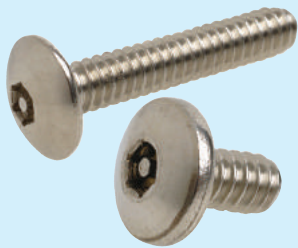

ALL-NEW EXTRA LARGE SHOULDER Security Screws —18-8 Stainless Steel

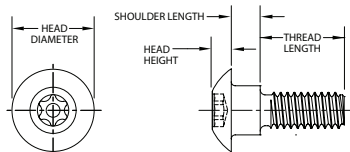

STANDARD 1/4" TRUSS HEAD
TAMPER RESISTANT 6-LOBE T27 DRIVE
GO GAGE PENETRATION: .070 MIN.

Tamperproof Security Tools for Extra Large Tamperproof Sex Bolts

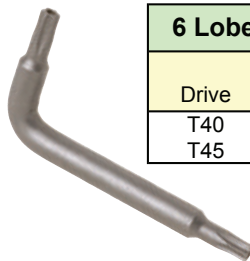

6 Lobe Hex Key	
Drive	Order Number
T40	KEYT40
T45	KEYT45



6 Lobe with Pin Bit		
Size	Hex Size	Order Number
T40	1/4"	BITT40
T45	1/4"	BITT45

SPECIAL ORDERS AVAILABLE—
Small Quantities to Large Volume



Tamperproof Sex Bolts



ALL-NEW EXTRA LARGE Truss Head Sex Bolts — 6 Lobe with Pin Security Drive

Female Sex Bolts and Male Tamperproof Truss Head Screws are sold separately

EXTRA LARGE 6 Lobe Tamperproof—Female Barrels							18-8 ST/ST
Barrel Diameter	Barrel Length	Thread Size	Thread Depth	Head Diameter	Head Height	Drive Size	Order Number
1/2	1/2"	3/8-16	5/16"	7/8"	1/4"	T40	Z4900T6S
	3/4	3/8-16	7/16	7/8	1/4	T40	Z4901T6S
	1	3/8-16	5/8	7/8	1/4	T40	Z4902T6S
	1-1/2	3/8-16	5/8	7/8	1/4	T40	Z4903T6S
	2	3/8-16	5/8	7/8	1/4	T40	Z4904T6S
5/8	1/2	1/2-13	5/16	1"	5/16"	T40	Z4906T6S
	3/4	1/2-13	7/16	1	5/16	T40	Z4907T6S
	1	1/2-13	5/8	1	5/16	T40	Z4908T6S
	1-1/2	1/2-13	5/8	1	5/16	T40	Z4909T6S
	2	1/2-13	5/8	1	5/16	T40	Z4910T6S
3/4	1/2	5/8-11	5/16	1-1/8"	3/8"	T45	Z4912T6S
	3/4	5/8-11	7/16	1-1/8	3/8	T45	Z4913T6S
	1	5/8-11	3/4	1-1/8	3/8	T45	Z4914T6S
	1-1/2	5/8-11	3/4	1-1/8	3/8	T45	Z4915T6S
	2	5/8-11	3/4	1-1/8	3/8	T45	Z4916T6S
7/8	1/2	3/4-10	5/16	1-1/4"	1/2"	T45	Z4918T6S
	3/4	3/4-10	7/16	1-1/4	1/2	T45	Z4919T6S
	1	3/4-10	3/4	1-1/4	1/2	T45	Z4920T6S
	1-1/2	3/4-10	3/4	1-1/4	1/2	T45	Z4921T6S
	2	3/4-10	3/4	1-1/4	1/2	T45	Z4922T6S

EXTRA LARGE 6 Lobe with Pin Truss Head Security Screws			18-8 STAINLESS STEEL	
Size	Head Diameter	Head Height	Drive	Order Number
3/8-16 x 3/4"	7/8"	1/4"	T40	Z4925SS
3/8-16 x 1-1/2	7/8	1/4	T40	Z4926SS
1/2-13 x 3/4	1	5/16	T40	Z4928SS
1/2-13 x 1-1/2	1	5/16	T40	Z4929SS
5/8-11 x 3/4	1-1/8	3/8	T45	Z4931SS
5/8-11 x 1-1/2	1-1/8	3/8	T45	Z4932SS
3/4-10 x 3/4	1-1/4	1/2	T45	Z4934SS
3/4-10 x 1-1/2	1-1/4	1/2	T45	Z4935SS

EXTRA LARGE 6 Lobe with Pin Truss Head Security Screws WITH SHOULDER							18-8 STAINLESS STEEL	
Size	Shoulder Diameter	Total Length Under Head	Shoulder Length	Thread Length	Head Diameter	Head Height	Drive	Order Number
3/8-16 x 3/4"	1/2"	1"	1/4"	3/4"	7/8"	1/4"	T40	Z4938SS
3/8-16 x 1-1/2	1/2	1-3/4	1/4	1-1/2	7/8	1/4	T40	Z4940SS
1/2-13 x 3/4	5/8	1	1/4	3/4	1	5/16	T40	Z4945SS
1/2-13 x 1-1/2	5/8	1-3/4	1/4	1-1/2	1	5/16	T40	Z4947SS
5/8-11 x 3/4	3/4	1	1/4	3/4	1-1/8	3/8	T45	Z4950SS
5/8-11 x 1-1/2	3/4	1-3/4	1/4	1-1/2	1-1/8	3/8	T45	Z4952SS
3/4-10 x 3/4	7/8	1	1/4	3/4	1-1/4	1/2	T45	Z4955SS
3/4-10 x 1-1/2	7/8	1-3/4	1/4	1-1/2	1-1/4	1/2	T45	Z4957SS





Tamperproof One-Way Sex Bolts

One Way Head Bathroom Partition Sex Bolts—The Complete System

Standard items for joining bathroom partitions and other secure installations.
One Way Tamperproof Heads — 18-8 Stainless Steel, with 10-24 threads.



See chart on facing page for available sizes and order numbers



Partition Information:

For 1/2" thick partitions, order (1) Z4378 Male and (1) Z4379 Female
For 1" thick partitions, order (1) Z4384 Male and (1) Z4381 Female
For 1-1/4" thick partitions, order (1) Z4384 Male and (1) Z4382 Female

Female Barrel

Stainless Steel—Truss Head with One Way Slot
1/4" barrel diameter • 10-24 threads
7/16" head diameter • Serrations under head

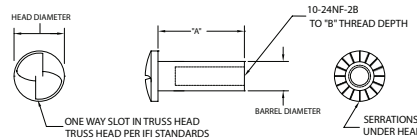

Male Shoulder Screw

Stainless Steel—Truss Head with One Way Slot
1/4" shoulder diameter • 10-24 threads
7/16" head diameter • Serrations under head

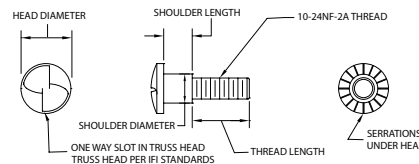

Male and Female Set

Stainless Steel—Truss Head with One Way Slot

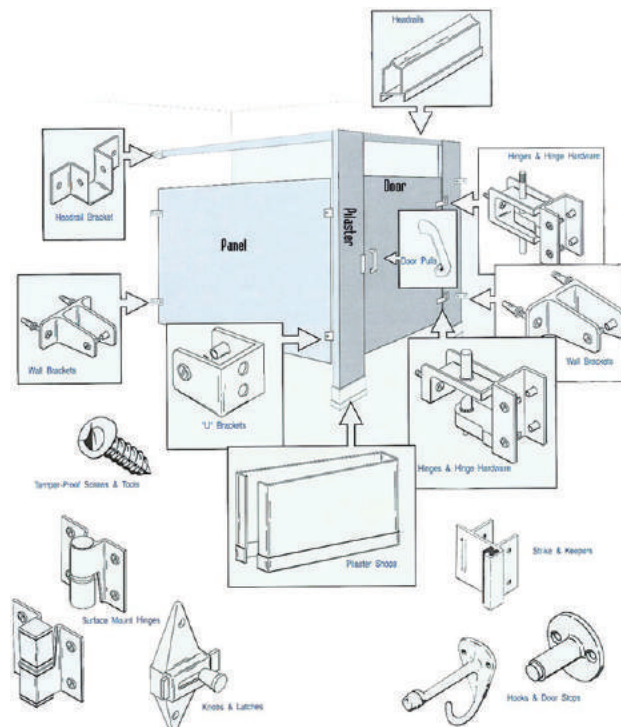

SPECIAL ORDERS AVAILABLE—
Small Quantities to Large Volume





Tamperproof One-Way Sex Bolts

One Way Head Partition Truss Head Female Barrel			18-8 STAINLESS STEEL	
Barrel Length	Barrel Diameter	Thread Size	Head Diameter	Order Number
1/4"	1/4"	10-24	7/16	Z4376
3/8	1/4	10-24	7/16	Z4379
1/2	1/4	10-24	7/16	Z4380
5/8	1/4	10-24	7/16	Z4377
3/4	1/4	10-24	7/16	Z4381
1	1/4	10-24	7/16	Z4382
One Way Head—No Serrations Under Head			STEEL ZINC	
1	5/16	12-24	31/64	Z4392

New Items in Red



One Way Head Partition Male Shoulder Screw			18-8 STAINLESS STEEL	
Shoulder Length	Total Length Under Head	Thread Length	Thread Size	Order Number
1/8	3/8	1/4	10-24	Z4378
1/8	1/2	3/8	10-24	Z4383
1/4	15/32	7/32	10-24	Z4375
1/4	19/32	11/32	10-24	Z4388
1/4	3/4	1/2	10-24	Z4384
1/4	15/16	11/16	10-24	Z4385
1/4	1-3/16	15/16	10-24	Z4386
1/4	1-5/16	1-1/16	10-24	Z4387



One Way Head Partition Sex Bolt Sets					18-8 STAINLESS STEEL	
Grip Range	Female Barrel Order Number	Female Barrel Length	Male Screw Order Number	Male Screw Shoulder Length	Quantity of Each Part	Set Order Number
1/2"	Z4379	3/8"	Z4378	1/8"	10	Z4379PAK
3/4	Z4380	1/2	Z4384	1/4	10	Z4380PAK
1	Z4381	3/4	Z4384	1/4	10	Z4381PAK
1-1/4	Z4382	1	Z4384	1/4	10	Z4382PAK



Button Head Socket Drive Barrel Bolts **USA** MADE

Button Head Socket Drive Barrel Bolts — Female 18-8 Stainless Steel

A line of contemporary barrel bolts that have a button head with a hex drive. The smooth domed appearance of the head lends a sleek finished look to all products and installations.

Our standard size range is from 1/4" diameter x 3/8" length up to 7/8" diameter x 3" length. Manufactured in the USA from durable and corrosion-resistant Type 303 Stainless Steel, these parts are fully machined for a more precise part.

Used in industrial, construction, marine, and transportation, they provide excellent strength and versatility. Used in furniture and commercial applications, they present a beautiful modern look and finished appearance.

Specials in any size are available with a quick turn-around from our factory.

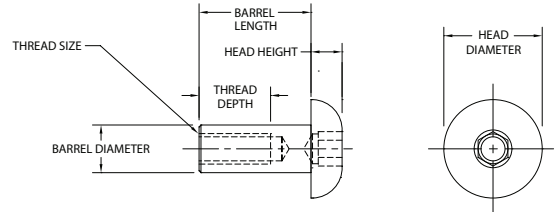

See chart on facing page for available sizes and order numbers



THESE SEX BOLTS ARE ALL MADE IN USA

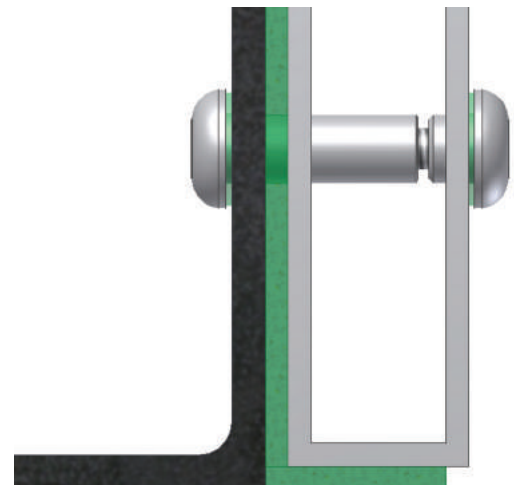
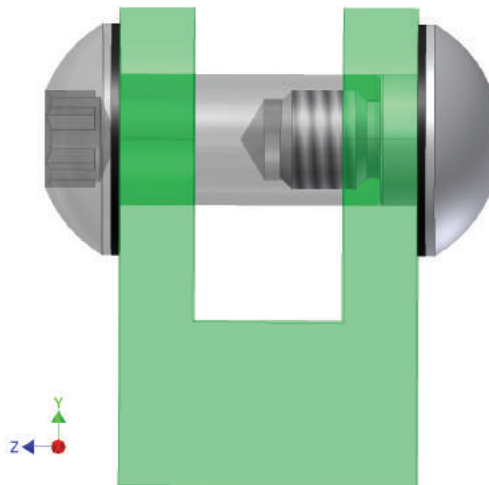

SPECIAL ORDERS AVAILABLE—
Small Quantities to Large Volume



USA MADE



Button Head Socket Drive

USA **MADE**

Button Head Socket Drive—Female Barrels							18-8 Stainless Steel	
Barrel Diameter	Barrel Length	Thread Size	Thread Depth	Head Diameter	Head Height	Hex Key Size	Order Number	
1/4	3/8"	10-24	3/16"	7/16"	1/8"	5/32"	Z1600	
	1/2	10-24	5/16	7/16	1/8	5/32	Z1602	
	3/4	10-24	3/8	7/16	1/8	5/32	Z1604	
	1	10-24	3/8	7/16	1/8	5/32	Z1606	
	1-1/4	10-24	3/8	7/16	1/8	5/32	Z1608	
3/8	1/2	1/4-20	3/8	21/32	3/16	7/32	Z1616	
	3/4	1/4-20	3/8	21/32	3/16	7/32	Z1618	
	1	1/4-20	3/8	21/32	3/16	7/32	Z1620	
1/2	1/2	3/8-16	3/8	7/8	1/4	5/16	Z1630	
	5/8	3/8-16	3/8	7/8	1/4	5/16	Z1631	
	3/4	3/8-16	3/8	7/8	1/4	5/16	Z1632	
	7/8	3/8-16	3/8	7/8	1/4	5/16	Z1633	
	1	3/8-16	3/8	7/8	1/4	5/16	Z1634	
	1-1/2	3/8-16	3/8	7/8	1/4	5/16	Z1710	
	1-3/4	3/8-16	3/8	7/8	1/4	5/16	Z1712	
	2	3/8-16	3/8	7/8	1/4	5/16	Z1714	
	2-1/2	3/8-16	3/8	7/8	1/4	5/16	Z1716	
3	3/8-16	3/8	7/8	1/4	5/16	Z1718		
5/8	1/2	1/2-13	5/16	1"	5/16	3/8	Z1720	
	3/4	1/2-13	7/16	1"	5/16	3/8	Z1722	
	1	1/2-13	5/8	1"	5/16	3/8	Z1724	
	1-1/2	1/2-13	5/8	1"	5/16	3/8	Z1726	
	1-3/4	1/2-13	5/8	1"	5/16	3/8	Z1728	
	2	1/2-13	5/8	1"	5/16	3/8	Z1800	
	2-1/2	1/2-13	5/8	1"	5/16	3/8	Z1802	
3	1/2-13	5/8	1"	5/16	3/8	Z1804		
3/4	1/2	5/8-11	5/16	1-1/8	3/8	3/8	Z1806	
	3/4	5/8-11	7/16	1-1/8	3/8	3/8	Z1808	
	1	5/8-11	3/4	1-1/8	3/8	3/8	Z1810	
	1-1/2	5/8-11	3/4	1-1/8	3/8	3/8	Z1812	
	1-3/4	5/8-11	3/4	1-1/8	3/8	3/8	Z1814	
	2	5/8-11	3/4	1-1/8	3/8	3/8	Z1816	
	2-1/2	5/8-11	3/4	1-1/8	3/8	3/8	Z1818	
3	5/8-11	3/4	1-1/8	3/8	3/8	Z1820		
7/8	1/2	5/8-11	5/16	1-1/4	1/2	1/2	Z1822	
	3/4	5/8-11	7/16	1-1/4	1/2	1/2	Z1824	
	1	5/8-11	3/4	1-1/4	1/2	1/2	Z1826	
	1-1/2	5/8-11	3/4	1-1/4	1/2	1/2	Z1828	
	1-3/4	5/8-11	3/4	1-1/4	1/2	1/2	Z1830	
	2	5/8-11	3/4	1-1/4	1/2	1/2	Z1832	
	2-1/2	5/8-11	3/4	1-1/4	1/2	1/2	Z1834	
	3	5/8-11	3/4	1-1/4	1/2	1/2	Z1836	

NEW EXPANDED LINE—LARGER SIZES NOW AVAILABLE

Button Head Socket Drive—Male Mating Screws							18-8 Stainless Steel	
Shoulder Diameter	Length Under Head	Shoulder Length	Thread Size	Thread Length	Head Diameter	Head Height	Hex Key Size	Order Number
1/4	1/4"	NONE	10-24	1/4"	7/16"	1/8"	5/32"	Z1838
	1/2	1/4	10-24	1/4	7/16	1/8	5/32	Z1768
	1	1/2	10-24	1/2	7/16	1/8	5/32	Z1769
3/8	3/8	NONE	1/4-20	3/8	21/32	3/16	7/32	Z1840
	3/4	1/4	1/4-20	1/2	21/32	3/16	7/32	Z1624
	1	1/2	1/4-20	1/2	21/32	3/16	7/32	Z1770
1/2	1/2"	NONE	3/8-16	1/2"	7/8	1/4	5/16	Z1842
	1	1/2	3/8-16	1/2	7/8	1/4	5/16	Z1772
	1-1/2	1	3/8-16	1/2	7/8	1/4	5/16	Z1774
	2	1-1/2	3/8-16	1/2	7/8	1/4	5/16	Z1776
5/8	1/2"	NONE	1/2-13	1/2"	1"	5/16	3/8	Z1844
	1	1/2	1/2-13	1/2	1"	5/16	3/8	Z1778
	1-1/2	1	1/2-13	1/2	1"	5/16	3/8	Z1780
	2	1-1/2	1/2-13	1/2	1"	5/16	3/8	Z1782
3/4	1/2"	NONE	5/8-11	1/2"	1-1/8	3/8	3/8	Z1846
	1	1/2	5/8-11	1/2	1-1/8	3/8	3/8	Z1784
	1-1/2	1	5/8-11	1/2	1-1/8	3/8	3/8	Z1786
	2	1-1/2	5/8-11	1/2	1-1/8	3/8	3/8	Z1788
7/8	1/2"	NONE	5/8-11	1/2"	1-1/4	3/8	3/8	Z1848
	1	1/2	5/8-11	1/2	1-1/4	3/8	3/8	Z1790
	1-1/2	1	5/8-11	1/2	1-1/4	3/8	3/8	Z1792
	2	1-1/2	5/8-11	1/2	1-1/4	3/8	3/8	Z1794



THESE SEX BOLTS ARE ALL MADE IN USA



Accurate Manufactured Products Group

USA **MADE**

Phone: 317-472-9000 • FAX: 317-472-9010 • email: sales@ampg.com • www.ampg.com



82° Flat Head Socket Drive Barrel Bolts **USA** **MADE**

82 Degree Flat Head Socket Drive Barrel Bolts — Female

18-8 Stainless Steel

Our 82° Flat Head Barrel Bolts are designed for use with countersunk holes, which allow the fasteners to sit flush with the surface, providing a clean and finished appearance. Made in the USA from Type 303 Stainless Steel which offers an excellent combination of strength and corrosion resistance.

Our standard size range is from 1/4" diameter x 3/8" length up to 7/8" diameter x 3" length. Specials are available in any size, call or email for a quote.



USA **MADE**

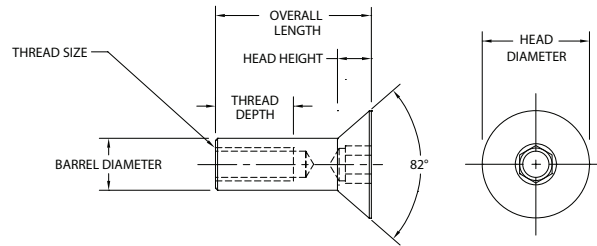

**THESE
SEX BOLTS
ARE ALL
MADE IN
USA**

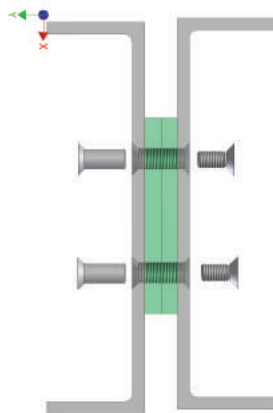
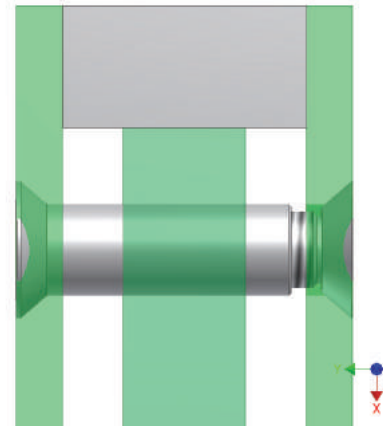

**SPECIAL ORDERS
AVAILABLE—
Small Quantities
to Large Volume**





82° Flat Head Socket Drive

USA **MADE**

82° Flat Head Socket Drive—Female Barrels							18-8 Stainless Steel
Barrel Diameter	Overall Length	Thread Size	Thread Depth	Head Diameter	Head Height	Hex Key Size	Order Number
1/4	3/8"	10-24	3/16*	33/64"	11/64"	5/32"	Z1640
	1/2	10-24	5/16*	33/64	11/64	5/32	Z1642
	3/4	10-24	3/8	33/64	11/64	5/32	Z1644
	1	10-24	3/8	33/64	11/64	5/32	Z1646
	1-1/4	10-24	3/8	33/64	11/64	5/32	Z1648
3/8	1/2	1/4-20	3/16*	3/4	15/64	7/32	Z1650
	3/4	1/4-20	3/8	3/4	15/64	7/32	Z1652
	1	1/4-20	3/8	3/4	15/64	7/32	Z1654
1/2	1/2	3/8-16	3/16*	7/8	1/4	5/16	Z1660
	3/4	3/8-16	3/8	7/8	1/4	5/16	Z1662
	1	3/8-16	1/2	7/8	1/4	5/16	Z1664
	1-1/2	3/8-16	1/2	7/8	1/4	5/16	Z1665
	1-3/4	3/8-16	1/2	7/8	1/4	5/16	Z1667
	2	3/8-16	1/2	7/8	1/4	5/16	Z1669
	2-1/2	3/8-16	1/2	7/8	1/4	5/16	Z1670
3	3/8-16	1/2	7/8	1/4	5/16	Z1671	
5/8	1/2	1/2-13	1/4*	1"	1/4	3/8	Z1672
	3/4	1/2-13	3/8	1"	1/4	3/8	Z1674
	1	1/2-13	5/8	1"	1/4	3/8	Z1676
	1-1/2	1/2-13	3/4	1"	1/4	3/8	Z1678
	1-3/4	1/2-13	3/4	1"	1/4	3/8	Z1680
	2	1/2-13	3/4	1"	1/4	3/8	Z1682
	2-1/2	1/2-13	3/4	1"	1/4	3/8	Z1683
3	1/2-13	3/4	1"	1/4	3/8	Z1684	
3/4	1/2	5/8-11	1/4*	1-1/8	1/4	3/8	Z1686
	3/4	5/8-11	3/8	1-1/8	1/4	3/8	Z1688
	1	5/8-11	5/8	1-1/8	1/4	3/8	Z1690
	1-1/2	5/8-11	3/4	1-1/8	1/4	3/8	Z1692
	1-3/4	5/8-11	3/4	1-1/8	1/4	3/8	Z1694
	2	5/8-11	3/4	1-1/8	1/4	3/8	Z1696
	2-1/2	5/8-11	3/4	1-1/8	1/4	3/8	Z1698
3	5/8-11	3/4	1-1/8	1/4	3/8	Z1699	
7/8	1/2	5/8-11	1/4*	1-1/4	1/4	1/2	Z1700
	3/4	5/8-11	3/8	1-1/4	1/4	1/2	Z1701
	1	5/8-11	5/8	1-1/4	1/4	1/2	Z1702
	1-1/2	5/8-11	3/4	1-1/4	1/4	1/2	Z1703
	1-3/4	5/8-11	3/4	1-1/4	1/4	1/2	Z1704
	2	5/8-11	3/4	1-1/4	1/4	1/2	Z1705
	2-1/2	5/8-11	3/4	1-1/4	1/4	1/2	Z1706
3	5/8-11	3/4	1-1/4	1/4	1/2	Z1707	

* Open Head

Flat Head Socket Drive—Male Mating Screws							18-8 Stainless Steel
Thread Size	Overall Length	Thread Length	Head Diameter	Head Height	Hex Key Size	Order Number	
10-24	3/8"	5/32"	33/64"	11/64"	5/32"	Z1730	
	5/8	25/64	33/64	11/64	5/32	Z1732	
	1	49/64	33/64	11/64	5/32	Z1734	
1/4-20	3/4	7/16	3/4	15/64	7/32	Z1736	
3/8-16	3/4	3/8	7/8	1/4	5/16	Z1738	
	1-1/4	7/8	7/8	1/4	5/16	Z1740	
	1-3/4	1	7/8	1/4	5/16	Z1742	
1/2-13	3/4	3/8	1"	1/4	3/8	Z1744	
	1-1/4	7/8	1"	1/4	3/8	Z1746	
	1-3/4	1	1"	1/4	3/8	Z1748	
5/8-11	3/4	3/8	1-1/8	1/4	3/8	Z1750	
	1-1/4	7/8	1-1/8	1/4	3/8	Z1752	
	1-3/4	1	1-1/8	1/4	3/8	Z1754	
	3/4	3/8	1-1/4	1/4	1/2	Z1756	
	1-1/4	7/8	1-1/4	1/4	1/2	Z1758	
1-3/4	1	1-1/4	1/4	1/2	Z1760		

NEW EXPANDED LINE—LARGER SIZES NOW AVAILABLE



THESE SEX BOLTS ARE ALL MADE IN USA

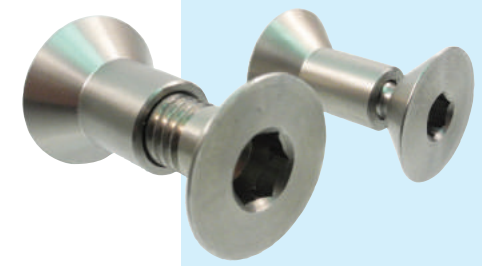

Accurate Manufactured Products Group

Phone: 317-472-9000 • FAX: 317-472-9010 • email: sales@ampg.com • www.ampg.com

USA **MADE**





Low Profile Head Socket Drive Bolts



Low Profile Head Socket Drive Bolts

Type 316 Stainless Steel

This line of matched head mating fasteners was developed for an Architect who required specific holding parameters in a low profile head that would blend into the project design. The heads of these low-profile barrel bolts are ideal in applications where material to be fastened is too thin to countersink; not allowing the use of countersunk screws. The large diameter heads of the low-profile barrel bolts were engineered to spread the load across a wide surface to provide greater holding power in thinner material applications. When looking for a mating fastener that can be more concealed than button and flat head style fasteners, low-profile head socket drive barrel bolts offer a sleek, unobtrusive and polished finish for any design.

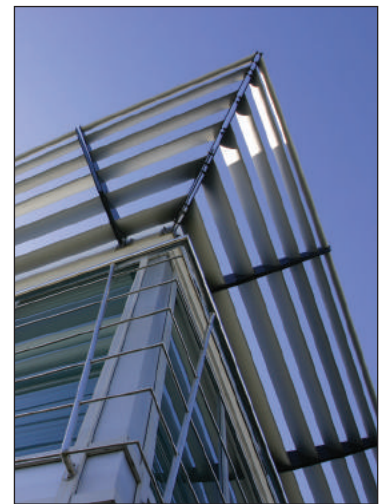
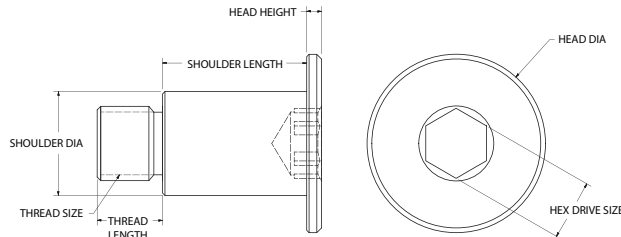
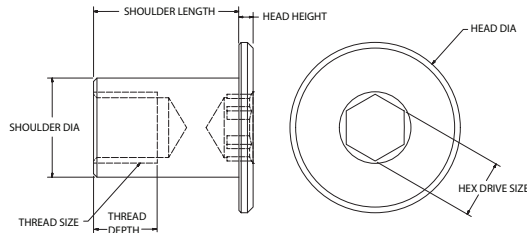

**THESE
SEX BOLTS
ARE ALL
MADE IN
USA**

**SPECIAL ORDERS
AVAILABLE—
Small Quantities
to Large Volume**

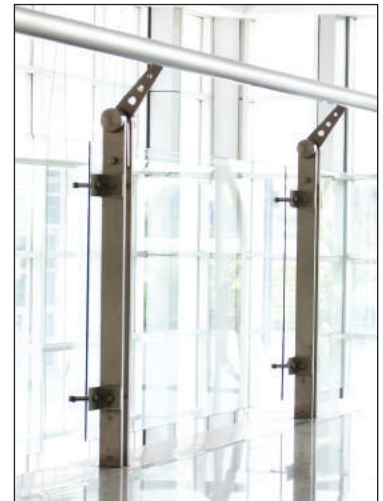
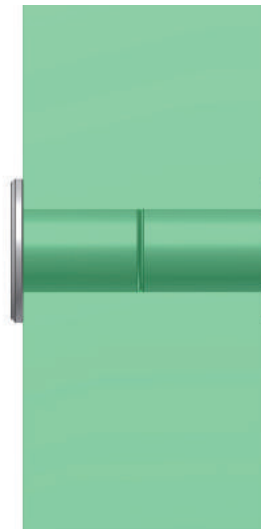



Low Profile Head Socket Drive Bolts

Low-Profile Head Socket Drive—Female Barrels							Type 316 SS	
Barrel Diameter	Barrel Length	Thread Size	Thread Depth	Head Diameter	Head Height	Hex Key Size	Order Number	
1/4"	3/8"	10-24	3/16"	9/16"	3/32"	5/32"	Z1508	
	1/2	10-24	5/16	9/16	3/32	5/32	Z1510	
	3/4	10-24	3/8	9/16	3/32	5/32	Z1512	
	1	10-24	3/8	9/16	3/32	5/32	Z1514	
	1-1/4	10-24	3/8	9/16	3/32	5/32	Z1516	
3/8"	1/2*	1/4-20	3/8*	25/32	3/32	7/32	Z1518	
	3/4	1/4-20	3/8	25/32	3/32	7/32	Z1520	
	1	1/4-20	3/8	25/32	3/32	7/32	Z1522	
1/2"	1/2*	3/8-16	3/8*	1	3/32	1/4	Z1524	
	3/4	3/8-16	3/8	1	3/32	1/4	Z1526	
	1	3/8-16	3/8	1	3/32	1/4	Z1528	
	1-1/2	3/8-16	3/8	1	3/32	1/4	Z1530	
	1-3/4	3/8-16	3/8	1	3/32	1/4	Z1532	
	2	3/8-16	3/8	1	3/32	1/4	Z1534	
	2-1/2	3/8-16	3/8	1	3/32	1/4	Z1536	
5/8"	3/4	1/2-13	7/16	1-1/8	1/8	3/8	Z1542	
	1	1/2-13	5/8	1-1/8	1/8	3/8	Z1544	
	1-1/2	1/2-13	5/8	1-1/8	1/8	3/8	Z1546	
	1-3/4	1/2-13	5/8	1-1/8	1/8	3/8	Z1548	
	2	1/2-13	5/8	1-1/8	1/8	3/8	Z1550	
	2-1/2	1/2-13	5/8	1-1/8	1/8	3/8	Z1552	
3/4"	3/4	5/8-11	7/16	1-3/8	1/8	3/8	Z1558	
	1	5/8-11	3/4	1-3/8	1/8	3/8	Z1560	
	1-1/2	5/8-11	3/4	1-3/8	1/8	3/8	Z1562	
	1-3/4	5/8-11	3/4	1-3/8	1/8	3/8	Z1564	
	2	5/8-11	3/4	1-3/8	1/8	3/8	Z1566	
	2-1/2	5/8-11	3/4	1-3/8	1/8	3/8	Z1570	
7/8"	3/4	5/8-11	7/16	1-1/2	1/8	1/2	Z1574	
	1	5/8-11	3/4	1-1/2	1/8	1/2	Z1576	
	1-1/2	5/8-11	3/4	1-1/2	1/8	1/2	Z1578	
	1-3/4	5/8-11	3/4	1-1/2	1/8	1/2	Z1580	
	2	5/8-11	3/4	1-1/2	1/8	1/2	Z1582	
	2-1/2	5/8-11	3/4	1-1/2	1/8	1/2	Z1584	

Low-Profile Head Socket Drive—Male Mating Screws							Type 316 SS	
Shoulder Diameter	Length Under Head	Shoulder Length	Thread Size	Thread Length	Head Diameter	Head Height	Hex Key Size	Order Number
1/4"	1/4"	NONE	10-24	1/4"	9/16"	3/32"	5/32"	Z1900
	1/2	1/4	10-24	1/4	9/16	3/32	5/32	Z1902
	1	1/2	10-24	1/2	9/16	3/32	5/32	Z1904
3/8"	3/8	NONE	1/4-20	3/8	25/32	3/32	7/32	Z1906
	3/4	1/4	1/4-20	1/2	25/32	3/32	7/32	Z1908
	1	1/2	1/4-20	1/2	25/32	3/32	7/32	Z1910
1/2"	1/2	NONE	3/8-16	1/2	1	3/32	1/4	Z1912
	1	1/2	3/8-16	1/2	1	3/32	1/4	Z1914
	1-1/2	1	3/8-16	1/2	1	3/32	1/4	Z1916
	2	1-1/2	3/8-16	1/2	1	3/32	1/4	Z1918
5/8"	1/2	NONE	1/2-13	1/2	1-1/8	1/8	3/8	Z1920
	1	1/2	1/2-13	1/2	1-1/8	1/8	3/8	Z1922
	1-1/2	1	1/2-13	1/2	1-1/8	1/8	3/8	Z1924
	2	1-1/2	1/2-13	1/2	1-1/8	1/8	3/8	Z1926
3/4"	1/2	NONE	5/8-11	1/2	1-3/8	1/8	3/8	Z1928
	1	1/2	5/8-11	1/2	1-3/8	1/8	3/8	Z1930
	1-1/2	1	5/8-11	1/2	1-3/8	1/8	3/8	Z1932
	2	1-1/2	5/8-11	1/2	1-3/8	1/8	3/8	Z1934
7/8"	1/2	NONE	5/8-11	1/2	1-1/2	1/8	3/8	Z1936
	1	1/2	5/8-11	1/2	1-1/2	1/8	3/8	Z1938
	1-1/2	1	5/8-11	1/2	1-1/2	1/8	3/8	Z1940
	2	1-1/2	5/8-11	1/2	1-1/2	1/8	3/8	Z1942

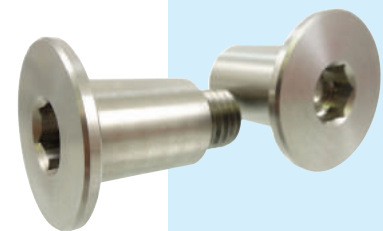

**THESE
SEX BOLTS
ARE ALL
MADE IN
USA**



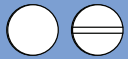

Binding Posts



Aluminum Binding Posts & Screws

Accurate has the largest selection of Binding Posts available with either a Rivet Head or a Truss Head. They are also available in several materials—Aluminum, Stainless Steel, and Solid Brass. Aluminum available Black Anodized on special order.

In addition to the standard printing industry binding applications, binding posts provide a clean, flush, and secure fastener for many other applications, such as helmets, as shown below.

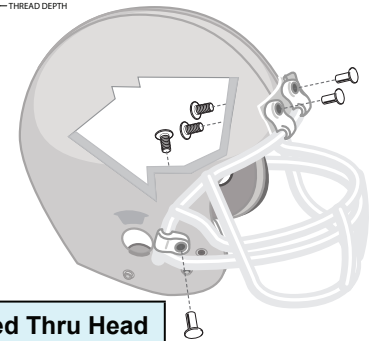
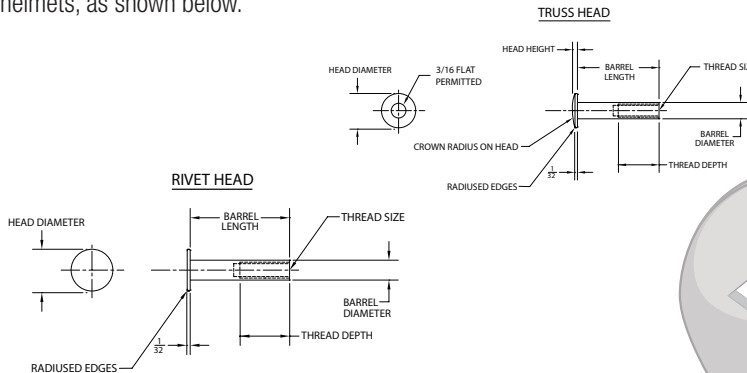
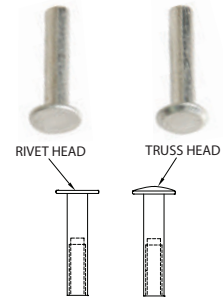

Female Barrels—Plain Aluminum

Truss Head Aluminum Binding Posts—Female—Tapped Thru Head						
1/8"	13/64	13/32	.050-.070	8-32	Unlimited	Z4302X
3/16"	13/64	13/32	.050-.070	8-32	Unlimited	Z4303
1/4"	13/64	13/32	.050-.070	8-32	Unlimited	Z4304
3/8"	13/64	13/32	.050-.070	8-32	Unlimited	Z4306X
1/2"	13/64	13/32	.050-.070	8-32	Unlimited	Z4308T



SPECIAL ORDERS AVAILABLE—
Small Quantities to Large Volume

Aluminum Binding Posts—Female Barrels						Rivet Head Closed Top	Truss Head Closed Top
Barrel Length	Barrel Diameter	Head Diameter	Head Height	Threads	Thread Depth	Order Number	Order Number
1/4"	13/64	13/32	.040-.070	8-32	3/16	Z4304C	—
3/8"	13/64	13/32	.040-.070	8-32	1/4	Z4306C	Z4306T
1/2"	13/64	13/32	.040-.070	8-32	3/8	Z4308	Z4308X
5/8"	13/64	13/32	.040-.070	8-32	3/8	Z4310	Z4310X
3/4"	13/64	13/32	.040-.070	8-32	3/8	Z4312	Z4312X
7/8"	13/64	13/32	.040-.070	8-32	3/8	—	Z4314X
1"	13/64	13/32	.040-.070	8-32	3/8	Z4316	Z4316X
1-1/4"	13/64	13/32	.040-.070	8-32	3/8	Z4320	Z4320X
1-1/2"	13/64	13/32	.040-.070	8-32	3/8	Z4324	Z4324X
1-3/4"	13/64	13/32	.040-.070	8-32	3/8	Z4328	Z4328X
2"	13/64	13/32	.040-.070	8-32	3/8	Z4332	Z4332X
2-1/4"	13/64	13/32	.040-.070	8-32	3/8	Z4336	Z4336X
2-1/2"	13/64	13/32	.040-.070	8-32	3/8	Z4344	Z4344X
2-3/4"	13/64	13/32	.040-.070	8-32	3/8	Z4346	Z4346X
3"	13/64	13/32	.040-.070	8-32	3/8	Z4348	Z4348X
3-1/4"	13/64	13/32	.040-.070	8-32	3/8	—	Z4350
3-1/2"	13/64	13/32	.040-.070	8-32	3/8	—	Z4358X
4"	13/64	13/32	.040-.070	8-32	3/8	—	Z4364X
4-1/2"	13/64	13/32	.040-.070	8-32	3/8	—	Z4366X
5"	13/64	13/32	.040-.070	8-32	3/8	—	Z4368X
6"	13/64	13/32	.040-.070	8-32	3/8	—	Z4396X



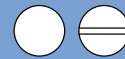

Binding Posts

Binding Post Screws— Plain Aluminum

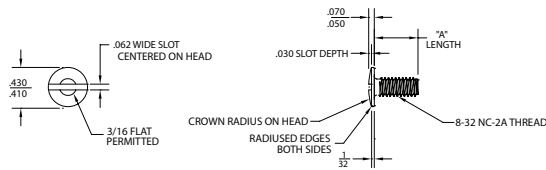

Aluminum Binding Post Screws			
Screw Size	Head Diameter	Head Height	Order Number
8-32 X 3/16	13/32	.050-.070	Z4302
8-32 X 1/4	13/32	.050-.070	Z4301
8-32 X 5/16	13/32	.050-.070	Z4300516
8-32 X 3/8	13/32	.050-.070	Z4300



Binding Post Sets— Plain Aluminum

Plain Aluminum Binding Post Sets						
Grip Range	Female Barrel Order Number	Female Barrel Length	Male Screw Order Number	Male Screw Length	Quantity of Each Part	Set Order Number
1/8"	Z4302X	1/8"	Z4302	3/16"	50	Z4302XPAK
3/16	Z4303	3/16	Z4302	3/16	50	Z4303PAK
1/4	Z4304C	1/4	Z4302	3/16	50	Z4304CPAK
3/8	Z4306C	3/8	Z4301	1/4	50	Z4306CPAK
1/2	Z4308	1/2	Z4301	1/4	50	Z4308PAK
5/8	Z4310	5/8	Z4301	1/4	50	Z4310PAK
3/4	Z4312	3/4	Z4301	1/4	50	Z4312PAK
7/8	Z4314X	7/8	Z4301	1/4	50	Z4314XPAK
1	Z4316	1	Z4301	1/4	50	Z4316PAK
1-1/4	Z4320	1-1/4	Z4301	1/4	50	Z4320PAK
1-1/2	Z4324	1-1/2	Z4301	1/4	50	Z4324PAK
1-3/4	Z4328	1-3/4	Z4301	1/4	25	Z4328PAK
2	Z4332	2	Z4301	1/4	50	Z4332PAK
2-1/4	Z4336	2-1/4	Z4301	1/4	50	Z4336PAK
2-1/2	Z4344	2-1/2	Z4301	1/4	50	Z4344PAK
2-3/4	Z4346	2-3/4	Z4301	1/4	50	Z4346PAK
3	Z4348	3	Z4301	1/4	50	Z4348PAK
3-1/2	Z4358X	3-1/2	Z4301	1/4	50	Z4358XPAK
4	Z4364X	4	Z4301	1/4	50	Z4364XPAK
4-1/2	Z4366X	4-1/2	Z4301	1/4	50	Z4366XPAK
5	Z4368X	5	Z4301	1/4	50	Z4368XPAK
6	Z4396X	6	Z4301	1/4	50	Z4396XPAK

Female Barrel has no slot — Male Screw has Slotted Truss Head
Plain Aluminum — Male and Female Barrel Packaged Together



Binding Post Extensions— Plain Aluminum

Binding Post Extensions—Aluminum						
Barrel Diameter	Barrel Length	Thread Size	Internal Tap Depth	External Stud Lth	Plating	Order Number
13/64	1/4	8-32	3/16	1/8	None	Z4370
13/64	1/2	8-32	3/8	1/4	None	Z4371
13/64	3/4	8-32	3/8	1/4	None	Z4372
13/64	3/4	8-32	3/8	1/4	Black	Z4372-BK
13/64	1	8-32	3/8	1/4	None	Z4373



Dimensions match the standard Aluminum Binding Posts
Threads: 8-32 Male, 8-32 Female

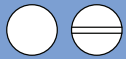

Binding Posts



Aluminum Binding Post—Female Barrel with Steel Permanent Drive Cap

Aluminum Female Barrel: Barrel Dia. 13/64", 8-32 Threads, Head Dia. 13/32", Head Height .040/.070".

Permanent Drive Screw: Steel with Nickel Plating. No Slot— These are tapped in, and cannot be unscrewed. Head Dia. .375-.410". Thread is spiral U Drive for permanent installation, .150" diameter.



Aluminum Binding Post Barrel & Steel Permanent Drive Cap						
Grip Range	Female Barrel Length	Male Screw Length	Female Barrel Order Number	Male Screw Order Number	Quantity of Each Part	Set Order Number
3/8"	3/8"	3/8"	Z4306X	Z4684	50	Z4306XCAP
1/2"	1/2"	3/8"	Z4308	Z4684	50	Z4308CAP
5/8"	5/8"	3/8"	Z4310	Z4684	50	Z4310CAP
3/4"	3/4"	3/8"	Z4312	Z4684	50	Z4312CAP
7/8"	7/8"	3/8"	Z4314X	Z4684	50	Z4314XCAP
1"	1"	3/8"	Z4316X	Z4684	25	Z4316XCAP
1-1/4"	1-1/4"	3/8"	Z4320	Z4684	25	Z4320CAP
1-1/2"	1-1/2"	3/8"	Z4324	Z4684	25	Z4324CAP
1-3/4"	1-3/4"	3/8"	Z4328	Z4684	25	Z4328CAP
2"	2"	3/8"	Z4332	Z4684	25	Z4332CAP

New Items in Red

Truss Head Black Anodized Aluminum—Female Barrels



Truss Head Binding Post—Female—Black Anodized Aluminum Tapped Thru The Head						
Barrel Length	Barrel Diameter	Head Diameter	Head Height	Thread Threads	Thread Depth	Order Number
1/8"	13/64	13/32	.050-.070	8-32	Unlimited	Z4302-BK
3/16"	13/64	13/32	.050-.070	8-32	Unlimited	Z4303-BK
1/4"	13/64	13/32	.050-.070	8-32	Unlimited	Z4304-BK
3/8"	13/64	13/32	.050-.070	8-32	Unlimited	Z4306-BK



Truss Head Binding Post—Female—Black Anodized Aluminum—Closed Top						
Barrel Length	Barrel Diameter	Head Diameter	Head Height	Thread Threads	Thread Depth	Order Number
3/8"	13/64	13/32	.040-.070	8-32	1/4	Z4306C-BK
1/2"	13/64	13/32	.040-.070	8-32	3/8	Z4308X-BK
5/8"	13/64	13/32	.040-.070	8-32	3/8	Z4310X-BK
3/4"	13/64	13/32	.040-.070	8-32	3/8	Z4312X-BK
7/8"	13/64	13/32	.040-.070	8-32	3/8	Z4314X-BK
1"	13/64	13/32	.040-.070	8-32	3/8	Z4316X-BK
1-1/4"	13/64	13/32	.040-.070	8-32	3/8	Z4320X-BK
1-1/2"	13/64	13/32	.040-.070	8-32	3/8	Z4324X-BK
1-3/4"	13/64	13/32	.040-.070	8-32	3/8	Z4328X-BK
2"	13/64	13/32	.040-.070	8-32	3/8	Z4332X-BK
2-1/2"	13/64	13/32	.040-.070	8-32	3/8	Z4344X-BK
2-3/4"	13/64	13/32	.040-.070	8-32	3/8	Z4346X-BK
3"	13/64	13/32	.040-.070	8-32	3/8	Z4348X-BK
4"	13/64	13/32	.040-.070	8-32	3/8	Z4364X-BK
4-1/2"	13/64	13/32	.040-.070	8-32	3/8	Z4366X-BK
5"	13/64	13/32	.040-.070	8-32	3/8	Z4368X-BK
6"	13/64	13/32	.040-.070	8-32	3/8	Z4396X-BK

SPECIAL ORDERS AVAILABLE—
Small Quantities to Large Volume



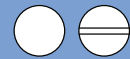

Binding Posts

Truss Head Black Anodized Aluminum—Male Screws

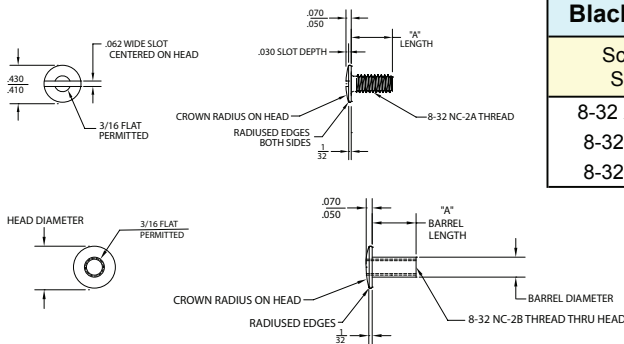

Black Anodized Aluminum Binding Post Screws			
Screw Size	Head Diameter	Head Height	Order Number
8-32 X 3/16	13/32	.050-.070	Z4302S-BK
8-32 X 1/4	13/32	.050-.070	Z4301-BK
8-32 X 3/8	13/32	.050-.070	Z4300-BK



Truss Head Black Anodized Aluminum—Sets

Female Barrel has no slot — Male Screw has Slotted Truss Head
Male Screw and Female Barrel Packaged Together as Set

Aluminum Binding Post Sets—Black Anodized Aluminum							
Grip Range	Female Barrel Length	Female Thread Depth	Male Screw Length	Female Barrel Order Number	Male Screw Order Number	Quantity of Each Part	Set Order Number
1/8"	1/8"	OPEN	3/16"	Z4302-BK	Z4302S-BK	25	Z4374150
3/16	3/16	OPEN	3/16	Z4303-BK	Z4302S-BK	25	Z4374151
1/4	1/4	OPEN	3/8	Z4304-BK	Z4300-BK	25	Z4374100
3/8	3/8	OPEN	3/8	Z4306-BK	Z4300-BK	25	Z4374102
1/2	1/2	1/4"	3/8	Z4308X-BK	Z4300-BK	25	Z4374103
5/8	5/8	3/8	3/8	Z4310X-BK	Z4300-BK	25	Z4374152
3/4	3/4	3/8	3/8	Z4312X-BK	Z4300-BK	25	Z4374153
7/8	7/8	3/8	3/8	Z4314X-BK	Z4300-BK	25	Z4374154
1	1	3/8	3/8	Z4316X-BK	Z4300-BK	10	Z4374155
1-1/4	1-1/4	3/8	3/8	Z4320X-BK	Z4300-BK	10	Z4374156
1-1/2	1-1/2	3/8	3/8	Z4324X-BK	Z4300-BK	10	Z4374157
1-3/4	1-3/4	3/8	3/8	Z4328X-BK	Z4300-BK	5	Z4374158
2	2	3/8	3/8	Z4332X-BK	Z4300-BK	5	Z4374159
2-1/2	2-1/2	3/8	3/8	Z4344X-BK	Z4300-BK	5	Z4374160
3	3	3/8	3/8	Z4348X-BK	Z4300-BK	5	Z4374161
4	4	3/8	3/8	Z4364X-BK	Z4300-BK	5	Z4374162
5	5	3/8	3/8	Z4368X-BK	Z4300-BK	5	Z4374163
6	6	3/8	3/8	Z4396X-BK	Z4300-BK	5	Z4374164



18-8 Stainless Steel Binding Posts—Open Truss Head Female Barrels

18-8 Stainless Steel Binding Posts—Female—Open Truss Head						
Barrel Length	Barrel Diameter	Head Diameter	Head Height	Threads	Thread Depth	Order Number
1/8"	13/64"	13/32"	.050-.070"	8-32	Unlimited	Z4302X-SS
3/16"	13/64	13/32	.050-.070	8-32	Unlimited	Z4303-SS
1/4"	13/64	13/32	.050-.070	8-32	Unlimited	Z4304-SS



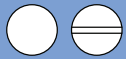

Binding Posts

18-8 Stainless Steel Binding Posts—Female—Truss Head



18-8 Stainless Steel Binding Posts—Female—Closed Truss Head						
Barrel Length	Barrel Diameter	Head Diameter	Head Height	Threads	Thread Depth	Order Number
1/4"	13/64	13/32	.040-.070	8-32	5/32	Z4304C-SS
3/8"	13/64	13/32	.040-.070	8-32	1/4	Z4306C-SS
1/2"	13/64	13/32	.040-.070	8-32	5/16	Z4308-SS
5/8"	13/64	13/32	.040-.070	8-32	3/8	Z4310-SS
3/4"	13/64	13/32	.040-.070	8-32	3/8	Z4312-SS
7/8"	13/64	13/32	.040-.070	8-32	3/8	Z4314X-SS
1"	13/64	13/32	.040-.070	8-32	3/8	Z4316-SS
1-1/4"	13/64	13/32	.040-.070	8-32	3/8	Z4320-SS
1-1/2"	13/64	13/32	.040-.070	8-32	3/8	Z4324-SS
1-3/4"	13/64	13/32	.040-.070	8-32	3/8	Z4328-SS
2"	13/64	13/32	.040-.070	8-32	3/8	Z4332X-SS
2-1/4"	13/64	13/32	.040-.070	8-32	3/8	Z4336X-SS
2-1/2"	13/64	13/32	.040-.070	8-32	3/8	Z4344X-SS
2-3/4"	13/64	13/32	.040-.070	8-32	3/8	Z4346X-SS
3"	13/64	13/32	.040-.070	8-32	3/8	Z4348X-SS
3-1/2"	13/64	13/32	.040-.070	8-32	3/8	Z4358X-SS
4"	13/64	13/32	.040-.070	8-32	3/8	Z4364X-SS
4-1/2"	13/64	13/32	.040-.070	8-32	3/8	Z4366X-SS
5"	13/64	13/32	.040-.070	8-32	3/8	Z4368X-SS
6"	13/64	13/32	.040-.070	8-32	3/8	Z4396X-SS

New Items in Red

18-8 Stainless Steel Binding Posts Sets



Binding Post Sets — 18/8 Stainless Steel							
Grip Range	Female Barrel Length	Female Thread Depth	Male Screw Length	Female Barrel Order Number	Male Screw Order Number	Quantity of Each Part	Set Order Number
1/8"	1/8"	OPEN	3/16"	Z4302X-SS	Z4302-SS	25	Z4374050
3/16	3/16	OPEN	3/16	Z4303-SS	Z4302-SS	25	Z4374051
1/4	1/4	OPEN	1/4	Z4304-SS	Z4301-SS	25	Z4374052
3/8	3/8	1/4"	3/8	Z4306C-SS	Z4300-SS	25	Z4374053
3/8	3/8	1/4"	3/8	Z4306C-SS	Z4300-SS	10	Z4374053-10
1/2	1/2	5/16"	3/8	Z4308-SS	Z4300-SS	10	Z4374054
5/8	5/8	3/8	3/8	Z4310-SS	Z4300-SS	10	Z4374055
3/4	3/4	3/8	3/8	Z4312-SS	Z4300-SS	10	Z4374056
1	1	3/8	3/8	Z4316-SS	Z4300-SS	10	Z4374057
1-1/4	1-1/4	3/8	3/8	Z4320-SS	Z4300-SS	10	Z4374058
1-1/2	1-1/2	3/8	3/8	Z4324-SS	Z4300-SS	10	Z4374059
1-3/4	1-3/4	3/8	3/8	Z4328-SS	Z4300-SS	10	Z4374060
2	2	3/8	3/8	Z4332X-SS	Z4300-SS	5	Z4374105
2-1/4	2-1/4	3/8	3/8	Z4336X-SS	Z4300-SS	5	Z4374106
2-1/2	2-1/2	3/8	3/8	Z4344X-SS	Z4300-SS	5	Z4374107
2-3/4	2-3/4	3/8	3/8	Z4346X-SS	Z4300-SS	5	Z4374108
3	3	3/8	3/8	Z4348X-SS	Z4300-SS	5	Z4374109
3-1/2	3-1/2	3/8	3/8	Z4358X-SS	Z4300-SS	5	Z4374110
4	4	3/8	3/8	Z4364X-SS	Z4300-SS	5	Z4374111
4-1/2	4-1/2	3/8	3/8	Z4366X-SS	Z4300-SS	5	Z4374112
5	5	3/8	3/8	Z4368X-SS	Z4300-SS	5	Z4374113
6	6	3/8	3/8	Z4396X-SS	Z4300-SS	5	Z4374114

New Items in Red

Female Barrel has no slot—Male Screw has Slotted Truss Head
Stainless Steel—Male and Female Barrel Packaged Together

SPECIAL ORDERS AVAILABLE—
Small Quantities to Large Volume



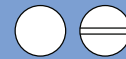

Binding Posts

USA MADE & IMPORT

18-8 Stainless Steel Binding Screws

18-8 Stainless Steel Binding Screws			
Screw Size	Head Diameter	Head Height	Order Number
8-32 X 3/16	13/32	.050-.070	Z4302-SS
8-32 X 1/4	13/32	.050-.070	Z4301-SS
8-32 X 3/8	13/32	.050-.070	Z4300-SS

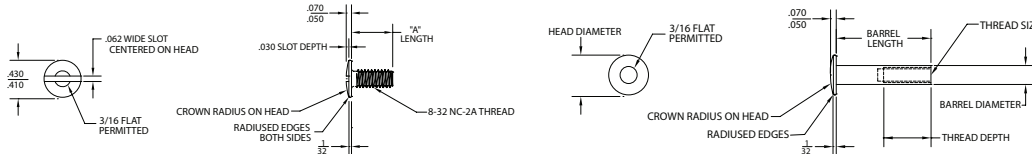

Brass Binding Posts—Female—Open Truss Head

Brass Binding Posts—Female Barrels—Open Truss Head						
1/8"	13/64	13/32	.050-.070	8-32	Unlimited	Z4302X-BR
3/16"	13/64	13/32	.050-.070	8-32	Unlimited	Z4303-BR
1/4"	13/64	13/32	.050-.070	8-32	Unlimited	Z4304-BR
3/8"	13/64	13/32	.050-.070	8-32	Unlimited	Z4306X-BR



Brass Binding Posts—Female—Closed Truss Head

Brass Binding Posts—Female Barrels—Closed Truss Head						
Barrel Length	Barrel Diameter	Head Diameter	Head Height	Thread Threads	Thread Depth	Order Number
1/4"	13/64	13/32	.040-.070	8-32	5/32	Z4304C-BR
3/8"	13/64	13/32	.040-.070	8-32	1/4	Z4306-BR
1/2"	13/64	13/32	.040-.070	8-32	5/16	Z4308-BR
5/8"	13/64	13/32	.040-.070	8-32	3/8	Z4310-BR
3/4"	13/64	13/32	.040-.070	8-32	3/8	Z4312-BR
7/8"	13/64	13/32	.040-.070	8-32	3/8	Z4314X-BR
1"	13/64	13/32	.040-.070	8-32	3/8	Z4316-BR
1-1/4"	13/64	13/32	.040-.070	8-32	3/8	Z4320X-BR
1-1/2"	13/64	13/32	.040-.070	8-32	3/8	Z4324X-BR
1-3/4"	13/64	13/32	.040-.070	8-32	3/8	Z4328X-BR
2"	13/64	13/32	.040-.070	8-32	3/8	Z4332X-BR
2-1/4"	13/64	13/32	.040-.070	8-32	3/8	Z4336X-BR
2-1/2"	13/64	13/32	.040-.070	8-32	3/8	Z4344X-BR
2-3/4"	13/64	13/32	.040-.070	8-32	3/8	Z4346X-BR
3"	13/64	13/32	.040-.070	8-32	3/8	Z4348X-BR
3-1/2"	13/64	13/32	.040-.070	8-32	3/8	Z4358X-BR
4"	13/64	13/32	.040-.070	8-32	3/8	Z4364X-BR
4-1/2"	13/64	13/32	.040-.070	8-32	3/8	Z4366X-BR
5"	13/64	13/32	.040-.070	8-32	3/8	Z4368X-BR
6"	13/64	13/32	.040-.070	8-32	3/8	Z4396X-BR



New Items in Red



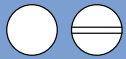

Binding Posts

Brass Binding Screws



Brass Binding Screws			
Screw Size	Head Diameter	Head Height	Order Number
8-32 X 1/4	13/32	.050-.070	Z4301-BR
8-32 X 5/16	13/32	.050-.070	Z4300-BR

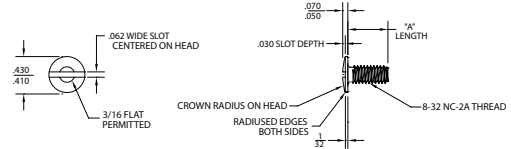

Brass Binding Post Sets

Female Barrel has no slot—
 Male Screw has Slotted Truss Head
 Plain Brass—Male and Female Barrel Packaged Together

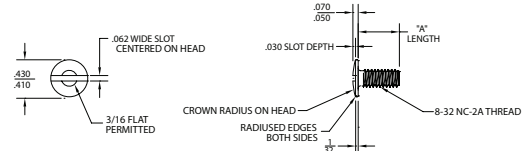
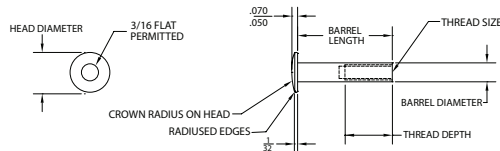

Brass Binding Post Sets							
Grip Range	Female Barrel Length	Female Thread Depth	Male Screw Length	Female Barrel Order Number	Male Screw Order Number	Quantity of Each Part	Set Order Number
3/16"	3/16"	OPEN	1/4"	Z4303-BR	Z4301-BR	25	Z4374001
1/4"	1/4"	OPEN	1/4"	Z4304-BR	Z4301-BR	25	Z4374002
3/8"	3/8"	1/4"	5/16"	Z4306-BR	Z4300-BR	25	Z4374003
1/2"	1/2"	3/8"	5/16"	Z4308-BR	Z4300-BR	25	Z4374004
5/8"	5/8"	3/8"	5/16"	Z4310-BR	Z4300-BR	25	Z4374120
3/4"	3/4"	3/8"	5/16"	Z4312-BR	Z4300-BR	25	Z4374005
7/8"	7/8"	3/8"	5/16"	Z4314X-BR	Z4300-BR	10	Z4374121
1"	1"	3/8"	5/16"	Z4316-BR	Z4300-BR	10	Z4374006
1-1/4"	1-1/4"	3/8"	5/16"	Z4320X-BR	Z4300-BR	10	Z4374122
1-1/2"	1-1/2"	3/8"	5/16"	Z4324X-BR	Z4300-BR	10	Z4374123
1-3/4"	1-3/4"	3/8"	5/16"	Z4328X-BR	Z4300-BR	10	Z4374124
2"	2"	3/8"	5/16"	Z4332X-BR	Z4300-BR	10	Z4374125
2-1/4"	2-1/4"	3/8"	5/16"	Z4336X-BR	Z4300-BR	5	Z4374126
2-1/2"	2-1/2"	3/8"	5/16"	Z4344X-BR	Z4300-BR	5	Z4374127
2-3/4"	2-3/4"	3/8"	5/16"	Z4346X-BR	Z4300-BR	5	Z4374128
3"	3"	3/8"	5/16"	Z4348X-BR	Z4300-BR	5	Z4374129
3-1/2"	3-1/2"	3/8"	5/16"	Z4358X-BR	Z4300-BR	5	Z4374130
4"	4"	3/8"	5/16"	Z4364X-BR	Z4300-BR	5	Z4374131
4-1/2"	4-1/2"	3/8"	5/16"	Z4366X-BR	Z4300-BR	5	Z4374132
5"	5"	3/8"	5/16"	Z4368X-BR	Z4300-BR	5	Z4374133
6"	6"	3/8"	5/16"	Z4396X-BR	Z4300-BR	5	Z4374134



SPECIAL ORDERS AVAILABLE—
Small Quantities to Large Volume



New Items in Red

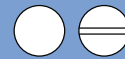

Binding Posts

USA MADE

Copper Binding Posts—Female—Closed Truss Head

Copper Binding Posts — Closed Top Rivet Head						
Barrel Length	Barrel Diameter	Head Diameter	Head Height	Threads	Thread Depth	Order Number
1/4"	13/64"	13/32"	.040-.070	8-32	5/32"	Z4304C-CU
3/8"	13/64"	13/32"	.040-.070	8-32	1/4"	Z4306-CU
1/2"	13/64"	13/32"	.040-.070	8-32	5/16"	Z4308-CU
5/8"	13/64"	13/32"	.040-.070	8-32	3/8"	Z4310-CU
3/4"	13/64"	13/32"	.040-.070	8-32	3/8"	Z4312-CU
1"	13/64"	13/32"	.040-.070	8-32	3/8"	Z4316-CU



New Items in Red

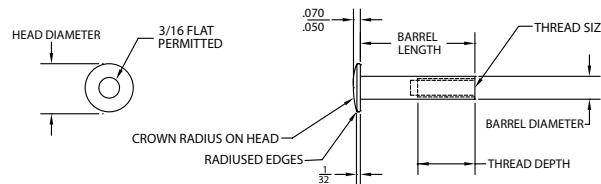

Solid Copper Binding Screws—Slotted Head

Copper Binding Screws — Slotted Head			
Screw Size	Head Diameter	Head Height	Order Number
8-32 X 1/4	13/32"	.040-.070	Z4301-CU
8-32 X 3/8	13/32"	.040-.070	Z4300-CU

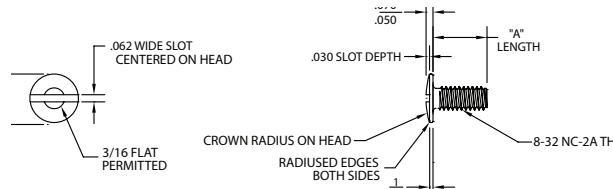

Copper Binding Post Sets

Female Barrel has no slot—

Male Screw has Slotted Truss Head

Plain Brass—Male and Female Barrel Packaged Together

Copper Binding Post Sets — Closed Top Rivet Head							
Grip Range	Female Barrel Length	Female Thread Depth	Male Screw Length	Female Barrel Order Number	Male Screw Order Number	Quantity of Each Part	Set Order Number
1/4"	1/4"	1/8"	3/8"	Z4304C-CU	Z4300-CU	10	Z4374140
3/8"	3/8"	1/4"	3/8"	Z4306-CU	Z4300-CU	10	Z4374141
1/2"	1/2"	3/8"	3/8"	Z4308-CU	Z4300-CU	10	Z4374142
5/8"	5/8"	3/8"	3/8"	Z4310-CU	Z4300-CU	10	Z4374143
3/4"	3/4"	3/8"	3/8"	Z4312-CU	Z4300-CU	10	Z4374144
1"	1"	3/8"	3/8"	Z4316-CU	Z4300-CU	10	Z4374145



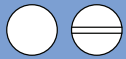

Binding Posts



Steel-Zinc Plated Binding Posts—Female Barrels



Steel-Zinc Plated Binding Posts—Female Barrels						
Barrel Length	Barrel Diameter	Head Dia.	Head Height	Threads	Thread Depth	Order Number
1/8	13/64	13/32	.050-.070	8-32	Thru	Z4302X-STL
3/16	13/64	13/32	.050-.070	8-32	Thru	Z4303-STL
1/4	13/64	13/32	.050-.070	8-32	Thru	Z4304-STL
3/8	13/64	13/32	.050-.070	8-32	1/4	Z4306C-STL
1/2	13/64	13/32	.050-.070	8-32	3/8	Z4308-STL
5/8	13/64	13/32	.050-.070	8-32	3/8	Z4310-STL
3/4	13/64	13/32	.050-.070	8-32	3/8	Z4312-STL
1	13/64	13/32	.050-.070	8-32	3/8	Z4316-STL
1-1/4	13/64	13/32	.050-.070	8-32	3/8	Z4320-STL
1-1/2	13/64	13/32	.050-.070	8-32	3/8	Z4324-STL
1-3/4	13/64	13/32	.050-.070	8-32	3/8	Z4328-STL
2	13/64	13/32	.050-.070	8-32	3/8	Z4332-STL

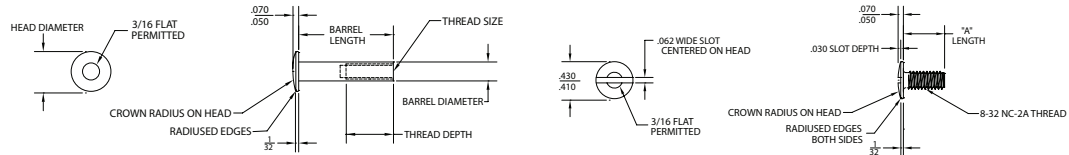

Steel-Zinc Plated Binding Screws—Slotted Head



Steel Zinc Binding Screws			
Screw Size	Head Diameter	Head Height	Order Number
8-32 x 3/16	13/32	.050-.070	Z4302-STL
8-32 X 3/8	13/32	.050-.070	Z4300-STL



Steel-Zinc Plated Binding Post Sets



Steel-Zinc Binding Post Sets							
Grip Range	Female Barrel Length	Female Thread Depth	Male Screw Length	Female Barrel Order Number	Male Screw Order Number	Quantity of Each Part	Set Order Number
1/8	1/8	Thru	3/16	Z4302X-STL	Z4302-STL	25	Z4302XPAK-STL
3/16	3/16	Thru	3/16	Z4303-STL	Z4302-STL	25	Z4303PAK-STL
1/4	1/4	Thru	3/16	Z4304-STL	Z4302-STL	25	Z4304PAK-STL
3/8	3/8	1/4	3/16	Z4306C-STL	Z4302-STL	25	Z4306CPAK-STL
1/2	1/2	3/8	3/8	Z4308-STL	Z4300-STL	25	Z4308PAK-STL
5/8	5/8	3/8	3/8	Z4310-STL	Z4300-STL	25	Z4310PAK-STL
3/4	3/4	3/8	3/8	Z4312-STL	Z4300-STL	25	Z4312PAK-STL
1	1	3/8	3/8	Z4316-STL	Z4300-STL	10	Z4316PAK-STL
1-1/4	1-1/4	3/8	3/8	Z4320-STL	Z4300-STL	10	Z4320PAK-STL
1-1/2	1-1/2	3/8	3/8	Z4324-STL	Z4300-STL	10	Z4324PAK-STL
1-3/4	1-3/4	3/8	3/8	Z4328-STL	Z4300-STL	10	Z4328PAK-STL
2	2	3/8	3/8	Z4332-STL	Z4300-STL	10	Z4332PAK-STL

SPECIAL ORDERS AVAILABLE—
Small Quantities to Large Volume



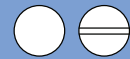

Binding Posts

Black Plastic Binding Post Barrels—Friction Fit

Plastic Binding Post Barrels: For use in 1/4" diameter holes. Barrel Diameter .215-.240. Slotted Truss Head, .100" Head Height. Friction Fit Internal Thread.

Black Plastic Binding Posts—Female Barrels—Friction Fit			
Grip Range	Female Barrel Length	Head Diameter	Female Barrel Order Number
1/2"	1/2"	25/64"	Z4670
5/8	5/8	25/64	Z4671
3/4	3/4	25/64	Z4672
1	1	25/64	Z4673
1-1/4	1-1/4	25/64	Z4674
1-1/2	1-1/2	25/64	Z4675
1-3/4	1-3/4	25/64	Z4676
2	2	25/64	Z4677
2-1/4	2-1/4	27/64	Z4678
2-1/2	2-1/2	27/64	Z4679
3-1/4	3-1/4	27/64	Z4680
4	4	27/64	Z4681

Black Plastic Caps

Black Plastic Binding Post Caps Permanent or Removable		
Head Height	For use with Friction Fit Plastic Binding Post Barrels	Order Number
7/64"	REMOVABLE: Slotted Binding Head 	Z4683
	PERMANENT: Unslotted Flat Head 	
.075"	PERMANENT: Unslotted Flat Head 	Z4682

Female Plastic Binding Posts—Slotted Head

Plastic Binding Posts—Female Barrels—Slotted Head									
Barrel Length	Barrel Diameter	Head Diameter	Head Height	Threads	Thread Depth	Material	Color	Order Number	
1/4"	.240"	3/8"	.100"	10-24	3/16"	Plastic	Black	Z4200	
1/4	.240	3/8	.100	10-24	3/16	Plastic	White	Z4209	
3/8	.240	3/8	.100	10-24	3/16	Plastic	Black	Z4201	
3/8	.240	3/8	.100	10-24	3/16	Plastic	White	Z4210	
1/2	.240	3/8	.100	10-24	3/16	Plastic	Black	Z4202	
1/2	.240	3/8	.100	10-24	3/16	Plastic	White	Z4211	
3/4	.240	3/8	.100	10-24	3/16	Plastic	Black	Z4203	
3/4	.240	3/8	.100	10-24	3/16	Plastic	White	Z4212	
7/8	.240	3/8	.100	10-24	3/16	Plastic	Black	Z4204	
1	.240	3/8	.100	10-24	3/16	Plastic	Black	Z4205	
1-1/4	.240	3/8	.100	10-24	3/16	Plastic	Black	Z4206	
1-1/2	.240	3/8	.100	10-24	3/16	Plastic	Black	Z4207	
2	.240	3/8	.100	10-24	3/16	Plastic	Black	Z4208	

Plastic Binding Post Screws—Threaded—Slot Head

Plastic Binding Post Male Screws—Slotted Head							
Size	Head Diameter	Head Height	Threads	Material	Color	Order Number	
10-24 X 3/16	3/8"	.100"	10-24	Plastic	Black	Z4219	
10-24 X 3/16	3/8	.100	10-24	Plastic	White	Z4218	

Black Plastic Binding Post Sets

Black Plastic Binding Post Sets						
Grip Range	Female Barrel Length	Female Thread Depth	Female Barrel Order Nbr	Male Screw Order Nbr	Qty of Each Part	Order Number
1/2	1/2	3/16	Z4202	Z4219	10	Z4202SET
3/4	3/4	3/16	Z4203	Z4219	10	Z4203SET
1	1	3/16	Z4205	Z4219	10	Z4205SET
1-1/4	1-1/4	3/16	Z4206	Z4219	10	Z4206SET
1-1/2	1-1/2	3/16	Z4207	Z4219	10	Z4207SET
2	2	3/16	Z4208	Z4219	10	Z4208SET





Slotted Head Sex Bolts



Slotted Truss Head—Female Barrels

These Sex Bolts have slotted Truss Heads, no knurl under the head, no mating screw. Available in Steel, Steel-Zinc, Plain Brass, Brass Chrome, Stainless Steel, & Aluminum

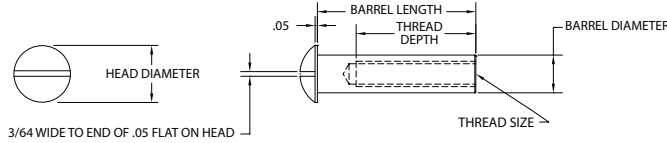

THESE SEX BOLTS ARE ALL MADE IN USA



Slotted Truss Head Sex Bolts—Female Barrels							
Barrel Diameter	Barrel Length	Thread Size	Thread Depth	Head Diameter	Head Height	Plating	Order Number
Steel—Various Platings							
13/64	3/8	8-32	1/4	7/16	9/64	Brass	Z4560-BR
13/64	3/8	8-32	1/4	7/16	9/64	Black Ox	Z4560-BX
Steel—Zinc Plated Material							
13/64	3/8	8-32	1/4	7/16	9/64	Zinc	Z4560-ZN
1/4	1/4	8-32	.200	3/8	1/8	Zinc	Z4500
1/4	1/2	8-32	1/4	3/8	1/8	Zinc	Z4505
1/4	3/4	8-32	1/2	3/8	1/8	Zinc	Z4510
1/4	1	8-32	1/2	3/8	1/8	Zinc	Z4520
5/16	5/8	1/4-20	1/2	1/2	9/64	Zinc	Z4552
5/16	3/4	10-32	1/2	7/16	9/64	Zinc	Z4535
3/8	3/4	1/4-20	1/2	9/16	5/32	Zinc	Z4541
3/8	1	1/4-20	1/2	9/16	5/32	Zinc	Z4542
3/8	1-9/16	1/4-20	3/4	9/16	3/16	Zinc	Z4570
Brass Material							
1/4	1/4	8-32	.200	3/8	1/8	Chrome	Z4600
1/4	1/4	8-32	.200	3/8	1/8	Plain	Z4605
1/4	1/2	8-32	1/4	3/8	1/8	Chrome	Z4610
1/4	1/2	8-32	1/4	3/8	1/8	Plain	Z4615
1/4	3/4	8-32	1/2	3/8	1/8	Chrome	Z4620
1/4	3/4	8-32	1/2	3/8	1/8	Plain	Z4625
1/4	1	8-32	1/2	3/8	1/8	Chrome	Z4630
1/4	1	8-32	1/2	3/8	1/8	Plain	Z4635
5/16	1/2	10-32	1/4	7/16	9/64	Chrome	Z4640
5/16	1/2	10-32	1/4	7/16	9/64	None	Z4645
5/16	3/4	10-32	1/2	7/16	9/64	Chrome	Z4650
5/16	3/4	10-32	1/2	7/16	9/64	None	Z4655
Stainless Steel Material							
1/4	1/4	8-32	.200	3/8	1/8	None	Z4700
1/4	1/2	8-32	1/4	3/8	1/8	None	Z4705
1/4	3/4	8-32	1/2	3/8	1/8	None	Z4710
1/4	1	8-32	1/2	3/8	1/8	None	Z4715
5/16	1/2	10-32	1/4	7/16	9/64	None	Z4720
5/16	3/4	10-32	1/2	7/16	9/64	None	Z4725
3/8	1/2	1/4-20	1/4	9/16	5/32	None	Z4730
3/8	19/32	1/4-20	1/2	9/16	5/32	None	Z4731
3/8	3/4	1/4-20	1/2	9/16	5/32	None	Z4732
3/8	1	1/4-20	1/2	9/16	5/32	None	Z4734
Aluminum Material							
3/8	1/4	1/4-20	3/16	9/16	1/8	None	Z4842
3/8	7/8	1/4-20	9/16	9/16	1/8	None	Z4844

SPECIAL ORDERS AVAILABLE—
Small Quantities to Large Volume





Slotted Head Sex Bolts

USA MADE

Slotted Oval Head Sex Bolts—Female Barrels

Slotted Oval Head Sex Bolts are measured from over the head to the end of the barrel, and have a standard 82 degree countersunk head.

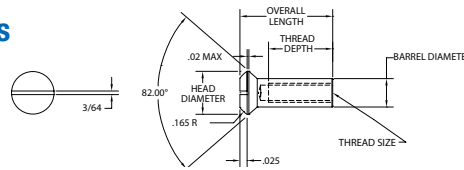

Slotted Oval Head Sex Bolts—Female Barrels (No Mating Screw)						
Barrel Diameter	Overall Length	Thread Size	Thread Depth	Head Diameter	Material & Finish	Order Number
3/16"	19/64"	6-32	.200"	1/4"	Brass Nickel	Z4800
3/16	25/64	6-32	.200	9/32	Brass Nickel	Z4802
3/16	17/32	6-32	5/16	1/4	Brass Nickel	Z4804
3/16	43/64	6-32	3/8	3/8	Brass Nickel	Z4810
3/16	5/8	6-32	5/16	1/4	Brass Nickel	Z4806
1/4	7/16	8-32	1/4	23/64	Brass Nickel	Z4812
1/4	7/16	10-32	.275	11/32	Brass Nickel	Z4814
1/4	41/64	10-32	1/4	3/8	Steel Nickel	Z4816

Slotted Flat Head Sex Bolts—Female Barrels

Slotted Flat Head Sex Bolts are measured from over the head to the end of the barrel, and have a standard 82 degree countersunk head.

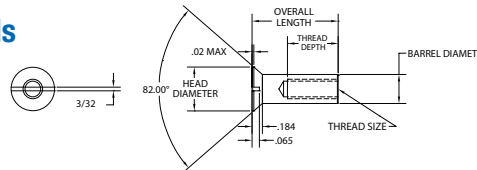

Slotted Flat Head Sex Bolts—Female Barrels (No Mating Screw)						
Barrel Diameter	Overall Length	Thread Size	Thread Depth	Head Diameter	Material & Finish	Order Number
13/64"	27/64"	8-32	Thru	5/16"	Steel Zinc	Z4830
13/64	1/2	8-32	Thru	5/16	Brass Plain	Z4832
13/64	3/4	8-32	Thru	5/16	Brass Plain	Z4834
5/16	7/16	10-32	Thru	1/2	Stainless	Z5026
5/16	3/4	10-32	Thru	1/2	Stainless	Z5028
5/16	1	10-32	Thru	1/2	Stainless	Z5030
.425	3/4	5/16-18	Thru	.715	Stainless	Z5035
.425	1	5/16-18	.600	.715	Stainless	Z5040

New Items in Red

Grommet Nuts—Slot Head, No Slot, & Open Head

Steel Zinc, Steel Brass Plated, & Stainless Steel

For hinge installations — available with slot for ease of installation, or without any slot for security installations. Used on Full Surface, Half Surface and Half Mortise Hinges, Prison Hinges and Heavy duty Institutional Hinges. Also used for installing door closers, panic bars, exit devices, kick plates, push plates, and all types of surface mounted door hardware.

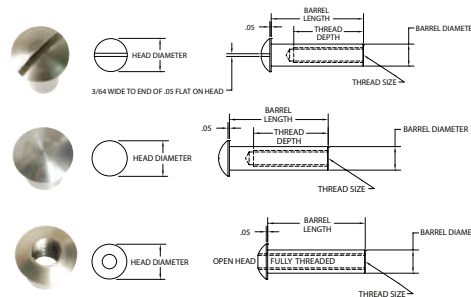

Grommet Nuts								
Barrel Diameter	Barrel Length	Thread Size	Thread Depth	Head Diameter	Material	Slotted Order Number	No Slot Order Number	Open Head Fully Threaded Order Number
5/16"	1/2"	10-32	1/4"	7/16"	Steel Zinc	Z4530	Z4521	Z4750
5/16	1/2	12-24	1/4	7/16	Steel Zinc	Z4511	Z4522	Z4751
3/8	1/2	1/4-20	1/4	9/16	Steel Zinc	Z4540	Z4523	Z4752
1/2	1/2	3/8-16	1/4	3/4	Steel Zinc	Z4512	Z4524	Z4753
5/16	1/2	10-32	1/4	7/16	Steel Brass Plated	Z4518	Z4525	Z4760
5/16	1/2	12-24	1/4	7/16	Steel Brass Plated	Z4513	Z4526	Z4761
3/8	1/2	1/4-20	1/4	9/16	Steel Brass Plated	Z4514	Z4527	Z4762
1/2	1/2	3/8-16	1/4	3/4	Steel Brass Plated	Z4515	Z4528	Z4763
5/16	1/2	10-32	1/4	7/16	Stainless Steel	Z4720	Z4529	Z4770
5/16	1/2	12-24	1/4	7/16	Stainless Steel	Z4516	Z4531	Z4771
3/8	1/2	1/4-20	1/4	9/16	Stainless Steel	Z4730	Z4532	Z4772
1/2	1/2	3/8-16	1/4	3/4	Stainless Steel	Z4517	Z4533	Z4773



THESE SEX BOLTS ARE ALL MADE IN USA



Accurate Manufactured Products Group

Phone: 317-472-9000 • FAX: 317-472-9010 • email: sales@ampg.com • www.ampg.com





Phillips, Hex Head, & T Head Sex Bolts



Phillips Truss Head Sex Bolts—Female Barrels

These Sex Bolts have Phillips Truss Heads, no knurl under the head, no mating screw. Available in Stainless Steel & Steel Chrome

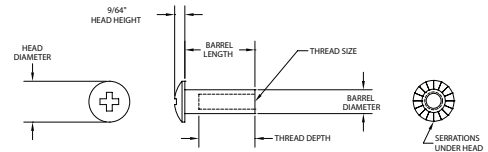

Phillips Truss Head Sex Bolts—Female Barrels									
Barrel Diameter	Barrel Length	Thread Size	Thread Depth	Head Diameter	Head Height	Material & Finish	Notes	Order Number	
3/16"	3/8"	6-32	1/4"	3/8"	3/32	Stainless	Serrations under head	Z4740	
7/32	3/8	8-32	1/4	7/16	3/32	Stainless	Serrations under head	Z4741	
1/4	1/2	10-24	3/8	9/16	9/64	Stainless	Serrations under head	Z4742	
1/4	1/2	10-24	3/8	13/32	1/8	Steel Chrome	Serrations under head	Z4850	
5/16	5/8	1/4-20	7/16	11/16	3/16	Stainless	Serrations under head	Z4743	
3/8	3/4	5/16-18	5/8	3/4	7/32	Stainless	Serrations under head	Z4744	
7/16	3/4	3/8-16	5/8	15/16	7/32	Stainless	Serrations under head	Z4745	

Hex Head Sex Bolts—Female Barrels

These Sex Bolts have Hex Heads, no knurl under the head, no mating screw. Available in Stainless Steel

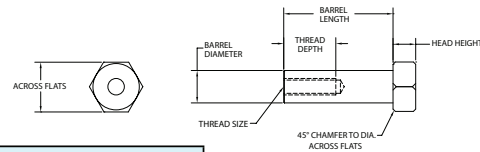

Hex Head Sex Bolts—Female Barrels—Stainless Steel						
Barrel Diameter	Barrel Length	Thread Size	Thread Depth	Across Flats	Head Height	Order Number
5/16"	1/2"	10-24	5/16"	1/2"	3/16"	Z4180-SS
5/16"	3/4	10-24	3/8	1/2	3/16	Z4181-SS
5/16"	1	10-24	3/8	1/2	3/16	Z4182-SS
3/8"	1/2	1/4-20	5/16"	5/8	13/64	Z4185-SS
3/8"	3/4	1/4-20	3/8	5/8	13/64	Z4186-SS
3/8"	1	1/4-20	3/8	5/8	13/64	Z4187-SS
1/2"	1/2	3/8-16	5/16"	3/4	1/4	Z4190-SS
1/2"	3/4	3/8-16	3/8	3/4	1/4	Z4191-SS
1/2"	1	3/8-16	3/8	3/4	1/4	Z4192-SS



T Head Aluminum Sex Bolts/Binding Posts—Female Barrels

Special "T Slot" style head is used in commercial railing systems.

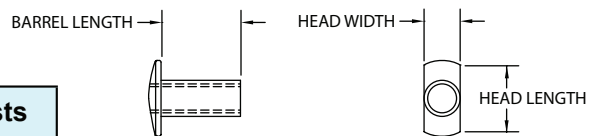

T Head Aluminum Binding Posts			
Barrel Length	A		Order Number
	Head Length	Head Width	
3/8"	.406"	.210"	Z4660
1/2	.406	.210	Z4661
5/8	.406	.210	Z4662
3/4	.406	.210	Z4663



SPECIAL ORDERS AVAILABLE—
Small Quantities to Large Volume



Connector Bolts & Nuts



Steel Connector Bolts (No Shoulder)

Connector Nuts and Bolts are used for joining any two parts or pieces together, with a finished appearance. Most commonly used to join panels together, such as cabinets, book cases, and other furniture fixtures. The hex drive allows maximum leverage and force to be applied to the connection. These fasteners have a low profile and beveled edges on the exposed head, presenting a decorative and finished look.

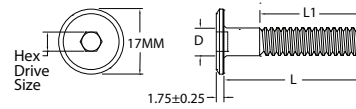

Available in Plain Steel, or with the following finishes: Black Oxide, Bronze, Nickel, Brass, or Zinc



Connector Bolts (No Shoulder)							STEEL		
Thread	L	L1	D	Hex Drive	Grip Range (MM)		Material	Finish	Order Number *
	Length Under Head	Thread Length	Shank Diameter		12MM Nut	17MM Nut			
1/4-20	20MM (.787")	17MM (.669")	5.4MM (.213")	4MM (.157")	21-25	21-30	Steel	Plain	Z4478-A
	23MM (.906")	13MM (.512")	5.4MM (.213")	4MM (.157")	24-28	24-33	Steel	Plain	Z4479-A
	25MM (.984")	22MM (.866")	5.4MM (.213")	4MM (.157")	26-30	26-35	Steel	Plain	Z4480-A
	30MM (1.181")	20MM (.787")	5.4MM (.213")	4MM (.157")	31-35	31-40	Steel	Plain	Z4481-A
	35MM (1.378")	30MM (1.181")	5.4MM (.213")	4MM (.157")	36-40	36-45	Steel	Plain	Z4482-A
1/4-20	40MM (1.575")	30MM (1.181")	5.4MM (.213")	4MM (.157")	41-45	41-50	Steel	Plain	Z4483-A
	45MM (1.772")	30MM (1.181")	5.4MM (.213")	4MM (.157")	46-50	46-55	Steel	Plain	Z4484-A
	50MM (1.969")	30MM (1.181")	5.4MM (.213")	4MM (.157")	51-55	51-60	Steel	Plain	Z4485-A
	60MM (2.362")	40MM (1.575")	5.4MM (.213")	4MM (.157")	61-65	61-70	Steel	Plain	Z4486-A
	70MM (2.756")	40MM (1.575")	5.4MM (.213")	4MM (.157")	71-75	71-80	Steel	Plain	Z4487-A
1/4-20	80MM (3.150")	40MM (1.575")	5.4MM (.213")	4MM (.157")	81-85	81-90	Steel	Plain	Z4488-A
	90MM (3.543")	40MM (1.575")	5.4MM (.213")	4MM (.157")	91-95	91-100	Steel	Plain	Z4489-A
	100MM (3.937")	40MM (1.575")	5.4MM (.213")	4MM (.157")	101-105	101-110	Steel	Plain	Z4490-A
	110MM (4.331")	40MM (1.575")	5.4MM (.213")	4MM (.157")	111-115	111-120	Steel	Plain	Z4491-A
	120MM (4.724")	40MM (1.575")	5.4MM (.213")	4MM (.157")	121-125	121-130	Steel	Plain	Z4492-A
5/16-18	40MM (1.575")	30MM (1.181")	7MM (.276")	5MM (.197")	N/A	41-50	Steel	Plain	Z4493-A
	50MM (1.969")	30MM (1.181")	7MM (.276")	5MM (.197")	N/A	51-60	Steel	Plain	Z4494-A
	60MM (2.362")	40MM (1.575")	7MM (.276")	5MM (.197")	N/A	61-70	Steel	Plain	Z4495-A
	70MM (2.756")	40MM (1.575")	7MM (.276")	5MM (.197")	N/A	71-80	Steel	Plain	Z4496-A
	80MM (3.150")	40MM (1.575")	7MM (.276")	5MM (.197")	N/A	81-90	Steel	Plain	Z4497-A
	100MM (3.937")	40MM (1.575")	7MM (.276")	5MM (.197")	N/A	101-110	Steel	Plain	Z4498-A

* REPLACE "A" IN THE ORDER NUMBERS WITH THE FOLLOWING CODE FOR A FINISH OTHER THAN PLAIN STEEL

CODE	FINISH
BX	BLACK OXIDE PLATED
BZ	BRONZE PLATED
NI	NICKEL PLATED
BR	BRASS PLATED
ZN	ZINC PLATED

Steel Connector Bolts (With Shoulder)

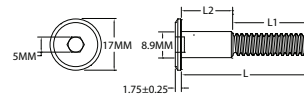

Connector Bolts (With Shoulder)							STEEL		
Thread	L	L1	L2	Hex Drive	Grip Range (MM)		Material	Finish	Order Number *
	Length Under Head	Thread Length	Shoulder Length		12MM Nut	17MM Nut			
1/4-20	23MM (.906")	13MM (.512")	10MM (.394")	5MM (.197")	24-28	24-33	Steel	Plain	Z4467-A
	30MM (1.181")	20MM (.787")	10MM (.394")	5MM (.197")	31-35	31-40	Steel	Plain	Z4468-A
	35MM (1.378")	25MM (.984")	10MM (.394")	5MM (.197")	36-40	36-45	Steel	Plain	Z4469-A
	40MM (1.575")	30MM (1.181")	10MM (.394")	5MM (.197")	41-45	41-50	Steel	Plain	Z4470-A
	45MM (1.772")	35MM (1.378")	10MM (.394")	5MM (.197")	46-50	46-55	Steel	Plain	Z4471-A
1/4-20	50MM (1.969")	40MM (1.575")	18MM (.709")	5MM (.197")	51-55	51-60	Steel	Plain	Z4472-A
	60MM (2.362")	35MM (1.378")	18MM (.709")	5MM (.197")	61-65	61-70	Steel	Plain	Z4473-A
	70MM (2.756")	35MM (1.378")	18MM (.709")	5MM (.197")	71-75	71-80	Steel	Plain	Z4474-A
	80MM (3.150")	35MM (1.378")	18MM (.709")	5MM (.197")	81-85	81-90	Steel	Plain	Z4475-A
	90MM (3.543")	35MM (1.378")	18MM (.709")	5MM (.197")	91-95	91-100	Steel	Plain	Z4476-A
	100MM (3.937")	35MM (1.378")	18MM (.709")	5MM (.197")	101-105	101-110	Steel	Plain	Z4477-A

* REPLACE "A" IN THE ORDER NUMBERS WITH THE FOLLOWING CODE FOR A FINISH OTHER THAN PLAIN STEEL

CODE	FINISH
BX	BLACK OXIDE PLATED
BZ	BRONZE PLATED
NI	NICKEL PLATED
BR	BRASS PLATED
ZN	ZINC PLATED

Steel Connector Nuts

Available in Plain Steel, or with the following finishes: Black Oxide, Bronze, Nickel, Brass, or Zinc

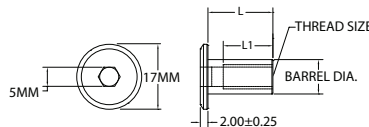

Connector Nuts				STEEL		
Thread	L	L1	D3	Material	Finish	Order Number
	Barrel Length	Thread Depth	Barrel Diameter			
1/4-20	12MM (.472")	8MM (.315")	9MM (.354")	Steel	Plain	Z4452-A
1/4-20	17MM (.669")	13MM (.512")	9MM (.354")	Steel	Plain	Z4456-A
5/16-18	17MM (.669")	13MM (.512")	11MM (.433")	Steel	Plain	Z4460-A

* REPLACE "A" IN THE ORDER NUMBERS WITH THE FOLLOWING CODE FOR A FINISH OTHER THAN PLAIN STEEL

CODE	FINISH
BX	BLACK OXIDE PLATED
BZ	BRONZE PLATED
NI	NICKEL PLATED
BR	BRASS PLATED
ZN	ZINC PLATED



Accurate Manufactured Products Group

Phone: 317-472-9000 • FAX: 317-472-9010 • email: sales@ampg.com • www.ampg.com



Sex Bolt Assortment Kits

Binding Post Assortment Kits—Aluminum, Brass, Stainless Steel

Features:

- 5 of the most popular internal thread female Binding Posts
- Matching screw fits in each barrel—total number of screws matches the number of barrels included
- Seeing the item makes it easy for your customer to figure out the right size
- Easy guide to re-order
- Use this Counter Display to show customers this hard to find product line!
- AVAILABLE FROM OUR STOCK IN ALUMINUM, BRASS, & 18-8 STAINLESS STEEL

Aluminum Assortment Kit Order # Z4195

18-8 Stainless Steel Assortment Kit Order # Z4196

Brass Assortment Kit Order # Z4197



New Item

Z4300(SS/BR)	Z4308(SS/BR)	Z4312(SS/BR)	Z4320(SS/BR)	Z4332(XSS/XBR)	Z4348(XSS/XBR)
8-32 X 3/8 SLOTTED BINDING POST MACHINE SCREW	13/64 X 1/2 BINDING POST 8-32 INTERNAL THREADS	13/64 X 3/4 BINDING POST 8-32 INTERNAL THREADS	13/64 X 1-1/4 BINDING POST 8-32 INTERNAL THREADS	13/64 X 2" BINDING POST 8-32 INTERNAL THREADS	13/64 X 3" BINDING POST 8-32 INTERNAL THREADS
Qty: 120 Pcs	Qty: 40 Pcs	Qty: 30 Pcs	Qty: 26 Pcs	Qty: 14 Pcs	Qty: 10 Pcs

Binding Post Assortment Kits—Steel Zinc

Features:

- 5 of the most popular internal thread female Binding Posts
- Matching screw fits in each barrel—total number of screws matches the number of barrels included
- Seeing the item makes it easy for your customer to figure out the right size
- Easy guide to re-order
- Use this Counter Display to show customers this hard to find product line!

Steel Zinc Assortment Kit Order # Z4198



New Item

Z4300-STL	Z4308-STL	Z4312-STL	Z4316-STL	Z4324-STL	Z4332-STL
8-32 X 3/8 SLOTTED BINDING POST MACHINE SCREW	13/64 X 1/2 BINDING POST 8-32 INTERNAL THREADS	13/64 X 3/4 BINDING POST 8-32 INTERNAL THREADS	13/64 X 1" BINDING POST 8-32 INTERNAL THREADS	13/64 X 1-1/2" BINDING POST 8-32 INTERNAL THREADS	13/64 X 2" BINDING POST 8-32 INTERNAL THREADS
Qty: 120 Pcs	Qty: 40 Pcs	Qty: 30 Pcs	Qty: 26 Pcs	Qty: 14 Pcs	Qty: 10 Pcs

Solar Install Kit—18-8 Stainless Steel, 530 Pcs.

Features:

- Everything you need to install solar panels on a standard racking system, including: Flange Nuts, Fender Washers, Truss Head Sex Bolts, Tamperproof 6-Lobe with Pin Barrels, Combo-Head Barrels, T-Handle Bolts, Hanger Bolts, & Fully Threaded Studs
- Steel Box with Compartments

Solar Install Kit Order # ZSolarkit1



 1/4-20 FLANGE NUT 18-8 ST/ST NUT40214C (100 PCS)	 1/4" EXTRA THK FENDER F/W 18-8 ST/ST Z9680SS (10 PCS)	 1/4" FENDER F/W 18-8 ST/ST Z9462188 (25 PCS)	 5/16" BARREL X 1/2" LTH TAMPERPROOF BARREL BOLT Z444876S USED AS A SECURITY NUT FOR 1/4-20 STUDS (25 PCS)	 3/8-16 FLANGE NUT 18-8 ST/ST NUT16038C (100 PCS)	 3/8" FENDER F/W 18-8 ST/ST Z3171188 (10 PCS)
 1/4-20 X 2 T BOLT 18-8 ST/ST Z501714C32 (25 PCS)	 1/4-20 X 2-1/2 T BOLT 18-8 ST/ST Z901714040 (25 PCS)	 1/4" BARREL X 2" COMBO HEAD 18-8 ST/ST SEX BOLT Z4432SS (25 PCS) 10-24 X 3/4 PHIL FLAT M/S 18-8 ST/ST (25 PCS) SCR22110C12	 5/16" BARREL X 1" LTH TAMPERPROOF BARREL BOLT Z444876S USED AS A SECURITY NUT FOR 1/4-20 STUDS (25 PCS)	 3/8" EXTRA THICK FENDER F/W 18-8 ST/ST Z9680SS (10 PCS)	 3/8" BARREL X 1" LTH COMBO HEAD BARREL BOLT Z4150SS (25 PCS) 5/16-18 X 3/4 PHIL FLAT M/S 18-8 ST/ST SCR22151C12 (25 PCS)
 1/4-20 X 2 HANGAR BOLT 18-8 ST/ST BOL50114C32 (25 PCS)	 1/4-20 X 3 HANGAR BOLT 18-8 ST/ST BOL50114C48 (25 PCS)	 1/4-20 X 3 FULL THREAD STUD 18-8 S/S STUD14C32SS (25 PCS)	 1/4-20 X 3 FULL THREAD STUD 18-8 S/S STUD14C48SS (25 PCS)	 3/8-16 X 3 HANGAR BOLT 18-8 ST/ST BOL50138C48 (25 PCS)	 3/8-16 X 3 FULL THREAD STUD 18-8 S/S STUD08C48SS (25 PCS)

SPECIAL ORDERS AVAILABLE—
Small Quantities to Large Volume



Sex Bolt Assortment Kits



18-8 Stainless Steel Sex Bolt Assortment Kit

Z4379PAK	Z4380PAK	Z4381PAK	Z4382PAK	Z4105SSPAK	Z4126SSPAK
Bathroom Partition Sex Bolts— assembled sets of male and female. 1/2" Grip Range, 1/4" Shoulder Dia.	Bathroom Partition Sex Bolts— assembled sets of male and female. 3/4" Grip Range, 1/4" Shoulder Dia.	Bathroom Partition Sex Bolts— assembled sets of male and female. 1" Grip Range, 1/4" Shoulder Dia.	Bathroom Partition Sex Bolts— assembled sets of male and female. 1-1/4" Grip Range, 1/4" Shoulder Dia.	3/16" Barrel Dia X 3/8" Lth 18-8 St/St with 6-32 Threads Combo Head Barrel Bolt with 6-32 X 5/16 Mating Male Screw 18-8 P/Ns Z4105SS + Z4074SS	13/64" Barrel Dia X 1/2" Lth 18-8 St/St with 8-32 Threads Combo Head Barrel Bolt with 8-32 X 5/16 Mating Male Screw 18-8 P/Ns Z4126SS + Z4075SS
Qty: 10 Sets	Qty: 10 Sets	Qty: 10 Sets	Qty: 10 Sets	Qty: 10 Sets	Qty: 10 Sets
Z4416SSPAK	Z4146SSPAK	Z5025	Z5125	Z5225	Z5325
1/4" Barrel Dia X 1" Lth 18-8 St/St with 10-24 Threads Combo Head Barrel Bolt with 10-24 X 5/16 Mating Male Screw 18-8 P/Ns Z4416SS + Z4085SS	3/8" Barrel Dia X 1/2" Lth 18-8 St/St with 5/16-18 Threads Combo Head Barrel Bolt with 5/16-18 X 5/16 Mating Male Screw 18-8 P/Ns Z4146SS + Z4096SS	5/16 Barrel X 1-3/16" Lth 18-8 St/St Architectural Sex Bolt & Mating Screw	5/16 Barrel X 1-9/16" Lth 18-8 St/St Architectural Sex Bolt & Mating Screw	3/8 Barrel X 1-9/16" Lth 18-8 St/St Architectural Sex Bolt & Mating Screw	3/8 Barrel X 2-1/16" Lth 18-8 St/St Architectural Sex Bolt & Mating Screw
Qty: 5 Sets	Qty: 5 Sets	Qty: 5 Sets	Qty: 5 Sets	Qty: 5 Sets	Qty: 5 Sets

18-8 S/S Security Sex Bolt Assortment Kit **Order # Z4401-KIT**

18-8 Stainless Steel Combo Head Barrel Bolt Assortment Kit

Z4404SS	Z4406SS	Z4408SS	Z4412SS	Z4416SS	Z4424SS
1/4 Barrel Dia X 1/4" Lth (open head) with 10-24 Screw (Z4085SS)	1/4 Barrel Dia X 3/8" Lth with 10-24 Screw (Z4085SS)	1/4 Barrel Dia X 1/2" Lth with 10-24 Screw (Z4085SS)	1/4 Barrel Dia X 3/4" Lth with 10-24 Screw (Z4085SS)	1/4 Barrel Dia X 1" Lth with 10-24 Screw (Z4085SS)	1/4 Barrel Dia X 1-1/2" Lth with 10-24 Screw (Z4085SS)
Qty: 30 Sets	Qty: 30 Sets	Qty: 20 Sets	Qty: 20 Sets	Qty: 20 Sets	Qty: 10 Sets
Z4135SS	Z4443SS	Z4146SS	Z4126SS	Z4128SS	Z4125SS
5/16 Barrel Dia X 3/8" Lth with 1/4-20 Screw (Z4095SS)	5/16 Barrel Dia X 1/2" Lth with 1/4-20 Screw (Z4095SS)	3/8 Barrel Dia X 1/2" Lth with 5/16-18 Screw (Z4096SS)	13/64 Barrel Dia X 1/2" Lth with 8-32 Screw (Z4075SS)	13/64 Barrel Dia X 3/4" Lth with 8-32 Screw (Z4075SS)	13/64 Barrel Dia X 3/8" Lth with 8-32 Screw (Z4075SS)
Qty: 20 Sets	Qty: 10 Sets	Qty: 10 Sets	Qty: 30 Sets	Qty: 20 Sets	Qty: 30 Sets

18-8 S/S Combo Head Barrel Bolt Assortment Kit **Order # Z4402-KIT**

Steel Zinc Barrel Bolt Assortment Kit

Z4105	Z4108	Z4404	Z4406	Z4408	Z4412
3/16 Barrel Dia X 3/8" Lth with 6-32 Screw (Z4074)	3/16 Barrel Dia X 3/4" Lth with 6-32 Screw (Z4074)	1/4 Barrel Dia X 1/4" Lth (open head) with 10-24 Screw (Z4085)	1/4 Barrel Dia X 3/8" Lth with 10-24 Screw (Z4085)	1/4 Barrel Dia X 1/2" Lth with 10-24 Screw (Z4085)	1/4 Barrel Dia X 3/4" Lth with 10-24 Screw (Z4085)
Qty: 50 Sets	Qty: 30 Sets	Qty: 30 Sets	Qty: 30 Sets	Qty: 20 Sets	Qty: 20 Sets
Z4416	Z4435	Z4438	Z4440	Z4443	Z4446
1/4 Barrel Dia X 1" Lth with 10-24 Screw (Z4085)	13/64 Barrel Dia X 1/4" Lth with 8-32 Screw (Z4075)	13/64 Barrel Dia X 1/2" Lth with 8-32 Screw (Z4075)	13/64 Barrel Dia X 3/4" Lth with 8-32 Screw (Z4075)	5/16 Barrel Dia X 1/2" Lth with 1/4-20 Screw (Z4095)	5/16 Barrel Dia X 1" Lth with 1/4-20 Screw (Z4095)
Qty: 20 Sets	Qty: 30 Sets	Qty: 30 Sets	Qty: 20 Sets	Qty: 20 Sets	Qty: 10 Sets

Steel Zinc Combo Head Barrel Bolt Assortment Kit **Order # Z4403-KIT**

Features:

- 12 of the most popular 18-8 Stainless Steel internal thread Sex Bolts
- 4 of the most popular Bathroom Partition Sets—18-8 S/S in 1/2", 3/4", 1", and 1-1/4" Grip Ranges
- All male and female Sets come assembled
- Assembled sets make it easy to figure out the right size
- Easy guide to re-order
- Use this Counter Display to show customers this hard to find product line!



Features:

- 12 of the most popular 18-8 St/St internal thread Combo Head Barrel Bolts
- Easy guide to re-order
- Use this Counter Display to show customers this hard to find product line!
- MOST ITEMS ALSO AVAILABLE IN TYPE 316 STAINLESS STEEL— FROM OUR STOCK



Features:

- 12 of the most popular Steel Zinc internal thread Combo Head Barrel Bolts
- Easy guide to re-order
- Use this Counter Display to show customers this hard to find product line!





**SPECIAL ORDERS
AVAILABLE—
Small Quantities
to Large Volume**

