

**Socio-Economic report of  
Nagaon Forest Division**

**Lowering Emissions and Enhancing Forests (LEEF) in  
Nagaon, Assam**



# Lowering Emissions and Enhancing Forests (LEEF) in Nagaon, Assam

**Socio-Economic report of Nagaon Forest Division**

**Assam Project on Forest and Biodiversity Conservation**

**&**

**IORA Ecological Solutions**

## Abbreviations

|         |  |
|---------|--|
| AEDA    | Assam Energy Development Energy                              |
| AFD     | French Development Agency                                    |
| ANR     | Assisted Natural Regeneration                                |
| APFBC   | Assam Project on Forest and Biodiversity Conservation        |
| BPL     | Below Poverty Line   |
| CPT     | Cattle Proof Trenches  |
| DoEF    | Department of Environment and Forests                        |
| EDC     | Eco Development Committee                                    |
| EE      | Executive Entity   |
| EPT     | Elephant Proof Trenches                                      |
| ER      | Emission Reductions  |
| FAO     | Food and Agriculture Organization                            |
| FGD     | Focus Grouped Discussions                                    |
| GDP     | Gross Development Product                                    |
| GHG     | Greenhouse Gas   |
| ICS     | Improved Cook Stove  |
| IPCC    | Inter-governmental Panel on Climate Change                   |
| JFMC    | Joint Forest Management Committee                            |
| LEEF    | Lowering Emissions, Enhancing Forests                        |
| MGNREGA | Mahatma Gandhi National Rural Employment Guarantee Act       |
| NDC     | Nationally Determined Contributions                          |
| NTFP    | Non Timber Forest Produce                                    |
| PDD     | Project Design Document                                      |
| QA/QC   | Quality Assurance/Quality Control                            |
| REDD    | Reducing Emissions from Deforestation and Forest Degradation |
| SAPCC   | State Action Plan for Climate Change                         |
| SDG     | Sustainable Development Goals                                |
| SHG     | Self Help Group  |
| UNFCCC  | United Nations Framework Convention on Climate Change        |
| VFC     | Village Forest Committee                                     |

## Contents

|   |           |
|---|-----------|
| <b>ABBREVIATIONS</b> .....                                    | <b>3</b>  |
| <b>CONTENTS</b> .....   | <b>4</b>  |
| <b>LIST OF FIGURES</b> .....                                  | <b>4</b>  |
| <b>LIST OF TABLES</b> .....                                   | <b>5</b>  |
| <b>EXECUTIVE SUMMARY</b> .....                                | <b>6</b>  |
| <b>1 INTRODUCTION</b> .....                                   | <b>7</b>  |
| <b>2 OBJECTIVE AND SCOPE</b> .....                            | <b>9</b>  |
| <b>3 OVERVIEW OF NAGAON DISTRICT</b> .....                    | <b>10</b> |
| 3.1 ADMINISTRATIVE ARRANGEMENT .....                          | 10        |
| 3.2 DEMOGRAPHIC DETAILS .....                                 | 10        |
| 3.3 PHYSICAL FEATURES OF NAGAON .....                         | 11        |
| 3.4 LIVELIHOOD .....  | 14        |
| 3.5 OTHER GENERAL INFORMATION .....                           | 15        |
| <b>4 METHODOLOGY AND APPROACH</b> .....                       | <b>15</b> |
| 4.1 DEFINING THE SCOPE .....                                  | 15        |
| 4.2 LIMITATION OF THE SURVEY .....                            | 15        |
| 4.3 APPROACH TO THE SURVEY AND ANALYSIS .....                 | 15        |
| 4.4 TOOLS USED .....  | 16        |
| 4.5 SAMPLING DESIGN .....                                     | 18        |
| 4.6 TARGET POPULATION .....                                   | 18        |
| 4.7 SAMPLING METHOD .....                                     | 18        |
| <b>5 RESULTS AND DISCUSSIONS</b> .....                        | <b>22</b> |
| 5.1 BACK GROUND OF STUDY AREA .....                           | 22        |
| 5.2 SOCIO ECONOMIC PROFILE .....                              | 23        |
| 5.3 FOREST DEPENDENCY .....                                   | 27        |
| 5.4 DRIVERS OF DEFORESTATION AND THE FOREST DEGRADATION ..... | 41        |
| 5.5 INTERVENTION DETAILS .....                                | 43        |
| 5.6 INTERVENTION PLAN .....                                   | 44        |
| 5.7 INTERVENTION MATRIX .....                                 | 45        |
| <b>6 ANNEXURE I: QUESTIONNAIRES</b> .....                     | <b>64</b> |
| <b>7 ANNEXURE II: ATTENDANCE SHEETS</b> .....                 | <b>77</b> |
| <b>8 ANNEXURE III: PHOTOGRAPHS FROM THE SURVEY</b> .....      | <b>78</b> |

## List of Figures

|   |    |
|---|----|
| Figure 1: Overview of REDD+ (Courtesy WWF) .....                                | 7  |
| Figure 2: District map of Nagaon .....  | 12 |
| Figure 3: Forest cover map of Assam and circled portion represents Nagaon ..... | 13 |
| Figure 4: Forest type of nagaon, 2015 .....                                     | 13 |

|   |    |
|---|----|
| Figure 5: Household Survey .....  | 17 |
| Figure 6: Focus Group Discussions .....                                     | 18 |
| Figure 7: Survey team orientation and field testing the questionnaires..... | 21 |
| Figure 8: Population in % age of Sampled Household .....                    | 23 |
| Figure 9: Census Classification .....                                       | 24 |
| Figure 10: Literacy status .....  | 24 |
| Figure 11: House type .....   | 25 |
| Figure 12: Normal house structure in Nagaon.....                            | 25 |
| Figure 13: Land holding pattern.....  | 26 |
| Figure 14: Primary and secondary occupation .....                           | 26 |
| Figure 15: Source of energy for cooking .....                               | 28 |
| Figure 16: Fuelwood collection in the study area .....                      | 29 |
| Figure 17: Source of fuelwood.....  | 30 |
| Figure 18: Range wise source of fuelwood .....                              | 30 |
| Figure 19: Frequency of Fuelwood Collection .....                           | 31 |
| Figure 20: Cooking devices used in the study area.....                      | 32 |
| Figure 21: Traditional stoves used in study area.....                       | 33 |
| Figure 22: Cattle feeding .....   | 33 |
| Figure 23: Fodder collection .....  | 34 |
| Figure 24: Timber collection from forests .....                             | 35 |
| Figure 25: Small timber used for fencing and agriculture activities .....   | 35 |
| Figure 26: NTFP Dekia (fern) and tuber .....                                | 39 |
| Figure 27: Arecanut drying using fuelwood .....                             | 39 |
| Figure 28: Raw Arecanut boiling.....  | 40 |
| Figure 29: Fuelwood stored in Arecanut processing industries.....           | 40 |
| Figure 30: FGD responses on drivers .....                                   | 41 |
| Figure 31: Household responses on drivers.....                              | 41 |
| Figure 32: Range wise responses on drivers .....                            | 42 |
| Figure 33: Intervention activities to reduce fuelwood consumption.....      | 44 |
| Figure 34: Mango Plantation.....  | 57 |
| Figure 35: Jackfruit Plantation .....                                       | 58 |

## List of Tables

|  |    |
|--|----|
| Table 1: Population data (Census 2011) of Nagaon district <sup>5</sup> .....   | 11 |
| Table 2: List of villages and number of households visited for survey .....    | 20 |
| Table 3: Population structure.....   | 23 |
| Table 4: Livestock details .....   | 27 |
| Table 5: Mode of fuelwood Transportation .....                                 | 30 |
| Table 6: Average distance travelled to collect fuelwood .....                  | 31 |
| Table 7: Use of timber and source.....   | 35 |
| Table 8: NTFP collected in the study area .....                                | 38 |
| Table 9 : Estimation of fuelwood required for one arecanut industry .....      | 40 |
| Table 11: Intervention activities to reduce fuelwood consumption .....         | 43 |
| Table 12: Intervention activities to reduce fodder collection.....             | 44 |
| Table 13: Intervention activities timber consumption.....                      | 44 |
| Table 10: List of interventions planned for Nagaon under the LEEF project..... | 45 |

## Executive Summary

REDD+ (Reducing Emissions from Deforestation and Forest Degradation) is an international forest conservation framework, through which countries are incentivized for any emissions reductions (ERs) achieved through proactive forest management, enhancement of forest carbon stocks and associated decrease in the rates of deforestation and forest degradation. After having identified current drivers and projected rates of deforestation and forest degradation, performance-based payments are made available to these countries based on the extent of their achieved ERs. The mechanism has received support towards implementation in developing countries. Article V in the Agreement under the UNFCCC 21st Conference of Parties, held in Paris in December 2015, encourages member countries towards achieving their climate mitigation goals through the REDD+ framework.

In recognition of the need for urgent action to reduce greenhouse gases (GHG) emissions and mitigate climate change, India's has come forward with a National REDD+ Policy to stimulate REDD+ activities in the country. Main objective of this policy is to provide a roadmap to construct strategies for designing REDD+ projects, implement them and leading to REDD+ readiness in the country.

Assam Project on Forest and Biodiversity Conservation (APFBC) under the Department of Environment and Forests (DoEF), Government of Assam, with the help of the French Development Agency (AFD) has initiated the project **Lowering Emissions, Enhancing Forests (LEEF)** in State's Nagaon district to mitigate climate change in the forestry sector through REDD+ actions. The aim of the project is to avail intended benefits of the REDD+ mechanism, which includes carbon and non-carbon benefits. The GHG emission reduction from forests can also contribute to India's commitments under its Nationally Determined Contributions (NDC) under the United Nations Framework Convention on Climate Change (UNFCCC) agreement. India has planned to create an additional carbon sink of 2.5 to 3 billion tons of CO<sub>2</sub> from forestry sector by 2030. The project will also help in achieving the Assam-specific Sustainable Development Goals (SDGs), which have been developed as the first State-level SDGs in India.

The project will achieve its objective through multi-layered planning, the stakeholders of which will also include the forest-dependent communities in the region. Studies have shown that there are several agents and drivers responsible for deforestation and forest degradation in the Nagaon district of Assam.

A thorough socio-economic survey across Nagaon's 7 ranges, including 58 villages and 567 households, was carried out to identify drivers of deforestation and forest degradation. The households surveyed were representative of large, medium and small farmers, and landless households. The driver identification process also resulted in a participatory identification of interventions. Unsustainable extraction of forest produces has been reported to be a major cause of forest degradation. In addition, study tried to throw on community's likeliness to participate in overall development, implementation and monitoring of proposed REDD+ project in the district.

## 1 Introduction

Inter-governmental Panel on Climate Change (IPCC) and other environmental agencies have conducted studies to evaluate changes in the global climatic patterns, and these changes are ascribed to anthropogenic emissions resulting in increased concentration of Greenhouse Gases (GHG) in the atmosphere, which then leads to global warming. These studies estimate that land use change, including deforestation and the forest degradation, accounts for 17-29% of global greenhouse gas emissions. Reducing emissions from deforestation and forest degradation (REDD+) is a climate change mitigation mechanism that aims to reduce the amount of GHGs emitted into the atmosphere by creating carbon sinks i.e. Forests. REDD+ is a mechanism that has been under negotiation by the United Nations Framework Convention on Climate Change (UNFCCC) since 2005, with the objective of mitigating climate change through reducing net emissions of greenhouse gases through enhanced forest management in developing countries. REDD+ along with carbon benefits, it also has non-carbon benefits such as sustainable development of local communities through livelihood generation, capacity building, clean water and air, biodiversity conservation, etc. A decisive element in the process of designing REDD+ strategies and action plans are thorough understanding of the drivers and agents responsible for deforestation and forest degradation. Therefore, in order to take REDD+ initiatives, thorough analysis and quantification of drivers and agents are necessary which is challenging one. This is a challenging task due to dynamic and diversified nature of communities as well as complexities involved in deforestation and forest degradation.

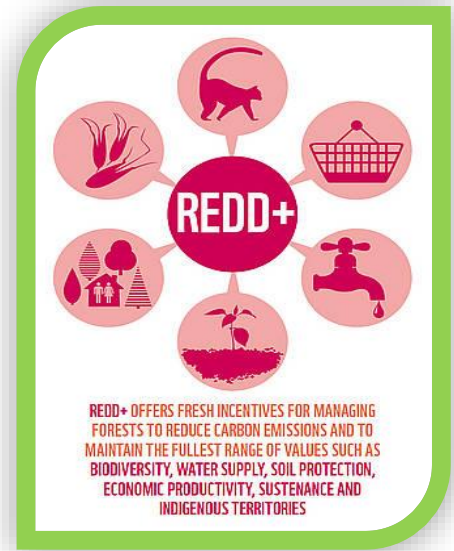

Figure 1: Overview of REDD+ (Courtesy WWF)

In order to ensure sustainable forest management, biodiversity conservation, and to explore livelihood alternatives of the forest dependent communities in Assam, the State Government with the help of the French Development Agency (AFD) has initiated a Project on Forest and Biodiversity Conservation (APFBC). The project will achieve its objective through multi-layer integrative planning involving stakeholders including the forest-dependent communities. This Project Design Document (PDD) details the Lowering Emissions, Enhancing Forests (LEEF) project in the Nagaon District. LEEF has been developed under the APFBC, as a district level Jurisdictional REDD+ project in Assam. The Department of Environment and Forests (DoEF) is the Executive Entity (EE) of the project.

The forests of Nagaon district are among the most biodiversity rich in India and are part of the Eastern Himalaya biodiversity hotspot; containing a National Park, which is also a World Heritage Site and a Wildlife Sanctuary, home to species such as the One-Horned Rhinoceros and the Tiger.

Climate change will intensify drought and floods in the State of Assam (DoEF, 2015)<sup>1</sup>, which will lead to loss of forest and may increase the impacts on other crucial sectors on which the people are dependent. In

<sup>1</sup> Assam SAPCC, 2015, <http://www.moef.gov.in/sites/default/files/Final%20draft%20ASAPCC%20document.pdf>

Nagaon, Very Dense Forest (VDF) account for only 5% while Open Forest (OF) is 51% of the total forest area. The cause for this is mainly degradation in forest quality and quantity, encroachments, fuel wood extraction, etc. The Assam State Action Plan for Climate Change (SAPCC) states, *“If mechanisms could be created to provide payments for mitigation benefits, these could add 5% to 10% to forestry GDP, based on the relative value of net carbon sequestration, compared with commercial benefits from forestry”*.

Socioeconomic survey is one of the widely used tools used to identify and quantify the drivers and agents, which are responsible for deforestation and forest degradation. This tool provides an understanding of local resource management systems, resource utilisation and the relative importance of resources for communities, households and villages. They can also be used to call forth insights on interaction with government decision-making systems, community perceptions of trends and priority issues, and community-based institutions and their role in the sustainable use and conservation of natural resources. Use of such tools is an important first step in engaging local communities.

The present Socioeconomic report gives an insight of current socioeconomic scenario in the region (Nagaon district) and as well as a broad overview of main drivers of deforestation and the forest degradation. The results presented here are based on desk literature studies and reviews, village level PRAs, focal group discussions and household level socio-economic surveys. Also this report outlines the interventions proposed by the communities during survey to address the drivers of deforestation and forest degradation.



## 2 Objective and Scope

The primary objective of the project is to develop a pilot jurisdictional REDD+ project in Nagaon district of Assam, India.

The main objective of this study report is to have a detailed understanding of the drivers and agents responsible for deforestation and forest degradation (D&D) in Nagaon district. The study includes generation of baseline data on prevailing socioeconomic and livelihood conditions of the communities living in and around the forests of Nagaon district.

Specifically, the objective of the study is to:

- ✓ Identify the agents and drivers responsible for deforestation and forest degradation
- ✓ Asses the direct and indirect causes behind deforestation and degradation
- ✓ Map all the relevant stakeholders in the district and record the opinion on willingness to participate in REDD+ project.
- ✓ Develop a strategy and action plan for REDD+ implementation through participatory approach

The project will achieve its objective through multi-layered planning, the stakeholders of which will also include the forest-dependent communities in the region.

### 3 Overview of Nagaon district

Nagaon (Now gong that is spelled by British) spreads across almost four thousand square kilometres of fertile alluvial soils Bharamhaputra river plains and densely forested hills<sup>2</sup>. People of Nagaon have played an important role in Quit India Movement<sup>3</sup> and Mahatma Gandhi visited this place in the year 1921. Nagaon history dates back to 3<sup>rd</sup> century when Bahauma Naraka Family believed to have ruled Assam about 355 AD. Shankadeva a famous Vaishnavite reformer was born in the Bordowa Satara of the Nagaon district who brought about a Renaissance in Assamese society with his preaching and through a famous play Ankia Nat. Nagaon name has special historical importance in the history of Assam. During 16<sup>th</sup> century, Kacharis attacked the Ahom kingdom which forced to people of Kaliabor and Raha to flee from the place. After the expulsion of Kacharis in the region, an officer Momai Tamuli Barbarhua of Ahom kingdom has rebuilt this area with new villages. The word 'Na' mean new and 'Gaon' means village. So this how this district has the name "Nagaon".

#### 3.1 Administrative arrangement

The Nagaon<sup>4</sup> district was carved out of Morigaon district and formed as a new district in the year 1989. At present Nagaon has geographical area of 3,993 sq.km consisting of 10 revenue circles<sup>5</sup>. The total number of revenue villages in the district is about 1,396. There are 18 development blocks in the district with 3 administrative sub-divisions, namely Nagaon, Kaliabor and Hojai. Recently Nagaon has been further divided in August 2015 and formed new district Hojai out of it comprising of three thesils of Nagaon district named Hojai, Doboka and Lanka.

#### 3.2 Demographic details

As per 2011 census, the district has total population of 28,26,006 with decadal growth of 22.09%<sup>6</sup>. Population density of the district is 711 which higher compared to states population density of 398 per sq.km. 86.97% of total population of Nagaon district lives in rural areas. Since time immemorial, the district manly comprises diverse ethnic groups. Major population of the district is from Muslim community followed by Hindus and Christians.

| Population                             |           |          |
|--|-----------|----------|
| Total                                  | Rural     | Urban    |
| 28,26,006                              | 24,57,906 | 3,68,100 |
| Percentage Decadal Growth (Persons)    |           |          |
| Total                                  | Rural     | Urban    |
| 22.09                                  | 20.70     | 32.27    |
| Sex Ratio(No. of Female per 1000 Male) |           |          |
| Total                                  | Rural     | Urban    |
| 962                                    | 962       | 963      |

<sup>2</sup> <http://www.icsr.org/Nagaon.pdf> (page no 11)

<sup>3</sup> District Census Book, 2011.

<sup>4</sup> Most of the secondary data quoted here is for the unified Nagaon + Hojai district. as census was conducted in 2011, before bifurcation of the districts.

<sup>5</sup> <http://nagaon.gov.in/glance.html>

<sup>6</sup> <http://nagaon.nic.in/cen2011assam.xls>

**Table 1: Population data (Census 2011) of Nagaon district<sup>6</sup>**

### 3.3 Physical features of Nagaon

The climate is very extreme climate compared to other parts of Assam. District experiences humid subtropical climatic conditions<sup>7</sup>. Rainfall increases towards the east and the west of Assam from this district. The District Nagaon is under the Agro Ecological Sub Region (ICAR) Assam and Bengal Plain, Hot Sub humid To Humid (Inclusion of Perhumid) Eco-Region (15.2) Agro-Climatic Zone (Planning Commission) Eastern Himalayan Region (II) Agro Climatic Zone (NARP) CENTRAL BRAHMAPUTRA VALLEY ZONE (AS-3). The average rainfall of the district is about 1800 mm. Rainfall pattern is changed drastically due to deforestation, El-Nino effect and urbanisation<sup>9</sup>. During the Socio-economic survey, people also admitted there is paradigm shift in raining pattern of the district. People recollected that they used to get very good rain spread across few months but now they are receiving same amount of rains for only few days. That means number of rainy days have decreasing over a period. The annual average maximum temperature is 30.4 ° Celsius and the minimum is 19.8 ° Celsius. The average altitude of the district is 60.6 m<sup>8</sup>.

#### 3.3.1 Location

Nagaon district falls between 25<sup>0</sup>-45' to 26<sup>0</sup>-45' North Latitude and 92<sup>0</sup>-33'-6" East Latitude<sup>9</sup>. The district is bounded by Sonitpur district and the river Brahmaputra in the north, West Karbi Anglong and North Cachar Hills in the south and East Karbi Anglong and Golaghat district in the east. Nagaon is the main access strip to upper Assam districts.

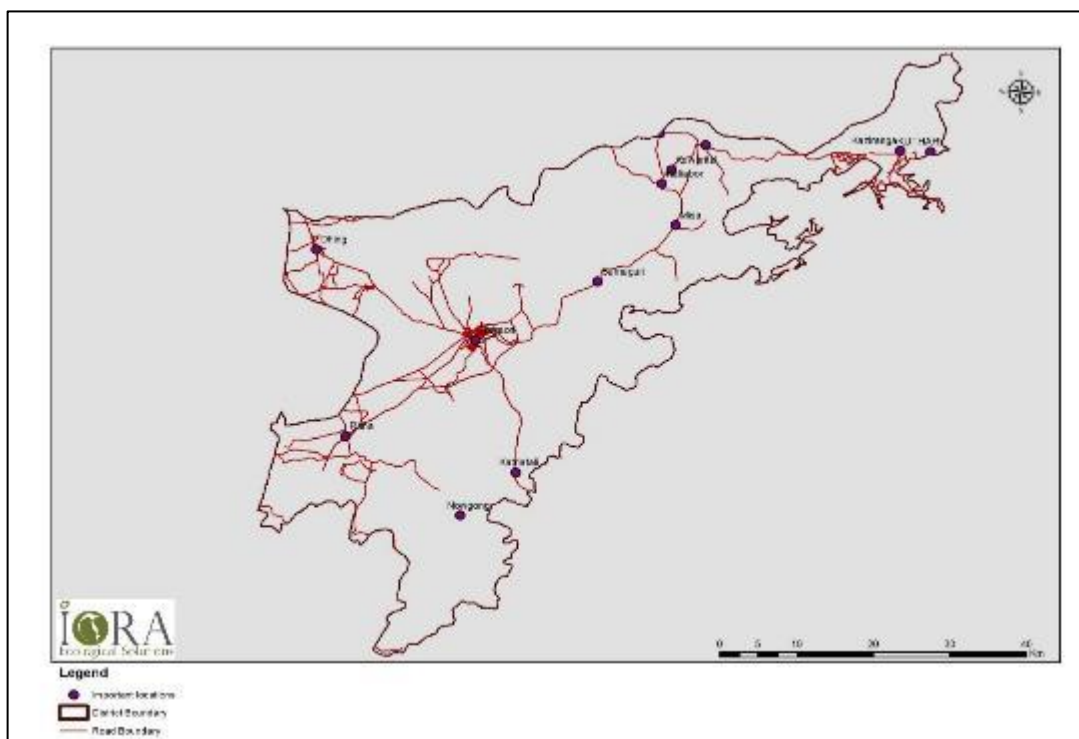

<sup>7</sup> [http://www.icarzcu3.gov.in/Dist\\_Agri\\_Inventory/Nagaon.pdf](http://www.icarzcu3.gov.in/Dist_Agri_Inventory/Nagaon.pdf) (pg no 8)

<sup>8</sup> <http://dcmsme.gov.in/dips/Nagaon.pdf> (pg no 4)

<sup>9</sup> <http://nagaon.nic.in/geog.html>

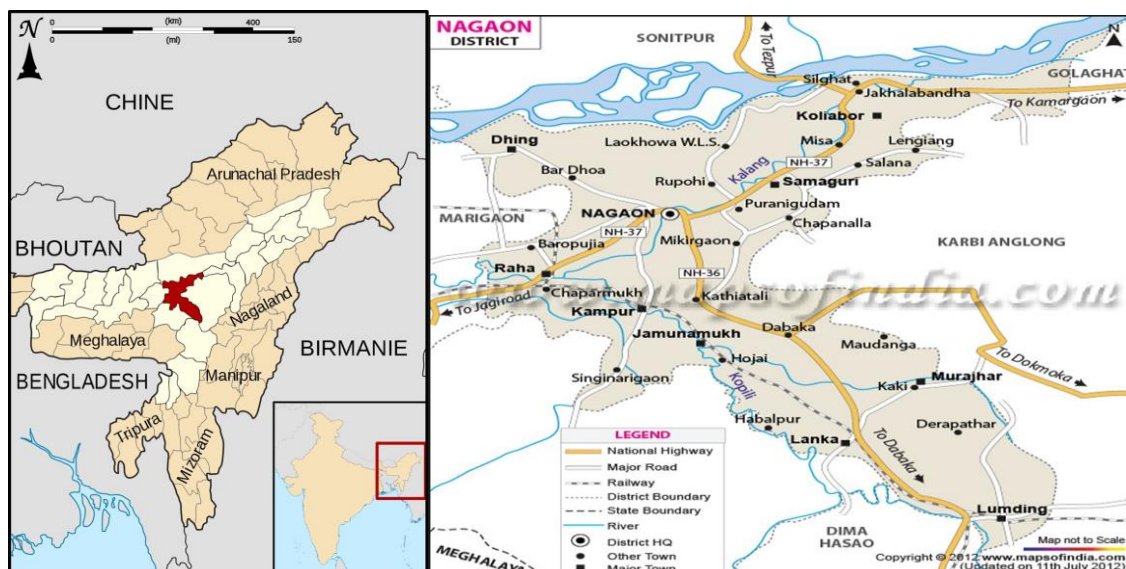

Figure 2: District map of Nagaon<sup>10</sup>

### 3.3.2 Flora and Fauna

Forests covers 20.7% of Nagaon' total geographical area with 793 sq.km of forest cover. This includes 40 sq.km of very dense forest, 351 sq.km of moderately dense forest and 402 sq.km of open forests. There is a decrease in the forest cover compared to the assessments made in 2013 to 2015, due to encroachment of forestland, biotic pressure, and rotational felling in tea garden<sup>11</sup>.

The Nagaon district is home for world famous one-horn Rhinoceroses and has one of the World Heritage site Kaziranga National Park. Apart from one-horn Rhinoceroses, it also hosts the Royal Bengal Tiger, Asiatic Elephant, Eastern Swamp Deer and the Asiatic Wild Buffalo. Nagaon also has one more sanctuary called Laokhowa Wildlife Sanctuary, which is situated, on the southern bank of Brahmaputra river having an area of 70.13 sq.km. Forests of Nagaon district varies from evergreen to Dry Deciduous type and dominated by Sal type species. Also the forests are classified into two classes namely Reserved forests and unclassified state forests.

<sup>10</sup> <http://www.nagaon.assampanchayat.gov.in/documents/7788737/0/nagaon-district-map.jpg?t=1370331895011>

<sup>11</sup> <http://fsi.nic.in/isfr-2015/isfr-2015-forest-and-tree-resources-in-states-and-union-territories.pdf> (pg no 16 and 17)

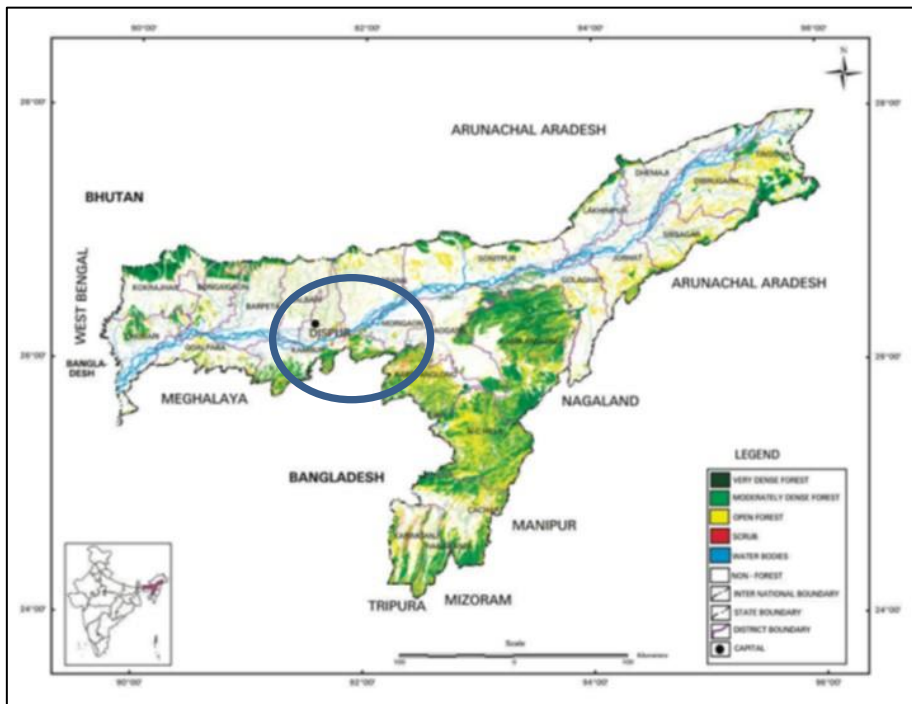

Figure 3: Forest cover map of Assam and circled portion represents Nagaon

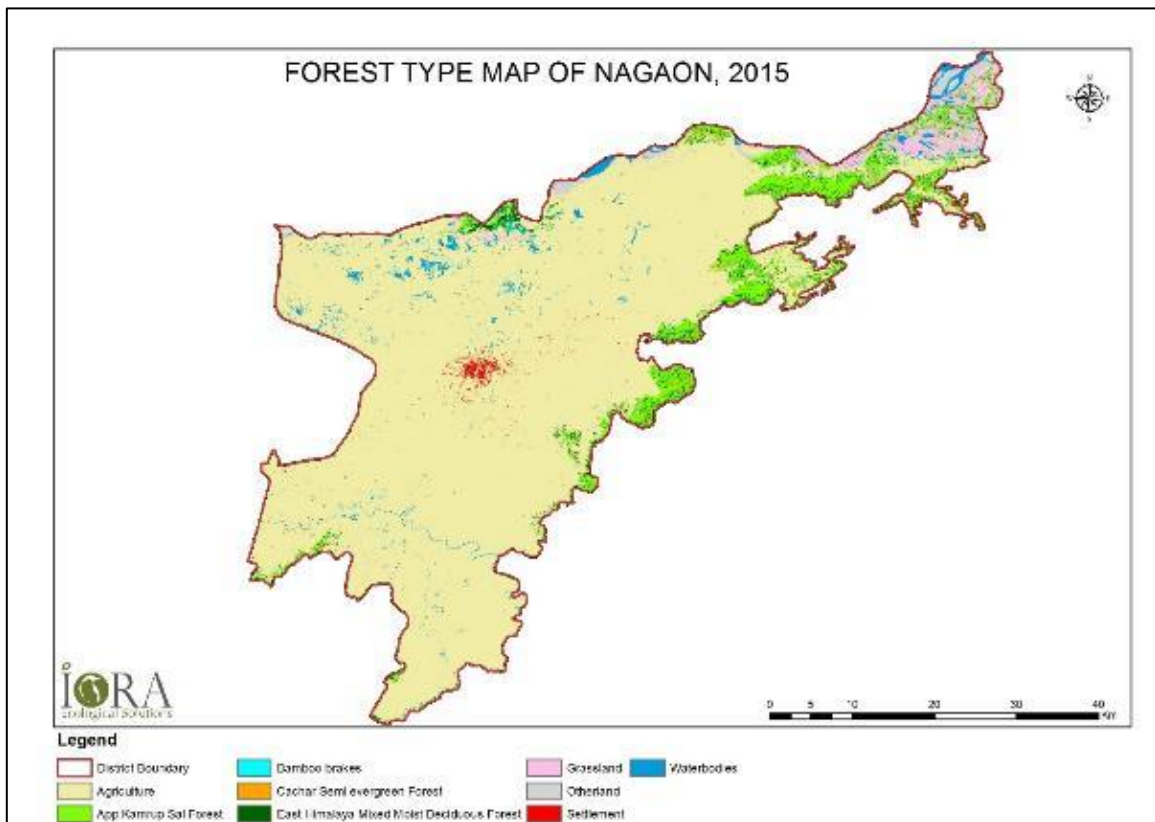

Figure 4: Forest type of nagaon, 2015

### 3.3.3 Climate

The annual average maximum temperature is 30.4° Celsius and the minimum is 19.8° Celsius. The average altitude of the district is 60.6 m<sup>12</sup>. December and January are the coldest months of the year with minimum temperature from 11.2°C to 12.7°C. From March to middle of November, the temperature is fairly high, July & August generally being the hottest months. The maximum temperature on an average rises up to 30.75°C.

### 3.3.4 Rainfall

Rainfall increases towards the east and the west of Assam from this district. The annual rainfall, on an average varies from 2.96 mm to 341.62 mm. A comparatively dry zone with average rainfall between 50 to 60 inches exists around Dhing (Brahmaputra plains). Over the past few year, rainfall pattern has been observed to have changed. This can be due to deforestation, El-Nino effect and urbanisation<sup>13</sup>. During the socio-economic survey, people also admitted there is paradigm shift in raining pattern of the district. People recollected that they used to get very good rain spread across few months but now they are receiving same amount of rains for only few days.

### 3.3.5 Rock and Soil

The project area is flat alluvial terrain with hills on its southern part. Most of the North Karbi-Anglong hills are composed of massive gneiss or foliated granite. The gneiss is composed mostly of quartz feldspar with magnetic hornblende and mica. The area consists of combined formations belonging to Pre-Cambrian Groups of rocks<sup>14</sup>, Semi-consolidated Formations of Tertiary age<sup>15</sup> and overlain by Unconsolidated Alluvial sediments of Quaternary age<sup>16</sup>.

The major soil type of the district is alluvial loamy which consists of a mixture of clay and sand in varying proportions. Low-lying areas are mainly marshy soil which are black in colour. The foothills and hill slopes mainly contain red soil which is good and suitable for forest growth.<sup>17</sup>

## 3.4 Livelihood

Agriculture is the principal occupation and income generating activity of the district. Besides that, handloom and weaving are two major economic activities of the communities. Rice, sugarcane, mustard, jute, coconuts, bananas and vegetable are the major crops grown in the district<sup>18</sup>. Total cropped area of the district is 3, 54,801 ha and net sown area is 2, 34,633 ha<sup>5</sup>. About 78% of total population of the district are dependent on agriculture<sup>19</sup>. Paddy being the principle crop in the district, rice becomes obvious choice as a staple food for the communities.

---

<sup>12</sup> <http://dcmsme.gov.in/dips/Nagaon.pdf> (pg no 4)

<sup>13</sup> <http://nagaon.nic.in/geog.html>

<sup>14</sup> <https://www.britannica.com/science/Precambrian-time>

<sup>15</sup> <http://wrmin.nic.in/writereaddata/WatertheResource/tab17562984991.pdf>

<sup>16</sup> <http://wrmin.nic.in/writereaddata/WatertheResource/tab17562984991.pdf>

<sup>17</sup> [http://www.cgwb.gov.in/District\\_Profile/Assam/Nagaon.pdf](http://www.cgwb.gov.in/District_Profile/Assam/Nagaon.pdf)

<sup>18</sup> <http://pmgsy.nic.in/pas128.asp>

<sup>19</sup> <http://nagaon.nic.in/econ.html>

### **3.5 Other general information**

Nagaon district hosts place called Bordowa, the birthplace of Mahapurush Srimantha Shankaradeva, the great artist, author and founder of Vaishnavism religion in Assam. Also consists of The Laokhowa Wildlife Sanctuary is situated at Lowkhowa namely covering an area of 70.13 km<sup>2</sup>. Nagaon is also known as Rice bowl of Assam. The major rivers of the district include the Brahmaputra, Kalong, Sonai, Nanoi, Jamuna, Kopili and the Barpani.

## **4 Methodology and Approach**

Nagaon district has a population density of 711 per sq km as per 2011 census compared to states population density of 398 per sq.km. In addition, 89% of total population live in rural parts of the district and most of them dependent forests for their livelihoods. From this, one can imagine the amount of pressure exerted by this population on forests resources to meet their day-to-day needs.

### **4.1 Defining the scope**

The main objective of this study is to identify the original and leading drivers for deforestation and forest degradation in Nagaon district. The effort is made through this study to identify possible intervention activities through participatory approach, which could be taken up through Jurisdictional REDD+ project.

### **4.2 Limitation of the survey**

Every study and research has its own limitations. This study is also not an exception from the limitations. Lack of first hand data about the communities, household details, community structures and difficult in approaching the remote areas due lack of road facilities as well as communication facilities are the major limitations of the study. Efforts have been made to collect data from far reaching communities too. Data collected during this study is completely based on communities' responses to questions pertaining to forests resource utilisation. The responses given by communities varied from person to person in a single village. Utmost care has been taken in collecting the information without any bias towards the study objective and communities perception.

### **4.3 Approach to the survey and analysis**

The study involved structured approach to assess the drivers, agents and the underlying causes of deforestation and degradation. An experience team with knowledge of local language to read, write and speak was formed to conduct the study. Apart from this team, a team of experts from forestry, social, and energy sectors from IORA Ecological Solutions were involved in sample design, questionnaire design and other activities of the study. An inclusive desk based study was conducted to acquire socio-economic information of the Nagaon district. The data was obtained from District profiles from different Government sources, Government reports, and scientific studies.

The survey was divided into both quantitative and qualitative data collection. The former one gives specific data, percentages and numbers to be gathered. The latter one gives us a more generalised view over a greater number of people. The results of both qualitative and quantitative studies are presented in the following sections

#### 4.4 Tools used

The study implemented most commonly used scientific and statistical tools to collect socio-economic information. The tools involved are in-depth interviews of individuals (**Household survey**), Focused Group Discussions (**FGDs**) with communities, dialogues, local consultations with relevant stakeholders and personal observation.

##### 4.4.1 Household Survey

Questionnaire was designed in consultation with the forest department and field tested before implementing at large scale data collection. Based on field studies the questionnaires was modified and fine-tuned to the local conditions and it has been translated to local Assamese language for better understanding of the questions for survey team and communities as well. A classroom session was held to the survey team members to explain the objectives of the study and the questionnaires. Since this is a Jurisdictional REDD+ project activity, the villages were selected within the administrative boundaries of Nagaon district. The households surveyed were representative samples from large, medium and small farmers and landless households. The questionnaire adopted for the survey is included in Annex 1. The survey was conducted between December 2016 and January 2017 months.







**Figure 5: Household Survey**

#### **4.4.2 Focus Group Discussions**

Villages in each range were selected randomly to conduct Focus Grouped Discussions (FGD). In total 26 FGDs at different villages were conducted during the study. FGDs included important and key informants from the villages like JFMC members, Panchayat members and other prominent people of the village. Forest department personal was also involved while conducting FGD.



## Figure 6: Focus Group Discussions

### 4.5 Sampling Design

#### 4.5.1 Determination of Sample Size

The sample size needed to be representative of a given population is based on the Krejcie, and Morgan equation<sup>20</sup>:

$$S = X^2NP(1- P) \div d^2(N -1) + X^2P(1- P).$$

Where:

|                |  |
|----------------|--|
| S              | Required sample size.  |
| X <sup>2</sup> | The table value of chi-square for 1 degree of freedom at the desired confidence level (X <sup>2</sup> =3.841). |
| N              | The population size.   |
| P              | The population proportion (assumed to be 0.50 since this would provide the maximum sample size).               |
| d              | The degree of accuracy expressed as a proportion (0.05).   |

As per Krejice and Morgon, the number of households (SS) to be surveyed for a population of about over a million population is 384. Assuming overall response rate of 80% from the sampled households, it has been decided to sample 384/0.8= 480 households. In this study, 567 households were surveyed for the REDD+ project to analyze the drivers responsible for deforestation and the forest degradation.

### 4.6 Target Population

The target population are the households and communities from the villages of 7 forest ranges whole Nagaon Forest Division within Nagaon district boundaries.

### 4.7 Sampling Method

#### 4.7.1 Assumptions

Nagaon district has 7 forest ranges under Nagaon forest division and whole of the district is covered by these 7 ranges. For the survey, all 7 ranges were considered. The following methodological assumptions were made to achieve the REDD+ project objectives.

- Total population in the district is considered homogeneous for sample size calculations. However sampling stratification is made on the basis of distance from forests, as adopted by FRI (1 km). two more buffers at 1 km to 5 km and 5 km were also created for mapping foret resource utilization. The fourth stratum consists of all the villages within the forests.

---

<sup>20</sup> Krejcie, R.V. and Morgan, D.W. 1970. Determining sample size for research activities. Educational and psychological measurement 30: 607-610 and <http://www.raosoft.com/samplesize.html>

- b) Households or villagers dependency on forest produce is inversely proportional to distance of forest from the households or villages<sup>21</sup>.
- c) We have assumed that many of the effects can have a compounding effect on the forest stock, for instance; grazing and fuelwood extraction together can have a more detrimental effect on forest stock. However in this study we have considered only the total stock removal under each activity, as compounding effect needs more time for estimations and are location specific. Further, this approach is also conservative.

#### 4.7.2 Allocation of Samples

Households or villagers dependency on forest produce is inversely proportional to distance of forest from the households or villages<sup>21</sup>. A list of villages from each range was sought from the forest department. A random stratified selection of minimum 6 villages was done to represent all the Forest Ranges. Again, these villages are segregated into 3 categories as described below.

They are,

- Households (Villages) within 1 KM from forest
- Households (Villages) within 1 to 5 KM from forest
- Households (Villages) beyond 5 KM from forest

In total 7 Forest Ranges, 58 villages and 567 households were visited to conduct the socio economic survey. The below table gives the Forest Ranges, Villages and the number of households visited to conduct the survey.

| Range            | Village                  | No of HHS |
|------------------|--------------------------|-----------|
| <b>Dhania</b>    | 1 No. Bhurbandha         | 10        |
|                  | 3 No. Bhagamukh          | 10        |
|                  | 3 No. Bhurbandha         | 10        |
|                  | 5 NO BHAGAMUKH           | 9         |
|                  | 6 NO BHAGAMUKH           | 1         |
|                  | 7 NO BHAGAMUKH           | 1         |
|                  | Sutirpar Chitalmari      | 11        |
| <b>Dharamtul</b> | Amsoi Gaon               | 10        |
|                  | Balikuchi                | 11        |
|                  | Burha rajagaon           | 10        |
|                  | Ganeshguri               | 10        |
|                  | Gashpara                 | 10        |
|                  | Niz sahari               | 10        |
| <b>Garajan</b>   | Barunguri Bongaon        | 10        |
|                  | Kaliyadangia Tongia gaon | 12        |
|                  | LalungGaon               | 10        |
|                  | Lawkhuwa Bongaon         | 8         |
|                  | Nalkata Bongaon          | 13        |
|                  | Salpara Bongaon          | 10        |
|                  | Senimari Bil             | 10        |
|                  | Sunsahar Bongaon         | 14        |
|                  | Sutirpar Bongaon         | 10        |

<sup>21</sup> Planning for forest resources and Biodiversity Management, Kailash Chandra Bose, IFS. (page no 176 and 177)

| Range               | Village                      | No of HHS  |
|---------------------|------------------------------|------------|
| <b>Kampur</b>       | 1 No. Kuhimari               | 3          |
|                     | 2 No. Kuhimari               | 7          |
|                     | 9 no Kheroni (Tongia gaon)   | 18         |
|                     | Atigaon                      | 7          |
|                     | Dakhin Jor Bagan             | 11         |
|                     | Jadupathar                   | 12         |
|                     | Kuhimari                     | 2          |
|                     | Lutumari Tapakuchi           | 9          |
|                     | Natun Garukhunda (Pilkhana1) | 16         |
|                     | Sitalmari                    | 13         |
| <b>Kathiatoli</b>   | 2 No. Pilkhana Bongaon       | 2          |
|                     | Borkacharigaon               | 11         |
|                     | Garogaon                     | 10         |
|                     | Garubandha                   | 8          |
|                     | Manuhargaon                  | 8          |
|                     | Rengbeng                     | 4          |
|                     | Sarupathar                   | 4          |
|                     | Tetelisara                   | 10         |
| <b>Nagaon Sadar</b> | Adarsha Gaon                 | 12         |
|                     | Alitangani                   | 13         |
|                     | Bejorgaon                    | 12         |
|                     | Dagaon                       | 12         |
|                     | Fuhaniati                    | 13         |
|                     | Ghugar gaon                  | 14         |
|                     | Rowmari                      | 13         |
|                     | Uriagaon                     | 15         |
| <b>Salona</b>       | Baghekhaiti                  | 1          |
|                     | Balijuri Karbigaon           | 11         |
|                     | Bolhula karbi gaon           | 15         |
|                     | Bonbahoni                    | 2          |
|                     | Hatimurah                    | 15         |
|                     | Nalbari Kacharigaon          | 10         |
|                     | Namkamakhya                  | 12         |
|                     | Samdhara                     | 10         |
|                     | Sunarigaon                   | 12         |
|                     | Uttar Borghat                | 10         |
| <b>Grand Total</b>  |                              | <b>567</b> |

**Table 2: List of villages and number of households visited for survey**

#### 4.7.3 Quality Assurance/Quality Control

The QA/QC procedure was to achieve good quality data through field measurements. The household level questionnaire was designed and field tested before administering the actual questionnaire survey. The survey team was first given an orientation and explained about the objective of study. The training was conducted by IORAs experience team. One day training was organised to team members at Nagaon DFO office and the questionnaires were field tested before employing at the large scale. After the field testing and based on the field observations by the team, questionnaires were fine-tuned and finalised.



**Figure 7: Survey team orientation and field testing the questionnaires**

## 5 Results and Discussions

We all know forests play an important role in livelihood generation of the communities especially who lives in and around of the forests. The box below highlights the importance of forest role as summarised by Byron & Arnold (1997).

Concerning the importance of forests to livelihoods:

*For millions of people living in forest environments, the forest forms such a dominant part of their physical, material, economic and spiritual lives that its importance is not most appropriately described and assessed in terms of the individual products or services that the forest provides.*

On the use of forests and forest products to supplement nutritional and medicinal needs:

*Forests and forest trees are the sources of a variety of foods that supplement and complement what is obtained from agriculture, of fuels with which to cook food, and of a wide range of medicines and other products that contribute to health and hygiene.*

About the use of forest products to meet seasonal food shortages:

*Forest foods are most extensively used to help meet dietary shortfalls during particular seasons in the year. Many agricultural communities suffer from seasonal food shortages, which commonly occur at the time of year when stored food supplies have dwindled and harvest new crops is only just beginning.*

### 5.1 Back ground of Study area

The present study was conducted in seven forest ranges of Nagaon forest division including 5 ranges from territorial division and 2 ranges from wildlife division. The ranges are Dharamtul, Kampur, Kathiatoli, Salona and Nagaon Sadar in territorial division and Dhaniala and Garajan ranges in Wildlife division. Nagaon Sadar range of territorial division does not have any notified or reserve forests but communities still depend forests of other ranges for fuelwood and Bamboo.

The Assam Forest department has identified few villages as forest villages. In earlier days to get the labour supply, the forest villages were established inside the forests. In addition to Forest Village, there is another type known as Taungya Village. The people from these villages are involved in plantations work such as clearing the site, burning the debris, stacking, hoeing in strips, making planting holes, planting, sowing seeds, weeding, cleaning & thinning etc. at present people from these villages do not provide any free services department for forestry works.

Two month long study was conducted in the project area to assess the current scenario of the drivers and agents responsible for deforestation and forest degradation. The study involves different stakeholder consultations within the project area. The study revealed that majority of the people do not have any idea about the alternatives available to replace fuelwood consumption and sustainable way of harvesting of

NTFPs. This is due to lack of awareness among the communities about the significance of forest resources. The forests and communities of the district are inseparable. The way of life of communities are well imbibed with forest. All of their cultural and religious activities and livelihood activities are dependent on forest resources. Other than forest resources availability, basic health and education facilities are not up to the mark. Villages lack health centres and school facilities. People also raised concerns about the reach of benefits to villagers of prevalent government schemes. Man animal conflicts are common in project area.

## 5.2 Socio Economic profile

As discussed in above section, the survey took place in two modes – household surveys through questionnaires and Focused Group Discussions village large people of the villages. The result is thus divided in two segments accordingly. This chapter will cover the findings from household survey.

### 5.2.1 Population Structure

During the survey, 58 villages and 567 households were visited across all the forest ranges of Nagaon forest division. The following Table 3 shows the population pattern of the surveyed households.

| Male  | Female | Children (<14 years) | Total |
|-------|--------|----------------------|-------|
| 1,201 | 1,149  | 823                  | 3,173 |

**Table 3: Population structure**

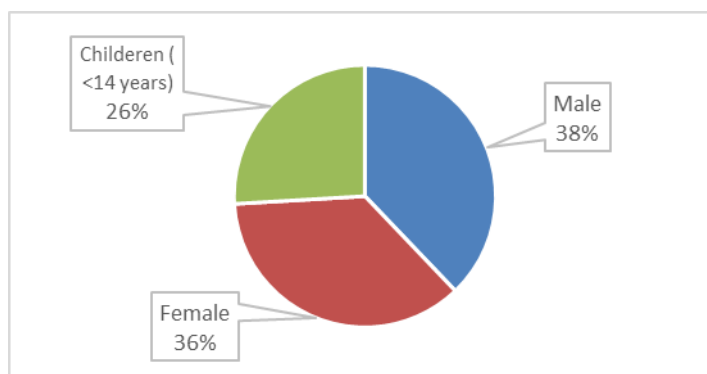

**Figure 8: Population in % age of Sampled Household**

The average household size is 6 members, with 4 adults and 2 children. Analysis revealed that the male: female ratio is 1000:956<sup>22</sup>. The survey results are in line with Assam Population Census data 2011.

### 5.2.2 Census Classification

Assam is tribal state which is the part of North Eastern (NE) region of India. From the survey (Figure 8) it is evident that majority of the people (35%) belong to schedule tribe followed by OBC, General, SC and MOBC.

<sup>22</sup> <http://www.census2011.co.in/census/state/assam.html>

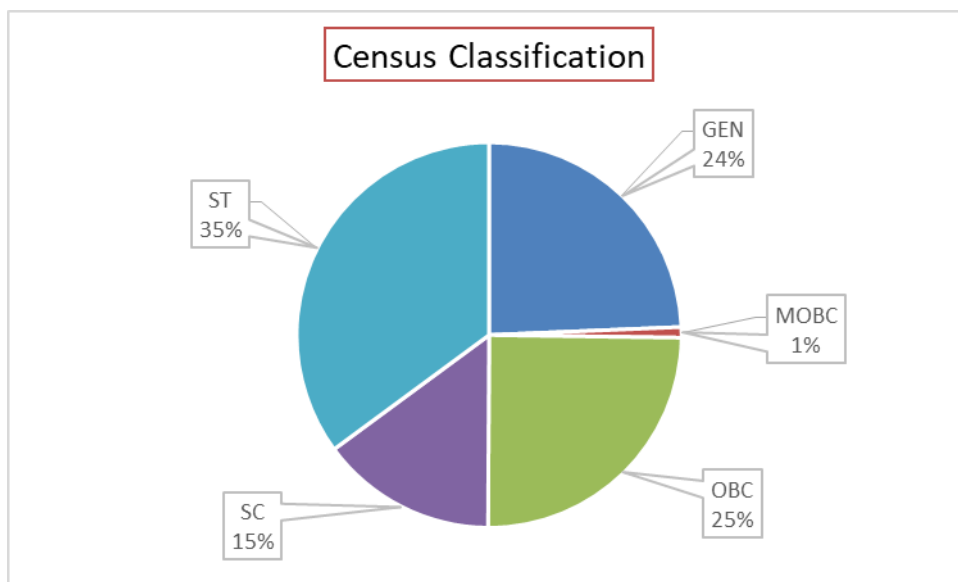

**Figure 9: Census Classification**

### 5.2.3 Literacy Status

Literacy plays an important role in livelihoods of communities. It determines the analytical capacities, decision making capacities of people. This is an important indicator of human development. The survey revealed that 29 % of respondents are uneducated. As per 2011 census, Assam literacy rate stands at 72.19%<sup>22</sup>. Only 4% of the respondents are completed graduations. More than of the people have completed primary and high school.

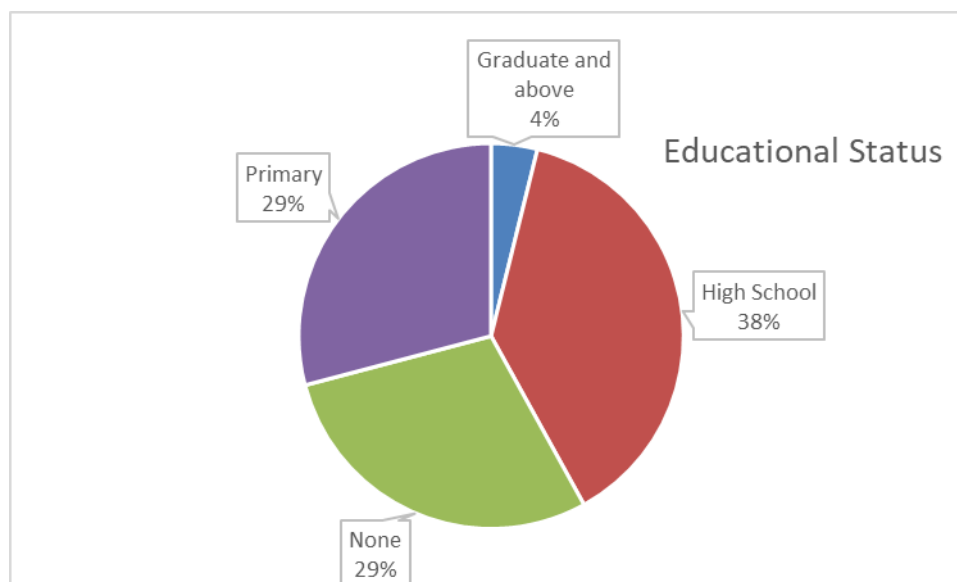

**Figure 10: Literacy status**

### 5.2.4 Dwelling units

Assam being north eastern state of India is prone to natural calamities like heavy rainfall, earthquakes. So communities prefer to build their houses which are climate resilient ones. Traditional Assam houses use light materials such as Bamboo, Ikra (locally available reed) to build houses. Traditional house construction



is based on several factors ranging from socio-cultural, economic to physical factors. The type of dwelling unit defines the requirement of timber for household construction and regular maintenance. Majority of the roofs of the dwelling units are covered with Metal sheets (83%). This type of house construction requires supporting beams to hold the sheets intact. These beams are made up of either timber or bamboo which is collected locally from the forests<sup>23</sup>.

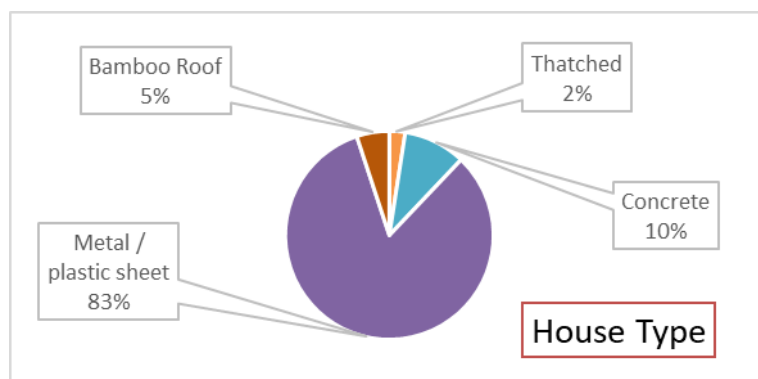

**Figure 11: House type**

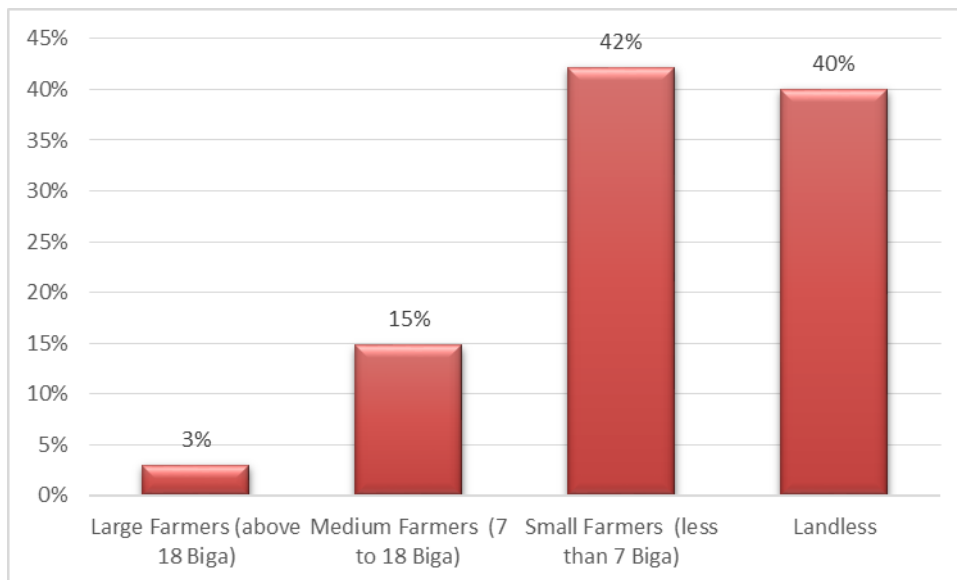

**Figure 12: Normal house structure in Nagaon**

### 5.2.5 Land holdings

In general, land holdings determine the poverty status of the communities. There is strong evidence of high correlation between rural poverty and land holding size of the communities. Poverty is very high of those communities who do not possess any land compared to communities who possess land. Greater the land holding lesser the poverty.

<sup>23</sup> [http://www.censusindia.gov.in/2011census/dchb/DCHB\\_A/18/1806\\_PART\\_A\\_DCHB\\_NAGAON.pdf](http://www.censusindia.gov.in/2011census/dchb/DCHB_A/18/1806_PART_A_DCHB_NAGAON.pdf) (page no24)

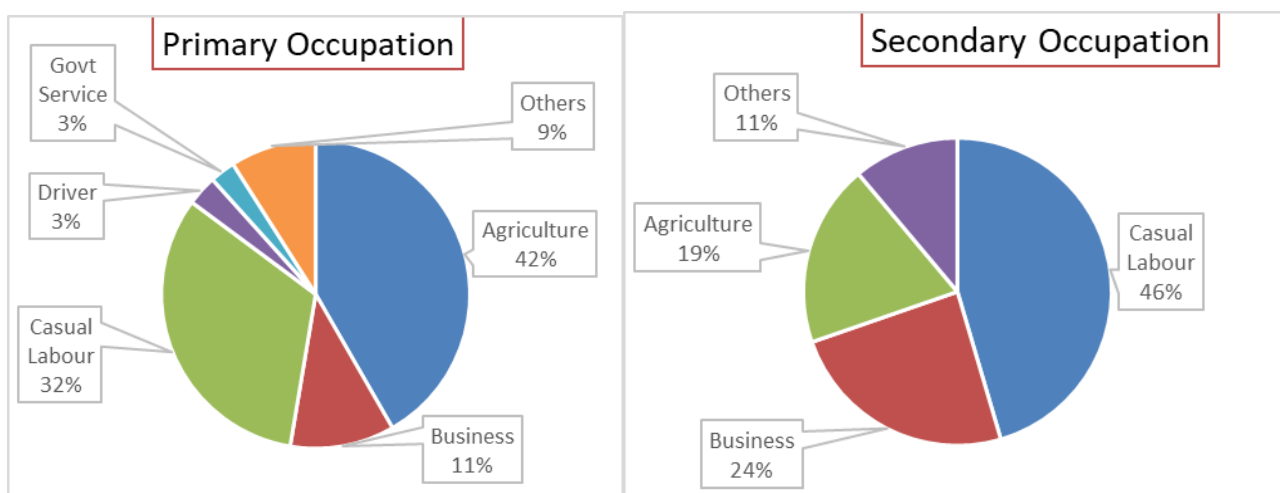

**Figure 13: Land holding pattern**

The above Figure 12 gives the details of land holding pattern of the study area. Majority of the population (40%) are landless population. 42% of the surveyed households have land holdings of less than 7 biga<sup>24</sup> land. This indicates people have to look for freely available resources to lead the life. Forests are the one which caters the needs of landless and small farmers, especially energy needs in the project area.

### 5.2.6 Occupation

Nagaon is an agrarian district. 42% of the surveyed household’s primary occupation is agriculture and this is followed by casual labours (32%) in agriculture related activities. Households with less land holding sizes also takes up casual labour as their secondary occupation. Other occupation involves carpenters, teachers, ex services man etc.



**Figure 14: Primary and secondary occupation**

<sup>24</sup> 1 Acre=2.5 biga

Interestingly survey revealed that primary occupation of 3% of the respondents is drivers of commercial vehicles. People also have local wine making business in which they consume fuelwood to process the wine. The processed wine is sold in local weekly markets of nearby villages.

### 5.2.7 Land under Cultivation

As discussed above agriculture is the primary occupation. Nagaon is known as rice bowl of Assam. So paddy is the major crop in the Nagaon district. Nearly 89% of people cultivate paddy as their primary crop. So rice is the staple food of the majority of the people. Jute finds the second place after rice crop and is grown as secondary crop. Vegetables like Brinjal, Potato are common vegetables grown and most of them consumed at household itself. Surplus production of paddy is sold to nearby agents and markets. Community fishing is also practiced in certain areas. Water is available in abundance for cultivation. Nearly 50% if land is irrigated from streams, wet lands, and small ponds next to their lands using either diesel or electrified pumps. Paddy is grown all over the year.

### 5.2.8 Livestock

Livestock and Indian rural communities are inseparable. Cattle plays an important role in livelihood generation of Indian rural population through milk, manure and part of the agriculture activities like ploughing, transporting, etc. Nowadays, mechanisation of agriculture activities has reduced the burden of livestock utilisation and as well as native breed cattle rearing. On the contrary, survey revealed that native breed dominates the cattle population in the region. Below Table 4 summarises the number of cattle present in the surveyed households.

| Cows   |             | Buffalo |             | Ox, Bulls |             |
|--------|-------------|---------|-------------|-----------|-------------|
| Native | Cross Breed | Native  | Cross Breed | Native    | Cross Breed |
| 816    | 11          | 4       | 0           | 91        | 0           |

**Table 4: Livestock details**

In addition, Sheep, Pig, Chicken and Gooses are reared in most of the households and used for meat purposes. Around 68% of surveyed households have cattle in their houses. An average of 3 cows is present per family.

### 5.3 Forest dependency

As we discussed in the section 6.2, nearly 40% of the families are landless and 42% of families are small and marginal farmers with less than 2 acre of land. Recently in Rajya Sabha it has been conveyed that 31.98% of Assam population lives below poverty line (BPL)<sup>25</sup>. Along with poverty population explosion has increased the demand for forestry products and thereby increasing the pressure in forests which leading to deforestation and degradation. This situation in the region demands the communities, living in the vicinity of forests, look for freely available resources to lead the day to day life. Since time immemorial forests are the common resource and service provider for human beings and as well as wild creatures. Assam forests are

<sup>25</sup> [https://www.telegraphindia.com/1170411/jsp/northeast/story\\_145661.jsp#.WQMIAcYIHIU](https://www.telegraphindia.com/1170411/jsp/northeast/story_145661.jsp#.WQMIAcYIHIU)

rich in resources and at present these forests are catering services to the needs of the people. The following section discusses the dependency of the communities on the forests.

### 5.3.1 Fuelwood

Due to lack of awareness and availability of clean energy sources such as LPG, Kerosene in the region, communities are forced to use fuelwood as their major energy source for cooking, heating water, cattle food preparation, etc. This creates a huge pressure on forests. Fuelwood is extracted daily by the communities and is the major source of the energy in forest fringe villages.

#### Source of energy for cooking and heating

Fuelwood is the major source of energy for cooking. Around 96% of the responded that wood is their main energy source for cooking and as well as heating water. Next comes the LPG with 25% of respondents said that they use LPG to for hospitality purposes such as preparing tea and coffee. Out of 567 households, only 17 households use LPG for cooking but they use fuelwood for heating water.

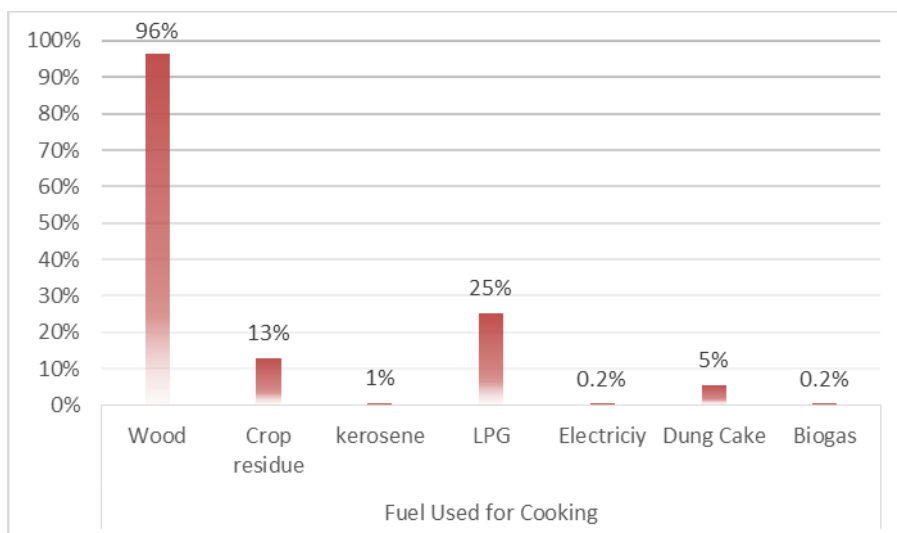

**Figure 15: Source of energy for cooking**

From the above graph it is evident that fuelwood is the common energy source used for cooking and heating water. An average of 3.22 tons of fuelwood is required per family per year. According to 2011 census, 81.37%<sup>26</sup> of the rural households of Nagaon district predominantly use firewood for cooking. Rural LPG penetration is less than 10%<sup>26</sup>. Therefore, fuelwood is the main energy source available for the communities.

<sup>26</sup> [http://www.censusindia.gov.in/2011census/dchb/1806\\_PART\\_B\\_DCHB\\_NAGAON.pdf](http://www.censusindia.gov.in/2011census/dchb/1806_PART_B_DCHB_NAGAON.pdf) (page no 341 and 342)



**Figure 16: Fuelwood collection in the study area**

**Mode of fuelwood collection**

From the above Figure 15 it is evident that communities collect fuelwood and transport using cycles or on their backs as head loads. Around 90% of respondents said that they collect fuelwood as head loads and very few 9% use small carts to transport fuelwood.

|                      | Head Load | Cart Load or cycle | Tractor Load |
|----------------------|-----------|--------------------|--------------|
| <b>Number of HHS</b> | 393       | 41                 | 4            |
| <b>% of HHS</b>      | 90%       | 9%                 | 1%           |

**Table 5: Mode of fuelwood Transportation**

**Source of fuelwood**

Forest is the main source of fuelwood for the communities in the region. Communities also buy fuelwood from the local sellers within the village. These sellers collect fuelwood from the forests. From the below graph it is evident that 59% (28%+31%) of fuelwood is collected from the forests. Communities also have few wood trees next to their agriculture fields and 23% of respondents said that they collect wood from their agriculture lands.

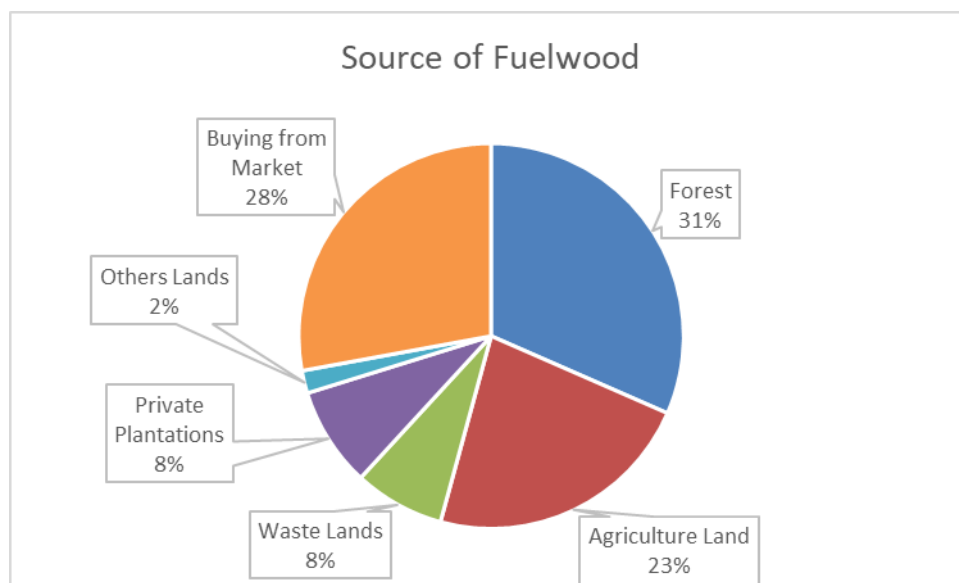

**Figure 17: Source of fuelwood**

| Range        | Forest | Agriculture Land | Waste Lands | Private Plantations | Buying from Market |
|--------------|--------|------------------|-------------|---------------------|--------------------|
| Dhania       | 27%    | 40%              | 29%         | 25%                 | 33%                |
| Dharamtul    | 87%    | 11%              | 0%          | 13%                 | 28%                |
| Garajan      | 29%    | 32%              | 13%         | 3%                  | 54%                |
| Kampur       | 26%    | 61%              | 5%          | 1%                  | 39%                |
| Kathiatoli   | 47%    | 42%              | 14%         | 26%                 | 40%                |
| Nagaon Sadar | 26%    | 26%              | 12%         | 16%                 | 46%                |
| Salona       | 77%    | 9%               | 7%          | 9%                  | 26%                |

**Figure 18: Range wise source of fuelwood**

The following are the common tree species collected as fuelwood in the study area.

*Mangifera indica, Ficus religiosa, Lagerstoemia flosreginae, Dillenia pentagyna Roxb, Spondias magnifera, Myristica kingie, Bambusa vulgaris, Trewia nudiflora, Tetrameles nudiflora, Zizyphus jujube, Phoebe oalparensis, Zanthoxylum budrunga, Alstonia scholaris, Holarrhena antidysenterica, Holarrhena pubescens Wall, Holarrhena pubescens Wall, Ficus glomerata, Wrightia tomentosa, Psidium guyava, Gmelina arborea,*

*Bombax Ceiba, Cassia fistula, Syzygium cuminii, Eupatorium odoratum, Garuga pinnata, Corchorus capsularis, Saccharum spontaenum, Ipomoea aquatic, Bauhini spp, Anthoccephalus cadamba, Ipomoea aquatic, Kayea floribunds, Artocarpus heterophyllum, Walsura robusta, Erythrina variegata, Zea mays, Erythrina variegata, Albizzia lucida, Pterospermum acerifolium, Azadirachta indica, Stereospermum chelonoides, Toona ciliata, Shorea robusta, Tectona grandis, Sapium baccatum, Lagerstroemia parviflora, Bombax ceiba, Cassia fistula, Areca catechu, Gynandropsis pentaphylla.*

### Frequency of collection

Communities collect fuelwood from different sources depending upon their consumption. The following figure depicts the frequency of collection of fuelwood in general.

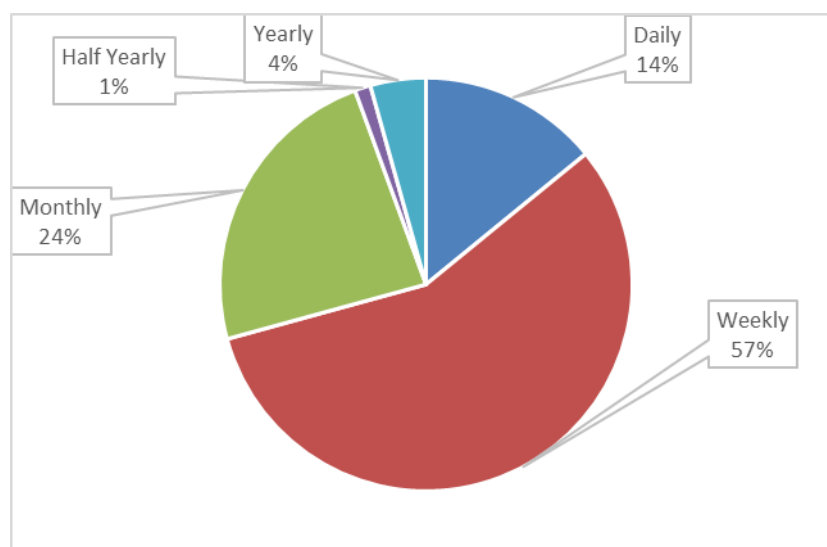

**Figure 19: Frequency of Fuelwood Collection**

57% of households said that they collect fuelwood on weekly basis and 24 of them said they collect fuelwood on monthly basis. The following Table 6 summarises the average distance travelled by the households to collect fuelwood in each range.

| Range        | Forest Distance (km) | Agriculture land Distance (km) |
|--------------|----------------------|--------------------------------|
| Dhania       | 0.4                  | 0.3                            |
| Dharamtul    | 2.3                  | 0.2                            |
| Garajan      | 0.7                  | 0.3                            |
| Kampur       | 0.5                  | 1.0                            |
| Kathiatoli   | 1.2                  | 0.6                            |
| Nagaon Sadar | 0.5                  | 0.4                            |
| Salona       | 2.2                  | 0.1                            |

**Table 6: Average distance travelled to collect fuelwood**

### Cooking device

Cooking devices used by the communities are of traditional ones which has very low efficiency. These are built using local available materials such as mud and sand. These stoves do not have any chimneys to vent out the smoke coming out of burning wood. Below Figure 19 lists the cooking devices used by the communities in the study area. It is evident that 91% of the cooking device is made out of mud.

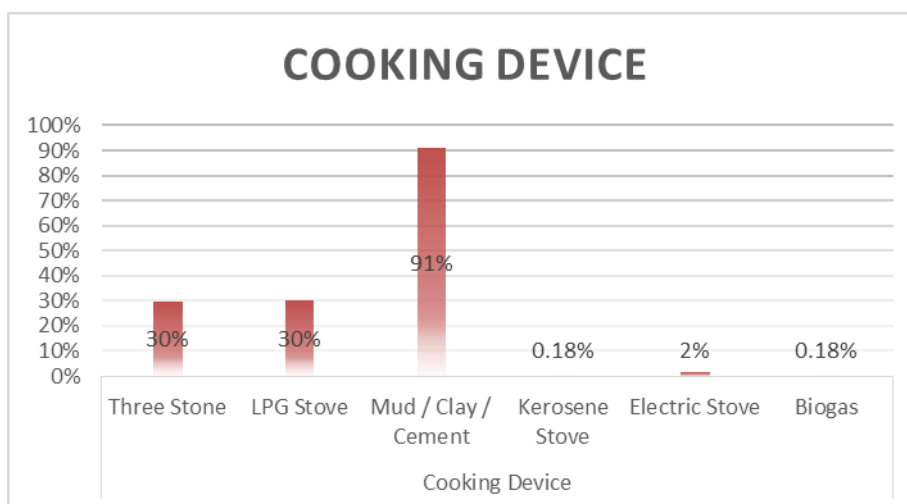

**Figure 20: Cooking devices used in the study area**

As we can see from above Figure 19, most of the families use traditional stoves built using locally available materials such as mud, sand, and small stones. These stoves are inefficient and consume a lot of fuelwood compared to improved cook stoves (ICS). Respondents do not know the alternative technologies or models available to replace the traditional stoves except LPG. LPG is penetrating to villages gradually. Poor supply chain and cost involved in procuring and refilling of LPG cylinders are making people back off from the LPG. At present, fuelwood is available at free of cost, and few households are buying from the market since they are engaged in some other work. Also, culturally, people prefer to use fuelwood to prepare food. By constant creation of awareness among the communities and introducing ICS, it will help reduce fuelwood consumption and thereby reduce deforestation and degradation.



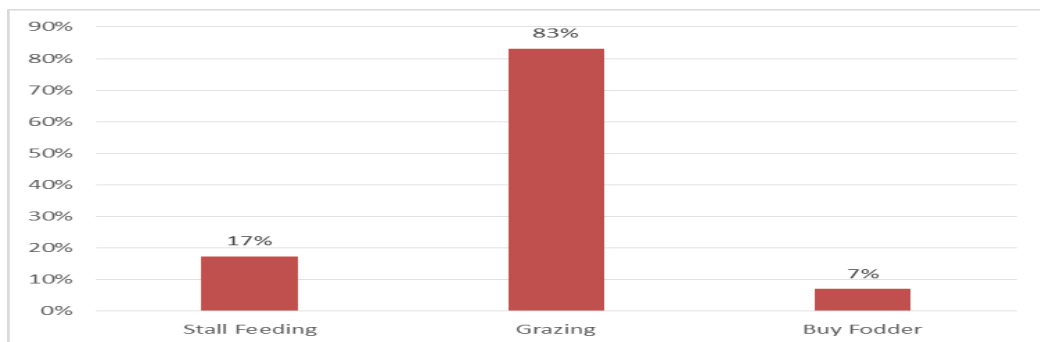



**Figure 21: Traditional stoves used in study area**

### 5.3.2 Fodder

Cattle in the study area are dominated by mainly by native breed. As discussed in section 6.2.9 we can observe that cows are common in the area. Present of buffalos and ox or bulls are very negligent as compared to cows. These cows are very much suited for the study areas' climatic conditions. People let the cattle to graze on openly. In the morning these cows leave homes, graze whole day and by sunset they return to the respective homes. These cows mainly graze in forests, open agriculture lands, etc.



**Figure 22: Cattle feeding**

From the above graph, it is evident that grazing (83% of households) is the common practice followed in the area since most of the cattle are native ones. These cattle are normally let out in the morning by households. These cattle will graze on agriculture lands and inside the nearby forest. Fodder is also collected from forests, agriculture lands to stall feed. 22% of the responded that they collect fodder from forest and 58% responded that they collect from different sources which include roadside area, nearby ponds, agriculture fields, etc. Cattle enter forests very easily because there are no Cattle Proof Trenches (CPT) along the forest boundary. This type grazing inside the forest will hinder the regeneration of forests since these cattle feed on younger saplings. There is need to construct CPT's or EPT (Elephant Proof Trenches) along the forest boundary. EPTs also help in preventing wild elephants entering villages thereby reducing man

animal conflicts. This man animal conflict issue will be discussed in separate section. Study conducted in different parts of Nagaon forests suggests that grazing is a point of concern for forest degradation<sup>27</sup>.



**Figure 23: Fodder collection**

### 5.3.3 Timber and Small timber

The main dwelling units of the communities in the area use metal sheets to cover the roof. As discussed in the section 6.2.4 83% of the responded house roof type is made up of metal sheets. To hold these metal sheets beam are required. These beams are made up of either timber or bamboos. People collect timber from forests for house construction and regular maintenance of houses. Apart from house construction and maintenance of houses, few people use timber for fencing the agriculture lands and house surroundings, making furniture. The main source of timber is forest and local markets. The following Table 7 describes the use and source of the timber and % of respondents.

| Use of Timber                   | Major source of Timber                       | % of HHS |
|---------------------------------|--|----------|
| Agriculture Fencing             | Forest                                       | 4%       |
| Fencing around residential area | Buying from market                           | 3%       |
| Fuelwood- commercial            | Forest                                       | 1%       |
| Furniture                       | Agricultural land                            | 1%       |
| House construction              | Buying from market                           | 55%      |
|                                 | Agricultural land                            | 18%      |
|                                 | Forest                                       | 9%       |
|                                 | purchase from market- local vendor           | 4%       |
|                                 | From the forest dept. depot                  | 3%       |
|                                 | Buying from forest through illegal harvester | 2%       |
| Fuelwood for cooking            | Buying from market                           | 1%       |

<sup>27</sup> <https://www.roij.com/open-access/concern-and-conservation-perspective-in-laokhowa-wildlife-sanctuary-of-nagaon-district-assam-india-.php?aid=48148> , <http://www.assamforest.in/knp-osc/linkpages.php?u=hr>

**Table 7: Use of timber and source**

Along with Bamboo communities use Segun (*Tectona grandis*), Neem (*Azadirachta Indica*), Jamoon (*Syzygium Cumini*), Mango (*Mangifera Indica*), Sal (*Shorea Robusta*), Gomari (*Gmelina arborea*) are the common timber species collected from the forests. Small timber is collected from the forests especially bamboos. People grow bamboo locally too. Locally grown bamboos are mainly used for maintenance and fencing purposes.

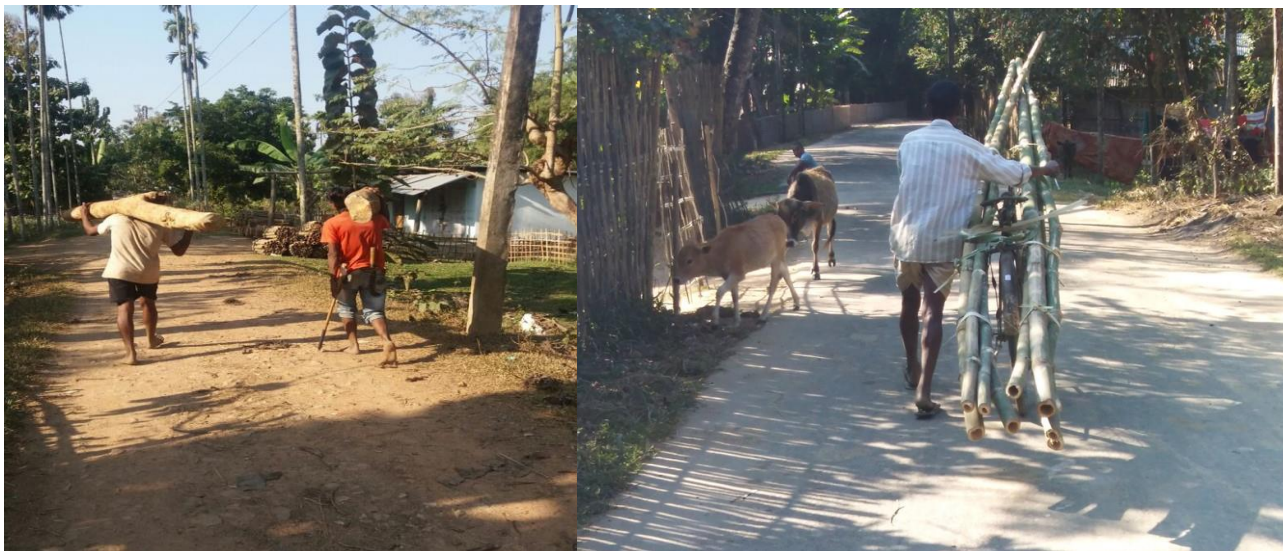

**Figure 24: Timber collection from forests**



**Figure 25: Small timber used for fencing and agriculture activities**

#### 5.3.4 Non Timber Forest Produce

The forest of Nagaon Division is rich in flora and fauna biodiversity and proliferate across different ecosystems. Considerable amount of NTFP is collected by communities from these forests. Natural herbs and shrubs are also present in the forests. The following are the list of NTFPs available in the Nagaon forest division (Source: Nagaon Working Plan).

#### **LIST OF NTFP SPECIES**

| <b><u>Local Name</u></b> | <b><u>English Name</u></b> | <b><u>Scientific Name</u></b>            |
|--------------------------|----------------------------|--|
| Bon Naharu               | Garlic chives              | <i>Allium tuberosum</i> Rottl. Ex Spreng |
| Bagh Asura               | Ragi                       | <i>Caesalpinia cuculata</i> Roxb.        |

| <u>Local Name</u>   | <u>English Name</u> | <u>Scientific Name</u>          |
|---------------------|---------------------|---------------------------------|
| Bontulasi           | Basil               | <i>Ocimum basilicum</i> L       |
| Dhekia              | Vegetable fern      | <i>Diplazium esculentum</i>     |
| Kochu               | Taro                | <i>Colocasia esculenta</i> L    |
| Kolmou              | Meia                | <i>Ipomea aquatic</i> Frosk     |
| Mati Kanduri        | --                  | <i>Alternanthera sessilis</i> L |
| Pippali             | Indian Long Pepper  | <i>Piper longum</i> L           |
| Pok Mou, Lach Kachi |                     | <i>Solanum nigrum</i> L         |
| Tora                | Galingale           | <i>Alpinia allughas</i>         |

### LIST OF HERBS & SHRUBS

| <u>Local Name</u> | <u>Scientific Name</u>                             | <u>Local Name</u> | <u>Scientific Name</u>                 |
|-------------------|--|-------------------|--|
| Abu-Tenga         | <i>Antidesma acidum</i> Retz                       | Helochi           | <i>Enhydra fluctuans</i> Lour          |
| Agora             | <i>Triumfetta rhomboidea</i> Jacq                  | Jhau              | <i>Tamarix dioica</i>                  |
| Assam lota        | <i>Eupatorium odoratum</i>                         | Jamlakhuti        | <i>Costus speciosus</i> Sm             |
| Akan              | <i>Calotropis gigante</i> & <i>Calotropis acia</i> | Jatiar            | <i>Phalaris arudinacea</i> Linn        |
| Bagh-ashora       | <i>Polygonus glabrum</i>                           | Kana-ximalu       | <i>Commelina duffusa</i> Barun F       |
| Bogi tora         | <i>Alpinia molluccensis</i>                        | Kaupat            | <i>Phrynium species</i>                |
| Bhat-tita         | <i>Solanum torvum</i> Swartz                       | Kauri thengia     | <i>Leea crispa</i> Willd               |
| Bhedelilata       | <i>Hedyotis scandens</i>                           | Khutura           | <i>Amaranthus viridis</i> Linn         |
| Bhekuri           | <i>Solanum indicum</i>                             | Kuchia-kota       | <i>Mimosa rubicaulis</i> Lam           |
| Bhotua Xak        | <i>Chenopodium album</i> Linn                      | Lajuki lota       | <i>Mimosa pudica</i> Linn              |
| Bor Manimuni      | <i>Hydrocotyle asiatica</i> Linn                   | Lekluru           | <i>Coffea bengalensis</i>              |
| Bondhonia         | <i>Ranunculus sceleratus</i> Linn                  | Mati-kaduri       | <i>Altermanthera sessils</i> (L) Br    |
| Bor-barial        | <i>Sida rohmbifolia</i> Linn                       | Makhi-loti        | <i>Flemingia strobilifera</i>          |
| Chawl dhowl       | <i>Ardisia humilis</i> Vahl                        | Mechaki           | <i>Debregeasia species</i>             |
| Dam deuka         | <i>Impatiens jurpia</i> Hk.f&Th                    | Moin              | <i>Catuna regam spinoisa</i> Tiruv     |
| Dhudhi Bon        | <i>Eubhorbia hitra</i> Linn                        | Patidoi           | <i>Clinogyne dichotoma</i>             |
| Dhopa tita        | <i>Phlogocanthus curviflorus</i>                   | Phutuka           | <i>Melastoma malabathricum</i>         |
| Durun xak         | <i>Leacus lanata</i>                               | Sorat-goch        | <i>Laportea crenulata</i>              |
| Dighlati          | <i>Litsea Salicifolia</i>                          | Ikora             | <i>Phragmites kakra</i> (Retz) Trin    |
| Erra goch         | <i>Ricinus communis</i> L                          | Tengesi           | <i>Marsilea qudrifolia</i>             |
| Gahoti-bon        | <i>Ageratum conyzoides</i> Linn                    | Tita-phul         | <i>Phlogocanthus thyriflorus</i>       |
| Go-naharu         | <i>Crinum amoenum</i> Roxb                         | Xal-pan           | <i>Desmodium gangeticum</i> Dc         |
| Hat-thenga        | <i>Senna occidentalis</i> (L) Link                 | Xaru-manimuni     | <i>Hydrocotyle sibthorpioides</i> Limk |
| Habida-cha        | <i>Polyathia suberosa</i>                          | Xaru-moin         | <i>Fagerlemdia fasciculate</i> Tiruv   |
| Han-boka          | <i>Olox acuminara</i>                              | Xaru-barial       | <i>Sida carpanifolia</i> Linn          |

### LIST OF CANES AND PALMS

| <u>Local Name</u> | <u>Scientific Name</u>     |
|-------------------|----------------------------|
| Bon-tal           | <i>Licuala peltata</i>     |
| Geruga-tamul      | <i>Pinanga gracillis</i>   |
| Jai-bet           | <i>Calamus tenuis</i>      |
| Hauka-bet         | <i>Calamus latifolius</i>  |
| Raidang-bet       | <i>Calamus flagellum</i>   |
| Rongkeli-bet      | <i>Calamus loptospadix</i> |

| <u>Local Name</u> | <u>Scientific Name</u>        |
|-------------------|-------------------------------|
| Tita-bet          | <i>Calamus tenuis</i>         |
| Toko-pat          | <i>Livistonia jenkinsiana</i> |

### **LIST OF GRASSES**

| <u>Local Name</u> | <u>Scientific Name</u>        |
|-------------------|-------------------------------|
| Ikra (Ekra)       | <i>Erinthus ravaneae</i>      |
| Jarmaniban        | <i>Eupatorium odoratum</i>    |
| Kush              | <i>Saccharum spontaneum</i>   |
| Meghela           | <i>Saccharum arundinaceum</i> |
| Nal               | <i>Phragmites karka</i>       |
| Sau               | <i>Pollinia ciliate</i>       |
| Sungress          | <i>Imperata arundinacea</i>   |

### **LIST OF BAMBOOS**

| <u>Local Name</u> | <u>Scientific Name</u>           |
|-------------------|----------------------------------|
| Bojal             | <i>Pseudostachym polymorphum</i> |
| Dalu              | <i>Teinostacoa sp.</i>           |
| Hill-jati         | <i>Bambusa pallida</i>           |
| Kako              | <i>Dendrocalamus hamiltonii</i>  |
| Kanta             | <i>Bambusa arundinaceae</i>      |
| Muli              | <i>Melocanna bambusoides</i>     |

### **LIST OF CLIMBERS**

| <u>Local Name</u> | <u>Scientific Name</u>         | <u>Local Name</u> | <u>Scientific Name</u>          |
|-------------------|--------------------------------|-------------------|---------------------------------|
| Amrolio-lota      | <i>Tapiria hirsute</i>         | Kata-ghoh         | <i>Dalbergia rimosa</i>         |
| Arkeng-lota       | <i>Combretum species</i>       | Kerek-lota        | <i>Hiptage madablota</i>        |
| Baghasora         | <i>Mezoneurum cucullatum</i>   | Kota-har          | <i>Capparis tenera</i>          |
| Bokul-lota        | <i>Embelia ribes</i>           | Kochai-lota       | <i>Acacia pennata</i>           |
| Barkhi-lota       | <i>Uncaria macrophylla</i>     | Laleng-chhali     | <i>Dalbergia tamarindifolia</i> |
| Bel-lota          | <i>Willoughbeia edulis</i>     | Lota-dimoru       | <i>Ficus scandens</i>           |
| Bhedali-lota      | <i>Paederia foetida</i>        | Lota-guti         | <i>Caesalpinia crista</i>       |
| Boga-lota         | <i>Strychnos laurina</i>       | Lota-mahudi       | <i>Croton caudatus</i>          |
| Bokal-bhi         | <i>Derris elliptica</i>        | Madhu-malati      | <i>Roydsia suaveolens</i>       |
| Bon-boguri        | <i>Ziziohus rugosa</i>         | Mamci-lota        | <i>Gnetum montanum</i>          |
| Cham-lota         | <i>Conocephalus suaveolens</i> | Mouhilika         | <i>Bridelia stipularis</i>      |
| Chonge-lota       | <i>Thunbergia coccinea</i>     | Nigoni-bual       | <i>Eryciba paniculata</i>       |
| Dat-bijla         | <i>Dalbergia stipulacea</i>    | Ou-lota           | <i>Delima sarmentosa</i>        |
| Deo-bhi           | <i>Linostoma decandrum</i>     | Paduri-lota       | <i>Paederia foetida</i>         |
| Dhekia-lota       | <i>Stenochleana palustre</i>   | Pan-lota          | <i>Spatholobus roxburghii</i>   |
| Dhobai-lota       | <i>Heptapleurum venulosum</i>  | Pani-lota         | <i>Vitis latifolia</i>          |
| Gahora-lota       | <i>Myxopyrum smilacifolium</i> | Pani-leteku       | <i>Vitis pedata</i>             |
| Ghilo-lota        | <i>Entada scandens</i>         | Pichola-lota      | <i>Hibiscus fragrans</i>        |
| Gulancha          | <i>Tinospora cordifolia</i>    | Pahari-lota       | <i>Dalhousiea bracteata</i>     |
| Hollock-lota      | <i>Combretum dasystachyum</i>  | Tabaki-lota       | <i>Cissampelos pareire</i>      |
| Hoguni-lota       | <i>Tinospora cordifolia</i>    | Tikoni-borua      | <i>Buettneria aspera</i>        |
| Jetelu-poka       | <i>Rubus ellipticus</i>        | Wakmi             | <i>Mucuma bracteata</i>         |

From the survey, it has been found that 24% of the households collect NTFPs from the forests. Most of them said that they collect these NTFPs for personal consumption only.

| NTFP Name      | Quantity collected per year (KG) |
|----------------|----------------------------------|
| Kachu          | 181                              |
| Dhekia         | 153                              |
| Bogori         | 30                               |
| Fish           | 27                               |
| Amla           | 18                               |
| Botatenga      | 15                               |
| Tita Phul      | 14                               |
| Bota Tenga     | 10                               |
| Bamboo Shoot   | 9                                |
| Samsori Pat    | 8                                |
| Masolanga      | 6                                |
| Bhebelilata    | 5                                |
| Kolmou Saak    | 4.5                              |
| Bagori         | 4                                |
| Amlakhi        | 4                                |
| Vebeli Lata    | 4                                |
| Kolphul        | 4                                |
| Pipali         | 3                                |
| Lai Sak        | 3                                |
| Forn           | 2.5                              |
| Mehek Pat      | 2                                |
| Kaldil         | 2                                |
| Toragojali     | 1                                |
| Mengsoring Pat | 1                                |
| Koinamari Pat  | 1                                |
| Gaztenga       | 1                                |
| Hanthu Pat     | 1                                |

**Table 8: NTFP collected in the study area**

Table 8 gives the list of NTFPs collected and the quantity of NTFP collected per year in the study area. Techniques use to collect these NTFPs is very primitive techniques which is unsustainable. There is need to educate the people on sustainable harvesting techniques and constant awareness creation among the communities about its importance.



**Figure 26: NTFP Dekia (fern) and tuber**

### **5.3.5 Arecanut Industries**

Rupohi and Sunaribali are the two places in Nagaon district where raw Arecanut is processed. Processed supari is marketed in South India especially in Karnataka and Tamil Nadu. There are nearly 150 industries in Rupohi and 50 in Sunaribali. These industries consumes considerable amount of fuelwood to process raw Arecanut. The following pictures give an idea about the usage of fuelwood in these industries.



**Figure 27: Arecanut drying using fuelwood**



**Figure 28: Raw Arecanut boiling**

These industries do not run all over the years. These are run during the months of November to April. Raw Arecanut is procured from nearby villages. But majority of the procurement is done from upper Assam districts. The raw Arecanut processing involves extracting fruit from shell, boiling the fruit and drying using fuelwood. Sun drying is also practiced but it is limited. Demand for supari dried using fuelwood is very high and so Arecanut is dried using fuelwood.

Following Table 9 gives an idea how much fuelwood is consumed by each Arecanut processing unit.

|   |        |               |
|---|--------|---------------|
| Supari processed per Month                | 1,000  | KG            |
| FW required to process 1Q of raw Arecanut | 80     | KG            |
| Total Fuelwood required                   | 80,000 | KG            |
| Total Fuelwood required                   | 80     | Tons/Month    |
| Operation months                          | 5      | No            |
| Total FW required per season              | 400    | Tons per Year |

**Table 9 : Estimation of fuelwood required for one arecanut industry**

These industries buy fuelwood from the local market or agents. Agents procure fuelwood from different parts of the district and supply to these industries as per demand. Till now these industries do not have any problem in procuring fuelwood. They do not any preference of wood species for Arecanut processing.



**Figure 29: Fuelwood stored in Arecanut processing industries**



Supari or Arecanut industry owners do not aware of the better technologies to process Arecanut. So it is very essential and important to educate these people about the consequences of using fuelwood at this rate and ask them to move towards implementing sustainable technologies such as dryers, improved boilers, etc.

#### 5.4 Drivers of deforestation and the forest degradation

The main objective of the study is identify the drivers responsible for deforestation and forest degradation (D&D). Socio-economic data collected in the area was analysed thoroughly to identify drivers responsible for D&D. as we discussed in the above section 4 both household survey and focused group discussion at village level were carried out. Structured questionnaires were used to collect data from both the approaches. Both at village and at household level, questions were asked to list the drivers for D&D. the following Figure 2 gives the responses given at village level FGDs.

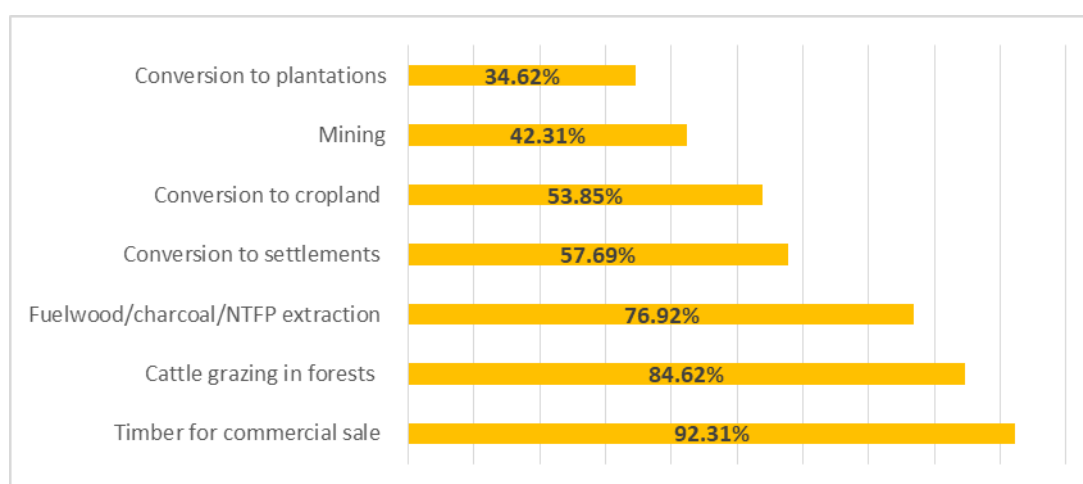

**Figure 30: FGD responses on drivers**

At household level each household was asked list the drivers responsible for D&D., the following Figure 29 summarises the drivers.

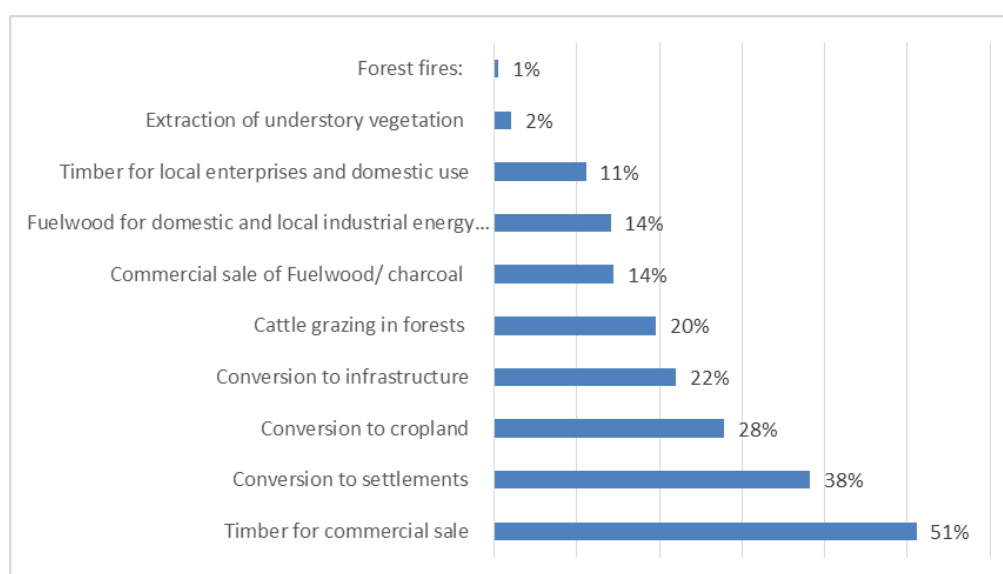

**Figure 31: Household responses on drivers**

From the above two graphs it is evident that timber collection is the major drive responsible for D&D. from the survey it is observed that fuelwood collection and grazing also are responsible for D&D.

### 5.4.1 Identified drivers of deforestation and degradation

#### Proximate and Underlying causes for D&D

We can categorise the drivers into two categories. one is proximate drivers and other is Underlying drivers. Proximate drivers are the drivers which are clearly visible and are the result of immediate human actions on the ground. Whereas underlying drivers refers to social, economic, cultural or other forces that lead to the proximate drivers. The below schematic diagram represent the drivers responsible for D&D in the study area.

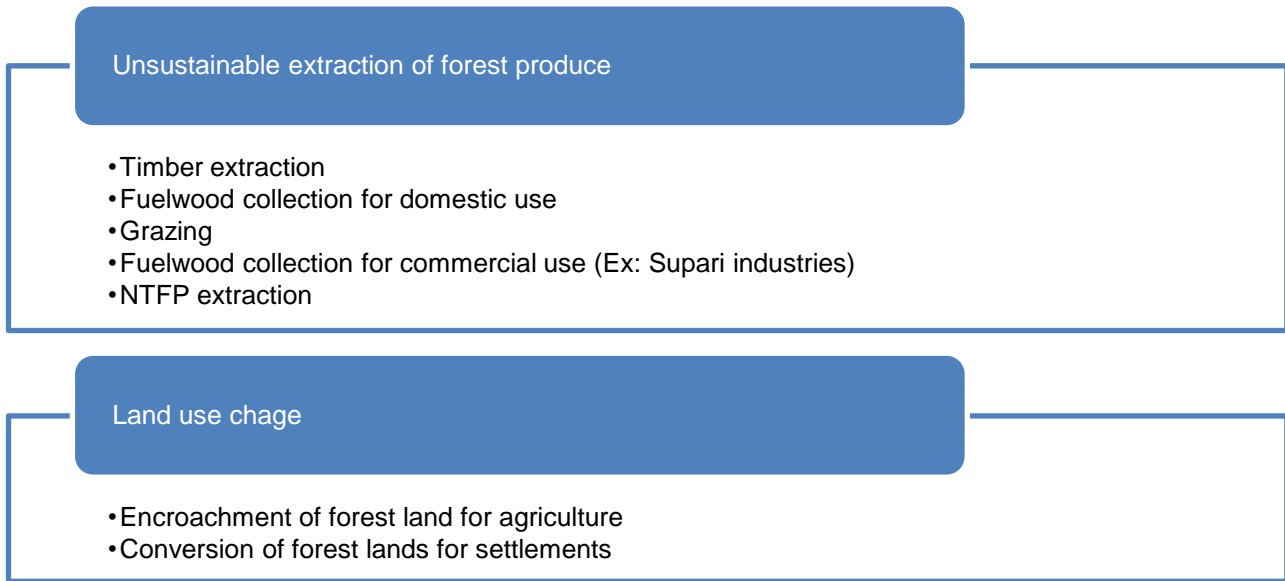

Range wise responses on drivers responsible for D&D are as follows.

| Range        | No of Respondents said "Yes" |                           |                              |                            |   |                                       |   |                           |                                     |               |                                 |
|--------------|------------------------------|---------------------------|------------------------------|----------------------------|---|---------------------------------------|---|---------------------------|-------------------------------------|---------------|---------------------------------|
|              | Conversion to cropland       | Conversion to settlements | Conversion to infrastructure | Timber for commercial sale | Timber for local enterprises and domestic use | Commercial sale of Fuelwood/ charcoal | Fuelwood for domestic and local industrial energy needs | Cattle grazing in forests | Extraction of understory vegetation | Forest fires: | Destructive harvesting of NTFP: |
| Dhania       | 26                           | 28                        | 23                           | 25                         | 5   | 7                                     | 1   | 18                        | 0                                   | 0             | 0                               |
| Dharamtul    | 20                           | 28                        | 8                            | 41                         | 6   | 12                                    | 12  | 19                        | 1                                   | 1             | 0                               |
| Garajan      | 33                           | 33                        | 20                           | 42                         | 22  | 16                                    | 3   | 13                        | 3                                   | 0             | 0                               |
| Kampur       | 20                           | 40                        | 5                            | 31                         | 4   | 2                                     | 21  | 9                         | 2                                   | 0             | 0                               |
| Kathiatoli   | 13                           | 17                        | 17                           | 30                         | 9   | 16                                    | 5   | 17                        | 3                                   | 2             | 1                               |
| Nagaon Sadar | 31                           | 42                        | 27                           | 63                         | 8   | 14                                    | 20  | 21                        | 2                                   | 0             | 0                               |
| Salona       | 15                           | 29                        | 25                           | 58                         | 9   | 15                                    | 18  | 14                        | 1                                   | 0             | 0                               |
| Total        | 158                          | 217                       | 125                          | 290                        | 63  | 82                                    | 80  | 111                       | 12                                  | 3             | 1                               |
| % of HHS     | 27.9%                        | 38.3%                     | 22.0%                        | 51.1%                      | 11.1%   | 14.5%                                 | 14.1%   | 19.6%                     | 2.1%                                | 0.5%          | 0.2%                            |

Figure 32: Range wise responses on drivers

Encroachment is prevailing in all ranges. From the above table we can see timber for commercial sale is major driver responsible for D&D and then follows the encroachment of forest land for cultivation. Population explosion is putting lot pressure on forests to create new settlements and demand to meet energy needs of the growing population. As per the study encroachment is the major driver in the study area<sup>28</sup>. Therefore, it is very important to freeze encroachment in Nagaon forest division by clearly marking the forest boundaries with CPTs and EPTs. Constant vigilance of forest boundaries is required along with communities help. As

<sup>28</sup> [https://www.ijirset.com/upload/2013/november/51\\_Concern.pdf](https://www.ijirset.com/upload/2013/november/51_Concern.pdf) (page no 3)

per Nagaon Forest Division working plan, forests are encroached in Lutumari, Borpani, Pilkhana, Kamakhya, Deosur, Jakota and Tetelia Boghora RF areas. The major threats faced by Nagaon forest division is follows (Source: Working Plan of Nagaon Forest Division).

- Forest fires
- Floods
- Illegal felling
- Encroachment
- Increased timber demand
- Increase in human animal conflict
- Political interference
- Yellow journalism

To arrest D&D in the Nagaon forest division it is necessary to implement intervention activities at the earliest. Following section discusses the possible intervention activities under REDD+ project in the area.

### 5.5 Intervention details

During the survey, questions were asked to list out the intervention activities which communities think possible in their area. The following tables summarises the range wise intervention activities to forest dependency at household level.

| Fuelwood                     |           |           |         |        |            |              |        |
|------------------------------|-----------|-----------|---------|--------|------------|--------------|--------|
| Range                        | Dhania    | Dharamtul | Garajan | Kampur | Kathiatoli | Nagaon Sadar | Salona |
| Intervention Activities      | No of HHs |           |         |        |            |              |        |
| LPG                          | 38        | 21        | 54      | 55     | 25         | 33           | 43     |
| ICS                          | 0         | 0         | 1       | 14     | 4          | 4            | 1      |
| Electric Stove               | 1         | 2         | 10      | 4      | 1          | 7            | 2      |
| Biogas                       | 2         | 1         | 0       | 0      | 1          | 1            | 6      |
| Create Awareness             | 0         | 1         | 0       | 0      | 2          | 0            | 4      |
| FD should take strict action | 3         | 0         | 0       | 2      | 6          | 1            | 1      |
| Govt should help us          | 1         | 0         | 5       | 2      | 2          | 6            | 3      |
| People shod grow more trees  | 1         | 1         | 1       | 3      | 1          | 5            | 0      |

**Table 10: Intervention activities to reduce fuelwood consumption**

As we can see majority of households suggested LPG is an alternative solution to reduce fuelwood consumption followed by electric stoves. Very few suggested Biogas and improved cook stove (ICS) as an alternatives since they do not have any idea about these solutions.



**Figure 33: Intervention activities to reduce fuelwood consumption<sup>29</sup>**

| Fodder  |                  |           |         |        |            |              |        |
|---|------------------|-----------|---------|--------|------------|--------------|--------|
| Range   | Dhania           | Dharamtul | Garajan | Kampur | Kathiatoli | Nagaon Sadar | Salona |
| <b>Intervention Activities</b>                              | <b>No of HHs</b> |           |         |        |            |              |        |
| Create awareness to grow more fodder in the own lands       | 2                | 0         | 2       | 4      | 4          | 0            | 0      |
| Govt Should take some action to improve fodder availability | 8                | 0         | 14      | 7      | 7          | 0            | 11     |

**Table 11: Intervention activities to reduce fodder collection**

| Timber   |                  |           |         |        |            |              |        |
|--|------------------|-----------|---------|--------|------------|--------------|--------|
| Range  | Dhania           | Dharamtul | Garajan | Kampur | Kathiatoli | Nagaon Sadar | Salona |
| <b>Intervention Activities</b>                 | <b>No of HHs</b> |           |         |        |            |              |        |
| Plantations in own land                        | 15               | 0         | 0       | 0      | 0          | 0            | 1      |
| increase in tree planation                     | 1                | 0         | 0       | 0      | 0          | 2            |        |
| Iron poles                                     | 0                | 3         | 6       | 5      | 1          | 5            | 3      |
| Govt should take strict action                 | 0                | 1         | 1       | 0      | 0          | 5            | 4      |
| Govt should help us in constructing the houses | 0                | 3         | 12      | 3      | 0          | 8            | 6      |
| RCC houses                                     | 0                | 1         | 0       | 3      | 0          | 4            |        |
| Awareness creation                             | 0                | 0         | 0       | 0      | 0          | 0            | 1      |

**Table 12: Intervention activities timber consumption**

From the above two table it is evident that communities suggested to create awareness among the communities to grow more fodder species and timber species on their own lands. Also communities indicated that government should take strict actions on those who collect timber from the forest. Along with strict actions communities demanded to give some sort of help to communities to build their houses by providing iron poles for beams.

## 5.6 Intervention plan

The following tables explain the various drivers and problems identified and the respective interventions planned for them.

<sup>29</sup> Details of the each intervention activity will discussed separate chapter

| S. No. | Name of Intervention   | Drivers Addressed   |
|--------|--|---|
| 1      | Alternative energy cooking system in households (ICS, LPG, biogas)   | Unsustainable fuelwood extraction from forests for cooking and heating purposes |
| 2      | Efficient fuelwood-based driers for arecanut processing in arecanut industries in Nagaon   |   |
| 3      | Efficient fuelwood-based boilers for Arecanut boiling in Arecanut industries in Nagaon   |   |
| 4      | Retrofitting existing brick kilns / Introducing new brick manufacturing technologies, for fuel efficient brickmaking   |   |
| 5      | Smokeless Biomass briquettes as a fuelwood substitute  |   |
| 6      | Smart patrolling to check unplanned extraction of forest resources and unplanned mining within forest land   | Encroachment, unplanned felling   |
| 7      | Construction of CPTs and EPTs for better defined boundaries to reduce encroachments  | Grazing, illegal transport of forest produce, encroachment                      |
| 8      | Bio-fencing to reduce encroachment, illegal felling and man-animal conflicts   | Encroachment, unsustainable fuelwood and NTFP extraction, man-animal conflicts  |
| 9      | Plantation activities:<br>Afforestation and Reforestation in non-forest lands for tree cover.<br>Assisted Natural Regeneration in forests to stop degradation  | Unsustainable extraction of fuelwood  |
| 10     | Promoting agro-forestry in large scale in non-forest lands   | Unsustainable extraction of fuelwood and timber                                 |
| 11     | Cultivation of medicinal plants as a measure of alternative livelihood and income enhancement  | Over-dependence on forest resources   |
| 12     | Sustainable grazing and livestock management<br>Silvi-pastoral and Horti-pastoral models<br>Fodder densification and stall feeding<br>Vaccination of livestock | Unsustainable fuelwood extraction from forests and overgrazing in forest lands  |

**Table 13: List of interventions planned for Nagaon under the LEEF project**

## 5.7 Intervention Matrix

### Alternative Energy for Households

|                                    |   |
|------------------------------------|---|
| <b>Name of the Intervention</b>    | Alternative energy cooking system in households (ICS, LPG, biogas)  |
| <b>Code</b>                        | FW-ICSLPG-HH  |
| <b>Description of the problem</b>  | Extraction of fuelwood is the major driver in the Nagaon forest division. 96% of the surveyed households use fuelwood for cooking and water heating purposes. 25% households use LPG, but only for hospitality purposes like preparing tea and coffee. An average of 3.22 tons of fuelwood is required per family per year. According to 2011 census, 81.37% <sup>30</sup> of the rural households of Nagaon district predominantly use firewood for cooking. 57% of the households said they collect fuelwood on a weekly basis. Rural LPG penetration is less than 10% <sup>26</sup> . So fuelwood is the main energy source available for the communities.   |
| <b>Description of the solution</b> | Deployment of a mix of alternative energy solutions for rural households to regulate fuelwood requirements and ease pressures on forests for fuelwood. This mix would involve provision of ICS, biogas plants and solar cookers tailored towards specific requirements of each Range in Nagaon District. These measures are backed up by government commitments towards clean energy deployment in rural households across India.<br>Under the Union Budget 2016-17, there are plans to extend cleaner energy solutions to 5 crore families in India over the next 3 years, with further plans to development induction cook stoves as well into this basket to enable cleaner cooking. Electric cook plates can also make use of solar power in remote rural areas of Assam, where LPG penetration may be low and solar energy be easier to provide <sup>31</sup> .<br>In addition, biogas is a proven alternative renewable clean energy technology that can play a huge role in decreasing fuelwood demand. Biogas is a clean and renewable energy |

<sup>30</sup> [http://www.censusindia.gov.in/2011census/dchb/1806\\_PART\\_B\\_DCHB\\_NAGAON.pdf](http://www.censusindia.gov.in/2011census/dchb/1806_PART_B_DCHB_NAGAON.pdf) (page no 341 and 342)

<sup>31</sup> Panagariya, A., and Jain, A.K. (2016); Electricity and Clean Cooking Strategy for India; NITI Aayog, Government of India.

solution which completely replaces the non-renewable biomass by introducing a system for utilizing cattle dung and organic matter to provide a clean gaseous fuel for cooking and lighting<sup>32</sup>.  
The distribution of LPG cylinders can be undertaken under the Pradhan Mantri Ujjwala Yojna (PMUY) where priority will be given to forest fringe villages.

### 1. ICS

The Ministry of New and Renewable Energy (MNRE) has approved some improved biomass cookstoves for widespread use across the country, as part of the Central Government-sponsored Unnat Chulha Abhiyan. Some of these are<sup>33</sup>:

| Model                       | Manufacturer   | Power output (kW) | Thermal efficiency (%) |
|-----------------------------|--|-------------------|------------------------|
| Harsha Multi-Fuel Cookstove | Unicus Engineering Pvt Ltd, Bhubaneswar (Odisha)       | 2.0               | 28.6                   |
| Vikram Bio Super Chulha Top | Vikram Stoves and Fabricators, Osmanabad (Maharashtra) | 2.77              | 31.95                  |
| Oorja K3 Dlx                | First Energy Pvt Ltd, Pune (Maharashtra)               | 1.51              | 37.26                  |
| TERI SPT-0610               | The Energy and Resources Institute (TERI), New Delhi   | 1.08              | 36.84                  |



### 2. Biogas

A typical family type biogas plant generates biogas from organic substances such as cattle –dung, and other bio-degradable materials such as biomass from farms, gardens,

Detailed description of the technology

<sup>32</sup> National Biogas and Manure Management Programme (NBMMP), Section 3, Technology. <http://www.mnre.gov.in/schemes/decentralized-systems/schems-2>

<sup>33</sup> Approved Models of Portable Improved Biomass Cookstoves, Ministry of New and Renewable Energy.

kitchens and night soil wastes etc. The process of biogas generation is called anaerobic digestion (AD). Such plants are ideal for households with livestock towards becoming self-dependent for the provision of cooking gas and enriched bio-manure.

Biogas is a mixture of methane (CH<sub>4</sub>) and carbon dioxide (CO<sub>2</sub>), and is generated by fermentation of cellulose-rich organic matter under anaerobic conditions. The optimum utilization depends upon the successful physical installations, which in turn depend upon plant design and its selection. The basic conversion principle is that when a non-ligneous biomass is kept in a closed chamber for a few days, it ferments and produces an inflammable gas. The anaerobic digestion consists of three stages: Hydrolysis; Acid Formation and Methane Fermentation.

Under the National Biogas and Manure Management Programme (NBMMP), the MNRE provides subsidies for fixed-dome Deenbandhu type models for use in households. The model is well known in India and is known for effective methane recovery and combustion<sup>34</sup>. Its technical specifications are as follows<sup>35</sup>

| Specification                   | Value                   |
|---------------------------------|-------------------------|
| Capacity                        | 2 m <sup>3</sup>        |
| Mixing Proportion (Water: Dung) | 1:1                     |
| Feed Material                   | Cattle Dung             |
| Flow rate                       | 0.47 m <sup>3</sup> /hr |
| Number and size of burners      | 2 burners of 4" size    |

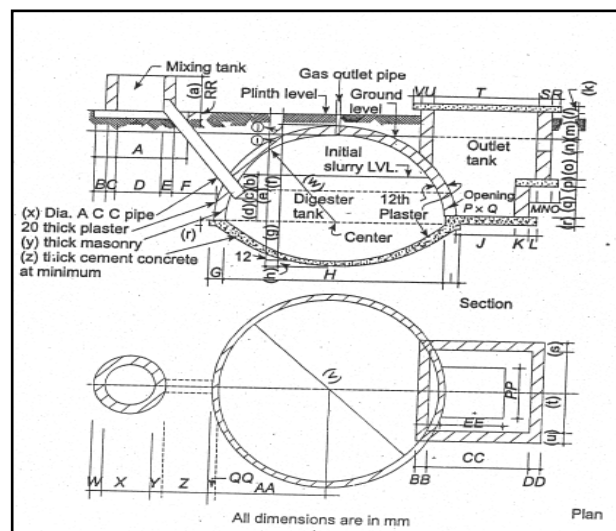

<sup>34</sup> National Biogas and Manure Management Programme (NBMMP), Section 3, Technology. <http://www.mnre.gov.in/schemes/decentralized-systems/schems-2>

<sup>35</sup> B.T. Nijaguna. 2002. Biogas Technology, New Age International Publishers, New Delhi.



**3) Liquefied Petroleum Gas (LPG)**

Provision of LPG connections and electric cook plates under relevant schemes and programs of the central and state governments in selected households in every district will be explored.

**Institutional Partners**

1. Social Forestry Wing, DoEF (Nodal agency for NBMMP)
2. Panchayat and Rural Development Department
3. AEDA
4. Planning and Development Department
5. Science and Technology Department
6. Gram Panchayats and VFCs

**Identified Barriers**

1. Lack of awareness about deleterious effects of fuelwood combustion
2. Lack of awareness about alternate efficient sources of cooking
3. Cultural barriers to accepting new systems
4. Lack of capacity towards installation and maintenance of biogas plants and solar cookers
5. Lack of a delivery network for installing/galvanize LPG cylinders, supply chain of LPG cylinders.



|   |  |
|---|--|
| <b>How will these be overcome through REDD+ project</b> | <ol style="list-style-type: none"> <li>1. Undertaking communication campaigns to sensitize communities towards alternative cooking systems and the ill-effects of fuelwood combustion</li> <li>2. Assisting in delivery mechanisms for uptake and installation and maintenance of ICS, biogas plants and solar cookers by convergence under government schemes</li> <li>3. Demonstration and monitoring of the maintenance of biogas plants</li> <li>4. Creation of an enabling environment to facilitate distribution of ICS</li> <li>5. Assisting in delivery mechanisms for uptake of LPG by convergence under government schemes</li> <li>6. Creation of an enabling environment to facilitate distribution of induction cook plates.</li> <li>7. Monitoring and evaluation of the identified interventions in all districts, overseen by the REDD+ Cell.</li> </ol> |
| <b>Implementation Plan</b>                              | <ol style="list-style-type: none"> <li>1. Using a scientific and objective decision support system to identify locations of maximum benefit for rollout of these activities.</li> <li>2. Calculation of benefits (in CO<sub>2</sub> eq.) and costs (in INR), and presentation to the DoEF and Government of Assam</li> <li>3. Development of community-level biogas plants, in coordination with local Gram Panchayats and VFCs</li> <li>4. Facilitating distribution of solar cookers and ICS with Gram Panchayats and VFCs</li> <li>5. Development of an Action Plan for the administration and monitoring of these interventions, together with the identified institutional partners and the DoEF, and coordinated by the REDD+ Cell.</li> </ol>   |
| <b>Co-benefits</b>                                      | Better health of women and children, decrease in indoor pollution, contribution to SDGs, decrease drudgery in collection of fuelwood, economic benefit as more time will be available for other income generation activities, skill development, better education as children will be freed from collection of fuelwood, improved standard of living   |
| <b>Potential convergence</b>                            | Pradhan Mantri Ujjwala Yojana, Unnat Chulha Yojana   |

### Efficient fuelwood-based driers for Arecanut processing

|   |   |                            |       |    |   |    |    |                         |        |    |                         |    |            |                  |   |  |   |            |                      |
|---|---|----------------------------|-------|----|---|----|----|-------------------------|--------|----|-------------------------|----|------------|------------------|---|--|---|------------|----------------------|
| <b>Name of the Intervention</b>           | Efficient fuelwood-based driers for arecanut processing in arecanut industries in Nagaon  |                            |       |    |   |    |    |                         |        |    |                         |    |            |                  |   |  |   |            |                      |
| <b>Code</b>                               | FW-DRY-AREC   |                            |       |    |   |    |    |                         |        |    |                         |    |            |                  |   |  |   |            |                      |
| <b>Description of the problem</b>         | <p>India is one of the world's largest producers of arecanut, with the maximum output from Karnataka, Kerala and Assam. In Assam in 2015-16, total area under arecanut cultivation was 77,000 Ha, with a production of more than 74,000 tons of arecanut, giving an average yield of 973 kg/Ha<sup>36</sup>. Nagaon district is one of the leading producers of arecanut in Assam, and is a major source of employment for households in Nagaon.</p> <p>There are an estimated 200 arecanut producing industries in Rupahi and Sunaribali areas of Nagaon district. Nut bearing usually starts 4-5 years after planting. After the kernel is taken out from the harvested arecanut, they are immediately boiled at a high temperature for a minimum of 12 hours<sup>37</sup>. From the results of the socio-economic survey conducted in Nagaon, it has been observed that significant amounts of fuelwood is utilized for drying of arecanut.</p> <p style="text-align: center;"><b>Table 2.1: Estimation of fuelwood required by 1 Arecanut Industry</b></p> <table border="1" style="margin-left: auto; margin-right: auto;"> <tr> <td>Supari processed per Month</td> <td>1,000</td> <td>KG</td> </tr> <tr> <td>FW required to process 1Q of raw Arecanut</td> <td>80</td> <td>KG</td> </tr> <tr> <td>Total Fuelwood required</td> <td>80,000</td> <td>KG</td> </tr> <tr> <td>Total Fuelwood required</td> <td>80</td> <td>Tons/Month</td> </tr> <tr> <td>Operation months</td> <td>5</td> <td></td> </tr> <tr> <td><b>Total Fuelwood required per season</b></td> <td><b>400</b></td> <td><b>Tons per Year</b></td> </tr> </table> | Supari processed per Month | 1,000 | KG | FW required to process 1Q of raw Arecanut | 80 | KG | Total Fuelwood required | 80,000 | KG | Total Fuelwood required | 80 | Tons/Month | Operation months | 5 |  | <b>Total Fuelwood required per season</b> | <b>400</b> | <b>Tons per Year</b> |
| Supari processed per Month                | 1,000   | KG                         |       |    |   |    |    |                         |        |    |                         |    |            |                  |   |  |   |            |                      |
| FW required to process 1Q of raw Arecanut | 80  | KG                         |       |    |   |    |    |                         |        |    |                         |    |            |                  |   |  |   |            |                      |
| Total Fuelwood required                   | 80,000  | KG                         |       |    |   |    |    |                         |        |    |                         |    |            |                  |   |  |   |            |                      |
| Total Fuelwood required                   | 80  | Tons/Month                 |       |    |   |    |    |                         |        |    |                         |    |            |                  |   |  |   |            |                      |
| Operation months                          | 5   |                            |       |    |   |    |    |                         |        |    |                         |    |            |                  |   |  |   |            |                      |
| <b>Total Fuelwood required per season</b> | <b>400</b>  | <b>Tons per Year</b>       |       |    |   |    |    |                         |        |    |                         |    |            |                  |   |  |   |            |                      |

<sup>36</sup> Directorate of Arecanut and Spices Development, Ministry of Agriculture, Government of India. [www.dasd.gov.in/index.php/statistics.html](http://www.dasd.gov.in/index.php/statistics.html)

<sup>37</sup> [www.gmggroup.in/arecanut-processing.html](http://www.gmggroup.in/arecanut-processing.html)

|   |   |
|---|---|
|   | Table 2.1 shows that approximately 400 tons of fuelwood is consumed by 1 arecanut industry in one season. This translates to over 80,000 tons of fuelwood being consumed by the arecanut industry in Nagaon every year. Conventional driers used for processing result in a large amount of thermal energy loss, leading to increased fuelwood requirements from all sources, primarily forests. This places pressure on local forests and leads towards deforestation and forest degradation – fuelwood efficient driers would bring down the pressure on forests for drying of arecanut and help maintain the forest carbon stocks in Nagaon. |
| <b>Description of the solution</b>                      | Fuelwood efficient driers for arecanut to bring down considerable fuelwood demand and provide environmental and social benefits to supari industries.   |
| <b>Detailed description of the technology</b>           | Fuelwood-efficient driers utilize significantly less fuelwood, reduce the curing period and associated pollution. One of the most famous such biomass driers is the ASTRA drier, which is a clean and efficient biomass-fired device, which saves fuelwood utilization and does not expose the operator to smoke. Drying is done in the ASTRA drier in the temperature range of 60-70°C using hot air, but can also be operated at temperatures in the vicinity of 100°C, if necessary <sup>38</sup> .<br>Use of solar-biomass hybrid driers will also be explored for undertaking this activity.   |
| <b>Institutional Partners</b>                           | <ol style="list-style-type: none"> <li>1. Agriculture Department</li> <li>2. Horticulture and Food Processing Department</li> <li>3. Panchayat and Rural Development Department</li> <li>4. Science and Technology Department</li> <li>5. AEDA</li> <li>6. Centre for Sustainable Technologies, Indian Institute of Science (Bangalore).</li> <li>7. Gram Panchayats and VFCs</li> </ol>  |
| <b>Identified Barriers</b>                              | <ol style="list-style-type: none"> <li>1. Lack of awareness about new techniques of arecanut drying</li> <li>2. Insufficient supply chains and delivery mechanisms of new drying technologies.</li> <li>3. Lack of production capacity to meet demand.</li> </ol>   |
| <b>How will these be overcome through REDD+ project</b> | <ol style="list-style-type: none"> <li>1. Undertaking communication campaigns to sensitize cultivators towards the ill-effects of fuelwood combustion and the benefits of adopting efficient driers for their crop.</li> <li>2. Installation and monitoring of efficient driers with selected beneficiaries through convergence with relevant Departments, and with coordination from local Gram Panchayats and VFCs</li> <li>3. Mobilization of adequate funding for the procurement, demonstration and deployment of these driers.</li> </ol>   |
| <b>Implementation Plan</b>                              | <ol style="list-style-type: none"> <li>1. Selection of beneficiaries in Nagaon based on objective criteria</li> <li>2. Facilitating distribution and sale of efficient driers in coordination with the VFCs and CST.</li> <li>3. Calculation of benefits (in CO<sub>2</sub> eq.) and costs (in INR), and presentation to the DoEF and Government of Assam</li> <li>4. Development of an Action Plan for administration and monitoring of driers, in coordination with DoEF and other Departments, overseen by the REDD+ Cell</li> </ol>   |
| <b>Co-benefits</b>                                      | Better price for good quality cardamom, economical benefit as less amount of fuelwood used.   |
| <b>Potential convergence</b>                            | Schemes under horticulture and agriculture departments to promote energy efficient driers.  |

### Efficient fuelwood based boilers for Arecanut boiling

|                                    |  |
|------------------------------------|--|
| <b>Name of the Intervention</b>    | Efficient FW based boilers for arecanut boiling in arecanut industries in Nagaon   |
| <b>Code</b>                        | FW-BOI-AREC  |
| <b>Description of the problem</b>  | As discussed in above table before drying arecanut either under sun or using FW, raw arecanut has to be boiled thoroughly for few hours. This boiling is under using traditional inefficient stoves which consumes lots of fuelwood. |
| <b>Description of the solution</b> | Fuelwood efficient boilers for arecanut to bring down considerable fuelwood demand and provide environmental and social benefits to supari industries.   |

<sup>38</sup> [www.astra.iisc.ernet.in/Pages/Faculty/somu/p2.html](http://www.astra.iisc.ernet.in/Pages/Faculty/somu/p2.html)

|  |   |
|--|---|
| <p><b>Detailed description of the technology</b></p>           | <p>Improved and efficient boilers or stoves are developed by TIDE technologies has very good thermal efficiency with 40% fuel savings compared to traditional stoves. The stoves are made from prefabricated ferro-concrete components that are transported to the user site and then assembled on site. Consistency in design and performance is obtained by use of production centre assembled prefabricated components. Three pan stove dimensions are 425cm x 111cm x 116 cm. Burning rate of the stove is 30 kg/hr. Two pan stove dimensions are 300cm x 111cm x 116cm. Burning rate of the stove is 25.8 kg/hr. Single pan stove dimensions are 96 cm diameter and 103 cm height. Fuel burning rate of the stove is 19.23 kg/hr. The three/two/single pan arecanut cooking stoves have the potential to conserve up to 60% of biofuels as compared to conventional devices.</p>  <p>Use of solar-biomass hybrid boilers will also be explored for undertaking this activity.</p> |
| <p><b>Institutional Partners</b></p>                           | <ol style="list-style-type: none"> <li>1. Agriculture Department</li> <li>2. Horticulture and Food Processing Department</li> <li>3. Panchayat and Rural Development Department</li> <li>4. Science and Technology Department</li> <li>5. AEDA</li> <li>6. Centre for Sustainable Technologies, Indian Institute of Science (Bangalore).</li> <li>7. Gram Panchayats and VFCs</li> </ol>  |
| <p><b>Identified Barriers</b></p>                              | <ol style="list-style-type: none"> <li>1. Lack of awareness about new techniques of arecanut boiling</li> <li>2. Insufficient supply chains and delivery mechanisms of new boiling technologies.</li> <li>3. Lack of production capacity to meet demand.</li> </ol>   |
| <p><b>How will these be overcome through REDD+ project</b></p> | <ol style="list-style-type: none"> <li>1. Undertaking communication campaigns to sensitize cultivators towards the ill-effects of fuelwood combustion and the benefits of adopting efficient boilers for their crop.</li> <li>2. Installation and monitoring of efficient boilers with selected beneficiaries through convergence with relevant Departments, and with coordination from local Gram Panchayats and VFCs</li> <li>3. Mobilization of adequate funding for the procurement, demonstration and deployment of these boilers.</li> </ol>  |
| <p><b>Implementation Plan</b></p>                              | <ol style="list-style-type: none"> <li>1. Selection of beneficiaries in Nagaon based on objective criteria</li> <li>2. Facilitating distribution and sale of efficient boilers in coordination with the VFCs and CST.</li> <li>3. Calculation of benefits (in CO<sub>2</sub> eq.) and costs (in INR), and presentation to the DoEF and Government of Assam</li> <li>4. Development of an Action Plan for administration and monitoring of boilers, in coordination with DoEF and other Departments, overseen by the REDD+ Cell</li> </ol>   |
| <p><b>Co-benefits</b></p>                                      | <p>Better price for good quality cardamom, economical benefit as less amount of fuelwood used.</p>  |
| <p><b>Potential convergence</b></p>                            | <p>Schemes under horticulture and agriculture departments to promote energy efficient boilers.</p>  |

### Fuel-efficient brick kilns

|  |   |
|--|---|
| <b>Name of the intervention:</b>                         | Retrofitting existing brick kilns / Introducing new brick manufacturing technologies, for fuel efficient brickmaking  |
| <b>Code:</b>   | ALT-AFW-BRK   |
| <b>Description of the problem</b>                        | Brick factories in the district consume a lot of fuelwood. On an average around 10 tons of fuelwood is used per kiln in a year for initial firing purpose. (FAO, 1988) There are around 300 brick kilns in Nagaon district (Sentinel Assam, May 2017), consuming more than 3,000 tons of fuelwood in a year.  |
| <b>Description of the solution</b>                       | Introduction of alternate household fuels like efficient burners and driers. Retrofitting existing brick factories to make them more fuel efficient.  |
| <b>Description of the technology</b>                     | Zig-zag kiln: <ul style="list-style-type: none"> <li>• 15-20% reduction in Specific Energy Consumption (SEC)</li> <li>• Upto 75% reduction in SPM emissions over FC-BTK</li> <li>• A higher percentage of Class I bricks are produced as compared to FC-BTK (80-85% Class I bricks as compared to 55-60% in FC-BTK)</li> <li>• Option for easy retrofit of FC-BTK to natural draught zig-zag kiln.</li> <li>• Like FC-BTK, zig-zag kilns also require solid fuels for firing.</li> <li>• Some of the fuels currently being used are saw dust, low and high grade coal, pet coke, agricultural residue etc. As zig-zag kiln is an energy efficient technology, it requires less fuel than FC-BTK.</li> </ul>   |
| <b>Institutional partners</b>                            | TARA, Development Alternatives, Shakti Foundation, Core Support Programme (Science and Society Division, Dept. of Science and Technology)   |
| <b>Identified barriers</b>                               | <ul style="list-style-type: none"> <li>• Lack of awareness of other technologies – Knowledge barrier</li> <li>• Lack of finances to invest in clean technologies – Financial barrier</li> <li>• Untrained labour – Technical barrier</li> </ul>   |
| <b>How will these be overcome through REDD+ project?</b> | <ul style="list-style-type: none"> <li>• Organising workshops for brick kiln workers on efficient fuels and kiln retrofitting</li> <li>• Training workshops for kiln workers (e.g. for honeycomb layering of bricks, optimal size of bricks, etc.)</li> <li>• Development of a financing mechanism for retrofitting existing kilns.</li> </ul>  |
| <b>Implementation plan</b>                               | <ul style="list-style-type: none"> <li>• Adoption of improved feeding, firing and operating practices in existing Fixed Chimney Bull's Trench Kilns (FCBTKs)</li> <li>• Retrofitting of kiln and converting into High Draft Kiln/ Fixed Chimney Bull's Trench Kiln with zig-zag firing.</li> <li>• Extensive Capacity Building Program</li> <li>• Effective policies and regulations required for implementing energy efficient technologies like Tunnel Kiln, Hoffman Kilns, TARA Eco Kiln, TARA BrickMek, etc.</li> <li>• Need for establishing the demand/market for resource efficient products like hollow and perforated bricks, and limiting the production of solid bricks in phases.</li> <li>• The technologies being capital intensive, requires mechanism for financial support before its replication on large scale.</li> </ul> |
| <b>Co-benefits</b>                                       | Economic benefit as less amount of fuelwood used. Improved health of brick kiln workers due to proper training and less pollution.  |
| <b>Potential convergence</b>                             | Initiatives by the Pollution Control Board of Assam (PCBA)  |

### Smokeless Biomass briquettes as a fuelwood substitute

|                                    |  |
|------------------------------------|--|
| <b>Name of the intervention:</b>   | Smokeless Biomass briquettes as a fuelwood substitute  |
| <b>Code</b>                        | ENE-BRQ-FW   |
| <b>Description of the problem</b>  | Unsustainable fuelwood extraction from forests (for household use, for fodder preparation and for use in small enterprises) to support rural communities is a major cause of deforestation and forest degradation in Nagaon. Illegal felling of fuelwood is reported in almost all ranges in Nagaon. |
| <b>Description of the solution</b> | Introduction of smokeless bio-briquettes using waste biomass and invasive species will help reduce fuelwood consumption, leading to the conservation and enhancement of Nagaon's forest carbon stocks. In addition, they will lead to the following benefits:  |

|  |   |
|--|---|
|  | <ul style="list-style-type: none"> <li>- Check the breakout of invasive species causing deterioration of forest health</li> <li>- Provide an outlet for disposal of agricultural and animal feed wastes</li> <li>- Make available organic fertilizer and opportunities for non-farm based livelihoods</li> <li>- Reduce health hazards from smoke and high emissions from burning fuelwood and biomass</li> </ul>   |
| <b>Detailed description of the technology</b>            | <p>About 400-500 gm of biodegradable waste is utilized for the production of 1 bio-briquette – 40-50 bio-briquettes can be manufactured per day.</p> <p>The processes involved in making bio-briquettes:</p> <ul style="list-style-type: none"> <li>- Collection and drying of bio-degradable waste and burning in a pit to make active charcoal.</li> <li>- Production of biochar by leaving the charcoal overnight and airtight upto 12 hours.</li> <li>- Mixing biochar with fine mud in 3:1 ratio, and adding water to make a paste</li> <li>- Putting biochar-mud mixture in the briquette moulding frame and drying.</li> </ul> |
| <b>Identified barriers</b>                               | <ol style="list-style-type: none"> <li>1. Lack of awareness about deleterious effects of fuelwood combustion</li> <li>2. Lack of awareness about alternate efficient sources of cooking</li> <li>3. Lack of established bio-briquettes manufacturing and delivery systems</li> <li>4. Lack of rural infrastructure to support bio-briquettes manufacturing</li> <li>5. Lack of data on availability of invasive species as well as agricultural and animal feed wastes</li> <li>6. Cultural barriers for take-up of alternative systems</li> </ol>  |
| <b>How will these be overcome through REDD+ project?</b> | <ol style="list-style-type: none"> <li>1. Building on existing communication campaigns to popularize the use of bio-briquettes across the state</li> <li>2. Assisting in procuring equipment, providing training and setting up of small enterprises focused on manufacturing and use of bio-briquettes</li> <li>3. Building on linkages and convergence with the government, public sector (NABARD) and private sector</li> </ol>  |
| <b>Implementation plan</b>                               | <ol style="list-style-type: none"> <li>1. Training and awareness campaigns on bio-briquettes shall be organised in all the districts in such a way that at least 4 representatives from each village attend the training program.</li> <li>2. One mould will be given to each village, the SHGs/JFMCs in each village can procure more moulds from wherever they prefer.</li> <li>3. A market chain will be established to market the bio-briquettes.</li> </ol>  |
| <b>Co-benefits</b>                                       | <ul style="list-style-type: none"> <li>• Better health of women and children, decrease in indoor pollution, contribution to SDGs, decrease drudgery in collection of fuelwood, economical benefit as more time will be available for any income generation activity, skill development, better education as children will be freed from collection of fuelwood, improved standard of living</li> <li>• There is employment generation as well where SHGs can form a group together and market bio-briquettes.</li> </ul>  |
| <b>Potential convergence</b>                             | Pradhan Mantri Ujjwala Yojana, Unnat Chulha Yojana  |

### Smart patrolling to check unplanned extraction of forest resources and unplanned mining within forestland

|                                    |  |
|------------------------------------|--|
| <b>Name of the intervention:</b>   | Smart patrolling to check unplanned extraction of forest resources and unplanned mining within forest land   |
| <b>Code:</b>                       | FML-PAT-MIN  |
| <b>Description of the problem</b>  | Few village communities extract small rocks from the forests and break them into small pieces (gravel) and sell. Over a period of time, this practice affects the forest soil and leads to forest degradation. |
| <b>Description of the solution</b> | Regular patrolling by forest personnel will discourage encroachers to illegally retrieve rocks from forests.   |
| <b>Institutional partners</b>      | Forest Department, Horticulture Department, National Horticulture Mission, Social Forestry Wing (Dept. of Environment & Forests, Govt. of Assam)   |
| <b>Identified barriers</b>         | <ul style="list-style-type: none"> <li>• Lack of capacity in JFMCs</li> </ul>  |

|  |  |
|--|--|
|  | <ul style="list-style-type: none"> <li>Neglecting the need of local community while focusing on timber-only forestry could threaten the sustainability (ecological and social) of sal forests.</li> </ul>  |
| <b>How will these be overcome through REDD+ project?</b> | <ul style="list-style-type: none"> <li>Integrating NTFPs could create the opportunity for local people to participate in forest management.</li> <li>Increasing NTFP production like pepper &amp; betel vine may contribute towards the economic opportunities and ultimately lead to the economic prosperity of local communities.</li> </ul>   |
| <b>Implementation plan</b>                               | <ul style="list-style-type: none"> <li>Constitution of JFMCs and preparation of micro plans.</li> <li>Nursery raising by JFMCs for creation of plantation and simultaneous raising of another people's nursery by each JFMC for income generation from sale of seedlings.</li> <li>Entry Point Activities like repairing of village road, construction of community hall, providing safe drinking water facility etc.</li> <li>Training and capacity building of JFM communities as well as forest personnel.</li> <li>Plantation over degraded forest by JFMCs.</li> <li>Infrastructure Development of Forest Department for better service delivery</li> <li>Exposure visit to other states.</li> <li>Support to JFMCs for Medicinal and Aromatic Plantation on PPP mode.</li> </ul> |

### Construction of CPTs and EPTs for better defined boundaries to reduce encroachments

|                                      |  |
|--------------------------------------|--|
| <b>Name of the intervention:</b>     | Construction of CPTs and EPTs for better defined boundaries to reduce encroachments  |
| <b>Code:</b>                         | FML-DBN-ENC  |
| <b>Description of the problem</b>    | The lack of artificial boundaries of a number of reserve forests leads to encroachment and regular felling and extraction of resources from the forest reserves. Ecological and social surveys conducted in the landscape indicate that Reserved Forests in Nagaon suffer from illegal encroachments due to lack of proper demarcation, unauthorized cattle grazing and lack of soil conservation leading to riverine and gully formations. Except for the Nagaon Sadar range, all ranges in Nagaon witness man-animal conflicts on a regular basis. Most of these incidents involve elephants.  |
| <b>Description of the solution</b>   | The need for strict vigilance through watchtowers to manage the boundary line of the reserve forests is there and proper demarcation with fixing of pillars in the division. Construction of CPTs and EPTs, as well as other relevant measures, to counter the multi-faceted challenges that RFs face in the Nagaon Division. These CPTs and EPTs are multi-purpose and useful towards forest management, utilizing least amount of resources for maintenance and construction. These can be constructed under MGNREGA funds through convergence with other state government departments by looking at various models practiced in different landscapes across India.  |
| <b>Description of the technology</b> | A watchtower is simply a structure with a platform a few meters high that can support one or two people and from which the surrounding area can be observed. It can be either be on a tree or as a stand-alone structure.<br><br>For CPTs and EPTs:<br>Common dimensions of such trenches are 3m wide at the top, 1m wide at the bottom and 2m deep. The design of the CPTs and EPTs may also depend on the challenge that needs to be addressed :<br><ul style="list-style-type: none"> <li>For cattle grazing, trench size of at least 4ft depth and 4ft width.</li> <li>For encroachment, trench size of 3ft height and 3ft width.</li> <li>For erosion control, trench size of 3ft height and 3ft width</li> </ul> These trenches are constructed after identification of vulnerable areas on the forest fringes where encroachment activities, man-animal conflicts and other issues have been repeatedly observed.<br>Other relevant measures that can be considered include the utilization of used rail tracks sourced from the Indian Railways for fencing purposes. This has already been tried on an experimental basis in Assam. |
| <b>Institutional partners</b>        | Department of Environment and Forests (DoEF), JFMCs  |
| <b>Identified barriers</b>           | <ul style="list-style-type: none"> <li>Lack of properly defined boundaries in reserve forests.</li> <li>Lack of awareness among communities regarding reserve forests.</li> </ul>  |

|  |   |
|--|---|
|  | <ul style="list-style-type: none"> <li>• Lack of capacity among the JFMCs.</li> <li>• There are reports that animals get injured in tea garden areas after falling into the deep trenches, dug within the garden areas for drainage of water.</li> <li>• Lack of funding towards construction of trenches</li> <li>• Lack of participation of local communities and VFCs towards construction</li> <li>• Defective construction and lack of maintenance</li> </ul>  |
| <b>How will these be overcome through REDD+ project?</b> | <ul style="list-style-type: none"> <li>• Regular surveillance will check encroachment.</li> <li>• Training campaign among communities regarding the importance of reserve forests.</li> <li>• CPTs and EPTs will make sure animals are not injured and man-animal conflicts are reduced.</li> </ul>   |
| <b>Implementation plan</b>                               | <ol style="list-style-type: none"> <li>1) Proper demarcation of reserve forests with help of the Forest Dept.</li> <li>2) Creating awareness among JFMCs and concerned forest communities regarding management of reserve forests.</li> <li>3) Construction of watch towers &amp; posting of staff on 24 hours duty during most vulnerable periods.</li> <li>4) Vaccination of cattle near the fringe villages needs to be done regularly and awareness camp &amp; animal health camps needs to be conducted with the help of veterinary doctors regularly.</li> <li>5) Elephant depredation hot spots needs to be identified.</li> <li>6) JFMC's (or) EDC's needs to be activated &amp; awareness to be given on protection to wildlife.</li> <li>7) Provision of funds to public for construction of stone wall/solar electric fencing around agricultural fields.</li> <li>8) Live/bio-fencing</li> <li>9) Construction of watchtowers &amp; posting of staff on 24 hours duty during most vulnerable periods.</li> <li>10) Identification of vulnerable areas with need for fencing based on objective criteria</li> <li>11) Exploring various models of trench construction</li> </ol> |

### Bio-fencing to counter encroachment

|                                    |  |
|------------------------------------|--|
| <b>Name of the intervention:</b>   | Bio-fencing to reduce encroachment, illegal felling and man-animal conflicts   |
| <b>Code:</b>                       | FM-BRDR-PLANT  |
| <b>Description of the problem</b>  | Encroachment and illegal felling is one of the many causes of deforestation and forest degradation. Further, in areas where agricultural fields are situated adjacent to forestlands, there are frequent man-animal conflicts.   |
| <b>Description of the solution</b> | Development of biological barriers such as agave plantation can stop the felling and transport of local timber, while also acting as a barricade against animal incursion. These natural barriers would supplement existing efforts undertaken by the DoEF, like surveillance through watchtowers and procurement of night-vision glasses, to check these illegal activities. In addition, such vegetative barriers restrict animals from foraging on agricultural produce and causing crop damages.   |
| <b>Description of technology</b>   | Agave plantations have been used across various states in India for live fencing due to its low maintenance requirements, growth of marginal lands and its soil binding properties. Agave leaves are thick and fleshy, and its tips are full of spines <sup>39</sup> . Rows of agave plantations would help check illegal encroachment, felling and transport of timber, as well as man-animal conflicts, by acting as a natural barrier. Other types of vegetation can also be explored to act as bio-fencing towards restricting these activities. |
| <b>Identified barriers</b>         | <ol style="list-style-type: none"> <li>1. Lack of protection and maintenance of these bio-fencing techniques</li> <li>2. Lack of capacity and training of local DoEF personnel and communities towards bio fencing</li> <li>3. Destruction of such fences by encroachers</li> </ol>  |

<sup>39</sup> [www.biogov.in/article/agave-a-multipurpose-dryland-plant/](http://www.biogov.in/article/agave-a-multipurpose-dryland-plant/)

|  |   |
|--|---|
| <b>How will these be overcome through REDD+ project?</b> | <ol style="list-style-type: none"> <li>1. Undertaking communication campaigns on the benefits of natural barriers to restrict these activities.</li> <li>2. Training and capacity building of JFMCs and local communities, in addition to convergence of central and state funds and schemes, on the plantation and maintenance of these bio-fences.</li> <li>3. Distribution of saplings (e.g. agave or other thorny species) of plants which can be used for live fences.</li> </ol>  |
| <b>Implementation plan</b>                               | <ol style="list-style-type: none"> <li>1. Training of DoEF personnel, JFMCs and local communities on the construction and maintenance of live fences</li> <li>2. Identification of areas which are priority plantations to take up agave plantation, geo-tagging them.</li> <li>3. Ground reconnaissance, raising agave, planting them in the prescribed manner.</li> <li>4. Development of strategies to converge the objectives of this intervention with other DoEF initiatives to check illegal felling and transport.</li> </ol> |
| <b>Co-benefits</b>                                       | Decrease man-animal conflict, encroachment, and smuggling.  |
| <b>Potential schemes</b>                                 | Existing DoEF schemes   |

### Afforestation/Reforestation and ANR activities

|   |  |
|---|--|
| <b>Name of the intervention:</b>              | Plantation activities: <ol style="list-style-type: none"> <li>1. Afforestation and Reforestation in non-forest lands for tree cover.</li> <li>2. Assisted Natural Regeneration in forests to stop degradation</li> </ol>   |
| <b>Code:</b>                                  | FM-ANR-AFD   |
| <b>Description of the problem</b>             | REDD+ interventions strives to decrease degradation and deforestation and associated emissions. Through LULC change mapping, it is observed that there are pockets of degradation and deforestation in Nagaon, which leads to emissions.   |
| <b>Description of the solution</b>            | Plantation activities in identified degraded pockets through Assisted Natural Regeneration (ANR) and gap plantation and identified non-forest pockets prone to deforestation (afforestation and reforestation) will help in enhancement of forest stock and increase forest and tree cover.  |
| <b>Detailed description of the technology</b> | <p>Afforestation and reforestation both refer to establishment of trees on lands not currently having trees. Reforestation refers to establishment of forest on land that had recent tree cover, whereas afforestation refers to land that has been without forest for much longer<sup>40</sup>. For such activities, it is stipulated that the identified land at the time of commencement of plantation is not a forest, and woody vegetation on the land is below the forest thresholds as decided for the national GHG inventory; which is a crown cover of 10%.</p> <p>ANR is a method for enhancing the establishment of secondary forest from degraded grassland and shrub vegetation by protecting and nurturing the mother trees and their wildlings inherently present in the area<sup>41</sup>. ANR activities are focused on lands currently classified as forests (and which meet the minimum eligibility criteria for forests mentioned above), but which may not remain one in the future due to anthropogenic pressures from the drivers of forest change identified in the socio-economic surveys conducted in the landscape. Depending on the existing condition and canopy cover of the identified area, the appropriate techniques and methods for plantations and development of the degraded landscape will be employed towards regenerating forest cover through selection of appropriate tree species, forest management, protection and monitoring.</p> |
| <b>Institutional partners</b>                 | JFMCs/EDCs   |
| <b>Identified barriers</b>                    | <ol style="list-style-type: none"> <li>1. Non-availability of degraded areas on a suitable scale.</li> <li>2. Lack of sufficient funds to undertake plantation activities across Nagaon.</li> <li>3. Lack of technology-driven cost effective monitoring of these plantations.</li> </ol>  |
| <b>How will these be overcome</b>             | <ol style="list-style-type: none"> <li>1. Training of DoEF personnel and JFMCs on undertaking best land regeneration practices through trainings planned under REDD+.</li> </ol>   |

<sup>40</sup> [www.ipcc.ch/ipccreports/sres/land\\_use/index.php?idp=47](http://www.ipcc.ch/ipccreports/sres/land_use/index.php?idp=47)

<sup>41</sup> [www.fao.org/forestry/anr/en/](http://www.fao.org/forestry/anr/en/)



|                               |   |
|-------------------------------|---|
| <b>through REDD+ project?</b> | <ol style="list-style-type: none"> <li>2. Undertaking communication campaigns focusing on the benefits of forest conservation and enhancement</li> <li>3. Distribution of native tree species seeds and saplings for plantation to JFMCs and EDCs under an appropriate scheme.</li> <li>4. Convergence of funds and schemes for better regeneration of degraded forest and non-forest land</li> </ol>   |
| <b>Implementation plan</b>    | <ol style="list-style-type: none"> <li>1. Identification and demarcation of degraded forest and non-forest land, its extent of degradation and suitability for A/R and ANR activities.</li> <li>2. Selection of suitable native species to be used for regeneration of forest through consultations within DoEF.</li> <li>3. Convergence of schemes and funds for implementing the plantation activities on the degraded lands.</li> <li>4. Expert consultations to identify, and attempt to overcome, expected challenges (environmental, ecological, and financial) for carrying out the regeneration of the degraded land.</li> <li>5. Development of an Action Plan for administration and monitoring of the intervention with JFMCs and DoEF.</li> <li>6. Year 3 onwards, further ANR to increase the forest stocks in a phased manner.</li> </ol> |
| <b>Co-benefits</b>            | Access to timber, fuelwood and fodder, increase the forest cover and health, provide labour to people in plantation and site preparation activities, decrease incidents of landslides.  |
| <b>Potential schemes</b>      | <p>All existing schemes and programs on afforestation, reforestation in the sites</p> <ul style="list-style-type: none"> <li>• National Afforestation Policy (NAP), NAEB (MoEFCC) [State Implementing Agency: State Forest Development Agency, Assam]</li> <li>• State Compensatory Afforestation Fund Management and Planning Authority (CAMPA)</li> <li>• Mahatma Gandhi National Rural Employment Guarantee Act (MGNREGA) [State Implementing Agency: Panchayat and Rural Development Department]</li> </ul>   |

### Promoting agro-forestry in large scale in non-forest lands

|   |  |
|---|--|
| <b>Name of the intervention:</b>              | Promoting agro-forestry in large scale in non-forest lands   |
| <b>Code:</b>                                  | FM-AGF-AFD/AGD/HORT  |
| <b>Description of the problem</b>             | REDD+ interventions strives to decrease degradation and deforestation and associated emissions. Through LULC change mapping, it is observed that there are pockets of degradation and deforestation in Nagaon, which leads to emissions.   |
| <b>Description of the solution</b>            | Agro-forestry will be promoted with a mix of fuelwood and other native fodder, fruit trees to address fuel, fodder and other livelihood needs of the communities   |
| <b>Detailed description of the technology</b> | <p>Promoting horticulture species such as mangoes, jack fruit, jamoon, etc. not only increases tree cover but also provide livelihoods to communities. Fruit processing industries will be promoted with proper market linkages. Farmer producing companies will be integrated with existing JFMCs which will have active participation of all stakeholders.</p> <p>Dedicated fuelwood plantations will be raised and managed sustainably to address fuelwood needs of the community. The species will be decided after consulting local communities with the help of forest department.</p> <div style="text-align: center;">  </div> <p style="text-align: center;"><b>Figure 34: Mango Plantation</b></p> |

|  |  |
|--|--|
|  |  <p style="text-align: center;"><b>Figure 35: Jackfruit Plantation</b></p>   |
| <b>Institutional partners</b>                            | JFMCs/EDCs   |
| <b>Identified barriers</b>                               | <ol style="list-style-type: none"> <li>1. Non-availability of degraded areas on a suitable scale.</li> <li>2. Lack of sufficient funds to undertake plantation activities across Nagaon.</li> <li>3. Lack of technology-driven cost effective monitoring of these plantations.</li> </ol>  |
| <b>How will these be overcome through REDD+ project?</b> | <ol style="list-style-type: none"> <li>1. Training of DoEF personnel and JFMCs on undertaking best land regeneration practices through trainings planned under REDD+.</li> <li>2. Undertaking communication campaigns focusing on the benefits of forest conservation and enhancement</li> <li>3. Distribution of native tree species seeds and saplings for plantation to JFMCs and EDCs under an appropriate scheme.</li> <li>4. Convergence of funds and schemes for better regeneration of degraded forest and non-forest land</li> </ol>  |
| <b>Implementation plan</b>                               | <ol style="list-style-type: none"> <li>1. Identification and demarcation of non-forest land which belongs to local farmer</li> <li>2. Selection of suitable native species to be used through consultations within DoEF.</li> <li>3. Convergence of schemes and funds for implementing the plantation activities on the agriculture lands.</li> <li>4. Expert consultations to identify, and attempt to overcome, expected challenges.</li> <li>5. Development of an Action Plan for administration and monitoring of the intervention with JFMCs and DoEF.</li> <li>6. Year 3 onwards, further ANR to increase the forest stocks in a phased manner.</li> </ol> |
| <b>Co-benefits</b>                                       | Source of fodder, timber and increased source of income through multi-tiered agriculture.  |
| <b>Potential schemes</b>                                 | <ul style="list-style-type: none"> <li>• Awareness schemes under agriculture department and agro-forestry promotion</li> <li>• Sub-Mission on Agroforestry (SMAF), National Mission for Sustainable Agriculture (NMSA), Govt. of India</li> </ul>  |

### Cultivation of medicinal plants

|                                    |  |
|------------------------------------|--|
| <b>Name of the intervention:</b>   | Cultivation of medicinal plants as a measure of alternative livelihood and income enhancement  |
| <b>Code:</b>                       | FM-MED-PLANT   |
| <b>Description of the problem</b>  | Around 24% of the surveyed households revealed they collect NTFPs, including herbs like Abu-Tenga ( <i>Antidesma acidum</i> Retz), Agora ( <i>Triumfetta rhomboidea</i> Jacq), Bagh-ashora ( <i>Polygonus glabrum</i> ), etc. Most of the households collect these NTFPs for personal consumption, which does not translate into monetary gains through NTFPs for the households.  |
| <b>Description of the solution</b> | <p>Plantation and collection of medicinal plants and linking it with herbal markets like the upcoming Food Park by Patanjali Ayurved will help the farmers by financially including them into the mainstream market.</p> <p>Patanjali is investing Rs 1300 crore for its Herbal and Mega Foodpark in Ballipara, Assam. This is estimated to give direct employment to 5000 people and benefit 1,00,000 farmers all across the state.</p> |

|  |   |
|--|---|
| <b>Detailed description of the technology</b>            | The Balipara unit of Patanjali will produce Rs 20,000 crore annual production with an annual production capacity of around 12 lakh MT. The unit will manufacture wide range of consumer products such as cosmetics, nutritional foods and kitchen essentials among others. The plant will produce rice bran oil from the remains of rice husks. (Patanjali Ayurved Ltd., November 2016)   |
| <b>Partner institutions</b>                              | 1. DoEF<br>2. JFMCs/EDCs/SHGs and Gram Panchayats<br>3. Patanjali Ayurved Ltd.<br>4. Horticulture Mission, Agriculture Department (Ayush Programme for cultivation of medicinal plants)   |
| <b>Identified barriers</b>                               | 1. Lack of awareness and knowledge of market potential of medicinal plants<br>2. Lack of resources and capacity of local communities towards the development and monitoring of medicinal plantations<br>3. Lack of coordination among institutions for the deployment of this intervention, along with other financial and technical towards adoption of these modern techniques  |
| <b>How will these be overcome through REDD+ project?</b> | 1. Undertaking communication campaigns on benefits from medicinal plants.<br>2. Training and capacity building on plantation techniques<br>3. Financial, technical and institutional support to overcome the barriers of medicinal plantation activities.   |
| <b>Implementation plan</b>                               | 1. Identification and selection of suitable lands for plantation activities.<br>2. Training, capacity building and promotion of medicinal plantations.<br>3. Facilitating distribution of seeds of ecologically adaptive and agro-climatically suitable species<br>4. Convergence of public funds and schemes for promoting and implementing medicinal plantations<br>5. Development of an Action Plan for administration and monitoring of the intervention with Gram Panchayats, JFMCs, and DoEF. |
| <b>Co-benefits</b>                                       | Increased income through alternative options. Reduced dependence on forest resources leading to less extraction and exploitation of forest resources.   |
| <b>Potential convergence</b>                             | Horticulture Mission, Agriculture Department (Ayush Programme for cultivation of medicinal plants)  |

### Sustainable grazing and livestock management:

1. Silvi-pastoral and Horti-pastoral models
2. Fodder densification and stall feeding
3. Vaccination of livestock

#### Silvi-pastoral and Horti-pastoral Models

|                                   |  |
|-----------------------------------|--|
| <b>Name of the intervention:</b>  | Silvi-pastoral and Horti-pastoral practices for sustainable grazing  |
| <b>Code:</b>                      | FM-SILV-HORT   |
| <b>Description of the problem</b> | Around 68% of surveyed households have cattle in their houses. An average of 3 cows is present per family. It is estimated that there are 2,087,631 livestock (NER databank) in the district, which require a constant supply of fodder and pasturelands. Poultry, Duckery, Goatery and Piggery are major backyard activities of the rural households for food and nutrition. Pig rearing is taken as a subsidiary occupation by the small and marginal farmers and the agricultural labourers of the tribal community. <sup>42</sup> According to the socio-economic survey, sheep, pig, chicken and geese are reared in most of the households and used for meat purposes. There are 480,208 rural households in Nagaon (Census 2011), with average of 4 livestock per household. From the socio-economic survey conducted in the landscape, it was found that 83% of the cattle goes for open grazing. And around 22% of the surveyed households revealed they collect fodder from forests. This leads to pressures on existing lands to provide fodder and pastures. |

<sup>42</sup> District Report: Nagaon, Baseline Survey of Minority Concentrated Districts, OKDISCD – Guwahati (Ministry of Minority Affairs, Govt. of India)

|  |   |
|--|---|
| <b>Description of the solution</b>                       | Development of silvi-pastoral models to meet the pasture demands of local livestock and to provide for the cultivation of trees for fuelwood purposes.  |
| <b>Detailed description of the technology</b>            | Silvi-pastoral systems advocate the cultivation of trees simultaneously with the cultivation of grasses and forage. In this system, the space between individual tree specimens in silvi-pastoral and horti-pastoral systems will be utilized for cultivation of grasses and forage for livestock. In-situ grazing will be provided for livestock throughout the year (in silvi-pastoral systems) and for a period of 3-4 months during fruiting season (in horti-pastoral systems). In addition, foliage to be made available for livestock consumption.   |
| <b>Partner institutions</b>                              | <ol style="list-style-type: none"> <li>1. DoEF</li> <li>2. JFMCs/EDCs/SHGs and Gram Panchayats</li> <li>3. Horticulture Mission, Agriculture Department</li> </ol>  |
| <b>Identified barriers</b>                               | <ol style="list-style-type: none"> <li>1. Lack of awareness and knowledge of silvi-pastoral and horti-pastoral practices and their benefits</li> <li>2. Lack of resources and capacity of local communities towards the development and monitoring of silvi-pastoral landscapes.</li> <li>3. Lack of coordination among institutions for the deployment of this intervention, along with other financial and technical towards adoption of these modern techniques</li> </ol>   |
| <b>How will these be overcome through REDD+ project?</b> | <ol style="list-style-type: none"> <li>1. Undertaking communication campaigns on benefit of forest conservation, importance of silvipastoral and hortipastoral practices</li> <li>2. Training and capacity building on silvipastoral and hortipastoral practices</li> <li>3. Distribution of ecologically adaptive and agro-climatically suitable tree species seeds and saplings for silvi-pastoral and horti-pastoral plantations</li> <li>4. Financial, technical and institutional support to overcome the barriers of silvipastoral and hortipastoral practices</li> </ol>   |
| <b>Implementation plan</b>                               | <ol style="list-style-type: none"> <li>1. Identification and selection of suitable lands for adoption of silvi-pastoral activities</li> <li>2. Designing of silvi-pastoral and horti-pastoral activities in consultation with experts and institutions and agencies like local NGOs, SHGs and others.</li> <li>3. Training, capacity-building and promotion of silvi-pastoral and horti-pastoral activities</li> <li>4. Facilitating distribution of seeds of ecologically adaptive and agro-climatically suitable species</li> <li>5. Convergence of public funds and schemes for promoting and implementing silvi-pastoral and horti-pastoral practices</li> <li>6. Development of an Action Plan for administration and monitoring of the intervention with Gram Panchayats, JFMCs, and DoEF.</li> </ol> |
| <b>Co-benefits</b>                                       | Source of fodder and decrease in soil erosion.  |
| <b>Potential schemes</b>                                 | <ul style="list-style-type: none"> <li>• Sub-Mission on Fodder and Feed Development, National Livestock Mission (Government of India)</li> <li>• Accelerated Fodder Development Programme, Department of Agriculture (Government of India)</li> </ul>   |

### Fodder Densification and stall-feeding

|                                   |  |
|-----------------------------------|--|
| <b>Name of the intervention:</b>  | Fodder densification and stall feeding   |
| <b>Code:</b>                      | ALM-FODD-FD  |
| <b>Description of the problem</b> | <p>Due to climate variations, sustenance of livestock production is at threat due to scarcity of fodder during drought periods. Also, for a majority of illiterate and semi-literate farmers to compute a balanced feed for animals.</p> <p>State Animal Husbandry Department sources say the present requirement of green fodder for cross-bred animals is 2.3 million MT but what's available is a mere 85,633 MT.<sup>43</sup> Crop residues, which are otherwise suitable for animal feeding are quite often burnt in the paddy fields or destroyed gradually without in utility, especially in Assam. (District Animal Husbandry and Veterinary Department, Nagaon)</p> |

<sup>43</sup> Kishore Talukdar, "Assam needs a white revolution", NEZINE (27-04-2016)

|  |  |
|--|--|
| <p><b>Description of the solution</b></p>            | <p>Densification of roughages and waste crop residues in compact blocks is an effective solution for livestock feed management. The digestibility of crop residues and other low quality forages can be increased through the action of rumen microbes by strategically mixing nitrogen and minerals that are deficient in these feed resources.</p> <p>The increase in digestibility of crop residues and low quality forages, in turn also increases their intake. Both these phenomena enhance the efficiency of nutrient utilization from these feed resources in animal food chains. Fodder densification machines are based on the formation of a complete diet in the form of densified feed blocks or pellets from straws mixed with minerals, oil seed cakes and other agro-industrial by-products.</p> <p>This technology will enhance income of farmers, decrease environmental pollution and help alleviate shortage of good quality seeds in tropical countries. In addition, the feed produced in the densified form as blocks or pellets could also provide complete feed to livestock in emergency situations. This will also enable efficient and cost-effective transport of fodder upon its densification into fodder blocks where up to 10 tons of feed block can be easily transported in a truck as against 4 ton loose fodder. (DAH&amp;VD, Nagaon)</p> <p>Fodder Cultivation Scheme for production of oat grass was not very popular, hence it was discontinued 2 years earlier. It can be started on a pilot basis in one or two villages.</p> <p>Absence of feed mill in the district the main cause of lack of quality feed for cattle which is the main obstacle for promoting stall feeding. Quality fodder and feed production can be promoted in some of the fringe villages of forest villages.</p>  |
| <p><b>Detailed description of the technology</b></p> | <p>The Densified Total Mixed Ration Block (DTMRB) technology has mostly been developed in India, through the collaborative efforts of animal nutritionists and feed technologists. It is different from the green forages or silage based complete feeds (Schroeder and Park, 1997; Kononoff, 2005). Since the fibrous crop residues are low density feeds, apart from difficulties in its handling and transportation, making a densified block from this loose and lighter stuff is challenging. A different approach and machinery are required for making such blocks from these residues and other dried roughages such as tree leaves and forest grasses.</p> <p>The first step in the process of making straw based feed blocks is the grinding of concentrate ingredients, followed by their mixing and addition of the feed additives. This is then followed by mixing of these ingredients and straw in proper proportions along with addition of molasses in a specifically designed TMR mixer, taking care that mixing is uniform and ingredients are not separated due to gravity. Finally, the weighed quantity of the mixed stuff is transferred into a hydraulic press to get the final product – the DTMRB.</p> <p><b>Machinery Needed</b></p> <ul style="list-style-type: none"> <li>• A grinder (hammer mill) and a mixer is required for making a normal concentrate mixture.</li> <li>• A specially designed TMR Mixer is required for mixing weighed quantities of low density crop residue (straws, stovers, bagasse, dried forest grasses, dried tree leaves etc.) and the high density concentrate. Molasses and any other liquid feed additive are also added at this stage. The mixing is done through vertical motion, so that there is no separation due to gravity</li> <li>• Weighed quantity of the mixed ingredients is transferred into densification machine (works on the principle of hydraulic compression) which compresses the forage and concentrate mixture into densified complete feed block.</li> </ul> |

|  |  |
|--|--|
|  |  <p>Machines of different capacities and different efficiencies are available in India. Installed capacity can vary from 0.5 to 3 tons per hour, which requires a motor of 20–40 horse power having a power consumption of 12–16 KW per tonne. These machines can produce feed blocks weighing from 7 kg to 30 kg.</p>   |
| <b>Partner institutes</b>                                | DoEF, Food and Agriculture Organization of the United Nations (FAO), District Animal Husbandry and Veterinary Department, Nagaon (Assam)   |
| <b>Identified barriers</b>                               | <ul style="list-style-type: none"> <li>• Insufficient nutrient provision to livestock</li> <li>• Lack of technical know-how to make densified fodder blocks in the region. (Technical barrier)</li> <li>• Lack of financial resources. (Financial barrier)</li> </ul>  |
| <b>How will these be overcome through REDD+ project?</b> | <ul style="list-style-type: none"> <li>• Efficient nutrients delivery system – less feed wastage</li> <li>• Provision of training and setting up of required machinery</li> <li>• Easy credit facilities</li> </ul>  |
| <b>Implementation plan</b>                               | <ul style="list-style-type: none"> <li>• Fodder densification through establishing of fodder banks and promotion of fodder grasses and legumes.</li> <li>• DTMRB can be effectively utilized as a combined source of protein, energy and minerals during drought situations. They also help in preventing loss of fertility in case of prolonged drought.</li> <li>• Establishment of Fodder Banks for storing and distribution of dry fodder.</li> <li>• The existing Gaushalas in the region should be made use of for storing and distribution of dry fodder/ feed blocks.</li> <li>• Fodder grasses and legumes of <i>Cenchrus ciliaris</i>, <i>Chloris gayana</i>, <i>Dichanthium</i>, <i>Stylosanthes</i>, <i>Clitori</i> needs to be propagated especially in the common grazing lands</li> </ul> |
| <b>Co-benefits</b>                                       | Fodder availability throughout the year for livestock. Better health of livestock because of optimum nutrient intake. Increased productivity of livestock.   |
| <b>Potential convergence</b>                             | <ul style="list-style-type: none"> <li>• Sub-Mission on Fodder and Feed Development, National Livestock Mission (Government of India)</li> <li>• Accelerated Fodder Development Programme, Department of Agriculture (Government of India)</li> </ul>  |

### Vaccination of livestock

|                                    |   |
|------------------------------------|---|
| <b>Name of the intervention:</b>   | Vaccination camps for disease-free livestock in forest villages   |
| <b>Code:</b>                       | ALM-VACC-LIV  |
| <b>Description of the problem</b>  | The livestock in the district is prone to diseases like rinderpest and Contagious Bovine Pleuropneumonia (CBPP), especially around the monsoon season. This leads to decline in productivity of livestock and livestock deaths. |
| <b>Description of the solution</b> | Vaccination camps can be arranged in the forest villages with support from the Veterinary Department along with Awareness camp on Dairy Development.  |

|  |  |
|--|--|
|  |  |
| <b>Detailed description of the technology</b>            | From the Veterinary and Animal Husbandry Department, their ongoing Vaccination Scheme for cattle for prevention of BQ, HS and FMD is given twice in villages throughout the state during the two seasons- pre monsoon and post monsoon.  |
| <b>Partner institutions</b>                              | <ol style="list-style-type: none"> <li>1. Veterinary and Animal Husbandry Department</li> <li>2. JFMCs/EDCs/SHGs and Gram Panchayats</li> </ol>  |
| <b>Identified barriers</b>                               | <ol style="list-style-type: none"> <li>1. Lack of awareness and knowledge animal treatments</li> <li>2. Lack of resources and capacity of local communities towards livestock vaccination</li> <li>3. Lack of coordination among institutions for the deployment livestock vaccination programmes</li> </ol> |
| <b>How will these be overcome through REDD+ project?</b> | <ol style="list-style-type: none"> <li>1. Undertaking communication campaigns on benefits from livestock vaccination</li> <li>2. Training and capacity building</li> </ol>   |
| <b>Implementation plan</b>                               | <ol style="list-style-type: none"> <li>1. Convergence of public funds and schemes for promoting and implementing livestock vaccination</li> <li>2. Development of an Action Plan for administration and monitoring of the intervention with Gram Panchayats, JFMCs, and DoEF.</li> </ol>                     |
| <b>Co-benefits</b>                                       | Improved livestock health. Increased productivity of livestock.  |
| <b>Potential convergence</b>                             | <ul style="list-style-type: none"> <li>• Sub-Mission on Fodder and Feed Development, National Livestock Mission (Government of India)</li> <li>• Accelerated Fodder Development Programme, Department of Agriculture (Government of India)</li> </ul>  |

## 6 Annexure I: Questionnaires

| REDD+:<br>Household Socio-Economic Questionnaire |   |                |                      |       |
|--|---|----------------|----------------------|-------|
| Date:  |   | Time:          | Interviewer name:    |       |
| Village  |   | Block          |                      |       |
| District   |   | Range          |                      |       |
| Name of Respondent                               |   |                |                      |       |
| Contact Number                                   |   | Male / Female: |                      |       |
| Educational Status                               | None <input type="checkbox"/> Primary <input type="checkbox"/> High School <input type="checkbox"/> Graduate and above <input type="checkbox"/>   |                | Age:                 |       |
| Census classification                            | ST <input type="checkbox"/> SC <input type="checkbox"/> OBC <input type="checkbox"/> Gen <input type="checkbox"/> Others <input type="checkbox"/> |                |                      |       |
| Household Size                                   | Male  | Female         | Children (<14 years) | Total |
|  |   |                |                      |       |

**Roof Type of the house:**

Thatched  Tiled  Concrete  Metal/plastic sheet  Bamboo roof  others: \_\_\_\_\_

| Livestock population | Native | Cross bred |
|----------------------|--------|------------|
| Cow                  |        |            |
| Buffalo              |        |            |
| Ox, Bulls            |        |            |
| Sheep and goat       |        |            |
| Horses               |        |            |
| Pigs                 |        |            |
| Other                |        |            |

**Type of Cooking Device**

Three Stone  Kerosene Stove   
 LPG Stove  Electric Stove   
 Mud/Clay/Cement  Improved Cook Stove   
 Biogas

**Fuel Used for Cooking**

Wood  Crop residue  Kerosene  LPG  Electricity  Coal  Charcoal   
 Dung Cake  Biogas  Others:  Specify: \_\_\_\_\_

**Consumption of Fuelwood**

|   |   |
|---|---|
| Cooking <input type="checkbox"/> No <input type="checkbox"/>  | Fuelwood used for heating water: Yes <input type="checkbox"/> No <input type="checkbox"/> |
| Cattle Food preparation : Yes <input type="checkbox"/> No <input type="checkbox"/>                            |   |
| For warming the space (room etc.): Yes <input type="checkbox"/> No <input type="checkbox"/> If yes, Quantity: |   |
| Season: Summer <input type="checkbox"/> Winter <input type="checkbox"/> Rainy Season <input type="checkbox"/> |   |
| For NTFP / MAPs processing: Yes <input type="checkbox"/> No <input type="checkbox"/>                          |   |
| For agricultural processing: Yes <input type="checkbox"/> No <input type="checkbox"/>                         |   |

( 1 )



## REDD+:

## Household Socio-Economic Questionnaire

Do you sell fuelwood Yes  No  If yes, fill below details

Quantity/month:

Amount/unit:

| Source of Fuelwood  | Forest | Agriculture Land, | Waste Land | Plantations |      | Other Lands | Buying From Market |
|---------------------|--------|-------------------|------------|-------------|------|-------------|--------------------|
|                     |        |                   |            | Pvt         | Govt |             |                    |
| % of the collection |        |                   |            |             |      |             |                    |
| Distance travelled  |        |                   |            |             |      |             |                    |

If you are buying fuelwood from market

Buy it from Local Vendor Proper market place 

Quantity bought per Month:

Amount spent per month:

|  |                       |   |                                    |                                       |  |
|--|-----------------------|---|------------------------------------|---------------------------------------|--|
| No. of people involved: Male:-   |                       | Female:-  |                                    | Children:-                            |  |
| Mode of Transportation   |                       | Head Load <input type="checkbox"/>  | Cart Load <input type="checkbox"/> | Tractor Load <input type="checkbox"/> |  |
| Other Mode   |                       |   |                                    |                                       |  |
| Frequency  | Time Spent/ frequency | Quantity collected in each Frequency:   |                                    |                                       |  |
| Daily  |                       |   |                                    |                                       |  |
| Weekly (times)   |                       |   |                                    |                                       |  |
| Monthly (times)  |                       |   |                                    |                                       |  |
| Quarterly (times)  |                       |   |                                    |                                       |  |
| Half yearly (times)  |                       |   |                                    |                                       |  |
| Yearly (times)   |                       |   |                                    |                                       |  |
| 1 Headload of firewood lasts for:  |                       | days (approx. headload weight: )  |                                    |                                       |  |
| Type of wood species collected   |                       | 1   |                                    |                                       |  |
|  |                       | 2   |                                    |                                       |  |
|  |                       | 3   |                                    |                                       |  |
| Reason   |                       |   |                                    |                                       |  |
| How do they collect the firewood?  |                       | Dead twigs <input type="checkbox"/> freshly cut twigs <input type="checkbox"/> dead logs <input type="checkbox"/> freshly cut wood <input type="checkbox"/> don't know <input type="checkbox"/> |                                    |                                       |  |
| Type and quality of fire wood  |                       | wet <input type="checkbox"/> dry <input type="checkbox"/> young saplings <input type="checkbox"/> mixed <input type="checkbox"/> others mention:  |                                    |                                       |  |
| Trading, Manufacturing and Processing works in which fuel wood is being utilized (Ex. Pottery, rope making, black smith, food processing, carpentry, bricks, charcoal, etc.) |                       |   |                                    |                                       |  |
| Type of Business / Activity  |                       | Quantity  | Details ( Ex income)               |                                       |  |
|  |                       |   |                                    |                                       |  |
|  |                       |   |                                    |                                       |  |
|  |                       |   |                                    |                                       |  |
| What should be done to lower the amount of Fuelwood collected from forests?  |                       |   |                                    |                                       |  |

**REDD+:  
Household Socio-Economic Questionnaire**

| Activity  | Mulching | Green Manure | Cattle bed |
|---|----------|--------------|------------|
| From which all places is it collected:                          |          |              |            |
| How much is collected?  |          |              |            |
| Distance travelled:   |          |              |            |
| Mode of transportation:   |          |              |            |
| Do you buy leaves (details, when how much):                     |          |              |            |
| What should be done to lower the amount collected from forests? |          |              |            |

**NTFP/ MAP Collection**

| NTFP/MAP Name | From Where | Distance travelled (Km) | Used for Personal (P) Commercial (C) |
|---------------|------------|-------------------------|--------------------------------------|
|               |            |                         |                                      |
|               |            |                         |                                      |
|               |            |                         |                                      |

**NTFP / MAP Collection Pattern**

| NTFP/Map Name | Harvesting /Collection period (Month) | No. of days harvesting | Time of collection (Hrs/days) | Total quantity collected / season | Method of collection |
|---------------|---------------------------------------|------------------------|-------------------------------|-----------------------------------|----------------------|
|               |                                       |                        |                               |                                   |                      |
|               |                                       |                        |                               |                                   |                      |
|               |                                       |                        |                               |                                   |                      |

**NTFP: Value addition pattern and practices**

| NTFP/MAP Name | No Change in form | Change in form (Cleaning, Drying, Sorting, Grading) | Quantity Sold (Kgs) | Price per KG sold | To Whom and where |
|---------------|-------------------|---|---------------------|-------------------|-------------------|
|               |                   |   |                     |                   |                   |
|               |                   |   |                     |                   |                   |
|               |                   |   |                     |                   |                   |

For NTFP / MAPs processing: Yes  No  If yes fill below rows.

|               |  |  |  |  |
|---------------|--|--|--|--|
| NTFP Name     |  |  |  |  |
| Quantity Used |  |  |  |  |

REDD+:  
Household Socio-Economic Questionnaire  
**Fodder**

|   |  |                                     |
|---|--|-------------------------------------|
| Stall Feeding <input type="checkbox"/>                                    | Grazing <input type="checkbox"/>   | Buy Fodder <input type="checkbox"/> |
| <b>If stall fed,</b>  |  |                                     |
| From which all places fodder is collected?                                | Forest <input type="checkbox"/> Agriculture land <input type="checkbox"/> other Specify: |                                     |
| Quantity collected in a week:   |  |                                     |
| Mode of transportation:   |  |                                     |
| Distance travelled:   |  |                                     |
| Preferred species (tree/shrub/grass etc.):                                |  |                                     |
| <b>If taken for grazing</b>   |  |                                     |
| To where:   | Forest   | Cropland                            |
|   | Other Specify:   |                                     |
| Distance travelled:   |  |                                     |
| <b>If bought</b>  |  |                                     |
| How much and what type of fodder?   |  |                                     |
| Price /Unit   |  |                                     |
| What should be done to lower the amount of fodder collected from forests? |  |                                     |

**Timber Details**

|  | Timber | Small Timber |
|--|--------|--------------|
| Do you buy timber (details, when and how much):  |        |              |
| Where is it collected (Forest, Private forests, Plantation , ToF, Agriculture land, purchased other Specify) |        |              |
| Purpose or main use of timber  |        |              |
| How much quantity is collected?  |        |              |
| Distance travelled for collection:   |        |              |
| Plant or tree species collected  |        |              |
| Mode of transportation:  |        |              |
| What should be done to lower the amount collected from forests?  |        |              |

**Man Animal Conflicts**

|                                |   |                         |
|--------------------------------|---|-------------------------|
| Any man-animal conflict:       | In your land: Yes : <input type="checkbox"/> No: <input type="checkbox"/>               |                         |
|                                | Among family members (Y/N): Yes : <input type="checkbox"/> No: <input type="checkbox"/> |                         |
|                                | Frequency of conflict/year:   |                         |
| If yes, which animal?          |   |                         |
| Type of conflict?              | Crop destruction  | Destruction of property |
|                                | Injury  | Death                   |
|                                | Others (Please specify):  |                         |
| Economic loss due to conflict? |   |                         |

**REDD+:**

**Household Socio-Economic Questionnaire**

|  |  |
|--|--|
| Compensation offered by FD?  |  |
| In your opinion, if these forests are conserved, is there a possibility of lesser conflict? Why? |  |

|                   |                   |
|-------------------|-------------------|
| <b>Livelihood</b> |                   |
| <b>Main</b>       | <b>Subsidiary</b> |
|                   |                   |

|   |                      |                 |                  |       |
|---|----------------------|-----------------|------------------|-------|
| Land holder:    Yes : <input type="checkbox"/> No: <input type="checkbox"/> |                      |                 |                  |       |
| If Yes..... Land Holding (Biga)   |                      |                 |                  |       |
| Irrigated (Biga)  | Source of irrigation | Rain fed (Biga) | Any other (Biga) | Total |
|   |                      |                 |                  |       |

**Agriculture**

**Crop Production and its usage**

| Crop Name | Production (quintal) | Own use (quintal) | Sale (quintal) | Sold where | Name and Place of trader | Price of sale (Rs/ quintal) |
|-----------|----------------------|-------------------|----------------|------------|--------------------------|-----------------------------|
|           |                      |                   |                |            |                          |                             |
|           |                      |                   |                |            |                          |                             |
|           |                      |                   |                |            |                          |                             |
|           |                      |                   |                |            |                          |                             |

**Value Addition (Agriculture-Products)**

| Name of Products | No Change in Form | Change in Form |        |         |         |
|------------------|-------------------|----------------|--------|---------|---------|
|                  |                   | Cleaning       | Drying | Sorting | Grading |
|                  |                   |                |        |         |         |
|                  |                   |                |        |         |         |
|                  |                   |                |        |         |         |
|                  |                   |                |        |         |         |

|   |  |  |  |  |
|---|--|--|--|--|
| For agricultural processing: Yes <input type="checkbox"/> No <input type="checkbox"/> If yes, fill below rows |  |  |  |  |
| Crop Name   |  |  |  |  |
| Quantity Used   |  |  |  |  |

REDD+:  
Household Socio-Economic Questionnaire  
Income from Other Sources

| Occupation | Income ( Rs/month) |
|------------|--------------------|
|            |                    |
|            |                    |
|            |                    |
| Others     |                    |

**Forest Degradation and Deforestation**

|  |   |
|--|---|
| Has forest degradation, deforestation and change of land use increased in the last 20 years/timeline in general? Yes <input type="checkbox"/> No <input type="checkbox"/> No Change <input type="checkbox"/> Don't Know <input type="checkbox"/> |   |
| If Yes, what are the reasons (drivers)?  |   |
| 1. Conversion to cropland <input type="checkbox"/>   | 2. Conversion to settlements <input type="checkbox"/>       |
| 3. Conversion to plantations <input type="checkbox"/>  | 4. Timber extraction <input type="checkbox"/>               |
| 5. Fuelwood/charcoal/NTFP extraction <input type="checkbox"/>  | 6. Cattle grazing in forests <input type="checkbox"/>       |
| 7. Forest fires <input type="checkbox"/>   | 8. Mining <input type="checkbox"/>                          |
| 9. Others (Please specify) <input type="checkbox"/>  |   |
| Have you made any efforts to regenerate the forests by planting trees/other steps?   | Yes : <input type="checkbox"/> No: <input type="checkbox"/> |
| If yes please give details?  |   |

**Other Information:**

| <b>Migration</b>                                   |  |
|--|--|
| No. of persons from your family migrated in a year |  |
| No. of days migrated in a year                     |  |
| Total annual Income during migration               |  |
| Major migration destinations                       |  |

|   |  |
|---|--|
| <b>Vehicles owned:</b>  |  |
| <b>How do you think we can have a better forests and forest management?</b> |  |
| <b>Any Livelihood option suggestions from the Family</b>                    |  |
|   |  |

FGD Questionnaire

**Village Level FGD Questionnaire**

|          |  |           |                   |  |
|----------|--|-----------|-------------------|--|
| Date:    |  | Time:     | Interviewer name: |  |
| Latitude |  | Longitude |                   |  |

**1. Location**

|              |  |             |  |
|--------------|--|-------------|--|
| Village      |  | District    |  |
| GP Name      |  | Block Name  |  |
| Forest Range |  | Forest Beat |  |

**2. Social Profile of Village**

|                    |                               |                               |                                  |          |
|--------------------|-------------------------------|-------------------------------|----------------------------------|----------|
| Number of Families | Total:                        | General:                      | SC:                              | ST:      |
|                    | Large Farmers (above 18 Biga) | Medium Farmers (7 to 18 Biga) | Small Farmers (less than 7 Biga) | Landless |
|                    |                               |                               |                                  |          |

**Livelihood Status**

| Occupation                               | Number of Families |
|--|--------------------|
|  |                    |
|  |                    |
|  |                    |
|  |                    |
|  |                    |
|  |                    |
|  |                    |
|  |                    |
|  |                    |
|  |                    |
| Number of Families seasonally migrating? |                    |
| For what purpose                         |                    |
| To where?                                |                    |

**3. Village Amenities**

a) **Health Facilities:** Government Hospital:  Private Clinic:  Primary Health Care Centre  School

b) **Drinking Water (State number of families accessing these sources)**

|              |  |              |  |
|--------------|--|--------------|--|
| Public taps  |  | Spring water |  |
| Water Tank   |  | Ponds        |  |
| Private Taps |  | Tube Well    |  |
| Others       |  |              |  |

## Village Level FGD Questionnaire

**c) Sanitation Facilities (No. of Families having these facilities)**

|                 |  |               |  |      |  |
|-----------------|--|---------------|--|------|--|
| Private toilets |  | Public Toilet |  | None |  |
|-----------------|--|---------------|--|------|--|

**d) Access to Electricity (No. of Families)**

|                    |  |                         |  |                                  |  |
|--------------------|--|-------------------------|--|----------------------------------|--|
| Electrified Houses |  | Non- Electrified Houses |  | Number of hrs electricity supply |  |
|--------------------|--|-------------------------|--|----------------------------------|--|

**4. Land Use Pattern**

| Total Area Land (specify acres/hectares)    |                    |             |
|---|--------------------|-------------|
|   |                    | Area (Biga) |
| Total Cultivated Land                       | Regular:           | Encroached: |
| Irrigated Land                              |                    |             |
| Rain fed Land                               |                    |             |
| Grazing land                                |                    |             |
| Forest Land                                 |                    |             |
| JFMC/EDC Land                               |                    |             |
| Others (C&D and any other)                  |                    |             |
| Crop  |                    |             |
| Crop Sown                                   | Area (Ac/Hec/Biga) |             |
|   |                    |             |
|   |                    |             |
|   |                    |             |
|   |                    |             |
|   |                    |             |
| Plantations (Ex. Mango, etc.) (Ac/Hec/Biga) |                    |             |
|   |                    |             |
|   |                    |             |
|   |                    |             |

**5. Housing details**

| House          |                  |
|----------------|------------------|
| Type of Houses | Number of Houses |
| Bamboo Roof    |                  |
| GCI Roof       |                  |
| Plastic Roof   |                  |
| Concrete       |                  |
| Stone roof     |                  |
| Thatched Roof  |                  |

## Village Level FGD Questionnaire

### 6. Forest Dependency

| Products                    | No of Families | Remarks | Species |
|-----------------------------|----------------|---------|---------|
| Firewood                    |                |         |         |
| Fodder                      |                |         |         |
| Agriculture Implements      |                |         |         |
| Fencing Poles               |                |         |         |
| Cattle Bed and Green Leaves |                |         |         |
| Mulching                    |                |         |         |
| Timber for Construction     |                |         |         |
| Bamboo                      |                |         |         |
|                             |                |         |         |
|                             |                |         |         |

### 7. NTFP extraction Status

#### a) Dependency

| NTFPs/MAP | Subsistence | Commercial | Income earned (Rs/unit quantity) | Distance travelled for procuring | Mode of Transport |
|-----------|-------------|------------|----------------------------------|----------------------------------|-------------------|
|           |             |            |                                  |                                  |                   |
|           |             |            |                                  |                                  |                   |
|           |             |            |                                  |                                  |                   |
|           |             |            |                                  |                                  |                   |
|           |             |            |                                  |                                  |                   |
|           |             |            |                                  |                                  |                   |
|           |             |            |                                  |                                  |                   |

#### b) Value addition pattern and practices

| S. N. | Name of NTFPs/MAPs | No Change in Form | Change in Form |        |         |         |
|-------|--------------------|-------------------|----------------|--------|---------|---------|
|       |                    |                   | Cleaning       | Drying | Sorting | Grading |
| 1     |                    |                   |                |        |         |         |
| 2     |                    |                   |                |        |         |         |
| 3     |                    |                   |                |        |         |         |
| 4     |                    |                   |                |        |         |         |
| 5     |                    |                   |                |        |         |         |

#### c) Commercial Users of NTFP (Ex. Hotels/tea stall, brick kilns, Jaggery, Ex. Pottery, rope making, black smith, food processing, carpentry, bricks, charcoal, etc.)

| NTFP and Type of Commercial user | Number of Families involved in the business |
|----------------------------------|---|
|                                  |   |



## Village Level FGD Questionnaire

|  |  |
|--|--|
|  |  |
|  |  |

### d) Any Other

|   |  |
|---|--|
| Is any group formed among collectors/traders of NTFP in your village?   | Yes <input type="checkbox"/> No <input type="checkbox"/> |
| If Yes kindly give details.   |  |
| What are the problems you face during collecting and selling of fuel wood or MAPs/ NTFPs?                                 |  |
| Any NTFP related activities undertaken in the village, i.e. processing, quality control, marketing etc.                   |  |
| Is there any wage rate for collection of NTFP?  | Yes <input type="checkbox"/> No <input type="checkbox"/> |
| If yes, what is the wage rate?  |  |
| What are the transport facilities available in the village for transporting the produce to local market/ nearest Markets? |  |

### 8. Fuelwood extraction pattern

Type of Road Accessibility: \_\_\_\_\_  
 Distance from Forest: \_\_\_\_\_

#### a) Cooking Devices and fuel wood consumption

|                   |                     |        |       |
|-------------------|---------------------|--------|-------|
| Traditional stove | LPG                 | Biogas | Other |
| Electricity Stove | Improved cook stove | Solar  |       |

#### b) For what purpose fuel wood is used

| Events               | Number of Events | Quantity/ event |
|----------------------|------------------|-----------------|
| Religious Activities |                  |                 |
| Marriages            |                  |                 |
| Deaths               |                  |                 |
|                      |                  |                 |

|   |         |                        |                 |
|---|---------|------------------------|-----------------|
| How many sell the firewood if so then where and what quantity                       |         |                        |                 |
| Do they purchase firewood from government distributor (Depot of forest department)? |         |                        |                 |
| What are the alternatives preferred for   |         |                        |                 |
| Cooking   | Heating | Agriculture Processing | NTFP processing |
|   |         |                        |                 |

## Village Level FGD Questionnaire

|  |  |
|--|--|
| What should be done to lower the amount of fuel wood collected from forests? |  |
|--|--|

### 9. Timber extraction Status

|   |     |                          |    |                          |                       |
|---|-----|--------------------------|----|--------------------------|-----------------------|
| Do you buy timber?  | Yes | <input type="checkbox"/> | No | <input type="checkbox"/> | If Yes fill below row |
| From Where?   |     |                          |    |                          |                       |
| If you don't buy, from which places it is collected:            |     |                          |    |                          |                       |
| Distance travelled for collection:                              |     |                          |    |                          |                       |
| Mode of transportation:   |     |                          |    |                          |                       |
| Mainly used for:  |     |                          |    |                          |                       |
| What should be done to lower the amount collected from forests? |     |                          |    |                          |                       |
|   |     |                          |    |                          |                       |

### 10. Livestock Details

#### a) Livestock population by type

| Livestock population  | Native | Cross bred |
|---|--------|------------|
| Cow   |        |            |
| Buffalo   |        |            |
| Ox, Bulls   |        |            |
| Sheep and goat  |        |            |
| Horses  |        |            |
| Pig   |        |            |
| Others  |        |            |
| What should be done to lower the amount of fodder collected from forests? |        |            |
|   |        |            |

#### b) Green manure and Cattle Bed

|   |  |
|---|--|
| From which all places is it collected:                          |  |
| How many families are collecting?                               |  |
| Distance travelled:   |  |
| Mode of transportation:   |  |
| How much is being bought? (details, when how much):             |  |
|   |  |
| What should be done to lower the amount collected from forests? |  |
|   |  |

### 11. Mulching

|   |  |
|---|--|
| From which all places is it collected:                          |  |
| How many families are collecting?                               |  |
| Distance travelled:   |  |
| Mode of transportation:   |  |
| Do you buy leaves for mulching (details, when how much):        |  |
|   |  |
| What should be done to lower the amount collected from forests? |  |
|   |  |

## Village Level FGD Questionnaire

### 12. Status of Forest /Identification of drivers of deforestation and degradation

|  |   |
|--|---|
| Has forest degradation, deforestation and change of land use increased in the last 20 years/timeline in general? Yes <input type="checkbox"/> No <input type="checkbox"/> No Change <input type="checkbox"/> Don't Know <input type="checkbox"/> |   |
| If Yes, what are the reasons (drivers)?  |   |
| 1. Conversion to cropland <input type="checkbox"/>   | 2. Conversion to settlements <input type="checkbox"/>       |
| 3. Conversion to plantations <input type="checkbox"/>  | 4. Timber extraction <input type="checkbox"/>               |
| 5. Fuelwood/charcoal/NTFP extraction <input type="checkbox"/>  | 6. Cattle grazing in forests <input type="checkbox"/>       |
| 7. Forest fires <input type="checkbox"/>   | 8. Mining <input type="checkbox"/>                          |
| 9. Others (Please specify) <input type="checkbox"/>  |   |
| Have you made any efforts to regenerate the forests by planting trees/other steps?   | Yes : <input type="checkbox"/> No: <input type="checkbox"/> |
| If yes please give details?  |   |

|   |  |
|---|--|
| Any government efforts/initiatives to address drivers of degradation :                              | Yes <input type="checkbox"/> No <input type="checkbox"/> |
| Govt. Schemes running in the village for improving forest degradation                               |  |
| Govt. Schemes completed in near past for improvement of forest degradation                          |  |
| Is any schemes (Govt. or private) running in the village for alternative source of energy/fuel wood |  |
| Any community or village level initiative taken to control deforestation                            |  |

### 13. A. Wild Animals causing most Damage:

1)                      2)                      3)                      4)                      5)

### B. Major Crops Damaged:

1)                      2)                      3)                      4)                      5)

### C) Major Livestock Loss:

1)                      2)                      3)                      4)                      5)

D) Any existing conflict resolution mechanism followed:

### 14. Do you think biodiversity conservation is important?

Yes  No

### 15. Preferred mode for forestry actions should be (tick more than 1 if applicable)

- a. Through the JFMCs.
- b. Other Community based organisations (apart from JFMC). Give eg:
- c. Through other organisations/NGOs/Educational institutions

## Village Level FGD Questionnaire

- d. Directly by the Government after consultation with community
- e. Directly by the Government, no need for any consultations.
- f. No opinion

16. How important is involvement of women in biodiversity conservation?

- a. Very important
- b. Less important
- c. No opinion

17. Do you think that the existing policies, laws and regulations (PLRs) are sufficient for protection of forests and biodiversity?

Yes  No

18. Extent of participation of community (in particular indigenous peoples and women) in implementation of project activities

- a. Good
- b. Need to improve
- c. No idea

19. Do you have community based monitoring for protection of forest?

Yes  No

20. Is there any established grievance mechanism to address concerns and conflicts in forest areas?

Yes  No

If yes what is the process:

21. Any Other information (Ex: Unique skills within the community etc.)

## 7 Annexure II: Attendance sheets

## 8 Annexure III: Photographs from the survey











---

Environmental Finance • Climate Policy • Clean Technology • Ecosystem Conservation

IORA Ecological Solutions Pvt. Ltd.

225 B, Indraprastha Gyanmandir Complex,

Lado Sarai Village, New Delhi – 110030

**Tel:** +91-11-41077549

**Fax:** +91-11-41023126

**Email:** [info@ioraecological.com](mailto:info@ioraecological.com)