

2022

de
en
fr



keeper



keeper

keeps your world



keeper

enjoy living
essential
efficient
ecological

Wir wollen die Lebenswelt eines jeden Menschen verbessern, der Freude am Aufbewahren & Bewahren, Ordnen & Organisieren hat.

Dafür entwickeln, designen und produzieren wir Spritzguss-Kunststoff-Produkte für den alltäglichen Gebrauch im Haushalt. Jedes Produkt steht dabei für mindestens eines unserer Markenversprechen.

ecological, efficient, essential – enjoy living.

keeper ist vielfältiger als man denkt! Ein **keeper** Produkt ist **ökologisch** und **wirtschaftlich** (erschwinglich). Vor allem aber: absolut **notwendig** – für mehr Freude im Leben. Bis 2025 wollen wir einen Großteil unserer Produkte aus umweltfreundlichen Rohstoffen herstellen, damit jeder Mensch seinen Alltag mit **keeper** noch nachhaltiger und mit noch mehr Freude gestalten kann.

We are working to improve the life of everyone who enjoys keeping and preserving, organising and structuring things.

For that purpose, we develop and design injection-moulded products for daily use at home. Every product stands for at least one of our brand promises.

ecological, efficient, essential – enjoy living.

keeper is much more diverse than you think! A **keeper** product is **ecological** and **economical** (affordable). But first and foremost: absolutely **essential** - for more fun in life. Until 2025, we strive to manufacture the major part of our products from environmentally friendly resources so everyone can live even more sustainably and joyfully with **keeper**.

Nous voulons améliorer le cadre de vie de chaque personne qui prend plaisir à conserver, à garder, à ranger et à organiser.

C'est pour cela que nous développons, concevons et produisons des produits en plastique moulés par injection et destinés à l'usage domestique quotidien. Chaque produit incarne au moins une de nos promesses de marque.

ecological, efficient, essential – enjoy living.

keeper est plus diversifié qu'on le pense ! Un produit **keeper** est **écologique** et **économique** (abordable). Mais surtout : absolument **indispensable** – pour plus de plaisir dans la vie. Nous souhaitons fabriquer une grande partie de nos produits à partir de matières premières respectueuses de l'environnement d'ici à 2025, afin que chacun puisse concevoir son quotidien selon une approche plus durable et avec encore plus de joie avec **keeper**.

niemand verpackt die dinge so gut wie die natur.



für alles andere gibt es keeper.

Das Lieblingsfutter von keeepy ist ein typischer Fall von „harte Schale, weicher Kern“. Und dabei hat die Natur sich was gedacht. Die Schale sorgt dafür, dass die Nuss lange frisch bleibt, nicht an Aroma verliert und sie schützt sie optimal, schließlich fällt sie ja nicht mit dem Fallschirm vom Baum auf den Boden. Kein Wunder also, dass **keeper** sich die Natur zum Vorbild nimmt, wenn es darum geht, ebenso sinnvolle Haushaltsprodukte zum Wahren und Bewahren, Frischhalten und frisch Zubereiten und vielem mehr zu entwickeln. Hier seht ihr einige von vielen Qualitätsmerkmalen, die ein **keeper** Produkt auszeichnen.

no packaging equals that of mother nature.

for anything else, there's keeepy.

keeepy's favourite food is a typical case of „hard shell, soft core“. And that has its natural purpose. The shell keeps the nut fresh and aromatic for a long time and offers high protection, for it does not fall down from the tree with a parachute. It is no surprise that **keeper** draws inspiration from nature to develop equally effective products for keeping, storing and preparing freshly and so much more. Here are some of our quality features that characterise a true **keeper** product.

personne n'emballé les choses aussi bien que la nature.

pour tout le reste, il y a keeepy.

L'aliment préféré de keeepy est un cas typique de « coque dure, cœur tendre ». Et la nature a bien pensé les choses. La coque veille à ce que la noix reste fraîche longtemps, qu'elle ne perde pas son arôme et elle la protège de manière optimale. En somme, elle ne tombe pas en parachute de l'arbre jusqu'au sol. Il n'est donc pas étonnant que **keeper** s'inspire de la nature quand il s'agit de développer des produits domestiques utiles pour conserver et garder, maintenir au frais, préparer tout frais et encore davantage. Vous voyez ici quelques-uns des nombreux critères de qualité caractéristiques d'un produit de **keeper**.



10 years
guarantee



german
design



made in eu

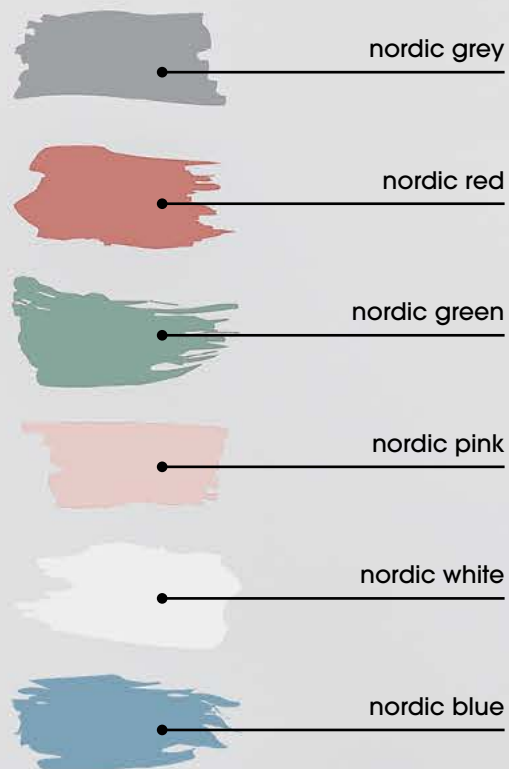

wenn schon, denn schon: hyggeliger neuanstrich

der trend weist nach norden

„Hyggelig“ ist ein stehender Begriff in der deutschen Sprache. Die Bedeutung: gemütlich, wohnlich, einfach rundum geborgen sein. Als Einrichtungsstil ist „Hygge“ im Grunde eine Hommage an das nordische Lebensgefühl und längst international ein festes Gestaltungskonzept, das auch **keeper** nun bewusst integriert.

der keeper farbkompas zur hyggeligkeit

Denn vor allem anderen ist Hygge nicht nur ein kurzweiliger Trend, sondern ein Lebensstil – und der passt perfekt zu **keeper**. So haben wir nicht nur der eigenen Marke, sondern der gesamten Produktwelt einen hyggeligen Neuanstrich verpasst. **keeper** hat mit den Nordic Colours eine optimal abgestimmte Farbpalette geschaffen, um es euch in euren Wohn- und Lebensräumen nachhaltig schön zu machen. Erlebt es selbst auf den nächsten Seiten.

if you're going to do it, do it: hyggel repaint

the trend points north

„Hyggelig“ is a standing term in the German language. The meaning: to be cozy, homelike, simply all-around secure. As an interior design style „Hygge“ is basically a homage to the Nordic attitude to life and has long since become an established design concept, which is now also consciously integrated by **keeper**.

the keeper color compass for hyggeligkeit

Because above all else Hygge is not only an entertaining trend, but a lifestyle - and that fits perfectly with **keeper**. So not only our own brand, but the entire product world has received a new hygge-style coat of paint. With the Nordic Colours **keeper** has created an excellent color range, to make your living and living spaces sustainably beautiful. Experience it for yourself on the next pages.

Tant qu'à faire, autant le faire : hyggeliger repaint

la tendance est au nord

„Hyggelig“ est un terme figé en allemand. Sa signification : confortable, tout simplement à l'abri, être à l'aise. En tant que style d'aménagement „Hygge“ est en fait un hommage au style à la joie de vivre nordique et depuis longtemps au niveau international un concept d'aménagement bien établi, que **keeper** a aussi adopté et intégré.

la boussole des couleurs de keeper pour hyggeligkeit

Car avant toute chose, le Hygge n'est pas seulement un style de tendance, mais un style de vie - et qui convient parfaitement à **keeper**. Ainsi, pas seulement notre marque, mais aussi l'ensemble de l'univers de produits a reçu un nouveau look hygge. Avec les couleurs nordiques, **keeper** a créé une gamme de couleurs parfaite pour vous permettre de vous sentir bien dans votre vie de manière durable. Découvrez-le par vous-même sur les pages suivantes.



inhalt 2022

content
sommaire



keeper
keeps your world

2 – 11



keeper home



52 – 69

keeper eco



12 – 23



keeper storage



70 – 111



keeper kitchen



24 – 51



keeper kids



112 – 159

keeper eco

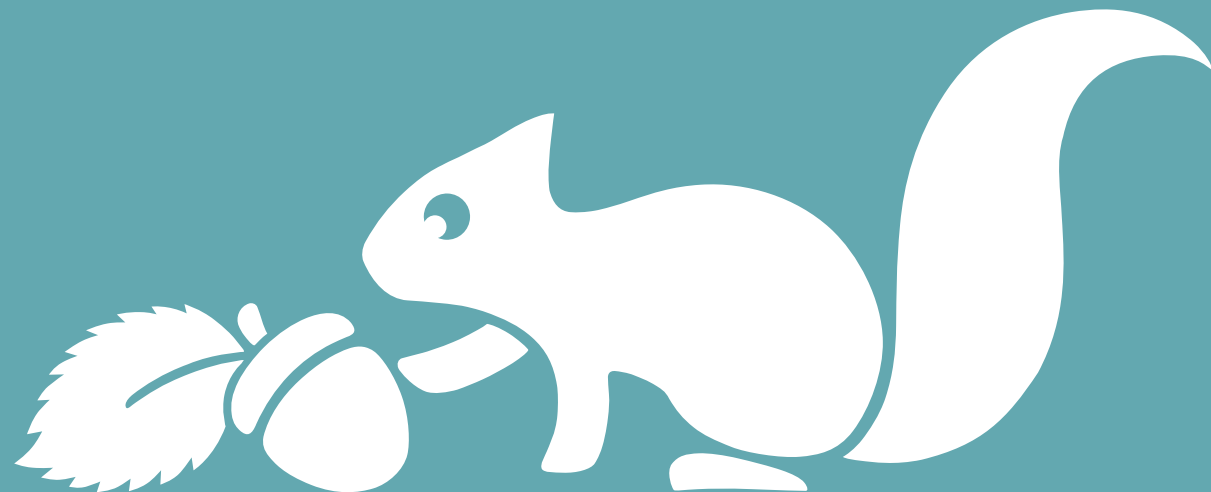

back to basics.

Unsere eco Produkte sind besonders ressourcenschonend, denn sie werden aus 100 Prozent Recyclingkunststoff hergestellt. Dieses sogenannte procyclen® wird aus recyceltem Verpackungsmaterial gewonnen und ist dabei trotzdem frei von Verunreinigungen durch andere Kunststoffe. So hat ein **keeper** Produkt nicht nur ein Vorleben, sondern auch noch ein Leben danach, denn die **keeper** eco line ist gleich im doppelten Sinne ressourcenschonend: Sie wird nicht nur nachhaltig produziert, sondern irgendwann auch nachhaltig entsorgt und recycelt. Und das frühestens nach zehn Jahren – darauf geben wir unser Wort.

back to basics.

Our eco products are especially resource-friendly since they are made from 100 percent recycling plastics. This so-called procyclen® is sourced from recycled packaging material and is free from contaminations with other synthetics. Thus, a **keeper** product not only has a past life, but also a life hereafter, because the **keeper** eco line is resource-friendly in two senses: Not only is it produced sustainably, but also discarded and recycled in the same way. After ten years at the earliest - you have our word on that.

back to basics.

Nos produits écologiques préservent particulièrement les ressources, car ils sont fabriqués à partir de plastique recyclé à 100 pour cent. Appelés procyclen®, ils sont obtenus à partir de matériel d'emballage recyclé, en étant malgré tout exempts des impuretés causées par d'autres plastiques. Ainsi, un produit **keeper** n'a pas seulement une vie antérieure, mais également une vie après, car l'eco line de **keeper** préserve les ressources à deux égards : Non seulement elle est produite de manière durable, mais elle est aussi éliminée et recyclée de manière durable. Et ce, au plus tôt après dix ans – vous avez notre parole.

keeper eco





nico

lebt von natur aus nachhaltig.

nico lives sustainably
by nature.

nico vit naturellement de
manière durable.

keeper

art.-bezeichnung cm/l
article description cm/l
désignation cm/l
↕ ↔ ↕

farbe
colour
couleur

ean13
barcode
ean13

mat. mam pal.
mat. moq pal.
mat. moq pal.

10678
svenja



bio-küchenabfall-
behälter mit
schwingdeckel 1,3 l

138 000 00



PP/ 6 432
regranulate

bio bin with swing lid

308 000 00



poubelle bio déchets
avec swing couvercle



www.blauer-engel.de/uz30a

10290
knot



bio-abfallbehälter 19 x 14,5 x 20,5
bin for bio wastes 4,5 l

138 000 00



PP/ 6 240
regranulate

poubelle pour bio
déchets

308 000 00



www.blauer-engel.de/uz30a

11705
mika



eimer mit ausguss ø 24 x 20
bucket with drain 5 l
seau avec bec verseur

138 000 00



PP/ 6 450
regranulate

308 000 00



679 000 00



www.blauer-engel.de/uz30a

11710
mika



eimer mit ausguss ø 30 x 28
bucket with drain 10 l
seau avec bec verseur

138 000 00



PP/ 6 480
regranulate

308 000 00



679 000 00



www.blauer-engel.de/uz30a

11804
elsa



bio-eimer mit deckel 37 x 29,5 x 27,5
oval 13 l

138 000 00



PP/ 6 192
regranulate

bio bucket with lid

308 000 00



bio seau avec
couvercle



www.blauer-engel.de/uz30a

10092
tilda



wanne ergonomisch 57,5 x 38 x 26,5
30,5 l

138 000 00



PP/ 5 280
regranulate

laundry tub
ergonomic

308 000 00



baquet à linge
ergonomique

679 000 00



www.blauer-engel.de/uz30a

keeper

10546
emil



art.-bezeichnung
article description
désignation

cm/l
cm/l
cm/l
↗ ↘ ↕

farbe
colour
couleur

ean13
barcode
ean13

mat. mam pal.
mat. moq pal.
mat. moq pal.

dreh-/stapelbox 38 x 28,5 x 20,5
turn around stacking box 15 l
boîte retournable/
empilable

138 000 00
308 000 00
679 000 00



PP/ 10 360
regranulate



www.blauer-engel.de/uz30a

art.-bezeichnung
article description
désignation

cm/l
cm/l
cm/l
↗ ↘ ↕

farbe
colour
couleur

ean13
barcode
ean13

mat. mam pal.
mat. moq pal.
mat. moq pal.

euro-box m 35 x 27 x 22
16 l

138 000 00
308 000 00
679 000 00



PP/ 6 96
regranulate



www.blauer-engel.de/uz30a

10188
emil



dreh-/stapelbox 41 x 34,5 x 22
turn around stacking box 24 l
boîte retournable/
empilable

138 000 00
308 000 00
679 000 00



PP/ 10 270
regranulate



www.blauer-engel.de/uz30a

15461
bruno



euro-box m

35 x 27 x 22
16 l

138 000 00
308 000 00
679 000 00



PP/ 6 96
regranulate



www.blauer-engel.de/uz30a

10516
emil



dreh-/stapelbox 44,5 x 34,5 x 27
turn around stacking box 30 l
boîte retournable/
empilable

138 000 00
308 000 00
679 000 00



PP/ 10 216
regranulate



www.blauer-engel.de/uz30a

15456
bruno



euro-box l

43 x 35 x 17,5
20,5 l

138 000 00
308 000 00
679 000 00



PP/ 6 66
regranulate



www.blauer-engel.de/uz30a

15453
bruno



euro-box xl

43 x 35 x 24
28 l

138 000 00
308 000 00
679 000 00



PP/ 6 72
regranulate



www.blauer-engel.de/uz30a

10536
emil



dreh-/stapelbox 54,5 x 39 x 29,5
turn around stacking box 45 l
boîte retournable/
empilable

138 000 00
308 000 00
679 000 00



PP/ 10 116
regranulate



www.blauer-engel.de/uz30a

15399
bruno



euro-box xxl

52 x 43 x 28
54 l

138 000 00
308 000 00
679 000 00



PP/ 6 36
regranulate



www.blauer-engel.de/uz30a



keeper

10306
swantje



art.-bezeichnung article description désignation	cm/l cm/l cm/l ↕ ↔ ↗	farbe colour couleur	ean13 barcode ean13	mat. mam pal. mat. moq pal. mat. moq pal.
abfallbehälter mit schwingdeckel 10 l	25 x 19 x 38,5	138 000 00		PP/ 6 324 regranulate
waste bin with swing lid		308 000 00		
poubelle avec couverture swing				



10603
magne



art.-bezeichnung article description désignation	cm/l cm/l cm/l ↕ ↔ ↗	farbe colour couleur	ean13 barcode ean13	mat. mam pal. mat. moq pal. mat. moq pal.
abfallbehälter mit flip-deckel 10 l	29,5 x 18 x 36,5	138 000 00		PP/ 6 192 regranulate
waste bin with flip lid		308 000 00		
poubelle avec couverture flip				



10307
swantje



art.-bezeichnung article description désignation	cm/l cm/l cm/l ↕ ↔ ↗	farbe colour couleur	ean13 barcode ean13	mat. mam pal. mat. moq pal. mat. moq pal.
abfallbehälter mit schwingdeckel 25 l	33,5 x 25,5 x 53,5	138 000 00		PP/ 5 110 regranulate
waste bin with swing lid		308 000 00		
poubelle avec couverture swing				



10604
magne



art.-bezeichnung article description désignation	cm/l cm/l cm/l ↕ ↔ ↗	farbe colour couleur	ean13 barcode ean13	mat. mam pal. mat. moq pal. mat. moq pal.
abfallbehälter mit flip-deckel 25 l	39,5 x 24 x 47,5	138 000 00		PP/ 5 100 regranulate
waste bin with flip lid		308 000 00		
poubelle avec couverture flip				



10453
rasmus



art.-bezeichnung article description désignation	cm/l cm/l cm/l ↕ ↔ ↗	farbe colour couleur	ean13 barcode ean13	mat. mam pal. mat. moq pal. mat. moq pal.
abfallbehälter mit roldeckel 10 l	25,5 x 19 x 39	138 000 00		PP/ 6 324 regranulate
waste bin with roll lid		308 000 00		
poubelle avec couverture roll				



10212
mats



art.-bezeichnung article description désignation	cm/l cm/l cm/l ↕ ↔ ↗	farbe colour couleur	ean13 barcode ean13	mat. mam pal. mat. moq pal. mat. moq pal.
mini-tonne	Ø 24 x 29	138 000 00		PP/ 5 300 regranulate
mini-bin	7 l	308 000 00		
mini-poubelle baril				



10454
rasmus



art.-bezeichnung article description désignation	cm/l cm/l cm/l ↕ ↔ ↗	farbe colour couleur	ean13 barcode ean13	mat. mam pal. mat. moq pal. mat. moq pal.
abfallbehälter mit roldeckel 25 l	34 x 26 x 54	138 000 00		PP/ 5 110 regranulate
waste bin with roll lid		308 000 00		
poubelle avec couverture roll				



10213
mats



art.-bezeichnung article description désignation	cm/l cm/l cm/l ↕ ↔ ↗	farbe colour couleur	ean13 barcode ean13	mat. mam pal. mat. moq pal. mat. moq pal.
maxi-tonne	Ø 36 x 42	138 000 00		PP/ 6 180 regranulate
maxi-bin	23 l	308 000 00		
maxi-poubelle baril				



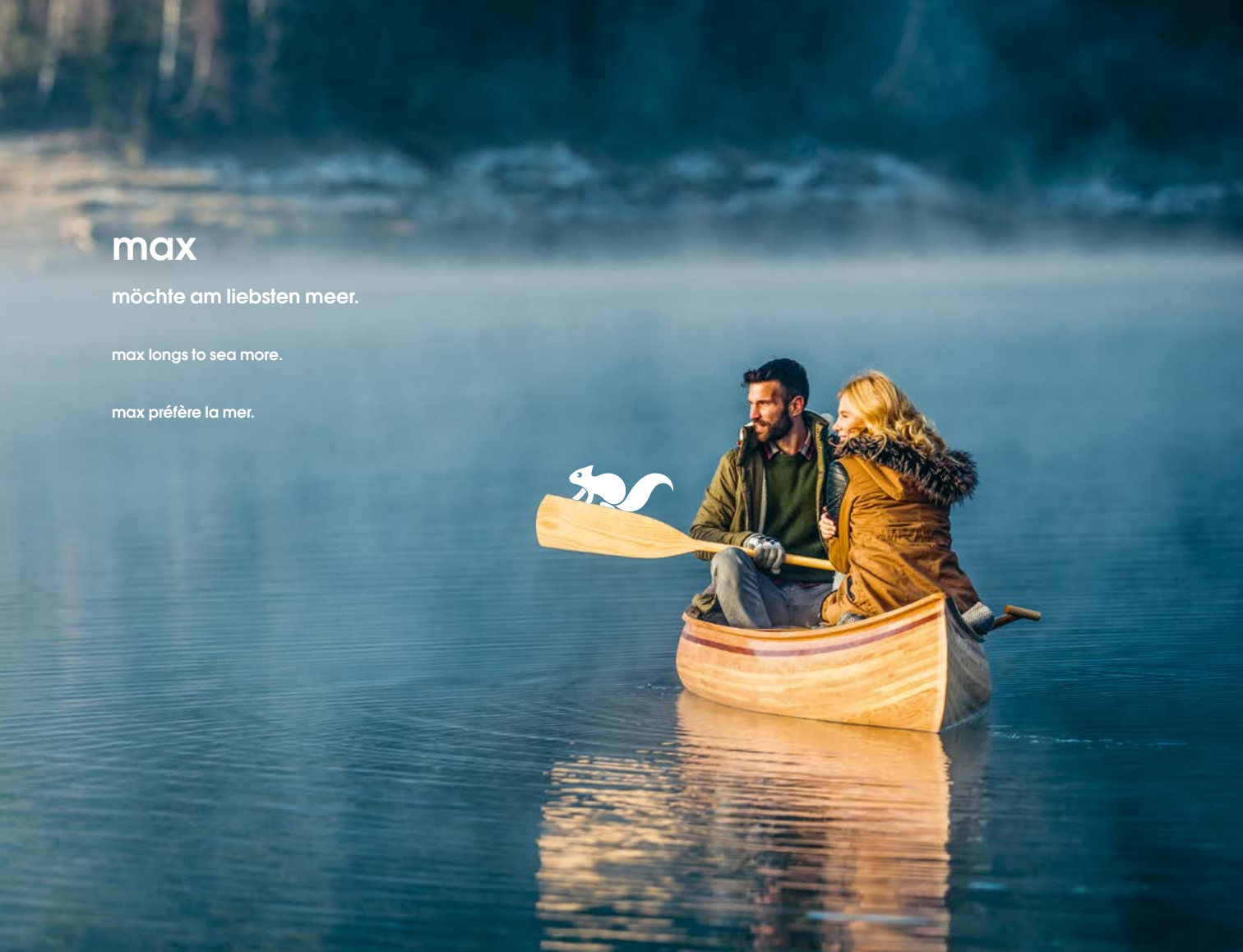

max

möchte am liebsten meer.

max longs to sea more.

max préfère la mer.

Bei mirko stapelt sich die Arbeit gerne mal. Und zwar ordentlich sortiert nach „Prio 1, Prio 2, Prio 3“. Oder wie viele mirkos auch immer aufeinander gestapelt werden sollen!

With mirko, sometimes work stacks up. Perfectly organized „Prio 1, Prio 2, Prio 3“, of course. Or how many mirkos need to be stacked on one another!

Bien entendu, parfaitement bien trié par « prio 1, prio 2, prio 3 ». Ou quelque soit le nombre de mirko devant être empilés !



keeper

art.-bezeichnung
article description
désignation

cm/l
cm/l
cm/l
↕ ↔ ↗

farbe
colour
couleur

ean13
barcode
ean13

mat. mam pal.
mat. moq pal.
mat. moq pal.

10374
mirko



stapelkörbchen A7 16 x 12 x 7
mini storage basket A7
corbeille A7

138 000 00
308 000 00
679 000 00



PP/ 10 5400
regranulate



www.blauer-engel.de/uz30a

10373
mirko



stapelkörbchen A6 20 x 16 x 7
mini storage basket A6
corbeille A6

138 000 00
308 000 00
679 000 00



PP/ 10 3600
regranulate



www.blauer-engel.de/uz30a

10372
mirko



stapelkörbchen A5 26.5 x 20 x 7
mini storage basket A5
corbeille A5

138 000 00
308 000 00
679 000 00



PP/ 10 1920
regranulate



www.blauer-engel.de/uz30a

10371
mirko



stapelkörbchen A4 36 x 26.5 x 7
mini storage basket A4
corbeille A4

138 000 00
308 000 00
679 000 00



PP/ 10 960
regranulate



www.blauer-engel.de/uz30a



keeper kitchen



omas gemüse Eintopf.

Die besten Rezepte sind die guten alten Familienrezepte. Die wir wahren und hüten wie unser Geheimnis. So auch Omas Gemüse Eintopf mit all den Köstlichkeiten aus dem Garten. Danach noch ein leckerer Nusskuchen frisch aus dem Ofen und ein selbstgepresster Orangensaft für die Kids.

Selber kochen, aufbewahren oder frischhalten. Alles ist besser als der Coffee-to-go aus dem beschichteten Pappbecher, die Fertiglasagne aus der Aluschale und die viel zu große Portion Spaghetti beim Italiener, die man nicht mal zur Hälfte schafft. Alles zum Kochen, Backen, Einfrieren, Frischhalten, Abwaschen und Transportieren findet ihr bei **keeper**.

grandma's veggie stew.

Old family recipes are the best. Which we store and protect like a secret. For example grandma's veggie stew with all the delicacies from the garden. Followed by a yummy nut cake straight out the oven and a self-pressed orange juice for the kids.

Cooking, storing or keeping it fresh. Anything is better than coffee to go from coated paper cups, ready-made lasagne straight out the aluminium bowl or the way too big portion of spaghetti from your favourite Italian restaurant you cannot even finish half way. Anything for cooking, baking, freezing, keeping food fresh, cleaning and transporting is available here at **keeper**.

la potée de légumes de grand-mère.

Les meilleures recettes sont les bonnes vieilles recettes de famille. Celles que nous gardons et protégeons comme un secret. C'était aussi le cas de la potée de légumes de grand-mère avec tous ses délices du jardin. Suivie encore d'un succulent gâteau à peine sorti du four et un jus d'orange pressé pour les enfants.

Cuisiner, conserver ou maintenir au frais par soi-même. Tout est meilleur que le café à emporter servi dans un gobelet en carton, les lasagnes toutes prêtes du récipient en alu et la portion de spaghettis bien trop grande du restaurant italien dont on laisse plus de la moitié. Vous trouvez ici, chez **keeper**, tout le nécessaire pour la cuisine, la pâtisserie, la congélation, le maintien au frais, le lavage et le transport.

keeper kitchen



keeper

10765
bruni



art.-bezeichnung cm/l
article description cm/l
désignation cm/l
↕ ↔ ↕

schüttdose 11 x 9 x 9,5
pouring jar 0,25l

boîte verseuse



farbe 624 000 00
colour 624 000 00
couleur 624 000 00

ean13 4 052396 051117



mat. mam pal.
mat. moq pal.
mat. moq pal.

PP/ 6 1152
SMMA/
TPE



10766
bruni



schüttdose 11 x 9 x 14,5
pouring jar 0,5l

boîte verseuse



624 000 00 4 052396 051124



PP/ 6 792
SMMA/
TPE



10767
bruni



schüttdose 11 x 9 x 25
pouring jar 1l

boîte verseuse



624 000 00 4 052396 051131



PP/ 6 432
SMMA/
TPE



10768
bruni



schüttdose 16,5 x 14,5 x 17
pouring jar 1,5l

boîte verseuse



624 000 00 4 052396 051148



PP/ 4 280
SMMA/
TPE



art.-bezeichnung cm/l
article description cm/l
désignation cm/l
↕ ↔ ↕

schüttdose 16,5 x 14,5 x 24,5
pouring jar 2,5l

boîte verseuse



farbe 624 000 00
colour 624 000 00
couleur 624 000 00

ean13 4 052396 051155



mat. mam pal.
mat. moq pal.
mat. moq pal.

PP/ 4 168
SMMA/
TPE



10769
bruni



knut

liebt es, morgens die knusprigen
körner in die schale zu kippen.

knut loves to dump the crunchy grains
into the bowl in the morning.

le matin, knut aime verser les
céréales croustillantes dans le bol.



keeper

art.-bezeichnung cm/l
 article description cm/l
 désignation cm/l
 ↳ ↳ ↳

farbe colour
 couleur

ean13 barcode
 ean13

mat. mam pal.
 mat. moq pal.
 mat. moq pal.

10734
emilio



runder torten- behälter flach 38 x 37,5 x 13,5 624 000 00
 4 052396 034561 PP/ 3 72
 TPE

round cake container flat

cloche à gâteau basse



10735
emilio



runder torten- behälter hoch 38 x 37,5 x 21 624 000 00
 4 052396 034578 PP/ 2 42
 TPE

round cake container high

cloche à gâteau haute



10737
gino



kastenkuchen- behälter 43 x 25 x 18 624 000 00
 4 052396 034608 PP/ 3 63
 TPE

loaf shaped cake container

boîte à gâteau



10762
tabea



puderzuckerstreuer 8,5 x 7,5 x 15,5 624 000 00
 4 052396 051032 PP/ 6 720
 POM/ TPE

icing sugar dispenser 180 ml

saupoudreuse de sucre glace



art.-bezeichnung cm/l
 article description cm/l
 désignation cm/l
 ↳ ↳ ↳

farbe colour
 couleur

ean13 barcode
 ean13

mat. mam pal.
 mat. moq pal.
 mat. moq pal.

10742
mariella



rührschüssel mit saugnapf 20 x 20 x 13 624 000 00
 4 052396 034523 PP/ 4 192
 1,5l TPE

mixing bowl with suction cup

bol à mixer antidérapant



10743
mariella



rührschüssel mit saugnapf 27 x 27 x 15 624 000 00
 4 052396 034530 PP/ 4 96
 3,5l TPE

mixing bowl with suction cup

bol à mixer antidérapant



30090
marla



4 in 1

set rührschüssel mit saugnapf + spritzschutzring + teigschaber 27 x 27 x 16 624 000 00
 4 052396 034547 PP/ 3 108
 1,5l & 3,5l TPE

set of mixing bowls with suction cup + splash guard + dough scraper

set de bols à mixer avec ventouse + couvercle anti-éclaboussures + spatule



10493
mario



messbecher ø 8,5 x 11,5 001 155 00
 4 052396 028669 PP 6 11232

measuring jug 0,25l

pichet doseur



keeper

10490
massimo



art.-bezeichnung
article description
désignation

cm/l
cm/l
cm/l
↕ ↔ ↗

messkanne
mit anti-rutsch-
funktion
0,5l
measuring jug
with anti-slip-function
pichet doseur
antidérapant

farbe
colour
couleur

130 155 00
680 155 00

ean13
barcode
ean13



mat. mam pal.
mat. moq pal.
mat. moq pal.

PP/
TPE 6 4704



10491
massimo



messkanne
mit anti-rutsch-
funktion
1l
measuring jug
with anti-slip-function
pichet doseur
antidérapant

130 155 00
680 155 00



PP/
TPE 6 2100



10492
massimo



messkanne
mit anti-rutsch-
funktion
1,5l
measuring jug
with anti-slip-function
pichet doseur
antidérapant

130 155 00
680 155 00



PP/
TPE 6 1776

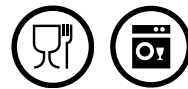

30045
matteo



4
in 1

set messkanne
mit anti-rutsch-
funktion und
spritzschutzring/
zitruspresse
1l

set measuring jug with
anti-slip-function and
splash guard/citrus squeezer

set pichet doseur antidérapant
avec couvercle anti-éclabou-
sures et presse-agrumes

130 155 00
680 155 00



PP/
TPE 3 444



10174
carlotta



art.-bezeichnung
article description
désignation

cm/l
cm/l
cm/l
↕ ↔ ↗

rührschüssel
mit anti-rutsch-
funktion
1,5l
mixing bowl
with anti-slip-function
bol à mixer
antidérapant

farbe
colour
couleur

130 000 00
680 000 00

ean13
barcode
ean13



mat. mam pal.
mat. moq pal.
mat. moq pal.

PP/
TPE 6 1728

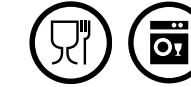

10175
carlotta



rührschüssel
mit anti-rutsch-
funktion
3,5l
mixing bowl
with anti-slip-function
bol à mixer
antidérapant

130 000 00
680 000 00



PP/
TPE 6 1440



30030
camilla



4
in 1

set rührschüssel
mit anti-rutsch-
funktion und
spritzschutz/
teigschaber
1,5l + 3,5l

set mixing bowl with
anti-slip-function
and splash guard/
dough scraper

set de bols à mixer
antidérapants avec
couvercle anti-écla-
boussures/spatule

130 000 00
680 000 00



PP/
TPE 3 180



10677
marco



party-butler 35 x 45 x 11



581 000 00
680 000 00



PP 6 96



keeper

11130
tina



art.-bezeichnung article description désignation	cm/l cm/l cm/l ↕ ↔ ↔	farbe colour couleur	ean13 barcode ean13	mat. mam pal. mat. moq pal. mat. moq pal.
--	-------------------------------	----------------------------	---------------------------	---

frischhaltedose mit clip	14 x 11 x 6,6 0,45 l	624 000 00		PP/ tritan	4	1344
--------------------------	-------------------------	------------	--	---------------	---	------

food storage box with clip

boîte fraîcheur avec clip



11131
tina



frischhaltedose mit clip	14 x 11 x 9 0,7 l	624 000 00		PP/ tritan	4	896
--------------------------	----------------------	------------	--	---------------	---	-----

food storage box with clip

boîte fraîcheur avec clip



11132
tina



frischhaltedose mit clip	22,5 x 13,5 x 6,5 1 l	624 000 00		PP/ tritan	4	600
--------------------------	--------------------------	------------	--	---------------	---	-----

food storage box with clip

boîte fraîcheur avec clip



11133
tina



frischhaltedose mit clip	16 x 16 x 8 1,15 l	624 000 00		PP/ tritan	4	700
--------------------------	-----------------------	------------	--	---------------	---	-----

food storage box with clip

boîte fraîcheur avec clip



Alle Angaben sind Füllmaße./All data are filling dimensions./Toutes les indications sont des mesures de remplis sage.

molly

mag möhrchen am liebsten,
wenn sie knacken.

molly prefers carrots the most
when they crunch.

molly aime les carottes quand
elles croquent.



11134
tina



frischhaltedose mit clip	22,5 x 13,5 x 8,2 1,35 l	624 000 00		PP/ tritan	4	400
--------------------------	-----------------------------	------------	---	---------------	---	-----

food storage box with clip

boîte fraîcheur avec clip



11135
tina



frischhaltedose mit clip	16 x 16 x 11,1 1,7 l	624 000 00		PP/ tritan	4	420
--------------------------	-------------------------	------------	---	---------------	---	-----

food storage box with clip

boîte fraîcheur avec clip



Alle Angaben sind Füllmaße./All data are filling dimensions./Toutes les indications sont des mesures de remplis sage.



silvie

sichert sich die süßesten früchte.

silvie secures itself the sweetest fruit.

silvie cueille les meilleurs fruits.



keeper

art.-bezeichnung
article description
désignation

cm/l
cm/l
cm/l
↕ ↔ ↗

farbe
colour
couleur

ean13
barcode
ean13

mat. mam pal.
mat. moq pal.
mat. moq pal.

1110
tino



frischhaltedose 22,5 x 13,5 x 6,5 632 000 00

food storage box 1 l

boîte fraîcheur



PP/ 4 600
tritan

1111
tino



frischhaltedose 16 x 16 x 8 632 000 00

food storage box 1,15 l

boîte fraîcheur



PP/ 4 700
tritan

1113
tino



frischhaltedose 14 x 11 x 6,6 632 000 00

food storage box 0,45 l

boîte fraîcheur



PP/ 4 1344
tritan

1112
tino



frischhaltedose 22,5 x 13,5 x 8,2 632 000 00

food storage box 1,35 l

boîte fraîcheur



PP/ 4 400
tritan

1114
tino



frischhaltedose 14 x 11 x 9 632 000 00

food storage box 0,7 l

boîte fraîcheur



PP/ 4 896
tritan

1115
tino



frischhaltedose 16 x 16 x 11,1 632 000 00

food storage box 1,7 l

boîte fraîcheur



PP/ 4 420
tritan

keeper

30689
mia „magic ice“



art.-bezeichnung article description désignation	cm/l cm/l cm/l ↕ ↔ ↗	farbe colour couleur	ean13 barcode ean13	mat. mat. mat.	mam moq moq	pal. pal. pal.
--	-------------------------------	----------------------------	---------------------------	----------------------	-------------------	----------------------

set 5 x tiefkühl-dose
wiederbeschreibbar,
rechteckig 15,5 x 10,5 x 6
5 x 0,5 l 680 286 00  4 052396 083026 PP 6 912

set 5 x food container
rewritable, rectangular

set 5 x boîte alimentaire
de conservation,
réinscriptible



30690
mia „magic ice“



set 4 x tiefkühl-dose
wiederbeschreibbar,
rechteckig 15,5 x 10,5 x 8,5
4 x 0,75 l 680 286 00  4 052396 083040 PP 6 900

set 4 x food container
rewritable, rectangular

set 4 x boîte alimentaire
de conservation,
réinscriptible



30691
mia „magic ice“



set 3 x tiefkühl-dose
wiederbeschreibbar,
rechteckig 15,5 x 10,5 x 11,5
3 x 1 l 680 286 00  4 052396 083071 PP 6 660

set 3 x food container
rewritable, rectangular

set 3 x boîte alimentaire
de conservation,
réinscriptible



30052
mia „magic ice“



set 3 x tiefkühl-dose
wiederbeschreibbar,
rechteckig 20,5 x 15,5 x 6,5
3 x 1,25 l 680 286 00  4 052396 083101 PP 6 624

set 3 x food container
rewritable, rectangular

set 3 x boîte alimentaire
de conservation,
réinscriptible



art.-bezeichnung article description désignation	cm/l cm/l cm/l ↕ ↔ ↗	farbe colour couleur	ean13 barcode ean13	mat. mat. mat.	mam moq moq	pal. pal. pal.
--	-------------------------------	----------------------------	---------------------------	----------------------	-------------------	----------------------

30692
mia „magic ice“



set 2 x tiefkühl-dose
wiederbeschreibbar,
rechteckig 20,5 x 15,5 x 10,5
2 x 2 l 680 286 00  4 052396 083125 PP 6 528

set 2 x food container
rewritable, rectangular

set 2 x boîte alimentaire
de conservation,
réinscriptible



lena

hat ein faible für die
farben der saison.

lena has a soft spot for the
colors of the season.

lena a un faible pour les
couleurs de la saison.

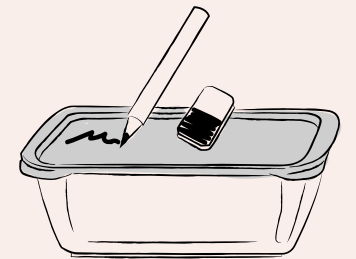

mia polar merkt sich einfach
alles, denn ihr Deckel ist
ganz einfach beschreibbar.
Und wieder-weg-radierbar.
Und wieder beschreibbar.
Und wieder ...

mia polar remembers anything
easily because her lid is writeable
- and erasable. And re-writeable.
And again erasable ...

mia polar se souvient simplement de
tout, car il est facile d'écrire sur son
couvercle. Et d'effacer. Et de réécri-
re. Et de ...



keeper

art.-bezeichnung	cm/l	farbe	ean13	mat.	mam	pal.
article description	cm/l	colour	barcode	mat.	moq	pal.
désignation	cm/l	couleur	ean13	mat.	moq	pal.
	↕ ↔ ↗					

30672
fredo fresh



set 5 x frischhaltedose, rechteckig	15,5 x 10,5 x 6 5 x 0,5 l	632 000 00			PP	6	912
---	------------------------------	------------	--	--	----	---	-----

set 5 x food storage box,
rectangular

set 5 x boîte alimentaire
de conservation,
rectangulaire



30673
fredo fresh



set 4 x frischhaltedose, rechteckig	15,5 x 10,5 x 8,5 4 x 0,75 l	632 000 00			PP	6	900
---	---------------------------------	------------	--	--	----	---	-----

set 4 x food storage box,
rectangular

set 4 x boîte alimentaire
de conservation,
rectangulaire



30674
fredo fresh



set 3 x frischhaltedose, rechteckig	15,5 x 10,5 x 11,5 3 x 1 l	632 000 00			PP	6	660
---	-------------------------------	------------	--	--	----	---	-----

set 3 x food storage box,
rectangular

set 3 x boîte alimentaire
de conservation,
rectangulaire



30675
fredo fresh



set 3 x frischhaltedose, rechteckig	20,5 x 15,5 x 6,5 3 x 1,25 l	632 000 00			PP	6	624
---	---------------------------------	------------	--	--	----	---	-----

set 3 x food storage box,
rectangular

set 3 x boîte alimentaire
de conservation,
rectangulaire



art.-bezeichnung	cm/l	farbe	ean13	mat.	mam	pal.
article description	cm/l	colour	barcode	mat.	moq	pal.
désignation	cm/l	couleur	ean13	mat.	moq	pal.
	↕ ↔ ↗					

30676
fredo fresh



set 2 x frischhaltedose, rechteckig	20,5 x 15,5 x 10,5 2 x 2 l	632 000 00			PP	6	528
---	-------------------------------	------------	--	--	----	---	-----

set 2 x food storage box,
rectangular

set 2 x boîte alimentaire
de conservation,
rectangulaire



30679
fredo fresh



set 3 x frischhaltedose, rechteckig	29 x 19 x 7 3 x 2,4 l	632 000 00			PP	6	252
---	--------------------------	------------	--	--	----	---	-----

set 3 x food storage box,
rectangular

set 3 x boîte alimentaire
de conservation,
rectangulaire



30680
fredo fresh



set 2 x frischhaltedose, rechteckig	29 x 19 x 9 2 x 3,3 l	632 000 00			PP	6	252
---	--------------------------	------------	--	--	----	---	-----

set 2 x food storage box,
rectangular

set 2 x boîte alimentaire
de conservation,
rectangulaire

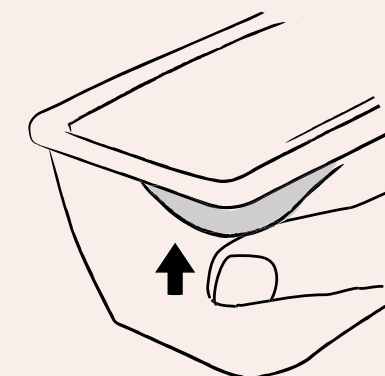

der fredo mit der ecke

Ganz einfach zu öffnen oder schließen,
dank des Deckels mit Eck-Lasche.

fredo with the corner
Very easy to open or close,
thanks to the lid with corner tab.

le fredo avec le coin
Très facile à ouvrir ou à fermer,
grâce au couvercle avec lan-
guette d'angle.



keeper

10694
carla „space tour“



art.-bezeichnung cm/l farbe ean13 mat. mam pal.
article description cm/l colour barcode mat. moq pal.
désignation cm/l couleur ean13 mat. moq pal.

deco-click-box mini 17 x 13 x 3,5 680 284 00 PP 10 2100
0,51 4 052396 081459

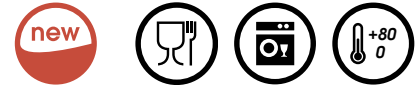

10697
carla „space tour“



deco-click-box midi 17 x 13 x 7 680 284 00 PP 10 1020
11 4 052396 081480



10694
carla „sweet day“



deco-click-box mini 17 x 13 x 3,5 581 283 00 PP 10 2100
0,51 4 052396 081442



10697
carla „sweet day“



deco-click-box midi 17 x 13 x 7 581 283 00 PP 10 1020
11 4 052396 081473



10694
carla „sandwich“



deco-click-box mini 17 x 13 x 3,5 315 282 00 PP 10 2100
0,51 4 052396 081435



10691
luca



art.-bezeichnung cm/l farbe ean13 mat. mam pal.
article description cm/l colour barcode mat. moq pal.
désignation cm/l couleur ean13 mat. moq pal.

click-box micro 11 x 7,5 x 6 315 000 00 PP 10 3000
0,351 4 052396 081305



10692
luca



click-box mini 17 x 13 x 3,5 315 000 00 PP 10 2100
0,51 4 052396 081336



10693
luca



click-box midi 17 x 13 x 7 315 000 00 PP 10 1020
11 4 052396 081367



10695
luca



click-box maxi 30 x 20 x 8,5 315 000 00 PP 5 300
3,71 4 052396 081398



10697
carla „sandwich“



deco-click-box midi 17 x 13 x 7 315 282 00 PP 10 1020
11 4 052396 081466



keeper

art.-bezeichnung article description désignation	cm/l cm/l cm/l ↕ ↔ ↗	farbe colour couleur	ean13 barcode ean13	mat. mat. mat.	mam moq moq	pal. pal. pal.
---	--------------------------------------	-----------------------------------	----------------------------------	-----------------------------	--------------------------	-----------------------------

14438
laura



mikrowellen-/ tiefkühl-dose 2in1	ø 16,5 x 12 1,5l	827 000 00		PP	6	480
-------------------------------------	---------------------	------------	--	----	---	-----

microwave-/
freeze container 2in1

boîte à congeler pour
le micro-ondes 2en1



14448
laura



mikrowellen-/ tiefkühl-dose 2in1	ø 24 x 14 4l	827 000 00		PP	2	150
-------------------------------------	-----------------	------------	--	----	---	-----

microwave-/
freeze container 2in1

boîte à congeler pour
le micro-ondes 2en1



14508
laura



mikrowellen-/ tiefkühl-dose 2in1	17 x 11 x 6 0,6l	827 000 00		PP	8	1120
-------------------------------------	---------------------	------------	--	----	---	------

microwave-/
freeze container 2in1

boîte à congeler pour
le micro-ondes 2en1



14518
laura



mikrowellen-/ tiefkühl-dose 2in1	17 x 17 x 6 1l	827 000 00		PP	4	700
-------------------------------------	-------------------	------------	--	----	---	-----

microwave-/
freeze container 2in1

boîte à congeler pour
le micro-ondes 2en1



art.-bezeichnung article description désignation	cm/l cm/l cm/l ↕ ↔ ↗	farbe colour couleur	ean13 barcode ean13	mat. mat. mat.	mam moq moq	pal. pal. pal.
---	--------------------------------------	-----------------------------------	----------------------------------	-----------------------------	--------------------------	-----------------------------

14528
laura



mikrowellen-/ tiefkühl-dose 2in1	28,5 x 17,5 x 6 1,8l	827 000 00		PP	4	384
-------------------------------------	-------------------------	------------	--	----	---	-----

microwave-/
freeze container 2in1

boîte à congeler pour
le micro-ondes 2en1



14538
laura



mikrowellen-/ tiefkühl-dose 2in1	28,5 x 17,5 x 9,5 3l	827 000 00		PP	4	256
-------------------------------------	-------------------------	------------	--	----	---	-----

microwave-/
freeze container 2in1

boîte à congeler pour
le micro-ondes 2en1



geraldine

hat beim gärtnern immer
alle hände voll zu tun.

geraldine has her hands full
when she is gardening.

géraldine a toujours de quoi
faire lorsqu'elle jardine.

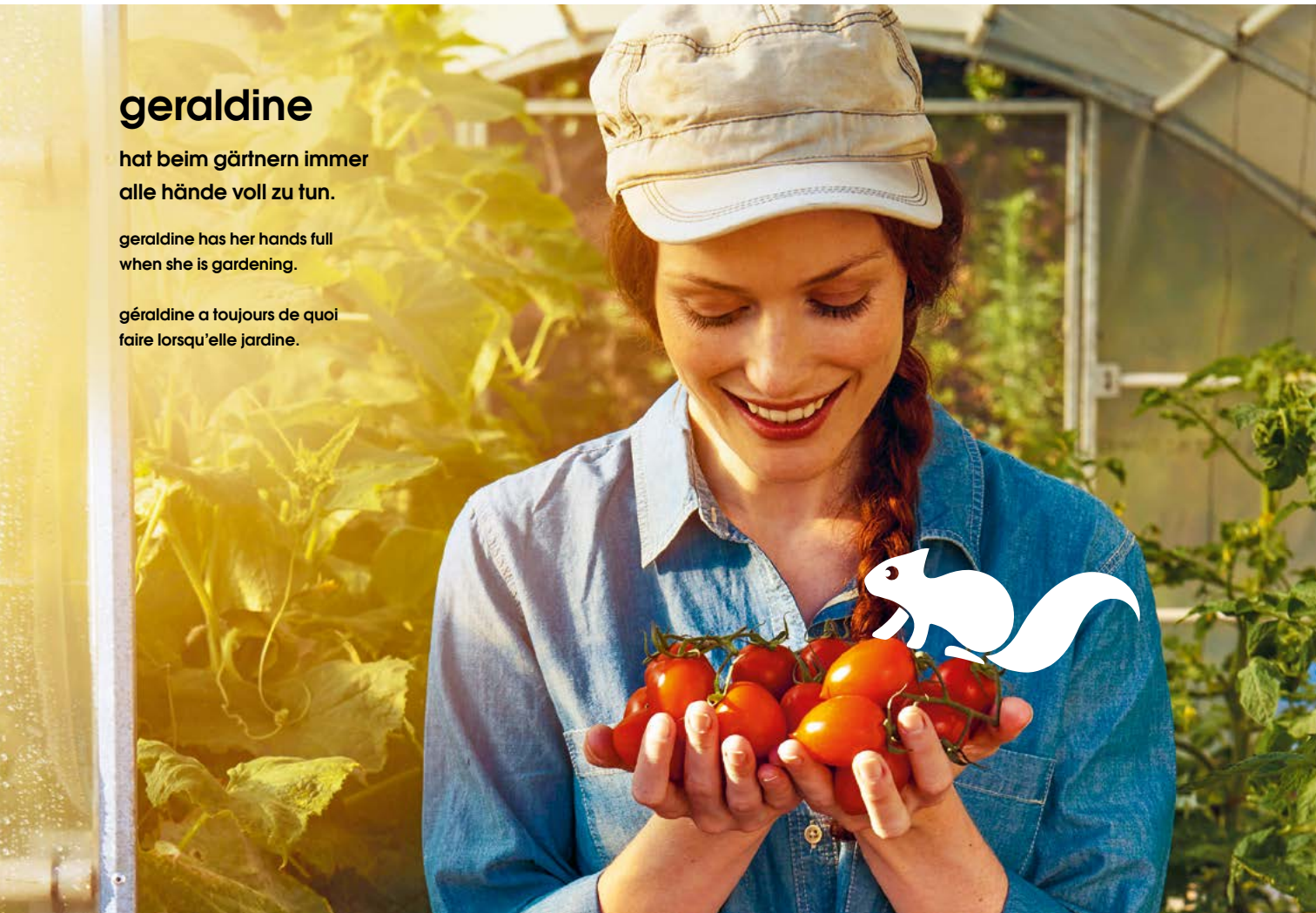

keeper

10162
pablo



besteckkasten
geschlossen
5 fächer

cutlery box
5 compartments

range couverts
5 compartiments



art.-bezeichnung
article description
désignation

cm/l
cm/l
cm/l

↕ ↔ ↔

farbe
colour
couleur

ean13
barcode
ean13

mat. mam pal.
mat. moq pal.
mat. moq pal.

33,5 x 26,5 x 5

001 000 00

130 000 00

4 001515 162012

4 052396 080773

PP 10 670

10163
pablo



besteckkasten
geschlossen
7 fächer

cutlery box
7 compartments

range couverts
7 compartiments



39,5 x 37 x 5

001 000 00

130 000 00

4 001515 163019

4 052396 080780

PP 10 450

10451
franca



besteckkasten
ausziehbar,
passt sich der gröÙe
der schublade an

cutlery box
adjustable,
adapts to suit the size
of the drawer

range couverts
extensible,
s'adapte à la taille du tiroir



38 x 32 x 7,5

100 000 00

max. 38 x 50,5 x 7,5

4 001515 451918

PP 6 108

10462
filippa



besteckkasten
mit schieber
13 fächer

cutlery box
with slider
13 compartments

range couverts
13 compartiments
avec élément
coulissant



38 x 42,5 x 7,5

100 000 00

4 001515 462914

PP 6 108

10468
fabrizio



keep-fresh-
container

ø 37 x 15
7,5l



art.-bezeichnung
article description
désignation

cm/l
cm/l
cm/l

↕ ↔ ↔

farbe
colour
couleur

ean13
barcode
ean13

mat. mam pal.
mat. moq pal.
mat. moq pal.

100 000 00

4 001515 468916

PP 6 192

10469
bella



mikrowellen-
abdeckhaube

microwave cover

couvre assiettes
micro-ondes



ø 26,5

001 000 00

4 001515 469012

PP 12 1152

10530
fabio



stielseiher

colander
with grip

passoire avec
manche



ø 24 x 11

001 000 00

130 000 00

4 001515 530019

4 052396 080759

PP 10 960

10532
fabienne



seiher

colander

passoire



ø 26 x 11

001 000 00

130 000 00

4 001515 532013

4 052396 080766

PP 10 2400

liam

ist heute noch tellerwäscher
und später vielleicht mal chef.

liam is a dishwasher today,
but one day, he might be a chef.

liam est encore plongeur
et peut-être un jour, chef.



10585 pierre



geschirrablaufkorb mit tablett small 39,5 x 29,5 x 8 001 000 00 130 000 00 PP 6 162

dish-drainer basket with tray small 130 000 00 4 001515 585019 4 052396 081251

petit égouttoir à vaisselle avec plateau



10586 pierre



geschirrablaufkorb mit tablett large 39,5 x 39,5 x 8 001 000 00 130 000 00 PP 6 120

dish-drainer basket with tray large 130 000 00 4 001515 586016 4 052396 081268

grand égouttoir à vaisselle avec plateau



10589 pascale



geschirrablaufkorb large 39,5 x 39,5 x 8 001 000 00 130 000 00 PP 6 660

dish-drainer basket large 130 000 00 4 001515 589017

grand égouttoir à vaisselle



keeper

art.-bezeichnung cm/l
article description cm/l
désignation cm/l
↕ ↔ ↴

farbe
colour
couleur

ean13
barcode
ean13

mat. mam pal.
mat. moq pal.
mat. moq pal.

10581 pino



besteckabtropfer 16 x 16 x 12 130 000 00 5 2660

cutlery drainer

égouttoir à couverts



10417 jean



cerealien-box 19 x 8 x 17 130 000 00 4 648

cereal-dispenser 1,25 l

boîte à céréales

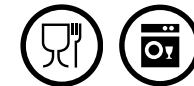

10418 jean



cerealien-box 21,5 x 9,5 x 24 130 000 00 4 280

cereal-dispenser 2,6 l

boîte à céréales

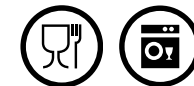

10419 jean



cerealien-box 24 x 11,5 x 30,5 130 000 00 4 200

cereal-dispenser 5 l

boîte à céréales

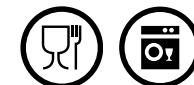

keeper

art.-bezeichnung cm/l
 article description cm/l
 désignation cm/l
 ↗ ↔ ↓



farbe
 colour
 couleur

ean13
 barcode
 ean13

mat. mam pal.
 mat. moq pal.
 mat. moq pal.

10481
 paola





schüttdose 6,5 x 4 x 12 100 000 00   PE/ 10 1920
 pouring jar 0,25 l SAN
 boîte à bec verseur



10484
 paola





schüttdose 8 x 4,5 x 15 100 000 00   PE/ 10 1120
 pouring jar 0,5 l PS
 boîte à bec verseur



10482
 paola





schüttdose 10,5 x 5,5 x 17 100 000 00   PE/ 10 640
 pouring jar 0,75 l PS
 boîte à bec verseur



10485
 paola



schüttdose 11 x 6,5 x 19 100 000 00   PE/ 10 560
 pouring jar 1 l PS
 boîte à bec verseur



frederik

ist nach dem sport so
 knackig wie sein müsli.



frederik is as crunchy as his
 muesli after playing sport.

frederik, après le sport, est autant
 à croquer que son muesli.



10483
 paola



schüttdose 11,5 x 7 x 21 100 000 00   PE/ 10 480
 pouring jar 1,5 l PS
 boîte à bec verseur



keeper home



das bisschen haushalt.

Zuhause ist es immer noch am schönsten! Oder immer wieder? Eben immer dann, wenn es nach getaner Arbeit wieder überall blitzt und blinkt. Dafür gibt es von **keeper** ein paar echte Haushaltshilfen, die euch tatkräftig zur Hand gehen – beim Putzen und beim Wischen. Bei der Wäsche und bei der Müllsortierung. Damit macht sich der Haushalt zwar auch noch nicht von allein, aber deutlich mehr Freude!

a little bit of housekeeping.

Home is wherever the heart is! Or ever again? Whenever everything is shining after the cleaning is done. For that, **keeper** has a few real household helpers that make life easier for you – in cleaning and wiping. For laundry and waste sorting. Housekeeping still does not take care of itself then, but it is much more fun at least!

un peu de ménage.

C'est toujours plus beau à la maison! Ou de nouveau plus beau? A chaque fois que tout à retrouvé son éclat, une fois le travail achevé. **keeper** propose quelques véritables aides domestiques qui vous donnent un fort coup de main pour l'époussetage et le nettoyage. La lessive et le tri des déchets. Certes, même avec ces aides, le ménage ne se fait pas tout seul, mais on y prend plus de plaisir!

keeper home



keeper

10782
lasse



art.-bezeichnung
article description
désignation

cm/l
cm/l
cm/l
↗ ↘ ↕

farbe
colour
couleur

ean13
barcode
ean13

mat. mam pal.
mat. moq pal.
mat. moq pal.

wäschekorb
ergonomisch
mit softgriffen

65 x 45 x 28,5
50 l

130 000 00



PP/
TPE 5 90

581 000 00



laundry basket
ergonomic
with soft-grips

corbeille à linge
ergonomique
avec poignées
souples

680 000 00



10783
janne



wanne
ergonomisch
mit softgriffen

65 x 45 x 28,5
50 l

130 000 00



PP/
TPE 5 90

581 000 00



laundry tub
ergonomic
with soft-grips

baquet à linge
ergonomique avec
poignées souples

680 000 00



10092
tilda



art.-bezeichnung
article description
désignation

cm/l
cm/l
cm/l
↗ ↘ ↕

farbe
colour
couleur

ean13
barcode
ean13

mat. mam pal.
mat. moq pal.
mat. moq pal.

wanne
ergonomisch

57,5 x 38 x 26,5
30,5 l

130 000 00



PP 5 280

laundry tub
ergonomic

581 000 00



baquet à linge
ergonomique

680 000 00



10093
anton



wäschekorb
ergonomisch

57,5 x 38 x 26,5
30,5 l

130 000 00



PP 5 280

laundry basket
ergonomic

581 000 00



corbeille à linge
ergonomique

680 000 00



10780
jost



wäschekorb

55 x 40 x 23

130 000 00



PP 5 180

laundry basket

32 l

581 000 00



corbeille à linge

680 000 00



10781
jost



wäschekorb

65 x 44 x 28

130 000 00



PP 5 90

laundry basket

52 l

581 000 00



corbeille à linge

680 000 00

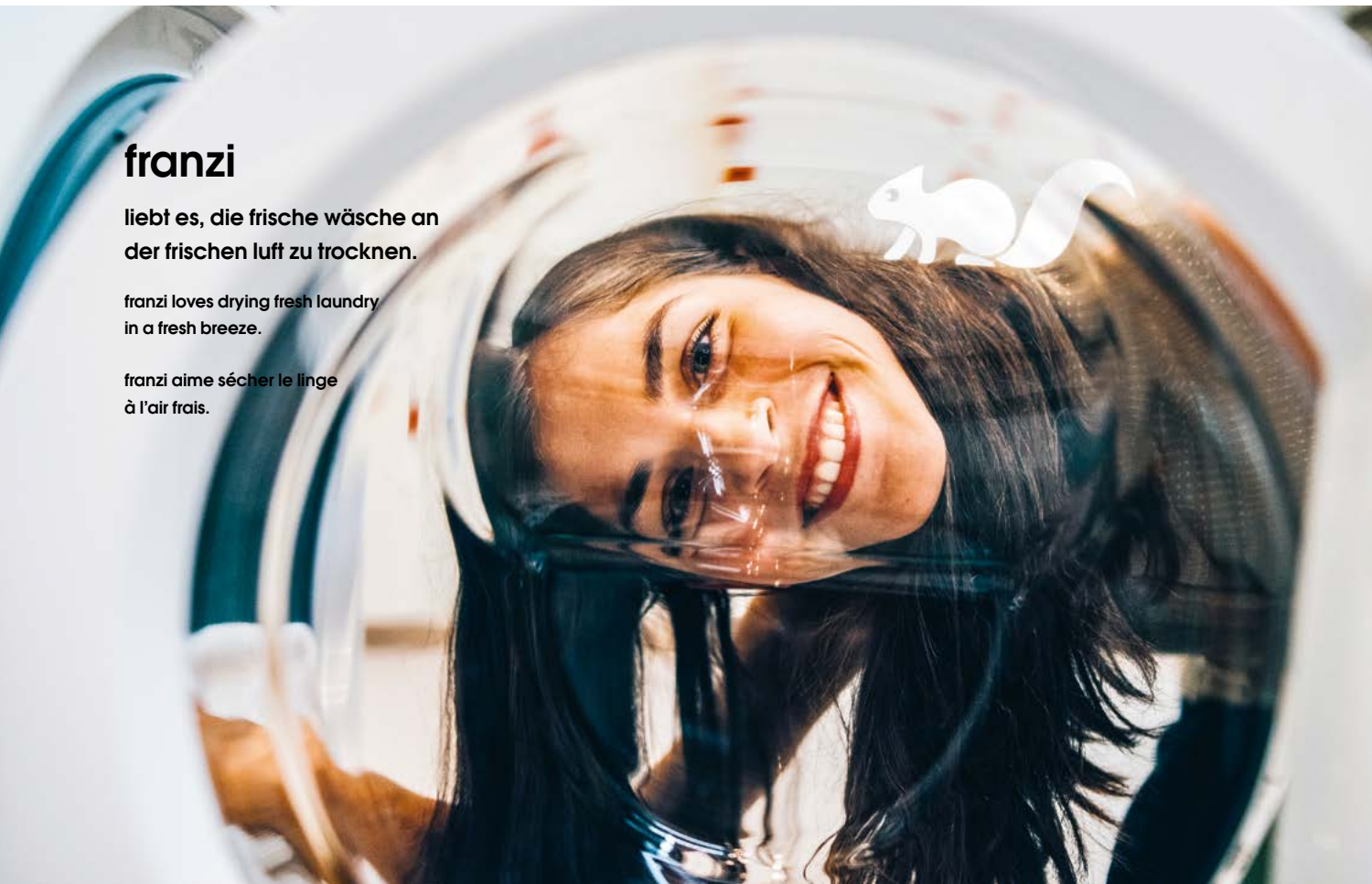

franzi

liebt es, die frische wäsche an
der frischen luft zu trocknen.

franzi loves drying fresh laundry
in a fresh breeze.

franzi aime sécher le linge
à l'air frais.



keeper

10785
aenna



art.-bezeichnung article description désignation	cm/l cm/l cm/l ↕ ↔ ↗	farbe colour couleur	ean13 barcode ean13	mat. mat. mat.	mam moq	pal. pal. pal.
wanne	55 x 40 x 23	130 000 00	4 052396 082258	PP	5	180
laundry tub	32 l	581 000 00	4 052396 082265			
baquet		680 000 00	4 052396 082272			

10786
aenna



art.-bezeichnung article description désignation	cm/l cm/l cm/l ↕ ↔ ↗	farbe colour couleur	ean13 barcode ean13	mat. mat. mat.	mam moq	pal. pal. pal.
wanne	65 x 44 x 28	130 000 00	4 052396 082289	PP	5	90
laundry tub	52 l	581 000 00	4 052396 082296			
baquet		680 000 00	4 052396 082302			

10701
per



art.-bezeichnung article description désignation	cm/l cm/l cm/l ↕ ↔ ↗	farbe colour couleur	ean13 barcode ean13	mat. mat. mat.	mam moq	pal. pal. pal.
wäschebox	45 x 34 x 60	130 000 00	4 052396 082319	PP	4	120
laundry hamper	60 l	581 000 00	4 052396 082326			
coffre à linge		680 000 00	4 052396 082333			

12456
piet



art.-bezeichnung article description désignation	cm/l cm/l cm/l ↕ ↔ ↗	farbe colour couleur	ean13 barcode ean13	mat. mat. mat.	mam moq	pal. pal. pal.
wäschebox	49 x 37 x 60	130 000 00	4 052396 082340	PP	4	60
laundry hamper	60 l	581 000 00	4 052396 082357			
coffre à linge		680 000 00	4 052396 082364			

10910
lotta



art.-bezeichnung article description désignation	cm/l cm/l cm/l ↕ ↔ ↗	farbe colour couleur	ean13 barcode ean13	mat. mat. mat.	mam moq	pal. pal. pal.
lifestyle-box	19,5 x 14 x 10	130 000 00	4 052396 081954	PP	6	4608
	1,8 l	581 000 00	4 052396 081961			
		680 000 00	4 052396 081978			

10911
lotta



art.-bezeichnung article description désignation	cm/l cm/l cm/l ↕ ↔ ↗	farbe colour couleur	ean13 barcode ean13	mat. mat. mat.	mam moq	pal. pal. pal.
lifestyle-box	29,5 x 19 x 15	130 000 00	4 052396 081985	PP	6	2100
	6 l	581 000 00	4 052396 081992			
		680 000 00	4 052396 082005			

10912
lotta



art.-bezeichnung article description désignation	cm/l cm/l cm/l ↕ ↔ ↗	farbe colour couleur	ean13 barcode ean13	mat. mat. mat.	mam moq	pal. pal. pal.
lifestyle-box	35,5 x 23,5 x 20	130 000 00	4 052396 082012	PP	6	900
	12 l	581 000 00	4 052396 082029			
		680 000 00	4 052396 082036			

10913
lotta



art.-bezeichnung article description désignation	cm/l cm/l cm/l ↕ ↔ ↗	farbe colour couleur	ean13 barcode ean13	mat. mat. mat.	mam moq	pal. pal. pal.
lifestyle-box	40 x 28 x 25	130 000 00	4 052396 082043	PP	6	640
	20 l	581 000 00	4 052396 082050			
		680 000 00	4 052396 082067			



keeper

12600
ilvie „polygon“



art.-bezeichnung article description désignation	cm/l cm/l cm/l ↕ ↔ ↗	farbe colour couleur	ean13 barcode ean13	mat. mat. mat.	mam moq moq	pal. pal. pal.
--	-------------------------------	----------------------------	---------------------------	----------------------	-------------------	----------------------

deco-eimer	ø 30 x 28	827 217 00	 	PP	6	480
------------	-----------	------------	--	----	---	-----

deco-bucket	10 l					
-------------	------	--	--	--	--	--

seau deco



12600
ilvie „stars“



deco-eimer	ø 30 x 28	519 196 00	 	PP	6	480
------------	-----------	------------	--	----	---	-----

deco-bucket	10 l					
-------------	------	--	--	--	--	--

seau deco



12600
ilvie „sea life“



deco-eimer	ø 30 x 28	680 285 00	 	PP	6	480
------------	-----------	------------	--	----	---	-----

deco-bucket	10 l					
-------------	------	--	--	--	--	--

seau deco





11705
mika



eimer mit ausguss	ø 24 x 20	001 000 NN	 	PP	6	450
-------------------	-----------	------------	--	----	---	-----

bucket with drain	5 l					
-------------------	-----	--	--	--	--	--

seau avec bec verseur		680 000 00	 			
-----------------------	--	------------	--	--	--	--



11710
mika



art.-bezeichnung article description désignation	cm/l cm/l cm/l ↕ ↔ ↗	farbe colour couleur	ean13 barcode ean13	mat. mat. mat.	mam moq moq	pal. pal. pal.
--	-------------------------------	----------------------------	---------------------------	----------------------	-------------------	----------------------

eimer mit ausguss	ø 30 x 28	001 000 NN	 	PP	6	480
-------------------	-----------	------------	---	----	---	-----

bucket with drain	10 l					
-------------------	------	--	--	--	--	--

seau avec bec verseur		680 000 00	 			
-----------------------	--	------------	---	--	--	--



10101
erik



eimer	ø 24 x 20	130 000 00	 	PP	10	1050
-------	-----------	------------	---	----	----	------

bucket	5 l					
--------	-----	--	--	--	--	--

seau		680 000 00	 			
------	--	------------	---	--	--	--

10104
erik



eimer	ø 28,5 x 26	130 000 00	 	PP	10	660
-------	-------------	------------	--	----	----	-----

bucket	10 l					
--------	------	--	--	--	--	--

seau		680 000 00	 			
------	--	------------	---	--	--	--

10787
thies



putzeimer oval	37 x 26,5 x 25	130 000 00	 	PP	6	528
----------------	----------------	------------	---	----	---	-----

cleaning bucket oval	13 l					
----------------------	------	--	--	--	--	--

seau de nettoyage ovale		680 000 00	 			
-------------------------	--	------------	---	--	--	--



10107
bent



putzeimer eckig	44 x 22 x 22,5	130 000 00	 	PP	10	500
-----------------	----------------	------------	---	----	----	-----

cleaning bucket rectangular	13 l					
-----------------------------	------	--	--	--	--	--

seau rectangulaire						
--------------------	--	--	--	--	--	--

keeper

10551
björk



art.-bezeichnung
article description
désignation

cm/l
cm/l
cm/l
↕ ↔ ↗

schüssel rund ø 20 x 8
bowl round 1,5l
cuvette ronde



farbe
colour
couleur

ean13
barcode
ean13

mat. mam pal.
mat. moq pal.
mat. moq pal.

001 000 00 4 001515 551014 PP 10 3630
315 000 00 4 052396 082388
680 000 00 4 052396 082395

art.-bezeichnung
article description
désignation

cm/l
cm/l
cm/l
↕ ↔ ↗

farbe
colour
couleur

ean13
barcode
ean13

mat. mam pal.
mat. moq pal.
mat. moq pal.

schüssel rund ø 36 x 15
bowl round 9l
cuvette ronde



001 000 00 4 001515 555012 PP 10 840
315 000 00 4 052396 082463
680 000 00 4 052396 082487

10552
björk



schüssel rund ø 24 x 10
bowl round 2,5l
cuvette ronde



001 000 00 4 001515 552011 PP 10 2030
315 000 00 4 052396 082401
680 000 00 4 052396 082418

10556
björk



schüssel eckig 34 x 34 x 12,5
bowl square 8l
cuvette carrée



001 000 00 4 001515 556019 PP 10 900
315 000 00 4 052396 082494
680 000 00 4 052396 082500

10553
björk



schüssel rund ø 28 x 11
bowl round 3,5l
cuvette ronde



001 000 00 4 001515 553018 PP 10 1370
315 000 00 4 052396 082425
680 000 00 4 052396 082432

10557
björk



schüssel eckig 38 x 38 x 15
bowl square 13l
cuvette carrée



001 000 00 4 001515 557016 PP 10 720
315 000 00 4 052396 082517
680 000 00 4 052396 082524

10554
björk



schüssel rund ø 32 x 13
bowl round 6l
cuvette ronde



001 000 00 4 001515 554015 PP 10 1280
315 000 00 4 052396 082449
680 000 00 4 052396 082456

10558
björk



schüssel eckig 38 x 32 x 14
bowl rectangular 9l
cuvette carrée



001 000 00 4 001515 558013 PP 10 480
315 000 00 4 052396 082531
680 000 00 4 052396 082548



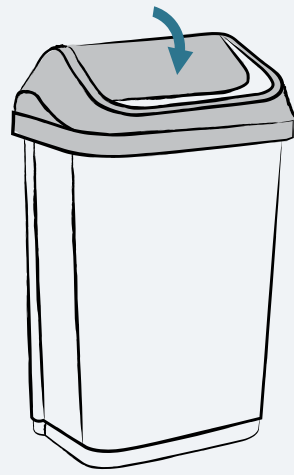

it's swing time, baby!

swantjes Schwingdeckel swingt ganz so, wie ihr es bei der täglichen Müllentsorgung am liebsten habt. Abnehmbar ist er übrigens auch. Da ist Musik drin!

It's swing time, baby!
swantje's swing lid swings in just the right way when you throw things out. By the way, it's also removable. That's a bonus!

It's swing time, baby!
Le couvercle oscillant de swantje swingue au rythme que vous lui donnez lors de l'usage quotidien. Et en plus, il est amovible. Cette poubelle mettra de l'ambiance dans votre cuisine !

keeper

art.-bezeichnung
article description
désignation

cm/l
cm/l
cm/l
↕ ↔ ↗

farbe
colour
couleur

ean13
barcode
ean13

mat. mam pal.
mat. moq pal.
mat. moq pal.

10453
rasmus



abfallbehälter
mit roldeckel
waste bin
with roll lid

25,5 x 19 x 39
10 l

160 000 00
826 000 00



4 001515 453950
4 052396 001709

PP 6 324

poubelle avec
couvercle roll



10306
swantje



abfallbehälter
mit schwingdeckel
waste bin
with swing lid

25 x 19 x 38,5
10 l

160 000 00
826 000 00



4 001515 306959
4 052396 001679

PP 6 324

poubelle avec
couvercle swing



10454
rasmus



abfallbehälter
mit roldeckel
waste bin
with roll lid

34 x 26 x 54
25 l

160 000 00
826 000 00



4 001515 454957
4 052396 001716

PP 5 110

poubelle avec
couvercle roll



10307
swantje



abfallbehälter
mit schwingdeckel
waste bin
with swing lid

33,5 x 25,5 x 53,5
25 l

160 000 00
826 000 00



4 001515 307956
4 052396 001686

PP 5 110

poubelle avec
couvercle swing



10455
rasmus



abfallbehälter
mit roldeckel
waste bin
with roll lid

39 x 29,5 x 67,5
50 l

160 000 00
826 000 00



4 001515 455954
4 052396 001723

PP 4 80

poubelle avec
couvercle roll



10308
swantje



abfallbehälter
mit schwingdeckel
waste bin
with swing lid

38,5 x 29 x 66
50 l

160 000 00
826 000 00



4 001515 308953
4 052396 001693

PP 4 80

poubelle avec
couvercle swing



let the good times roll!

rasmus' Deckel rollt mindestens genauso schön wie das „r“ in seinem Namen. rrrrrasmus. Für alles, das raus muss.

let the good times roll!
rasmus' lid rolls just as perfectly as the „r“ in his name. rrrrrasmus. For anything that goes around.

Payons-nous du bon temps...
en roulant ! Le couvercle de rasmus roule au moins aussi bien que le « r » de son nom. rrrrrasmus. Pour tout ce qui doit partir.

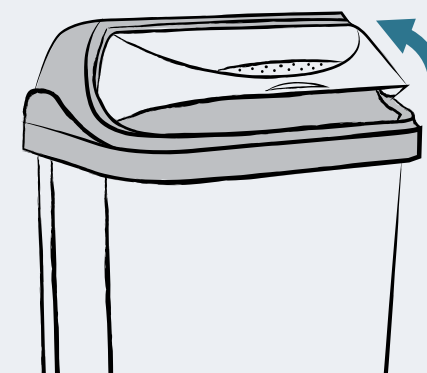

keeper

10603
magne



art.-bezeichnung
article description
désignation

cm/l
cm/l
cm/l
↕ ↔ ↗

farbe
colour
couleur

ean13
barcode
ean13

mat. mam pal.
mat. moq pal.
mat. moq pal.

abfallbehälter
mit flip-deckel

29,5 x 18 x 36,5
10 l

160 000 00



4 052396 022216



315 000 00
4 052396 081879



680 000 00
4 052396 081886



826 000 00
4 052396 022247



waste bin
with flip lid

poubelle avec
couvercle flip



10604
magne



abfallbehälter
mit flip-deckel

39,5 x 24 x 47,5
25 l

160 000 00



4 052396 022223



315 000 00
4 052396 082715



680 000 00
4 052396 082722



826 000 00
4 052396 022254



waste bin
with flip lid

poubelle avec
couvercle flip



10605
magne



abfallbehälter
mit flip-deckel

40 x 30 x 61,5
45 l

160 000 00



4 052396 022230



315 000 00
4 052396 082739



680 000 00
4 052396 082746



826 000 00
4 052396 022261



waste bin
with flip lid

poubelle avec
couvercle flip

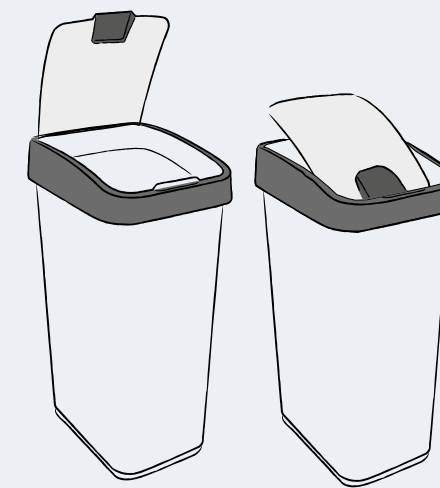

magne kann swing und flip

Tanzschritte und Skate-Tricks? Nein! Hier geht es um den genialen Abfallbehälter magne. Sein Deckel ist sowohl nach oben aufklappbar als auch nach unten schwingbar. Das macht ihn flexibel einsetzbar. Guter Move, magne!

magne knows how to swing and flip
Dance steps and skate tricks? No! This is about the ingenious waste bin magne. Its lid can be opened upwards and swung downwards. This makes it flexible to use. Good move, magne!

magne sait swinguer et flipper
Des pas de danse et des figures de skate ? Non ! Il s'agit ici de l'ingénieuse poubelle magne. Son couvercle à la fois s'ouvre vers le haut et pivote vers le bas. Elle est donc utilisable de manière flexible. Bon mouvement, magne!

10300
gunnar



treteimer
pedal bin
poubelle à pédale

39,5 x 29 x 43

160 000 00



4 001515 300957

PP

2

32



11536
torge



treteimer
pedal bin
poubelle à pédale

37,5 x 29,5 x 46

160 000 NN



4 052396 058413

PP

2

32



keeper

art.-bezeichnung
article description
désignation

cm/l
cm/l
cm/l
↕ ↔ ↗

farbe
colour
couleur

ean13
barcode
ean13

mat. mam pal.
mat. moq pal.
mat. moq pal.

11599
ole



system-müllsack-
ständer 35 x 40 x 75
refuse bag system
système de support
pour sac poubelle

160 000 NN



PP 2 60



art.-bezeichnung
article description
désignation

cm/l
cm/l
cm/l
↕ ↔ ↗

farbe
colour
couleur

ean13
barcode
ean13

mat. mam pal.
mat. moq pal.
mat. moq pal.

10212
mats



mini-tonne ø 24 x 29
mini-bin 7 l
mini-poubelle baril

160 000 00



PP 5 300

826 000 00



10151
jasper



papierkorb ø 29 x 31
waste-paper basket 11,5 l
poubelle ronde
à papier

160 000 00



PP 10 900

826 000 00



10213
mats



maxi-tonne ø 36 x 42
maxi-bin 23 l
maxi-poubelle baril

160 000 00



PP 6 180

826 000 00



10214
mats



supermax-tonne ø 50 x 55
supermax-bin 50 l
poubelle supermax

160 000 00



PP 6 48

826 000 00



10219
hugo



mega-tonne ø 55 x 60,5
mega-bin 70 l
poubelle mega

259 000 00



PP 3 48

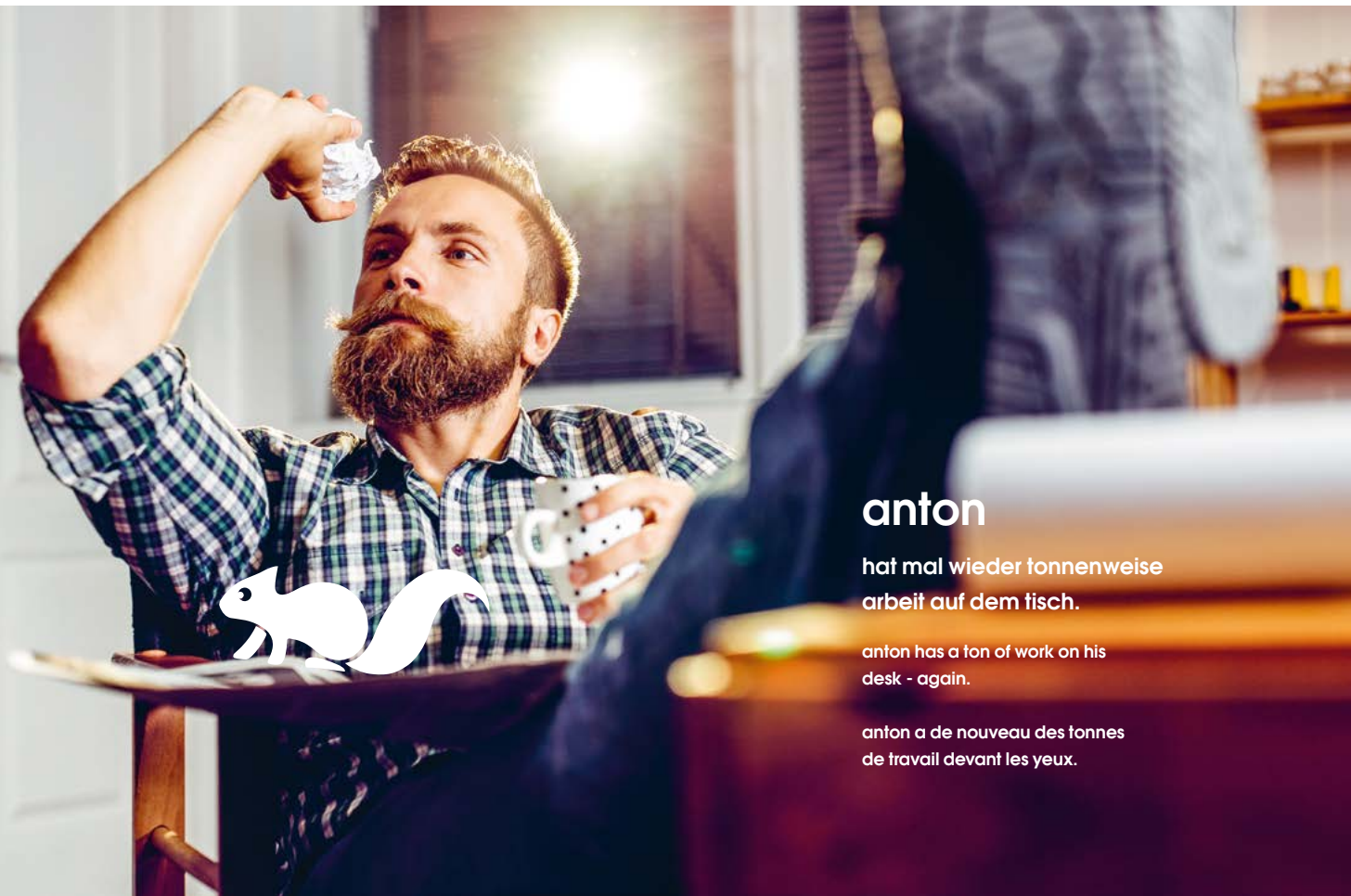

anton

hat mal wieder tonnenweise
arbeit auf dem tisch.

anton has a ton of work on his
desk - again.

anton a de nouveau des tonnes
de travail devant les yeux.

keeper storage



**auspacken, anpacken,
einpacken.**

Zuhause gibt es immer was zu tun. Da wird gebastelt und gebaut. Der eine liebt die Handarbeit, der andere das Handwerk. Und damit euer Material und Werkzeug immer griffbereit und platzsparend verstaut ist, kommt **keeper** mit einer großen Auswahl von Kisten und Boxen um die Ecke. Die einen lassen sich bis unter die Decke stapeln, die anderen lassen sich easy durch die Werkstatt rollen. Also dann: Packen wir es an!

**take it, tackle it,
tick it off.**

There's always something to do around the house. Crafting and building. Some love needlework, others handicrafts. For your tools and materials to be always stored space-savily and ready for use, **keeper** just comes around the corner with a broad selection of boxes and containers. Some can be stacked up under the ceiling, others are easy to roll around. What are you waiting for? Let's tackle it!

**déballer, prendre en main,
emballer.**

À la maison, il y a toujours quelque chose à faire ! On y bricole et on y construit. L'un aime le travail manuel, l'autre le bricolage. Et pour que votre matériel et vos outils restent rangés à portée de main et sans encombrer, **keeper** arrive accompagné d'une grande sélection de caisses et de boîtes. Les unes s'empilent jusqu'au plafond et les autres traversent facilement l'atelier en roulant. Alors : Prenons les choses en main !

keeper storage





keeper

art.-bezeichnung	cm/l	farbe	ean13	mat.	mam	pal.
article description	cm/l	colour	barcode	mat.	moq	pal.
désignation	cm/l	couleur	ean13	mat.	moq	pal.
	↕ ↔ ↗					

art.-bezeichnung	cm/l	farbe	ean13	mat.	mam	pal.
article description	cm/l	colour	barcode	mat.	moq	pal.
désignation	cm/l	couleur	ean13	mat.	moq	pal.
	↕ ↔ ↗					

11094
lina „jungle“





aufbewahrungsbox 29 x 19 x 12,4 130 273 00   PP 6 192
 storage box 4,21
 boîte de rangement



11094
lina „sweet home“





aufbewahrungsbox 29 x 19 x 12,4 684 254 00   PP 6 192
 storage box 4,21
 boîte de rangement



11095
lina „jungle“





aufbewahrungsbox 29 x 19 x 18 130 273 00   PP 6 144
 storage box 6,61
 boîte de rangement



11095
lina „sweet home“





aufbewahrungsbox 29 x 19 x 18 684 254 00   PP 6 144
 storage box 6,61
 boîte de rangement



11096
lina „jungle“



aufbewahrungsbox 39 x 29 x 12,4 130 273 00   PP 6 96
 storage box 101
 boîte de rangement



11096
lina „sweet home“





aufbewahrungsbox 39 x 29 x 12,4 684 254 00   PP 6 96
 storage box 101
 boîte de rangement



11097
lina „jungle“





aufbewahrungsbox 39 x 29 x 18 130 273 00   PP 6 72
 storage box 15,31
 boîte de rangement



11097
lina „sweet home“



aufbewahrungsbox 39 x 29 x 18 684 254 00   PP 6 72
 storage box 15,31
 boîte de rangement



keeper

11100 hubert & hilda



art.-bezeichnung
article description
désignation

cm/l
cm/l
cm/l
↕ ↔ ↗

universal-box und
einsatz für
universal-box

29 x 19 x 12,4
4,2l

storage box
with insert

boîte de rangement
avec insert

farbe
colour
couleur

666 000 00



878 000 00



ean13
barcode
ean13

mat. mam pal.
mat. moq pal.
mat. moq pal.

PP 6 192

11101 hubert & hilda



universal-box und
einsatz für
universal-box

29 x 19 x 18
6,6l

storage box
with insert

boîte de rangement
avec insert

666 000 00



878 000 00



11102 hubert & hilda



universal-box und
einsatz für
universal-box

39 x 29 x 12,4
10l

storage box
with insert

boîte de rangement
avec insert

666 000 00



878 000 00



11103 hubert & hilda



universal-box und
einsatz für
universal-box

39 x 29 x 18
15,3l

storage box
with insert

boîte de rangement
avec insert

666 000 00



878 000 00



hubert & hilda

halten fest, was du nicht
loslassen kannst.

hubert & hilda keep what you
can't let go.

hubert & hilda maintiennent
fermement ce que vous ne
pouvez pas lâcher.



keeper

art.-bezeichnung
article description
désignation

cm/l
cm/l
cm/l
↕ ↔ ↔

farbe
colour
couleur

ean13
barcode
ean13

mat. mam pal.
mat. moq pal.
mat. moq pal.

art.-bezeichnung
article description
désignation

cm/l
cm/l
cm/l
↕ ↔ ↔

farbe
colour
couleur

ean13
barcode
ean13

mat. mam pal.
mat. moq pal.
mat. moq pal.

10370
jonas



stapelkörbchen A7 16 x 12 x 7
mini storage basket A7
corbelle A7



130 000 00  4 052396 082838 PP/TPE 10 5400
680 000 00  4 052396 082845

10374
mirko



stapelkörbchen A7 16 x 12 x 7
mini storage basket A7
corbelle A7

001 000 00  4 052396 028324 PP 10 5400
130 000 00  4 052396 082913

10369
jonas



stapelkörbchen A6 20 x 16 x 7
mini storage basket A6
corbelle A6



130 000 00  4 052396 082852 PP/TPE 10 3600
680 000 00  4 052396 082869

10373
mirko



stapelkörbchen A6 20 x 16 x 7
mini storage basket A6
corbelle A6

001 000 00  4 052396 028386 PP 10 3600
130 000 00  4 052396 082920

10368
jonas



stapelkörbchen A5 26,5 x 20 x 7
mini storage basket A5
corbelle A5



130 000 00  4 052396 082876 PP/TPE 10 1920
680 000 00  4 052396 082883

10372
mirko



stapelkörbchen A5 26,5 x 20 x 7
mini storage basket A5
corbelle A5

001 000 00  4 052396 028423 PP 10 1920
130 000 00  4 052396 082937

10367
jonas



stapelkörbchen A4 36 x 26,5 x 7
mini storage basket A4
corbelle A4



130 000 00  4 052396 082890 PP/TPE 10 960
680 000 00  4 052396 082906

10371
mirko



stapelkörbchen A4 36 x 26,5 x 7
mini storage basket A4
corbelle A4

001 000 00  4 052396 028461 PP 10 960
130 000 00  4 052396 082944

keeper

10940
cornelia



art.-bezeichnung article description désignation	cm/l cm/l cm/l ↕ ↔ ↗	farbe colour couleur	ean13 barcode ean13	mat. mat.	mam moq	pal. pal.
--	-------------------------------	----------------------------	---------------------------	--------------	------------	--------------

kristallbox	29,5 x 19,5 x 12,5	001 000 00		4 001515 940016	PP	5	640
crystalbox	4 l						
cristalbox		827 000 00		4 052396 082982			



10429
cornelia



art.-bezeichnung article description désignation	cm/l cm/l cm/l ↕ ↔ ↗	farbe colour couleur	ean13 barcode ean13	mat. mat.	mam moq	pal. pal.
--	-------------------------------	----------------------------	---------------------------	--------------	------------	--------------

kristallbox	59,5 x 39,5 x 17	001 000 00		4 001515 429016	PP	5	120
crystalbox	28 l						
cristalbox		827 000 00		4 052396 083057			



10944
cornelia



kristallbox	39,5 x 29,5 x 9,5	001 000 00		4 001515 944014	PP	5	320
crystalbox	7 l						
cristalbox		827 000 00		4 052396 083002			

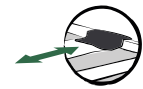

10426
cornelia



kristallbox	79,5 x 39,5 x 17	001 000 00		4 001515 426015	PP	5	85
crystalbox	33 l						
cristalbox							



10941
cornelia



kristallbox	39,5 x 29,5 x 17,5	001 000 00		4 001515 941013	PP	5	280
crystalbox	12 l						
cristalbox		827 000 00		4 052396 083019			



10942
cornelia



kristallbox	59,5 x 39,5 x 34	001 000 00		4 001515 942010	PP	5	100
crystalbox	52 l						
cristalbox		827 000 00		4 052396 083064			



10945
cornelia



kristallbox	39,5 x 29,5 x 30	001 000 00		4 001515 945011	PP	5	240
crystalbox	24 l						
cristalbox		827 000 00		4 052396 083033			



10427
cornelia



kristallbox	79,5 x 39,5 x 40	001 000 00		4 001515 427012	PP	5	65
crystalbox	83 l						
cristalbox							



keeper

art.-bezeichnung article description désignation	cm/l cm/l cm/l ↕ ↔ ↗	farbe colour couleur	ean13 barcode ean13	mat. mat. mat.	mam moq	pal. pal. pal.
--	-------------------------------	----------------------------	---------------------------	----------------------	------------	----------------------

10439
konrad



kristallbox mit rollen	59,5 x 39,5 x 18 28 l	001 000 00		PP	5	120
---------------------------	--------------------------	------------	--	----	---	-----

crystalbox
with casters

cristalbox avec roues



10436
konrad



kristallbox mit rollen	79,5 x 39,5 x 18 33 l	001 000 00		PP	5	85
---------------------------	--------------------------	------------	--	----	---	----

crystalbox
with casters

cristalbox avec roues



10943
konrad



kristallbox mit rollen	59,5 x 39,5 x 35 52 l	001 000 00		PP	5	100
---------------------------	--------------------------	------------	--	----	---	-----

crystalbox
with casters

cristalbox avec roues



10437
konrad



kristallbox mit rollen	79,5 x 39,5 x 41 83 l	001 000 00		PP	5	65
---------------------------	--------------------------	------------	--	----	---	----

crystalbox
with casters

cristalbox avec roues



romy

hat ihre sieben Sachen auf dem
rücken und den rest eine weltreise lang
bei cornelia und konrad verstaut.

romy has all of her belongings on her back
and the rest is stowed away in cornelia
and konrad for a round the world trip.

romy porte ses affaires sur son dos et a
laissé le reste à cornelia et konrad
pendant son tour du monde.



kon-rad. Ganz genau. Der enge Verwandte
von cornelia ist gern auf Rädern unterwegs.
Besser gesagt: auf Rollen, die seinen Trans-
port absolut easy machen. Sein Deckel ist
durch seitliche Clips verschließbar. Eine
wahrlich rundrollende Sache!

kon-rad. Exactly. cornelia's close relative loves to
travel on wheels. Put more clearly: on roller wheels that
make transporting extremely easy. Of course, he is also
extremely sturdy. His lid can be closed with clips at the
side. Something that really rolls around!

kon-rad. Pour être plus exact. Le parent proche de
cornelia se déplace volontiers sur des roues. Ou mieux
encore : sur des roulettes qui facilitent absolument
son transport. Son couvercle se ferme par des clips
latéraux. Une affaire tournant vraiment bien rond !

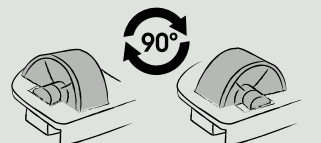
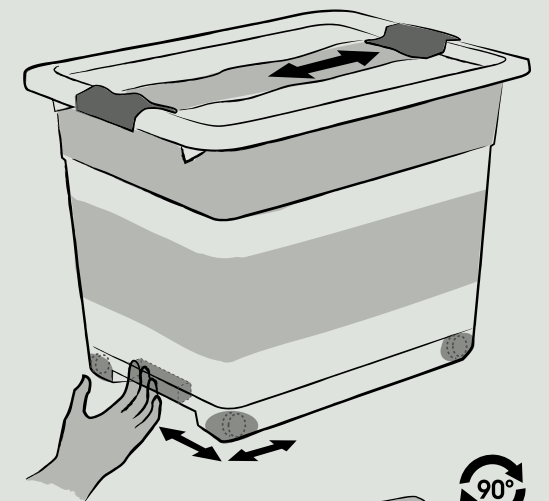



natalie

liebt es, sich mal ein
wochenende durch
die freie natur zu boxen.

natalie loves boxing through
nature on a weekend.

natalie aime faire de la boxe en
pleine nature le weekend.

keeper

art.-bezeichnung
article description
désignation

cm/l
cm/l
cm/l
↕ ↔ ↔

farbe
colour
couleur

ean13
barcode
ean13

mat. mam pal.
mat. moq pal.
mat. moq pal.

11011
ronja



clipbox
extra stabil
27 l

120 000 00



PP 5 200

clipbox
extra strong

clipbox
extra solide



11012
ronja



clipbox
extra stabil
55 l

120 000 00



PP 5 100

clipbox
extra strong

clipbox
extra solide



11013
ronja



clipbox
extra stabil
115 l

120 000 00



PP 5 50

clipbox
extra strong

clipbox
extra solide



ronja hält mit Sicherheit dicht und ist
absolut unerschütterlich.

ronja is absolutely tight and unshakeable.

ronja garde tout hermétiquement en toute sécurité
et elle est absolument inébranlable.

lalala – lara, lars, larissa.

- modular stapelbar
- ansprechendes design
- praktisch in der handhabung
- deckel durch clips verschließbar
- transparenz sorgt für leichten einblick in die box

- modular stackable
- attractive design
- convenient handling
- lid can be closed with clips
- transparency provides easy insight into the box

- module empilable
- design séduisant
- manipulation facile
- le couvercle se ferme à l'aide de clips
- la transparence de la boîte permet de voir le contenu



11020
lara



clipbox



19,5 x 15 x 6

1,15 l

001 000 00



PP 5 3840

11021
lara



clipbox



19,5 x 15 x 8,5

1,6 l

001 000 00



PP 5 3740

keeper

art.-bezeichnung
article description
désignation

cm/l
cm/l
cm/l
↕ ↔ ↔

farbe
colour
couleur

ean13
barcode
ean13

mat. mam pal.
mat. moq pal.
mat. moq pal.

11022
lara



clipbox



19,5 x 15 x 11

2 l

001 000 00



PP 5 3680

11024
lara



clipbox



19,5 x 15 x 16

3 l

001 000 00



PP 5 3550

11025
lara



clipbox



29 x 20 x 8

3,1 l

001 000 00



PP 5 1440

11029
lara



clipbox



29 x 20 x 18

6,5 l

001 000 00



PP 5 1340



keeper

art.-bezeichnung
article description
désignation

cm/l
cm/l
cm/l
↕ ↔ ↗

farbe
colour
couleur

ean13
barcode
ean13

mat. mam pal.
mat. moq pal.
mat. moq pal.

11028
lara



clipbox

39 x 20 x 11

001 000 00

4 052396 048698

PP 5 1055

5,75 l

11031
lara



clipbox

39 x 29 x 11

001 000 00

4 052396 048544

PP 5 520

8,5 l

11032
lara



clipbox

39 x 29 x 16,5

001 000 00

4 052396 048551

PP 5 480

12,5 l

11033
lara



clipbox

39 x 29 x 21

001 000 00

4 052396 048568

PP 5 485

15,5 l

11050
larissa



clipbox
mit griff

29 x 29 x 11

001 000 00

4 052396 048667

PP 5 520

6 l

clipbox
with handle

clipbox
avec poignée

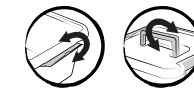

11051
larissa



clipbox
mit griff

29 x 29 x 16,5

001 000 00

4 052396 048674

PP 5 520

9 l

clipbox
with handle

clipbox
avec poignée

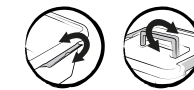

11052
larissa



clipbox
mit griff

29 x 29 x 26

001 000 00

4 052396 048681

PP 5 480

13 l

clipbox
with handle

clipbox
avec poignée

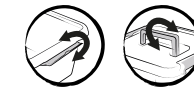

11053
larissa



clipbox
mit griff

39 x 20 x 11

001 000 00

4 052396 063554

PP 5 480

5,75 l

clipbox
with handle

clipbox
avec poignée

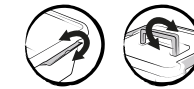

11056
larissa



clipbox
mit griff

39 x 29 x 21

001 000 00

4 052396 063585

PP 5 240

15,5 l

clipbox
with handle

clipbox
avec poignée

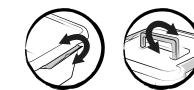

keeper

art.-bezeichnung	cm/l	farbe	ean13	mat.	mam	pal.
article description	cm/l	colour	barcode	mat.	moq	pal.
désignation	cm/l	couleur	ean13	mat.	moq	pal.
	↗ ↘ ↕					

**11040
lars**



clipbox mit rollen	58 x 39 x 16	001 000 00		PP	5	240
	29 l					
clipbox with casters						
clipbox avec roues						



**11041
lars**



clipbox mit rollen	76 x 39 x 16	001 000 00		PP	5	170
	35 l					
clipbox with casters						
clipbox avec roues						



**11042
lars**



clipbox mit rollen	58 x 39 x 25	001 000 00		PP	5	220
	40 l					
clipbox with casters						
clipbox avec roues						



**11044
lars**



clipbox mit rollen	58 x 39 x 35	001 000 00		PP	5	200
	60 l					
clipbox with casters						
clipbox avec roues						



art.-bezeichnung	cm/l	farbe	ean13	mat.	mam	pal.
article description	cm/l	colour	barcode	mat.	moq	pal.
désignation	cm/l	couleur	ean13	mat.	moq	pal.
	↗ ↘ ↕					

**11045
lars**



clipbox mit rollen	76 x 57 x 18	001 000 00		PP	5	80
	61 l					
clipbox with casters						
clipbox avec roues						

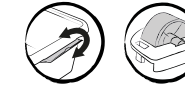

**11046
lars**



clipbox mit rollen	76 x 39 x 35	001 000 00		PP	5	150
	75 l					
clipbox with casters						
clipbox avec roues						

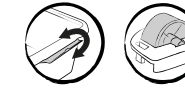

**11047
lars**



clipbox mit rollen	58 x 39 x 42	001 000 00		PP	5	175
	80 l					
clipbox with casters						
clipbox avec roues						

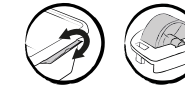

**11048
lars**



clipbox mit rollen	76 x 57 x 42	001 000 00		PP	5	65
	145 l					
clipbox with casters						
clipbox avec roues						

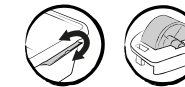

**Vollpacken, schließen und
ab geht das Rollenspiel.**

Pack up, close and off you go rolling.

Charger, fermer et c'est parti pour le jeu à roulettes.

keeper

10574
bea



art.-bezeichnung article description désignation
cm/l cm/l cm/l
↕ ↔ ↗

farbe colour couleur
ean13 barcode ean13
mat. mam pal. mat. moq pal. mat. moq pal.

clearbox 19,5 x 16,5 x 8,5 001 000 00 4 052396 004304 PP 6 864



10578
bea



clearbox 33 x 19,5 x 12 001 000 00 4 052396 004311 PP 6 672



10575
bea



clearbox 39 x 26,5 x 10 001 000 00 4 052396 004328 PP 6 432



10576
bea



clearbox 39 x 33,5 x 9 001 000 00 4 052396 004335 PP 6 288



10579
bea



clearbox 39 x 26,5 x 14 001 000 00 4 052396 004342 PP 6 378



10577
bea



art.-bezeichnung article description désignation
cm/l cm/l cm/l
↕ ↔ ↗

farbe colour couleur
ean13 barcode ean13
mat. mam pal. mat. moq pal. mat. moq pal.

clearbox 39 x 33,5 x 18 001 000 00 4 052396 004359 PP 6 252



10580
bea



clearbox 39 x 33,5 x 32 001 000 00 4 052396 022056 PP 6 180



10582
bea



clearbox 59 x 39 x 18 001 000 00 4 052396 022063 PP 6 144



10583
bea



clearbox 59 x 39 x 35 001 000 00 4 052396 022100 PP 6 120



keeper

art.-bezeichnung	cm/l	farbe	ean13	mat.	mam	pal.
article description	cm/l	colour	barcode	mat.	moq	pal.
désignation	cm/l	couleur	ean13	mat.	moq	pal.
	↕ ↔ ↗					

30205
bea



clearbox set 19,5 x 16,5 x 8,5 001 000 00 4 052396 081053 PP 3 150
5 x 1,7 l



30019
bea



clearbox set 33 x 19,5 x 12 001 000 00 4 052396 004373 PP 3 112
4 x 5,6 l



30020
bea



clearbox set 39 x 26,5 x 14 001 000 00 4 052396 004366 PP 3 72
3 x 11 l



30031
bea



clearbox set 39 x 33,5 x 18 001 000 00 4 052396 011876 PP 3 42
3 x 18 l



30050
bea



clearbox set 19,5 x 16,5 x 8,5 001 000 00 4 052396 015409 PP 3 42
3 x 1,7 l

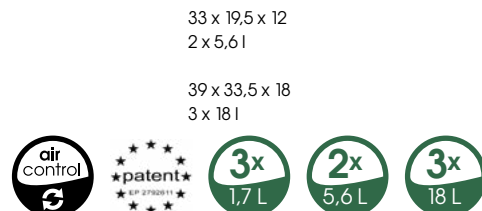

bent & mieke

zeigen ihren schuhen heute
mal die welt von oben.

bent & mieke show their shoes
the world from above today.

bent & mieke montrent à leurs
baskets le monde par en haut.

Wie man sie auch dreht und wendet: bea ist ein Knüller! Die Box ist ideal geeignet für die Aufbewahrung von Bekleidung, Accessoires, Schuhen und Gürteln und bringt Ordnung ins Regal – staubsicher, perfekt stapelbar und jederzeit einsehbar. Das einzigartige Air-Control-System sorgt entweder für frischen Wind oder einen luftdichten Verschluss – je nachdem, wie ihr den Deckel dreht.

How she twists and turns: bea is a bestseller! The box is ideally suited for storing clothes, accessories, shoes and belts, and tidies up your shelves. It is dust-proof, can be perfectly stacked and is always ready to hand. The unique air-control system provides either a fresh breeze or an airtight lock depending on how you turn the lid.

On peut la tourner dans tous les sens : bea reste épatante ! La boîte idéale pour le rangement de vêtements, accessoires, chaussures et ceintures, elle met de l'ordre dans les étagères – elle protège de la poussière, s'empile à la perfection et présente son contenu sans s'ouvrir. Le système Air-Control unique en son genre assure soit une bonne aération soit une fermeture hermétique – selon la position du couvercle.

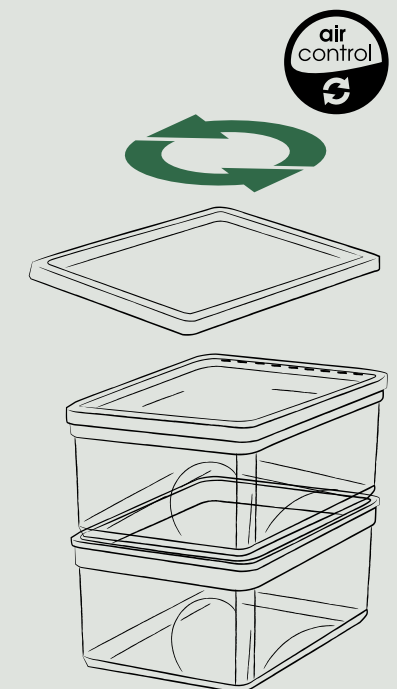

keeper

10882
robert



art.-bezeichnung
article description
désignation

cm/l
cm/l
cm/l
↕ ↔ ↔

farbe
colour
couleur

ean13
barcode
ean13

mat. mam pal.
mat. moq pal.
mat. moq pal.

transportbox
tragkraft bis 30 kg
20 l

transport box
loading capacity
up to 30 kg

130 000 00
826 000 00



PP 6 96

boîte de transport
jusqu'à 30 kg
de capacité de
chargement



10884
robert



transportbox
tragkraft bis 60 kg
45 l

130 000 00
826 000 00



PP 4 36

transport box
loading capacity
up to 60 kg

boîte de transport
jusqu'à 60 kg
de capacité de
chargement



10886
robert



transportbox
tragkraft bis 60 kg
64 l

130 000 00
826 000 00



PP 6 36

transport box
loading capacity
up to 60 kg

boîte de transport
jusqu'à 60 kg
de capacité de
chargement



10877
rolf



transportroller für
transportboxen und
-körbe

400 000 00



PE 3 36

transport roller for
transport boxes and
baskets

plateau de transport
à roues pour transport
box et basket



art.-bezeichnung
article description
désignation

cm/l
cm/l
cm/l
↕ ↔ ↔

farbe
colour
couleur

ean13
barcode
ean13

mat. mam pal.
mat. moq pal.
mat. moq pal.

10883
robert



transportkorb
tragkraft bis 30 kg
22 l

130 000 00



PP 8 64

transport basket
loading capacity
up to 30 kg

basket de transport
jusqu'à 30 kg de
capacité de
chargement



10885
robert



transportkorb
tragkraft bis 60 kg
64 l

130 000 00



PP 6 36

transport basket
loading capacity
up to 60 kg

basket de transport
jusqu'à 60 kg de
capacité de
chargement



10828
roberta



deckel für
transportbox

130 000 00
826 000 00



PP 10 840

lid for
transport box

couvercle pour boîte
de transport



10829
roberta



deckel für
transportbox
und -korb

130 000 00
826 000 00



PP 10 440

lid for
transport box
and basket

couvercle pour boîte
et basket de transport



keeper

art.-bezeichnung cm/l
article description cm/l
désignation cm/l
↕ ↔ ↔

farbe
colour
couleur

ean13
barcode
ean13

mat. mam pal.
mat. moq pal.
mat. moq pal.

10066
luis



euro-box mit
softgriffen 39 x 29 x 22
20l
eurobox with
soft-grips
euro-box avec
poignées souples

001 000 00



PP/
TPE 6 96



10068
luis



euro-box mit
softgriffen 59 x 39 x 32
64l
eurobox with
soft-grips
euro-box avec
poignées souples

001 000 00



PP/
TPE 6 36



10069
luisa



deckel für eurobox
mit softgriffen 40 x 30
20l
lid for eurobox
with soft-grips
20l
couverture pour euro-
box avec poignées
souples 20l

001 000 00



PP 10 1200

10070
luisa



deckel für eurobox
mit softgriffen 60 x 40
64l
lid for eurobox
with soft-grips
64l
couverture pour euro-
box avec poignées
souples 64l

001 000 00



PP 10 500

luis & luisa: hui, traumpaar!

Zu jeder Box passt ein Deckel, sagte
das nicht Omi schon? Genau so ist es!
luis & luisa schwören euch Treue in allen
Zeiten und halten in jeder Lebenslage
fest zusammen.

luis & luisa: ooh, dream team!
Every box fits a lid, isn't this what grandma already
said? That's exactly how it is! luis & luisa swear to be
faithful to you in all times and stick firmly together
in every situation.

luis & luisa : quel couple de rêve !
A chaque boîte correspond un couvercle, grand-
mère ne l'a pas dit? C'est exactement ça ! luis &
luisa vous jurent fidélité en tous temps et se tiennent
fermement ensemble dans toutes les situations.

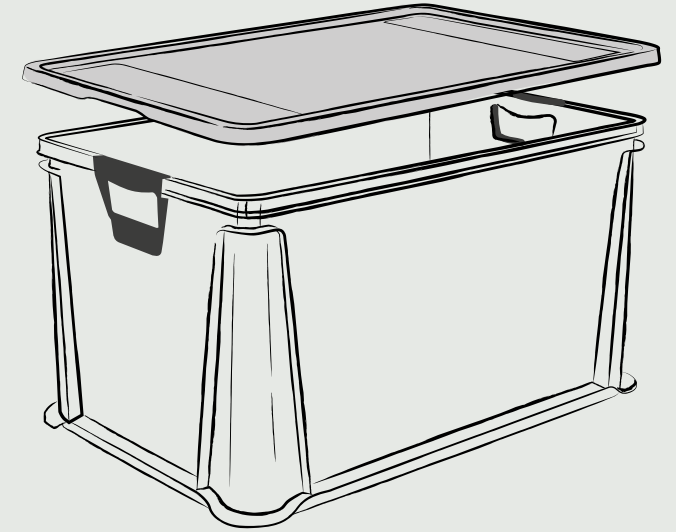

robin & sammy

denken beim umzug
out-of-the-box.

robin & sammy think out-of-
the-box when moving.

robin & sammy pensent out-of-
the-box lors d'un déménagement.

keeper

art.-bezeichnung	cm/l	farbe	ean13	mat.	mam	pal.
article description	cm/l	colour	barcode	mat.	moq	pal.
désignation	cm/l	couleur	ean13	mat.	moq	pal.
	↕ ↔ ↗					

10844
eckhart



transportbehälter	39,5 x 29,5 x 17,5	826 000 00			PP	5	280
extra stabil	12 l			4 052396 015072			
transport box							
extra strong							
transport box							
extra-solide							



10845
eckhart



transportbehälter	39,5 x 29,5 x 30	826 000 00			PP	5	240
extra stabil	24 l			4 052396 015096			
transport box							
extra strong							
transport box							
extra-solide							



10831
eckhart



transportbehälter	79,5 x 39,5 x 17	826 000 00			PP	5	85
extra stabil	33 l			4 052396 031577			
transport box							
extra strong							
transport box							
extra-solide							



10847
eckhart



transportbehälter	59,5 x 39,5 x 34	826 000 00			PP	5	100
extra stabil	52 l			4 052396 015089			
transport box							
extra strong							
transport box							
extra-solide							



art.-bezeichnung	cm/l	farbe	ean13	mat.	mam	pal.
article description	cm/l	colour	barcode	mat.	moq	pal.
désignation	cm/l	couleur	ean13	mat.	moq	pal.
	↕ ↔ ↗					

10830
eckhart



transportbehälter	79,5 x 39,5 x 40	826 000 00			PP	5	65
extra stabil	83 l			4 052396 023107			
transport box							
extra strong							
transport box							
extra-solide							



mick

legt wert auf jeden millimeter.

mick places importance
on every single millimetre.

mick se penche sur
chaque millimètre.

keeper

art.-bezeichnung article description désignation
 cm/l cm/l cm/l
 farbe colour couleur
 ean13 barcode ean13
 mat. mam pal. mat. moq pal. mat. moq pal.

10297
ben



profi-klappbox mit softgriffen 54 x 37 x 28 160 000 00 4 001515 297950 PP/TPE 5 120
 45 l
 folding box extra strong with soft-grips
 casier pliant avec poignées souples



10297
ben



profi-klappbox mit softgriffen 54 x 37 x 28 315 000 00 4 052396 083972 PP/TPE 5 120
 45 l
 folding box extra strong with soft-grips
 casier pliant avec poignées souples



10297
ben



profi-klappbox mit softgriffen 54 x 37 x 28 680 000 00 4 052396 083989 PP/TPE 5 120
 45 l
 folding box extra strong with soft-grips
 casier pliant avec poignées souples



mit ben klappt's endlich

Den Einkauf tragen, Altglas wegbringen, Picknick im Grünen ... Endlich mal einer, der immer alles mitmacht – und sich schmal macht, wenn es nix zu tun gibt.

with ben, it finally works
 Carrying the shopping, taking away old glass, picnics in the countryside ... Finally, someone who always does everything - and makes himself look small when there is nothing to do.

avec ben, ça marche enfin
 Porter les courses, emporter le verre usagé, pique-niquer dans la nature ... Enfin quelqu'un qui fait toujours tout - et qui se fait tout petit quand il n'y a rien à faire.



10222
emma



art.-bezeichnung article description désignation
 cm/l cm/l cm/l
 farbe colour couleur
 ean13 barcode ean13
 mat. mam pal. mat. moq pal. mat. moq pal.

einkaufsbox faltbar 38,5 x 28,5 x 21 130 000 00 4 052396 083224 PP 5 240
 foldable shoppo box 18,5 l 581 000 00 4 052396 083231
 casier à provisions pliable 680 000 00 4 052396 083248



10878
alma



einkaufskorb 40 x 29 x 22,5 130 000 00 4 052396 083309 PP 10 720
 shoppo basket 15 l 581 000 00 4 052396 083316
 panier à provisions 680 000 00 4 052396 083323



10224
ida



klappbox 48 x 35 x 23 130 000 00 4 052396 083262 PP/ 5 140
 folding box 32 l 680 000 00 4 052396 083286
 casier pliant



10298
alex



deckel für klappbox 32 l 49 x 36 130 000 00 4 052396 083194 PP 10 640
 lid for folding box 32 l
 couvercle pour casier pliant 32 l



10299
alex



deckel für klappbox 45 l 54 x 38 826 000 00 4 052396 075236 PP 10 660
 lid for folding box 45 l
 couvercle pour casier pliant 45 l



keeper

10541
emil



art.-bezeichnung article description désignation	cm/l cm/l cm/l ↕ ↔ ↗	farbe colour couleur	ean13 barcode ean13	mat. mat.	mam moq	pal. pal.
dreh-/stapelbox	35 x 20,5 x 15	001 000 00		PP	10	660
turn around stacking box	7 l	315 000 00				
boîte empilable/ retournable		437 000 00				
		680 000 00				

10546
emil



art.-bezeichnung article description désignation	cm/l cm/l cm/l ↕ ↔ ↗	farbe colour couleur	ean13 barcode ean13	mat. mat.	mam moq	pal. pal.
dreh-/stapelbox	38 x 28,5 x 20,5	001 000 00		PP	10	360
turn around stacking box	15 l	315 000 00				
boîte empilable/ retournable		437 000 00				
		680 000 00				

10188
emil



art.-bezeichnung article description désignation	cm/l cm/l cm/l ↕ ↔ ↗	farbe colour couleur	ean13 barcode ean13	mat. mat.	mam moq	pal. pal.
dreh-/stapelbox	41 x 34,5 x 22	001 000 00		PP	10	270
turn around stacking box	24 l	315 000 00				
boîte empilable/ retournable		437 000 00				
		680 000 00				

10516
emil



art.-bezeichnung article description désignation	cm/l cm/l cm/l ↕ ↔ ↗	farbe colour couleur	ean13 barcode ean13	mat. mat.	mam moq	pal. pal.
dreh-/stapelbox	44,5 x 34,5 x 27	001 000 00		PP	10	216
turn around stacking box	30 l	315 000 00				
boîte empilable/ retournable		437 000 00				
		680 000 00				

10536
emil



art.-bezeichnung article description désignation	cm/l cm/l cm/l ↕ ↔ ↗	farbe colour couleur	ean13 barcode ean13	mat. mat.	mam moq	pal. pal.
dreh-/stapelbox	54,5 x 39 x 29,5	001 000 00		PP	10	116
turn around stacking box	45 l	315 000 00				
boîte empilable/ retournable		437 000 00				
		680 000 00				

10542
emilia



art.-bezeichnung article description désignation	cm/l cm/l cm/l ↕ ↔ ↗	farbe colour couleur	ean13 barcode ean13	mat. mat.	mam moq	pal. pal.
deckel für dreh-/stapelbox 7 l	35,5 x 21	001 000 00		PP	10	4640
lid for turn around stacking box 7 l						
couvercle pour boîte empilable/ retournable 7 l						

10547
emilia



art.-bezeichnung article description désignation	cm/l cm/l cm/l ↕ ↔ ↗	farbe colour couleur	ean13 barcode ean13	mat. mat.	mam moq	pal. pal.
deckel für dreh-/stapelbox 15 l	38 x 29	001 000 00		PP	10	3120
lid for turn around stacking box 15 l						
couvercle pour boîte empilable/ retournable 15 l						

10180
emilia



art.-bezeichnung article description désignation	cm/l cm/l cm/l ↕ ↔ ↗	farbe colour couleur	ean13 barcode ean13	mat. mat.	mam moq	pal. pal.
deckel für dreh-/stapelbox 24 l	43 x 36	001 000 00		PP	10	830
lid for turn around stacking box 24 l						
couvercle pour boîte empilable/ retournable 24 l						

10517
emilia



art.-bezeichnung article description désignation	cm/l cm/l cm/l ↕ ↔ ↗	farbe colour couleur	ean13 barcode ean13	mat. mat.	mam moq	pal. pal.
deckel für dreh-/stapelbox 30 l	45,5 x 35,5	001 000 00		PP	10	800
lid for turn around stacking box 30 l						
couvercle pour boîte empilable/ retournable 30 l						

10537
emilia



art.-bezeichnung article description désignation	cm/l cm/l cm/l ↕ ↔ ↗	farbe colour couleur	ean13 barcode ean13	mat. mat.	mam moq	pal. pal.
deckel für dreh-/stapelbox 45 l	55,5 x 40	001 000 00		PP	10	1360
lid for turn around stacking box 45 l						
couvercle pour boîte empilable/ retournable 45 l						

keeper

10271
franz



art.-bezeichnung article description désignation	cm/l cm/l cm/l ↕ ↔ ↗	farbe colour couleur	ean13 barcode ean13	mat. mat. mat.	mam moq	pal. pal. pal.
multi-box s	35 x 21 x 15 6,5l	001 000 00	4 001515 271011	PP	10	540
		827 000 00	4 052396 083347			

10272
franz



multi-box m	35 x 27 x 21 13,5l	001 000 00	4 001515 272018	PP	10	400
		827 000 00	4 052396 083354			

10273
franz



multi-box l	43 x 35 x 15 16l	001 000 00	4 001515 273015	PP	10	210
		827 000 00	4 052396 083361			

10274
franz



multi-box xl	43 x 35 x 23 24l	001 000 00	4 001515 274012	PP	10	210
		827 000 00	4 052396 083378			

10275
franz



multi-box xxl	52 x 43 x 26 44l	001 000 00	4 001515 275019	PP	10	120
		827 000 00	4 052396 083385			

10246
franziska



art.-bezeichnung article description désignation	cm/l cm/l cm/l ↕ ↔ ↗	farbe colour couleur	ean13 barcode ean13	mat. mat. mat.	mam moq	pal. pal. pal.
deckel für multi-box s	35 x 21	827 000 00	4 052396 083392	PP	10	1600
lid for multi-box s						
couvercle pour multi-box s						

10247
franziska



deckel für multi-box m	35 x 27	827 000 00	4 052396 083408	PP	10	1280
lid for multi-box m						
couvercle pour multi-box m						

10248
franziska



deckel für multi-box l + xl	43 x 35	827 000 00	4 052396 083415	PP	10	600
lid for multi-box l + xl						
couvercle pour multi-box l + xl						

10249
franziska



deckel für multi-box xxl	52 x 43	827 000 00	4 052396 083422	PP	10	420
lid for multi-box xxl						
couvercle pour multi-box xxl						

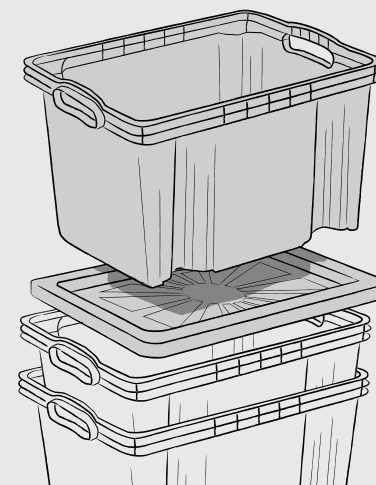

franz der kann's

Stilsicher und stabil verwahrt er allerlei Dinge. Und im Duo mit franziska heißt es: Deckel drauf und gut!

franz - yes he can
Stylish and stable, he stores all kinds of things. And in a duo with franziska, it's lid on and good!

franz, il sait y faire
Il conserve toutes sortes de choses avec style et stabilité. Et en duo avec franziska, c'est : couvercle sur le dessus et c'est bon!



keeper

art.-bezeichnung article description désignation	cm/l cm/l cm/l ↕ ↔ ↗	farbe colour couleur	ean13 barcode ean13	mat. mat. mat.	mam moq	pal. pal. pal.
--	-------------------------------	----------------------------	---------------------------	----------------------	------------	----------------------

15461
bruno



euro-box m	35 x 27 x 22 16 l	001 000 NN	4 052396 058840	PP	6	96
------------	----------------------	------------	-----------------	----	---	----

15456
bruno



euro-box l	43 x 35 x 17,5 20,5 l	001 000 NN	4 052396 058833	PP	6	66
------------	--------------------------	------------	-----------------	----	---	----

15453
bruno



euro-box xl	43 x 35 x 24 28 l	001 000 NN	4 052396 058826	PP	6	72
-------------	----------------------	------------	-----------------	----	---	----

15399
bruno



euro-box xxl	52 x 43 x 28 54 l	001 000 NN	4 052396 058819	PP	6	36
--------------	----------------------	------------	-----------------	----	---	----

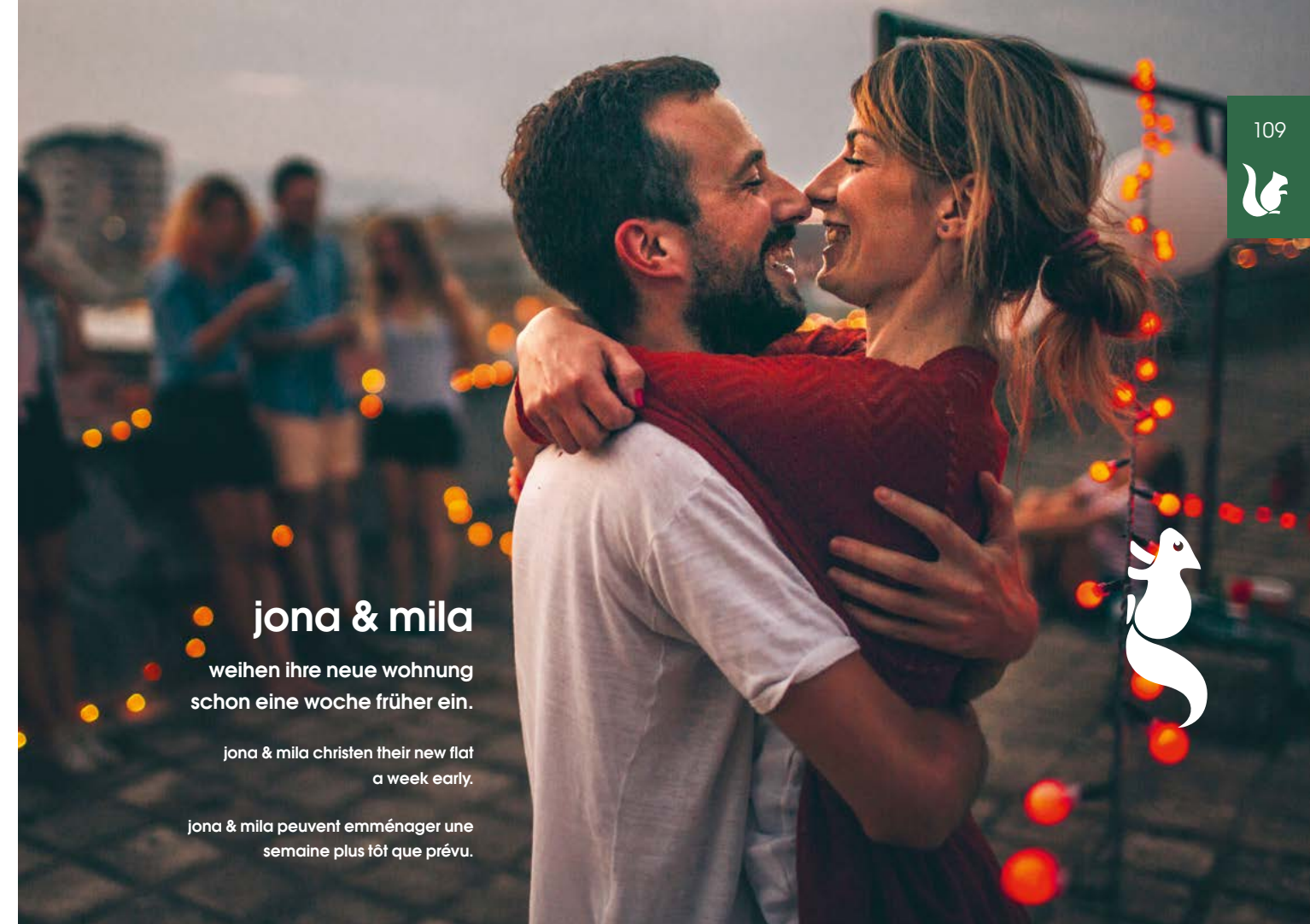

jona & mila

weihen ihre neue wohnung
schon eine woche früher ein.

jona & mila christen their new flat
a week early.

jona & mila peuvent emménager une
semaine plus tôt que prévu.



10230
tim



trittthocker
step stool
tabouret



36,5 x 30 x 24	826 000 00		4 001515 084499	PP	5	210
	160 000 00		4 001515 230957			

10902
max



maxi-hocker
maxi-stool
maxi tabouret

41 x 33,5 x 42,5	826 000 00		4 052396 013665	PP	5	120
	160 000 00		4 052396 013672			

keeper

10125
fred



art.-bezeichnung
article description
désignation

cm/l
cm/l
cm/l
↕ ↔ ↗

körbchen
mini basket
mini panier

25 x 17 x 10

farbe
colour
couleur

001 000 00



827 000 00



4 001515 125017
4 052396 082661

mat. mam pal.
mat. moq pal.
mat. moq pal.

PP 10 1980

art.-bezeichnung
article description
désignation

cm/l
cm/l
cm/l
↕ ↔ ↗

wännchen
mini tub
mini box

30 x 20 x 11
4,5l

farbe
colour
couleur

001 000 00



827 000 00



4 001515 136013
4 052396 082692

mat. mam pal.
mat. moq pal.
mat. moq pal.

PP 10 1280

10126
fred



körbchen
mini basket
mini panier

30 x 20 x 11

001 000 00



827 000 00



4 001515 126014
4 052396 082678

PP 10 1440

10390
fritz



dreh-/stapelkorb s
turn-around
stacking basket s
boîte retournable/
empilable s

30 x 20 x 13

001 000 00



4 001515 390019

PP 10 960

10391
fritz



dreh-/stapelkorb m
turn-around
stacking basket m
boîte retournable/
empilable m

40 x 25 x 15

001 000 00



4 001515 391016

PP 10 660

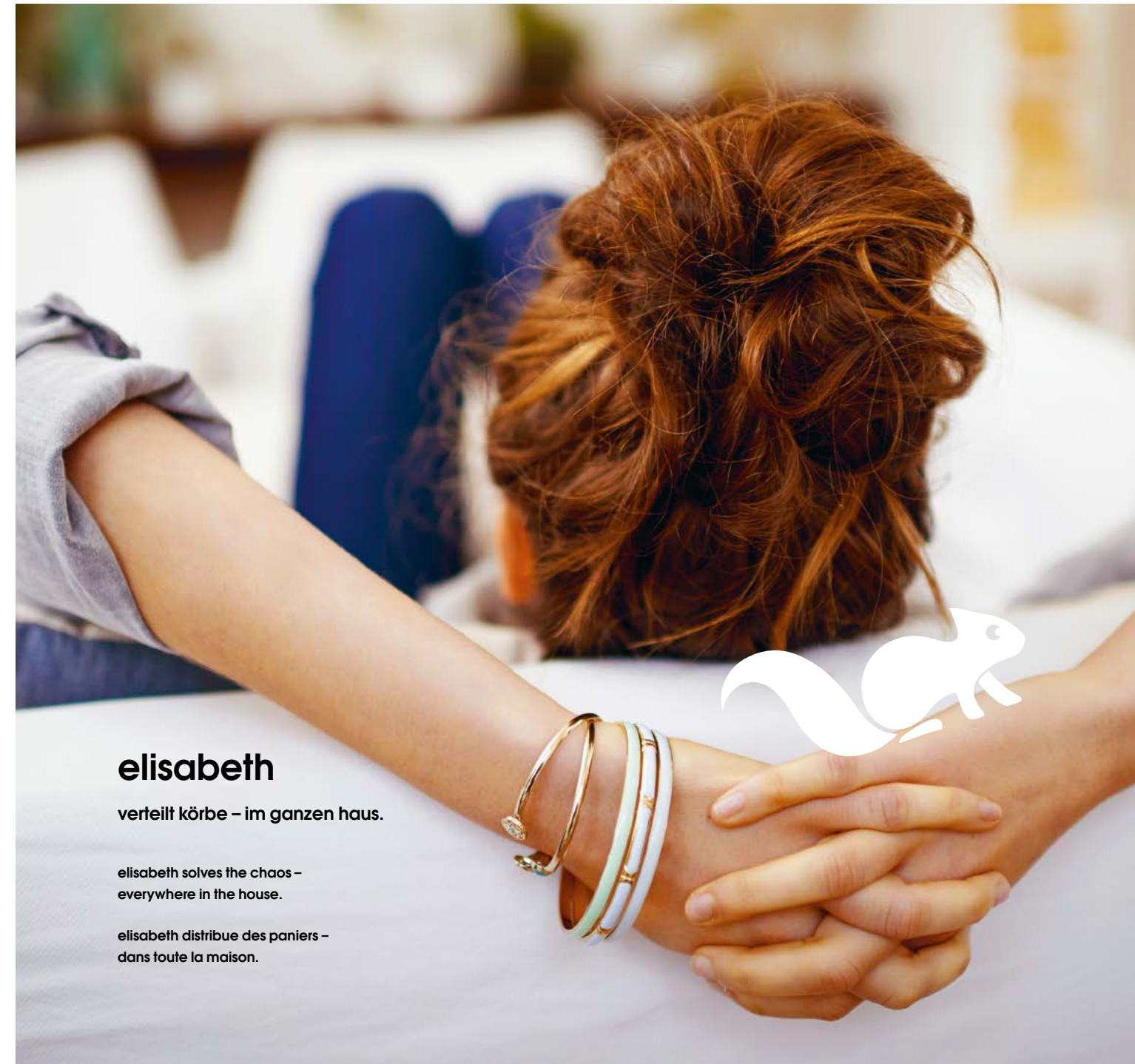

elisabeth

verteilt körbe – im ganzen haus.

elisabeth solves the chaos –
everywhere in the house.

elisabeth distribue des paniers –
dans toute la maison.



keeper kids



kunerbunter kinderkrum.

Von minnie bis winnie und von peppa bis paw patrol ... Das sind die großen Helden unserer kleinen Helden. Sie begleiten die Kids beim Großwerden und verhelfen mit tollen Motiven auf noch tolleren Produkten von der Badewanne über den Toiletten-sitz bis hin zum Tritthocker zu immer mehr Selbstständigkeit. Und damit weder Ordnung noch die vielen Kindheits-erinnerungen zu kurz kommen, warten die zahlreichen Aufbewahrungsmöglichkeiten nur darauf, von euch mit Leben und Liebe gefüllt zu werden.

crazy colours for kids.

From minnie to winnie and from peppa to paw patrol ... They are the big heroes for our little heroes. They are always with the kids and help them grow up with their cool pictures on even cooler products ranging from the bath tub to the toilet seat to the step stool, towards being increasingly more independent. And for the perfect balance between order and childhood memories, our countless storage appliances are just waiting to be full of your life and love.

trucs d'enfants de toutes les couleurs.

De minnie à winnie et de peppa à la paw patrol ... Ce sont les grands héros de nos petits héros. Ils accompagnent les enfants pendant leur croissance et, avec leurs motifs magnifiques, ils les aident à gagner une plus grande autonomie sur des produits encore plus superbes de la salle de bains au tabouret, en passant par le siège des toilettes. Et afin de ne négliger ni l'ordre ni les nombreux souvenirs d'enfance, les nombreuses possibilités de conservation n'attendent qu'une chose : que vous les remplissiez de vie et d'amour.

keeper kids



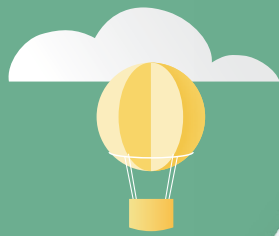

10
years
guarantee



kasimir 4 in 1 der thron, der mitwächst

kasimir 4 in 1: the throne that grows with you
kasimir 4 en 1: le trône qui grandit avec toi

maxi

fühlt sich bereit für die
krönung!

maxi feels ready for the
coronation!

maxi se sent prêt pour le
couronnement!



es war einmal ... eine windel!

Vom ersten Töpfchengang – der Thronbesteigung – über die Nutzung des Toilettensitzes zum Tritthocker-Einsatz: kasimir 4 in 1 bietet absoluten Komfort für Babys bzw. Kleinkinder durch eine passgerechte und anatomische Form. Mit pflegeleichter Oberfläche und herausnehmbarem Auffangbehälter ist nicht nur kasimir einfach zu reinigen: Dank praktischem Feuchttuchspender bleibt auch der oder die Thronende immer sauber. Die Anti-Rutsch-Funktion garantiert einen sicheren Halt und eine stabile Sitzposition. So kann man sich ganz dem Sitz der Krone widmen. Herrschaftlich!

once upon a time ... a diaper!

From the first potty walk - the ascent to the throne - to the use of the toilet seat to the step stool insert: kasimir 4 in 1 offers absolute comfort for babies or toddlers thanks to a fitting and anatomical shape. With an easy-care surface and removable collecting tank, not only kasimir is easy to clean: Thanks to a practical wipe dispenser, the enthroning one also always stays clean. The anti-slip function guarantees a secure hold and a stable sitting position. So you can devote yourself entirely to the seat of the crown. Lordly!

il était une fois ... une couche !

Du premier pot - l'accession au trône - à l'utilisation du siège de toilettes jusqu'à l'insert du tabouret marchepied: kasimir 4 en 1 offre un confort absolu aux bébés ou aux jeunes enfants grâce à une forme adaptée et anatomique. Avec sa surface facile à entretenir et son réservoir amovible, kasimir n'est pas le seul à être facile à nettoyer: Grâce au pratique distributeur de lingettes humides, le ou la qui trône reste lui aussi toujours propre. La fonction antidérapante garantit un maintien sûr et une position assise stable. On peut ainsi se consacrer entièrement à l'assise de la couronne. Magnifique!

schritt für schritt ein thron wächst mit.

step by step – throne and you go ahead.
pas à pas. – un trône grandit avec toi.

1

töpfchen: kasimir und die thronbesteigung
potty: kasimir and the ascent to the throne
pot: kasimir et l'accension au trône



+25
kg

2

toilettenaufsatz: kasimir sichert den sitz der herrschaft
toilet training seat: kasimir secures the seat of dominion
siège de toilette: kasimir sécurise le siège de la seigneurie



+25
kg

3

trittthocker: kasimir und die erobering des großen throns
step stool: kasimir and the conquest of the great throne
marche pied: kasimir et la conquête du grand trône

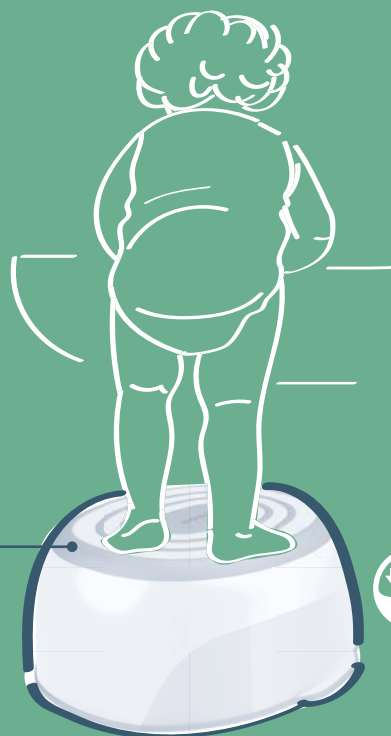

+100
kg

4

feuchttuchspender: Immer wieder ein happy end
wipe dispenser: always a happy ending
compartiments à lingettes: toujours un happy end



keeper

art.-bezeichnung article description désignation	cm/l cm/l cm/l ↕ ↔ ↗	farbe colour couleur	ean13 barcode ean13	mat. mat.	mam moq	pal. pal.
--	-------------------------------	----------------------------	---------------------------	--------------	------------	--------------

18649
kasimir



4
in 1

babytopf deluxe 4in1	34,9 x 31,5 x 26,2	519 000 00	4 052396 080315	PP/ TPE	1	36
potty deluxe 4in1		581 000 00	4 052396 080322			
pot bébé deluxe 4en1		684 000 00	4 052396 080339			

new

anti-
slip

18678
kasimir „winnie“



4
in 1

babytopf deluxe 4in1	34,9 x 31,5 x 26,2	100 238 00	4 052396 083330	PP/ TPE	1	36
potty deluxe 4in1						
pot bébé deluxe 4en1						

new

anti-
slip

18678
kasimir „minnie“



4
in 1

babytopf deluxe 4in1	34,9 x 31,5 x 26,2	581 247 00	4 052396 082685	PP/ TPE	1	36
potty deluxe 4in1						
pot bébé deluxe 4en1						

new

anti-
slip

18678
kasimir „mickey“



4
in 1

babytopf deluxe 4in1	34,9 x 31,5 x 26,2	684 247 00	4 052396 083507	PP/ TPE	1	36
potty deluxe 4in1						
pot bébé deluxe 4en1						

new

anti-
slip



18423
maria „winnie“



art.-bezeichnung
article description
désignation

cm/l
cm/l
cm/l
↕ ↔ ↗

farbe
colour
couleur

ean13
barcode
ean13

mat. mam pal.
mat. moq pal.
mat. moq pal.

babywanne 84 cm
mit stöpsel
baby bath 84 cm
with plug
baignoire 84 cm
avec vidange

100 238 00



PP 5 255



18420
maria „winnie“



babywanne 100 cm
mit stöpsel

100 238 00



PP 5 200

baby bath 100 cm
with plug

baignoire 100 cm
avec vidange



18618
leon „winnie“



anatomischer
babybadesitz mit
anti-rutsch-funktion

53 x 25 x 22



PP/
TPE 5 330

anatomic
baby bath chair with
anti-slip-function

siège de bain
ergonomique
antidérapant

18670
adam „winnie“



babytopf mit
anti-rutsch-funktion

38 x 27 x 23,5



PP/
TPE 5 855

potty with
anti-slip-function

pot bébé
antidérapant

10819
ewa „winnie“



kinder-toilettensitz
mit anti-rutsch-
funktion

40 x 30 x 15



PP/
TPE 5 720

toilet training seat
with anti-slip-
function

réducteur de siège wc
antidérapant

18679
olga „winnie“



art.-bezeichnung
article description
désignation

cm/l
cm/l
cm/l
↕ ↔ ↗

farbe
colour
couleur

ean13
barcode
ean13

mat. mam pal.
mat. moq pal.
mat. moq pal.

toilettensitz soft 35,5 x 30,5 x 5

262 238 00



PP+ 4 144

soft toilet training seat

réducteur de siège
wc soft



18431
tomek „winnie“



trittthocker mit
anti-rutsch-funktion

40,5 x 28,5 x 14

100 238 00



PP/
TPE 5 400

step stool with
anti-slip-function

marchepied
antidérapant



10032
igor „winnie“



trittthocker
zweistufig
mit anti-rutsch-funktion

40 x 37 x 21

100 238 00



PP/
TPE 5 210

double step stool
with anti-slip-function

double marchepied
antidérapant



11800
karol „winnie“



windeleimer
mit deckel und trage-
griff

37x29,5x27,5

100 238 00



PP 5 160

nappy-bin
with lid and handle

seau à langes
avec couvercle
et anse



keeper

art.-bezeichnung article description désignation	cm/l cm/l cm/l ↕ ↔ ↗	farbe colour couleur	ean13 barcode ean13	mat. mat. mat.	mam moq moq	pal. pal. pal.
---	--------------------------------------	-----------------------------------	----------------------------------	-----------------------------	--------------------------	-----------------------------

18496
amelia „winnie“



wickelunterlage baby changing mat matelas à langer	70 x 50 x 5	100 238 00			PP	3	75
--	-------------	------------	--	--	----	---	----

18497
pawel „winnie“



wickelunterlage mit messlatte baby changing top with measure matelas à langer avec point de référence	70 x 50 x 10	100 238 00			PVC/ PUR/ MDF	2	32
---	--------------	------------	--	--	---------------------	---	----

18500
antek „winnie“



reisewickelunterlage travel mat matelas à langer de voyage	zusammenge- faltet / folded / pliée: 29 x 13 x 5 ausgebreitet / assembled / dispersée: 58 x 40 x 0,5	100 238 00			PVC/ PUR	8	576
---	--	------------	--	--	-------------	---	-----

pu der bär

ist unverkäuflich.

pooh the bear
is not for sale.

winnie l'ourson
n'est pas à vendre.



art.-bezeichnung article description désignation	cm/l cm/l cm/l ↕ ↔ ↗	farbe colour couleur	ean13 barcode ean13	mat. mat. mat.	mam moq moq	pal. pal. pal.
---	--------------------------------------	-----------------------------------	----------------------------------	-----------------------------	--------------------------	-----------------------------

12236
karolina „winnie“



dreh- & stapelbox mit deckel turn-around stacking box with lid boîte empilable/ retournable avec couvercle	38 x 29,5 x 20,5 15 l	001 238 00			PP	5	160
--	--------------------------	------------	--	--	----	---	-----



12237
karolina „winnie“



dreh- & stapelbox mit deckel turn-around stacking box with lid boîte empilable/ retournable avec couvercle	42,5 x 35,5 x 22,5 24 l	001 238 00			PP	5	120
--	----------------------------	------------	--	--	----	---	-----



12238
karolina „winnie“



dreh- & stapelbox mit deckel turn-around stacking box with lid boîte empilable/ retournable avec couvercle	45 x 35 x 27 30 l	001 238 00			PP	5	90
--	----------------------	------------	--	--	----	---	----



12239
karolina „winnie“



dreh- & stapelbox mit deckel turn-around stacking box with lid boîte empilable/ retournable avec couvercle	55,5 x 40 x 30 45 l	001 238 00			PP	5	60
--	------------------------	------------	--	--	----	---	----



18423
maria „minnie“



art.-bezeichnung
article description
désignation

cm/l
cm/l
cm/l
↕ ↔ ↗

farbe
colour
couleur

ean13
barcode
ean13

mat. mam pal.
mat. moq pal.
mat. moq pal.

babywanne 84 cm
mit stöpsel
baby bath 84 cm
with plug
baignoire 84 cm
avec vidange

581 247 00



PP 5 255



18670
adam „minnie“



babytopf mit
anti-rutsch-funktion
poity with
anti-slip-function
pot bébé
antidérapant

581 247 00



PP/TPE 5 855

10819
ewa „minnie“



kinder-toilettensitz
mit anti-rutsch-
funktion
toilet training seat
with anti-slip-
function
réducteur de siège wc
antidérapant

581 247 00



PP/TPE 5 720

18431
tomek „minnie“



trittthocker mit
anti-rutsch-funktion
step stool with
anti-slip-function
marchepied
antidérapant

581 247 00



PP/TPE 5 400



10032
igor „minnie“



trittthocker
zweistufig
mit anti-rutsch-funktion
double step stool
with anti-slip-function
double marchepied
antidérapant

581 247 00



PP/TPE 5 210



art.-bezeichnung
article description
désignation

cm/l
cm/l
cm/l
↕ ↔ ↗

farbe
colour
couleur

ean13
barcode
ean13

mat. mam pal.
mat. moq pal.
mat. moq pal.

12236
karolina „minnie“



dreh- & stapelbox
mit deckel
15 l
turn-around stacking
box with lid
boîte empilable/
retournable avec
couvercle

581 247 00



PP 5 160



12237
karolina „minnie“



dreh- & stapelbox
mit deckel
24 l
turn-around stacking
box with lid
boîte empilable/
retournable avec
couvercle

581 247 00



PP 5 120



12238
karolina „minnie“



dreh- & stapelbox
mit deckel
30 l
turn-around stacking
box with lid
boîte empilable/
retournable avec
couvercle

581 247 00



PP 5 90



12239
karolina „minnie“



dreh- & stapelbox
mit deckel
45 l
turn-around stacking
box with lid
boîte empilable/
retournable avec
couvercle

581 247 00



PP 5 60



keeper

18423
maria „mickey“



art.-bezeichnung
article description
désignation

cm/l
cm/l
cm/l
↕ ↔ ↔

farbe
colour
couleur

ean13
barcode
ean13

mat. mam pal.
mat. moq pal.
mat. moq pal.

babywanne 84 cm
mit stöpsel

84 x 49 x 29

684 247 00



PP 5 255

baby bath 84 cm
with plug

baignoire 84 cm
avec vidange



18670
adam „mickey“



babytopf mit
anti-rutsch-funktion

38 x 27 x 23,5

684 247 00



PP/TPE 5 855

poity with
anti-slip-function

pot bébé
antidérapant

10819
ewa „mickey“



kinder-toilettensitz
mit anti-rutsch-
funktion

40 x 30 x 15

684 247 00



PP/TPE 5 720

toilet training seat
with anti-slip-
function

réducteur de siège wc
antidérapant

18431
tomek „mickey“



trittthocker mit
anti-rutsch-funktion

40,5 x 28,5 x 14

684 247 00



PP/TPE 5 400

step stool with
anti-slip-function

marchepied
antidérapant



10032
igor „mickey“



trittthocker
zweistufig
mit anti-rutsch-funktion

40 x 37 x 21

684 247 00



PP/TPE 5 210

double step stool
with anti-slip-function

double marchepied
antidérapant



art.-bezeichnung
article description
désignation

cm/l
cm/l
cm/l
↕ ↔ ↔

farbe
colour
couleur

ean13
barcode
ean13

mat. mam pal.
mat. moq pal.
mat. moq pal.

12236
karolina „mickey“



dreh- & stapelbox
mit deckel

38 x 29,5 x 20,5

684 247 00



PP 5 160

15 l

turn-around stacking
box with lid

boîte empilable/
retournable avec
couvercle



12237
karolina „mickey“



dreh- & stapelbox
mit deckel

42,5 x 35,5 x 22,5

684 247 00



PP 5 120

24 l

turn-around stacking
box with lid

boîte empilable/
retournable avec
couvercle



12238
karolina „mickey“



dreh- & stapelbox
mit deckel

45 x 35 x 27

684 247 00



PP 5 90

30 l

turn-around stacking
box with lid

boîte empilable/
retournable avec
couvercle



12239
karolina „mickey“



dreh- & stapelbox
mit deckel

55,5 x 40 x 30

684 247 00



PP 5 60

45 l

turn-around stacking
box with lid

boîte empilable/
retournable avec
couvercle



keeper

art.-bezeichnung cm/l
article description cm/l
désignation cm/l
↕ ↔ ↔

farbe
colour
couleur

ean13
barcode
ean13

mat. mam pal.
mat. moq pal.
mat. moq pal.

11086
kaja „minnie & mickey“



aufbewahrungsbox 29 x 19 x 12,4
storage box 4,2l
boîte de rangement

555 247 00



4 052396 077018

PP 6 192

684 247 00



4 052396 077049



11087
kaja „minnie & mickey“



aufbewahrungsbox 29 x 19 x 18
storage box 6,6l
boîte de rangement

555 247 00



4 052396 077056

PP 6 144

684 247 00



4 052396 077193



11088
kaja „minnie & mickey“



aufbewahrungsbox 39 x 19 x 12,4
storage box 10l
boîte de rangement

555 247 00



4 052396 077209

PP 6 96

684 247 00



4 052396 077216



11089
kaja „minnie & mickey“



aufbewahrungsbox 39 x 29 x 18
storage box 15,3l
boîte de rangement

555 247 00



4 052396 077230

PP 6 72

684 247 00



4 052396 077247



fabian

hat seine eigene ordnung.
auch für den straßenverkehr.

fabian has its own order.
also for road traffic.

fabian a son propre ordre.
même pour les transports routiers.



klick-klack findet ihr was freude macht

Mit kaja macht sogar Ordnung Spaß. Im liebevollen Design „minnie & mickey“ wird smart verwahrt, was Kinderherzen höherschlagen lässt.

click-clack you can find what brings joy
With kaja even order is fun. In the loving design „minnie & mickey“, you can smartly store everything that makes children's hearts beat faster.

clic-clac vous trouvez ce qui fait plaisir
Avec kaja, même l'ordre est un plaisir. Le joli design „minnie & mickey“ permet de ranger intelligemment tout ce qui fait plaisir aux enfants.

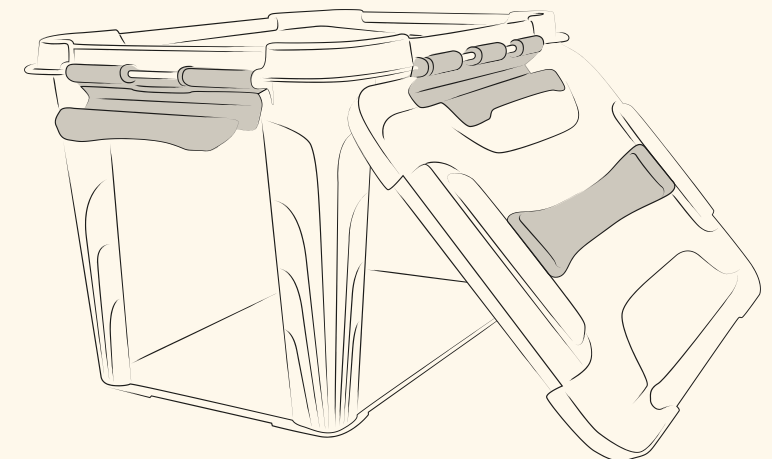

theo

sammelt heimlich schnee für den sommer.

theo secretly collects snow for the summer.

theo garde secrètement de la neige pour l'été.



keeper

art.-bezeichnung
article description
désignation

cm/l
cm/l
cm/l
↕ ↔ ↔

farbe
colour
couleur

ean13
barcode
ean13

mat. mam pal.
mat. moq pal.
mat. moq pal.

18670
adam „frozen“

babytopf mit
anti-rutsch-funktion

38 x 27 x 23,5

100 088 NN



PP/
TPE 5 855



potty with
anti-slip-function

pot bébé
antidérapant

10819
ewa „frozen“

kinder-toilettensitz
mit anti-rutsch-
funktion

40 x 30 x 15

100 088 NN



PP/
TPE 5 720



toilet training seat
with anti-slip-
function

réducteur de siège wc
antidérapant

18431
tomek „frozen“

trittbocker mit
anti-rutsch-funktion

40,5 x 28,5 x 14

100 088 NN



PP/
TPE 5 400



step stool with
anti-slip-function

marchepied
antidérapant

+80
kg

10032
igor „frozen“

trittbocker
zweistufig
mit anti-rutsch-funktion

40 x 37 x 21

100 088 NN



PP/
TPE 5 210



double step stool
with anti-slip-function

double marchepied
antidérapant

+120
kg

18679
olga „frozen“

toilettensitz soft 35,5 x 30,5 x 5

100 088 00



PP+ 4 144

soft toilet training seat

réducteur de siège
wc soft

soft
touch



keeper

12236
karolina „frozen“



art.-bezeichnung
article description
désignation

cm/l
cm/l
cm/l
↕ ↔ ↗

farbe
colour
couleur

ean13
barcode
ean13

mat. mam pal.
mat. moq pal.
mat. moq pal.

dreh- & stapelbox
mit deckel
15 l

684 212 00



PP 5 160

turn-around stacking
box with lid

boîte empilable/
retournable avec
couvercle



12237
karolina „frozen“



dreh- & stapelbox
mit deckel
24 l

42,5 x 35,5 x 22,5 684 212 00



PP 5 120

turn-around stacking
box with lid

boîte empilable/
retournable avec
couvercle



12238
karolina „frozen“



dreh- & stapelbox
mit deckel
30 l

45 x 35 x 27 684 212 00



PP 5 90

turn-around stacking
box with lid

boîte empilable/
retournable avec
couvercle



12239
karolina „frozen“



dreh- & stapelbox
mit deckel
45 l

55,5 x 40 x 30 684 212 00



PP 5 60

turn-around stacking
box with lid

boîte empilable/
retournable avec
couvercle



anabell

hat einen grund ihr prinze-
sinnen-
kleid zu tragen: es ist dienst-
tag.

anabell has a reason to wear her princess
dress: it's Tuesday.

anabell a une raison de porter sa robe de
princesse : c'est mardi.



18670
adam „cars“



art.-bezeichnung
article description
désignation

cm/l
cm/l
cm/l
↕ ↔ ↔

farbe
colour
couleur

ean13
barcode
ean13

mat. mam pal.
mat. moq pal.
mat. moq pal.

babytopf mit
anti-rutsch-funktion

potty with
anti-slip-function

pot bébé
antidérapant

401 171 00



PP/
TPE 5 855

10819
ewa „cars“



kinder-toilettensitz
mit anti-rutsch-
funktion

40 x 30 x 15

401 171 00



PP/
TPE 5 720

toilet training seat
with anti-slip-
function

réducteur de siège wc
antidérapant

18679
olga „cars“



toilettensitz soft 35,5 x 30,5 x 5

401 085 NN



PP+ 4 144

soft toilet training seat

réducteur de siège
wc soft



18431
tomek „cars“



trittthocker mit
anti-rutsch-funktion

40,5 x 28,5 x 14

401 171 00



PP/
TPE 5 400

step stool with
anti-slip-function

marchepied
antidérapant



10032
igor „cars“



trittthocker
zweistufig
mit anti-rutsch-funktion

40 x 37 x 21

401 171 00



PP/
TPE 5 210

double step stool
with anti-slip-function

double marchepied
antidérapant



art.-bezeichnung
article description
désignation

cm/l
cm/l
cm/l
↕ ↔ ↔

farbe
colour
couleur

ean13
barcode
ean13

mat. mam pal.
mat. moq pal.
mat. moq pal.

12236
karolina „cars“



dreh- & stapelbox
mit deckel

38 x 29,5 x 20,5

401 231 00



PP 5 160

15 l

turn-around stacking
box with lid

boîte empilable/
retournable avec
couvercle



12237
karolina „cars“



dreh- & stapelbox
mit deckel

42,5 x 35,5 x 22,5

401 231 00



PP 5 120

24 l

turn-around stacking
box with lid

boîte empilable/
retournable avec
couvercle



12238
karolina „cars“



dreh- & stapelbox
mit deckel

45 x 35 x 27

401 231 00



PP 5 90

30 l

turn-around stacking
box with lid

boîte empilable/
retournable avec
couvercle



12239
karolina „cars“



dreh- & stapelbox
mit deckel

55,5 x 40 x 30

401 231 00



PP 5 60

45 l

turn-around stacking
box with lid

boîte empilable/
retournable avec
couvercle



keeper

18670
adam „peppa“



art.-bezeichnung
article description
désignation

cm/l
cm/l
cm/l
↕ ↔ ↔

farbe
colour
couleur

ean13
barcode
ean13



mat. mam pal.
mat. moq pal.
mat. moq pal.

babytopf mit
anti-rutsch-funktion

potty with
anti-slip-function

pot bébé
antidérapant

519 194 00

PP/
TPE

5 855

10819
ewa „peppa“



kinder-toilettensitz
mit anti-rutsch-
funktion

40 x 30 x 15

519 194 00



PP/
TPE

5 720

toilet training seat
with anti-slip-
function

réducteur de siège wc
antidérapant

18431
tomek „peppa“



trittthocker mit
anti-rutsch-funktion

40,5 x 28,5 x 14

519 194 00



PP/
TPE

5 400

step stool with
anti-slip-function

marchepied
antidérapant



10032
igor „peppa“



trittthocker
zweistufig
mit anti-rutsch-funktion

40 x 37 x 21

519 194 00



PP/
TPE

5 210

double step stool
with anti-slip-function

double marchepied
antidérapant



12236
karolina „peppa“



art.-bezeichnung
article description
désignation

cm/l
cm/l
cm/l
↕ ↔ ↔

farbe
colour
couleur

ean13
barcode
ean13



mat. mam pal.
mat. moq pal.
mat. moq pal.

dreh- & stapelbox
mit deckel

15 l

turn-around stacking
box with lid

boîte empilable/
retournable avec
couvercle



12237
karolina „peppa“



dreh- & stapelbox
mit deckel

42,5 x 35,5 x 22,5

001 194 00



PP

5 120

24 l

turn-around stacking
box with lid

boîte empilable/
retournable avec
couvercle



12238
karolina „peppa“



dreh- & stapelbox
mit deckel

45 x 35 x 27

001 194 00



PP

5 90

30 l

turn-around stacking
box with lid

boîte empilable/
retournable avec
couvercle



12239
karolina „peppa“



dreh- & stapelbox
mit deckel

55,5 x 40 x 30

001 194 00



PP

5 60

45 l

turn-around stacking
box with lid

boîte empilable/
retournable avec
couvercle





keeper

art.-bezeichnung	cm/l	farbe	ean13	mat.	mam	pal.
article description	cm/l	colour	barcode	mat.	moq	pal.
désignation	cm/l	couleur	ean13	mat.	moq	pal.
	↕ ↔ ↔					

18679
olga „paw patrol“





toilettensitz soft	35,5 x 30,5 x 5	401 137 00			PP+	4	144
soft toilet training seat				4 052396 070866			
réducteur de siège wc soft							

soft
touch

art.-bezeichnung	cm/l	farbe	ean13	mat.	mam	pal.
article description	cm/l	colour	barcode	mat.	moq	pal.
désignation	cm/l	couleur	ean13	mat.	moq	pal.
	↕ ↔ ↔					



18670
adam „paw patrol“



babytopf mit anti-rutsch-funktion	38 x 27 x 23,5	100 137 00			PP/TPE	5	855
potty with anti-slip-function				4 001515 029056			
pot bébé antidérapant							



10819
ewa „paw patrol“



kinder-toilettensitz mit anti-rutsch-funktion	40 x 30 x 15	100 137 00			PP/TPE	5	720
toilet training seat with anti-slip-function				4 001515 029070			
réducteur de siège wc antidérapant							

18431
tomek „paw patrol“





trittthocker mit anti-rutsch-funktion	40,5 x 28,5 x 14	100 137 00			PP/TPE	5	400
step stool with anti-slip-function				4 001515 029094			
marchepied antidérapant							

+80
kg

10032
igor „paw patrol“



trittthocker zweistufig mit anti-rutsch-funktion	40 x 37 x 21	100 137 00			PP/TPE	5	210
double step stool with anti-slip-function				4 052396 032055			
double marchepied antidérapant							

+120
kg

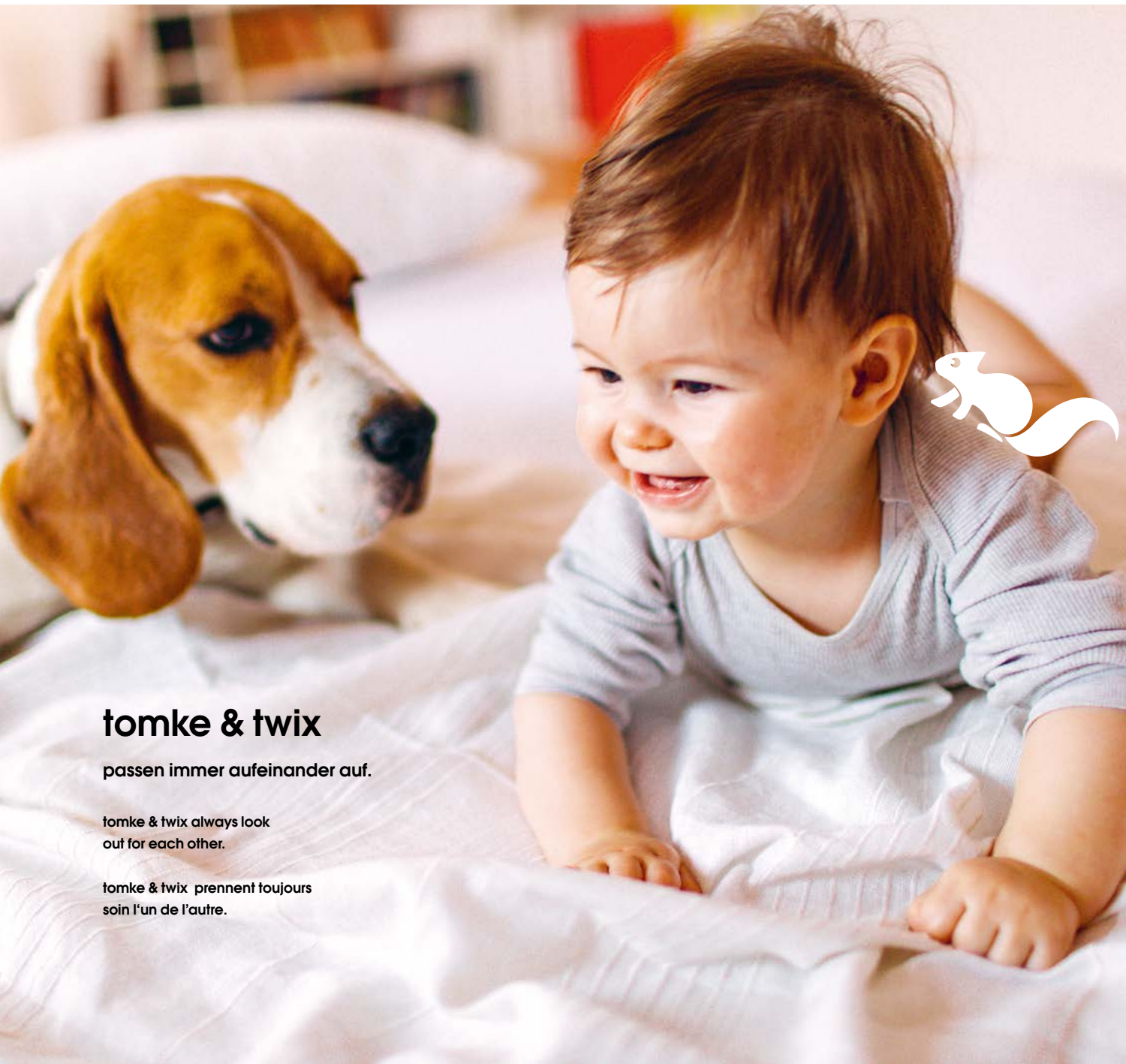

tomke & twix

passen immer aufeinander auf.

tomke & twix always look out for each other.

tomke & twix prennent toujours soin l'un de l'autre.



keeper

art.-bezeichnung article description désignation	cm/l cm/l cm/l ↕ ↔ ↗	farbe colour couleur	ean13 barcode ean13	mat. mat. mat.	mam moq moq	pal. pal. pal.
--	-------------------------------	----------------------------	---------------------------	----------------------	-------------------	----------------------

12236
karolina „paw patrol“



dreh- & stapelbox mit deckel	38 x 29,5 x 20,5	632 137 00			PP	5	160
turn-around stacking box with lid	15 l			4 052396 081534			
boîte empilable/ retournable avec couvercle							



12237
karolina „paw patrol“



dreh- & stapelbox mit deckel	42,5 x 35,5 x 22,5	632 137 00			PP	5	120
turn-around stacking box with lid	24 l			4 052396 081541			
boîte empilable/ retournable avec couvercle							



12238
karolina „paw patrol“



dreh- & stapelbox mit deckel	45 x 35 x 27	632 137 00			PP	5	90
turn-around stacking box with lid	30 l			4 052396 081558			
boîte empilable/ retournable avec couvercle							



12239
karolina „paw patrol“



dreh- & stapelbox mit deckel	55,5 x 40 x 30	632 137 00			PP	5	60
turn-around stacking box with lid	45 l			4 052396 081565			
boîte empilable/ retournable avec couvercle							



lilli & balu

sinnieren gerade über
die herausforderungen
ihrer nächsten mission.

lilli & balu are currently
pondering the challenges
of their next mission.

lilli & balu réfléchissent
aux défis de leur prochaine
mission.

keeper

18670
adam „fireman sam“



art.-bezeichnung
article description
désignation

cm/l
cm/l
cm/l
↕ ↔ ↔

farbe
colour
couleur

ean13
barcode
ean13



mat. mam pal.
mat. moq pal.
mat. moq pal.

PP/
TPE 5 855

babytopf mit
anti-rutsch-funktion

potty with
anti-slip-function

pot bébé
antidérapant

10819
ewa „fireman sam“



kinder-toilettensitz
mit anti-rutsch-
funktion

40 x 30 x 15

401 203 00



PP/
TPE 5 720

toilet training seat
with anti-slip-
function

réducteur de siège wc
antidérapant

18431
tomek „fireman sam“



trittstuehle mit
anti-rutsch-funktion

40,5 x 28,5 x 14

401 203 00



PP/
TPE 5 400

step stool with
anti-slip-function

marchepied
antidérapant

+80
kg

10032
igor „fireman sam“



trittstuehle
zweistufig
mit anti-rutsch-funktion

40 x 37 x 21

401 203 00



PP/
TPE 5 210

double step stool
with anti-slip-function

double marchepied
antidérapant

+120
kg

12236
karolina „fireman sam“



art.-bezeichnung
article description
désignation

cm/l
cm/l
cm/l
↕ ↔ ↔

farbe
colour
couleur

ean13
barcode
ean13



mat. mam pal.
mat. moq pal.
mat. moq pal.

dreh- & stapelbox
mit deckel

15 l

turn-around stacking
box with lid

boîte empilable/
retournable avec
couvercle

new

12237
karolina „fireman sam“



dreh- & stapelbox
mit deckel

42,5 x 35,5 x 22,5

401 203 00



PP 5 120

24 l

turn-around stacking
box with lid

boîte empilable/
retournable avec
couvercle

new

12238
karolina „fireman sam“



dreh- & stapelbox
mit deckel

45 x 35 x 27

401 203 00



PP 5 90

30 l

turn-around stacking
box with lid

boîte empilable/
retournable avec
couvercle

new

12239
karolina „fireman sam“



dreh- & stapelbox
mit deckel

55,5 x 40 x 30

401 203 00



PP 5 60

45 l

turn-around stacking
box with lid

boîte empilable/
retournable avec
couvercle

new

maja

weiß genau, wie man mit bärenhunger umgeht.

maja knows exactly how to deal with bear hunger.

maja sait exactement comment gérer une faim d'ours.

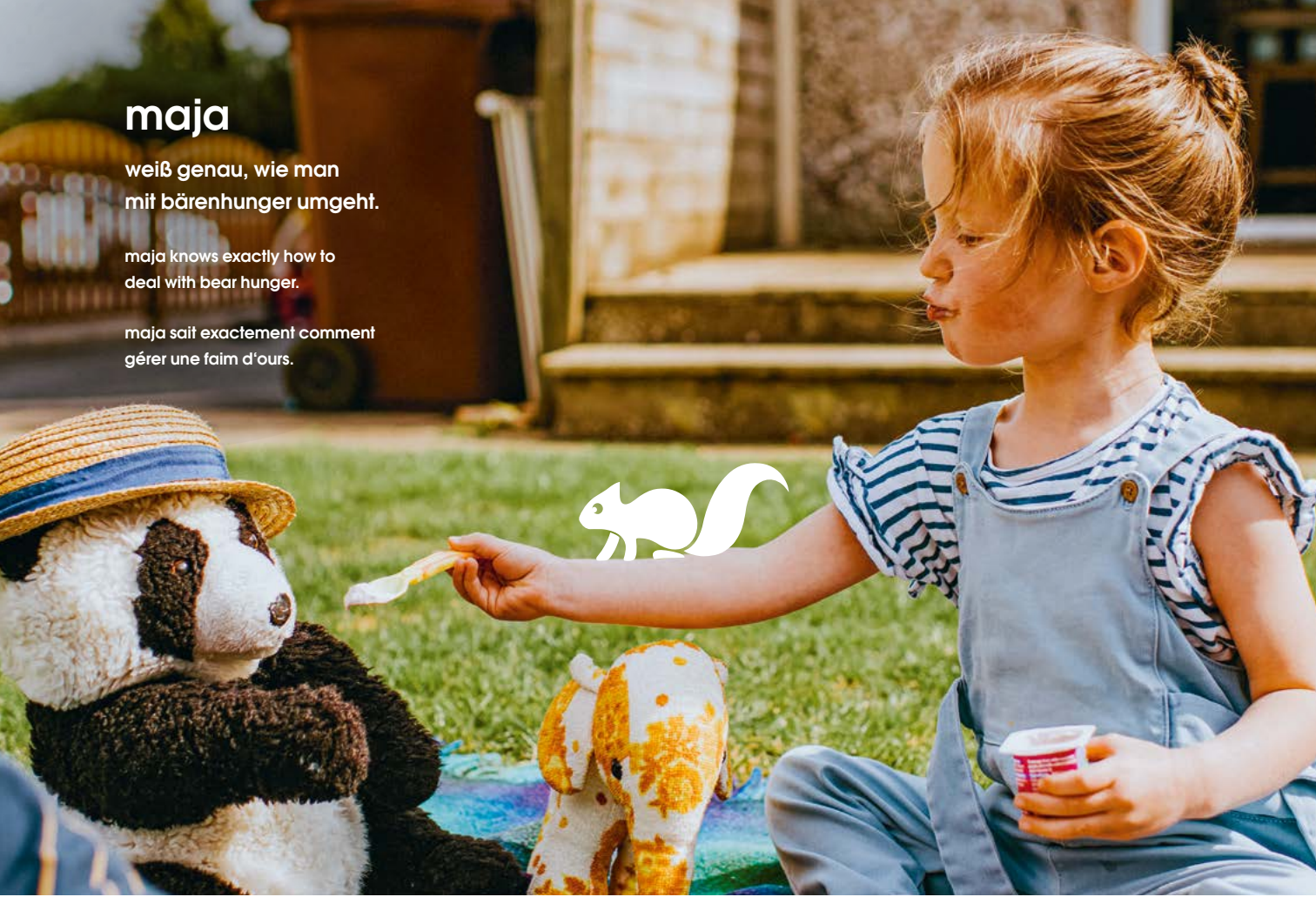

18673 amelia „panda“



wickelunterlage 70 x 50 x 5 100 241 00  PP 3 75
baby changing mat
matelas à langer

18672 pawel „panda“



wickelunterlage mit messlatte 70 x 50 x 10 100 241 00  PVC/ PUR/ MDF 2 32
baby changing top with measure
matelas à langer avec point de référence

keeper

art.-bezeichnung cm/l
article description cm/l
désignation cm/l

farbe colour
couleur

ean13 barcode
ean13

mat. mam pal.
mat. moq pal.
mat. moq pal.

18426 maria „panda“



babywanne 84 cm mit stöpsel 84 x 49 x 29

100 241 00 

 4 052396 072853

PP 5 255

baby bath 84 cm with plug

baignoire 84 cm avec vidange



18436 wiktoria „panda“



babywanne 84 cm 84 x 49 x 29

100 241 00 

 4 052396 072679

PP 5 255

baby bath 84 cm

baignoire 84 cm

18437 wiktoria „panda“



babywanne 100 cm 100 x 51 x 29

100 241 00 

 4 052396 072686

PP 5 200

baby bath 100 cm

baignoire 100 cm

keeper

art.-bezeichnung	cm/l	farbe	ean13	mat.	mam	pal.
article description	cm/l	colour	barcode	mat.	moq	pal.
désignation	cm/l	couleur	ean13	mat.	moq	pal.
	↕ ↔ ↗					

18648
adam „panda“



babytopf mit anti-rutsch-funktion	38 x 27 x 23,5	100 241 00		PP/ TPE	5	855
<p>potty with anti-slip-function</p> <p>pot bébé antidérapant</p>						

18650
ewa „panda“



kinder-toilettensitz mit anti-rutsch- funktion	40 x 30 x 15	100 241 00		PP/ TPE	5	720
<p>toilet training seat with anti-slip- function</p> <p>réducteur de siège wc antidérapant</p>						

18642
tomek „panda“



trittthocker mit anti-rutsch-funktion	40,5 x 28,5 x 14	100 241 00		PP/ TPE	5	400
<p>step stool with anti-slip-function</p> <p>marchepied antidérapant</p>						

+80
kg

10031
igor „panda“



trittthocker zweistufig mit anti-rutsch-funktion	40 x 37 x 21	100 241 00		PP/ TPE	5	210
<p>double step stool with anti-slip-function</p> <p>double marchepied antidérapant</p>						

+120
kg



luise

**gibt heute das mode-
motto vor: schick in strick.**

luise proudly presents today's
fashion motto chic in knitwear.

luise présente la devise de la mode
d'aujourd'hui : chic en tricot.

keeper

30076
natalia „stars“



art.-bezeichnung article description désignation	cm/l cm/l cm/l ↕ ↔ ↗	farbe colour couleur	ean13 barcode ean13	mat. mat. mat.	mam moq	pal. pal. pal.
babywanne mit softgriff, stöpsel und sitz	bath: 86 x 45,5 x 32,5	■	4 052396 045277	PP/ TPE	3	24
baby bath with soft handle, plug and chair	chair: 48 x 25,5 x 11					
baignoire bébé avec poignée souple, bouchon et dossier						



18426
maria „stars“



art.-bezeichnung article description désignation	cm/l cm/l cm/l ↕ ↔ ↗	farbe colour couleur	ean13 barcode ean13	mat. mat. mat.	mam moq	pal. pal. pal.
babywanne 84 cm mit stöpsel	84 x 49 x 29	■	4 052396 048421	PP	5	255
baby bath 84 cm with plug						
baignoire 84 cm avec vidange						



18648
adam „stars“



art.-bezeichnung article description désignation	cm/l cm/l cm/l ↕ ↔ ↗	farbe colour couleur	ean13 barcode ean13	mat. mat. mat.	mam moq	pal. pal. pal.
babytopf mit anti-rutsch-funktion	38 x 27 x 23,5	■	4 052396 045024	PP/ TPE	5	855
potty with anti-slip-function						
pot bébé antidérapant						

18650
ewa „stars“



art.-bezeichnung article description désignation	cm/l cm/l cm/l ↕ ↔ ↗	farbe colour couleur	ean13 barcode ean13	mat. mat. mat.	mam moq	pal. pal. pal.
kinder-toilettensitz mit anti-rutsch- funktion	40 x 30 x 15	■	4 052396 044881	PP/ TPE	5	720
toilet training seat with anti-slip- function						
réducteur de siège wc antidérapant						

18642
tomek „stars“



art.-bezeichnung article description désignation	cm/l cm/l cm/l ↕ ↔ ↗	farbe colour couleur	ean13 barcode ean13	mat. mat. mat.	mam moq	pal. pal. pal.
trittthocker mit anti-rutsch-funktion	40,5 x 28,5 x 14	■	4 052396 045000	PP/ TPE	5	400
step stool with anti-slip-function						
marchepied antidérapant						



10031
igor „stars“



art.-bezeichnung article description désignation	cm/l cm/l cm/l ↕ ↔ ↗	farbe colour couleur	ean13 barcode ean13	mat. mat. mat.	mam moq	pal. pal. pal.
trittthocker zweistufig mit anti-rutsch-funktion	40 x 37 x 21	■	4 052396 044867	PP/ TPE	5	210
double step stool with anti-slip-function						
double marche- ped antidérapant						



18673
amelia „stars“



art.-bezeichnung article description désignation	cm/l cm/l cm/l ↕ ↔ ↗	farbe colour couleur	ean13 barcode ean13	mat. mat. mat.	mam moq	pal. pal. pal.
wickelunterlage	70 x 50 x 5	■	4 052396 068689	PP	3	75
baby changing mat						
matelas à langer						

18672
pawel „stars“



art.-bezeichnung article description désignation	cm/l cm/l cm/l ↕ ↔ ↗	farbe colour couleur	ean13 barcode ean13	mat. mat. mat.	mam moq	pal. pal. pal.
wickelunterlage mit messlatte	70 x 50 x 10	■	4 052396 068665	PVC/ PUR/ MDF	2	32
baby changing top with measure						
matelas à langer avec point de référence						

keeper

30076
natalia „stars“



art.-bezeichnung
article description
désignation

cm/l
cm/l
cm/l
↕ ↔ ↗

farbe
colour
couleur

ean13
barcode
ean13

mat. mam pal.
mat. moq pal.
mat. moq pal.

babywanne mit
softgriff, stöpsel
und sitz

bath:
86 x 45,5 x 32,5

chair:
48 x 25,5 x 11

519 196 00



PP/
TPE 3 24

baby bath with
soft handle, plug
and chair

baignoire bébé avec
poignée souple,
bouchon et dossier



18426
maria „stars“



babywanne 84 cm
mit stöpsel

84 x 49 x 29

519 196 00



PP 5 255

baby bath 84 cm
with plug

baignoire 84 cm
avec vidange



18648
adam „stars“



babytopf mit
anti-rutsch-funktion

38 x 27 x 23,5

519 196 00



PP/
TPE 5 855

potty with
anti-slip-function

pot bébé
antidérapant

18650
ewa „stars“



kinder-toilettensitz
mit anti-rutsch-
funktion

40 x 30 x 15

519 196 00



PP/
TPE 5 720

toilet training seat
with anti-slip-
function

réducteur de siège wc
antidérapant

18642
tomek „stars“



art.-bezeichnung
article description
désignation

cm/l
cm/l
cm/l
↕ ↔ ↗

farbe
colour
couleur

ean13
barcode
ean13

mat. mam pal.
mat. moq pal.
mat. moq pal.

trittthocker mit
anti-rutsch-funktion

40,5 x 28,5 x 14

519 196 00



PP/
TPE 5 400

step stool with
anti-slip-function

marchepied
antidérapant



10031
igor „stars“



trittthocker
zweistufig
mit anti-rutsch-funktion

40 x 37 x 21

519 196 00



PP/
TPE 5 210

double step stool
with anti-slip-function

double marchepied
antidérapant



18673
amelia „stars“



wickelunterlage

70 x 50 x 5

519 196 00



PP 3 75

baby changing mat

matelas à langer

18672
pawel „stars“



wickelunterlage
mit messlatte

70 x 50 x 10

519 196 00



PVC/
PUR/
MDF 2 32

baby changing top
with measure

matelas à langer
avec point
de référence



keeper

12240
karolina „stars“



art.-bezeichnung article description désignation	cm/l cm/l cm/l ↕ ↔ ↗	farbe colour couleur	ean13 barcode ean13	mat. mat.	mam moq	pal. pal.
dreh- & stapelbox mit deckel 15 l turn-around stacking box with lid boîte empilable/ retournable avec couvercle	38 x 29,5 x 20,5	519 196 00		PP	5	160



12241
karolina „stars“



art.-bezeichnung article description désignation	cm/l cm/l cm/l ↕ ↔ ↗	farbe colour couleur	ean13 barcode ean13	mat. mat.	mam moq	pal. pal.
dreh- & stapelbox mit deckel 24 l turn-around stacking box with lid boîte empilable/ retournable avec couvercle	42,5 x 35,5 x 22,5	519 196 00		PP	5	120



12242
karolina „stars“



art.-bezeichnung article description désignation	cm/l cm/l cm/l ↕ ↔ ↗	farbe colour couleur	ean13 barcode ean13	mat. mat.	mam moq	pal. pal.
dreh- & stapelbox mit deckel 30 l turn-around stacking box with lid boîte empilable/ retournable avec couvercle	45 x 35 x 27	519 196 00		PP	5	90



12243
karolina „stars“



art.-bezeichnung article description désignation	cm/l cm/l cm/l ↕ ↔ ↗	farbe colour couleur	ean13 barcode ean13	mat. mat.	mam moq	pal. pal.
dreh- & stapelbox mit deckel 45 l turn-around stacking box with lid boîte empilable/ retournable avec couvercle	55,5 x 40 x 30	519 196 00		PP	5	60



11094
kaja „stars“



art.-bezeichnung article description désignation	cm/l cm/l cm/l ↕ ↔ ↗	farbe colour couleur	ean13 barcode ean13	mat. mat.	mam moq	pal. pal.
aufbewahrungsbox storage box boîte de rangement	29 x 19 x 12,4 4,2 l	130 196 00		PP	6	192



11095
kaja „stars“



art.-bezeichnung article description désignation	cm/l cm/l cm/l ↕ ↔ ↗	farbe colour couleur	ean13 barcode ean13	mat. mat.	mam moq	pal. pal.
aufbewahrungsbox storage box boîte de rangement	29 x 19 x 18 6,6 l	130 196 00		PP	6	144



11096
kaja „stars“



art.-bezeichnung article description désignation	cm/l cm/l cm/l ↕ ↔ ↗	farbe colour couleur	ean13 barcode ean13	mat. mat.	mam moq	pal. pal.
aufbewahrungsbox storage box boîte de rangement	39 x 19 x 12,4 10 l	130 196 00		PP	6	96



11097
kaja „stars“



art.-bezeichnung article description désignation	cm/l cm/l cm/l ↕ ↔ ↗	farbe colour couleur	ean13 barcode ean13	mat. mat.	mam moq	pal. pal.
aufbewahrungsbox storage box boîte de rangement	39 x 29 x 18 15,3 l	130 196 00		PP	6	72



roxy & tuana

möchten mit den hennen
rennen fahren.

roxy & tuana want to race
the hens.

roxy & tuana veulent faire une
course avec les poules.



18426 maria „funny farm“



babywanne 84 cm mit stöpsel 84 x 49 x 29 315 063 00   PP 5 255

baby bath 84 cm
with plug

baaignoire 84 cm
avec vidange



18436 wiktoria „funny farm“



babywanne 84 cm 84 x 49 x 29 315 063 00   PP 5 255

baby bath 84 cm

baaignoire 84 cm

18437 wiktoria „funny farm“



babywanne 100 cm 100 x 51 x 29 315 063 00   PP 5 200

baby bath 100 cm

baaignoire 100 cm

keeper

art.-bezeichnung cm/l
article description cm/l
désignation cm/l

farbe
colour
couleur

ean13
barcode
ean13

mat. mam pal.
mat. moq pal.
mat. moq pal.

18648 adam „funny farm“





babytopf mit anti-rutsch-funktion 38 x 27 x 23,5 315 063 00   PP/TPE 5 855

potty with anti-slip-function

pot bébé antidérapant

18650 ewa „funny farm“



kinder-toilettensitz mit anti-rutsch-funktion 40 x 30 x 15 315 063 00   PP/TPE 5 720

toilet training seat with anti-slip-function

réducteur de siège wc antidérapant

18642 tomek „funny farm“



trittthocker mit anti-rutsch-funktion 40,5 x 28,5 x 14 315 063 00   PP/TPE 5 400



step stool with anti-slip-function

marchepied antidérapant



10031 igor „funny farm“



trittthocker zweistufig mit anti-rutsch-funktion 40 x 37 x 21 315 063 00   PP/TPE 5 210

double step stool with anti-slip-function

double marchepied antidérapant



keeper

18426
maria „hippo“



art.-bezeichnung
article description
désignation

cm/l
cm/l
cm/l
↕ ↔ ↗

farbe
colour
couleur

ean13
barcode
ean13

mat. mam pal.
mat. moq pal.
mat. moq pal.

babywanne 84 cm 84 x 49 x 29
mit stöpsel

100 012 NN



PP 5 255

baby bath 84 cm
with plug

baignoire 84 cm
avec vidange



18436
wiktorja „hippo“



babywanne 84 cm 84 x 49 x 29

100 012 NN



PP 5 255

baby bath 84 cm

baignoire 84 cm

18437
wiktorja „hippo“



babywanne 100 cm 100 x 51 x 29

100 012 NN



PP 5 200

baby bath 100 cm

baignoire 100 cm

18648
adam „hippo“



babytopf mit
anti-rutsch-funktion

38 x 27 x 23,5

100 012 00



PP/TPE 5 855

potty with
anti-slip-function

pot bébé
antidérapant

18650
ewa „hippo“



kinder-toilettensitz
mit anti-rutsch-
funktion

40 x 30 x 15

100 012 NN



PP/TPE 5 720

toilet training seat
with anti-slip-function

réducteur de siège wc
antidérapant

18642
tomek „hippo“



trittthocker mit
anti-rutsch-funktion

40,5 x 28,5 x 14

100 012 NN



PP/TPE 5 400

step stool with
anti-slip-function

marchepied
antidérapant



10031
igor „hippo“



trittthocker
zweistufig
mit anti-rutsch-funktion

40 x 37 x 21

100 012 NN



PP/TPE 5 210

double step stool
with anti-slip-function

double marchepied
antidérapant



nils
hat nur augen für mama.

nils only has eyes for
mommy.

nils n'a d'yeux que
pour maman.

keeper

10334
wiktorja „little duck“



art.-bezeichnung article description désignation	cm/l cm/l cm/l ↕ ↔ ↗	farbe colour couleur	ean13 barcode ean13	mat. mat. mat.	mam moq moq	pal. pal. pal.
--	-------------------------------	----------------------------	---------------------------	----------------------	-------------------	----------------------

babywanne 84 cm	84 x 49 x 29	581 000 00			PP	5	255
baby bath 84 cm		680 000 00					
baaignoire 84 cm							

10336
wiktorja „little duck“



babywanne 100 cm	100 x 51 x 29	581 000 00			PP	5	200
baby bath 100 cm		680 000 00					
baaignoire 100 cm							

12028
franeK „little duck“



babytopf comfort	30 x 25 x 22	581 048 00			PP	5	720
potty comfort		680 048 00					
pot bébé comfort							

10013
tomeK „little duck“



trittthocker mit anti-rutsch-funktion	40,5 x 28,5 x 14	581 000 00			PP/ TPE	5	400
step stool with anti-slip-function		680 000 00					
marchepied antidérapant							

+80
kg

10015
dawid



art.-bezeichnung article description désignation	cm/l cm/l cm/l ↕ ↔ ↗	farbe colour couleur	ean13 barcode ean13	mat. mat. mat.	mam moq moq	pal. pal. pal.
--	-------------------------------	----------------------------	---------------------------	----------------------	-------------------	----------------------

universalständer für babywannen 84/100 cm		100 000 NN			steel	1	20
---	--	------------	--	--	-------	---	----

universal stand for baths
84/100 cm
pied universel pour baignoires
84/100 cm



zusammengeklappt/folded/plié:
84 cm: 127 x 55 x 40 cm
100 cm: 127 x 55 x 48 cm
aufgestellt/assembled/déplié:
84 cm: 97 x 55 x 85 cm
100 cm: 97 x 55 x 95 cm

10340
iwona



babybadenetZ		133 185 00			PUR/ PP/ polyester/ cotton	5	810
--------------	--	------------	--	--	-------------------------------------	---	-----

hamac de bain pour bébé

produkt / product / produit: 71 x 103 x 1 cm

verkaufsverpackung / sales packaging /
emballage pour la vente: 20,5 x 15,5 x 6,5 cm



elvis

formt seine haare
mit schaumfestiger.

elvis styles his hair with
styling mousse.

elvis modèle ses cheveux
avec une mousse coiffante.





art.-nr. art-no. réf.	name name nom	art.-bezeichnung	article description	désignation produit	seite page page
10013	tomek	trittthocker mit anti-rutsch-funktion "little duck"	step stool with anti-slip-function "little duck"	marchepléd antidérapante "little duck"	158
10015	dawid	universalständer für babywannen 84 / 100 cm	universal stand for baths 84 / 100 cm	pléd universel pour baignoire bébé 84 / 100 cm	159
10031	igor	trittthocker zweistufig mit anti-rutsch-funktion "panda"	double step stool with anti-slip-function "panda"	double marchepléd antidérapant "panda"	146
10031	igor	trittthocker zweistufig mit anti-rutsch-funktion "stars"	double step stool with anti-slip-function "stars"	double marchepléd antidérapant "stars"	149, 151
10031	igor	trittthocker zweistufig mit anti-rutsch-funktion "funny farm"	double step stool with anti-slip-function "funny farm"	double marchepléd antidérapant "funny farm"	155
10031	igor	trittthocker zweistufig mit anti-rutsch-funktion "hippo"	double step stool with anti-slip-function "hippo"	double marchepléd antidérapant "hippo"	157
10032	igor	trittthocker zweistufig mit anti-rutsch-funktion "winnie"	double step stool with anti-slip-function "winnie"	double marchepléd antidérapant "winnie"	121
10032	igor	trittthocker zweistufig mit anti-rutsch-funktion "minnie"	double step stool with anti-slip-function "minnie"	double marchepléd antidérapant "minnie"	124
10032	igor	trittthocker zweistufig mit anti-rutsch-funktion "mickey"	double step stool with anti-slip-function "mickey"	double marchepléd antidérapant "mickey"	126
10032	igor	trittthocker zweistufig mit anti-rutsch-funktion "frozen"	double step stool with anti-slip-function "frozen"	double marchepléd antidérapant "frozen"	131
10032	igor	trittthocker zweistufig mit anti-rutsch-funktion "cars"	double step stool with anti-slip-function "cars"	double marchepléd antidérapant "cars"	134
10032	igor	trittthocker zweistufig mit anti-rutsch-funktion "peppa"	double step stool with anti-slip-function "peppa"	double marchepléd antidérapant "peppa"	136
10032	igor	trittthocker zweistufig mit anti-rutsch-funktion "paw patrol"	double step stool with anti-slip-function "paw patrol"	double marchepléd antidérapant "paw patrol"	139
10032	igor	trittthocker zweistufig mit anti-rutsch-funktion "fireman sam"	double step stool with anti-slip-function "fireman sam"	double marchepléd antidérapant "fireman sam"	142
10066	luis	euro-box mit softgriffen 20 l	euro-box with soft-grips 20 l	euro-box avec poignées souples 20 l	98
10068	luis	euro-box mit softgriffen 64 l	euro-box with soft-grips 64 l	euro-box avec poignées souples 64 l	98
10069	luisa	deckel für euro-box mit softgriffen 20 l	lid for euro-box with soft-grips 20 l	couvercle pour euro-box avec poignées souples 20 l	98
10070	luisa	deckel für euro-box mit softgriffen 64 l	lid for euro-box with soft-grips 64 l	couvercle pour euro-box avec poignées souples 64 l	98
10092	tilda	wanne ergonomisch 30,5 l	laundry tub ergonomic 30,5 l	baquet à linge ergonomique 30,5 l	17, 57
10093	anton	wäschekorb ergonomisch 30,5 l	laundry basket ergonomic 30,5 l	corbeille à linge ergonomique 30,5 l	57
10101	erik	eimer 5 l	bucket 5 l	seau 5 l	61
10104	erik	eimer 10 l	bucket 10 l	seau 10 l	61
10107	bent	putzimer eckig 13 l	cleaning bucket rectangular 13 l	seau rectangulaire 13 l	61
10125	fred	körbchen 25 x 17 x 10 cm	mini basket 25 x 17 x 10 cm	mini panier 25 x 17 x 10 cm	110
10126	fred	körbchen 30 x 20 x 11 cm	mini basket 30 x 20 x 11 cm	mini panier 30 x 20 x 11 cm	110
10136	wilma	wännchen 30 x 20 x 11 cm	mini tub 30 x 20 x 11 cm	mini box 30 x 20 x 11 cm	111
10151	jasper	papierkorb 11,5 l	waste-paper basket 11,5 l	poubelle ronde à papier 11,5 l	68
10162	pablo	besteckkasten geschlossen 5 fächer	cutlery box 5 compartments	range couverts 5 compartments	46
10163	pablo	besteckkasten geschlossen 7 fächer	cutlery box 7 compartments	range couverts 7 compartments	46
10174	carlotta	rührschüssel mit anti-rutsch-funktion 1,5 l	mixing bowl with anti-slip function 1,5 l	bol à mixer antidérapant 1,5 l	33
10175	carlotta	rührschüssel mit anti-rutsch-funktion 3,5 l	mixing bowl with anti-slip function 3,5 l	bol à mixer antidérapant 3,5 l	33
10180	emilia	deckel für dreh-/stapelbox 24 l	lid for turn around stacking box 24 l	couvercle pour boîte empilable/retournable 24 l	105
10188	emil	dreh-/stapelbox 24 l	turn around stacking box 24 l	boîte empilable / retournable 24 l	18, 104
10212	mats	mini-tonne 7 l	mini-bin 7 l	mini-poubelle baril 7 l	21, 69
10213	mats	maxi-tonne 23 l	maxi-bin 23 l	maxi-poubelle baril 23 l	21, 69
10214	mats	supermax-tonne 50 l	supermax-bin 50 l	poubelle supermax 50 l	69
10219	hugo	mega-tonne 70 l	mega-bin 70 l	poubelle mega 70 l	69
10222	emma	einkaufsbox faltbar 18,5 l	foldable shoppy box 18,5 l	casier à provisions pliable 18,5 l	103
10224	ida	klappbox 32 l	folding box 32 l	casier pliant 32 l	103
10230	tim	trittthocker	step stool	tabouret	109
10246	franziska	deckel für multi-box s	lid for multi-box s	couvercle pour multi-box s	107
10247	franziska	deckel für multi-box m	lid for multi-box m	couvercle pour multi-box m	107
10248	franziska	deckel für multi-box l + xl	lid for multi-box l + xl	couvercle pour multi-box l + xl	107
10249	franziska	deckel für multi-box xxl	lid for multi-box xxl	couvercle pour multi-box xxl	107
10271	franz	multi-box s 6,5 l	multi-box s 6,5 l	multi-box s 6,5 l	106
10272	franz	multi-box m 13,5 l	multi-box m 13,5 l	multi-box m 13,5 l	106
10273	franz	multi-box l 16 l	multi-box l 16 l	multi-box l 16 l	106
10274	franz	multi-box xl 24 l	multi-box xl 24 l	multi-box xl 24 l	106
10275	franz	multi-box xxl 44 l	multi-box xxl 44 l	multi-box xxl 44 l	106
10290	knut	bio-abfallbehälter 4,5 l	bin for bio wastes 4,5 l	poubelle pour bio déchets 4,5 l	17
10297	ben	prof-klappbox mit softgriffen 45 l	folding box extra strong with soft-grips 45 l	casier pliant avec poignées souples 45 l	102
10298	alex	deckel für klappbox 32 l	lid for folding box 32 l	couvercle pour casier pliant 32 l	103
10299	alex	deckel für klappbox 45 l	lid for folding box 45 l	couvercle pour casier pliant 45 l	103
10300	gunnar	tretermer 7 l + 15 l	pedal bin 7 l + 15 l	poubelle à pédale 7 l + 15 l	67
10306	swantje	abfallbehälter mit schwingdeckel 10 l	waste bin with swing lid 10 l	poubelle avec couvercle swing 10 l	20, 64
10307	swantje	abfallbehälter mit schwingdeckel 25 l	waste bin with swing lid 25 l	poubelle avec couvercle swing 25 l	20, 64

art.-nr. art-no. réf.	name name nom	art.-bezeichnung	article description	désignation produit	seite page page
10308	swantje	abfallbehälter mit schwingdeckel 50 l	waste bin with swing lid 50 l	poubelle avec couvercle swing 50 l	64
10334	wiktoria	babywanne 84 cm "little duck"	baby bath 84 cm "little duck"	baignoire 84 cm "little duck"	158
10336	wiktoria	babywanne 100 cm "little duck"	baby bath 100 cm "little duck"	baignoire 100 cm "little duck"	158
10340	iwona	babybadenez	baby bath net	hamac de bain pour bébé	159
10367	jonas	stapelkörbchen A4	mini storage basket A4	corbeille A4	78
10368	jonas	stapelkörbchen A5	mini storage basket A5	corbeille A5	78
10369	jonas	stapelkörbchen A6	mini storage basket A6	corbeille A6	78
10370	jonas	stapelkörbchen A7	mini storage basket A7	corbeille A7	78
10371	mirko	stapelkörbchen A4	mini storage basket A4	corbeille A4	23, 79
10372	mirko	stapelkörbchen A5	mini storage basket A5	corbeille A5	23, 79
10373	mirko	stapelkörbchen A6	mini storage basket A6	corbeille A6	23, 79
10374	mirko	stapelkörbchen A7	mini storage basket A7	corbeille A7	23, 79
10390	fritz	dreh-/stapelkorb s	turn around stacking basket s	boîte retournable/empilable s	110
10391	fritz	dreh-/stapelkorb m	turn around stacking basket m	boîte retournable/empilable m	110
10417	jean	cerealien-box 1,25 l	cereal-dispenser 1,25 l	boîte à céréales 1,25 l	49
10418	jean	cerealien-box 2,6 l	cereal-dispenser 2,6 l	boîte à céréales 2,6 l	49
10419	jean	cerealien-box 5 l	cereal-dispenser 5 l	boîte à céréales 5 l	49
10426	cornelia	kristallbox 33 l	crystalbox 33 l	cristalbox 33 l	81
10427	cornelia	kristallbox 83 l	crystalbox 83 l	cristalbox 83 l	81
10429	cornelia	kristallbox 28 l	crystalbox 28 l	cristalbox 28 l	81
10436	konrad	kristallbox mit rollen 33 l	crystalbox with casters 33 l	cristalbox avec roues 33 l	82
10437	konrad	kristallbox mit rollen 83 l	crystalbox with casters 83 l	cristalbox avec roues 83 l	82
10439	konrad	kristallbox mit rollen 28 l	crystalbox with casters 28 l	cristalbox avec roues 28 l	82
10451	franca	besteckkasten ausziehbar	cutlery box adjustable	range couverts extensible	46
10453	rasmus	abfallbehälter mit roldeckel 10 l	waste bin with roll lid 10 l	poubelle avec couvercle roll 10 l	20, 65
10454	rasmus	abfallbehälter mit roldeckel 25 l	waste bin with roll lid 25 l	poubelle avec couvercle roll 25 l	20, 65
10455	rasmus	abfallbehälter mit roldeckel 50 l	waste bin with roll lid 50 l	poubelle avec couvercle roll 50 l	65
10462	filippa	besteckkasten mit schieber 13-fächer	cutlery box with slider 13-compartments	range couverts 13 compartiments avec élément coulissant	46
10468	fabrizio	keep-fresh-container	keep-fresh-container	keep-fresh-container	47
10469	bella	mikrowellenabdeckhaube	microwave cover	couvre assiettes micro-ondes	47
10481	paola	schüttdose 0,25 l	pouring jar 0,25 l	boîte à bec verseur 0,25 l	50
10482	paola	schüttdose 0,75 l	pouring jar 0,75 l	boîte à bec verseur 0,75 l	50
10483	paola	schüttdose 1,5 l	pouring jar 1,5 l	boîte à bec verseur 1,5 l	51
10484	paola	schüttdose 0,5 l	pouring jar 0,5 l	boîte à bec verseur 0,5 l	50
10485	paola	schüttdose 1 l	pouring jar 1 l	boîte à bec verseur 1 l	50
10490	massimo	messkanne mit anti-rutsch-funktion 0,5 l	measuring jug with anti-slip-function 0,5 l	pichet doseur antidérapant 0,5 l	32
10491	massimo	messkanne mit anti-rutsch-funktion 1 l	measuring jug with anti-slip-function 1 l	pichet doseur antidérapant 1 l	32
10492	massimo	messkanne mit anti-rutsch-funktion 1,5 l	measuring jug with anti-slip-function 1,5 l	pichet doseur antidérapant 1,5 l	32
10493	mario	messbecher 0,25 l	measuring jug 0,25 l	pichet doseur 0,25 l	31
10516	emil	dreh-/stapelbox 30 l	turn around stacking box 30 l	boîte empilable/retournable 30 l	18, 104
10517	emilia	deckel für dreh-/stapelbox 30 l	lid for turn around stacking box 30 l	couvercle pour boîte empilable/retournable 30 l	105
10530	fabio	stielseiher	colander with grip	passoire avec manche	47
10532	fabienne	seiher	colander	passoire	47
10536	emil	dreh-/stapelbox 45 l	turn around stacking box 45 l	boîte empilable/retournable 45 l	18, 104
10537	emilia	deckel für dreh-/stapelbox 45 l	lid for turn around stacking box 45 l	couvercle pour boîte empilable/retournable 45 l	105
10541	emil	dreh-/stapelbox 7 l	turn around stacking box 7 l	boîte empilable/retournable 7 l	104
10542	emilia	deckel für dreh-/stapelbox 7 l	lid for turn around stacking box 7 l	couvercle pour boîte empilable/retournable 7 l	105
10546	emil	dreh-/stapelbox 15 l	turn around stacking box 15 l	boîte empilable/retournable 15 l	18, 104
10547	emilia	deckel für dreh-/stapelbox 15 l	lid for turn around stacking box 15 l	couvercle pour boîte empilable/retournable 15 l	105
10551	björk	schüssel rund 1,5 l	bowl round 1,5 l	cuvette ronde 1,5 l	62
10552	björk	schüssel rund 2,5 l	bowl round 2,5 l	cuvette ronde 2,5 l	62
10553	björk	schüssel rund 3,5 l	bowl round 3,5 l	cuvette ronde 3,5 l	62
10554	björk	schüssel rund 6 l	bowl round 6 l	cuvette ronde 6 l	62
10555	björk	schüssel rund 9 l	bowl round 9 l	cuvette ronde 9 l	63
10556	björk	schüssel eckig 8 l	bowl square 8 l	cuvette carrée 8 l	63
10557	björk	schüssel eckig 13 l	bowl square 13 l	cuvette carrée 13 l	63



art.-nr. art.-no. réf.	name name nom	art.-bezeichnung	article description	désignation produit	seite page page
10558	björk	schüssel eckig 9 l	bowl rectangular 9 l	cuvette carrée 9 l	63
10574	bea	clearbox 1,7 l	clearbox 1,7 l	clearbox 1,7 l	92
10575	bea	clearbox 8 l	clearbox 8 l	clearbox 8 l	92
10576	bea	clearbox 9 l	clearbox 9 l	clearbox 9 l	92
10577	bea	clearbox 18 l	clearbox 18 l	clearbox 18 l	93
10578	bea	clearbox 5,6 l	clearbox 5,6 l	clearbox 5,6 l	92
10579	bea	clearbox 11 l	clearbox 11 l	clearbox 11 l	92
10580	bea	clearbox 30 l	clearbox 30 l	clearbox 30 l	93
10581	pino	besteckabtropfer	cutlery drainer	égouttoir à couverts	49
10582	bea	clearbox 30 l	clearbox 30 l	clearbox 30 l	93
10583	bea	clearbox 52 l	clearbox 52 l	clearbox 52 l	93
10585	pierre	geschirrablaufkorb mit tablett small	dish-drainer basket with tray small	petit égouttoir à vaisselle avec plateau	48
10586	pierre	geschirrablaufkorb mit tablett large	dish-drainer basket with tray large	grand égouttoir à vaisselle avec plateau	48
10589	pascale	geschirrablaufkorb large	dish-drainer basket large	grand égouttoir à vaisselle	48
10603	magne	abfallbehälter mit flip-Deckel 10 l	waste bin with flip lid 10 l	poubelle avec couvercle flip 10 l	21, 66
10604	magne	abfallbehälter mit flip-Deckel 25 l	waste bin with flip lid 25 l	poubelle avec couvercle flip 25 l	21, 66
10605	magne	abfallbehälter mit flip-Deckel 45 l	waste bin with flip lid 45 l	poubelle avec couvercle flip 45 l	66
10677	marco	party-butler	party-butler	party-butler	33
10678	svenja	bio-küchenabfallbehälter mit schwingdeckel 1,3 l	bio bin with swing lid 1,3 l	poubelle bio déchets avec swing couvercle 1,3 l	17
10691	luca	click-box micro 0,35 l	click-box micro 0,35 l	click-box micro 0,35 l	43
10692	luca	click-box mini 0,5 l	click-box mini 0,5 l	click-box mini 0,5 l	43
10693	luca	click-box midi 1 l	click-box midi 1 l	click-box midi 1 l	43
10694	carla	deco-click-box "space tour" mini 0,5 l	deco-click-box "space tour" mini 0,5 l	deco-click-box "space tour" mini 0,5 l	42
10694	carla	deco-click-box "space tour" mini 0,5 l	deco-click-box "space tour" mini 0,5 l	deco-click-box "space tour" mini 0,5 l	42
10694	carla	deco-click-box "space tour" mini 0,5 l	deco-click-box "space tour" mini 0,5 l	deco-click-box "space tour" mini 0,5 l	42
10695	luca	click-box maxi 3,7 l	click-box maxi 3,7 l	click-box maxi 3,7 l	43
10697	carla	deco-click-box "space tour" midi 1 l	deco-click-box "space tour" midi 1 l	deco-click-box "space tour" midi 1 l	42
10697	carla	deco-click-box "space tour" midi 1 l	deco-click-box "space tour" midi 1 l	deco-click-box "space tour" midi 1 l	42
10697	carla	deco-click-box "space tour" midi 1 l	deco-click-box "space tour" midi 1 l	deco-click-box "space tour" midi 1 l	43
10701	per	wäschebox 60 l	laundry hamper 60 l	coffre à linge 60 l	58
10734	emilio	runder tortenbehälter flach	round cake container flat	cloche à gâteau basse	30
10735	emilio	runder tortenbehälter hoch	round cake container high	cloche à gâteau haute	30
10737	gino	kastenkuchenbehälter	loaf shaped cake container	boîte à gâteau	30
10742	mariella	rührschüssel mit saugnapf 1,5 l	mixing bowl with suction cup 1,5 l	bol à mixer antidérapant 1,5 l	31
10743	mariella	rührschüssel mit saugnapf 3,5 l	mixing bowl with suction cup 3,5 l	bol à mixer antidérapant 3,5 l	31
10762	tabea	puderzuckerstreuer	icing sugar dispenser	saupeudreuse de sucre glace	30
10765	bruni	schüttdose 0,25 l	pouring jar 0,25 l	boîte verseuse 0,25 l	28
10766	bruni	schüttdose 0,5 l	pouring jar 0,5 l	boîte verseuse 0,5 l	28
10767	bruni	schüttdose 1 l	pouring jar 1 l	boîte verseuse 1 l	28
10768	bruni	schüttdose 1,5 l	pouring jar 1,5 l	boîte verseuse 1,5 l	28
10769	bruni	schüttdose 2,5 l	pouring jar 2,5 l	boîte verseuse 2,5 l	29
10780	jost	wäschekorb 32 l	laundry basket 32 l	corbeille à linge 32 l	57
10781	jost	wäschekorb 52 l	laundry basket 52 l	corbeille à linge 52 l	57
10782	lasse	wäschekorb ergonomisch mit softgriffen 50 l	laundry basket ergonomic with soft-grips 50 l	corbeille à linge ergonomique avec poignées souples 50 l	56
10783	janne	wanne ergonomisch mit softgriffen 50 l	laundry tub ergonomic with soft-grips 50 l	baquet à linge ergonomique avec poignées souples 50 l	56
10785	aenna	wanne 32 l	laundry tub 32 l	baquet 32 l	58
10786	aenna	wanne 52 l	laundry tub 52 l	baquet 52 l	58
10787	thies	putzelimer oval 13 l	cleaning bucket oval 13 l	seau de nettoyage ovale 13 l	61
10819	ewa	kinder-toilettensitz mit anti-rutsch-funktion "winnie"	toilet training seat with anti-slip-function "winnie"	réducteur de siège wc antidérapant "winnie"	120
10819	ewa	kinder-toilettensitz mit anti-rutsch-funktion "minnie"	toilet training seat with anti-slip-function "minnie"	réducteur de siège wc antidérapant "minnie"	124
10819	ewa	kinder-toilettensitz mit anti-rutsch-funktion "mickey"	toilet training seat with anti-slip-function "mickey"	réducteur de siège wc antidérapant "mickey"	126
10819	ewa	kinder-toilettensitz mit anti-rutsch-funktion "frozen"	toilet training seat with anti-slip-function "frozen"	réducteur de siège wc antidérapant "frozen"	131
10819	ewa	kinder-toilettensitz mit anti-rutsch-funktion "cars"	toilet training seat with anti-slip-function "cars"	réducteur de siège wc antidérapant "cars"	134
10819	ewa	kinder-toilettensitz mit anti-rutsch-funktion "peppa"	toilet training seat with anti-slip-function "peppa"	réducteur de siège wc antidérapant "peppa"	136
10819	ewa	kinder-toilettensitz mit anti-rutsch-funktion "paw patrol"	toilet training seat with anti-slip-function "paw patrol"	réducteur de siège wc antidérapant "paw patrol"	139
10819	ewa	kinder-toilettensitz mit anti-rutsch-funktion "fireman sam"	toilet training seat with anti-slip-function "fireman sam"	réducteur de siège wc antidérapant "fireman sam"	142

art.-nr. art.-no. réf.	name name nom	art.-bezeichnung	article description	désignation produit	seite page page
10828	roberla	deckel für transportbox 40 x 30 cm	lid for transport box 40 x 30 cm	couvercle pour boîte de transport 40 x 30 cm	97
10829	roberla	deckel für transportbox und -korb 60 x 40 cm	lid for transport box and basket 60 x 40 cm	couvercle pour boîte et basket de transport 60 x 40 cm	97
10830	eckhart	transportbehälter extra stabil 83 l	transport box extra strong 83 l	transport box extra-solide 83 l	101
10831	eckhart	transportbehälter extra stabil 33 l	transport box extra strong 33 l	transport box extra-solide 33 l	100
10844	eckhart	transportbehälter extra stabil 12 l	transport box extra strong 12 l	transport box extra-solide 12 l	100
10845	eckhart	transportbehälter extra stabil 24 l	transport box extra strong 24 l	transport box extra-solide 24 l	100
10847	eckhart	transportbehälter extra stabil 52 l	transport box extra strong 52 l	transport box extra-solide 52 l	100
10877	rolf	transportroller für transportboxen und -körbe	transport roller for transport boxes and -baskets	plateau de transport à roues pour transport box et basket	96
10878	alma	einkaufskorb 15 l	shuppy basket 15 l	panier à provisions 15 l	103
10882	robert	transportbox 20 l	transport box 20 l	boîte de transport 20 l	96
10883	robert	transportkorb 22 l	transport basket 22 l	basket de transport 22 l	97
10884	robert	transportbox 45 l	transport box 45 l	boîte de transport 45 l	96
10885	robert	transportkorb 64 l	transport basket 64 l	basket de transport 64 l	97
10886	robert	transportbox 64 l	transport box 64 l	boîte de transport 64 l	96
10902	max	maxi-hocker	maxi-stool	maxi tabouret	109
10910	lolta	lifestyle-box 1,8 l	lifestyle-box 1,8 l	lifestyle-box 1,8 l	59
10911	lolta	lifestyle-box 6 l	lifestyle-box 6 l	lifestyle-box 6 l	59
10912	lolta	lifestyle-box 12 l	lifestyle-box 12 l	lifestyle-box 12 l	59
10913	lolta	lifestyle-box 20 l	lifestyle-box 20 l	lifestyle-box 20 l	59
10940	cornelia	kristallbox 4 l	crystalbox 4 l	cristalbox 4 l	80
10941	cornelia	kristallbox 12 l	crystalbox 12 l	cristalbox 12 l	80
10942	cornelia	kristallbox 52 l	crystalbox 52 l	cristalbox 52 l	81
10943	konrad	kristallbox mit rollen 52 l	crystalbox with casters 52 l	cristalbox avec roues 52 l	82
10944	cornelia	kristallbox 7 l	crystalbox 7 l	cristalbox 7 l	80
10945	cornelia	kristallbox 24 l	crystalbox 24 l	cristalbox 24 l	80
11011	ronja	clipbox extra stabil 27 l	clipbox extra strong 27 l	clipbox extra solide 27 l	85
11012	ronja	clipbox extra stabil 55 l	clipbox extra strong 55 l	clipbox extra solide 55 l	85
11013	ronja	clipbox extra stabil 115 l	clipbox extra strong 115 l	clipbox extra solide 115 l	85
11020	lara	clipbox 1,15 l	clipbox 1,15 l	clipbox 1,15 l	86
11021	lara	clipbox 1,6 l	clipbox 1,6 l	clipbox 1,6 l	86
11022	lara	clipbox 2 l	clipbox 2 l	clipbox 2 l	87
11024	lara	clipbox 3 l	clipbox 3 l	clipbox 3 l	87
11025	lara	clipbox 3,1 l	clipbox 3,1 l	clipbox 3,1 l	87
11028	lara	clipbox 5,75 l	clipbox 5,75 l	clipbox 5,75 l	88
11029	lara	clipbox 6,5 l	clipbox 6,5 l	clipbox 6,5 l	87
11031	lara	clipbox 8,5 l	clipbox 8,5 l	clipbox 8,5 l	88
11032	lara	clipbox 12,5 l	clipbox 12,5 l	clipbox 12,5 l	88
11033	lara	clipbox 15,5 l	clipbox 15,5 l	clipbox 15,5 l	88
11040	lars	clipbox mit rollen 29 l	clipbox with casters 29 l	clipbox avec roues 29 l	90
11041	lars	clipbox mit rollen 35 l	clipbox with casters 35 l	clipbox avec roues 35 l	90
11042	lars	clipbox mit rollen 40 l	clipbox with casters 40 l	clipbox avec roues 40 l	90
11044	lars	clipbox mit rollen 60 l	clipbox with casters 60 l	clipbox avec roues 60 l	90
11045	lars	clipbox mit rollen 6 l	clipbox with casters 6 l	clipbox avec roues 6 l	91
11046	lars	clipbox mit rollen 75 l	clipbox with casters 75 l	clipbox avec roues 75 l	91
11047	lars	clipbox mit rollen 80 l	clipbox with casters 80 l	clipbox avec roues 80 l	91
11048	lars	clipbox mit rollen 145 l	clipbox with casters 145 l	clipbox avec roues 145 l	91
11050	larissa	clipbox mit griff 6 l	clipbox with handle 6 l	clipbox avec poignée 6 l	89
11051	larissa	clipbox mit griff 9 l	clipbox with handle 9 l	clipbox avec poignée 9 l	89
11052	larissa	clipbox mit griff 13 l	clipbox with handle 13 l	clipbox avec poignée 13 l	89
11053	larissa	clipbox mit griff 5,75 l	clipbox with handle 5,75 l	clipbox avec poignée 5,75 l	89
11056	larissa	clipbox mit griff 15,5 l	clipbox with handle 15,5 l	clipbox avec poignée 15,5 l	89
11086	kaja	aufbewahrungsbox "minnie&mickey" 4,2 l	storage box "minnie&mickey" 4,2 l	boîte de rangement "minnie&mickey" 4,2 l	128
11087	kaja	aufbewahrungsbox "minnie&mickey" 6,6 l	storage box "minnie&mickey" 6,6 l	boîte de rangement "minnie&mickey" 6,6 l	128
11088	kaja	aufbewahrungsbox "minnie&mickey" 10 l	storage box "minnie&mickey" 10 l	boîte de rangement "minnie&mickey" 10 l	128
11089	kaja	aufbewahrungsbox "minnie&mickey" 15,3 l	storage box "minnie&mickey" 15,3 l	boîte de rangement "minnie&mickey" 15,3 l	128
11094	lina	aufbewahrungsbox "jungle" 4,2 l	storage box "jungle" 4,2 l	boîte de rangement "jungle" 4,2 l	74



art.-nr. art-no. réf.	name name nom	art.-bezeichnung	article description	désignation produit	seite page page
11094	lina	aufbewahrungsbox "sweet home" 4,2 l	storage box "sweet home" 4,2 l	boîte de rangement "sweet home" 4,2 l	75
11094	kaja	aufbewahrungsbox "stars" 4,2 l	storage box "stars" 4,2 l	boîte de rangement "stars" 4,2 l	153
11095	lina	aufbewahrungsbox "jungle" 6,6 l	storage box "jungle" 6,6 l	boîte de rangement "jungle" 6,6 l	74
11095	lina	aufbewahrungsbox "sweet home" 6,6 l	storage box "sweet home" 6,6 l	boîte de rangement "sweet home" 6,6 l	75
11095	kaja	aufbewahrungsbox "stars" 6,6 l	storage box "stars" 6,6 l	boîte de rangement "stars" 6,6 l	153
11096	lina	aufbewahrungsbox "jungle" 10 l	storage box "jungle" 10 l	boîte de rangement "jungle" 10 l	74
11096	lina	aufbewahrungsbox "sweet home" 10 l	storage box "sweet home" 10 l	boîte de rangement "sweet home" 10 l	75
11096	kaja	aufbewahrungsbox "stars" 10 l	storage box "stars" 10 l	boîte de rangement "stars" 10 l	153
11097	lina	aufbewahrungsbox "jungle" 15,3 l	storage box "jungle" 15,3 l	boîte de rangement "jungle" 15,3 l	74
11097	lina	aufbewahrungsbox "sweet home" 15,3 l	storage box "sweet home" 15,3 l	boîte de rangement "sweet home" 15,3 l	75
11097	kaja	aufbewahrungsbox "stars" 15,3 l	storage box "stars" 15,3 l	boîte de rangement "stars" 15,3 l	153
11100	hubert & hilda	universal-box und einsatz für universal-box 4,2 l	storage box with insert 4,2 l	boîte de rangement avec insert 4,2 l	76
11101	hubert & hilda	universal-box und einsatz für universal-box 6,6 l	storage box with insert 6,6 l	boîte de rangement avec insert 6,6 l	76
11102	hubert & hilda	universal-box und einsatz für universal-box 10 l	storage box with insert 10 l	boîte de rangement avec insert 10 l	76
11103	hubert & hilda	universal-box und einsatz für universal-box 15,3 l	storage box with insert 15,3 l	boîte de rangement avec insert 15,3 l	76
11110	tino	frischhaltedose 1 l	food storage box 1 l	boîte fraîcheur 1 l	37
11111	tino	frischhaltedose 1,15 l	food storage box 1,15 l	boîte fraîcheur 1,15 l	37
11112	tino	frischhaltedose 1,35 l	food storage box 1,35 l	boîte fraîcheur 1,35 l	37
11113	tino	frischhaltedose 0,45 l	food storage box 0,45 l	boîte fraîcheur 0,45 l	36
11114	tino	frischhaltedose 0,7 l	food storage box 0,7 l	boîte fraîcheur 0,7 l	36
11115	tino	frischhaltedose 1,7 l	food storage box 1,7 l	boîte fraîcheur 1,7 l	37
11130	tina	frischhaltedose mit clip 0,45 l	food storage box with clip 0,45 l	boîte fraîcheur avec clip 0,45 l	34
11131	tina	frischhaltedose mit clip 0,7 l	food storage box with clip 0,7 l	boîte fraîcheur avec clip 0,7 l	34
11132	tina	frischhaltedose mit clip 1 l	food storage box with clip 1 l	boîte fraîcheur avec clip 1 l	34
11133	tina	frischhaltedose mit clip 1,15 l	food storage box with clip 1,15 l	boîte fraîcheur avec clip 1,15 l	34
11134	tina	frischhaltedose mit clip 1,35 l	food storage box with clip 1,35 l	boîte fraîcheur avec clip 1,35 l	35
11135	tina	frischhaltedose mit clip 1,7 l	food storage box with clip 1,7 l	boîte fraîcheur avec clip 1,7 l	35
11536	lorge	treteimer 2 x 11 l	pedal bin 2 x 11 l	poubelle à pédale 2 x 11 l	67
11599	ole	system-müllsackständer	refuse bag system	système de support pour sac poubelle	68
11705	mika	eimer mit ausguss 5 l	bucket with drain 5 l	seau avec bec verseur 5 l	16, 60
11710	mika	eimer mit ausguss 10 l	bucket with drain 10 l	seau avec bec verseur 10 l	16, 61
11800	karol	windeleimer mit deckel und tragegriff "winnie"	nappy bin with lid and handle "winnie"	seau à langes avec couvercle et anse "winnie"	121
11804	elsa	bio-eimer mit deckel oval 13 l	bio bucket with lid 13 l	bio seau avec couvercle 13 l	17
12028	franek	babytopf comfort "little duck"	potty comfort "little duck"	pot bébé comfort "little duck"	158
12236	karolina	dreh-/stapelbox mit deckel "winnie" 15 l	turn around stacking box with lid "winnie" 15 l	boîte empilable/retournable avec couvercle "winnie" 15 l	123
12236	karolina	dreh-/stapelbox mit deckel "minnie" 15 l	turn around stacking box with lid "minnie" 15 l	boîte empilable/retournable avec couvercle "minnie" 15 l	125
12236	karolina	dreh-/stapelbox mit deckel "mickey" 15 l	turn around stacking box with lid "mickey" 15 l	boîte empilable/retournable avec couvercle "mickey" 15 l	127
12236	karolina	dreh-/stapelbox mit deckel "frozen" 15 l	turn around stacking box with lid "frozen" 15 l	boîte empilable/retournable avec couvercle "frozen" 15 l	132
12236	karolina	dreh-/stapelbox mit deckel "cars" 15 l	turn around stacking box with lid "cars" 15 l	boîte empilable/retournable avec couvercle "cars" 15 l	135
12236	karolina	dreh-/stapelbox mit deckel "peppa" 15 l	turn around stacking box with lid "peppa" 15 l	boîte empilable/retournable avec couvercle "peppa" 15 l	137
12236	karolina	dreh-/stapelbox mit deckel "paw patrol" 15 l	turn around stacking box with lid "paw patrol" 15 l	boîte empilable/retournable avec couvercle "paw patrol" 15 l	140
12236	karolina	dreh-/stapelbox mit deckel "fireman sam" 15 l	turn around stacking box with lid "fireman sam" 15 l	boîte empilable/retournable avec couvercle "fireman sam" 15 l	143
12237	karolina	dreh-/stapelbox mit deckel "winnie" 24 l	turn around stacking box with lid "winnie" 24 l	boîte empilable/retournable avec couvercle "winnie" 24 l	123
12237	karolina	dreh-/stapelbox mit deckel "minnie" 24 l	turn around stacking box with lid "minnie" 24 l	boîte empilable/retournable avec couvercle "minnie" 24 l	125
12237	karolina	dreh-/stapelbox mit deckel "mickey" 24 l	turn around stacking box with lid "mickey" 24 l	boîte empilable/retournable avec couvercle "mickey" 24 l	127
12237	karolina	dreh-/stapelbox mit deckel "frozen" 24 l	turn around stacking box with lid "frozen" 24 l	boîte empilable/retournable avec couvercle "frozen" 24 l	132
12237	karolina	dreh-/stapelbox mit deckel "cars" 24 l	turn around stacking box with lid "cars" 24 l	boîte empilable/retournable avec couvercle "cars" 24 l	135
12237	karolina	dreh-/stapelbox mit deckel "peppa" 24 l	turn around stacking box with lid "peppa" 24 l	boîte empilable/retournable avec couvercle "peppa" 24 l	137
12237	karolina	dreh-/stapelbox mit deckel "paw patrol" 24 l	turn around stacking box with lid "paw patrol" 24 l	boîte empilable/retournable avec couvercle "paw patrol" 24 l	140
12237	karolina	dreh-/stapelbox mit deckel "fireman sam" 24 l	turn around stacking box with lid "fireman sam" 24 l	boîte empilable/retournable avec couvercle "fireman sam" 24 l	143
12238	karolina	dreh-/stapelbox mit deckel "winnie" 30 l	turn around stacking box with lid "winnie" 30 l	boîte empilable/retournable avec couvercle "winnie" 30 l	123
12238	karolina	dreh-/stapelbox mit deckel "minnie" 30 l	turn around stacking box with lid "minnie" 30 l	boîte empilable/retournable avec couvercle "minnie" 30 l	125
12238	karolina	dreh-/stapelbox mit deckel "mickey" 30 l	turn around stacking box with lid "mickey" 30 l	boîte empilable/retournable avec couvercle "mickey" 30 l	127
12238	karolina	dreh-/stapelbox mit deckel "frozen" 30 l	turn around stacking box with lid "frozen" 30 l	boîte empilable/retournable avec couvercle "frozen" 30 l	132
12238	karolina	dreh-/stapelbox mit deckel "cars" 30 l	turn around stacking box with lid "cars" 30 l	boîte empilable/retournable avec couvercle "cars" 30 l	135
12238	karolina	dreh-/stapelbox mit deckel "peppa" 30 l	turn around stacking box with lid "peppa" 30 l	boîte empilable/retournable avec couvercle "peppa" 30 l	137













art.-nr. art-no. réf.	name name nom	art.-bezeichnung	article description	désignation produit	seite page page
12238	karolina	dreh-/stapelbox mit deckel "paw patrol" 30 l	turn around stacking box with lid "paw patrol" 30 l	boîte empilable/retournable avec couvercle "paw patrol" 30 l	140
12238	karolina	dreh-/stapelbox mit deckel "fireman sam" 30 l	turn around stacking box with lid "fireman sam" 30 l	boîte empilable/retournable avec couvercle "fireman sam" 30 l	143
12239	karolina	dreh-/stapelbox mit deckel "winnie" 45 l	turn around stacking box with lid "winnie" 45 l	boîte empilable/retournable avec couvercle "winnie" 45 l	123
12239	karolina	dreh-/stapelbox mit deckel "minnie" 45 l	turn around stacking box with lid "minnie" 45 l	boîte empilable/retournable avec couvercle "minnie" 45 l	125
12239	karolina	dreh-/stapelbox mit deckel "mickey" 45 l	turn around stacking box with lid "mickey" 45 l	boîte empilable/retournable avec couvercle "mickey" 45 l	127
12239	karolina	dreh-/stapelbox mit deckel "frozen" 45 l	turn around stacking box with lid "frozen" 45 l	boîte empilable/retournable avec couvercle "frozen" 45 l	132
12239	karolina	dreh-/stapelbox mit deckel "cars" 45 l	turn around stacking box with lid "cars" 45 l	boîte empilable/retournable avec couvercle "cars" 45 l	135
12239	karolina	dreh-/stapelbox mit deckel "peppa" 45 l	turn around stacking box with lid "peppa" 45 l	boîte empilable/retournable avec couvercle "peppa" 45 l	137
12239	karolina	dreh-/stapelbox mit deckel "paw patrol" 45 l	turn around stacking box with lid "paw patrol" 45 l	boîte empilable/retournable avec couvercle "paw patrol" 45 l	140
12239	karolina	dreh-/stapelbox mit deckel "fireman sam" 45 l	turn around stacking box with lid "fireman sam" 45 l	boîte empilable/retournable avec couvercle "fireman sam" 45 l	143
12240	karolina	dreh-/stapelbox mit deckel "stars" 15 l	turn around stacking box with lid "stars" 15 l	boîte empilable/retournable avec couvercle "stars" 15 l	152
12241	karolina	dreh-/stapelbox mit deckel "stars" 24 l	turn around stacking box with lid "stars" 24 l	boîte empilable/retournable avec couvercle "stars" 24 l	152
12242	karolina	dreh-/stapelbox mit deckel "stars" 30 l	turn around stacking box with lid "stars" 30 l	boîte empilable/retournable avec couvercle "stars" 30 l	152
12243	karolina	dreh-/stapelbox mit deckel "stars" 45 l	turn around stacking box with lid "stars" 45 l	boîte empilable/retournable avec couvercle "stars" 45 l	152
12456	piet	wäschebox 60 l	laundry hamper 60 l	coffre à linge 60 l	58
12600	ivie	deco-eimer "polygon" 10 l	deco-bucket "polygon" 10 l	seau deco "polygon" 10 l	60
12600	ivie	deco-eimer "polygon" 10 l	deco-bucket "polygon" 10 l	seau deco "polygon" 10 l	60
12600	ivie	deco-eimer "polygon" 10 l	deco-bucket "polygon" 10 l	seau deco "polygon" 10 l	60
14438	laura	mikrowellen-/tiefkühl-dose 2in1 1,5 l	microwave-/freeze container 2in1 1,5 l	boîte à congeler pour le micro-ondes 2en1 1,5 l	44
14448	laura	mikrowellen-/tiefkühl-dose 2in1 4 l	microwave-/freeze container 2in1 4 l	boîte à congeler pour le micro-ondes 2en1 4 l	44
14508	laura	mikrowellen-/tiefkühl-dose 2in1 0,6 l	microwave-/freeze container 2in1 0,6 l	boîte à congeler pour le micro-ondes 2en1 0,6 l	44
14518	laura	mikrowellen-/tiefkühl-dose 2in1 1 l	microwave-/freeze container 2in1 1 l	boîte à congeler pour le micro-ondes 2en1 1 l	44
14528	laura	mikrowellen-/tiefkühl-dose 2in1 1,8 l	microwave-/freeze container 2in1 1,8 l	boîte à congeler pour le micro-ondes 2en1 1,8 l	45
14538	laura	mikrowellen-/tiefkühl-dose 2in1 3 l	microwave-/freeze container 2in1 3 l	boîte à congeler pour le micro-ondes 2en1 3 l	45
15399	bruno	euro-box xxl 54 l	euro-box xxl 54 l	euro-box xxl 54 l	19, 108
15453	bruno	euro-box xl 28 l	euro-box xl 28 l	euro-box xl 28 l	19, 108
15456	bruno	euro-box l 20,5 l	euro-box l 20,5 l	euro-box l 20,5 l	19, 108
15461	bruno	euro-box m 16 l	euro-box m 16 l	euro-box m 16 l	19, 108
18420	maria	babywanne 100 cm mit stöpsel "winnie"	baby bath 100 cm with plug "winnie"	baignoire 100 cm avec vidange "winnie"	120
18423	maria	babywanne 84 cm mit stöpsel "winnie"	baby bath 84 cm with plug "winnie"	baignoire 84 cm avec vidange "winnie"	120
18423	maria	babywanne 84 cm mit stöpsel "minnie"	baby bath 84 cm with plug "minnie"	baignoire 84 cm avec vidange "minnie"	124
18423	maria	babywanne 84 cm mit stöpsel "mickey"	baby bath 84 cm with plug "mickey"	baignoire 84 cm avec vidange "mickey"	126
18426	maria	babywanne 84 cm mit stöpsel "panda"	baby bath 84 cm with plug "panda"	baignoire 84 cm avec vidange "panda"	145
18426	maria	babywanne 84 cm mit stöpsel "stars"	baby bath 84 cm with plug "stars"	baignoire 84 cm avec vidange "stars"	148, 150
18426	maria	babywanne 84 cm mit stöpsel "funny farm"	baby bath 84 cm with plug "funny farm"	baignoire 84 cm avec vidange "funny farm"	154
18426	maria	babywanne 84 cm mit stöpsel "hippo"	baby bath 84 cm with plug "hippo"	baignoire 84 cm avec vidange "hippo"	156
18431	tomek	trittthocker mit anti-rutsch-funktion "winnie"	step stool with anti-slip-function "winnie"	marchepied antidérapante "winnie"	121
18431	tomek	trittthocker mit anti-rutsch-funktion "minnie"	step stool with anti-slip-function "minnie"	marchepied antidérapante "minnie"	124
18431	tomek	trittthocker mit anti-rutsch-funktion "mickey"	step stool with anti-slip-function "mickey"	marchepied antidérapante "mickey"	126
18431	tomek	trittthocker mit anti-rutsch-funktion "frozen"	step stool with anti-slip-function "frozen"	marchepied antidérapante "frozen"	131
18431	tomek	trittthocker mit anti-rutsch-funktion "cars"	step stool with anti-slip-function "cars"	marchepied antidérapante "cars"	134
18431	tomek	trittthocker mit anti-rutsch-funktion "peppa"	step stool with anti-slip-function "peppa"	marchepied antidérapante "peppa"	136
18431	tomek	trittthocker mit anti-rutsch-funktion "paw patrol"	step stool with anti-slip-function "paw patrol"	marchepied antidérapante "paw patrol"	139
18431	tomek	trittthocker mit anti-rutsch-funktion "fireman sam"	step stool with anti-slip-function "fireman sam"	marchepied antidérapante "fireman sam"	142
18436	wiktoria	babywanne 84 cm "panda"	baby bath 84 cm "panda"	baignoire 84 cm "panda"	145
18436	wiktoria	babywanne 84 cm "funny farm"	baby bath 84 cm "funny farm"	baignoire 84 cm "funny farm"	154
18436	wiktoria	babywanne 84 cm "hippo"	baby bath 84 cm "hippo"	baignoire 84 cm "hippo"	156
18437	wiktoria	babywanne 100 cm "panda"	baby bath 100 cm "panda"	baignoire 100 cm "panda"	145
18437	wiktoria	babywanne 100 cm "funny farm"	baby bath 100 cm "funny farm"	baignoire 100 cm "funny farm"	154
18437	wiktoria	babywanne 100 cm "hippo"	baby bath 100 cm "hippo"	baignoire 100 cm "hippo"	156
18496	amelia	wickelunterlage "winnie"	baby changing mat "winnie"	matelas à langer "winnie"	122
18497	pawel	wickelunterlage mit messlatte "winnie"	baby changing top with measure "winnie"	matelas à langer avec point de référence "winnie"	122
18500	antek	reisewickelunterlage "winnie"	travel mat "winnie"	matelas à langer de voyage "winnie"	122
18618	leon	babybadesitz mit anti-rutsch-funktion "winnie"	anatomic baby bath chair with anti-slip-function "winnie"	siège de bain bébé antidérapant "winnie"	120
18642	tomek	trittthocker mit anti-rutsch-funktion "panda"	step stool with anti-slip-function "panda"	marchepied antidérapant "panda"	146
18642	tomek	trittthocker mit anti-rutsch-funktion "stars"	step stool with anti-slip-function "stars"	marchepied antidérapant "stars"	149, 151





keeper

art.-nr. art-no. réf.	name name nom	art.-bezeichnung	article description	désignation produit	seite page page
18642	tomek	trittthocker mit anti-rutsch-funktion "funny farm"	step stool with anti-slip-function "funny farm"	marchepied antidérapant "funny farm"	155
18642	tomek	trittthocker mit anti-rutsch-funktion "hippo"	step stool with anti-slip-function "hippo"	marchepied antidérapant "hippo"	157
18648	adam	babytopf mit anti-rutsch-funktion "panda"	potty with anti-slip-function "panda"	pot bébé antidérapant "panda"	146
18648	adam	babytopf mit anti-rutsch-funktion "stars"	potty with anti-slip-function "stars"	pot bébé antidérapant "stars"	148, 150
18648	adam	babytopf mit anti-rutsch-funktion "funny farm"	potty with anti-slip-function "funny farm"	pot bébé antidérapant "funny farm"	155
18648	adam	babytopf mit anti-rutsch-funktion "hippo"	potty with anti-slip-function "hippo"	pot bébé antidérapant "hippo"	156
18649	kasimir	babytopf deluxe 4in1	potty deluxe 4in1	pot bébé deluxe 4en1	119
18650	ewa	kinder-toilettensitz mit anti-rutsch-funktion "panda"	toilet training seat with anti-slip-function "panda"	réducteur de siège wc antidérapant "panda"	146
18650	ewa	kinder-toilettensitz mit anti-rutsch-funktion "stars"	toilet training seat with anti-slip-function "stars"	réducteur de siège wc antidérapant "stars"	148, 150
18650	ewa	kinder-toilettensitz mit anti-rutsch-funktion "funny farm"	toilet training seat with anti-slip-function "funny farm"	réducteur de siège wc antidérapant "funny farm"	155
18650	ewa	kinder-toilettensitz mit anti-rutsch-funktion "hippo"	toilet training seat with anti-slip-function "hippo"	réducteur de siège wc antidérapant "hippo"	157
18670	adam	babytopf mit anti-rutsch-funktion "winnie"	potty with anti-slip-function "winnie"	pot bébé antidérapant "winnie"	120
18670	adam	babytopf mit anti-rutsch-funktion "minnie"	potty with anti-slip-function "minnie"	pot bébé antidérapant "minnie"	124
18670	adam	babytopf mit anti-rutsch-funktion "mickey"	potty with anti-slip-function "mickey"	pot bébé antidérapant "mickey"	126
18670	adam	babytopf mit anti-rutsch-funktion "frozen"	potty with anti-slip-function "frozen"	pot bébé antidérapant "frozen"	131
18670	adam	babytopf mit anti-rutsch-funktion "cars"	potty with anti-slip-function "cars"	pot bébé antidérapant "cars"	134
18670	adam	babytopf mit anti-rutsch-funktion "peppa"	potty with anti-slip-function "peppa"	pot bébé antidérapant "peppa"	136
18670	adam	babytopf mit anti-rutsch-funktion "paw patrol"	potty with anti-slip-function "paw patrol"	pot bébé antidérapant "paw patrol"	139
18670	adam	babytopf mit anti-rutsch-funktion "fireman sam"	potty with anti-slip-function "fireman sam"	pot bébé antidérapant "fireman sam"	142
18672	pawel	wickelunterlage mit messlatte "panda"	baby changing top with measure "panda"	matelas à langer avec point de référence "panda"	144
18672	pawel	wickelunterlage mit messlatte "stars"	baby changing top with measure "stars"	matelas à langer avec point de référence "stars"	149, 151
18673	amelia	wickelunterlage "panda"	baby changing mat "panda"	matelas à langer "panda"	144
18673	amelia	wickelunterlage "stars"	baby changing mat "stars"	matelas à langer "stars"	149, 151
18678	kasimir	babytopf deluxe 4in1 "winnie"	potty deluxe 4in1 "winnie"	pot bébé deluxe 4en1 "winnie"	119
18678	kasimir	babytopf deluxe 4in1 "winnie"	potty deluxe 4in1 "winnie"	pot bébé deluxe 4en1 "winnie"	119
18678	kasimir	babytopf deluxe 4in1 "winnie"	potty deluxe 4in1 "winnie"	pot bébé deluxe 4en1 "winnie"	119
18679	olga	toilettensitz soft "winnie"	soft toilet training seat "winnie"	réducteur de siège wc soft "winnie"	121
18679	olga	toilettensitz soft "frozen"	soft toilet training seat "frozen"	réducteur de siège wc soft "frozen"	130
18679	olga	toilettensitz soft "cars"	soft toilet training seat "cars"	réducteur de siège wc soft "cars"	134
18679	olga	toilettensitz soft "paw patrol"	soft toilet training seat "paw patrol"	réducteur de siège wc soft "paw patrol"	138
30019	bea	set 4 x clearbox 5,6 l	set 4 x clearbox 5,6 l	set 4 x clearbox 5,6 l	94
30020	bea	set 3 x clearbox 11 l	set 3 x clearbox 11 l	set 3 x clearbox 11 l	94
30030	camilla	set rührschüssel mit anti-rutsch-funktion	set mixing bowl with anti-slip-function	set de bols à mixer antidérapants	33
30031	bea	set 3 x clearbox 18 l	set 3 x clearbox 18 l	set 3 x clearbox 18 l	94
30045	matteo	set messkanne mit anti-rutsch-funktion	set measuring jug with anti-slip-function	set pichet doseur antidérapant	32
30050	bea	set 3 x 1,7 l / 2 x 5,6 l / 3 x 18 l clearbox	set 3 x 1,7 l / 2 x 5,6 l / 3 x 18 l clearbox	set 3 x 1,7 l / 2 x 5,6 l / 3 x 18 l clearbox	94
30052	mia	set 3 x tiefkühl-dose "magic ice" 1,25 l	set 3 x food container "magic ice" 1,25 l	set 3 x boîte "magic ice" 1,25 l	38
30076	natalia	babywanne mit softgriff, stöpsel und sitz "stars"	baby bath with soft handle, plug and chair "stars"	baïnoire bébé avec poignée souple, bouchon et dossier "stars"	148, 150
30090	maria	set rührschüsseln mit saugnapf	set of mixing bowls with suction cup	set de bols à mixer avec ventouse	31
30205	bea	set 5 x clearbox 1,7 l	set 5 x clearbox 1,7 l	set 5 x clearbox 1,7 l	94
30672	fredo fresh	set 5 x frischhaltedose 0,5 l	set 5 x food storage box 0,5 l	set 5 x boîte alimentaire 0,5 l	40
30673	fredo fresh	set 4 x frischhaltedose 0,75 l	set 4 x food storage box 0,75 l	set 4 x boîte alimentaire 0,75 l	40
30674	fredo fresh	set 3 x frischhaltedose 1 l	set 3 x food storage box 1 l	set 3 x boîte alimentaire 1 l	40
30675	fredo fresh	set 3 x frischhaltedose 1,25 l	set 3 x food storage box 1,25 l	set 3 x boîte alimentaire 1,25 l	40
30676	fredo fresh	set 2 x frischhaltedose 2 l	set 2 x food storage box 2 l	set 2 x boîte alimentaire 2 l	41
30679	fredo fresh	set 3 x frischhaltedose 2,4 l	set 3 x food storage box 2,4 l	set 3 x boîte alimentaire 2,4 l	41
30680	fredo fresh	set 2 x frischhaltedose 3,3 l	set 2 x food storage box 3,3 l	set 2 x boîte alimentaire 3,3 l	41
30689	mia	set 5 x tiefkühl-dose "magic ice" 0,5 l	set 5 x food container "magic ice" 0,5 l	set 5 x boîte "magic ice" 0,5 l	38
30690	mia	set 4 x tiefkühl-dose "magic ice" 0,75 l	set 4 x food container "magic ice" 0,75 l	set 4 x boîte "magic ice" 0,75 l	38
30691	mia	set 3 x tiefkühl-dose "magic ice" 1 l	set 3 x food container "magic ice" 1 l	set 3 x boîte "magic ice" 1 l	38
30692	mia	set 2 x tiefkühl-dose "magic ice" 2 l	set 2 x food container "magic ice" 2 l	set 2 x boîte "magic ice" 2 l	39

keeper

symbole/symbols/symboles

	geeignet für Lebensmittelkontakt / suitable for food contact / adapté au contact avec des produits alimentaires		laugenbeständig / acid-resistant / résistant aux alcalis		Clip mit air control / clip with air control / clip avec air control
	mikrowellengeeignet 400 W max. 3 Min. / suitable for microwave 400 W max. 3 min. / convient pour le micro-ondes 400 W max. 3 min.		Nutzungstemperatur / operating temperature / température d'utilisation		Tragkraft / capacity / capacité
	spülmaschinengeeignet / dishwasher-safe / résistant au lave-vaisselle		kristallklar / crystal clear / clair comme de l'eau de roche		Größe Müllbeutel / size garbage bags / sac compatible
	tiefkühlgeeignet / suitable for freezing / adapté à la surgélation		wasserdicht / waterproof / imperméable à l'eau		patentiert / patented / breveté

PE	Polyethylen / Polyethylene / Polyéthylène	POM	Polyoxymethylen / Polyoxymethylene / Polyoxyméthylène		Breite / Width / Largeur
PP	Polypropylen / Polypropylene / Polypropylène	SAN	Styrol-Acrylnitril / Styrene Acrylnitrile / Acrylonitrile styrène		Länge / Length / Longueur
PS	Polystyrol / Polystyrene / Polystyrène	SMMA	Styrol-Methyl-Methacrylat / Styrene-Methyl Methacrylate / Méthacrylate de Styrène-Méthyl		Höhe / Height / Hauteur
PUR	Polyurethanschaum / Polyurethane Foam / Mousse de Polyurethane	PVC	Polyvinylchlorid / Polyvinyl chloride / Chlorure de polyvinyle		Volumen / Volume / Volume
TPE	Thermoplastisches Polyurethan Elastomer / Thermoplastic Polyurethan Elastomere / Thermoplastique	MDF	Faserplatte / Fiberboard / Panneau de fibres	GS	Geprüfte Sicherheit durch Prüfinstitut / Proofed safety by institute / Test de sécurité approuvé par l'institut de sécurité

keeper

dekore/decors/décors



012 – hippo



203 – fireman sam



273 – jungle



048 – little duck



212 – frozen



282 – sandwich



063 – funny farm

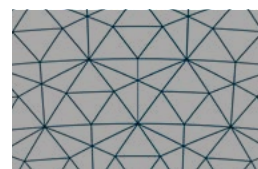

217 – polygon



283 – sweet day



088 – frozen



231 – cars



284 – space tour



137 – paw patrol



238 – winnie



285 – sea life



171 – cars



241 – panda



286 – magic ice



194 – peppa pig



247 – minnie/mickey



196 – stars



254 – sweet home

keeper

farben/colors/coloris

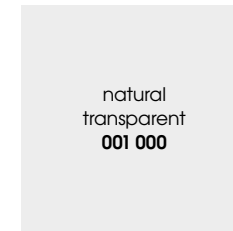

natural
transparent
001 000

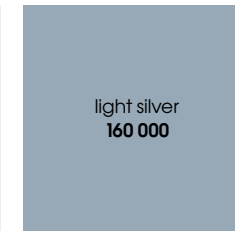

light silver
160 000

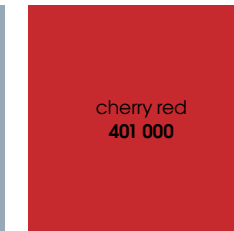

cherry red
401 000

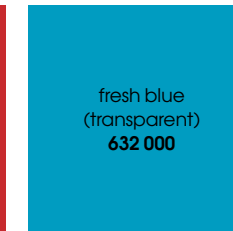

fresh blue
(transparent)
632 000



crystal grey
(transparent)
827 000

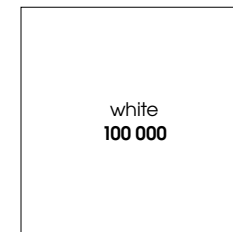

white
100 000

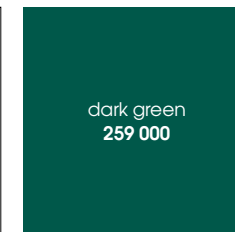

dark green
259 000



nordic red
437 000



aqua blue
666 000

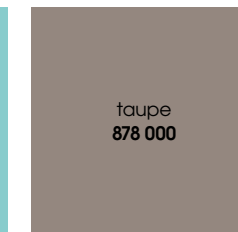

taupe
878 000

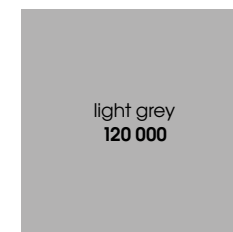

light grey
120 000

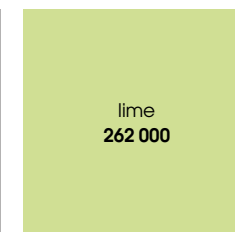

lime
262 000



nordic white
519 000



eco blue
679 000

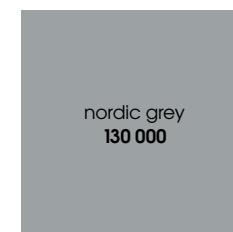

nordic grey
130 000



eco green
308 000



pastell rose
555 000



nordic blue
680 000



soft grey
133 000



nordic green
315 000



nordic pink
581 000

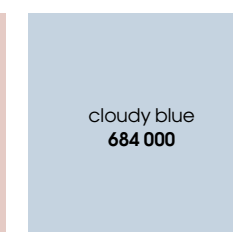

cloudy blue
684 000



eco grey
138 000

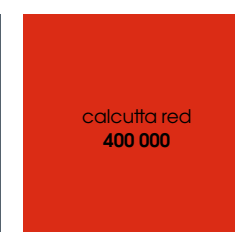

calcutta red
400 000

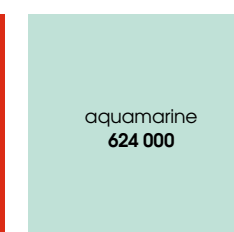

aquamarine
624 000

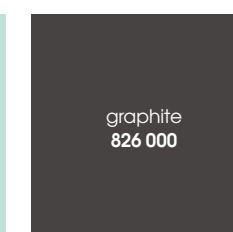

graphite
826 000



we are
keeper

impresum
rechtliche hinweise

keeper GmbH
postdamm 43
D - 32351 stemwede

fon +49 5773 801-0
fax +49 5773 801-50

info@**keeper**.com
www.**keeper**.com

Copyright 2022 © **keeper** GmbH
Alle Rechte vorbehalten.

Nachdruck sowie Vervielfältigungen,
auch auszugsweise, sind ohne ausdrück-
liche Genehmigung der **keeper** GmbH
nicht gestattet.

Druckfehler, Irrtümer, Farb- und Modell-
änderungen vorbehalten.
Alle Maße sind Circaangaben.

Mit Erscheinen dieses Kataloges verlieren
alle bisherigen Kataloge ihre Gültigkeit.

Gedruckt auf 100 % Recyclingpapier.

imprint
legal information

keeper GmbH
postdamm 43
D - 32351 stemwede

fon +49 5773 801-0
fax +49 5773 801-50

info@**keeper**.com
www.**keeper**.com

Copyright 2022 © **keeper** GmbH
All rights withheld.

Reprints and duplication, even extracts,
without express consent from
keeper GmbH are not permitted.

All rights for misprints, errors, colour and
design modifications withheld.
All measurements are approximate.

All previous catalogues cease to be valid
upon publication of this catalogue.

Printed on 100 % recycled paper.

empreinte
mentions légales

keeper GmbH
postdamm 43
D - 32351 stemwede

fon +49 5773 801-0
fax +49 5773 801-50

info@**keeper**.com
www.**keeper**.com

Copyright 2022 © **keeper** GmbH
Tous droits réservés.

La reproduction et l'utilisation de ce
document sont interdites sans l'approba-
tion de **keeper** GmbH.

Tous droits réservés pour les erreurs d'im-
pression, les erreurs, et les modifications
de couleur et de motifs. Toutes les mesu-
res sont noncontractuelles.

Avec la parution de ce catalogue, tous
les catalogues précédents perdent leurs
validités.

Imprimé sur du papier 100 % recyclé.



keeper.com

