



Apple

**OUTDOOR
/ / SUPPLY**

**SERVING THE BARN, SHED, AND
OUTDOOR PLAY INDUSTRY**



2021 EDITION

CATALOG

1-800-704-8112

2850 APPLETON ST., CAMP HILL, PA 17011

Our Mules Deliver™



When you're needing more power, there's no Mule that will deliver like the **Mule 737T**. With a standard 10,000 pound lifting capacity with power rotator, 119,000 in. lb.* of axle torque, and 10,000 pound capacity dollies, the **Mule 737T** is especially equipped for the most extreme deliveries of largest sheds and cabins in the industry. It offers 54% more power than the **Mule 624T**, with an electronic fuel-injected 37HP Vanguard engine. The **Mule 737T** features our patented i-Trax technology for extreme floatation. Whether you're looking for the **Mule 413** with its history of endurance and reliability or the **Mule 737T** with its unprecedented power, we're here for you.

MULE 737T

CARDINAL
MANUFACTURING LLC
Our Mules Deliver.™

888.323.8737
info@cardinalmfg.net



3D ONLINE!

STORAGE BUILDING DESIGNER

- Let your customers build their own storage building 24/7 in the comfort of their home.
- Never under or over price a storage building again.
- While the competition is closed, you can be making sales on your own website.
- Save time and mistakes by clearly showing what your customer will receive.
- Ultimately, this optimal online experience for custom products will translate to more sales and greater profitability.



**CUSTOMIZED
TO FIT
YOUR NEEDS!**



**LOW AS
\$199
PER MONTH**



**CALL TODAY
TO SCHEDULE
A FREE DEMO**



📍 EMail: info@3dfish.net



Your Buildings, Your Options, Your Prices, Your Customers.
Integrated with Your domain name and Your theme.
Integration available with your CRM and Order Systems.
Always has the latest features and improvements.

www.3Dfish.net
888-672-1035

How your shed designer works for you!

1. A prospect visits your website
2. The prospect interacts with an interactive 3D configuration tool. The tool allows the individual to evaluate different options and accessories, see the price, and the product they have configured.
3. The prospect clicks Order to purchase the building they have designed. The prospect, now customer's design is transmitted to directly to your sales team.
4. Your sales team engages with the prospect by reviewing the product they have configured and answering any questions they may have.
5. Your sales team finalizes the purchase with the customer.

*Example
print out*



Shed Dealer
123 Any Road
Anytown, ST 00000
Phone: 123-456-7890

Design ID: JS1582
Presented For:
John Smith
123 Any Road
Anytown, ST 00000
Phone: 123-456-7890
Email: e@domain.com

Left View

Right View

Rear View

Left Interior View

Right Interior View

12x20 Vinyl A-Frame

Base Price.....	\$5300.00
Standard Features:	
Pressure Treated Floor Joists.....	No Charge
Roofing Felt.....	No Charge
Options:	
6" Fiberglass Doors.....	\$225.00
24x36 Window.....	\$175.00
24x36 Window.....	\$175.00
24x36 Window.....	\$175.00
8" Transom Window.....	\$150.00
8' x 16" Shelving.....	\$40.00
12' x 4' Loft.....	\$150.00
Garden End Vents.....	\$90.00
Sub-Total.....	\$5595.00
Tax (OH 7.5%).....	\$422.38
Total.....	\$7017.38



📍 4496 Mahoning Ave #928, Youngstown, OH 44515
Telephone: 614-996-6991 | Toll Free: 888-672-1035
EMail: info@3dfish.net www.3Dfish.net

INDEX

A

ANCHOR HARDWARE 28, 43, 52

ANCHOR BOLT SET 28

ANCHOR DRIVE MACHINE 28

BARBED ROCK/MACADAM ANCHOR 28

EYE STYLE SHED ANCHOR 28

MOBILE HOME ANCHOR 28

SHED ANCHOR 28

SLEEVE ANCHORS 43

STRAP BOLT & NUT 28

WEDGE ANCHORS 52

B

BARREL BOLTS 23

LOOP STYLE 23

BEARINGS 37

GLIDER BEARINGS 37

ROCKER BEARINGS 37

BITS 72-74

BIT HOLDER 72

COUNTERSINK 74

DRILL BITS 73

MAGNETIC NUT DRIVERS 72

PADDLE BITS 74

PHILLIPS 72

PLUG CUTTERS 74

QUICK RELEASE 73

ROUTER 74

SQUARE DRIVER 72

STAR BIT 72

YANKEE DRIVER 72

BOLTS 36, 52, 58-68

CARRIAGE BOLTS 65-67

CHAIR BOLT 52

EYE BOLTS 36

HANGER BOLTS 60

HEX BOLTS 61-64

LAG BOLTS 58-60

ROUND HEAD MACHINE 28

STRAP BOLT & NUT 28

THREAD COVERS 71

THREADED ROD 68

BUBBLE INSULATION 17

C

CARRIAGE BOLTS 65-67

FULL BODY 68

STAINLESS STEEL 67

TREATED LUMBER COATED 66

YELLOW ZINC PLATED 66

ZINC PLATED 65

CAULK 76

CHAIN 33-34

DOUBLE LOOP CHAIN 33

SWING SET CHAIN 34

WELDED CHAIN 33

CHAIR SWIVEL 37

COIL STOCK 29

CONCRETE SCREWS 41

CREDIT APPLICATION 6

CUPOLAS 77

D

DECORATIVE ITEMS

FLOWER BOXES 9

SHUTTERS 9

DOOR BRACES 24

DOOR HARDWARE

BARN PULL 22

BARREL BOLTS 23

BRACES 24

CANE BOLTS 22

DOOR BRACES 24

DOOR KNOBS 19, 21

DROP LATCH 22

HORSESHOE DROP LATCH 22

INSIDE DOOR HANDLE 21

KEYS 21

QUARTER ARCH WINDOWS 15

SLAM STRIPS 18

T-HANDLE 21

DOORS 18, 19, 20

DOOR GLASS 19

DOOR SLABS 19

PET DOOR 38

ROLL UP DOOR 18

STEEL FRAME DOOR 20

E

EAR PLUGS 75

EYE BOLTS & LAGS 36

F

FLOWER BOXES 9

G

GLIDER HARDWARE 37

GLIDER ARMS 37

GLIDER BEARINGS 37

GLIDER SPACERS 37

H

HANDLES

L-HANDLE 21

PULLS 22

T-HANDLE 21

TULIP DOOR KNOB 19

HANGER BOLTS 60

HEX BOLTS 61-64

GRADE 2 62

GRADE 5 63

GRADE 8 64

STAINLESS STEEL 61

HINGES 25-27

BUTT 26

COLONIAL DECORATIVE 25

CONTINUOUS 26

DOUBLE DUTCH DOOR 27

HEAVY DUTY T-HINGE 25

HINGE SCREWS 27

HORSE BARN GATE HINGE 27

HINGE WITH PINNEL 27

SHED BUMPER 26

SUPER HEAVY DUTY HINGE 27

I

INDOOR HARDWARE

CHAIR SWIVEL 37

INSULATION 17

ADHESIVE TAPE 17

BUBBLE INSULATION 17

K

KEYS 21

KNOTBUSTER SCREWS 44-45

L

LAG BOLTS 58-60

CHAIR LAG 52

STAINLESS STEEL 59

TREATED LUMBER COATED 59

YELLOW ZINC PLATED 58

LAGS 60

EYE LAGS 36

LOG HOME 60

YELLOW ZINC 58

ZINC PLATED 58

LATCHES 22-24

DROP 24

PUSH BUTTON 22

SPRING 23

LIGHTHOUSE ACCESSORIES 39

WINDOWS & DOORS 39

LIGHTS 39

LIGHTHOUSE BEACON LIGHT 39

SOLAR LIGHTS 39

M

METAL BUILDING HARDWARE 29

600' ROLL GALVANIZED STRAP 29

DOUBLE SLOT BUCKLE WITH STRAP 29

HEX TEK SCREWS 29

HURRICANE STRAPS 29

N

NAILS 42-43

WIRE COLLATED COIL NAILS 42

NUTS 70-71

FLANGE 70

LOCK 71

TEE 70

O

ORDER FORM 7

P

PACKAGING MATERIALS 75

CLEAR PLASTIC TAPE 75

PARTS BOXES 75

STRETCH FILM 75

PET DOOR 38

Q

QUICK\$CREWS 53-57

R

ROLL UP DOORS 18

S

SCREWS 41-57

CONCRETE SCREWS 41

FURNITURE SCREWS 44-49

HEX HEAD LOG HOME SCREWS 60

HEX TEK SCREWS 29

HINGE SCREWS 27

KNOTBUSTER 44-45

QUICK\$CREWS 53-57

STAR DRIVE 44-46

TRIM SCREWS 48

WOOD SCREWS 50-51

SHUTTERS 9

SKYLIGHTS 17

SOLAR LIGHTS

SHED LIGHT 39

WALL LIGHT 39

STAPLES 40-41

STRETCH FILM 75

SWING HARDWARE 30-36

CHAIN 33

GLIDER SWING 30

TICK TACK TOE BOARD 32

T

THREADED ROD 68

THRESHOLDS 18

TRUSS PLATE 29

V

VENTILATION 16-17

ALUMINUM UNDER SOFFIT VENTS 17

GABLE VENTS 17

LOUVERED EXHAUST VENTS 16

RIDGE VENTS 17

W

WASHERS 68-69

FENDER 69

FLAT 69

HOT DIPPED GALVANIZED 69

LOCK 68

WEDGE ANCHORS 52

WINDOWS 10-15

ARCH TOP 13

CHICKEN COOP 11

CRANK OUT 11

DOUBLE HUNG 12

DOUBLE PANE 11

GABLE 14-15

HALF ROUND WINDOWS 15

INSULATED 12

QUARTER ARCH WINDOWS 15

SUNBURST 14

TRANSOM WINDOWS 13

WOOD STAIN 74

CREDIT APPLICATION

Our credit terms are subject to the following:



- A credit limit may be applied or adjusted, determined by our credit department.
- Returned checks will be charged an NSF fee of \$30.00.
- Accounts with balances over 45 days past due will be subject to an interest rate of 1-1/2% per month, up to 18% per year.
- Accounts will be placed "On Hold" and future orders will not be released until past due amounts are paid in full.
- Slow paying accounts may have credit terms removed.

APPLICANT INFORMATION

COMPANY NAME:	COMPANY CODE (IF KNOWN):	
CONTACT NAME:		
BILLING ADDRESS:		
CITY:	STATE:	ZIP:
SHIPPING ADDRESS (IF DIFFERENT THAN BILLING):		
CITY:	STATE:	ZIP:
PHONE:	FAX:	
EMAIL:	WEBSITE:	

TRADE REFERENCES – COMPANIES ALREADY EXTENDING CREDIT TO YOU.

COMPANY NAME:	COMPANY NAME:	COMPANY NAME:
CONTACT NAME:	CONTACT NAME:	CONTACT NAME:
ADDRESS:	ADDRESS:	ADDRESS:
CITY, STATE & ZIP:	CITY, STATE & ZIP:	CITY, STATE & ZIP:
PHONE:	PHONE:	PHONE:
FAX:	FAX:	FAX:
CREDIT LIMIT:	CREDIT LIMIT:	CREDIT LIMIT:

INVOICING

<input type="checkbox"/>	PLEASE SEND MY INVOICES IN THE MAIL (ALL INVOICES WILL BE MAILED UNLESS NOTED OTHERWISE).
<input type="checkbox"/>	(PAPERLESS) PLEASE SEND MY INVOICES VIA EMAIL TO:
<input type="checkbox"/>	(PAPERLESS) PLEASE SEND MY INVOICES VIA FAX TO:

SIGNATURE

I hereby certify that the information contained herein is complete and accurate. This information has been furnished with the understanding that it is to be used to determine the amount and conditions of the credit to be extended. Furthermore, I hereby authorize the companies listed in this credit application to release necessary information to Apple Outdoor Supply in order to verify the information contained herein. Upon approval, this entitles me to purchase from Apple Outdoor Supply on Open Account to the extent of the Credit Limit approved. I understand this extension of credit is conditional upon favorable payment within terms; service charges will apply for past due balances and Open Account privileges may be suspended for negligent or insufficient payments. I have also read and agree to Apple Outdoor Supply' Policies & Procedures.

TITLE: _____ DATE: _____

COMPANY REPRESENTATIVE: _____

(PLEASE PRINT)

(SIGNATURE)

COMPANY POLICIES & PROCEDURES

We are Available Monday - Friday, 8:00am - 4:00pm

Contact Our Sales Team to Place Orders, Check Status of an Order, or Obtain Help Tracking a Shipped Order

General Email: orders@applefasteners.com

Fax#: 1-800-633-7916

Phone#: 1-800-704-8112

North Carolina Branch: ncsales@applefasteners.com

Tennessee Branch: tnsales@applefasteners.com

To Make a Payment, Discuss and Invoice, or Obtain Help with a Discrepancy:

Email: custcare@applefasteners.com

Placing Orders: Thank you for choosing Apple Outdoor Supply! It is important to read the information outlined here. By placing an order it will be assumed that you agree to conduct business under these Policies and understand the Terms & Conditions of Freight Charges and Freight Claims.

- 1.) Emailed/Written Orders: Please use the Part Numbers provided in the catalog, this is the Best Way to assure accuracy when placing orders. If we have your email address or fax number on file, a confirmation of your order will be sent; any changes that need to be made to your order will be noted.
- 2.) You may submit orders using the order form provided in this catalog, and/or using your own purchase order forms.
- 3.) Please submit orders with the following information: Billing Address, Ship-To Address, Company Name, Contact Name, Phone Number, Email Address, any Special Delivery Instructions, Receiving Hours, Changes to Account Information, and/or anything effecting your account or delivery.
- 4.) When placing an order by phone, please have your account information and item part numbers ready. Please ask the order taker to repeat your order back to confirm the order is correct.
- 5.) Non-Stock items or made-to-order may require a 25% deposit (reviewed on a case by case basis). "Special Orders" will require a signed quote, or written confirmation. Quotes & holds will only be good for 5-days, if we do not receive a response within 5-days the order/quote will be canceled.

*Please be aware we do reserve the right to limit the amount ordered, if said order conflicts with current inventory levels, or conflicts with projected usage.

* Prices & policies are subject to change. Apple Outdoor Supply is not liable for any inaccuracies, misprints or errors in the information provided herein. Occasionally items displaying immediate availability may become unavailable. We reserve the right to substitute with similar items of comparable quality.

**Special Orders can be defined as any product ordered in for a specific customer; this applies to both catalog and non-catalog items. Special orders cannot be returned, or cancelled once ordered. Lead times for special orders may vary, and we encourage our customers to place orders with allowance for extended lead times.

Account Information and Credit Terms: Apple Outdoor Supply will open an immediate account over the phone and ship orders C.O.D., or Prepaid with a Credit Card, or by mailing a Check or Money Order. To apply for credit, please submit a credit application. A credit application can be found at the front of this catalog, or you may request one by contacting us. Upon approval, open credit terms will be placed on your account.

Our credit terms are subject to the following:

- A credit limit may be applied or adjusted, as determined by our credit department.
- Returned Checks will be charged an NSF Fee of \$30.00.
- Accounts with balances over forty five (45) days past due will be subject to an interest rate of 1-1/2% per month, up to 18% per year.

Your account will be placed "ON HOLD" and future orders will not be released until past due amounts are paid.

• Orders are invoiced the day following either shipment from our warehouse or delivery via Apple's truck. If you do not receive your invoice in the mail 3-4 days after shipping, or 1 day for email or fax, please contact us. It is the consumers responsibility to pay invoices in a timely matter in accordance with our agreed credit terms. If you have not received an invoice, you MUST contact us right away.

- Slow paying accounts may be subject to having credit terms removed.
- Early pay discounts are only available on merchandise, not on freight or fuel charges; and may only be used when invoices are paid with checks or money orders.

Pick-Up Policy: All orders to be picked-up from our warehouse(s) must be given with a 24-hour notice; Orders will be available for pick-up between the times of 9am -11am & 1pm - 3pm Mon. - Fri. If the product in question is a "special order", we will notify you when the product arrives; after this standard pick-up policies will apply. If an order cannot be picked-up within 48 hours after the order is ready, daily storage fees may be charged. If a pick-up order is cancelled after our staff has picked the product, a restocking fee of 25% of the total order will be charged. Customers may use a freight carrier of their choice, but must provide a bill of landing prior to shipping and must have the order picked up within a 24 hour period. We will provide weight and dimensions for bill of landing.

Local Deliveries: Local Deliveries are reserved for customers who are located in close proximity to our facilities and can receive orders via Apple Outdoor Supply trucks. Delivery charges may apply and may vary by location and/or type of item delivered. Please check with your Sales Rep. to understand the charges that might be applicable to your delivery. Availability of local deliveries varies by location, routes, time order of placement and space on truck.

Freight Policy: Freight is shipped with a 3rd party carrier and is shipped under the following assumptions.

- The company has normal business hours (Monday - Friday: 8am - 5pm)
- The building has a loading/unloading dock.
- The location is NOT considered "Residential" or located in a "Remote Area". "Remote" and "Residential" areas are defined and determined by the freight carrier.
- The customer understands they will be responsible for all accessorial fees. Accessorial fees are charges for additional services.

Accessorial fees include but are not limited to the following: Lift-Gate Services, Delivery Appointments, Remotes Access/ Residential Charges, Re-Delivery Charges, Storage fees, etc. Therefore, if you do not have a dock, have limited business hours, and/or operate from home, farm, or remote area, you need to let us know at the time of order placement.

* Apple Outdoor Supply will determine the carrier for your order based on rate and reliability. If you want us to ship your order with the carrier of your choice, please inform the order taker at the time of order placement. We will honor this request whenever possible, and ship your order COLLECT.

All shipments, including backorders, will be subject to the freight policies. Policies include the cost of freight for regular "dock to dock" deliveries.

COMPANY POLICIES & PROCEDURES



Under our NEW freight policy, WE WILL NOT HOLD orders indefinitely to "Ship Complete". Orders will be shipped in the most efficient and effective way as possible, this means receiving backorders and shipments from different warehouses. If you do not wish to leave any items on backorder, please request "Ship and Call Complete" when placing an order. Unless specified otherwise, all mailed orders will be ship & call complete.

* We reserve the right to delay shipping your order in the short-term for the arrival of an inbound container or the arrival of other domestic product.

How Freight Charges are Determined

- There is a MINIMUM charge for each LTL freight order. (Refer to the chart below for each state's minimum charge)
- However, the total amount of freight charged for each order Will Not exceed the given percentage of the order total. (After the minimum LTL freight charge has been reached; refer to the chart below for the percentage rate of each state)
- Freight is applied to all shipments of your order.
- We will not add product to existing orders or backorders.

FREIGHT RATE ZONE BY STATE	MINIMUM AMOUNT	NOT TO EXCEED THIS PERCENTAGE OF YOUR ORDER VALUE	FREIGHT RATE ZONE BY STATE	MINIMUM AMOUNT	NOT TO EXCEED THIS PERCENTAGE OF YOUR ORDER VALUE
RATE ZONE 1	\$110	12%	RATE ZONE 4	\$260	15%
DE, GA, IL, IN, KY, MD, NC, NJ, OH, PA, SC, TN, VA, WV			KS, ME, ND, NM, SD, TX		
RATE ZONE 2	\$140	13%	RATE ZONE 5	\$300	25%
AL, AR, CT, FL, MI, MO, MS, NE, NH, OK, RI, VT, WI			CO, ID, UT, WY		
RATE ZONE 3	\$160	13%	FULL FREIGHT RATE	TBD	TBD
IA, LA, MA, MN, NY			AK, CA, MT, NV, OR, WA		
			ALL CANADIAN PROVINCES		

* Exceptions to this are Over-Sized such as: Roll Doors, Slab Doors, Pre-Hung Doors, and Bubble Insulation. These items must be placed on individual orders, cannot be combined with other items, and will be subject to full freight charges. Additionally, other items considered "Special Order", such as painted screws, plated items, drop ship items (i.e. drip edge), non-stock items sourced per order, etc., must be on individual orders and cannot be combined with other items.

Disclaimer on Loss or Damaged Shipments: In order to expedite your claim for loss or damage on shipments, you must inspect and count your freight at the time of delivery and then notate the shortage/damage on the Bill of Landing (BOL) delivery receipt. The box count (different from the skid count) is listed on the delivery receipt, this should be compared to your packing slip to insure receipt of all items. Promptly contact the Customer Care department at Apple Outdoor Supply. When possible, please supply a copy of the BOL and the pictures of the damaged product. Please send images and claims to custcare@applefasteners.com. Apple Outdoor Supply will then contact the shipping company, and start the claim process on your behalf. Credits to your account will be applied once the freight company provides payment.

Orders from Apple Outdoor Supply leave our warehouse complete and in good condition. Your signature on the delivery receipt confirms you received your shipment in good and complete condition, signing the BOL assumes you (the consumer) take full responsibility of the shipment. Therefore, if you do not notate damage or loss on the BOL, Apple Outdoor Supply will not be held responsible for lost or damaged product.

Order Discrepancies / Returns: If, for some reason, you are not completely satisfied with your order, please contact our Customer Care Department at custcare@applefasteners.com or by calling 1-800-704-8112 immediately after delivery to report the problem. Return paperwork & instructions will be provided to you; if you receive Local Deliveries, your driver will handle the return.

Please provide the reason for your return request, the invoice number, and the part number(s) of the item(s) you wish to return.

Please do not return any materials to Apple without obtaining an authorization number. The return authorization number must appear on the outside of all boxes being returned. A credit will be issued when the product has been received and counted by our warehouse personnel.

Apple Outdoor Supply reserves the right to deduct the credit amount of your return by the cost of the return freight, apply a Restocking Charge up to 25%, charge a minimum Return Service Fee of \$25.00, or outright deny credit of any amount on returns under the following conditions:

- Special Order Merchandise
- Refused or Cancelled Orders
- Installed Windows
- Incorrectly Ordered Products
- Customer Request
- Stock Buy Backs
- Merchandise Installed/used, in Poor or Non-Resale Condition
- Errors not reported within thirty (30) days
- Conditional Loss or Damaged Shipments (See Disclaimer Below)

Instances where Apple Outdoor Supply has made an error, we will make every effort and assume full responsibility to correct the discrepancy at our expense.

SHUTTERS & FLOWER BOXES

COLOR GUIDE

Please note that the colors shown below are an approximate color reproduction.



APPLE LOUVERED TYPE MOLDED SHUTTERS

Solid Mold Color, Not Painted
Colors Match Flower Boxes
UV Protected, Colorfast
Lifetime Guarantee



*SHIPPING ONLY AVAILABLE IN FULL BOX QUANTITIES ONLY.

PART #	SIZE	BOX QTY
LSN621	6 X 21	10 PR
COLORS AVAILABLE	BEDFORD BLUE, BLACK, DARK BROWN, FOREST GREEN, GREY, MAROON, PAINTABLE, PACIFIC BLUE, REDWOOD, WHITE.	
LSN922	9 X 22	10 PR
COLORS AVAILABLE	ALMOND, BLACK, CLAY, DARK BROWN, FOREST GREEN, GREY, MAROON, PAINTABLE, PACIFIC BLUE, REDWOOD, SLATE BLUE, WHITE.	
LSN927	9 X 27	10 PR
COLORS AVAILABLE	ALMOND, BEDFORD BLUE, BLACK, CLAY, DARK BROWN, FOREST GREEN, GREY, MAROON, PAINTABLE, PACIFIC BLUE, REDWOOD, SLATE BLUE, WHITE, WEATHER WOOD.	
LSN936	9 X 36	10 PR
COLORS AVAILABLE	ALMOND, BEDFORD BLUE, BLACK, CEDAR, CLAY, DARK BROWN, FOREST GREEN, GREY, MAROON, PAINTABLE, PACIFIC BLUE, REDWOOD, SLATE BLUE, WHITE, WEATHER WOOD.	

ASK ABOUT OUR ABS PAINTABLE SHUTTERS!

APPLE FLOWER BOXES

Rot or Fade Resistant
Made From Polyethylene
Colors Match Louvered Shutters
Lifetime Guarantee - MFG Defect



*SOLD IN FULL BOX QUANTITIES ONLY

PART #	LENGTH X WIDTH X HEIGHT	BOX QTY
FBSTD18	18 X 6 X 5"	4
COLORS AVAILABLE	BEDFORD BLUE, BLACK, CEDAR, CLAY, DARK BROWN, FOREST GREEN, GREY, MAROON, PAINTABLE, REDWOOD, WHITE.	
FBSTD24	24 X 6 X 5"	4
COLORS AVAILABLE	BEDFORD BLUE, BLACK, CEDAR, CLAY, DARK BROWN, FOREST GREEN, GREY, MAROON, PAINTABLE, REDWOOD, SLATE BLUE, WEATHER WOOD, WHITE.	
FBSTD30	30 X 6 X 5"	4
COLORS AVAILABLE	BLACK, CEDAR, CLAY, DARK BROWN, FOREST GREEN, GREY, REDWOOD, SLATE BLUE, WHITE.	

APPLE RAISED PANEL SHUTTERS

Solid Mold Color
Colors Match Flower Boxes
UV Protected, Colorfast
Lifetime Guarantee



9"



12"

*SHIPPING ONLY AVAILABLE IN FULL BOX QUANTITIES ONLY.

PART #	SIZE	BOX QUANTITY
9" COLORS AVAILABLE - BLACK, DARK BROWN, FOREST GREEN, GREY, MAROON, PACIFIC BLUE, PAINTABLE, REDWOOD, TERRA CLAY, WHITE		
RP922	9 X 22	10 PR
RP927	9 X 27	10 PR
RP936	9 X 36	10 PR
12" COLORS AVAILABLE - BLACK, FOREST GREEN, REDWOOD, WHITE & PAINTABLE		
RP1236	12 X 36"	5 PR
RP1243	12 X 43"	5 PR



SPECIAL PRICED VERTICAL SLIDER WINDOWS

White or Brown, J-Lap or Flush, 4x4 Grid Windows

Aluminum

Includes Screen
3 MIL Float Glass

J-Lap is 7/8" Wide for Vinyl or Metal Siding
Pallets of 28

MEETS AAMA 1701.2-02 (PRIMARY WINDOW AND SLIDING GLASS DOOR VOLUNTARY STANDARD FOR UTILIZATION IN MANUFACTURED HOUSING) REQUIREMENTS FOR WINDZONE 3.

**UPS Shipping NOT Available, Freight Truck Skids ONLY.*

PLEASE SPECIFY COLOR; WHITE OR BROWN & MOUNTING; J-LAP OR FLUSH		
W X H	DESCRIPTION	BUCK SIZE
18 X 23	4 X 4 GRID	18.25" X 23"
18 X 27	4 X 4 GRID	18.25" X 27.06"
18 X 36	4 X 4 GRID	18.25" X 35.75"
24 X 27	4 X 4 GRID	24.25" X 27.06"
24 X 36	4 X 4 GRID	24.25" X 36"
30 X 30	4 X 4 GRID	30" X 30"
30 X 36	6 X 6 GRID	30.25" X 35.75"
36 X 36	4 X 4 GRID	36.25" X 36"



**FLORIDA SPEC
CERTIFIED**
(ASTM CERTIFIED
WINDZONE 3
IMPACT RESISTANT)

W X H	DESCRIPTION	BUCK SIZE
24 X 36	4 X 4 GRID	24.25" X 36"
30 X 36	6 X 6 GRID	30.25" X 35.75"
36 X 36	4 X 4 GRID	36.25" X 36"

PLAYHOUSE WINDOWS

Aluminum

Tempered Glass
Includes Screen
Pallets of 56

MEETS AAMA 1701.2-02 (PRIMARY WINDOW AND SLIDING GLASS DOOR VOLUNTARY STANDARD FOR UTILIZATION IN MANUFACTURED HOUSING) REQUIREMENTS FOR WINDZONE 3.



W X H	DESCRIPTION	BUCK SIZE
12 X 18	WHITE / BROWN FLUSH 4 X 4 GRID	12" X 18"
14 X 21	WHITE / BROWN FLUSH/ J-LAP 4 X 4 GRID	14" X 21"
14 X 27	WHITE / BROWN FLUSH/ J-LAP 4 X 4 GRID	14" X 27"



MILL FINISH WINDOWS

Aluminum

No Grid
No Paint
Flush Mount
Includes Screen

(ASTM CERTIFIED WINDZONE 3
IMPACT RESISTANT)

**UPS Shipping Not Available, Freight Truck Skids Only*

PART #	W X H	BUCK SIZE	BOX QTY
W18X27FM	18 X 27"	18.25" X 27.06"	4
W22X35FM	22 X 35"	22.25" X 35.75"	4
W24X27FM	24 X 27"	24.25" X 27.06"	4
W24X35FM	24 X 35"	24.25" X 35.75"	4
W30X27FM	30 X 27"	30.25" X 27.06"	4
W30X30FM	30 X 30"	30.25" X 30"	4
W36X35FM	36 X 35"	36.25" X 35.75"	4



DOUBLE PANE VERTICAL SLIDER WINDOWS

Aluminum

Includes Screen
Flush Mount
4 x 4 Grid

PART #	DESCRIPTION	BUCK SIZE	SKID QTY
W24X36W4G-DBL	24 X 36" 4 X 4 GRID WHITE	24.25" X 36"	22
W24X36B4G-DBL	24 X 36" 4 X 4 GRID BROWN	24.25" X 36"	22
W36X36W4G-DBL	36 X 36" 4 X 4 GRID WHITE	36.25" X 36"	22
W36X36B4G-DBL	36 X 36" 4 X 4 GRID BROWN	36.25" X 36"	22

Bulk - Sold on Pallets of 22 Only

**UPS Shipping NOT Available, Freight Truck Skids ONLY.*

CRANK OUT WINDOW

Aluminum

Crank Included with Window
Includes Screen



**UPS Shipping NOT Available, Freight Truck Skids ONLY.*

PART #	W X H	COLOR	PANES	BOX QTY
W18X23B-CO	18 X 23"	BROWN	3	2
W18X23W-CO	18 X 23"	WHITE	3	2
W24X16B-CO	24 X 16"	BROWN	2	2
W24X16W-CO	24 X 16"	WHITE	2	2
W24X27B-CO	24 X 27"	BROWN	2	2
W24X27W-CO	24 X 27"	WHITE	2	2
W36X23B-CO	36 X 23"	BROWN	3	2
W36X23W-CO	36 X 23"	WHITE	3	2
W15X60B-CO	60 X 15"	BROWN	4	2
W15X60W-CO	60 X 15"	WHITE	4	2



CHICKEN COOP WINDOWS

Aluminum

Patent #US D828,580 S

White or Brown
Flush Mount
Hinged Tilt-out
Wire Mesh Screen
Detent Ball Latch

PART #	DESCRIPTION	PALLET QUANTITY
W14X21W-CC	14 X 21" WHITE	40
W14X21B-CC	14 X 21" BROWN	40
W18X23W-CC	18 X 23" WHITE	40
W18X23B-CC	18 X 23" BROWN	40
W24X27W-CC	24 X 27" WHITE	20
W24X27B-CC	24 X 27" BROWN	20

WINDOW CRANKS

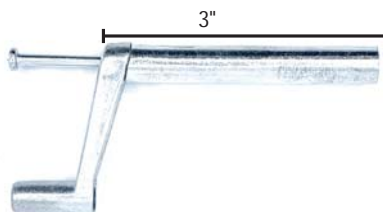

PART #	STEM LENGTH
CRANK4.4	4-1/2" OAL (3" STEM)



Kimro

USA MADE

**Vinyl Double Pane
INSULATED WINDOWS
SINGLE HUNG**

**Flush Mount
White Only
Includes Screen &
Grids
Pallets of 15**

***UPS SHIPPING NOT AVAILABLE, FREIGHT TRUCK SKIDS ONLY
USA Made Windows Available In Almost Any Size. Please Call For Quote.**

PART #	W X H	BOX QTY
W18X27W4G-PVC	18 X 27"	1
W24X27W4G-PVC	24 X 27"	1
W24X36W4G-PVC	24 X 36"	1
W30X36W6G-PVC	30 X 36"	1
W30X39W6G-PVC	30 X 39"	1

NEW SIZE

Kimro

USA MADE

**VINYL DOUBLE PANE
INSULATED WINDOWS
SINGLE HUNG**

**J-Lap
(7/8" Wide for Vinyl or Metal Siding)
Includes Screen & Grids
White or Clay
Pallets of 15**



***UPS SHIPPING NOT AVAILABLE, FREIGHT TRUCK SKIDS ONLY
USA Made Windows Available In Almost Any Size. Please Call For Quote.**

PART #	W X H	COLOR	GRID	BOX QTY
W18X27BJ4GPVC-D	18 X 27"	CLAY	4 X 4	1
W18X27WJ4GPVC-D	18 X 27"	WHITE	4 X 4	1
W24X27BJ4GPVC-D	24 X 27"	CLAY	4 X 4	1
W24X27WJ4GPVC-D	24 X 27"	WHITE	4 X 4	1
W24X36BJ4GPVC-D	24 X 36"	CLAY	4 X 4	1
W24X36WJ4GPVC-D	24 X 36"	WHITE	4 X 4	1
W30X36BJ6GPVC-D	30 X 36"	CLAY	6 X 6	1
W30X36WJ6GPVC-D	30 X 36"	WHITE	6 X 6	1
W36X40BJ6GPVC-D	36 X 40"	CLAY	6 X 6	1
W36X40WJ6GPVC-D	36 X 40"	WHITE	6 X 6	1



Apple
OUTDOOR SUPPLY

**Vinyl Double Pane
INSULATED WINDOWS
SINGLE HUNG**

**J-Lap
(7/8" Wide for Vinyl or Metal Siding)
Brown or White
Includes Screen & Grids
1 Window Per Box
Pallets of 10**

***UPS SHIPPING NOT AVAILABLE, FREIGHT TRUCK SKIDS ONLY**

PART #	W X H	COLOR	GRID
W24X27BJ4G-PVC	24.25 X 27.062	BROWN	4 X 4
W24X27WJ4G-PVC	24.25 X 27.062	WHITE	4 X 4
W24X36BJ4G-PVC	24.25 X 35.75	BROWN	4 X 4
W24X36WJ4G-PVC	24.25 X 35.75	WHITE	4 X 4
W30X36BJ6G-PVC	30.25 X 35.75	BROWN	6 X 6
W30X36WJ6G-PVC	30.25 X 35.75	WHITE	6 X 6
W30X39WJ6G-PVC	30.25 X 39.625	WHITE	6 X 6
W36X40BJ6G-PVC	36.25 X 39.625	BROWN	6 X 6
W36X40WJ6G-PVC	36.25 X 39.625	WHITE	6 X 6



Kimro

USA MADE

**Vinyl Double Pane
INSULATED WINDOWS
DOUBLE HUNG**

**J-Lap
(7/8" Wide for Vinyl or Metal Siding)
White
Includes Full Screen & Grids
Clay available +10%
Pallets of 15**

***UPS SHIPPING NOT AVAILABLE, FREIGHT TRUCK SKIDS ONLY
USA Made Windows Available In Almost Any Size. Please Call For Quote.**

PART #	W X H	COLOR	GRID	BOX QTY
W24X36W4GDH	24 X 36"	WHITE	4 X 4	1
W30X36W4GDH	30 X 36"	WHITE	4 X 4	1
W30X40W4GDH	30 X 40"	WHITE	4 X 4	1
W36X40W4GDH	36 X 40"	WHITE	4 X 4	1



TRANSOM WINDOWS

Vinyl

J-Lap Mount
White & Brown
Double Pane Insulated
Tempered Glass
1 Window Per Box

PART #	SIZE	COLOR	GRID
TRANS1023BJ-PVC	10 X 23"	BROWN	3
TRANS1023WJ-PVC	10 X 23"	WHITE	3
TRANS1024BJ-PVC	10 X 24"	BROWN	4
TRANS1024WJ-PVC	10 X 24"	WHITE	4
TRANS1029BJ-PVC	10 X 29"	BROWN	5
TRANS1029WJ-PVC	10 X 29"	WHITE	5
TRANS1030BJ-PVC	10 X 30"	BROWN	5
TRANS1030WJ-PVC	10 X 30"	WHITE	5
TRANS1035WJ-PVC	10 X 35"	WHITE	6
TRANS1035BJ-PVC	10 X 35"	BROWN	6
TRANS1060WJ-PVC	10 X 60"	WHITE	9
TRANS1072WJ-PVC	10 X 72"	WHITE	11

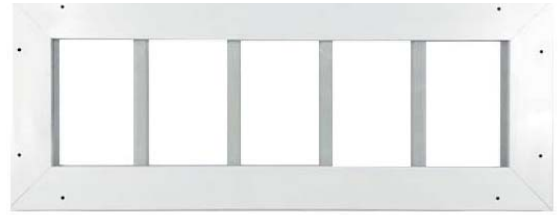

TRANSOM WINDOWS

Vinyl

Flush Mount
White
Self Trimmed
Tempered Glass

PART #	SIZE	GRID	BOX QTY
TRANS1018W3G-PV	10 X 18"	3	4
TRANS1023W3G-PV	10 X 23"	3	4
TRANS1029W4G-PV	10 X 29"	4	4
TRANS1035W5G-PV	10 X 35"	5	4

TRANSOM WINDOWS

Aluminum

4 Windows Per Box
Tempered Glass



*UPS SHIPPING NOT AVAILABLE, FREIGHT TRUCK SKIDS ONLY

ARCH TOP WINDOWS

Single Hung
Aluminum

Flush Mount
White
Includes Screen
& Grids



SOLD IN BOXES OF 4

PART #	W X H	BUCK SIZE
W18X23W4GRT	18 X 23"	18.25" X 33"
W18X27W4GRT	18 X 27"	19.75" X 38.25"
W24X27W4GRT	24 X 27"	25.75" X 41.25"
W24X36W4GRT	24 X 36"	25.75" X 50"

PART #	SIZE	MOUNT	COLOR	GRID
TRANS1018B3G	10 X 18"	FLUSH	BROWN	2
TRANS1018W3G	10 X 18"	FLUSH	WHITE	2
TRANS1018WJ3G	10 X 18"	J-LAP	WHITE	2
TRANS1023B3G	10 X 23"	FLUSH	BROWN	3
TRANS1023W3G	10 X 23"	FLUSH	WHITE	3
TRANS1024B3G	10 X 24"	FLUSH	BROWN	3
TRANS1024W3G	10 X 24"	FLUSH	WHITE	3
TRANS1024WJG	10 X 24"	J-LAP	WHITE	3
TRANS1029B4G	10 X 29"	FLUSH	BROWN	4
TRANS1029W4G	10 X 29"	FLUSH	WHITE	4
TRANS1030B4G	10 X 30"	FLUSH	BROWN	4
TRANS1030WG	10 X 30"	FLUSH	WHITE	4
TRANS1030WJG	10 X 30"	J-LAP	WHITE	4
TRANS1035B5G	10 X 35"	FLUSH	BROWN	5
TRANS1035W5G	10 X 35"	FLUSH	WHITE	5
TRANS1040B6GT	10 X 40"	FLUSH	BROWN	6
TRANS1040W6GT	10 X 40"	FLUSH	WHITE	6
TRANS1046B7GT	10 X 46"	FLUSH	BROWN	7
TRANS1046W7GT	10 X 46"	FLUSH	WHITE	7
TRANS1060W9G	10 X 60"	FLUSH	WHITE	9
TRANS1060WJ9G	10 X 60"	J-LAP	WHITE	9
TRANS1060B9G	10 X 60"	FLUSH	BROWN	9
TRANS1072W11G	10 X 72"	FLUSH	WHITE	11
TRANS1072B11G	10 X 72"	FLUSH	BROWN	11
TRANS1072WJG	10 X 72"	J-LAP	WHITE	11

*ALL OVER SIZED ITEMS WILL BE PLACED ON A SEPARATE PALLET AND BILLED SEPERATELY. FULL FREIGHT IS APPLIED TO THESE ITEMS.

WINDOWS

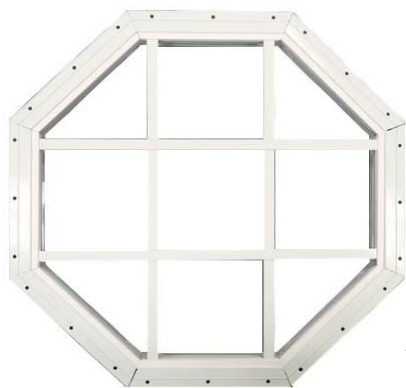

OCTAGON GABLE WINDOW

Aluminum
Tempered Glass
Brown Or White
Available in Flush Mount or J-lap

PART #	DESCRIPTION	BOXQTY
WOCT14W	14" WHITE FLUSH	4
WOCT14B	14" BROWN FLUSH	4
WOCT14WJ	14" WHITE J-LAP	4
WOCT14BJ	14" BROWN J-LAP	4
WOCT18W	18" WHITE FLUSH	4
WOCT18BR	18" BROWN FLUSH	4
WOCT18WJ	18" WHITE J-LAP	4
WOCT18BJ	18" BROWN J-LAP	4

OCTAGON GABLE WINDOW

PVC
Self Trimmed
Tempered Glass
Single Pane



PART #	DESCRIPTION	BOXQTY
WOCT14W-PVC	14" WHITE PVC	4
WOCT18W-PVC	18" WHITE PVC	4



12" SQUARE GABLE WINDOW

PVC
Self Trimmed
Tempered Glass

PART #	DESCRIPTION	BOX QTY
W12X12W4G-PVC	WHITE PVC	4

HALF MOON SUNBURST WINDOW



Aluminum
Tempered Glass
Brown or White
Available in Flush Mount or J-lap

ITEM NUMBER	SIZE	COLOR	MOUNT	GRID	QTY
14BSUNBURST	14.25"	BROWN	FLUSH	3	4
14BSUNBURST-J	14.25"	BROWN	J-LAP	3	4
14SUNBURST	14.25"	WHITE	FLUSH	3	4
14SUNBURST-J	14.25"	WHITE	J-LAP	3	4
18BSUNBURST	18.25"	BROWN	FLUSH	3	4
18BSUNBURST-J	18.25"	BROWN	J-LAP	3	4
18SUNBURST	18.25"	WHITE	FLUSH	3	4
18SUNBURST-J	18.25"	WHITE	J-LAP	3	4
24BSUNBURST	24"	BROWN	FLUSH	4	4
24BSUNBURST-J	24"	BROWN	J-LAP	4	4
24SUNBURST	24"	WHITE	FLUSH	4	4
24SUNBURSTJ	24"	WHITE	J-LAP	4	4
30BSUNBURST	30"	BROWN	FLUSH	4	4
30BSUNBURST-J	30"	BROWN	J-LAP	4	4
30SUNBURST	30"	WHITE	FLUSH	4	4
30SUNBURSTJ	30"	WHITE	J-LAP	4	4

10" ROUND GABLE WINDOW



Aluminum
Flush Mount Only
Tempered Glass
Metal Frame
Sold in Lots of 4

PART #	COLOR	STYLE	BOX QTY
WROUND10W	WHITE	FLUSH	4
WROUND10B	BROWN	FLUSH	4

OCTAGON GABLE WINDOW



PVC

1 - Per Box
J-Lap
Tempered Glass
Double Pane Insulated

PART #	DESCRIPTION	BOX QTY
WOCT14WJ-PVC	14" WHITE PVC	1
WOCT14BJ-PVC	14" BROWN PVC	1
WOCT18WJ-PVC	18" WHITE PVC	1
WOCT18BJ-PVC	18" BROWN PVC	1

OCTAGON GABLE WINDOW



Aluminum

4 - Per Box
White or Brown
Flush or J-lap
Hinged Tilt-out
Wire Mesh Screen
Tempered Glass
Detent Ball Latch

PART #	DESCRIPTION	BOX QTY
WOCT14W-TO	14" WHITE FLUSH	4
WOCT14B-TO	14" BROWN FLUSH	4
WOCT14WJ-TO	14" WHITE J-LAP	4
WOCT14BJ-TO	14" BROWN J-LAP	4
WOCT18W-TO	18" WHITE FLUSH	4
WOCT18B-TO	18" BROWN FLUSH	4
WOCT18WJ-TO	18" WHITE J-LAP	4
WOCT18BJ-TO	18" BROWN J-LAP	4

12" SQUARE GABLE WINDOW



J-LAP RECESS



FLUSH MOUNT

Aluminum

Tempered Glass
Available in Brown or White

PART #	COLOR	STYLE	BOX QTY
W12X12W4G	WHITE	FLUSH	4
W12X12B4G	BROWN	FLUSH	4
W12X12WJ4G	WHITE	J-LAP	4
W12X12BJ4G	BROWN	J-LAP	4

HALF ROUND WINDOWS



Aluminum

6 Lite Windows
Tempered glass
Flush mount

PART #	SIZE	COLOR	BOX QTY
W28X25WHR	28.5 X 25"	WHITE	4
W28X25BHR	28.5 X 25"	BROWN	4

QUARTER ARCH WINDOWS



LEFT SIDE

Aluminum

6 Lite Windows
Tempered glass
Flush mount



RIGHT SIDE

PART #	SIZE	SIDE	COLOR	BOX QTY
W15X29WQR	15 X 29"	RIGHT	WHITE	4
W15X29BQR	15 X 29"	RIGHT	BROWN	4
W15X29WQL	15 X 29"	LEFT	WHITE	4
W15X29BQL	15 X 29"	LEFT	BROWN	4
W15X23WQR	15 X 23"	RIGHT	WHITE	4
W15X23BQR	15 X 23"	RIGHT	BROWN	4
W15X23WQL	15 X 23"	LEFT	WHITE	4
W15X23BQL	15 X 23"	LEFT	BROWN	4

VENTILATION

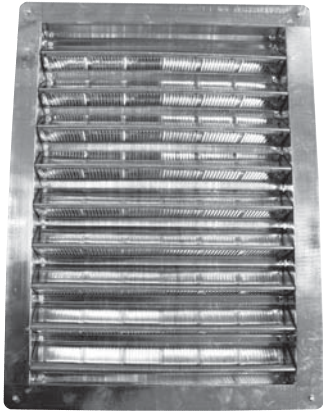

**12 X 18"
RECESSED
GABLE VENTS**

ALUMINUM

PART #	DESCRIPTION	BOX QTY
PR12X18M	12 X 18" MILL	12



**12 X 12"
RECESSED GABLE
VENTS**

ALUMINUM

PART #	DESCRIPTION	BOX QTY
PR12X12M	12 X 12" MILL	12
PR12X12BR	12 X 12" BROWN	12
PR12X12W	12 X 12" WHITE	12
PR12X12BRJ	12 X 12" BROWN, J-LAP	12
PR12X12WJ	12 X 12" WHITE, J-LAP	12

*BOX QUANTITIES MAY VARY



**CLASSIC GABLE
VENTS**

Buck Size- 8" x 10"
White
Paintable
Injection Molded Styrene
Uses #8 Screws

PART #	DESCRIPTION	BOX QTY
CV12X18W-PE	12 X 15-1/2" WHITE	10
CV12X18P	12 X 15-1/2" PAINTABLE	10



**8 X 8"
APPLE
ALUMINUM
RECTANGLE
WALL VENTS**

Available in Flush Mount
or J-lap



**LOUVERED
EXHAUST
VENTS**

PART #	DESCRIPTION	BOX QTY
BV4X16B	4 X 16" BROWN	50
BV4X16W	4 X 16" WHITE	50
BV8X16B	8 X 16" BROWN	50
BV8X16W	8 X 16" WHITE	50
BV8X16M	8 X 16" MILL	50

PART #	SIZE	DESCRIPTION	BOX QTY
PR8X8M	8 X 8"	FLUSH MILL	10
PR8X8	8 X 8"	FLUSH WHITE	10
PRJ8X8W	8 X 8"	J-LAP WHITE	10
PR8X8BRN	8 X 8"	FLUSH BROWN	10
PRJ8X8BRN	8 X 8"	J-LAP BROWN	10
PR8X8BLK	8 X 8"	FLUSH BLACK	10
PRJ8X8BLK	8 X 8"	J-LAP BLACK	10

PLEASE NOTE THAT *EXTRA UPS CHARGES APPLY TO ALL VENTS.

*DENSITY AND OVER-SIZED ITEM CHARGE.

VENTILATION & INSULATION

ALUMINUM UNDER SOFFIT VENTS



Intake Ventilation
Aluminum Louvered Construction
Reversible for Flush or Recessed Mounting

PART #	SIZE/COLOR	BOX QTY
SV258M	2-5/8" X 8' MILL	50
SV258W	2-5/8" X 8' WHITE	50

***ALL OVER SIZED ITEMS WILL BE PLACED ON A SEPERATE PALLET AND BILLED SEPERATELY. FULL FRIEGHT IS APPLIED TO THESE ITEMS.**

6" ROUND GABLE VENTS



Vinyl
White

PART #	DESCRIPTION	BOX QTY
GV600-W	6" ROUND WHITE VENT	40

SUNTEK SKYLIGHTS



Unbreakable Polycarbonate
Bronze Tinted Glass
Easy to Install
10 Windows Per Box

***Full Box Quantities Only**

ROLL OUT RIDGE VENTS



PART #	SIZE
RRV50	50' X 10-1/2"



Approved Vapor Barrier

ADHESIVE TAPE

Pressure Sensitive Acrylic Adhesive

PART #	SIZE	DESCRIPTION	BOX QTY
15852	2" X 150'	WHITE POLY	16
15853	3" X 150'	WHITE POLY	16

PART #	SIZE	BOX QTY
SF1414B/C	14 X 14"	10
SF1422B/C	14 X 22"	10
SF1430B/C	14 X 30"	10
SF2222B/C	22 X 22"	10
SF2246BC	22 X 46"	10

DOUBLE BUBBLE INSULATION

Clean, Lightweight, Easy To Install
White with Silver (Reflective)
Saves Energy and Money
Item may be subject to oversized freight charge.



***ALL OVER SIZED ITEMS WILL BE PLACED ON A SEPERATE PALLET AND BILLED SEPERATELY. FULL FRIEGHT IS APPLIED TO THESE ITEMS.**

PART #	SIZE	BUBBLE LAYER
DBBL4X125-SW	4' X 125'	DOUBLE
DBBL6X125-SW	6' X 125'	DOUBLE
SBBL4X125-SW	4' X 125'	SINGLE
SBBL6X125-SW	6' X 125'	SINGLE
SBBL7X125-SW	7' X 125'	SINGLE

PLEASE NOTE THAT *EXTRA SHIPPING CHARGES MAY APPLY

*DENSITY AND OVER-SIZED ITEM CHARGES DETERMINED BY FREIGHT CARRIERS.



ASTA Door Corporation

ROLL UP DOORS

- Strong, Durable Materials
- Smooth, Quiet Operation
- Easy to Install
- Multiple Applications
- Low Maintenance
- Minimal Back Room Required
- Rust Resistant
- Complements Existing Buildings



STANDARD COLORS: GLOSSY WHITE, BUCKSKIN TAN, BROWN, BRONZE, CEDAR RED, HUNTER GREEN, ROYAL BLUE, POWDER BLUE, CHARCOAL GREY

12% UPCHARGE FOR PATRIOT RED AND UNCLE BOB YELLOW

STANDARD FEATURES:

Curtain: 26 gauge galvanized steel curtain with baked epoxy primer and polyester topcoat

Bottom Bar: 2" x 1 1/2" x 16 gauge galvanized steel angle fastened to aluminum retainer with bulb astragal

Locks: Hardened steel slide bolt attached to exterior of curtain suitable for padlocking

Drum / Axle Assembly: 30 gauge topsheet attached to 20 gauge galvanized drums with ball bearings, supported by 14 gauge 1" o.D. Galvanized steel tubing

Guides: 18 gauge galvanized steel channels (2" deep per side) with pvc wearstrips

Operation: Manual / push-up (rope) up to 10'0" wide x 10'0" high

Tension Hardware Assembly: Cast steel tension wheel attached to door axle interacts with the tension pawl mounted on the support bracket for spring tension adjustment

Hardware: For mounting to wood (steel or block/masonry available upon request)

Measurements: Based on rough opening

CALL FOR QUOTES

DOOR'S WIDTH RANGE FROM 3' - 10'

DOOR'S HEIGHT RANGE FROM 6' - 10'

PART #	DESCRIPTION	MIN. ORDER
ROLL-HANDLE	ADDITIONAL HANDLE FOR ROLL-UP	1
ROLL-HSEAL	HEADER SEAL FOR ROLL-UP DOORS	75' ROLL
ROLL-MINILOCK	ADDITIONAL MINI LOCK FOR ROLL-UP	1

***PLEASE NOTE: ALL DOORS ARE PALLETIZED SEPARATE FROM OTHER HARDWARE. ALL DOOR ORDERS WILL BE SHIPPED SEPARATELY AT FULL FREIGHT COST.**

SLAM STRIPS



MADE FROM 100% EXPANDED PVC MATERIAL

TWO SIZES AVAILABLE!

MOUNTS TO THE SIDE OF ONE DOOR OF A DOUBLE DOOR SET-UP TO STOP THE OTHER DOOR FROM SWINGING IN TOO FAR.

PART #	SIZE	BOX QTY
SLAM372	3"x72"	10
SLAM378	3"x78"	10

***ALL OVER SIZED ITEMS WILL BE PLACED ON A SEPARATE PALLET AND BILLED SEPARATELY. FULL FREIGHT IS APPLIED TO THESE ITEMS.**

DIAMOND PLATE THRESHOLDS

17 Gauge Aluminum

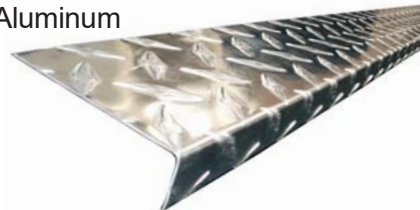

***ALL OVER SIZED ITEMS WILL BE PLACED ON A SEPARATE PALLET AND BILLED SEPARATELY. FULL FREIGHT IS APPLIED TO THESE ITEMS.**

PART #	SIZE/FINISH	BOX QTY
DP112348	1-1/2" BEND X 3" DROP X 48" LONG	25
DP112372	1-1/2" BEND X 3" DROP X 72" LONG	25
DP112472	1-1/2" BEND X 4" DROP X 72" LONG	25
DP11251272	1-1/2" BEND X 5-1/2" DROP X 72" LONG	25
DP112572	1-1/2" BEND X 5" DROP X 72" LONG	25
DP1125108	1-1/2" BEND X 5" DROP X 108" LONG	25
DP1125120	1-1/2" BEND X 5" DROP X 120" LONG	25

FIBERGLASS DOOR SLABS

Sizes: Width (27", 30-1/2", 35-3/4")
Height (72" & 78")
Thickness (1-3/4")

*Slab Only

***PLEASE NOTE: ALL DOORS ARE PALLETIZED SEPARATE FROM OTHER HARDWARE, THEREFORE ALL DOOR ORDERS WILL BE SHIPPED SEPARATELY.**

WHITE DOORS WILL BE SPECIAL ORDER ONLY (NON-STOCK ITEM) IN FULL PALLET QUANTITIES. PLEASE CALL FOR MORE INFORMATION.



6-PANEL FIBERGLASS 4-LITE FIBERGLASS 9-LITE FIBERGLASS

PART #	DESCRIPTION
FBDR	FIBERGLASS PANEL DOOR
FBAD	FIBERGLASS ARCH TOP: *NON-STOCK ITEM
FBDR-W	FIBERGLASS PAINTED WHITE: *NON-STOCK ITEM

Door Slabs Sold in Lots of 25 for freight truck shipping.

Freight costs apply on doors shipped via Common Carrier.

Apple Outdoor Supply & the manufacturer warranty all doors for 5 years from date of manufacture.

SPECIAL ORDER PREHUNG DOORS

Made to Order - Call for Pricing and Availability



PREHUNG DOOR OPTIONS

- Prehung: Wood or PVC
- Door Slab: Fiberglass (Primed)
- Door Glass: not installed or installed (extra cost) (4, 9, 11 Lite or 1/2 Moon Sunburst)
- Single Bore or Double Bore
- Wood Brick Mold

Looking at the structure from the outside, please choose the following:

- Inswing (swings inward)
- Outswing (swings outward)
- Hinge Placement (see description below)

Prehung Doors Sold in Lots of 6 to ship common carrier. (Can combine sizes & window configurations.)

Manufacturer warranty all doors for 5 years for manufacturer defects. There will be additional freight cost on doors shipped via Common Carrier.

DOOR GLASS

Windows for 30"+ Slabs
SCREWS INCLUDED



WINDOW DESCRIPTION

4 LITE TRANSOM WINDOW: 8" X 22.5"

NEW 4 LITE TRANSOM WINDOW: 10" X 22.5"

9 LITE WINDOW

11 LITE WINDOW

HINGE Placement

Choosing Door Swing

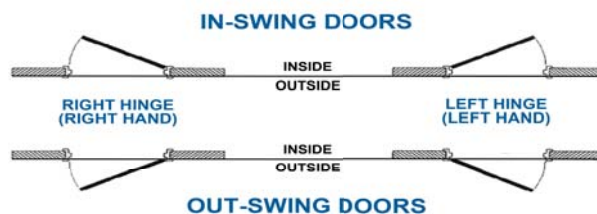

TULIP STYLE ENTRY DOOR KNOBS

Complete Lockset
Keyed Alike (come in sets of 3) or Keyed Differently



PART #	SIZE/COLOR	BOX QTY
43944	ANTIQUE BRASS KEYED ALIKE	1
43958	ANTIQUE BRASS KEYED DIFFERENTLY	1
43952	BRIGHT BRASS KEYED ALIKE	1
43960	BRIGHT BRASS KEYED DIFFERENTLY	1
43974	STAINLESS STEEL KEYED ALIKE	1
43973	STAINLESS STEEL KEYED DIFFERENTLY	1

DOOR BLOCKING

Hinge Placement Locations

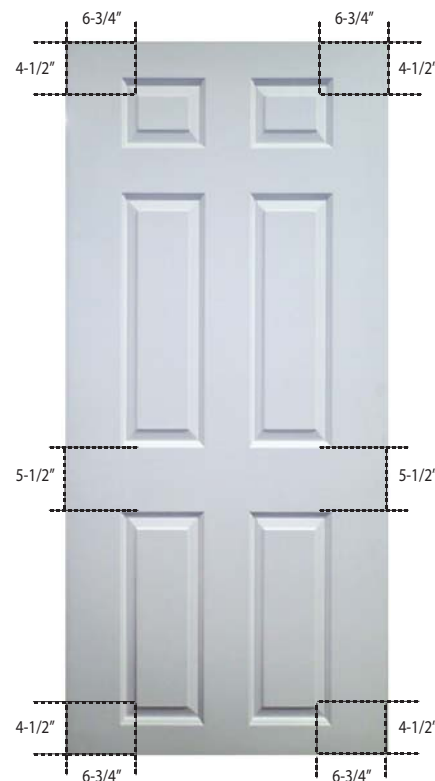

PREHUNG FIBERGLASS ENTRY DOORS WITH STEEL FRAME



*All Prehung
Metal Frame
Fiberglass
Doors Open
Outward*

*Choose Left
or Right Side
Hinges*

1-3/4"
SOLID
WOOD BLOCK



**SOLD IN
PALLETS
OF 8**

Screw right to frame
Cutout for door knob
White primed for paint
Thickness (1-1/2")

***PLEASE NOTE: ALL DOORS ARE PALLETIZED SEPARATE FROM OTHER HARDWARE. ALL DOOR ORDERS WILL BE SHIPPED SEPARATELY AT FULL FREIGHT COST.**

PART NUMBER	DESCRIPTION
SF3678LH-OS	IN-STOCK, STEEL FRAME PRE-HUNG
SF3678LH-OS9L	IN-STOCK, STEEL FRAME PRE-HUNG
SF3678RH-OS	IN-STOCK, STEEL FRAME PRE-HUNG
SF3678RH-OS9L	IN-STOCK, STEEL FRAME PRE-HUNG

* 72" DOORS ARE AVAILABLE FOR SPECIAL ORDER. CONTACT US FOR MORE INFORMATION.

STEM LENGTH GUIDE	
HANDLE STEM LENGTH	DOOR THICKNESS
3-1/2"	1" TO 2"
4"	1-3/4" TO 2-3/4"
4-1/2"	2-3/4" TO 3-3/4"
5-1/2"	3-3/4" TO 4-3/4"
6"	4-3/4" TO 5-3/4"



TBACKB-GEN



TBACKB-STD/
TBACKB-SMALL

INSIDE DOOR HANDLE

Made from Solid Steel
Set Screw Included

Uses 1/8" Hex Key

***SOLD IN FULL BOX
QUANTITIES ONLY.**



APPLE HEAVY DUTY DECORATIVE L-HANDLE LOCKS

Includes 2 Keys
Keyed Differently #1-200

PART #	DESCRIPTION	BOX QTY
LHHD312BKD-M	3-1/2" BLACK	50
LHHD400BKD-M	4" BLACK	50
LHHD412BKD-M	4-1/2" BLACK	50
LHHD512BKD-M	5-1/2" BLACK	50
LHHD600BKD-M	6" BLACK	50

PART #	DESCRIPTION	BOX QTY
TBACKB-STD	BLACK INSIDE HANDLE: 1-7/8" X 4-3/4"	50
TBACKB-SMALL	BLACK INSIDE HANDLE: 1-7/8" X 3-3/4"	50
TBACKB-GEN	BLACK INSIDE HANDLE: 2" X 3-3/4"	50
SSS14038C	1/4-20 X 3/8" SET SCREWS	100
THANDLE1/8	1/8" T-HANDLE HEX KEY WRENCH	1

APPLE L-HANDLE LOCKS

Includes 2 Keys

**Does Not Include Inside Door Handle*

Please specify the following:
Keyed Differently #1-200
(end part # with D-M) or
Keyed Alike (end part # with K-A)

**If key type is not specified, whichever is readily available will be sent*



APPLE T-HANDLE LOCKS

Includes 2 Keys

**Does Not Include Inside Door Handle*

Please specify the following:
Keyed Differently #1-200 (end part # with D-M)
or Keyed Alike (end part # with K-A)

**If key type is not specified, whichever is readily available will be sent*

PART #	DESCRIPTION	BOX QTY
TH312CHK	3-1/2" CHROME	50
TH312BK	3-1/2" BLACK	50
TH400CHK	4" CHROME	50
TH400BK	4" BLACK	50
TH412CHK	4-1/2" CHROME	50
TH412BK	4-1/2" BLACK	50
TH512CHK	5-1/2" CHROME	50
TH512BK	5-1/2" BLACK	50
TH600CHK	6" CHROME	50
TH600BK	6" BLACK	50
TH634CHK	6-3/4" CHROME	50
TH634BK	6-3/4" BLACK	50

PART #	DESCRIPTION	BOX QTY
LH300CHK	3" CHROME	50
LH312CHK	3-1/2" CHROME	50
LH312BK	3-1/2" BLACK	50
LH412CHK	4-1/2" CHROME	50
LH412BK	4-1/2" BLACK	50
LH512CHK	5-1/2" CHROME	50
LH512BK	5-1/2" BLACK	50

SPARE KEYS

PART #	DESCRIPTION
MASTER KEY	MASTERKEY SET FOR L-HANDLE OR T-HANDLE, 2 KEYS/SET



DOOR HARDWARE



CANE BOLTS

Includes All Hardware Shown

PART #	SIZE	BOXQTY
CANE18	18" ZINC	40
CANE18BLK	18" BLACK	40
CANE24Z	24" ZINC	40



APPLE SMALL SCREEN DOOR LATCH

Black in Color

Includes all Hardware Shown

PART #	BOX QTY
LATCHB	100

UNIVERSAL GATE LATCH KIT

Includes One Rod Stem, Two Latches (to secure open & closed positions) & Ten #8 x 1" Phillips Pan Head Screws.
Black or Zinc



SOLD AS A KIT ONLY. INDIVIDUAL PIECES NOT AVAILABLE.

PART #	DESCRIPTION	BOXQTY
UGLZ	ZINC KIT	50
UGLBLK	BLACK KIT	50
UGLSTEMB	BLACK STEM	100



SCREEN DOOR PULL

PART #	FINISH	BOX QTY
PULLYZ	YELLOW	500
PULLBLK	BLACK	500

5" DECORATIVE PULL

Black



PART #	FINISH	BOX QTY
DECPULL5B	BLACK	500

6-1/2" BARN PULL

Black Powder Coated



PART #	BOX QTY
PULL612B	50

HORSESHOE DROP LATCH

Black Zinc
4-1/2 x 9"

Includes All Hardware Shown



PART #	BOX QTY
HORSEDRLTCH	20

APPLE HEAVY DUTY SWIVEL HASPS



PART #	SIZE	BOX QTY
SH412Z	4-1/2" ZINC	100
SH412B	4-1/2" BLACK	100

APPLE SPRING LATCH

Black Powder Coat Finish



PART #	SIZE	BOX QTY
BBSPRINGLD	5/16" PIN LIGHT DUTY	50
BBSPRINGHD	1/2" PIN HEAVY DUTY	50

LOOP STYLE NON SPRING LOCKING BARREL BOLTS

Yellow Zinc Plated



PART #	DESCRIPTION	BOX QTY
BBLOOPLL-NS	1-1/2" LONG PIN	200



LOOP STYLE BARREL BOLTS

Yellow Zinc Plated

Spring Loaded to Provide Locking Abilities

Base Plate Measures 1 x 1-5/8"

Short Pin Measures 7/8" Locked

Long Pin Measures 1" Unlocked & 1-1/2" Locked

PART #	SIZE/TYPE	BOX QTY
BBLOOPLZ	SHORT LOCKING	200
BBLOOPLLZ	LONG LOCKING	200

APPLE HEAVY DUTY BARN LATCH

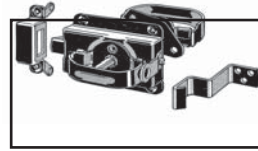

PICTURED TOGETHER



5" Pin Length Fits Doors up to 4" Thick

PART #	SIZE/FINISH	BOX QTY
BL30Z	3" ZINC	20
BL30B	3" BLACK	20

APPLE HEAVY DUTY SHED LATCH

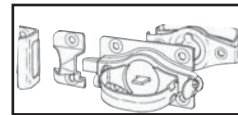

PICTURED TOGETHER



PART #	SIZE/FINISH	BOX QTY
SL20Z	2" ZINC 2-3/4" Pin Length	20
SL20B	2" BLACK 2-3/4" Pin Length	20
SL30Z	3" ZINC 3-3/4" Pin Length	20
SL30B	3" BLACK 3-3/4" Pin Length	20

APPLE SUPER DUTY BARREL BOLT

5/8" Diameter Pin- "Very Heavy"



PART #	SIZE	BOX QTY
BB500ZHD-SW	5" ZINC	50

APPLE HEAVY DUTY BARREL BOLTS

Locking Style has Flat Spot in Barrel to provide

NON LOCKING Locking Abilities. LOCKING



PART #	SIZE/TYPE	BOX QTY
BB212Z	2-1/2" NONLOCK	100
BB300Z	3" NONLOCK	100
BB400Z	4" NONLOCK	100
BBL400Z	4" LOCKING	100
BBL600Z	6" LOCKING	100

DOOR HARDWARE

APPLE BARN & SCREEN DOOR BRACES



Made in USA

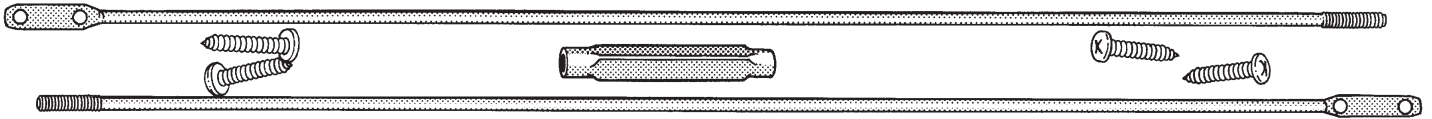

PART #	DESCRIPTION	BOX QTY
DB50Z	50" HEAVY DUTY	100
DB42ZH	42" HEAVY DUTY	100

APPLE CHAIN BOLTS 6"

Heavy Duty Construction
Includes All Hardware Shown



PART #	COLOR	BOX QTY
CB600Z-W	ZINC	50

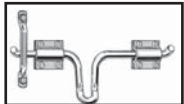

INSTALLED

LARGE DROP LATCH



Includes all hardware shown!

PART #	DESCRIPTION	BOX QTY
GL1135B	10-1/2" BLACK	30
GL1135Z	10-1/2" ZINC	30

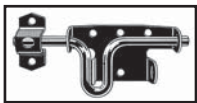

INSTALLED

SMALL DROP LATCH



Use #8 Hinge Screw

PART #	DESCRIPTION	BOX QTY
DLSMZ	6-3/4" ZINC	50
DLSMB	6-3/4" BLACK	50

GATE HOOK & EYE

Heavy Duty Construction



PART #	SIZE	BOX QTY
GH200ZH	2"	500
GH300ZH	3"	100
GH400ZH	4"	100
GH600ZH	6"	100

APPLE SCREEN DOOR SPRING HINGES

Black in Color



PART #	BOX QTY
HISCREENB	40 PAIR

APPLE SCREEN DOOR SPRING KIT

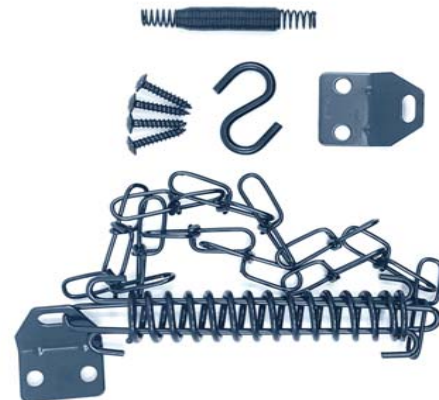

Includes All Hardware Shown

PART #	FINISH	BOX QTY
SCREENCHAIN	ZINC	100
SCREENCHAINB	BLACK	100

APPLE HEAVY DUTY T-HINGES

(WITH AND WITHOUT NYLON BUSHINGS)

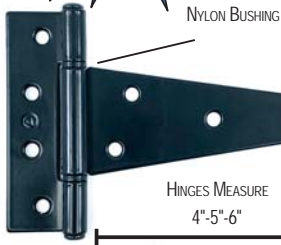

NYLON BUSHING

KEEPS DOORS FROM BINDING

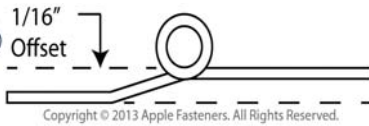

HINGES MEASURE
4"-5"-6"

All pins staked and nickel
Nylon Bushings between Knuckles
Undercoated With Spin Galvanization For Rust Protection
Black powder coat contains Ultra U.V. Protection
Full Box Quantities Only

PART #	SIZE / COLOR	BOX QTY	SKID QUANTITY
WITH BUSHINGS			
HIA4Z-NW	4" ZINC	100	3000
HIA4B-NW	4" BLACK	100	3000
HIA5Z-NW	5" ZINC	100	3000
HIA5B-NW	5" BLACK	100	3000
HIA6Z-NW	6" ZINC	50	2000
HIA6B-NW	6" BLACK	50	2000
WITHOUT BUSHINGS			
HIA4Z	4" ZINC	100	3000
HIA4B	4" BLACK	100	3000
HIA5Z	5" ZINC	100	3000
HIA5B	5" BLACK	100	3000
HIA6Z	6" ZINC	50	2000
HIA6B	6" BLACK	50	2000
HIA8Z	8" ZINC	50	2000
HIA8B	8" BLACK	50	2000

APPLE LIGHT DUTY T-HINGE



Black Powder Coated
Full Box Quantities Only
Great for Playhouses & Shutters

PART #	SIZE/COLOR	BOX QTY
HIAL2B	2" BLACK	200
HIAL3B	3" BLACK	200
HIAL4B	4" BLACK	100
HIAL8B	8" BLACK	100

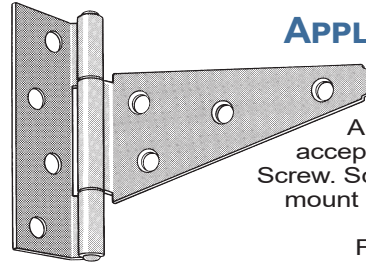

APPLE "BENT" STYLE HEAVY DUTY T-HINGE

A concealed hinge that is bent to accept 3/4" trim board. Use #10 Hinge Screw. Screw holes on rear of T-Hinge to mount easily to reverse side of door.

Full Box Quantities Only

PART #	SIZE/COLOR	BOX QTY
HIBENT6Z	6" ZINC	50
HIBENT6B	6" BLACK	50
HIBENT6Z-NW	6" ZINC WITH NYLON WASHERS	50
HIBENT6B-NW	6" BLACK WITH NYLON WASHERS	50



APPLE COLONIAL DECORATIVE HINGE WITH NYLON BUSHINGS

Black Powder Coated
Nylon Bushings between Knuckles
All Hinges Undercoated with Spin Galvanization for Rust Protection
Colonial Hinges use #8 Hinge Screw

PART #	SIZE/COLOR	BOX QTY
WITH BUSHINGS		
HICDEC4B-NW	4" BLACK W/ IN LINE HOLES	100
HICDEC5B-NW	5" BLACK	100
HICDEC6B-NW	6" BLACK	50
WITHOUT BUSHINGS		
HICDEC4B	4" BLACK	100
HICDEC5B	5" BLACK	100
HICDEC6B	6" BLACK	50
WITH BUSHING & IN LINE HOLES		
HICDEC6B-NWIN	6" BLACK	50

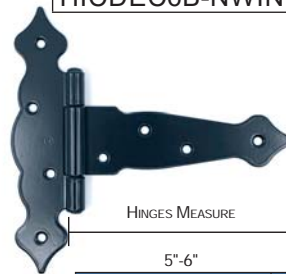

APPLE ORIGINAL DECORATIVE HINGE

Use #8 Hinge Screws

PART #	DESCRIPTION	BOX QTY
HIDEC5B	5" BLACK	100
HIDEC5B-NW	5" BLACK WITH NYLON WASHERS	100
HIDEC6B	6" BLACK	50
HIDEC6B-NW	6" BLACK WITH NYLON WASHERS	50

HINGES & BUMPERS



72" CONTINUOUS BARN HINGE

Aluminum with Aluminium Pin
1-1/2" Open or 2" Open
.060 Thick, 1/2 Knuckle, 1/8" Pin
Holes every 2"



**SOLD IN FULL BOXES QUANTITIES ONLY*
**ALL OVER SIZED ITEMS WILL BE PLACED ON A SEPERATE PALLET AND*
BILLED SEPERATELY. FULL FRIEGHT IS APPLIED TO THESE ITEMS.

PART #	SIZE	BOX QTY
CH11272AL	72 X 1-1/2"	125
CH2072AL	72 X 2"	100

**BOX QUANTITIES MAY VARY*



DOOR BUMPER

White
2-3/4" Length x 2-1/4" Width

PART #	BOX
SHBUMP	100

13" APPLE COLONIAL STRAP HINGE



Black Powder Coated
Use Black #8 Pan Square Or Phillips Screw

PART #	SIZE	BOX QTY
HISTRAPB	13" BLACK	50

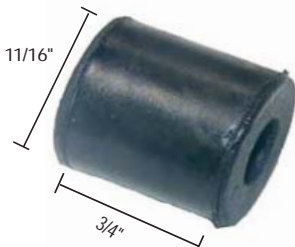

BARN HINGE BUMPER

Hinge Mounted to stop door from contacting Flower Box or Shed.
Black

PART #	BOX
2609/017	100

SHED BUMPER

Mount to Trim to stop door from contacting Flower Box or Shed.
Hole relief for flat head screws.
Black



PART #	BOX QTY
BUMP/SHED	50



APPLE HEAVY DUTY BUTT HINGES

Black
Full Box Quantities Only
Price Per Pair

PART #	DESCRIPTION	BOX QTY
HIBUT3B	3X3" BLACK SQUARE	50 PR



Stainless Steel
Full Box Quantities Only

PART #	SIZE	BOX QTY
HIBUT4SS	4X4"	100 EA

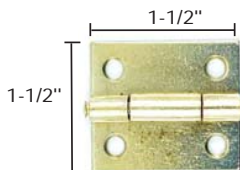

1-1/2" x 1-1/2"
Full Box Quantities Only
Price Per Pair
Uses #6 Screws

PART #	DESCRIPTION	BOX QTY
HIBUT112Z	1-1/2 X 1-1/2" ZINC	50 PR
HIBUT2Z	2 X 2" ZINC	100 PR
HIBUT112BB	1-1/2 X 1-1/2" BRIGHT BRASS	50 PR

Yellow Zinc
Full Box Quantities Only
Square Corners
Edge Holes Only



PART #	DESCRIPTION	BOX QTY
HIBUT412YZ-EH	4-1/2 X 4-1/2"	50 EA

Full Box Quantities Only
Use #10 Hinge Screw



PART #	SIZE/COLOR	BOX QTY
HIB312Z	3-1/2" ZINC	50 EA
HIB312B	3-1/2" BLACK	50 EA



Round Corners
Full Box Quantities Only
Use #10 Hinge Screw
Price Per Pair

PART #	SIZE/COLOR	BOX QTY
HIBUT312YZ	3-1/2 X 3-1/2" YELLOW ZINC	100 EA
HIBUT312BLK	3-1/2 X 3-1/2" BLACK	100 EA
HIBUT4YZ	4 X 4" YELLOW ZINC	100 EA

12" DECORATIVE GATE HINGE



Black Powder Coated
Swings Right or Left
Countersunk Holes, use #8 Hinge Screw

PART #	SIZE	BOX QTY
HIDECGATEBLK	12"	25

12" DOUBLE DUTCH DOOR HINGE



Black Powder Coated
Countersunk Holes, use #8 Hinge Screws

PART #	SIZE	BOX QTY
HIDBLGATEBLK	12"	10

17" DOUBLE DUTCH REVERSIBLE HINGE



Black Powder Coated
Solid Pin
10 per box
Use 3/8" Lag Bolts
13-1/2" x 19-1/4" (17" from pin to end)

PART #	DESCRIPTION	BOX QTY
HIDBLDUTCH16	17" BLACK	10

17" SINGLE DUTCH HINGE



Solid Pin
Black Powder Coated
Use 3/8" Lag Bolts
8" x 19-1/4" (17" from pin to end)

PART #	DESCRIPTION	BOX QTY
HIDUTCHSINGLE	17" BLACK	10

20" BLACK SUPER HEAVY DUTY BARN HINGE



Black Powder Coated
10" x 23" (20" from pin to end)
Use 3/8" Lag Bolts

PART #	SIZE	BOX QTY
HIDECGATE20	20" BLACK SUPER HEAVY DUTY	10

HORSE BARN HINGE WITH PINNEL



Black Powder Coated
Uses 3/8" Carriage Bolt

PART #	SIZE/COLOR	BOX QTY
HISPBLK16	16" BLACK	20
HISPBLK20	20" BLACK	20

22" HORSE BARN GATE HINGE

Black Powder Coated
5-1/2 x 22-1/2"
Uses 3/8" Carriage & Lag Bolts



PART #	SIZE	BOX QTY
HISTRAP20-SB	5-1/2 X 22"	10

APPLE COUNTERSUNK HINGE SCREWS



Type 17 Cutter Tip# 2 Square & Star Drive
Black are 100% Coated

PART #	DESCRIPTION	BOX QTY
ZINC		
HISCR08112Z	#8 X 1-1/2" ZINC	5000
HISCR08134Z	#8 X 1-3/4" ZINC	5000
HISCR08200Z	#8 X 2" ZINC	4000
HISCR08212Z	#8 X 2-1/2" ZINC	3000
HISCR08300Z	#8 X 3" ZINC	3000
HISCR08114Z	#8 X 1-1/4" ZINC	7000
KKB10112Z	#10 X 1-1/2" ZINC	4000
KKB10200Z	#10 X 2" ZINC	3000
KKB10212Z	#10 X 2-1/2" ZINC	2000
KKB10300Z	#10 X 3" ZINC	1500
BLACK		
HISCR08114B	#8 X 1-1/4" BLACK	7000
HISCR08112B	#8 X 1-1/2" BLACK	5000
HISCR08134B	#8 X 1-3/4" BLACK	5000
HISCR08200B	#8 X 2" BLACK	4000
HISCR08214B	#8 X 2-1/4" BLACK	4000
HISCR08212B	#8 X 2-1/2" BLACK	3000
HISCR08300B	#8 X 3" BLACK	3000
HISCR09214B	#9 X 2-1/4" BLACK	3000
HISCR09212B	#9 X 2-1/2" BLACK	3000
HISCR10112B	#10 X 1-1/2" BLACK	4000
HISCR10200B	#10 X 2" BLACK	3000
HISCR10300B	#10 X 3" BLACK	1500
ZINC - STAR DRIVE		
HTX08114Z	#8 X 1-1/4" ZINC	7000
HTX08112Z	#8 X 1-1/2" ZINC	5000
HTX08134Z	#8 X 1-3/4" ZINC	5000
HTX08200Z	#8 X 2" ZINC	4000
HTX08212Z	#8 X 2-1/2" ZINC	3000
HTX08300Z	#8 X 3" ZINC	2500
HTX10112Z	#10 X 1-1/2" ZINC	4000
HTX10200Z	#10 X 2" ZINC	3000
HTX10212Z	#10 X 2-1/2" ZINC	2000
HTX10300Z	#10 X 3" ZINC	1500
BLACK - STAR DRIVE		
HTX08114B	#8 X 1-1/4" BLACK	7000
HTX08112B	#8 X 1-1/2" BLACK	5000
HTX08134B	#8 X 1-3/4" BLACK	5000
HTX08200B	#8 X 2" BLACK	4000
HTX08212B	#8 X 2-1/2" BLACK	3000
HTX08300B	#8 X 3" BLACK	2500
HTX10112B	#10 X 1-1/2" BLACK	4000
HTX10200B	#10 X 2" BLACK	3000
HTX10212B	#10 X 2-1/2" BLACK	2000
HTX10300B	#10 X 3" BLACK	1500

EARTH ANCHORS

MOBILE HOME ANCHOR

UPS SHIPPING NOT AVAILABLE



5/8" x 30" Long
Double Auger 4" Wide

PART #
4430

EYE STYLE SHED ANCHOR

UPS SHIPPING NOT AVAILABLE



5/8" x 30" Long
Double Auger 4" Wide

PART #
74430

BARBED ROCK / MACADAM ANCHOR

UPS SHIPPING NOT AVAILABLE



30" Long
With Anchor Bracket

PART #
BARANCHOR



GALVANIZED HURRICANE STAKE

1-1/4" x 17-5/8"

PART #	BOX QTY
STAKE	30

ANCHOR DRIVE MACHINE

SPECIAL ORDER ONLY
LEAD TIMES FALL BETWEEN
4-8 WEEKS. PLEASE CALL
FOR MORE INFORMATION.



12 RPM 1/2 HP Motor
120v.- 60 cycle- 9amp
On-Off Switch with
Forward & Reverse
90 Day Warranty



PART #	DESCRIPTION
2730	MACHINE
2741	3/4" ADAPTER

EYE ANCHOR BOLT SET



1/2-13 x 5" Bolt, Full Thread
1/2" Fender F/W
1/2-13 Hex Nut

PART #
EBOLTHDW



STRAPPING CLIPS

PART #	BOX QTY
STRAPSEAL	200

STRAP BOLT & NUT



Use with #4430
400pc/Keg
8pc/Bag- 50 Bags/Keg

PART #
2010-BOLT

METAL BUILDING HARDWARE

DOUBLE SLOT BUCKLE WITH STRAP

Use with Part #4430
6' Strap Assembled
Comes 4 per Bundle



PART #
2566



600' ROLL GALVANIZED STRAP

Use with Part #4430

PART #
2670

DOUBLE SLOT BUCKLE



PART #	BOX QTY
2SLOTSTRAP	200

HURRICANE STRAPS

Galvanized Steel



PART #	BOX QTY
H25AZ	100

HURRICANE TIES

Galvanized Steel

PART #	BOX QTY
H1Z	100



HEX TEK SCREWS

Self Drilling For Steel to Steel Applications.
With Bonded Washer



PART #	BOX QTY
HTEK12034-ANEO	4,000
HTEK12034Z	4,000

*BOX QUANTITIES MAY VARY



COIL STOCK

.019 Guage Aluminum 24" x 50'

Additional colors available in full pallets only. Call for quotes.



STANDARD COIL STOCK

PART #	COLOR
COILSTD-BLK	BLACK
COILSTD-BRN	BROWN
COILSTD-WHT	WHITE

PVC-TEXTURED COIL STOCK

PART #	COLOR
COILPVC-BLK	BLACK
COILPVC-BRN	BROWN
COILPVC-WHT	WHITE

TRUSS ASSEMBLY PLATES

Zinc Plated
Nail Tooth



ADDITIONAL SIZES AVAILABLE UPON REQUEST!

PART #	SIZE	BOX QTY
TRUSSPLT2X4	2" x 4"	582
TRUSSPLT3X4	3" x 4"	360
TRUSSPLT3X5	3" x 5"	288
TRUSSPLT3X6	3" x 6"	216
TRUSSPLT4X4	4" x 4"	204
TRUSSPLT4X6	4" x 6"	162

**OVERSIZED BOXES, SPECIAL FREIGHT CHARGES MAY APPLY, UPS SHIPPING NOT AVAILABLE

***PLEASE NOTE THAT EXTRA UPS CHARGES APPLY TO ALL COIL STOCK.

*DENSITY AND OVER-SIZED ITEM CHARGE.

SWING HARDWARE

***ALL SWINGSET HARDWARE IS SOLD IN FULL BOX QUANTITIES ONLY**



MOLDED TIRE

Measures
Approximately
25" Wide x 7" High

PART #	COLOR	BOX QTY
TIREBLU	BLUE	1
TIREMAR	MAROON	
TIREGRN	GREEN	
TIREBLK	BLACK	
FASTENERS & CHAIN SOLD SEPARATELY		



HEAVY DUTY ADJUSTABLE GLIDER HANGER

PART #	COLOR	CASE QTY
DBLGLIDEBRKTGN	GREEN	4 PR
DBLGLIDEBRKTYEL	YELLOW	
DBLGLIDEBRKTBL	BLUE	
DBLGLIDEBRKTMAR	MAROON	
4 PAIRS PER CASE		

10" PLASTIC HAND GRIPS



PART #	COLOR	CASE QTY
SMHANDGRIPGN	GREEN	24 PR
SMHANDGRIPYEL	YELLOW	
SMHANDGRIPBL	BLUE	
SMHANDGRIPMAR	MAROON	
INCLUDES (2) 1/4x1-3/4" LAG BOLTS & (2) 1/4" FLAT WASHERS FOR MOUNTING & PLASTIC PLUGS TO COVER LAG BOLTS		

BUOY BALL



PART #	COLOR	BOX QTY
BUOY-GN	GREEN	1
NO CHAINS OR ROPE ATTACHED		

32" STEEL LADDER HANDLE



PART #	COLOR	CASE QTY
LADDERHANDGN	GREEN	12PR
LADDERHANDYEL	YELLOW	
LADDERHANDBL	BLUE	
LADDERHANDMAR	MAROON	
DOES NOT INCLUDE FASTENERS FOR MOUNTING		



DELUXE GLIDER SWING

Eye Bolts Included
Chain NOT Included

NON SLIP GRIP

PART #	COLOR	CASE QTY
DBLGLIDE-GN	GREEN	1
DBLGLIDER-YEL	YELLOW	
DBLGLIDE-BL	BLUE	
BULK PURCHASE- 48 (1 SKID) OF 1 COLOR		QTY
DBLGLIDE-GNBK	GREEN	48
DBLGLIDE-BLBK	BLUE	

LARGE MOLDED TIRE

Measures Approximately
27-1/2" Wide
x 9" High



PART #	COLOR	BOX QTY
TIRELG-BL	BLUE	1
TIRELG-GN	GREEN	
FASTENERS & CHAIN SOLD SEPARATELY, TIRECONNECT RECOMMENDED		

ATTENTION: IN ORDER TO COMPLY WITH THE LATEST RULES SET FORTH BY THE NEW "CONSUMER PRODUCT SAFETY IMPROVEMENT ACT OF 2008" APPLE FASTENERS HAS HAD THIRD PARTY TESTING PERFORMED ON ALL THE APPLICABLE PRODUCTS FOR LEAD LIMITS AS WELL AS BANNED PHthalATES. THOSE TEST RESULTS ARE AVAILABLE AS A "CERTIFICATE OF COMPLIANCE" AND MUST BE FURNISHED TO EACH MANUFACTURER, DISTRIBUTOR AND RETAILER. IN ORDER TO OBTAIN A COPY, PLEASE CALL CUSTOMER SERVICE AT 1-800-704-8112.



BELT SEAT SWING

PART #	COLOR	BOX QTY
BELTSEATGN	GREEN	24
BELTSEATYEL	YELLOW	
BELTSEATBL	BLUE	
BELTSEATMAR	MAROON	

FASTENERS & CHAIN SOLD SEPARATELY
QL14314Z & SH516334Z RECOMMENDED

MOLDED TRAPEZE BAR WITH SNAP HOOKS



PART #	COLOR	BOX QTY
TRAPEZEPLGN	GREEN	12
TRAPEZEPLYEL	YELLOW	
TRAPEZEPLBL	BLUE	

SNAP HOOKS INCLUDED;
CHAIN NOT INCLUDED



FULL BUCKET SWING

PART #	COLOR	BOX QTY
BUCKETGN	GREEN	6
BUCKETYEL	YELLOW	
BUCKETBL	BLUE	
BUCKETMAR	MAROON	

FASTENERS & CHAIN SOLD SEPARATELY

TRAPEZE BAR



PART #	COLOR	BOX QTY
TRAPEZE-GN	GREEN	6
TRAPEZE-YEL	YELLOW	
TRAPEZE-BL	BLUE	

S-HOOKS INCLUDED;
CHAIN NOT INCLUDED



CHILD SWING SEAT

Ropes and Hooks Included

PART #	COLOR	BOX QTY
CHILDSEATGN	GREEN	1
CHILDSEATYEL	YELLOW	
CHILDSEATBL	BLUE	

ROPES & HOOKS INCLUDED;
CHAIN NOT INCLUDED



TRIANGLE HANDLES

PART #	COLOR	BOX QTY
TRIANGLE-GN	GREEN	24
TRIANGLE-YEL	YELLOW	
TRIANGLE-BL	BLUE	
TRIANGLE-MAR	MAROON	

SWING HARDWARE

***ALL SWINGSET HARDWARE IS SOLD IN FULL BOX QUANTITIES ONLY**

CLIMBING ROCKS

4 Pieces per Set
36 Sets per Case



PART #	COLOR	CASE QTY
CLIMBROCK/GN	GREEN	36
CLIMBROCK/YEL	YELLOW	
CLIMBROCK/BL	BLUE	
CLIMBROCK/MAR	MAROON	
DOES NOT INCLUDE FASTENERS FOR MOUNTING		

19" CAPTAIN'S WHEEL

Includes (3) Lag Bolts For Mounting



PART #	COLOR	BOX QTY
CAPWHEELGN	GREEN	4
CAPWHEELYEL	YELLOW	
CAPWHEELBL	BLUE	
*UPS SHIPPING NOT RECOMMENDED. EXTRA CHARGES APPLY.		

PERISCOPE

Includes (2) #10x1-1/4" Flat Head Screws for Mounting



PART #	COLOR	BOX QTY
PERIGN/YEL	GREEN/YELLOW	12
PERIYEL/BL	YELLOW/BLUE	

BINOCULARS

Includes (2) #10x1-1/4" Flat Head Screws for Mounting



PART #	COLOR	BOX QTY
BINOCGN/YEL	GREEN/YELLOW	12
BINOCYEL/BL	YELLOW/BLUE	

TELESCOPE

Includes (2) #10x1-1/4" Flat Head Screws for Mounting



PART #	COLOR	BOX QTY
TELEGR/YEL	GREEN/YELLOW	12
TELEYEL/BL	YELLOW/BLUE	

11" STEERING WHEEL

Includes Plastic Center Cap, 5/16 X 2-1/2" Lag Bolt & 5/16" & Flat Washer For Mounting



PART #	COLOR	BOX QTY
STEERGN	GREEN	12
STEERYEL	YELLOW	
STEERBL	BLUE	
STEERMAR	MAROON	
*UPS SHIPPING NOT RECOMMENDED. EXTRA CHARGES APPLY.		

TIC-TAC-TOE BOARD



PART #	BOX QTY
TICTACTOE	1

TELEPHONE



PART #	COLOR	BOX QTY
TELEGN	GREEN	24

ATTENTION: IN ORDER TO COMPLY WITH THE LATEST RULES SET FORTH BY THE NEW "CONSUMER PRODUCT SAFETY IMPROVEMENT ACT OF 2008" APPLE OUTDOOR SUPPLY HAS HAD THIRD PARTY TESTING PERFORMED ON ALL THE APPLICABLE PRODUCTS FOR LEAD LIMITS AS WELL AS BANNED PHTHALATES. THOSE TEST RESULTS ARE AVAILABLE AS A "CERTIFICATE OF COMPLIANCE" AND MUST BE FURNISHED TO EACH MANUFACTURER, DISTRIBUTOR AND RETAILER. IN ORDER TO OBTAIN A COPY, PLEASE CALL CUSTOMER SERVICE AT 1-800-704-8112.

SWING HARDWARE

Factory cut to length chain available - Call for quote* *Cut to length takes 90 days*



5/8" DIAMETER MARINE GRADE ROPE

2 Rolls per Case
200 Feet per Roll

PART #	COLOR	CASE QTY
ROPEGN	GREEN	400'
ROPEYEL	YELLOW	
ROPEBL	BLUE	
ROPEMAR	MAROON	

ECONOMY CHAIN WELDED



2/0 - 400# BREAKING

PART #	TYPE	CTN QTY
CHAIN2/0PTZ	2/0 PASS ZINC	1000 FT
CHAIN2/0PTYZ	2/0 PASS YELLOW	1000 FT



S-SHAPED HOOKS

Zinc Plated

PART #	SIZE	BOX QTY
SH14200	1/4 X 2"	700
SH14212	1/4 X 2-1/2"	500
SH516300Z	5/16 X 3"	200
SH516334Z	5/16 X 3-3/4"	250

DOUBLE LOOP CHAIN



2/0 - 255# BREAKING
4/0 - 365# BREAKING

PART #	TYPE	CTN QTY
CHAIN2/0	2/0 ZINC	2500 FT
CHAIN2/0-AWC	2/0 AWC	2500 FT
CHAIN2/0YZ	2/0 YELLOW	2500 FT
CHAIN2/0-100	2/0 ZINC	100 FT
CHAIN4/0	4/0 ZINC	1500 FT



APPLE E-HOOKS

Great For Connecting Chain Links Together.

PART #	SIZE/FINISH	BOX QTY
EH316Z	3/16 X 3-1/2" ZINC	500
EH316YZ	3/16 X 3-1/2" YELLOW ZINC	500

WELDED CHAIN



Passing Link
700# Breaking

Passing Link Chain is designed to be wide enough to allow links to pass through one another freely, eliminating kinking.

PROOF COIL
800# BREAKING

EXTRA HEAVY DUTY SWING SPRINGS

500 pound rated
Overall length is 7"
Steel with Zinc Finish

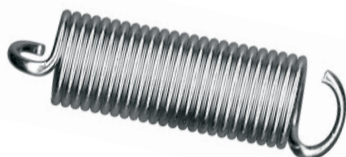

PART #	QTY
SPRINGXHD	40

PART #	TYPE	CTN QTY
CHAIN3/16	3/16" PROOF ZINC	1000 FT
CHAIN3/16-100	3/16" PROOF ZINC	100 FT
CHAIN3/16 PT	3/16" PASS ZINC	1000 FT
CHAIN3/16 PT-AWC	3/16" PASS AWC	1000 FT
CHAIN3/16 PT-100	3/16" PASS ZINC	100 FT
CHAIN3/16 PTYZ	3/16" PASS YELLOW	1000 FT
CHAIN3/16PTSS	3/16" PASS 304 SS	1000 FT
CHAIN3/16PTSS-1	3/16" PASS SS	100 FT
CHAIN1/4	1/4" PROOF ZINC	1000 FT

SWING SET CHAIN

*LINKS ARE 3/16" THICK

*ALL CHAIN SOLD IN PAIRS, 12 PAIRS PER CASE

SOFT GRIP SWING CHAIN



PART #	COLOR	DESCRIPTION	CASE QTY
42" FOR USE WITH TRAPEZE			
CHAINSG42-GNZ	GREEN	42" ZINC COAT 4/0 STRAIGHT LINK CHAIN (24" SOFT GRIP COATED)	12 PR
CHAINSG42-YELZ	YELLOW		
CHAINSG42-BLZ	BLUE		
54" FOR USE WITH DOUBLE GLIDER			
CHAINSG54-GNZ	GREEN	54" ZINC COAT 4/0 STRAIGHT LINK CHAIN (24" SOFT GRIP COATED)	12 PR
CHAINSG54-YELZ	YELLOW		
CHAINSG54-BLZ	BLUE		
66" FOR USE WITH BELT SWING			
CHAINSG66-GNZ	GREEN	66" ZINC COAT 4/0 STRAIGHT LINK CHAIN (24" SOFT GRIP COATE	12 PR
CHAINSG66-YELZ	YELLOW		
CHAINSG66-BLZ	BLUE		

MOLDED SWING CHAIN

PART #	COLOR	DESCRIPTION	CASE QTY
*FOR USE WITH TRAPEZE			
CHAINPVCGN-42Z	GREEN	42" ZINC COAT 4/0 STRAIGHT LINK CHAIN (24" PLASTISOL COAT)	12 PR
CHAINPVCYEL-42Z	YELLOW		
CHAINPVCBL-42Z	BLUE		
*FOR USE WITH DOUBLE GLIDER			
CHAINPVCGN-54Z	GREEN	54" ZINC COAT 4/0 STRAIGHT LINK CHAIN (24" PLASTISOL COAT)	12 PR
CHAINPVCYEL-54Z	YELLOW		
CHAINPVCBL-54Z	BLUE		
*FOR USE WITH BELT SWING			
CHAINPVCGN-66Z	GREEN	66" ZINC COAT 4/0 STRAIGHT LINK CHAIN (24" PLASTISOL COAT)	12 PR
CHAINPVCYEL-66Z	YELLOW		
CHAINPVCBL-66Z	BLUE		





TIRE SWIVELS



PART #	DESCRIPTION	CASE QTY
TSS3PHD	3 POINT TIRE SWIVEL	10

PART #	DESCRIPTION	CASE QTY
#3294	OUTDOOR POWDER COATED	12



TIRE EYE BOLTS

PART #	DESCRIPTION	CASE QTY
TIREBOLTGALV	HOT DIPPED GALVANIZED	18



SWING HANGERS



PART #	DESCRIPTION	BOX QTY
SH2HSSH	2 HOLE SNAP HOOK DACROMET	50

PART #	DESCRIPTION	BOX QTY
SH2HSEH	2 HOLE E-HOOK DACROMET	50
SH2HSSEH	2 HOLE E-HOOK STAINLESS STEEL	100



PART #	DESCRIPTION	BOX QTY
CAST-SV	2 HOLE CAST ZINC	20



PART #	DESCRIPTION	BOX QTY
CAST-SV4H	4 HOLE CAST ZINC	20

SWING HARDWARE



SNAP-HOOK SWING SWIVEL LAG

Snap Hook Lag Style

PART #	DESCRIPTION	BOX QTY
SHLAG38312SS	3/8" X 3-1/2" STAINLESS STEEL	100
SHLAG38312Z	3/8 X 3-1/2" ZINC	100

SNAP-HOOK SWING SWIVEL BOLT

Snap Hook Style
Zylan Coated



PART #	DESCRIPTION	BOX QTY
SHH38600G	3/8-16 X 6" MACHINE GALV FOR 4 X 4 LUMBER	100
SHH38800G	3/8-16 X 8" GALV FOR 6 X 6 LUMBER	100



E-HOOK SWING SWIVEL LAG

Lag Style

PART #	SIZE/STYLE	BOX QTY
LS38312Z	3/8 X 3-1/2" ZINC LAG	100
LS38312-TLC	3/8 X 3-1/2" TLC LAG	100

S-HOOK SWING SWIVEL BOLT

Machine Bolt Style



PART #	SIZE/STYLE	BOX QTY
BS38312G	3/8-16 X 3-1/2" MACHINE GALV FOR 2 X 4 LUMBER	200
BS38600G	3/8-16 X 6" MACHINE GALV FOR 4 X 4 LUMBER	200
BS38800G	3/8-16 X 8" GALV FOR 6 X 6 LUMBER	100



EYE LAG SCREWS

MEASURED OVERALL LENGTH
ZINC PLATED
SOLD IN FULL BOXES ONLY

PART #	SIZE	EYE SIZE	BOX QTY
ELAG262258Z	.262 X 2-5/8"	3/4"	1000
ELAG14334Z	1/4 X 3-3/4"	9/16"	900
ELAG516400Z	5/16 X 4"	3/4"	600
ELAG516600Z	5/16 X 6"	3/4"	400
ELAG38412Z	3/8 X 4-1/2"	1-1/8"	350
ELAG38800Z	3/8 X 8"	1-1/8"	225

*Box QUANTITIES MAY VARY

PEAR SHAPED QUICK LINKS

Zinc
5/8" Opening



PART #	SIZE	BOX QTY
QL14314Z	1/4 X 3 1/4"	200

APPLE SPRING ACTION SNAP HOOKS

1/4" - BREAKING POINT 395#
5/16" - BREAKING POINT 500#



PART #	SIZE	BOX QTY
SH14Z	1/4 X 2-1/2"	200
SH14-TLC	1/4 X 2-1/2"	200
SH14SS	1/4" STAINLESS	200
SH516	5/16 X 3-1/4"	200
SH516-TLC	5/16 X 3-1/4"	200
SH38	3/8 X 4"	200



EYE BOLTS

MEASURED OVERALL LENGTH
ZINC PLATED
SOLD IN FULL BOXES ONLY

PART #	LENGTH	EYE SIZE	BOX QTY
EBOLT14200Z	1/4 X 2"	9/16"	2000
EBOLT14212Z	1/4 X 2-1/2"	9/16"	1500
EBOLT14300Z	1/4 X 3"	9/16"	1500
EBOLT14400Z	1/4 X 4"	9/16"	1000
EBOLT14500Z	1/4 X 5"	9/16"	1000
EBOLT14600Z	1/4 X 6"	9/16"	900
EBOLT516314Z	5/16 X 3-1/4"	3/4"	800
EBOLT516400Z	5/16 X 4"	3/4"	700
EBOLT516500Z	5/16 X 5"	3/4"	600
EBOLT516600Z	5/16 X 6"	3/4"	500
EBOLT38212Z	3/8 X 2-1/2"	1"	550
EBOLT38400Z	3/8 X 4"	1"	400
EBOLT38500Z	3/8 X 5"	1"	350
EBOLT38600Z	3/8 X 6"	1"	300
EBOLT38800Z	3/8 X 8"	1"	250

*Box QUANTITIES MAY VARY

APPLE QUICK LINKS

Small is 1/4" Opening
Wide is 7/16" Opening

3/16" - BREAKING POINT 660#



PART #	SIZE	BOX QTY
QL316Z	3/16" SMALL ZINC	200
QL316TLC	3/16" SMALL TLC	200
QL316ZW	3/16" WIDE ZINC	200
QL316WTLC	3/16" WIDE TLC	200
QL316WSS	3/16" WIDE STAINLESS	100
QL14Z	1/4" ZINC	200

CHAIR SWIVELS & GLIDER HARDWARE

GLIDER ARMS

Ordering Glider Arms:

1. Choose Material: Yellow Zinc or Stainless Steel
2. Choose Hole Size: 5/16" or 3/8"
3. Choose Arm Length: 6-1/2" or 7-1/2"

***ALL GLIDER ARMS WILL NOW HAVE ROUNDED EDGES.**



SOLD IN FULL BOXES ONLY

PART #	SIZE/FINISH	BOX QTY
GA516612YZ-RD	5/16" X 6-1/2" YELLOW ZINC	100
GA516712YZ-RD	5/16" X 7-1/2" YELLOW ZINC	100
GA38612YZ-RD	3/8" X 6-1/2" YELLOW ZINC	100
GA38712YZ-RD	3/8" X 7-1/2" YELLOW ZINC	100
GA516S612SS-RD	5/16" X 6-1/2" STAINLESS STEEL	100
GA516S712SS-RD	5/16" X 7-1/2" STAINLESS STEEL	100
GA38S612SS-RD	3/8" X 6-1/2" STAINLESS STEEL	100
GA38S712SS-RD	3/8" X 7-1/2" STAINLESS STEEL	100



APPLE GLIDER BEARINGS

High Quality Pressed 1-1/8" OD
Glider Bearings are Perfect for use in Gliders, Windmills, or
Wheelbarrows.
Full Box Quantities Only

PART #	SIZE/FINISH	BOX QTY
GB516YZ	5/16" YELLOW ZINC	500
GB516SS	5/16" STAINLESS STEEL	500
GB38YZ	3/8" YELLOW ZINC	500
GB38SS	3/8" STAINLESS STEEL	500
GB12YZ	1/2" YELLOW ZINC	500



APPLE "STEM" ROCKER BEARINGS

7/8" OD Bearing
A MUST for Indoor Rockers!
Full Box Quantities Only

PART #	STEM LENGTH	BOX QTY
STB38034-IM	3/8 X 3/4"	500
STB38100-IM	3/8 X 1"	500



SIDE ANGLE



GLIDE SWIVEL

Use for Gliders
All Stainless Steel Construction
Heavy Gauge
3/4" Bolts & Nuts

PART #	DESCRIPTION	BOX QTY
GLIDESWIVELSS	GLIDER SWIVEL	5



NYLON GLIDER SPACERS

Used for spacing when
making all-
wood glider arms.

PART #	SIZE	BOX QTY
GS3834	3/8 ID X 3/4" LONG	100
GS3858	3/8 ID X 5/8" LONG	100

HEAVY DUTY OUTDOOR CHAIR SWIVELS



SIDE ANGLE

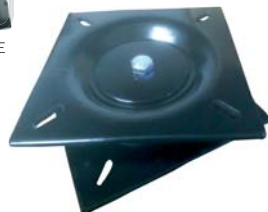

BLACK POWDER COATED

Measures 6-3/4"

Delrin sleeve provides low friction and high stiffness for shape retention when subjected to varying degrees of temperature, moisture and pressure.

PART #	DESCRIPTION	BOX QTY
CHAIRSWIVEL	HEAVY DUTY CHAIR SWIVEL	5

STAINLESS STEEL

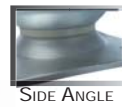

SIDE ANGLE

PART #	DESCRIPTION	BOX QTY
CHAIRSWIVELSS	STAINLESS STEEL HEAVY DUTY CHAIR SWIVEL	5

INDOOR HARDWARE & MISCELLANEOUS

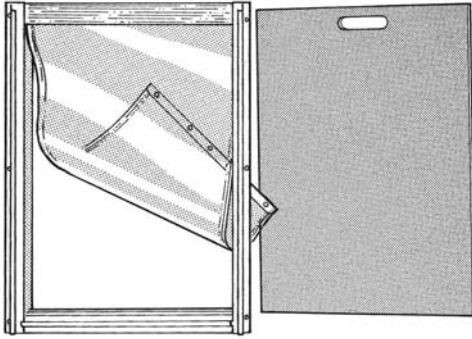

PET DOOR

Buck size:
15.25" x 21.75"
Overall size:
17-11/16" x 23-1/4"

PART #
PETDOOR15X20



NYLON GLIDES

Made from nylon for a smooth glide on furniture legs
Comes with 1" screws

PART #	SIZE	BOX QTY
NG34	3/4" ROUND	100
NG78	7/8" ROUND	100
NG114	1-1/4" ROUND	100



NYLON TACK GLIDES

Beige

PART #	SIZE	BOX QTY
PS-1	5/8" ROUND	1,000
PS-2	3/4" ROUND	1,000
PS-3	7/8" ROUND	1,000



APPLE COLONIAL DECORATIVE H-HINGE

Black in Color
1-1/2 X 3-1/2"
Use S&G #145 Screws

PART #	DESCRIPTION	BOX QTY
HHIDECB	BLACK	250



APPLE COLONIAL SQUARE H-HINGE

Black in Color
1-3/4" x 2-1/2"
Use S&G #145 Screws

PART #	BOX QTY
HHIDECBS	1000

APPLE MAGNETIC CATCH & PLATE

Screws Included



PART #	TYPE	PACK QTY
MAGCATCH	SINGLE	100
MAGDBL	DOUBLE	100



SHELF BRACKETS

2 Per Set with Screws
10-1/2" (shelf area)
White

PART #	SIZE	BOX QTY
#3301	6 X 6"	50 PR

LIGHTS & LIGHTHOUSE ACCESSORIES

LIGHTHOUSE WINDOWS & DOORS

Colors Available:

Beige, Black, Brown, Brick Red, Clay, Dark Grey, Fire Engine Red, Light Grey, Maroon, Navy Blue, Red, White

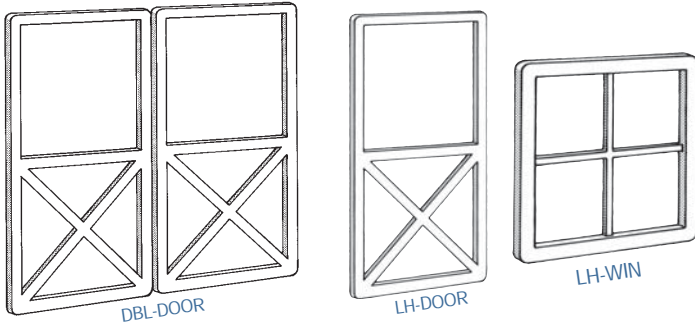

UV Color Protected
Made from a Rubber/Plastic
Material for ease of installation.

***ORDER WHILE SUPPLIES LAST**

PART #	SIZE	BOX QTY
LH-DOOR	3-1/8" X 6"	100
DBL-DOOR	6" X 6"	100
LH-WIN	3-1/8" X 3-1/8"	100

LIGHTHOUSE BEACON LIGHT

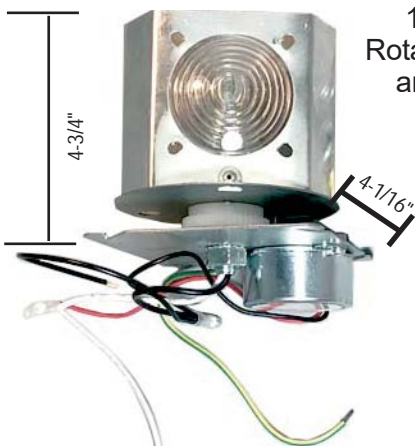

12 Lights Per Case
Rotates 360° to resemble
an actual lighthouse.

PART #	DESCRIPTION
LH-LITE	LIGHTHOUSE BEACON
LH-BULB	LIGHTHOUSE LIGHT BULB

**ADD LIGHT TO THE INTERIOR OF ANY STRUCTURE,
NO ELECTRICITY REQUIRED!**

SOLAR SHED LIGHT

- 8W LED SOLAR LIGHT
- HIGH LUMINOUS EFFICIENCY
16*0.5W HIGHPOWER LEDs
- LARGE CAPACITY LI-ION RECHARGEABLE
BATTERY 11.1 V 1200MAH
- LED-LIFETIME UP TO 50,000 HOURS
- WORKING TIME: CONTINUE
WORKING UP TO 8HRS;
- 4W SINGLE CRYSTALLINE SOLAR PANEL
- FAST CHARGING TIME ADAPTS
LONG TIME RAINING DAYS
- SM WATERPROOF WIRE SUITABLE
FOR ALL-WEATHER
- SOLAR PANEL MEASURES 8" X 8-1/2"
LIGHTS ARE APPROXIMATELY 6"
ATTACHED TO A 16' CORD.
- PART# WD-800180A



SOLAR WALL LIGHT

- 0.36 WATT SOLAR LIGHT
- 5 SUPER BRIGHT LEDs
- WORKING TIME: CONTINUE
WORKING UP TO 8HRS
- TAKES 3x600MA BATTERY
& 1.2V AA BATTERY
- SOLAR PANEL: 6.5V SOMA
- SOLAR PANEL MEASURES 4-1/4" X 4 3/4"
- LIGHT MEASURES 8-3/4" X 2-1/2" X 2"
- PART# AK-5035



PART #	DESCRIPTION
WD-800180A	SOLAR SHED LIGHT
AK-5035	SOLAR WALL LIGHT



JACK CHAIN

Used for Lighthouse
Railings

Use Plated for Indoor use.
Use Solid Brass for Outdoor use.

LINKS CAN
INTERLOCK

PART #	ROLL
CHAIN#16DBLB	200' BRASS



BRASS ORNAMENTS

Solid Brass Construction

PART #	DESCRIPTION
SMANCHOR	SMALL ANCHOR 2-1/4 X 1-1/2"
LGANCHOR	LARGE ANCHOR 3-1/2 X 2-1/2"
LGEAGLE	LARGE EAGLE

16 GAUGE MEDIUM CROWN EG STAPLES

10 BOXES PER CASE



PART #	SIZE	BOX QTY
MADE TO FIT: SENCO - HITACHI - AND MORE		
MCS716058G	7/16 x 5/8"	20M
MCS716034G	7/16 x 3/4"	20M
MCS716078G	7/16 x 7/8"	10M
MCS716100G	7/16 x 1"	10M
MCS716118G	7/16 x 1-1/8"	10M
MCS716114G	7/16 x 1-1/4"	10M
MCS716138G	7/16 x 1-3/8"	10M
MCS716112G	7/16 x 1-1/2"	10M
MCS716158G	7/16 x 1-5/8"	10M
MCS716134G	7/16 x 1-3/4"	10M
MCS716200G	7/16 x 2"	10M
MADE TO FIT: BOSTITCH AND MORE		
MCB12034G	1/2 x 3/4"	20M
MCB12078G	1/2 x 7/8"	10M
MCB12100G	1/2 x 1"	10M
MCB12114G	1/2 x 1-1/4"	10M
MCB12112G	1/2 x 1-1/2"	10M
MCB12134G	1/2 x 1-3/4"	10M
MCB12200G	1/2 x 2"	10M
MADE TO FIT PASLODE - PASLODE IMPULSE - AND MORE		
MCP12034G	1/2 x 3/4"	20M
MCP12100G	1/2 x 1"	10M
MCP12114G	1/2 x 1-1/4"	10M
MCP12112G	1/2 x 1-1/2"	10M
MCP12134G	1/2 x 1-3/4"	10M
MCP12200G	1/2 x 2"	10M
MADE TO FIT: DUOFAST - PASLODE 3150 MODEL - AND MORE		
MCD716058G	7/16 x 5/8"	20M
MCD716078G	7/16 x 7/8"	15M
MCD7161316G	7/16 x 1-3/16"	10M
MCD716112G	7/16 x 1-1/2"	10M
MCD716134G	7/16 x 1-3/4"	10M
MCD716200G	7/16 x 2"	10M

*Box QUANTITIES MAY VARY

18 GAUGE NARROW CROWN EG STAPLES

10 BOXES PER CASE

PART #	SIZE	BOX QTY
DUOFAST - HITACHI - SENCO - SPOTNAIL - AND MORE		
GALVANIZED		
NCS14012G	1/4 x 1/2"	5M
NCS14058G	1/4 x 5/8"	5M
NCS14034G	1/4 x 3/4"	5M
NCS14078G	1/4 x 7/8"	5M
NCS14100G	1/4 x 1"	5M
NCS14118G	1/4 x 1-1/8"	5M
NCS14114G	1/4 x 1-1/4"	5M
NCS14138G	1/4 x 1-3/8"	4M
NCS14112G	1/4 x 1-1/2"	5M
STAINLESS STEEL		
NCS14058SS	1/4 x 5/8"	8M
NCS14034SS	1/4 x 3/4"	4M
NCS14100SS	1/4 x 1"	5M
NCS14114SS	1/4 x 1-1/4"	5M

*Box QUANTITIES MAY VARY

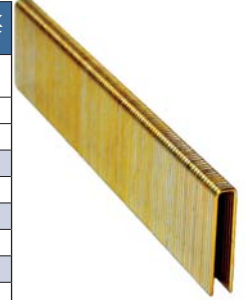

16 GAUGE WIDE CROWN EG STAPLES

10 Boxes/Case



PART #	SIZE	BOX QTY
BOSTITCH - AND MORE		
WCB1058G	1 x 5/8"	10M
WCB1034G	1 x 3/4"	10M
WCB1100G	1 x 1"	10M
WCB1114G	1 x 1-1/4"	10M
WCB1112G	1 x 1-1/2"	5M
WCB1134G	1 x 1-3/4"	5M
SENCO - AND MORE		
WCS1058	1 x 5/8"	10M
WCS1034	1 x 3/4"	10M
WCS1078G	1 x 7/8"	10M
WCS1100	1 x 1"	10M
WCS1114	1 x 1-1/4"	10M
WCS1112	1 x 1-1/2"	5M
WCS1134	1 x 1-3/4"	5M
WCS1200	1 x 2"	5M
PASLODE - AND MORE		
WC1516034G	15/16 x 3/4"	10M
WC1516078G	15/16 x 7/8"	10M
WC1516100G	15/16 x 1"	10M
WC1516114G	15/16 x 1-1/4"	10M

*Box QUANTITIES MAY VARY

FINE WIRE STAPLES

10 Boxes/Case



PART #	SIZE	BOX QTY
DUOFAST & MORE; CROWN SIZE 12.6MM OR .496 INCHES		
FWD14	1/4"	5M
FWD516	5/16"	5M
FWD38	3/8"	5M
FWD12	1/2"	5M
FWD916	9/16"	4M
ARROW - A11 - & MORE; CROWN SIZE 10.6MM OR .417 INCHES		
FWA14	1/4"	5M
FWA516	5/16"	5M
FWA38	3/8"	5M
FWA12	1/2"	5M
FWA916	9/16"	3M
BOSTITCH - STCR 5019 - & MORE		
FWB14	1/4"	5M
FWB516	5/16"	5M
FWB38	3/8"	5M
FWB916	9/16"	3M

*Box QUANTITIES MAY VARY

PREBENA CARTON CLOSING STAPLES

20,000 per Carton

PART #	SIZE	BOX QTY
CCS58	5/8"	10M

*Box QUANTITIES MAY VARY



CONCRETE SCREWS & ANCHOR HARDWARE



HAMMER TACKERS

For fastening of roofing felt paper, insulation, weather stripping, carpet, and padding.

PART #	DESCRIPTION
FWTA	HAMMER TACKER FOR ARROW & A11 TYPE.
*ONLY FITS STAPLES UP TO 3/8"	



ELECTRO-GALVANIZED FINISH STAPLES

PART #	SIZE	BOX QTY
MADE TO FIT: BOSTITCH MODEL SX150K-1 & SX32X		
K12	7/32 x 1/2"	5M
K16	7/32 x 5/8"	5M
K19	7/32 x 3/4"	5M
K22	7/32 x 7/8"	5M
K25	7/32 x 1"	5M
K28	7/32 x 1-1/8"	5M
K30	7/32 x 1-3/16"	5M
K35	7/32 x 1-3/8"	5M

*Box QUANTITIES MAY VARY

HEX HEAD SLEEVE ANCHORS

Made in USA
Great for Block Wall
Anchoring



PART #	SIZE	BOX QTY
SA14138Z	1/4 X 1-3/8"	100
SA14214Z	1/4 X 2-1/4"	100
SA516112Z	5/16 X 1-1/2"	100
SA516212Z	5/16 X 2-1/2"	100
SA38178Z	3/8 X 1-7/8"	50
SA38300Z	3/8 X 3"	50
SA38400Z	3/8 X 4"	50
SA12214Z	1/2 X 2-1/4"	50
SA12300Z	1/2 X 3"	25
SA12400Z	1/2 X 4"	25
SA12600Z	1/2 X 6"	25
SA58300Z	5/8 X 3"	25
SA58600Z	5/8 X 6"	10
SA34414Z	3/4 X 4-1/4"	5
SA34614Z	3/4 X 6-1/4"	5

*Box QUANTITIES MAY VARY

CONCRETE SCREWS

Hex Head



PART #	SIZE	BOX QTY
3/16"		
HCON316114	3/16 X 1-1/4"	100
HCON316134	3/16 X 1-3/4"	100
HCON316214	3/16 X 2-1/4"	100
HCON316234	3/16 X 2-3/4"	100
HCON316314	3/16 X 3-1/4"	100
HCON316400	3/16 X 4"	100
1/4"		
HCON14114	1/4 X 1-1/4"	100
HCON14134	1/4 X 1-3/4"	100
HCON14214	1/4 X 2-1/4"	100
HCON14234	1/4 X 2-3/4"	100
HCON14314	1/4 X 3-1/4"	100
HCON14334	1/4 X 3-3/4"	100
HCON14400	1/4 X 4"	100
HCON14500	1/4 X 5"	100
HCON14600	1/4 X 6"	100

*Box QUANTITIES MAY VARY

CONCRETE SCREWS

Flat Phillips



PART #	SIZE	BOX QTY
3/16"		
FCON316114	3/16 X 1-1/4"	100
FCON316134	3/16 X 1-3/4"	100
FCON316214	3/16 X 2-1/4"	100
FCON316234	3/16 X 2-3/4"	100
FCON316314	3/16 X 3-1/4"	100
1/4"		
FCON14114	1/4 X 1-1/4"	100
FCON14134	1/4 X 1-3/4"	100
FCON14214	1/4 X 2-1/4"	100
FCON14234	1/4 X 2-3/4"	100
FCON14314	1/4 X 3-1/4"	100
FCON14334	1/4 X 3-3/4"	100

*Box QUANTITIES MAY VARY

SS = STAINLESS STEEL

RS = RING SHANK

HDG = HOT DIPPED GALVANIZED

SM = SMOOTH

SCREW = SCREW SHANK

EG = ELECTRONIC GALVANIZED

*HOT DIPPED GALVANIZED IS ACQ LUMBER COMPATIBLE.

SIZE/PENNY CONVERSIONS

2D= 1" 3D= 1-1/4" 4D= 1-1/2"	5D= 1-3/4" 6D= 2" 7D= 2-1/4"	8D= 2-3/8" 10D= 3"	12D= 3-1/4" 16D= 3-1/2" 20D= 4"	30D= 4-1/2" 40D= 5" 60D= 6"
------------------------------------	------------------------------------	-----------------------	---------------------------------------	-----------------------------------

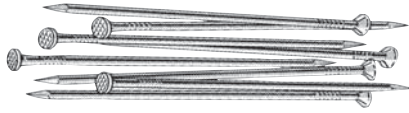

CEMENT COATED SINKERS

GALVANIZED BOX NAILS

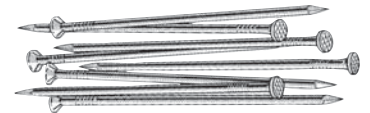

PART #	BOX
NAIL8D	50 LBS
NAIL10D	50 LBS
NAIL12D	50 LBS
NAIL16D	50 LBS
NAIL20D	50 LBS

PART #	BOX
NAIL8DBOXG	50 LBS
NAIL10DBOXG	50 LBS
NAIL12DBOXG	50 LBS
NAIL16DBOXG	50 LBS

15° WIRE COLLATED COIL NAILS

To Fit: Atro Roll 85/900, BEA 701 DC, Bostitch N70C, N86C, Hitachi NV 50A, NV65AA, Senco SCN 300

PART #	DESCRIPTION	BOX QTY
CN112083HDGR	1-1/2 x 083 HDG RS	12600
CN134090RSG	1-3/4 X 090 RS EG	12600
CN134092RHDG	1-3/4 x 092 RS HDG	12600
CN2316092RHDG	2-3/16 x 092 RS HDG	7200
CN2092RSHDG	2 x 092 RS HDG	9000
CN2099RS	2 x 099 RS	9000
CN2099RSHDG	2 x 099 RS HDG	9000
CN214099SHDG	2-1/4 x 099 HDG	9000
CN212092HDGR	2-1/2 x 092 RS HDG	9000
CN238113RSHDG	2-3/8 x 113 RS HDG	6000
CN3120SM	3 x 120 SM	4500
CN3120RSHDG	3 x 120 RS HDG	4500



ELECTRO-GALVANIZED

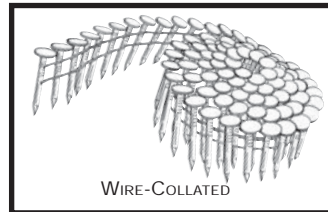

WIRE-COLLATED



HOT-DIPPED GALVANIZED



SMOOTH



15° ROOFING COLLATED COIL NAILS

For Use in Roof Nailers. Does NOT Fit Paslode Roof Nailers

PART #	SIZE	BOX QTY
RN1078G	7/8"	7.2M
RN100G	1"	7.2M
RN114G	1-1/4"	7.2M

*BOX QUANTITIES MAY VARY

*BOX QUANTITIES MAY VARY

31-33° TAPE COLLATED STRIP NAILS, CLIPPED HEAD

Sold in Full Boxes Only. Call For Any Size Not Listed.

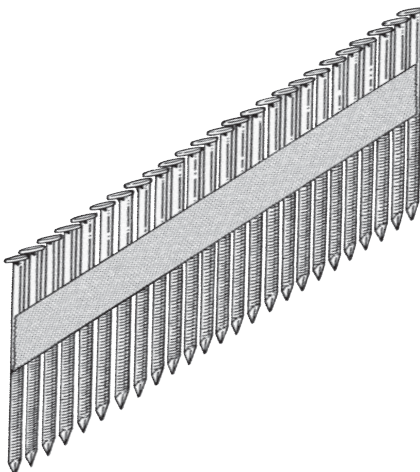

PART #	SIZE/TYPE	BOX QTY
CHN2113HDGR	2 X 113 HDG RING SHANK	5000
CHN2113RS	2 X 113 RING SHANK	5000
CHN238113HDGR	2-3/8 X 113 HDG RING SHANK	5000
CHN238113RS	2-3/8 X 113 RING SHANK	5000
CHN238113SM	2-3/8 X 113 SMOOTH	6000
CHN3120HDGR	3 X 120 RING SHANK HDG	2500
CHN3120RS	3 X 120 RING SHANK	2500
CHN3120SM	3 X 120 SMOOTH	2500
CHN3131SM	3 X 131 SMOOTH	2500
CHN314120HDGR	3-1/4 X 120 HDG RING SHANK	2500
CHN314120RS	3-1/4 X 120 RING SHANK	2500
CHN314120SM	3-1/4 X 120 SMOOTH	2500
CHN314131SM	3-1/4 X 131 SMOOTH	2500

*BOX QUANTITIES MAY VARY

SS = STAINLESS STEEL

RS = RING SHANK

HDG = HOT DIPPED GALVANIZED

SM = SMOOTH

SCREW = SCREW SHANK

EG = ELECTRONIC GALVANIZED

*HOT DIPPED GALVANIZED IS ACQ LUMBER COMPATIBLE.

18 GAUGE BRAD NAILS

To Fit: Senco - Hitachi - Paslode - Porter Cable - Bostitch and most 18 Gauge Nailers.
10 Boxes/Case

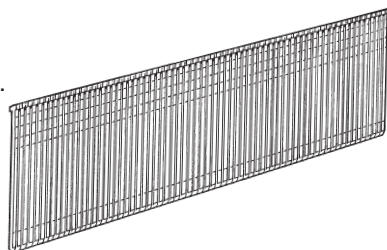

PART #	SIZE	BOX QTY
GALVANIZED		
BN18012G	1/2"	10M
BN18058G	5/8"	5M
BN18034G	3/4"	5M
BN18078G	7/8"	5M
BN18100G	1"	5M
BN18118G	1-1/8"	5M
BN18114G	1-1/4"	5M
BN18112G	1-1/2"	5M
BN18134G	1-3/4"	5M
BN18200G	2"	5M

*Box QUANTITIES MAY VARY

16 GAUGE FINISH NAILS

To Fit: Senco - Hitachi - Paslode - Porter Cable - Bostitch and most 16 Gauge Nailers.
10 Boxes/Case



PART #	SIZE	BOX QTY
GALVANIZED		
FN16034G	3/4"	5M
FN16078G	7/8"	5M
FN16100G	1"	5M
FN16118G	1-1/8"	5M
FN16114G	1-1/4"	5M
FN16112G	1-1/2"	2.5M
FN16134G	1-3/4"	2.5M
FN16200G	2"	2.5M
FN16214G	2-1/4"	2.5M
FN16212G	2-1/2"	2.5M
STAINLESS STEEL		
FN16112SS	1-1/2"	2.5M
FN16200SS	2"	2.5M
FN16212SS	2-1/2"	2.5M

*Box QUANTITIES MAY VARY

15 GAUGE ANGLE FINISH NAILS

To Fit: Senco-Porter Cable
10 Boxes/Case
33-34 Degrees

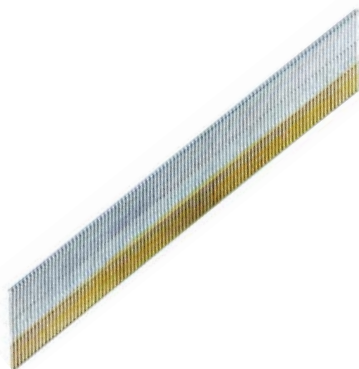

PART #	SIZE	BOX QTY
GALVANIZED		
FN15112G	1-1/2"	4M
FN15134G	1-3/4"	4M
FN15200G	2"	4M
FN15212G	2-1/2"	4M

*Box QUANTITIES MAY VARY

PAINING CHARGES

THERE IS A \$70 MINIMUM PAINT CHARGE, YOU MAY REFERENCE THE CHART BELOW TO DETERMINE IF YOU ARE OVER THE MINIMUM. THE PRICING SHOWN ON THE BELOW CHART IS PER THOUSAND. SAMPLES MUST BE PROVIDED WITH EACH PAINT ORDER.

IF COLOR MATCHING IS REQUIRED FROM YOUR SAMPLE, PLEASE ADD \$40 TO THE OVERALL PRICE.

CALL TO QUOTE PRICE ON ADDITIONAL SIZES AND ITEMS, SUCH AS LAG BOLTS, HEX BOLTS, SCREWS WITH WASHERS, AND SPECIALTY SCREWS.

*PLEASE ALLOW AT LEAST 3-4 WEEKS FOR PAINTING TO BE COMPLETED.

LENGTH	SCREW SIZE				
	#4-6	#7-8	#9-10	#12	#14
1/2"	\$3.91	\$3.91	\$4.48	\$5.20	\$7.85
3/4"	\$3.91	\$4.10	\$4.65	\$5.96	\$9.28
1"	\$4.10	\$4.65	\$5.32	\$7.07	\$12.05
1-1/4"	\$4.32	\$4.99	\$5.86	\$7.31	\$12.60
1-1/2"	\$4.99	\$5.32	\$6.87	\$8.63	\$13.83
1-3/4"	\$5.32	\$7.20	\$8.07	\$10.06	\$14.60
2"	\$6.42	\$8.30	\$9.74	\$12.05	\$15.71
2-1/4"	\$7.85	\$10.18	\$11.85	\$13.60	\$16.38
2-1/2"	\$10.19	\$11.85	\$13.48	\$15.05	\$17.15
2-3/4"	\$12.05	\$13.48	\$15.05	\$16.38	\$19.91
3"	\$13.83	\$14.60	\$15.71	\$17.47	\$25.76

KNOTBUSTER™ FURNITURE SCREWS

MANUFACTURED BY APPLE OUTDOOR SUPPLY
*YELLOW ZINC KNOTBUSTER™ PICTURED.



SQUARE-HEAD



STAR-HEAD



NIBS UNDER THE HEAD FOR EASE IN COUNTERSINKING

COURSE THREADS, GRABS AND HOLDS TIGHT

TYPE 17 CUTTER TIP REDUCES SPLITTING

50% THREAD ON ALL KNOTBUSTER™ SCREWS 2" AND LONGER

ZINC PLATED KNOTBUSTER™

#2 Square Drive



PART #	SIZE	BOX QTY
KB06034Z	#6 X 3/4"	10000
KB06100Z	#6 X 1"	10000
KB06114Z	#6 X 1-1/4"	10000
KB06112Z	#6 X 1-1/2"	10000
KB06134Z	#6 X 1-3/4"	10000
KB06200Z	#6 X 2"	8000
KB08118Z	#8 X 1-1/8"	8000
KB08114Z	#8 X 1-1/4"	7000
KB08112Z	#8 X 1-1/2"	5000
KB08134Z	#8 X 1-3/4"	5000
KB08200Z	#8 X 2"	4000
KB08214Z	#8 X 2-1/4"	4000
KB08212Z	#8 X 2-1/2"	3000
KB08300Z	#8 X 3"	2500
KB08312Z	#8 X 3-1/2"	1500
KB10114Z	#10 X 1-1/4"	5000
KB10112Z	#10 X 1-1/2"	4000
KB10134Z	#10 X 1-3/4"	4000
KB10200Z	#10 X 2"	3000
KB10214Z	#10 X 2-1/4"	2000
KB10212Z	#10 X 2-1/2"	2000
KB10300Z	#10 X 3"	1500
KB10312Z	#10 X 3-1/2"	1000
KB10400Z	#10 X 4"	1000
KB10412Z	#10 X 4-1/2"	1000
KB10500Z	#10 X 5"	1000
KB12300Z	#12 X 3"	1500

YELLOW ZINC PLATED KNOTBUSTER™

Provides 20% Better Corrosion Resistance
Matches Wood Well
#2 Square Drive



PART #	SIZE	BOX QTY
KB06100YZ	#6 X 1"	10000
KB06114YZ	#6 X 1-1/4"	10000
KB06112YZ	#6 X 1-1/2"	10000
KB08114YZ	#8 X 1-1/4"	7000
KB08112YZ	#8 X 1-1/2"	5000
KB08134YZ	#8 X 1-3/4"	5000
KB08200YZ	#8 X 2"	4000
KB08214YZ	#8 X 2-1/4"	4000
KB08212YZ	#8 X 2-1/2"	3000
KB08300YZ	#8 X 3"	2500
KB10112YZ	#10 X 1-1/2"	4000
KB10200YZ	#10 X 2"	3000
KB10214YZ	#10 X 2-1/4"	2000
KB10212YZ	#10 X 2-1/2"	2000
KB10300YZ	#10 X 3"	1500
KB10312YZ	#10 X 3-1/2"	1000
KB10400YZ	#10 X 4"	1000

YELLOW ZINC PLATED STAR DRIVE

ZINC PLATED STAR DRIVE

PART #	SIZE	BOX QTY
KBTX08114Z	#8 X 1-1/4"	7000
KBTX08112Z	#8 X 1-1/2"	5000
KBTX08134Z	#8 X 1-3/4"	5000
KBTX08200Z	#8 X 2"	4000
KBTX08214Z	#8 X 2-1/4"	4000
KBTX08212Z	#8 X 2-1/2"	3000
KBTX08300Z	#8 X 3"	2500

PART #	SIZE	BOX QTY
KBTX08114YZ	#8 X 1-1/4"	7000
KBTX08112YZ	#8 X 1-1/2"	5000
KBTX08134YZ	#8 X 1-3/4"	5000
KBTX08200YZ	#8 X 2"	4000
KBTX08214YZ	#8 X 2-1/4"	4000
KBTX08212YZ	#8 X 2-1/2"	3000
KBTX08300YZ	#8 X 3"	2500

TYPE 305 & 316 STAINLESS KNOTBUSTER™

Square Drive; 50% Thread 2" and Up - ACQ Approved



PART #	SIZE	BOX QTY
305 GRADE		
KB06158SS	#6 X 1-5/8"	5000
KB08118SS	#8 X 1-1/8"	10000
KB08114SS	#8 X 1-1/4"	7000
KB08112SS	#8 X 1-1/2"	5000
KB08134SS	#8 X 1-3/4"	5000
KB08200SS	#8 X 2"	4000
KB08212SS	#8 X 2-1/2"	3000
KB08300SS	#8 X 3"	2500
KB10112SS	#10 X 1-1/2"	4000
KB10200SS	#10 X 2"	2500
KB10214SS	#10 X 2-1/4"	2000
KB10212SS	#10 X 2-1/2"	2000
KB10300SS	#10 X 3"	1500
KB10312SS	#10 X 3-1/2"	1000
KB10400SS	#10 X 4"	1000
KB14400SS	#14 X 4"	1000
316 GRADE "MARINE QUALITY"		
KB08114SS-316	#8 X 1-1/4"	7000
KB08112SS-316	#8 X 1-1/2"	5000
KB08134SS-316	#8 X 1-3/4"	5000
KB08200SS-316	#8 X 2"	4000
KB08212SS-316	#8 X 2-1/2"	3000
KB08300SS-316	#8 X 3"	2500
KB10112SS-316	#10 X 1-1/2"	4000
KB10200SS-316	#10 X 2"	3000
KB10212SS-316	#10 X 2-1/2"	2000
KB10300SS-316	#10 X 3"	1500
KB10312SS-316	#10 X 3-1/2"	1000

TYPE 305 & 316 STAINLESS STEEL STAR DRIVE

PART #	SIZE	BOX QTY
305 GRADE		
KBTX08114SS	#8 X 1-1/4"	7000
KBTX08112SS	#8 X 1-1/2"	5000
KBTX08134SS	#8 X 1-3/4"	5000
KBTX08200SS	#8 X 2"	4000
KBTX08212SS	#8 X 2-1/2"	3000
KBTX08300SS	#8 X 3"	2500
316 GRADE		
KBTX08114SS-316	#8 X 1-1/4"	7000
KBTX08112SS-316	#8 X 1-1/2"	5000
KBTX08134SS-316	#8 X 1-3/4"	5000
KBTX08200SS-316	#8 X 2"	4000
KBTX08212SS-316	#8 X 2-1/2"	3000
KBTX08300SS-316	#8 X 3"	2500

WEATHER MATCH KNOTBUSTER™

Treated Lumber Coating - Approved for ACQ Lumber

1000 Hour LONG LIFE COATING

Square Drive /Phil Combo Drive

Will Match Treated Lumber Color
50% Thread 2" and Up



PART #	SIZE	BOX QTY
KB06100WM-TLS	#6 X 1"	10000
KB06114WM-TLS	#6 X 1-1/4"	10000
KB08118WM-TLS	#8 X 1-1/8"	10000
KB08114WM-TLS	#8 X 1-1/4"	7000
KB08112WM-TLS	#8 X 1-1/2"	5000
KB08134WM-TLS	#8 X 1-3/4"	5000
KB08200WM-TLS	#8 X 2"	4000
KB08214WM-TLS	#8 X 2-1/4"	4000
KB08212WM-TLS	#8 X 2-1/2"	3000
KB08300WM-TLS	#8 X 3"	2500
KB09200WM-TLS	#9 X 2"	4000
KB09214WM-TLS	#9 X 2-1/4"	4000
KB09212WM-TLS	#9 X 2-1/2"	3000
KB09300WM-TLS	#9 X 3"	2500
KB10112WM-TLS	#10 X 1-1/2"	4000
KB10200WM-TLS	#10 X 2"	3000
KB10212WM-TLS	#10 X 2-1/2"	2000
KB10300WM-TLS	#10 X 3"	1500
KB10312WM-TLS	#10 X 3-1/2"	1000
KB10400WM-TLS	#10 X 4"	1000
KB10412WM-TLS	#10 X 4-1/2"	1000
KB10500WM-TLS	#10 X 5"	1000

WEATHER MATCH STAR DRIVE

PART #	SIZE	BOX QTY
KBTX08114WM-TLS	#8 X 1-1/4"	7000
KBTX08112WM-TLS	#8 X 1-1/2"	5000
KBTX08134WM-TLS	#8 X 1-3/4"	5000
KBTX08200WM-TLS	#8 X 2"	4000
KBTX08214WM-TLS	#8 X 2-1/4"	4000
KBTX08212WM-TLS	#8 X 2-1/2"	3000
KBTX08300WM-TLS	#8 X 3"	2500
KBTX09300WM-TLS	#9 X 3"	2500
KBTX10112WM-TLS	#10 X 1-1/2"	4000
KBTX10200WM-TLS	#10 X 2"	3000
KBTX10212WM-TLS	#10 X 2-1/2"	2000
KBTX10300WM-TLS	#10 X 3"	1500
KBTX10312WM-TLS	#10 X 3-1/2"	1000
KBTX10400WM-TLS	#10 X 4"	1000
KBTX10500WM-TLS	#10 X 5"	1000

XYLAN CERAMIC COATED BUGLE HEAD SCREWS

1000 Hour Salt Spray-
ACQ Approved
Type 17 Cutter Tip
Silver In Color
No Nibs
50% Thread 2" & Up



PART #	SIZE	BOX QTY
KB08114NY-TLS	#8 X 1-1/4"	7000
KB08112NY-TLS	#8 X 1-1/2"	5000
KB08134NY-TLS	#8 X 1-3/4"	5000
KB08200NY-TLS	#8 X 2"	4000
KB08214NY-TLS	#8 X 2-1/4"	4000
KB08212NY-TLS	#8 X 2-1/2"	3000
KB08300NY-TLS	#8 X 3"	2500
KB10112NY-TLS	#10 X 1-1/2"	4000
KB10200NY-TLS	#10 X 2"	3000
KB10212NY-TLS	#10 X 2-1/2"	2000
KB10300NY-TLS	#10 X 3"	1500
KB10312NY-TLS	#10 X 3-1/2"	1000
KB10400NY-TLS	#10 X 4"	1000

TYPE 305 STAINLESS BUGLE HEAD SCREWS

ACQ Approved
Type 17 Cutter Tip
#2 Square Drive
No Nibs
50% Thread 2" & Up



PART #	SIZE	BOX QTY
BHSQ08100SS	#8 X 1"	10000
BHSQ08114SS	#8 X 1-1/4"	7000
BHSQ08112SS	#8 X 1-1/2"	5000
BHSQ08134SS	#8 X 1-3/4"	5000
BHSQ08200SS	#8 X 2"	4000
BHSQ08214SS	#8 X 2-1/4"	4000
BHSQ08212SS	#8 X 2-1/2"	3000
BHSQ08300SS	#8 X 3"	2500
BHSQ10112SS	#10 X 1-1/2"	4000
BHSQ10200SS	#10 X 2"	2500
BHSQ10212SS	#10 X 2-1/2"	2000
BHSQ10300SS	#10 X 3"	1500
BHSQ10312SS	#10 X 3-1/2"	1000
BHSQ10400SS	#10 X 4"	1000
BHSQ14400SS	#14 X 4"	1000

TYPE 316 STAINLESS BUGLE HEAD SCREWS "MARINE QUALITY"

ACQ Approved
Type 17 Cutter Tip
#2 Square Drive
No Nibs
50% Thread 2" & Up



PART #	SIZE	BOX QTY
BHSQ08100SS-316	#8 X 1"	10000
BHSQ08114SS-316	#8 X 1-1/4"	7000
BHSQ08112SS-316	#8 X 1-1/2"	5000
BHSQ08134SS-316	#8 X 1-3/4"	5000
BHSQ08200SS-316	#8 X 2"	4000
BHSQ08212SS-316	#8 X 2-1/2"	3000
BHSQ08300SS-316	#8 X 3"	2500
BHSQ10112SS-316	#10 X 1-1/2"	4000
BHSQ10200SS-316	#10 X 2"	2500
BHSQ10212SS-316	#10 X 2-1/2"	2000
BHSQ10300SS-316	#10 X 3"	1500
BHSQ10400SS-316	#10 X 4"	1000

STAINLESS STEEL STAR DRIVE BUGLE HEAD SCREWS



PART #	SIZE	BOX QTY
BHTX08112SS	#8 X 1-1/2"	5000
BHTX08134SS	#8 X 1-3/4"	5000
BHTX08200SS	#8 X 2"	4000
BHTX08214SS	#8 X 2-1/4"	4000
BHTX08300SS	#8 X 3"	2500

TYPE 316 STAINLESS "MARINE QUALITY" BUGLE HEAD SCREWS



Star Drive

PART #	SIZE	BOX QTY
BHTX08114SS-316	#8 X 1-1/4"	7000
BHTX08112SS-316	#8 X 1-1/2"	5000
BHTX08134SS-316	#8 X 1-3/4"	5000
BHTX08200SS-316	#8 X 2"	4000
BHTX08212SS-316	#8 X 2-1/2"	3000
BHTX08300SS-316	#8 X 3"	2500

POLY BUSTER COMPOSITE DECKING SCREW

For Use in Composite Lumber



PART #	SIZE	DESCRIPTION	BOX QTY
PB08212-W52	#8 X 2-1/2"	RED	3000
PB08212-W72	#8 X 2-1/2"	TAN	3000
STAINLESS STEEL - SQUARE DRIVE			
PB08114SS	#8 X 1-1/4"	STAINLESS	7000
PB08112SS	#8 X 1-1/2"	STAINLESS	5000
PB08134SS	#8 X 1-3/4"	STAINLESS	5000
PB08200SS	#8 X 2"	STAINLESS	4000
PB08212SS	#8 X 2-1/2"	STAINLESS	3000
TYPE 316 STAINLESS STEEL - SQUARE DRIVE			
PB08112SS-316	#8 X 1-1/2"	STAINLESS	5000
PB08134SS-316	#8 X 1-3/4"	STAINLESS	5000
PB08200SS-316	#8 X 2"	STAINLESS	4000
PB08212SS-316	#8 X 2-1/2"	STAINLESS	3000
STAINLESS STEEL - STAR DRIVE			
PBTX08112SS	#8 X 1-1/2"	STAINLESS	5000
PBTX08134SS	#8 X 1-3/4"	STAINLESS	5000
PBTX08200SS	#8 X 2"	STAINLESS	4000
PBTX08212SS	#8 X 2-1/2"	STAINLESS	3000
TYPE 316 STAINLESS STEEL - STAR DRIVE			
PBTX08112SS-316	#8 X 1-1/2"	STAINLESS	5000
PBTX08134SS-316	#8 X 1-3/4"	STAINLESS	5000
PBTX08200SS-316	#8 X 2"	STAINLESS	4000
PBTX08212SS-316	#8 X 2-1/2"	STAINLESS	3000

PAN HEAD SQUARE DRIVE PARTICLE BOARD SCREWS

Deep Coarse Thread
Type 17 Cutter
#2 Square Drive



PART #	SIZE	BOX QTY
ZINC PLATED		
PSPB08012Z	#8 X 1/2"	10000
PSPB08058Z	#8 X 5/8"	10000
PSPB08034Z	#8 X 3/4"	10000
PSPB08100Z	#8 X 1"	10000
PSPB08114Z	#8 X 1-1/4"	7000
PSPB08112Z	#8 X 1-1/2"	5000
PSPB08200Z	#8 X 2"	5000
STAINLESS STEEL		
PSPB08034SS	#8 X 3/4"	10000
PSPB08100SS	#8 X 1"	10000
PSPB08114SS	#8 X 1-1/4"	7000
PSPB08112SS	#8 X 1-1/2"	5000
PSPB08134SS	#8 X 1-3/4"	5000
PSPB08200SS	#8 X 2"	4000

SLOTTED HEX WASHER HEAD WOOD SCREWS



Zinc Plated

PART #	SIZE	BOX QTY
HWWS06012Z	#6 X 1/2"	20000
HWWS06058Z	#6 X 5/8"	18000
HWWS06034Z	#6 X 3/4"	16000
HWWS06100Z	#6 X 1"	14000
HWWS08012Z	#8 X 1/2"	14000
HWWS08058Z	#8 X 5/8"	12000
HWWS08034Z	#8 X 3/4"	8000
HWWS08100Z	#8 X 1"	8000
HWWS08114Z	#8 X 1-1/4"	8000
HWWS08112Z	#8 X 1-1/2"	6000
HWWS10100Z	#10 X 1"	8000
HWWS10114Z	#10 X 1-1/4"	6000
HWWS10112Z	#10 X 1-1/2"	5000
HWWS10200Z	#10 X 2"	4000
HWWS10212Z	#10 X 2 1/2"	4000
HWWS12034Z	#12 X 3/4"	6000
HWWS12100Z	#12 X 1"	6000
HWWS12114Z	#12 X 1-1/4"	4000
HWWS12112Z	#12 X 1-1/2"	4000
HWWS12200Z	#12 X 2"	3000
HWWS12212Z	#12 X 2-1/2"	2500
HWWS14034Z	#14 X 3/4"	4000
HWWS14100Z	#14 X 1"	3000
HWWS14114Z	#14 X 1-1/4"	3000
HWWS14112Z	#14 X 1-1/2"	2500
HWWS14200Z	#14 X 2"	2000
HWWS14212Z	#14 X 2-1/2"	2000
HWWS14300Z	#14 X 3"	1500

TRU-GRIP METAL SCREWS

With Metal/Rubber Washer
Used For Roofing or Siding



PART #	SIZE	BOX QTY
TG10100G	#10 X 1"	5000
TG10112G	#10 X 1-1/2"	4000
TG10200G	#10 X 2"	2500
TG10212G	#10 X 2-1/2"	2000

THE HEADS OF TRU-GRIP SCREWS CAN BE PAINTED TO MATCH THE COLOR OF YOUR CHOICE.

PLEASE PROVIDE COLOR SAMPLE.

PLEASE CALL FOR PRICING

INDOOR/FINE FURNITURE SCREWS

M=1000
C=100

DRYWALL SCREWS

Coarse Thread
#2 Phillips Drive
Black Phosphate Coated



PART #	SIZE	BOX QTY
DWC06100B	#6 X 1"	10000
DWC06114B	#6 X 1-1/4"	8000
DWC06158B	#6 X 1-5/8"	5000
DWC06200B	#6 X 2"	3500
DWC06214B	#6 X 2-1/4"	3000
DWC08212B	#8 X 2-1/2"	2500
DWC08300B	#8 X 3"	2000
DWC10312B	#10 X 3-1/2"	1000
DWC10400B	#10 X 4"	1000
DWC10412B	#10 X 4-1/2"	1000
DWC10500B	#10 X 5"	1000
DWC10600B	#10 X 6"	1000

DRYWALL SCREWS

Coarse Thread
#2 Phillips Drive
Yellow Zinc



PART #	SIZE	BOX QTY
DWC06100YZ	#6 X 1"	10000
DWC06114YZ	#6 X 1-1/4"	8000
DWC06158YZ	#6 X 1-5/8"	5000
DWC06200YZ	#6 X 2"	3500
DWC08212YZ	#8 X 2-1/2"	2500
DWC08300YZ	#8 X 3"	2000
DWC10312YZ	#10 X 3-1/2"	1000
DWC10400YZ	#10 X 4"	1000
DWC10412YZ	#10 X 4-1/2"	1000
DWC10500YZ	#10 X 5"	1000
DWC10600YZ	#10 X 6"	1000

APPLE QUALITY FACE FRAME SCREWS

Zinc Plated
Type 17 Cutter
#2 Square Drive

PART #	SIZE	BOX QTY
FINE THREAD- FOR HARD WOODS		
FFR06114F	#6 X 1-1/4" ZINC	8000
FFR07114F	#7 X 1-1/4" ZINC	8000
FFR06112F	#6 X 1-1/2" BLACK	7000
FFR07112F	#7 X 1-1/2" ZINC	7000
COARSE THREAD- FOR SOFT WOODS		
FFR06114C	#6 X 1-1/4" ZINC	8000
FFR07114C	#7 X 1-1/4" ZINC	8000
FFR06112C	#6 X 1-1/2" ZINC	7000
FFR07112C	#7 X 1-1/2" ZINC	7000
HI-LO THREAD- FOR ALL WOODS		
FFR06114HL	#6 X 1-1/4" ZINC	8000
FFR06112HL	#6 X 1-1/2" ZINC	7000

TRIM SCREWS

#1 Square Drive
Black Phosphate
NO Cutter Tip Available



PART #	SIZE	BOX QTY
TRIM06100B	#6 X 1"	10000
TRIM06158B	#6 X 1-5/8"	5000
TRIM06214B	#6 X 2-1/4"	3000
TRIM08300B	#8 X 3"	2000

STAINLESS TRIM SCREWS

#1 Square Drive
Stainless
Great for Vinyl Decking
Type 17 Cutter Tip



PART #	SIZE	BOX QTY
TYPE 305 STAINLESS		
TRIM07100SS	#7 X 1"	5000
TRIM07114SS	#7 X 1-1/4"	5000
TRIM07158SS	#7 X 1-5/8"	4000
TRIM07214SS	#7 X 2-1/4"	3500
TRIM07300SS	#7 X 3"	2000
TYPE 316 STAINLESS		
TRIM07158SS-316	#7 X 1-5/8"	4000
TRIM07214SS-316	#7 X 2-1/4"	3500

INDOOR/FINE FURNITURE SCREWS

ULTIMATE FURNITURE SCREWS



Black Phosphate
Type 17 Cutter Tip
#2 Square/Phillips Drive
Nibs

PART #	SIZE	BOX QTY
UFS06058B	#6 X 5/8"	10000
UFS06034B	#6 X 3/4"	10000
UFS06100B	#6 X 1"	10000
UFS06114B	#6 X 1-1/4"	10000
UFS06112B	#6 X 1-1/2"	10000
UFS08100B	#8 X 1"	10000
UFS08114B	#8 X 1-1/4"	8000
UFS08112B	#8 X 1-1/2"	5000
UFS08134B	#8 X 1-3/4"	4000
UFS08200B	#8 X 2"	4000
UFS08212B	#8 X 2-1/2"	3000
UFS08300B	#8 X 3"	2500
UFS10114B	#10 X 1-1/4"	5000
UFS10112B	#10 X 1-1/2"	4000
UFS10134B	#10 X 1-3/4"	3500
UFS10200B	#10 X 2"	3000
UFS10212B	#10 X 2-1/2"	2500
UFS10300B	#10 X 3"	1500
UFS10312B	#10 X 3-1/2"	1000
UFS10400B	#10 X 4"	1000

ROUND WASHER HEAD SCREWS TYPE 17- STAINLESS

#2 Square Drive



PART #	SIZE	BOX QTY
RWH08112SS	#8 X 1-1/2"	5000
RWH08134SS	#8 X 1-3/4"	5000



MODIFIED TRUSS SCREWS

Phillips Drive
Zinc

PART #	SIZE	BOX QTY
MT080916Z	#8 X 9/16"	10000
MT08034Z	#8 X 3/4"	8000
MT08100Z	#8 X 1"	5000
MT08114Z	#8 X 1-1/4"	5000
MT08158Z	#8 X 1-5/8"	5000
MT08200Z	#8 X 2"	2000

ROUND WASHER HEAD

Black Phosphate
Type 17 Cutter Tip
#2 Square/Phillips Drive
#8= 11/32" Washer OD
#10=7/16" Washer OD
**Except #10 x 1" = 3/8" washer*



PART #	SIZE	BOX QTY
RWH08012B	#8 X 1/2"	10000
RWH08058B	#8 X 5/8"	10000
RWH08034B	#8 X 3/4"	10000
RWH08100B	#8 X 1"	10000
RWH08114B	#8 X 1-1/4"	7000
RWH08112B	#8 X 1-1/2"	5000
RWH08134B	#8 X 1-3/4"	4000
RWH08200B	#8 X 2"	4000
RWH08212B	#8 X 2-1/2"	3000
RWH08300B	#8 X 3"	2000
RWH10100B	#10 X 1"	5000
RWH10114B	#10 X 1-1/4"	5000
RWH10112B	#10 X 1-1/2"	4000
RWH10134B	#10 X 1-3/4"	4000
RWH10200B	#10 X 2"	3000
RWH10212B	#10 X 2-1/2"	2000
RWH10300B	#10 X 3"	1500

PAN HEAD PHILLIPS DRIVE WOOD SCREWS



ZINC PLATED

PART #	SIZE	BOX QTY
PPWS06012Z	#6 X 1/2"	20000
PPWS06058Z	#6 X 5/8"	18000
PPWS06034Z	#6 X 3/4"	16000
PPWS06100Z	#6 X 1"	14000
PPWS08012Z	#8 X 1/2"	14000
PPWS08058Z	#8 X 5/8"	12000
PPWS08034Z	#8 X 3/4"	8000
PPWS08100Z	#8 X 1"	8000
PPWS08114Z	#8 X 1-1/4"	8000
PPWS08112Z	#8 X 1-1/2"	8000
PPWS10012Z	#10 X 1/2"	10000
PPWS10058Z	#10 X 5/8"	8000
PPWS10034Z	#10 X 3/4"	8000
PPWS10100Z	#10 X 1"	6000
PPWS10114Z	#10 X 1-1/4"	5000
PPWS10112Z	#10 X 1-1/2"	4000
PPWS10200Z	#10 X 2"	4000
PPWS12034Z	#12 X 3/4"	6000
PPWS12100Z	#12 X 1"	6000
PPWS12114Z	#12 X 1-1/4"	4000
PPWS12112Z	#12 X 1-1/2"	4000
PPWS12200Z	#12 X 2"	3000
PPWS12212Z	#12 X 2-1/2"	2500
PPWS14034Z	#14 X 3/4"	4000
PPWS14100Z	#14 X 1"	3000
PPWS14114Z	#14 X 1-1/4"	3000
PPWS14112Z	#14 X 1-1/2"	2500
PPWS14200Z	#14 X 2"	2000
PPWS14212Z	#14 X 2-1/2"	2000
PPWS14300Z	#14 X 3"	1500

*Box QUANTITIES MAY VARY

PAN HEAD SQUARE DRIVE WOOD SCREWS

STAINLESS STEEL

#6 Screws use #1 Square Bit
#8 & #10 Screws use #2 Square Bit

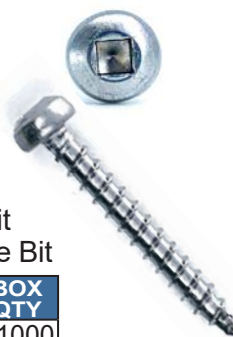

PART #	SIZE	BOX QTY
PSWS06012SS	#6 X 1/2"	1000
PSWS06058SS	#6 X 5/8"	1000
PSWS06034SS	#6 X 3/4"	1000
PSWS06100SS	#6 X 1"	1000
PSWS08012SS	#8 X 1/2"	1000
PSWS08058SS	#8 X 5/8"	1000
PSWS08034SS	#8 X 3/4"	1000
PSWS08100SS	#8 X 1"	1000
PSWS08114SS	#8 X 1-1/4"	1000
PSWS08112SS	#8 X 1-1/2"	1000
PSWS08200SS	#8 X 2"	1000
PSWS10034SS	#10 X 3/4"	1000
PSWS10100SS	#10 X 1"	1000
PSWS10114SS	#10 X 1-1/4"	1000
PSWS10112SS	#10 X 1-1/2"	1000
PSWS10200SS	#10 X 2"	1000

*Box QUANTITIES MAY VARY

PAN HEAD SQUARE DRIVE WOOD SCREWS

ZINC PLATED

#6 Screws use #1 Square Bit
#8 & #10 Screws use #2 Square Bit



PART #	SIZE	BOX QTY
PSWS06012Z	#6 X 1/2"	1000
PSWS06058Z	#6 X 5/8"	1000
PSWS06034Z	#6 X 3/4"	1000
PSWS06100Z	#6 X 1"	1000
PSWS08012Z	#8 X 1/2"	1000
PSWS08058Z	#8 X 5/8"	1000
PSWS08034Z	#8 X 3/4"	1000
PSWS08100Z	#8 X 1"	1000
PSWS08114Z	#8 X 1-1/4"	1000
PSWS08112Z	#8 X 1-1/2"	1000
PSWS08200Z	#8 X 2"	1000
PSWS10012Z	#10 X 1/2"	1000
PSWS10034Z	#10 X 3/4"	1000
PSWS10100Z	#10 X 1"	1000
PSWS10114Z	#10 X 1-1/4"	1000
PSWS10112Z	#10 X 1-1/2"	1000
PSWS10200Z	#10 X 2"	1000
PSWS10212Z	#10 X 2-1/2"	1000

*Box QUANTITIES MAY VARY

FLAT HEAD PHILLIPS WOOD SCREWS



STAINLESS STEEL

PART #	SIZE	BOX QTY
FPWS06012SS	#6 X 1/2"	1000
FPWS06058SS	#6 X 5/8"	1000
FPWS06034SS	#6 X 3/4"	1000
FPWS06100SS	#6 X 1"	1000
FPWS08012SS	#8 X 1/2"	1000
FPWS08058SS	#8 X 5/8"	1000
FPWS08034SS	#8 X 3/4"	1000
FPWS08100SS	#8 X 1"	1000
FPWS08114SS	#8 X 1-1/4"	1000
FPWS08112SS	#8 X 1-1/2"	1000
FPWS08134SS	#8 X 1-3/4"	1000
FPWS08200SS	#8 X 2"	1000
FPWS08212SS	#8 X 2-1/2"	1000

*BOX QUANTITIES MAY VARY

FLAT HEAD PHILLIPS WOOD SCREWS



ZINC PLATED

PART #	SIZE	BOX QTY
FPWS06012Z	#6 X 1/2"	20000
FPWS06058Z	#6 X 5/8"	18000
FPWS06034Z	#6 X 3/4"	16000
FPWS06100Z	#6 X 1"	14000
FPWS08012Z	#8 X 1/2"	14000
FPWS08058Z	#8 X 5/8"	12000
FPWS08034Z	#8 X 3/4"	8000
FPWS08100Z	#8 X 1"	8000
FPWS08114Z	#8 X 1-1/4"	8000
FPWS08112Z	#8 X 1-1/2"	8000
FPWS10012Z	#10 X 1/2"	10000
FPWS10058Z	#10 X 5/8"	8000
FPWS10034Z	#10 X 3/4"	8000
FPWS10100Z	#10 X 1"	6000
FPWS10114Z	#10 X 1-1/4"	5000
FPWS10112Z	#10 X 1-1/2"	4000
FPWS10200Z	#10 X 2"	4000
FPWS12034Z	#12 X 3/4"	6000
FPWS12100Z	#12 X 1"	6000
FPWS12114Z	#12 X 1-1/4"	4000
FPWS12112Z	#12 X 1-1/2"	4000
FPWS12200Z	#12 X 2"	3000
FPWS14034Z	#14 X 3/4"	4000
FPWS14100Z	#14 X 1"	3000
FPWS14114Z	#14 X 1-1/4"	3000
FPWS14112Z	#14 X 1-1/2"	2500
FPWS14200Z	#14 X 2"	2000
FPWS14212Z	#14 X 2-1/2"	2000
FPWS14300Z	#14 X 3"	1500

*BOX QUANTITIES MAY VARY

PAN HEAD PHILLIPS WOOD SCREWS



STAINLESS STEEL

PART #	SIZE	BOX QTY
PPWS06012SS	#6 X 1/2"	1000
PPWS06058SS	#6 X 5/8"	1000
PPWS06034SS	#6 X 3/4"	1000
PPWS06100SS	#6 X 1"	1000
PPWS08012SS	#8 X 1/2"	1000
PPWS08058SS	#8 X 5/8"	1000
PPWS08034SS	#8 X 3/4"	1000
PPWS08100SS	#8 X 1"	1000
PPWS08114SS	#8 X 1-1/4"	1000
PPWS08112SS	#8 X 1-1/2"	1000
PPWS10012SS	#10 X 1/2"	1000
PPWS10058SS	#10 X 5/8"	1000
PPWS10034SS	#10 X 3/4"	1000
PPWS10100SS	#10 X 1"	1000
PPWS10114SS	#10 X 1-1/4"	1000
PPWS10112SS	#10 X 1-1/2"	1000
PPWS10200SS	#10 X 2"	1000

*BOX QUANTITIES MAY VARY

WAFER HEAD CHAIR BOLT & LAG



Stainless Steel - 304 Grade

PART #	SIZE	BOX QTY
CHAIR BOLTS		
WCB14114SS	1/4-20 X 1-1/4"	800
WCB14112SS	1/4-20 X 1-1/2"	1800
WCB14200SS	1/4-20 X 2"	1300
WCB14214SS	1/4-20 X 2-1/4"	1200
WCB14212SS	1/4-20 X 2-1/2"	1100
WCB14234SS	1/4-20 X 2-3/4"	1100
WCB14300SS	1/4-20 X 3"	1000
WCB14314SS	1/4-20 X 3-1/4"	900
WCB14312SS	1/4-20 X 3-1/2"	1000
WCB14400SS	1/4-20 X 4"	800
CHAIR LAG		
JCL14112SS	1/4 X 1-1/2"	1800
JCL14200SS	1/4 X 2"	1300
JCL14212SS	1/4" X 2-1/2"	1000
JCL14300SS	1/4 X 3"	1000
JCL14312SS	1/4 X 3-1/2"	1100
JCL14400SS	1/4 X 4"	800

Stainless Steel - 316 Grade

PART #	SIZE	BOX QTY
CHAIR BOLTS		
WCB14200SS-316	1/4-20 X 2"	1300
WCB14214SS-316	1/4-20 X 2-1/4"	1200
WCB14212SS-316	1/4-20 X 2-1/2"	1100
WCB14234SS-316	1/4-20 X 2-3/4"	1100
WCB14300SS-316	1/4-20 X 3"	1000
WCB14314SS-316	1/4-20 X 3-1/4"	900
WCB14312SS-316	1/4-20 X 3-1/2"	1000
WCB14400SS-316	1/4-20 X 4"	800
5/16" DIAMETER		
WCB516112SS-316	5/16" X 1-1/2"	1200
WCB516200SS-316	5/16" X 2"	1000
WCB516212SS-316	5/16" X 2-1/2"	900
WCB516300SS-316	5/16" X 3"	800
WCB516312SS-316	5/16" X 3-1/2"	700
WCB516400SS-316	5/16" X 4"	600
CHAIR LAG		
JCL14212SS-316	1/4 X 2-1/2"	1000
JCL14300SS-316	1/4 X 3"	1000
JCL14312SS-316	1/4 X 3-1/2"	1100
JCL14400SS-316	1/4 X 4"	800

*BOX QUANTITIES MAY VARY

FLANGE TYPE INSERT

Made from Zinc Diecast/Nickel Plated
"No Rust"

PART #	SIZE	BOX QTY
D142020	1/4 -20	1000
D561825	5/16 - 18	1000



WEDGE ANCHORS

Zinc Plated or Stainless Steel

*Please call for Stainless Steel Pricing



PART #	SIZE	BOX QTY
1/4"		
WA14134	1/4 X 1-3/4"	100
WA14214	1/4 X 2-1/4"	100
WA14314	1/4 X 3-1/4"	100
3/8"		
WA38214	3/8 X 2-1/4"	100
WA38234	3/8 X 2-3/4"	100
WA38300	3/8 X 3"	100
WA38312	3/8 X 3-1/2"	100
WA38334	3/8 X 3-3/4"	100
WA38500	3/8 X 5"	50
WA38612	3/8 X 6-1/2"	50
1/2"		
WA12234	1/2 X 2-3/4"	50
WA12334	1/2 X 3-3/4"	50
WA12414	1/2 X 4-1/4"	25
WA12512	1/2 X 5-1/2"	25
WA12700	1/2 X 7"	25
WA12812	1/2 X 8-1/2"	25
WA121000	1/2 X 10"	25
WA121200	1/2 X 12"	25
5/8"		
WA58312	5/8 X 3-1/2"	25
WA58412	5/8 X 4-1/2"	25
WA58500	5/8 X 5"	25
WA58600	5/8 X 6"	25
WA58700	5/8 X 7"	25
WA58812	5/8 X 8-1/2"	25
WA581000	5/8 X 10"	10
WA581200	5/8 X 12"	10
3/4"		
WA34414	3/4 X 4-1/4"	20
WA34434	3/4 X 4-3/4"	20
WA34512	3/4 X 5-1/2"	20
WA34614	3/4 X 6-1/4"	10
WA34700	3/4 X 7"	10
WA34812	3/4 X 8-1/2"	10
WA341000	3/4 X 10"	10
WA341200	3/4 X 12"	10

*BOX QUANTITIES MAY VARY

HEX POWER BIT

For Use With 1/4" Chair Bolts



PART #	SIZE	PACK QTY
SBIT5322	5/32 HEX	5

INSTALLATION QUICKCUTTERS™ CABINET INSTALLATION SCREWS

Combo Round Washer Head
Zinc



PART #	SIZE	QTY
7927	#10 X 2-1/2"	1500
7935	#10 X 3"	1500
7936	#10 X 3-1/2"	1000
7937	#10 X 4"	1000

FACE FRAME & POCKETHOLE ASSEMBLY SCREWS

No Oily Residue No Metal Slivers

PART #	SIZE	QTY
FINE THREAD- TYPE 17, YELLOW ZINC		
13574	#6 X 1-1/2" SQ-PN	7000
Hi-Lo THREAD- TYPE 17 YELLOW ZINC		
13576	#7 X 1-1/2" SQ-PN	7000

INSTALLATION QUICKCUTTERS™ CABINET INSTALLATION SCREWS

Combo Round Washer Head
Zinc w/White Painted Heads



PART #	SIZE	QTY
8010	#10 X 2-1/2"	1500
8011	#10 X 3"	1500
8012	#10 X 3-1/2"	1000
8013	#10 X 4"	1000

POCKETHOLE ASSEMBLY SCREWS

Square Drive Modified Pan Head

PART #	SIZE	QTY
COARSE THREAD- FOR SOFT WOODS PLAIN & DRI LUBE		
13004	#7 X 1"	10000
4080	#7 X 1-1/4"	8000
4081	#7 X 1-1/2"	7000
FINE THREAD- FOR HARD WOODS QUICKCUTTER™ AUGER PLAIN & DRI LUBE		
4082	#6 X 1-1/4"	8000
5215	#6 X 1-1/2"	7000
FINE THREAD- FOR HARD WOODS PLAIN & DRI LUBE		
13003	#6 X 1"	10000
2722	#6 X 1-1/4"	8000
2724	#6 X 1-1/2"	7000
Hi-Lo THREAD- FOR ALL WOODS PLAIN & DRI LUBE		
4084	#7 X 1-1/4"	8000
4085	#7 X 1-1/2"	7000

ASSEMBLY QUICK\$CREWS®

PHILLIPS FLAT HEAD

Black With Nibs & Type 17 Cutter Tip



PART #	SIZE	QTY
10900	#8 X 1"	11000
10901	#8 X 1-1/4"	9000
10902	#8 X 1-1/2"	7000
10903	#8 X 1-5/8"	6000
10904	#8 X 1-3/4"	5000
10905	#8 X 2"	4000
10906	#8 X 2-1/4"	3000
10907	#9 X 2-1/2"	2500
10908	#9 X 3"	2000

AC QUICKCUTTERS™ ACQ LUMBER ASSEMBLY SCREWS

Square Flat Head with Nibs
Ultraguard



PART #	SIZE	QTY
13336	#8 X 1-5/8"	5000
13337	#8 X 2"	4000
13338	#8 X 2-1/4"	3000
13339	#8 X 2-1/2"	2500
13340	#8 X 3"	2000
13341	#10 X 3-1/2"	1000
13342	#10 X 4"	1000
13343	#10 X 4-1/2"	800
13344	#10 X 5"	500
13345	#10 X 6"	500

QUICKCUTTERS™ HARDWOOD

ASSEMBLY SCREWS

Combo Flat Head
Nibs, Zinc



PART #	SIZE	QTY
9021	#8 X 1"	11000
3122	#8 X 1-1/4"	9000
3123	#8 X 1-1/2"	7000
3124	#8 X 1-5/8"	6000
5453	#8 X 1-3/4"	5000
3125	#8 X 2"	4000
5896	#8 X 2-1/2"	2500
5897	#8 X 3"	2000

QUICKCUTTERS™ HARDWOOD

ASSEMBLY SCREWS

Combo Flat Head
With Nibs
Plain & Dri Lube



PART #	SIZE	QTY
9020	#8 X 1"	11000
5440	#8 X 1-1/4"	9000
5441	#8 X 1-1/2"	7000
5442	#8 X 1-3/4"	5000
5443	#8 X 2"	4000
5444	#8 X 2-1/4"	3000
5445	#8 X 2-1/2"	2500
5446	#8 X 3"	2000
9484	#10 X 3-1/2"	1000
9485	#10 X 4"	1000

POCKETHOLE SCREWS

Square Drive, Round Washer Head



Fine Thread

PART #	SIZE	QTY
5285	#7 X 1-1/4"	8000
5286	#7 X 1-1/2"	6000

QUICKCUTTERS™

HARDWOOD ASSEMBLY SCREWS

Combo Round Washer Head
Plain & Dri Lube



PART #	SIZE	QTY
7304	#8 X 1"	11000
7306	#8 X 1-1/4"	9000
7307	#8 X 1-1/2"	7000
7308	#8 X 1-5/8"	6000
7309	#8 X 1-3/4"	5000
7310	#8 X 2"	4000
7311	#8 X 2-1/4"	3000
7312	#8 X 2-1/2"	2500
7313	#8 X 3"	2000

ASSEMBLY QUICK\$CREWS®

Phillips Pan Head
Black

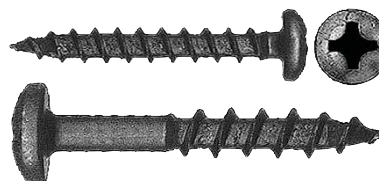

PART #	SIZE	QTY
144	#6 X 1/2"	30000
145	#6 X 5/8"	25000
146	#6 X 3/4"	20000
5173	#6 X 1"	15000
6882	#8 X 1/2"	15000
147	#8 X 5/8"	12000
148	#8 X 3/4"	10000
150	#8 X 1"	9000
151	#8 X 1-1/4"	9000
152	#10 X 5/8"	10000
154	#10 X 3/4"	9000
155	#10 X 1"	7000
5973	#10 X 1-1/4"	6000

DRAWER FRONT ADJUSTING SCREWS



Large Round Washer Head
Combo Drive
Zinc

PART #	SIZE	QTY
7200	#8 X 7/8"	8000
9989	#8 X 1"	7000
10252	#8 X 1-1/8"	6000
10253	#8 X 1-1/4"	6000
10254	#8 X 1-1/2"	5000

DRAWER FRONT ADJUSTING SCREWS

Phillips Large Round Washer Head
Type 17 Cutter Tip
Zinc



PART #	SIZE	QTY
9022	#8 X 7/8"	8000
9023	#8 X 1"	7000
9024	#8 X 1-1/8"	6000
9025	#8 X 1-1/4"	6000
9532	#8 X 1-1/2"	5000

ROUND WASHER HEAD & TRUSS HEAD



Type 17 Cutter Tip
Zinc

PART #	SIZE	QTY
8883	#8 X 3/4"	10000

DRAW BOLTS

Zinc



PART #	SIZE	QTY
322	1/4-20 X 3-1/2"	500
5368	1/4-20 X 4"	350

QUICK\$CREWS® FLAT HEAD HARDWARE

#2 Square Drive
Type 17
Zinc



PART #	SIZE	QTY
13465	#6 X 1/2"	25000
13466	#6 X 5/8"	25000
13467	#6 X 3/4"	20000
13468	#6 X 1"	13000
13469	#6 X 1-1/4"	10000
13470	#6 X 1-1/2"	8000

QUICK\$CREWS® COMBO FLAT HEAD SCREWS

#2 Square Drive/Phillips Head Combo
Zinc



PART #	SIZE	QTY
6478	#6 X 5/8"	25000
4617	#6 X 3/4"	20000

QUICK\$CREWS® PHILLIPS FLAT HEAD SCREWS

PART #	SIZE	QTY
ZINC		
9014	#6 X 1/2"	25000
9015	#6 X 5/8"	25000
9016	#6 X 3/4"	25000
ANTIQUE BRASS		
232	#6 X 1/2"	25000
235	#6 X 5/8"	25000
BRIGHT BRASS		
9063	#6 X 1/2"	25000
4722	#6 X 5/8"	25000

QUICK\$CREWS® PHILLIPS UNDERCUT SCREWS



Drawer Slide Screws
#5 Head

PART #	SIZE	QTY
7229	#6 X 1/2" ZINC	25000
7230	#6 X 5/8" ZINC	25000
7231	#6 X 3/4" ZINC	20000

UNDERCUT QUICK\$CREWS®

For Hinges and Drawer Slides
Type 17

PART #	SIZE	QTY
ZINC		
6055	#6 X 7/16"	35000
6056	#6 X 1/2"	25000
6057	#6 X 5/8"	25000
6058	#6 X 3/4"	20000
ANTIQUE BRASS		
6063	#6 X 5/8"	25000
BRIGHT BRASS		
6059	#6 X 1/2"	25000
6061	#6 X 3/4"	25000

**QUICK\$CREWS® PHILLIPS
.275 OD FLAT HEAD SCREW**



PART #	SIZE	QTY
9526	#6 X 1/2"	25000
9501	#6 X 5/8"	25000
9594	#6 X 3/4"	20000

**QUICK\$CREWS® PHILLIPS LOW PROFILE
ROUND WASHER HEAD SCREWS**

For Ball Bearing Drawer Slides
Zinc



PART #	SIZE	QTY
5213	#8 X 7/16"	20000
4688	#8 X 1/2"	14000

DRAWER SLIDE SCREWS

Low Profile Pan Head
Phillips Drive
Zinc



PART #	SIZE	QTY
13355	#6 X 7/16"	25000
13356	#6 X 1/2"	25000

DRAWER SLIDE SCREWS

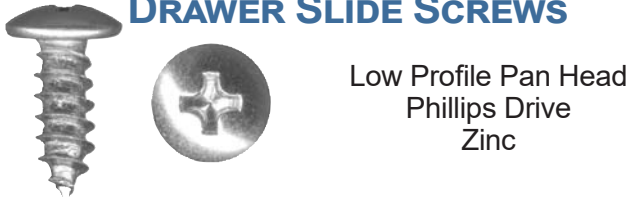

PART #	SIZE	QTY
11572	#6 X 7/16"	30000

**PHILLIPS OVAL HEAD HARDWARE
QUICK\$CREWS®**

PART #	SIZE	QTY
ANTIQUE BRASS		
238	#5 X 5/8"	30000
239	#6 X 5/8"	20000
BRIGHT BRASS		
640	#6 X 5/8"	20000

**QUICK\$CREWS®
PHILLIPS PAN HEAD SCREWS**

Type 17 Cutter Tip

	PART #	SIZE	QTY
	ZINC		
	8085	#8 X 5/8"	12000
	8086	#8 X 3/4"	10000
	9799	#12 X 5/8"	7000
	9800	#12 X 3/4"	6000
	9801	#12 X 1"	5000
	ANTIQUE BRASS		
	8081	#6 X 1/2"	30000
	8082	#6 X 5/8"	25000
	7891	#6 X 5/8"	12000
	NICKEL		
	10991	#10 X 5/8"	10000
	10918	#10 X 3/4"	9000
	10993	#10 X 1"	7000

**QUICK\$CREWS® #6 HEAD
COMBO TRUSS HEAD SCREWS**



PART #	SIZE	QTY
10255	#8 X 7/16"	20000

ZINC PLATED LAG BOLTS

Sold in Full Boxes Only



PART #	SIZE	BOX QTY
1/4" ZINC LAG BOLTS		
LAG14100Z	1/4 X 1"	3000
LAG14114Z	1/4 X 1-1/4"	2500
LAG14112Z	1/4 X 1-1/2"	1800
LAG14134Z	1/4 X 1-3/4"	1800
LAG14200Z	1/4 X 2"	1400
LAG14212Z	1/4 X 2-1/2"	1100
LAG14300Z	1/4 X 3"	900
LAG14312Z	1/4 X 3-1/2"	800
LAG14400Z	1/4 X 4"	700
LAG14412Z	1/4 X 4-1/2"	650
LAG14500Z	1/4 X 5"	600
LAG14600Z	1/4 X 6"	500
5/16" ZINC LAG BOLTS		
LAG516100Z	5/16 X 1"	1600
LAG516114Z	5/16 X 1-1/4"	1300
LAG516112Z	5/16 X 1-1/2"	1100
LAG516134Z	5/16 X 1-3/4"	1000
LAG516200Z	5/16 X 2"	850
LAG516212Z	5/16 X 2-1/2"	650
LAG516300Z	5/16 X 3"	600
LAG516312Z	5/16 X 3-1/2"	500
LAG516400Z	5/16 X 4"	425
LAG516412Z	5/16 X 4-1/2"	375
LAG516500Z	5/16 X 5"	350
LAG516600Z	5/16 X 6"	300
3/8" ZINC LAG BOLTS		
LAG38112Z	3/8 X 1-1/2"	800
LAG38134Z	3/8 X 1-3/4"	750
LAG38200Z	3/8 X 2"	700
LAG38212Z	3/8 X 2-1/2"	500
LAG38300Z	3/8 X 3"	400
LAG38312Z	3/8 X 3-1/2"	325
LAG38400Z	3/8 X 4"	300
LAG38412Z	3/8 X 4-1/2"	275
LAG38500Z	3/8 X 5"	250
LAG38600Z	3/8 X 6"	200
1/2" ZINC LAG BOLTS		
LAG12134Z	1/2 X 1-3/4"	425
LAG12200Z	1/2 X 2"	400
LAG12300Z	1/2 X 3"	300
LAG12312Z	1/2 X 3-1/2"	200
LAG12400Z	1/2 X 4"	175
LAG12412Z	1/2 X 4-1/2"	150
LAG12500Z	1/2 X 5"	125
LAG12600Z	1/2 X 6"	125
LAG12700Z	1/2 X 7"	100

*BOX QUANTITIES MAY VARY

YELLOW ZINC PLATED LAG BOLTS

Sold in Full Boxes Only



PART #	SIZE	BOX QTY
1/4" YELLOW ZINC LAG BOLTS		
LAG14112YZ	1/4 X 1-1/2"	1800
LAG14200YZ	1/4 X 2"	1400
LAG14212YZ	1/4 X 2-1/2"	1100
LAG14300YZ	1/4 X 3"	900
LAG14312YZ	1/4 X 3-1/2"	800
LAG14400YZ	1/4 X 4"	700
5/16" YELLOW ZINC LAG BOLTS		
LAG516200YZ	5/16 X 2"	850
LAG516212YZ	5/16 X 2-1/2"	650
LAG516300YZ	5/16 X 3"	600
LAG516312YZ	5/16 X 3-1/2"	500
LAG516400YZ	5/16 X 4"	425
LAG516412YZ	5/16 X 4-1/2"	375
LAG516500YZ	5/16 X 5"	350
3/8" YELLOW ZINC LAG BOLTS		
LAG38212YZ	3/8 X 2-1/2"	500
LAG38300YZ	3/8 X 3"	400
LAG38312YZ	3/8 X 3-1/2"	325
LAG38400YZ	3/8 X 4"	300
LAG38412YZ	3/8 X 4-1/2"	275
LAG38500YZ	3/8 X 5"	250

*BOX QUANTITIES MAY VARY

STAINLESS STEEL LAG BOLTS

Sold in Full Boxes Only



PART #	SIZE	BOX QTY
1/4" STAINLESS STEEL LAG BOLTS		
LAG14112SS	1/4 X 1-1/2"	500
LAG14200SS	1/4 X 2"	500
LAG14212SS	1/4 X 2-1/2"	500
LAG14300SS	1/4 X 3"	500
LAG14312SS	1/4 X 3-1/2"	500
LAG14400SS	1/4 X 4"	500
5/16" STAINLESS STEEL LAG BOLTS		
LAG516112SS	5/16 X 1-1/2"	500
LAG516134SS	5/16 X 1-3/4"	500
LAG516200SS	5/16 X 2"	500
LAG516212SS	5/16 X 2-1/2"	500
LAG516300SS	5/16 X 3"	300
LAG516312SS	5/16 X 3-1/2"	300
LAG516400SS	5/16 X 4"	300
LAG516412SS	5/16 X 4-1/2"	300
LAG516500SS	5/16 X 5"	300
3/8" STAINLESS STEEL LAG BOLTS		
LAG38200SS	3/8 X 2"	100
LAG38212SS	3/8 X 2-1/2"	100
LAG38300SS	3/8 X 3"	100
LAG38312SS	3/8 X 3-1/2"	100
LAG38400SS	3/8 X 4"	100
LAG38500SS	3/8 X 5"	100
LAG38600SS	3/8 X 6"	100
1/4" TYPE 316 STAINLESS STEEL LAG BOLTS		
LAG14112SS-316	1/4 X 1 1/2"	500
LAG14200SS-316	1/4 X 2"	500
LAG14212SS-316	1/4 X 2 1/2"	500
LAG14300SS-316	1/4 X 3"	500
LAG14312SS-316	1/4 X 3 1/2"	500
5/16" TYPE 316 STAINLESS STEEL LAG BOLTS		
LAG516200SS-316	5/16 X 2"	500
LAG516212SS-316	5/16 X 2 1/2"	500
LAG516300SS-316	5/16 X 3"	300

*Box Quantities May Vary

TREATED-LUMBER-COATED LAG BOLTS

Sold in Full Boxes Only



PART #	SIZE	BOX QTY
1/4" TLC LAG BOLTS		
LAG14112TLC	1/4 X 1-1/2"	1800
LAG14200TLC	1/4 X 2"	1400
LAG14212TLC	1/4 X 2-1/2"	1100
LAG14300TLC	1/4 X 3"	900
LAG14312TLC	1/4 X 3-1/2"	800
LAG14400TLC	1/4 X 4"	700
5/16" TLC LAG BOLTS		
LAG516200TLC	5/16 X 2"	850
LAG516212TLC	5/16 X 2-1/2"	650
LAG516300TLC	5/16 X 3"	600
LAG516312TLC	5/16 X 3-1/2"	500
LAG516400TLC	5/16 X 4"	425
LAG516412TLC	5/16 X 4-1/2"	375
LAG516500TLC	5/16 X 5"	350
3/8" TLC LAG BOLTS		
LAG38212TLC	3/8 X 2-1/2"	500
LAG38300TLC	3/8 X 3"	400
LAG38312TLC	3/8 X 3-1/2"	325
LAG38400TLC	3/8 X 4"	300
LAG38412TLC	3/8 X 4-1/2"	275
LAG38500TLC	3/8 X 5"	250

*Box Quantities May Vary

**TLC- TREATED LUMBER COATING-
A 1000+ HOUR COATING
APPROVED FOR OUTDOOR USE
WITH ACQ
TREATED LUMBER**



HANGER BOLT DRIVER BIT

PART #	SIZE	QTY
HBD1/4	1/4" DRIVER BIT	1
HBD5/16	5/16" DRIVER BIT	1
HBD3/8	3/8" DRIVER BIT	1

HANGER BOLTS

Plain Steel Available in 1/4" & Zinc Plated Available for 5/16"
3/8" Available- Call for Current Pricing
Sold in Full Box Quantities Only

PART #	SIZE	BOX QTY
1/4" PLAIN		
HB14200P	1/4 X 2"	3000
HB14212P	1/4 X 2-1/2"	2500
HB14300P	1/4 X 3"	2000
HB14312P	1/4 X 3-1/2"	1500
5/16" ZINC		
HB516200Z	5/16 X 2"	2000
HB516212Z	5/16 X 2-1/2"	2000
HB516300Z	5/16 X 3"	1500
HB516312Z	5/16 X 3-1/2"	1000
HB516400Z	5/16 X 4"	1000

*Box QUANTITIES MAY VARY

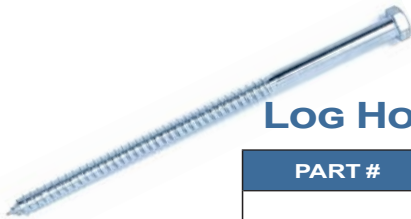

LOG HOME SCREWS

PART #	SIZE	BOX QTY
3/8"		
LB38800Z	3/8 X 8"	200
LB381000Z	3/8 X 10"	100
LB381200Z	3/8 X 12"	100
1/2"		
LB12800Z	1/2 X 8"	100
LB121000Z	1/2 X 10"	100
LB121200Z	1/2 X 12"	100

HEX HEAD LOG HOME SCREWS



Yellow Zinc, Use 5/16" Magnetic Nut Driver

PART #	SIZE	BOX QTY
LH14600H	1/4 X 6"	250
LH14800H	1/4 X 8"	250
LH141000H	1/4 X 10"	250

WASHER LAG BOLTS

*NOTE: 1/4" HAS A 5/8" O.D. WASHER
5/16" HAS A 3/4" O.D. WASHER



Type 17 Cutter Tip

ZINC PLATED

PART #	SIZE	BOX QTY
1/4"		
WLAG14200Z	1/4 X 2"	1400
WLAG14212Z	1/4 X 2-1/2"	1100
WLAG14300Z	1/4 X 3"	900
WLAG14312Z	1/4 X 3-1/2"	800
WLAG14400Z	1/4 X 4"	700
5/16"		
WLAG516200Z	5/16 X 2"	850
WLAG516212Z	5/16 X 2-1/2"	650
WLAG516300Z	5/16 X 3"	600
WLAG516312Z	5/16 X 3-1/2"	500
WLAG516400Z	5/16 X 4"	400

YELLOW ZINC

PART #	SIZE	BOX QTY
1/4"		
WLAG14200YZ	1/4 X 2"	1400
WLAG14212YZ	1/4 X 2-1/2"	1100
WLAG14300YZ	1/4 X 3"	900
WLAG14312YZ	1/4 X 3-1/2"	800
WLAG14400YZ	1/4 X 4"	700
5/16"		
WLAG516200YZ	5/16 X 2"	850
WLAG516212YZ	5/16 X 2-1/2"	650
WLAG516300YZ	5/16 X 3"	600
WLAG516312YZ	5/16 X 3-1/2"	500
WLAG516400YZ	5/16 X 4"	400

TREATED-LUMBER-COATED

PART #	SIZE	BOX QTY
WLAG516200TLC	5/16 X 2"	850
WLAG516212TLC	5/16 X 2-1/2"	650
WLAG516300TLC	5/16 X 3"	600
WLAG516312TLC	5/16 X 3-1/2"	500
WLAG516400TLC	5/16 X 4"	425

*Box QUANTITIES MAY VARY

WAVER HEAD LOG HOME SCREWS

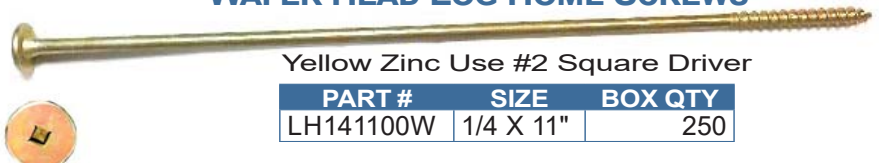

Yellow Zinc Use #2 Square Driver

PART #	SIZE	BOX QTY
LH141100W	1/4 X 11"	250

TYPE 316 STAINLESS STEEL HEX BOLTS "MARINE QUALITY"

Sold in Full Boxes Only



PART #	SIZE	BOX QTY
1/4" TYPE 316 SS HEX BOLTS		
HB14200SS-316	1/4-20 X 2"	500
HB14214SS-316	1/4-20 X 2-1/4"	500
HB14212SS-316	1/4-20 X 2-1/2"	500
HB14234SS-316	1/4-20 X 2-3/4"	500
HB14300SS-316	1/4-20 X 3"	500
HB14312SS-316	1/4-20 X 3-1/2"	500
5/16" TYPE 316 SS HEX BOLTS		
HB516200SS-316	5/16-18 X 2"	500
HB516214SS-316	5/16-18 X 2-1/4"	500
HB516212SS-316	5/16-18 X 2-1/2"	500
HB516300SS-316	5/16-18 X 3"	500
HB516312SS-316	5/16-18 X 3-1/2"	500

*BOX QUANTITIES MAY VARY

TYPE 304 STAINLESS STEEL HEX BOLTS

Sold in Full Boxes Only



PART #	SIZE	BOX QTY
1/4" SS HEX BOLTS		
HB14034SS	1/4-20 X 3/4"	500
HB14100SS	1/4-20 X 1"	500
HB14114SS	1/4-20 X 1-1/4"	500
HB14112SS	1/4-20 X 1-1/2"	500
HB14134SS	1/4-20 X 1-3/4"	500
HB14200SS	1/4-20 X 2"	500
HB14214SS	1/4-20 X 2-1/4"	500
HB14212SS	1/4-20 X 2-1/2"	500
HB14234SS	1/4-20 X 2-3/4"	500
HB14300SS	1/4-20 X 3"	500
HB14312SS	1/4-20 X 3-1/2"	500
HB14400SS	1/4-20 X 4"	500
5/16" TYPE SS HEX BOLTS		
HB516034SS	5/16-18 X 3/4"	500
HB516100SS	5/16-18 X 1"	500
HB516114SS	5/16-18 X 1-1/4"	500
HB516112SS	5/16-18 X 1-1/2"	500
HB516134SS	5/16-18 X 1-3/4"	500
HB516200SS	5/16-18 X 2"	500
HB516214SS	5/16-18 X 2-1/4"	500
HB516212SS	5/16-18 X 2-1/2"	500
HB516300SS	5/16-18 X 3"	500
HB516312SS	5/16-18 X 3-1/2"	500
HB516400SS	5/16-18 X 4"	500
HB516412SS	5/16-18 X 4-1/2"	500
HB516500SS	5/16-18 X 5"	500
3/8" SS HEX BOLTS		
HB38034SS	3/8-16 X 3/4"	300
HB38100SS	3/8-16 X 1"	300
HB38114SS	3/8-16 X 1-1/4"	300
HB38112SS	3/8-16 X 1-1/2"	300
HB38134SS	3/8-16 X 1-3/4"	300
HB38200SS	3/8-16 X 2"	300
HB38212SS	3/8-16 X 2-1/2"	300
HB38300SS	3/8-16 X 3"	300
HB38312SS	3/8-16 X 3-1/2"	300
HB38400SS	3/8-16 X 4"	300
HB38412SS	3/8-16 X 4-1/2"	300
HB38500SS	3/8-16 X 5"	300
HB38512SS	3/8-16 X 5-1/2"	300
HB38600SS	3/8-16 X 6"	300

*BOX QUANTITIES MAY VARY

* HEX BOLT GRADE MARKINGS

GRADE 2



GRADE 5



GRADE 8



THREADS PER INCH (TPI)

BOLT SIZE	COARSE THREAD	FINE THREAD
1/4	20	28
5/16	18	24
3/8	16	24
7/16	14	20
1/2	13	20
9/16	12	18
5/8	11	18

The Unified Thread Standard (UTS) defines a standard thread form and series—along with allowances, tolerances, and designations—for screw threads commonly used in the United States and Canada. It is the main standard for bolts, nuts, and a wide variety of other threaded fasteners used in these countries.

*Stainless markings vary.
Most stainless is non-magnetic.

GRADE 2 HEX BOLTS

M=1000
C=100

GRADE 2 ZINC PLATED

Sold in Full Boxes Only

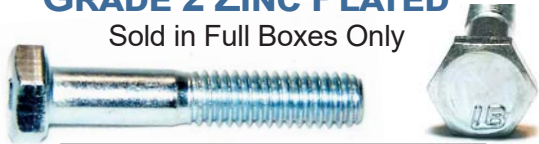

PART #	SIZE	BOX QTY
1/4" GR 2 HEX BOLTS		
H2B14012Z	1/4 X 1/2"	5000
H2B14058Z	1/4 X 5/8"	4800
H2B14034Z	1/4 X 3/4"	4000
H2B14100Z	1/4 X 1"	3600
H2B14114Z	1/4 X 1-1/4"	2800
H2B14112Z	1/4 X 1-1/2"	2400
H2B14134Z	1/4 X 1-3/4"	1800
H2B14200Z	1/4 X 2"	1600
H2B14214Z	1/4 X 2-1/4"	1300
H2B14212Z	1/4 X 2-1/2"	1300
H2B14234Z	1/4 X 2-3/4"	900
H2B14300Z	1/4 X 3"	900
H2B14312Z	1/4 X 3-1/2"	750
H2B14400Z	1/4 X 4"	700
5/16" GR 2 HEX BOLTS		
H2B516012Z	5/16 X 1/2"	3100
H2B516058Z	5/16 X 5/8"	2800
H2B516034Z	5/16 X 3/4"	2600
H2B516100Z	5/16 X 1"	2200
H2B516114Z	5/16 X 1-1/4"	1800
H2B516112Z	5/16 X 1-1/2"	1600
H2B516134Z	5/16 X 1-3/4"	1300
H2B516200Z	5/16 X 2"	1200
H2B516214Z	5/16 X 2-1/4"	900
H2B516212Z	5/16 X 2-1/2"	900
H2B516300Z	5/16 X 3"	700
H2B516312Z	5/16 X 3-1/2"	600
H2B516400Z	5/16 X 4"	450
H2B516412Z	5/16 X 4-1/2"	400
H2B516500Z	5/16 X 5"	300
3/8" GR 2 HEX BOLTS		
H2B38034Z	3/8 X 3/4"	1800
H2B38100Z	3/8 X 1"	1500
H2B38114Z	3/8 X 1-1/4"	1300
H2B38112Z	3/8 X 1-1/2"	1000
H2B38134Z	3/8 X 1-3/4"	1000
H2B38200Z	3/8 X 2"	800
H2B38214Z	3/8 X 2-1/4"	700
H2B38212Z	3/8 X 2-1/2"	650
H2B38234Z	3/8 X 2-3/4"	600
H2B38300Z	3/8 X 3"	500
H2B38312Z	3/8 X 3-1/2"	400
H2B38400Z	3/8 X 4"	325
H2B38412Z	3/8 X 4-1/2"	300
H2B38500Z	3/8 X 5"	300
H2B38512Z	3/8 X 5-1/2"	300
H2B38600Z	3/8 X 6"	300

*Box QUANTITIES MAY VARY

PART #	SIZE	BOX QTY
7/16" GR 2 HEX BOLTS		
H2B716100Z	7/16 X 1"	800
H2B716114Z	7/16 X 1-1/4"	700
H2B716112Z	7/16 X 1-1/2"	600
H2B716134Z	7/16 X 1-3/4"	550
H2B716200Z	7/16 X 2"	450
H2B716214Z	7/16 X 2-1/4"	400
H2B716212Z	7/16 X 2-1/2"	350
H2B716234Z	7/16 X 2-3/4"	325
H2B716300Z	7/16 X 3"	300
H2B716312Z	7/16 X 3-1/2"	250
H2B716400Z	7/16 X 4"	250
H2B716412Z	7/16 X 4-1/2"	225
H2B716500Z	7/16 X 5"	225
H2B716600Z	7/16 X 6"	125
1/2" GR 2 HEX BOLTS		
H2B12034Z	1/2 X 3/4"	900
H2B12100Z	1/2 X 1"	750
H2B12114Z	1/2 X 1-1/4"	650
H2B12112Z	1/2 X 1-1/2"	600
H2B12134Z	1/2 X 1-3/4"	500
H2B12200Z	1/2 X 2"	450
H2B12214Z	1/2 X 2-1/4"	400
H2B12212Z	1/2 X 2-1/2"	325
H2B12234Z	1/2 X 2-3/4"	300
H2B12300Z	1/2 X 3"	250
H2B12312Z	1/2 X 3-1/2"	250
H2B12400Z	1/2 X 4"	200
H2B12412Z	1/2 X 4-1/2"	175
H2B12500Z	1/2 X 5"	150
H2B12512Z	1/2 X 5-1/2"	150
5/8" GR 2 HEX BOLTS		
H2B58100Z	5/8 X 1"	400
H2B58114Z	5/8 X 1-1/4"	350
H2B58112Z	5/8 X 1-1/2"	300
H2B58134Z	5/8 X 1-3/4"	300
H2B58200Z	5/8 X 2"	250
H2B58214Z	5/8 X 2-1/4"	225
H2B58212Z	5/8 X 2-1/2"	200
H2B58234Z	5/8 X 2-3/4"	200
H2B58300Z	5/8 X 3"	175
H2B58312Z	5/8 X 3-1/2"	150
H2B58400Z	5/8 X 4"	125
H2B58412Z	5/8 X 4-1/2"	100
H2B58500Z	5/8 X 5"	90
H2B58512Z	5/8 X 5-1/2"	75

*Box QUANTITIES MAY VARY

GRADE 5 ZINC PLATED

Sold in Full Boxes Only



PART #	SIZE	BOX QTY
1/4" GR 5 HEX BOLTS		
H5B14012Z	1/4 X 1/2"	5000
H5B14058Z	1/4 X 5/8"	4800
H5B14034Z	1/4 X 3/4"	4000
H5B14100Z	1/4 X 1"	3600
H5B14114Z	1/4 X 1-1/4"	2800
H5B14112Z	1/4 X 1-1/2"	2400
H5B14134Z	1/4 X 1-3/4"	1800
H5B14200Z	1/4 X 2"	1600
H5B14214Z	1/4 X 2-1/4"	1300
H5B14212Z	1/4 X 2-1/2"	1300
H5B14234Z	1/4 X 2-3/4"	900
H5B14300Z	1/4 X 3"	900
H5B14312Z	1/4 X 3-1/2"	750
H5B14400Z	1/4 X 4"	700
5/16" GR 5 HEX BOLTS		
H5B516012Z	5/16 X 1/2"	3100
H5B516058Z	5/16 X 5/8"	2800
H5B516034Z	5/16 X 3/4"	2600
H5B516100Z	5/16 X 1"	2200
H5B516114Z	5/16 X 1-1/4"	1800
H5B516112Z	5/16 X 1-1/2"	1600
H5B516134Z	5/16 X 1-3/4"	1300
H5B516200Z	5/16 X 2"	1200
H5B516214Z	5/16 X 2-1/4"	900
H5B516212Z	5/16 X 2-1/2"	900
H5B516300Z	5/16 X 3"	700
H5B516312Z	5/16 X 3-1/2"	600
H5B516400Z	5/16 X 4"	450
H5B516412Z	5/16 X 4-1/2"	400
H5B516500Z	5/16 X 5"	300
3/8" GR 5 HEX BOLTS		
H5B38034Z	3/8 X 3/4"	1800
H5B38100Z	3/8 X 1"	1500
H5B38114Z	3/8 X 1-1/4"	1300
H5B38112Z	3/8 X 1-1/2"	1000
H5B38134Z	3/8 X 1-3/4"	1000
H5B38200Z	3/8 X 2"	800
H5B38214Z	3/8 X 2-1/4"	700
H5B38212Z	3/8 X 2-1/2"	650
H5B38234Z	3/8 X 2-3/4"	600
H5B38300Z	3/8 X 3"	500
H5B38312Z	3/8 X 3-1/2"	400
H5B38400Z	3/8 X 4"	325
H5B38412Z	3/8 X 4-1/2"	300
H5B38500Z	3/8 X 5"	300
H5B38512Z	3/8 X 5-1/2"	300
H5B38600Z	3/8 X 6"	300

*Box QUANTITIES MAY VARY

PART #	SIZE	BOX QTY
7/16" GR 5 HEX BOLTS		
H5B716100Z	7/16 X 1"	800
H5B716114Z	7/16 X 1-1/4"	700
H5B716112Z	7/16 X 1-1/2"	600
H5B716134Z	7/16 X 1-3/4"	550
H5B716200Z	7/16 X 2"	450
H5B716214Z	7/16 X 2-1/4"	400
H5B716212Z	7/16 X 2-1/2"	350
H5B716234Z	7/16 X 2-3/4"	325
H5B716300Z	7/16 X 3"	300
H5B716312Z	7/16 X 3-1/2"	250
H5B716400Z	7/16 X 4"	250
H5B716412Z	7/16 X 4-1/2"	225
H5B716500Z	7/16 X 5"	225
H5B716600Z	7/16 X 6"	125
1/2" GR 5 HEX BOLTS		
H5B12034Z	1/2 X 3/4"	900
H5B12100Z	1/2 X 1"	750
H5B12114Z	1/2 X 1-1/4"	650
H5B12112Z	1/2 X 1-1/2"	600
H5B12134Z	1/2 X 1-3/4"	500
H5B12200Z	1/2 X 2"	450
H5B12214Z	1/2 X 2-1/4"	400
H5B12212Z	1/2 X 2-1/2"	325
H5B12234Z	1/2 X 2-3/4"	300
H5B12300Z	1/2 X 3"	250
H5B12312Z	1/2 X 3-1/2"	250
H5B12400Z	1/2 X 4"	200
H5B12412Z	1/2 X 4-1/2"	175
H5B12500Z	1/2 X 5"	150
H5B12512Z	1/2 X 5-1/2"	150
5/8" GR 5 HEX BOLTS		
H5B58100Z	5/8 X 1"	400
H5B58114Z	5/8 X 1-1/4"	350
H5B58112Z	5/8 X 1-1/2"	300
H5B58134Z	5/8 X 1-3/4"	300
H5B58200Z	5/8 X 2"	250
H5B58214Z	5/8 X 2-1/4"	225
H5B58212Z	5/8 X 2-1/2"	200
H5B58234Z	5/8 X 2-3/4"	200
H5B58300Z	5/8 X 3"	175
H5B58312Z	5/8 X 3-1/2"	150
H5B58400Z	5/8 X 4"	125
H5B58412Z	5/8 X 4-1/2"	100
H5B58500Z	5/8 X 5"	90
H5B58512Z	5/8 X 5-1/2"	75

*Box QUANTITIES MAY VARY

GRADE 8 HEX BOLTS

M=1000
C=100

GRADE 8 ZINC PLATED

Sold in Full Boxes Only



PART #	SIZE	BOX QTY
1/4" GR 8 HEX BOLTS		
H8B14012Z	1/4 X 1/2"	5000
H8B14034Z	1/4 X 3/4"	4000
H8B14100Z	1/4 X 1"	3600
H8B14114Z	1/4 X 1-1/4"	2800
H8B14112Z	1/4 X 1-1/2"	2400
H8B14134Z	1/4 X 1-3/4"	1800
H8B14200Z	1/4 X 2"	1600
H8B14214Z	1/4 X 2-1/4"	1300
H8B14212Z	1/4 X 2-1/2"	1300
H8B14300Z	1/4 X 3"	900
H8B14312Z	1/4 X 3-1/2"	750
H8B14400Z	1/4 X 4"	700
5/16" GR 8 HEX BOLTS		
H8B516012Z	5/16 X 1/2"	3100
H8B516100Z	5/16 X 1"	2200
H8B516114Z	5/16 X 1-1/4"	1800
H8B516112Z	5/16 X 1-1/2"	1600
H8B516134Z	5/16 X 1-3/4"	1300
H8B516200Z	5/16 X 2"	1200
H8B516214Z	5/16 X 2-1/4"	900
H8B516212Z	5/16 X 2-1/2"	900
H8B516300Z	5/16 X 3"	700
H8B516312Z	5/16 X 3-1/2"	600
H8B516400Z	5/16 X 4"	450
3/8" GR 8 HEX BOLTS		
H8B38034Z	3/8 X 3/4"	1800
H8B38100Z	3/8 X 1"	1500
H8B38114Z	3/8 X 1-1/4"	1300
H8B38112Z	3/8 X 1-1/2"	1000
H8B38134Z	3/8 X 1-3/4"	1000
H8B38200Z	3/8 X 2"	800
H8B38214Z	3/8 X 2-1/4"	700
H8B38212Z	3/8 X 2-1/2"	650
H8B38300Z	3/8 X 3"	500
H8B38312Z	3/8 X 3-1/2"	400
H8B38400Z	3/8 X 4"	325
H8B38412Z	3/8 X 4-1/2"	300
H8B38500Z	3/8 X 5"	300

*BOX QUANTITIES MAY VARY

PART #	SIZE	BOX QTY
7/16" GR 8 HEX BOLTS		
H8B716100Z	7/16 X 1"	800
H8B716114Z	7/16 X 1-1/4"	700
H8B716112Z	7/16 X 1-1/2"	600
H8B716134Z	7/16 X 1-3/4"	550
H8B716200Z	7/16 X 2"	450
H8B716214Z	7/16 X 2-1/4"	400
H8B716212Z	7/16 X 2-1/2"	350
H8B716234Z	7/16 X 2-3/4"	325
H8B716300Z	7/16 X 3"	300
H8B716312Z	7/16 X 3-1/2"	250
H8B716400Z	7/16 X 4"	250
H8B716412Z	7/16 X 4-1/2"	225
H8B716500Z	7/16 X 5"	225
H8B716600Z	7/16 X 6"	125
1/2" GR 8 HEX BOLTS		
H8B12034Z	1/2 X 3/4"	900
H8B12100Z	1/2 X 1"	750
H8B12114Z	1/2 X 1-1/4"	650
H8B12112Z	1/2 X 1-1/2"	600
H8B12134Z	1/2 X 1-3/4"	500
H8B12200Z	1/2 X 2"	450
H8B12214Z	1/2 X 2-1/4"	400
H8B12212Z	1/2 X 2-1/2"	325
H8B12234Z	1/2 X 2-3/4"	300
H8B12300Z	1/2 X 3"	250
H8B12312Z	1/2 X 3-1/2"	250
H8B12400Z	1/2 X 4"	200
H8B12412Z	1/2 X 4-1/2"	175
H8B12500Z	1/2 X 5"	150
5/8" GR 8 HEX BOLTS		
H8B58100Z	5/8 X 1"	400
H8B58112Z	5/8 X 1-1/2"	300
H8B58134Z	5/8 X 1-3/4"	300
H8B58200Z	5/8 X 2"	250
H8B58214Z	5/8 X 2-1/4"	225
H8B58212Z	5/8 X 2-1/2"	200
H8B58300Z	5/8 X 3"	175
H8B58312Z	5/8 X 3-1/2"	150
H8B58400Z	5/8 X 4"	125

*BOX QUANTITIES MAY VARY

ZINC PLATED

Sold in Full Boxes Only

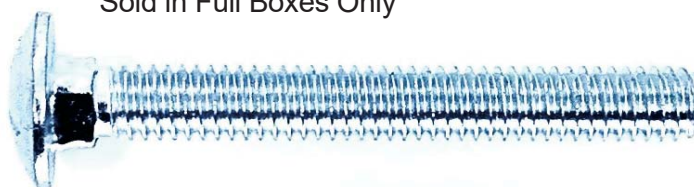

PART #	SIZE	BOX QTY
3/16"		
CB10100Z	3/16 X 1"	7000
CB10114Z	3/16 X 1-1/4"	6000
CB10112Z	3/16 X 1-1/2"	5000
CB10200Z	3/16 X 2"	3500
CB10212Z	3/16 X 2-1/2"	3000
CB10300Z	3/16 X 3"	2500
1/4"		
CB14114Z	1/4 X 1-1/4"	2500
CB14112Z	1/4 X 1-1/2"	1800
CB14134Z	1/4 X 1-3/4"	1800
CB14200Z	1/4 X 2"	1400
CB14214Z	1/4 X 2-1/4"	1200
CB14212Z	1/4 X 2-1/2"	1100
CB14234Z	1/4 X 2-3/4"	1000
CB14300Z	1/4 X 3"	900
CB14314Z	1/4 X 3-1/4"	900
CB14312Z	1/4 X 3-1/2"	800
CB14334Z	1/4 X 3-3/4"	800
CB14400Z	1/4 X 4"	700
CB14412Z	1/4 X 4-1/2"	650
CB14500Z	1/4 X 5"	600
CB14512Z	1/4 X 5-1/2"	550
CB14600Z	1/4 X 6"	500
5/16"		
CB516112Z	5/16 X 1-1/2"	1100
CB516134Z	5/16 X 1-3/4"	1000
CB516200Z	5/16 X 2"	850
CB516214Z	5/16 X 2-1/4"	800
CB516212Z	5/16 X 2-1/2"	650
CB516234Z	5/16 X 2-3/4"	600
CB516300Z	5/16 X 3"	600
CB516314Z	5/16 X 3-1/4"	550
CB516312Z	5/16 X 3-1/2"	500
CB516400Z	5/16 X 4"	425
CB516412Z	5/16 X 4-1/2"	375
CB516500Z	5/16 X 5"	350
CB516512Z	5/16 X 5-1/2"	325
CB516600Z	5/16 X 6"	300

*Box QUANTITIES MAY VARY

PART #	SIZE	BOX QTY
3/8"		
CB38112Z	3/8 X 1-1/2"	800
CB38134Z	3/8 X 1-3/4"	750
CB38200Z	3/8 X 2"	700
CB38214Z	3/8 X 2-1/4"	600
CB38212Z	3/8 X 2-1/2"	500
CB38234Z	3/8 X 2-3/4"	450
CB38300Z	3/8 X 3"	400
CB38312Z	3/8 X 3-1/2"	325
CB38400Z	3/8 X 4"	300
CB38412Z	3/8 X 4-1/2"	275
CB38500Z	3/8 X 5"	250
CB38512Z	3/8 X 5-1/2"	225
CB38600Z	3/8 X 6"	200
CB38612Z	3/8 X 6-1/2"	200
CB38700Z	3/8 X 7"	200
CB38800Z	3/8 X 8"	200
CB381000Z	3/8 X 10"	160
CB381200Z	3/8 X 12"	150
1/2"		
CB12112Z	1/2 X 1-1/2"	500
CB12134Z	1/2 X 1-3/4"	425
CB12200Z	1/2 X 2"	400
CB12212Z	1/2 X 2-1/2"	300
CB12300Z	1/2 X 3"	250
CB12312Z	1/2 X 3-1/2"	200
CB12400Z	1/2 X 4"	175
CB12412Z	1/2 X 4-1/2"	150
CB12500Z	1/2 X 5"	125
CB12512Z	1/2 X 5-1/2"	125
CB12600Z	1/2 X 6"	125
CB12612Z	1/2 X 6-1/2"	100
CB12700Z	1/2 X 7"	100
CB12712Z	1/2 X 7-1/2"	100
CB12800Z	1/2 X 8"	100
CB12900Z	1/2 X 9"	90
CB121000Z	1/2 X 10"	90
CB121100Z	1/2 X 11"	80
CB121200Z	1/2 X 12"	75

*Box QUANTITIES MAY VARY

YELLOW ZINC PLATED

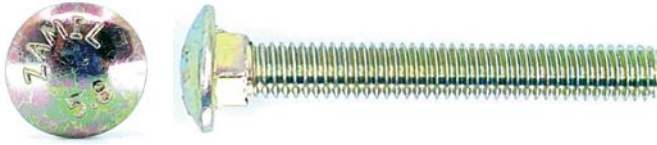

Sold in Full Boxes Only

TREATED LUMBER COATED



Sold in Full Boxes Only

TLC- TREATED LUMBER COATING- A 1000+ HOUR COATING APPROVED FOR OUTDOOR USE WITH ACQ TREATED LUMBER

PART #	SIZE	BOX QTY
1/4"		
CB14114YZ	1/4 X 1-1/4"	2500
CB14112YZ	1/4 X 1-1/2"	1800
CB14200YZ	1/4 X 2"	1400
CB14214YZ	1/4 X 2-1/4"	1200
CB14212YZ	1/4 X 2-1/2"	1000
CB14234YZ	1/4 X 2-3/4"	1000
CB14300YZ	1/4 X 3"	900
CB14314YZ	1/4 X 3-1/4"	900
CB14312YZ	1/4 X 3-1/2"	800
CB14400YZ	1/4 X 4"	700
CB14412YZ	1/4 X 4-1/2"	650
CB14500YZ	1/4 X 5"	600
CB14512YZ	1/4 X 5-1/2"	550
CB14600YZ	1/4 X 6"	500
5/16"		
CB516200YZ	5/16 X 2"	850
CB516214YZ	5/16 X 2-1/4"	800
CB516212YZ	5/16 X 2-1/2"	650
CB516300YZ	5/16 X 3"	600
CB516314YZ	5/16 X 3-1/4"	550
CB516312YZ	5/16 X 3-1/2"	500
CB516400YZ	5/16 X 4"	400
CB516412YZ	5/16 X 4-1/2"	375
CB516500YZ	5/16 X 5"	350
CB516512YZ	5/16 X 5-1/2"	325
CB516600YZ	5/16 X 6"	300
3/8"		
CB38200YZ	3/8 X 2"	700
CB38212YZ	3/8 X 2-1/2"	500
CB38300YZ	3/8 X 3"	400
CB38312YZ	3/8 X 3-1/2"	325
CB38400YZ	3/8 X 4"	300
CB38412YZ	3/8 X 4-1/2"	275
CB38500YZ	3/8 X 5"	250

*Box QUANTITIES MAY VARY

PART #	SIZE	BOX QTY
1/4"		
CB14114TLC	1/4 X 1-1/4"	2500
CB14112TLC	1/4 X 1-1/2"	1800
CB14200TLC	1/4 X 2"	1400
CB14214TLC	1/4 X 2-1/4"	1200
CB14212TLC	1/4 X 2-1/2"	1000
CB14234TLC	1/4 X 2-3/4"	1000
CB14300TLC	1/4 X 3"	900
CB14314TLC	1/4 X 3-1/4"	900
CB14312TLC	1/4 X 3-1/2"	800
CB14400TLC	1/4 X 4"	700
CB14412TLC	1/4 X 4-1/2"	650
CB14500TLC	1/4 X 5"	600
CB14512TLC	1/4 X 5-1/2"	550
CB14600TLC	1/4 X 6"	500
5/16"		
CB516200TLC	5/16 X 2"	850
CB516214TLC	5/16 X 2-1/4"	800
CB516212TLC	5/16 X 2-1/2"	650
CB516300TLC	5/16 X 3"	600
CB516314TLC	5/16 X 3-1/4"	550
CB516312TLC	5/16 X 3-1/2"	550
CB516400TLC	5/16 X 4"	425
CB516412TLC	5/16 X 4-1/2"	375
CB516500TLC	5/16 X 5"	350
CB516512TLC	5/16 X 5-1/2"	325
3/8"		
CB38200TLC	3/8 X 2"	700
CB38212TLC	3/8 X 2-1/2"	500
CB38300TLC	3/8 X 3"	400
CB38312TLC	3/8 X 3-1/2"	325
CB38400TLC	3/8 X 4"	300
CB38412TLC	3/8 X 4-1/2"	275

*Box QUANTITIES MAY VARY

TYPE 304 STAINLESS STEEL CARRIAGE BOLTS

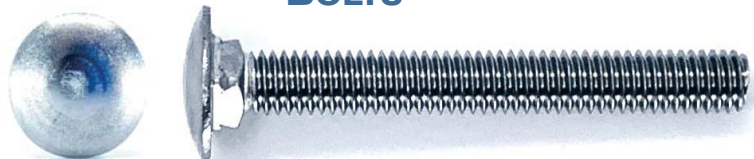

Sold in Full Boxes Only

PART #	SIZE	BOX QTY
1/4" SS CARRIAGE BOLTS		
CB14112SS	1/4 X 1-1/2"	500
CB14134SS	1/4 X 1-3/4"	500
CB14200SS	1/4 X 2"	500
CB14214SS	1/4 X 2-1/4"	500
CB14212SS	1/4 X 2-1/2"	500
CB14234SS	1/4 X 2-3/4"	500
CB14300SS	1/4 X 3"	500
CB14314SS	1/4 X 3-1/4"	500
CB14312SS	1/4 X 3-1/2"	500
CB14400SS	1/4 X 4"	200
CB14600SS	1/4 X 6"	200
5/16" SS CARRIAGE BOLTS		
CB516112SS	5/16 X 1-1/2"	500
CB516134SS	5/16 X 1-3/4"	500
CB516200SS	5/16 X 2"	500
CB516214SS	5/16 X 2-1/4"	500
CB516212SS	5/16 X 2-1/2"	500
CB516234SS	5/16 X 2-3/4"	500
CB516300SS	5/16 X 3"	300
CB516312SS	5/15 X 3-1/2"	300
CB516400SS	5/16 X 4"	300
CB516412SS	5/16 X 4-1/2"	200
CB516500SS	5/16 X 5"	200
CB516600SS	5/16 X 6"	200
3/8" SS CARRIAGE BOLTS		
CB38212SS	3/8 X 2-1/2"	100
CB38300SS	3/8 X 3"	100
CB38312SS	3/8 X 3-1/2"	100
CB38400SS	3/8 X 4"	100
CB38500SS	3/8 X 5"	100
CB38600SS	3/8 X 6"	100

*Box QUANTITIES MAY VARY

TYPE 316 STAINLESS STEEL CARRIAGE BOLTS "MARINE QUALITY"

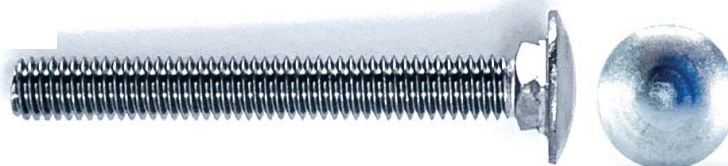

Sold in Full Boxes Only

PART #	SIZE	BOX QTY
1/4" TYPE 316 SS CARRIAGE BOLTS		
CB14200SS-316	1/4-20 X 2"	500
CB14214SS-316	1/4-20 X 2-1/4"	500
CB14212SS-316	1/4-20 X 2-1/2"	500
CB14234SS-316	1/4-20 X 2-3/4"	500
CB14300SS-316	1/4-20 X 3"	500
CB14314SS-316	1/4-20 X 3-1/4"	500
CB14312SS-316	1/4-20 X 3-1/2"	500
CB14400SS-316	1/4-20 X 4"	200
5/16" TYPE 316 SS CARRIAGE BOLTS		
CB516112SS-316	5/16-18 X 1-1/2"	500
CB516200SS-316	5/16-18 X 2"	500
CB516214SS-316	5/16-18 X 2-1/4"	500
CB516212SS-316	5/16-18 X 2-1/2"	500
CB516234SS-316	5/16-18 X 2-3/4"	500
CB516300SS-316	5/16-18 X 3"	300
CB516314SS-316	5/16-18 X 3-1/4"	300
CB516312SS-316	5/16-18 X 3-1/2"	300
CB516400SS-316	5/16-18 X 4"	300

*Box QUANTITIES MAY VARY

ROUND HEAD MACHINE BOLT



*Used Mainly as Glider Bolts

PART #	SIZE	BOX QTY
ZINC PLATED		
RHMS38312Z	3/8 X 3-1/2"	400
RHMS38400Z	3/8 X 4"	300
STAINLESS STEEL		
RHMS38312SS	3/8 X 3-1/2"	400

GRADE 5 CARRIAGE BOLTS-FULL BODY



Used Mainly as Carriage Wheel Bolts
Zinc Plated or Plain

PART #	SIZE	BOX QTY
ZINC		
C5B516214FBZ	5/16 X 2-1/4"	800
C5B516212FBZ	5/16 X 2-1/2"	650
PLAIN		
C5B516214FBP	5/16 X 2-1/4"	800
C5B516212FBP	5/16 X 2-1/2"	650



THREADED ROD

ADD 30% FOR FINE THREAD

PART #	SIZE	BOX QTY
ZINC PLATED		
TR14072Z	1/4-20 X 6'	80
TR516072Z	5/16- 18 X 6'	50
TR38072Z	3/8-16 X 6'	35
TR716072Z	7/16-14 X 6'	25
TR12072Z	1/2-13 X 6'	20
TR58072Z	5/8-11 X 6'	12
TR34072Z	3/4-10 X 6'	8
TR78072Z	7/8-9 X 6'	6
TR1072Z	1-8 X 6'	5
TR114072Z	1-1/4-7 X 6'	3
TYPE 304 STAINLESS STEEL		
TR14072SS	1/4-20 X 6'	25
TR516072SS	5/16- 18 X 6'	20
TR38072SS	3/8-16 X 6'	20
TR716072SS	7/16-14 X 6'	15
TR12072SS	1/2-13 X 6'	10
TR58072SS	5/8-11 X 6'	8
TR34072SS	3/4-10 X 6'	6
TR78072SS	7/8-9 X 6'	5
TR1072SS	1-8 X 6'	3

LOCK WASHERS



SOLD BY THE THOUSAND.

PART #	SIZE	BOX QTY
STAINLESS STEEL		
LW14SS	1/4"	1M
LW516SS	5-16"	1M
LW38SS	3-8"	1M
LW716SS	7/16"	1M
LW12SS	1/2"	1M
ZINC PLATED		
LW06Z	#6	1M
LW08Z	#8	1M
LW10Z	#10	1M
LW14Z	1/4"	1M
LW516Z	5/16"	1M
LW38Z	3/8"	1M
LW716Z	7/16"	1M
LW12Z	1/2"	1M

*UPS SHIPPING NOT RECOMMENDED, EXTRA CHARGES APPLY



USS FLAT WASHERS

Our Most
Common Washer

SOLD BY THE THOUSAND.

PART #	SIZE
ZINC	
FWUSS14Z	1/4"
FWUSS516Z	5/16"
FWUSS38Z	3/8"
FWUSS716Z	7/16"
FWUSS12Z	1/2"
FWUSS58Z	5/8"
FWUSS34Z	3/4"
FWUSS100Z	1"
YELLOW ZINC	
FWUSS14YZ	1/4"
FWUSS516YZ	5/16"
FWUSS38YZ	3/8"

FENDER FLAT WASHERS

Zinc



SOLD BY THE THOUSAND.

PART #	SIZE
FFW316100Z	3/16 X 1"
FFW316114Z	3/16 X 1-1/4"
FFW316112Z	3/16 X 1-1/2"
FFW14100Z	1/4 X 1"
FFW14114Z	1/4 X 1-1/4"
FFW14112Z	1/4 X 1-1/2"
FFW516100Z	5/16 X 1"
FFW516114Z	5/16 X 1-1/4"
FFW516112Z	5/16 X 1-1/2"
FFW516200Z	5/16 X 2"
FFW38100Z	3/8 X 1"
FFW38114Z	3/8 X 1-1/4"
FFW38112Z	3/8 X 1-1/2"
FFW38200Z	3/8 X 2"
FFW12112Z	1/2 X 1-1/2"
FFW12200Z	1/2 X 2"



FLAT WASHERS

Stainless Steel

SOLD BY THE THOUSAND.

PART #	SIZE
STAINLESS STEEL	
FW14SS	1/4"
FW516SS	5/16"
FW38SS	3/8"
FW716SS	7/16"
FW12SS	1/2"
TYPE 316 STAINLESS STEEL	
FW14SS-316	1/4"
FW516SS-316	5/16"

SAE FLAT WASHERS

Smaller ID & OD
than USS



SOLD BY THE THOUSAND.

PART #	SIZE
ZINC PLATED	
FWSAE06Z	#6
FWSAE08Z	#8
FWSAE10Z	#10
FWSAE14Z	1/4"
FWSAE516Z	5/16"
FWSAE38Z	3/8"
FWSAE716Z	7/16"
FWSAE12Z	1/2"
FWSAE58Z	5/8"
FWSAE34Z	3/4"
FWSAE100Z	1"
STAINLESS STEEL	
FWSAE14SS	1/4"
FWSAE516SS	5/16"
FWSAE38SS	3/8"
TYPE 316 STAINLESS STEEL	
FWSAE14SS-316	1/4"
FWSAE516SS-316	5/16"



HOT DIPPED GALVANIZED FLAT WASHERS

SOLD BY THE THOUSAND.

PART #	SIZE
FWUSS14HDG	1/4"
FWUSS516HDG	5/16"
FWUSS38HDG	3/8"
FWUSS12HDG	1/2"

FLANGE NUT



SOLD BY THE THOUSAND.

PART #	SIZE
ZINC	
FN1420Z	1/4-20
FN51618Z	5/16-18
FN3816Z	3/8-16
FN71614Z	7/16-14
FN1213Z	1/2-13
FN5811Z	5/8-11
FN3410Z	3/4-10
YELLOW ZINC	
FN1420YZ	1/4-20
FN51618YZ	5/16-18
FN3816YZ	3/8-16
STAINLESS STEEL	
FN1420SS	1/4-20
FN51618SS	5/16-18
FN3816SS	3/8-16
FN1213SS	1/2-13
TYPE 316 STAINLESS STEEL	
FN1420SS-316	1/4-20
FN51618SS-316	5/16-18



LARGE FLANGE NUT

SOLD BY THE THOUSAND.

PART #	SIZE
ZINC	
FNL1420Z	1/4-20
FNL51618Z	5/16-18
YELLOW ZINC	
FNL1420YZ	1/4-20

ACORN NUTS



NEW LOW PRICE FOR STAINLESS!!!

**FULL-BOXES ONLY*

PART #	SIZE	BOX QTY
NICKEL		
AN1420N	1/4-20	600
AN51618N	5/16-18	600
AN3816N	3/8-16	600
STAINLESS STEEL		
AN1420SS	1/4-20	100
AN51618SS	5/16-18	100
AN3816SS	3/8-16	100
316		
AN1420SS-316	1/4-20	100



TEE NUTS

Zinc
3 or 4 Prongs

SOLD BY THE THOUSAND.

PART #	DESCRIPTION	BARREL
1/4"		
TNUT14203PR516	1/4-20 3 PRONG	5/16
TNUT14204PR716	1/4-20 4 PRONG	7/16
5/16"		
TNUT516183PR38	5/16-18 3 PRONG	3/8
TNUT516183PR58	5/16-18 3 PRONG	5/8
TNUT516184PR38	5/16-18 4 PRONG	3/8
TNUT516184PR58	5/16-18 4 PRONG	5/8
3/8"		
TNUT38163PR716	3/8-16 3 PRONG	7/16
TNUT38163PR58	3/8-16 3 PRONG	5/8
TNUT38164PR716	3/8-16 4 PRONG	7/16
TNUT38164PR58	3/8-16 4 PRONG	5/8



Lock NUTS

Nylon Insert

SOLD BY THE THOUSAND.

PART #	SIZE
ZINC	
LNN1420Z	1/4-20
LNN51618Z	5/16-18
LNN3816Z	3/8-16
LNN71614Z	7/16-14
LNN1213Z	1/2-13
LNN5811Z	5/8-11
LNN3410Z	3/4-10
YELLOW ZINC	
LNN1420YZ	1/4-20
LNN51618YZ	5/16-18
LNN3816YZ	3/8-16
TYPE 304 STAINLESS STEEL	
LNN1420SS-WAX	1/4-20
LNN51618SS-WAX	5/16-18
LNN3816SS	3/8-16
LNN1213SS	1/2-13
TYPE 316 STAINLESS STEEL	
LNN1420SS-316	1/4-20
LNN51618SS-316	5/16-18
TREATED LUMBER COATING (T.L.C.)	
LNN1420TLC	1/4-20
LNN51618TLC	5/16-18
LNN3816TLC	3/8-16



HEX NUTS

SOLD BY THE THOUSAND.

PART #	SIZE
ZINC	
HN0440Z	4-40
HN0632Z	6-32
HN0832Z	8-32
HN1024Z	10-24
HN1032Z	10-32
HN1420Z	1/4-20
HN51618Z	5/16-18
HN3816Z	3/8-16
HN71614Z	7/16-14
HN1213Z	1/2-13
HN5811Z	5/8-11
HN3410Z	3/4-10
YELLOW ZINC	
HN1420YZ	1/4-20
HN51618YZ	5/16-18
HN3816YZ	3/8-16
TYPE 304 STAINLESS STEEL	
HN1420SS	1/4-20
HN51618SS	5/16-18
HN3816SS	3/8-16
HN1213SS	1/2-13
TYPE 316 STAINLESS STEEL	
HN1420SS-316	1/4-20
HN51618SS-316	5/16-18
TREATED LUMBER COATING (T.L.C.)	
HN1420TLC	1/4-20
HN51618TLC	5/16-18



BOLT THREAD COVERS

Used to Protect Threads on Lawn Furniture Bolts.

SOLD BY THE THOUSAND.

PART #	SIZE	COLOR
BC14	1/4"	BLACK
BC516	5/16"	BLACK
BC38	3/8"	BLACK

**TLC- TREATED LUMBER COATING-
A 1000+ HOUR COATING APPROVED
FOR OUTDOOR USE WITH ACQ
TREATED LUMBER**

KNOTBUSTER™ SQUARE DRIVER BITS



The Best Bits Made.
Lasting 3-4 times longer than other driver bits.

PART #	SIZE	PACK QTY
KBIT1X1	#1 X 1" INSERT	5
KBIT1X2	#1 X 2" POWER	5
KBIT1X3	#1 X 3" POWER	5
KBIT1X4	#1 X 4" POWER	5
KBIT1X6	#1 X 6" POWER	5
KBIT2X1	#2 X 1" INSERT	5
KBIT2X2	#2 X 2" POWER	5
KBIT2X3	#2 X 3" POWER	5
KBIT2X4	#2 X 4" POWER	5
KBIT2X6	#2 X 6" POWER	5

STANDARD DUTY DRIVER BITS



PART #	SIZE	PACK QTY
SBITS1X2	#1 X 2" POWER	5
SBITS1X3	#1 X 3" POWER	5
SBITS1X4	#1 X 4" POWER	5
SBITS2X2	#2 X 2" POWER	5
SBITS2X3	#2 X 3" POWER	5
SBITS2X4	#2 X 4" POWER	5

STAR BIT



PART #	DESCRIPTION	PACK QTY
12205B	T-20 1-15/16"	5
STARBIT-25X2	T-25 2"	5
T-30TORX	T-30	5

"YANKEE" STYLE DRIVER BITS



PART #	SIZE	PACK QTY
YBIT2X3SMPH	SMALL PHILLIPS	5
YBIT2X3LGPH	LARGE PHILLIPS	5
YBIT2X3LGSQ	LARGE SQUARE	5

PHILLIPS DRIVER BITS



PART #	SIZE	PACK QTY
PHBITS1X1	#1 X 1" INSERT	5
PHBITS1X2	#1 X 2"	5
PHBITS1X3	#1 X 3"	5
PHBITS1X4	#1 X 4"	5
PHBITS1X6	#1 X 6"	5
PHBITS2X1	#2 X 1"	5
PHBITS2X2	#2 X 2"	5
PHBITS2X3	#2 X 3"	5
PHBITS2X4	#2 X 4"	5
PHBITS2X6	#2 X 6"	5
PHBITS3X2	#3 X 2"	5

IMPACTECH™ SPIRALS ABSORB IMPACT BITS

Tips are CNC Machined
Made for Impact Tools
**other sizes available upon request*



#2 PHILLIPS DRIVE IMPACT BITS		
PART #	LENGTH	PACK QTY
P125P2A	1" INSERT	50
P150P2A	2"	25
P170P2A	2-3/4"	25
P190P2A	3-1/2"	25
P1150P2A	6"	10
#2 SQUARE DRIVE IMPACT BITS		
PART #	LENGTH	PACK QTY
P125R2A	1" INSERT	50
P150R2A	2"	25
P170R2A	2-3/4"	25
P190R2A	3-1/2"	25
P1150R2A	6"	10

HEX MAGNETIC NUT DRIVERS

SOLD INDIVIDUALLY

PART #	SIZE
MSH14	1/4"
MSH516	5/16"
MSH38	3/8"
MSH716	7/16"
MSH916	9/16"



BIT HOLDER

SOLD INDIVIDUALLY

PART #	SIZE
BITHOLDER	1/4 X 3"





CTD DRILL SETS



1/16-3/8 by 64ths
(21 pc set)
190-AG #44130
-AND-
1/16-1/2 by 64ths
(29 pc set)
190-AG #44150
Made in USA

PART #	DESCRIPTION	PIECES PER SET
SP-21	1/16-3/8 BY 64THS	21
SP-29	1/16-1/2 BY 64THS	29

HIGH SPEED M-T STEEL DRILL BITS



Very Tough Bits
Made in USA



PART #	SIZE	PACK QTY
DB116	1/16"	12
DB564	5/64"	12
DB332	3/32"	12
DB764	7/64"	12
DB18	1/8"	12
DB964	9/64"	12
DB532	5/32"	12
DB1164	11/64"	12
DB316	3/16"	12
DB1364	13/64"	12
DB732	7/32"	12
DB1564	15/64"	12
DB14	1/4"	12
DB1764	17/64"	12
DB932	9/32"	12
DB1964	19/64"	6
DB516	5/16"	6
DB2164	21/64"	6
DB1132	11/32"	6
DB2364	23/64"	6
DB38	3/8"	6
DB12	1/2"	6

QUICK RELEASE 1/4" HEX SHANK



- 135° SPLIT POINT- MAGNUM SUPER PREMIUM
- 1/4" HEX SHANK
- SPECIAL HI-MOLYBDENUM TOOL STEEL
- DRILL IS MECHANICAL LENGTH WITH A QUICK RELEASE
- BODY & CLEARANCE TREATED FOR MAXIMUM LUBRICITY
- ESPECIALLY DESIGNED FOR HAND HELD DRILLS
- 135° SPLIT POINT FOR FAST PENETRATION AND ACCURATE STARTING WITHOUT CENTER PUNCH.



RECOMMENDED USE IN WORK HARDENING GRADES OF STAINLESS STEEL
& OTHER HARD METAL DRILL APPLICATIONS.
MADE IN USA

PART #	DIAMETER	LENGTH
34501	1/16"	2-5/8"
34521	3/32"	3-1/4"
34541	1/8"	3-1/2"
34561	5/32"	3*1/2"
34581	3/16"	3-3/4"
34611	7/32"	4"
34631	1/4"	4-1/4"
34651	9/32"	3-13/16"
34671	5/16"	4"
34691	11/32"	4-7/32"
34711	3/8"	4-1/4"
34731	13/32"	4-1/2"
34751	7/16"	4-1/2"
34771	15/32"	4-7/8"
34791	1/2"	5"

HIGH SPEED STEEL-TAPER POINT DRILLS



PART #	SIZE	DRILL DIAMETER	PACK QTY
20100109	#4 SCREW	7/64"	5
20100125	#5 SCREW	1/8"	5
20100140	#6 SCREW	9/64"	5
20100156	#7 SCREW	5/32"	5
20100171	#8 SCREW	11/64"	5
20100203	#10 SCREW	13/64"	5
20100218	#12 SCREW	7/32"	5
20100234	#14 SCREW	15/64"	5

STANDARD WOOD SCREW SIZES AND PREDRILLING RECOMMENDATIONS

SCREW SIZE (GAUGE)		#4	#5	#6	#7	#8	#9	#10	#12	#14	
HEAD BORE SIZE	HEAD SIZE	15/64	1/4	9/32	5/16	11/32	23/64	25/64	7/16	1/2	
	COUNTERSINK SIZE	1/4	5/16	5/16	5/16	3/8	3/8	7/16	7/16	1/2	
SCREW SHANK - HOLE SIZE		7/64	1/8	9/64	5/32	11/64	3/16	13/64	7/32	1/4	
STRAIGHT PILOT DRILL SIZE	HARDWOOD	5/64	3/32	7/64	7/64	1/8	9/64	9/64	5/32	11/64	
	SOFTWOOD	1/16	5/64	3/32	3/32	7/64	1/8	1/8	9/64	5/32	
RECOMMENDED COUNTERSINK		C4	C5	C6	C7	C8	C9	C102	C12	C14	
PHILLIPS HEAD PIONT SIZE		#1	#2						#3		
SQUARE DRIVE BIT SIZE		#0	#1			#2			#3		

BITS, SEALANT & STAIN

PLUG CUTTERS



Good for Soft or Hard Woods
1/4" Shank Size
Made in USA

PART #	SIZE	PLUG SIZE
11640375	#5, 6, 7, 8 SCREWS	3/8"
11640500	#10, 12, 14 SCREWS	1/2"

PILOT HOLE ROUTER BITS



Made in USA

PART #	SIZE/TYPE	PK QTY
WK62000	1/4" HIGH SPEED	5
WKW70000	1/4" CARBIDE	5
WKW62012	3/8" HIGH SPEED	5
WK70004	3/8" CARBIDE	5
WKW70008	1/2" CARBIDE	5

TYPE "C" FOUR FLUTE COUNTERSINK

Good for Soft & Hardwoods
Made in USA

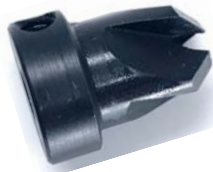

PART #	SIZE	CUTTING DIAMETER	BIT SIZES	PACK QTY
C-4	#4 SCREW	5/16"	7/64"	5
C-5	#5 SCREW	3/8"	1/8"	5
C-6	#6 SCREW	3/8"	9/64"	5
C-7	#7 SCREW	3/8"	5/32"	5
C-8	#8 SCREW	3/8"	11/64"	5
C-10	#10 SCREW	7/16"	13/64"	5
C-12	#12 SCREW	1/2"	7/32"	5
C-14	#14 SCREW	1/2"	1/4"	5

EASY CUT POWER PADDLE BITS

Made in USA



PART #	SIZE
EC14	1/4"
EC516	5/16"
EC38	3/8"
EC716	7/16"
EC12	1/2"
EC916	9/16"
EC58	5/8"
EC34	3/4"
EC78	7/8"
EC100	1"
EC118	1-1/8"
EC114	1-1/4"
EC112	1-1/2"



SILICONE WOOD STAIN & SEALER

Semi Transparent
Resists UV & Water Damage
Enhance Wood's Natural Beauty

AVAILABLE IN:

1 CASE (6x 1 GALLON CONTAINERS PER CASE)

5 GALLON CONTAINER

30 GALLON CONTAINER

*NOTE: ONE BOTTLE OF STAIN TREATS 1 GALLON. AVERAGE COVERAGE AREA = 325 SQ FT (DEPENDING ON SURFACE)

STAIN COLORS AVAILABLE FOR COLORING:



CEDAR NUTMEG CHARCOAL REDWOOD CRIMSON

WATERPROOFING

WOOD STAIN

SILICONE

Semi Transparent
Resists UV & Water Damage
Enhance Wood's Natural Beauty

Made in the USA



STRETCH FILM HAND ROLLS

PART #	SIZE	GAUGE/ COLOR	CASE QTY
SF370C	3" X 1000'	70 CLEAR	18 ROLLS
SF570C	5" X 1000'	80 CLEAR	12 ROLLS

STRETCH FILM ROLLS WITH HANDLES



PART #	CASE QTY	SIZE	GAUGE/ COLOR
SF2080C	4 ROLLS	20" X 1000'	80 CLEAR

STRETCH FILM ROLLS



PART #	SIZE	GA/ COLOR	CASE QTY
SF1880C	18" X 1500'	80 CLEAR	4 ROLLS
SF1890C	18 X 1500'	90 CLEAR	4 ROLLS



FOAM EAR PLUGS

Super Soft
Conforms to Inner Ear
Canal
Reusable

PART #	PACK QTY	CASE QTY
SAS6100	50 PAIRS	200 PAIRS



CLEAR PLASTIC TAPE

2.0 mil Tape
UPS Approved for 35lb or lighter
cartons.

PART #	CASE QTY	SIZE
TAPE3C	24 ROLLS	3" X 110 YARDS
TAPEGUN3"	1	N/A

HIGHLIGHT HAND WRAPPING TOOL

For 18" Stretch Film
Hand Tool
High Quality

PART #
HANDWRAP

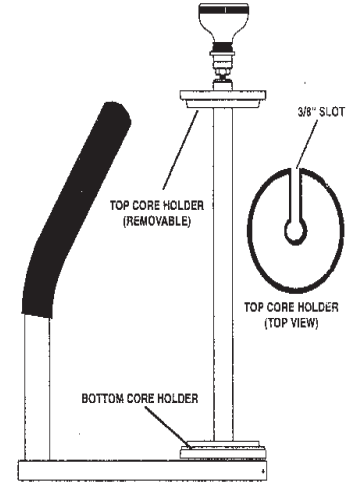

SMALL PARTS BOXES



Great for Packing Small Screws
or Other Hardware

PART #	SIZE	L X W X D	QTY
BOX12	#12	2-1/2 X 1-1/2 X 3-1/2"	100
BOX23	#23	3 X 2 X 4"	100
BOX35	#35	3-5/8 X 2-1/4 X 4-1/4"	100
BOX55	#55	3-5/8 X 2-3/4 X 5-1/2"	100
BOX97	#97	5 X 3 X 6-1/2"	100

BATTERIES

PART #	DESCRIPTION	PACK QTY
AA	AA BATTERY	4
AAA	AAA BATTERY	4



POLYSEAMSEAL CLEAR ACRYLIC CAULK

Paintable
 Silicon added for adhesion.
 Great for windows, doors and vents.
 Holds to brick, wood, vinyl and aluminum.
 Provides a weather resistant, flexible seal to protect against air, moisture, and dirt.

PART #	CASE QTY	SIZE
CAULKPOLY	12	10oz

HM-270 100% CONSTRUCTION SILICONE CAULK



Excellent for Non-porous material
 Waterproof & Weatherproof
 Easy Extrusion in any weather
 Permanently Flexible

PART #	CASE QTY	SIZE
CAULK-HM270	12	10oz

PRO SERIES PL-200 CONSTRUCTION ADHESIVE



Waterproof
 Fast Tack-Sets Quickly
 An all purpose adhesive for bonding all types of paneling and plywood to most any surface.

PART #	CASE QTY	SIZE
CAULKCA10	12	10.2oz
CAULKCA28	12	28oz

PRO SERIES CLEAR H2U ACRYLIC URETHANE



A high performance sealant for windows, doors and siding.
 High adhesion and flexibility
 Holds to most materials.
 Paintable

PART #	CASE QTY	SIZE
CAULPS	12	10.2oz

QUAD POLYMER SEALANT



Provides the highest level of adhesion and flexibility.
 Clearest Caulk Available
 Paintable

PART #	CASE QTY	SIZE
CAULKQUAD	12	10.2oz

APPROVED CAULK FOR SKYLIGHTS



Bronze Color to match Skylight
 Approved Caulk for Skylights, Windows and Siding

PART #	CASE QTY	SIZE
SBR100	24	10oz

All cupolas will fit a roof pitch of 8/12 or less, base extensions available for steeper pitch.

Cupolas include packaging for shipping.

Aluminum roof colors: Black, Brown, Coppertone.

PVC Base

Non-Stock Item: Average Lead Times Run 2-3 Weeks

***UPS Shipping Not Available, Freight Truck Skids Only**

***ALL OVER SIZED ITEMS WILL BE PLACED ON A SEPARATE PALLET AND BILLED SEPARATELY. FULL FREIGHT IS APPLIED TO THESE ITEMS.**



**SHED CUPOLA
WINDOWS
PAGODA ROOF**

PART #	DESCRIPTION
WPR16X23	16" BASE X 23" HIGH
WPR21X29	21" BASE X 29" HIGH
WPR25X37	25" BASE X 37" HIGH
WPR30X46	30" BASE X 46" HIGH



**SHED CUPOLA
LOUVERS
PAGODA ROOF**

PART #	DESCRIPTION
LPR16X21	16" BASE X 21" HIGH
LPR21X27	21" BASE X 27" HIGH
LPR25X34	25" BASE X 34" HIGH
LPR30X42	30" BASE X 42" HIGH



**SHED CUPOLA
WINDOWS
HIP ROOF**

PART #	DESCRIPTION
WHR16X20	16" BASE X 20" HIGH
WHR21X25	21" BASE X 25" HIGH
WHR25X33	25" BASE X 33" HIGH
WHR30X40	30" BASE X 40" HIGH



**SHED CUPOLA
LOUVERS
HIP ROOF**

PART #	DESCRIPTION
LHR16X18	16" BASE X 18" HIGH
LHR21X23	21" BASE X 23" HIGH
LHR25X30	25" BASE X 30" HIGH
LHR30X36	30" BASE X 36" HIGH

WEATHERVANES



PART #	SIZE / COLOR	BOX QTY
WVBHORSE24	24" HORSE, BLACK	1
WVBROOSTER	24" ROOSTER, BLACK	1
WVCROOSTER	30" ROOSTER, COPPER	1



DEFINED BY QUALITY.

DEDICATED TO BUILDING BETTER BARNES FOR 35 YEARS.

PANELS

- * 7/16 OSB
- * 7/16 **Thermostat** Radiant Barrier Sheathing



**ENGINEERED
WOODS**

FLOORING

- * 5/8" & 3/4" **Shed Floor** Treated Plywood
- * 5/8" & 3/4" **PerformMAX** Flooring with MDO Face
- 25 Year Warranty for Sheds
- * 5/8" & 3/4" **Roseburg** TG2E SFTS UL
- * 5/8" & 3/4" **CMPC** T&G UL



SIDING

- * 19/32" T-1-11 Treated
- * 15/32" Premium Fir T-1-11
- * 15/32" & 19/32" **DuraTemp** Siding
- All Lengths (6', 7', 8', 9', 10')
- Primed & Unprimed Options
- 50 Year Warranty for Sheds

Roseburg

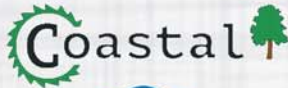

TREATED SOUTHERN YELLOW PINE

- * 2x4
- * 2x6
- * 4x4
- * 4x6 Notched Runners
- * 6x6 and beyond- up to 32' length
- * 5/4 x 6 Decking
- * 1x4 Trim
- * ALL SYP is available in a #1, #2, or #3 grade
- * Complementary precision cut to specified length



EUROPEAN SPRUCE

- * 2x4
- * 2x6
- * No Wane, No Stain
- * ALL SPF is available in a Premium, #2/Btr, or Stud
- * Complementary precision cut to specified length



BARN TRIM

- * 1x3" - 1x12"
- * All 16' Length and Primed



DIMENSIONAL DOUG FIR

- * 2x4
- * 2x6
- * Full length + PET length
- * Treated and Brite
- * Home and Frame Grades

UNIQUE SPECIALTY PRODUCTS

- * 2x6 Smooth Face Log Cabin Siding
- * 2x8 Hand Hewn Log Cabin Siding
- * 1x4, 1x6 & 1x8 T&G V-Match
- * 6x6 and beyond Doug Fir Timbers
- * Western Red Cedar Products
- * Aluminum Garage Door Seals



Call us for your quote today!
Mo Lunsford
Sammy Lail
Erica Goodnight
Kimbrie Church



Toll Free: 877.501.9663
www.UnionGroveLumber.com

SERVING THE SHED INDUSTRY FOR OVER 30 YEARS

CANADIAN & EUROPEAN SPRUCE

#3, Stud, #2 & Btr., Select,
Premium and European

- 1x3 6-16'
- 1x4 6-16'
- 2x3 4-16'
- 2x4 4-20'
- 2x6 6-16'
- 2x8 8-16'



**Handling all Canadian & European Sawmills*

SOUTHERN YELLOW PINE

#2 & #3 grade

- 2x4
- 2x6
- 4x4
- 4x6
- 6x6
- 5/4 x 6
- special cut-to-size

TREATED PANEL PRODUCTS

- 5/8" V600 CCA .25 KDAT
- 3/4" V600 CCA .25 KDAT



PANEL PRODUCTS

- 7/16" OSB
- 7/16" Thermostat® Radiant Barrier Sheathing
- 1/2" 3-ply and 4-ply Sheathing
- 5/8" Plytanium® Plywood
- 5/8" & 3/4" DryPly® Plywood w/ water repellent coating
- 5/8" V600/BC
- 3/4" V600/BC
- 5/8" & 3/4" PerformMAX Square Edge
- 5/8" & 3/4" PerformMAX T&G



OTHER PRODUCTS

- Western Red Cedar #2 Perfections
- Western Red Cedar #1 & #2 Royals
- Fishing Creek Shingle Panels



BARNTRIM BY MIRATEC

- 1x3" - 1x12"
- 16' length



DURATEMP SIDING BY ROSEBURG

- 7', 8', 9', 10' lengths
- 1/2" or 5/8" thickness



EASTERN WHITE PINE

1x10 BarnTex, 1x4, 1x6 & 1x8

- WP4 E&CB
- S4S
- T&G
- Live Edge



JAMES HARDIE

- HardiePlank Lap Siding Select Cedarmill
- HardiePanel Vertical Siding Select Cedarmill
- HardiePanel Vertical Siding Sierra 8



Tom Merkert – Lumber Trader

410.280.6882 | tmerkert@capitalforest.com

Morgan Merkert – Assistant Trader

410.919.0189 | mmerkert@capitalforest.com

Nicole Pruitt – Inside Sales

410.280.6889 | npruitt@capitalforest.com

CAPITAL FOREST PRODUCTS

Proud Sponsor:



800.255.3405

www.CapitalForestSheds.com



2850 APPLETON ST.
CAMP HILL, PA 17011
1-800-704-8112