

PROJECT BOTANY

EXPLORING NATIVE PLANTS
OF THE
UNITED STATES

An Ecoregional
Curriculum
by the



Institute
for
Applied
Ecology

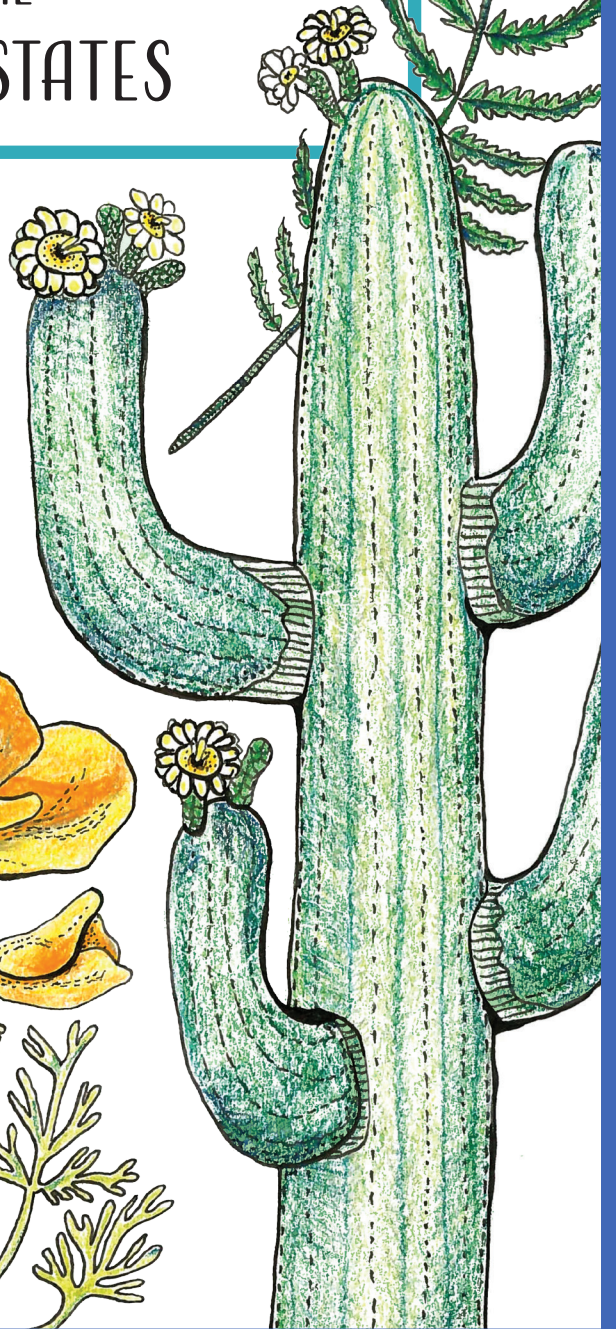

Project Botany: **Exploring the Native Plants of the United States**

An Ecoregional Curriculum

Contributors:

Jennie Cramer, Jody Einerson, Larkin Guenther, Carolyn Menke, Ian Silvernail, and Sarah Stevens

Illustrations:

Amanda Devine
Barbara Gleason
Ella Samuel
Jody Einerson
Larkin Guenther

Front Cover Illustration:

Ella Samuel

Back Cover Illustration:

Larkin Guenther

Content Editor:

Jill Bushakra

Graphic Design:

Adam Payson
Jessica Brothers

Institute for Applied Ecology
563 SW Jefferson Ave. Corvallis, OR
541-753-3099
projectbotany@appliedeco.org

Acknowledgements

We would like to thank the following people for their contribution in producing Project Botany:

Special thanks to the following for their vision and continued support in producing and expanding this curriculum:

Peggy Olwell—Bureau of Land Management, Plant Conservation Lead, BLM National Program
Joan Seevers—Bureau of Land Management, Plant Conservation Lead, Oregon/Washington
Nancy Sawtelle—Bureau of Land Management, Plant Ecologist, Eugene District, Oregon

Thank you to the USDA Bureau of Land Management for providing funding and support for the creation of this curriculum.

Special thanks to the Earth Partnership for Schools Program for acting as a model in developing place-based curriculum. University of Wisconsin-Madison Arboretum, 1207 Seminole Highway, Madison, WI 53711.
<https://arboretum.wisc.edu/>

Advisors

Teresa Matteson, Benton Soil and Water Conservation District

Heath Keirstead, Benton Soil and Water Conservation District

Maggie Livesay, OSU Extension Faculty; 4-H Youth Development

Jeff Mitchell, Philomath High School

Paul Bradley, Wilson Elementary School

Dan Bregar, Crescent Valley High School

Holly McRae, Willamette Resources and Education Network

Sujaya Rao, Oregon State University Faculty Rural Science Education

Kendra Mingo, Willamette University Botanist

Brad Withrow-Bobinson, OSU Extension Faculty Forestry

Dio Morales, Curriculum Design Consultant

Andy Moldenke, OSU Botany and Plant Pathology

Melissa Kirkland, USFS Botanist

Jenny Lippert, US Forestry Service Botanist

Holly LeMasurier, Middle Fork Willamette Watershed Council

Tim Whitley, Rachel Carson High School

Loren Gerig, Woodburn High School

Elly Veyera, Wy'east Middle School

Mary Ann Schmidt, Oregon Trout Healthy Waters Institute

Jennifer Martin, Owyhee Watershed Council

Jon Souder, Coos Watershed Association

Piloting Teachers

April Fong, Linda Wolf, Sean Kenna, Loren Gerig, Edith Moore, Kevin Celtura, Tim Whitley, Jonathan Pope, Michelle Barry, Lacy Meahm, Brian Wach, Jeff Mitchell

Content Reviewers and Content Experts

Tom Kaye, Institute of Applied Ecology Director,
OSU Botany and Plant Pathology

Carolyn Menke, IAE, Plant Conservation Biologist

Rob Fiegenger, IAE, Native Seed Network

Melanie Gisler, IAE, Restoration Ecologist

Matt Blakely-Smith, IAE, Restoration Biologist

Amanda Stanley, IAE, Ecology

Stacy Moore, IAE, Ecological Education Director

Berta Youtie, Eastern Oregon Stewardship Services

Tim Rodenkirk, BLM Coos Bay Botanist

Laura Potash Marin, Mt. Baker Snoqualmie National
Forest Botanist

Kristi Mergenthaler, Siskiyou Field Institute, Botanist

Gene Yates, Wallowa-Whitman National Forest
Botanist

Katie Grenier, Deschutes/Ochoco National Forest
Botanist

Marty Stein, Siuslaw National Forest Botanist

Susan Fritts, BLM Medford District Botanist

Douglas Kendig, BLM Medford District Botanist

Teresa Matteson, Benton Soil & Water Conservation
District

Kathy Pendergrass, Natural Resources Conservation
Service Plant Material Specialist

Marcia Wineteer, BLM Medford District Botanist

Robert Kentta, Cultural Resources Director,
Confederated Tribes of Siletz Indians

Wenix Red Elk, Public Outreach and Education
Coordinator, Confederated Tribes of the Umatilla
Indian Reservation

Misty Thorsgard, Cultural Resources, Confederated
Tribes of the Grand Ronde

Mary Van Brocklin, Falconproof

Reid Schuller, Botanist

We would also like to thank:

Project Budburst for partnering on the lesson, "Phenology: Tracking the Seasons in Your World."
The Commission for Environmental Cooperation, for the use of maps and resources relating to and defining the
ecoregions of North America.



About the Institute for Applied Ecology

Founded in 1999, the Institute for Applied Ecology (IAE) is a non-profit organization established to provide a service to public and private agencies and individuals by developing and communicating information on ecosystems and effective management strategies. IAE offers habitat restoration services complete with management plans, site preparation, maintenance, and monitoring. Our Native Seed Network connects buyers and sellers of native seed while our Conservation Research program conducts native ecosystem research and monitoring and provides surveys for rare plants. The Ecological Education Program provides learning opportunities for all ages through place-based education and service-learning projects. For additional copies of the curriculum contact:

Institute for Applied Ecology
563 SW Jefferson Ave.
Corvallis, OR 97330
www.appliedeco.org
projectbotany@appliedeco.org

Project Botany:

Exploring the Native Plants of the United States

Table of Contents

Introduction 1

Making it Place-Based	viii
1. For Teachers	ix
2. Writing a Curriculum for Your Region	xi

Introduction 2

1. What Is a Plant?	2
2. Explore the Ecoregions of the United States	12
3. Field Journaling: Observations From a Special Spot	23

Section 1: Plant Identification

4. What's in a Name?	27
5. Botanical Terms Challenge	33
6. The Secret Life of Flowers	43
7. Plants Have Families, Too	52
8. Botany Bouquet	58
9. Drupes, Pomes, and Loculicidal Capsules: A Botanist's Lingo for Describing Native Fruits	62
10. Make Your Own Plant Collection	67
11. Plant Adaptations: Create-A-Plant	73
12. Mechanics of a Key	83
13. Make a Field Guide for Your School	89

Section 2: The Ecoregions of the United States

14. The Place I Call Home	94
---------------------------------	----

Section 3: The Ecology of Native Plants

15. Ecosystem Comparisons	100
16. Leaf to Landscape: Ecological Scale	109
17. Survival Quest: A Pollination Game	113
18. What's Going Down Underground?	122
19. Plant Wars: A Tale of Offense and Defense	130

Section 4: The Good, the Bad, and the Ugly: Native and Non-native Plants

20. Nurture a Native Garden Project part A	137
Nurture a Native Garden Project part B	142
Nurture a Native Garden Project part C	149

21.	Weed Explosion	156
22	Measuring and Monitoring Plant Populations	164

Section 5: Ethnobotany

23.	Who Walked Here Before You	172
24.	Burden Basket: Plants as Fiber	180
25.	Plants As Medicine	189

Section 6: Climate Change and Phenology

26.	Phenology: Tracking the Seasons in Your World.	197
27.	Plant Migration Game: A Race Between Plants and Climate Change	204

Section 7: The Future of Native Plants

28.	Nobody Right, Nobody Wrong: A Role-Playing Game.	214
29.	Biodiversity and Ecosystem Services	226
30.	Saving Botanical Treasures: Threatened and Endangered Plants	233
31.	Design a Habitat Restoration Plan	244

References	255
-------------------------	-----

Glossary	258
-----------------------	-----

Appendices

Appendix I: Field Guide Recommendations for Your Ecoregion	269
Appendix II: Ethnobotany Resources	273
Appendix III: Ecoregions of the United States	274
Appendix VI: Make Your Own Quadrat Frame	281

Introduction

Getting Started

The Institute for Applied Ecology (IAE) is a non-profit organization with the mission to conserve native ecosystems through restoration, research and education. This high school curriculum was developed by working with students through our in-school programs to meet a need for science-based lessons focused on native plants.

The goal of the curriculum is to introduce students to the wondrous biodiversity of flora, and the connections between plants and their ecosystems. It is designed to serve as a general template for any ecoregion in the United States, with guidance provided to make the lessons place-based for your specific ecoregion. The lessons encourage students to study what is outside their door and in the surrounding region. Along with the knowledge gained through these lessons, students will gain the skills to be informed and active citizens in local natural area issues and decisions in their future.

Development of the lessons followed the principles of North America Association of Environmental Educators (NAAEE) Guidelines for Excellence incorporating fairness & accuracy, depth, emphasis on skills building, action orientation, instructional soundness, and usability. The overall curriculum goal is to lead students in the exploration and wonder of their local native plant life. It is not intended to teach general concepts such as photosynthesis, plant growth, evolution, or natural selection that high school students receive in biology class.

A twenty-five member advisory council made up of teachers, students, science curriculum developers, natural resource agency educators and field sciences have guided the development of this project.

Our guiding principles of lesson development:

- 1. Place-based:** The local community is the starting point for teaching concepts in science and culture; students learn about where they live.
- 2. Hands-on:** Students actively use all of their senses to explore nature, stewardship, and science.
- 3. Inquiry-based:** Students learn science by asking and answering questions as a guide to discovering the world around them.
- 4. Experiential:** Students don't just learn, they DO .
- 5. Service-learning:** Learning activities directly benefit community, motivating students by giving extrinsic value to their work.
- 6. Education Standards:** Aligned with Oregon Department of Education high school standards and incorporates service learning methods.
- 7. Fosters community partnerships:** Students forge relationships with peers and professionals by taking part in their community.
- 8. Interdisciplinary:** Curriculum components integrate across disciplines teaching about native plants through science, math, social studies, art, and literacy.
- 9. Developed within the framework of the NAAEE Guidelines for Excellence:** Fairness and accuracy, depth, emphasis on skills building, action orientation, instructional soundness, and usability.

Organization of Curriculum:

Lessons progress from basic plant identification into more advanced topics. The curriculum is designed to be a complete unit of study. We understand that many teachers are unable to commit to the entire unit of study, so lessons can also be used individually. All lessons start with a Teacher Page, check there for the Teacher Hints and Additional Information sections to find any essential skills or background needed from earlier lessons. Additional background information, study topics and curricula are included with each of the lessons for further study.

Student Pages are written for the students to be self-guided in their studies. What better ways for them to practice their literacy skills than to read, interpret, and follow written directions? As the teacher, you will need to be familiar with the background information and reflection activities found on the Student Pages. Of course, as the teacher, you maintain the control to use this student-directed learning feature as it works best in your classroom.

All lesson data or work sheets provided will follow the Student Pages. Occasionally lessons will ask students to create their own data collection sheet.

Lessons suggest ways to integrate student studies into service-learning and community projects.

Making the Most of This Curriculum:

1. Create a student field journal at the beginning of the study

Encourage students to use them throughout the course of study. Allow time for students to observe, explore, and document their discoveries in their field journals each time you take them outdoors. You will find the “In the Field” sections often reference journals. In addition, the journal can be used throughout the curriculum as an assessment tool and portfolio. Over time their journals will become handy references for them to check back to when they are in the field. See the activity “Field Journaling”; Observations from a Special Spot to get you started.

2. Purchase field guides specifically written for your ecoregion

Check Appendix I for our recommended list of guides for your ecoregion. Field guides are an essential part of becoming familiar with local plant identification. Several of the lessons reference students using these field guides. Ideally your classroom will have one available for each pair of students. Grants are often available to purchase field study equipment, including field guides.

3. Make it place-based

See the “Making it Place-Based” section for hints on how to tie these lessons in with your local area. Encourage students to make connections with the landscape that surrounds them. We believe that place-based education is important because it fosters an emotional attachment to the local landscape, it creates informed and engaged citizens, and it empowers students and communities.

4. Get involved in the community

Many of the lessons in this curriculum are well-suited for service-learning. Use the suggestions here or be creative to find your own way for your class to become involved in serving your community as they learn.



Making it Place-Based: Adapting the Project Botany Curriculum to Your Region

Overview

Nature is not something found in a faraway place. Wilderness is not limited to exotic locales featured on nature documentaries. Nature is all around us. This curriculum is intended to serve as a guide to the study of the native plants that define our local landscapes. By making some modifications to each lesson to reflect the local ecosystems and landscape, your students will gain a better understanding and appreciation of the place that they call home. Encourage your students to become active and knowledgeable stewards of the local landscape.

As you move through this curriculum, draw on your own knowledge of the place you call home. Place-based education author David Sobel suggests asking yourself the following questions²:

1. Where do I live?
2. What is the nature of this place?
3. What sustains my community?

As humans, the way we live is influenced profoundly by our ecosystems. It can be easy to take the familiar landscapes of our local communities for granted. The natural features of your region play a major part in determining the major land-uses that occur there, the basis of the local economy, the locations of cities and towns, the population size, and the local culture. The more we learn about the ecosystems that we are a part of, the more we are filled with wonder, curiosity, and a sense of place.

An understanding of our local landscape not only increases our quality of life, but is essential to being an informed, responsible citizen. By adapting this Project Botany curriculum to your region, you can encourage students to take a closer look at their surroundings and to build a deep appreciation for the local landscape. Familiarity with their region's natural character and literacy in local conservation issues will foster a sense of empowerment in the students who will act as tomorrow's land stewards.

Why Place-based Education?

There is great value in an education that is rooted in the local community. Centering education on the local community results in students who are grounded in their understanding of the world. Viewing the world through a local lens gives meaning and relevance to otherwise abstract concepts, and gives students a sense of their place in the world as global citizens. Locally engaged students who understand their surroundings gain efficacy as stewards of their communities, and through this empowerment, as global citizens.

In this Tutorial:

Section 1: Making it Place-Based: For Teachers

Contains general hints for the classroom teacher to incorporate place-based education into these lessons.

Section 2: Making it Place-Based: Writing a Curriculum for Your Region

Intended for organizations, informal educators, individuals, or agencies who plan to make modifications to produce an adaptation of this curriculum specifically for their region

Section 1: Making it Place-Based: For Teachers

Not only is place-based environmental education crucial to fostering an appreciation of the natural world, it also encourages interest and buy-in amongst students. These guidelines will help you to incorporate place-based education into your lessons to engage your students and foster a sense of empowerment.

- **Regional field guides:** Stock your classroom with field guides written specifically for your area. Contact local botanists and naturalists for recommendations, and see Appendix I for a list of suggested field guides. It can be helpful to have a number of different field guides for your region, as not all guides include the same plants or cover the same information. Various methods of organization used by different authors can also benefit different types of learners in your classroom. We suggest having one field guide per pair of students.
- **Get outside!** Getting your class outdoors can be as simple as stepping out onto the school yard. Remind students that nature is all around them, and encourage them to look closely to observe natural processes occurring in the grass of a soccer field, the trees lining the streets, or in alleyway weeds. Spending even a few minutes outside during the class period can help students see firsthand examples of what they are studying. If you can, arrange trips to nearby natural areas to increase the opportunity for observing. This increases the opportunity for observing native plants and the interactions between various biotic and abiotic factors in a functioning ecosystem. Use Table 1 at the end of this section to help locate nearby natural areas that will aid your native plant studies.
- **Contact a botanist or naturalist:** Books can only get you so far—it helps to have someone with firsthand knowledge of your area speak with your class and provide a clearer picture of the natural landscape around your area. Have an expert come into your classroom or accompany your class on a field trip. Use the list at the end of this section as a guide to help you find a local expert.
- **Study local history:** Understanding the history of the people who have lived in your area in the past will help you understand what the landscape has to offer. Challenge yourself and your students to understand how your current community has been and continues to be shaped by its natural surroundings.
- **Do a service-learning project:** Service-learning and citizen science are ideal ways to get students involved with the community as they learn. There are many benefits to emphasizing citizen science projects. Students who are able to contribute data directly to scientists become more engaged in the learning process. This direct involvement leads to a sense of empowerment which is important in the cultural climate of ecophobia. In the lesson “Phenology: Tracking the Seasons in Your World”, your students can work on a citizen science project through Project BudBurst, a national citizen science project affiliated with the National Ecological Observatory Network (NEON) and the Chicago Botanic Garden.
- **Hint:** Read “Section 2: Making it Place-Based: Writing a Curriculum for Your Region.” Though this section is intended for those who are writing and producing a new version of this Project Botany curriculum, there are many useful hints that will help you in your own modifications for your classroom.

Resources for finding local natural areas and botany experts:

- City Parks Departments
- County Parks Departments
- State Parks Departments/ Department of Natural Resources
- Bureau of Land Management lands: <http://www.blm.gov/wo/st/en.html>
- Wildlife Refuges: United States Fish and Wildlife Service: <http://www.fws.gov/refuges/>
- National Parks and Monuments: National Park Service: <http://www.nps.gov/findapark/index.htm>
- National Forests: United States Forest Service: <http://www.fs.fed.us/locatormap/>
- The Nature Conservancy Preserves: <http://my.nature.org/preserves/>
- Conservation land trusts
- Botanical Gardens
- Native Plant Societies – Most states have a NPS chapter



Section 2: Making it Place-Based: Writing a Curriculum for Your Region

This section is intended for organizations, informal educators, individuals, or agencies who plan to make modifications to produce an adaptation of this curriculum specifically for their region.

If you plan on producing a regional adaptation of this Project Botany curriculum, please contact the Institute for Applied Ecology. IAE will provide you with the most up-to-date version of this curriculum, along with resources to additional regional curricula.

Adapting the Project Botany Curriculum

Creating a native plant curriculum specific to your region begins first and foremost with becoming familiar with the native plant education needs for your region. This general guide will help you modify this Project Botany curriculum such that it provides a comprehensive, place-based educational tool for your region.

1. Determine the boundaries of your region.
 2. Assemble a group of advisors.
 3. Determine native plant educational needs for your region.
 4. Develop a mission.
 5. Understand the major ecosystems and habitat types within your region.
 6. Assemble a list of locally significant native plant species.
 7. Assemble a list of accessible natural areas within your region.
 8. Familiarize yourself with the education standards for your region.
 9. Consult the NAAEE Guidelines for Excellence
 10. Modify existing Project Botany lessons and/or add lessons that address your region's ecosystems, habitats, species, and conservation issues.
 11. Distribution
-



1. Determine the boundaries of your region

The first step in creating a regional native plant curriculum is to decide specifically what region you wish to address. The possibilities are endless and depend upon your goals for the project. You may wish to provide a highly specific curriculum for use within a specific mountain range, valley, or level III ecoregion. Alternatively, you may broaden the scope and address an entire state or group of states that form a cohesive region. When deciding on the boundaries of your region, consider the following:

- **Audience:** Who will be using your curriculum? A curriculum written for urban schools may be much different than one focused on rural areas. While your curriculum may be written for audiences of any background,

having an idea of who will be using your product will help determine your writing style, focus, suggested readings, and class activities.

- **Ecosystem homogeneity:** Larger regions inevitably include a wider variety of ecosystems, habitats, and conservation issues. Curricula written for larger regions therefore face the challenge of including enough detail and local information to truly inspire a sense of place and knowledge of one's local ecosystem. Strive to delineate a region that is defined by shared ecological characteristics.
- **Educational standards:** While many states use national educational standards for math and language arts, others continue to use their own set of core standards. Standards in science, social studies, and technology can also vary from state to state. For those considering multi-state regions, look into the educational standards for each state you hope to include before finalizing your region.

2. Assemble a group of advisors

The first step in creating a comprehensive native plant curriculum for your area is to find advisors with expertise in botany, natural sciences, ethnobotany, and education. A good way to contact teachers is through your state's chapter of the National Science Teachers Association. Some Canadian provinces and U.S. territories have chapters as well. We suggest reaching out to language arts teachers, as the Project Botany framework lends itself well to reading, writing, listening, and speaking standards. Most states and provinces have chapters of the National Council of Teachers of English, which provides a good platform for reaching out to language arts teachers in your area.

Connect with local American Indian tribes for guidance on information concerning regional history, land use history, and ethnobotany. Most tribes have a website that will help you connect with the right person.

Refer to the list below for suggestions on where to find experts from various natural science fields.

- City Parks Departments
- County Parks Departments
- State Parks Departments/ Department of Natural Resources
- Bureau of Land Management lands: <http://www.blm.gov/wo/st/en.html>
- Wildlife Refuges: United States Fish and Wildlife Service: <http://www.fws.gov/refuges/>
- National Parks and Monuments: National Park Service: <http://www.nps.gov/findapark/index.htm>
- National Forests: United States Forest Service: <http://www.fs.fed.us/locatormap/>
- The Nature Conservancy Preserves: <http://my.nature.org/preserves/>
- Conservation land trusts
- Botanical Gardens
- Native Plant Societies – Most states have a NPS chapter

3. Determine educational needs for your region

Your advisory council will help define major goals for your native plant curriculum. Their experience will help you determine major educational needs in your region. For example, are there specific natural resource subjects or issues that you would like to focus on? Depending on the nature of your region, your focus might be on sustainable forestry issues, threatened and endangered plants, prairie ecosystems, wetlands, etc. There are two basic approaches to finding a topical focus. One tactic is to focus on major, region-defining issues. In this case, your curriculum may take on the role of preparing students for their future roles as stewards and decision-makers within your region. Alternatively, you may focus on addressing issues that receive little attention and are not widely publicized in your area. Of course, it often makes sense not to select a particular topic to focus on, but rather provide a more general curriculum that addresses many native plant subjects and issues with equal weight. The education and botany representatives on your advisory council can provide input on particular issues or subjects that they feel should be emphasized.

Your native plant curriculum can also be geared towards meeting other general education needs. For example, lessons and supplemental exercises may emphasize building writing, speaking, or math skills. Work with education representatives from your advisory council to determine whether and how to modify lessons in the Project Botany framework to help teachers in your region meet their students' educational needs.

Spend some time researching existing natural resource and native plant educational materials in your region. Internet surveys provide an efficient means to reach formal and informal educators in your region. Strive to fill gaps in existing native plant curricula, build on current resources, and understand the needs and desires of educators.

4. Develop a mission

Keeping in mind your intended audience and the educational needs of your region, work with your advisory council to develop a clear mission statement and goals to guide you as you produce your curriculum. Example mission statements include:

- To promote conservation and appreciation of the native flora of the prairie potholes wetlands of the Great Plains.
- To increase the understanding of native plants and the stewardship of green spaces in New England's urban centers.
- To promote an awareness of humans as a part of their local ecosystems.

5. Understand the major ecosystems and habitat types within your region

Utilize a variety of resources to become well-versed in the natural characteristics of your region. Begin by using the CEC's ecoregion descriptions to understand the geology, topography, land use, habitat types, and key plant and wildlife species. Work with members of your advisory council to learn more about the ecology of your region and the key natural resource issues and challenges facing citizens and land managers. Before beginning to modify the Project Botany curriculum, you should have a solid foundation of knowledge surrounding both the natural history and current events in your region.

6. Assemble a list of locally significant native plant species

Using examples that students can relate to will bring lessons to life and give them a richness that will create a greater interest and understanding. Consult with botanists, naturalists, and use your own knowledge of local ecosystems to create an informal list of example plant species that hold a place in the local culture, are frequently sighted, and contribute significantly to wildlife habitat. The goal should be to expand students' awareness of species that they are likely to encounter, hear about, or read about in your area. The types of species you use will be dependent upon your educational goals for your native plant curriculum.

- **Charisma:** Beautiful, unique, and intriguing plants come in all shapes and sizes. They may be common or rare. Charisma isn't necessarily aesthetic; consider functional appeal, such as the nutrient-fixing properties of legumes and alders, habitat value, or pollinator relationships.
- **Community dominance (current or historic):** Students may be superficially aware of locally dominant or common species without having a great deal of knowledge about the plants that define (or that historically defined) their region. Examples of species include sagebrush (*Artemisia* spp.) in the Great Basin, big bluestem (*Andropogon gerardii*) in parts of the Great Plains, or longleaf pine (*Pinus palustris*.) in parts of the South.
- **Significant wildlife habitat value:** All native plants are valuable in one form or another as elements of wildlife habitat. Some species however, are especially valuable, either because they are important for many wildlife species or because they are crucial resources for just a few. For example, a plant species that is the only host for a species of butterfly larvae is highly valuable because the survival the butterfly species is directly dependent upon the plant. Willows (*Salix* spp.) are good examples of plants widely used by wildlife, as their leaves, twigs, bark, and buds are eaten by many wildlife species, particularly as winter forage; they are important to the diet of beaver; they stabilize stream banks; they provide cover for calving moose and other animal species; and they provide stream shade important to the survival of many fish and aquatic invertebrates.
- **Unique niche/adaptations:** Plants are astounding in the diversity of the niches that they fill. Some plants have evolved particularly unique forms and roles. These plants can serve as great tools to inspire and excite students about nature and evolution. Examples include carnivorous plants, cacti, mangrove species, or flowers that have evolved to entice very specific pollinators.
- **Economic importance:** Many regions are economically dependent upon specific native plants. Students are likely to recognize the names of these species, but may not recognize the plant itself or know much about its ecology or history. By increasing their knowledge about these plants, they can become more responsible citizens and stewards. Examples include the sugar maple (*Acer saccharum*) of the Northeast, Douglas fir (*Pseudotsuga menziesii*) in the Pacific Northwest, and various bunchgrasses where rangeland and livestock grazing is prevalent.
- **Ethnobotanical significance:** Historically, indigenous American Indian tribes, and later European immigrants, were highly dependent upon plant species that had edible, medicinal, or fiber qualities. Some of these species held (and often still hold) prominent places in the economies, diets, migrations, ceremonies, and lore of various tribes. Examples include the widely eaten and traded camas (*Camassia*

quamash) of the Northwest, bitterroot (*Lewisia rediviva*) in the Rocky Mountains, and American ginseng (*Panax quinquefolius*) of the Appalachian region.

- **Threatened/endangered species:** While threatened and endangered animals often receive media attention and their plights are widely publicized, plants on endangered species lists (both federal and state) are often unknown amongst the general public. However, once students know the names and stories behind local rare species, they are likely to start noticing their mention in the news and community discussions. Due to the precarious state of these species, it is important that we foster awareness of our local rare plants. Federally listed plants in your region can be found at the United States Fish and Wildlife Service website (<http://www.fws.gov/endangered/>). Look to state departments of fish and wildlife or natural resources to find state-listed threatened and endangered species, which likely vary from federal lists from your area.

7. Assemble a list of accessible natural areas within your region

Encouraging students to experience nature and botany right outside their doors is extremely valuable. We suggest teachers take advantage of the outdoor classrooms that exist all around them—schoolyards, gardens, parks, agricultural fields, vacant lots, hedgerows, and many other locations provide an unexpected opportunity for teaching about nature. It is also highly beneficial to introduce students to nearby natural areas, where they can experience intact ecosystem processes, enjoy the sounds of nature, and have a chance to explore a wild place. This increases the opportunity for observing native plants and the interactions between various biotic and abiotic factors in a functioning ecosystem. Many teachers and students will be pleasantly surprised to discover new natural areas near them. Use table 1 to help assemble a list of local natural areas.



8. Familiarize yourself with the academic standards for your region

It is important that native plant curricula assist teachers in addressing academic standards in science, math, language arts, social studies, and technology. The subject of native plants lends itself well to cross-disciplinary teaching. To ensure the efficacy of native plant curricula, it is necessary to understand and incorporate the academic standards for your region. Lesson modification should be done with your region's standards in mind to maximize the opportunities for meeting and reinforcing crucial academic concepts. In addition, it is highly beneficial to include a key which directly correlates each lesson to the standards met.

As of December 2016, forty-two states and the District of Columbia are members of the Common Core State Standards (CCSS) Initiative, which include standards in Language Arts, Mathematics, and Literacy in History/ Social Studies and Science/Technical Subjects. In addition, 18 states and the District of Columbia are in the process of adopting a new set of national science standards, called the Next Generation Science Standards (NGSS). Find out if your region is using these national academic standards and work with educators to understand and interpret them in the context of the Project Botany curriculum. Project Botany: Exploring the Native Plants of the United States curriculum has been written in correlation with both of these sets of national standards.

While many states use national educational standards for math and language arts, others continue to use their own set of core standards. Standards in science, social studies, and technology can also vary from state to state.

For those considering multi-state regions, look into the educational standards for each state you hope to include before finalizing your region.

9. Modify existing Project Botany lessons and/or add lessons that address your region's ecosystems, habitats, species, and conservation issues

Lessons should focus on the interactions between geology, topography, climate, and biota, all of which shape one another in order to form an ecosystem. From this section, students should gain an understanding of what the nature of their region is, and how the nature of the region is shaped by the combination of various biotic and abiotic factors.

The Ecoregions of the United States lesson serves as a template to design a lesson exploring the level III ecoregions that comprise your region. Use the Commission for Environmental Cooperation's level III ecoregion descriptions and maps. If your region is small, consider using level IV ecoregions as well.

Use regional conservation plans as a starting point for students to learn about conservation challenges and solutions in your area.



10. Distribution

Teacher workshops and conferences are the best outlets for distributing your curriculum. You can also make your curriculum available through your organization's website, local conservation agencies and non-profits, local parks, and visitor centers.

Teacher Workshops:

- Give an overview of the curriculum's features, contents, and helpful hints that will make the book more user-friendly.
- Pick two or three engaging lessons to demonstrate during the workshop. Be sure to bring all necessary supplies. Pick lessons that make sense based on the time of year.
- After completing each lesson, ask participants to share how they would modify or adapt the lesson to fit their particular class.
- Use the opportunity to introduce other beneficial materials, such as local field guides, naturalists, potential service-learning projects, field trip locations, etc.
- Have participants fill out evaluations to inform your current and future projects.



Resources

1. Cramer, Jennie, and Jody Einerson. *From Salmonberry to Sagebrush: Exploring Oregon's Native Plants*. 2011.
2. Sobel, David. *Place-based Education: Connecting Classrooms & Communities*. Great Barrington, MA: Orion Society, 2005.
3. Scherrer, Wendy. *Celebrating Wildflowers Across the Nation: How to Develop a Regional Native Plant Education Program*. Sedro-Woolley, WA: North Cascades Institute, 1999.

Section 1:
**Plant
Identification**



What is a Plant?

It is not the strongest of the species that survives, nor the most intelligent that survives. It is the one that is the most adaptable to change.

— Charles Darwin (1809-1882)

Time Estimate:
1-2 hours

Best Season:
spring,
fall



Teacher Hints

Consider splitting students into groups for the background reading. Each group can be in charge of learning about one group of plants or plant-like organisms, and presenting a short summary of the information about that group to the class.

Assessments

- 1 Compare and contrast major differences in structure and reproduction between two of the groups of organisms studied.
- 2 Define "plant."
- 3 Explain the evolutionary relationships and progression of plants and plant-like organisms.

Overview

Students explore the diversity among plants and plant-like organisms, such as fungi, algae, and lichens, which may be mistaken for plants. This lesson emphasizes the structural and reproductive differences between the groups and the relationships between these organisms within an evolutionary context.

Preparation

- ◆ Collect examples of the different groups of organisms represented in this lesson. Try to collect at least three species of each.
- ◆ Reproductive structures are easier to observe when magnified, so provide a dissecting scope or hand lens.
- ◆ At each station except for the lichens, include a life cycle diagram. The lichen life cycle is omitted because much remains to be understood about lichen reproduction.

Additional Information

Life cycle diagrams

- ◆ Algae: <http://www.resnet.wm.edu/~mcmath/bio205/diagrams/botun05d.gif>
- ◆ Angiosperms: <http://www.mun.ca/biology/scarr/Angiospermae.html>
- ◆ Bryophytes: http://www.cavehill.uwi.edu/bio_courses/bl14apl/images_bryos/moss_life_cycle.jpeg
- ◆ Ferns: <http://sciencelearn.org.nz/Contexts/Ferns/Sci-Media/Animations-and-Interactives/Fern-life-cycle>
- ◆ Gymnosperms: <http://www.ck12.org/biology/Gymnosperm-Life-Cycle/lesson/Gymnosperm-Life-Cycle/>
- ◆ Sporophyte and gametophyte relationship in bryophytes, ferns, and seed plants: <http://utweb.ut.edu/hosted/faculty/wprice/seedpl08.pdf>
- ◆ Fungi (Basidiomycetes): http://www.bio.brandeis.edu/fieldbio/Fungi_Miller_Stevens_Rumann/Pages/fungi_life_cycle_anatomy_page.html
- ◆ Tree of Life Web Project; a collaborative website with many beautiful photos that diagram the evolutionary relationship between different groups of organisms: <http://tolweb.org/tree/>.



What is a Plant?

It is not the strongest of the species that survives, nor the most intelligent that survives. It is the one that is the most adaptable to change.

— Charles Darwin (1809-1882)

Materials Needed

- ♦ hand lenses
- ♦ life cycle diagrams (all stations except lichens)
- ♦ examples of 3 species from each category of organisms
- ♦ datasheet
- ♦ paper for drawings

Learning Objectives

- ♦ Learn the differences and similarities among algae, fungi, lichens, bryophytes, ferns and their allies, and seed-bearing plants
- ♦ Explore plant and plant-like diversity within an evolutionary context
- ♦ Use a hand lens and/or microscope to explore anatomical diversity

Vocabulary Words

lichen	parasite
spore-bearing plants	foliose
seed-bearing plants	fruticose
moss	crustose
hyphae	spore
sporophyte	rhizoid
mycelium	cuticle
saprophyte	vascular
mycorrhizae	angiosperm
	gymnosperm

Overview

In this lesson, you will explore the diversity among plants and plant-like organisms, such as fungi, algae, and lichens, which may be mistaken for plants. This lesson will emphasize the structural and reproductive differences among the groups and the relationships among these organisms within an evolutionary context.

Background Information

Have you ever looked at a soft, moist, fuzzy piece of green growing on a tree or on the ground and wondered what it is? Is it a plant? Maybe it is a moss or a lichen or algae. What is the difference and how do you know? What about a mushroom? It is growing out of the soil. Does that make it a plant? What is a plant, anyway?

What makes a plant a plant? First, almost all plants make their own food and produce oxygen by taking in carbon dioxide and water through the process of photosynthesis. Second, all plants have cell walls to help support them, which animals do not have (although some other types of organisms do). Thirdly, plants have a cuticle, or waxy coat, on their stems and leaves to protect them from drying out. You will notice that the plant-like organisms share some but not all of these traits.

The story of plants, including bryophytes, ferns, and seed-bearing plants, and other similar and often confused groups of organisms, such as fungi, lichens, and algae, can be woven with an evolutionary thread. This story is sewn by our understanding of the life cycles, structures, and ecology of different groups of plants.

It is a well-supported hypothesis that life on Earth began in the oceans and over time colonized the land. There is considerable debate in the scientific community about which plants were the first to colonize land, giving rise to the evolution of ferns and their allies, cone-bearing plants, and flowering land plants. Algae are widely considered to be the evolutionary precursors of plants, and in some cases, algae are considered plants themselves. But which plants were the first to live on land? Many theories have been advanced. Today, the most recent theories indicate that liverworts are likely the evolutionary predecessors to the higher plants that we know today. This is an ongoing point of investigation, and further research is needed.

As you read the following sections on different groups of plants and plant-like organisms, pay special attention to the similarities and differences that add to our understanding of the evolutionary relatedness among these organisms. Keep in mind that no moss has ever turned into a fern in one generation. This story is one that has been developing for several billion years. Nothing happens quickly when it comes to plant evolution!



What is a Plant?

Plant-like, but not really plants...

Fungi

Fungi are a wonderfully diverse group of organisms, with great variation in form, habitat, and manner of acquiring necessary nutrients. Many of you quite likely recognize mushrooms, with their typical cap and stalk form, wild abundance of colors, and presence in a variety of habitats. There are many types of fungi other than the mushrooms, including the cup, jelly, teeth, coral, and crust fungi. There are also puffballs, truffles, rusts, smuts, and the unicellular yeasts, all of which are classified as fungi. An important thing to note about fungi (with the exception of yeasts) is that the part that you generally see and recognize is only a small fraction of the entire fungus. The rest of the fungus is in the soil, tree, leaf, insect, dead wood, or other substrate on which the fungus grows. This part of the fungus exists as very thin, elongate strands known as hyphae. Collectively the hyphae are known as mycelium, making up the vast majority of the mass of the fungus. A simple analogy can help to explain this. The mycelium is like an apple tree, with its trunk and all its branches and leaves; the "fruiting body" of the fungus that you see is like the apple itself.

Fungi are likely more closely related to animals than they are to plants, though they were originally classified as plants. The two groups have many similarities, including possessing a cell wall (animals have none) and lacking the ability to move on the landscape. However, the cell wall is often made of chitin, the very same biological compound that makes the exoskeleton of insects and crustaceans. Fungi can reproduce

via the production of spores, a characteristic they share with some plants. Another major difference is that fungi do not have leaves, do not possess chlorophyll, and consequently do not photosynthesize.

Therefore, fungi must have other means of acquiring nutrients. As a result, fungi are classified into three major groups based on their

mode of nutrition: 1) saprophytes that live off of dead and decaying matter, 2) mycorrhizae ("fungus-root") that form special connections with plant roots and exchange nutrients directly with roots, and 3) parasites that live off of other living tissue. Fungi play a critical role in the recycling of nutrients, which is incredibly important to the function of ecosystems. Fungi are a principal food source for a variety of organisms, making them a major player in the maintenance of biodiversity on Earth.

While fungi are not direct evolutionary descendants of plants, their story is very directly tied to the migration of plants from the sea to land throughout geologic time. There are many studies that cite the importance of mycorrhizae in this process. Evidence indicates that it was these connections between fungi and plant roots that allowed plants to colonize terrestrial habitats and still access sufficient water and nutrients. Mycorrhizal connections, found in 90% of plant families, greatly increase the surface area of plant roots, increasing overall water uptake. Additionally, numerous types of fungi have been found among the fossils of the oldest land plants.



Lichens

Lichens come in diverse forms and are found in almost every habitat on Earth, including terrestrial, marine, and aquatic ecosystems. The smallest lichens in the world are nearly microscopic; the largest lichens are up to a square foot in size. Some are leaf-like (foliose), others have a bunch of shrubby stalks (fruticose), and others appear to just be a crust on a rock, tree, or soil (crustose). In addition to being found on almost any natural substrate, such as rock, bark, soil, or leaves, lichens can also be found attached to many man-made items, such as cement, asphalt, metal, and even plastic. Unlike most plants, lichens have no roots and therefore derive all of their moisture and nutrition from the atmosphere around them. Lichens can be different hues of



What is a Plant?

gray, greenish gray, and brown. Some lichens can be quite bright in color, such as red, orange, and yellow.

Lichens are a biological marvel, and an incredible example of symbiosis. They are not a single organism like the rest of the groups explored here, but actually two, and sometimes three organisms living intertwined together so that they are virtually indistinguishable. When they are found separately, these organisms look nothing like they do when combined as a lichen. Lichens always contain a fungus and an organism that can perform photosynthesis, usually algae, and occasionally a cyanobacterium. The most basic function of the fungus is to provide a moist habitat for the algae or cyanobacteria. The algae or cyanobacteria perform photosynthesis much like plants; the sugars created from photosynthesis are used by the fungus for its nutrition. Lichens are officially classified as fungi.

So who's in charge, the fungus or the algae? Or do they cooperate equally? At this point, the answer is unclear. Lichens have commonly been described as two organisms living together in harmony, each benefiting equally from the interaction. More recently, many lichenologists have begun to support the idea that the fungus harnesses the algae to do work for it. One lichenologist has said that lichens are fungi that have discovered agriculture. As you explore the world of lichens you'll have an opportunity to think about this interesting scientific conundrum.

Lichens play a significant role in the ecosystem. They provide food and habitat for invertebrates and animals; are involved in nitrogen-cycling benefiting plants; and produce oxygen through photosynthesis. One widespread species, *Lobaria pulmonaria*, is often called "the lungs of the forest" because of the vast amount of oxygen it produces through photosynthesis. Because they are rootless and receive all of their water and nutrients from the atmosphere, lichens are also highly valued as biological indicators of air pollution, as many species' ranges are dictated by the quality of the air in which they live.

The in-between...

Algae

Algae are a very challenging group of organisms to classify, as the word refers not to an entirely related group

of organisms, but to organisms with several different ancestries. The classification of algae is debated among biologists.

Unlike the seed-bearing plants, algae lack a cuticle and stomata and are therefore restricted to moist habitats. Most algae also differ from plants in that they lack true roots and leaves and the body is not differentiated into highly specialized cells for structural support and water transport, though in some cases specialized cells do exist. In most cases, algae simply don't need these specialized cells because they are supported by the water column in which they live. Like fungi, lichens, bryophytes, and ferns, algae reproduce by dispersing spores into their environment; they do not produce flowers or seeds. However, like plants, algae do perform photosynthesis; as a result, many are green, though others are red, brown, or myriad shades in between. Only some algae are very likely to be confused with plants; these may include the larger green, red, and brown algae that are commonly referred to as seaweeds.

Algae are widely considered to be the evolutionary precursor to land plants. This assertion is based on the structural evidence listed in the previous paragraph. In recent years, genetic analysis has supported this hypothesis.

Algae are found in virtually every habitat on Earth as long as water is present, even for a very short time of the year. They even live in extreme environments, including hot springs, salt pans, and beneath thick sheets of ice. Algae are a major component in the plankton that forms the base of the marine food chain. Ecologically, they provide very important nutrition for many animal species.

And now for the real plants...

Bryophytes

Bryophytes are small, herbaceous plants that live closely packed in cushions or mats on rock, soil, and trees and on human-made substrates such as asphalt and concrete. They are found in a wide diversity of habitat types around the globe. The three main types of bryophytes are mosses, liverworts, and hornworts. Like other plants, bryophytes have leaves photosynthesize to produce the sugars they need for metabolism.



What is a Plant?

Bryophytes lack the specialized water-conducting cells, roots, waxy cuticle and stomata that are involved in transporting water. The lack of these anatomical advances limits the size of the bryophyte and restricts it to moist habitats. The lack of these structures means that the entire plant, including the root-like rhizoids, absorb water like a sponge.

Bryophytes have a very different life cycle than the higher plants. These life cycle differences are considered support for the hypothesis that bryophytes were the first land plants. The life cycle of plants is divided into two main stages and is known as alternation of generations. This life cycle is defined by the number of copies of chromosomes that are found in the nucleus of each cell during each stage. In bryophytes, the main body of the plant that you see that includes the leaves is known as the haploid gametophyte, meaning it contains one copy of chromosomes. The tiny sporophyte is diploid, meaning it contains two copies of chromosomes, one from the mother and one from the father. The sporophyte forms when a sperm from a male organ swims through the watery film on the leaves of a bryophyte and travels to a female organ on the same or different plant. The sperm is entirely exposed to the environment during this time. In seed-bearing plants, this life cycle is reversed, with the main leafy part of the plant being diploid and the haploid part only occurring in the pollen and ovule. While understanding this difference may require some time studying the topic, life cycles are a major piece of evidence pointing to the evolutionary relationships among different types of plants.

Bryophytes play valuable ecological roles. In some forests, bryophytes play a major role in regulating humidity, acting as big sponges, absorbing and releasing water into the atmosphere. Bryophytes also have extensive wildlife value, hosting a number of small invertebrates, acting as food for others, and providing nesting and bedding material for birds and small mammals. Even some large animals, such as the mountain goat, rely on bryophytes for a portion of their diet.

Ferns & their allies

Ferns and their allies (plants that are very similar to ferns, such as clubmosses, spikemosses, quillworts, whiskferns, and horsetails) frequently exist as denizens of the shady undergrowth in forests, with an affinity for moist, dark places. Some ferns are aquatic and live in symbiosis with bacteria. A large diversity of ferns may also be found in other habitats, including rock faces and open meadows. These plants may be found growing from the ground, on rotting logs, in rock crevices, and as epiphytes along tree trunks and up in the canopy. In rock, different species of ferns are found to occupy very specific niches defined by the chemistry of the rock on which they grow.



Ferns and their allies grow in moist environments because their reproduction requires free water. Like bryophytes, ferns and their allies fluctuate between the diploid and haploid life stages. In ferns and their allies, the diploid sporophyte phase is the the form we see, while the haploid gametophyte stage is reduced to a 1-2 cm heart-shaped body (thallus) on which the spore and egg producing structures are found. Fertilization requires free water for the sperm to swim through to reach the egg-bearing structure. The sporophyte grows from the fertilized egg. Many scientists agree that this major reduction in the haploid gametophyte part of the life cycle is evidence that ferns are an evolutionary link between bryophytes and other land plants.

Ferns and their allies share additional characteristics. Much like the bryophytes, they all reproduce using spores and never produce flowers or seeds. Ferns and their allies all have



What is a Plant?

In the Field!

Go to a habitat area with a diverse assemblage of organisms, native or otherwise, that is on or near your school grounds. With a partner, find an example from each of the groups of organisms discussed in this lesson. When you find each organism, ask yourself the appropriate question. Why is this a fungus? Why is this a bryophyte? Why is this an algae? Use the time in the field as an opportunity to review what you know about each group of organisms. Get out some field guides for the more obscure groups and see if you can match the ones you are finding to the photos in the book.



Science Inquiry

- ◆ Lichens can be indicators of air quality, and they can also indicate areas with excess nutrients. Complete some basic research and design a simple field investigation to evaluate the effects of air quality or pollution on patterns in lichen diversity.
- ◆ Pick three or more different locations to collect data. Try to sample along what you think might be a gradient in air pollution based on your knowledge and observations about human use of the area. Extremes might be an industrial area (be sure to look for crustose lichens on pavement and buildings) and an old-growth forest. If you live in a more rural setting, try comparing the lichens present on fence posts in a heavily used livestock yard to the lichens on nearby trees. Any setting can work—just look closely and try to find a gradient in land use (past or present).
- ◆ Take photos or draw pictures of the lichens you see in each area.
- ◆ Are there any lichens that are present in all of your sample areas? Are there any found only in the more polluted areas? Are there any found just in pristine areas?
- ◆ What might be some confounding variables in this study?
- ◆ Follow the directions found at http://tolweb.org/treehouses/?treehouse_id=2974 to construct a 3D model of the tree of life. In this activity, you will create a visual display of the tree of life, showing the evolutionary relationships among major groups of organisms, highlighting where plants and fungi fall within the greater diversity of life on Earth.



Self Assessments

- 1** Which group of organisms is best adapted to dry, terrestrial environments and why?
- 2** How do fungi differ from plants?
- 3** How do algae differ from plants?
- 4** Describe how lichens are an excellent example of a biological symbiosis.

What is a Plant?

Directions

1. Your teacher has established 6 stations, each highlighting one of the groups of organisms discussed above. Ideally, stations will be visited in the following order: fungi, lichens, algae, bryophytes, ferns and their allies, and finally seed-bearing plants. If you can't start at the first station, try to visit the stations in order, as it will serve to emphasize the evolutionary relationship among the groups. As you visit each station use the following directions as a guide.
2. Begin by reading the background information for each station. Make note of the structures that define each group of organisms and what those structures indicate about the evolutionary relationship among groups of organisms.
3. Make a sketch of the example organisms at each station. Be sure to look closely at each and make note of the significant structures you read about in the background information that set each group of organisms apart from the others. Refer to the background information for clues about these noteworthy structures. Write the name of each structure on your drawing and draw an arrow pointing to it.
4. Choose one example organism and look closely at the reproductive parts through a hand lens or dissecting microscope. Draw a close-up of what you see through your hand lens/dissecting microscope and label the structures.
5. Examine the life cycle of the group of organisms. Each life cycle diagram contains a lot of information. Note that the true plants undergo alternation of generations. The organisms that are not true plants do not undergo alternation of generations. List the life stages that are haploid and the life stages that are diploid. While this may seem like an obscure way to show differences between the organisms, it is central to understanding how life cycles changed in the process of plant evolution.
6. At each station, fill out the boxes in the attached data sheet. This data sheet summarizes the major characteristics that are used to define each of the groups of organisms that you are exploring.

Resources

- ♦ Arora, David. 1986. *Mushrooms Demystified*, Second Edition. Ten Speed Press. Berkeley. 959 pp.
- ♦ Brodo, Irwin M., Sylvia D. Sharnoff, and Stephen Sharnoff. 2001. *Lichens of North America*. Yale University Press, New Haven, Connecticut, 795 pp.
- ♦ <http://www.seaweed.ie/index.html> -- Michael Guirey's seaweed site. Contains excellent background information on marine algae.
- ♦ <http://www.bryoecol.mtu.edu/> -- An excellent online book introducing bryophytes and their ecology.
- ♦ <http://bryophytes.plant.siu.edu/index.html> -- A thorough resource on bryophytes hosted by Southern Illinois University Carbondale
- ♦ <http://www.biology.duke.edu/bryology/LiToL/LwtsonGreenTree.html> -- The Liverwort Tree of Life Project. Interesting information about the evolution of land plants and the taxonomic relationship of bryophytes to the higher plants.
- ♦ <http://www.xs4all.nl/~steurh/engplant/eblad1.html> -- A concise history of plant evolution and the colonization of land, with specific reference to the fossil record.
- ♦ <http://www.devoniantimes.org/opportunity/forests.html> -- An interesting story of early plant evolution during the Devonian period.
- ♦ <http://ocid.nacse.org/lichenland/> -- A website with links to others that provide basic information about lichen biology and identification.
- ♦ <http://www3.interscience.wiley.com/journal/123233992/abstract?CRETRY=1&SRETRY=0> -- Reference about mycorrhizae and their role in land plant colonization.



What is a Plant?

Data Sheet

	Use Photosynthesis?	True leaves?	True roots?	Spores or seeds?	Type of vascular tissue?	Cuticle and stomata?	Unicellular or multicellular?	Internal or external fertilization?
Fungi								
Lichens								
Algae								
Bryophytes								
Ferns and fern allies								
Seed-bearing plants								

What is a Plant?

Teacher Answer Key

	Use Photosynthesis?	True leaves?	True roots?	Spores or seeds?	Type of vascular tissue?	Cuticle and stomata?	Unicellular or multicellular?	Internal or external fertilization?
Fungi	N	N	N	spores	N	N	both	
Lichens	Y	N	N	spores	N	N	multi	
Algae	Y	N	N	spores	N	N	both	external
Bryophytes	Y	Y	N	spores	simple	some liverworts	multi	external
Ferns and their allies	Y	Y	Y	spores	complex	Y	multi	external
Seed-bearing plants	Y	Y	Y	seeds	complex	Y	multi	internal



Exploring the Ecoregions of the United States

There is an eternal landscape, a geography of the soul; we search for its outlines all our lives.
—Josephine Hart (Contemporary)

Time Estimate:

One Session

Best Season:

Any



Teacher Hints

- ◆ Students need to be familiar with plant adaptations before attempting this lesson. Try doing the Create-A-Plant lesson before this lesson.
- ◆ Stress that the goal of this activity is not to get every correct answer, but rather to put creative thought into the connections between a plant's physical environment and its adaptations. Grade based on the logic of students' explanations rather than their specific answers.
- ◆ To begin, students should look only at side A of their Plant Profile cards. After writing down their predictions and explanations, they can flip the cards over to see the range maps for each species.

Overview

Students gain an understanding of the concept of ecoregions. Ecoregions are geographic areas with distinctive climatic, geographic, and ecological features. Students will learn about the drivers of diversity in our landscape and explore the interactions between various biotic and abiotic features of the natural world. Through this process students will discover the vast diversity of plant life in their country. Students will learn to connect plant adaptations with the physical environment.

Preparation

- ◆ Access the Commission for Environmental Cooperation Website to view Level I Ecoregion maps and descriptions.
- ◆ Print copies of the Level I Ecoregion Descriptions from Appendix III.
- ◆ Print out copies of the Plant Adaptations Chart for student use.
- ◆ Copy and cut out Plant Adaptation Profile cards. For each plant, there is a side A and a side B. You can either affix both sides together so that students can flip over their cards to side B when they are ready, or you can simply keep two sets of cards and hand out side A first and then side B when the students are ready.

Assessments

- 1 Name three factors that define an ecoregion.
- 2 Discuss the connections between geology and climate.
- 3 Be able to describe three adaptations that would allow a plant to thrive in the ecoregion of your choice.

Additional Information

- ◆ EPA maps and ecoregion descriptions: <https://www.epa.gov/eco-research/ecoregions-north-america>, click on "Downloads" and "Ecological Regions of North America (CEC 1997) (pdf = 6 mb)"
- ◆ Ecoregion Profiles (Appendix III)
- ◆ Native Seed Network Oregon ecoregion map <http://www.nativeseednetwork.org>; general overview of ecoregions



Exploring the Ecoregions of the United States

There is an eternal landscape, a geography of the soul; we search for its outlines all our lives.
—Josephine Hart (Contemporary)

Materials Needed

- ◆ Plant Profile cards
- ◆ Plant adaptations chart (From the “Create-a-Plant” Lesson)
- ◆ Ecoregion description cards
- ◆ Computer with internet access
- ◆ Scratch paper

Learning Objectives

- ◆ Locate and name the 13 level I ecoregions of the United States
- ◆ Describe and gain understanding about the connections between the geology, climate, and vegetation of the ecoregions of the United States
- ◆ Appreciate the variety of this country’s diverse landscapes & the biodiversity it supports
- ◆ Understand connections between a plant’s physical environment and its adaptations

Vocabulary Words

biome
ecoregion
topography

Overview

This lesson introduces the concept of ecoregions. Ecoregions are geographic areas with distinctive climatic, geographic, and ecological features. In this lesson, you will learn about the drivers of diversity in our landscape and explore the interactions between various biotic and abiotic features of the natural world. Through this process you will discover the vast diversity of plant life in your country. You will explore the relationship between plant adaptations and the physical environment.

Background Information

The United States is home to an incredible diversity of ecosystems and native plants. Picture the humid, tropical forests of the Florida everglades; the vast, grassy prairies of the Great Plains; the spines of the Rocky Mountains and the Appalachians; Alaska’s arctic tundra; the temperate rainforests of the Pacific Northwest; and the arid deserts of the Southwest. Each of our unique ecosystems is characterized by distinctive plant communities. As you move across the country from north to south or from east to west, you will notice that the vegetation changes dramatically as you pass through different ecological regions.

As biologists, we need a way to classify these regions to help us study the flora and fauna and interact with our natural resources appropriately. At a very broad level, we can organize different types of ecosystems into **biomes**. Types of biomes include forest, desert, grassland, tundra, marine, and freshwater. However, we know that not all forests are the same; nor are any two desert, grassland, marine, or freshwater systems the same, so we further divide biomes into **ecoregions**. An ecoregion is a geographic area characterized by distinctive climate, soil, geology, topography, and vegetation. An ecoregion is a geographic area characterized by distinctive climate, soil, geology, topography, and biota interacting together. The constant interplay of the different components creates the vast diversity of our landscape. This has led to a fundamental change in natural resource management, moving away from managing individual species and towards managing systems as a whole.

One major driver of climate is latitude. As you move from south to north, the climate generally becomes much cooler, due to the angle and duration of sun exposure. The northernmost ecoregion in the United States is the Arctic Coastal Plain, which has an average annual temperature of -11°C (12.2°F), while the southernmost ecoregion in the continental U.S., the Florida Coastal Plain, has an average annual temperature of about 23.5°C (74.3°F).

Latitude alone does not fully explain the variation in temperature and climate, however. Temperature and precipitation are affected by geologic features,



Exploring the Ecoregions of the United States

Background Information, continued

which help drive the wide variability in climate as you move from east to west and north to south. Elevation plays a major role in climate, because air thins and cools as it rises. Alpine areas thus tend to have much cooler climates than one would expect based on latitude alone. Another major way geology affects climate is through the rain shadow effect, where moisture is essentially trapped by a mountain range. For example, when moisture-laden air masses moving east from the Pacific Ocean rise up to cross over the Sierra Nevada Mountains, they cool and the moisture they hold condenses and falls as precipitation. As a result, the air that reaches the leeward side of the mountains is dry, and very little moisture reaches the deserts east of the mountain range. This phenomenon shapes climates around the world, from the Great Basin to Colorado's Front Range to the Gobi desert north of the Himalayas. This effect can also occur on a much smaller scale where mountain ranges are lower in elevation. Can you think of a place you know where the rain shadow effect is evident?

Another important factor that shapes the character of ecoregions is soil, which is crucial in determining which plant species can survive and thrive. Soils are influenced by many variables, including the type of rock from which they are formed (parent material), chemical composition, pH, texture, **topography**, climate, vegetation, and age.

Topography, with its influences on hydrology and soils, is also an important shaping force for ecoregions. For example, a hilly landscape may display a mosaic of different soils and different vegetation types. Because of the erosive force of water running off a hillside, these slopes tend to have shallow, poorly developed soils, on which only certain plants can thrive. Soil is then deposited in the valley bottoms below, which results in deeper, richer soils, where other species prefer to grow. Water running off of hillsides and collecting in gullies and drainages can also promote the growth of certain water-loving species in these wet zones. Next time you are outside, see if you notice a certain species (or group of species) whose location on the landscape corresponds with specific features of the topography.

Ecoregions do not exist in isolation, but interact and often blend into one another. Sometimes the transition between one ecoregion and another is abrupt and obvious, but the division is generally more gradual. The transition zone between two ecoregions contains characteristics and species from both ecoregions, and provides important and unique intermediate habitats.



There are different levels of ecoregional organization, as well as different methods of classifying ecoregions. We will be using a common classification system, used by the Commission for Environmental Cooperation (CEC) and the Environmental Protection Agency (EPA), which uses three different nested scales, or levels, of ecoregion divisions. We will start by using the broadest divisions, Level I, which splits the United States into thirteen ecoregions.* Each of these broad ecoregions can be divided into subsequently smaller and smaller units for more detailed study. Later on you will study your own Level I ecoregion in more detail by investigating the smaller Level III ecoregions that comprise it.

***Note:** The state of Hawaii represents the thirteenth ecoregion, classified by the Nature Conservancy as the Hawaiian High Islands Ecoregion. Hawaii is not included in the CEC ecoregion classification system.



Exploring the Ecoregions of the United States

Student Directions

1. In this activity, you will use information about the physical characteristics of ecoregions to make predictions about the native plants that thrive there.
 2. Split into groups of three or four students. Each group will need:
 - a. Description cards for the thirteen major ecoregions of the United States [Level I Ecoregion Profile cards (Appendix III)]
 - b. A set of Plant Profile cards
 - c. Scratch paper
 - d. A copy of the Plant Adaptations Chart
 3. Read carefully over the description of each ecoregion. Pay special attention to the physical characteristics. As you read, think about the adaptations a plant might have to survive under such conditions. Here are some things to pay attention to as you read about each ecoregion:
 - ◆ **Climate:** How hot or cold is this ecoregion? How much moisture does the ecoregion receive? If an area is very dry, might wildfires be a frequent disturbance there? Are there large differences in temperature and/or precipitation from one season to the next, or are the seasons more moderated? If the conditions vary greatly from season to season, a plant may need adaptations to survive both drought and moisture, heat and cold.
 - ◆ **Soils:** Are the soils generally deep or shallow? Are they high in nutrients or low? Are they prone to erosion? Are they waterlogged and boggy, or well drained?
 - ◆ **Geography:** Is this ecoregion mountainous, or does it primarily cover large open plains? Are there many wetlands, bogs, rivers, or lakes in this ecoregion?
 - ◆ **Biological Interactions:** What types of animals are common in this ecoregion? Remember, the native plants and animals of an ecoregion have evolved together. Many native plants therefore exhibit adaptations that are responses to their interactions with particular animals.
 4. Now look over the Plant Profile cards, only at side A. Each card represents a species native to the United States. Read over the adaptations that each plant has.
 5. Use your knowledge of plant adaptations to hypothesize which ecoregion(s) each plant belongs to. Your plant may belong to multiple ecoregions. For each plant, write down how its adaptations allow it to survive under the conditions of the ecoregions where you think it may live. The goal is not to get all of the right answers, but rather to use your logic and creativity to make connections between a physical environment and the characteristics of each species.
 6. Once you have finished writing your predictions and explanations, flip over your Plant Profile cards to side B to see the range maps for your species. Did your predictions match up? How did they differ? Why do you think each species exists where it does? Record your thoughts on any differences between your predictions and the true ranges.
- Note:** The range maps indicate in which states each species occurs. The species do not necessarily exist throughout the entirety of the highlighted states.

CLASS DISCUSSION

- ◆ There were several different conifer species in this activity. What were some of the differences among them and how did they help the trees survive in their respective habitats?
- ◆ What were some of the seemingly contradictory adaptations displayed by different desert species? How does each allow plants to thrive in that environment?



Exploring the Ecoregions of the United States

In the Field

Explore the role of topography and geology on native vegetation communities. Take a trip to a natural area near your school. Identify different topographic zones within the natural area: e.g. hillsides, hilltops, riparian bottomlands, drainages, open meadows. Walk through these areas and make note of the changing vegetation types as you move from one zone into the next. Do moisture levels also seem to correlate to the topography? If you can't tell, make your best guess based on your knowledge about how water flows on the landscape. Bring a compass. Are there differences in the vegetation between north-facing and south-facing aspects?



Science Inquiry

Design an experiment that tests the effects of a climatic variable on plant growth for different species. For example, you could choose to test various moisture levels, temperatures, or sunlight exposure. Research online or using a seed catalogue to find seeds for two different native plant species that come from different climates. Predict how well each will grow under different conditions. Base your prediction (hypothesis) on the climate conditions in the home range of each species.

- ◆ Remember that you must include controls in your experiment.
- ◆ Decide how you will measure your response variable. For example, you could measure the number of surviving sprouts or the number of leaves or height of the plants after a certain amount of time.
- ◆ Try sprouting seeds in egg cartons filled with potting soil.
- ◆ Be sure to check if your species need any special seed treatments for germination to occur; failing to do so may compromise the results of your experiment.

Data collection/analysis: After about four weeks of growth, measure your response variable (number of leaves, height, etc.) and analyze your data. Was your hypothesis correct? If not, why do you think you got the results that you did?



Reflection

- Use your creativity and design an imaginary ecoregion. Include information about the geology, soils, climate, and weather patterns. How do all of these factors interact with each other? What kinds of vegetation and animals live in the various parts of your ecoregion? How are these native plants adapted to the places they live? Be sure to describe the connections between the abiotic and biotic factors of your imaginary ecoregion. Try drawing a map that shows mountain ranges, valleys, deserts, forests, and bodies of water.





Exploring the Ecoregions of the United States

Taking it Further

- ◆ Use Google Earth (or a comparable online software) to visit your ecoregion. Locate your community and view vegetation and landforms. Choose a different ecoregion and compare what you see. Choose an ecoregion adjacent to yours and also one that is across the country from you to compare and contrast.
- ◆ Assemble a timeline of the geologic history of the ecoregion of your choice and explain how it was formed.

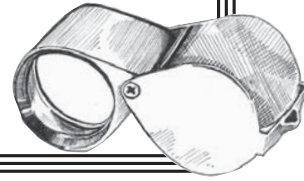

Assessments

- 1** Name the factors that define an ecoregion.
- 2** Discuss the connections between geology and climate.
- 3** Choose an ecoregion and describe three adaptations that would allow a plant to thrive there.

Resources

To bring students' attention to nature in an urban setting:

- ◆ Mitchell, Joseph. "The Rivermen." In *Up in the Old Hotel*. New York: Random House, 1993.
- ◆ Pyle, Robert Michael. *The Thunder Tree: Lessons from an Urban Wildland*. New York: Lyons, 1998. Print.
- ◆ Tallmadge, John. *The Cincinnati Arch: Learning from Nature in the City*. Athens: University of Georgia, 2004. Print.

General Nature Writing:

- ◆ Leopold, Aldo, and Charles Walsh Schwartz. *A Sand County Almanac: And Sketches Here and There*. New York: Oxford UP, 1987. Print.
- ◆ Assorted nature writings of John Muir, Aldo Leopold, Henry David Thoreau, Rachel Carson, Wendell Berry, Bernd Heinrich, and others.



Exploring the Ecoregions of the United States

Larix laricina

1A

- ◆ Adventitious roots can grow from the trunk and stems.
- ◆ The trees have the ability to transport oxygen to the root system.
- ◆ Chemicals produced in the wood have anti-fungal and anti-bacterial properties that prevent decay.
- ◆ The leaves are thin, waxy needles.
- ◆ Although the tree has needles, they are deciduous and are shed in the fall.



Thuja plicata

2A

- ◆ A chemical called Thujaplicin is produced in the wood of the tree and acts as an anti-fungal and anti-bacterial agent, preventing the wood from rotting.
- ◆ The tree can grow over 60 meters tall (200 ft) with diameters of more than 2.5 meters (8 ft).
- ◆ These trees are very long-lived, often surviving to be over 1,000 years old.
- ◆ This tree is an evergreen conifer, with leaves that are scale-like and waxy.



Quercus albus

3A

- ◆ The broad, green leaves are deciduous and are shed in the fall.
- ◆ Populations of this tree will produce very little fruit for a number of years, followed by a year of extremely high fruit production, a strategy called mast-fruiting.
- ◆ The trees of this species have both a very deep taproot and a system of widely branching lateral support roots.
- ◆ The seeds are spread by squirrels, who cache the fruits and often forget about them.



Eriophorum callitrix

4A

- ◆ The reproductive organs are densely covered in wooly hairs, giving the flowering heads the appearance of cotton balls.
- ◆ The leaves are thin, narrow, grass-like and dark green.
- ◆ The plants grow low to the ground.
- ◆ These plants grow in clumped tussocks.
- ◆ Underground rhizomes store carbohydrates.





Exploring the Ecoregions of the United States

Foquieria splendens 5A

- ◆ The small, waxy leaves are deciduous and appear only during periods of precipitation, after which they are shed and the plant becomes dormant. The plant can leaf out and shed its leaves multiple times per season depending on precipitation cycles.
- ◆ After the leaves are shed, the leaf bases harden into stiff, sharp spines.
- ◆ Pollinated by hummingbirds.
- ◆ Generally live to be about 60 years old.

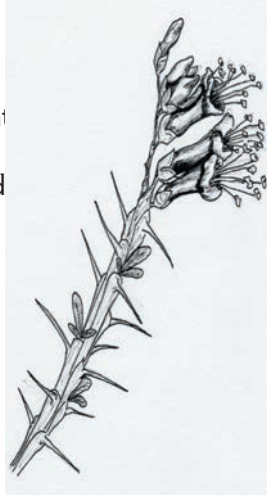

Andropogon gerardii 6A

- ◆ Tall grass with narrow, thin leaves.
- ◆ Extensive root system, may be more than 2 meters (6.5 ft) deep.
- ◆ Growth tissue and stored carbohydrates are located in the crown at the base of a plant, where they are protected.
- ◆ Sparse hairs on the leaf blades and stem.
- ◆ C₄ metabolism allows it to collect and store CO₂ during the night and close its stomata during the day while it photosynthesizes.



Artemisia tridentata 7A

- ◆ Dense white hairs cover the leaves of this shrub.
- ◆ The root system has two components: a very deep taproot, and a network of very shallow and finely branched lateral roots around the soil surface.
- ◆ Two types of leaves are present; one set is evergreen and is maintained year-round, while the other set is deciduous.
- ◆ Low-growing and long-lived.
- ◆ Bitter chemicals give the shrub a pungent smell and bitter taste.



Avicennia germinans 8A

- ◆ Salt is excreted from the waxy, leathery leaves.
- ◆ Specialized root appendages called “pneumatophores” grow up from the soil surface. Hollow channels (aerenchyma) allow the pneumatophores to act like snorkles, allowing for increased gas exchange.
- ◆ Water is stored in specialized cells inside the waxy leaves.





Exploring the Ecoregions of the United States

Geraea canescens

9A

- ♦ A short-lived annual, this plant can complete its entire life cycle—germinate, grow, and reproduce—within a very short period of time.
- ♦ The seeds lie dormant until they are triggered to germinate by significant moisture; then growth is rapid.
- ♦ White hairs cover the leaves and stems.



Tamarack (*Larix laricina*)

1B

Tamarack is native to Canada and the United States' northeastern forests. The tree is adapted to survive in very cold winter conditions, when water is locked up as ice and unavailable for use. But it also has adaptations that allow it to survive in waterlogged bogs during the summer months.

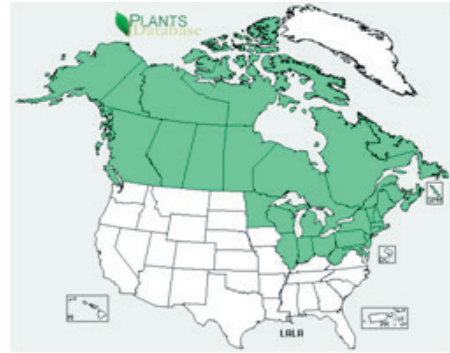

USDA, NRCS. 2013. The PLANTS Database (<http://plants.usda.gov>, 21 August 2013). National Plant Data Team, Greensboro, NC 27401-4901 USA.

Western red cedar (*Thuja plicata*)

2B

Western red cedar is found in the northwestern forests of our country, where along the Pacific coast it isn't uncommon for annual precipitation to exceed 300 cm (about 10 ft). Western red cedar's adaptations allow it to thrive in this wet, light-limited environment.



USDA, NRCS. 2013. The PLANTS Database (<http://plants.usda.gov>, 21 August 2013). National Plant Data Team, Greensboro, NC 27401-4901 USA.

White oak (*Quercus alba*)

3B

Native to the eastern temperate forests of the United States, the white oak can survive both hot summers and cool winters. The tree can thrive as part of the dense canopy that covers the region. It has come to depend on (and outwit) the mammals native to the vast forest ecosystem where it evolved to disperse its seeds.



USDA, NRCS. 2013. The PLANTS Database (<http://plants.usda.gov>, 21 August 2013). National Plant Data Team, Greensboro, NC 27401-4901 USA.



Exploring the Ecoregions of the United States

Arctic cottongrass 4B (*Eriophorum callitrix*)

Arctic cottongrass is found in the northern reaches of our continent, where it must survive extremely cold temperatures, frozen water, and thin soils. This sedge has only a very brief growing season in which to reproduce.



USDA, NRCS. 2013. The PLANTS Database (<http://plants.usda.gov>, 21 August 2013). National Plant Data Team, Greensboro, NC 27401-4901 USA.

Ocotillo 5B (*Fouquieria splendens*)

A beautiful shrub of southwestern deserts, ocotillo is well-adapted to arid conditions with sparse and relatively unpredictable rainfall. Like many plants from this region, ocotillo uses thorns to protect itself from hungry and thirsty herbivores. It also relies on native fauna to pollinate its striking red flowers.



USDA, NRCS. 2013. The PLANTS Database (<http://plants.usda.gov>, 21 August 2013). National Plant Data Team, Greensboro, NC 27401-4901 USA.

Big bluestem 6B (*Andropogon gerardii*)

This grass is a dominant species in the tall grass prairies that once covered vast tracts of lands in the middle of our nation. The incredibly extensive root system reaches down into the deep soils that are characteristic of much of this region. Its adaptations reflect a need to survive hot, dry summers, frequent fires and an abundance of large, grazing ungulates.

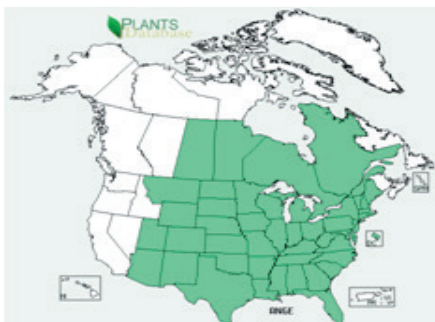

USDA, NRCS. 2013. The PLANTS Database (<http://plants.usda.gov>, 21 August 2013). National Plant Data Team, Greensboro, NC 27401-4901 USA.

Big sagebrush 7B (*Artemisia tridentata*)

A dominant species over much of the arid interior of our country, big sagebrush thrives despite little precipitation, harsh, cold winters, and hot, windy summers. Though vast herds of large grazing mammals have shared the region with sagebrush, only a few of them will eat the bitter tasting foliage.

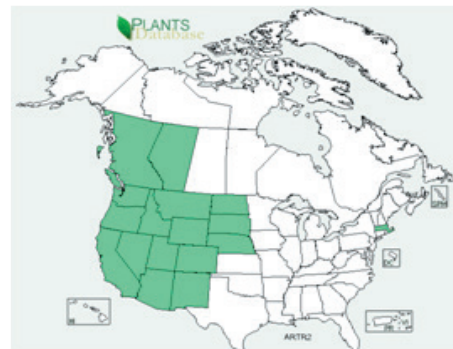

USDA, NRCS. 2013. The PLANTS Database (<http://plants.usda.gov>, 21 August 2013). National Plant Data Team, Greensboro, NC 27401-4901 USA.



Exploring the Ecoregions of the United States

Black mangrove 8B (*Avicennia germinans*)

Where the swamps of the southern tropical forests meet the ocean, black mangroves thrive despite harsh conditions. The saying “water, water, everywhere, but not a drop to drink,” is applicable in these habitats—any plants that live here must have some way of dealing with excess salt in order to obtain water, making it an expensive resource.



USDA, NRCS. 2013. The PLANTS Database (<http://plants.usda.gov>, 21 August 2013). National Plant Data Team, Greensboro, NC 27401-4901 USA.

Desert gold 9B (*Geraea canescens*)

Desert gold, also called the desert sunflower, lives in extreme desert environments, including California’s Death Valley. Its modified life cycle allows the plant to survive under incredibly arid conditions, making the desert bloom when a rare rainfall allows.



USDA, NRCS. 2013. The PLANTS Database (<http://plants.usda.gov>, 21 August 2013). National Plant Data Team, Greensboro, NC 27401-4901 USA.





Field Journaling: Observations from a Special Spot

To see a wren in a bush, call it "wren," and go on walking is to have (self-importantly) seen nothing. To see a bird and stop, watch, feel, forget yourself for a moment, be in the bushy shadows, maybe then feel "wren"— that is to have joined in a larger moment with the world.

— Gary Snyder, *Language Goes Two Ways*, (1930–present)

Time Estimate:

90 minutes

Best Season:

All seasons

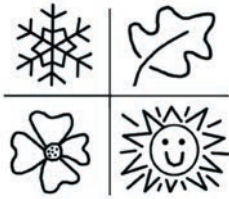

Assessments

- 1 Record one observation in detail or several small observations.
- 2 Make observations using multiple senses (e.g. smell, touch, hearing).
- 3 Remain on task and do not be disruptive of fellow students.

Overview

A field journal can be used to record observations and questions, to make drawings, and to pursue ideas. This lesson is an introduction to using a field journal for all of these things and more. Students can use their field journals to support their study of native plants and ecosystems. It can be a handy reference for places they have visited, new terms they have learned, and plants that they have identified.

Teacher Hints

- ◆ Share some plant related field journal entries from Lewis and Clark's *Voyage of Exploration* or excerpts from other explorers with your students. Show them the journal entries to show how the authors used drawings to enhance their writing.
- ◆ Before beginning, read students a few passages from Aldo Leopold's book, *A Sand County Almanac*. If possible, make a few copies available for students to read further on their own. Consider assigning passages for students to read at home.
- ◆ For students who are reluctant to write, encourage sketching. Ask them to add a few words about their drawing, maybe notes on size or color. Ask them to record the weather and the date. Each time have them include a little bit more written detail about their drawings. Pretty soon they will be writing!
- ◆ When you take students outdoors for journal writing, act as the timekeeper. Have them observe quietly for 10 minutes before they start to write. Then allow them 20 minutes to write and draw. Give them a few minutes of warning before time is up, to allow them to gradually return to the group after their time alone. Allow 15 minutes for sharing.
- ◆ Have students record journaling prompts from the directions and have students tape these to the inside cover of their journal. Encourage them to refer to this list whenever they have trouble starting.
- ◆ A field journal is an excellent way to cross subject barriers to integrate science with studies of language, history, and art.

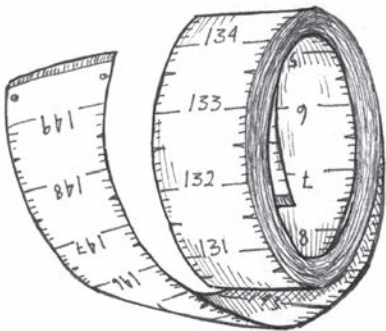



Field Journaling: Observations from a Special Spot

To see a wren in a bush, call it "wren," and go on walking is to have (self-importantly) seen nothing. To see a bird and stop, watch, feel, forget yourself for a moment, be in the bushy shadows, maybe then feel "wren" — that is to have joined in a larger moment with the world.

— Gary Snyder, *Language Goes Two Ways*, (1930–present)

Materials Needed

- ◆ field journal
- ◆ pencil
- ◆ colored pencils, crayons, or paints (optional)

Learning Objectives

- ◆ Practice observation skills using sight, sound, smell and touch
- ◆ Use multiple styles of writing to record nature observations
- ◆ Promote awareness of seasonal changes and patterns through observations over time
- ◆ Use a field journal as a tool to gather, analyze, and interpret data in field research

Vocabulary Words

observation

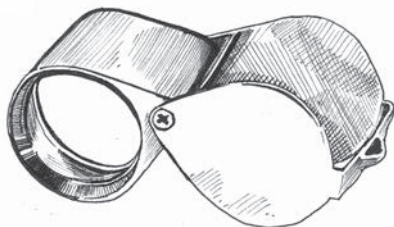

Overview

A field journal can be used to record observations and questions, to explore your feelings, to make drawings, and to pursue ideas. A field journal can contain lists, poetry, data, and sketches. This lesson is an introduction to using a field journal for all of these things and more. You can use your field journal to support your study of native ecosystems. It can be a handy reference for places you have visited, new terms that you have learned, and plants that you have identified.

Background Information

Developing **observation** skills takes practice. Using a field journal regularly can help you hone your observation skills as well as record and reflect on the experiences you have in the natural world. You can use writing, drawing, and photographs to make entries and guide the observation process. There is no right or wrong way to keep a field journal – each person will bring her or his own unique style. The more time you spend recording in your field journal, the more you will see and notice around you, and the more fun it will become! If you keep detailed notes, you will be able to record seasonal and year to year changes going on around you. Practice using your field journal throughout your native plant study and it can become a useful reference.

A field journal is a great place to record observations you make in the natural world. Great naturalists and scientists throughout history have kept extensive field journals, many of which continue to be used for scientific inquiries today. For example, the journals of Lewis and Clark provide excellent information and illustrations of the flora and fauna and climate of the regions they explored over 100 years ago. The journals of famous naturalists Henry David Thoreau, Aldo Leopold, and many backyard naturalists have been used to track environmental changes, inspire naturalists, and inform scientists. Use your journal as a portfolio to keep information learned in studying nature, a place to record "I wonder" questions to pursue, and for inspiration in your writing and art work. As you get older, your field journal will be a great place to look for fond memories of cool places you have visited, interesting critters or phenomena you have observed, and poetic thoughts you have recorded. In addition, looking back on your journal is a great way to track how many new things you have learned as time flies by. Your journal may be an excellent record of your history when you become a famous scientist, but first and foremost, your journal is for you.



Field Journaling: Observations from a Special Spot

Student Directions

Make your journal:

1. Create a field journal to collect your work and to record your thoughts, questions, and observations while studying nature. Use a composition book, spiral bound book, "Rite in the Rain" journal, or make your own.
2. Personalize your journal by decorating the cover and include your name and dates the journal will cover.
3. Always bring your field journal to class with you and add your thoughts, discoveries, and questions. In addition, take it on field trips, and record your observations when you are outside of class.
4. With every journal entry, always begin by recording the date, time of day, location, and the weather.

Choose a special spot:

5. Find special spot in a natural area, close to the school, or near your house; this should be a location you can return to and visit throughout the year. Select your spot by yourself and take note of where you are so that you can return at a later date. Settle into your spot and quietly spend at least 10 minutes just observing, without writing. Really get to know your spot: look at it, smell it, feel it, and listen. Who and what else is there with you?
6. Look closely at a leaf or bit of soil. Look in the distance at the horizon. Look at the nooks and crannies around you.

7. Listen carefully for loud and softer sounds, to the wind, insects and birds. What else do you hear?
8. What sensations do you feel? Coolness or warmth, something soft, hard, sharp, fuzzy?
9. Explore the smells—of the soil, plants, and the air. Do these smells remind you of anything?
10. Describe how it feels to sit in this spot. Do you feel peaceful and relaxed?
11. What is happening at your spot? Are there cycles, natural processes or food webs you can observe?
12. Who or what has been at your spot before you? What signs show you they were there?
13. How is your spot part of the larger area surrounding it?
14. Enter your observations in any form that you want - you can make lists, write an essay, jot down thoughts, write a poem, create a drawing, or any combination or the above.
15. Make sure you have noted the date, time, and the location of your special spot so you can return for later observations.
16. Gather as a class and share your observations. How were they similar or different? Did you discover anything about your spot that surprised you?

Taking it Further

- ◆ Visit your special spot monthly (or more often if you like) and create a record of changes over time. If you can, visit your spot for more than one year: look for recurring patterns and differences from prior years.
- ◆ Identify 2-3 plants (or more!) at your spot. Explore some of the reasons that you think they are well-suited to your spot.





Field Journaling: Observations from a Special Spot

In the Field!

Take your field journal on all your field trips. When you first arrive, make general observations and record them in your journal. During your trip, focus on one thing that catches your eye to write about further. At the end of your trip look over your entry and add any details that you would like to remember about your trip. Don't forget to record the date and add general information about the location and weather.

Science Inquiry

- While at your special spot, use an "I wonder" statement to generate ideas to investigate further (for example: I wonder why there is only one oak tree in the field?)
- Now jot down some possible explanations for your question (e.g. there is only one oak tree because someone planted it, or a deer ate the others as seedlings, or fire burned all but one oak acorn). Use observations about the area to form your hypotheses.
- Try to generate ways to test your ideas or research the answer to your question. Enlist your teacher for help if needed.



Reflection

- Create a story based on your observations.
- Use your observations, your knowledge of plant ecology, and, most importantly, your imagination to develop a story of the site history of your spot. Explain how the vegetation and other features have changed over the years, being sure to give explanations of why and how these changes have occurred. How might the history of this spot explain the characteristics you observe there now?

Assessments

- 1 Record one observation in detail, using words and drawing.
- 2 Make observations using more than one sense.
- 3 Remain on task and be courteous of other students working.

Resources

- The journals of the Lewis and Clark expedition online (see actual journal entries): <http://lewisandclarkjournals.unl.edu/>
- Leopold, Aldo, Charles Walsh Schwartz. 1966. *A Sand County Almanac. With Other Essays on Conservation from Round River.* New York: Oxford UP.
- The journals of Henry David Thoreau (typewritten excerpts): http://thoreau.library.ucsb.edu/writings_journals.html
- National Wildlife Federation article about Thoreau and phenology: <http://www.nwf.org/nationalwildlife/article.cfm?issueID=117&articleID=1510>
- Leslie, Claire Walker and Charles E. Roth. 2000. *Keeping a Nature Journal: Discover a Whole New Way of Seeing the World Around You.* Storey Publishing, North Adams, MA.
- Field journal resource: <http://www.amnh.org/>



What's In a Name?

What's in a name? That which we call a rose by any other name would smell as sweet.

—William Shakespeare (*Romeo and Juliet*)

Time Estimate:

15-20 minutes inside;
additional time needed for
field journal and outside

Best Season:

fall,
winter,
spring



Preparation

Student pairs will need access
to a computer with internet
capability.

Additional Information

- ◆ <http://www.calflora.net/botanicalnames/pronunciation.html> : Botanical Latin hints
- ◆ <http://plants.usda.gov/> : USDA NRCS PLANTS Database home page
- ◆ *The Jepson Manual: Higher Plants of California.* Hickman, James C (ed.). University of California Press, Berkley, 1996.
- ◆ <http://oregonstate.edu/dept/ldplants/sci-names.htm> : Concise information on scientific names
- ◆ <http://ibot.sav.sk/icbn/main.htm> : International Association for Plant Taxonomy website with the official regulations on botanical nomenclature

Overview

This lesson uses a technology-based practical application to explore scientific names. Students will access the United States Department of Agriculture (USDA) website to explore some of the challenges with using common names. They will learn a brief history of scientific names, general rules on how to write scientific names, and hints for pronouncing botanical Latin.

Teacher Hints

- ◆ Plants commonly referred to as “thistles” provide an excellent opportunity to explore the utility of scientific names and the challenges with common names. For example, the plants in the genus *Cirsium* are referred to as thistles, while the genus *Centaurea* represents star thistles, plants in the genus *Sonchus* are sowthistles, and plants called Russian thistles are in the genus *Salsola*. Each of these genera, however, are distinctly different. Make a set of thistle identification cards for your region. Find photos and a species list on the USDA PLANTS database site. Use these cards when you go out in the field to help students identify the “thistles” found in your area. When using photos from this site, set a good example for your students and include the credits on your cards. This may also be set up as a student project.
- ◆ If your students need extra practice to remember the proper techniques for writing scientific names, make up a worksheet writing scientific names incorrectly and have students rewrite them in the correct form.

Assessments

- 1 Students can recognize and use proper formatting for written scientific names. (capitalization—Genus, species; *italics* if typed, underlined if handwritten).
- 2 Students can describe at least one situation where it is important to use scientific names and why.
- 3 Students can name at least one situation where using a common name is preferable.



What's In a Name?

What's in a name? That which we call a rose by any other name would smell as sweet.

—William Shakespeare (1564-1616), *Romeo and Juliet*

Materials Needed

- ♦ internet access
- ♦ digital camera for use outdoors (optional)

Learning Objectives

- ♦ Become familiar with a technical website resource to gather scientific information
- ♦ Understand the function of scientific names
- ♦ Understand the importance of using scientific names
- ♦ Understand the uses for common names of plants
- ♦ Write scientific names in the proper format

Vocabulary Words

genus/genera
species
binomial nomenclature
scientific name
common name
taxonomy



Overview

This lesson uses a computer-based application to explore the importance of scientific names. Using the USDA PLANTS database website, you will explore the importance of using scientific names to describe plants and the challenges that arise from the use of common names. You will do this by researching a group of familiar and common plants, the thistles. Learn the history of scientific and common names, formatting guidelines for writing names, and hints for pronouncing botanical Latin that will make you sound like a pro.

Background Information

Chances are you are familiar with a plant called a thistle. The name “thistle” is a common name used to describe many different plants that are spiny or prickly. However, some plants that are called thistles have no spines. If someone says they saw a thistle, how do we know which one they are describing?

Common names can function appropriately when everyone uses the same name for the same plant. However, this is a rare occurrence. Most plants are known by more than one common name. Sometimes these names differ from one region to another. Common names also do not cross over language barriers. Imagine a plant found in both Arizona and northern Mexico, where the common name for a plant found in both of these neighboring places would be different in Spanish and English. This variation can make plant names very confusing! In spite of this variation and the challenges that arise from it, common names are used frequently. They are easy to pronounce, can be easier to remember than scientific names, and are often descriptive of the plant (i.e. blackberry). All of these factors contribute to the utility of common names in communicating with your friends and acquaintances in your community. However, there is often a need for a greater level of accuracy than common names allow. For this use, we have a standardized system of scientific names that do not change by language, region, or local usage. As you learn some of the Latin roots used to make scientific names, they become easier to understand and remember, and can help you learn more about the cool plants where you live.

Scientists have experimented with many systems for classifying living things. Prior to the invention of our current system, scientific names were long descriptive phrases that were hard to remember. An example of a plant name under one such system was *Physalis annua ramosissima ramis angulosis glabris, foliis dentato-serratis*. Now that is hard to remember! The system in use today was created by Carolus Linnaeus (1707-1778), a Swedish botanist and physician. Linnaeus's system, referred to as binomial nomenclature (bi = two, nomen = name, calo = call), involves a standardized two-part name.

What's In a Name?

Background Information, continued

In binomial nomenclature, the name for the species above was shortened to *Physalis annua*. Although other earlier scientists had worked on such a system, Linnaeus formalized the system and in 1753 published names for all known plant species in his book *Species Plantarum*. Linnaeus is credited with implementing the hierarchal classification system and is often referred to as the father of taxonomy (the science of classification).

This hierarchal classification system uses the genus name and a species name to make up the scientific name of an organism. Scientific names use Latin and sometimes ancient Greek as the root sources. Latin was chosen for several reasons; it is not used as a modern spoken language and therefore does not change with slang and the introduction of new words, it was historically used for scientific classification, and it allows for the standardization of scientific names regardless of the native spoken language. This naming system gives each species a surname and a personal name, just like you. For example, if your name is Sally Ford, your surname is "Ford," and your personal name is "Sally." In binomial nomenclature, the equivalent of a surname is called the genus and the equivalent of the personal name is called the specific epithet. However, in this system of naming, the genus name comes first and the specific epithet comes second. For example, the Latin name for oak trees is *Quercus*. This is the genus name, which is shared by the "sibling" species of oak, just as siblings share a last name. Each "sibling" oak has a unique species name, similar to how your first name and your siblings' first names are unique in your family. For example, in the eastern United States, you are likely to come across red oak, *Quercus rubra* (rubr = red). As you travel west you may encounter *Quercus ellipsoidalis* (ellipsoid refers to this species' ellipse-shaped acorns) in the interior of the country. You could find *Quercus gambelii* (named after the naturalist William Gambel) in the arid West.

Just like you may know other students who have the same first name as you, sometimes the specific epithet for two different plants are the same, but only if those plants are in different genera.

Scientific names often reference a physical characteristic of the plant, a famous person or scientist, or the geography of a plant's range. They can come from a person (*Lewisia* for Capt. Meriwether Lewis), ancient Greek (*Daphne* from Greek mythology), a local language (*Camassia* for a Native American word Camas), a false resemblance (*Pseudotsuga* = a false *Tsuga*), a place (*tennesseensis* = Tennessee), a color (*alba* = white), a landscape where the species might be found (*montanum*=mountain) or a description (*contorta* = twisted).

To maintain this standardized naming system, there are some basic rules.

- The genus is listed first and is always capitalized.
- The specific epithet is listed second, is never capitalized, and is unique among members of the same genus.
- The entire two-part name should be underlined if hand written or in *italics* if typed.
- When writing a name multiple times, use the entire name the first time. In successive uses of the scientific name in the same work, abbreviate the genus by using only its first letter, e.g. *Quercus rubra* becomes *Q. rubra*.

Botanical Latin Tips

from *The Jepson Manual: Higher Plants of California* (pg. 11,12)

Many people avoid using scientific names because they don't feel comfortable pronouncing them. For each new Latin name you encounter, remember that there is commonly more than one way to say it. Botanist William Stearn said, "Botanical Latin is essentially a written language, but the scientific names of plants often occur in speech. How they are pronounced really matters little provided they sound pleasant and are understood by all concerned..." Even professional botanists can be strikingly different in the way they pronounce names. If you feel unsure of yourself, remember a bit of wisdom from a wise botanist: "When someone presumes to correct your pronunciation, a knowing smile is an appropriate response."



What's In a Name?

Quick tips for pronouncing Latin

1. Divide words into syllables (it is safe to assume every vowel belongs to a different syllable)
2. Pronounce every syllable
3. General practice is
 - **a:** "ah" not "ay"
 - **e:** "eh" not "ee"
 - **i:** "ee" not "eye"
 - **y:** as in "cynic" not "eye"
 - **ae:** "eye" not "ee"
 - **ii:** held longer "eeee"
 - **ti, ci:** "tee" or "cee" not "she"
 - **ch:** generally "k" not as in "ouch"
 - **g:** as in "go" not "gem"

Student Directions

1. Each person or pair needs to work at a computer with internet access. Use the handout at the end of this lesson as a guide.
2. Go to the website <http://plants.usda.gov/>. This website is designed for use with scientific or common names.
3. Search on the USDA Plants Database website for the common name "thistle." Search options are located on the upper left of the homepage. Type in the word "thistle" and chose the option "common name."
4. How many records are returned (noted at the top of the results page)?
5. How many different genera come up for the name thistle?
6. Scan down the right hand column of common names. Locate "common sowthistle" and write down the scientific name for this plant using proper form.
7. Click on the "common sowthistle" entry to learn more. Would you find this plant in your state? Is this plant native or introduced? If introduced, where did it come from (hint: you will need to search further on related links to answer this question)?
8. Look at the pictures on the website. Have you seen this plant before? Examine the pictures and look for it on your walks around town or on trips to the country.
9. Now look specifically at the genus *Cirsium*. How many *Cirsium* species are there in your state? Find one species of *Cirsium* that is invasive and one that is native to your state and write their common and scientific names on your worksheet.
10. Now click on the map of your state on the website and see if you can find a species of thistle that is found specifically in the county where you live.
11. Investigate the Latin word definitions of the scientific names you found. Look up both the genus and specific epithet. You can use a website such as: <http://www.winternet.com/~chuckg/dictionary.html>. Why do you think it was given the scientific name that it has?



What's In a Name?

Taking it Further

- ◆ Do another name search based on a common plant name in your ecoregion (try daisy) or a plant from your field work.
- ◆ Research the naming conventions for Latin, base words, prefix/suffixes, and form agreements.
- ◆ Research and write a paper on the history of plant taxonomy or a famous botanist (some examples: Carolus Linnaeus, David Douglas, Meriwether Lewis, etc.).

Self Assessments

- 1 Can you write scientific names in the proper format?
- 2 Name a situation where it is important to use scientific names and explain why.
- 3 Name a situation where using a common name is preferable.

Reflection

- ◆ Now you are familiar with a great botanical web resource.
- ◆ Brainstorm and describe how databases such as the
- ◆ USDA Plants Database might be used for conservation
- ◆ or scientific projects.



In the Field!

Find all the plants in your area that people call "thistles." A good place to start is by searching the common name "thistle" on the PLANTS database site. Record your findings. While in the field, take a photo, make a sketch, or make an herbarium specimen in a plant press. In the classroom, identify and label each photo, sketch, or pressing with the scientific name, and write a description of each plant. How many different "thistles" did you find?

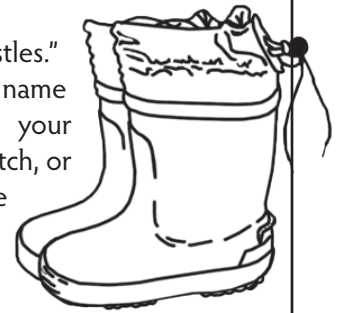

Science Inquiry

Collect at least two plants that people call "thistles" but are different species, and if possible, are from different genera. Use a dissecting scope or a hand lens to carefully look at your specimens. Make sketches and notes about your observations. What makes these species different? Be sure to look at all of the plant parts and note the differences. Now make notes about the similarities. What features do you think led people to call both of these plants "thistles?" Can you think of a better common name that reflects what is unique about these species?



References

- ◆ Stearn, William T. *Botanical Latin*. David & Charles, London, third edition 1983 pp.53-54.
- ◆ USDA, NRCS. 2008. The PLANTS Database (<http://plants.usda.gov>, 4 September 2008). National Plant Data Center, Baton Rouge, LA 70874-4490 USA.
- ◆ Hickman, James C. *The Jepson Manual: Higher Plants of California*. University of California Press, Berkley, 1996



What's In a Name?

Names _____ Date _____

Go to the website <http://plants.usda.gov/> to start your search

1. Search for the common name "thistle." How many records are returned? _____
2. Count the number of different genera with the common name "thistle." How many do you find? _____
3. Find "common sowthistle." What is the scientific name for this plant? _____
4. Click on common sowthistle to learn more about this plant. Is this plant found in your state? _____
5. Is it a native plant or introduced species? _____
6. If introduced, where did it originally come from? _____
7. Download a picture of the sowthistle with proper photo credits. Have you seen this species? _____
If so, where did you see it? _____
8. What is the meaning of the scientific name for the common sowthistle? Use this website:
<http://www.winternet.com/~chuckg/dictionary.html>.

9. Why do you think it was given its scientific name? _____

10. Now do steps 1-9 for the genus *Cirsium*. Write what you find here. Can you find any native species in that genus?



Botanical Terms Challenge

Learn a new language and get a new soul. —Czech Proverb

Time Estimate:

30-45 minutes

Best Season:

any



Teacher Hints

- ◆ Include this activity in students' field journals for a vocabulary reference on field trips and during outdoor activities.

Assessments

- 1 Give students a stem with leaves, flowers, or fruits attached and ask them write a description using at least 4 new vocabulary words.
- 2 Read students the description of a particular plant species from a field guide. Have students sketch the whole plant or plant part with only the description to guide them.

Overview

Students gain an understanding of plant structure and descriptive botanical terminology required for advanced botanical studies.

Preparation

- ◆ The crossword included in this lesson is designed to be a review of botanical terminology. Some students may have learned these terms in grades K-8 while others may be learning them for the first time. The words learned in this section are used throughout the curriculum. If students do not have any experience with plant terminology or need more than a quick review, use the included Botanical Terms Self-Study sheet to review or introduce basic botanical terminology.
- ◆ Assemble sufficient references for student teams to work on definitions independently. Field guides, internet resources, and biology/botany textbooks listed in "Additional Information" below are good options. Discuss how to determine if a source of information is reliable, especially if students are using the internet.
- ◆ For the "In the Field!" section, collect twigs with more than one leaf to show twig attachment patterns. Each team should use a different species.



Additional Information

- ◆ Harris, James G. and Melinda Woolf. 1994. *Plant Identification Terminology: An Illustrated Glossary*. Sixth Edition. Spring Lake Publishing, Spring Lake, Utah.
- ◆ A discussion of leaf form and function; includes possible journaling topics: <http://www.learner.org/jnorth/tm/tulips/FormFunction.html>
- ◆ A long list of botanical terminology and definitions : <http://www.calflora.net/botanicalnames/botanicalterms.html>
- ◆ Most field guides contain glossaries of plant terminology.
- ◆ A teacher resource with techniques for teaching new vocabulary to students : http://www.nifl.gov/partnershipforreading/publications/reading_first1vocab.html

Botanical Terms Challenge

Learn a new language and get a new soul. —Czech Proverb

Materials Needed

- ◆ colored pencils for drawings (optional)

Vocabulary Words

Basic plant anatomy:

root	fibrous root
taproot	stem
vein	petiole
axil	leaf margin
bud	flower
fruit	seed
node	internode

Leaf shapes & patterns:

simple	compound
opposite	alternate
whorled	basal
palmate	pinnate
lobed	

Basic flower and fruit parts

sepal	petal
tepala	bract
pistil	ovary
carpel	style
stigma	peduncle
stamen	filament
anther	receptacle

Overview

This lesson will teach basic and advanced botanical vocabulary so that users can identify and describe plant anatomy and function. This will ease identification and lead to a better understanding of plant biology. The vocabulary list below contains essential plant terminology for activities in this curriculum.

Learning Objectives

- ◆ Understand basic botanical terminology required for high school level activities
- ◆ Increase botanical vocabulary to assist with describing and identifying plants
- ◆ Relate plant structure to function

Background Information

One of the most formidable tasks of the aspiring botanist is gaining a working knowledge of the vast terminology required to use a typical plant identification guide. Botanists love to make up new words that are rarely used outside of the world of botany! The experience of trying to properly identify a plant without a working botanical vocabulary can be challenging and frustrating for the beginning plant lover. The purpose of this lesson is to teach you basic botanical terms and introduce some more complicated terminology.

Botanists commonly use several different words to describe similar things. For example, if a plant has hair on its leaves, there are several possible words that you may use to describe the type of hair you see. A leaf that is tomentose would have lots of short, woolly hairs; a leaf that is pubescent would have short, soft hairs; a scabrous leaf would be rough to the touch, resulting from the presence of stiff short hairs. And the list goes on... One might question why we need to differentiate between types of hair. The easy answer to this is that different hairs serve different functions. For example, tomentose leaves are nearly white in appearance, making them able to reflect solar radiation in high light environments so they do not burn. Scabrous leaves may serve to deter insect predators and herbivores. When you are learning these new terms, try to think a bit about how the form you are learning about may serve a useful function to the survival of a plant.

Often, botanical terms can be best described with a simple illustration rather than words. Refer to the illustrations on the following page to learn about some of the basic parts and shapes of plants. You can also utilize the websites and books listed in the "Resources" section to find pictures of the words in your vocabulary list.

It is important that everyone in your group develop a similar basic foundation in plant anatomy and terminology. This activity is self guided—you can proceed at your own speed, or you may choose to work with a partner. Your goal should be to become familiar with all the terms listed in this activity.

Botanical Terms Challenge

Leaf Types

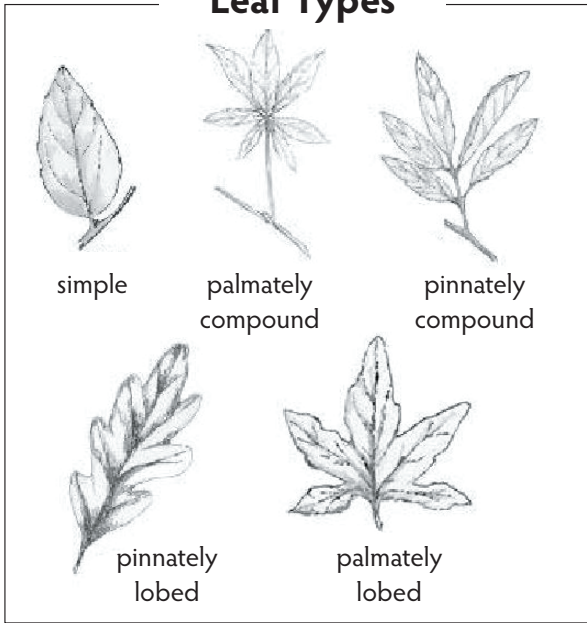

Leaf Shapes

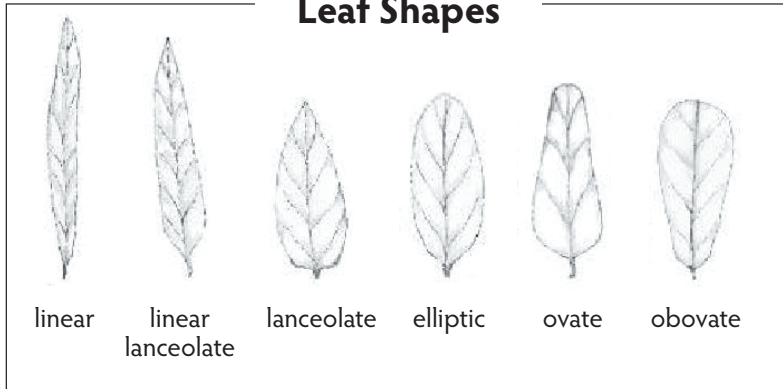

Leaf Attachments & Arrangements

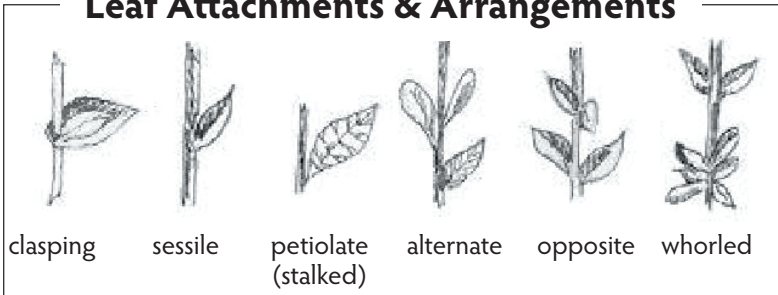

Above illustrations (not including Parts of a Perfect Flower) done by Adair Peterson taken from *Wildflowers of the Northern and Central Mountains of New Mexico* by Littleton and Burns

Parts of a Perfect Flower

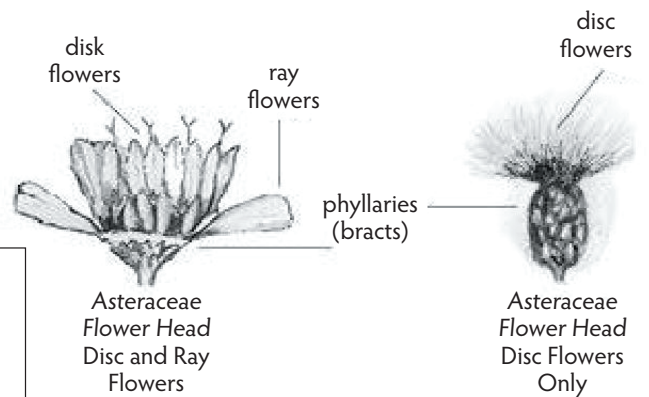
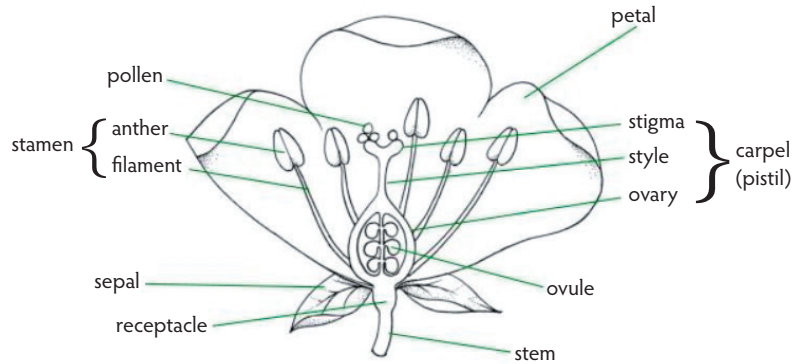

Common Types of Asteraceae Involucres

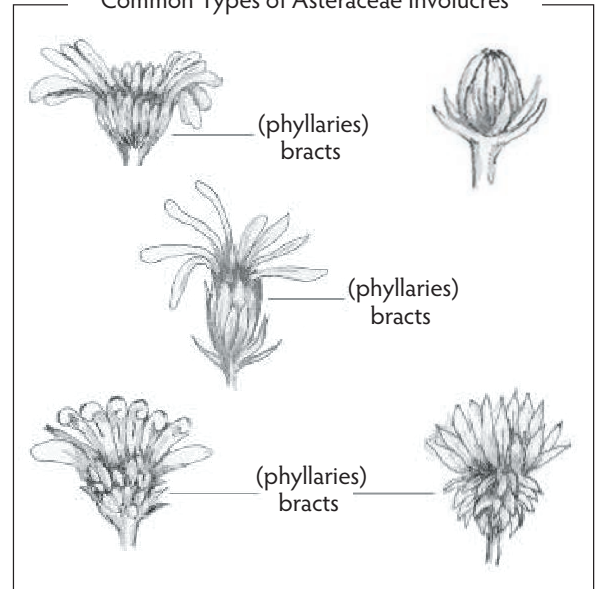

Inflorescence Type

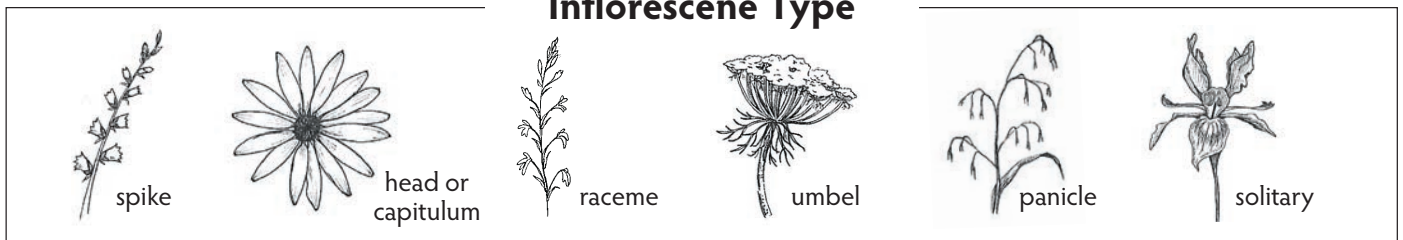

Student Directions

Option 1: Vocabulary Building Sheet

1. Work individually or in pairs.
2. Complete vocabulary sheets by writing one new word in each box. In the appropriate columns, write a definition and the knowledge connection. The knowledge connection should be a reference to the function of the plant part or something else about the word that will help you to remember it. Fold your paper to cover all but the word column; this will line up a drawing box on the back of the sheet with each word. In this box, draw a simple illustration of the vocabulary word. Use field guide glossaries, textbooks, or internet sources to complete the definition and knowledge connection boxes.
3. Use your completed sheet to test yourself. Fold the paper so that the vocabulary word and drawing are visible. Can you give a definition and function for this plant part? If you need a clue, uncover the knowledge connection column. Check your answer by uncovering the written definition.

Option 2: Crossword

1. Work individually or in pairs to complete the Botanical Terminology crossword. The words in this puzzle are basic terms that you will need in future lessons. Use the glossary, field guides, textbooks, or internet sources to complete your crossword.

Taking it Further

Build your botanical vocabulary by using the vocabulary sheets to learn the lingo in "The Secret Life of Flowers" and "Drupes, Pomes, and Locul icidal Capsules: a Botanist's Lingo for Describing Native Fruits" lessons. If you are a real plant nerd (an excellent thing!), make your own vocabulary lists! Look through the glossary section of your favorite local field guides and add words that you feel are important in your plant study.

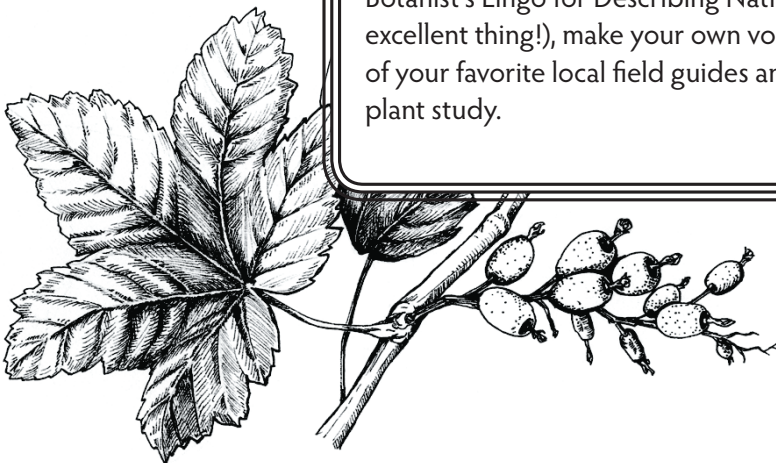

In the Field!

[Note to Instructor: Each team should collect a plant with leaves attached (be sure students are aware of poison oak, poison ivy, poison sumac, and giant hogweed!) and attach a number label to it. Be sure each team works with a different species.]

1. Use unlined paper and fold it in half widthwise to make 2 – 5.5" x 8.5" sections. Record team member names and your plant's number on the back of your paper.
2. On one half of the front of your paper, sketch your twig and leaves showing important details. Be sure to show the leaf attachment, shape, margin, and anything that would help others to identify your plant. If you have them, use a magnifying glass or a hand lens to look closely at the hairs and textures on the leaves and stem of your plant.
3. On the other half of the front of your paper, write a detailed description of your plant. Make sure the description matches your drawing and is as complete as possible. Use terminology from the vocabulary list.
4. Collect the twigs and description papers. Display the twigs with the numbers visible so that teams can rotate around to view them. Fold the description papers in half. Shuffle and hand out the description papers to the teams with the description side visible and the drawing hidden. Encourage students to use only the written description, not the drawing, to make the match. Try to match the written descriptions on the paper to one of the numbered twigs.
5. Assess your description. Did it make matching the twigs easier or more difficult? If some of the twigs were similar, how much detail is needed to make a correct match? What else could you have included that could have made matching easier? Would measurements help?

Science Inquiry

For each of the following growing conditions, make a list in your field journal of the leaf characteristics that you think would help a plant thrive: windy, very dry, very wet, low light (shade), and high light (full sun). Keep your list for testing in future lessons.

As you explore different habitats, take note of the leaf characteristics. Do leaves in a sunny meadow tend to look different than the leaves that you find near the heavily shaded forest floor? How might those leaf characteristics help the plant thrive in that particular habitat?



-
- **Reflection**
 - Make a journal entry about leaf shapes or margins. Make a sketch or leaf rubbing of two leaves that have different shapes. Why do you think leaves come in so many different shapes and with so many different types of margins? Put on your analytical hat and brainstorm. How might those differences benefit the plant?
-



Botanical Terms Challenge

Picture



Botanical Terms Challenge

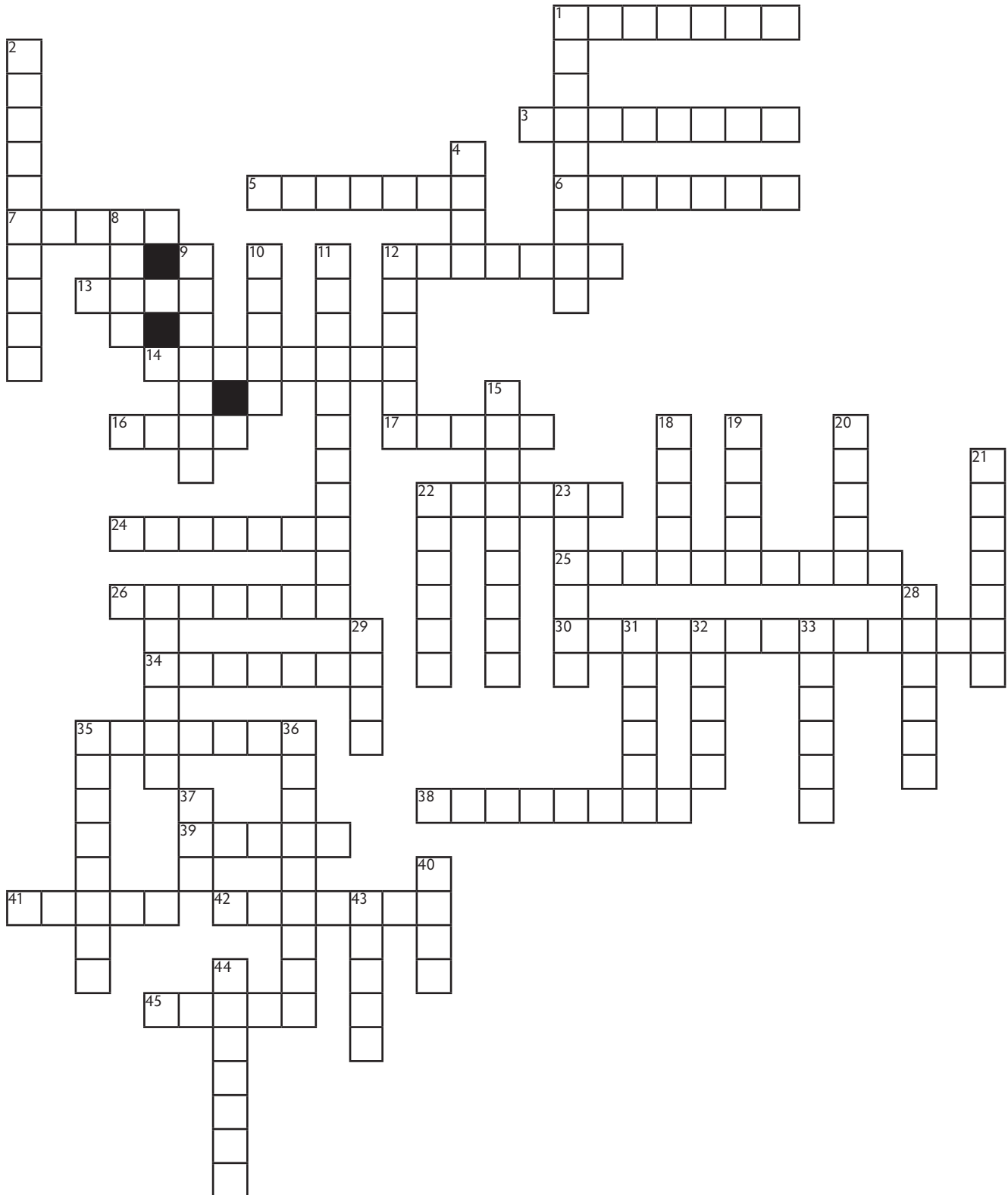

Botanical Terms Challenge

Across

1. Heart-shaped
3. Two leaves growing directly across from each other on a stem
5. Underground stem
6. Without stem, stalk, or petiole
7. Enlarged base of the pistil; contains developing seed
12. Leaflets or veins arranged on each side of a common stalk
13. Small swelling or knob where new growth originates
14. Thread-like stalk that supports the anther
16. A rounded, modified, underground stem for storage, not a root
17. Leaves with margins that are deeply cut, but not all the way to the midrib.
22. Portion of pistil receptive to pollen
24. Leaf that is divided from a central point into lobes
25. Structure atop the stem where flower parts attach
26. Division of a compound leaf
30. Cluster of flowers
34. A primary, thick root
35. The whorl of a flower comprised of the petals
38. Single flower, not in a cluster
39. Umbrella-like inflorescence with multiple small flowers
41. Ripened flower part that contains the seeds
42. Branched inflorescence; central stalk with side stalks containing multiple flowers
45. Unbranched inflorescence with single, unstalked flowers

Down

1. Inflorescence with numerous small flowers on a single base
2. Leaves that are significantly longer than wide and widest below the middle, gradually tapering toward the apex
4. Transports water, sugars, and minerals within the leaf
8. Anchors the plant and takes up nutrients and water
9. Stalk that attaches the leaf to the stem
10. A modified leaf in the whorl between the sepals and stamens, often colorful
11. Fruit doesn't open at maturity
12. Female reproductive structure of the flower
15. Fruit opens at maturity
18. Part that connects the stigma to the ovary
19. Small, leaf-like part at the base of a flower
20. Positioned at the base of the plant
21. Leaf arrangement where three or more leaves arise from the same node
22. Male reproductive structure of the flower
23. Edge of a leaf
27. Leaf margin that is not toothed, notched, or divided
28. Enlarged, pollen-bearing part of the stamen
29. Above-ground plant part that supports leaves and flowers
31. Often colorful and showy; the reproductive unit
32. Oval or egg-shaped
33. Undivided leaf
35. Leaf divided into two or more leaflets
36. A leaf arrangement along the axis in which the leaves are not opposite to each other or whorled
37. Undeveloped stem or flower; covered with scales
40. Blade; primary site of photosynthesis
43. Flower whorl beneath the petals
44. Branching root system

Self Assessments

- 1** Examine a plant specimen. Write a thorough description using the vocabulary words in this lesson. Your description should include the shape and arrangement of the leaves, flowers, and fruits as well as any other key characteristics that would help someone identify the plant you are describing.
- 2** Use your Vocabulary Building Sheet and quiz yourself. Keep your sheet and refer to it throughout your study.
- 3** Work with a partner. One partner will read a plant description from a field guide aloud. The other partner will sketch the plant from the written description only. The reader will need to give detailed and complete descriptions.



Resources

- ♦ Harris, James G. and Melinda Woolf. 1994. *Plant Identification Terminology: An Illustrated Glossary*. Sixth Edition. Spring Lake Publishing, Spring Lake, Utah.
- ♦ Hough, John. 1953. *Scientific Terminology*. Rhinehart & Company, Inc.: New York.
- ♦ A long list of botanical terminology and definitions:
<http://www.calflora.net/botanicalnames/botanicalterms.html>
- ♦ Most field guides contain glossaries of plant terminology. See appendix I for suggested field guides for your area.
- ♦ A discussion of leaf form and function; includes possible journaling topics:
<http://www.learner.org/jnorth/tm/tulips/FormFunction.html>



The Secret Life of Flowers

Nobody sees a flower really; it is so small. We haven't time, and to see takes time—like to have a friend takes time.

—Georgia O'Keeffe (1887-1986)

Time Estimate:

1 class session,
additional time for
art project

Best Season:

spring

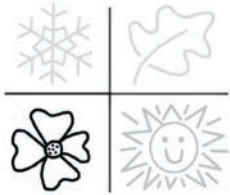

Teacher Hints

- ◆ Divide students into teams and give each team a flower in water.
- ◆ Give students time to explore their flowers. Hand out a flower anatomy diagram sheet or project on an overhead for classroom viewing. Take a minute to point out the parts of the flower. Explain that it can be called a perfect flower if it has both male and female parts, or an imperfect flower if it has only male or only female parts.

Overview

Students will dive into the inner workings of a flower and put their own creative spin on their findings, combining science observation with artistic appreciation and expression. In the process, they will learn flower anatomy, function, and inflorescence type.

Teacher Preparation

- ◆ Set up a classroom display of inflorescence types for students to view. Use live flowers, if available, labeled and in water. If live flowers are not available, use photographs.
- ◆ Visit your local farmers market or ask a florist to donate slightly wilted flowers to use in this activity.
- ◆ For dissecting, choose large, solitary flowers. Flowers in the lily family are especially useful for this activity because their floral anatomy is generally well developed and easily viewed.

Assessments

- 1 Label the parts of a flower and name the function of each.
- 2 Define perfect and imperfect flower.
- 3 Describe inflorescence types.

Additional Information

- ◆ <http://biology.clc.uc.edu/Courses/Bio303/coevolution.htm> : an overview of co-evolution with many examples
- ◆ <http://www.fairchildgarden.org/uploads/docs/Education/teacher%20training/flower%20power/Flower%20Dissection%20LabII.pdf> : advanced flower dissection lesson
- ◆ <http://pollinator.org/nappc/index.html>: Natures Partners: Pollinators, Plants, and You; a pollinator curriculum, with excellent background information



The Secret Life of Flowers

Nobody sees a flower really; it is so small. We haven't time, and to see takes time—like to have a friend takes time.

—Georgia O'Keeffe (1887-1986)

Materials Needed

- ◆ large flower for dissecting (one per student pair)
- ◆ Exacto knife
- ◆ labeled flower diagram
- ◆ 11x17 white paper
- ◆ hand lens

Learning Objectives

- ◆ Name and locate the parts of a flower
- ◆ Discuss flower anatomy and function
- ◆ Define the difference between a perfect and an imperfect flower
- ◆ Describe an inflorescence type.
- ◆ Understand the role of pollinators in shaping flower anatomy
- ◆ Understand plant reproduction and the role of pollination
- ◆ Connect left brain and right brain processes of science and art



Overview

What skills do scientists and artists share? Although artists are thought to be more intuitive and subjective, and scientists are often associated with being rational and objective, both utilize a keen sense of observation in their work. In this lesson, you will immerse yourself in the inner workings of a flower, using your creative skills to record your findings. In the process, you will learn flower anatomy, function, and inflorescence types.

Background Information

Some flowers announce their presence with bold colors, while others are more dependent on other features like scent and size for successful pollination. Some are simple in form, while others are more complicated mazes.

Flowers have inspired humans with their beauty and fragrances for centuries, and we've honored them with symbolic meanings ranging from fertility, joy, and love to more sinister interpretations of deceit and death. The ultimate purpose of flowers though is to ensure that plants produce offspring.

While animals can move from place to place looking for a mate, imagine how challenging reproduction is for a plant rooted to the ground! Over millions of years, flowers have evolved with a diverse range of strategies to guarantee that male pollen is transferred to female flower parts so fertilization and seed production can occur. Together, these processes of pollination and fertilization that occur within the flower to produce seeds are a type of **sexual reproduction**, ensuring that genes from parent plants are recombined in novel ways. This diversifies the genetic composition of the resulting offspring (seeds), and thus allows for selection and adaptation (evolution) to occur. It involves the fusing of gametes (sperm and egg) from two partners.

Flowers and seeds are not the only way for plants to create offspring, though. Asexual reproduction, also known as vegetative reproduction, is also common in plants. Asexual reproduction requires no flowers, and results in offspring that are genetically identical to the parent plant. Plants have found many different ways to reproduce asexually. You might be familiar with the stolons, or runners, of strawberry plants, or the "eyes" of potatoes that sprout new growth if left in the cupboard for too long. The branches of many trees and vines can be propagated simply by placing them in damp soil, where they will sprout roots and become separate, self-sustaining plants. Quaking aspen (*Populus tremuloides*) is a tree that makes vigorous use of vegetative reproduction; large stands of what appear to be individual trees are in fact connected underground, and the mass of underground roots continues to put up new trunks as older trees die. Sometimes even leaves can form new plants, like the tiny plantlets that form all along the edge of the leaves of the house-plant "mother of thousands" (*Kalanchoe daigremontiana*).



The Secret Life of Flowers

Vocabulary Words

Flower parts

receptacle	anther
bract	stamen
sepal	style
calyx	stigma
petal	pistil
corolla	ovule
filament	ovary

Inflorescence types and parts

solitary flower	spike
composite head	raceme
peduncle	panicle
pedicel	umbel

Flower types

imperfect flower
perfect flower

Other

sexual reproduction
asexual reproduction
nectar

Background Information, continued

Sexual reproduction is the combining of two sets of chromosomes, one set from each parent, and introduces genetic diversity. **Asexual reproduction** does not introduce genetic diversity as only one parent is involved and no genetic material is exchanged. Asexual reproductions does not usually require flowers, therefore the energy cost is reduced and the process tends to be faster than sexual reproduction.

Vegetative reproduction is an example of asexual reproduction. In this case, plant parts disperse or sprout or root from a parent plant.

A potato tuber is an example of vegetative reproduction. Plants that sprout from the "eyes" of the tuber are clones of the parent plant. Fragmentation is another form of vegetative reproduction. Each fragment grows into a genetic clone of the source plant.

A disadvantage of these processes is that the plants may be spaced closely together and compete for limited resources. Another disadvantage is no new genetic diversity is introduced. Genetic diversity is important if growing conditions change or pests or disease are introduced. This could be a disadvantage if the plant is in poor conditions, as it wouldn't have strong powers of regeneration, and so it wouldn't be able to reproduce. On the positive side, it can produce many new individuals very quickly.

Each method of reproduction has advantages and disadvantages. Each method of reproduction has advantages and disadvantages. Overall, asexual reproduction is faster and requires less energy input than sexual reproduction as flowers, pollen and nectar are energetically expensive to form. The major advantage of sexual reproduction is the exchange of genetic materials, which introduces genetic diversity in the progeny. Genetic diversity serves as a way for populations to adapt to environmental changes and enhances long-term survival of the species. Of course, sexual reproduction has won out in this day and age of flowering plants, which is why we have such beautiful and amazing floral diversity throughout the world.

Since so many plants produce flowers, a basic understanding of floral anatomy will aid you tremendously in the proper identification of plants. In learning to identify plants, it is important to understand that flower anatomy and structure is directly linked to

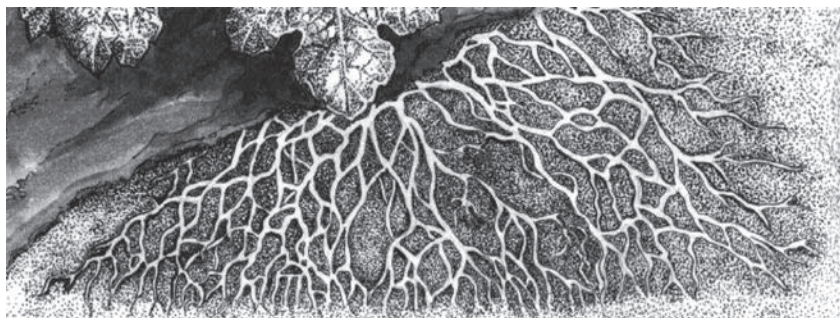



Background Information, continued

pollination. This plant-pollinator relationship one of the best examples of co-evolution in nature.

Relying on wind to move pollen, as grasses, some wildflowers, and many trees do, is the oldest method of pollination. In these cases, plants produce massive quantities of pollen, with only a small amount reaching its destination on another flower of the same species. These species often have small or no petals so as not to block the wind and are rarely showy since they do not need to draw in any pollinators. They commonly have feathery stigmas that comb pollen from the air. But a more efficient — and fantastic — means of pollination, observed widely among flowering plants, is achieved by luring unsuspecting animal partners to inadvertently transfer pollen from one flower to another as they search for food.

Insects — especially beetles, ants, flies, bees and wasps, butterflies, and moths — are the predominant animal pollinators. They have physical characteristics that make them extremely efficient in locating flowers and transferring pollen from one flower to another. Flowers and their pollinators have evolved together throughout time, frequently engaging in relationships in which the two depend on each other for survival.

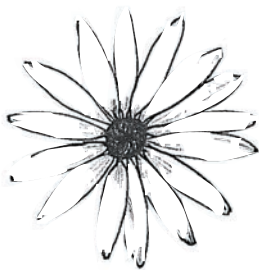

Of course, animals don't do the work of pollination for nothing (or even realize they are doing the work in the first place), so plants offer rewards to attract pollinators. Animals use flowers as sources of food for themselves and their offspring. First of all, animal-pollinated flowers produce **nectar**, a sugary substance that also contains vitamins, amino acids, and other nutrients. The amount of nectar a flower typically produces relates to the needs of its pollinators. Second, pollen itself is a good source of protein for many animals. Finally, a few plants reward their pollinators with fatty oils, resins, or wax.

A typical flower contains the necessary anatomy to support transferring pollen and producing seeds. Flowers come in a

broad range of sizes, shapes, and colors, from beautiful and showy to the modest and plain, but most flowers are made up of the same basic parts arranged in the same order. Flower parts are commonly described as occurring in whorls, or rings, with different anatomical parts usually occurring in the same order, regardless of species.

A flower is attached to the rest of the plant by a stalk called the **peduncle**. At the end of the peduncle is the **receptacle**, which is where the reproductive parts of the flower attach. The first, outermost whorl is made up of **sepals**, which collectively are called the **calyx**. They form a protective, petal-like layer that covers an unopened bud, and are usually small and inconspicuous when a flower is open. The sepals are usually green and peel back as the flower opens; sometimes they will even fall off as the bud opens. In some species, however, the sepals may be large and showy, and may be hard to distinguish from petals. In some flowers, there is an additional whorled ring outside of the sepals. This ring is made up of **bracts**, or modified leaf-like structures. A common example of bracts in a flower is in the Pacific dogwood, *Cornus nuttallii*. What may appear as large, white petals are actually bracts. The petals on this species are actually tiny.

The next whorl in from the sepals is the petals. The **petals** are typically the most noticeable parts of flowers, and are designed to attract and provide platforms for insects, bats, birds, and other roving pollinators. All of the petals of a flower are collectively referred to as the **corolla**. Think of the petals as being billboards or flags advertising and drawing attention to the flower.

The male parts, or **stamens**, make up the third whorl. They can be quite long to maximize exposure to wind and pollinators, or hidden inside the flowers to force pollinators to touch the stigmas on their way in or out, or able to lengthen and shorten over time, as needed. The stamen is made up of the **filament**, a thread-like stalk that supports the **anther**, which produces and releases pollen. Animal-pollinated plants have large, irregular pollen grains with lots of tiny hooks, spines, and craters on the surface. A rough texture and sticky surface ensure that the pollen will stick to a visiting animal's hair, scales, feathers, or appendages and then stay there until the animal visits another flower. At the next flower, the pollen will be rubbed off onto the strategically placed stigma.



The Secret Life of Flowers

Background Information, continued

The center of a flower usually contains the female whorl, the pollen-receiving **pistil**. The stigma at the pistil's tip evolved to trap pollen and may be sticky, feathery, or folded. At the base of the pistil, the ovary protects **ovules** (eggs), which become seeds when fertilized. When they're ready to accept pollen, stigmas prepare themselves for the transfer. They may be pushed upward by the long **style** that supports them, lean toward the male parts, or become stickier. When a pollinator carrying pollen from another plant brushes against the **stigma**, pollen is transferred. If the conditions are right, the pollen grain germinates and sends a tube down the style and fertilizes an ovule, leading to seed production. Once the ovules are fertilized the **ovary** wall changes to become the fruit and protect the developing seeds.

In some cases the ovary wall becomes fleshy and in other cases the ovary wall become dry and hard.

At the base of many flowers are nectaries, which produce the nectar. Since this food treasure is typically tucked deeply in the flower, pollinators are coaxed into touching the flower's reproductive organs, thus transferring pollen in their search for nourishment.

As is always the case in nature, there are exceptions to the rule. Many plants produce flowers containing both male and female parts. These are referred to as **perfect flowers**. But some plant species have some flowers that contain only male parts and some that contain only female parts, both referred to as **imperfect flowers**. In these cases, one of the whorls described above will be absent from the flower's anatomy. In some species, these two types of flowers are located on the same plant; in others they are found on separate plants.

There is a long list of vocabulary that is used to describe the way in which flowers are attached together to form a group of

flowers. Sometimes plants have flowers that are found singly on the plant. These are called **solitary flowers**. More commonly, flowers are found in clusters, called an inflorescence. Like the anatomy of a flower itself, the arrangement of flowers in a cluster varies widely, a testament to the diversity of pollinators and plant adaptations to ensure healthy reproduction. A cluster of small flowers in a flat to rounded shape, such as Queen Anne's Lace, is called an **umbel**. A cluster comprised of a long central stalk with flowers attached directly to the stalk is called a **spike**. A spike with flowers attached by short stalks (**pedicels**) is called a **raceme**. A raceme that is further branched is called a **panicle** (many grasses, but not nearly all!). Flowers in the Sunflower family (Asteraceae) may look like single flowers; however, if you look closely, each flower head is actually composed of numerous individual flowers, sometimes hundreds. These are called composite flowers.

One explanation for the vast and varied differences of flower shapes, sizes, colors, and smells is that flowers have co-evolved with their pollinators. When you are in this indispensable partnership, flowers and pollinators are utterly dependent on one another for survival. In turn, we depend on this process for much of the food we enjoy. In the process of exploring flower anatomy, you gain the skills to understand not only how to identify plants, but also to observe nature's diversity in greater detail.

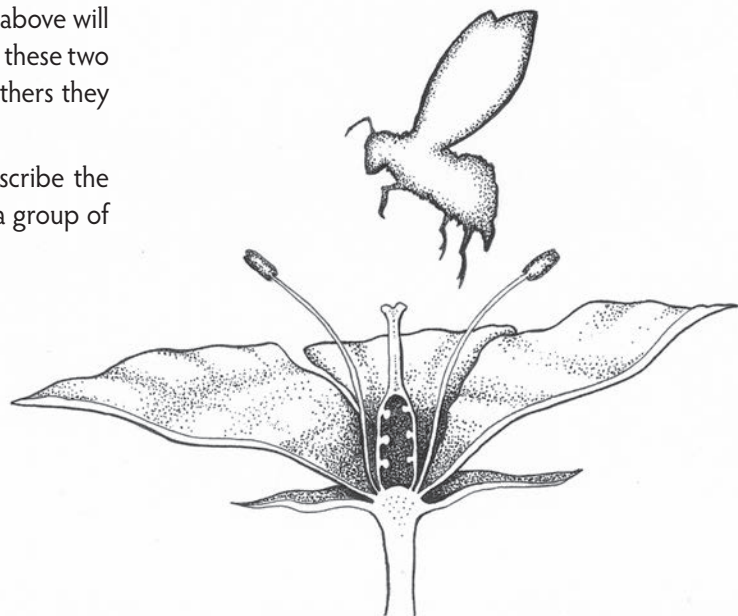



Student Directions

1. Work with a partner on this activity. You will be sharing a flower, but each of you will turn in your own 3-panel sheet. Help each other to locate the flower parts.
2. Observe your flower closely. Can you see all of the reproductive parts or does the plant hide some of its flower parts? Take note of the size, showiness, color, aroma, and anything else interesting that you observe. Use a hand lens to observe closer. Can you see nectar or pollen? Take a few minutes to brainstorm with your partner about why your flower has evolved (or developed) to be this way. Think of where it might grow and how it might be pollinated. Write down your ideas.
3. Fold and crease an 11x17 inch paper into three equal parts (like a brochure). Open the paper and in the first panel, draw your flower. Include the pedicel (flower stem) and how it is attached to the flower. Draw the flower as accurately as you can, showing all the different parts that are visible without touching your flower.
4. Compare your flower to the diagram of "A Perfect Flower" Look for the reproductive parts of your flower. Most flowers have both; some have one or the other. The parts are easy to find on some flowers, such as a lily. On some flowers, such as a sunflower, the parts are very difficult to see. If the male and female parts are not visible, gently move or remove a petal or two. In the second panel of your data sheet draw the inner whorls of your flower [pistil(s) and stamen(s)]. Is your flower perfect or imperfect?
5. Carefully use your knife to cut a cross section through the center of your flower. Try to slice through the ovary to show the inside. This will take a steady hand as the ovary is often quite small. Use your hand lens to view the inner parts of your flower closely. What does the inside of the ovary look like?
6. In the third panel of your data sheet draw an extreme close-up of the inner flower parts. Be as accurate as possible, use your hand lens and fill your drawing panel with what you see.
7. Using the flower diagram as a guide, label the parts of your flower. Use the panel(s) that best shows the parts you are referencing.
8. Label your flower with the inflorescence type. Compare to the flower diagram or classroom display and your vocabulary words.

Taking it Further Turn your drawings into an art project:

- ♦ Color your 3 panel sheet and use shading techniques to show depth. Cut out the panels and mount them on a complementary color background.
- ♦ View your flower like a pollinator might see it and draw a part of your flower that you find most interesting. Draw the piece in great detail, large like Georgia O'Keeffe would have. Fill the page or even larger, letting parts of the flower trail off the page. Use your hand lens to look for subtle vein patterns, hairs, color variations, nectar droplets, etc. and include these observations in your drawing. The great American artist Georgia O'Keeffe painted flowers like this. View some of her works online for inspiration.
- ♦ Portray your flower in an alternate artistic medium of your choice from the perspective of a pollinator. Painting, sculpting, film making, poetry/creative writing, music, dance; the options are limitless.
- ♦ Invent a flower for a specific new pollinator (you could use a black bear!). What kind of characteristics will this flower need to attract the pollinator? What shape, size, and smell would the flower have? Include a drawing and description of your new flower.



The Secret Life of Flowers

In the Field!

Go outside to the schoolyard or to a natural area to draw flowers in the field. Discover the nuances of different flowers. Many of our native wildflowers are small and take close observation to note their beauty. View flowers with a hand lens to look for the fine details that you learned about.

Visit a field of wildflowers. Look for different types of inflorescences. Is one type more common than others? See if you can find the flowers on more cryptic species such as grasses and sedges, or willows. Visit the same site several times over the course of the year. Does the type of dominant inflorescence change? Could inflorescence type be linked to pollination? Is one type of inflorescence more common at specific times (March compared to May)? Why? Remember that flowers must be open at the same time as their pollinators are active in order to reproduce. How might climate change affect the plant-pollinator relationship?



Science Inquiry

Study a native flower. Draw the flower in your field journal and identify the parts, making notes about the color, scent, nectar, pollen, and anything else you observe. Be sure to date your journal entry. Use your observations and the background information to hypothesize what and how this flower is pollinated. Keep your prediction and re-visit your journal entry after studying pollinators in the Native Plant Ecology section. Re-evaluate your original hypothesis. Do you want to make changes? How would you test it?

In the spring and summer, do a comparative study between two habitat types, analyzing aspects of floral structure that you learned in this lesson. Choose two habitat types that are readily accessible near your school (e.g. prairie, woodland, wetland). In each habitat, choose ten plant species and make notes about important aspects of their floral structure. Record the plant form (herb/forb, shrub, or tree), inflorescence type, whether it has perfect or imperfect flowers, and whether it is wind or animal pollinated. It is not necessary that you know the name of the plant for this exercise, though it should be recorded if you know. Do you notice any trends? Is one inflorescence type more common in one habitat type than another? Is there a difference in the abundance of perfect or imperfect flowers between habitats? Are wind or animal pollinated plants more common in one habitat type? Make these comparisons across different plant forms (tree, shrub, herb, grass, etc.) and see if you notice any trends. Speculate as to what causes these trends.

•••••

Reflection

• Georgia O’Keeffe had a unique way of viewing flowers •
 • and was drawn to their beautiful flowing lines. Pick your •
 • favorite flower and write as if you are looking at a section of •
 • your flower through a microscope. Make the lines of your •
 • writing flow like the lines of the flower in one of O’Keeffe’s •
 • paintings. Think outside of the box; what are ways you •
 • could make your writing “flow”? Use your creativity. You •
 • might also write a poem to accompany your illustration. •

•••••

Self Assessments

1 Label the parts of a flower and name the function of each.

2 Define perfect and imperfect flower

3 Describe inflorescence types.



The Secret Life of Flowers

Leaf Types

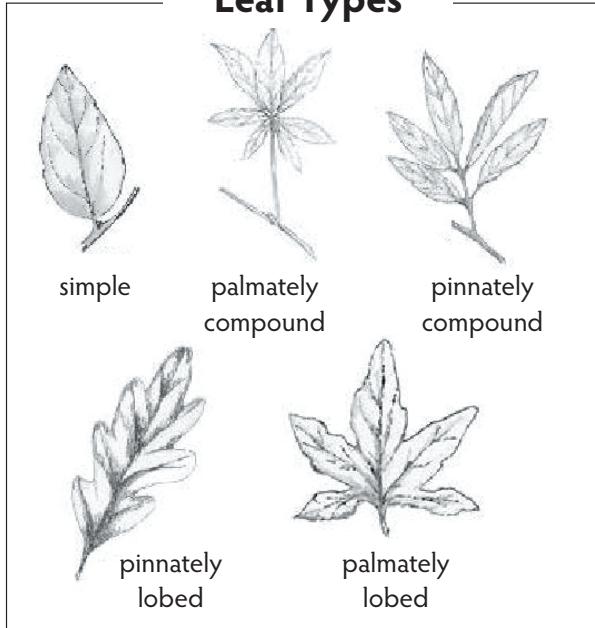

Parts of a Perfect Flower

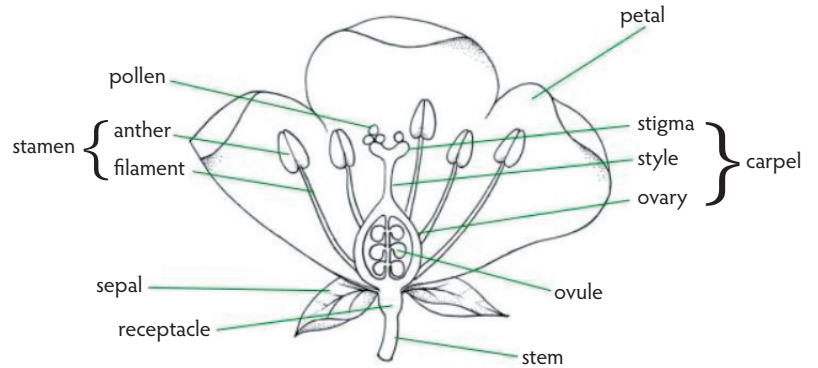

Leaf Shapes

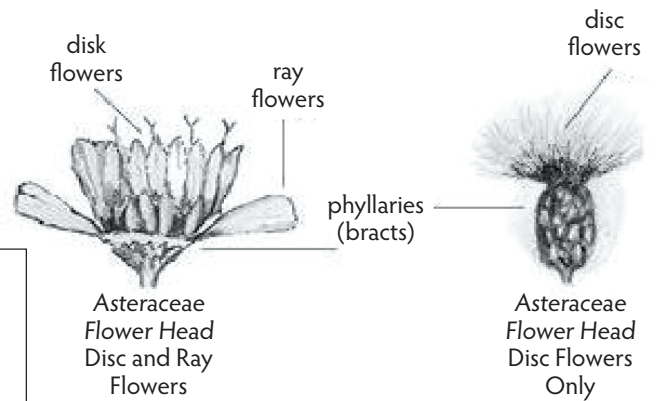
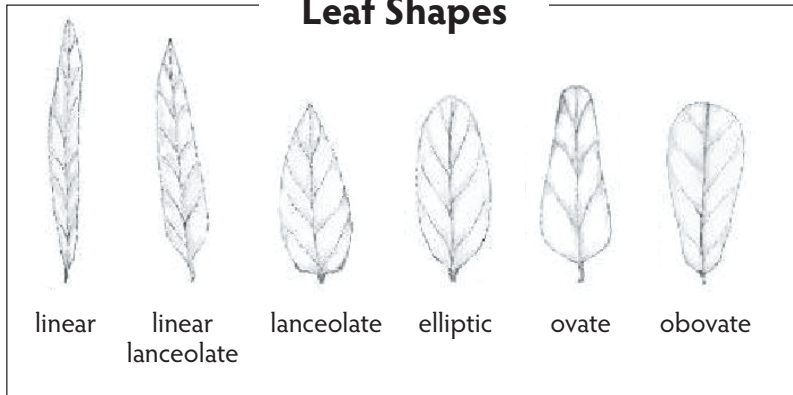

Leaf Attachments & Arrangements

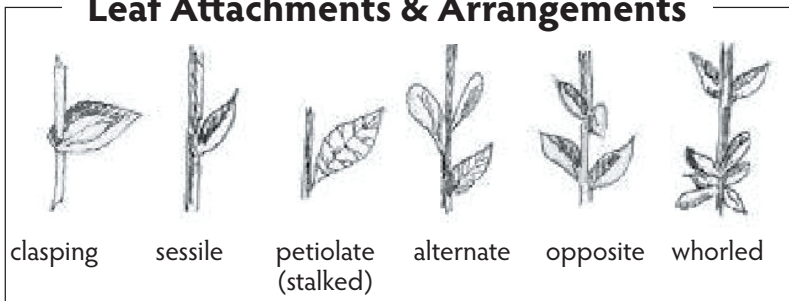

Common Types of Asteraceae Involucres

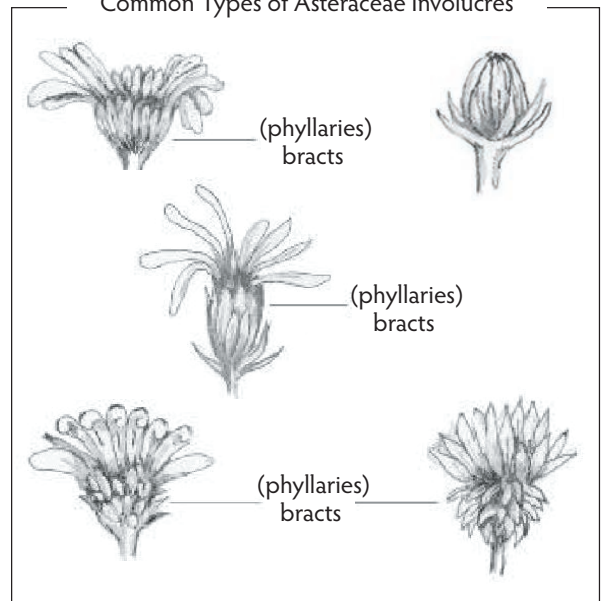

Above illustrations (not including Parts of a Perfect Flower) done by Adair Peterson taken from *Wildflowers of the Northern and Central Mountains of New Mexico* by Littleton and Burns

Inflorescence Type

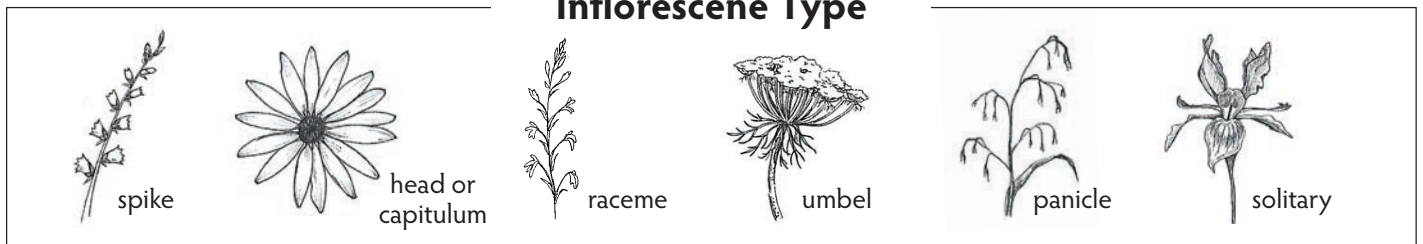



Inflorescence Type

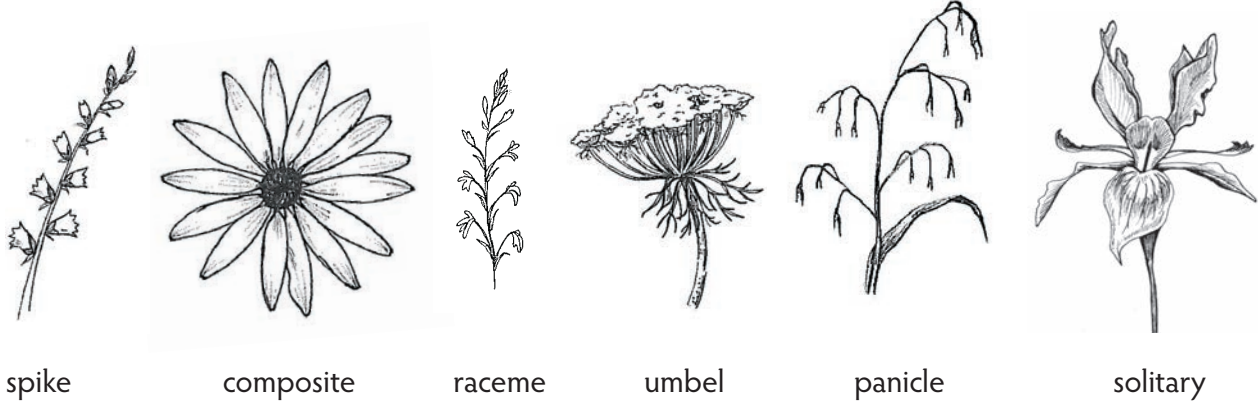

A Perfect Flower

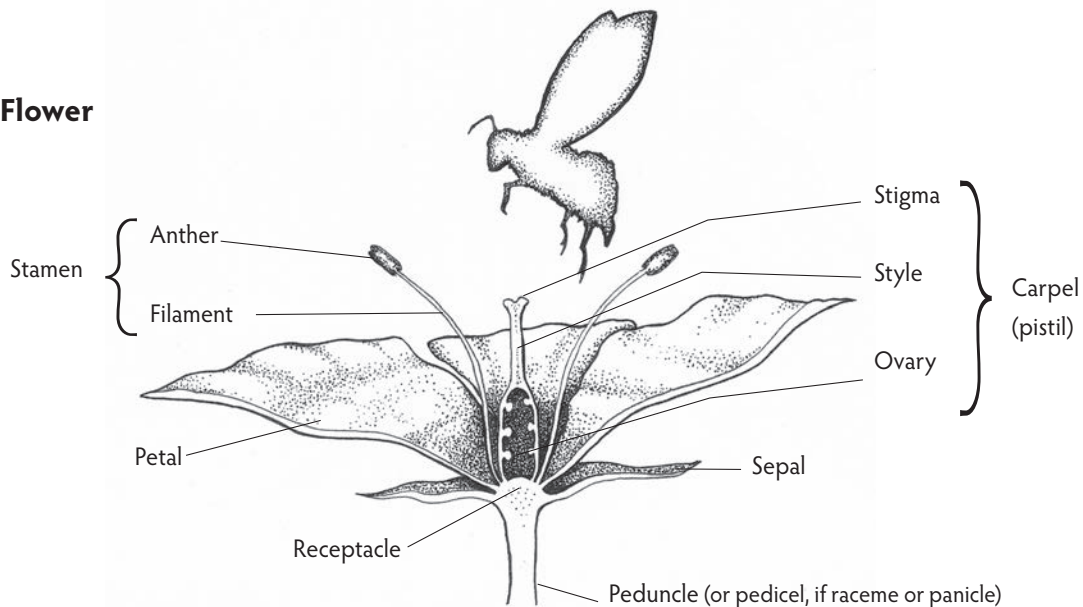

Resources

1. Harris, James G. and Melinda Woolf. 1994. *Plant Identification Terminology: An Illustrated Glossary*. Sixth Edition. Spring Lake Publishing, Spring Lake Utah. <http://biology.clc.uc.edu/Courses/Bio303/coevolution.htm> : Overview of co-evolution with many examples
2. <http://www.exploratorium.edu/gardening/index.html> Exploratorium Website : Interactive website
3. <http://www.kew.org/ksheets/pdfs/b4flower.pdf> -- Kew Gardens : Definitions & diagrams of flower structure fact sheet
4. <http://visual.merriam-webster.com/plants-gardening/plants/flower/structure-flower.php> : Flower Structure from Merriam Webster online visual dictionary



Plants Have Families, Too

Time Estimate:

15 minutes for each plant family (includes time to investigate and discuss findings)

Best Season:

winter (with photos or florist specimens), spring, summer, fall

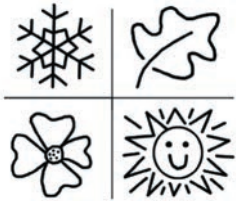

Assessments

- 1 Give the common name and Latin name for each plant family learned.
- 2 List at least two unique characteristics from each family learned.
- 3 Identify one representative of each plant family learned.

I have seen trees as my friends. When they grow along my path, I reach out to them, draw their needles through my hands, and smile. I say their names, an acknowledgment of kinship.

—David Sobel (Contemporary)

Overview

Students learn about the science of taxonomy by observing patterns of plant characteristics of related species in families widely represented in their ecoregion.

Preparation

- ◆ Gather specimens from roadsides, florists, or gardens. Beware of hybrid plants in gardens or at the florist that sometimes have doubled flower parts, which might confuse students.
- ◆ Wilted and dry flowers are hard to work with and observe, so keep specimens moist and out of the heat.
- ◆ If plants are no longer blooming, students can investigate fruits, seeds, and seed dispersal mechanisms. As an alternative, collect photos of plants, flowers and fruits to do this activity in winter.
- ◆ Set up stations with representative species of each plant family. Give each station a number. Have enough stations so there are 3-4 students at a station at a time.
- ◆ Divide students evenly among the stations. Act as timekeeper, have groups move at 10 minute intervals to the next station.





Plants Have Families, Too

Materials Needed

- ♦ plant specimens in flower or seed
- ♦ hand lens
- ♦ observation sheet hand out (copy into field journal to have a handy reference in the field)
- ♦ pencils

Vocabulary Words

native
non-native

Learning Objectives

- ♦ Observe and identify flower, fruit, and leaf structures of plants
- ♦ Identify and recognize patterns and characteristics that group plants into families
- ♦ Understand the science of taxonomy in classifying and naming organisms

I have seen trees as my friends. When they grow along my path, I reach out to them, draw their needles through my hands, and smile. I say their names, an acknowledgment of kinship.

—David Sobel (Contemporary)

Overview

Learn about the science of taxonomy by observing patterns of plant characteristics of related species in common families.

Background Information

In this lesson you will learn to identify the most common plant families from your area. Why study plant families as part of plant identification? It would be close to impossible to blindly thumb through a field guide to find the plant you are looking for. It would take a tremendous amount of time to read each description and compare each photo in the field guide to your plant. Understanding plant families is a very helpful tool to make plant identification easier and to understand the relationships between species. When you see a plant you don't know, if you know family characteristics, you will narrow your list of candidates and make identification easier. Also, some families have a tendency to share functional, edible, medicinal, or poisonous properties. Knowing the plant families is a fun way to become more familiar with the wild places around you. Walking down a trail in your local forest, it's always a treat to recognize plants. Even if you don't know the specific plant, being able to place it in a family is exciting and connects you to your ecoregion.

Several plant families common in our part of the world are:

1. Mint family : *Lamiaceae*
2. Daisy family : *Asteraceae*
3. Parsley family : *Apiaceae*
4. Rose family : *Rosaceae*
5. Grass family : *Poaceae*
6. Sedge family : *Cyperaceae*
7. Pea family : *Fabaceae*
8. Lily family : *Liliaceae*
9. Pine family : *Pinaceae*



Plants Have Families, Too

Student Directions

When you have finished this activity, try it outdoors. It will help you understand the composition of plant communities.

1. Divide into groups, with one group starting at each plant family station.
2. Examine the related specimens at your first station. Look for characteristics that the plants at this station have in common. Examples include numbers of flower parts, the arrangement of the leaves, and many more. Draw or write descriptions of the characteristics you observe that seem to define this family. Spend 8-10 minutes studying this family and then, when instructed, discuss your findings within your group until you are instructed to change stations.
3. Rotate through all the stations. Again observe the new plant family and record your observations, discussing your findings within your small group.
4. After rotating through all the stations, gather together to share as a large group. What characteristics seem to identify each family? Were there any families in which you found species that didn't seem to quite fit the general family characteristics?
5. Match the shared characteristics that you find on the Plant Families chart to your observed plants. Label your sheet with the family name and add any key traits from the chart that you don't have.
6. Write the family name and important traits into your field journal for reference in the field.
7. Practice your Latin by learning to say and spell the names of the plant families you have just learned.

Taking it Further

- ◆ Research representatives from your ecoregion's native species for each of the families you studied. When you create your list, note what type of habitat characteristics or ecology they prefer to live in (for example: wet, dry, shade). When identifying plants, the ecology is an important clue that can be used to help you get a positive identification.
- ◆ There are many, many plant families in the world. Look at a field guide for your region or use the internet to learn about some of the other plant families that are found in your area. Do you recognize any of them?



Plant Families Chart

FAMILY NAME	CHARACTERISTICS					COMMON NATIVES	COMMON WEEDS	GARDEN OR LANDSCAPE PLANTS
	GENERAL	LEAF	FLOWER	FRUIT				
Lamiaceae (lay-mee-AY-see-ee) mint family	aromatic; stem cross-section square	leaves opposite, may be toothed or lobed, but not divided	small flowers in clusters; five petals joined at base, form a tube split into upper and lower lip; stamen number varies; flowers bi-laterally symmetrical (zygomorphic) Inflorescence: terminal (on top of the plant) or in whorl (leaves attach to the stem)	single flower produces four nutlets	wild bergamot (<i>Monarda fistulosa</i>), selfheal (<i>Prunella vulgaris</i>)	Spearmint (<i>Mentha spicata</i>)	basil, peppermint, rosemary, thyme, lavender, oregano	
Asteraceae (as-ter-AY-see-ee) daisy or sunflower family	some heads have only disk flowers (thistles and snakeroots), others have only ray flowers (dandelions, chicory); many species have both ray and disk flowers (sunflowers, asters); bracts: flower head is subtended by involucre bracts, modified leaves that protect the growing bud	alternate or occasionally opposite; usually toothed, lobed, or divided	small flowers in center called disk flowers, long petal-like flowers are ray flowers; all flowers attach to fleshy area (receptacle) and make up a single inflorescence Inflorescence: although may look like single flower, is actually cluster of flowers called a head, which may contain a few to hundreds of individual flowers	achene (small, hard seed, often with a papus attached to the top for seed dispersal by wind)	Woolly sunflower (<i>Eriophyllum lanatum</i>), big sagebrush (<i>Artemisia tridentata</i>)	ox-eye daisy (<i>Leucanthemum vulgare</i>); dandelion (<i>Taxacrum officinale</i>)	artichoke, lettuce, sunflower, asters, chrysanthemums, chamomile, cosmos, echinacea	
Apiaceae (ay-pee-AY-see-ee) parsley or carrot family	seeds often aromatic; stems often hollow; some very poisonous; many others are common culinary herbs	alternate, often basal, usually compound, with sheathing leaf bases	5-parted, fused sepals; petals often yellow or white; 5 stamens; ovary inferior (attached beneath the flower parts) Inflorescence: simple or compound umbels (umbel is flat or convex and umbrella-like)	schizocarp (dry fruit that splits in two)	cow parsnip (<i>Heraclium maximum</i>), poison hemlock (<i>Conium maculatum</i>), desert parsley (<i>Lomatium spp.</i>)	Queen Anne's lace, wild Carrot (<i>Daucus carota</i>)	carrot, parsley, dill, fennel, parsnip, celery	
Rosaceae (row-ZAY-see-ee) rose family	usually two stipules are at base of leaf stalk	alternate, simple, divided or lobed, often toothed	5 sepals, 5 petals, one or many pistils, many have stamens in rings of five; Floral cup: most have a floral cup beneath the flower which may be a shallow saucer, deep bowl, or tube shape	achenes, pomes, drupes, capsules, and follicles; determined by floral cup and fertilization process	wild strawberry (<i>Fragaria spp.</i>), chokecherry (<i>Prunus virginiana</i>)	Sulfur cinquefoil (<i>Potentilla recta</i>), sweet briar rose (<i>Rosa eglanthera</i>)	apple, pear, cherry, peach, plum, strawberry, raspberry, apricot, almond, rose	
Poaceae (po-AY-see-ee) grass family	wind pollinated; hollow stem between the nodes	usually long and narrow, with the base of the leaf, the sheath, wrapped around the stem. Leaf attaches to the stem at a ligule, a small membranous part (often important for identification)	small florets on dense spikes or open clusters, three stamens, one pistil, bracts instead of sepals or petals, the grass floret is surrounded by a second pair of bracts called the lemma (on the outside) and palea (tucked inside); Inflorescence: upright or drooping spike, raceme, or panicle	a single grain (caryopsis)	big bluestem (<i>Andropogon gerardii</i>), tufted hairgrass (<i>Deschampsia caespitosa</i>)	Cheatgrass (<i>Bromus tectorum</i>), creeping bentgrass (<i>Agrostis stolonifera</i>)	wheat, oats, rice, barley, corn, rye, sugar cane, bamboo	

Plant Families Chart

FAMILY NAME	CHARACTERISTICS					COMMON NATIVES	COMMON WEEDS	GARDEN OR LANDSCAPE PLANTS
	GENERAL	LEAF	FLOWER	FRUIT				
Fabaceae (fa-BAY-see) bean or pea family	nodules on roots of plants in this family have a symbiotic relationship with bacteria in the genera <i>Rhizobium</i> and <i>Bradyrhizobium</i> , which acquire food and a protected home in root nodules; in exchange, the bacteria provide the plant with nitrogen	alternate, compound with three to numerous leaflets, two stipules located at base of leaf stalk	5 petals, each with a specific name – one banner on the top, one wing on each side, and two largely fused lower petals called the keel; the keel surrounds 10 stamens fused into a tube or 9 fused and one solitary stamen; flowers are structurally adapted for pollination by bees (the bee lands on the keel, triggering the stamen cluster to be exposed and showering the bee with pollen); Inflorescence: flowers are usually borne on a stalk of many flowers called a raceme	a pod that when dried, often splits along the two lengthwise edges or at the joints between each seed (legume)	American vetch (<i>Vicia americana</i>), lupine (<i>Lupinus</i> spp.), milkvetch (<i>Astragalus</i> spp.)	common sweet clover (<i>Melilotus officinalis</i>), Scotch broom (<i>Cytisus scoparius</i>)	peas, beans, peanuts, lentils, alfalfa, clover, honey locust (tree), wisteria	
Liliaceae (lil-ee-AY-see-ee) lily family	perennial herbs with bulbs or rhizomes	simple, entire, alternate or in a basal rosette with parallel veins	showy, w/ two whorls of 3 tepals (petals and sepals combined), star shaped (radially symmetric), perfect (both male and female parts), often with stripes or spots, 5 stamens, ovary superior (base of ovary attached to base of tepals) Inflorescence: sometimes a raceme (stalk of many flowers), umbel, or often one terminal flower	loculicidal capsule or occasionally a berry	Fawnlily (<i>Erythronium</i> spp.), Trillium (<i>Trillium</i> spp.)	daylily, hyacinth, garlic, onion, chives, asparagus, tulips, daffodils		
Pinaceae (pine-AY-see-ee) pine family	mostly trees, evergreen, pollen dispersed by wind	needle-like; borne in whorls on branches	Separate male and female flowers; not showy	seeds borne in a woody cone (no fruits; Gymnosperm means "naked seed")	Lodgepole pine (<i>Pinus contorta</i>), pitch pine (<i>Pinus rigida</i>)	blue spruce, stone pine (pine nuts)		
Cyperaceae (cy-per-AY-see-ee) sedge family	commonly found in wet areas; though not always true. Stem: three-sided, triangular in cross-section, frequently solid between nodes; roll stem between fingers to feel edges. In largest genus in family, <i>Carex</i> , ovary is surrounded by a persistent sac-like bract called a perigynium, often topped by a beak when mature (part can be very important in identification).	upon first glance, often look like plants in the grass family, but leaves are arranged in three vertical rows along stem and are closed at the base	small, grouped in spikelets; floret is surrounded by bracts (small, modified leaves) and have no petals or sepals; usually three stamens and one pistil with two to three stigmas Inflorescence: spike or panicle	a nutlet (a small nut with a hard outer covering)	Lakeshore sedge (<i>Carex lenticularis</i>), Eastern rough sedge (<i>Carex scabrata</i>)	papyrus, water chestnut, ornamental sedges		

Botany Bouquet

All of us are watchers—of television, of time clocks, of traffic on the freeway—but few are observers. Everyone is looking, not many are seeing.

—Peter M. Leschak (1951-present)

Time Estimate:

30-45 minutes

Grade Level:

9-12

Best Season:

spring
summer
fall



Overview

This activity awakens basic plant observation skills as students examine and describe plants collected by the teacher. Students have fun making up descriptive common names for their species and getting up close and personal with their species to make a great description. Students present their species to their class. The activity is followed by a discussion on the usefulness of a language of plant terminology to help with plant description.

Teacher Hints

- ◆ This activity is a good starting point to a plant studies unit because it highlights for students that specialized terminology might be useful in attempting to describe plants and that a system for identifying plants would be handy.
- ◆ This activity also works as an “ice-breaker” among a group of students who do not know each other.
- ◆ Adapted from: Earth Partnership For Schools K-12 Curriculum Guide, University of Wisconsin-Madison Arboretum
- ◆ Citations: Global Strategy for Plant Conservation <http://www.bgci.org/worldwide/gspc/>

Preparation

- ◆ Prepare bouquets of wild plant species (native or non-native) from your area. You will need one bouquet for each group of students. Each bouquet needs to be made up of the same plants and contain one plant for each person in the group.
- ◆ Divide the class into groups (adapt to fit your classroom, making groups of 3-5 students), and give each group one of the bouquets.
- ◆ Hand the students a hand lens or magnifying glass and instruct them to use it to get intimate with their plant.
- ◆ If you can, be prepared with the common and scientific name of the plants used in the bouquet for sharing at the end of this activity. Be able to supply the real name and description of each plant that the students can't identify. Add an additional ecological or human use for each plant to make it memorable.

Assessments

- 1 Look for detail in the group description of the plant, and for names that are creative.
- 2 Did students make observations about every visible part of the plant?
- 3 Did students make any creative interpretations about parts of the plants they cannot see or habitat, pollinations, or uses?



Botany Bouquet

All of us are watchers—of television, of time clocks, of traffic on the freeway—but few are observers. Everyone is looking, not many are seeing.

—Peter M. Leschak (1951-present)

Materials Needed

- ◆ sample plant cuttings that are representative of the native plants in or around your school grounds
- ◆ hand lenses or magnifying glasses
- ◆ several plant identification/field guides (see Appendix I for suggestions for your region)

Vocabulary Words

botany

Overview

Explore the usefulness of a common plant language. Use your observational skills to examine and describe plants by getting up close and personal. Give your plant a made-up name using its characteristics to guide you. Then share your new plant with your classmates.

Learning Objectives

- ◆ Develop and use botanical observational skills
- ◆ Examine different plants and compare how they differ structurally from one another
- ◆ Increase understanding of plant diversity

Background Information

How can you tell one type of plant from another? If you were a trained botanist (a person who studies plants) you would have the skills needed to identify the plant through descriptions, keys, botanical drawings or photographs, and habitat knowledge. The first step for you to obtain these skills is to develop your observation skills.

Observation is the act of noticing. Observational skills are very important in all fields of science and in all aspects of life. In this activity we are going to stretch our plant observational skills, using them to differentiate among local plants. Carefully examine the plant you have been given. Use your hand lens or magnifying glass to observe fine details. Notice not only the flower color, but the size and numbers of different parts. Are there other colors inside the flower aside from the color of the petals? Do you see hairs on your plants? If so, where? When observing the leaf, compare the top and bottom. Look at the shape, number and edges of your leaves. In addition to using your eyes for your observations, use touch and smell. Feel the texture of your leaves and stems. Crush the leaf tip and smell it. *Please do not taste your plant!* Since you do not know its identification and natural history, you don't know if it may be poisonous. Once you are an adept botanist, the world of edible wild plants will be more accessible.

Use your observations to write a description of your plant. Draw your plant. Describe your plant with enough detail that someone could pick it out of a field of hundreds of other plants. Lastly, choose a name for your plant that will help describe something about its appearance or natural history.

When you observe plants closely you will begin to notice how different they are. The United States has around 19,000 known native plant species. This doesn't





Botany Bouquet

Background Information, continued

include landscape plants from other parts of the world, agricultural plants developed for food use, or invasive plants that were accidentally or purposely introduced to the country. The term “native plant” is usually used to describe a plant that naturally grew in its current habitat prior to European settlement.

As you work through this activity you will get a better understanding of the need for a system of sorting and naming plants. It is not necessary for you to know the name of your plant. If you do know the name, keep it to yourself until the very end of the activity when you can share it with your classmates. For now, examine your plant as if you are a pioneering botanist who has never seen it before.

Student Directions

1. If you know the names of the plants being passed out please do not share that information until the end of the activity.
2. Have each member of your group take one plant from the bouquet.
3. Take 3 minutes to look at your plant closely and give your plant a descriptive name (for example: wooly, tough-stemmed daisy).
4. Use your hand lens or magnifying glass as well as all your senses (except taste) to get to know your plant. Take turns pointing out your observations to others in your small group.
5. As a group, come up with a creative name for your plant based on your close observations. In addition, designate one member of the group to write a description you come up with as a group. Make your description detailed so a stranger could pick out your plant from a field of many plants. Be sure to describe all the parts of the plant if they are present, including: roots, leaves, stem, flowers, fruits, seeds.
6. If you have time, flip through a field guide and try to find the real name of your plant. Look at the description and see if you can learn something about the uses of your plants or something you did not notice in your observations. What kind of habitat does your plant live in?
7. Present the name and description of your plant to the rest of the class. Hold up your plant and pass it around to other students so they can examine your plant.
8. If your group knows the real common and scientific name of your plant, you can share it now with the class (you do not need to know this piece of information).
9. If your small group does not know the name, ask the class if anyone knows it. Your teacher can help with this if needed.

CLASS DISCUSSION

- ◆ Did anyone have trouble describing any part of their plants for lack of a word to describe what they were observing? What plants parts were hard to describe?
- ◆ Discuss the need for a common plant vocabulary that all can understand.
- ◆ Would it be helpful to have another way to identify plants other than flipping through a field guide?
- ◆ Do you have any ideas of another way to identify plants?
- ◆ Do you think any of the plants from the bouquet are closely related to one another? What makes you think that? (Point out similarities on the plants.)
- ◆ Based on your observations, do you think any of the plants perform similar functions? What makes you say this? (For example, perhaps there were two sticky plants.)



Botany Bouquet

In the Field!

Try this activity when working in a new outdoor area. It will help you to improve your observational and identification skills, which will help you get to know the plants in your area. Include observations about the habitat in the location where you find your plants. Look around for several individuals of the same species. Are there many or just a few? Does your plant seem to prefer sunny locations or shady spots? Does it like low, moist areas, or can it handle a drier spot? Write down your observations and use them to help you locate your plant in a field guide for your area.

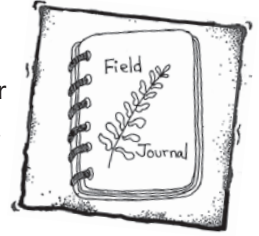

Reflection

Write a short story or poem that describes your plant, its characteristics, human and/or wildlife uses, adaptations related to habitat, and the root words of the plant's scientific name.

Taking it Further

1. Collect other plant samples and complete this activity with additional plants from a different ecosystem or area.
2. Research a plant species; describe its characteristics, habitat where the species is most likely to be found, and common human uses. Make an oral report to the class and conduct peer reviews of these reports.
3. Develop a web page on the plant species from this activity using photos, drawings, and life history information.



Self Assessments

- 1** Look for details in group descriptions of the plant and for names that are creative.
- 2** Did you make observations about every visible part of the plant?
- 3** Did you make any creative interpretations about parts of the plants you cannot see or habitat, pollination, or uses?



Drupes, Pomes, & Loculicidal Capsules

A Botanist's Lingo for Describing Fruits

Time flies like an arrow, fruit flies like a banana. —Groucho Marx (1890-1977)

Time Estimate:

45-60 minutes in the classroom

Best Season:

fall,
winter



Teacher Hints

- ◆ Let students sample store-bought fruits by having bite-sized samples at each station.
- ◆ Encourage students to use hand lenses to examine fruit carefully.

Assessments

- 1 Students use a key to classify common grocery fruits and apply to native fruits.
- 2 Through observation, students make inferences to seed dispersal methods by analyzing fruit types.
- 3 Identify and name the three parts of a fruit as applied to common fruit types.

Supplies: plates, cutting boards, and knives for slicing fruits. Clippers for collecting native plant materials.

Overview

In this hands-on lab, students learn about the basic parts and development of fruits. By classifying familiar fruits using observable characteristics and fruit type vocabulary words, students familiarize themselves with the botanical origins of fruits and the adaptations of different fruit types. Following the lab experience, students can extend their new knowledge of fruits to native plants by collecting fruits of native species in the field and comparing them to familiar fruits to understand their botanical relationships. This is a great winter activity, as many native fruits can be foraged easily in the wintertime and many tropical examples are available in the grocery store.

Preparation

Collect fruit and set up about ten stations chosen from the list below. Number the stations, and include at least two or more of each suggested fruit at the station. Include one that is whole and one cross section for each different fruit used.

- ◆ **pome:** apple, pear, quince
- ◆ **berry:** tomato, grape, avocado, pomegranate, date
- ◆ **drupe:** peach, plum, nectarine, apricot, cherry, olive, walnut (including hull and shell), almond (including hull and shell)
- ◆ **nut:** hazelnut, acorn, chestnut
- ◆ **caryopsis:** corn, wheat, barley, oat, rice
- ◆ **legume:** bean (in pod), peanut (in shell), snow pea (in pod)
- ◆ **achene:** sunflower seed in shell
- ◆ **aggregate fruit:** blackberry, raspberry, strawberry
- ◆ **pepo:** cucumber, pumpkin, squash, pineapple, fig

Include for "expert" vocabulary:

- ◆ **hesperidium:** orange, lemon, lime, grapefruit

For native fruit, set up the lab with wild fruit and have students repeat the activity. Field guides can help you classify wild fruit types. Some suggestions:

- ◆ **pome:** crab apple, rose hip, hawthorn, mountain ash
- ◆ **berry:** blueberry, cranberry, gooseberry, huckleberry, manzanita, honeysuckle, currants
- ◆ **drupe:** pin & bitter cherry, choke cherry, elderberry
- ◆ **nut:** chestnut, hazelnut, acorn, chinquapin, walnut
- ◆ **legume:** lupine, vetch, locust
- ◆ **samara:** maple, ash, elm
- ◆ **caryopsis:** any grass species
- ◆ **achene:** sunflowers, dandelion, thistles, burdock
- ◆ **capsule:** iris, violet, poppy, many of Lily family
- ◆ **aggregate fruit:** blackberry, salmonberry, thimbleberry, brambles, and their relatives

Additional Information

Plant Genome Research, Boyce Thompson Institute for Plant Research. Lesson—Tomato DNA Extraction and Dissection. Students learn the parts of a fruit by dissecting a tomato: <http://bti.cornell.edu/pgrp/pgrp.php?id=302>



Drupes, Pomes, & Loculicidal Capsules

A Botanist's Lingo for Describing Fruits

Time flies like an arrow, fruit flies like a banana. —Groucho Marx (1890-1977)

Materials Needed

- ◆ magnifying or hand lens
- ◆ Key to Fruit Types handout

Vocabulary Words

Amateur Botanist

drupe	simple fruit
pome	multiple fruit
achene	aggregate fruit
locule	pericarp
hip	seed
capsule	nut
legume	ovule
berry	ovary
indehiscent	carpel
dehiscent	

Expert Botanist

exocarp	silique
mesocarp	schizocarp
endocarp	nutlet
pepo	samara
hesperidium	caryopsis
follicle	accessory fruit

Professional Botanist

parthenocarp
funiculus
circumscissile capsule
loculicidal capsule
poricidal capsule
septicidal capsule

Overview

In this lab, you will learn how to classify fruits and understand their development. You will have a chance to familiarize yourself with the botanical origins of fruits and the adaptations of different fruit types. Compare what you learn in the lab to the fruits of native plants to understand their botanical relationships.

Learning Objectives

1. Develop and use observational skills on multiple scales
2. Understand how fruits are categorized botanically
3. Increase understanding of plant diversity
4. Apply knowledge of familiar fruits to local native plants

Background Information

If a friend asks you for a piece of fruit, they might give you a strange look if you hand them a cucumber. Or perhaps you have heard people argue as to whether a tomato is a fruit or a vegetable. In the grocery store, things that are sweet and potentially used in desserts are generally labeled as fruits. In the world of botany, the term "fruit" means something else, and encompasses many things that are commonly referred to as vegetables, nuts, and even grains.

From a botanist's perspective, a fruit is the ripened (mature) ovary of the flower containing one or more seeds. Sometimes a fruit contains other parts of the flower as well. Fruits develop after a flower is pollinated and the ovules inside the flower's ovaries are fertilized. Every fruit contains one or more seeds inside (with the exception of some commercial fruits that are intentionally bred to be seedless). Fruits come in many shapes and sizes and are divided into different fruit types with specific botanical names to describe their form and function. As the seed develops or matures, the ovary tissue undergoes changes that result in fruit. This ovary-turned-fruit is made up of three layers, the **exocarp** (outer), **mesocarp** (middle) and **endocarp** (inner), collectively called the pericarp and which surround the seed(s). These three layers are easy to see in some fruit, such as peach (a) and avocado (a berry). In peach, the endocarp is the hard pit surrounding the seed. In avocado the endocarp is a thin layer not much different from the mesocarp surrounding the seed. In other plants, such as grasses, the pericarp layers are very hard to see. Fruits with similar forms are often evolutionarily related, such as a cucumber and zucchini. However, other fruits that look nothing alike, such as apple, cherry, strawberry and raspberry, all belong to the Rose Family (*Rosaceae*).



Drupes, Pomes, & Loculicidal Capsules

A Botanist's Lingo for Describing Fruits

Background Information, continued

Why is it important to be familiar with the different types of fruit? Field guides often use fruits as an important feature for identifying plants. Being able to distinguish fruit type will get you one step closer to proper identification. Plants from the same family may have the same fruit type, but as previously mentioned with Rosaceae, this is not always the case. Fruit type can also give you a hint as to how the seeds are dispersed.

The method by which a fruit is dispersed can generally be determined by examining the structure of the fruit itself. Fleshy, sweet fruit is likely to be eaten, with the seeds transported inside of an animal to be deposited somewhere else with a ready made packet of fertilizer to get it started. Hard nuts are cached (buried) by squirrels and jays to eat later in the winter, but many are never found and from them sprout new trees. Light seeds may be dispersed by wind or water, and often have special appendages on them such as wings, parachutes, or corky floats to aid in the process. Some fruits also have hooked barbs on them that adhere to animal fur for dispersal. During this exploration,

you will have an opportunity to think critically about the mechanisms of dispersal of native fruits.

What do the fruits you find in the grocery store have in common with our native plants? Many of our native plants have domesticated relatives that have delicious edible fruit. For example, the tasty cherry you find in the produce section is related to the native bitter cherry (*Prunus emarginata*) and wild black cherry (*Prunus serotina*), which have fruit so bitter that they are inedible for humans when unprocessed. If you look at native plants, you will find that many of them have fruits that are similar to ones you are familiar with from the grocery store. However, many fruits that are popular to eat are shipped from subtropical and tropical areas, such as bananas, pineapples, and citrus, and have no local relatives.

Student Directions

1. Divide evenly across the stations. Begin by visiting only the stations with commercial, grocery store fruits. Wild fruits will be examined later.
2. Spend 3-5 minutes at each station. Note the number of the station on your paper (use a half sheet of paper for each station), sketch a cross section of the fruit, and write a description in words. Observe closely all the details you find in each group. Is the fruit soft, fleshy, dry, hard? How many seeds are there? What is the arrangement and texture of the pericarp? Are there any chambers within the fruit? Note anything else that may be an important identifying feature. Use the magnifying lens.
3. Use the Key to Fruit Types to determine what type of fruit is at each station. Fill in the fruit type in the top corner of your data sheet.
4. Rotate to the next fruit station; write the station number and continue to sketch and gather observations.
5. After you have visited all of the stations with commercial fruits, visit the native, wild fruits stations. Follow the same directions for the native fruits stations as you did for the grocery fruit. Use a hand lens to examine the fruits carefully, as wild fruits are often much smaller than their grocery store cousins.





Drupes, Pomes, & Loculicidal Capsules

A Botanist's Lingo for Describing Fruits

Taking it Further

Take this lab one step further by finding a plant with fruits (or fruits from the grocery store) and making observations and inferences as to what method of seed dispersal this plant uses (mechanical, wind, water, animal carried).

Examine the structures of the fruit and make your best guess as to how the fruit may be dispersed to new sites. Refer to the paragraph in the background information for clues. What structures on the fruit lead you to think that it is dispersed in that way?

Self Assessments

- 1 Use observation skills to identify fruit types using a dichotomous key. Apply the knowledge to native plant fruits.
- 2 Through observation, make inferences about seed dispersal methods by analyzing fruit types.
- 3 Identify and name the three parts of a fruit as applied to common fruit types.

In the Field!

Take an outing in fall to see how many different wild fruit types you can collect. When collecting, if you know the name of the plant, write it down. Take your collection back to the classroom. Dissect your wild fruits and use your observation skills to classify them by fruit type. How many different types of fruit did you find? If you were able to identify any of the plants when collecting, look in the field guide to see what type of fruit it has. Does your plant name and fruit type match what is found in the field guide?

When you are finished with this activity, dispose of the seeds in the trash can. Invasive plants are common and it is likely that you have them in your collection. Don't take a chance of spreading them, act responsibly and dispose of the seeds properly.

Science Inquiry

Are certain types of fruits more common in a specific ecosystem? Do comparative studies in the late summer or early fall to find out. Choose two ecosystem types that are easy for you to access. Riparian, woodland, forest, shrubland, wetland, and prairie are all reasonable choices. Determine some simple parameters to follow. An example would be to collect fruits from 10 species in a riparian area and 10 in a prairie. Determine the fruit types found in each ecosystem and compare. Does one fruit type predominate? Are the types of fruits found between the two ecosystems different? Do the types of fruits found in the ecosystems reflect some advantage related to habitat (i.e. corky, buoyant fruits in the riparian area that float well on water or light and airy seeds in prairies that can be dispersed by the wind)?



- • • • •
- **Reflection**
- Use your imagination. Invent a fruit and draw it inside and out. Hypothesize
- about why this fruit looks, tastes, smells, and grows where it does. Describe
- in detail how each characteristic of your fruit helps your plant survive and
- disperse in its habitat. Write a story or poem about your fruit, or from a
- fruit's perspective.
- • • • •

Resources

- ♦ *Plant Identification Terminology, An Illustrated Glossary* Sixth Edition, Harris, James & Melinda, 2001, Spring Lake Publishing, Utah.



Dichotomous Key to Common Fruit Types

- 1a. Fruit from more than one ovary but from a single flower **Aggregate fruit**
- 1b. Fruit from one ovary from one flower (simple fruit).....2
 - 2a. Fruit fleshy at maturity.....3
 - 3a. Fruit with single large, hard pit containing the seed (stone fruit).....**Drupe**
 - 3b. Fruit without a large, hard pit.....4
 - 4a. Fruit with a papery endocarp (inner layer of ovary) forming a core.....**Pome**
 - 4b. Fruit without a papery endocarp, fleshy throughout.....5
 - 5a. Exocarp (or skin) thin, not leathery or hard.....**Berry**
 - 5b. Exocarp thickened, leathery or hard (modified berries).....6
 - 6a. Exocarp leathery with aromatic oil glands, citrus.....**Hesperidium**
 - 6b. Exocarp hard or variously thickened, oil glands absent, gourds, melons, and squash.....**Pepo**
 - 2b. Fruit dry at maturity.....7
 - 7a. Dehiscent (splits open at maturity).....8
 - 8a. Fruit from a single ovary with only one locule (chamber or cell)....9
 - 9a. Fruit splitting along two lines (sutures) producing two halves like a pea pod.....**Legume**
 - 9b. Fruit splitting along one line only not producing two parts or halves.....**Follicle**
 - 8b. Fruit from several fused ovaries, usually with two or more locules.....**Capsule**
 - 7b. Indehiscent, does not split open at maturity.....10
 - 10a. Fruit wall forming a wing.....**Samara**
 - 10b. Fruit wall not forming a wing.....11
 - 11a. Pericarp not thick or hardened; fruit small.....**Achene**
 - 11b. Pericarp hard; fruit usually rather large but if small then called nutlets.....**Nut**

Adapted with permission, the University of the Ozarks



Make Your Own Plant Collection

Time Estimate:

1 field session, 1 class session;
can be structured as an
ongoing project

Best Season:

spring,
summer,
fall

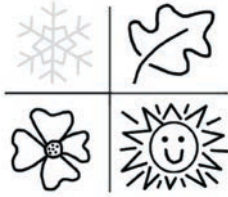

Teacher Hints

- ◆ Have students practice plant collection techniques using weedy species. Then move on to creating a native plant herbarium collection once they are proficient at collecting and mounting.
- ◆ Alternatives to making the cardboard presses in the lesson include: purchase a plant press, make your own from plywood boards, or use old telephone books with additional weight to press the plants flat.
- ◆ For the class herbarium, use archival quality paper for mounting the specimens. Store specimens laying flat in large boxes or metal cabinets for long life. Don't leave the mounts exposed to sunlight. Monitor periodically for insect damage.

Are we happy to suppose that our grandchildren may never be able to see an elephant except in a picture book?

—Sir David Attenborough (1926-present)

Overview

Construct or purchase a plant press, collect native plants, and create an herbarium for your school. Students learn the skills needed for the project by assembling a plant press and making their own personal herbarium of local species. They will learn proper techniques for collecting, pressing, labeling, mounting, and storing plant materials. Students will practice their botanical terminology and plant identification skills.

Preparation

Introduce this lesson by starting a classroom discussion on what botanists and students can learn from a collection of pressed plant specimens. Make sure to cover:

- ◆ allows for the observation of plants at different stages in their life cycle (i.e. vegetative, flowering, fruiting)
- ◆ can be used as a reference to help identify plants
- ◆ provides a sample of the variability within a species
- ◆ provides an official record of what plant species are found in an area

Assessments

- 1** Produce four herbarium specimens using correct procedures for collecting, pressing, mounting, and labeling each specimen.
- 2** Record complete field notes when collecting: include date, location, plant description, and habitat notes.
- 3** Label the specimen with common and scientific names using the proper form and demonstrate correct use of botanical terminology.

Additional Information

- ◆ The New York Botanical Garden herbarium is the largest in the western hemisphere with over 1.5 million digital specimens available online: <http://www.nybg.org/science/>
- ◆ The American Society of Plant Taxonomists website has a database of herbaria located in the United States organized by state. You can access the database at: <https://www.aspt.net/>



Make Your Own Plant Collection

Materials Needed

- ◆ newspaper
- ◆ mounting paper—heavy cardstock for individual specimens; archival paper for class herbarium
- ◆ Elmer's glue
- ◆ water (to thin out glue)
- ◆ small paint brushes
- ◆ 5-6 cardboard pieces per student (8 1/2 x 11 inches)
- ◆ acid-free resume paper (for labels)
- ◆ large rubber bands or webbing straps
- ◆ plant pruner for collecting
- ◆ shovel or trowel

Learning Objectives

- ◆ Learn and demonstrate proper techniques to collect, dry, preserve, and catalog plant specimens
- ◆ Start or contribute to a classroom herbarium with a usable system of organization
- ◆ Use botanical terminology as well as common and Latin names to correctly describe a plant specimen (review)
- ◆ Practice plant identification skills (review)

Vocabulary Words

herbarium
herbaria

Are we happy to suppose that our grandchildren may never be able to see an elephant except in a picture book?

—Sir David Attenborough (1926-present)

Overview

Through this activity, you will learn the botanical skills needed to record and preserve plant specimens by creating an herbarium. You will assemble a plant press and make a personal herbarium of local weed species. In doing so, you will learn the proper technique for collecting, pressing, labeling, mounting, and storage of your collection. This will also give you an opportunity to practice using your plant identification skills. You will also participate in making a classroom herbarium by creating or adding to a collection of native plant specimens for your school.

Background Information

An herbarium is a library of dried, pressed plant specimens that are identified, labeled, and catalogued. Herbarium specimens can be used for many purposes. Accurate identification of a freshly collected plant can be made by comparison with an herbarium specimen. Herbaria are used by scientists in their studies of plant form, to compare range and measurements, and to help in the construction of guidebooks. Specimens are also used in DNA analysis to study plant relationships.

Each specimen in the herbarium is labeled with the name of the plant, the person collecting, date collected, and location of collection. Often the label will include additional helpful information like the plant community the specimen was found in, soil type, pollinators or known uses. Herbarium specimens are treated with the utmost care so that they will survive and be available for study for hundreds of years. An herbarium is an historic record of where and when plants grew. Additional applications for the study of herbarium specimens include how climate change has affected plants. For example, specimens can document the range of species, demonstrate change in characteristics over time and across habitats, track the spread of non-native weeds, and confirm the former ranges of now-rare plant species.

Herbaria are located around the world and are often housed at museums, botanical gardens, or universities. Many modern day herbaria are available online for access worldwide. The Academy of Natural Sciences in Philadelphia, Pennsylvania houses a very famous herbarium collection from the Lewis and Clark Expedition 1804-1806. This collection is documented so that it can be cross referenced to the dates and locations found in the diary entries of Lewis and Clark. The museum houses 226 specimens from the expedition which are still in amazing condition more than 200 years later!

Herbaria are made up of plant specimens that are dried and pressed so as to highlight features that enhance identification. A specimen should include all parts



Make Your Own Plant Collection

Background Information, continued

of a plant, including roots, flowers, and fruit, if possible. The collected plant is carefully positioned on blotter paper, labeled, sandwiched between layers of cardboard, and tightly squeezed within the plant press until dried. Plant collectors will document the location, date, and all other pertinent information in a field book. Once the plant is completely dry, it is mounted on archival quality paper with a detailed label. Herbaria sheets are collected into folders by species and folders are filed alphabetically by family, genus, and specific epithet. The folders are stored lying flat, usually in metal cases or cabinets in climate controlled rooms to help preserve them.

Herbaria can also be very useful for figuring out where extinct or very rare species previously existed. Written records on specimen labels indicate location and habitat information that can be used by conservation biologists to decide where to relocate species that they are reintroducing.

One more important aspect for consideration in the development of an herbarium is your plant collection ethic. Below is a list of ethics that can guide you. Look them over and discuss them as a class. Should they be expanded? Why or why not?

Ethics of Collecting Guidelines:

- ◆ Tread lightly—what does that mean to you?
- ◆ Don't take any plants that you will not be pressing.
- ◆ Take care not to spread seeds of invasive plants.
- ◆ Know your region's rare and endangered plants. If you are lucky enough to find them, take only pictures of these.
- ◆ Do not collect a plant if you do not see at least 10 others of that kind in your location. Why is this important?
- ◆ Be aware that you may be harmed by your interaction with some plants. Take necessary precautions and watch for plants that can sting, have thorns, or give you rashes.
- ◆ Learn the process of collecting, pressing and mounting a plant collection by using readily available local weeds to start. Although pressing plants sounds fairly straightforward it takes attention to detail and careful handling to do it well. Practice the techniques and then move on to developing a school herbarium project.

Directions

1. Assemble a personal plant press. You will need 5-6 pieces of heavy cardboard, several sections of newspaper, and 4 long, heavy rubber bands. Cut the cardboard pieces to the size of a folded newspaper. Use newspaper as your blotter paper to position your plant specimen, plus use additional layers of newspaper between each specimen to help absorb moisture. Use an 8 ½ x 11 sheet of paper as a size guide; your finished specimen will be mounted on this size paper.
2. Make a weed collection from your home, roadside or vacant lot (follow the steps below). Collect 4-5 different weed specimens. Do not collect from parks, natural areas, or personal property without the owner's consent. BE RESPONSIBLE; do not spread weeds. Be sure to contain any seeds that may fall off your collections and dispose of extra weedy materials that you bring back to the classroom in the trash.
3. To collect your first plant; carefully dig up a weed, trying to get as much of the root system as possible. Be aware that many weeds have deep tap roots that will break if you dig too shallowly. Try to collect a plant that is average size and vigor of nearby plants. This will make a better example of the species than a plant that is the smallest that you can find. Gently clean the dirt from the roots of the plant.



Make Your Own Plant Collection

4. Arrange the plant on the inside of a folded newspaper. Once the plant is dried, you will not be able to move parts around without breaking it. You must be careful to arrange the plant to properly show its leaves, roots, flowers and/or fruits. Lay a leaf out flat so that you can see the shape and show the arrangement along the stem. Lay another leaf so that the underside is showing. Include flowers, if possible, arrange some flat open and some in profile and fruits. Include the roots if you can; brush the excess dirt off before putting in the press. If your plant is too tall to fit on the newspaper, you will need to bend the stem to make it fit. Another mounting method if your plant is too large for one sheet of paper is to cut the plant and position it on more than one sheet. Number the sheets so that they can be reassembled in the proper order. Try to minimize overlapping plant parts; it can lead to moldy plant parts and makes them hard to see once they are dry.
5. Label each specimen with a number directly on the newspaper and a corresponding numbered entry into your field journal. Include the name of the plant if you know it, the location, date, your name, and any additional information that you can. Additional information may include the names of other plants growing nearby, the type of ecosystem (forest, field, wetland), whether it was growing in the sun or shade, pollinators observed, or notes about the soil.
6. If for some reason you cannot put your plant in the press right away, seal it in a plastic bag and keep it out of direct sunlight until you can place it in the press. Try not to squish it or break any of the branches.
7. Assemble specimens in your press like layers of a sandwich. The cardboard is the bread; add a few layers of newspaper, then your specimen, another couple layers of newspaper, a piece of cardboard for strength, and repeat until the press is full. Finish with a final cardboard piece and bind with 4 large rubber bands.
8. Take your press home. Lay it on a flat, dry surface in a warm location to dry (a sunny window, the top of the refrigerator, a furnace room, or a car with the windows rolled up will suffice). Add additional weights (books) to help squeeze the moisture out of the plants. If you have a very succulent plant, change the newspapers every day for the first couple of days.
9. Leave the plants in the press until completely dry. This can range from a couple of days to a couple of weeks, depending on the thickness of the plant material and the air temperature and humidity.
10. Mount the specimen once it is completely dry. Use heavy cardstock paper for display. Carefully remove the specimen from the newspaper by the stem. It might be helpful to use tweezers when working with delicate plant material. Arrange the dried plant on the paper and adhere with drops of white glue at multiple points along the stem and the outer leaves. For heavy plants, you can glue strips of paper over them to hold at key points. Set aside and let the glue dry before handling.
11. Design a label to go on your specimens. Be sure it includes the plant name, date, your name, where it was collected, and any special notes. Glue a label to the bottom right corner of the paper on which you mounted your specimen.
12. Write a habitat description that goes with your pressed plant. Include a general description of the form and identifying features of your species. Specimens will fade with age so be sure to include notes in the description on the flower and leaf color.
13. Contact a plant expert (examples: a local nursery, local Forest Service or BLM botanist, Native Plant Society member) if you are having difficulty identifying your specimen.
14. Visit one of the online herbaria listed in the resource section to see an example of a mounted plant specimen and label.



*Student
Project*

Make Your Own Plant Collection

In the Field!

Visit a real herbarium! If you are near a local university or botanical garden, take a field trip and check out their herbarium. Visit the American Society of Plant Taxonomists website to find an herbarium in your area. Ask to see some specimens from the 1800s and compare them to some more recent specimens of the same species. Are there any noticeable differences?

Create an herbarium for your school. Give the herbarium a theme that can be expanded or added to from year to year (examples: plants on the school grounds, or from a natural area that students visit regularly, or a broad ecoregion collection). Offer tours of your herbarium to other science classes or to younger grades in your school.

- ♦ Be careful not collect too many samples of a single species. Work to fill gaps in the herbarium collection if it is an ongoing project.
- ♦ Reread the Ethics of Collecting Guidelines in the Background section before going out to collect.
- ♦ Learn which rare and endangered plants exist in the area from which you will be collecting so that you can avoid collecting them. Over collection is one of the causes of decline for several rare plant species. Instead, take a digital camera and make a visual record of the plant if you are lucky enough to see one. Get an overall photo of the plant, a wider photo showing the habitat, and multiple close-ups of leaves, stems, flowers, and fruit. Include a ruler or other object for scale to show the size of the plant. Take notes as you would if you were collecting a specimen. Mount the photos and include the page in your herbarium.



.....

• **Reflection**

- What are some of the things that you could learn by developing an herbarium at your school? What would be the benefits to your class? How would a class 10 years from now benefit from your work?
- How can you be sure that you are not damaging a rare plant population? Is there a time that taking a rare plant specimen would be acceptable? Justify your reasoning. Can you add at least one additional rule to the Ethics of Collecting plants? What would it be?

.....



Make Your Own Plant Collection

Taking it Further

Develop a filing system for the class herbarium. Specimens are commonly organized alphabetically first by family, then genus, and finally the specific epithet. Write an explanation of how your system works so that others can follow it. Organize a way to track additional records, such as a notebook with a page devoted to each species and a way to enter information about occurrences including the name of the observer, the date, and location. Be sure to make it easy for visitors to access the needed records.



Self Assessments

- 1** Evaluate your pressed plant specimen. Are you happy with the way the pressing turned out? If not, review the procedures. Did you accurately follow them? If you are unhappy with your pressing, try it again, making sure that the plant has as little moisture in it as possible and that you have positioned it carefully.
- 2** Design a label to go on your mounted pressing. Did you collect all the information that was needed to make a good label?
- 3** Evaluate your written description. Did you use proper botanical terminology? This may be important if you need help from a botanist to identify your plant.



Resources

- ◆ The New York Botanical Garden herbarium is the largest in the western hemisphere, with over 1.5 million digital specimens available online. This diverse herbarium has specimens from around the world, and includes vascular plants, fungi, and lichens: <http://www.nybg.org/science/>
- ◆ The Ohio State University Museum of Biological Diversity Herbarium can also be accessed online. This herbarium has worldwide coverage, with a focus on the flora of the Northeastern U.S. View the specimens at: <http://herbarium.osu.edu/>
- ◆ The American Society of Plant Taxonomists website has a database of herbaria located in the United States organized by state. Access the database at: <http://www.aspt.net/databases/herbaria/naherbaria.php>



Create-A-Plant

Imagination is more important than knowledge. For while knowledge defines all we currently know and understand, imagination points to all we might yet discover and create.
—Albert Einstein (1879-1955)

Time Estimate:

45-60 minutes, additional time for detailed plant drawings

Best Season:

Any



Teacher Hints

- ◆ Be sure that students have a basic foundation in plant terminology before using this lesson. The “Botanical Terminology Challenge” lesson provides a review or a means of learning this new vocabulary.
- ◆ Information about scientific names can be found in the “What’s In a Name?” lesson of this curriculum

Additional Information

- ◆ Harris and Harris. 2001. *Plant Identification Terminology: An Illustrated Glossary*. 6th edition. Spring Lake Publishing, Spring Lake, UT. 206 pages.

Overview

In this lesson, students will explore plant adaptations and demonstrate their accumulated knowledge and understanding of plant identification by creating a fictional plant species. Working from a checklist of possible traits, students will determine the physical characteristics, ecology, habitat, history, and uses of their newly invented species. Students will show their understanding of the connections between anatomy and habitat by creating a field guide page with a sketch of their plant, a written description, and will give their plant both a common and scientific name.

Preparation

- ◆ Prepare copies of the Plant Adaptations Chart for students to explore and use in designing their plants.
- ◆ Have a field guide available. Point out features on the page such as the physical description of the plant, habitat, confusing species, and special characteristics and uses. Show the students photos, drawings, or diagrams of unique aspects of the species, measurements, plant descriptions, and habitat details.
- ◆ This activity can be used as an assessment tool at the completion of the Plant Identification Section. Students apply their knowledge of botanical terms, scientific names, habitat, and life history characteristics. Students will make creative connections between the traits of their plant and how the traits help the plant adapt to the habitat they create for it.

Assessments

Students will submit their checklist and field guide page for grading. Check for the following:

- 1** Does their plant sketch and description match the checklist options?
- 2** Is the written description complete, using proper botanical terms, and including metric measurements?
- 3** Did the student use proper format for writing scientific names?
- 4** Did the student put thought into relating plant anatomy/adaptations to their habitat choice, dispersal mechanism and pollinator?
- 5** Was the student creative in making a unique species?



Create-A-Plant

Imagination is more important than knowledge. For while knowledge defines all we currently know and understand, imagination points to all we might yet discover and create.

—Albert Einstein (1879-1955)

Materials Needed

- ♦ plant traits checklist
- ♦ Plant Adaptations Chart
- ♦ drawing materials
- ♦ metric ruler
- ♦ blank field guide template
- ♦ various field guides to use as examples

Learning Objectives

- ♦ Demonstrate knowledge of botanical terminology
- ♦ Correlate plant characteristics (form) with adaptation to habitat and life history (function)
- ♦ Apply knowledge of scientific and common names
- ♦ Engage imagination to advance scientific and critical thinking processes
- ♦ Associate visual images with new vocabulary by labeling drawings to accentuate important plant identification characteristics

Vocabulary Words

Adaptation

Habitat



Overview

Demonstrate your understanding of botanical vocabulary and natural history by inventing a new plant species. You will explore the diverse adaptive strategies plants use to survive in various habitats. You will choose the physical and ecological characteristics of your species from a checklist of traits and give it a common and scientific name. In the end, you will create a page with a detailed sketch of your new species and a written description to be used in a field guide.

Background Information

Plants can be found growing nearly from pole to pole on our planet, thriving under a vast diversity of conditions. From dry deserts to frigid tundras to rainforests, every environment provides a unique suite of challenges to the plants that live there. To survive, plants have adapted to the environments in which they live through generations and generations of natural selection.

Because plants are sessile (that is, they are immobile), they cannot move around to find resources and more favorable conditions. This puts them under extraordinary pressure to come up with adaptive strategies to survive and reproduce in the face of whatever challenges their environment delivers. In this way, plants become a reflection of their environment, both past and present. When you look at a plant, the characteristics you observe can give you clues about its habitat and the challenges that it faces to survive and reproduce. Every physical feature that you observe plays some functional role for the plant.

Not all adaptations are visible to the human eye. Physiological adaptations allow plants to survive in all kinds of environments, too. For example, to cope with hot and dry conditions, some plants open their stomata only in the cool of the night, and then metabolically fix and store the carbon dioxide they capture until daylight, when they can photosynthesize without losing precious moisture from open pores. In frigid temperatures, some plants can produce antifreeze proteins that slow ice formation.

Spend some time looking at the Plant Adaptations Chart. This chart lists some examples of adaptations that allow plants to survive under various conditions. As you look over the chart, you will notice that there are many different strategies for surviving in a particular type of environment. Some of these strategies are almost complete opposites—for example, some desert plants have very short life cycles that can be carried out entirely during a short period of precipitation, avoiding drought altogether. Other plants living right next to these fast-paced annuals instead have very long life cycles, growing extremely slowly to cope with limited resources. The prevalence of desert plants using both of these very



Create-A-Plant

Background Information, continued

different approaches illustrates that there is no one right strategy for survival.

Think about the unique conditions where you live. Is the climate hot or cold? Does moisture fall as snow in the winter? Are summers windy and dry? How are the plants that you see around you adapted to these conditions?

This activity will give you a chance to showcase what you already know about plant anatomy and terminology and expand your knowledge about adaptations. You will use your creative side to create a fictional plant. Remember that plants can appear as simple as a single tiny leaf, such as the pond-dwelling duckweed, or as complex as an elaborate orchid that grows in a tree canopy. Your plant can be large or small, woody or herbaceous. Does it have thorns or chemical defenses to keep it safe from predators? What makes your plant well suited to grow in the habitat you choose for it? Be sure to give it the adaptations it will need to survive there. Remember, a plant's appearance and traits are a product of the place where it lives and evolved.

When you open a field guide, you may see that each species entry is frequently divided into sections. Each

section contains information intended to help you identify your species and understand its natural history. Each field guide is different, but most contain sections with general information, as well as specific information about the leaves, flowers, fruits, ecology, and any special notes that will aid in identification. Plants are an extremely diverse group of organisms; the information presented in field guides organizes this diversity and helps to distinguish one species from another.

When you make your field guide page, be sure to include all the details that someone will need to identify your plant. Many field guides also contain ethnobotanical information regarding historical human uses of plants. Be sure to add this type of information for your created plant. For example, is your plant used for food, as a tool, or for medicinal purposes? In what other ways could plants be used?

Field guides include not only a written description, but also a photo or drawing. Draw your plant, illustrating the traits that you have chosen, being careful to show and label the features that make your plant unique.

Student Directions

1. Begin by choosing a habitat for your plant. Would you find it in the desert, forest, prairie, wetland, or elsewhere? Make your choice as general or specific as you like—perhaps your plant is a generalist that lives in grasslands around North America, or maybe it is endemic to a natural area near your hometown. Take a minute to think about what life is like in your chosen habitat; is it dry, wet, shady, sunny, hot, cold, or somewhere in between? Think about your habitat as you work through the checklist; what plant traits do you think would be most successful in your chosen habitat? For example, large flat leaves may lose excess moisture to evaporation and are not well suited to an arid habitat such as a desert but would work well in a shady forest understory.
2. Work through your plant creation checklist. Choose one option from each section to define the characteristics of your plant. The list will guide the evolution of your fictional plant. If you come across an option that you do not understand, consult your terminology glossary, check a field guide or dictionary, or review earlier activities.
3. Create adaptations in your plant that relate to the habitat type that you picked on your checklist. Use the Plant Adaptations Chart to come up with ideas, but don't be limited by the examples on the chart—this is by no means a complete list. Brainstorm other adaptations you have seen or heard of, or come up with some that are completely new. Be sure to explain each adaptation and how it benefits your plant.
4. When you have completed your checklist, design your field guide page. Your drawing should show



Create-A-Plant

- your checked characteristics. Fill in the smaller boxes with close-up detail of your leaf, flower, and fruit. Be sure your drawings clearly match your choices on the checklist.
- Follow prompts on the field guide template checklist and write a description for your plant. Start with a general description of the plant and progress to the details such as leaf shape, leaf margin, and so forth through the page. Use botanically correct terminology for your descriptions.
 - A field guide will always include measurements to help in identification. Metric measurements are generally preferred in science. Measurements of greater than 1 meter (m) should be expressed as meters, while those less than 1 meter should be expressed as centimeters (cm), and you might even want to use millimeters (mm) for very small details. Include measurements for your overall plant size, and for individual details.
 - Write a description of your fictional plant's habitat. Consider light, moisture, elevation, and associated vegetation. Describe how the adaptations help your plant survive in this habitat.
 - Give your plant a scientific and common name. Use correct form for writing names. If you need a review, look at the "What's In a Name?" activity.

-
- Reflection**
- Tell the story of the evolution of your plant. What did its ancestors look like? Where did they live? What environmental conditions and challenges (also called "selection pressures") induced the changes and adaptations that are now evident in your plant? How might it continue to evolve in the future in a changing environment?
-

In the Field!

Visit a local natural area and closely observe the plants you find there. What features do you notice that might help each plant survive in its habitat? How do these adaptations benefit the plants? Do you notice certain characteristics that are shared amongst many species in the same area? Record your ideas in your field journal.



Taking it Further

Assemble all of the field guide pages for your class into one field guide. Create a dichotomous key to the plants in your field guide. Your class might even choose to assemble them into fictional plant families.

- Self Assessments**
- Submit checklist and field guide page for assessment.
 - Do the checklist, sketches and description show that you have an understanding of the plant terms used?
 - Is the written description complete, using proper botanical terms, metric measurements, and a scientific name written in the correct format?
 - Did you relate your plant's anatomy to adaptations to its habitat?

- Resources**
- ♦ Harris and Harris. 2001. *Plant Identification Terminology: An Illustrated Glossary*. 6th edition. Spring Lake Publishing, Spring Lake, UT. 206 pages.



Plant Adaptations Chart

CHALLENGE	ADAPTATION	HOW IT WORKS	EXAMPLES
LIMITED WATER			
	Hairs	Hairs slow down the movement of air over the surface of leaves and stems to minimize water loss by evaporation. Light-colored hairs can also reflect solar radiation.	Sagebrush, desert ironwood
	Water Storage	Some plants store large amounts of water within their stems and leaves for use during dry periods. Waxy coatings and thorns help protect these water stores.	Cacti, aloe
	Reduced leaves	Decreasing or eliminating leaf surface area minimizes water loss by evaporation.	Conifers, cacti
	Specialized root systems	Deep root systems allow plants to reach low water tables. Alternatively, extensive, shallow root systems maximize absorption of light precipitation by capturing water that doesn't infiltrate deeply into soil layers.	Mesquite, saguaro cacti, sagebrush
	Specialized Life Cycle	Rapidly developing annuals can carry out their entire life cycle during short periods of rain, avoiding drought periods. Other plants develop very slowly to minimize their requirements of limited resources, but live for many years.	Ghostflower, Bigelow's monkeyflower
	Dormancy	Both mature plants and seeds can remain inactive for long periods of drought. Growth can then be triggered very rapidly by precipitation.	Ocotillo
	CAM Photosynthesis (Crassulacean Acid Metabolism)	Some plants can conserve water by opening their stomata only in the cool of the night, and then storing the carbon dioxide they capture until daylight, when they can photosynthesize without losing precious moisture from open pores.	Cacti, purslane
HIGH MOISTURE OR AQUATIC CONDITIONS			
	Hollow or spongy stems	Air spaces in stems transport oxygen to waterlogged plant roots.	Cattail
	Flexible stems	Plants growing in the water column can bend in currents without breaking.	Water lily
	Prolonged seed viability	Seeds can wait to germinate for many years until they come in contact with soil and air.	Bulrush, cattail
	Floating leaves	Buoyant leaves allow plants rooted in standing water to reach sunlight and air. Stomata are located on the upper surface of the leaf for gas exchange.	Water lily
	Lenticels	Specialized pores allow plants to absorb nutrients, water, and necessary gasses from the water.	Willows
	Modified root systems	Modified and adventitious roots can extend above the waterlogged soil or water line to allow contact with oxygen. This also provides support in soft soil.	Mangroves
	Rot Prevention	Anti-fungal or anti-bacterial chemicals can help prevent rotting.	Cedar, larch



Plant Adaptations Chart

CHALLENGE	ADAPTATION	HOW IT WORKS	EXAMPLES
HOT CONDITIONS			
	Hairs	Hairs can insulate a plant against heat. Light-colored hairs can also reflect solar radiation.	Brittlebush
	Leaves used as shade	The arrangement of leaves, spines and persistent dead leaves on the plant can provide umbrella-like shade.	Joshua tree
	Altered daily rhythms	Flowers may open only at night to attract nocturnal pollinators that avoid daytime heat.	Evening primroses
COLD CONDITIONS			
	Evergreen needles	Evergreen needles allow plants to photosynthesize all year, extending the short growing seasons in cold regions of the world. The narrow, waxy needles decrease water loss in regions where moisture is locked up as ice. They also help shed heavy snow to prevent broken branches.	Pines, spruces, hemlocks
	Deciduous leaves	Shedding broad leaves during cold months prevents damage from the cold and lack of water. Deciduous plants can be found where moisture is plentiful in some seasons, but unavailable in cold seasons because it is frozen.	Oaks, willows, maples
	Small size	Small, low-growing plants, sometimes called "dwarf," are more protected from cold air, and require less water and nutrients.	Arctic willow
	Hairs	Thick, woolly hairs help insulate plants against cold air and wind.	Lousewort
	Seasonal dormancy	Dormancy during the cold months prevents damage from the cold and lack of water. Soil moisture is often unavailable in cold conditions because it is frozen.	Broadleaf trees, larch
	Antifreeze proteins	Damage from freezing can be prevented with specialized proteins that slow ice formation.	Antarctic hairgrass
	Tussocks	A clumped or bunched growth form, sometimes called a tussock, helps trap warmth and insulate plants from cold conditions.	Arctic cottongrass
	Underground structures	Energy-storing structures like rhizomes and corms help plants get a head start in areas with a short growing season.	Arctic lupine
LIMITED NUTRIENTS			
	Symbiotic relationships	Soil bacteria including <i>Rhizobia spp.</i> and <i>Frankia spp.</i> form nodules on the roots of certain plants and fix nitrogen into a usable form. Some fungi can help plants increase their absorption of water and nutrients. Under some soil conditions, certain nutrients can only be taken up by plants with the help of these fungi.	Legumes, alders
	Carnivory	In nutrient-poor soils, some plants obtain nutrients by trapping and digesting insects and other arthropods.	Pitcher plant



Plant Adaptations Chart

CHALLENGE	ADAPTATION	HOW IT WORKS	EXAMPLES
LIMITED LIGHT			
	Vines	Vining plants use larger plants as ladders to reach light without putting energy into producing large supporting trunks and branches.	Muscadine
	Broad leaves	Increased leaf area maximizes the photosynthetic capacity in light-limited conditions, but result in increased water loss as well.	Oaks, maples
	Specialized life cycle	Some understory plants in deciduous forests develop and mature early in spring in order to utilize light before they are shaded out by the growth of leaves on larger trees.	Spring beauty, trillium
	Height	Trees can grow very slowly under low-light conditions, eventually reaching incredible heights in order to reach sunlight at the canopy of a forest. A very strong trunk and root system are required to support such height, which can only be obtained through plentiful water and nutrients.	Oaks, cedars, maples, hemlocks
FIRE			
	Serotinous cones	Cones can be sealed tightly by resin, open only after the intense heat of fire, which allows seeds to germinate under optimal conditions and repopulate burned areas.	Lodgepole pine
	Resprouting	Substantial underground structures like rhizomes, root crowns, and branches are protected by the insulating soil and can allow plants to survive and continue to grow after the aboveground portions have been burned.	Many grasses, Rabbitbrush
	Thick bark	Thick plates of armor-like bark can allow trees to survive some fires with little damage.	Ponderosa pine
HERBIVORY			
	Armaments	Different types of armaments work against different types of herbivores. Large thorns and spines deter larger animals like deer, while hairs can be effective at deterring insects.	Cacti, roses
	Toxins	A wide variety of toxins, both mild and potent, keep herbivores from eating certain plants. Effects can range from bitter tastes to skin irritation to fatal poisonings.	Poison ivy, water hemlock
	Protected crown	Buds and stored carbohydrates located in the crown at the base of a plant are protected and allow for quick and low-cost recovery if the top of the plant is grazed.	Grasses
	Mast-fruiting	This is a phenomenon where individuals of a certain species will produce very few seeds for several years, followed by a year of high seed production. It is thought that this helps keep the population of seed predators low so they don't devastate the seed bank each year.	White oak



Create-A-Plant

Plant Creation Checklist

Habitat type (where does your plant live)



wetland prairie/grassland
 forest desert/arid lands
 alpine peak other _____

Habitat Clues — adaptations your plant exhibits that make it suited to live here





Stem

single multiple

Leaf Attachment to Stem

petiole  sessile 

Leaf Arrangement

alternate  opposite 
 whorled  basal 

Leaf Margin

entire serrate
 lobed other _____

Leaf Shape

cordate ovate
 lanceolate palmate
 other _____

Leaf Division

simple
 compound (palmate/pinnate)

How does your plant protect itself from predation?

Pollinator (refer to Secret Life... lesson, or learn more in the Native Plant Ecology section)

bee butterfly
 beetle wind
 bird moth
 bat other _____



Create-A-Plant

Plant Creation Checklist

Inflorescence Type

composite



umbel



raceme



spike



panicle



solitary



Flower

perfect flower

imperfect flower

number of petals _____

number of stamens _____

Seed Dispersal Method (refer to Drupes...lesson)

mechanical/throw

animal - edible

wind/blow or shake

water/float

animal - hitchhike

animal - cache

other _____

Fruit Type (illustrate)

drupe



pome



samara



nut



legume



berry



other _____

Ethnobotanical Use (historical human use)

food

medicinal

fiber

tools

other _____

Author _____



Create-A-Plant

Field Guide Page

Plant Name

Habitat:

Description:

Leaves:

Inflorescence/Flower:

Fruit:

Ethnobotanical use:

Field Notes (include adaptations and defense):



Mechanics of a Key

Obstacles don't have to stop you. If you run into a wall, don't turn around and give up. Figure out how to climb it, go through it, or work around it

—Michael Jordan (1963-present)

Time Estimate:

Part 1: 40 minutes,

Part 2: 20-30 minutes

Best Season:

All



Teacher Hints

1. Set the stage for this activity by leading a discussion on human diversity and how important diversity is to the health of the community of people. Link this to plant diversity and health of plant ecosystems (a more diverse ecosystem tends to be more resistant to environmental change).
2. Part 2 and 3 introduce students to using two common but different versions of a dichotomous tree key. Walk the students through the steps while identifying a native tree.
3. Most keys are heavy with botanical vocabulary. Try printing out the glossary from this curriculum or providing copies of *Plant Identification Terminology*.

Overview

Learn how to identify plants using a dichotomous key by walking through the steps of constructing a key to the students' shoes. Once students are comfortable with how a key works, they transfer their knowledge to keying out native plants using local field guides.

Teacher Preparation

- ♦ Read background information and become familiar with the how a dichotomous key works. Many field guides also have descriptions of how a key works and specifically how the key in that book works. If you are using a specific guide with your students, it may be helpful to read this section. It is usually found at the beginning of the guide.
- ♦ When trying out a dichotomous key on a native tree, try starting with a native evergreen, which often are more simple to key out and can be used in any season.
- ♦ Make copies of a tree key from a regional field guide for students to use in Part 2 of the activity.

Assessments

- 1 Student can explain how to use a dichotomous key
- 2 Students can work in a cooperative group to construct a simple key
- 3 Students are able to key out a native plant using one or more dichotomous keys

Additional Information/Reference

- ♦ Detka, Jon. *Designing & Using a Dichotomous Key*. [Return of the Natives: A Cycle of Restoration Curriculum](#). Watershed Institute California State University Monterey Bay. <http://watershed.csUMB.edu/ron/roncor/cor/did.htm>
- ♦ Harris, James G., and Melinda Woolf Harris. *Plant Identification Terminology: An Illustrated Glossary* 6th edition. Spring Lake, UT: Spring Lake Pub., 2001.



Mechanics of a Key

Obstacles don't have to stop you. If you run into a wall, don't turn around and give up. Figure out how to climb it, go through it, or work around it.

—Michael Jordan (1963-present)

Materials Needed

Part 1:

- ◆ blank dichotomous key handout
- ◆ flexible measuring tapes

Part 2:

- ◆ field guide with plant key
- ◆ overhead transparency of key page
- ◆ native tree species to key out (on school grounds or use pictures if not available)

Learning Objectives

1. Learn to use a dichotomous key
2. Develop the ability to phrase key questions to construct a key
3. Create a key for others to use

Vocabulary Words

dichotomous

Overview

Learn how a dichotomous key works by walking through the steps of creating a key to the shoes in your classroom. Apply your newly learned keying skills to using a key to native plants and you will be well on your way to identifying native plants.

Background Information

A **dichotomous key** is a useful tool that natural scientists use to identify all kinds of living (or sometimes non-living) things. The word dichotomous comes from the Greek dichotomia, meaning divided (from dicha, meaning “in two”). A dichotomous key works by dividing one large group of objects (in our case plants) into two smaller groups by using characteristics that do not overlap. The wording is written as such that none of the objects in the group can belong to both divisions. The key is put together in steps that you walk through in order, one step at a time. Each step will divide the group of objects into smaller and smaller groups until you have just one option and an exact identification.

A great way to learn how to use a key successfully is to construct one of your own. The best test of your key is to give it to others and see if they can successfully identify something with it. A key can be made in many ways and still get to the same end. The nature of the questions and the order that you ask them can vary; it is only critical that the key works to get you to the correct answer.

The key will provide a series of paired statements. It works kind of like a *Choose Your Own Adventure Book*; each of the two statements will guide you along a different path to another set of statements. Continuing in this step-by-step manner, you will eventually discover an object’s identity.

Each step is made up of a pair of statements, called a “couplet.” Here is an example of a simple dichotomous key couplet. These paired statements split evergreen, coniferous trees into one group, while deciduous, broadleaf trees comprise a second group:

1a. Trees with leaves that are needle-like or scale-like and evergreen. .Group 1
OR

1b. Trees with leaves that are broad and deciduous.Group 2

Hint: Pay attention to the numbers and letters at the beginning of each statement. Each of the two statements in a couplet will always have the same number at the beginning. If you choose the first statement (ex. 1a), the next steps you follow will be indented below 1a. If you choose 1b., you will go forward choosing the next steps indented below 1b.



Mechanics of a Key

Each statement will tell you the number of the couplet to take next—just like the page directions in a *Choose Your Own Adventure* Book. See the simplified example below. This takes some practice to get used to!

Example:

Imagine you find an evergreen conifer with needles that are between 1.5 and 2 cm long, and cones that are dark brown and about 2 cm long. Here is a possible dichotomous key, with the correct steps for this species written in bold:

- 1a. Trees with leaves that are needle-like or scale-like and evergreen 2**
- 2a. Leaves are scale-like *Juniperus*
- 2b. Leaves are needles 3**
- 3a. Leaves are between 1.5 and 2.5 cm 4**
- 4a. Seed cones are 3 to 8 cm long, cone scales are dark purple, red, or brown 5
- 5a. Seed cones 3 to 7 cm long, leaves blue-green and square in cross section *Picea glauca*
- 5b. Seed cones 4 to 8 cm long, leaves dark green and flat in cross section *Tsuga balsamea*
- 4b. Seed cones are 1.5 to 3 cm long, dark brown *Tsuga canadensis***
- 3b. Leaves are between 5 and 13 cm long 6
- 6a. Leaves in bundles of 5 *Pinus stroba*
- 6b. Leaves in bundles of 3 *Pinus rigida*
- 1b. Trees with leaves that are broad and deciduous 7
- 7a. Leaves palmately lobed, up to 20 cm long; 25-35 m tall; bark brown-gray and furrowed; produces sweet sap that can be harvested *Acer saccharum*
- 7b. Leaves ovoid shaped, edges doubly serrate; 18-30m tall; bark thin and white or reddish-brown, shedding in paper-like sheets *Betula papyrifera*

In this activity, you will make a dichotomous key to the shoes in your classroom. Follow these simple guidelines to make your key a success:

1. Your first pair of statements should divide the shoes in your class into two categories based on some fairly obvious trait, such as closed-toe shoes vs. sandals, or boots vs. shoes. Try to focus on traits that are commonly shared between several individuals, though it is okay to divide out one or a couple of individuals earlier in the key if they are very obviously different.
2. Continue to build your key by asking more questions. The objective of each step should be to identify a clear trait that divides the remaining individuals into only two groups. Remember, it is vital that each statement must be worded so as to have only two possible answers.
3. The statement should refer to a trait that is obvious, unambiguous, and observable. Traits that are opinions (coolest, best, most fun, etc.) do not belong in a dichotomous key.
4. Continue to pose questions in your key until all shoes have been identified.
5. Once complete, give your key to a partner and see if they can follow it.

Directions

Part 1:

1. Carefully read over the background information before starting and refer to it as needed.
2. Either a teacher or a designated recorder should write down each key step that the class chooses as you make your dichotomous key.
3. Start with the entire class placing one of their shoes in a single group. This will help you visualize how the key works.
4. The first step of the key will divide the class into two parts by making a statement with only two possible categories. Remember, as you ask these questions you will want to use traits that are obvious (easily seen) and measurable, not subjective (such as "cool"). Record the first question on your empty key sheet at the top. Now physically move the shoes into the two new groupings.



Mechanics of a Key

Directions, continued

- The next step is to divide your group of shoes again. Here's a hint: notice that each grouping has only two answers. For example: "Divide into those that have blue laces and those that do not have blue laces." Notice that the question didn't ask you to divide into those with blue laces and those with green laces, since it is possible that other shoe lace colors, such as black, brown, orange, gray, multi-colored, or pink may be present. Record your division on your key sheet and physically separate your shoes into those groups.
- Continue to work through the groups until each shoe has been individually identified. Be sure that you have recorded each step on the dichotomous handout.
- Once you have a completed key to the entire class, choose a classmate and try to identify their shoe by working through the key. Were you able to properly identify them?
- Discussion questions. How does the statement "Shoes with mud on the bottoms" work? What if you used this key with the classroom tomorrow? Would the muddy shoe statement still lead to the same person? For the same reason, the easiest and best plant keys do not depend on having a flower or fruit visible; you might have one to look at today, but next week is a different story. It is, however, quite common for keys to focus on flower and fruit characteristics, as they are quite often necessary for proper identification.

Part 2:

- Key out a native tree species outside (or from photographs if your school has no native trees) using a tree field guide for your region.
 - The first step in this key will likely ask you if you have an evergreen or deciduous tree. Subsequent steps will help you to narrow down the identity of your native tree.
 - Walk through the steps of the key by following the numbers until you reach a name for your plant.
 - Confirm that you have arrived at the right species by finding a description for the appearance and habitat of your species and make sure that they match with the individual you chose. For example, if you chose a tree from a low wetland and then the species you arrive at in the key lives high in the mountains, you know you have made a mistake somewhere in the key. This happens to professional botanists all the time. When this happens, go back to any couplets (pairs of statements) where you were unsure about which statement to choose and choose the one you did not choose the first time. See where this takes you. Sometimes keying out a difficult species can be a bit of an adventure so have fun with it!
- Hint:** It helps to write down which choices you make as you key out a species.
- Even if you think you know the name of the tree, work through all of the steps in the key for practice. Then try another species. The more you do this, the easier it gets!

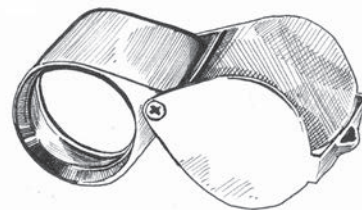

Self Assessments

- 1 Explain how to use a dichotomous key.
- 2 Cooperate as a group to construct a simple key, trade keys, and critique the results.
- 3 Identify a native plant using one or more dichotomous keys from local field guides.



Mechanics of a Key

Taking it Further

Using your field guide, key out two plants from the same plant family. Use plants from one of the following families

(see activity "Plants Have Families Too" for native plant species suggestions):

- ◆ *Liliaceae* (lily family)
- ◆ *Fabaceae* (pea family)
- ◆ *Apiaceae* (parsley or carrot family)
- ◆ *Lamiaceae* (mint family)

For an extra challenge, try:

- ◆ *Asteraceae* (sunflower family)

In the Field!

Using a field guide to identify native plants is the backbone of this section of the curriculum. You have learned about plant terms, plant families, scientific names, plant keys, and you now have the skills and tools to identify plants. Take a local field guide out into nature and identify the plants you see! Don't forget to look for helpful clues, such as the ecology of your plant. Where does it live? Are you looking at a plant in a wetland, grassland, on a mountain or in a forest? These are all clues that will help you identify the plant you have found. You now have the basic tools to identify plants; it is now your challenge to increase your skills with practice, practice, practice!



Reflection

- Each plant you key out may be unique, but it is also a member of a larger ecological grouping. Plants live in communities and are part of an even larger ecosystem. Look at one of the plants that you have identified and write about how the plant you chose belongs to a larger community of interacting species. Think about both the plant and yourself in the context of your communities and in your larger ecosystems. What do you have in common with your plants species? How does your role in your community compare to that of your plant?

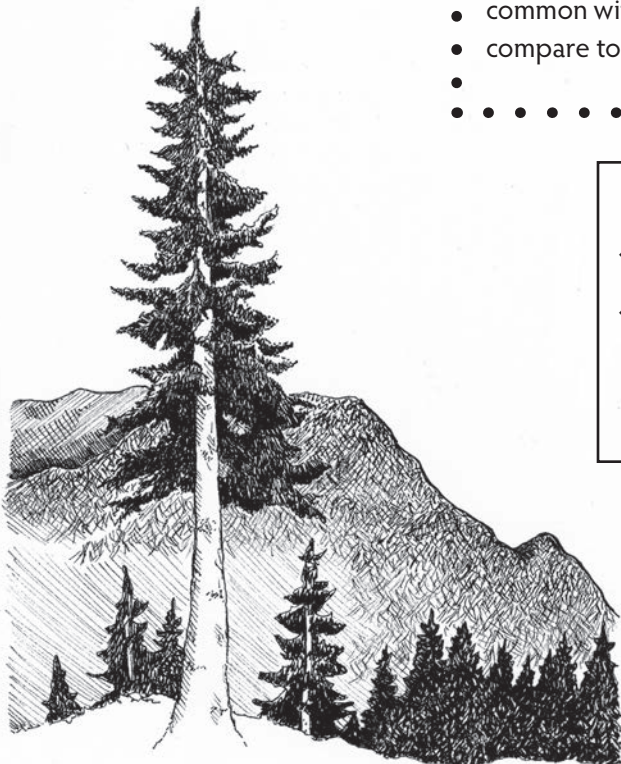

Resources

- ◆ Field guides for your ecoregion (see Appendix for listings)
- ◆ Detka, Jon. *Designing & Using a Dichotomous Key*. Return of the Natives A Cycle of Restoration Curriculum. Watershed Institute California State University Monterey Bay. <http://watershed.csumb.edu/ron/roncor/cor/did.htm>



Make A Field Guide

The voyage of discovery is not in seeking new landscapes but in having new eyes.
—Marcel Proust (1871-1922)

Time Estimate:

Part 1: 60 minute session

Part 2: Additional field and class sessions needed

Best Season:

Spring,
Summer,
Fall

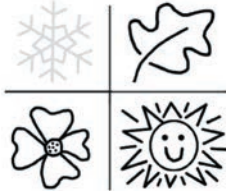

Overview

Students culminate the exploration of botanical skills learned in the plant identification section of this curriculum by constructing a field guide to the plants (and more, if desired) of a natural area on or near the school grounds.

Preparation

- ◆ Before taking students outdoors, scope out a suitable location for this activity, preferably on the school grounds or close by. If possible, use a natural area with a diversity of plant species.
- ◆ Divide the students into teams of four or fewer.

Teacher Hints

- ◆ Begin with “Mechanics of a Key” and “Invent-A-Plant” activities in this guide. You and your students will need to understand how a dichotomous key works and how they are constructed as well as the components of a field guide page before beginning this activity.
- ◆ The “In the Field!” section below can help your school make a community service connection with a local park or natural area. Identify a location that is accessible to your students and approach the governing organization for permission. Explain what your students will be doing and that they will present them with the finished project. Invite a staff person from the organization to help mentor the students. Invite them on the field trip to the natural area to learn more about its ecosystems and history.
- ◆ Consider the scope of your guide. For example, you could have students produce a guide to just the trees in your school yard, or broaden the scope to include both trees and shrubs.
- ◆ One possibility is to build your guide year by year, so that the first class produces a guide to trees, the next year produces a section on shrubs, and the following year adds a section for wildflowers.
- ◆ To make this lesson more challenging, instruct your students to choose plants for their key that have a lot of physical similarities (i.e. several conifer species). To make this lesson easier, have your students choose plants that are obviously very different.

Assessments

Exchange keys among student groups and have each group test other groups' keys for effectiveness. Write a peer review of the key or guide that others have constructed. The review should be balanced, noting both positive attributes of the guide and giving constructive suggestions for improvement.

What works well about the key? Did they include terminology that you could understand? Were the steps of the key easy to follow? What constructive suggestions can you give for improving the ease of use?

Make A Field Guide

The voyage of discovery is not in seeking new landscapes but in having new eyes.
—Marcel Proust (1871-1922)

Materials Needed

Part 1:

- ◆ flagging tape
- ◆ dichotomous key handout (Mechanics of a Key lesson)
- ◆ clipboard
- ◆ pencils
- ◆ waterproof marker

Part 2:

- ◆ field guide template (Create-a-Plant lesson)
- ◆ colored pencils
- ◆ digital camera (optional)
- ◆ computer (optional)

Learning Objectives

- ◆ Construct a dichotomous key to plants in your area
- ◆ Apply plant terminology correctly
- ◆ Compare and contrast plant structure and function

Vocabulary Words

dichotomous key

Overview

Put your new plant identification skills to work. Use your knowledge of dichotomous keys, plant terminology, families, and scientific names to construct a key to a natural area on or near the school grounds.

Background Information

In this activity, you will design a field guide to the plants (and more if you like!) on your school grounds or a natural area in your community. A field guide will be an excellent asset to your community and will provide visitors to the area with important natural history and botanical information. Your teacher may ask that you engage in additional community service opportunities, such as using your field guide as a tool to lead groups on tours, or giving presentations to groups to promote use of the area.

The previous activity, “Mechanics of a Key,” gives you the groundwork for constructing a dichotomous key, which will be necessary to include for people to be able to use your field guide.

To ensure the success of your dichotomous key, each question can only have two possible answers. Your key will not function properly if there are more than two answers per question. Read the following pair of statements and find the problem: “Plant is less than 30 cm tall.” OR “Plant is more than 30 cm tall.” In which category would a plant that is exactly 30 cm tall be placed? This statement needs to be reworded to read: “Plant is less than or equal to 30 cm tall,” OR, “Plant is more than 30 cm tall.” Now there are only two possible options.

The Invent-A-Plant activity will give you an idea of the type of information that should be included in a field guide. Review the background information for this activity. Remember to use the other skills from the plant identification section (such as terminology). Each page in your field guide should include a photo or drawing (or both) that shows the general look of the plant with close-ups for distinguishing features. The following is an example of what a page for the paper birch (*Betula papyrifera*) might look like. Key features to be sure to include for each plant are in parentheses:

Example: Paper Birch (*Betula papyrifera*)

- ◆ **General description:** Deciduous; medium-sized tree, averaging 16 meters tall, up to 30 meters; young branches and trees have reddish brown color; in mature trees, the white bark peels from the trunk in papery strips, and is generally marked with distinct horizontal lines and raised pores. (deciduous vs. evergreen; tree, shrub, grass, or forb; height; bark characteristics)
- ◆ **Leaves:** Alternate; simple; oval to round with sharp-pointed tips; about 10 cm long; green above, pale below; double-serrate margins. (arrangement; simple vs. compound; color; size; basic shape; margin description)
- ◆ **Flowers:** Staminate catkins (4-10 cm) form in the fall and mature in May-July. Female catkins (2.5-5 cm) emerge in May-July. (where applicable: color; number of petals; symmetry; size; arrangement; time of emergence)
- ◆ **Fruits:** Winged nutlets, 1.5 mm x 1 mm; wings broader than main body of nutlet; light brown. (type, color, size, description, mode of dispersal)
- ◆ **Ecology:** Generally in moist sites, from low to medium elevations; open to dense woods; found mixed with a variety of other species, generally in second-growth forest. (where it lives; with what other species; specific soil types or habitats if relevant)
- ◆ **Enthonobotany:** The peeling bark can be used for basket-making and canoes; the sap was chewed and used as glue. (how Native American tribes or other people use this species)
- ◆ **Notes:** Young stands of paper birch provide palatable browse and good cover for deer and moose. Porcupines eat the inner bark. The seeds provide food for a variety of birds and small mammals. Colonizes rapidly following fire. Do some research to learn more about your plants wildlife uses and other cool facts. Consider including observations about your species in the area you are working—for example, perhaps there is a large stand of your plant on the south edge of the property, or you notice that the plant seems to prefer the shade of certain trees, etc.

Student Directions

Part 1

1. Divide into teams of 4 or fewer.
2. Each team should first select individuals of different plant species from a small area. To make this project more challenging, choose plant species that share more obvious similarities. Place a flag next to each one and number consecutively with a permanent marker. Choose plants with flowers or fruit if they are available. Try to choose plants that are fairly close together for ease of comparison. Carefully examine each of your plants.
3. Devise the first pair of statements for your key. Remember:
 - ◆ Begin with statements that are broad and general and apply to all of your individuals. For example: "Plants have woody stems" OR "Plants are herbaceous (non-woody)." All paired statements should have only two possibilities. Be sure that none of your options are subjective or relative. For example, you cannot ask if a plant is tall or short. You must give specific measurements.
 - ◆ Be careful with statements that can vary greatly from one individual plant to the next (such as colors or measurements). Be sure to observe several individual plants of the same species before deciding to include these characteristics in your key.
 - ◆ Consider the time of year. If you are doing this activity in the spring, the same species might be much taller later in the summer. You can cross-check your information with a field guide for your region or an online source.
4. Continue working through your key in this manner until your key directs the user through the series of statements to the individual plant.



Make A Field Guide

Directions, continued

5. Fill in your blank key handout when you are confident that the questions you have chosen will lead the reader to the individual plants.
6. When finished, exchange the test keys with another group and try to work through their key filling in the number of the plants for the answer. When you are done, look at the answer key. How did you do? What parts of their key work well and are clear? What parts are confusing? How would you improve their key?

Part 2: Make a field guide for a natural area of your schoolyard.

1. Do a complete survey of the plant species in the area you will be describing. Note the habitat and specific locations where each is growing. Record vital information for each of the plants that are in your key on the identification handout. Describe the plants as completely as possible, using correct plant terminology. Include a sketch or photograph of the species.
2. Use a published plant field guide to identify your species. If you are unable to make a positive identification, collect a specimen to press (ONLY collect if you have permission) and check with local experts who can help you identify them (check the appendix of this guide for a list).
3. In the classroom, use the internet and other field guides to collect research about your species. Collect additional information on bloom times, flowers, fruits, and the scientific name. Be sure to find out to which plant family your species belongs.
4. Assemble your information together in the form of a field guide page for your species. The first pages of your guide should be a dichotomous key to all of the species. Devote a half or whole page of your field guide to each plant. Include a description, drawing or photograph, the common and scientific names, and anything else interesting that you discovered in your research. Use published plant field guides as examples for the type of information that is important to include.

Taking it Further

- ◆ Design a brochure or booklet for a natural area at or near your school.
- ◆ Use a computer program to design the brochure to advance your technological design skills. Include a simple map, a key for identifying the plants, descriptions, photos, and the common and scientific names for all the plants in the key. If available, include some site history information in your brochure. Make your brochure available for others to use by putting up a display at the front of the school, sharing with other classrooms, or giving a presentation to a teacher staff meeting, parent or community group. Or, create a kiosk at the natural area and have your brochure available for curious visitors.
- ◆ Work with an elementary school to make a field guide to schoolyard plants. Design a simple key that uses only pictures or drawings. Teach a group of younger students to use it.

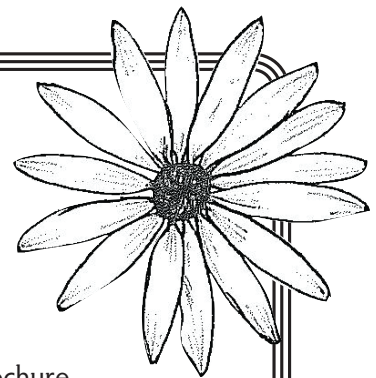



Make A Field Guide



In the Field!

Volunteer to make a brochure or field guide to be used in a city or county park.

- ◆ Have a staff person accompany you on your visit to help define the area for your field guide and to help with identification. Go to the site and choose a short interpretive walk for the field guide. Choose the plants that you would like to include in your field guide. Divide into groups with each group managing a part of the field guide. Different groups can be in charge of making a simple map with identification stops, constructing a key, taking photographs, and writing the descriptions.
- ◆ Return to the classroom and use a computer to make a brochure for the park. The brochure should have the name of the park and credit the class as creators of the brochure (example: created by Any School, 8th period biology students, 2008). Ask an expert to review your brochure for accuracy and your teacher to proofread for errors. When you have finished the project, present the park with a printed brochure and an electronic copy for future use.

Science Inquiry

Use your inquiring mind. Design a different way of sorting or classifying plants to identify them. Some field guides divide plants by growth form or flower color or plant family. What other ways can you come up with? No classification system is perfect. What are the advantages and disadvantages of the system you chose?



.....

• **Reflection**

• Like most skills, plant identification improves with practice. Do you feel that you have the tools you need to identify plants? Write the steps that you would use to identify a new plant. Make a list of skills you need to practice or improve on to make plant identification easier for you. This can be called your plan of study for plant identification. Could this planning process help you learn another skill or help with a different subject at school?

• Write in your journal. What do you gain by learning the names of plants? Can you connect with and appreciate the plants without learning their names? What are some of the other ways that you can experience plants other than by identifying them?

.....



The Place I Call Home

Time Estimate:

Two sessions, and/or time outside of class

Best Season:

Any

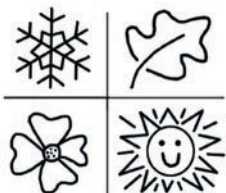

Life is like a landscape. You live in the midst of it but can describe it only from the vantage point of distance.
—Charles Lindbergh (1902-1974)

Overview

In this lesson, students will take an in-depth look at their home ecoregion. The major, Level I ecoregions of the United States can be broken down further into Level II and Level III ecoregions, which are nested within one another. Each group of students will be assigned to study one of the Level III ecoregions that comprise the Level I ecoregion where they live. They will present their research to the rest of the class.

Teacher Hints

- ◆ Consider setting a minimum number of resources students must use to research their ecoregion.
- ◆ This lesson works well when preceded by the Exploring the Ecoregions of the United States lesson, where students are introduced to the concept of ecoregions and the ways in which abiotic factors influence the biotic elements of a region

Preparation

- ◆ Print copies of the profile of your Level I ecoregion from the “Level I ecoregion descriptions” handout from the “Exploring the Ecoregions of the United States Lesson”, or have your students access the information online at: ftp://ftp.epa.gov/wed/ecoregions/cec_na/CEC_NAeco.pdf
- ◆ You will need to look at a map of the Level I ecoregions (see website above) to determine which Level I ecoregion you call home. Appendix III lists the Level III ecoregions that are nested within your Level I ecoregion. Assign one of these Level III ecoregions to each group of students to study and present to the class.

Assessments

- 1 Name and describe a rare or invasive plant species found in your ecoregion.
- 2 Name and locate one (or more) natural areas in your ecoregion.
- 3 Describe at least two primary land-uses in your ecoregion.



Additional Information

- ◆ Descriptions of Level I ecoregions: ftp://ftp.epa.gov/wed/ecoregions/cec_na/CEC_NAeco.pdf
- ◆ Descriptions of Level III ecoregions: http://www.cec.org/sites/default/files/Atlas/Files/Terrestrial_Ecoregions_L3/TerrestrialEcoregions_L3_GeoPDF.zip



The Place I Call Home

Materials Needed

- ◆ profile cards for your Level I ecoregion (Appendix III)
- ◆ poster board OR
- ◆ Powerpoint
- ◆ computer and internet access

Learning Objectives

- ◆ Use logic and creativity to relate the physical and geographic attributes of an ecoregion to its biological characteristics
- ◆ Use reliable resources to research an ecoregion
- ◆ Compile and present information

Vocabulary Words

topography
rainshadow
geology
latitude

Life is like a landscape. You live in the midst of it but can describe it only from the vantage point of distance.

—Charles Lindbergh (1902-1974)

Overview

What makes your ecoregion special? Whether you have lived in your ecoregion for a long or short time, it holds many surprises. In this lesson, you will take an in-depth look at your home ecoregion. The major, Level I ecoregions of the United States can be broken down further into Level II and Level III ecoregions, which are nested within one another. You will be assigned to study one of the Level III ecoregions that comprise the Level I ecoregion where you live to understand your ecoregion in greater detail. You will present your research to the rest of the class.

Background Information

In the last lesson, we learned about the way climate and major geologic factors influence the different regions of our country. In this lesson, we will shift our focus to a smaller scale. You will study your own ecoregion in greater detail, to gain a better understanding of the place that you call home. You will use the knowledge gained from the last lesson to look for similar patterns within your own local landscape. As you become familiar with your own ecoregion, think about what you already know based on your observations of your surroundings.

Ask yourself the following questions about the place you call home:

- ◆ Where do I live?
- ◆ What is the nature of this place?
- ◆ What sustains my community?

Picture where your hometown is located on a map of the world. Are you near or far from the equator? One of the primary factors that influences the “personality” of your ecoregion is the **latitude**. This affects the overall climate of your region, and the prevalence of seasons. As you move from south to north, the climate generally becomes much cooler, due to the angle and duration of sun exposure. The Earth’s tilted axis means that ecoregions located far to the south or north of the equator spend part of the year pointed away from the sun, causing winter. The farther from the sun an ecoregion is located, the more pronounced the seasonal changes are. Think about the yearly seasonal changes you observe. Are they subtle or dramatic? You might detect changes in temperature, weather patterns, migrating animals, and vegetation.

Now think about where you are located on the continent. If you live near the Great Lakes or near the ocean, you might experience the moderating effects of water on climate. Water responds very slowly to changing temperatures, so regions adjacent to large bodies of water often have relatively warmer winters and cooler summers than inland locales of similar latitude. If you live in the



The Place I Call Home

Background Information, continued

interior of the country, far from large bodies of water, you likely experience seasonal changes that are much more extreme.

Next, consider the elevation where you live. How far above sea level is your hometown? How might that affect the climate? Elevation can make a big difference on both large and small scales. For example, snow might be a rare occurrence in one location, while another location just a few miles away and a few hundred feet higher in elevation might experience snow regularly in the winter.

Geology and **topography** (the surface shape of the landscape) are also key parts of every ecoregion's character. Is the area where you live influenced by the **rainshadow** effect? You might live on the windward side of a mountain range, and thus receive a great deal of precipitation as air masses rise in elevation and release their moisture. Or, perhaps you live on the leeward side of a mountain range, where little precipitation falls and the climate is more arid. Aspect, or the direction a slope faces, is important to the local climate, too—a town located on a north-facing slope might still be facing winter-like conditions when the warm weather of spring has arrived on south-facing slopes.

How do these abiotic factors—geology, topography, latitude, climate, and soils—affect the native vegetation in your area? Think back to what you know about plant adaptations. What kinds of adaptations do plants need to survive where you live? Consider the local native plants that you know. How do they exhibit some of these adaptations?

Why do you live there? Our cities and towns are located where they are for a reason. New York City, for example, grew out of a flourishing beaver trade. The winding waterways and wetlands were lush with a diversity of native forests and marsh vegetation that supported a wide variety of life forms, including a robust beaver population. It was the lucrative beaver trade that led to European settlement of the area and eventually dramatic growth into the city it is today. On the other side of the continent, the heavy rainfall captured by the Cascade Range in the

Pacific Northwest produces rainforests of immense trees. The timber industry that sprung up to harvest these trees led to the growth of cities and towns throughout the northwest, such as Seattle, Washington. Then there are small towns in the Midwestern corn belt, where much of our country's food supply is grown. The extensive fibrous root systems and nitrogen-fixing associations of native prairie vegetation helped to form the deep, fertile soils in this region, making it an ideal place to grow food crops. Where is your hometown? What was it about the natural landscape that led to the settlement of that location?

What sustains your community? The economy and culture of the place you live reflect its natural history. In North Dakota, for example, Mandan tribes grew squash, beans, and corn in the fertile soils deposited by floods along the banks of the Missouri River and its tributaries. If you look at satellite imagery of the Missouri today, you can see farm fields lining the rivers where farmers still benefit from the fertile soil deposits and accessible water. Farther from the rivers, cattle now graze the same bunch grasses that once sustained a different ungulate, the American bison. While our country has changed considerably over the years, our various communities continue to be sustained by many of the same ecosystem processes. What are the major land uses in your region? Do you live among forests, where the timber industry is still a major industry, or in an agricultural area? From which rivers does your community draw its drinking water? What are the historic and prehistoric legacies of land-use in your area?

Many of us now live in urban areas, where our communities may not be obviously centered around agriculture or forestry. But though they may be inconspicuous, natural processes are still present and going on all around us. Whether you live in the city or on a farm, our lives are intertwined with the natural features of the places where we live.



Student Directions

1. Break into groups of two to four people. You will be working together to study one section of your Level I ecoregion.
2. Begin by reading about about your Level I ecoregion. Your teacher will give you a hardcopy, or you can find the EPA website at ftp://ftp.epa.gov/wed/ecoregions/cec_na/CEC_NAeco.pdf. This profile page will have information on the physical setting, biological setting, and human activities that characterize your ecoregion.
3. Your teacher will assign your group to study one of the Level III ecoregions that is nested within the larger Level I ecoregion in which you live.
4. Access a description of your Level III ecoregion at http://www.cec.org/sites/default/files/Atlas/Files/Terrestrial_Ecoregions_L3/TerrestrialEcoregions_L3_GeoPDF.zip This will provide a good background, but you will need to do additional research elsewhere. Good sources of additional information include: publications and websites from the Bureau of Land Management, the EPA, the United States Forest Service, or the United States Fish and Wildlife Service; brochures, websites, or travel information for natural areas or parks within the ecoregion.
5. You will likely encounter unfamiliar terminology. Part of your task will be to look up unknown words and use your new vocabulary to help your class understand your ecoregion.
6. Use the information to prepare a presentation to give to the class. Use posters or Powerpoint to include visual aids that will help your classmates picture your ecoregion. Be sure to include a map that indicates the location of your ecoregion.
7. Much of the material that you will be asked to discuss during your presentation will not come directly from research, but from brainstorming your own hypotheses based on your understanding of the interplay between physical, climatic, and biological features. Be sure to refer to the background information for help with this, and share ideas within your group to come up with creative and informed hypotheses.
8. Your presentation should discuss the following:
9. Location: Where is your ecoregion located? Use a map to show the general location of your ecoregion, and relate it to the location of major mountain ranges, oceans, and lakes.
10. Physical Characteristics: Describe the general topography of your ecoregion. Is it mostly mountainous, or does it primarily cover large open plains? Are there many wetlands, rivers, or lakes in your ecoregion?
11. Climate: What is the average annual temperature? What is the annual average precipitation? At what time of year does this precipitation usually fall, and in what form (e.g. rain or snow)? How do the physical characteristics of your ecoregion affect the climate? How might they affect climates of neighboring ecoregions? How might neighboring ecoregions affect the climate of your ecoregion?
12. Biological Characteristics: What are some of the most common groups of native plant species in your ecoregion (for example, is your ecoregion dominated by coniferous trees, deciduous trees, or small shrubs)? Why might this group of species thrive here? Hint: Think about the physical characteristics and the climate in your ecoregion, and what adaptations plants need to survive in such a setting.
13. Human Activities: What are some of the primary land-uses in your ecoregion? What features of your ecoregion make this a profitable use of the land? What are some of the notable impacts on the landscape caused by these land-uses? Can you think of ways these impacts might be minimized or reduced?
14. Diversity within Ecoregions: Even Level III ecoregions are very large, and the landscapes they encompass are very diverse. Your Level III ecoregion has many different plant communities within it. Use a combination of research and your own observations to describe the variety of plant communities encompassed by your ecoregion. What abiotic factors might affect and help form these communities? Hint: A botanist is a good



The Place I Call Home

Student Directions, continued

15. person to contact for more information here; try reaching out to botanists from the Bureau of Land Management (BLM), US Forest Service, US Fish and Wildlife Service, or other agencies, non-profits, or watershed councils.
16. Local Plants: Include a profile of one native plant and one invasive plant that occurs in your ecoregion. Include descriptions of the appearance, adaptations and habitat of your two plant examples.

How are they adapted to live in your ecoregion?
17. Be sure to cite the sources you used for research.
18. Present your information to the class. Be sure that everyone in your group plays a part. Use your creativity to display images and information that help your classmates to picture your ecoregion.

CLASS DISCUSSION

- ◆ How does human activity impact your ecoregion now? How do you expect it to change in the next 10 years? The next 50 years? Include both negative impacts and positive impacts.
- ◆ What actions can you take to minimize harmful impacts and enhance positive impacts on your local area?

Taking it Further

Build an ecoregion guidebook: Each group should create a profile page for their group's Level III ecoregion. Include information with the headings: Physical Characteristics, Climate, Biological Characteristics, Human Activity, and Plant Communities. Add pictures that help illustrate the natural features of your ecoregion. Put all of the profile pages together to make a guidebook for your entire Level I ecoregion. Work together to design a cover and a description of the ecoregion as a whole for the introduction.

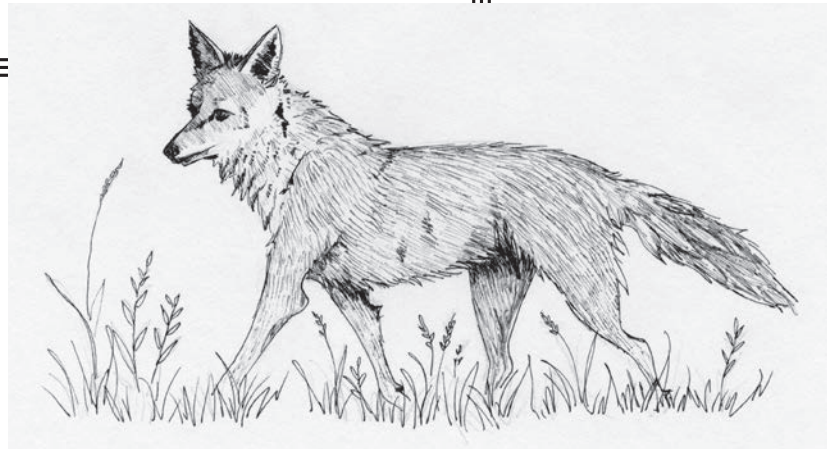



The Place I Call Home

In the Field!

Go on a field trip or go on your own time to a natural area in your own Level III ecoregion. Bring a hand lens and your field journal. Find and observe several samples of different native plant species and take careful notes in your field journal about each plant. Use your knowledge of plant adaptations to explain how each species is adapted to your ecoregion. Where else might these species thrive? What factors do you think limit the range of each species?

Science Inquiry

Do this exercise before beginning work on your ecoregion presentation: Use your knowledge of the physical characteristics of your ecoregion, latitude, and other features to predict where the divisions for the smaller ecoregions that comprise your ecoregion might lie. Use Google Earth to examine the location of mountain ranges, large bodies of water, and valleys. Look up (or draw from your own experience) the wind patterns in your part of the country to help you understand the climate. Draw your predicted divisions on a map of your Level 1 ecoregion. Explain how you came up with your divisions.

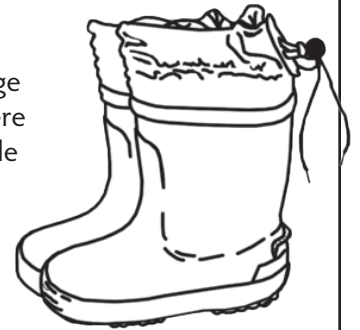

Reflection

- What sets your Level III ecoregion apart from the others around it? What makes it a special place? Think about what you like about the different seasons: winter, spring, summer and fall. Are there things that you enjoy doing outdoors that are enhanced by or only possible in your ecoregion? Do you have a special place that you like to visit? Describe it. If you don't have a particular special place, think about characteristics that would make an outdoor place special to you—describe it. What are some things that you can do to help the conservation efforts in your community, ecoregion, and state?

Assessments

- 1 Name and describe one native and one invasive plant species found in your ecoregion.
- 2 Name and locate one (or more) natural areas in your ecoregion.
- 3 Describe at least two primary land-uses in your ecoregion.

Resources

- ♦ Descriptions of level I ecoregions: ftp://ftp.epa.gov/wed/ecoregions/cec_na/CEC_NAeco.pdf
- ♦ Descriptions of level III ecoregions: http://www.cec.org/sites/default/files/Atlas/Files/Terrestrial_Ecoregions_L3/TerrestrialEcoregions_L3_GeoPDF.zip



Ecosystem Comparisons

Between every two pines is a doorway to a new world.

—John Muir

Time Estimate:

1 hour or more—can be divided into two sessions

Best Season:

fall,
spring

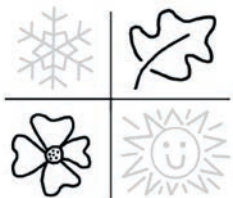

Teacher Hints

- ♦ Students will choose two distinctly different ecosystems, such as a prairie and a forest, and compare biotic and abiotic factors in those areas. Since students will be learning about biotic and abiotic factors and their influence on ecosystems, consider supplementing this lesson with other lessons on soils and natural cycles, such as energy, water, or nutrients.
- ♦ “Nothing in biology makes sense except in the light of evolution.” (Theodosius Dobzhansky). Emphasize evolutionary adaptation to the specific ecosystems the students study.
- ♦ Interactions in ecology are rarely simple. Help students to understand that not only do abiotic factors affect biological organisms, but that the reverse is true, also.

Overview

In this lesson students will collect data to compare and contrast two or more ecosystem types in your ecoregion. Using this data, students will identify key adaptations that plants have evolved to survive in different ecosystems.

Preparation

- ♦ Obtain meter square frames or hula hoops. Meter square frames are much easier for incorporating math.
- ♦ Identify areas for study. Students will need two different ecosystem types to study. It is helpful if the two systems are near or adjacent to one another, but this is not necessary. Try to find two areas that are distinctly different. Ideas include an open prairie or grassland, a deciduous forest, a coniferous forest, a riparian area, or a wetland. In an urban environment this could be as simple as different sections of a park or open lot, as long as different biotic and abiotic features can be observed.
- ♦ Provide copies of the Plant Adaptations Chart (from the Create-A-Plant lesson).

Assessments

- 1 Create visual displays of data (e.g., graphs, tables) comparing observations.
- 2 Explain similarities and differences among ecosystems.
- 3 Demonstrate an understanding of the connection between the biotic (living) and abiotic (non-living) factors of an ecosystem.
- 4 Name a characteristic that would allow a plant to survive in each of the following situations: low light, high light, wind, low moisture, and high moisture.

Additional Information

- ♦ Background on succession: Pidwirny, M. (2006). *Plant Succession. Fundamentals of Physical Geography*, 2nd Edition: <http://physicalgeography.net/fundamentals/9i.html>
- ♦ Missouri Botanical Garden, background on Biology of Plants and Plant Adaptations: <http://mbgnet.net/bioplants/adapt.html>



Ecosystem Comparisons

Between every two pines is a doorway to a new world.

—John Muir

Materials Needed

Each team needs:

- ◆ clipboard, pencil, and data sheet
- ◆ thermometer suitable for air and soil temperature readings
- ◆ meter square frame or hula hoop
- ◆ trowel
- ◆ small metric ruler
- ◆ compass

Overview

In this lesson you will collect data to compare and contrast two or more ecosystems in your ecoregion. Using your data, you will identify key characteristics that plants have evolved to survive the conditions in different ecosystems.

Learning Objectives

- ◆ Collect and evaluate ecosystem data to compare two ecosystems
- ◆ Identify plant phenotypes (plant characteristics) adapted to specific environmental conditions
- ◆ Identify connections between biotic (living) and abiotic (non-living) things

Vocabulary Words

ecosystem
adaptation
biotic
abiotic
quadrat
communities
succession
disturbance
climax community
allelopathy
mutualism
competition
parasitism
predation
phenotype
natural selection

Background Information

Through careful observation of different ecosystems, an ecologist can study how plants adapt to different environmental conditions. In this lesson you will identify key ecosystem properties and compare them between ecosystems in the region. You will investigate questions such as: How do soils differ in a forest, grassland, and wetland? Do plants in one ecosystem have different characteristics than plants in another ecosystem? As you study and compare ecosystems, learn how plants and animals adapt to their environment, and what conditions they need to survive.

Ecosystems are self-sustaining systems in nature that include both the living organisms and the nonliving elements within them. Ecosystems are dynamic; energy, nutrients and water constantly cycle through them. Within each ecosystem there are **communities** made up of **biotic** (living) organisms, including flora (plants) and fauna (animals). Interactions between all the organisms tie the ecosystem together into a functional unit.

Interactions between organisms can be classified into different types. In **mutualism**, two species both benefit from their interaction with each other. The relationships between nitrogen-fixing bacteria and legume plants, and between pollinators and flowering plants are two examples of mutualisms. The opposite of mutualism is **competition**, when two organisms struggle to acquire the same resource. Competition is generally costly to both organisms. Plants compete for sunlight, water, space, and nutrients. They employ several methods for this—they shade out the competition, send out far reaching roots, and sometimes even produce chemicals (**allelopathy**) to poison their competition. Other interactions can occur between herbivores and plants (predation), and parasites and plants (**parasitism**). In some cases, plants can even parasitize other plants.



Ecosystem Comparisons

Background Information, continued

All ecosystems change over time in a process called **succession**. Succession can be rapid or slow, but is a continuous process that occurs in all types of ecosystems. The successional “clock” can be reset after an ecosystem is disturbed. Naturally occurring **disturbances** can include fire, flood, landslides, or volcanic eruptions. Manmade disturbances may result from habitat restoration, logging, farming, or any activity that clears away the current vegetation, fungi, bacteria, and microorganisms that are key to ecosystem function. In the absence of a disturbance, succession generally occurs so slowly that it is difficult to observe or detect it. This type of succession is illustrated when grassland changes to forest, or when a pond fills in over time. If no disturbances interrupt the succession cycle, it eventually comes to a near standstill, a point where the ecosystem is hardly changing at all. This standstill is referred to as the **climax community**.

In this lesson you will examine **abiotic** (nonliving) factors such as air, water, and sunlight and observe how they affect biotic (living) factors in two distinctly different ecosystems. By making detailed site observations, you will connect plants’ phenotype (physical characteristics) to the characteristics of the ecosystem in which they live. For example, plants are adapted to different levels of sunlight, moisture, temperature, and wind. Low-light environments frequently include plants with larger leaf surface areas to capture more sunlight for photosynthesis. In high-light environments, leaves tend to be narrow to reduce surface area and minimize the loss of moisture through evaporation. Look for these types of patterns when you make your observations. Think of other **adaptations** plants could exhibit. Look at leaf margins (edges), surface area characteristics (e.g., shape, texture, and size) as well as the angle of the leaf to sunlight. How might plants adapt

to other conditions and challenges, such as drought, flood, fire, wind, and limited space? Keep in mind that plants must also defend against **predation** and attract pollinators—all at the same time, and all in the name of survival.



Individual plants cannot adapt to conditions within their own lifetime. However, over many generations, through **natural selection**, the most “fit” **phenotypes** (the ones best suited to the environment) will be more successful, and increase in frequency and number. For example, if a narrow-leaved plant germinates in a heavily shaded environment, it is unlikely that the plant will secure enough light to survive and reproduce. If this phenotype is unable to reproduce, it will not persist in this environment. In this way, plant communities are gradually shaped by the ecosystems they inhabit. In turn, these plants affect and change the rest of the ecosystem.



Student Directions

Compare two different ecosystems (e.g., forest vs. grassland, woodland vs. wetland), by examining air and soil temperatures, soil moisture, surface litter, wind speed, canopy cover (shading), plant community composition, plant characteristics, evidence of wildlife, and how all these factors come together to make up an ecosystem.

1. Divide into teams. For 30-45 minutes, following steps 2 through 10, collect and record data about your first ecosystem.
 2. On your data sheet, record the date, time, general weather conditions (e.g., sunny, cloudy), and a simple site description.
 3. Use a square meter frame or hula hoop as a quadrat. Place the meter square frame or hula hoop into a random section of the ecosystem. Calculate in centimeters the total area of your quadrat, then figure out the dimensions of 1%, 5% and 10% of the total area. For example, in a one square meter plot, is 1% 10 cm by 10 cm, or 5 cm by 5 cm, or 2 cm by 2 cm? This will help you estimate later. Use the data sheet to record your observations as you work through the steps outlined below.
 4. **Air temperature:** take a reading 1 meter from the ground. Allow 3 minutes for the thermometer to register the correct reading.
 5. **Light levels:** estimate how much sunlight reaches the ground in your quadrat. To do this look up and figure out what percent of the sky you can see through the canopy.
 6. **Wind speed and direction:** estimate wind speed on a scale of 0 (no wind) to 10 (strong wind).
 7. **Soil studies:**
 - ◆ Place your hand on the soil to feel for moisture levels. Stick your finger in 2 cm to check if it is different from the surface. Is it wet (mud on your hand), moist, or dry?
 - ◆ Surface litter: examine the dead material and decomposition (such as leaves, stems, dead insects, etc.) on the surface of the soil. List what you see and measure the depth (thickness) of the litter layer in centimeters.
 - ◆ Take soil temperature readings at 3 cm and 10 cm depths. With a trowel, slice into the soil layer to 3 cm, insert your thermometer and tuck the soil back around it, leaving it for 3 minutes before recording the reading. Repeat this process at 10 cm.
8. **Plant studies:**
- ◆ Canopy cover: Estimate the percent of your quadrat that is covered by overhead vegetation (trees or tall shrubs). Imagine that you are lying on the ground with your head in the quadrat and look at the sky. Zero percent (0%) cover would mean that no overhead vegetation is visible; complete cover (100%) would mean that you cannot not see the sky above your quadrat.
 - ◆ Percent ground cover: estimate the percent of your quadrat that is covered in vegetation. Can you see bare ground, rocks, or woody debris between the vegetation? Record in percent the makeup of the ground cover (e.g., forbs/herbs, grasses, moss, etc.) as indicated on the data sheet.
 - ◆ Plant observations: how many different species of plants do you see in your quadrat? It is not necessary to identify specific plants by name. Count the number of different plant species with leaves that: are very narrow (less than 1 cm), narrow (less than or equal to 3 cm), and broad (greater than 3 cm wide). Record the total number





Ecosystem Comparisons

of species you see. Estimate the height of each type/layer of plant cover (e.g., herbaceous, shrub, tree). Note leaf characteristics (e.g., waxy, fuzzy, smooth), leaf margin type (e.g., wavy, toothed, smooth), and life cycle stage (e.g., blooming, fruiting, shedding leaves) for each type of plant.

9. Evidence of wildlife:

- ◆ Look in your quadrat for insects, spiders and other invertebrates. Describe or try to identify them. Make a quick sketch and record what they were doing, (e.g. eating, flying, sitting under leaves).
- ◆ Look closely for evidence of animals you don't see. Are there chewed leaves, webs, tracks, holes, or frass (insect droppings) or scat (animal droppings) visible?

10. **Aesthetics:** Describe any patterns you observe in textures, colors, or contrasts at your site. When looking for patterns it can be helpful to “soften” your gaze; try not to focus on any one thing but view the landscape as a whole.

11. Spend another 30-45 minutes repeating steps 2-10 in a different ecosystem, then analyze the results of your two studies.



CLASS DISCUSSION

1. In what ways are the two ecosystems alike? How are they different? What are some of the factors that cause the similarities and differences between the two ecosystems?
2. What are some connections between biotic and abiotic factors in each ecosystem? What are some ways that you think the abiotic factors affected the biota of the ecosystems? What are some ways that you observed the biota affecting the abiotic characteristics of each ecosystem?
3. How do you think plants in the two ecosystems influence the light, temperature, and soils around them?
4. What plant characteristics did you observe that appear to be adaptations to their environment?
5. How do you think plants in the each ecosystem interact or affect each other?
6. In what ways are plants and animals likely to interact in one or both ecosystems? Consider at least three



Ecosystem Comparisons

Taking it Further

Compare other ecosystems, looking for the connecting patterns of biotic and abiotic factors. More specific ecosystem types include: deciduous woodland, conifer forest, wetland, wet prairie, dry prairie, shrublands, desert, high alpine, lawn, or different successional stages of any of these examples.

Science Inquiry

Can you make any inferences about how the individual plant phenotypes, the makeup of plant communities and the ecosystem characteristics are all related? Use your data to examine this subject further.

- ◆ Organize and display the data from your class in a graphic format.
- ◆ Analyze the data in the graphic format to visualize possible patterns.
- ◆ From the data and analysis, propose a question or hypotheses that can be tested to support your inference. Work with your team members to write your hypotheses.



Reflection

Pick one of the ecosystems and make a mind map for it. Put the name of the ecosystem in a circle at the center of a page; add the biotic and abiotic factors, listing each in circles that surround and attach to the center circle. Search for relationships between the factors and connect the circles with lines. Write the connection or interaction along the line. Use the discussion questions as prompts. Write about one of the interactions from your mind map in detail. Explore all the possible connections between the two interacting elements, as well as what abiotic factors might influence them. How have the organisms adapted to be successful in the ecosystem?

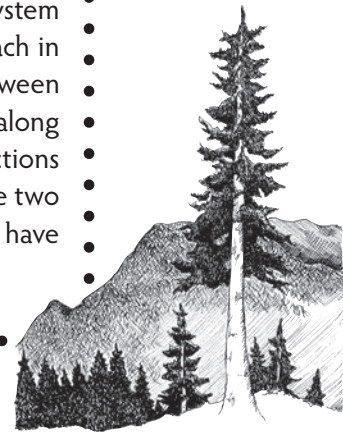

Assessments

- 1 Create visual displays of data (e.g., graphs, tables) comparing observations between the ecosystems.
- 2 Explain similarities and differences between the ecosystems you studied.
- 3 Demonstrate an understanding of the connection between the biotic (living) and abiotic (nonliving) factors of an ecosystem.
- 4 Name adaptations plants might have to survive in each of the following situations: low light, high light, wind, low moisture, and high moisture.

Resources

- ◆ Basic website on studying ecosystems: <http://scienceaid.co.uk/biology/ecology/>
- ◆ Pidwirny, M. (2006). Plant Succession. *Fundamentals of Physical Geography*, 2nd Edition. <http://www.physicalgeography.net/fundamentals/9i.html>
- ◆ Missouri Botanical Garden, Biology of Plants, Plant Adaptations. <http://www.mbgnet.net/bioplants/adapt.html>
- ◆ Raven, P. H., Evert R.F., & Eichhorn, S.E. (1992). *Biology of Plants* (5th ed.). New York: Worth Publishers.



Ecosystem Comparisons

Worksheet

Ecosystem Comparisons

Team Members _____

Date _____

		Site 1	Site 2
Location/site and weather description	Time:		
	Site location description:		
	Overall weather description:		
Weather Data	Air temperature:		
	Sunlight:		
	Wind :		
Soil	Soil temperature:		
	Moisture:		
	Surface litter:		
	Rocks:		
	Texture:		
	Additional observations (color, consistency):		
Percent Cover	Canopy cover/type and percent:		
	Ground cover/type and percent:		



Ecosystem Comparisons

		Site 1	Site 2
Plant Observations (characteristics)	# plants with very narrow leaves (≤ 1 cm): # plants with narrow leaves (1-3 cm): # plants with broad leaves (> 3 cm): Height herbaceous layer: Height shrub layer: Height tree layer: Additional observations for each type of plant (leaf characteristics, life cycle stage):		
Wildlife –Direct Observations or Evidence			
Aesthetic – visual patterns	Texture: Color: Contrasts:		



Ecosystem Comparisons

Site Analysis

Name:

Which site had the greatest number of plant species?

How are the plants similar at the two sites?

How are the plants different at the two sites?

How do you explain the differences in the plants between the two sites?

How do you think the abiotic elements affect the plants growing at each site?

What connections did you observe between living and non-living things in each environment?



Leaf to Landscape: Ecological Scale

Nature is painting for us, day after day, pictures of infinite beauty.

—John Ruskin (1819-1900)

Time Estimate:

1–1.5 hours

Best Season:

Any

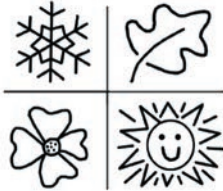

Additional Information

- ♦ Leopold, Aldo, and Charles Walsh Schwartz. *A Sand County Almanac: And Sketches Here and There*. New York: Oxford UP, 1987. Print.
- ♦ Assorted nature writings of John Muir, Aldo Leopold, Henry David Thoreau, Rachel Carson, Wendell Berry, Bernd Heinrich, and others.
- ♦ Mitchell, Joseph. "The Rivermen." In *Up in the Old Hotel*. New York: Random House, 1993.
- ♦ Pyle, Robert Michael. *The Thunder Tree: Lessons from an Urban Wildland*. New York: Lyons, 1998. Print.
- ♦ Tallmadge, John. *The Cincinnati Arch: Learning from Nature in the City*. Athens: University of Georgia, 2004. Print.

Assessments

- 1 Summarize the activity by comparing and contrasting views, and discussing the processes associated with different ecological scales.
- 2 Participate in the activity; work independently and join discussions.

Overview

Students will use drawings to understand the different perspectives gained from making observations on different ecological scales. Students will focus on the local habitat by drawing three different views: one landscape view, one smaller scale view, and one magnified close-up view. This activity encourages aesthetic appreciation for the local landscape while exercising flexible thinking skills and hand-eye coordination. Drawing emphasizes careful observation of detail and patterns in the natural world.

Teacher Hints

- ♦ Encourage doing this activity in pen for the upper grades; it discourages editing. The object is to practice observation skills and gain appreciation for their surroundings, rather than to produce a perfect drawing.
- ♦ Stress to students that this exercise is to help observe what is around them, rather than to judge their drawing abilities.
- ♦ Read quotes from literature of descriptions of landscape perspectives (see Resource section).
- ♦ Repeat this activity in different landscapes (prairie, forest, wetland), or in the same place during different seasons. This activity is more challenging in a forested setting with a limited landscape or vista.
- ♦ Between each drawing session, regroup and share what students saw, as well as their feelings about what they saw at each step. This is a good way to keep students on schedule—or some will become so involved in one drawing that they won't finish the activity.
- ♦ Have students use their 5 x 7 frame to draw a template on their paper for each of the three drawings before starting. Stress that their drawing should fill this frame. Also, encourage them to spend the entire 20 minutes drawing. If they finish drawing before the activity is over, they can go back and add more to it.

Preparation

1. Prepare 5 x 7 rectangular viewing frames for students to use for their artwork. Or, assemble supplies and have students prepare their own before beginning the activity. Another option is to purchase old empty picture frames from a second hand store.
2. Pick out a good location where students have a view of the larger landscape as well as interesting details close up. Try to avoid areas with too many distractions if possible.



Leaf to Landscape: Ecological Scale

Nature is painting for us, day after day, pictures of infinite beauty.

—John Ruskin (1819-1900)

Overview

You will begin to understand the different perspectives gained from making observations on different scales. You will focus on the local habitat by drawing three different views, one landscape view, one smaller scale view, and one magnified close-up view. This activity encourages aesthetic appreciation for the local landscape while exercising flexible thinking skills and hand-eye coordination. Drawing emphasizes careful observation of detail and patterns in the natural world.

Materials Needed

- ◆ 5" x 7" viewing frame from photo mat board, cardboard or poster board
- ◆ pencil or pen
- ◆ hand lens or magnifying glass
- ◆ optional colored pencils

Learning Objectives

- ◆ Practice observation skills on multiple scales
- ◆ Translate observations to paper through illustration
- ◆ Interpret and compare multiple views of the same landscape
- ◆ Encourage flexible thinking skills

Vocabulary Words

abiotic	microscopic
landscape	perspective
macroscopic	ecosystem

Background Information

By making observations on different scales, from landscape to microscopic, you can observe patterns in nature from many **perspectives**. A nimble mind that can make observations on multiple scales and from many perspectives will be able to approach complex problems with greater ease.

As we observe the form of the landscape at different ecological scales, we can contemplate the functioning or processes that occur at those different levels to make our ecosystems function as a whole. For example, at the **landscape** scale, we might observe patterns related to processes such as climate, nutrient and water cycling, and soil formation. At a human scale, we can examine wildlife habitat, erosion, herbivory, and many other functions. On a **microscopic** scale, we can focus on photosynthesis, pollination, and decomposition.

As you observe patterns in each of the three scales, you will also observe the work of the natural processes that are occurring. At the landscape scale, larger patterns and processes are at work. Look for patterns in the vegetation, notice relationships between topography and vegetation type, and ponder the environmental factors such as climate, soil type, geology, landforms, and water that create the patterns you see in your frame. For example, where do individuals of a particular type of tree occur? Do they correspond to other features in the landscape? In the close-up view, do you see plants growing in clusters or individually? Do you have different layers of plants (ground level and canopy)? What kind of colors, textures, and contrasts do you see? Can you see things moving (such as insects) in your view? In the microscopic view, look very closely at one part of one plant (such as the underside of the leaf). Look for patterns and textures, colors and contrasts. Do you see hairs in certain areas, or can you see pores on the leaf surface? Think about what types of processes might create the patterns you see.

When looking at patterns within a landscape, be aware of large scale abiotic patterns creating what you see, and also notice the micro-abiotic factors that create patterns. Looking for these small-scale patterns can explain why a certain plant grows in one place but is absent from a similar looking area just meters away. Look for patterns and textures, colors and contrasts. Think about what types of processes might create the patterns you see. What patterns and processes might you find at all three scales?

Patterns we observe in vegetation can be directly linked to abiotic factors of the



Leaf to Landscape: Ecological Scale

Background Information, continued

ecosystem, be it on a macro or microscopic scale. In this activity, focus on the abiotic factors you see at a human scale. For example, with a large rock or boulder in a meadow, we might ask, "How does this rock affect the plants that grow in the meadow?" Plants growing close to the rock could take advantage of differences in microclimate, such as moisture trapped by the shade on the north side, additional heat stored in the rock to keep the plant warm through the night, shade on the roots, cooler morning sun/afternoon shade (or the opposite). If the rock is located on a slope, the rock could channel water towards or away from certain

areas. The rock could provide relief from harsh winds. The warmth and protection of the rock could be a benefit to insects and reptiles. All of these impacts could be taking place in the space of a couple meters. What other **abiotic** factors could affect plants growing nearby (examples: slope, soil type, light, water, wind, temperature variances)? How does each plant affect its neighbors?

Use this opportunity for observation and drawing to pay close attention to details and patterns around you. While you draw, formulate hypotheses to explain why you are seeing the features and patterns that you observe.

Directions

1. Discuss what things you might notice in a landscape or macro view. With your eyes closed, listen to your teacher read an inspiring quote from literature. Imagine how the scene must have looked to the writer.
2. Spread out. Look through your viewing frame at arm's length, select a spot, and draw the landscape view you see in your frame on your paper. Take your time to observe before beginning. Look for and include in your drawing patterns of color, texture and contrast. Regroup and share your drawings and feelings while looking at the landscape.
3. Discuss the process at work in a close-up view and listen to your teacher read a quote. Now select a spot to observe and draw the detail of your landscape close-up. Use your viewing frame to look at an area at your feet and draw what you see. Look for details, differences in size, color, shapes. Regroup and share your drawings and feelings while making observations at the close-up scale.
4. In the microscopic view, pick one plant to look at in greater detail. Isolate an area of the plant by looking through a hand lens and explore in close detail what you see. Fill your drawing frame with what you see in the hand lens. Pay particular attention to patterns, textures, and colors as you draw. Look at your subject, then take a minute to draw, and then look again. Repeat this process until you have sufficient detail. Fill your entire frame with what you see! Regroup and share. Did this view turn up any surprises? What processes are at work to create what you see at this scale?

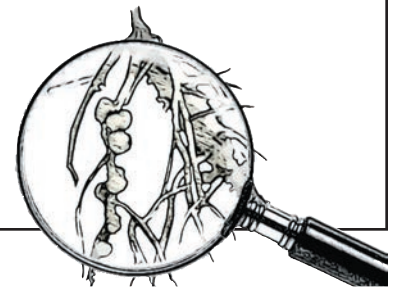

Resources

- ♦ Mitchell, Joseph. "The Rivermen." In *Up in the Old Hotel*. New York: Random House, 1993.
- ♦ Tallmadge, John. *The Cincinnati Arch: Learning from Nature in the City*. Athens: University of Georgia, 2004. Print.
- ♦ Leopold, Aldo, and Charles Walsh Schwartz. *A Sand County Almanac: And Sketches Here and There*. New York: Oxford UP, 1987. Print.
- ♦ Writings of John Muir, Aldo Leopold, Henry David Thoreau, Rachel Carson, Wendell Berry, Bernd Heinrich, and others.



Leaf to Landscape: Ecological Scale

In the Field!

Use this activity as a companion to the "Ecosystem Comparisons." This activity will help you connect your visual observations with the biotic and abiotic factors of a site. With practice and over time, this will allow you to analyze the patterns you are seeing and infer the processes that you have observed.

Science Inquiry

- ◆ Draw a microscopic view of a leaf and use it to explore plant adaptations through your drawing and inquiry thinking skills. Draw a 5" x 7" frame and fill it with what you see in the magnifying glass or hand lens view.
- ◆ Write and answer this question, "What other thing, in nature or man-made, does this remind me of?" Ask yourself, "Why does it remind me of this?" Was it because it had hairs or fuzz, what about the vein pattern, or margin? Add this to your answer.
- ◆ Now ask yourself, "Could the function of the leaf be similar to what it reminds me of?"
- ◆ Analyze your idea. Could this function help the plant adapt to the environment in which it is found? How would this help the plant to survive or reproduce? For example, say your leaf has tiny hairs or fuzz, maybe it reminds you of a fuzzy blanket. What is the function of a fuzzy blanket? What does this tell you about fuzz on a leaf? What other functions could a fuzzy leaf serve?

Taking it Further

Leaf drawing tips: Measure the long axis of your leaf. Multiply this number by 2. Draw a faint line on the page that is this long. Measure the width of the leaf and multiply this number by two. Draw a faint line this long across your first line so that each line crosses the other in its middle (like a plus sign). These lines will guide how wide and long to draw your leaf and help you draw on the correct scale. Other parts of the leaf (petiole, distance between veins, etc.) can also be drawn to scale by measuring and multiplying by 2. Then include a scale bar in your drawing. If you are working with a big leaf you can use the same method to make a cross but divide the measurement by 2 to get the length and width.

- ◆ **Inferring processes:** Have each person share their landscape picture with a friend or with the class. Compare and contrast each drawing. What processes are emphasized in one drawing versus another?

Reflection

- Use your drawings as a source of inspiration for a journal entry. Think back to the readings your teacher read to you at the beginning of this exercise. Describe one of your views in detail like the author your teacher read to you. Describe your landscape so that the reader can imagine exactly what you experienced. Don't forget to include the smells, weather, and sounds that made your spot special. Which scale do you like the most and why?

Assessments

- 1** Summarize the activity by comparing and contrasting views, and discussing the processes associated with different ecological scales.
- 2** Participate in the activity; work independently and join discussions.



Survival Quest: A Pollination Game

Bugs are not going to inherit the earth. They own it now. So we might as well make peace with the landlord.
—Dr. Thomas Eisner (1929–present)

Time Estimate:

1 session (30-45 min)

Best Season:

spring

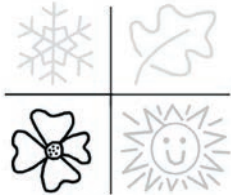

Additional Information

- ♦ The Xerces Society's Pollinator Resource Center: <http://www.xerces.org/pollinator-resource-center/>
- ♦ University of Iowa Bug Guide for the U.S. and Canada: <http://bugguide.net>
- ♦ Use the map on the Native Seed Network website to find a native plant list for your ecoregion. <http://www.nativeseednetwork.org/>. Cross reference these species with those found for your region on the Xerces Society website.

Assessments

- 1 Explain mutualism between flowers and pollinators.
- 2 Gain understanding of co-evolution, and be able to explain the process as it relates to plants and pollinators.
- 3 Relate flowers' traits to specific pollinators that they attract; make predictions about pollinators by looking at flowers.

Overview

In this lesson, students gain a basic understanding of co-evolution as it applies to native plants and their pollinators by studying local flowers.

Preparation

- ♦ Use this lesson in conjunction with the lesson "Secret Life of Flowers" for students that need a refresher on flower anatomy and for additional background information.
- ♦ The discussion in the "Taking it Further" section asks students for strategies a pollinator may use if it is unable to find a food source. Some avenues to explore with students are that pollinators have different life stages that don't require feeding, that they change what they eat, or migrate. Your students will probably come up with more.
- ♦ Field component hints for observing pollinators:
 - ♦ Have students wear neutral colored clothing and ask them not to use scented products (perfumes, hair gels, etc.).
 - ♦ Schedule observations for midday on a sunny day with low wind.

Teacher Hints

- ♦ You can use a list of native plants from your ecoregion (found on the Native Seed Network website) as a starting point for this activity. If you have a native wildflower garden at your school, this is a good opportunity to talk about insect diversity and different types of pollinators as a part of your garden project.
- ♦ The second part of this activity should be completed in a natural area. If you don't have access to a natural area, an alternate activity can be completed using the USDA Plants Database.
- ♦ Supply students with a basic guide to insect identification. They will not need to know specific species of insects but it will be helpful for them to classify insects by order (i.e., beetle, fly, and bee) and to differentiate between a moth and butterfly. The Xerces Society website is a good resource for locating a pollinator guide and information for your area. The University of Iowa Bug Guide for the U.S. and Canada provides a good overview of different types of insects.
- ♦ Create a monitoring log and record pollinator observations from year to year in a native wildflower garden at your school.
- ♦ Use this lesson in conjunction with your studies of evolution.



Survival Quest: A Pollination Game

Bugs are not going to inherit the earth. They own it now. So we might as well make peace with the landlord.
—Dr. Thomas Eisner (1929–present)

Materials Needed

- ◆ botanical field guide
- ◆ insect field guide
- ◆ clipboard and pencil for each team
- ◆ hand lens
- ◆ binoculars (optional)
- ◆ pipe-cleaner

Learning Objectives

- ◆ Explore the concept of co-evolution of flowers and pollinators
- ◆ Define mutualism and describe how flowers and pollinators demonstrate this concept
- ◆ Increase your appreciation for the value of pollinators
- ◆ Examine one of the interconnections between plants and animals within ecosystems

Vocabulary Words

co-evolution
mutualism
pollination
generalist
specialist

Overview

In this lesson you will explore co-evolution as it applies to native plants and their pollinators by examining flowers out in the field.

Background Information

Have you ever heard someone mention the phrase “the birds and the bees”? Do you know where that phrase comes from? It comes from plants and how they reproduce! Birds and bees play key roles as pollinators in plant reproduction, by transferring the genetic material from flower to flower. **Pollination** is the transfer of pollen from male flower parts (stamen) to the female flower parts (stigma) and is how plants reproduce sexually. Through **co-evolution**, plants and their pollinators have developed a mutually beneficial relationship, adapting their form and function to make both their lives more successful. As such, the lives of plants and their pollinators are tightly intertwined. Without pollinators the health of our native plants and ecosystems would falter. In addition, pollination greatly benefits humans. Estimates suggest that one third of the human food supply is dependent on the work of pollinators to produce crops such as blueberries, almonds, melons, pears, apples, and even chocolate!



Pollinators can be insects such as bees, butterflies, flies, and beetles, hummingbirds, and mammals such as bats and small rodents. Many plants, such as grasses and coniferous trees, are pollinated by wind. Some plants, such as the peanut, are self-pollinating and may not even require a pollinator, although this is rare in nature.

Plants and their pollinators have developed an intimate ecological relationship during the process of co-evolution. Plants, being stationary organisms (no legs!), need a means to transport their pollen to other plants for sexual reproduction. For many plant species, animal pollinators visit flowers to get food in the form of pollen and nectar and in the process, unwittingly transfer pollen to other plants in their travels to other flowers for another feast. Picture a bee diving into a flower, going head first deep down to reach the nectar glands at the bottom of the flower. Stamens hang down from above, dangling dusty pollen, which brushes the hairy back of the bee as it forages for sweetness. As the bee leaves, it unintentionally carries that pollen to the next flower, where it dives down to



Survival Quest: A Pollination Game

Background Information, continued

forage again, dropping the pollen it carries there onto the sticky stigma, pollinating the flower.

What does a flower that is wind pollinated look like? First, it generally has no petals or very tiny petals, since petals are for attracting pollinators and can block the flow of wind. Secondly, as wind pollination is uncontrolled, the stamens of wind-pollinated flowers are long, dangling, and produce lots of pollen, thereby increasing the chance of the pollination. The stigmas of wind-pollinated flowers are also often large, exerted, and feathery, so they can comb the air for pollen.

Flowers have evolved an amazing array of scents, colors, markings, and shapes that make them attractive to specific pollinators and facilitate the transfer of pollen to the pollinator. Some plants have evolved physical barriers that restrict the access to their nectar to one specific type or species of pollinator. For example, trumpet shaped flowers favor the extended beak of the hummingbird; Secondly, as wind pollination is uncontrolled, the stamens of wind-pollinated flowers are long, dangling, and produce lots of pollen, thereby increasing the chance of the pollination. A special petal on lupine flowers acts as a lever, limiting access to all but the heaviest of insects, the bumblebees.

Pollinators are rewarded with high-quality food for their services. Pollinators feed on different flower products, such as sugary nectar, protein-rich pollen, fatty oils, resins or waxes. Pollinator specificity reduces the need to produce

excess pollen and improved pollination efficiency, thereby improving reproductive success. Pollinators have a reliable food source, thereby reducing the amount of energy spent foraging. Pollination benefits the plant and the pollinator, a relationship that is called **mutualism**.

Pollinators have adapted physical characteristics that allow them to gather and transport pollen as they seek food. Some insects have fuzzy hair that brushes against the anthers of a flower and carry pollen, and some bees have structures called pollen baskets on their legs specifically for transporting the protein rich food back to the hives.

Plants have developed many interesting and unique methods of attracting pollinators. Some orchids have developed flowers that look or smell like female insects, using sight or scent to trick male insects into visiting and pollinating the flower. Some orchids, such as, the mountain lady's slipper (*Cypripedium montanum*) and the fairy slipper (*Calypso bulbosa*) have a pouch-shaped flower part, which is easy to enter but, because of strategically located small hairs, limits the pollinator to a single exit, forcing the pollinator to walk directly through its pollen. Moth pollinated flowers tend to be pale colored or white and highly scented, often only opening or releasing their scent at night to attract the night-flying moths. Some flowers smell like rotten meat to attract flies as their pollinators. In many cases, these flowers bloom early in the season before other insects are active. Skunk cabbage (*Symplocarpus foetidus*) is one example of this.





Survival Quest: A Pollination Game

Student Directions

Part 1:

1. Work in teams of two to complete the pollinator data table. Your quest is to find local native flowers that will attract each of the listed pollinators on the table. Use the Pollinator Chart for guidance in flower shape, color, and other features needed to attract the target pollinator.
2. Look in local field guides (or better yet, in the field) for flowers that display the traits you are seeking to complete your sheet (color, shape, scent, etc.)
3. For additional information about bloom times or flower photos, check out <http://plants.usda.gov/>.
4. Try to locate two different native plant flower sources for each pollinator in your chart.

Part 2: The Survival Quest Challenge

5. Choose an insect or bird pollinator (not wind) from the data sheet. Your challenge will be to feed it for the entire season!
6. Research your pollinator to find out when it is active in your area. For example, a migratory hummingbird might be in your area from March to September, or a butterfly may have two hatch periods with adults flying in May and July. These will be the target times for you to feed your pollinator.
7. Armed with this knowledge, find flowers that will match the traits that the pollinator is attracted to and will be blooming in the time periods needed. If the pollinator is active for a long period, you will probably need multiple flowers with staggered bloom times to make it through the season.
8. **Discussion:** What might happen if you (and the pollinator) are unable to find the flowers needed at the proper times? What are some of the possible options for the pollinator? What will happen to the plants whose pollinators cannot locate them?

Taking it Further

Design a native plant garden with one or more pollinators in mind. Choose flowers with the traits that attract the intended pollinator. Look also at bloom times and try to include flowers that will bloom in succession over a long period of time. Manage your site for pollinators: refrain from using pesticides, leave older growth standing to provide habitat for overwintering insects, and allow plants to reseed themselves. Consider constructing nest sites for bees and other pollinators—you can find instructions and suggestions on the Xerces Society website. Monitor the site and create an observation log for future students to assess pollinator activity over time in the garden area.

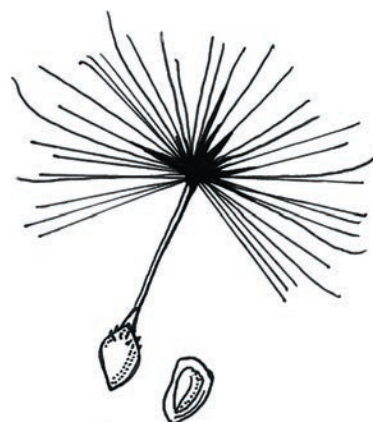



Survival Quest: A Pollination Game

In the Field!

- ◆ Put your pollinator knowledge to the test. Work in teams, spread out from other teams, and pick one flower or group of flowers to observe. Use the Pollinator Observation sheet and start by filling in the “Flower Traits” section.
- ◆ Now back away from your flower and sit quietly observing. One team member can watch through the binoculars while the other acts as recorder. Switch half way through your observation period. Closely observe your flower for 15-20 minutes.
- ◆ After the observation period, answer the remaining questions on your sheet.
- ◆ Pollinators can be affected by weather conditions. Try observing flowers at different times of the day or evening (possibly even at night!). Most insects will be active at midday on a warm day; wind can discourage butterflies and moths. Hummingbirds tend to be more active in early morning and late evening. Moths and bats are more active at night. What if you are not able to observe any pollinators? What does this tell you?
- ◆ Finish by taking a pipe-cleaner and trying to collect pollen from your flower. Take note of where you find it, distances, amounts, and hidden avenues to access it. Does this fit with the rest of your observations?



Science Inquiry

Now that you have a background in understanding pollination services, investigate the reproduction of insectivorous (insect eating) plants. As a class or in small groups make a list of “I wonder” questions you would like to investigate about insectivorous plants and pollination. Choose one question to investigate further. If you are fortunate enough to have access to an insectivorous plant, carry out your investigation in person and make first-hand observations. Otherwise you will need to conduct your investigation through research.

For background on carnivorous plants:

- ◆ Botanical Society of America. http://www.botany.org/carnivorous_plants/
- ◆ International Carnivorous Plant Society. <http://www.carnivorousplants.org/>



Survival Quest: A Pollination Game

Reflection

- Create a unique flower/pollinator relationship. Choose a species to be your pollinator—it could be a bear, human, slug, alien, or whatever you choose. Now invent a flower that will attract your pollinator and only your pollinator.
- Describe in writing or sketch what your flower looks like. List how it attracts the pollinator, how it limits access to the pollen to only your pollinator, and how the pollen is carried for transfer to the next flower. Remember to make it a mutualistic relationship—what will your pollinator receive in return?
- Also consider the following: scientists predict that plant/pollinator relationships may be greatly affected by climate change. How might climate change affect the plant/pollinator relationship?

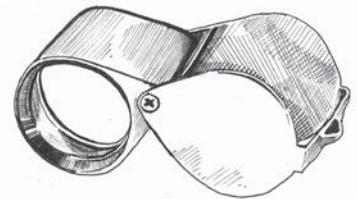

Self Assessments

- 1** Define the word mutualism and explain how plant-pollinator interactions are a mutualistic relationship.
- 2** Explain the concept of co-evolution and how it relates to plants and pollinators.
- 3** Be able to group flowers by traits to predict their pollinators.

Resources

- ♦ US Forest Service, Celebrating Wildflowers website: <http://www.fs.fed.us/wildflowers/index.shtml>
- ♦ Assorted wildflower field guides for your region
- ♦ USDA Plants Database <http://plants.usda.gov/> for flower photos and information
- ♦ The Xerces Society's Pollinator Resource Center. Find information about native pollinator plants for your region, as well as pollinator identification guides and much more: <http://www.xerces.org/pollinator-resource-center/>



Survival Quest: A Pollination Game

Survival Quest: Pollinator Data Table

Native Plant		Bloom dates	Pollinator
1.			Bee
2.			
1.			Hummingbird
2.			
1.			Butterfly
2.			
1.			Fly
2.			
1.			Wind
2.			
1.			Beetle
2.			
1.			Moth
2.			



Survival Quest: A Pollination Game

Pollinator Observation Sheet (In the Field section)

Names: _____ Date: _____

Time: _____

General Weather Conditions: _____

Location of Plant Observed: _____

Name of Plant: _____

Sketch your flower:

Predict the pollinator for this flower _____

Flower traits that indicate which pollinators:

- 1.
- 2.
- 3.

Observations of the flower:

Visitors observed? (record all seen)	What were they doing (watch carefully)?	How long did they stay?	Where did they go when they left?	Name or sketch of visitor

Did your observations support your pollinator prediction?

What questions do you still have after your observations?

Pollinator Chart

Flower Trait	Bats	Bees	Beetles	Birds	Butterflies	Flies	Moths	Wind
Color	Dull white, green, or purple	Bright white, yellow, blue, or UV	Dull white or green	Scarlet, orange, red, or white	Bright including red and purple	Pale and dull to dark brown or purple; flecked with translucent patches	Pale and dull red, purple, pink, or white	Dull green, brown, or colorless; petals absent or reduced
Nectar guides	Absent	Present	Absent	Absent	Present	Absent	Absent	Absent
Odor	Strong musty; emitted at night	Fresh, mild, pleasant	None to strongly fruity or fetid	None	Faint but fresh	Putrid	Strong, sweet; emitted at night	None
Nectar	Abundant; somewhat hidden	Usually present	Sometimes present; not hidden	Ample; deeply hidden	Ample; deeply hidden	Usually absent	Ample; deeply hidden	None
Pollen	Ample	Limited; often sticky and scented	Ample	Modest	Limited	Modest	Limited	Abundant; small, smooth, and not sticky
Flower Shape	Regular; bowl shaped—closed during day	Shallow; have landing platform; tubular	Large, bowl-like,	Large; funnel-like; cups, strong perch support	Narrow tube with spur; wide landing pad	Shallow; funnel-like or complex and trap-like	Regular; tubular without a lip	Regular; small and stigmas exerted

*Pollinator chart taken from: US Forest Service, Celebrating Wildflowers website, May 16, 2008, <http://www.fs.fed.us/wildflowers/pollinators/syndromes.shtml> U.S. Forest Service Rangeland Management Botany Program, 1400 Independence Ave., SW, Mailstop Code: 1103, Washington DC



What's Going Down Underground

We know more about the movement of celestial bodies than about the soil underfoot.
— Leonardo da Vinci (1452-1519)

Time Estimate:

45-60 minutes
in classroom or lab

Best Season:

spring,
summer,
fall



Teacher Hints

Soil biology is an important and complex subject and this lesson only scratches the surface of the knowledge a good botanist will need. Consider expanding this lesson to study the chemical and physical characteristics of soil, nutrient cycling, and the soil food web and how they relate to native plants.

Assessments

1 Name and describe at least one interaction between plants and microorganisms that occurs under the soil surface.

2 Cooperate in a group to make observations, record data, and discuss findings.

3 Define the term rhizosphere and list at least three processes that take place there.

Overview

Students explore soils and the connections between cycles of nutrients, microorganisms, and plants. Observe evidence of interactions between plants and nitrogen-fixing bacteria and mycorrhizal fungi in the soil. Gain an understanding of the roles bacteria and fungi play in ecosystems, and the benefits of bacteria and fungi in the soil, observe evidence of interactions.

Preparation

- ◆ Collect an assortment of root samples (or have students collect) — include at least one legume, one conifer tree, and one bunch grass. Collect root ends from conifers (cedars, pines, firs, spruces or hemlocks) from a healthy forest; trees in a landscape setting may or may not have mycorrhizal fungi. Several legumes—such as clover, lupine, and vetch—are commonly found in lawns or weedy areas. To find a bunch grass, the easiest place to go is a prairie or wetland. Bunchgrasses are grasses whose stems are joined in a clump or bunch rather than appearing as individual stems like in a lawn. Observe evidence of interactions. Arrange lab: prepare a root sampling bag for each lab group. Use a gallon resealable bag to contain an assorted sample of the roots mentioned above. Gently knock off excess soil; the roots do not need to be completely clean. Each group will need: hand lenses, data sheets, and dissecting microscopes. Microscopes can be shared between groups.
- ◆ Allow students time to carefully examine their root samples. After initial observations, encourage them to look more closely using the microscopes. They can gently wash root tips in water and dissect root sections and nodules, exposing additional interesting colors and tissue structure.

Additional Information

- ◆ USDA Natural Resource Conservation Service: <http://soils.usda.gov/education/>
- ◆ Soil Science Society of America: <https://www.soils.org/>
- ◆ USDA Natural Resource Conservation Service. The Soil Biology Primer: http://soils.usda.gov/sqi/concepts/soil_biology/biology.html
- ◆ Portland State University, Ecoplexity: <http://ecoplexity.org/>



What's Going Down Underground

We know more about the movement of celestial bodies than about the soil underfoot.
— Leonardo da Vinci (1452-1519)

Materials Needed

- ◆ root samples (a sampling that includes nitrogen fixing nodules, mycorrhizae, and roots)
- ◆ gallon resealable bags
- ◆ hand lens
- ◆ dissecting microscope
- ◆ ruler

Learning Objectives

- ◆ Gain understanding of soil microorganisms
- ◆ Gain understanding of the nitrogen cycle
- ◆ Use visual observations to find plant/microorganism interactions
- ◆ Describe the processes that you observe on plant roots
- ◆ Diagram and explain the soil food web
- ◆ Describe mutualism as a biological interaction

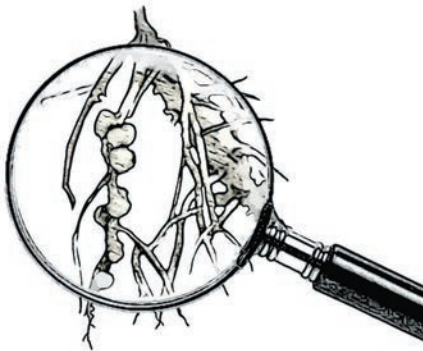

Overview

In this lesson you will explore soils by learning about the relationships that connect nutrients, microorganisms, and plants. You will study how plants, bacteria, and fungi work together in mutualistic processes that take place in the soil. You will use hands-on skills to observe evidence of these interactions on the roots of plants, gain an understanding of the roles bacteria and fungi play in the ecosystem, and explore some of the benefits of having bacteria and fungi in the soil.

Background Information

Humans are enamored by the beauty and utility of plants and our interactions with them. Our interactions occur most often with the above-ground parts: stems, leaves, flowers and fruit. These parts provide structure, energy (photosynthesis through the leaves) and sexual reproduction (transmission of pollen through the flowers). But we often forget that the ecosystems we are a part of do not stop at ground level; in fact, the soils beneath our feet are amongst the most biologically diverse and active habitats known to science! A single teaspoon of soil may contain many, many millions of living organisms, from earthworms and arthropods to fungi and protozoa. All of these living organisms interact with one another in complex food webs.

Underground are the hidden parts of plants—the roots. Plants are unique in that they exist both above and below ground. Think of plants and their roots as being liaisons or ambassadors between the aboveground portions of ecosystems that we can see and the belowground components beneath our feet. Soils are reservoirs of resources like essential mineral nutrients, and it is plants that make those resources available to those of us who live above ground.

Roots and their interactions with the soil are incredibly important to plants, their function in ecosystems, and their utility to humans and other species. Roots provide essential services such as taking up much-needed moisture and essential mineral nutrients, anchoring the plant and holding the soil in place, and providing reproduction by some asexual methods. Roots also provide homes to symbiotic bacteria and fungi in the soil that are critical to the survival of plants and all species that depend of them (that's pretty much every living thing!).

The most common types of root systems are fibrous roots and taproots. **Fibrous roots** have multiple branches that are similar in size. This type of root system is found on grasses and other **monocots** (plants with a single seed leaf or cotyledon). **Taproots** consist of an enlarged main root with extremely fine branching roots. Most **dicots** (plants with two seed leaves or cotyledons) have taproots. The carrot is a familiar taprooted dicot. Although most roots



What's Going Down Underground

Vocabulary Words

fibrous roots
taproot
adventitious root
corm
tuber
rhizome
bulb
monocot
dicot
nitrogen fixation
legume
rhizobia bacteria
Frankia bacteria
mycorrhizal fungi
hyphae
mycelium
ectomycorrhizae
endomycorrhizae
rhizosphere
symbiotic
mutualistic

Background Information, continued

are found underground, there are exceptions, such as **adventitious** roots. Adventitious roots grow off the stem and sometimes help support the stem (as in prop roots) or start a new plant by anchoring an arching branch where it touches the ground. Something that all roots share is their lack of nodes (small bumps where new leaf or stem growth begins).

Sometimes adaptive stem growth is found underground and can be mistaken for roots. Corms, rhizomes, and tubers are all types of underground stems. A **corm** is an underground structure covered with papery leaves (e.g., lily), a **rhizome** is an underground horizontal stem (e.g., iris), and a **tuber** is a thickened rhizome adapted to store food (e.g., potato). A **bulb** is another underground structure that is actually a bud with thickened, fleshy layers called scales. Onions are bulbs you eat. Although all of these are root-like structures that even perform root-like functions, they are actually stem tissue growing underground.

Most plants require soil as a medium for growth and to provide moisture and mineral nutrients. Soil is teeming with life and activity! Within the rhizosphere (an area approximately one millimeter thick surrounding plant roots) the biological activity is ten times greater than elsewhere in the soil. Microorganisms are attracted to and feed on the sugars and other organic compounds that seep from plant roots. In turn, the microorganisms in the rhizosphere layer help to break down and decompose dead plant cells. The respiration of these microorganisms produces carbon dioxide that acidifies alkaline soils. The microorganisms also produce gummy substances that hold soil particles together. These activities benefit plants, but the rhizosphere can also harbor microorganisms carrying diseases or microorganisms acting as parasites and producing galls. The rhizosphere hosts many very important **symbiotic** associations, two of which we will study in this lesson—nitrogen-fixation and mycorrhizal.





What's Going Down Underground

Background Information, continued

Nitrogen-Fixation

Nitrogen is a macronutrient, an essential nutrient for plant growth, and for all living organisms. Although nitrogen gas makes up the majority of the atmosphere (80%), nitrogen gas (N_2) is unavailable for plant (or animal) use. Plants can only take up nitrogen in the form of ammonium (NH_4^+) or nitrate (NO_3^-). In the rhizosphere, bacteria inhabit the roots of plants and form nodules that capture N_2 from the air and convert it to a form that plants can use. **Nitrogen fixation** is the process by which atmospheric nitrogen gas (N_2) is converted into ammonia by a group of bacteria called rhizobia. The ammonia created by this process is subsequently available for many important biological molecules such as amino acids, proteins, vitamins, and nucleic acids (to form DNA). In the rhizosphere, the roots of specific species provide the bacteria with a home (a nodule), water, and carbohydrates. In return, the plant receives nitrogen in a useable form right next to its roots. Nitrogen-fixing bacteria are host specific, meaning they have the ability to infect and nodulate only the roots of certain plant species. One of the most common of these associations is between plants of the **legume** family (*Fabaceae*) (e.g., peas, beans, clover, vetch, and lupine) and the group of bacteria called **rhizobia** (in the genera

Rhizobium and *Bradyrhizobium*). It is a common agricultural practice to harvest crops and then plant a species of legume to add nitrogen back into the soil. The legume family contains many plants we commonly eat (e.g., peas, beans, and soybeans) or grow for livestock food (e.g., clover and alfalfa), as well as a diversity of native plants. Nitrogen-fixing rhizobia bacteria are commonly added to agricultural legume seed crops and backyard garden plantings to maximize their nitrogen-fixing effects. In native ecosystems, nitrogen-fixers provide the majority of the available nitrogen for other plants to uptake. After it is taken up by plants, nitrogen is available for wildlife, livestock, and humans to consume in the vegetation they eat, providing critical building blocks for proteins and DNA in their bodies. Because nitrogen is constantly being lost from the soil and it is primarily replaced by nitrogen-fixers, nitrogen-fixing species are critical to native ecosystem function, especially in prairies, where soils are nitrogen poor. However, in some ecosystems, agricultural practices have resulted in an overabundance of nitrogen, which can facilitate invasion by non-native species.

Mycorrhizal associations

The second important belowground association we will examine is between plant roots and mycorrhizal fungi. These fungi, which form an

underground net of white cottony threadlike connections between the roots of plants, help capture needed but hard to find nutrients for the plants with which they grow, such as phosphorous and zinc, among others. Some nutrients do not move readily through soil, so plants may have a hard time finding sufficient levels needed for optimal growth within their own root system. **Mycorrhizal fungi** inhabit the roots of plants to get food (carbohydrates), and in return their **hyphae** (thin, thread-like growths that spread through the soil) absorb nutrients that the fungi then share with their host plant. This association allows plants to mine larger areas to obtain the nutrients they need. The mycorrhizal hyphae form interconnecting networks between soil particles and the roots of plants, and will often network between the roots of many neighboring plants. You can see evidence of some types of mycorrhizae in their aboveground reproductive structure—a mushroom! However, not all mushrooms are the fruiting bodies of mycorrhizae and not all mycorrhizae produce large visible reproductive structures.

Mycorrhizal associations occur on almost all plants with the exception of a few species, like crucifers such as broccoli and mustard. Much remains unknown about mycorrhizae and soil biota in general.



What's Going Down Underground

Student Directions

1. Form small groups (2-3) for the lab section. Each group will receive a sample of plant roots to examine.
2. Remove root samples from the bag and spread out on a piece of paper. Observe the roots closely. Divide the roots into similar looking groups. On your data sheet give each group a sample number.
3. Note the roots' general characteristics such as type (taproot vs. fibrous), shape, color, texture (woody vs. fleshy), length, girth. Look carefully for nodules and record in your notes if you find them. Are there any underground structures such as bulbs or corms? Record a description using the above characteristics to help you differentiate the root samples. Use words and sketches to produce a complete description that would help someone identify which roots are which.
4. Examine your root samples more closely using some of the tools available in your classroom. Use a hand lens or dissecting microscope to get a closer look at the details of your roots: root hairs, root tips, color changes, root thickness changes, unusual branching patterns, foreign material attached, and anything else that you observe. Add your observations to your data sheet. As you do this, imagine the job your roots need to do such as taking up water and nutrients,

holding your plant and soil in place and think about how the roots you are looking at might be adapted for accomplishing these tasks in the environment in which they are found.

5. Read the background information from this activity. Discuss with your group whether any of your root samples exhibit characteristics associated with rhizobia (nitrogen-fixation) or mycorrhizal relationships. Add this to the "relationship observed" column, and include a quick sketch of what the nodules or hyphae look like.
6. Dissect roots to try to understand abnormalities from the inside. What do they look like? How are they different from normal looking sections of the root?
7. Share your group's findings with the class. Did the groups have similar findings or were the results different? Did the root samples come from a variety of plants? Look at the plant tops. Are there similarities between the roots from different samples that correspond to similarities between the plant tops?

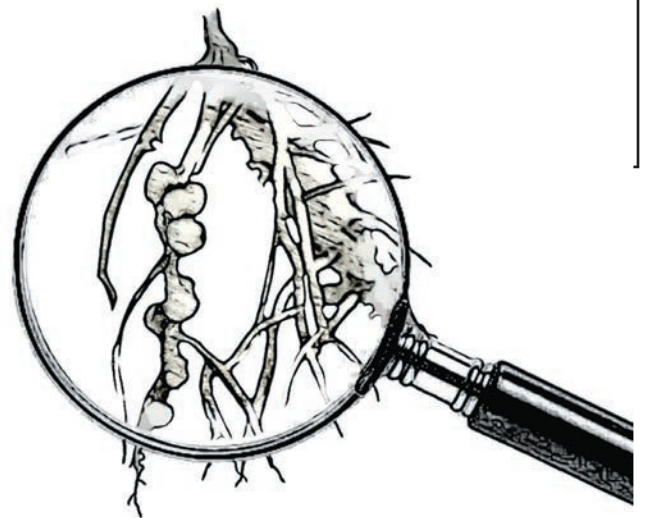



What's Going Down Underground

Taking it Further

- ◆ Learn more about soils, which are a key factor in plant growth and distribution. Look into the chemical and physical properties of soil and how they affect plant growth. Additional soil characteristics that are important to plant growth include: pH, nutrient cycles, particle size, organic matter, and water infiltration.
- ◆ Study the components of the soil food web and how they work together. Diagram a simple web.
- ◆ View a worm composting bin and diagram the soil food web you find there.

Self Assessments

- 1** Name and describe at least one interaction between plants and microorganisms that take place at the soil level.
- 2** Work as part of a cooperative group to make observations, record data, and discuss findings.
- 3** Define the term *rhizosphere* and list at least three processes that take place there.

Resources

- ◆ Soil and Water Conservation Society (SWCS). 2000. Soil Biology Primer. Rev. ed. Ankeny, Iowa
- ◆ Soil and Water Conservation Society. 2010: http://soils.usda.gov/sqi/concepts/soil_biology/biology.html

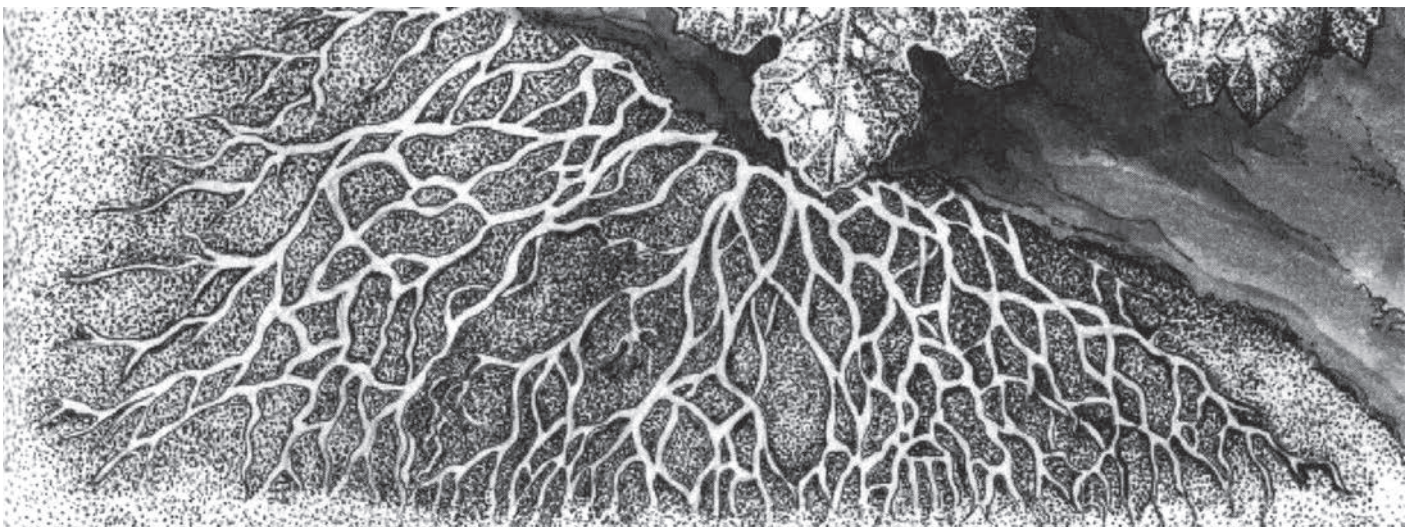



What's Going Down Underground

Root Sample Data Sheet

Sample number	General root characteristics (root hairs, tips, thickness, foreign material attached)	Observations	Describe evidence of any relationships observed
	Color Branching structure Length		
	Color Branching structure Length		
	Color Branching structure Length		
	Color Branching structure Length		



Plant Wars: A Tale of Offense and Defense

Time Estimate:

30-45 minutes

Best Season:

spring,
summer,
fall

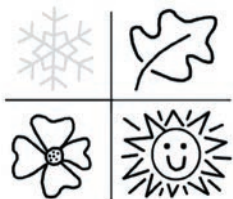

"We can complain because rose bushes have thorns, or rejoice because thorn bushes have roses."

—Abraham Lincoln (1809-1865)

Overview

In this lesson, students will explore how plants defend themselves from herbivores using physical (thorns, waxy leaves) and chemical (poison) defenses. Students will read, research, discuss, observe, and speculate about the chemical defenses of plants, how they work, and how humans use them. They will also look at how other species counteract these chemicals in the intricate dance of co-evolution.

Teacher Hints

- Use this lesson in conjunction with your studies of evolution.
- See the Ethnobotany section of this curriculum for more about plant medicines.
- Take time to explore the "Science Inquiry" section for project ideas related to plant chemicals.

Preparation

- Locate suitable outdoor sites for plant observations.
- Introduce the plant observations with class discussion. Ask students to brainstorm: "How do plants defend themselves from insects and browsing animals?" Keep a list of their ideas.
- Conduct the plant observations during class or assign them for outside of class time. Without giving students any background information, have them complete the plant defense observations. Copy just the activity directions for students to carry in their field journal to guide their observation session.

Assessments

- 1 Explain the difference between physical and chemical plant defenses.
- 2 Describe how co-evolution between plants and herbivorous insects can occur.
- 3 Make detailed observations and use them to make inferences.

Additional Information

- The Natural History Museum of London. *Seeds of Trade* <http://www.nhm.ac.uk/>: the history and uses of plants used by humans. Search by plant name, use type, or geographical distribution.
- Smithsonian Institution's National Museum of Natural History. *Plant Defenses--Plant-Insect Interactions (Without the Insect)*. <http://insectzoo.msstate.edu/Curriculum/Activities/defense.html> - lesson using poinsettias to test plant defenses (they have a milky sap similar to milkweed).
- University of Colorado at Boulder, Biological Science Initiative http://www.colorado.edu/Outreach/BSI/k12activities/chem_ecology.html - 2 lessons on plant chemical defenses (high school); allelopathy investigation, and plant chemical defenses for herbivory.





Student Project

Materials Needed

- ◆ field journal
- ◆ copy of directions

Learning Objectives

- ◆ Hone observation skills; record data and discuss findings
- ◆ Gain understanding of different methods of plant defenses against herbivory
- ◆ Learn about the process of co-evolution between two species
- ◆ Increase understanding of interactions between species in plant communities
- ◆ Gain understanding of human interactions with plant chemicals

Vocabulary Words

co-evolution
herbivory
allelopathy
phytochemical
phytotoxin
antioxidant
angiosperm

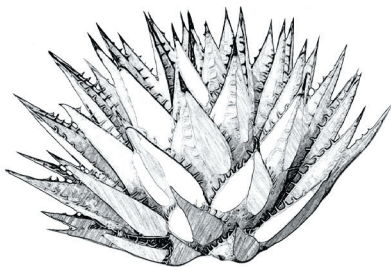

Plant Wars: A Tale of Offense and Defense

"We can complain because rose bushes have thorns, or rejoice because thorn bushes have roses."
—Abraham Lincoln (1809-1865)

Overview

In this lesson you will explore how plants defend themselves from herbivores using physical (thorns, waxy leaves) and chemical (poison) defenses. You will read, research, discuss, observe, and speculate about the chemical defenses of plants, how they work, and how humans use them. You will also look at how other species counteract these defenses in the intricate dance of species co-evolution.

Background Information

Plants face a large challenge that most animals do not face: they are sessile. That is, they cannot move around. This presents a number of challenges: plants cannot flee to escape predators, they cannot move to find a more hospitable environment, and they cannot search for limited resources. Since plants cannot escape less than ideal circumstances, they must evolve. In this lesson, we will focus on the evolution of physical and chemical plant defenses. We will also look at how other species counteract these defenses in the intricate dance of co-evolution.

Plants may not be able to flee from their predators, but they have evolved physical and chemical strategies to defend themselves from attacks from hungry herbivores. Herbivory is the process of animals eating plants. If you have ever gone blackberry picking and had your arms and hands shredded by giant prickles, you know that consuming blackberries comes with a price! The prickles on blackberries are just one of several types of defenses that plants have evolved to deter herbivory.

Some of the physical defenses that protect plants' vulnerable and valuable parts are thorns, hairs, and spines. The effectiveness of each depends on the type of herbivore attempting to consume the plant. Large thorns may be more effective against mammalian herbivores such as deer, while hairs are better deterrents to some insect herbivores. Some plants also produce compounds such as waxes and resins that physically alter the external texture of the plant, making feeding challenging. In such cases, an insect may have difficulty gaining traction on a leaf surface or physically biting through the leaf cuticle. Other plants attract and/or house insects that defend the plant. A particularly famous example of this is the *Acacia*-ant symbiosis, in which ants live inside the large, hollow thorns of the *Acacia* tree and aggressively deter herbivores. Still other plants, such as some species of gooseberries, produce spiny fruits that deter animals from consuming the seed.

While all plants share the same basic chemical processes that support growth and metabolic functions such as photosynthesis and respiration, many plants



Plant Wars: A Tale of Offense and Defense

Background Information, continued

produce secondary chemicals to defend themselves against herbivores as well as against other plants. These secondary chemicals act as toxins that can disrupt an herbivore's metabolism or make the plant indigestible. When talking about plant defenses you will encounter terms like phytochemical and phytotoxin (phyto- means "plant").

In order to compete with other plants for space, sunlight, nutrients, and water, some plants have evolved ways to keep other plants out of their way. Some plants produce phytochemicals that disrupt the growth, reproduction, or survival of other plants. This process is called allelopathy. For example, the black walnut tree produces a chemical that suppresses other plants under its canopy. If you know of a black walnut tree nearby, see if you can find any other plants growing underneath it.

Not all phytochemicals are used for defense. Plants also use chemicals for beneficial interactions with insects, such as the colors, and scents essential to attract and support pollination.

The evolution of angiosperms (flowering plants) coincides with an explosion in the diversity of insect species on Earth. Insects have repeatedly adapted their eating behaviors to co-evolve with changing plant characteristics though time. For example, early insects had mandibles (jaw and mouth parts) for biting and chewing primitive vegetation. As more complex vascular plants evolved, insects adapted more specialized mouth parts, such as probing stylets

for sucking sap (aphids), and long proboscises for drinking nectar (butterflies). This process of two species adapting in response to each other is called co-evolution.

The diversification of insects likely provided the selective evolutionary pressure that led to plant defense (and offense) adaptations. For example, some plants have adapted to produce chemicals that inhibit the absorption of nutrients in the digestive tracts of herbivores or act as poisons to kill the herbivore directly. In turn, some herbivores have adapted their metabolism to feed on poisonous plants in spite of the plant's attempt to deter them with chemical defenses. Such changes come at a cost—some butterfly larvae have become such specialized feeders that they are limited to eating just a single species of plant! The plant still gains some benefit from its poisons, since very few herbivores can tolerate eating it. The specialized herbivore benefits from the very limited competition for food. Can you think of other benefits of this limited relationship to the plants or herbivore? What about the downsides? What happens to these specialized herbivores if the population of their host plant declines?

Some herbivores eat a larger variety of plants, but are still limited to species from a single plant family. A common butterfly, the cabbage white, is such an example. The cabbage white larvae feed only on plants in the *Brassicaceae*, or mustard family, such as cabbage and broccoli. This

butterfly is often found in gardens and agricultural fields, and is considered a pest since its food needs put it in direct competition with agricultural productivity.

Still other herbivores are generalists, feeding on a much broader range of host plants. The painted lady butterfly is a generalist whose larvae are known to feed on more than 100 different plants from three or more families. Generalists usually have a broad habitat range—the painted lady is found in Africa, North America, South America, Asia, and Europe. It may seem that a generalist has the best survival strategy, but such a lifestyle has its downsides. A generalist must compete for food with many other species, and might need to travel widely to secure enough resources for its needs.

A further twist on plant chemicals is that some butterflies that have adapted to eating poisonous plants are able to store the phytotoxins in their own body for their defense, making them poisonous or unpalatable to their predators. The larvae of the monarch butterfly feed on the milkweed plant, storing toxic chemicals found in the plant's sap. The toxic chemicals are passed from the larval stage to the adult butterfly stage. This makes the monarch butterfly (and larvae) foul tasting to its predators. Birds quickly learn to avoid the orange and black pattern of the monarch butterfly.

Restoration ecologists can take advantage of certain insect-plant interactions to control invasive weeds.



Plant Wars: A Tale of Offense and Defense

Background Information, continued

To control some invasive plant species, biological controls can be introduced to an area threatened by the invasives. These are generally insects that originate in the native ranges of the invasive weed in question and have evolved to specialize only on that particular weed species—thus, they can help keep those populations in check without also feeding on native plants.

Phytochemicals also affect humans, since we can also be herbivores. Over time, through knowledge passed

down through generations of native peoples to the work of scientists worldwide, we have figured out how to use many of these amazing phytochemicals for both our pleasure and our pain. Some plant chemicals exhibit addictive properties—from opium in heroin to nicotine in tobacco to the caffeine found in chocolates, colas, and coffee. Other plant chemicals contain essential oils like citronella and menthol and toxic compounds found in latex and resins. The anti-cancer drug Taxol, originally isolated from the Pacific

yew (*Taxus brevifolia*), also comes from this category. Yet another group of chemicals contain flavonoids that make up red, blue, yellow and white color pigments. The flavonoids can act as antioxidants, which are thought to be beneficial to human cells. Blueberries, red grapes and strawberries, foods known for high antioxidant levels, contain color pigments from flavonoids. Many plant chemicals are also known for their antiseptic, antiviral, and/or antibacterial properties, all of which are important to humans.

Directions:

Observing plant defenses

1. Choose an area to look for plant defenses; it could be located in your schoolyard, home garden, or a natural area. Create a journal page or data sheet of your own. Find one plant exhibiting evidence of physical defenses and one that you think has some chemical defenses. Record the date and location; include the scientific name of the plants and a detailed description, including the habitat.
2. A plant must survive in a dangerous world to reproduce. Answer the following: How do you think your plant defends itself? Add sketches if needed. This requires careful observations. Look for any physical characteristics that you think might be used to deter herbivores. Examine the plant for textures like fuzzy leaves or physical structures that could be used to shield vulnerable parts. Make notes on what you find. What kind of herbivore do you think is being deterred? Small herbivores like insects may need different deterrents than larger herbivores like mammals.
3. Pick one leaf from your plant. Caution—some plants contain skin irritants and toxins; take precautions. Do

not touch the sap to your skin or taste anything! Do you observe any oozing or liquid material coming from the damaged leaf or branch? Note whether it is clear or milky. Smear the substance on a piece of paper. Is it sticky? What does it look like (e.g., color, consistency)? Rip a piece of the leaf or cut across the surface. What do you see? Crush your leaf with a rock on your paper. Grind it well (but don't rip the paper), and smell it. How would you describe the odor? What pigments or colors do you observe on the paper?





Plant Wars: A Tale of Offense and Defense

Directions, continued

4. Does the plant show any signs of wildlife use? For example, describe any chew marks, leaf tunnels, unusual growths, scars on the stems, or insect eggs. Note their location on the plant. Make predictions or direct observations of what caused these signs. Do you see any evidence of plant defenses (e.g., sealing off wounds, unusual growth patterns)? Continue to use sketches to help record your observations.
5. Look at the immediate area around your plant. Does your plant seem to be successfully competing with neighboring plants for resources? Look for excessive crowding from other plants. Does your plant look droopy, wilted or show unusual coloring (leaves yellowing, purplish or brown colored areas)? If your plant appears robust and healthy without crowding from neighboring plants, why do you think it is not crowded? Maybe you have a landscape plant that people have weeded around. If you are in a natural area, how do you think your plant competes for space?
6. Return to the classroom and read through the background information again. Does it help you understand your observations?
7. Discuss these questions in class: What types of defenses did you observe? Did the background reading help you understand your observations? Does your plant exhibit both physical and chemical defenses? If you observed herbivory damage or crowding, brainstorm different adaptations that might prevent these from occurring on the plants you observed.





Plant Wars: A Tale of Offense and Defense

Taking it Further

Some native plants are known to be poisonous at some level to humans, wildlife, or livestock. Choose one plant or plant family from the list below (or find your own), and carry out additional research. Find out the category of chemical(s) it contains and write about its effects on mammals. Some plants store their poisonous chemicals in only certain parts (e.g., seeds), while others contain the compounds throughout the plant. Include this information in your research write-up.

<i>Ranunculaceae</i> (Buttercup family)	many in this family
<i>Fabaceae</i> (Pea family)	many, including some lupines and milkvetches
<i>Apiaceae</i> (Carrot family)	many, including water hemlocks and poison hemlock
<i>Liliaceae</i> (Lily family).....	many including Death camas, <i>Zigadenus venenosus</i>
<i>Urtica dioica</i>	Stinging nettle
<i>Hypericum perforatum</i>	St. Johnswort
<i>Asclepias</i> spp.	Milkweeds
<i>Dicentra</i> spp.	Bleeding heart
<i>Toxicodendron</i> spp.	Poison ivy, poison oak, and poison sumac
<i>Rhododendron</i> spp.	Rhododendron

Self Assessments

- 1** Explain the difference between physical and chemical plant defenses and name two of each.
- 2** Describe how co-evolution between plants and herbivorous insects can occur.
- 3** Make detailed observations and use your observations to make inferences.

Resources

- ♦ Armstrong, Wayne P., *Wayne's Word On-line Textbook of Natural History*. Palomar College Arboretum. <http://waynesword.palomar.edu/chemid1.htm>.



Plant Wars: A Tale of Offense and Defense



In the Field!

Being able to identify poisonous plants can be important to your health and comfort. Go on a field trip and take your local field guide to identify as many poisonous plants as you can find. Use the poisonous native plant list from this lesson to start. Many invasive plants also contain poisonous compounds and could be added to your list. Several of the plants from the list can cause severe skin reactions when touched, so keep your distance! In your poisonous plant search, continue to look for signs of herbivory, and note any signs in your field journal. Remember that insects may have adapted to tolerate chemicals found in these plants.

Science Inquiry

- ◆ Allelopathy describes how plants use phytochemicals to affect the growth of neighboring organisms. Allelopathy might be a factor in the enormous success of some invasive plant species. Design an inquiry project to test this theory using a local invasive plant.
 - ◆ Make detailed observations of an invasive plant in its natural surroundings. Do you see evidence that it is suppressing competition from neighboring plants?
 - ◆ Plants can manufacture phytochemicals in specific plant parts or throughout their entire system. How can this knowledge help you set up your inquiry project?
 - ◆ Formulate a hypothesis or question statement about the allelopathic properties of the invasive plant.
 - ◆ Test your hypothesis. One possible way to do this is to water seedlings with slurry made from the invasive plant and water. Make the slurry by blending the entire plant or a specific part of it (e.g., the leaves) with water. How might the slurry affect the results of your test? Determine how frequently you will water the plants, as well as how long you will collect your data.
 - ◆ Gather data. What will you measure? What methods will you use to collect data? How often and how long will you collect data? What will be your control?
 - ◆ Analyze your data. Does it support your hypothesis? How could you improve the focus of your hypothesis or testing next time? Example: If your test showed that Canada thistle suppressed radish seedlings, could this be extrapolated to Canada thistle suppressing all plant growth? Why or why not? Brainstorm ways to improve on your inquiry project.



Reflection

- Humans, as part of the ecosystem, participate in many different biological interactions with plants. Name two plant interactions in which you participate. Analyze one in depth. How would it affect the ecosystem if the plant you interact with was no longer part of the environment? How would it affect you? What changes could ripple through the ecosystem? What other organisms would be negatively affected? Would any organisms be positively affected?
- Identify one way that you can positively affect plants in your day-to-day life.





Nurture a Native Garden Project: Part 1: Research and Planning

Time Estimate:

several class sessions

Best Season:

fall,
winter

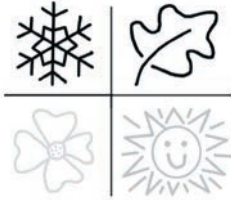

Why try to explain miracles to your kids when you can just have them plant a garden?

—Robert Brault, gardener (contemporary)

Overview

Explore the definition of the term “wildflower” and explore people’s perceptions of the word. Research native flowering plants for your local habitat. In this lesson, students embark on a native plant garden project by working through the planning stages in the first of three lessons. This lesson offers service-learning opportunities to share knowledge with your community.

Teacher Hints

- ◆ For your planting projects use local sources for seed, and native plants whenever possible. Beware of “wildflower” mixes; many contain species that are not native to your ecoregion, or even native to North America.
- ◆ Continue this lesson as a multiyear project. Classes can add to the garden and do long term monitoring on the project. Gather data and survival rates from past planting to assess the long term results. Results can be compared from year to year. Students can collect seed from the garden for future seedling projects or to sell for fundraising.
- ◆ Species recommendations for your ecoregion can be found on the Native Seed Network webpage. Use the map feature on this site to locate your ecoregion and see a list of native species that grow there. Where community data is available, use species that naturally co-occur in plant communities.

Preparation

- ◆ Collect plant species lists from natural areas and field guides for your ecoregion. Consult with natural resource agencies, native plant societies, parks and natural areas, and extension offices for help with species lists.
- ◆ Assemble a variety of wildflower seed packets or labels for student teams to use in research. Packets can be found at garden centers, plant nurseries, and mail order. Find mixes that state the species contained.
- ◆ Site preparation is covered in Nurture a Native Garden Project Part II. It is best to start this process as early as possible, once a site has been identified.

Assessments

- 1 Give the common and scientific names of 2-3 wildflowers that grow in your ecoregion.
- 2 Give one reason to conserve native plant species.
- 3 Work as part of a group to prepare a project presentation (example: oral report, or poster).

Additional Information

- ◆ Species recommendations for your ecoregion can be found on the Native Seed Network webpage, found at <http://www.nativeseednetwork.org/ecomap?state=USA>.



Nurture a Native Garden Project: Part 1: Research and Planning

Materials Needed

- ♦ plant species lists and field guides for your ecoregion
- ♦ computer/internet
- ♦ wildflower seed mix packets with ingredients lists
- ♦ graph paper
- ♦ clipboard
- ♦ compass
- ♦ measuring tape

Learning Objectives

- ♦ Gain appreciation for local flowering species and their place in the ecosystem
- ♦ Use research skills to compile a list of 8-10 native flowering plants from your ecoregion
- ♦ Increase plant knowledge and identification ability over time
- ♦ Work as part of a team to plan a native plant garden

Vocabulary Words

native species
wildflower
invasive

Why try to explain miracles to your kids when you can just have them plant a garden?
—Robert Brault, gardener (contemporary)

Overview

What is a wildflower? Explore the definition of “wildflowers” and people’s perceptions of the word. Put together a journal page of 8-10 native flowers that you like. Work as part of a team to plan a native garden for your schoolyard. Share your project as a community service activity.

Background Information

“Wildflower” is a term with different meanings for different people. To some, wildflower describes the mix of weeds blooming in a vacant lot, to others the beauty of the flowers produced by native plants, and to still others a cultivated mix of small flowering plants. This activity will help to define the term “wildflower,” as well as view the word “wildflower” with a critical eye.

Garden stores, mail order suppliers, and upscale gift shops are all sources of “wildflower” seed mixes. Unfortunately these mixes are often the source of seeds that can become invasive in your region. Some wildflower mixes are labeled Eastern or Western, but rarely are they specially mixed for one state let alone one ecoregion within a state, or even better yet one plant community. The problem arises with the way the seed mixes are used. Manufacturers of these seed mixes are probably intending them for yards and flower beds, but many times they are not used for these purposes. Many people view **wildflowers** as something beautiful and at the same time beneficial to the environment. They end up being spread at country weddings, memorial services, to beautify pasture land, or to re-seed construction sites. In these cases the seed is left to spread into unintended locations and natural areas, and possibly start **invasive** plant problems. Oxeye daisy (*Leucanthemum vulgare*), an introduced species from Eurasia, is such a plant; it has become a common weed in many places throughout North America.

Why should you care about introduced wildflowers? Introduced plants can crowd out **native species**, affect critical ecosystem interactions, and disrupt the balance of natural systems. Not all introduced plants cause problems, but some easily become invasive. Most people do not usually weigh these factors when deciding whether to spread wildflower seed.

How can you help raise awareness in your community? One step your class can take is to begin a native plant demonstration garden for your community. Why create a native plant garden? It can provide the aesthetics of beautiful flowers, and become an integral part of a restored ecosystem. A schoolyard native plant garden may not supply the complexity or diversity of a natural ecosystem, but it will support the local ecology by providing habitat for native pollinators and other invertebrates, small mammals, birds, and some reptiles and amphibians. A well-planned native garden will require few outside resources (e.g., water, fertilizer) once it is established. Creating the garden and maintaining and monitoring the site over time will supply an outdoor laboratory site for continued classroom use and research.





Nurture a Native Garden Project: Part 1: Research and Planning

Student Directions

Part 1: Research

1. What is a native wildflower? Write a definition using your present knowledge. Save this definition to consult again at the end of the lesson.
2. Make a pictorial bouquet of native flowers specific to your local ecosystem. Follow the steps below to identify 8-10 native flowering plants to include. Choose flowers that you find attractive, in a variety of colors and shapes.
3. Start by compiling lists of native plants found in your ecoregion. Species lists may come from the Native Seed Network website, or from field guides written for your area.
4. Narrow your list to species that are well suited to grow in your local ecosystem. Look at the ecology or cultural information sections of field guides for help. Be sure to pay attention to requirements and preferences like elevation and moisture.
5. Assemble a field journal page to showcase your 8-10 flowering species in a pictorial bouquet. Draw the flowers or use color photos (taken yourself or printed from copyright-free digital library sources). Arrange and adhere your bouquet in the middle of the page, and arrange field notes around the outside of the bouquet. Give the common and scientific name, habitat information, and pollinator, if known, for each of your species.
6. Now compare your native plant flowering bouquet with the species lists found in purchased wildflower seed mixes.
7. Work in teams to research one of the purchased wildflower seed mix packets. List the flower species from the ingredients list. Research each plant's range, and note whether it is a plant native to your ecoregion. When finished, prepare a bar graph that compares native to non-native species found in the seed packet. Share with the class and discuss: how many of the different wildflower seed packets would be suitable to plant in your ecoregion?
8. Revisit your definition of a native wildflower. Has your definition changed? Rewrite a definition to better represent your current knowledge.

9. Class discussion: "wildflower" can be a misleading term that is open to interpretation. How would you change the term or the image to better define it? How would you educate the public of your image change and why it is necessary?

Part 2: Creating a Native Plant Garden— Site Planning

1. Divide into teams that will each perform a task: (1) map the school grounds, (2) create a species list for your native garden, (3) identify native garden sites, (4) perform baseline plant survey of sites, (5) market project to school administrators, and (6) locate seed or plant sources for your garden.
2. Team 1: Map the school grounds, identifying locations of possible garden sites. If you have a small area to work with, use measuring tapes and graph paper to make a scale map. If you have a large area you might use pacing to make an estimated map or approach the school office to see if they have a school map that you could use as a template. Create a master map (by hand drawing or on the computer); make several copies.
3. Team 2: Research flowering native plants to include in your garden. Create a list of 10-15 native plants that are suited for your schoolyard ecosystem. Look at sun/shade, moisture levels, and soils. Additional criteria could include species that are commonly available in your area, grow relatively easily from seed, are aesthetically pleasing, and are important nectar sources for local pollinators. There may be a nearby natural site that you can use to get ideas of what species will do well in your garden.





Nurture a Native Garden Project: Part 1: Research and Planning

Student Directions, continued

1. Team 3: Identify one or two suitable sites for the native garden. Sites could be a little-used patch of grass, an underutilized corner, neglected garden spot, or the entrance to your school. Try to make it a place that people will visit and consider if it is a spot that teachers will allow students to visit alone. Make sure to find out if the school has plans for a new building or ball field and do not put your garden there. Check with the maintenance staff at your school and make sure they are on board. You don't want them to mow your garden! Observe and make detailed notes on each of your target sites. How much direct sunlight does it get, and for how many hours a day? What are the soil moisture levels at wet and dry times of the year? Make special notes about building overhangs or water sources nearby. In addition, look for a site that can be enjoyed and appreciated by the student body and school visitors. Mark your two top choices on a copy of the map created by the mapping team.
2. Team 4: Conduct a baseline plant population survey of the two sites identified by the site location team. Identify plant species presently growing at the site. Add the location of all native plants (if there are any) to the map created by the mapping team. Include a key of plant species on the map.
3. Team 5: Market the native wildflower garden to the principal and the school groundskeeper. Give them an overview of the benefits of a native wildflower garden, your class's planning work, and a proposal for taking on a native wildflower garden project. Use PowerPoint or visuals during your presentation. Conclude your presentation by asking for their approval to continue with the native plant garden.
4. Team 6: Using the list of 10-15 native wildflower species, locate sources of native seed or potted plants. Native plant nurseries, seed sellers, and local plant growers can all be sources. A local watershed council or conservation district may be able to give you recommendations of seed and plant material sources. Contact the sources in person, by phone, or by email to introduce yourself and your school. Give them a brief introduction about your project and what you hope to accomplish. Many providers will donate or give discounts to school projects.
5. After all the teams have completed their projects, come together as a class to make decisions. Each team should share their work with the group. As a group, pick your final choice for the site and species to include. Keep the school groundskeeper apprised of your final site location.

Taking it Further

Take on a community service aspect for this project:

- ♦ Write and submit a news article for your school or community paper about native wildflowers and your school native wildflower garden project. Make the article informative by stressing the importance of native plant communities for local pollinators or benefits of a native wildflower garden.
- ♦ Educate the public about the drawbacks associated with wildflower mixes used in wild areas. Create a marketing campaign to get the word out. Posters, letters to the editor, and speaking to community groups, are some possible ways of getting your message out.





Nurture a Native Garden Project: Part 1: Research and Planning

In the Field!

Plan a follow-up field trip to a natural area to view native wildflowers blooming in the spring. Many U.S. Forest Service offices have lists of wildflower hikes in the area. Inquire about peak viewing dates to guide your planning. Ask also if they have a species list for the area. Inquire into the possibility of having their local botanist lead the hike. Take your field journal and/or a camera to record your flower observations.

Science Inquiry

Take baseline monitoring information for your native wildflower garden site. Observe and record soil moisture levels, diversity of plant populations, and insect and wildlife observations or signs. This information can be used in future monitoring and science inquiry projects. Do this in both fall and spring and compare your data. Is your site more diverse in the fall or spring? Try doing this type of monitoring in two different habitats. Are some habitats better to monitor in fall and some in spring? What about summer? What do you think? Design a study to test this.



Assessments

- 1** Give the common and scientific names of 3 wildflowers that grow in your region.
- 2** Give one reason to conserve native plant species.
- 3** Team participation in the project: working together with other members, finishing assigned duties, and helping out where needed.

-
- ### Reflection
- Choose your favorite native wildflower and document all the connections
 - between the plant and the local ecosystem that you can confirm or even
 - imagine. How did the seed get to where it started? What does it need
 - to grow? What kind of pollinators does it support? How does the flower
 - connect to you? Did learning about native wildflowers increase their
 - appeal to you? Do you have any feelings of connection to the ecosystem
 - you live in? Can you identify 1 or 2 things that you can do personally to
 - promote native plant conservation?
-

Resources

- ♦ U.S. Forest Service Celebrate Wildflowers website: <http://www.fs.fed.us/wildflowers/index.shtml>
- ♦ Native Seed Network species list by ecoregion: <http://www.nativeseednetwork.org/ecomap?state=USA>
- ♦ Native Plant Societies: look online to find a chapter near you.
- ♦ USDA Plants Database: <http://plants.usda.gov/>



Nurture a Native Garden Project: Part 2: Starting Seeds and Growing Plants

Time Estimate:

6-8+ weeks (continuing project)

Best Season:

Spring (dependent on region)

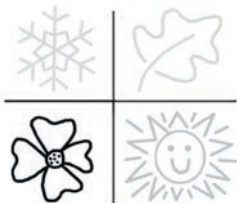

The creation of a thousand forests is in one acorn.

—Ralph Waldo Emerson (1803–1882)

Overview

Part two of this native garden project will focus on starting seeds and growing plants for your native plant garden. In the process, students will learn about seed germination techniques and basic plant care. Potted plants grown by the students will be the basis of a science inquiry project that will contribute to a knowledge base for future seed projects.

Preparation

Gather or purchase supplies needed well in advance of starting this project. Potting soil can sometimes be hard to locate in the winter months.

Teacher Hints

- ◆ Review appropriate background information for each section before starting (seed treatments, planting, plant care, hardening off, and transplanting).
- ◆ Set up a student watering schedule for potted plants.
- ◆ Extend the science inquiry section by requiring students to write up a scientific report on their experiment. The reports can be saved or summarized for future classes to re-test or build on the experiments and contribute to the ongoing research for this activity.



Assessments

- 1** Demonstrate knowledge of seeds, seed germination, and adaptations as they apply to local species.
- 2** Participate in an experiment, gaining skills in science inquiry steps.
- 3** Follow through on a long term project requiring attention to detail.
- 4** Submit a written report of the science inquiry project.

Additional Information

- ◆ A Partnership for Plants in Canada – additional lessons about growing native plants: http://www.bgci.org/canada/edu_act_class/
- ◆ *Wild Ones: Native Plants, Natural Landscapes Landscaping with Native Plants Guide* – reasons, ethics, design, seed treatments, planting, local genetics: https://archive.epa.gov/greenacres/web/pdf/wo_2004b.pdf
- ◆ *American Horticultural Society Plant Propagation: The Fully Illustrated Plant-by-Plant Manual of Practical Techniques*. Alan Toogood, editor. DK Publishing, Inc. New York.



Nurture a Native Garden Project: Part 2: Starting Seeds and Growing Plants

Materials Needed

- ♦ native wildflower seeds
- ♦ resealable bags
- ♦ permanent marking pen (e.g. Sharpie)
- ♦ pots
- ♦ trays
- ♦ potting medium
- ♦ watering wand
- ♦ fertilizer

Learning Objectives

- ♦ Understand the biology of seeds, seed dispersal, forces of nature that work on seeds, and seed adaptations
- ♦ Start and grow native plants from seeds
- ♦ Prepare a site and plants for a native plant garden
- ♦ Set up a science inquiry project using native plant

Vocabulary Words

embryo
endosperm
seed coat
dormancy
scarification
stratification
germination

The creation of a thousand forests is in one acorn.

—Ralph Waldo Emerson (1803–1882)

Overview

Part two of this native plant project will focus on starting seeds and growing plants for a native wildflower garden at your school. Learn about preparing seed, germinating, planting, and how to care for plants. Your potted plants will be the basis of a science inquiry project that will contribute to a knowledge base for future projects in the garden.

Background Information

Seeds are the reproductive units of flowering plants. They are typically made up three parts: the **embryo** (immature plant), **endosperm** (stored food), and **seed coat** (covering). The function of a seed is to protect and nourish the embryo and to assist in the dispersal of plants to new locations.

Seeds require optimal conditions for **germination** (sprouting) to ensure survival for the fragile young seedling. Most plant seeds mature in late summer or fall, but seeds will not germinate until the following spring when weather conditions are favorable. This lag time between when a seed is produced and seed germination is called **dormancy**. Seeds rely on specific cues from their environment to tell them when conditions are right to begin growth. To break dormancy, seeds may require warmth, cold, moisture, certain levels of light, or specific combinations of these factors, depending on the species and habitat conditions. Some seeds are even fire dependent, requiring high temperatures or in some cases, smoke, to release them from the resinous materials that protect them.

Seed dispersal, the distribution of seeds away from the source plant, contributes to the health of the species. Seeds dispersed to new favorable locations can grow without competing with the parent plant. Plants exhibit many different methods of dispersing seed, using wind, water, fur, birds, or insects to get from place to place. Can you think of any plants that use humans as their primary dispersal agents?

Under natural conditions, seeds will germinate when they are ready. We can manipulate conditions to prompt seeds to germinate outside of their natural cycle. Seed treatments are used to mimic the natural processes for breaking dormancy and to eliminate the barriers to germination. There are three general types of treatments (and many variations) used to break seed dormancy of native plants: 1) cold-moist **stratification**; 2) **scarification**; and 3) other special treatments including heat, alternating between warm and cold, harvest timing, and the use of chemical plant hormones. These last methods are only used in special circumstances and won't be addressed in this lesson. Some seeds have double dormancy and require combinations of treatments. You will need to do research on the species you have chosen for your garden to determine what kinds of seed treatments you will need to do.



Student Project

Nurture a Native Garden Project: Part 2: Starting Seeds and Growing Plants

1. Cold-moist stratification is a technique used to fool plants into “thinking” spring has arrived and it is time to germinate. Many plants evolved in areas where winters are cold and moist, followed by a spring that is warm and moist, and those are the conditions that we must mimic in order to convince these species that it is time to germinate. To do this, you can put seed in a mixture of moist sand, peat, soil, or vermiculite in a cooler, or if it is cold enough, outside, in a temperature of about 5 °C. Much cooler and the seed will freeze; much warmer and it might not receive enough chill to germinate. The seed is stored under conditions that mimic common winter temperatures. The moisture level should be similar to a damp sponge. It is common to use a 30 day period of cold-moist stratification, although some species may need as little as 1 day or as much as 90 days (or up to 6 months for some alpine species). Following the time in the cold, transfer your seeds to a warm (20 °C) environment mimicking spring and continue to keep them moist. Many native plants such as sedges, buttercups, native lilies, and others require cold-moist stratification, though not all do. They should begin to germinate in 1-2 weeks.

2. Scarification is the act of breaking through the seed coat. This can be accomplished by rubbing sandpaper across the seed coat, by pouring hot water onto the seeds, using an acid to break through the seed coat, or using a razor blade to nick the seed coat. Different scarification techniques are used depending on the permeability and thickness of the seed coat. More often than not, scarification is an easy process of gently scratching the seed coat with sandpaper. Acid scarification is used for seeds with tough, thick seed coats. The acid acts as a mimic of the conditions the seed encounters when passing through an animal’s digestive tract. Soaking seed in near-boiling water breaks down the waxy cuticle associated with some species. Nature takes care of this process on its own. How do you think it does this?



It is important when germinating seeds and growing plants in artificial conditions to keep the area as clean as possible to minimize conditions that can lead to rot and disease. To start, always wash your hands before handling seed. It is advisable to buy sterile media (e.g. potting soil) or sterilize it yourself in a 400 degree oven for one hour.

By physically treating the seed to conditions that mimic nature, we are able to accelerate the germination process when growing seeds in the classroom or greenhouse setting. If the seeds were planted in the field in the fall, the physical and biological processes they encountered on the soil will naturally break dormancy to allow the germination process the following spring. Sometimes it will take a seed years to break dormancy in nature.





Student Directions

Growing Native Plants from Seed: Identify local native plants to grow from “Nurture a Native Plant Garden Part 1”. Locate sources of seed to purchase or ask for a donation.

Seed Treatment

1. Follow the general guidelines below or any specific instructions you received from the source of your seed. Consult www.nativeplantnetwork.org for specific seed treatments for your species.
2. Seeds planted directly outdoors in the fall will not need pre-treatment.
3. Scarification—Only if your species requires scarification (does it have a hard, impermeable seed coat?) Lightly rub your seeds with sandpaper until you have a small spot where water can get into the seed. You do not need to (and should not) remove the entire seed coat. You can check for a breach in the seed coat with a hand lens.
4. Stratification—For cold-moist stratified seed. For very large or very small seed: fill a resealable bag $\frac{2}{3}$ full with sterilized sand, vermiculite or peat and moisten so it is damp but not flooded. Mix seeds in with the damp planting medium in the bag and seal. Be sure your medium stays moist the whole time.
5. Medium and large seed that you will want to plant in individual pots should be stratified in germination boxes with moist blotter paper.
5. Label the bags with a permanent marker and include species name, date, treatment regimen, and seed source.
6. Refrigerate the bags for at least 30 days unless the instructions you found for your species indicate otherwise. Check the bags weekly for signs of mold or algal growth.
7. If you don't know the preferred method of treatment, do an experiment with several different methods (i.e. scarified vs. not, 14 days of cold vs. 30 vs. 60) and compare the results from your experiment to determine the best technique. Write down and save your protocols for future classes.

Continue to the planting directions on the next page after completing the discussion below.

Discussion

- ◆ What natural process are we imitating by using sandpaper to penetrate the seed coat?
- ◆ How does seed scarification link to the food web?
- ◆ Which seeds require moist-cold stratification and which do not?
- ◆ What is the shortest length of time required for stratification and what is the longest?
- ◆ How long can you keep seeds in cold-moist storage?
- ◆ How can you relate what treatment the seed needs to the local climate patterns?





Student Directions, continued

Planting Seeds

1. Fill 4" pots $\frac{2}{3}$ full of damp planting medium. Tap the pots to remove air spaces and add more medium if necessary to be $\frac{2}{3}$ full. Plant one or two seeds in each pot. Carefully cover the seed and gently press it into the potting medium. You will need two pots each for the science inquiry section. If you are starting extremely small seed, too small to work with individually, use the following method. Once the seed has been through stratification, gently spread the seed mixture on the top of your potting media in a tray to make soil contact. Be careful to not cover your seed with potting soil.
2. Label your pots and trays with your name, species and date with a plant tag or masking tape.
3. Place your pots in trays and gently water with a fine mist.
4. Place plants in a greenhouse if available, a south-facing window, or under florescent lights for 12 hours per day.
5. Check your plants daily, keeping them moist but not wet. If your plants are in a greenhouse make a watering schedule and take turns with your classmates.
6. Watch for germination and keep plants moist until they become established. Once established, adjust the watering schedule as recommended for your species. Wetland plants will need more moisture than upland plants.

Harden-Off Plants

1. A few weeks before planting out the seedlings, prepare them for the outdoors by a process called hardening-off. Plan your outdoor planting date after the last frost date for your region. Gradually move plants outdoors into a protected area two weeks prior to your planting date. Bring them back in at night or cover them with frost cloth for the first couple of nights, and on nights that you expect a frost. Slowly introduce the plants to direct sunlight by increasing the hours they are exposed over the two week period. At the end of the hardening off process the plants should be accustomed to the number of hours of sunlight that they will be exposed to in the garden (this will vary from shade to full sun).
2. Your seedlings are now ready to transplant out in the wildflower garden.

Discussion

- ◆ Compare germination rates for those species that require treatment to those that do not require treatment.
- ◆ Can seeds be planted too close together, or too far apart? If you grew multiple species, which germinated the fastest?
- ◆ Did your species all require treatments?
- ◆ What natural processes are each of the treatments mimicking?
- ◆ Why is it important evolutionarily for seeds to require these treatments prior to germination?
- ◆ What does it protect them from?

Taking it Further

- ◆ Chart the growth of your plants: when did they germinate, get their first true leaves, reach a certain height? Compile the information in graphs with labels.
- ◆ Explore seed germination rates. Count out a specific number of seeds and write down the number (100 seeds makes for easy math but this can be done with any number). Keep track of the number that germinate and record that number. What percentage of your seeds germinated? What trends do you see? Do some of the seeds germinate faster than others? If so, why? Why might some species have high germination rates while others have low germination rates?



Nurture a Native Garden Project: Part 2: Starting Seeds and Growing Plants

In the Field!

Start the native garden preparation for your transplant seedlings. Draw a map of the garden area on graph paper. Indicate which areas you will plant with each species. Check online to find out the full size of the species that you will be planting in the garden, so your spacing will be right when they are full grown. An overcrowded garden can be a frustrating maintenance project in the long run. Mark on the map where to place the plants. Use this map on planting day to guide where to plant. You can always adjust the map as inevitable changes are made on planting day. Begin site preparation as early as possible. If you start in the fall, cover the site with overlapping pieces of cardboard or several thicknesses of newspaper. Hold this down with a generous layer of compost or fall leaves. This will smother the weeds and grass and amend the soil in preparation for your transplants in the spring.

Science Inquiry

Design a science inquiry project:

1. As a class, brainstorm growing protocols for native species that could be scientifically tested. Examples of variables that could be tested are: types of soils, fertilization amounts and types, seed chilling or stratification methods, scarification and methods, temperatures, lighting conditions, addition of mycorrhizae or microbes, or come up with your own ideas. Narrow your choice to one variable to test.
2. Design a question to be tested based on the one variable. Work with two groups of 10 or more plants; one group to test your variable and the other to act as a control. Label the groups with your name and treatment or control.
3. Using your prior knowledge and simple research, formulate a hypothesis or a statement of what you expect to happen. Write down your hypothesis and include your reasoning. This is the beginning of your scientific report.
4. Design a sheet to collect your data. As a class, decide what data you will be collecting (plant height, number of leaves, largest leaf dimension, and others) and the frequency that you will collect it. Date each collection of data and use metric measurements when gathering data. Data can be recorded manually or on a computer spreadsheet program.
5. Consider continuing your experiment outside or you can conclude your findings when the plants are put in the garden.
6. At the conclusion, write up your results in a scientific report. Start with your hypothesis, outline the steps of your experiment, graph your data, analyze your results, and state your conclusion. Did your experiment support your hypothesis or not? Did the experiment lead to any new questions to test?
7. Pool the class data and analyze as a whole. Were your individual results consistent with the class results? If not, why might they be different? Did the experiment produce clear results? Did the class results prove your hypothesis or not? What challenges did you have? How could the experiment be improved?





Student Project

Nurture a Native Garden Project: Part 2: Starting Seeds and Growing Plants

Reflection

This project requires many steps, covers a great deal of time, and requires working in pairs and teams in a cooperative environment. What part of this project did you find the most fun or rewarding? What parts did you find most difficult? What did you learn about your strengths and weaknesses during this project? What did you learn about your working style over the course of this project? How does this fit with working in a team environment? What do you think are the benefits and weaknesses of working as part of a group? What could you do to make this a more positive experience? How do you feel your project will impact future generations?

Self Assessments

- 1** Discuss your understanding of seeds and their adaptations to the local environment.
- 2** Participate in a group science inquiry experiment. Develop a hypothesis, gather and analyze data, make conclusions.
- 3** What did you learn by writing the report?



Resources

- ◆ *Wild Ones: Native Plants, Natural Landscapes Landscaping with Native Plants Guide:* http://www.epa.gov/greenacres/wildones/wo_2004b.pdf



Nurture a Native Garden Project: Part 3: Planting and Celebration

Time Estimate:

2 or more sessions

Best Season:

Spring

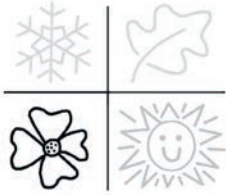

To own a bit of ground, to scratch it with a hoe, to plant seeds and watch their renewal of life - this is the commonest delight of the race, the most satisfactory thing a man can do.
—Charles Dudley Warner (1829 - 1900)

Overview

Students learn transplanting techniques, how to organize and carry out the planting day, and planning a garden celebration. The third stage of this project connects students with community through a service-learning project.

Preparation

- ◆ Plan far in advance for this day. You will need to (or have your students) research to determine the best time to transplant. This may vary by the species you have and the region in which you live. Contact local nurseries, extension services, or watershed councils for advice.
- ◆ Prepare for pre-planting activity by making a copy of transplanting steps (see copy page at end of lesson). Cut this list into strips, each with one step, and put the slips of paper into an envelope for each team of students. The transplanting steps are listed in the correct order on the copy page. You may wish to refer to this list as a key when helping students.
- ◆ Encourage your students to create illustrated transplanting storyboards as part of a community service-learning project, as well as to reinforce their learning.

Assessments

- 1 Students draw and describe in a cartoon storyboard, or write out simple step-by-step directions, how to plant a transplant in the garden.
- 2 Students write a job advertisement and description for their role in the planting day celebration as if they were going to hire someone to do the job they did. Be sure to have a list of qualities that would make someone good for the job (e.g. organized, attention to detail, experience with native plants, etc.).
- 3 Students discuss the benefits of their project to the local ecosystem and to the community.

Additional Information

- ◆ *Wild Ones: Native Plants, Natural Landscapes Landscaping with Native Plants Guide* – goes into reasons, ethics, design, seed treatments, planting, local genetics: https://archive.epa.gov/greenacres/web/pdf/wo_2004b.pdf

Teacher Hints

- ◆ Empower your students by offering them specific leadership roles in this stage.
- ◆ Facilitate leadership by guiding students into planting day committees, working with students to outline individual duties, and helping them create reasonable timelines.
- ◆ Additional community service connections: buddy up with an elementary school class and use the student storyboards to help instruct the young students in transplanting.
- ◆ Continue this project from year to year; hold a garden birthday party where everyone adds gifts to the garden through art projects, new plantings, or general maintenance. Extend the project by working with other schools or natural areas to add wildflower areas at their site. Collect and use your own seed. Sell seed or transplants as a fundraiser for the garden.
- ◆ After finishing planting, walk through the planting area and do some quality control to ensure that the transplants were well-planted. Check for exposed roots and for plants that are in holes that are too shallow or too deep. Make sure plants are marked so they can be easily watered while they are adjusting to their new environment.



Nurture a Native Garden Project: Part 3: Planting and Celebration

Materials Needed

- ◆ transplanting sequence instruction slips
- ◆ storyboard template
- ◆ drawing materials
- ◆ shovels
- ◆ pin flags
- ◆ gloves
- ◆ water
- ◆ mulch
- ◆ celebration supplies

Learning Objectives

- ◆ Work as a group: form committees, plan project, outline individual responsibilities, create a timetable, and complete your planting project
- ◆ Learn and demonstrate proper planting techniques
- ◆ Creatively share the project with other students and the community
- ◆ Increase your knowledge of the local ecosystem

Vocabulary Words

transplant
mulch

To own a bit of ground, to scratch it with a hoe, to plant seeds and watch their renewal of life - this is the commonest delight of the race, the most satisfactory thing a man can do.

—Charles Dudley Warner (1829 - 1900)

Overview

Plant the fruits (or flowers) of your labor in your native plant garden! Learn transplanting techniques, organize, and plant your garden area. Take a leadership role by organizing project committees and a garden celebration. Share your project with your community through your celebration, media coverage, or working on a planting project with a buddy class at an elementary school.

Background Information

In the “Nurture a Native Garden Project” thus far you have learned about local native flowering plants, seed starting techniques, and how to grow transplants (seedlings). In this third and final lesson you will plant your garden and celebrate your hard work and the birth of this garden with your community.

By creating a native plant garden that is adapted to local conditions, you are helping local ecosystems and the critters who use them. The native garden will provide habitat for wildlife and pollinators, and use fewer resources, such as water and fertilizer, than a garden of non-native ornamental plants. Native plants are adapted to local soils and climatic conditions (although these are changing as the climate changes). Like all new gardens, the newly planted native plants will appreciate a little added care the first year or two and will always require weeding and maintenance as vigorous non-natives try to invade. Learn and follow proper planting techniques so you will maximize the chances that your plants will survive. To protect the new plants from competition, hold moisture in the soil, and make new plants easier to find, be sure to mulch or spread a protective layer of compost, leaves, or other natural materials around the base of your plant. Don't forget to water throughout the first and possibly second summer, to establish healthy plants for the future.

There are several things that you can do to ensure the long term success for your project. Work with your teacher to create a plan for continued maintenance. Future classes can water, weed, and mulch established plants. Native gardens can use help defending against competition from invasive plant species. You can also collect seeds and increase populations each year by growing additional transplants. Work with the grounds maintenance staff and come up with a long-term plan to keep the garden happy and healthy. Encourage them to eliminate pesticide use on your schoolyard in order to protect local pollinators and wildlife that will be attracted to your plantings.

No matter the size of your project, planting day should be a celebration of your successes and a dedication for your native plant garden. Consider including a nature reading, original poetry, a song or art work at your celebration. A large celebration could extend to the





Nurture a Native Garden Project: Part 3: Planting and Celebration

Background Information, continued

entire school or even be a community event. Invite guests such as your parents, principal, superintendent, mayor, retired teachers, and your City Council and encourage them to help with the planting. Use the celebration as a service to educate the community on the benefits of a native plant garden. Create a guide to the native plants in the garden, or design a mural of the blooming

plants to be enjoyed year round. Invite the media to cover your event and take pictures and submit a story to your school paper. Don't forget to acknowledge donors or volunteers that have helped make your project possible. Also remember to have fun! Your native plant garden is a great accomplishment and contribution to your native ecosystems and to your community!



Student Directions Pre-planting activity

1. Work in teams of 2-4 students. Each team will receive an envelope of transplanting steps. Work as a team to arrange the slips in the correct order. When you are finished, check your order against the teacher's key.
2. Create a cartoon storyboard of transplanting steps to use with elementary students. Draw a simple illustration and number each step of the process in the boxes of the storyboard. Laminate the storyboard for outdoor use. Use the storyboards during a community planting or donate them to a young elementary class for a gardening project.

Organizing the planting

1. Assemble a planting map. Use the maps from Part I, and add an overlay that marks the planting locations for your transplants. Take into consideration the mature size of the plants and space the planting sites accordingly. Be sure to keep in mind light requirements. As some of your species grow taller over the years, what areas will become shady? How does this affect which species you should plant there? Mark the sites on the ground with labeled pin flags (color coded flags work well if transplanting assorted species), making sure they correlate to the map.
2. Gather needed supplies: shovels, watering containers, mulch, pin flags, gloves, and planting map.

Planting Day

1. Plant out your plants in spring when soils are dry enough to work. If you are unsure of timing, consult with local gardening experts (e.g. Extension Service, or garden nursery staff). Harden-off transplants starting 2 weeks before your proposed planting date (see "Nurture a Native II" for instructions).
2. Gather all supplies and plants. Review planting steps and do a planting demonstration.
3. Use the planting map to match the species to the planting location. Color coded pin flags will help you locate exact spots.
4. Start with planting sites in the middle of the garden and work towards the outer edges. This will help to prevent accidentally trampling plants. Place the colored pin flag next to the new planting to help people avoid stepping on them.



Nurture a Native Garden Project: Part 3: Planting and Celebration

Planting Day, continued

- Remember to take your time while planting. This is not a race. It is important that the transplants are handled with care and placed in a properly sized hole, with no large air pockets or exposed roots so they can thrive.
- Label plants with plant tags and mark the locations on the garden map. An accurate map will be essential for future monitoring of the site.
- Set up a student watering schedule to help the new plants establish and get them through the dry summer months. Check with the groundskeeper; they may be willing to help over summer break.
- Some native plants can be started by direct seeding in the fall or early spring. Use this method to supplement your plantings or if you are working in a very large area. Also, bulbs should be planted in the fall.

Celebration

- Make planting day a celebration or plan a garden dedication. As with most large projects, they can be easier if broken into smaller parts. Divide the class into committees and delegate responsibilities. Keep the celebration simple; pick and choose what best fits your class and resources. Below are ideas you might consider, plus add your own.
- Invite the media to your planting day or act as your own press coverage. Take photos and submit an article to your local paper. Don't forget to include the who, what, where, when, and why.
- Have a ribbon cutting ceremony and invite the school board, school administrators, and staff. Choose a class representative and an invited guest to cut the ribbon together.
- Make a sign for your garden site.
- Create a local wildflower booklet or brochure to go with your garden.
- Videotape or photograph before, during, and after, write a summary, and put together a project scrapbook.
- Conduct a fundraiser for future garden maintenance expenses. Make packets of mixed native wildflower seeds to sell.
- Include an information sheet with the species included in the seed packet and the importance of using local native plants in our landscapes.
- Can you think of other ways to commemorate your project?

Taking it Further

Suggestions for a long-term commemoration of the project:

- ◆ Adopt a buddy class from an elementary school and invite them to your planting day and celebration.
- ◆ Alternatively, visit their school and help them plant a native plant garden. Lead a wildflower craft project or create a game to play for the day.
- ◆ Commemorate your garden project artistically: create a mural (paint on a wall that is adjacent to the garden area, or on canvas to hang indoors), make mosaic stepping stones, build a bench or garden art, make a fabric or paper artwork quilt for the school hall, make a scrapbook and include student garden-inspired art work, hold a poetry contest.





Nurture a Native Garden Project: Part 3: Planting and Celebration

In the Field!

Grow extra transplants and share with the community by planting in parks and public natural areas. Approach your city, county, or state parks offices first. Explain your project and the benefits to the local ecosystems. Ask for permission and guidance to select proper planting locations. You might even find that if you approach the parks department before starting your project they might donate money, supplies, or knowledge to help you.

Science Inquiry

Investigate different mulching materials. Set up a test plot in your garden area that has similar soil and sunlight conditions. Select 24 plants of the same species and similar health and size. Plant them in a row or transect with 0.5-1 meter spacing, depending on their size, between plants. Test 6 different mulching materials using four plants along the transect for each material. Mulch ideas might include: woodchips, compost, cardboard, plastic, straw, and others. Be sure that all the test plants receive the same amount of added water over the test period. Monitor for several months, or years, if possible. Gather data on the size and vigor of the plants, as well as the effectiveness of excluding weed growth at the base of plants.



Reflection

- Read the section from *A Sand County Almanac* by Aldo Leopold that corresponds to the month you are in. Aldo Leopold was attuned to the natural world and appreciated even the smallest parts of his ecosystem. Write about your environment, tuning into the smallest pieces. What did you learn about your environment in this project?
- What is happening in your garden right now? How does the native wildflower garden connect you to the larger ecosystem? Something will be happening in your garden every moment of the year. Even when it appears that very little is happening, challenge yourself to find something. Remember to think about processes that you cannot see, inside plants or below the soil's surface.

Self Assessments

- 1** Rate yourself as a committee member. Did you participate in making decisions, volunteer for a task, complete your task by the timetable, and work well with others?
- 2** Give instruction or demonstrate the steps to transplanting plants into the garden.
- 3** Describe the benefits of the native plant garden to the local ecosystem.

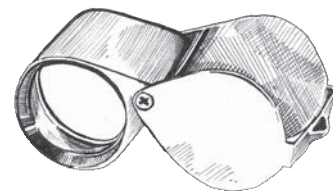

Resources

- ♦ Leopold, Aldo. 1949. *A Sand County Almanac*. Oxford University Press, USA.



Nurture a Native Garden Project: Part 3: Planting and Celebration

Preplanting activity. Transplanting sequence

instruction slips: make a copy, cut into strips, and place in an envelope for each team of students.

- ◆ Dig a hole (as deep as and wider than the pot) and place the soil carefully to the side.
- ◆ Support the top of the plant with your hand across the top of the pot, being careful not to crush the plant, and turn the pot upside down.
- ◆ Gently squeeze or tap the pot to release the plant.
- ◆ Tease the roots out, if they are tightly coiled around in a circle, loosen the roots to encourage new growth.
- ◆ Place the plant in the ground so that the crown (where the stem and roots meet) is right at the soil surface, not above or below.
- ◆ Make sure the roots are pointing down (not up) and spread out inside the hole, especially the root tips.
- ◆ Refill the hole with the dirt removed when digging, making sure to fill in all around the roots.
- ◆ Gently press the dirt around the plant to fill air holes and completely cover the roots.
- ◆ Mulch around the base of the plant to conserve moisture and suppress weed competition.
- ◆ Water.
- ◆ Stand back and admire your work. Wish your plant luck out there in the wild!



*Student
Project*

Nurture a Native Garden Project: Part 3: Planting and Celebration

Storyboard Template



Weed Explosion

A weed is a plant whose virtues have not yet been discovered.

—Ralph Waldo Emerson

Time Estimate:

Classroom: 1 session.

Hands-on: 3-4 sessions over a 2 week period

Best Season:

spring
fall



Teacher Hints

Taking it Further hints:

- ◆ Noxious weeds are defined under the Federal Plant Protection Act of 2000, as well as by most states. Students can explore noxious and invasive species as defined both federally and by their state, and learn about the different classifications of weeds.
- ◆ The USDA's Introduced, Invasive, and Noxious Plants webpage has information on federally-listed noxious weeds as well as links to state-listed noxious weeds.

Science Inquiry hints:

- ◆ Look for dandelion seed heads during spring and early fall. They should be readily available on the school grounds, nearby disturbed areas, roadsides, or gardens.

Overview

Students will learn the characteristics of invasive plants, how they affect species and ecosystems, and the human impacts of their invasion. Students will examine a widespread weed, bull thistle, and study its effects using a mathematical simulation to track a bull thistle introduction and expansion. Students will explore what happens when one seed of bull thistle lands and create a data table and graph the growth of the adult population over a five-year period.

Preparation

Introduce students to the factors that limit the spread of plant populations; natural limits (e.g. disease, predators, geographic, soil, and climatic limitations) as well as human limits (e.g. herbicides, pulling). Brainstorm with your students to create your own definition of a weed, and discuss the related terms from the vocabulary list. What makes a weed an invasive plant? Are all weeds invasive? Are all non-native species weeds? Are there any native species that are weeds? Lead the class into listing the characteristics of what makes a plant a weed. Do invasive plants have the same limiting factors as native plants, why or why not?

Assessments

- 1** Use math skills to complete data tables, figure percentages, and graph data
- 2** Name 4-5 characteristics of invasive plants
- 3** Discuss the difference between eradication and control and where each is appropriate
- 4** Identify several ways that invasive plants are introduced and strategies to prevent their spread.

Additional Information

- ◆ USDA Introduced, Invasive, and Noxious Plants webpage: <http://plants.usda.gov/java/noxiousDriver#federal>
- ◆ The National Invasive Species Council website: <https://www.doi.gov/invasivespecies/>
- ◆ Alien Invasion Curriculum, an invasive plant K-12 curriculum: <http://www.weedinvasion.org/>
- ◆ Cornell Environmental Inquiry Program. *Invasion Ecology*: <http://ei.cornell.edu/> science inquiry program for high school age students.
- ◆ Vaccaro, Lynn. *Breaking into the Seed Bank*, High School Lesson: http://csip.cornell.edu/Curriculum_Resources/CSIP/Vaccaro/Vaccaro_Seed.html



Weed Explosion

A weed is a plant whose virtues have not yet been discovered.

—Ralph Waldo Emerson

Materials Needed

- ♦ bull thistle worksheets
- ♦ graph paper
- ♦ colored pencils
- ♦ calculator
- ♦ For Science Inquiry Section:
 - ♦ shallow planting tray
 - ♦ sterile potting soil
 - ♦ dandelion data sheet
 - ♦ resealable plastic bag

Learning Objectives

- ♦ Become familiar with weedy vocabulary
- ♦ Gain insight into the traits that allow a species to become invasive
- ♦ Identify ways that invasive plants can disrupt the balance of an ecosystem, and cause economic damage
- ♦ Use mathematical skills in making predictions, data collection, and graphing

Vocabulary Words

native	seed-bank
non-native	germination
weed	eradication
noxious	biennial
invasive	perennial
exotic	annual
introduced	

Overview

What is a weed and what makes a weed an invasive plant? Learn how invasive plants affect ecosystems, how to prevent invasive introductions, and how introductions are being managed. Look at one invasive species, bull thistle (*Cirsium vulgare*), found throughout the United States. Use a simulation to model a bull thistle introduction and create a graph to show its growth and spread over a five year period. Watch how a single seed falling onto bare ground can create a weed explosion when left unmanaged.

Background Information

Invasive plants are a growing threat to native plant populations worldwide. Disturbances to ecosystems can result from natural causes such as wildfires, disease, or normal succession cycles, and from human causes. Whenever land is cleared by natural disturbance or by cultivating, logging, or housing developments, then left bare, there is an opportunity for invasive plants to take a hold.

Due to our modern mobile, global society, people are a prime cause of the spread of invasive plants. Humans often contribute to the spread of invasive plants without even being aware of it. Exotic plants are brought for ornamentals into gardens from all parts of the world, with little knowledge of the consequences of their impact on the local ecosystem. Weed seeds can come mixed in with the seeds of crops, or with other imports. Seeds can travel embedded in the tread of car and bike tires, and even on your shoes. Humans are not the only means of spreading seeds; wildlife and pets can carry seeds on their fur, eat and deposit them in their feces, and birds deposit seeds along fence rows and under trees. Seeds can even catch a long ride on the feathers of migrating birds.

It is very difficult for scientists to predict which plants will become invasive and which will not. Not all introduced plants become invasive. Those that do generally share a variety of characteristics that allow them to be successful invaders. These plants are usually generalists, tolerating a wide range of environmental conditions. They are able to reproduce quickly, tend to produce abundant seed, and disperse their seeds with ease--all traits that give them a jump on slower growing native plants. Their large numbers of seeds frequently overwinter in the top layers of soil to form a seed bank that can carry over for years. The seeds in the seed bank wait until the conditions are perfect for germination, and then grow rapidly. Introduced plants that become invasive also have few natural population controls in their new environment. In moving to a new place, they leave behind the diseases, parasites and predators that may have helped to control their numbers in their own native ecosystem. In fact, many, species that become invasive are not particularly common in their homeland, but once they escape disease and predators, their populations are unchecked and can explode.



Weed Explosion

Background Information, continued

There are many misleading or confusing terms used to describe introduced species. Invasive, introduced, weed, non-native, exotic, and noxious are all words that are frequently used to describe plants that are not native to an ecosystem. However, not all of these plants become invasive and cause problems. Most landscaped yards are filled with beautiful plants that do not endanger native ecosystems; these plants can be called introduced, non-native, or exotic. "Weed" is a generic term that is commonly used to refer to troublesome plants, but the term weed can also be used to describe any plant that grows where you do not want it. Many native plants could be considered weeds if they grow where people do not want them. The term "noxious weed" actually has a legal definition: "any plant designated by a Federal, State, or county government as injurious to public health, agriculture, recreation, wildlife, or property."



Why should we be concerned about invasive plants? Invasive weeds have been identified by many land management agencies as the number one obstacle to promoting healthy ecosystems. Invasive plant populations can rapidly expand to dominate natural plant communities, destroy wildlife habitat, reduce plant and animal diversity, and cost millions of dollars to control or in losses of land

productivity.

To slow the devastating economic and environmental effects of weeds, invasive plant management is usually broken into two categories, control or eradication. Many weeds are so common and widespread that there is little hope of eradicating them from the landscape. Instead the focus on these species is on maintaining control and limiting new expansions. Early detection of new invasive species is handled differently. These plants have been targeted because they are problems in some areas, but not yet reached neighboring areas or spread out of control. By training people to recognize these newly introduced species, and with sufficient effort to remove them when they are found, eradication (complete elimination) may be possible.

Methods to control invasive plants are grouped into four categories: prevention, mechanical (mowing and fire), biological (releasing insect or disease predators and parasites), and chemical (herbicides) control. Prevention is the least expensive and the least harmful to the environment but involves extensive coordination throughout the state to be sure that all are aware when a plant species is a threat. Mechanical methods of control generally involve interrupting some stage of plant life cycle by hoeing, mowing, cutting, burning, or mulching to kill the plant or to prevent seed production. Biological control methods often use herbivory to the plant (e.g., importing a beetle that specializes on eating a certain weedy species) or disease-causing organisms to control specific plants. Chemical control uses herbicides to kill the plant or chemical means to suppress seed germination. Challenge yourself to identify ways that you may inadvertently spread invasive plants, and what steps you could take to prevent the spread. Try to control weeds with the least toxic method to protect yourself and the environment. If everyone were conscious of invasive species and helped to control their introduction and spread, our native ecosystems and our economy would benefit greatly.



Weed Explosion

Student Directions

Work with a partner or individually.

1. First read through the Bull Thistle Introduction Scenario worksheet, which contains the information needed to fill in the life history table at the bottom of the page and to complete this exercise. Bull thistle (*Cirsium vulgare*) is a biennial, a plant that lives for two years and does not produce seed until the second year. For our calculations, the mature plant dies the second year after producing seed. This information is key to your calculations.
2. Use the life history table to compute the formulas for the worksheet. Double check your formulas before continuing.
3. Year 0 on the worksheet represents the bull thistle introduction (a seed arriving in hay) and is filled in for you. Use your formulas to complete the remaining years on the worksheet.
4. Graph your results by hand or use a computer. Make a line graph of the size of the adult plant population over time as well as the accumulating seed bank. Add a caption to your graph, and label the axes to show units and scale.
5. Map how far the bull thistle could spread over a 5-year period if wind disperses the seed. Directions are on the worksheet. Use graph paper and place a dot on the midpoint of your paper to represent your first plant. Assume there are no landscape barriers to seed dispersal. How far could the thistle's offspring spread from the original parent plant? Use an appropriate scale for your graph paper and draw a circle around your initial plant showing the distance that the seeds will travel each year of the five years of the model. Your map will show circles that enlarge each year as the seeds travel outward. Use meters as the scale to compute this spread.
6. Looking at your graph; compute the total square meters that the bull thistle could cover at the end of the 5-year model. How does this compare to the size of a football field?

CLASS DISCUSSION

- ◆ What happened to the numbers of adult bull thistle plants over the 5 year period?
- ◆ What happened to the number of seeds in the seed bank? What kind of growth curve do the graphs show?
- ◆ Can you explain the dip in the numbers in the early years?
- ◆ Do you think you would see a similar growth pattern in perennial or annual weeds?
- ◆ What advantages or disadvantages do you see for plants that are annuals, biennials, and perennials?
- ◆ What would happen if some students came in year three and helped out by pulling half of the adult plants?
- ◆ How would that slow the spread of the species?

Taking it Further

Visit the USDA Introduced, Invasive, and Noxious Plants webpage (<http://plants.usda.gov/java/noxiousDriver#federal>) and compile a list of invasive plant species for your state. Pick one invasive weed species that occurs in your area to research. See if you can find a place where this weed grows and familiarize yourself with what it looks like. Educate others at your school or in the community by creating a weed guide on a school bulletin board with photos and descriptions.

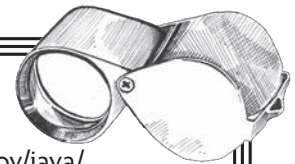



Weed Explosion



In the Field!

Take part in an invasive weed removal project. Local parks or public lands are in need of your services. Think how a class full of energetic weed pullers can make a difference. And, you won't have to take any tests or quizzes while you are out there! Consider making it a long term project. Adopt an area and return for monthly weed patrols, and you will make a lasting difference for your community!

Science Inquiry

Step I

1. Use the common dandelion (*Taraxacum officinale*) to compute germination rates on your own. Dandelions have a spring blooming season and a secondary fall bloom period. Proper plant identification is important as other common yard weeds can have similar seed heads that can be mistaken for dandelions. Review your plant identification sources before collecting seed heads.
2. Work with a partner, locate and carefully pick an entire mature seed head and place in a resealable bag to prevent seed loss. Count and record the number of flower buds, open flowers, developing seed heads, and mature seed heads on each plant you collect from.
3. Return to the classroom. Make a prediction of how many seeds are on your seed head (each person should make their own prediction) and record your predictions.
4. Carefully remove the seed heads from the bag, count and record the number of seeds, saving all the seeds. Counting hints: Work on a sheet of dark colored paper. Use forceps, toothpick, or a pencil point to push seeds to the side as you count them (keep them on the paper). Make a tally mark for each 10 seeds and then total your tallies at the end (otherwise it is easy to lose count). Compare your actual count to your prediction. How close was your prediction?
5. Share seed count numbers among the entire class; were the numbers similar or do they vary greatly? What could be some of the reasons for this?

Step II

6. Plant all of the seeds from your seed head into a shallow planting tray. Mark the tray with your name(s). Half fill a pan with moist sterile potting soil. Spread the seeds fairly evenly over the soil surface, firmly patting the seeds into the soil. The seeds will need good contact with the soil to germinate but should not be covered. Mist with spray bottle to make the soil damp but not soggy. Place plastic wrap over the tray to retain moisture. Why might you want to use sterile potting soil instead of garden soil?
7. Place trays in a sunny windowsill. Keep moist and check periodically for sprouting seeds. Keep a tally of the seeds that germinate and remove them with a tweezers. This will ensure that you do not count the sprouts more than once. Record the number each time you remove sprouts. Continue gathering sprout data for 2-3 weeks (dispose of the seedlings responsibly – don't spread invasive plants!) Tally the final number of seedlings. Calculate the percentage of the seeds that germinated using the total number of seeds planted. This is your germination rate.
8. Use your germination rate to make additional predictions. Take the number of buds, flowers, and seed heads from your original plant to predict the how many seeds one mature plant could produce. Record the number. Why is this number a prediction and not concrete data?
9. Extend the activity to monitoring one dandelion plant for an entire season. Flag your plant and visit daily, pick all flower heads and buds, and keep a tally of how many you collect. How many seedlings can one mature dandelion plant produce? Figure this by multiplying the number of flower heads by the number of seeds per flower head, then multiply this by your germination rate. Is this an accurate number, why or why not?



Weed Explosion

CLASS DISCUSSION

1. Compare data, how much variance was there?
2. What could be the reasons for differences?
3. How many seedlings do you think would actually survive outside, and why?
4. How could you gather data on total yearly production?
5. How could you test the seedlings for survival rates?
6. What else do you wonder about?

Reflection

- Ask yourself, why should you be concerned about invasive weeds?
- What are some ways to prevent invasive weeds from spreading?
- What are some natural factors that might limit the growth of weeds?
- How do humans inadvertently spread weed seeds? What could you do to help prevent the spread of weeds? What are some of the ecological consequences of the spread of invasive weeds? What are some of the economic consequences? Name some factors that might limit the viability of seeds in the seed bank? Can you think of any reasons weeds are beneficial?

Assessments

- 1 Use math skills to compute weed germination rates, survival rates, and to make graphs.
- 2 Name 5 characteristics of invasive plants.
- 3 Discuss the difference between eradication and control and when each is appropriate.
- 4 Explain two ways that invasive plants can damage an ecosystem.
- 5 Identify one way that people spread invasive plants and one or two strategies to prevent that method of spreading.



Resources

- ◆ USDA PLANTS database for pictures <http://plants.usda.gov/>
- ◆ California Dept. of Food and Agriculture. Encyclopedia Data Sheets, Thistles. <https://www.cdfa.ca.gov/plant/IPC/encycloweedia/weedinfo/cirsium.htm>



Weed Explosion

Bull Thistle (*Cirsium vulgare*) Introduction Scenario

Description:

Bull thistle (*Cirsium vulgare*) is native to Eurasia and is now widely established across North America. It has spines on hairy leaves and large purple flower heads. Bull thistle can be found in almost all parts of the United States and is thought to have been accidentally introduced multiple times through contaminated seed sources. It is commonly found

in disturbed areas and will spread into farmland, pasture, rangeland, and recently logged sites. Found in sunny locations, it can displace native and cultivated grasses and forbs. Bull thistle is a biennial and produces seed on mature second year plants. After seed production the plant dies.

Introduction Scenario:

A bull thistle was introduced to a state park when a seed head was accidentally caught on the frame of a visitor's car. Bull thistle seed heads contain anywhere from 100-300 seeds each and plants can produce anywhere from 1-400 seed heads. Both of these figures depend on many factors such as nutrition, soil, competition, and water available to the plant throughout its life.

In our model, the bull thistle is introduced to a healthy grassland ecosystem. In this scenario, the thistle will have to compete for several resources and will produce only 20 seed heads per adult plant. Research shows that 95% of the seeds that bull thistle produces are viable and capable of germinating. In our grassland, only 15% will germinate the first season. This reduced germination rate could result from a healthy vegetation layer covering the ground that prevents many seeds from coming into contact with soil. In this environment, only 1% of seeds that germinate will survive the rigors of nature to become tiny seedlings.

Survival can be challenging even for an invasive plant species. All plants need sufficient water, sunlight, and nutrients to make it through the summer, and in our model, only half will live through that first summer. The seedlings that do survive will start to grow and make a rosette (whorl of basal leaves), increasing their footprint and giving the plant more space to collect the necessary resources. Once a bull thistle becomes a rosette, it develops sharp spines on the leaves that deter many animals from eating it. These

spines help to increase the chance of survival, and 97% of these rosette stage plants will now survive to maturity and produce seed.

Bull thistle seeds have feathery appendages that allow for wind dispersal, but easily detach when the seed is mature. This means the vast majority of mature seeds fall near the parent plant, though some of the seeds are transported by wind and establish plants in new locations. Scientists who study invasive plants use advanced models to calculate distances that seeds can travel under optimal conditions. These studies suggest that up to 10% of bull thistle seeds may travel more than 27 meters with relatively little wind.

What happens to the remaining viable seeds that did not germinate? Under the correct conditions, this seed can be stored in the upper layers of the soil or thatch, waiting to sprout when the conditions are right. This natural storehouse of seeds is called the seed bank. Seeds may remain dormant in the seed bank for different durations, depending on physical factors such as the seed coat and exposure to the elements. Some invasive plants such as field bindweed have seeds that can survive in the seed bank for 60 years! Bull thistle seeds have a relatively short life in the seed bank, remaining viable for no more than five years. In our model, 50% of the seeds in the seed bank will germinate in the following year; the other 50% will remain in the seed bank.

Weed Explosion

Find the information in the text above to complete the life history table

Life History Table	Answers
1. Plant life cycle (annual, biennial, perennial)	
2. Average number of seeds in a seed head	
3. Number of seed heads per adult plant <i>in this model</i>	
4. Percentage of new seeds that are viable	
5. Percentage of viable seeds that will germinate	
6. Percentage of germinated seed that will establish seedlings	
7. Percentage of seedlings to survive 1 st year to become rosettes	
8. Percentage of rosettes that become 2 nd year adult plants	
9. Distance that seeds can travel by wind on relatively calm day	
10. Percentage of seed bank seeds that will germinate each year	

Life History Table	Answer Key
1. Plant life cycle (annual, biennial, perennial)	Biennial
2. Average number of seeds in a seed head	200
3. Number of seed heads per adult plant <i>in this model</i>	20
4. Percentage of new seeds that are viable	95%
5. Percentage of viable seeds that will germinate	15%
6. Percentage of germinated seed that will establish seedlings	1%
7. Percentage of seedlings to survive 1 st year to become rosettes	50%
8. Percentage of rosettes that become 2 nd year adult plants	97%
9. Distance that seeds can travel by wind on relatively calm day	27 meters
10. Percentage of seed bank seeds that will germinate each year	50%

References:

- Zouhar, Kris. 2002. *Cirsium vulgare*. In: Fire Effects Information System, [Online]. U.S. Department of Agriculture, Forest Service, Rocky Mountain Research Station, Fire Sciences Laboratory (Producer). Available: <https://www.feis-crs.org/feis/> [2008, November 5].



Measuring and Monitoring Plant Populations

An experiment is a question which science poses to Nature, and a measurement is the recording of Nature's answer.
—Max Planck (1858–1947)

Time Estimate:

15-30 minute introduction,
60 minute field session

Best Season:

spring
summer



Overview

When botanists and ecologists work in the field, it is often not practical or possible for them to count and measure every plant. In these cases, how do they collect accurate data on plant populations? Field biologists use different methods of sampling portions of a larger population or plant community to collect data that is representative of the whole. The data can then be used to describe the overall population or habitat. This lesson will introduce you to several methods of sampling plant populations and the different types of data that can be collected.

Assessments

- 1 Students can explain what sampling is and discuss the strengths and weaknesses of using sampling as compared to a census to measure plant populations.
- 2 Students can describe two or more methods of sampling plant populations and discuss their applications.
- 3 Students can describe two or more types of data to collect and their applications.

Preparation

- ◆ Students should complete the exercises in the Estimating Percent Cover worksheet before attempting the lesson.
- ◆ Students will conduct a plant population survey to sample one common (abundant) and one uncommon (rare) plant within the survey area. Choose an area to support such a set up. A natural meadow would supply an area for several student teams to work.
- ◆ Break the class into teams of two to four students. Each team will conduct a survey in the same general area. Students can then compare and discuss results.

Teacher Hints

- ◆ Differential education—ways to adjust the level of this lesson:
- ◆ To introduce more difficulty, add additional sampling methods for more advanced students to compare.
- ◆ To simplify the lesson, reduce the sample size or reduce the types of data collected.
- ◆ To help students visualize percent cover, cut out paper squares to show 1% of a square meter quadrat (10 cm x 10 cm), 5% (22 cm x 22 cm), and 10% (31 cm x 31 cm). Bring these into the field to use as examples.

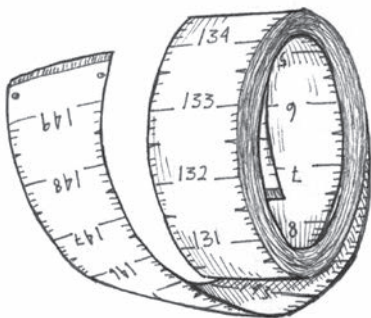

Resources

- ◆ Elzinga, C. L., Salzer, D.W., & Willoughby, J.W. Measuring and Monitoring Plant Populations. Bureau of Land Management. BLM technical reference manual 1730-1, BLM/RS/ST-98/005+1730: <http://www.blm.gov/nstc/library/pdf/MeasAndMon.pdf> (this document is large and takes time to download)
- ◆ Cornell University and Penn State University, Environmental Inquiry for high school students, Invasive Species: <http://ei.cornell.edu/ecology/invspec/>



Measuring and Monitoring Plant Populations

An experiment is a question which science poses to Nature, and a measurement is the recording of Nature's answer.
—Max Planck (1858–1947)

Materials Needed

- ♦ metric measuring tapes
- ♦ quadrat frames (directions to make square meter quadrats in appendix)
- ♦ clipboard/data sheet/pencil
- ♦ wooden stakes
- ♦ compass
- ♦ field guides

Learning Objectives

- ♦ Become familiar with methods of sampling plant populations and their applications
- ♦ Explore different plant population attributes that can be measured (e.g., percent cover, presence/absence, counting individual plants) and their applications
- ♦ Use a sampling protocol to collect different types of data and compare two plant populations
- ♦ Analyze data and interpret results

Vocabulary Words

transect
plot
quadrat
percent cover
plant population
frequency
azimuth

Overview

When botanists and ecologists work in the field, it is often not practical or possible for them to count and measure every plant. In these cases, how do they collect accurate data on plant populations? Field biologists use different methods of sampling portions of a larger population or plant community to collect data that is representative of the whole. The data can then be used to describe the overall population or habitat. This lesson will introduce you to several methods of sampling plant populations and the different types of data that can be collected.

Background Information

Botanists and ecologists sample plant populations for many reasons, including monitoring or “keeping tabs” on a population of rare plants, comparing the results of habitat treatments in an experiment, or determining the impact of an activity (e.g., building a new road through a sensitive habitat, wildfire, or grazing) on a plant population.

When you are out in the field there are many things you can measure and monitor. For example, on an individual plant, you could measure its height, the number of leaves, flowers, or fruits it has. These are examples of measurements that indicate the vigor of individual plants. For a population of a certain species, you could record the total number of individuals, the amount of land it covers, how many reproductive individuals versus those not reproducing, and many other traits. For a community, you could measure the number of species, how many individuals of each species there are, how those species are distributed over the land, and/or many other traits. So, given limited amounts of time, money, and with specific objectives, how does an ecologist decide which types of data to collect and how and when to collect them? It depends on the question of interest for the study or experiment. Some common types of data collection to meet different objectives are listed below.





Measuring and Monitoring Plant Populations

Background Information, continued

Presence/absence: Is the species of interest present or not? This is likely the fastest and easiest type of data to collect. However, it only lets the researcher know if the species is present or absent. It does not provide information about its dominance, or distribution within the habitat.

Frequency: This tells us the percentage of plots within a larger sample in which the species is present. For example, if ten plots are placed in a meadow, and species A is present in one of the ten, it has 10% frequency. This measure of the plant population does not indicate how abundant the plant is. In the example above, even if there are five individuals of species A in one out of ten plots, species A's frequency within the sample is still only 10%. Similarly, if Species A is found in only one plot of ten, its frequency will be the same regardless of if it takes up 100% of the area in that plot, or is just found taking up less than 1% in a little corner. The main advantages of frequency data are that it is quick to collect and the accuracy is less prone to human error.

Percent cover: This is a measure of the proportion of the ground (often within a plot or transect) covered by the body of a plant (from a bird's eye view). This method is extremely useful for plants that spread clonally (e.g., grasses or aspen), or for plants that may produce multiple stems that appear to be multiple plants or where counting individuals is unreasonably time consuming. This is a very useful measure for comparing the abundance of different species. A drawback of measuring cover is that it can vary drastically for an individual plant over the course of the growing season and can be more difficult for researchers to make an objective and accurate measure. This measure is commonly used in plant community research involving multiple species. This method works best for species that are evenly distributed through the area to be sampled and works less well for species that are very patchy or found only along the edges.

Population estimates: If a population is too large in extent or number to feasibly measure or count every individual, sampling is used to estimate the size of the population without actually counting every plant. During sampling, a representative portion of the population

is counted and then this data is extrapolated to estimate the size of the entire population. For this method to be legitimate, the part of the population that is counted (the sample) must be selected carefully, in an unbiased manner and must also be representative of the rest of the population as a whole. Frequently, randomization is used to choose the sample, so that every part of the population has an equal chance of being chosen for sampling.

Census (complete population counts): This is the preferred method when possible. No statistical analysis is required and therefore any changes in counts from year to year are real. A drawback to this method is that it can be extremely costly in person power, time, and money.

What determines which sampling method one should use and the type of data to collect? Factors including population size and distribution, the area to survey, the time available, and the ecosystem characteristics (e.g., density of vegetation, slope, etc.) must be considered. The researcher may select one of many possible sampling methods and layouts to use during the survey, including the following:

Photo points: A picture is worth a thousand words! With this method, the surveyor takes photos in the four cardinal directions (north, east, south and west) from a set of permanently marked points within the area of interest. The photo points should give a good visual assessment of the entire area. Photo points can then be revisited over time, the photos re-taken, and compared to the initial (baseline) photos to evaluate change over time.

Transects: These can be long, narrow strips or wide belts that traverse the landscape. The area within the boundary of the transect is sampled and transects are placed randomly or in intervals across the area to be sampled. Target species within the transect can be counted or percent cover of any or all species present can be assessed. Transects can also be a line (essentially, a very narrow belt); in this case, often the presence of all species that occur along the line or at specific intervals along the line are recorded. Long transects may be easier to establish in some habitats (e.g., prairie) than oth-



Student Project

Measuring and Monitoring Plant Populations

Background Information, continued

ers (e.g., dense forest). The longer a transect is, the more likely it is to capture variation within your population. Transects are especially useful when the target species you are trying to monitor is patchy on your landscape. Transects are usually placed parallel to one another on the landscape and then run at the same azimuth (angle). The number of transects needed to describe a larger area will depend on how variable the habitat is, the size of the transect, and the size of the area to be sampled.



Plots: Plots are often square, although they can also be round or rectangular, areas within which data are collected. Square plots are often called quadrats. The size

of plots can vary, though one meter square plots are common. As with a transect, if the purpose of the plots is to describe a larger area, the plots need to be randomly placed (e.g., using a set of random numbers as coordinates to position plots in a grid overlain on the site). The number of plots needed to describe a larger area will depend on how variable the habitat is, the size of the plot, and the size of the area to be sampled.

Once you have collected your data, the next step is data analysis. Until you do this you just have a bunch of numbers on a piece of paper. Your analysis will be guided by the objectives of your study. If the purpose is to compare two (or more) parts of a plant population, perhaps to test a hypothesis, the data collected needs to be evaluated to determine if a statistical difference exists, and how likely it is that any observed difference has not just occurred by chance.

Student Directions

1. Choose one common and one less common plant species that you will sample in your survey, or decide to sample all species. Make sure you can recognize younger and older or flowering and non-flowering individuals. Decide as a class whether the entire class will use the same two plants, or whether each group will do different ones. This monitoring exercise will answer the question of how common your chosen plant species are within the survey site.
2. Set up a 50 meter long transect in your study area. Make sure you are not biasing the placement of your transect. In your groups, develop a method to randomize the direction (azimuth) of your transect. Use a compass to lay out your transect.
3. Once your transect is established, collect data every 5 meters starting at the 5 meter mark along the transect line by placing the bottom left corner of a 1 meter square quadrat frame at the meter mark and lining it up with the tape (if the bottom left corner is at 0 m, the bottom right corner should line up at 1 m, etc).
4. At each sample point (5 m, 10 m, etc.) collect three types of data (presence/absence, percent cover, and a complete census) for both the common and uncommon plant species. Collect your last data at 50 m, so you have a total of ten samples.
5. Compile your data in a spreadsheet. Calculate the frequency (% of plots in which your species is found) at which each species was present in your sample of ten plots. Calculate the average, maximum and minimum percent cover for each species. Average your census data for each species. Do the same techniques yield similar or different results?



Measuring and Monitoring Plant Populations

CLASS DISCUSSION

- ◆ Which type of data most accurately represents the difference you think you observed between the common and uncommon plants?
- ◆ Weigh the efficiency and speed of data collection against the usefulness of the information you collected. Which methods were best for the plants you studied?
- ◆ How could you change your methods to collect more accurate data?
- ◆ How might you change the data you collect if you had a different research question?

Taking it Further

Create a visual display to illustrate the differences between the three types of data. Create bar graphs comparing the data from each of the three methods with a bar for the percentage of that species estimated using each of the three techniques. Do this for each species you studied. Are the results of the three techniques similar or is there a big difference in the percentage each estimated? How do the three differ for rare versus common species? Do you think your results would change if you sampled more plots?

Self Assessments

- 1** Explain what sampling is and discuss the strengths and weaknesses of using sampling versus a census to measure plant populations.
- 2** Name two or more methods of sampling plant populations and discuss their applications.
- 3** Name two or more types of data that can be collected and their applications.





Measuring and Monitoring Plant Populations

In the Field!

Conduct a plant population survey on your school grounds. The object of your survey will be to compare native plant populations to non-native plant populations. As a class, decide, to focus on percent cover, frequency, number of species (species richness) or some other population measure. Consider your survey objective and the topography of the area to be surveyed to choose the most appropriate sample method to use and type of data to collect. Make sure you can differentiate between all the plants you will encounter in your survey. You can learn to identify them or just give them your own names as long as you can tell them apart consistently. Divide into teams with each team surveying a different area of the school ground. Collect your data, and then come together as a class to do the analysis.

Science Inquiry

Put your new knowledge to work. Work in teams to design a science inquiry project that uses a plant sampling technique to gather data. Observe the plants around your school and find something that interests you to form your inquiry question. Perhaps you are curious if more species of plants grow within 5 meters of the parking lot as opposed to 5-10 meters from the parking lot, how many weeds are present on the soccer field, what percent of the vegetative cover is made up of native trees, versus shrubs, versus herbs, versus grasses, if the presence of trees (shade) influences the number and type of plants found in an area, or in what area invasive species are more prevalent on your school grounds. Decide on the sampling protocol you will use and the type of data you will collect. Conduct your survey, gather data, and analyze your results. Did your results answer your initial question? In what way do you think that your results would differ if you had used a different sampling protocol? Share with your class and get to know your schoolyard.



-
- **Reflection** •
- What did you learn about measuring plant populations? Why do you think
 - there are so many different methods used? Why would you want to change
 - the sampling protocol to best fit a situation? Should the sampling method
 - influence your interpretation of the data? Would you have greater confi-
 - dence in some methods of data collection than others?
-

Resources

- ◆ Elzinga, C. L., Salzer, D.W., & Willoughby, J.W. *Measuring and Monitoring Plant Populations*. Bureau of Land Management. BLM technical reference manual 1730-1, BLM/RS/ST-98/005+1730: <http://www.blm.gov/nstc/library/pdf/MeasAndMon.pdf> (this document is large and takes time to download)
- ◆ Cornell University and Penn State University, Environmental Inquiry for high school students, Invasive Species: <http://ei.cornell.edu/ecology/invspec/>



Measuring and Monitoring Plant Populations

Estimating Percent Cover

Percent cover is a measurement used by botanists and ecologists to describe and quantify plant communities and habitat. It refers to the proportion of the ground that is covered by a specific habitat component, which could be a certain plant species, bare ground, or the canopy of a tree overhead. Because percent cover is not tied to a specific measurement unit (like inches or centimeters), it is easy to compare across different sample unit sizes and shapes.

A good starting point is to evaluate the percent cover of plant species or types of plants within a 1 meter x 1 meter quadrat frame (see diagram). The first step is to orient yourself to the proportion of the area in the quadrat that equals 1%, 5%, or 10%. For a 1 meter x 1 meter (100 cm x 100 cm) frame, the total area is 10,000 square centimeters. Therefore:

- ◆ 1% of 10,000 is 100 cm², or the area of a square that is 10 cm x 10 cm in size.
- ◆ 5% of 10,000 is 500 cm², or about the area of a square that is 22 cm x 22 cm in size.
- ◆ 10% of 10,000 is 1000 cm², or the area of a square that is 31.5 cm x 31.5 cm in size.

Example: 1 meter x 1 meter quadrat

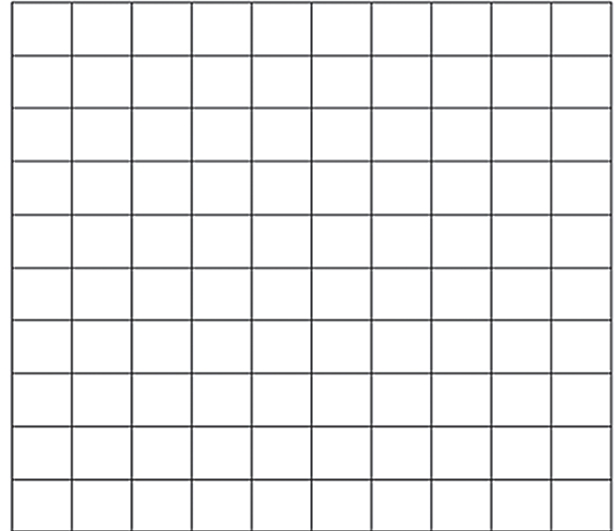

Each square is 10 cm x 10 cm, or equal to 1% cover.

Try measuring the dimensions of your hand, then figure out the percent cover it would occupy in your one meter square. What percentage would a typical 8.5" x 11" piece of paper such as your datasheet, be?

Now, apply what you've learned to estimate the actual percent cover of plants on the ground. Using the diagram below, estimate the cover of the three plants, A, B, and C, within the quadrat. Again, remember that this quadrat has guidelines that are 10 cm apart, or in a 10 cm grid. Plants are never square, so you will have to visually move around and mentally "squish" the plant area into the grid to estimate its cover.



Measuring and Monitoring Plant Populations

Estimating Percent Cover

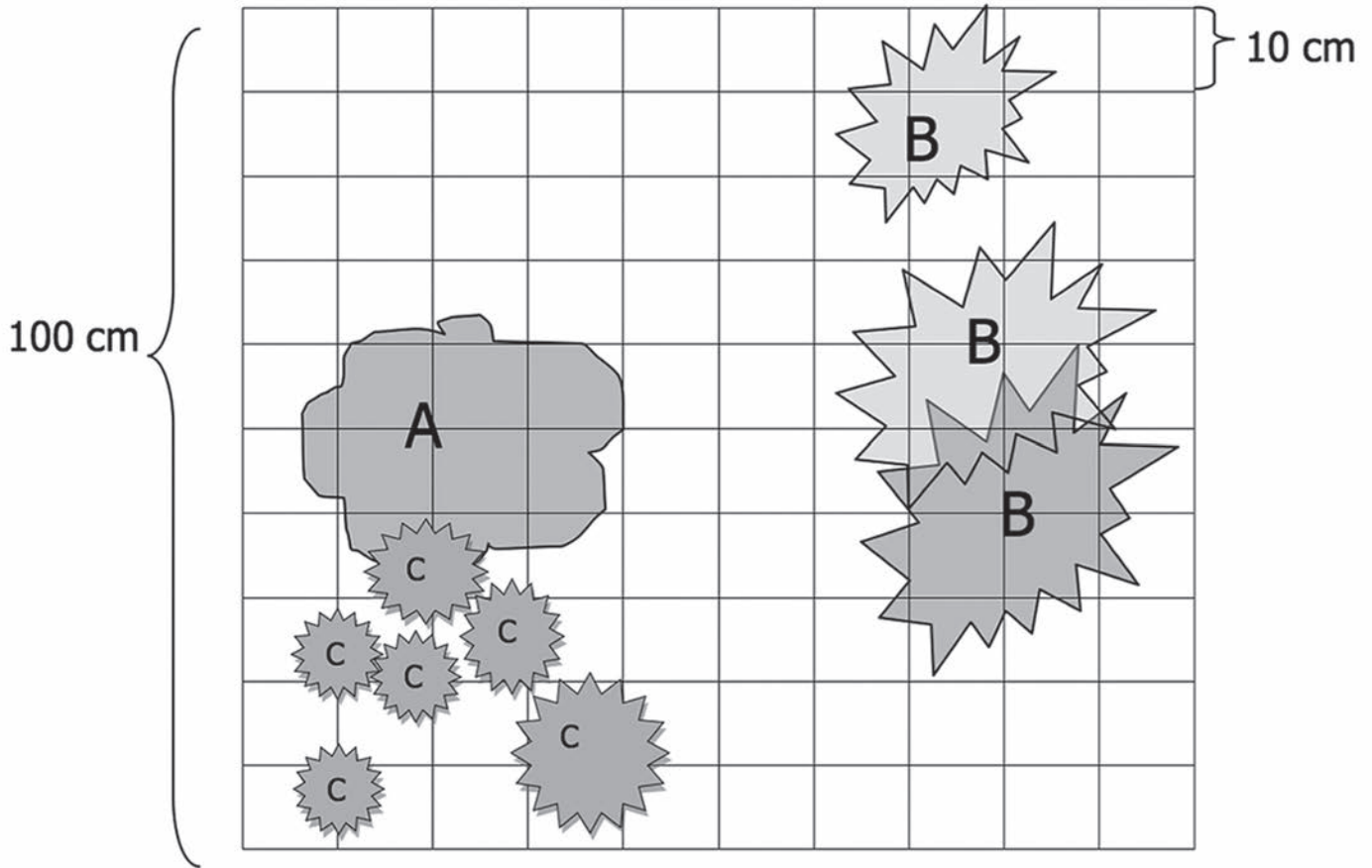

What percent cover do you estimate for Plant Species A? _____

What % cover do you estimate for Plant Species B? _____

What % cover do you estimate for Plant Species C? _____

What is the total % vegetative cover for the plot? _____

As you get more practice in estimating the percent cover of plants of different shapes and sizes, you will get much faster at the process. In some cases you may have overlapping plant layers, and you may end up with a total cover that exceeds 100%.



Who Walked Here Before You?

Time Estimate:

1 session, with possible time outside of class for research

Best Season:

Any

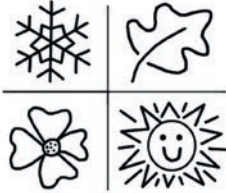

In the old days when we were a strong and happy people, all our power came to us from the sacred hoop of the nation, and so long as the hoop was unbroken the people flourished.

—Black Elk (1863-1950)

Overview

Students will learn about a regional American Indian culture by studying their connection with the natural world. Students will investigate how Native Peoples used native plant species for food, medicine, shelter, tools, and other applications following the yearly natural cycles of the ecosystem. Students will gain insight into the ingenuity and resourcefulness required to live off the land.

Assessments

- 1 Name one important food plant from your area and describe its historic and current use..
- 2 Name at least one American Indian tribe that lives and/or lived in your local area.
- 3 Describe the cycle of a harvest year for an American Indian tribe from your area.

Preparation

- ◆ Students will need access to computers and the internet.



Teacher Hints

- ◆ Help streamline research by providing students with information about local historic and current American Indian tribes.
- ◆ You can also streamline research by providing a list of possible edible, medicinal, or fiber plants for students to choose from. See the references section or regional field guides for species in your region.

Additional Information

- ◆ Ethnobotany documents: <http://unesdoc.unesco.org/images/0014/001458/145847e.pdf>
- ◆ National Museum of the American Indian, Smithsonian Institute. American Indian collections research: <http://www.americanindian.si.edu/searchcollections/home.aspx>
- ◆ American Indian Ethnobotany Database: <http://naeb.brit.org/>
- ◆ Print compilation of plants used by American Indians for food, medicine, shelter tools, and other applications: Moerman, Daniel E. *Native American Ethnobotany*.



Who Walked Here Before You?

Materials Needed

- ◆ Computer with internet access
- ◆ Comprehensive regional field guides with ethnobotanical information

Learning Objectives

- ◆ Define ethnobotany and understand the ethnobotanical resources of local native plants
- ◆ Gain insight into the connection between people, ecosystems, traditional knowledge, and resource management where you live
- ◆ Develop a greater understanding of and respect for other cultures
- ◆ Explore native plants used for food, medicine, fiber, and shelter
- ◆ Introduce the concept of a harvest year as it applies to a tribe from your area
- ◆ Identify how native people manage landscapes to promote resource availability historically and in the present day
- ◆ Identify tribes in your local area, their present day location, and historical ranges

Vocabulary Words

ethnobotany edible
seasonal round medicinal
culture fiber plant
harvest year

In the old days when we were a strong and happy people, all our power came to us from the sacred hoop of the nation, and so long as the hoop was unbroken the people flourished.
—Black Elk (1863-1950)

Overview

Learn about a regional American Indian culture by studying their connection with the natural world. Investigate how Native Peoples used native plant species for food, medicine, shelter, tools, and other applications following the yearly natural cycles of the ecosystem. Gain insight into the ingenuity and resourcefulness required to live off the land.

Background Information

Cultures all around the world are shaped by plants. As a part of an ecosystem, we are dependent upon the living organisms around us in order to survive and thrive. Although the way we use plants may have changed over time, plants provide the basic necessities of our lives—they provide food to nourish us, fiber to cloth us, building material to shelter us, medicine to heal us, and beauty to sustain us. The acts of gathering, preparing, and using these materials are cornerstones in the shaping of a culture. Ethnobotany is a word that you will commonly hear to describe people's use of plants. The word can be broken down into the root words, "ethno," meaning culture, and "botany," which is the study of plants; thus, "ethnobotany" is the study of the relationship between people and plants. This word can encompass historical and present day uses of plants.

Before globalization and modern technology gave us access to goods from around the world and to synthetic materials, human cultures were dependent upon the plants native to their respective homelands. Imagine that you live in a time where there are no grocery stores, no clothing stores, no hardware stores, no furniture stores, no video games. What would you eat? What would you use for shelter, warmth, and comfort? What would you do for entertainment? All of these necessities—and many more—once had to be produced from the natural resources found nearby. Thus, each culture was a reflection of the ecosystem in which they lived. Regional cuisines were determined by the edible plants, animals, and fungi that were available in the immediate area, or within trading distance. If you lived in the eastern United States, you may have looked forward to the ripening of the sweet pawpaw fruits in the early fall. If you were a member of certain tribes in the Rocky Mountains, you may have timed your yearly migrations to coincide with the emergence of bitterroot plants, whose roots you would harvest and store for use throughout the year. Likewise, the materials used for shelter, clothing, medicine, and tools varied depending on what plants and animals were available in the area.



Who Walked Here Before You?

Background Information, continued

These important plants have been woven into the folklore, mythology, and religions of the cultures which depend upon them.

Historically, the life of the tribe was determined by seasonal changes of the landscape. Patterns of movement and activity reflected the location and seasonal availability of particular foods and resources. This annual cycle of activities, movements, and harvests is called a seasonal round. Through these seasonal rounds, native cultures were inextricably linked with seasonal changes.

As the ecosystem shaped the culture of the native people, the people were also shaping the ecosystem. Native peoples manipulated plant species by collecting seeds and cuttings of plants with desirable or improved characteristics. Important species were managed with techniques that would ensure sustainable harvests of plants that provided food, shelter, medicine, fiber, dye, wax and other daily needs. Plant species that were important enough to manipulate by native peoples in the Americas were corn, tomatoes, squash, potatoes, nut- and berry-producing shrubs and trees, and tobacco. Trading among tribes and European settlers spread these improved plants far and wide to be incorporated into many cultures and cuisines.

Native peoples manipulated ecosystems by using fire to maintain grasslands and savannas to encourage grazing by big game and create habitat for important plant species. Native people around North America were wildland managers that used generations of acquired skills to manage and sustain what grew around them and to create habitat for particular species that were essential to their survival. In the West, fire was used to improve habitat for camas, the bulb of which was an important food source. In the East, much of the "wilderness" encountered by early European settlers was the result of native people using small scale fires to create a mosaic of forested and open meadows, which resulted in increased plant and animal diversity and productivity.

Some tribes still practice traditional management techniques and cultural practices. Many also employ modern land management technologies such as using a Global Positioning System (GPS) and a Geographic Information System (GIS) to help map and monitor

traditional resource gathering sites. Before European immigration, tribes would often travel great distances to gather the plant materials that they needed. Today private land ownership often limits the areas that can be used for gathering, but securing access to continue traditional gathering is a high priority for many tribes. This may take the form of collaborating with public land agencies to secure gathering rights, as well as purchasing lands to set aside for this purpose.

Limited access is only one impediment to gathering plants. Others that you might not readily think of include environmental hazards such as toxic chemicals and herbicides. One surprising environmental hazard found in wetlands is lead shot from hunting, which causes high levels of lead to accumulate in the plant species growing in the contaminated water and soil. By far, the most common problem limiting ability of native peoples and others to gather plants is loss of suitable plant habitat from draining of wetlands, land development, and the introduction and spread of invasive weeds. Gathering and using plants remains an integral part of many native cultures today. Often, important harvest events are marked with celebration ceremonies. These ceremonies connect culture, spirituality, and the land.

While globalization and technology have allowed us to access plants from around the world, our cultures continue to be influenced by native plants. For example, the native sugar maple (*Acer saccharum*) of the eastern United States continues to be culturally significant. Berry picking from wild species of huckleberries, raspberries, blueberries, chokecherries, pawpaws, and many others continues to be an important tradition throughout the country. Native plants also are often important symbols of our regions, imparting a sense of pride in the places we call home. Examples include the saguaro cactus in the southwest, the maple in the northeast, redwoods in northern California, and many others. People everywhere note the changing seasons by what native plants are blooming, what fruits are ripening, or what colors the leaves are turning. Regardless of where you live, native plants determine the character of your ecosystem.



Who Walked Here Before You?

Student Directions

In this activity you will study the historic use of native plants in your ecosystem. Each group will study one native plant used for food, medicine, or fiber. You will then work together as a class to compile your data and create a harvest calendar which shows which plants were harvested and used at various times of the year.

1. Determine which tribes lived and live in your local area. American Indian tribes are incredibly diverse and each has its own unique culture and way of using native plants, animals, and other resources. Your class should choose one local tribe to study.
2. Break into teams. Each team will research one edible, medicinal, or fiber plant from your local area.
3. You will research how one plant was used by a tribe in your area. Use books and online resources to discover plants that were used by the American Indian tribes in your area.
4. Use the data collection sheet provided to research the answers to all the questions. Some of the questions will be difficult and might even be beyond the resources that you have readily available. Work with a research librarian for local sources, contact historical societies, local museums, and websites associated with the American Indian tribes in your area. Don't forget to look for some of this information in comprehensive plant field guides for your region.
5. When you have completed your research, come together as a class to connect the story of these plants in relationship with each other and the cultures that use them. Each plant story will now become part of a larger seasonal picture that highlights how native plants can be an important part of a peoples' diet and how this works into the greater story of culture. Take a look at how an historic Indian culture managed their food system.
6. Across the top of a white board make a column for each month of the year. Under each month write the name of the plants that would be harvested at that time, and the ecosystem that the plant would be found in (i.e. May/June, camas, wet prairie; September, pawpaw fruits, riparian bottomlands). In this way you create a calendar showing the a general idea of the seasonal round for the tribe.
7. To be complete, add other food sources in addition to plants to your calendar (fishing, hunting, gathering mushrooms). You can also add information about other items that may have been gathered, such as materials for building shelter, making tools, or creating clothing.
8. Use the information that you have gathered and think about where each food comes from around your local area. How far might the tribe have travelled
9. from one harvesting location to the next? Can you think of places nearby that may have been sites used for harvesting various foods and materials? This basic information will give you a glimpse of the distances travelled by a local tribe throughout the seasonal round to fulfill its needs.
10. Use your creativity to put together a visual calendar of the harvest year from information on the white board. Document ecosystems of the different resources and when the tribe would have to move to that area to harvest. A circular calendar, or seasonal round, which represents an unending cycle, is often used to depict the harvest year. You can also choose another creative way to portray the cycle.



Who Walked Here Before You?

CLASS DISCUSSION

- ◆ Historically, how did tribes know when it was time to move to a new area for harvesting?
- ◆ What would happen if it was a bad growing year and the harvest of certain plants was scant or non-existent?
- ◆ Were some foods more valuable than others?
- ◆ How did tribes know which plants to eat and which to avoid?
- ◆ Do you think you could be resourceful enough to hunt and gather a nutritious diet to avoid illness?
- ◆ What would you need to learn in order to do this?
- ◆ Can you give at least two reasons why it is important to really know about the sources of your food today even though you do not have to gather it yourself?



Self Assessments

- 1** Name one important food plant from your area and describe in detail its role within the culture of people historically and today.
- 2** Name at least one American Indian tribe that lives and/or lived in your local area.
- 3** Describe the cycle of a harvest year for an American Indian tribe from your area.

Resources

- ◆ National Museum of the American Indian, Smithsonian Institute. American Indian collections research: <http://www.americanindian.si.edu/searchcollections/home.aspx>
- ◆ Native American Ethnobotany Database: <http://naeb.brit.org/>
- ◆ Print compilation of plants used by American Indians for food, medicine, shelter tools, and other applications: Moerman, Daniel E. *Native American Ethnobotany*.



Who Walked Here Before You?



In the Field!

Create an ethnobotanical herbarium of plants used by local tribes. Preserve specimens for future classes to use. Collect one sample to put in a plant press (only collect if the plant is common—follow the guidelines in the plant press activity). If plants are unavailable or rare, assemble the herbarium with pictures or illustrations. Include the researched ethnobotany information on the herbarium sheets.

Science Inquiry

Science inquiry is a term used in education and research today, but the concept has been practiced by people for a very long time. The use of inquiry skills has allowed humans to survive and thrive in the world. How did America's indigenous people use inquiry skills historically? How was information organized, stored, and shared? Write out your ideas for how native people may have gone about researching and answering the following questions concerning resources found in their ecosystems.

- ◆ Is this particular plant safe to eat?
- ◆ Does this plant have any medicinal value?
- ◆ What is the best method for preparing this plant so that it can be eaten or used as medicine?
- ◆ What dosages are safe for this medicinal plant?
- ◆ How can this species be harvested sustainably to provide for future years and generations?

Reflection

One way that traditional knowledge about plants was passed from generation to generation was through stories told by elders. These stories often included animal figures and a moral. Create a story for your plant that will encourage respect for your species for generations to come. Convey the importance of your plant (see worksheet questions) as you weave in a creative story with characters, a setting, and a moral. Your story can be written or a more traditional oral story. If you choose an oral story, you may want to make a simple storyboard to help you remember all the parts. Think about ways a storyteller can make a story more interesting for the audience (using different voices for the characters, props, costumes, comedy, or a twist ending).



Who Walked Here Before You?

Weaving the Story of _____

(put your plant name here)

Look at native plants used for food and fiber in a historical and present day context and use the information to weave a story used in the lesson.

Question

Answer

Species name	
Describe your species	
Habitat and range	
What tribe(s) used this species?	
What was/is the plant used for? (can be multiple uses)	
What part(s) of the plant were used?	
What time of year was the plant harvested in your ecoregion? What signs did people look for to indicate the timing and location of harvest?	
How was the plant gathered? What harvesting tools or methods were used?	
How was the plant prepared? (cooking and serving methods)	
Where populations of the species actively cultivated and/or managed? If so, how?	
Are there any stories, folklore, myths, or cultural ceremonies associated with the plant? Describe.	
How does this plant fit into the ecosystem? (consider: wildlife, invertebrates, pollinators, soil life, decomposition, nutrients, sunlight, water, habitat) Ask the question, "What does this plant depend on, and who depends on this plant?"	
Do people still use this plant today for similar purposes? How have its uses changed over time?	



Who Walked Here Before You?

Look at your own food practices or ceremonies in the context of your own life; Thanksgiving Day, saying grace, Passover Seder meal, significance of Easter eggs, Japanese tea ceremony, traditional foods for your family, and others.

Question

Answer

Name one food ceremony that you take part in:	
What is the significance of the ceremony?	
What special food(s) is/are associated with the ceremony?	
What is the cultural origin of the ceremony?	
What foods are characteristic of your local culture?	
Are any local native species commonly used in your local cuisine?	

Resources:

- ◆ Ethnobotany section of regional field guides
- ◆ University of Michigan—Dearborn, Native American Ethnobotany. A Database of Foods, Drugs, Dyes and Fibers of Native American Peoples, Derived from Plants. <http://naeb.brit.org/>
- ◆ USDA NRCS Plants Database: <http://plants.usda.gov/> and associated links



My Burden Basket: How Native Plants Are Used For Fiber

Time Estimate:

1-2 sessions

Best Season:

spring,
fall



He breathed on her and gave her something that she could not see or hear or smell or touch, and it was preserved in a little basket, and by it all the arts of design and skilled handwork were imparted to her descendants.

—Kotai'aqan (Columbia River Basketry, 1994)

Overview

This lesson introduces native plant fibers and their uses, with a focus on cordage, baskets, and decorative techniques. Students will gain an appreciation for basket function and design by studying traditional weaving materials and techniques. Students will then collect, prepare, and construct cordage or a simple burden basket practicing techniques and using various plant materials.

Assessments

- 1 Describe what makes some plant materials more useful as fiber plants.
- 2 List two native plant materials that are valued for their fiber.
- 3 Define cordage, explain how it is constructed, and list some of its uses.
- 4 Name several traditional uses for basketry.

Preparation

- ◆ Scope out locations to take the students on a gathering trip. Materials can be found in many locations: long grasses can be collected from vacant lots or roadsides; cattails, rushes, and sedges can be found in most wet areas. Challenge the students to make use of what they can find growing locally. City gathering requires creative thinking. English ivy may be readily available in urban areas. Ask permission before collecting any plants. Or, ask students to collect plant material from home to bring into class.
- ◆ **WARNING:** Make sure everyone can identify harmful plants (e.g. poison ivy), if they grow in your collecting area.
- ◆ Work with students to create ethical collecting guidelines for the class to use. Be sure that the students discuss such things as: responsible harvesting, cutting rather than pulling plant materials (unless it is invasive), avoiding over-collecting, and asking permission from landowners.

Additional Information

- ◆ The Language of Native American Baskets from the weavers view. <http://www.nmai.si.edu/exhibitions/baskets/subpage.cfm?subpage=intro>
- ◆ Ethnobotany documents: <http://unesdoc.unesco.org/images/0014/001458/145847e.pdf>
- ◆ National Museum of the American Indian, Smithsonian Institute. American Indian collections research: <http://www.americanindian.si.edu/searchcollections/home.aspx>
- ◆ Native American Ethnobotany Database: <http://naeb.brit.org/>
- ◆ Print compilation of plants used by American Indians for food, medicine, shelter tools, and other applications: Moerman, Daniel E. *Native American Ethnobotany*.
- ◆ Otis Tufton Mason: *American Indian Basketry*
- ◆ Entwined with Life, Native American Basketry. Exhibit and website for the Burke Museum of Washington: <http://www.burkemuseum.org/static/baskets/> Search by culture to view basketry exhibits



My Burden Basket: How Native Plants Are Used For Fiber

Materials Needed

pruners/clippers

- ◆ plastic bags
- ◆ gloves
- ◆ dish pan
- ◆ spray bottle
- ◆ old towels
- ◆ colored raffia or yarns for decorative design (optional)
- ◆ project direction sheet(s)

Learning Objectives

- ◆ Learn what makes some plants useful for baskets and cordage
- ◆ Gain an appreciation of the history of baskets and cordage used by American Indians
- ◆ Understand the role of management in utilizing fiber plants
- ◆ Sample hands-on techniques using plant materials to make cordage and basketry
- ◆ Gain appreciation for the decorative designs used to personalize baskets (dyes, colored plant materials, motifs) as well as the techniques that create them
- ◆ Understand that ecosystems influence available plant fiber materials



He breathed on her and gave her something that she could not see or hear or smell or touch, and it was preserved in a little basket, and by it all the arts of design and skilled handwork were imparted to her descendants.

—Kotai'aqan (Columbia River Basketry, 1994)

Overview

This lesson introduces native plant fibers and their uses, with a focus on cordage, baskets, and decorative tech. You will gain an appreciation for basket function and design by studying traditional weaving materials and techniques. Go on a collecting walk to gather materials and then construct a simple burden basket, practicing the techniques and using various plant materials. Now jump in and try it yourself!

Background Information

For millennia, people have used plant fibers to meet the needs of daily life, from making simple twine to bind things to building entire houses. Traditionally, plant fiber has played a large role in many cultures, but with the proliferation of manmade materials like plastics, this need has diminished, as have the skills that go with it. At one time plants provided the materials for food storage containers, clothing, utensils, tools, and adornments. A woman who needed water from a stream would use a basket made from tree bark and waterproofed with plant waxes. Today, we just reach for the nearest bucket. Although modern society still depends on plants to supply fiber for paper, cloth, and lumber for building materials, much has changed in just the last couple centuries making our relationship with the plants around us very different than it once was.

What makes some plants useful as fiber plants? First, the plant must include fiber cells. These cells tend to be long, thin, and tapered on the ends. All plant cells have cell walls, making them tougher than animal cells, but fiber cells have extra thick cell walls that are reinforced with a substance called lignin. Lignin is a compound that makes fiber cell walls stronger, more waterproof, and more resistant to attack by fungi, bacteria and animals. Fiber cells are one of many plant structures that help support plants, letting them grow to reach sunlight, supporting their vascular tissue (water and sugar transporting cells), and providing them with protection from other organisms. Fiber cells are often present in the wood or bark of hardwoods, including oak (*Quercus spp.*), ash (*Fraxinus spp.*), and maple (*Acer spp.*). The stems of some plants such as flax (*Linum spp.*) and jute (*Chorcorus spp.*) also have fiber cells, which make these plants useful for fabrics like linen and weaving items like floor mats and bags, respectively. Fiber cells are also present in the leaves of many grass or grass-like plants, such as sisal (*Agave spp.*), which is used for twine and rope.

Traditionally, many American Indian tribes used fiber from native plants, as well as other natural materials, to meet their needs for baskets, rope, fishing



My Burden Basket: How Native Plants Are Used For Fiber

Vocabulary Words

- fiber cell
- lignin
- cordage
- coiling
- twining
- weft
- warp
- burden basket
- tumpline
- open weave
- overlay

Background Information, continued

traps and nets, cooking containers, water jugs, garments, and houses! Nature supplied everything they needed. Although many of these traditional plant uses have declined, people, Indian and otherwise, still find time to gather materials and produce objects made from plants. In our busy modern times, creating a useful beautiful object with your own hands from materials collected yourself can be very fulfilling. What are some of the things you would need to know about fiber plants, design, and construction techniques to be able to make your own containers?

To begin, you might analyze the form and function of each container's design. One common container design is called a burden basket. Sturdy burden baskets were frequently worn on the back much like today's backpacks. Burden baskets were made for carrying heavy items such as firewood or for when the wearer needed their hands free, such as while harvesting. Such baskets were often cone shaped and outfitted with a tumpline, a strap over the forehead or shoulders, and used for hands free transporting. The cone shape fits comfortably, while distributing the weight on the wearer's back. The large opening at the top allowed for easy filling by tossing items over the shoulder, and the cone shape discouraged thrown items from bouncing out. Tumplines were a tightly woven strap made of soft pliable materials for the wearer's

comfort. The baskets were often made of an open weave to hold bulky items while contributing a minimum of weight in basket material to carry. At times, baskets were quickly woven on site to transport materials back to camp. Coastal tribes would use the open weave burden baskets for collecting clams to allow the user to rinse and drain the clams in one container. Tightly woven burden baskets were used to harvest small seeds and berries. The burden basket is just one of many designs perfectly suited for

its jobs. Studying other basket types, you will find they too were designed to perform the function needed in an equally efficient manner.

There are many techniques for making baskets, with two common methods being twining and coiling. The twining method uses two pliable "weft" strands that are twisted around a more rigid "warp" or foundation structure. This method was used to make some of the specialized baskets like water jugs, cooking containers, and soft hats. In the second technique, coiling, the base foundation is a spiral of materials that are sewn together with a pliable fiber thread.

Cordage is another essential tool of native people that uses plant fiber. Cordage is made by twisting multiple fiber strands together into strong cords that can in turn be used in ropes, nets, and baskets. Many native plants are prized for making strong



Cordage





My Burden Basket: How Native Plants Are Used For Fiber

Background Information, continued

cordage and these vary by region.

Plant fibers can be used as cordage, bundled, or in their natural form as weaving material.

Baskets can be constructed of many different native plant materials, but some species stand out for their superior fiber or weaving attributes. Shoots of hazel and willow, spruce roots, the inner bark of cedar, yucca root, and the stems and leaves of rushes and grasses are all prized materials. Historically, cattails and rushes were be woven into mats with many uses (e.g. clothing, sleeping, house siding, and even canoes!). Traditionally, baskets were used in all aspects of life; some were plain and quickly made for immediate use. Other baskets show painstaking attention to detail and were intricately decorated. Some baskets show geometric patterns that are woven in or overlaid in contrasting colors. Plant materials supply the colors for these designs. For example, black often came from maidenhair fern stems, white came from bear grass, and reds were made with a dye from the inner bark of alder. Highly decorated baskets are cherished, culturally important, used in ceremonies, and passed down from generation to generation.

Different plant species have different optimum times for harvest. Trees and shrubs are often harvested early in the year when new growth is lush and supple. Reeds and grasses are typically harvested later in the season when their growth becomes more fibrous. Preparation for use can include softening fibers, stripping bark, or splitting larger canes.

Traditionally, fire was used by many Oregon tribes as a management technique to promote long, straight plant re-growth for harvest. This traditional management method has become more difficult to use with changing times although it is still employed in natural areas around the state.

Gathering native plant materials requires ethical collecting practices to ensure access for future generations as well as to protect significant natural ecosystems and species. Ethical collecting includes preventing over-collection to minimize population damage. When gathering plant material, one should minimize damage to the parent plant by cutting and removing only a small section of plant, not disturbing the roots, and never taking whole plants. Collect only from large plant populations and allow plants to reproduce between

collections. Using thoughtful practices can allow you to harvest plants fibers without hurting plant populations. Think also about actions you can take to protect or enhance native plant populations for the future. Imagine the connection you would have to your environment if you used plants to supply all your needs, from containers to clothes!



coiling

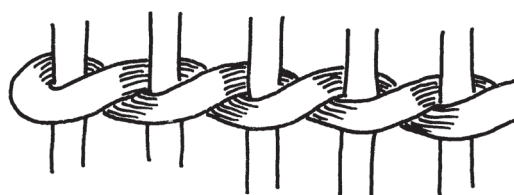

twining

Self Assessments

- 1 Describe what makes some plant materials more useful as fiber plants.
- 2 List two native plant materials that are valued for their fiber.
- 3 Define cordage, explain how it is constructed, and list some of its uses.
- 4 Name several traditional uses for basketry.



My Burden Basket: How Native Plants Are Used For Fiber

Student Directions

1. Think of all the containers that you come into contact with daily; food storage, cooking, eating, backpacks, purses, boxes, water bottles, and egg cartons. We are surrounded by containers of all uses, shapes, and sizes. Make a list of 10 containers that you commonly use daily. Take 5 from your list and brainstorm ways that you could construct an adequate replacement container using materials found in nature. Share your best ideas with the class.
2. **Class discussion:** How often did baskets come up as a container in the brainstorming session? What are the pros and cons of using traditional vs. present day container materials? Be sure to address such things as: individual vs. mass production, knowledge of materials, cost, time, and skills. Don't forget to include issues concerning sustainability and environmental integrity.
3. Challenge yourself to learn some of the traditional art of using native plants to make utilitarian and decorative objects. Choose one of the project sheets from this lesson and learn a new skill.
4. Go on a gathering walk to collect materials needed for your project (cordage and/or baskets). Work with a partner or in a small team. Each team will need pruners/clippers, a plastic bag, and gloves.
5. Spring is a good time to collect flexible young twigs from willows. Grasses are best collected in summer once they have gone to seed and just as they begin to lose their green color. Cattail is best collected in fall, when the leaves have dried and are less fleshy.
6. Review responsible gathering guidelines and how to identify plants to be avoided (i.e. stinging nettle, poison ivy, and poison oak). Collect in an area where you have permission (your teacher will guide you), and take precautions to avoid damaging the plants; cut rather than pull out or tear your materials, don't over collect or gather more than you need. Use gloves to protect your hands while collecting.
7. Traditionally, most fiber materials are collected when they are green and are dried before use. This helps to keep the basket weaving tight, because green materials will shrink as they dry and may disrupt the weave. This might not be an important factor in a large gathering basket, but it is critical in baskets used to hold water. We will be using green, un-dried materials for this project because of time limitations, and because green materials are easier to work with.
8. Once you return to the classroom, organize your collected materials. Separate similar materials into piles so that all of the grasses are in one pile, the willow in another, and so on. Prepare your materials by removing leaves, cutting off seed heads, etc. Store your materials in a folded damp towel to keep them moist and pliable until you are ready to use them.
9. If you are working with dried materials, soak them in water for several hours to make them more flexible before working with them.
10. Consult the project sheets for directions to make your specific project.

Taking it Further

- ◆ Add to the "Who Walked Here Before You?" activity by adding fiber plants to the seasonal round calendar created in that lesson. Include where they were collected, at what time of year, special handling or preparations, and what they were used for.
- ◆ Research other historical and modern uses of plant fibers. What other cultures of the past depended on plant fibers for everyday items? What items do you use regularly that include plant fibers?

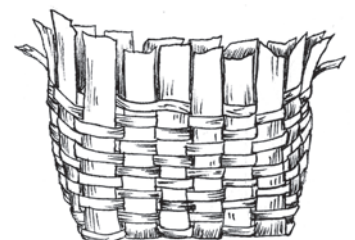



My Burden Basket: How Native Plants Are Used For Fiber

In the Field!

- ◆ Take a field trip to a museum with basket collections, or contact the cultural resources department of one of the tribes in your area to inquire about viewing their collections. Take your field journal and sketch your favorite piece, including information on the materials used. Cross-reference the plant materials in a local field guide, and include other plant history and ethnobotany in your journal entry.
- ◆ Examine baskets that you have at home or in stores. Look closely at the weaving. Mass produced baskets tend to be woven using a different technique than the traditional methods you learned in this lesson. Can you identify how they are different?

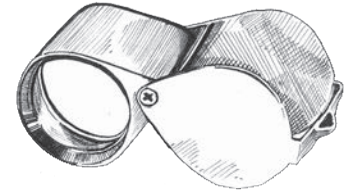

Science Inquiry

Fiber plant materials are valued for many attributes, including strength, durability, availability, and beauty. Fiber was used for cordage to make rope, snares, fishing line, and nets, where strength was critical. Design a way to test the strength of cordage materials. Make cordage from several different fiber sources and compare their strength. Write up a simple analysis of your trials. Explain how you controlled for different variables in your testing. Consider testing for other qualities such as strength when wet, durability, and ease of use.



-
- ◆ **Reflection**
 - ◆ Cultures throughout time have used their skills to decorate their homes and belongings.
 - ◆ How would you decorate a basket to express what is important to you? Design a basket that you would call beautiful. Share it either through making it, drawing it, or writing a detailed description. If you feel artistically challenged in this activity, try using small-square graph paper and color in the squares to make your display your pattern.
 - ◆ Geometric patterns lend themselves well to this technique.
-

Resources

- ◆ Entwined with Life, Native American Basketry. Exhibit and website for the Burke Museum of Washington: <http://www.burkemuseum.org/static/baskets/>. Search by culture to view basketry exhibits
- ◆ The Language of Native American Baskets from the weavers view. <http://www.nmai.si.edu/exhibitions/baskets/subpage.cfm?subpage=intro>
- ◆ Ethnobotany documents: <http://unesdoc.unesco.org/images/0014/001458/145847e.pdf>
- ◆ National Museum of the American Indian, Smithsonian Institute. American Indian collections research: <http://www.americanindian.si.edu/searchcollections/home.aspx>
- ◆ Native American Ethnobotany Database: <http://naeb.brit.org/>
- ◆ Print compilation of plants used by American Indians for food, medicine, shelter tools, and other applications: Moerman, Daniel E. *Native American Ethnobotany*.
- ◆ Otis Tufton Mason: *American Indian Basketry*



My Burden Basket: How Native Plants Are Used For Fiber

Make a Simple Burden Basket

Gather, prepare plant materials, and make a simple cone-shaped burden basket using the twining technique.

Directions

Materials Needed

- ♦ plant fibers for weaving (see Appendix III for traditional fiber plants, or improvise, experiment, and try found plant materials that may have historically been available in your area)
- ♦ thin, flexible, straight twigs (5 or more per student)
- ♦ rubber bands
- ♦ pruners
- ♦ optional: colored raffia or yarns for design work

1. Make a rigid form for your basket out of straight, supple twigs of uniform size. Use a minimum of 5 twigs, approximately the diameter of a pencil and 10-12 inches in length. Using additional sticks or longer sticks will make a larger basket. Bundle the twigs together with a rubber band approximately 1 ½ inches up from the bottom.



2. Fan out the longer end of the twigs to make a cone-shaped form for your weaving.

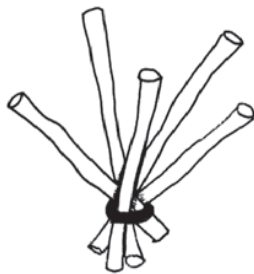

3. Prepare your plant weaving materials. If you are using green, supple materials, little preparation is necessary. The drawback is these materials will shrink as they dry and can leave your weaving loose. If you have collected dry materials, presoak them before using to make them flexible and less prone to breaking. Wrap the fibers in a warm wet towel, and leave for 30 – 60 minutes before using. Raffia must also be presoaked.

4. Prepare your weaving strands. In the twining

technique, you will use two strands of the material, each one passing on either side of the twig form and then twisting between the sticks, alternating as you work around the basket.

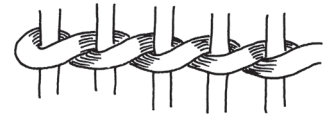

5. Start by taking an 18-24 inch strand of fiber and folding it loosely about one third from one end. This will stagger the ends, making it easier to add new weaving material smoothly. Place the fold around one of the twigs at the bottom of the basket form (near the rubber band) and start. Don't forget to make the twining weave, the double strands need to cross between each twig.

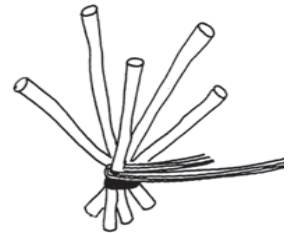

6. Continue weaving your strands around the twig form, twisting your fiber to alternate back to front at each twig.

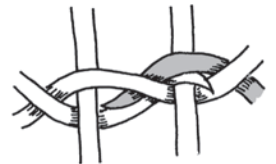

7. When you start to run out of weaving material, add a new strand by laying the new strand overlapping the old one 3-4 inches. This technique is called splicing. Then continue weaving as before.

8. After each course around your twig form, be sure to push the weaving materials down to fill in empty spaces.

9. **Hints:** To keep your cone shape basket form, start weaving with thinner materials (e.g. grasses). As you work up the cone, use weaving material of thicker diameter or double-up the fiber strands. Additionally, if you are right-handed, hold your left hand (switch if you are left-handed) in a fist in the center of your basket to maintain the spread shape as you weave. This will keep your basket spread and keep you from pulling in the twigs in by weaving too tightly.

10. To finish the edge of your basket, make a loop



Student Project

My Burden Basket: How Native Plants Are Used For Fiber

Make a Simple Burden Basket, continued

knot around the last twig and tuck the ends into the weaving below. An experienced weaver can finish their basket so you cannot even find the ends of the strand. Don't expect this for your first attempts. You have just finished a very simple twining weave basket. Don't expect your first weaving attempts to be uniform or tight. If you find this interesting, try a more detailed how-to book or take a basketry class.

or seed heads on your plant fibers or using different diameter strands for twining.

12. Design by color: Traditionally designs were created from naturally colored fiber (e.g. black from maidenhair fern, white from bear grass) or dyed materials (e.g. red from the inner bark of alder, yellow from the inner bark of Oregon grape). You can add color with yarn or raffia fiber worked into your design.

Add a Design (for ambitious basket weavers)

11. Design by texture: Use different textured fibers or weaving materials. Experiment with leaving the leaves

References

- Jensen, Elizabeth. *Baskets from Nature's Bounty*. Interweave Press, Loveland, Colorado USA 1991. ISBN 0-9340226-69-9

Making Fiber Cordage

Directions:

Materials Needed

- ♦ one-foot section of two-ply twisted natural twine (jute, sisal, or hemp)
- ♦ plant fibers—cattail is one of the easiest to identify and find, other traditional plant fiber can be found in Appendix III.



1. Get a feel for cordage by investigating a piece of readymade twine. Observe the twisting pattern. Unravel it slowly and note how the cord twists as you pull it apart. Look for the direction of the twist. If you stop pulling the twine and give it slack, it will most likely re-twist slightly. The twisting motion is what holds the twine together and makes it strong. Most twine is made by machines. Your early cordage

attempts will not be as uniform, but with practice your skills will improve.

2. Prepare your plant fibers. Remove extra leaves, seed heads, or outer bark. Plant fibers will need to be free from chafe and pithy interior materials. Roll or rub the fiber by hand, or lightly pound it with a rock to divide the fibers. Divide larger leaves such as cattails by standing on the leaf tip and pulling the ends apart, making several smaller strands out of one leaf. Prepare fibers of uniform size to produce a higher quality product. Green fibers can be used soon after collecting but may shrink when dried. If working with dry fibers, wrap them in a damp towel to make them pliable. For dry cattails, soak them about 15 minutes before working; other types of fibers may need longer soaking times.





My Burden Basket: How Native Plants Are Used For Fiber

Making Fiber Cordage, continued

3. Take 2 strands of different lengths and tie them together with a knot in one end. This makes it easier to add new materials as you add to your cord.

4. Have a partner hold the knot or clip it to a stationary object to hold while you are twisting. Take a fiber strand in each hand about 6" from the knot. Twist both strands tightly to the right.

5. Once you have the two strands twisted, pass your right hand over your left and switch the bundles in your hands. This will produce the double twist.

6. Continue twisting the individual strands to the right for another 6" and cross your hands again, right over left



and switch bundles. Continue in this pattern to make your cord as long as needed. Make sure you are always twisting and crossing your hands in the same direction.

7. When you come to the last 3-4 inches of your fiber strand, you will need to splice in a new fiber piece to continue. Overlap the thinnest end of the new fiber with the old, and just twist the two together as you work.

8. You may end up with some fiber "hairs" sticking out but these can be trimmed off when you are completed. If you staggered the ends of your initial fiber these spliced joints will come at different spots on your cord.

9. When your cord reaches your desired length, end by tying an overhand knot including both ends.

10. Use your cordage to tie things together, make a handle for a basket, or add beads and turn it into a friendship bracelet.

Resources:

- ◆ US Bureau of Land Management, Salem Oregon. *Exploring Oregon's Past: A Teacher's Activity Guide*. Salem office 503-375-5646
- ◆ Native American Cordage: <http://www.nativetech.org/cordage/> by Tara Prindle, 1994. The website of Native American Technology & Art.
- ◆ Jensen, Elizabeth. *Baskets from Nature's Bounty*. Interweave Press, Loveland, Colorado USA 1991. ISBN 0-9340226-69-9
- ◆ Cordage and other basketry directions: <http://basketmakers.com/topics/tutorials/cordagea.htm>

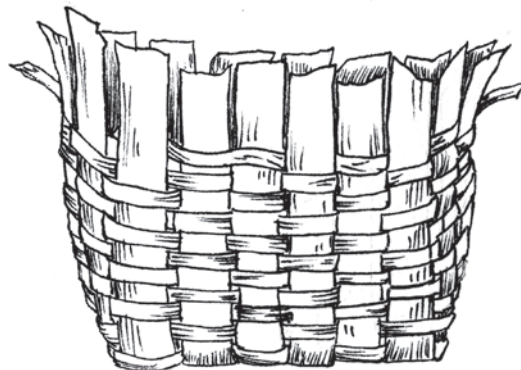



Plants as Medicine: Make Your Own Herbal Salve

In all things of nature there is something of the marvelous.

—Aristotle (384 BC-322 BC)

Time Estimate:

1 field session, 2 classroom sessions

Best Season

late winter,
spring



Assessments

- 1 Define phytochemical and explain one or two environmental processes that prompt plants to produce secondary chemicals.
- 2 Explain the importance of biodiversity to the medical and pharmaceutical fields.
- 3 Give two examples of plants used in modern medicine.

Additional Information

- ♦ See Appendix II for ethnobotanical resources for your region
- ♦ Black Cottonwood (*Populus balsamifera* L. ssp. *trichocarpa*) Plant Guide. USDA-NRCS http://plants.usda.gov/plantguide/pdf/cs_pobat.pdf

Overview

Students learn about common medicinal products that are derived from plants found in the United States and research medicinal properties of plants in a historical context. Students will study the medicinal properties of species in the genus *Populus*, which includes poplars, cottonwoods, and aspen. These native trees are found throughout much of the US and are generally associated with wetlands and riparian areas. Students put their knowledge to work by making their own healing salve from poplar buds.

Preparation

For an alternative format: combine class discussions and collecting buds into one session, assign the remainder of the lesson as homework, and use a second session for students to make their salve. Infuse the herbal oil one day ahead (this should only take a few minutes to start). Oil can be re-warmed in a double boiler before adding the beeswax.

Teacher Hints

- ♦ *Populus* species vary around the country. Consult a local botanist or regional field guides for information on species near you. **Note:** introduced poplars used for wood and pulp production are less valuable medicinally because they contain less resin. Try to use native species for this project.
 - ♦ **Northeast:** Balsam poplar (*Populus balsamifera*), eastern cottonwood (*Populus deltoides*)
 - ♦ **Southeast:** Eastern cottonwood (*Populus deltoides*)
 - ♦ **Midwest:** Balsam poplar (*Populus balsamifera*), eastern cottonwood (*Populus deltoides*)
 - ♦ **West:** Black cottonwood (*Populus balsamifera* ssp. *trichocarpa*), narrowleaf cottonwood (*Populus angustifolia*), eastern cottonwood (*Populus deltoides*), quaking aspen (*Populus tremuloides*)
 - ♦ **Southwest:** Fremont cottonwood (*Populus fremontii* ssp. *Fremontii*), eastern cottonwood (*Populus deltoides*), quaking aspen (*Populus tremuloides*)
- ♦ To collect *Populus* buds, look in early spring and collect before the buds open but are resinous to the touch. *Populus* species commonly grow in wet areas: along waterways, streams, rivers, lakes, and wetlands. Finding fallen branches from storms is a good way to access the buds.
- ♦ Self-heal (*Prunella vulgaris*) can also be used as an alternative if poplar or cottonwood are not available.
- ♦ Your study of medicinal ethnobotany could be expanded by having each student group research a different native plant with medicinal uses.



Plants as Medicine: Make Your Own Herbal Salve

In all things of nature there is something of the marvelous.

—Aristotle (384 BC-322 BC)

Materials Needed

- ♦ Classroom session
- ♦ online computer access for ethnobotany and phytochemical research
- ♦ plant field guides with ethnobotany information
- ♦ Salve making supplies
- ♦ glass jar with lid
- ♦ olive oil
- ♦ crockpot (for quick method)
- ♦ old pan and spoon to mix salve
- ♦ latex gloves
- ♦ candy thermometer
- ♦ glass measuring cup
- ♦ strainer
- ♦ beeswax (2-3 oz. for each pint of infused oil)
- ♦ cheese grater
- ♦ small salve containers (i.e. lip gloss containers, very small jars, baby food jars) enough for all the students
- ♦ labels for salve
- ♦ vitamin E capsules or oil (optional)

Vocabulary Words

phytochemical
biochemical
analgesic
herbalist
pheromones
antibacterial
ubiquitous
medicine

Overview

In this lesson you will learn about common medicinal products that are derived from plants found in the United States and research medicinal properties of plants in a historical context. You will study the medicinal properties of species in the genus *Populus*, which includes poplars, cottonwoods, and aspen. These native trees are found throughout much of the US and are generally associated with wetlands and riparian areas. Then, put your knowledge to work by making your own healing salve from poplar buds.

Learning Objectives

- ♦ Gain a basic understanding of plants used as medicine, highlighting American Indian uses
- ♦ Define phytochemical and understand the purpose of secondary biochemicals in response to the environment, and learn how humans harness phytochemicals for their medicinal properties
- ♦ Examine the connections between plant biodiversity, potential future of discoveries in plant medicine, and untested plant compounds
- ♦ Study the historic uses of a native plant, including its biochemical properties
- ♦ Participate in collecting and producing a plant medicine (*Populus* bud healing salve)

Background Information

The history of humans using plants as medicine begins long ago before writing and language even existed to record it. Much of what we know about the early history of ethnobotany (the human use of plants) is patched together from early rock pictographs. The first known depictions of plants used for medicinal purposes are from the cave paintings of Lascaux in France, which are radiocarbon dated to be from 13,000-25,000 BCE. Early written records of the use of herbs for medicine come from Sumerian tablets (3500 BCE), ancient Egyptian writings (1000 BCE), and the Old Testament of the Bible. Herb use has also been documented in the early cultures of India (1900 BCE) and China (2700 BCE). Many ethnobotanists suspect that the use of plants as medicine extends much farther back in human history, but there are no records to prove this. Plants have been such an important part of medicine that botany was considered a branch of medicine until about 150 years ago, at which time the use of chemical treatments and synthetic medicines began to gain popularity. However, many of the medicines that are used in conventional medicine are still derived from phytochemicals that originated in plants and now can be synthesized in today's laboratories. Phytochemicals, which are various chemical



Plants as Medicine: Make Your Own Herbal Salve

Background Information, continued

compounds produced naturally in plants, continue to be studied by pharmaceutical companies in the search for new, effective medicines. Recently there has been a growing resurgence of interest in the use of herbs to prevent and treat illness. This has led to a renewed interest in looking at the world's plants as a storehouse of medical wealth.

The indigenous people of our country have a long history of using plants, fungi, and other natural resources for healing. In earlier times, people had a general knowledge of which plants were used for treating common illnesses as well as rare or serious conditions. This wisdom was passed down to the next generation through stories from tribal elders. Many cultures also had (and many still have) designated healers with specialized training in plant medicine who can invoke ceremonies or intervene with the spirits to help with healing. Generations of observations, trial and error testing, and plant knowledge has been passed on in this way for millennia. The wealth of indigenous people's plant knowledge locally and worldwide is immense, but with changing societies and cultures much of the information is being lost. Still, worldwide it is estimated that 80% of indigenous people continue to use plant remedies. Worldwide, there are many efforts to record these indigenous healers' knowledge of medicinal plants so that it is not lost.

Despite the extensive history of

medicinal plants, estimates are that only 10% of plants have been investigated for possible medicinal use. Modern science has yet to explore the phytochemical properties of countless plant species, and many of those species that have not been studied are being lost to extinction. The loss of any species may be a lost opportunity for a future medical breakthrough that could cure or alleviate the symptoms of diseases. The significance of this becomes apparent when you consider that twenty-five percent of all prescription drugs in this country contain at least one ingredient that was extracted or derived from plants.

Many common medicines used today are linked to native plants that are found in the United States. One example is aspirin (*acetylsalicylic acid*). People have used the bark of willows (*Salix* spp.) to alleviate pain and fevers. *Salix* spp. contain salicin, a naturally occurring anti-inflammatory compound. Studies of the chemical activity of salicin led to the discovery and invention of aspirin, which is now among the more common pain relievers on the market. Another medicinal compound with which you may be familiar is menthol, the aromatic compound derived from plants in the mint family, used for its decongestant and topical pain-killing properties. Another very notable example is the Pacific yew (*Taxus brevifolia*), which has produced the potent anticancer drug Taxol. Taxol is derived from the bark of this native tree, and has become one of the most widely used drugs used in treatments for several cancers.

All plants produce chemical compounds to help them absorb nutrients, photosynthesize, and produce color pigments. Plants also produce secondary chemicals in response to their environment. They can act as defense against herbivores, disease, fungi or competition with other plants. They can be used to attract specific pollinators. They can be produced during times of stress to change the physical chemistry of the plant until conditions improve.

Because of the great variety of environmental conditions and organisms to which plants must respond, there are a wealth of secondary chemicals found in nature. These diverse secondary chemicals often can be harnessed to serve our medicinal needs. Many of these secondary chemicals have supplied the human pharmacy for millennia. Even today, that pharmacy continues to grow as our knowledge of botany and chemistry expands. However, as we lose biodiversity through extinction, many undiscovered medicines are lost forever.





Plants as Medicine: Make Your Own Herbal Salve

Student Directions

Part 1: Research medicinal plant uses

1. As a brainstorm or discussion session explore the following concepts as a class. What makes a substance “medicine”? How do you make personal judgments on what medicines you use? If a particular medication is available without a prescription, , who should be responsible for ensuring correct usage and dosage? When you buy unregulated herbal medicines, how do you know you are getting the real thing? Much of our medicinal plant knowledge comes from indigenous people. Who owns the rights to the knowledge of and the use of these plant medicines? If more people use plant medicines by collecting plant materials in the wild, how will we protect the populations of those species from overharvesting?
2. Work in small groups to investigate a local native species for its medicinal properties and historical uses. Find and record on your data sheet four historical medicinal uses for your plant, what part of the plant is used (example: resin, bark, leaves), and the type of preparation (example: tea, salve, poultice). This information can be found in field guides that contain ethnobotany information, or use online sources (see resource section).
3. Research the phytochemicals found in your plant. You can try using Dr. Dukes Phytochemical and Ethnobotanical Databases website at <http://www.ars-grin.gov/duke/>. Look under Plant Searches and click on “chemicals and activities in a particular plant.” On this screen click “scientific name,” then type in the Latin name of your plant and select “submit query”. This gives you a filtered list. Click on a specific name and it comes up with the details.
4. The resulting search will list the phytochemicals found in your plant followed by their location in the plant (e.g., leaf, bark, essential oil). Scan the list to look for the plant parts you listed on your handout. Enter up to 3 phytochemicals along with where they are located and their biological actions (example: 2,6-dimethoxy-p-benzoquinone; bark; antibacterial, fungicide, pesticide). Match your results to the ethnobotanical uses you listed on your handout sheet.
5. Define the biological activity you have recorded in simple terms. For example, antibacterial: destroys or suppresses bacterial growth.
6. When your team has completed the data sheet, discuss your findings within your group. Write a conclusion to your research. Can you support the historical medicinal uses with the phytochemical analysis? Why or why not?

Part 2: Make a healing salve from resinous cottonwood buds for minor skin irritations

1. See the “In the Field” section for directions to collect Populus buds, or use buds that your teacher has already collected.
2. Smell the buds. Does the scent remind you of anything?
3. Lay the cottonwood buds out to dry for a day before proceeding. Water on the buds does not mix well with the oil and can lead to mold in your finished product.
4. Use clean sterilized containers for all the steps of the process. Wear latex gloves to maintain the purity of your finished product.
5. Make an herb-infused oil by one of the two following methods:
 - ♦ **Traditional method:** Fill a sterile pint jar with the cottonwood buds. Fill the remainder of the jar with olive oil, leaving no head room or air space, and cap. Place the jar in a bowl or container to collect any overflow. Leave in a warm place for 4-6 weeks. Periodically check to add more oil as needed. Heat can cause overflow.

Continued on next page.



Plants as Medicine: Make Your Own Herbal Salve

Directions, continued

- ♦ **Quick method:** Spread the cottonwood buds in the bottom of a slow cooker and just cover with olive oil (this will likely require at least a pint of oil). Heat the mixture, trying to maintain temperatures near 100 °F for 4-5 hours. Let the mixture reach 120 °F, then turn off the pot and let it cool to 100 °F before turning on the pot again. Repeat this process for another 4-5 hours.
- 6. When the infused oil mixture is finished (from either method), strain the oil into a clean double boiler pan.
- 7. Take the warm infused oil and gradually stir in shredded beeswax (retaining a small amount). Use the large holes of a cheese grater to shred the wax. Warm the oil slightly in a double boiler just enough to cause the wax to melt. Use 1 ½ ounce of beeswax to a pint of infused oil. To test consistency, remove a spoonful of the mixture and put in the refrigerator to cool to room temperature. If it is too soft, add small amounts of beeswax to thicken. If it is too hard, add a small amount of infused oil.
- 8. Vitamin E can be added to the salve at this point to act as a natural preservative. Empty 2-6 capsules into the salve and stir.
- 9. When the salve is finished, pour into sterile small containers and leave to cool. Cap the containers when the mixture has cooled to room temperature. Label with the name of the salve, the ingredients, and the date.

Taking it Further

1. Class critical thinking activity--How can modern society benefit from exploring new uses of medicinal plants? Explore the subject from each of the following perspectives: American Indians with historical plant medicinal knowledge, drug company executive, the consumer (or patient), conventional doctor, pharmacist, alternative medicine doctor, public lands manager, and a farmer growing medicinal herbs. There are no right or wrong answers and all points of view should be heard with respect.
2. Investigate a global perspective on the issues of regulating herbal medicines. Look into the following report: Regulatory Situation of Herbal Medicines – A Worldwide Review. 1998, World Health Organization Report. February 12, 2009. <http://www.who.int/medicinedocs/en/d/Jwhozip57e/4.2.8.html> . This document is easily accessed and includes quick links to herbal regulations in many countries of the world.
3. Use Google Scholar to find an article on the medicinal use of *Populus balsamifera*. Write a summary of the article and include proper citations and the website link to the article.





Plants as Medicine: Make Your Own Herbal Salve

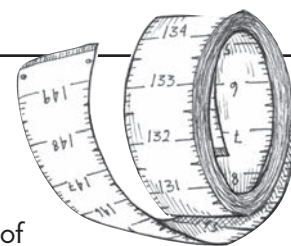

In the Field!

Collect your own *Populus* buds to make salve. *Populus* species generally grow in areas with plenty of moisture in the soil, often near rivers and streams, wetlands, lake edges, and wet ditches. A regional field guide or local botanist can help you decide what species of *Populus* you will find in your area. The timing of collection will also depend on where you live, with buds maturing from late winter through spring. You can ask a local botanist or naturalist for guidance on both location and timing for collection. Collect buds when they are large or swollen in appearance. Some of the buds may be dripping resin. At this point they will be easy to break from branches. Trees will often lose branches in windy conditions, so try collecting soon after blustery weather. Take a field guide on your trip to help you with tree identification. For winter tree identification concentrate on looking for the shape of the tree (tall somewhat columnar), the bark of mature trees (dark gray, and deeply furrowed), the location of the leaf buds on the branches (alternate), a distinctive sweet and spicy odor, and sticky resinous buds. Also check underneath the tree for old fallen leaves to help confirm your identification. Always remember to check with land owners before harvesting, and tread lightly. You will need to collect enough buds to fill a pint size jar (one jar for the entire class).

Science Inquiry

Exploring the medicinal properties of plants is a fascinating subject with many avenues for science inquiry projects. The following are two suggestions that will require additional class sessions to study background information, learn procedures, carry out the experiment, and writing up the findings.

- ♦ Leaf Chromatography Lab: Separate chemical compounds from leaves to compare between different plants. Compare and contrast by testing plants with known topical medicinal properties against others. The following lab will give you procedures for setting up the experiment https://jrsowash.wikispaces.com/file/view/leaf_chromatography.instructor.pdf
- ♦ Testing for Antibacterial Properties of Plants: Research the ethnobotanical uses of local native plants with antibacterial properties or plants that were historically used on wounds. Test plants with known antibacterial properties, as well as a few others. The following lab will give you procedures for setting up an experiment <http://www.actionbioscience.org/biodiversity/lessons/plotkinlessons.pdf>. Lichens can also be used or substituted for plants in this experiment. Research using several lichen species can be referenced below:
- ♦ http://lichens.science.oregonstate.edu/antibiotics/lichen_antibiotics.htm - paper on the antibacterial properties of lichens
- ♦ <http://ispub.com/IJAM/5/2/4012> - journal article in the Internet Journal of Alternative Medicine. Citation: S. Malhotra, R. Subban, A.P. Singh. Lichens- Role in Traditional Medicine and Drug Discovery. *The Internet Journal of Alternative Medicine*. 2008. Volume 5 Number 2.





Plants as Medicine: Make Your Own Herbal Salve

Reflection

- Write about the ethnobotanical knowledge in your family. Include what you use and how you use it. Search your memory or, better yet, interview your parents or grandparents to record your family's ethnobotanical history. Think of foods you might eat to stay healthy, such as eating your carrots for good eyesight (why?). What does your family do for a sore throat, cough, or stomachache? The plants you list could be ones you eat, drink as teas, or use in other ways. Don't forget to check your medicine cabinet for such things as aspirin, menthol, or herbal throat lozenges. Think of the plants that you use daily.

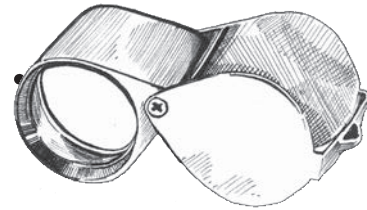

1 Self Assessments

Define phytochemical and explain one or two environmental processes that prompt plants to produce secondary chemicals.

2 Explain the importance of biodiversity to the medical and pharmaceutical fields.

3 Give two examples of plants used in modern medicine.

Resources

- Dr. Duke's Phytochemical and Ethnobotanical Databases. <http://www.ars-grin.gov/duke/> - click on Plant Searches, Chemicals and activities in a particular plant. Then search by plant scientific name (be sure it is spelled correctly).
- Moerman, Daniel E. 2000. *Native American Ethnobotany*. Timber Press, Portland. ISBN 0-88192-453-9. A comprehensive collection of many plants with descriptions of their uses.
- Foster, S. and C. Hobbs. 2002. *The Peterson Field Guide Series A Field Guide to Western Medicinal Plants and Herbs*. Houghton Mifflin Co, New York. ISBN 0-395-83807-X. A field guide with photographs of each plant and descriptions of their uses.
- Green Pharmacy, Dr. Jim Duke's Botanical Desk Reference. <http://www.greenpharmacy.com/>.
- http://plants.usda.gov/plantguide/pdf/cs_pobat.pdf. USDA-NRCS Plant Guide. Black Cottonwood *Populus balsamifera* L. ssp. *trichocarpa*.



Plants as Medicine: Make Your Own Herbal Salve

Name(s)

Plant name (common and scientific)

Ethnobotany Information Source Used (column A & B)

A	B	C	D
Historical Use	Plant Part Used	Phytochemicals in Plant Part	Phytochemical Biological Activity
		1. 2. 3.	1. 2. 3.
Historical Use	Plant Part Used	Phytochemicals in Plant Part	Phytochemical Biological Activity
		1. 2. 3.	1. 2. 3.
Historical Use	Plant Part Used	Phytochemicals in Plant Part	Phytochemical Biological Activity
		1. 2. 3.	1. 2. 3.
Historical Use	Plant Part Used	Phytochemicals in Plant Part	Phytochemical Biological Activity
		1. 2. 3.	1. 2. 3.

Use the following web link for column C & D: <https://phytochem.nal.usda.gov/phytochem/search>

Pick one of the ethnobotanical uses from your chart, use phytochemistry research to support or deny the plant's medicinal use.



Phenology: Tracking the Seasons in Your World

Time Estimate:

Regular short observation periods; or can be a single one-time observation

Best Season:

fall equinox, spring equinox or when plants are especially active (leafing, flowering, fruiting) in your area



If you want an adventure, take the same walk that you took yesterday, and do so again tomorrow.

—John Burroughs (1837-1921)

Overview

Introduce the science of phenology, which is the study of biological changes as the seasons unfold. Students will use observation skills to track seasonal changes, collect data, and learn real world applications. They will relate nature observations to climate and examine how global change is affecting species, habitats, and ecosystems. Students will learn about the connections between phenology observations and the study of climate change and have the opportunity to participate in a citizen science program to contribute to a national database of climate change information.

Preparation

- ◆ Introduce the activity by leading a discussion to enable students to explore and review what they know about the seasons: what causes them, how plants (and other organisms) react to seasonal changes, what triggers those changes in living organisms to happen (daylight hours, temperatures, calendar dates, weather), and what do those seasonal changes tell us. Use this discussion for the students to throw out ideas or make statements of what they already know or believe. Facilitate the students' exploration of the answers to these questions and more throughout the activity.
- ◆ Go through the Observing Plants tutorial on the Project BudBurst website (budburst.org) to become familiar with the project and how it works.
- ◆ Read the Registration Guide for Middle/High School Teachers found under the Educator tab on the Project BudBurst website and create Teacher and Student reporting accounts. If you want your students to make Regular Reports of plants, follow the instructions in the Registration Guide for adding sites and plants to your students' accounts.
- ◆ Download and print Regular Report or Single Report forms for your students from the Project BudBurst website or have the students do this as part of the activity once they have decided on a plant to monitor.

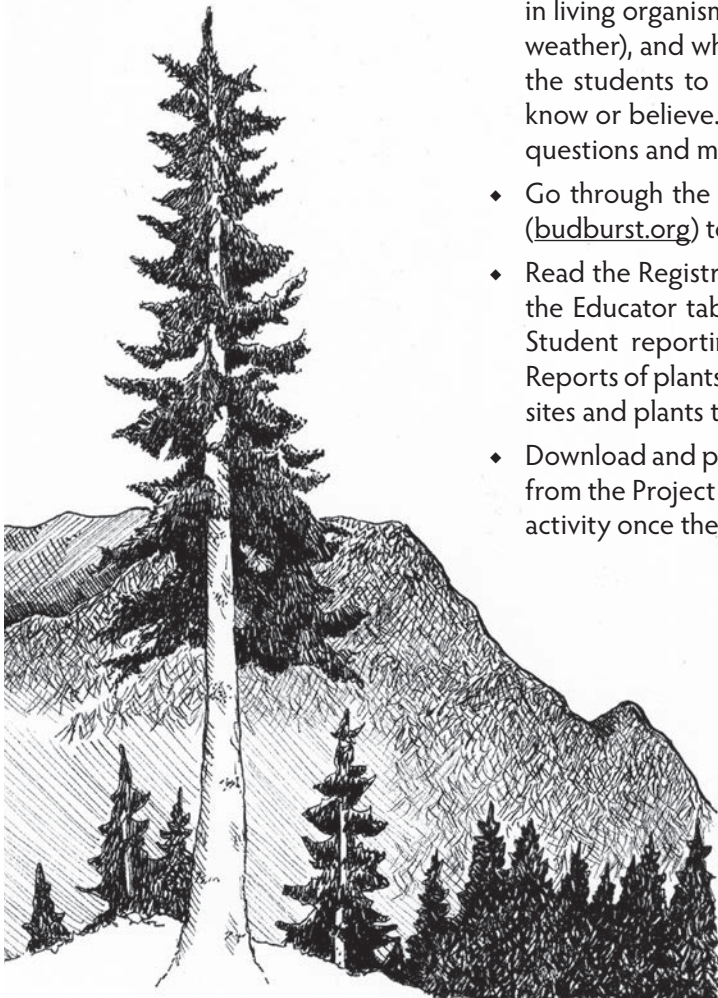



Phenology: Tracking the Seasons in Your World

This lesson was produced in partnership with Project BudburstSM, a national field campaign designed to engage the public in the collection of ecological data based on the timing of plant phenology.

Project BudBurst™

Teacher Hints

- ◆ This activity is most meaningful as a long term project, tracking the events of the seasons for an entire year or multiple years in their field journal. We suggest having students make Regular Reports both for their own understanding of natural cycles and to provide the most beneficial data for climate change scientists.
- ◆ Streamline the plant selection process by creating a list of Project BudBurst plants that occur near your school grounds, then let students choose from your list.

Assessments

- 1** Describe how plants and animals respond to seasonal changes based on first hand observations.
- 2** Show basic understanding of natural cycles and how they are affected by temperature and day length.
- 3** Explain how phenology studies can be used for climate change research.



Additional Information

- ◆ Project BudBurst <http://budburst.org/> - a National Ecological Observatory Network citizen science project that engages individuals in making observations of the timing of leafing, flowering, and fruiting of plants. Observations from participants contribute to a better understanding of how plants respond to climate change at local, regional, and continental scales. Resources: Educator Implementation Guides for Grades 5-8 and K-12 <http://budburst.org/educators>
- ◆ National Phenology Network USA <http://www.usanpn.org/>. Citizen science projects and additional resources: Haggerty, Brian P. and Susan J. Mazer. *The Phenology Handbook: A Guide to Phenological Monitoring by Students, Teachers, Families and Nature Enthusiasts*. 2008 University of California, Santa Barbara for the UCSB Phenology Stewardship Program. https://ndep.nv.gov/tribe/docs/env_mgr_ref_docs/Climate%20Change/Phenology_Handbook_2nd_ed_Abridged.pdf



Phenology: Tracking the Seasons in Your World

Materials Needed

- ◆ Phenology journal (including Project BudBurst Report Forms)
- ◆ Drawing materials such as markers, colored pencils, and pens
- ◆ Plant field guides for your area
- ◆ Optional: camera, binoculars, hand lens
- ◆ Optional: Project BudBurst Identification Guide for your plant

Learning Objectives

- ◆ Be able to make observations and record data on the timing of leafing, flowering and fruiting of plants being studied
- ◆ Understand nature's seasonal cycles and what influences those changes
- ◆ Explain how knowledge of phenology has been used by humans in the past
- ◆ Understand how phenology observations can be used in scientific research
- ◆ Participate in a plant phenology based citizen science program

Vocabulary Words

phenology
phenophase
equinox
solstice
day length

If you want an adventure, take the same walk that you took yesterday, and do so again tomorrow.
—John Burroughs (1837-1921)

Overview

Everyone takes notice of the seasons around them to some degree, even if only to soak in the first warm sunny days of spring. Now you can discover more about nature and the place you live by exploring phenology, the science that measures the timing of life cycle events throughout the seasons for all organisms. Use your observation skills and your senses to track the seasonal changes of species and habitats and create a phenology journal. Participate in a citizen science program to contribute to a national database of phenology information for researchers studying climate change.

Background Information

Phenology is the study of natural events that reoccur periodically in relation to climate and seasonal change. Examples include bird migration and changing of leaf color in autumn. The word phenology comes from the Greek words "phaino" (to show or appear) and "logos" (to study). Life on Earth has long been intimately tied to observations of (or instinctual or innate reactions to) phenological cycles. Before weather stations and written calendars, humans needed to keep track of natural cycles to predict when to hunt, gather edible fruits and nuts, and plant their crops. Many native peoples linked natural events with cycles of the moon, the re-appearance of a migrating bird species, or the timing of many other natural events. Today, people observe and record natural events to stay in tune with the seasons, keep time with the natural order, and to gain a better understanding of the life histories of different species. Other animals are cued in to phenological cycles as well.

The annual discovery of the first bloom of a plant was an event treasured and recorded by conservationist and naturalist Aldo Leopold. In *A Sand County Almanac*, he wrote, "Every week from April to September there are on average ten wild plants coming into first bloom. In June, as many as a dozen plants may burst their buds on a single day." Leopold kept daily journals of observations whenever he happened to be in the natural world. These journals held the keys to understanding patterns among plants, animals, weather, water, soil, and land. By regularly recording natural events, particularly those events occurring on family walks, Leopold and his children would compare changes from year to year, as they learned about the natural world.





Phenology: Tracking the Seasons in Your World

Background Information, continued

Author and naturalist Henry David Thoreau was one of the first to record extensive phenology data in the United States. He kept detailed journals that recorded bloom time data for over 500 wildflowers that grew in the area he lived near Concord, Massachusetts between 1852 and 1858. His work was continued by botanist Alfred Hosmer in 1878 and 1888-1902. Recently, scientists have collected data on the same wildflowers in the same location to make comparisons that might be related to climate change. Their comparative studies show that plants are blooming an average of one week earlier than in Thoreau's time.

The timing of life history events, or **phenophases**, is crucial to the interactions between different organisms. The ebb and flow of resources that results from seasonal changes affects the entire food web. For example, as spring arrives in a deciduous forest, an event called "bud burst" marks the beginning of the growing season. The emergence of these first new leaves represents the end of a famine season for herbivores like caterpillars. The little grazers have evolved to hatch to correspond to bud burst and the availability of high-quality food. In turn, many insectivorous birds carefully time their reproduction so their young fledge just in time to take advantage of the influx of nutrient-rich young caterpillars. Can you think of ways that organisms higher up in the food chain may in turn time their life events to correspond with those of the songbirds?

In this way, seemingly small or insignificant seasonal changes or events can ripple through a food web and have profound effects. Spend some time thinking about the changes that occur during spring where you live. Perhaps the water level in rivers rise as a result of snowmelt or rain, or May brings a flush of new green grass. How might some of these events affect different levels of the food chain?

The study of phenology is particularly pertinent in the context of climate change. Changes in weather with the seasons, such as temperature and precipitation, signal many organisms to enter new phases of their lives. For example, warmer, earlier springs have led to earlier bud burst for many tree species. Other organisms must therefore change the timing of their reproductive events

to maintain the link with their food source. The trouble is that organisms rely on a variety of cues to tell them when it is time to act and not all organisms rely on the same cues. Birds, for example, use day length as a cue for some of their phenophases, a cue that doesn't change as the climate warms. Some plants, however, use a combination of temperature, precipitation, and day length for their cues. Temperature and precipitation are influenced by climate change. The environmental cues used by migratory birds wintering in South America, for example, do not provide information on the conditions occurring in their northern breeding grounds. For these and other reasons, organisms at different levels of the food chain are exhibiting something called "phenological mismatch," where shifts in the life cycles for predator and prey don't correspond with one another. The full impacts of this trend are not fully understood, and are the subject of much research.

What do the seasons look like where you live? Select a place around your home, schoolyard, or a favorite place you like to visit. Walk the same route in spring, summer, fall, and winter and tune your senses into what is occurring around you. You do not need to travel a great distance to study phenology, it is happening all around you. This activity focuses on the phenology of plants, but others are tracking phenology as it applies to wildlife, insects, fungi and nearly every type of life on Earth.





Phenology: Tracking the Seasons in Your World

Student Directions

In this activity you will take part in a citizen science project. Project BudBurst is a nationwide program that engages the public in gathering important phenological data about plants. This data is used by scientists to understand the impacts of climate change on plants locally, regionally, and nationally. Thousands of participants submitting individual observations around the country in a consistent manner provide a uniquely valuable set of data for climate scientists. In this activity, you will learn about two different ways to observe plants with Project BudBurst, through Regular Reports and Single Reports. You will then contribute to the Project BudBurst data set by making either a Single Report or repeated Regular Reports on a plant you observe. During the growing season, plants often move through their phases quickly, sometimes going from one phase to another in just a day, so you will need to watch your plant carefully and be on the look out for changes!

Option 1: Regular Reports

Observing a plant regularly throughout the growing season and over many growing seasons provides detailed information about its phenology. With Regular Reports, you will observe your plant regularly and record the date at which it reaches certain events in its life cycle (i.e. bud burst, first flower, full fruit, and more). This is also called event-based monitoring. You will record the date of occurrence for as many of your plant's phenophases as possible. Your data collection will be part of a phenology journal. A phenology journal is a place to record the changes that you observe in the natural world.

1. Ask your teacher to provide you with login and password information for your Project BudBurst account. Your teacher should have added a plant for you to monitor to your account.
2. Your teacher will provide you with a Regular Report form for your plant. Include the Regular Report form with your field journal. Be sure to record all of the information requested on the form, paying close attention to detail. You will keep this Regular Report form in your journal as you continue to make observations about your plant over the coming weeks. The specific data you collect depends on whether you are monitoring a deciduous tree or shrub, a wildflower, an evergreen tree or shrub, or a grass, so be sure you have the correct report form for your chosen plant.
3. For your first journal entry, write a thorough description of your plant's location and habitat. Next, draw a map of your location and describe what plants you find there. Describe the plant you are going to observe in detail. What do the leaves look like (size, amount, color)? Does your plant have buds, flowers, or seeds? How does your plant interact with its environment? Do you observe any activity around your plant (insect, bird, squirrel, or other)? Look closely!
4. Visit your plant regularly—a few times a week during its active growing season. You will be watching for certain events that are listed on your Project BudBurst Regular Report form—bud burst, emergence of the first leaf, first fruit, and others. When one of these events occurs, be sure to note the date in your field journal, as well as the weather, and other observations about your plant and its habitat. Note changes that occur around your plant as time passes.
5. After you observe an event, such as first leaf, submit your observation data to the Project Budburst website. Once you are logged in to your account, be sure to select "Submit a Regular Report" from the list of options. Be sure to remember this step! This will provide important information for climate scientists to use.
6. Make additional observations about your plant. How does the overall appearance of your plant change with time? Does it get taller or bushier? Do the leaves change color or appearance? What color are the flowers? Who pollinates the flowers? Look for when ripe fruits appear on the plants. What happens to the fruits? What happens to the seeds? Do they fall on the ground, are they eaten by birds, or do they catch on your socks? What other changes do you notice about your plant as the days pass?



Phenology: Tracking the Seasons in Your World

Student Directions, continued

- Note what is happening around your plant. Is the ground wet or dry? What is the weather like? What other plants are near your plant? What animal signs are at your location? Spend at least 10 minutes closely observing your plant (time yourself!), and then spend an additional 5-10 minutes recording your observations in your journal. Add to your journal entries with sketches and photographs.
- Track the growth of a new leaf. Flag a new leaf with a piece of yarn and take regular measurements (use metric scale) of length and width. Each time you make an entry in your journal, update the measurements of your leaf. How long did it take for the leaf to reach its maximum size? Compare these numbers with your classmates studying a different species. Is your plant a fast grower or does it grow more slowly?
- Always note the date and time of each journal entry and add weather information including wind direction, cloud cover, and temperature. Visit the websites in the resource section to add day length and climate data for your observation days.
- Things to think about: If you kept a phenology journal from year to year, how accurate do you think your predictions could become? What do you think it would show? In what ways could the information be useful to others?

Option 2: Single Report

- Ask your teacher to provide you with your login information for your Project BudBurst account.
- With a group of three or four other students, decide which plant you will monitor. Explore the plants in the Project BudBurst database from the "Plants to Observe" page. You can choose one of Project BudBurst's 10 most wanted plants, or check to see if your favorite local plant is included in their database.
- Once you have chosen a plant, it's time to go observe it! Your teacher will provide you with a Single Report form for your plant. You will be collecting specific data depending on whether you have chosen to monitor a deciduous tree or shrub, a wildflower, an evergreen tree, etc.
- Out in the field, observe your plant. Fill out your Single Report form thoroughly and carefully, paying close attention to your plant. If you do not know your latitude and longitude, you can find it using Project BudBurst's map feature when you enter your data on the website later.
- In the comments section of your Single Report form, make notes about the habitat, the weather, and other observations about your site.
- Now submit your data online at the Project Budburst website so scientists can use your data in their research. Once you are logged in to your account, be sure to select "Submit a Single Report" from the list of options. You are now part of a nationwide effort to better understand the effects of climate change on plants in your area!

Resources

- ♦ <http://budburst.org/> Project Budburst - an organization collecting citizen science data about plants and climate change
- ♦ https://ndep.nv.gov/tribe/docs/env_mgr_ref_docs/Climate%20Change/Phenology_Handbook_2nd_ed_Abridged.pdf - *The Phenology Handbook A Guide to Phenological Monitoring by Students, Teachers, Families and Nature Enthusiasts*. Brian P Haggerty and Susan J. Mazer. 2008: University of California, Santa Barbara for the UCSB Phenology Stewardship Program
- ♦ http://aa.usno.navy.mil/data/docs/RS_OneDay.php Sunset and Sunrise times for your town
- ♦ <http://www.ncdc.noaa.gov/oa/ncdc.html> National Climate Data Center
- ♦ Leopold, Aldo. *A Sand County Almanac*. 1949. Oxford University Press, New York.



Phenology: Tracking the Seasons in Your World

In the Field!

Team up with an elementary school to mentor younger students and teach them about phenology. Together, choose a special, prominent tree in their school yard to monitor and report your findings to Project BudBurst. Read about the BudBurst Buddies program (budburstbuddies.org) for elementary students and use resources from the website with the students. Have the students share their observations about the tree and record them in one place. Take a photo of the class gathered around the tree. Return regularly with the class to make new observations and take a photo. At the end of the school year you can look back at how the tree and the students have changed. Take a copy of Aldo Leopold's *A Sand County Almanac*, and pick out some fun passages to read aloud to the students outside beneath the tree or read to the students from the BudBurst Buddies story.



Science Inquiry

What do you think causes the seasonal changes that you observe in plants? Could it be the hours or angle of the sunlight, temperature, amount of rainfall, or something entirely different? Narrow your predictions to one hypothesis to test. Do an initial search to find information that might support your hypothesis. Design an experiment that would test your hypothesis. Your experiment could be in the classroom, in a greenhouse, or out in the field.

Think about how you would control for other factors that may influence your results. Write a proposal describing your hypothesis, the testing protocol, and how your experiment will control for outside factors. If you have the time and resources, carry out your experiment.



-
- **Reflection** •
- What seasonal changes do you go through? Think about how you react to
- temperature, light and dark. What signs in your body and outside tell you that
- fall is approaching? How do your senses help you detect these changes? What
- new sounds, smells, and colors occur? What signs tell you that winter, spring and
- summer are approaching? What is your favorite season and why?
-

Taking it Further

Make a permanent phenology log for the classroom by setting up a notebook with index dividers for each month and a sheet of notebook paper for each day of the month. Record the date but not the year itself (i.e. January 1, not January 1, 2014) at the top of each page, add the year to the left margin, and then make notes about what occurs each day. Everyone in the class can share their observations in the same book. The log can be added to each year; just add the current year in the left margin and place the new observations underneath. Add pages when needed. Look for the same events to occur (for example, first flower on a certain species in your native garden) year after year. Note whether those same events occurred on the same calendar day, earlier, or later in the year and think about why those changes may have occurred. This document will become more valuable with added years and may indicate possible relationships between climate change and biological cycles in your schoolyard and town.



Plant Migration: A Race Between Plants and Climate Change

Time Estimate:

45 minutes

Best Season:

winter

Climate is what we expect, weather is what we get.

—Mark Twain (1835 – 1910)

Overview

Students are bombarded daily with news of climate change and the impacts of their “global footprint” on the environment, but little information is out there about how climate change is projected to affect plants, especially native plants. In this lesson, students will play a game to explore some of the potential impacts and challenges of climate change on plant life in North America.

Teacher Hints

- ♦ Students should have a general background in climate change science to fully appreciate this lesson and explore the potential impacts on plants. See “Additional Information” for resources.

Assessments

- 1 Discuss the impacts that affected the species’ success or decline during the game.
- 2 Name three potential negative impacts of a changing climate on plants.
- 3 Identify one or more positive impacts of a warmer climate on plants.
- 4 Describe why certain types of plants may be more adaptable than others to changing climatic conditions.

Preparation

- ♦ The game will be played in groups of 4-5 students. Photocopy and enlarge enough game boards and gather additional materials for the entire class in advance. Bowls of dry beans or other small objects can act as the seed bank or currency. Two handfuls of seeds per group should be sufficient.
- ♦ Photocopy and cut out Plant Cards. Plant Cards are drawn at the end of the game to assess the final fate of your plant.
- ♦ Gather or make pieces to move around the board (one for each player). Pieces can be objects (paper clips, rocks) or as simple as colored paper squares.
- ♦ Consider having students color and laminate the boards for long term use.



Additional Information

- ♦ Climate Literacy: The Essential Principles of Climate Sciences: <http://www.globalchange.gov/browse/educators>
- ♦ NOAA Office of Education - climate change information and curricula for educators: <http://www.education.noaa.gov/tclimate.html>



Plant Migration: A Race Between Plants and Climate Change

Materials Needed

- ◆ Game of a Plant's Life board
- ◆ one die
- ◆ dry beans or other "currency"
- ◆ container for "currency"
- ◆ player pieces
- ◆ plant cards

Learning Objectives

- ◆ Explore potential impacts of climate change on plants
- ◆ Gain insight into predicted climate shifts
- ◆ Speculate how different species will adapt to climate change based on their life history strategies
- ◆ Learn how climate change can affect plant conservation and invasive species issues

Vocabulary Words

climate
weather
greenhouse gas
microclimate
seed dispersal
assisted migration
carbon sink

Climate is what we expect, weather is what we get.

—Mark Twain (1835 – 1910)

Overview

Almost daily we hear about climate change and its likely impacts on humans, but how will climate change affect plants, especially native plants? Changes in our native flora as a result of climate change will have lasting impacts on wildlife, water nutrient cycling, and on humans. In this lesson you will play a board game to explore some of the potential impacts and challenges of climate change on plant life in North America.

Background Information

Shifts in climate have altered the Earth's ecosystems throughout geologic time. Now, evidence is rampant that the Earth's climate is changing at an accelerated rate due to the human-caused accumulation of greenhouse gases in our atmosphere. Scientists can sample air bubbles in ancient polar ice to investigate the characteristics of the atmosphere from thousands of years ago, which reveal that while there have been periodic climate shifts throughout the history of the Earth, in recent years there has been a distinct warming trend that is strongly correlated with human activities. When our society industrialized, we began to combust large amounts of fossil fuels and wood for energy, releasing carbon dioxide (CO₂) into the Earth's atmosphere. CO₂ is considered a greenhouse gas because it traps solar radiation in the lower atmosphere, effectively heating the Earth. While this greenhouse effect is critical to maintain warmth to support life on Earth, the massive amounts of greenhouse gasses generated by humans enhance the effect.

Scientists have developed very complex models to predict how the Earth's systems may react to further increases in CO₂ concentrations. Modeling is useful on a global scale and to some extent on a regional scale, but local microclimates are so varied that it is impossible to predict accurately the effects of climate change on a precise local level. The effects of climate change will not be consistent across the globe. The effects of climbing temperatures will be complicated by many interacting processes. Models indicate that the United States as a whole will face increased average annual temperatures, but the resulting changes in factors such as the extent of temperature change, precipitation, the timing of precipitation, climate variability, and extreme weather events will vary widely from place to place. Due to the great variability across the landscape, conditions

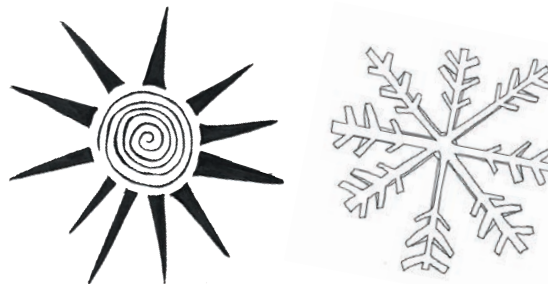



Plant Migration:

A Race Between Plants and Climate Change

Background Information, continued

may improve for certain plants in some areas and decline in others.

Climate change will have a pronounced effect on native plants. While animals and humans have the option of relocating in response to climatic shifts, individual plants cannot move to find more suitable conditions. When we think about the effect of climate change on plants, we must realize that factors such as rising temperatures are acting on individual plants, and the collective responses of those individuals result in changes in the entire population.

We can begin by looking at how individual plants may react to the stresses inflicted by a changing climate. Shifts in temperature and precipitation patterns will be the main drivers of potential impacts on vegetation. Plants exist in a continual state of competition with neighboring plants. Subtle changes in environmental conditions or the availability of resources affect their ability to compete effectively and therefore to survive and reproduce successfully. Just as they do for animals like yourself, adverse conditions cause physiological stress to plants. As plants respond to stress, they may shift their energy allocation to focus on growth or reproduction. While under stress, plant metabolic processes are overtaxed, which reduces their ability to resist diseases or insect infestations. The stresses each individual faces will affect its ability to survive and reproduce.

Increased temperatures can cause phenological changes, such as spring bud burst, to happen earlier in the year than usual. Why does this

matter? Such alterations in timing may cause disruptions in a plant's intricate relationships with co-evolved insect pollinators. If the pollinators emerge at the normal time, they may miss the earlier flowering of their target species. In another example, many species of insect pests are currently controlled by cold winter temperatures that kill most of their larvae. As winters become warmer, more of the pest larvae survive to adulthood, and some pest species



may even complete two life cycles in one season, causing twice the damage.

The effects of climate change on the fitness of individual plants will vary over their range, and this affects the state of the population as a whole. Though the effects on individual plants may seem small, the collective responses of these individuals result in profound changes at the population level. Many species are expected to experience range shifts as certain areas become uninhabitable

for them and other new locations become suitable. For example, in the northeastern United States, the range of the sugar maple (*Acer saccharum*), a native plant highly valued for the production of maple syrup, is expected to retreat northward as the climate warms. As conditions change, the tree will lose its competitive edge and disappear from much of the southern portion of its current habitat. Who will this affect? Many people who rely on maple syrup production for their livelihood will, of course, see major impacts from this range shift. The forests where maples now exist will also be much changed in ways that are harder to predict, as maples play an important role in nitrogen and water cycling. The alteration of even one species' range can have a ripple effect.

What should be taken into account when predicting a species' success in the face of climate change? Species that are generalists and can thrive in a wide variety of conditions will be the most successful in a rapidly changing environment. Species that are rare, and especially those that specialize in a unique environment, are less likely to adapt well to climate change. These species already have very low population numbers, low diversity, often use less prolific seed dispersal strategies, and as a result will be less competitive. Seed dispersal is key for survival in an unstable climate. Species that disperse large quantities of seed over great distances have a higher potential of reaching sites with more favorable conditions. These will likely be more successful than long-lived perennial plants that only produce a few seeds. Because invasive plants



Plant Migration: A Race Between Plants and Climate Change

Background Information, continued

are often generalists and have strong seed dispersal ability that allows them to rapidly colonize new areas, they may be better suited than many native plants to shift or expand their range to cope with climate change.

Climate shifts will likely have an impact on lands already set aside for conservation. Current habitat preserves may see new species move in, while the original target conservation species may migrate to new regions. Land managers and preserve designers are beginning to consider these potential shifts in habitat and species compositions as they manage existing preserves and plan new ones. It is important to predict where species of concern may be able to find suitable habitat to identify and conserve

potential refuges in a changing climate. Restoration ecologists are also considering the impacts of climate change on their projects. As they try to restore degraded habitats to their natural state, ecologists should consider how future climate shifts may affect the habitat.

Assisted migration is a new and controversial topic of conversation among restoration ecologists--should restoration ecologists relocate species to new habitats that will be suitable in the face of climate change, assisting them in survival? These and other questions make native plant conservation in the face of a changing climate more challenging and will require conservation biologists to work creatively, hedge bets by conserving

more plants than would be necessary without climate change and make our efforts to reduce greenhouse gases and slow climate change that much more important.

Forest conservation plays an important role in climate change discussions. Trees assimilate atmospheric CO₂ during photosynthesis, and as trees grow, they act as carbon sinks. Planting trees and protecting existing stands may help sequester excess carbon that has already entered the atmosphere. While climate change presents many challenges for plant life, there are still steps we can take to slow the rate of greenhouse gas emissions and mitigate the effects of climate change on native species.





Plant Migration: A Race Between Plants and Climate Change

Student Directions

Read over the background information to get a working understanding of climate change and its potential impacts on plant life.

1. Set up your **Game of a Plant's Life** board. Shuffle the Plant Cards, place them face down in the center, and select your game piece.
 2. Rules for the game:
 - ◆ Each player starts with 3 seeds from the Seed Bank
 - ◆ Roll a single die on your turn to move forward
 - ◆ At the start of the game, you may select one of the two paths for germination
 - ◆ Once the two paths merge, you have germinated and become a representative of the entire population of your species
 - ◆ You must stop at the STOP spaces, even if you still have more spaces to move, and wait for your next turn to proceed
 - ◆ When you reach a STOP space, you get one seed for successfully navigating another year – pay close attention to how the conditions change at STOP spaces
- ◆ As you move around the board, you will pick up or return seeds to the bowl as your space instructs
 - ◆ The object of the game is to accumulate as many seeds as possible
 - ◆ If you run out of seeds during the game, your species has gone extinct and you are out
 - ◆ Once you reach the end of the board, draw a Plant Card
 - ◆ Your Plant Card explains how many seeds you need to survive – if you do not have enough seeds, your plant doesn't survive
 - ◆ To win, a player must have enough seeds to fulfill their Plant Card requirement AND have the most seeds overall

CLASS DISCUSSION

It is hard to predict how individual plant species will be affected by climate change. Plant life cycle strategies can help you start to speculate.

- ◆ Do you think all plants will be affected by changing climate equally? Why or why not?
- ◆ Do you think humans should move plants to expand their range, or into new types of habitats, in an attempt to help plants cope with climate shifts? If so, how far would you be comfortable with moving them? Or is there a measure other than distance you would use to determine where to move plants?
- ◆ What about moving endangered plants? How might moving plants affect ecosystems? Do you have any new ideas on how restoration ecologists might help native plants survive climate change?



Plant Migration: A Race Between Plants and Climate Change



In the Field!

Look for a native plant population that appears to be limited to growing within specific micro-abiotic factors on the landscape (read about micro-abiotic factors in the background information in An Ecosystem Through an Artist's Eye lesson). How might this plant population be enhanced or inhibited by climate change? Is it possible that this plant could expand/contract its population at this site because of changing climate? Support your ideas.

Science Inquiry

Climate change data is being recorded daily by citizen scientists throughout the world in one of several phenology observation programs (see "Phenology: Tracking the Seasons in Your World" lesson). The records kept by Henry David Thoreau at Walden Pond in the mid-1800s have proven invaluable for climate change scientists who have used them to discover that not all species in a given area respond the same way to climate change. Research the results that have been found from Thoreau's observations and use them to inspire you to collect your own data that may become very relevant to scientists and decision makers someday. Consider adopting your favorite native plant or natural area and observing and recording its phenology data over a long time. Keep your data in a special field journal devoted to this plant. Try to observe the start and end date of bud burst, bloom, seed set, and leaf fall or dormancy. It will be extremely important to record the location where you collected your data, and to continue to collect data every year for as long as possible. Though your sample size will be very small (only one plant!), in future years your data could help track how the range of that species changes, as well as climate-related phenology changes. If you are able to collect data over a years or decades, watch for trends in your data and share them with others. Submit your data to Project BudBurst to help add to our knowledge about climate change.



Reflection

- Choose a native species from your area. It can be your favorite, or just one you
- would like to learn more about. Write a paragraph that describes how you think
- it might respond to climate change. Through observation or research,
- find out how your plant is pollinated, how it disperses seeds, and
- what conditions it lives in. All of these factors can be used to support
- your idea. Write how you feel about climate change and the fact
- that nature as we know it is changing during your lifetime because of
- human impacts. How does this make you feel? Does it motivate you to
- live in a certain way?





*Student
Project*

Plant Migration:

A Race Between Plants and Climate Change

Taking it Further

Research and report back to the class about the plant group on your Plant Card. New scientific research is giving us updated information all the time. What news can you find out about how climate change is affecting this specific plant species or general plant type (e.g., wetland plants)?

Self Assessments

- 1** Discuss the impacts that affected the success of your species during the game.
- 2** Name three potential impacts of a warmer climate on plants.
- 3** Identify one or more positive impacts of a warmer climate on plants.
- 4** Describe why certain types of plants may adapt more rapidly than others to changing conditions.

Resources

- ◆ U. S. Global Change Research Program, Climate Literacy: The Essential Principles of Climate Sciences. <http://www.globalchange.gov/browse/educators>
- ◆ U.S. Global Change Research Program, general and regional climate information: <http://globalchange.gov>

Pitcherplant
Darlingtonia californica



Status: rare
Habitat: bog
Seeds needed to survive and reproduce - 13

Bull thistle
Cirsium vulgare

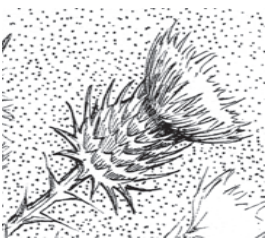

Status: invasive
Habitat: open areas
Seeds needed to survive and reproduce - 1

Longleaf pine
Pinus palustris

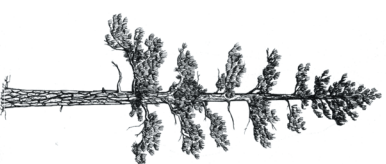

Status: uncommon
Habitat: dry forest
Seeds needed to survive and reproduce - 11

Big Bluestem
Andropogon gerardii



Status: uncommon
Habitat: prairie
Seeds needed to survive and reproduce - 8

Partridgefoot
Luetkea pectinata

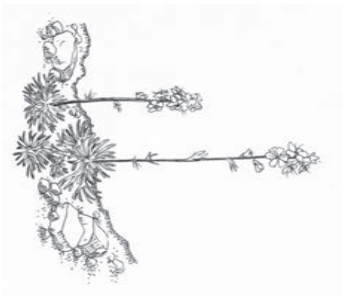

Status: common
Habitat: alpine meadow
Seeds needed to survive and reproduce - 7

Red oak
Quercus rubra



Status: common
Habitat: dry upland
Seeds needed to survive and reproduce - 10

Alpine blueberry
Vaccinium boreale

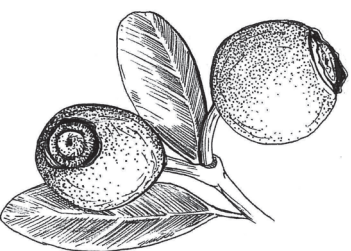

Status: rare
Habitat: alpine
Seeds needed to survive and reproduce - 12

Trillium
Trillium ovatum



Status: common
Habitat: moist woods
Seeds needed to survive and reproduce - 5

Game of a Plant's Life:

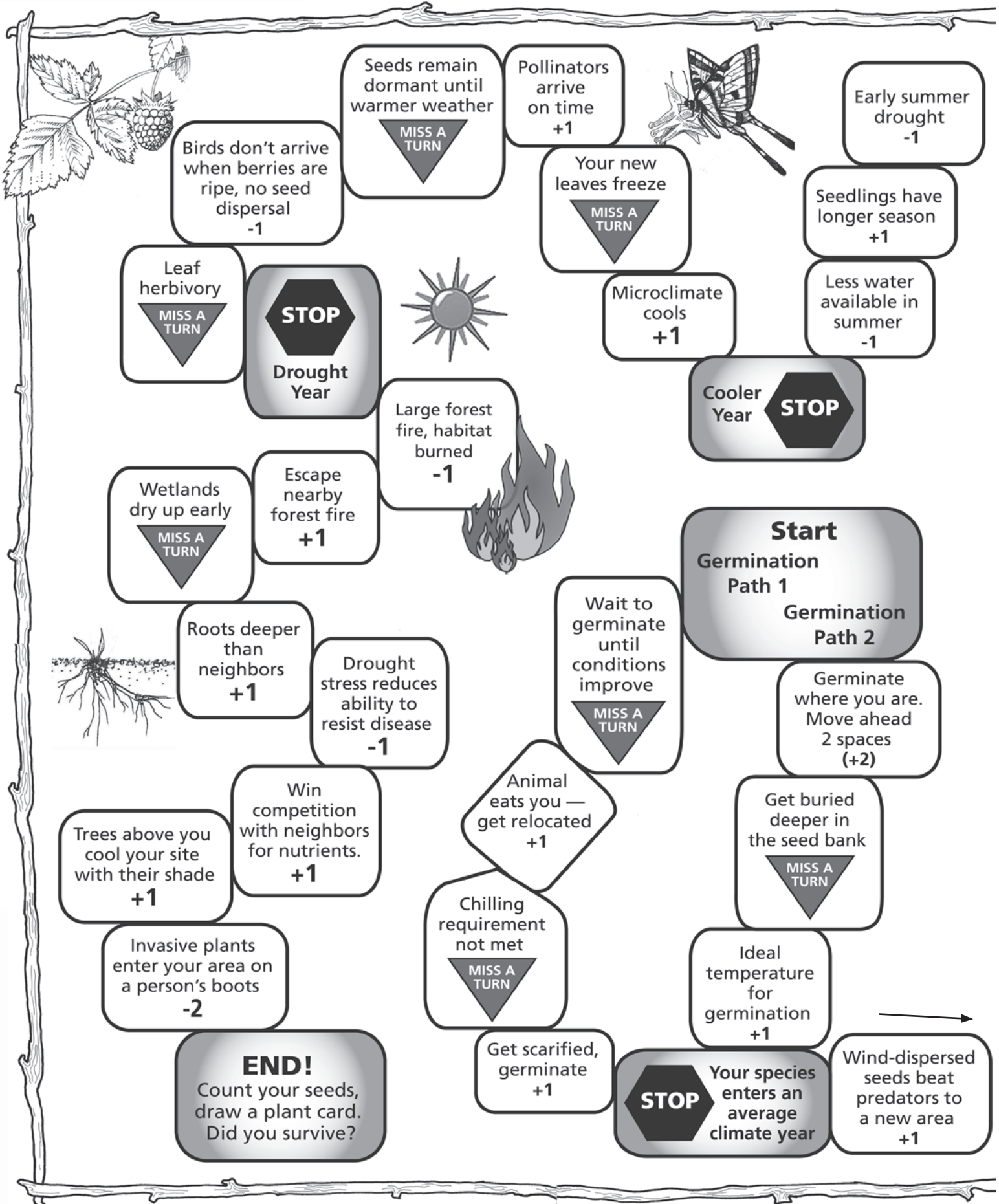

A Survival Quest Game

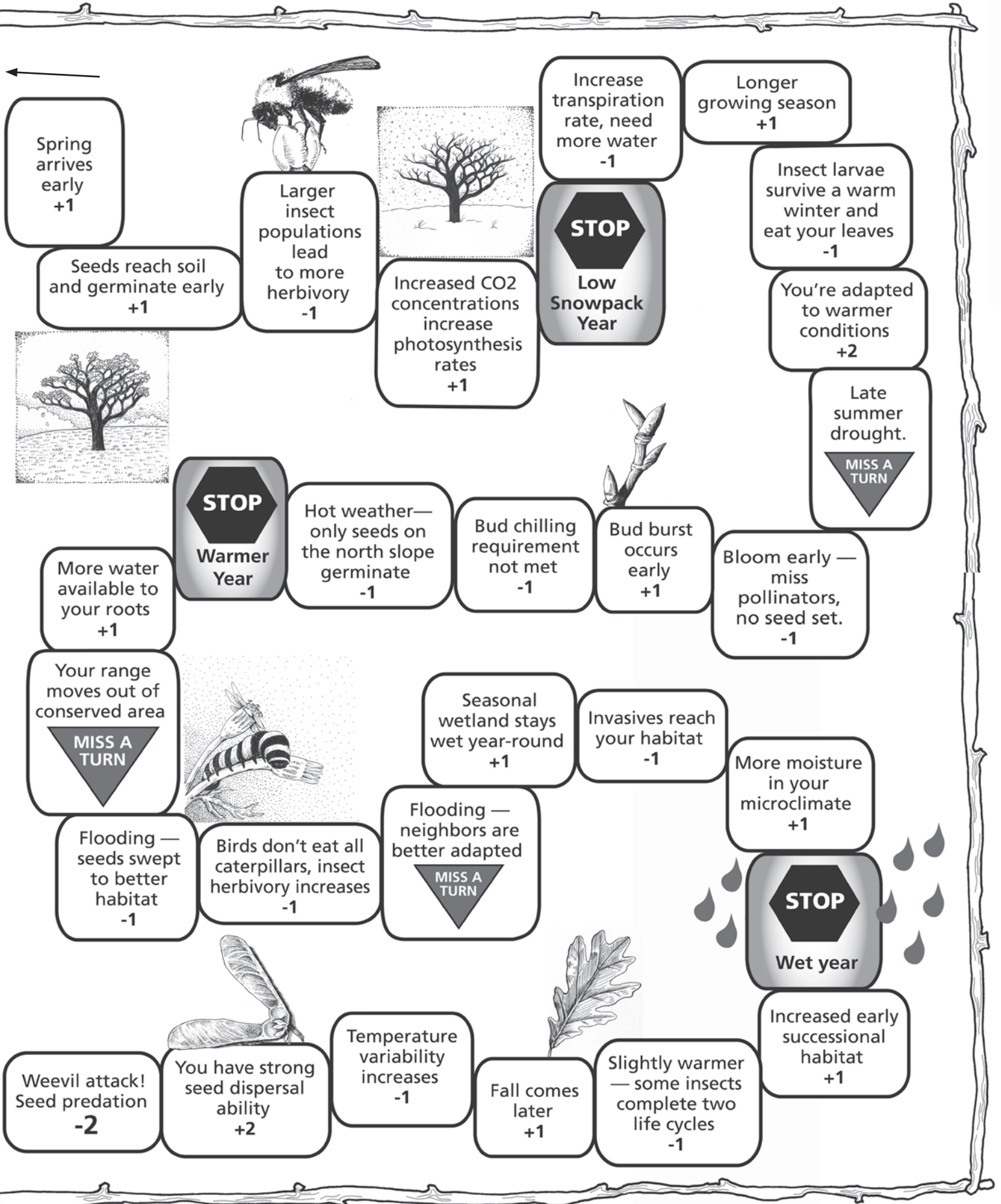



Time Estimate:

1 hour, plus time outside of class for research

Best Season:

Any

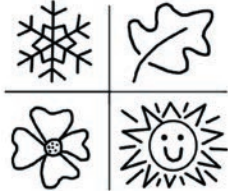

Assessments

- 1 Students participate in the discussion in a positive way.
- 2 Students state their opinion on a controversial environmental subject and give one or more reasons based in fact to back up their opinion.
- 3 Students demonstrate empathy by listening to differing viewpoints and voice respectful disagreement.

Teacher Hints

- ◆ Try not to frame this as a debate, which focuses students on winning, but rather a discussion, so that the emphasis will be on listening. To make role-playing productive: keep discussion focused and make objectives clear to the students. Students need productive feedback from the teacher and/or peers, and the freedom to explore alternate roles. Students need to listen to other viewpoints,

Nobody's Right, Nobody's Wrong: A Role-Playing Game

Begin challenging your own assumptions. Your assumptions are your windows on the world. Scrub them off every once in awhile, or the light won't come in.

—Alan Alda, *Scientific American Frontiers* (1936–present)

Overview

In this lesson, students will play a role-playing game based on issues in local ecosystem management and conservation. We have included three fully developed example scenarios to explore different issues that pertain to various ecoregions, as well as three additional ideas for scenarios that may be more applicable to your area. We suggest that locally applicable scenarios be used if possible. Students will develop roles, form an opinion that reflects their position, and defend their position during the game. This lesson exposes students to understanding and cultivating empathy for differing viewpoints on controversial issues, and helps prepare students for future stewardship decisions.

Preparation

Make it Place-based: You don't have to limit your choice of discussion to the three scenarios included in this lesson. There are endless possibilities for discussion of controversial ecosystem issues. It is likely that you and your students are aware of local issues that can be addressed. Try looking to the local newspaper for ideas, or look at some additional ideas listed below. Pick an issue that is applicable and timely in your local area.

Once you have selected an issue for your students to address, use the three scenarios that are included in this lesson as templates for guidance in designing your own discussion.

- ◆ Decide on a scenario for your class to play out. Create a sheet that explains the background story and the various roles that students will play. You will need to provide enough detail for a constructive and informed conversation.
- ◆ Determine a specific decision that needs to be made. This gives the conversation a clear goal.
- ◆ Identify specific roles for each student or group of students. Give them time to think about and research the viewpoints and concerns of the demographic that they are representing.
- ◆ Provide background information or time for research so that students can back up their ideas and arguments.





Nobody's Right, Nobody's Wrong: A Role-Playing Game

Teacher Hints, continued

weigh all sides of the issue, and form an opinion. The goal is that students will come to have empathy for stakeholders on all sides of each issue, regardless of their position.

- ◆ Establish clear guidelines of acceptable behavior in role-playing games. Controversial issues can and often do lead to strong feelings and arguments; it is important that no one feels intimidated. As part of the debriefing at the end of the game, consider adding discussion about handling such issues in real-life situations.
- ◆ These scenarios are intended to be applicable to the area where you live. The scenarios that we have included can be used for the following locations: Urban and developed areas: Land Use Planning and Endangered Species. Non-forest rangeland: Grazing in Riparian Areas. Forested regions: Forest Management. We include additional ideas for scenarios in your area. See the "Preparation" section for hints on designing more locally applicable scenarios.
- ◆ For larger groups, assign multiple copies of roles or create additional roles of your own. For smaller groups leave out some roles, but be sure to balance both sides of the issue. Students reluctant to participate in oral projects could pair up as teams.

Possible Discussion Scenarios

Land Use Planning and Endangered Species:

See description for Scenario 1.

Grazing in Riparian Areas: See description for Scenario 2.

Forest Management: See description for Scenario 3.

Agricultural Runoff: Agricultural runoff has led to massive algal blooms in water bodies around the world, threatening the native plants and wildlife that depend on these habitats. The food and jobs produced by the agricultural industry are essential to the economy of the United States. However, healthy lakes, estuaries, and oceans are economically important, and are of great intrinsic value to people and living systems. Should your state government place stricter regulations on agricultural runoff?

Hydraulic Fracturing: Hydraulic fracturing, often called fracking, is a process used to extract natural gas from deposits in shale rock. The process requires drilling and injecting fluid at extremely high pressures into the ground. The impacts of this process are many: millions of gallons of water are required, often in locations where water is scarce; large volumes of toxic chemicals are mixed with water in the fracturing fluid, which can contaminate both groundwater and surface water; and natural gas is a fossil fuel which contributes to the carbon dioxide load in our atmosphere. However, natural gas is a more efficient and cleaner fuel than petroleum and coal. Natural gas extraction is also an important economic industry, and is a source of energy that doesn't need to be imported from outside the United States. Should your city council grant permission to companies to utilize hydraulic fracturing around your town?

Dam Removal: Dams provide many benefits to society: they provide flood control; they can offer a source of clean, renewable energy in the form of hydroelectric power; and the reservoirs they create are often economically important recreation areas. They also have highly significant impacts on the streams and rivers that they blockade: dams prevent or inhibit the movement of fish and other animals throughout the waterway; they eliminate flood events, which are of critical importance to the structure of the waterway itself and the surrounding riparian areas; they change water temperatures and sediment loads, which can make rivers uninhabitable to some native species. Should the dam on a nearby river be removed?





Student Project

Materials Needed

- ◆ Scenario descriptions

Learning Objectives

- ◆ Examine values and beliefs in controversial environmental issues
- ◆ Explore diverse opinions in a safe environment through role-playing
- ◆ Gain insight into problem-solving skills, using defined steps to analyze the process
- ◆ Exercise the process of being an informed citizen and making personal stewardship decisions
- ◆ Learn ways to become involved in local policy issues

Vocabulary Words

stewardship



Nobody's Right, Nobody's Wrong: A Role-Playing Game

Begin challenging your own assumptions. Your assumptions are your windows on the world. Scrub them off every once in awhile, or the light won't come in.

—Alan Alda, *Scientific American Frontiers* (1936–present)

Overview

In this lesson you will explore a local issue surrounding ecosystem management and conservation topics through a non-judgmental role-playing game. Develop and play your role at a mock planning meeting and in the end weigh all sides and form your own opinion.

Background Information

If you read, listen to or watch the news you can't help but hear stories of conflict over environmental issues (e.g., the Endangered Species Act, water quality issues, or climate change) which are frequently out in front of the public. In your community, there may be conflict over the management of native ecosystems that have people with very strong opinions pitted against one another in what seems like a feud of monumental proportions. How do these issues become such conflicts? Conflict can arise when people feel that their livelihood or safety are threatened by the conservation of natural resources.

There are no right or wrong answers to the issues in this activity. The main purpose of this role-playing game is to provide an opportunity to explore viewpoints on controversial environmental issues in a non-judgmental atmosphere. Begin by considering what environmental stewardship means. It is generally defined as the concept of responsible caretaking, or management of the environment for future generations. Under this definition of stewardship, we are all responsible for natural resource management and each decision we make can influence all kinds of future impacts, including economic, social, cultural, and environmental. It is said that many native peoples took into consideration the impact of all decisions on the next seven generations. How do we form our opinions when making stewardship decisions? Often we fall back on our values—an individual's standard of right and wrong. Factors such as economics, education, politics, spiritual beliefs, and culture all go into forming our values. As you can imagine, this complex stew of values can make reaching an agreement on environmental issues difficult, and often requires diplomacy and compromise among all the parties involved. Practice listening to the viewpoints of others; understand that they bring different values to the table, and that most people generally want to do what they feel is the "right" thing.

How does role-playing help you to work through controversial subjects? This role-playing exercise will give you time to organize your thoughts, listen to different sides of the issue, and weigh all the information before forming your own opinion on a controversial environmental subject.



Nobody's Right, Nobody's Wrong: A Role-Playing Game

Student Directions

1. This activity has no right or wrong answers. It is designed to help you evaluate your own feelings, and form your own personal viewpoint while listening to and weighing the differing viewpoints of others. You will gain the most by participating fully, but relax and view the role-playing as a learning experience. Ask questions as needed to clarify your understanding, but respect the opinions of others. The purpose of this activity is to get everyone involved and thinking about the friction that can arise over environmental concerns among different segments of our society and how you will address these issues in your future.
2. Student roles:
 - ◆ 3-5 students will act as the planning board (decision makers), with one appointed or elected chairperson for the group
 - ◆ remaining students will be the audience participants
3. Read over the scenario and clarify any questions within your class before starting. You will be assigned a role to play. Take time to develop your character's background and values, using both your imagination and research about the topic that you are assigned. You can work individually or discuss this with others, but the viewpoints and concerns you will discuss should reflect your character and not your personal viewpoint. Play your role as accurately as possible; realize that it may not mirror your own viewpoint, but do your best to empathize (walk in your character's shoes).
4. Start the game: the setting is a planning board or task force meeting (the board will sit together as a panel). Audience participants sit facing the panel. The chairperson will call the meeting to order, read the scenario, and explain rules of the meeting. Audience members will give a brief (3-4 minutes) presentation representing their character's opinion on the issue and how they feel it should be resolved. Board members can ask questions and take notes to help them make a final decision at the end of the meeting.
5. At the conclusion of the meeting, call a brief recess. At this time, the board will meet privately to reach their decision. During the board recess, conduct two polls of audience members. First, vote as your character would vote in this scenario. Then vote as you would personally vote, (not your character), after weighing all the presentations you heard during the meeting.
6. Have the board announce their final decision and reasons. Tally the audience vote; does it agree or disagree with the board decision?

CLASS DISCUSSION

- ◆ Is there any part of this conflict that both sides of the issue can agree on?
- ◆ What values do both sides share?
- ◆ How might a person's values influence their viewpoint?
- ◆ How do you recognize bias?
- ◆ How would you weigh information to determine bias?
- ◆ Do you recognize how your values have influenced your decisions?
- ◆ What have you learned through participating in this meeting?
- ◆ Do you think it has improved your listening skills, why or why not?
- ◆ Values and prior knowledge will shape your first impressions; did any of the presentations cause you to change your first impression?
- ◆ How successful do you think a solution will be if it requires people to change or compromise their values?
- ◆ Look at the issue; what do you think would happen if no decision is made?
- ◆ Do you see any parallels between this local issue and larger global issues?





Nobody's Right, Nobody's Wrong: A Role-Playing Game

In the Field!

Get involved with planning in your area. Attend a meeting or hearing regarding local issues concerning natural areas and resources. This could include proposed changes to current zoning, a timber sale, a housing development, oil or gas expansion, the designation of a new wilderness or natural area, or new rules or regulations regarding how people can use public lands. Look to local papers, contact the local Bureau of Land Management or Forest Service office, or ask other involved citizens about upcoming meetings. If possible, visit the area that would be affected by the proposed changes. You don't have to make up your mind or have a strong opinion about the outcome of the meeting; it is a great idea to simply be involved and know what is happening in your community so that you can be part of the process.

Science Inquiry

Read and analyze a scientific paper based on an endangered species monitoring study. Ask your librarian to help locate a paper, or search websites such as Google Scholar using the genus and species names of your species of interest. Read the paper with an analytical eye; identify the question or hypothesis of the research, how the hypothesis was tested, and what procedures they followed. Read the results and conclusion. Write a short summary of the research and your analysis. Was the research well done or not? Explain your reasoning. Was the conclusion supported by the data?



Reflection

- Reflect on the definition of stewardship: what does it mean to you personally? Do you feel that you have a responsibility as a citizen to help make decisions on land management issues? How can an individual's actions make a difference to their community, to the world? Identify a stewardship decision you make that could affect someone in another part of the world. Do you think the role-playing activity will change the way that you make decisions in the future? Explain your reasoning.

Taking it Further

- Read a current article about a controversial environmental issue taking place in your community. Analyze the article for bias; is it a balanced portrayal of the issue or is it written from one perspective? Identify other positions that might not have been addressed.
- Become involved with a local issue. Participate in public hearings or planning commission meetings, or write a letter to your government representative or the local paper. Express your opinion, back your opinion with examples, propose a solution(s) to the problem—don't just complain.

Self Assessments

- 1** Participate in the role-playing activity in a positive and productive way; researching, presenting, and discussing material within your character's role.
- 2** Listen and weigh others' opinions and demonstrate respectful disagreement.
- 3** State your opinion on the subject and give at least one reason to back up the opinion.

Resources

See individual scenarios for recommended resources.



Nobody's Right, Nobody's Wrong: A Role-Playing Game

Scenario 1: Land Use Planning and Endangered Species

Setting:

A city planning commission meeting

Background:

Oak Valley is a town with a population of 100,000 in a densely populated area. The city has been growing steadily and at the last review of the City's comprehensive plan, it was decided that they needed to expand residential and commercial areas through rezoning previously undeveloped land adjacent to the city. Zoning laws require cities to designate the boundaries of areas intended for residential, industrial, commercial, and agricultural use. The town has financed an extensive study to identify appropriate lands to include in the expansion. It has considered the cost and feasibility of extending city services, included enough buildable land (both residential and commercial), and incorporated the city transportation plans to handle twenty years of projected growth.

Problem:

The new land planned for rezoning as residential and commercial areas includes a rather large population of a threatened plant species that is the host plant for an endangered butterfly found only in this region. Surveys have not found any butterflies associated with the host plants on this particular property, but a known population does exist within a two-mile radius of the site, within the flight range of the endangered butterfly. This means that the threatened plant population could be key to the endangered butterfly's recovery. It also could mean that future discovery of the butterfly on lands within the rezoned areas would require development to comply with the federal Endangered Species Act (ESA). This could result in restrictions on development, or complications, and added cost to development.

Differing Viewpoints:

The city would like to approve the rezoning plan and continue with their expansion plans. They have already spent thousands of dollars to work on feasibility studies and feel they have put together the best plan for the city. To modify or change their plans at this point would require spending additional tax money which could be better used to supply much needed social services (e.g., schools, police).

On the flip side, environmental groups are frustrated that the city would make plans that risk damaging critical butterfly habitat. They feel the city should cut their losses and start over in their planning. They feel that the expenses are minimal to protect endangered species and are prepared to fight this issue.

The Community:

Everyone in this community is connected in one way or another to this issue, and decisions will have a ripple effect throughout Oak Valley. Limiting future growth could discourage new employers, limit tax revenue, and impact social services. Taking away potential butterfly habitat could irreparably damage the species' chances for recovery, permanently removing a key species from the local ecosystem, and permanently degrading the environment, as well as create sprawl, reducing the rural character of the outskirts of the city. If the issue is not resolved, it may require court action that could be very costly for all parties and persist for years. Time is of the essence for both parties.

The Decision:

Should the rezoning plan be approved or not?



Nobody's Right, Nobody's Wrong: A Role-Playing Game

Scenario 1: Land Use Planning and Endangered Species, continued

Stakeholders

Science and Government:

- ♦ Oak Valley city planning commission member
- ♦ US Fish and Wildlife biologist
- ♦ Oak Valley Mayor

Business and Labor:

- ♦ solar panel manufacturer with a new business hoping to locate in the rezoned area
- ♦ restaurant owner
- ♦ small business owner that needs to expand but cannot find a location
- ♦ housing developer

Landowners/managers:

- ♦ land owner within the area proposed for rezoning
- ♦ land owner outside of area

proposed for rezoning

- ♦ tribal land manager from adjacent lands

Recreational Interests:

- ♦ naturalist, local birder, and hiker
- ♦ community parks advocate
- ♦ skate park skateboarder

Conservation Groups:

- ♦ national wildlife organization representative
- ♦ land conservancy non-profit representative

Other Interests:

- ♦ high school student
- ♦ attorney that defends one of the parties' interest
- ♦ land zoning advocate
- ♦ wild card – make your own role

Resources

- ♦ US Fish and Wildlife Endangered Species page: <http://www.fws.gov/endangered/>
- ♦ Research your own local and state zoning laws by accessing local government websites.
- ♦ Do an internet search to find current information on your chosen topic.





Nobody's Right, Nobody's Wrong: A Role-Playing Game

Scenario 2: Grazing and Riparian Areas

Setting:

A government task force to discuss regulating livestock access to streams

Background:

Sage City is a small town (population 2,000) in a rural, agricultural area that is home to a mix of people inside city limits and in the surrounding rural areas. Citizens include workers from a wood products manufacturing business that has attracted new families to the area, the ranching community, and needed service and support people. The city is served by a school district that draws from the town and rural constituents. In recent years, Sage City has attracted a growing retired population, which has relocated to enjoy the outdoor recreation opportunities.

Problem:

Riparian areas throughout much of the open rangeland in the area lack suitable vegetation critical for stream bank stabilization and to provide shade, which strongly influences water quality and therefore fish and wildlife habitat. Vegetation filters chemical pollutants, prevents erosion and excess sediment, and reduces stream temperatures, all of which are important for clean water and suitable fish habitat. Past water quality improvement efforts have focused on controlling large-source pollutants such as factory discharge, erosion from logging and agriculture, and sewage. This has improved overall water quality, but further improvements have stalled. More recent efforts have focused on non-point source pollution (runoff from urban, suburban, and rural locations). Livestock grazing has been identified as a major non-point source pollutant for many rural areas. Livestock tend to congregate around water sources, grazing and trampling stream bank vegetation. This can cause gullies at stream crossings, promotes erosion, and increases water temperatures by reducing shade.

Differing Viewpoints:

In recent years, a conservation organization has purchased a couple of old ranches in the Sage City area with plans to restore the native ecosystems. Its priority

is to restore riparian areas and improve water quality in the streams that run through the properties. The restoration will provide habitat for fish, wildlife and songbirds, with the long-term goal to improve stream water quality and fish populations.

The ranching community is in favor of improved stream quality, but has concerns with the methods the organization is proposing. By implicating their livestock as the cause of damage, they feel they are being unfairly blamed for the problem. In addition, ranchers fear that the restoration efforts will encourage predatory wildlife such as wolves and coyotes that will harass and kill their livestock. Management efforts to keep livestock out of riparian areas could require fencing off riparian areas, and potentially developing new water sources for their livestock. This is a financial burden that many of the ranchers feel they cannot afford with present meat prices and could force them to stop ranching. This is a problem not only with livestock on ranches but also livestock on federal land under grazing leases. In fact, public lands may be more affected because there is less incentive to upkeep the land.

The Community:

At present there are no state or federal laws regulating livestock damage to streams. Both the manufacturing and timber industries are required to comply with water quality regulations, so Sage City's wood products manufacturing industry is regulated, as is the timber industry that supplies them. Other connections can be through properties that generate taxes for services, supply businesses, and recreational income that comes into the area. Everyone in the community is connected in one way or another and decisions will have a ripple effect throughout.

The Decision:

Should livestock access to riparian areas be regulated? If so, what should the regulations be?



Nobody's Right, Nobody's Wrong: A Role-Playing Game

Scenario 2: Grazing and Riparian Areas, continued

Stakeholders

Science and Government:

- ◆ Bureau of Land Management (BLM) rangeland manager
- ◆ State department of fish and wildlife biologist
- ◆ teacher with a spouse/partner who is a rancher
- ◆ invasive species specialist

Business and Labor:

- ◆ local livestock feed store owner
- ◆ sheep rancher with federal grazing lease
- ◆ fly fishing and rafting guide
- ◆ small business grocery store owner
- ◆ owner of wood products manufacturing business
- ◆ large animal veterinarian
- ◆ local organic farmer

Landowners/managers:

- ◆ retired small acreage homesteader
- ◆ tribal land manager – with interest

in restoring fish populations

- ◆ cattle rancher/landowner
- ◆ wheat farmer
- ◆ homeowner (in town) employed in manufacturing

Recreational Interests:

- ◆ outdoor recreationist (canoeing and camping)
- ◆ hunter

Conservation Groups:

- ◆ restoration ecologist from conservation organization
- ◆ member of conservation organization – retired school principal
- ◆ member of a group protesting land use limitations

Other Interests:

- ◆ high school student (graduating senior)
- ◆ wild card – make your own role

Resources

- ◆ Negative Effects of Livestock Grazing Riparian Areas: <http://protectmustangs.org/?p=3275>
- ◆ Public Rangelands: Some Riparian Areas Restored But Widespread Improvement Will Be Slow: <http://archive.gao.gov/d16t6/136218.pdf>
- ◆ Local water quality regulations website: search websites for your local and state governments.
- ◆ Do an internet search to find current information on your chosen topic.

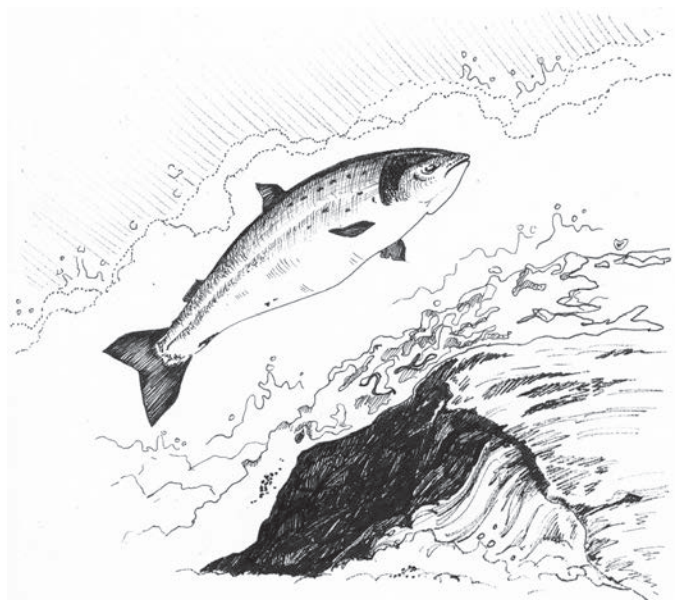



Nobody's Right, Nobody's Wrong: A Role-Playing Game

Scenario 3: Forest Management

Choose a topic that best fits a current forest issue in your ecoregion.

Topic Ideas:

- ◆ Is Thinning Essential to Forest Health?
- ◆ Forest Wildfires: Suppression or Let it Burn?
- ◆ After a Fire: Replanting or Natural Revegetation?
- ◆ Clearcutting: Healthy or Unhealthy?
- ◆ Sustainable Forest Harvest: Short-term vs. Long-term Gains
- ◆ Other current topics could include: protection of old growth forests, protecting watersheds, managing ecosystems, forest fragmentation, road building, and carbon sequestering to buffer climate change.

Setting:

A town hall-style debate

Background:

Forests in the United States are made up of a mosaic of federal, state, private and tribal ownerships. They are made up of natural areas, as well as forests that are actively managed for economic gains from wood products, non-timber forest products, recreation, and ecosystem services, among others. With all these different factors of ownership and management, forests in recent years have often been at the center of controversy.

Problem:

Resolve conflicting ideas in managing forests for multiple uses.

Differing Viewpoints:

For years there have been bitter arguments over forest management, pitting industry against conservation. Hot button topics have involved economic uses of the forest, fire, erosion control, riparian protection, and imperiled or endangered species.

Historic forest management practices have come into

question with new scientific discoveries. Is clear cutting a good idea? Is reforestation by planting a single tree species sustainable? Wood products are essential to our everyday lives, and forests supply jobs, but how do we manage them to maintain health and resources for future generations?

recently, the public is becoming more aware of the vast array of ecosystem services that forests provide, including water filtration, air purification, carbon sequestration, climate moderation, and erosion control, among others. Forests are also valued for recreation, cultural, and aesthetic values. This adds up to a lot of potentially conflicting uses for a finite resource.

The Community:

Decisions regarding forest management have far-reaching implications. These decisions affect jobs, the economy, forest health, air and water quality, and human enjoyment.

The Decision:

What is the best way to manage our forests for current and future generations?





Nobody's Right, Nobody's Wrong: A Role-Playing Game

Scenario 3: Forest Management, continued

Stakeholders

Science and Government:

- ◆ U.S. Forest Service employee
- ◆ State department of forestry fire suppression manager
- ◆ restoration ecologist
- ◆ local town planning commission member
- ◆ Bureau of Land Management (BLM) logging contract advisor
- ◆ US Fish and Wildlife biologist
- ◆ University forestry researcher

Business and Labor:

- ◆ logging company owner
- ◆ paper mill manager
- ◆ outdoor store employee
- ◆ international wood products company board member

Landowner/manager:

- ◆ homeowner on the forest/town interface
- ◆ tribal land manager of adjacent tribe-owned land
- ◆ small woodland owner

Recreational Interests:

- ◆ wilderness hiker and camper
- ◆ avid fly fisher
- ◆ outdoor photographer
- ◆ deer/elk hunter

Conservation Groups:

- ◆ moderate conservation club member (e.g. Sierra Club, Nature Conservancy)
- ◆ radical conservationist/tree sitter (e.g. Earth First!)

Other Interests:

- ◆ wild cards - make up your own role that represents your community

Resources

- ◆ Use the internet to find current information on your chosen topic. Focus on government websites such as those for national forests in your area and state forestry webpages





Nobody's Right, Nobody's Wrong: A Role-Playing Game

Role Development Sheet

Your Name _____ Scenario Title _____

Name of your character:		Age:	Gender:
Briefly describe your fictional self (work, hobbies, home, family, values).	How does the issue affect your fictional life (economics, politics, ethics, etc.)? Does it conflict with any of your values?		
Do you support or oppose the issue (in character)?	Give reasons to support your position (in character).		

Role Development Sheet

Your Name _____ Scenario Title _____

Name of your character:		Age:	Gender:
Briefly describe your fictional self (work, hobbies, home, family, values).	How does the issue affect your fictional life (economics, politics, ethics, etc.)? Does it conflict with any of your values?		
Do you support or oppose the issue (in character)?	Give reasons to support your position (in character).		



Biodiversity and Ecosystem Services: Can't Live Without 'Em

Time Estimate:

one or two sessions
(45-90 minutes)

Best Season:

spring,
fall

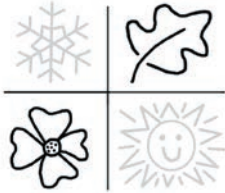

Uniformity is not nature's way; diversity is nature's way.

—Vandana Shiva (1952-present))

Overview

In this lesson students will explore biodiversity, global endemic hotspots and ecosystem services. Students will conduct a schoolyard plant diversity survey. Extend or build on the activity to learn about ecosystem service concepts and to explore a science inquiry question about biodiversity.

Assessments

- 1 Define biodiversity and describe why it is important.
- 2 Define ecosystem services and name 5 you benefited from today.
- 3 Demonstrate or describe a method of measuring and calculating plant diversity.
- 4 Compare and analyze the results of two or more plant diversity surveys.

Preparation

- ◆ Use a map to help the students visualize the entire schoolyard.
- ◆ Decide on areas of the school grounds to use for the plant diversity survey. Mark particular sites or areas to use for the plant diversity survey. Spread the surveys over an assortment of vegetation types (landscaped, lawn, weedy, or others if you have them). Pre-mark these sites on a map or help the students locate their site on the map when they finish.
- ◆ Review with your students the "Estimating Percent Cover" worksheet from the Measuring and Monitoring Plant Populations lesson. If they have not done this lesson, have all students practice on one test plot and compare the results.

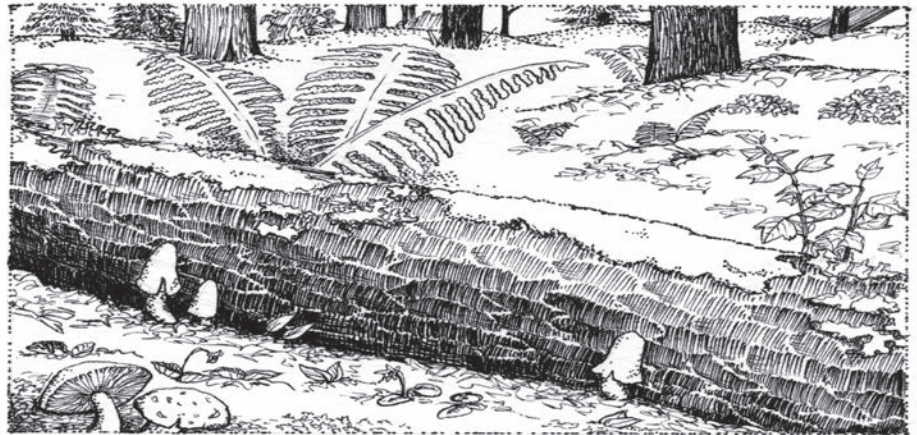

Teacher Hints

- ◆ Have students work in teams of two, with one spotter and one recorder, to conduct a plant diversity survey on the school grounds. Assign student teams to work in different areas to get a good representation of plant life on the school grounds.
- ◆ For step #5 of the student directions: follow the protocols in the Plant Press activity or use green leaves and adhere them to the butcher paper with contact paper.

Additional Information

- ◆ Ecosystem Services: A Primer. Links to ecosystem services background articles and lessons appropriate for high school students: <http://www.actionbioscience.org/environment/esa.html>
- ◆ Nature's Services, article about the value of ecosystem services: <http://www.rand.org/>



Biodiversity and Ecosystem Services: Can't Live Without 'Em

Materials Needed

- ◆ schoolyard map
- ◆ 4-meter string loops (one for each survey team)
- ◆ clipboard and paper
- ◆ butcher paper
- ◆ optional: toothpicks, field guides, plant press, adhesive contact paper

Learning Objectives

- ◆ Define the terms biodiversity and hotspot
- ◆ Conduct a simple plant diversity inventory
- ◆ Gather, analyze, and present data
- ◆ Understand the concept of ecosystem services, name several, and discuss their biological and economic values

Vocabulary Words

biodiversity
endemic
hotspot
ecosystem services
percent cover

Uniformity is not nature's way; diversity is nature's way.

—Vandana Shiva (1952-present)

Overview

In this activity, you will explore biodiversity, global endemic hotspots and ecosystem services. You will conduct a schoolyard plant diversity survey and learn about the concept of ecosystem services while exploring a science inquiry question about biodiversity.

Background Information

Have you ever considered that the food you eat for breakfast is brought to you each morning by the wind that pollinated the grasses that produced the grains that make up your cereal, or that the clear, cold, clean water you drink every day was likely purified for you by a wetland or perhaps the root system of an entire forest? Trees in your schoolyard capture dust, dirt, and harmful gases from the air you breathe. The bright fire of oak or pine logs you light to keep warm on cold nights and the medicine you take to quell the pain of a headache come to you from nature's warehouse of services. Through the intricate processes in ecosystems, biodiversity provides clean air, water, food, medicine, shelter and a wealth of interactions between species that keep an ecosystem functioning and healthy. In addition, biodiversity provides us with recreational opportunities, aesthetic beauty, and cultural and spiritual connections for the human soul. Natural ecosystems perform fundamental life-support services upon which human civilization depends. Unless human activities are carefully planned and managed, valuable ecosystems will continue to be impaired or destroyed.

The term "**biodiversity**" encompasses the variety of all living things and includes the diversity of species, the genetic diversity within species, and the diversity of ecosystems that these species call home. Scientists estimate that the Earth is home to 10-30 million species, but have named and cataloged only a fraction of that number so far. Advances in DNA sequencing and knowledge of the genetic code continue to open up new worlds of organisms that have yet to be identified.

How do scientists measure biodiversity? To do this, they evaluate the two primary components of diversity in the field, which are species richness and species evenness. Species richness refers to the total number of different species an area supports, but does not take into account the number of individuals of each species. In this measure, a single individual carries as much weight as a species with many individuals.





Biodiversity and Ecosystem Services: Can't Live Without 'Em

Background Information, continued

Species evenness refers to the relative abundance of each species present. Consider a meadow with 30 species present. It has a species richness of 30. Its species evenness would be assessed by how many individuals of each of the 30 species were present. If there were 1,000 of one species, and only one of each of the other 29 species, the meadow would have low species evenness. A community with one or two species dominating is considered less diverse than a community in which all 30 species have a similar abundance. As species richness and evenness both increase, so does species diversity.

How do biodiversity and healthy ecosystems provide **ecosystem services**? Let's use the example of plants. They provide the oxygen that we need to breathe and store carbon from the atmosphere. We depend on plants to provide our food both directly (such as fruits, vegetables, and grains) and indirectly, as food for animals that provide meat and dairy products. Plants mitigate the impacts of drought by helping to hold moisture within the soil, and moderate floods through stabilizing soil to prevent erosion and landslides.

Plants also filter our water by taking up pollutants and trapping them in their biomass. Some essential ecosystem services are listed below.

Assigning monetary values to ecosystem services can be challenging. For example, what if acid rain or another disaster sterilized the soil over a large area of farmland or forestland, eliminating soil fungi and microorganisms essential for decomposition and nutrient cycling? Soil fertility would no longer be naturally renewed. If farming or timber production in the area were necessary, what would it cost to remove materials that would not be broken down and to continuously apply fertilizer? Alternatively, if pollinators declined dramatically, what would it cost cherry farmers that are dependent on having their trees pollinated to produce a crop? You could think of ecosystem services as being like the infrastructure of a city: you may not think about or notice the water supply, sewer lines, electric grid, road systems and emergency response teams that keep your town functioning daily, but they are always there. The study of ecosystem services reminds us of the enormous

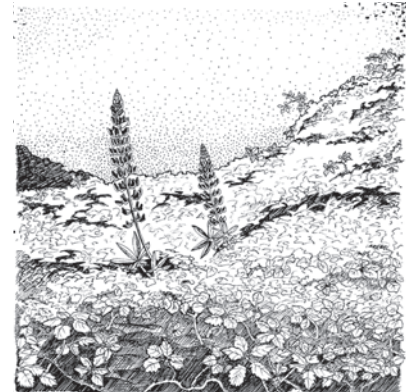

complexity of life forms that are behind the scenes, playing critical and essential roles in supporting our own lives and activities.

Studying the fossil record, paleontologists have noted continual extinctions of species over the history of the Earth, but recently the extinction rate appears to be rapidly increasing. In fact, the evidence shows that we are currently in the midst of a mass extinction event. This loss of biodiversity could have huge impacts on the ecosystem services on which humans rely. What factors lead to biodiversity loss? Habitat loss, in which humans change natural ecosystems through development, farming, filling wetlands, changing water courses, and generally expanding the human footprint, is a primary cause. Habitat loss can also occur naturally through

Essential Ecosystem Services

- ◆ soil fertility
- ◆ water filtration
- ◆ carbon sequestration
- ◆ flood control
- ◆ drought mitigation
- ◆ air purification
- ◆ nutrient cycling
- ◆ pollination of crops
- ◆ and native species
- ◆ recreation
- ◆ moderation of weather extremes
- ◆ moderation of climate
- ◆ medicine sources
- ◆ genetic diversity
- ◆ seed dispersal
- ◆ erosion control
- ◆ decomposition of waste
- ◆ protection from harmful ultraviolet rays
- ◆ control of agricultural pests
- ◆ regulation of disease carrying organisms
- ◆ capturing energy through photosynthesis



Biodiversity and Ecosystem Services: Can't Live Without 'Em

Background Information, continued

volcanic activity, wildfire, and individual species loss to disease or competition. Additional factors that diminish biodiversity include climate change, the proliferation of invasive species, the overuse of resources, and pollution.

In the discussion of worldwide biodiversity loss, you may come across the term "biodiversity hotspot." To be designated a biodiversity hotspot, an area must be home to a high level of biodiversity, including more than 1500 **endemic** plant species, and it must be under significant threat from human activities. The global non-profit organization Conservation International lists 34 **hotspots** worldwide. For example, the California Floristic Province

is a biodiversity hotspot in North America. This hotspot extends from Baja California into southern Oregon, in the Klamath Mountain ecoregion, also called the Siskiyou Mountains. In addition, the World Wildlife Fund (WWF) named the Siskiyou Bioregion as one of 200 WWF-selected global hotspots on Earth. The Klamath-Siskiyou area alone is home to 131 native plants found nowhere else. The region is so diverse because it is a mixing pot between 5 major biotic regions: the Great Basin, Coast Range, Cascades, Sierra Nevada and Central Valley of California.

Although the concept of a biodiversity hotspot may sound grim, there is much that can be done to protect biodiversity, beginning at home.

You can contribute to preserving biodiversity by choosing to live a more sustainable lifestyle, decreasing use of fossil fuels, conserving water, recycling, and gardening. Become an informed citizen and use your voice and vote to educate and lead. On a community-wide level, protect wild areas, work to restore degraded habitats, and support ecological education and sustainable development.



Student Directions

1. For this activity, focus on measuring plant diversity in your schoolyard. Work in teams of two to measure the diversity of plants using a meter square (or a 4-meter string tied into a loop and staked into a square). Each team will measure a different area of the schoolyard.
2. Set the plot frame on the ground. Count the number of different plant species and other plant-like organisms (algae, lichens, etc.) present in the plot. This is your plot's species richness.
3. Estimate the **percent cover** of different species of plants or plant-like organisms that are living within the square. It is not essential to know the name of the plants (although this is helpful). Note: The total percent cover can be more than 100% if some of the plants are overlapping others.
4. Calculate the Simpson's diversity index (D) for your plot. Use the following equation for Simpson's diversity index:

$$\text{Diversity (D)} = 1 - \{\text{sum } (p(i)^2)\}$$

where $p(i)$ = the proportional abundance of species i

You can use either decimal or percentage values; both will come out the same. If species i has cover of 78% and the total cover is 140%, then $p(i)$ is $78/140 = 0.55$ or $0.78/1.40 = 0.55$

To calculate D, square each $p(i)$ value, add all values, and subtract the total from 1.

In this index of species diversity, D ranges from 1 to 0, with 1 representing infinite diversity and 0 representing no diversity. In the example in the table below, you may have the following species composition in your plot, where you found one grass, two things that looked like daisies but were clearly two different species, and one shrub:



Biodiversity and Ecosystem Services: Can't Live Without 'Em

Student Directions, continued

Species	Percent cover	$p(i)$	$p(i)^2$
grass #1	40 %	$(40/130)=0.307$	$(0.307)^2=0.094$
daisy #1	15 %	$(15/130)=0.115$	$(0.115)^2=0.013$
daisy #2	40 %	$(40/130)=0.307$	$(0.307)^2=0.094$
shrub #1	35 %	$(35/130)=0.269$	$(0.269)^2=0.072$
Sum	130%		0.273

$$1 - 0.273 = 0.727$$

$$\text{Diversity (D)} = 0.727$$

The final number may seem abstract but remember this is a relative measure. It lets you know how diverse your plot is between no diversity (0) and infinite diversity (1). In our example, our diversity index is 0.727. This may seem high since we only had four species, but remember that species evenness plays a role as well. Note that our species composition was relatively even, with no one species dominating completely. For comparison, use the same four species but change it so one species is at 91% and the other three are at 3% and see how your diversity index changes.

- You may also collect plant specimen samples in a plant press. Use butcher paper to make a large chart of your findings. A simple way to classify your findings is to divide the plants by category and press a leaf specimen from each. Record the results by grouping types of plants together: tree, shrub, grasses, broadleaf herbaceous, mosses, and so on, with the sample of the leaves. Hang all the plot sample charts for the class to compare results.
- Extra Credit: Identify the plants at your site. Label with scientific and common name. Are they native or non-native?
- Return to the classroom and add your site location to the schoolyard map. Record the species richness and species diversity of your plot on the map. When all the teams have added their data to the map, discuss the results. Do the most diverse plots also have the greatest species richness? Discuss the difference between diversity and richness.
- Make a graph of the class results (plot number, species diversity, and species richness). Which areas have the highest diversity? Which the lowest? Do the numbers correlate to any patterns that you observed on the school grounds (landscaped areas vs. native areas)? Do humans influence the abundance or diversity of plant life? Explain your reasoning. Do you think native plant diversity and non-native plant diversity show the same patterns? Explain why or why not.

CLASS DISCUSSION

- What does "biodiversity" mean? (Hint: Break the word into parts to help formulate a definition).
- Why do you think biodiversity is important in an ecosystem?
- How is biodiversity an indicator of the health of the environment? Explain your reasoning.
- How does the reduction of biodiversity harm the environment? How is it bad for humans? Can you think of any positive things that come from the reduction of biodiversity?
- Think about your own habitat. Would you consider it biodiverse; why or why not?



In the Field!

Conduct an additional plant inventory to compare with your schoolyard inventory. Choose an invasive weedy site, a park, a natural area, an agricultural field, your backyard, or another area. Hang a large map of the local area and mark spots that have been surveyed. Compared to these additional sites, how diverse do you think your schoolyard is?

Science Inquiry

Ask a question about a nearby landscape that can be investigated using the plant diversity survey protocol. Questions can be related to the plant forms that are associated with certain locations, the number of invasive plants found in cultivated and uncultivated locations, or the plant leaf forms found in sunny vs. shady locations. These are just examples of some of the questions that could be generated by the schoolyard studies. See if you can come up with your own. Now write your question in a form that can be tested. Provide detail about the testing process (depending on your question) and if possible follow through with the testing.

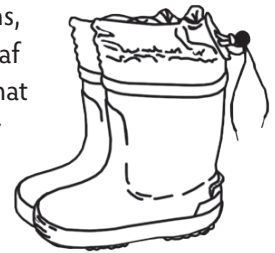

Taking it Further

The ecosystem services concept puts an economic value on the services that nature provides us (such as clean air, clean water, nutrient cycling, and so on) and from which we benefit. If people see the economic value of ecosystems, they will be more inclined to conserve and preserve them.

- ◆ Research one of the ecosystem services listed in the background material for this lesson. Make a flashcard for your service using a 4x6 card. Write the name of the service on the front of the card. Answer the following questions on the back: 1) How does the service work in the natural world? 2) How does the service benefit humans? 3) What part do plants play in the service? 4) How much do you think this service is worth? Pool all the flashcards and create a game.
- ◆ Advanced discussion: Conservation policies often seem to be at odds with economic growth. How could environmental policy and economic growth work together to sustain biodiversity? How would this help focus conservation efforts on biodiversity hotspots? What could be done to preserve biodiversity in your ecoregion? What kind of ecosystem services does your schoolyard provide? Can you calculate what these services may be worth? What do you think the benefits and drawbacks are to assigning monetary values to nature?





Biodiversity and Ecosystem Services: Can't Live Without 'Em

Reflection

- Should we be concerned about species extinctions? Why or why not? What is the status of biodiversity in your region, and are you concerned about it? Why? Do you think you should be concerned with the loss of species in remote biodiversity hotspots that most people will never see or visit? Explain your reasoning in an essay or poem or illustrate the result in a drawing or painting.



Self Assessments

- 1 Define biodiversity and describe why it is important. What is a biodiversity hotspot?
- 2 Define ecosystem services and name 5 you benefited from today.
- 3 Demonstrate or describe a method of measuring and calculating plant diversity.
- 4 Compare and analyze the results of two or more plant diversity surveys.

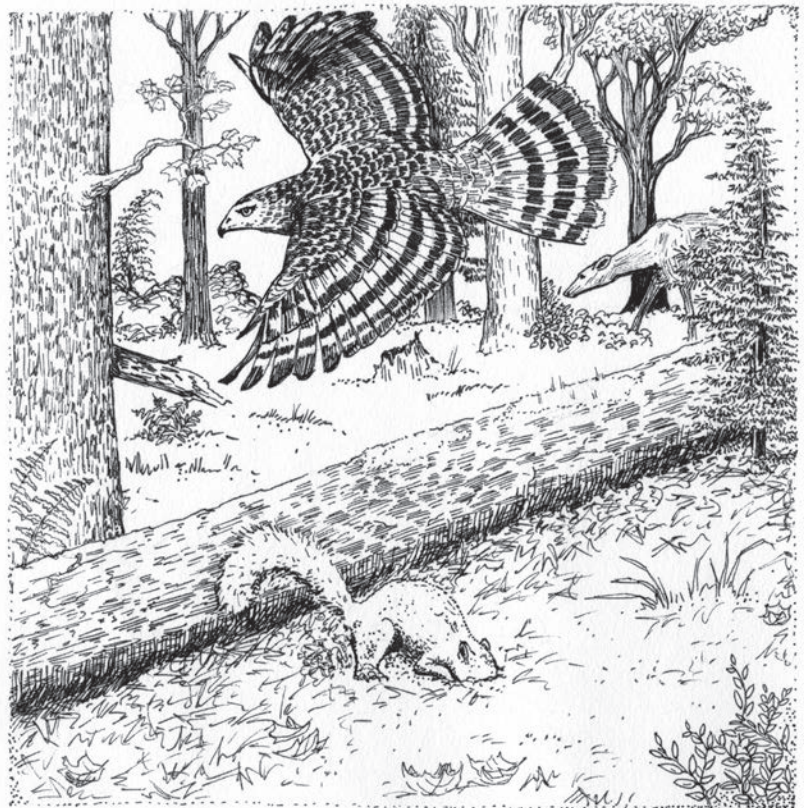

Resources

- ◆ "Estimating Percent Cover" worksheet from the Measuring and Monitoring Plant Populations lesson in this guide.
- ◆ Information about worldwide biodiversity hotspots: <http://www.cepf.net/resources/hotspots/Pages/default.aspx>
- ◆ E.O. Wilson is a well-known ecologist and author who has long advocated for the preservation of worldwide biodiversity. Learn more by reading his articles, essays, and books. Visit: <http://eowilsonfoundation.org>



Threatened and Endangered Plants

Time Estimate:

2 sessions

Best Season:

any

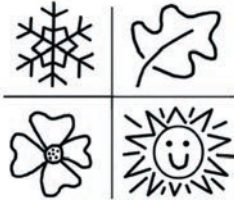

Teacher Hints

- ♦ See <http://www.jigsaw.org/> for tips on implementing the jigsaw model. It is designed to reduce conflict, improve motivation, and increase enjoyment of the learning experience.
- ♦ In Part 2, use the field guide template sheet from the Create-a-Plant lesson, which can also be adapted to include threatened and endangered wildlife species.

Assessments

- 1 Demonstrate a basic knowledge of the Endangered Species Act (ESA) and understand how citizens can be involved in shaping endangered species regulations.
- 2 Identify at least one threatened and endangered plant or animal that lives in your state.
- 3 Write an opinion of the ESA, supported with evidence.

The loss of a keystone species is like a drill accidentally striking a power line. It causes lights to go out all over.

—E.O. Wilson (1929 - present)

Overview

Do any threatened or endangered (T & E) species live in your backyard? Or perhaps, we should say, do you live in the habitat of any threatened or endangered species? This lesson introduces the Endangered Species Act (ESA). Students learn how to influence government decisions and voice opinions on local rare species issues.

Preparation

- ♦ **Jigsaw activity set up:** assign students to core groups of four. Groups need to include a mix of abilities, gender, and backgrounds. Have the members of the group count off by fours and these will become the secondary expert working groups.
- ♦ Each expert working group will be a research team. Give them class time to work together, making sure all members of the group participate.
- ♦ Conduct a pre-activity class discussion to assess prior knowledge and opinions of endangered species conservation.
- ♦ **Discussion ideas:** Explore personal opinions on the conservation of rare species. Ask if students can name any rare species that occur in your state. Do they know of any species that have gone extinct in the last 100-200 years? What, if anything, happens in an ecosystem when an animal or plant species becomes extinct? Should we do anything to protect and recover endangered species? How much effort and money should we spend to keep species from going extinct? Explore possible reasons to protect rare species (e.g., aesthetics, moral reasons, ecosystem services, future medical discoveries).



Additional Information

- ♦ United States Fish & Wildlife Service. Endangered species home page. <http://www.fws.gov/endangered/index.html>
- ♦ The Citizen's Guide to the Endangered Species Act: https://www.givengain.com/unique/esc/upload/citizens_guide_esa.pdf



Threatened and Endangered Plants

Materials Needed

- ♦ computer with internet access for research
- ♦ copies of the ESA readings for jigsaw group activity
- ♦ jigsaw question sheets

Learning Objectives

- ♦ Explore the Endangered Species Act (ESA)
- ♦ Learn how the public input process works in government actions (ESA process of listing a species)
- ♦ Find out about state laws and conservation organizations that work to preserve rare species
- ♦ Learn about rare plant species in your state
- ♦ Improve your research skills

Vocabulary Words

extinct
endangered species
threatened species
candidate species
rare
extirpated
species of concern
endemic
delisting
downlisting

The loss of a keystone species is like a drill accidentally striking a power line. It causes lights to go out all over.

—E.O. Wilson (1929 - present)

Overview

Do any threatened or endangered (T & E) species live in your backyard? How would you feel if they did? This lesson introduces you to endangered, threatened and rare plants of your state. You will collaborate with your classmates to become familiar with the basics of the Endangered Species Act (ESA). You will learn how you can influence government decisions, and voice your opinions on local rare species issues.

Background Information

We often hear in the news of high profile near-extinction wildlife species: the polar bear, California condor, and gray wolf, to name a few. Did you know that there are threatened, endangered and at-risk species in your area, too? People living near **rare** species are frequently unaware that these species exist, and are often uninformed as to what has put the species in jeopardy. Species rarity is often linked to habitat loss, among other issues, and shares the same causes that fuel the biodiversity decline.

Federal and state laws protect species that are listed as **endangered** or **threatened**. The primary protection comes under the federal Endangered Species Act (ESA), which is administered by the United States Fish and Wildlife Service (USFWS) and the National Marine Fisheries Service (NMFS). The USFWS has the primary responsibility for terrestrial and freshwater organisms, while the NMFS takes the lead on critical marine species such as whales and anadromous fish, such as salmon. As with most laws, the ESA can be challenging to parties on all sides of the issue. For example, private landowners with rare species on their property are often concerned about losing the right to use their land as they like. Conservation organizations are working to save rare species and their habitats and private lands provide critical habitat for many species. Is there a middle ground where private landowners can feel safe from regulations and species can still be saved?

Investigating how the ESA works, how public input can affect species listings, and your role in shaping public policy is a way to learn about where policy and science meet to work to recover endangered species. During the first part of this activity you will gain a basic understanding of the history of the ESA, its components, and how it works to protect species. You will also have an opportunity to design a better law that may be more effective at saving species than the ESA.



Threatened and Endangered Plants

Student Directions

Part I: Jigsaw Activity

1. You will be divided into groups of 4 students- your core group for the jigsaw activity. Each person in the core group will be responsible for learning one section of the information needed for the group as a whole. The success of the group depends on each person doing their part.
2. In your core group count off 1, 2, 3, and 4. All the number 1s in the class will form an expert group on the ESA Basics and History, 2s will be the ESA Species Listing Process, 3s will be ESA Critical Habitats and Habitat Conservation Plans, and 4s will be ESA Recovery and Delisting.
3. Each expert group will work together in class to research its topic and answer a set of questions. Use the USFWS endangered species page <http://www.fws.gov/endangered/index.html> as a starting point. Each expert group may work on the questions together or divide them up. Keep your answers brief and concise. Come up with a way to share what you learned (draw a diagram, create a game, etc.) when you return to your core group.
4. Return to your core group and take turns teaching each other the key points you learned in your expert group. Encourage your core group to ask questions during the presentations so everyone benefits from your research!
5. Be prepared to have your teacher test your knowledge on the basics of the ESA.
6. Discussion Extension – discuss the merits and pitfalls of the ESA and any changes you think would improve it. Common arguments about the ESA include: the law values endangered species over humans; the law does not do enough to protect endangered species; the ESA listing process is too slow, allowing species to lose critical numbers during the wait; and the program is too costly. What do you think and why? Should money be spent saving individual endangered species or should it be spent to preserve and enhance entire ecosystems in peril?

Part II: Apply your ESA knowledge to your state

1. There are rare plants all around the United States. Some are listed under the federal ESA, and others are listed under state ESA laws, which have different implications and meanings.
2. Create a list of rare plants in your state. Include the name of the plant (scientific and common) and its status under the federal and/or state ESAs. A good resource for creating this list is the USFWS website, where you can find endangered species listed by state: <http://www.fws.gov/endangered/>. You can use the map to see which threatened and endangered plants occur near your area.
3. Create a field guide page for one rare plant from your state (use the template from Create-a-Plant). Have everyone in the class cover at least one species so the class will end up with a field guide to all the rare plants of your state.
4. As with any research project, be sure that you cite your sources both for written content and photos. Write the citation information directly on your field guide page. Keep track of the sources of your information as you conduct your research.
- ♦ Search by scientific name on the internet. Many rare plants have extensive records associated with them, such as research, public hearings, etc. Use this information to fill in the missing parts of your field guide. Include the reasons why the plant is rare and a summary of the steps to downlisting or delisting if a recovery plan has been completed.
5. Use easy to understand language and define unfamiliar terms in your field guide so it will be useful for the general public.
6. Complete your field guide page with a high-quality picture (with proper copyright credits) or a color drawing and references.
7. Assemble everyone's pages to create a rare plant field guide for your ecoregion.



Threatened and Endangered Plants

Taking it Further

Use the maps on the USFWS website to plot where all of the federally threatened and endangered species in your state occur. Use color-coding to draw ranges on a map of your state. Do the ranges follow general patterns? For example, do most of the rare species occur in mountainous areas of your state, or in arid basins, or along a coastline? Take what you know about land uses in these areas and form a hypothesis about why endangered species occur where they do in your state.

Assessments

- 1** Demonstrate a basic working knowledge of the ESA. How can the public get involved in species listings?
- 2** Write a paragraph expressing your opinion on an aspect of the Endangered Species Act. Support your opinion with evidence or examples.
- 3** Name one (or more) threatened or endangered plant species from your ecoregion.

Resources

- ♦ US Fish & Wildlife Service. Find species listed under Federal ESA as well as species of concern. <http://www.fws.gov/endangered/>

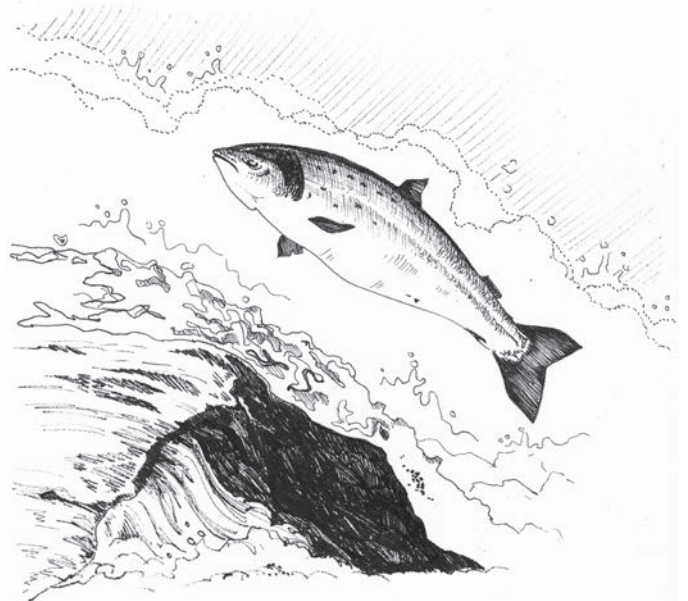



Threatened and Endangered Plants

Expert Group 1

Endangered Species Act (ESA)—Basics and History

Questions:

1. What is the purpose of the ESA?
2. Who administers the ESA?
3. What species are eligible for protection under the ESA?
4. The ESA protects species by prohibiting take. Define take as it applies to wildlife in the ESA.
5. Do the same take prohibitions apply to plants, and if not, how are they different?
6. Describe how the federal government works with state governments in regard to the ESA.
7. In what year did Congress pass the Endangered Species Act into law as we know it?
8. Has the ESA been changed since it first became law?
9. From its start, Congress authorized funding the ESA through 1992. How has the ESA been funded since 1992?

Cut here

Expert Group 2

Endangered Species Act (ESA)—Species Listing Process

Questions:

1. What are **candidate species**?
2. What are the two ways that species can become listed under the ESA? Give a short explanation of both.
3. What are the five basic factors that influence whether a species is listed?
4. When enough scientific information has been submitted to consider a species for listing under the ESA, biologists at the USFWS draft a **proposed listing rule**; what is included in the listing proposal?
5. The ESA requires a final determination on the listing of a species to be completed within what time period?
6. Outline the process for public input into an ESA listing proposal.
7. ESA listing decisions are required to be based on best scientific principles. In this process they solicit peer review. Explain this process.
8. If all the steps are completed and the species listing is approved, what happens next?



Threatened and Endangered Plants

Expert Group 3

Endangered Species Act (ESA)—Critical Habitat and Habitat Conservation Plans

Questions:

1. What is **critical habitat**?
2. What is the purpose of designating **critical habitat**?
3. How is **critical habitat** determined?
4. What are Habitat Conservation Plans (HCP)?
5. What do HCP do?
6. Many HCP require **mitigation** to offset take of endangered species authorized by incidental take permits. **Mitigation** is completed through specific conservation strategies that are manageable and enforceable. List several examples of mitigation practices.

Cut here

Expert Group 4

Endangered Species Act (ESA)— Species Recovery and Delisting

Questions:

1. The United States Fish and Wildlife Service (USFWS) uses many techniques to **recover** endangered species. List 3-5 such techniques.
2. What does **recovery** mean?
3. Give an example of a partnership that the USFWS has made to help **recover** endangered plant species.
4. Define the terms **delisting** and **downlisting**, as used in the ESA.
5. What happens after a species has been **delisted**?



Threatened and Endangered Plants

Answer Key

Expert Group 1: ESA — Basics and History

1. What is the purpose of the ESA? The ESA protects and recovers imperiled species and their habitats.
2. Who administers the ESA? It is administered by the Interior Department's U.S. Fish and Wildlife Service (USFWS) and the Commerce Department's National Marine Fisheries Service (NMFS).
3. What species are eligible for protection under the ESA? All species of plants and animals, except pest insects, are eligible for listing as endangered or threatened.
4. The ESA protects species by prohibiting take. Define take as it applies to wildlife in the ESA. Take is "to harass, harm, pursue, hunt, shoot, wound, kill, trap, capture, or collect or attempt to engage in any such conduct." Take may include significant habitat modification or degradation where it actually kills or injures wildlife by significantly impairing essential behavioral patterns, including breeding, feeding, or sheltering.
5. Do the same take prohibitions apply to plants, and if not, how are they different? Listed plants are not protected from take under the federal ESA, although it is illegal to collect or maliciously harm them on federal land. Protection from commercial trade and the effects of federal actions do apply for plants. State Endangered Species Acts may provide additional protection for plants on some land ownerships.
6. Describe how the federal government works with state governments in regards to the ESA? The federal government encourages states to develop and maintain conservation programs for threatened and endangered species. Federal funding is available to promote state participation. Some state laws and regulations are even more restrictive than the federal ESA in granting exceptions or permits.
7. In what year did Congress pass the Endangered Species Act into law as we know it? 1973.
8. Has the ESA been changed since it first became law? Significant changes to the law have been added in the form of amendments but the basic structure of the 1973 Act has been preserved.
9. From its start, Congress authorized funding the ESA through 1992. How has the ESA been funded since 1992? Congress has annually appropriated funds.

Threatened and Endangered Plants

Answer Key

Expert Group 2: ESA — Species Listing Process

1. What are **candidate** species? Species for which the USFWS has sufficient information on their biological status and threats to propose them as endangered or threatened under the Endangered Species Act (ESA), but for which development of a proposed listing regulation is precluded by higher priority activities.
2. What are the two ways that species can become listed under the ESA? Give a short explanation. 1) Petition process: any person may petition the Secretary of the Interior to add a species, or 2) Candidate assessment process: USFWS biologists identify species as candidates for listing.
3. What are the five basic factors that influence whether a species is listed? 1) The present or threatened destruction, modification, or curtailment of the species' habitat or range. 2) Overutilization for commercial, recreational, scientific, or educational purposes. 3) Disease or predation. 4) The inadequacy of existing regulatory mechanisms. and 5) Other natural or manmade factors affecting the species' continued existence.
4. When enough scientific information has been submitted to consider a species for listing under the ESA, biologists at the USFWS draft a proposed listing rule; what is included in the listing proposal? Background information on the species (taxonomy, historic and current range, population information, habitat requirements, etc.), a summary of the threats faced by the species, a determination and/or designation of critical habitat if appropriate, examples of available conservation measures, and a preview of actions that would be prohibited (as well as actions that would not be prohibited) if the species were to be listed.
5. The ESA requires a final determination on the listing of a species to be completed within what time period? A decision on whether to make the proposed listing final must be completed within 12 months from when the proposal is published.
6. Outline the process for public input into an ESA listing proposal. 1) Press release announcing the proposal is published in area newspapers, and personal contacts are made by Field Office, Regional Office, and Washington, D.C. Office personnel. 2) Direct notification of cities and counties, state agencies, federal agencies, Congressional offices, local organizations, and others. 3) A 60-day public comment period begins once a listing proposal is published in the Federal Register. 4) A public hearing must be held if one is requested within 45 days of publication of the proposed rule. 5) Public meetings also may be held in areas where the species occurs to provide the public with information about the species and the proposed listing. 6.) The public comment period may be extended or reopened at any time; however, extensions must be within reason.
7. ESA listing decisions are required to be based on best scientific principles. In this process they solicit peer review, explain this process. The USFWS contacts several peer reviewers during the open comment period, provides them with the listing proposal, and asks them to review the document for scientific accuracy. Current USFWS policy requires at least three independent reviewers to be contacted. The reviewers are free to comment on any aspect of the proposal, but they may also be asked to consider specific questions regarding the species' taxonomy or biology.
8. If all the steps are completed and the species listing is approved, what happens next? The rule becomes effective 30 days after publication (to allow Congress to review the listing) and the species is officially added to the Federal Endangered and Threatened Species List.



Threatened and Endangered Plants

Answer Key

Expert Group 3: ESA—Critical Habitat and Habitat Conservation Plans

1. What is critical habitat? Specific geographic area(s) that contain(s) features essential for the conservation of a threatened or endangered species and that may require special management and protection. Critical habitat may include an area that is not currently occupied by the species but that will be needed for its recovery.
2. What is the purpose of designating critical habitat? Federal agencies are required to consult with the USFWS on actions they carry out, fund, or authorize to ensure that their actions will not destroy or adversely modify critical habitat. In this way, a critical habitat designation protects areas that are necessary for the conservation of the species.
3. How is critical habitat determined? Biologists consider physical and biological features needed for life processes and successful reproduction of the species, including: 1) Space for individual and population growth and for normal behavior; 2) Cover or shelter; 3) Food, water, air, light, minerals, or other nutritional or physiological requirements; 4) Sites for breeding and rearing offspring; and 5) Habitats that are protected from disturbances or are representative of the historic geographical and ecological distributions of a species.
4. What are Habitat Conservation Plans? HCP are planning documents required as part of an application for an incidental take permit. They describe the anticipated effects of the proposed take; how those impacts will be minimized, or mitigated; and how the HCP is to be funded.
5. What do HCP do? In developing habitat conservation plans, people applying for incidental take permits describe measures designed to minimize and mitigate the effects of their actions to ensure that listed species will not be jeopardized.
6. Many HCP require mitigation to offset take of endangered species authorized by incidental take permits. Mitigation is completed through specific conservation strategies that are manageable and enforceable. List several examples of mitigation practices. Mitigation practices include, but are not limited to, payment into an established conservation fund or bank; preservation (via acquisition or conservation easement) of existing habitat; enhancement or restoration of degraded or former habitat; establishment of buffer areas around existing habitats; modifications of land use practices; and restrictions on access.





Threatened and Endangered Plants

Jigsaw Groups Answer Key

Expert Group 4: ESA—Species Recovery and Delisting

1. The USFWS uses many techniques to recover endangered species; list 3-5 such techniques. Techniques include restoring and acquiring habitat, removing introduced animal predators or invasive plant species, conducting surveys, monitoring individual populations, and breeding species in captivity and releasing them into their historic range.
2. What does recovery mean? Recovery is the process by which the decline of an endangered or threatened species is arrested and threats are removed or reduced, ensuring the long-term survival of the species in the wild. At that point the species is recovered, and protection from the ESA is no longer necessary.
3. Give an example of a partnership that the USFWS has made to help recover endangered plant species. A national partnership with the Center for Plant Conservation, which has expertise in conserving plants. Founded in 1984, the Center is supported by a nationwide consortium of 29 botanical gardens and arboreta. With about one of every 10 plant species in the United States facing potential extinction, the Center is the only national organization dedicated exclusively to conserving rare native plants.
4. Define the terms delisting and downlisting as used in the ESA. **Delisting:** To delist species, the USFWS is required to determine that threats have been eliminated or controlled, based on several factors, including population sizes and trends and the stability of habitat quality and quantity. **Downlisting:** When the USFWS reclassifies species from endangered to threatened, a less dire status, they downlist them. If some of the threats have been controlled and the population has met recovery objectives for downlisting, the USFWS may consider changing the status of an endangered species to threatened.
5. What happens after a species has been delisted? The Endangered Species Act requires the USFWS, in cooperation with the states, to monitor species for at least five years after delisting to assess their ability to sustain themselves without the protective measures of the Act. If, within the designated monitoring period, threats to the species change or unforeseen events change the stability of the population, the USFWS may extend the monitoring period or relist the species.

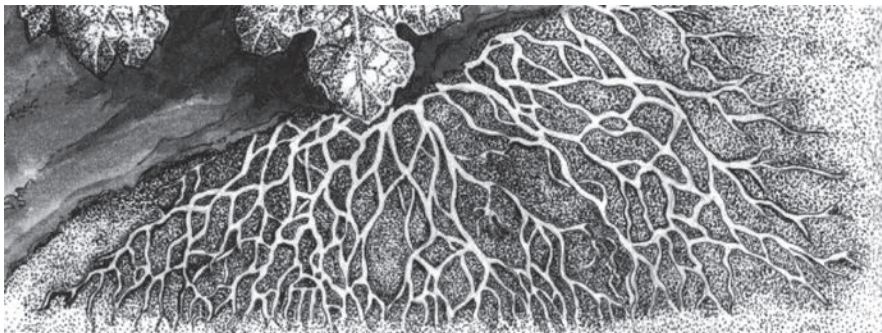



Designing a Habitat Restoration Plan

Time Estimate:

2 class sessions

Best Season:

any



Never doubt that a small group of thoughtful committed citizens can change the world; indeed, it is the only thing that ever has.

—Margaret Mead (1901-1978)

Overview

This lesson introduces the basics of habitat restoration through exploring restoration concepts, terminology, and methods. Learn about common restoration tools and weigh the trade-offs land managers juggle when planning a restoration project. Students will work as part of a team to plan, budget, and market a restoration plan to a land manager.

Assessments

- 1 List the component parts of a successful habitat restoration plan.
- 2 List and explain two tools used in each: planning, site prep, restoring vegetation, and monitoring in habitat restoration projects.
- 3 Work as part of a team to complete a habitat restoration project proposal.

Additional Information

- ♦ The SER International Primer on Ecological Restoration: http://c.ymcdn.com/sites/www.ser.org/resource/resmgr/custompages/publications/SER_Primer/ser_primer.pdf
- ♦ Native Seed Network: <http://www.nativeseednetwork.org/>

Preparation

- ♦ Class discussion: brainstorm what it means to “restore a native ecosystem”. Have the class formulate a definition. Discussion questions: What part do humans play in restoration? Can restoration happen naturally? How and when? When is a restoration complete? Explore other associated words: reclamation, mitigation, reintroduction, conservation, degrade, disturbance, native, non-native, and invasive species.
- ♦ Create a class word bank list to collect terms and definitions associated with habitat restoration.

Teacher Hints

- ♦ This lesson includes many aspects of the engineering design standards: defining a problem and stating a goal; brainstorming solutions; comparing solutions using the concept of trade-offs; then creating, analyzing, and refining a plan within set criteria; identifying strengths and weaknesses; and describing how it is more effective than alternative plans.
- ♦ Team projects can be run as a class competition. Invite local land management agency personnel (e.g., U.S. Forest Service, Bureau of Land Management, City, County, or State Parks/Natural Areas Departments), other teachers, or an ecologist, botanist, or forester to act as judges.
- ♦ Use this lesson to introduce a service-learning project. Partner with your local watershed council or other natural resource agencies on a nearby habitat restoration project. Ask to view their restoration plan, or to be involved in creating it.
- ♦ For advanced students, add an additional layer to the restoration plan. Have them research appropriate plant species for a local habitat restoration site. Find and price seed, plug, or plant material cost to include in their plan.



Designing a Habitat Restoration Plan

Materials Needed

- ◆ Budget worksheet
- ◆ site map
- ◆ tracing paper for overlays
- ◆ colored pencils

Learning Objectives

- ◆ Increase understanding of habitat restoration terminology.
- ◆ List several restoration tools.
- ◆ Use engineering design process skills to create a habitat restoration plan.
- ◆ Practice persuasive writing skills to market a habitat restoration proposal.

Vocabulary Words

habitat restoration
disturbance
reference site
reintroduction
rehabilitate
reclamation
mitigation
re-establish

Never doubt that a small group of thoughtful committed citizens can change the world; indeed, it is the only thing that ever has.

—Margaret Mead (1901-1978)

Overview

This lesson introduces the basics of habitat restoration through exploring restoration concepts, terminology, and methods. Learn about common restoration tools and weigh the trade-offs land managers juggle when planning a restoration project. You will work as part of a team using design principles to plan, budget, and market a restoration plan to a land manager.

Background Information

Habitat restoration goes beyond protecting or preserving land and natural resources. Through the use of a wide variety of techniques and tools, restoration ecologists are learning to return degraded land to a condition that resembles its pre-disturbance state in both community structure and function.

The Society for Ecological Restoration (SER) International defines **habitat restoration** as “the process of assisting the recovery of an ecosystem that has been degraded, damaged, or destroyed.” Many aspects of restoration are still being debated amongst scientists and on-the-ground practitioners in the habitat restoration community. A prime pending question is how to define the end result of a restoration project. In North America, should we be restoring conditions thought to have occurred before Euro-American settlement? What about ecosystems that had been influenced by human cultures prior to European contact? The indigenous people of our country manipulated ecosystems with fire for thousands of years; how should that be taken into account? Can we really re-create an ecosystem that existed hundreds of years ago and do we even have the necessary data to do so? Since ecosystems are constantly changing through the process of succession, what stage of succession should a restoration project strive to reach? These are all questions that land managers and restoration practitioners must address while planning a project.

Humans are altering natural ecosystems at an accelerating rate, frequently through resource extraction or urbanization. In an attempt to counteract some of this habitat destruction, the process of **mitigation** has been introduced by government regulatory agencies. How does the mitigation system work? If a wetland, for example, is destroyed to build a new shopping mall, the mall builders must create (or pay to create) a new wetland in another location to compensate for the loss of the wetland now under the shopping mall. The theory behind mitigation is that there is no net loss of habitat. Do you think creating or enhancing an existing wetland in a different location can fully compensate for the loss of a naturally existing wetland?



Designing a Habitat Restoration Plan

Background Information, continued

In some cases, clean-up and **restoration** of an extremely polluted or degraded site is considered mitigation. At many mining sites the topography, hydrology, and soils of a site have been so altered that it is impossible to restore them to their original condition. In that case, the goal is often merely to reduce pollution from the site and **rehabilitate** it to a usable state. This process is termed "**reclamation**".

In some forests that have been intensively harvested in the past and have had natural fire suppressed, we debate whether or not to thin or remove crowded trees and underbrush to mimic the ecosystem that might have existed with natural fire return intervals and less human intervention. Does this qualify as restoration? Can you think of other ways humans have altered natural ecosystems and are now trying to restore them?

Could restoration have a role in trying to react to climate change? Future restoration debates may center on how climate change may affect plant communities and species ranges. Should we attempt to restore new habitats for species outside their current ranges to plan for the future? Should humans protect some species but not others?

Challenge yourself to define additional terms related to habitat restoration. Some words that you might see used in restoration project discussions are: **re-establish**, **rehabilitate**, and **reintroduce**. Can you think of or find others?

Habitat restoration is a complex process with many steps. All restoration projects include some similar components,

including: defining current and desired future conditions; setting goals and objectives; planning; seeking public involvement and input; establishing work timelines; long term monitoring; and continued management. Good recordkeeping is essential and helps guide the project over the long term. Restoration projects are not completed in a season or even a year, but require many years. The end goal is a self-sustaining ecosystem which resembles a model or reference ecosystem from a similar site.

The chart beginning on the next page includes some restoration tools land managers use to accomplish restoration objectives. This is not an all-inclusive list, but it covers many commonly used restoration tools. Use the information in the chart to help you guide your own decisions as you work through your restoration plan.





Designing a Habitat Restoration Plan

Restoration Tool	Explanation	Benefit	Challenges
Part 1: Planning—Long term success of restoration			
Conduct baseline inventory	Describe current conditions, create list of plant and wildlife species present, note dominant species & rare species	Needed for long term comparison	Can be costly when inventorying a large site
Pick a model or reference ecosystem (What is the desired future condition?)	Study a nearby habitat to act as a model of what the restoration is attempting to achieve	Planning tool for species composition	Possibly no similar sites nearby to use as reference
Use historical data	Search original land surveyor records or explorer's journals to learn about the site's historical conditions	Information can give an overview of the major species present prior to development changes	Records may be difficult to locate, hard to read, incomplete
Create master plan	Write a plan to guide each step of the restoration	A document that all parties can use to guide activities	Plan needs to be kept current with modifications, timetable and monitoring data
Part 2: Restore historical topography and hydrology			
Earthmoving	Large machinery to restore historic topography	Restore natural hydrology	Disturbs soils, may interfere with native plants and wildlife
Drain tile removal	Remove drain tile, ditches, and culverts	Restore natural hydrology; most common at wet sites	May affect neighboring property & local flooding
Dam or water diversion removal	Take out earthen dams and swales that restrain or channel water	Restore natural hydrology	May affect neighboring property & local flooding
Part 3: Site Prep—Control unwanted vegetation (encroaching trees/shrubs, invasive species, other unwanted plants), open areas for planting, reduce competition for seedlings and transplants			
Hand pulling, digging, or cutting	Manually pull, dig, or cut out individual plants.	Good control for small infestations, generally low impact	Labor intensive, may disturb the soil
Herbicide	Chemical control through spot spraying (individual plants) or broadcast spraying (large infestations)	Good for large areas, fast, relatively inexpensive	Leaves chemical residues in soil and water, timing is crucial for application, need chemical applicators license, spray can drift off property, not suitable near water, can have negative effect on pollinators and wildlife
Mowing	Cutting vegetation close to ground level	Prevents plants from producing seed, good control of annuals	Weather or terrain may not be suitable, correct timing essential, repeat mowing will be necessary
Prescribed burning	Low intensity, controlled burn of ground level vegetation	Mimics historic disturbance regime, encourages growth of grasses and flowering plants, discourages shrubs and trees	High cost, permits required, specialized equipment and trained staff needed, weather can be an issue



Designing a Habitat Restoration Plan

Restoration Tool	Explanation	Benefit	Challenges
Part 4: Restore Natural Vegetation—Seeding			
Local seed collection	Hand collect seed from plants at your site or nearby areas	Seed source is well adapted for your site	Labor intensive; plant identification & seed collecting knowledge needed, seed cleaning and storage may be required
Regional seed collected	Purchase seed grown for regional restoration projects	Genetics similar to the plants native to the region	Locating the needed seed may be difficult or impossible
Direct seeding	Directly spread seed onto ground at the site, using broadcast seeding or a seed drill	Inexpensive, less labor-intensive, ideal for large areas	Some species don't establish well from seed, less able to compete with invasive plants than transplants
Plant propagation	Start and grow plants from seed, then transplant to restoration site	Gives more control over seed source and quality of material, plants available when needed	May require greenhouse, specialized seed starting knowledge, time to care for plants
Plant relocations	Move plants from local areas slated for development	Saves plants that might otherwise be destroyed; ensures local plants are used	May be labor intensive, and can only occur at certain times of year
Transplant plugs	Purchase small plants in small rocket-shaped pots	Relatively inexpensive, good availability, efficient to plant	More expensive than seeding, plants are small
Transplant bareroot plants	Purchase started plants for planting when dormant	Relatively inexpensive, easy to plant	Need to be planted when dormant, weather & accessibility issues
Transplant potted plant materials	Purchase well-rooted plants in pots of larger sizes	Established plants	Relatively expensive, will probably need watering for first year
Natural re-establishment of native plants and wildlife	Allow native plants and animals to recolonize on their own. Often native animals return after native plants and food sources have been reestablished.	Inexpensive, uses local seed source, Useful at sites with a minimum of destruction to be repaired.	Slow, leaves areas open for establishment of invasive plants
Part 5: Monitoring—Evaluation			
Mapping	Create a data library. Maintain map of site plantings, locate invasive problems, can use GPS	Guides restoration, essential in communicating with partners	Need to keep updated with changes over time
Photo points	Photos taken from permanently marked fixed points (e.g., a fence post) regularly for long term monitoring	Time saving, general view of restoration, easy to duplicate, inexpensive, gives good overview of changes to site	Gives only a general overview, no specific numerical data, limited use when following specific plant populations
On the ground data collection	Counting (sampling, percent cover, complete counts)	Can give more detailed information, good for tracking specific plant populations	Labor intensive, costly
Part 6: Long Term Maintenance—Simulating natural disturbance cycle and controlling problem species			
Prescribed burning	Low intensity, controlled burn of ground level vegetation, used in grassland and prairie restoration	Mimics historical disturbance regime, encourages growth of grasses and flowering plants, discourages shrubs and trees	Expensive, permits required, specialized equipment and trained staff needed, can only occur under correct weather conditions



Designing a Habitat Restoration Plan

Restoration Tool	Explanation	Benefit	Challenges
Part 6: Long Term Maintenance, continued			
Mowing	Uses large machinery to limit height of vegetation or prevent invasive plants from setting seed, used in grassland and prairie restoration	Replace disturbance regimen to control unwanted vegetation	Equipment can spread weed seeds from other sites, cut material (thatch) may accumulate over time and require removal
Livestock grazing	Run cattle, sheep, goats, or other livestock for part of the year, used in prairie restoration	Can control height of vegetation, browsers (goats) can target brush or grazers (cows, sheep) can target grasses	Animals may feed indiscriminately on all plant material, overgrazing can be harmful, trampling of sensitive species, uncontrolled access to water can denude stream banks, may spread exotic and invasive species

Student Directions

Restoration Scenario: A local landowner recently left a ten acre rural property to a conservation group, Ecosystem Protection Services. The donation came with the stipulation that the land be restored back to prairie to enhance habitat for native plants and wildlife and increase local biodiversity. Previously the site was used for livestock grazing, and it is currently a mixture of non-native grasses and invasive weeds. The site historically supported open prairie that was maintained by Native American tribes who routinely burned the area. The topography is a combination of upland and lowland that is bisected by a standing or slow moving water course during the wet season.

1. Work in teams of 2-4 students to create a restoration plan packet. Your plan will be submitted to the conservation group, Ecosystem Protection Services, as a bid proposal to do the actual restoration work. The plan needs to cover the first year of work including site preparations, restoring natural vegetation, and monitoring. You need to balance the restoration goals, current conditions at the site, environmental concerns you identify, and the costs of your project. There is no single right answer or approach to this project. Use your proposal letter to justify your team's decisions.
2. Identify your restoration goal from the scenario. Write it in your own words using the appropriate restoration terminology. Be sure to extract all the useful information from the scenario for your plan.
3. Use the site map to help design your restoration plan. The map identifies topography, current vegetation, and other factors that you need to take into consideration (e.g., water, neighboring housing). Use one or more map overlays to diagram your restoration plan.
4. Make a budget using the Final Student Budget Keep in mind the individual rate sheet units and the size of your site. Remember that the costs are generally per acre and you are working at a ten acre site. Give an itemized cost for each restoration tool used and calculate the grand total cost for the entire project.
5. Write out a restoration plan to accompany your map. Use your Restoration Plan Budget Worksheet to guide you in the steps needed. Include the tools you will use in site prep, restoring vegetation, and monitoring. The site may dictate using more than one method or tool to reach your plan goals.
6. Sell your proposal by writing a persuasive letter to accompany your bid. Your letter should include why you think your plan describes the best option. The letter should be signed by all the members of your team and addressed to the proper organization.
7. Your completed bid proposal packet will be used to assess your entire team's grade (see rubric at end of lesson).



Designing a Habitat Restoration Plan

In the Field!

Take a field trip to view a restoration project in progress. Ask the managers of the restoration project to talk to the class about what they are doing at the site, including their restoration goals, how the site was selected, what historical data they used, the steps of the project, and where they are in the restoration process. If available, visit restoration sites in various stages of completion (beginning, middle and finished). Make observations in your field journal at each of the sites. Compare the sites: how do they differ, not only in ecosystem type but progress toward their desired future conditions?

Science Inquiry

Collecting monitoring data to assess restoration site conditions before, during and after a restoration project allows land managers to learn what restoration techniques are most effective. They can then use the information to improve future restoration work. Ask if you may be involved in any monitoring that goes along with the restoration site. Talk to the agencies involved to find out what methods they use and what they hope to learn.

Many natural areas have been historically maintained by fire at some frequency. Today, using prescribed fire can frequently come into conflict with present-day policies. Air quality regulations, public perceptions, and safety concerns can all make using prescribed fire a challenge. Brainstorm alternative methods for maintaining a restoration site. How would you test your methods?



-
- **Reflection** •
- This activity has touched on some of the philosophical difficulties •
- associated with habitat restorations. Use what you know to •
- evaluate the ways environmental ethics, public opinion, scientific •
- work, and/or government policy impact your environment and •
- society. Explore your own personal views on one of these topics. •
-
-
-

Taking it Further

Contact a local land management agency to participate in a habitat restoration project. A restoration project is a long term commitment. By partnering with a local project run by a natural resource agency, the class can take as small or as large a part as time allows. Work with your partnering agency to identify lessons that will make this project a true community service-learning experience.

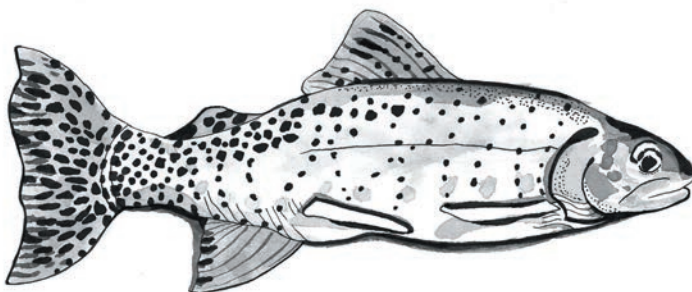



Student Project

Designing a Habitat Restoration Plan

Self Assessments

- 1 What are the component parts of a successful restoration plan?
- 2 List and explain two tools used in each: planning, site prep, restoring vegetation, and monitoring in restoration projects.
- 3 Work as part of a team to complete a restoration project proposal. What did you learn?

Resources

- ◆ The SER International Primer on Ecological Restoration: http://c.ymcdn.com/sites/www.ser.org/resource/resmgr/custompages/publications/SER_Primer/ser_primer.pdf
- ◆ Apostol, Dean, and Marcia Sinclair. (2006.) *Restoring the Pacific Northwest: The Art and Science of Ecological Restoration in Cascadia*. Island Press.
- ◆ A Guide to Prairie and Wetland Restoration in Eastern Nebraska: http://www.prairieplains.org/assets/files/restoration_manual_1.pdf

Prairie Restoration Project Rubric

CATEGORY	Novice (1)	Apprentice (2)	Crew leader (3)	Professional (4)
Restoration Goal	Written in complete sentences, but copied from scenario. No attempt to use restoration terminology.	Written in complete sentences. Includes some factors from scenario, and uses at least one restoration terminology word.	Written using student's words, missing only one or two components, and uses one or more restoration terminology words.	Written in student's own words, encompasses all components from scenario, written in complete sentence form, and showing proper usage of restoration terminology.
Site Map With Overlay	Site map missing overlay. Incomplete key, or map and key do not match restoration tools from plan.	Site map with overlay. Missing one or two restoration tools from plan, or key is not complete or clear.	Site map with overlay. Missing one restoration tool from plan, or key is not complete or clear.	Site map with one or more overlays. Overlay shows all restoration tools used from plan, includes clear and complete key to match plan.
Restoration Plan	Plan is incomplete, missing one or more of the restoration tools needed, or plan does not include entire year.	Plan complete but does not include entire year in logical form, or is missing one of the required restoration tools needed.	Plan complete and addresses all restoration tools needed. Logical plan format could be improved.	Plan is logical to follow, written in paragraph or outline form. Includes one year timetable for site, and addresses all the restoration tools needed.
Budget Sheet	Budget sheet is not complete, missing tools from plan, mistakes in math, or does not include total project costs.	Budget sheet has one or more errors in matching plan, or errors in math, or total project costs.	Budget sheet matches plan, specifies tools used. Math has one or two errors in figuring tool costs.	Budget sheet matches plan and specifies tools used. Math is correct for individual tools and extended for entire job. Total cost of project figured correctly.
Bid Proposal in Persuasive Letter	Letter sloppy, not properly addressed, not signed, or not in proper letter format. Letter does not explain decisions made in plan.	Letter is neat and in proper format. Letter explains some but not all decisions made in plan.	Letter is neat and in proper format. Letter is persuasive in selling the proposal and explains most of the decisions made in the plan.	Letter neat, written in proper format, addressed to company name and signed by all team members. Demonstrates persuasive writing in selling proposal, and explaining all decisions made in plan.



Designing a Habitat Restoration Plan

Map – 10 acre site

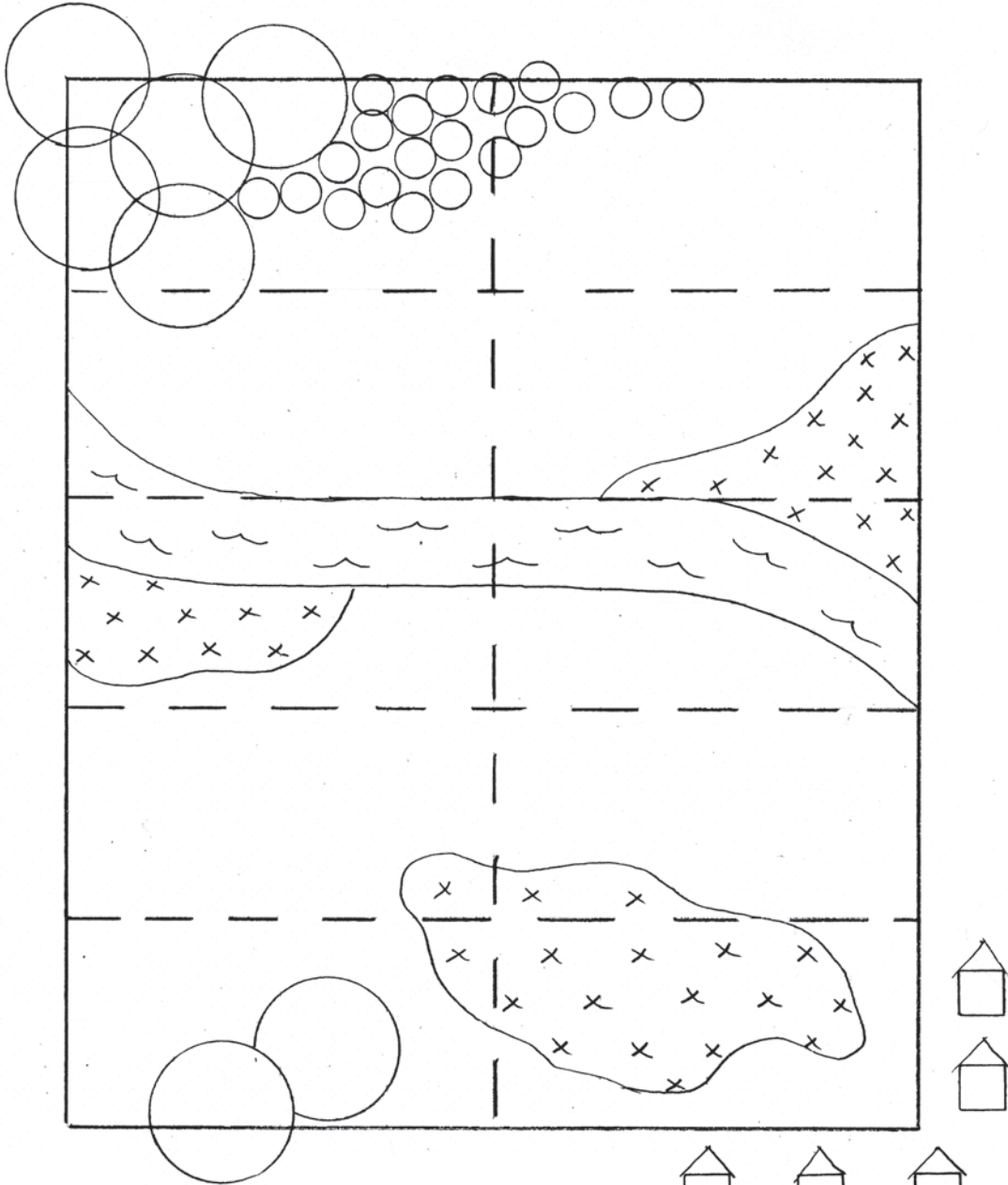

KEY		Water drainage	
Tree		House	
Shrub		Invasive weeds	



Designing a Habitat Restoration Plan

Restoration Plan Budget Worksheet

Activity	Cost/acre	Hourly rate	Cost/pound	Cost/plug	Cost per site	Additional notes
Prescribed burn					\$3,000-5,000	Price range depends on site complexity, location, types of vegetation fuel, and permits
Brush clearing (mechanical)		\$91				Estimate 1 hr/acre
Spot spray		\$61				Estimate 1 hr/acre
Broadcast spray	\$55					Need to be aware of drift issues close to water and housing
Hand pulling		\$25				Estimate 4 hr/acre
Tractor work (seeding, mowing)		\$75				
Plug planting (100 plugs per hour)		\$50				
Grass seed (rate of 5lbs/acre)			\$25			
Wildflower seed (forbs) (rate of 3-5lbs/acre)			\$1000			
Grass & grass-like plug (1210/acre at 6 ft. spacing)				\$0.45		
Wildflower plug (forbs) (1210/acre at 6 ft. spacing)				\$1.40		
Monitoring		\$75.00				Price range depends on site complexity, size, and method used for monitoring. Estimate 1 hr for photo point, 8 hr for sampling, 24 hr for complete count.



Designing a Habitat Restoration Plan

Final Student Budget

	Tool Used	Labor Costs	Cost/Unit (Acres or Hours)	Total Cost for 10 Acre Site
Site prep				
Restoring Natural Vegetation				
Project Monitoring				
Total Project Costs				



References

Exploring Oregon's Ecoregions

Commission for Environmental Cooperation. (2009). "Ecological Regions of North America." Map. Montreal, Canada: Commission for Environmental Cooperation.

U.S. Environmental Protection Agency. (2006). Level III ecoregions of the continental United States (revision of Omernik, 1987): Corvallis, Oregon, USEPA – National Health and Environmental Effects Research Laboratory, Map M-1, various scales.

Wiken, Ed, Francisco Jiménez Nava, and Glenn Griffith. (2011). North American Terrestrial Ecoregions—Level III. Commission for Environmental Cooperation, Montreal, Canada.

The Nature Conservancy (2007). The Hawaiian High Islands Ecoregion. Retrieved from: <http://www.hawaiiecoregionplan.info/ecoregion.html>

University of California Museum of Paleontology. (2007). The World's Biomes. Retrieved from <http://www.ucmp.berkeley.edu/exhibits/biomes/index.php>

Stein, B.A. (2002). States of the Union: Ranking America's Biodiversity. Arlington, Virginia: NatureServe. Retrieved from <http://www.natureserve.org/library/stateofunions.pdf>.

Field Journaling: Observations from a Special Spot

Adapted with permission from: Earth Partnership for Schools. (2007). *K-12 Curriculum Guide*. Madison, WI: University of Wisconsin-Madison Arboretum.

SECTION 1: PLANT IDENTIFICATION

1. What's In A Name?

Hickman, J.C., Ed. (1993). *The Jepson Manual: Higher Plants of California*. Berkeley, CA: University of California Press.

6. The Secret Life of Flowers

Adapted with permission from: National Gardening Association. (1999, September). Digging into Flowers: Pollen, Petals, Pistils, & Other Parts. *Growing Ideas: A Journal of Garden-Based Learning*, 10(3), 4.

The Pollinator Partnership. (2007). *Nature's Partners: Pollinators, Plants, and You. A Comprehensive Pollinator Curriculum For Grades 3-6*. Retrieved from <http://www.pollinator.org/nappc/PDFs/curriculum.pdf>.

Adapted with permission from: National Gardening Association. (1999, September). The Secret Life of Flowers. *Growing Ideas: A Journal of Garden-Based Learning*, 10(3), 1.

7. Plants Have Families Too

Adapted with permission from: Earth Partnership for Schools. (2007). *K-12 Curriculum Guide*. Madison, WI: University of Wisconsin-Madison Arboretum.

8. Botany Bouquet

Adapted with permission from: Earth Partnership for Schools. (2007). *K-12 Curriculum Guide*. Madison, WI: University of Wisconsin-Madison Arboretum.

Secretariat of the Convention on Biological Diversity (n.d.). *Global Strategy for Plant Conservation*. Montreal, Quebec, Canada: Secretariat of the Convention on Biological Diversity.

9. Drupes, Pomes, & Loculicidal Capsules

Dichotomous Key To Common Fruits adapted with permission from Sean T. Coleman, Ph.D., Associate Professor of Biology, University of the Ozarks.

Kessler, R. & Stuppy, W. (2006). *Seeds: Time Capsules of Life* (A. Papadakis, Ed.). Buffalo, NY: Firefly Books.

10. Make Your Own Plant Collection

Botanic Garden Conservation International. (n.d.). Museum National d'Histoire Naturelle. Retrieved from <http://www.bgci.org/garden.php?>

The Academy of Natural Sciences. (2004). *The Lewis and Clark National Bicentennial Celebration*. Retrieved from <http://www.libertyparkusafd.org/>

University of California at Davis. (n.d.). *UC Davis Center for Plant Diversity Herbarium*. Retrieved from <http://herbarium.ucdavis.edu/herbarium.html>

Lawrence, B.A. & Kaye, T.N. (2009). Reintroduction of *Castilleja levisecta*: Effects of ecological similarity, source population genetics, and habitat quality. *Restoration Ecology*: <http://onlinelibrary.wiley.com/doi/10.1111/j.1526-100X.2009.00549.x/abstract>

SECTION 2: ECOREGIONS OF OREGON

14. The Place I Call Home

Commission for Environmental Cooperation. (2009). "Ecological Regions of North America." Map. Montreal, Canada: Commission for Environmental Cooperation.

U.S. Environmental Protection Agency (2006). Level III Ecoregions Of The Continental United States (revision of Omernik, 1987): Corvallis, Oregon, USEPA – National Health and Environmental Effects Research Laboratory, Map M-1, various scales.

Wiken, E., Nava, F.J. & Griffith, J. (2011). North American

References

Terrestrial Ecoregions—Level III. Commission for Environmental Cooperation, Montreal, Canada.

The Nature Conservancy. (2007). The Hawaiian High Islands Ecoregion. Retrieved from: <http://www.hawaiiiecoregionplan.info/ecoregion.html>.

15. Ecosystem Comparisons

Adapted with permission from: Earth Partnership for Schools. (2007). *K-12 Curriculum Guide*. Madison, WI: University of Wisconsin-Madison Arboretum.

Raven, P.H., Evert R.F., & Eichhorn, S.E. (1992). *Biology of Plants* (5th ed.). New York: Worth Publishers.

SECTION 3: ECOLOGY OF NATIVE PLANTS

17. Survival Quest: A Pollination Game

US Forest Service. (2010, October). *Celebrating Wildflowers: Pollinator Syndromes*. Retrieved from <http://www.fs.fed.us/wildflowers/pollinators/syndromes.shtml>.

Oregon Orchid Society. (n.d.). *Orchid Conservation*. Retrieved from <http://www.oregonorchidsociety.org/conservation>.

18. What's Goin' Down Underground

Singer, M.J. & Munns, D.N. (1999). *Soils: An Introduction* (4th ed.). New Jersey: Prentice-Hall, Inc.

Rothrock, P.E. & Squiers, E.R. (2003). Early Succession in a Tallgrass Prairie Restoration and the Effects of Nitrogen, Phosphorus, and Micronutrient Enrichments. *Proceedings of the Indiana Academy of Science*, 112, 160-168.

Campbell, N.A., Reece J.B., Urry, L.A., Cain, M.L., Wasserman, S.A., Minorsky, P.V. & Jackson, R.B. (2008). *Biology* (8th ed.). San Francisco, CA: Pearson Benjamin Cummings.

19. Plant Wars: A Tale of Offense and Defense

Allelopathy. (n.d.). Retrieved from <http://en.wikipedia.org/wiki/Allelopathy>.

Plant defense against herbivory. (n.d.). Retrieved from http://en.wikipedia.org/wiki/Plant_defense_against_herbivory.

Wisconsin Department of Natural Resources. (2004, December). *Butterfly Field Guide: Butterfly-Host Plant Relationships*. Retrieved from: <http://dnr.wi.gov/>.

Raven, P. H., Evert R.F., & Eichhorn, S.E. (1992). *Biology of Plants* (5th ed.). New York: Worth Publishers.

Labandeira, C.C., Dilcher, D.L., Davis, D.R., & Wagner, D.L. (1994). Ninety-seven million years of angiosperm-

insect association: paleobiological insights into the meaning of co-evolution. *Proceedings of the National Academy of Science of the U.S.A.* 91(25): 12278–12282.

Roberts, M.F. & Wink, M. (Eds.). (1998). *Alkaloids: Biochemistry, Ecology, and Medicinal Applications*. New York: Plenum Press.

Gershezon, J. & Kreis, W. (1999). Biochemistry of terpenoids. In M. Wink, *Biochemistry of plant secondary metabolism*. London, England: Sheffield Academic Press.

Van Soest, P. J. (1982). *Nutritional Ecology Of The Ruminant: Ruminant Metabolism, Nutritional Strategies, The Cellulolytic Fermentation, And The Chemistry Of Forages And Plant Fibers*. Corvallis, OR: O & B Books.

SECTION 4: THE GOOD, THE BAD, AND THE UGLY: NATIVE, NON-NATIVE, AND INVASIVE PLANTS

21. Weed Explosion

ODA Plant Division, Noxious Weed Control. (2010). *Bull thistle*. Retrieved from http://www.oregon.gov/ODA/PLANT/WEEDS/profile_bullthistle.shtml.

Oregon Department of Agriculture Noxious Weed Control Program. (2010). *Noxious Weed Control Policy and Classification System*. Retrieved from <http://www.oregon.gov/ODA/shared/Documents/Publications/Weeds/NoxiousWeedPolicyClassification.pdf>.

Zouhar, K. (2002). *Cirsium vulgare*. In Fire Effects Information System. Retrieved from U.S. Department of Agriculture, Forest Service, Rocky Mountain Research Station, Fire Sciences Laboratory website: <http://www.fs.fed.us/database/feis/plants/forb/cirvul/introductory.html>.

Sheley, R., Petroff, J. & Borman, M. (1999). *Introduction to Biology and Management of Noxious Rangeland Weeds*. Corvallis, OR: Oregon State University Press.

US Department of the Interior Bureau of Land Management. (2010, August). *Invasive and Noxious Weeds*. Retrieved from <http://www.blm.gov/wo/st/en/prog/more/weeds.html>.

22. Measuring and Monitoring Plant Populations

Elzinga, C.L., Salzer, D.W. & Willoughby, J.W. *Measuring and Monitoring Plant Populations*. Bureau of Land Management. BLM technical reference manual 1730-1, BLM/RS/ST-98/005+1730: <http://www.blm.gov/nstc/library/pdf/MeasAndMon.pdf>.

References

SECTION 5: ETHNOBOTANY

23. Who Walked Here Before You

Hartless, W. (1945). William Hartless. In Jacobs, M., *Kalapuya Texts*. (p.342). Seattle: University of Washington Press.

U.S. Department of Agriculture Natural Resource Conservation Service. (2000). *Technical notes: Plant Guide for Common Camas, Ethnobotany, Culture, Management, and Use*. Plant Materials No. 25, Portland, OR.

24. My Burden Basket: How Native Plants Are Used For Fiber

The Language of Native American Baskets from the Weaver's View. (n.d.). *Burden baskets*. Retrieved from <http://www.nmai.si.edu/exhibitions/baskets/subpage.cfm?subpage=burden>.

25. Plants As Medicine: Make Your Own Herbal Salve

Medicinal plants. (n.d.). Retrieved September 12, 2008 from http://en.wikipedia.org/wiki/Medicinal_plants.

Waksmundzka-Hajnos, M., Sherma, J. & Kowalska, T. (Eds.). (2008). *Chromatographic Science Series: Thin Layer Chromatography in Phytochemistry* (Vol. 99). Boca Raton, FL: CRC Press.

Reid, W.V., Laird, S.A., Meyer, C.A., Gamez, R., Sittenfeld, A. Janzen, D.H., Gollin, M.A. & Juma, C. (1993, May). *Biodiversity Prospecting: Using Genetic Resources for Sustainable Development*. Retrieved from <http://www.wri.org/publication/biodiversity-prospecting-using-genetic-resources-sustainable-development>.

Raven, P.H., Evert R.F., & Eichhorn, S.E. (1992). *Biology of Plants* (5th ed.). New York: Worth Publishers.

World Health Organization. (1998). *Regulatory Situation of Herbal Medicines—A Worldwide Review*. Retrieved from <http://www.who.int/medicinedocs/en/d/jwhozip57e/4.2.8.html>.

SECTION 6: CLIMATE CHANGE AND PHENOLOGY

26. Phenology: Tracking the Seasons in Your World

Leopold, A. (1949). *A Sand County Almanac*. New York: Oxford University Press.

Miller-Rushing, A.J. & Primack, R.B. (2008). Global Warming and Flowering Times in Thoreau's Concord: A Community Perspective. *Ecology*, 89(2), 332–341.

Visser M.E, Both C, Lambrechts M.M. (2004). Global Climate Change Leads To Mistimed Avian Reproduction. *Adv. Ecol. Res.* 35, 89–110.

Visser M.E., van Noordwijk A.J., Tinbergen J.M., Lessells C.M. (1998). Warmer Springs Lead To Mistimed Reproduction In Great Tits (*Parus major*). *Proc. R. Soc. B.* 265, 1867–1870.

27. Plant Migration Game: A Race Between Plants and Climate Change

Climate Impacts Group. (2008, March). *About Pacific Northwest Climate Change*. Retrieved from <https://cig.uw.edu>.

Gutro, R. (2005, February). *What's The Difference Between Climate And Weather?* Retrieved from National Aeronautics and Space Administration website: http://www.nasa.gov/mission_pages/noaa-n/climate/climate_weather.html.

Climate Leadership Initiative. (2010). *Projected Impacts to Natural Systems in the Mid-Willamette Subbasin: Summary Report*. Eugene, OR: Institute for a Sustainable Environment.

SECTION 7: THE FUTURE OF NATIVE PLANTS

29. Biodiversity and Ecosystem Services: Can't Live Without 'Em

Simpson, E.H. (1949). Measurement of diversity. *Nature*, 163, 688.

Alonso, A., Dallmeier, F., Granek, D. & Raven, P. (2007). *Biodiversity: Connecting with the Tapestry of Life* (2nd ed.). Washington, DC: Smithsonian Institute.

California Academy of Sciences. (2005). *Hotspot: California on the Edge*. Retrieved from <http://www.calacademy.org/exhibits>.

31. Oregon's Native Ecosystems: Design a Habitat Restoration Plan

Clewell, A., Rieger, J. & Munro, J. (2000). *Guidelines for Developing and Managing Ecological Restoration Projects*. Available on the Society for Ecological Restoration website, www.ser.org.

Society for Ecological Restoration International Policy and Science Working Group. (2004). *The SER International Primer on Ecological Restoration*. Society for Ecological Restoration, Tucson, AZ. Available at www.ser.org.

Glossary

- Abiotic the non-living elements of an ecosystem. Example: rocks, water
- Accessory fruit a succulent fruit developing from the receptacle instead of the pistil. A strawberry is an example, with the ripened ovaries' small achene on the fruit surface.
- Achene a simple, dry, indehiscent fruit with a single, small seed that attaches to the ovary wall at only one point, as in the fruit of a sunflower.
- Adaptation. a process over multiple generation in which a species changes to better fit the habitat. Example: Natural selection would favor the deeper-rooted plants during climate shifts that cause drought conditions.
- Adventitious root. . . a root structure developing in an unusual location, such as growing from a stem.
- Aggregate fruit a cluster of small fleshy fruit, as in the cluster of drupelets that make up a raspberry. Arising from several pistils in a single flower, each producing a single drupe that are connected to form the aggregate.
- Allelopathy. the process whereby one plant species produces biochemicals to inhibit the growth of other plant species.
- Alternate. a leaf pattern where one leaf grows from each node on the stem, alternating sides of the stem.
- Analgesic a medicinal pain reliever.
- Angiosperm. a flowering plant that produces seeds in a fruit.
- Annual. a plant that completes its entire life cycle in the same year; germinate, flower, set seed and die.
- Anther the enlarged, pollen-bearing part of the stamen; located at the tip of the filament.
- Antibacterial a substance that inhibits or destroys bacteria.
- Antioxidant a substance that slows oxidation. In the human body it counteracts the negative effects of oxidation on body tissues.
- Assisted migration . . deliberately moving members of a species from their present habitat to a new location with the intent of permanent establishment. Most commonly used in response to habitat loss and climate change.
- Axil the angle point between the stem and the leaf growing from it.
- Azimuth. a description of a location as it relates to North in degrees, minutes, and seconds.
- Basal. leaves growing from the base of the plant stem.
- Berry a simple, fleshy, indehiscent fruit with many seeds, like a tomato or blueberry.
- Biennial a plant that takes two years to complete its life cycle; usually forming a rosette of leaves the first year, and producing flowers and fruit the second year.
- Binomial nomenclature a two-part unique scientific name consisting of a genus and specific epithet. Example: *Camassia quamash*.
- Biochemical a chemical process in living organisms.
- Biodiversity the variation of all life forms within an ecosystem; often used to measure the health of a given ecosystem.
- Biome. the world's major ecological communities, defined by the predominant flora and climate, and covering large geographic areas. Examples: desert, forest, grassland, tundra.
- Biotic the living elements that make up an ecosystem.
- Botany the scientific study of plants.
- Bract. a small, leaf-like part at the base of a flower or along the flowering stem
- Bud. undeveloped stem or flower; covered with scales.
- Bulb a short, vertical, thickened underground stem such as an onion; NOT a root.
- Burden basket a woven basket, usually conical-shaped with pointed or flattened bottom, made in an assortment of sizes and weaves to accommodate the load to be carried.
- Calyx the outermost whorl of flower parts, the collective name for the sepals.

Glossary

- Candidate species. . . plant and animal species that are proposed for addition to the Federal Endangered Species Act (ESA).
- Capsule. a dry, dehiscent fruit with more than one carpel.
- Carbon sink places of carbon accumulation, such as in large forests (organic compounds) or ocean sediments (calcium carbonate); carbon is thus removed from the carbon cycle for moderately long to very long periods of time.¹
- Carpel one section of an ovary.²
- Caryopsis a simple, dry, indehiscent fruit with a single seed that is firmly attached to the ovary wall on all sides and found in grasses; a grain.
- Circumscissile
Capsule a capsule which separates into horizontal top and bottom sections.
- Classification In biological science, a method to group and categorize organisms.
- Clearcut a method of harvesting timber in which all the trees are removed and then the entire plot is replanted.
- Climate the long term predictable weather; the average weather conditions of a particular place over a long period of time. Climate is what allows you to predict what the weather conditions will be next year.
- Climax community. . . the final stage of succession, in which there is a relatively stable plant community with many complex interactions between organisms.
- Coevolution. the process in which species exert selective pressure on each other and gradually evolve new features or behaviors as a result of those pressures.¹
- Coiling. a basket-making technique in which coils of materials are stitched together in a spiraling pattern; designs are made by using different color stitching material.
- Common name a name by which a species is known to the general public, rather than its scientific or taxonomic name; can vary by region or country.
- Community all the organisms within a particular habitat, interacting in a complex food web.
- Competition an interaction between organisms or species for a limited supply of one or more resources (such as food, water, and territory).
- Composite flower . . the clustering of numerous small flowers together on a single flower base (receptacle).
- Compound. a leaf divided into two or more separate leaflets.
- Conservation
biology the scientific study of nature and biodiversity, with the focus on protecting species, their habitats, and ecosystems through stewardship of entire biological communities.
- Cordage several strands of fiber twisted together to make string or rope.
- Cordate. heart-shaped.
- Corm a short, enlarged, vertical underground stem covered with papery leaves.
- Corolla. all the petals of a flower.
- Cotyledon the first leaf of a plant embryo; sometimes called a seed leaf.
- Crustose a crust-like growth form that is closely attached to the substrate, like paint, generally adhering to the lower surface.³
- Cultural landscape . . a landscape created by people and their culture; a product of nature and of human interaction with nature, that the associated people define as heritage resources.⁴
- Culture a system of beliefs, values, and assumptions about life that guide behavior and are shared by a group of people. It includes customs, language, and material artifacts. These are transmitted from generation to generation, rarely with explicit instructions.⁵
- Cuticle a waxy layer found on leaves or stems.
- Day-length duration of the period from sunrise to sunset.⁶
- Dehiscent a type of fruit that opens or releases seed when mature.
- Delisting the process of removing an animal or plant species from the Federal

Glossary

- Dichotomous a splitting of a whole into exactly two non-overlapping parts; from “dichotomy”.
- Dichotomous key. a tool to identify objects (such as plants); a succession of paired choices that progressively lead to a final identification.
- Dicot a plant that sprouts two seed leaves or cotyledons; “di” meaning two, and “cot” referring to cotyledon.
- Disturbance a temporary pronounced change in an ecosystem. This can be a natural disturbance such as fire or flood, or a human-caused disturbance such as clearcutting.
- Dominant species the most numerous and vigorous species. Ecological communities are described and defined by their dominant species.
- Dormancy. a temporary non-growing period in the life cycle of a plant or seed.
- Drupe a simple, fleshy, indehiscent fruit with a single seed with a stony covering, such as a peach or cherry.
- Ecoregion denote areas within which ecosystems (and the type, quality, and quantity of environmental resources) are generally similar. Ecoregions classify patterns and the composition of biotic and abiotic phenomena using geology, physiography, vegetation, climate, soils, land use, wildlife, and hydrology. Examples: Willamette Valley; Northern Basin and Range.⁸
- Ecosystem. an interacting system of biotic and abiotic elements.
- Ecosystem services. the life-sustaining services provided by healthy diverse ecosystems. Examples: flood control; water and air purification; pollination; nutrient cycling.
- Ectomycorrhizae. mycorrhizal fungi that grow on the surface layers of the roots and are commonly associated with trees⁹
- Embryo the un-sprouted young plant contained within the seed.
- Endangered species. an animal or plant species in danger of extinction within the foreseeable future throughout all or a significant portion of its range (see also ESA).⁷
- Endangered Species Act (ESA). The Endangered Species Act of 1973 is federal legislation, intended to provide a means to conserve the ecosystems upon which endangered and threatened species depend, and to provide programs for the conservation of those species, thus preventing extinction of plants and animals. The law is administered by the Department of Interior’s Fish and Wildlife Service (FWS) and the Commerce Department’s National Oceanic and Atmospheric Administration (NOAA) Fisheries, depending on the species protected.⁷
- Endemic found only in a specific geographic area.
- Endocarp the innermost layer of a fruit
- Endomycorrhizae mycorrhizal fungi that grow within the root cells and are commonly associated with grasses, row crops, vegetables, and shrubs.⁹
- Endosperm. the food tissue contained with the embryo within the seed.
- Entire a margin of a leaf that is not toothed, notched or divided.
- Equinox two times during the year (spring and fall) when the sun crosses the plane of the Earth’s equator and day and night are of equal length.¹⁰
- Eradication elimination, complete destruction.¹⁰ Example: The widespread eradication of a species can lead to extinction.
- Ethnobotany the study of the relationship between people and the plants in their environment.
- Exocarp the outermost layer of a fruit
- Exotic introduced, not native
- Extinct a species that no longer exists (see also ESA)
- Extirpated. a species that no longer survives in regions that were once part of its range, but that still exists elsewhere in the wild or in captivity (see also ESA)
- Famine food. a readily available food source strongly associated with hardship

Glossary

- Fauna the animal life of a given area or region
- Fiber cell a plant cell with a thickened wall that gives structure
- Fiber plant a plant used or cultivated for its fibers; fibers used to make or manufacture products
- Fibrous root a root system where the roots are all approximately the same thickness; a system of small, branching roots
- Fibrous resembling fibers
- Field journal a place to record one's observations, interpretations, and data while working in or enjoying the outdoors, used by scientists and naturalists
- filament a thread-like stalk that supports the anther
- Flora the plant life of a given area or region
- Flower The reproductive structure of a flowering plant in which seed development takes place; often colored and showy.
- Foliose a lichen growth form with lobes, loosely or tightly attached to the substrate; leaf-like ³
- Follicle a dry, dehiscent fruit with a single carpel opening on a single side
- Forest thinning a forest management practice of removing trees to allow more space between trees, to maximize growth, and/or to protect from fire and diseases
- Frankia* bacteria a bacteria the converts atmospheric nitrogen gas into ammonia in a process known as nitrogen fixation. *Frankia* bacteria live in root nodules of some woody plants.¹¹
- Frequency the number of occurrences within a given time period.¹⁰
- Fruit ripened flower part that contains the seeds.
- Fruticose a three-dimensional growth form of a lichen, not differentiated into upper and lower surfaces, and including pendulous and stringy, upright, or bushy forms.³
- Fuels reduction using management tools such as thinning, brush removal, and prescribed burns to reduce the amount of surface fuels, to prevent or lessen the severity of wildfires.
- Funiculus the stem-like stalk of a seed, connecting ovule to the placenta.
- Generalist species an organism able to thrive in a wide variety of environmental conditions and with varied resources.
- Genus/
genera (plural) a group of species with similar characteristics or relationship; within the taxonomic classification system following "family." It forms the first word of a scientific name; always Capitalized and italicized.
- Germination the process whereby seeds or spores sprout and begin to grow.¹⁰
- Greenhouse gas gases that trap heat in the atmosphere. Some occur naturally and are emitted in natural processes; others are generated by human activity.¹²
- Gymnosperm a plant that produces seeds in a cone-like structure, instead of contained in the ovary of a fruit.
- Habitat an area that provides a plant or animal with a suitable combination of nutrients, water, shelter, and living space.
- Harden off a process in which plants grown in a greenhouse are slowly exposed to natural conditions (temperatures, sunlight, water) before being planted outdoors.
- Herbaceous a plant with no woody stems; leaves and stems may die down to soil level at the end of the growing season or may persist year round. Can be annual, biennial, or perennial.
- Herbalist someone that uses herbs for healing and medicinal purposes.
- Herbarium/
herbaria (plural) a collection or library of preserved plant specimens. Specimens are dried and mounted or preserved in alcohol for studying taxonomy or geographic distribution; they act as a historical record of change over time.
- Herbivory the consumption of plants by animals, including insects.
- Hesperidium a fleshy fruit with a tough outer skin

Glossary

- Hip or rind. Examples: oranges, lemons.
a berry-like fruit containing many achenes. Example: rose hip.
- Hotspot In reference to biodiversity, hotspot refers to a region that must meet two strict criteria: it must contain at least 1,500 species of vascular plants (>0.5 % of the world's total) as endemics, and it has to have lost at least 70 percent of its original habitat. Twenty five biodiversity hotspots have been identified worldwide.¹³
- Hyphae microscopic fungi cells that usually grow as long threads or strands.⁹
- Imperfect flower a single-sex flower; containing pistils or stamens but not both.
- Indehiscent A fruit that does not open upon maturity.
- Inflorescence a cluster of flowers.
- Internode the part of the stem between leaf nodes.
- Introduced a species that is brought in to an ecosystem by humans (whether accidentally or on purpose) and becomes established there. If the presence of this species causes negative effects in its new location, it is considered "invasive."
- Invasive a species, typically non-native, that causes harm to the environment, economy, or human health.
- Lanceolate a lance- (or sword-) shaped leaf, much longer than wide, with the widest part of the leaf towards the base or bottom.
- Landscape the visible expanse of an area of land, encompassing physical elements (landforms, water bodies), biotic elements (dominant flora and fauna), and human elements (buildings, roads, farms).¹⁴
- Leaf margin the edge of a leaf.
- Leaf flattened, above-ground piece of a plant attached to a stem, usually green during the growing season; uses sunlight to make food for the plant (photosynthesis).
- Leaflet a division of a compound leaf that is similar to a leaf but is attached to a leaf vein instead of the stem.
- Legume a simple, dry, dehiscent fruit that opens along both long edges, as in the fruit of a member of the pea family.
- Lignin a natural polymer found in plant cells that binds cellulose fibers to harden and strengthen cell walls of plants.¹⁰
- Lobed with rounded segments on the margin, such as an Oregon white oak leaf.
- Locule the cavity in the ovary that contains the seed or the anther that contains pollen.
- Loculicidal capsule a dehiscent fruit that disperses seed through the locule cavity.
- Macro very large in scale, scope, or capability.¹⁰
- Margin used to describe the edge of a leaf.
- Mesocarp the middle layer of a fruit.
- Micro-abiotic a small-scale look at an ecosystem's abiotic elements. Example: Small-scale topography (such as cliff, boulder) can affect soils, wind, moisture and other factors that influence plant growth or plant selection in a given spot.
- Microclimate small, local atmospheric zones in which the climate differs from the surrounding area. Example: a protected place that remains warmer than the surrounding area.
- Microscopic so small as to be invisible without a microscope.
- Mitigation steps taken to avoid or minimize negative environmental impacts. Mitigation can include taking protective steps, repairing, restoring, or compensating by replacing.¹⁵
- Monocot a plant that sprouts one seed leaf or cotyledon; "mono" meaning one, and "cot" referring to cotyledon.
- Mulch a protective layer put over soil to inhibit evaporation or weed growth, to control soil temperature, to enrich the soil, or to prevent the dispersal of pathogens.
- Multiple fruit a fruit formed from several separate flowers on a single axis, as in a pineapple.
- Mutualism a symbiotic relationship between two different species in which each gains benefits from the other; they

Glossary

- are interdependent.¹⁰
- Mycelium large mass of fungi hyphae.⁹
- Mycorrhizal fungi . . a type of fungi that colonizes plant roots. They form a mutualistic relationship in which plants supply carbon for the fungi and fungi bring soil nutrients (phosphorus, nitrogen, micronutrients, and perhaps water) to the plant.⁹
- Native a plant that is naturally found in an area, as opposed to a plant that people introduce into an area; see “introduced”.
- Naturalized introduced species, now established in a natural landscape and integrated into the ecosystem.
- Natural landscape . . a landscape unaffected by humans.
- Natural selection . . a process of evolution that acts on variation within a population. Organisms with traits favored within a given set of environmental circumstances have a selective advantage over individuals with different traits; favored traits are only advantageous within a particular situation and may not aid survival in other circumstances.¹⁶
- Nectar a sweet liquid produced in flowers to attract pollinators. Pollinators benefit from the nutrient source and the plant benefits from their pollination services.
- Nitrogen fixing a process in which bacteria convert atmospheric nitrogen gas, which is unavailable for plant use, into ammonia, that can then be taken up by plants. This mutualistic interaction takes place underground in the roots of plants, in the legume family and in some woody plants.
- Node swelling or knob where new growth originates.
- Non-native a plant introduced, purposely or accidentally, by human activity.
- Nonvascular plants lacking a system of cells modified to transport water and nutrients.
- Noxious plant classified as injurious to public health, agriculture, recreation, wildlife, or any public or private property.¹⁷
- Nut indehiscent fruit; hard and dry, usually with one seed.
- Nutlet a small nut.
- Observation the act of noticing or paying attention, using one’s senses.¹⁰ In science, a basic method of collecting data or of developing an understanding of a system.
- Open weave a basket-weaving technique which leaves openings between the weaving; allows water to drain, or used for carrying large items such as firewood.
- Opposite a leaf pattern where two leaves grow across from each other at the same node on the stem.
- Organism an individual living thing that can react to stimuli, reproduce, grow, and maintain homeostasis. Can be a virus, bacterium, fungus, plant, or animal.¹⁵
- Ovary the enlarged base of the pistil that contains the developing seed.
- Ovate oval or egg-shaped, widest at the base.
- Overlay a technique used to add color designs on twined baskets. The colored weaving fiber is woven on the inside of the basket and brought to the front with a half twist to replace the standard weaving fibers as the design calls for. The colored fiber will replace the standard fiber and the weaving will slant in the same direction as the rest of the twining.
- Ovule the unfertilized seed.
- Palmate a shape and vein pattern that is divided from a central point into lobes; similar to a hand with spread fingers.
- Panicle a flower arrangement with a central stalk and branched side stalks, with multiple flowers that mature from the base to the tip.
- Parasite an organism that grows, feeds and is sheltered on or in a different organism while contributing nothing to the survival of its host.¹⁸
- Parasitism a relationship between two different types of organisms in which one benefits (the parasite) at the expense of the other (host).
- Parthenocarpy fruit developed without fertilization or seed development.
- PediceL the stalk of a single flower attached in an inflorescence or a grass.
- Peduncle the stalk of a single flower.

Glossary

- Pepo. an indehiscent fruit; fleshy with many seeds and a tough outer rind/skin or exocarp. Examples: squash, cucumber.
- Percent cover. percent of measured area (for example: ground, sky) covered by a target species; a method of collecting data when monitoring plant populations
- Perennial. a plant that lives three or more years.
- Perfect flower a flower that has both male (stamen) and female (pistil) reproductive parts.
- Pericarp. the outer wall of a fruit.
- Perspective the appearance of things relative to one another as determined by their distance from the viewer.¹⁰
- Petal the whorl of modified flower leaves; usually the brightly-colored, showy part of the flower.
- Petiole a stalk that attaches the leaf to the stem.
- Phenology the study of the timing of life cycle events in plants and animals in relation to changes in season and climate.¹⁹
- Phenotype the observable traits or characteristics of an organism.
- Pheromones. a chemical substance secreted externally by some animals (especially insects) that influences the physiology or behavior of other animals of the same species.¹⁰
- Photoperiod the duration of daily exposure to light, either naturally or artificially.²⁰
- Phytochemical. a plant-derived chemical.
- Phytotoxin a chemical produced by a plant that is toxic to other plants or animals.
- Pinnate leaves or veins emerging from a central stalk or vein.
- Pistil the female reproductive part of the flower, including the stigma, style, and ovary.
- Plant community. all the different plant populations existing within a certain area or habitat.
- Plant diversity the number of plant species per unit of area.²¹
- Plant population. a group of individuals, usually of the same species, within a specific area and at a given time.
- Plot. a small area (frequently a meter square) used as a representative sample within a larger study site.
- Pollination. the process of transferring pollen between anther and stamen.
- Pome a simple, fleshy, indehiscent fruit with a leathery or papery core, such as an apple.
- Poricidal capsule. a dehiscent fruit that opens at pores.
- Precipitation water falling from clouds in any form, such as rain, snow, or sleet.
- Predation a symbiotic relationship between two different species in which one, the predator, feeds on the other, the prey.
- Prescribed burn a management tool used in forestry and ecosystem restoration to clear land of excess organic ground material, get rid of unwanted vegetation, prepare a site for planting, and/or encourage the growth of favorable species.
- Puadrat a square frame used for sampling.
- Raceme a flower arrangement with a central stalk and single, individually-stalked flowers that branch from the central stalk and generally mature from the base to the tip.
- Rare infrequent or uncommon within a sampling site; or scarce within a species' habitat range.
- Receptacle structure at the end of the flower stalk where the flower parts attach.
- Reclamation working to bring disturbed land back to its natural state; reclamation of mining sites.
- Rehabilitation to make habitable or useful again; to return to original condition.
- Reintroduction to return members of a species to their historical range. This strategy is sometimes used when a species has become locally extinct or if its population is threatened.²²
- Restoration. the act, process, or result of returning a degraded or former habitat to a healthy, self-sustaining condition that resembles as closely as possible its pre-disturbed state.²³
- Restoration ecology the application of the principles of ecology to the restoration of derelict, degraded and fragmented ecosystems.²⁴

Glossary

- Rhizobia bacteria . . . the nitrogen-fixing organism associated with root nodules on legumes.¹⁵
- Rhizoid a root-hair-like structure found on moss, liverworts, and some vascular plants.²⁵
- Rhizome an underground stem that travels between plants; differs from a root by the presence of nodes.
- Rhizosphere the microhabitat immediately surrounding plant roots.¹⁵
- Riparian the transitional ecosystem between land and water; the land directly influenced by water along rivers, lakes, and streams.¹⁵
- Root part of a plant without leaves; usually found underground. Roots anchor the plant and take up nutrients (food) and water.
- Samara a simple, dry, indehiscent fruit with wings, as in the fruit of a maple.
- Saprophyte an organism that lives on dead or decaying organic matter.
- Scarification process of cutting or softening of the seed coat to hasten germination.²⁵
- Schizocarp an indehiscent fruit; dry; at maturity, splits into one-seed segments.
- Scientific name the two-part Latin name assigned to a species under the system of binomial nomenclature established in the 1700s by Swedish botanist Carolus Linnaeus.²⁶
- Seasonal round the annual pattern followed in the production or collection of food.²⁷
- Seed coat the outer covering on a seed.
- Seed dispersal methods by which plants spread their seeds. Examples: animal ingestion, wind, water.²⁸
- Seed a mature or ripened ovule.
- Seed-bank a place where seeds are stored for long term preservation; seeds that are present in or on the soil.
- Seed leaf the embryo's first leaf; cotyledon.
- Sepal the green, leaf-like parts of a flower that usually sit directly below the petals.
- Septa the tissue separating the locules.
- Septicidal capsule . . a fruit that disperses seed through the septa.
- Serrate a leaf margin with teeth like a saw.
- Sessile without a stalk, stem, or petiole.
- Silique a dehiscent fruit; dry, longer than wide, and separating into two halves.
- Simple leaf an undivided leaf that is not separated into individual leaflets, but may still be lobed.
- Simple fruit a fruit developing from a single ovary.
- Solitary flower occurring singly and not in a cluster.
- Solitary single.
- Solstice one of the two times of the year (summer/winter) when the sun is at its greatest distance from the equator.¹⁰
- Specialist species . . . an organism that can only thrive in a limited or narrow range of environmental conditions and resources.
- Species a group of organisms that share a unique set of common characteristics and that (usually) can reproduce among themselves but not with other such groups.¹⁵ A species is the basic unit in taxonomic classification, under genus.
- Species of concern an informal term referring to a species that might be in need of conservation action. Such species receive no legal protection and use of the term does not necessarily imply that a species will eventually be proposed for listing under the Endangered Species Act (ESA).⁷
- Spike a flower arrangement with an unbranched, central stalk and single, un-stalked flowers that mature from the base to the tip.
- Spore a walled reproductive cell body capable of giving rise to a new individual, either directly or indirectly
- Stamen the male reproductive part of the flower, including the anther and filament.
- Staple food a food making up the dominant part of the diet, that supplies a major part of a person's nutritional needs for survival; readily available.
- Stem part of the plant that supports the leaves and buds; usually grows above ground.
- Stewardship the responsibility to care for our natural resources sustainably, that is, in a way that preserves them for

Glossary

- Stigma future generations.
the portion of the pistil that is receptive to pollen.
- Stomata the pores or openings which allow the exchange of gases.
- Storyboard a graphic organizer; a series of panels of rough sketches outlining a sequence of actions. Borrowed from the film-making industry.
- Stratification the process of exposing seeds to low temperatures to mimic nature and improve germination rates.
- Structure Structure is a fundamental and sometimes intangible notion covering the recognition, observation, nature, and stability of patterns and relationships of entities.¹⁴
- Style narrow part of the pistil that connects the stigma to the ovary.
- Substrate a surface on which an organism grows or is attached.¹⁰
- Succession in ecology, the gradual and orderly process of change in an ecosystem brought about by the progressive replacement of one community by another until a stable climax is established.¹⁰
- Symbiosis a long-standing relationship between two different species. Usually understood to mean mutualism (beneficial to both); but can also take the form of commensalism (beneficial to one, neutral to the other) or parasitism (beneficial to one, costly or damaging to the other).¹⁵
- Taproot a large central root from which smaller roots branch off, such as a carrot.
- Taxonomy in biology, the study of the general principles of scientific classification; a classification of organisms into groups based on similarities of structure, origin, or other characteristics.¹⁰
- Tepal common term for sepals and petals when both look very much alike.²⁹
- Threatened species an animal or plant species likely to become endangered within the foreseeable future throughout all or a significant portion of its range (see also ESA).⁷
- Topography detailed study of the surface features of a region ¹⁰
- Traditional knowledge knowledge gained through long-standing traditions and practices of regional indigenous communities.
- Transect a line on the ground along which sample plots or points are established for collecting data.³⁰
- Transplant in plants, a technique of moving a plant from one location to another, as in planting a potted plant in the ground.
- Tuber a fleshy, thickened, underground stem. A plant structure used to store nutrients for plant re-growth during the next growing season. Also a means of asexual reproduction.
- Tumpline a woven or leather strap, worn across the forehead or shoulders, attached to a burden basket for hands-free carrying.
- Twining a basketry weaving technique using two or more weft strands passed around the warp structure and twisted. By using different color, size, or texture weft strands, this technique lends itself to intricate decorative design.
- Ubiquitous being present everywhere at once ¹⁰
- Umbel a flat-top or convex umbrella-like inflorescence with multiple small flowers; individual flower stalks arise from approximately the same point.
- Urban growth boundary (UGB) a management tool used to contain urban areas and limit their expansion. It divides land that is urban—to be used for housing, shops, factories—from land that is non-urban and to be used for purposes such as conservation, agriculture, mineral extraction, airports and the like. An urban growth boundary encourages urban consolidation and protects valued non-urban areas from urban development.³¹
- Vascular tissue tissue that conducts water and nutrients through the plant body in higher

Glossary

	plants. ¹⁰
Vein	transports water, sugars, and minerals within the leaf blade; can be seen radiating throughout the leaf.
Warp	in reference to basketry, the vertical elements that the weft fibers weave around; commonly the elements that give a basket structure.
Weather	the atmospheric conditions at a given time, as in rain or sunshine.
Weed.....	any plant out of place, unwanted where it is growing, difficult to get rid of, with an ability to spread. ³²
Weft.....	the horizontal weaving fibers of a basket or mat.
Whorled.....	a leaf arrangement in which three or more leaves are growing from the same node on the stem.
Wildfire.....	a rapidly spreading fire, often occurring in wildland areas, that is out of control. ²⁴
Wildflower.....	wild or uncultivated flowering plant. ¹⁰
Woody	made of, containing, or resembling wood; made hard like wood as the result of the deposition of lignin in the cell walls. Examples: woody plants; perennial herbs with woody stems. ¹⁰



Endnotes

1. Environmental Science: A Global Concern, online glossary, McGraw-Hill Online Learning Center: highered.mcgraw-hill.com/sites/0070294267/student_view0/glossary_a-d.html
2. Horticulture and Crop Science, online glossary of plant parts, Ohio State University: hcs.osu.edu/
3. Epiphytes and Forest Management, online glossary, Oregon State University: people.oregonstate.edu/~mccuneb/glossary.htm
4. Sonoran Desert Educational Center, online kids' glossary: www.pima.gov/cmo/sdcp/kids/gloss.html
5. Building Bridges: A Peace Corps Classroom Guide to Cross-Cultural Understanding: www.peacecorps.gov/www/publications/bridges/pdf/BuildingBridges.pdf
6. National Weather Service Glossary: www.nws.noaa.gov/glossary/index.php
7. US Fish & Wildlife Service Endangered Species Program, online glossary: www.fws.gov/endangered/about/glossary.html
8. Ecoregions, Western Ecology Division, Environmental Protection Agency: www.epa.gov/wed/pages/ecoregions.htm
9. Tugel, Arlene, Ann Lewandowski, Deb Happe-vonArb, eds. 2000. Soil Biology Primer. Rev. ed. Ankeny, Iowa: Soil and Water Conservation Society. Available online: soils.usda.gov/sqi/concepts/soil_biology/biology.html
10. WordNet, Princeton University: wordnet.princeton.edu/
11. Frankia and Actinorhizal Plants: web2.uconn.edu/mcbstaff/benson/Frankia/FrankiaHome.htm
12. Climate Change—Greenhouse Gas Emissions, U.S. Environmental Protection Agency: https://19january2017snapshot.epa.gov/climatechange_.html
13. Biodiversity Hotspots, Conservation International: www.biodiversityhotspots.org/
14. Wikipedia, the Free Encyclopedia: en.wikipedia.org
15. Biology-Online.org: www.biology-online.org/dictionary
16. Understanding Evolution, University of California Museum of Paleontology: evolution.berkeley.edu/evolibrary/article/evo_01

Glossary

17. Noxious Weed Policy and Classification System 2000, Oregon Department of Agriculture Noxious Weed Control Program: www.oregon.gov/oda/plant/weeds/docs/weed_policy.pdf?ga=t
18. Todar's Online Textbook of Bacteriology: www.textbookofbacteriology.net/NHPR.html
19. Project Budburst: www.budburst.org
20. Glossary of Meteorology: <http://glossary.ametsoc.org/?s=p&p=25>
21. Celebrating Wildflowers, U.S. Forest Service: www.fs.fed.us/wildflowers/Rare_Plants/index.html
22. National Geographic's Strange Days on Planet Earth, glossary: www.pbs.org/strangedays/glossary/R.html
23. Water Habitat Restoration; Air, Water, and Climate Change; Executive Office of Energy and Environmental Affairs, Mass.gov: <http://www.mass.gov/eea/>
24. Wiktionary, the Free Dictionary: en.wiktionary.org/wiki/
25. Raven, PH, RF Evert, and SE Eichhorn. 1992. *Biology of Plants* 5th Edition. Worth Publishers.
26. Encyclopedia of Life Learning + Education Group, Museum of Comparative Zoology, Harvard University, glossary: education.eol.org/glossary
27. Definitions of Anthropological Terms, Oregon State University: oregonstate.edu/instruct/anth370/gloss.html
28. Jean-Michel Cousteau Ocean Adventures, PBS, online glossary: www.pbs.org/kqed/oceanadventures/glossary/
29. Key to the Common Spring Wildflowers, glossary, Victoria College, Texas: www2.victoriacollege.edu/dept/bio/flower/key/terms/Glossary.htm
30. The Science Behind Algonquin's Animals online glossary, Algonquin Provincial Park: www.sbaa.ca/glossary.asp
31. The Victorian Coastal Strategy 2008, online glossary, Victorian Coastal Council, Melbourne, Australia: www.vcc.vic.gov.au/
32. Alien Invasion: Plants on the Move, curriculum glossary: weedinvason.org/



APPENDIX I: Recommended Field Guides

Recommended Botanical Field Guides and Natural History References

*	Field Guide.
**	Field Guide; organized by plant families and contain dichotomous keys to help in plant identification. We recommend using these guides when possible.
^	Field Guide; organized by family.
***	Natural history of the botanical community.

GENERAL: TREES OF NORTH AMERICA

Brockman, C. Frank et al. *Trees of North America: A Field Guide to the Major Native and Introduced Species North of Mexico*. New York: St. Martin's, 2001. *

Kershner, Bruce et al. *National Wildlife Federation Field Guide to Trees of North America*. New York: Sterling, 2008. **

Sibley, David. *The Sibley Guide to Trees*. New York: Alfred A. Knopf, 2009. *

SOUTHEAST

Bryson, Charles T., and Michael S. DeFelice. *Weeds of the South*. Athens: University of Georgia, 2009. **^

Hemmerly, Thomas E. *Appalachian Wildflowers*. Athens: University of Georgia, 2000. *

Kirkman, L. Katherine., Claud L. Brown, and Donald Joseph Leopold. *Native Trees of the Southeast*. Portland, OR: Timber, 2007. **

Medina, Barbara F., and Victor Medina. *Southern Appalachian Wildflowers: A Field Guide to Common Wildflowers of the Southern Appalachian Mountains, including Great Smoky Mountains National Park, the Blue Ridge Parkway, and the Chattahoochee National Forest*. Guilford, CT: Falcon, 2002. *

Miller, James H., and Karl V. Miller. *Forest Plants of the Southeast and Their Wildlife Uses*. Athens: University of Georgia, 2005. *

Nelson, Gil. *Atlantic Coastal Plain Wildflowers: A Field Guide to the Wildflowers of the Coastal Regions of Virginia, North Carolina, South Carolina, Georgia, and Northeastern Florida*. Guilford, CT: FalconGuide,

2006. *

Nelson, Gil. *East Gulf Coastal Plain. A Field Guide to the Wildflowers of the East Gulf Coastal Plain, including Southwest Georgia, Northwest Florida, Southern Alabama, Southern Mississippi, and Parts of Southeastern Louisiana*. Guilford, CT: Falcon, 2005. *

Neyland, Ray. *Wildflowers of the Coastal Plain: A Field Guide, Includes the Lower Mississippi River Valley, Gulf, and Atlantic Coastal States*. Baton Rouge: Louisiana State UP, 2009. *^

Spira, Timothy P. *Wildflowers & Plant Communities of the Southern Appalachian Mountains & Piedmont: A Naturalist's Guide to the Carolinas, Virginia, Tennessee, & Georgia*. Chapel Hill: University of North Carolina, 2011. **

Sorrie, Bruce A. *A Field Guide to Wildflowers of the Sandhills Region: North Carolina, South Carolina, Georgia*. Chapel Hill: UNC, 2011. *

Taylor, Walter Kingsley. *Florida Wildflowers: A Comprehensive Guide*. Gainesville: University of Florida, 2013. *

Vidrine, Malcolm F. *The Cajun Prairie: A Natural History*. Eunice, LA: M.F. Vidrine, 2010. ***

NORTHEAST

Clemants, Steven Earl., and Carol Gracie. *Wildflowers in the Field and Forest: A Field Guide to the Northeastern United States*. New York: Oxford UP, 2006. **

Kricher, John C., and Gordon Morrison. *A Field Guide to Eastern Forests, North America*. Boston: Houghton Mifflin, 1988. *

APPENDIX I: Recommended Field Guides

Recommended Botanical Field Guides and Natural History References

*	Field Guide.
**	Field Guide; organized by plant families and contain dichotomous keys to help in plant identification. We recommend using these guides when possible.
^	Field Guide; organized by family.
***	Natural history of the botanical community.

Leopold, Donald Joseph. *Native Plants of the Northeast: A Guide for Gardening & Conservation*. Portland, OR: Timber, 2005. ***

Peterson, Roger Tory, and Margaret McKenny. *A Field Guide to Wildflowers: Northeastern and North-central North America*. Boston: Houghton Mifflin, 1996. *

GREAT LAKES

Black, Merel R., Emmet J. Judziewicz, and Merel R. Black. *Wildflowers of Wisconsin and the Great Lakes Region: A Comprehensive Field Guide*. Madison, WI: University of Wisconsin, 2009. *

Chadde, Steve. *A Great Lakes Wetland Flora*. Pocket Flora Press. 2002. **^

GREAT LAKES (continued)

Oslund, Clayton, and Michele Oslund. *What's Doin' the Bloomin'?: Pictorial Field Guide to Wildflowers, by Season, of the Upper Great Lakes Regions, Eastern Canada and Northeastern U.S.* Duluth, MN: Plant Pics LLP, 2002. *

Peterson, Roger Tory, and Margaret McKenny. *A Field Guide to Wildflowers: Northeastern and North-central North America*. Boston: Houghton Mifflin, 1996. *

Tekiela, Stan. *Wildflowers of Michigan Field Guide*. Cambridge, MN.: Adventure Publications, 2000. *

Tekiela, Stan. *Wildflowers of Minnesota: Field Guide*. Cambridge, MN: Adventure Publications, 1999. *

Weatherbee, Ellen Elliott. *Guide to Great Lakes Coastal Plants*. Ann Arbor: University of Michigan, 2006. *

Yatskievych, Kay. *Field Guide to Indiana Wildflowers*. Bloomington: Indiana UP, 2000. *

GREAT PLAINS

Farrar, Jon. *Field Guide to Wildflowers of Nebraska and the Great Plains*. Lincoln, Neb.: Nebraskaland Magazine, 1990. *

Freeman, Craig Carl., and Eileen K. Schofield. *Roadside Wildflowers of the Southern Great Plains*. Lawrence, Kan.: University of Kansas, 1991. *

Kirkpatrick, Zoe Merriman. *Wildflowers of the Western Plains: A Field Guide*. Austin: University of Texas, 1992. *^

Kirt, Russell R., Henrietta H. Tweedie, and Roberta L. Simonds. *Prairie Plants of the Midwest: Identification and Ecology*. Champaign, IL: Stipes Pub., 1995. *

Ladd, Douglas M., and Frank Oberle. *Tallgrass Prairie Wildflowers: A Field Guide to the Wildflowers, Grasses, and Woody Vines of the Tallgrass Prairie*. Guilford, CT: Globe Pequot, 2005. *

Savage, Candace Sherk. *Prairie: A Natural History*. Vancouver: Greystone, 2011. ***

SOUTHWEST

Blackwell, Laird R. *Great Basin Wildflowers: A Field Guide to Common Wildflowers of the High Deserts of Nevada, Utah, and Oregon*. Guilford, CT: Falcon-Guide, 2006. *^

Bowers, Janice Emily., and Brian Wignall. *Shrubs and Trees of the Southwest Deserts*. Tucson, AZ: Southwest Parks and Monuments Association, 1993. *

APPENDIX I: Recommended Field Guides

Recommended Botanical Field Guides and Natural History References

*	Field Guide.
**	Field Guide; organized by plant families and contain dichotomous keys to help in plant identification. We recommend using these guides when possible.
^	Field Guide; organized by family.
***	Natural history of the botanical community.

Brown, David E. *Biotic Communities: Southwestern United States and Northwestern Mexico*. Salt Lake City: University of Utah, 1994. *

Carter, Jack L., Martha A. Carter, and Donna J. Stevens. *Common Southwestern Native Plants: An Identification Guide*. Silver City, NM: Mimbres Pub., 2003. *

Fagan, Damian, D. D. Dowden. *Canyon Country Wildflowers: A Guide to Common Wildflowers, Shrubs, and Trees*. Guilford, CT: FalconGuides, 2012. *

Fischer, Pierre C. *Seventy Common Cacti of the Southwest*. Tucson, AZ: Southwest Parks and Monuments Association, 1991. *

Mackay, Pam. *Mojave Desert Wildflowers: A Field Guide to Wildflowers, Trees, and Shrubs of the Mojave Desert, including the Mojave National Preserve, Death Valley National Park, and Joshua Tree National Park*. Morrison Book Publishing, LLC: Kearney (Nebraska), 2013. *^

Mozingo, Hugh Nelson, and Christine Stetter. *Shrubs of the Great Basin: A Natural History*. Reno: University of Nevada, 1987. *^

Niehaus, Theodore F. *Southwestern and Texas Wildflowers*. Norwalk, CT: Easton, 1984. *

Quinn, Meg. *Wildflowers of the Desert Southwest*. Tucson, AZ: Rio Nuevo Pub., 2000. *

Spellenberg, Richard. *Sonoran Desert Wildflowers: A Field Guide to Common Species of the Sonoran Desert, including Anza-Borrego Desert State Park, Saguaro National Park, Organ Pipe Cactus National Monument, Ironwood Forest National Monument, and the Sonoran Portion of Joshua Tree National Park*. Guil-

ford, CT: Falcon, 2003. *

Stewart, Jon Mark. *Mojave Desert Wildflowers: A Field Guide to High Desert Wildflowers of California, Nevada, and Arizona*. Albuquerque, NM: Jon Stewart Photography, 1998. *^

Taylor, Ronald J and Kathleen Ort (ed.). *Desert Wildflowers of North America*. Missoula, MT: Mountain Pub., 1998.*^

Taylor, Ronald J. *Sagebrush Country: A Wildflower Sanctuary*. Missoula, MT: Mountain Pub., 1992. *^

Whitson, Tom D., and L. C. Burrill. *Weeds of the West*. Western Society of Weed Science in Cooperation with the Western United States Land Grant Universities Cooperative Extension Services and the University of Wyoming, 2006.*

PACIFIC NORTHWEST

Clark, Lewis. *Wildflowers of Field and Slope in the Pacific Northwest*. Harbour Publishing. 2002.*

Clark, Lewis. *Wildflowers of Forest and Woodland in the Pacific Northwest*. Harbour Publishing. 2003.*

Clark, Lewis. *Wildflowers of the Mountains in the Pacific Northwest*. Harbour Publishing. 2003. *

Clark, Lewis. *Wildflowers of the Pacific Northwest*. Harbour Publishing. 1998. *

Clark, Lewis. *Wildflowers of the Sea Coast in the Pacific Northwest*. Harbour Publishing. 2004. *

Ross, Robert A., *Wildflowers of the Western Cascades*. Henrietta L. Chambers and Shirley A. Stevenson. 1988. Timber Press. *

Fagan, Damian. *Pacific Northwest Wildflowers: A Guide to Common Wildflowers of Washington, Oregon, Northern California, Western Idaho, Southeast Alaska and British Columbia*. Helena, MT: Falcon Pub., 2006. *

Gilkey, Helen M., La Rea Dennis and L.D. Johnston. *Handbook of Northwestern Plants. Revised Edition*. Oregon State University Press. 2001. *^

Horn, Elizabeth L. *Coastal Wildflowers of the Pacific Northwest: Wildflowers and Flowering Shrubs from British Columbia to Northern California*. Missoula, MT: Mountain Pub., 1993. *

Pojar, Jim, A. MacKinnon, and Paul B. Alaback. *Plants of the Pacific Northwest Coast: Washington, Oregon, British Columbia & Alaska*. Redmond, WA: Lone Pine Pub., 1994 ***^

Taylor, Ronald J. *Northwest Weeds: The Ugly and Beautiful Villains of Fields, Gardens, and Roadsides*. Missoula, MT: Mountain Pub., 1990. *

Turner, Mark, and Phyllis Gustafson. *Wildflowers of the Pacific Northwest*. Portland, OR: Timber, 2006. *

INTERMOUNTAIN WEST

Craighead, John J., Frank C. Craighead, and Ray J. Davis. *A Field Guide to Rocky Mountain Wildflowers: Northern Arizona and New Mexico to British Columbia*. Boston: Houghton Mifflin, 1991. *

Kershaw, Linda, A. MacKinnon, and Jim Pojar *Plants of the Rocky Mountains*. Edmonton: Lone Pine Pub., 1998. **

Pesman, M. Walter and Dan Johnson *Meet the Natives: A Field Guide to Rocky Mountain Wildflowers, Trees, and Shrubs: Bridging the Gap between Trail and Garden*. Boulder, CO: Johnson, 2011. Print. *

Petrides, George A. *Trees of the Rocky Mountains and Intermountain West*. Mechanicsburg, PA: Stackpole, 2005.

Scotter, G. W., Hälle Flygare, and G. W. Scotter. *Wildflowers of the Rocky Mountains*. North Vancouver, B.C.: Whitecap, 2007. *

Taylor, Ronald J. *Desert Wildflowers of North America*. Missoula, MT: Mountain Pub., 1998. ^

Taylor, Ronald J. *Sagebrush Country: A Wildflower Sanctuary*. Missoula, MT: Mountain Pub., 1992. ^

Watts, Tom. *Rocky Mountain Tree Finder: A Pocket Manual for Identifying Rocky Mountain Trees*. Berkeley, CA: Nature Study Guild, 2008. **

Wingate, Janet L. *Rocky Mountain Flower Finder: A Guide to Wildflowers Found below Tree Line in the Rocky Mountains*. Berkeley: Nature Study Guild, 1990. **

HAWAII

Hall, John B., John P. Hoover, Ken Suzuki, and Robert Aldinger. *A Hiker's Guide to Trailside Plants in Hawaii*. Honolulu, Hawaii: Mutual Pub., 2008. *

Kepler, Angela Kay. *Hawaii's Floral Splendor: A Friendly Color Identification Guide to Native and Introduced Flowers of All the Hawaiian Islands*. Honolulu, Hawaii: Mutual Pub., 1997. *

Sohmer, S. H., and Robert Gustafson. *Plants and Flowers of Hawaii*. Honolulu: University of Hawaii, 1987. *

Walther, Michael. *A Guide to Hawai'i's Coastal Plants*. Honolulu, HI: Mutual Pub., 2004.*

Wood, Paul, and Ron Dahlquist. *Flowers and Plants of Hawaii*. Waipahu, Hawaii: Island Heritage, 2005. *



APPENDIX II: Ethnobotany Resources

PRINT RESOURCES	
Moerman, Daniel E. <i>Native American Ethnobotany</i> . Portland, Or.: Timber, 1998.	A leading compendium of the plants used by North American native peoples for medicine, food, fiber, and dye.
Ford, Richard I. <i>Prehistoric Food Production in North America</i> . Ann Arbor, MI: Museum of Anthropology, University of Michigan, 1985. Print.	A scientific journal article discussing prehistoric food production among North America's native peoples.
Sumner, Judith. <i>The Natural History of Medicinal Plants</i> . Portland, Or.: Timber, 2008.	A look at the chemistry of pharmaceutical native plants used by various cultures.
Berzok, Linda Murray. <i>American Indian Food</i> . Westport, CT: Greenwood, 2005.	The changing story of Native American food culture including prehistory and American history after European arrival. Includes some recipes and information on foraging and preparation.
Kavasch, E. Barrie. <i>Native Harvests: American Indian Wild Foods and Recipes</i> . Mineola, NY: Dover Publications, 2005.	A recipe book and primer on Native American foods and food preparation, including descriptions of ceremonial and medicinal plants.
Waheenee, and Gilbert Livingstone Wilson. <i>Native American Gardening: Buffalobird-Woman's Guide to Traditional Methods</i> . Mineola, NY: Dover Publications, 2005. Print.	The result of Wilson's early 1900s interview with Buffalobird-woman, a North Dakota Hidatsa woman, on the traditional agricultural methods of her tribe. A fascinating primer on traditional gardening and food production in the Great Plains.
Moore, Michael. <i>Medicinal Plants of the Pacific West</i> . Santa Fe: Museum of New Mexico, 2011.	A thorough guide to medicinal plants of the Pacific Northwest.
Moore, Michael. <i>Medicinal Plants of the Mountain West</i> . Santa Fe: Museum of New Mexico, 2003.	A thorough guide to medicinal plants of the mountain west region.
Tilford, Gregory L. <i>Edible and Medicinal Plants of the West</i> . Missoula, MT: Mountain Pub., 1997.	Ethnobotany of the mountain west region.
Kershaw, Linda. <i>Edible & Medicinal Plants of the Rockies</i> . Edmonton: Lone Pine Pub., 2000.	Ethnobotany of the mountain west region.
Moore, Michael. <i>Medicinal Plants of the Desert and Canyon West: A Guide to Identifying, Preparing, and Using Traditional Medicinal Plants Found in the Deserts and Canyons of the West and Southwest</i> . Santa Fe, NM: Museum of New Mexico, 1989.	A thorough guide to the medicinal plants of the desert Southwest.
Alfs, Matthew, and Matthew Alfs. <i>Edible & Medicinal Wild Plants of the Midwest</i> . New Brighton, MN: Old Theology Book House, 2013.	Midwestern edible and medicinal plants guide.
Peterson, Lee, and Roger Tory Peterson. <i>A Field Guide to Edible Wild Plants of Eastern and Central North America</i> . Boston: Houghton Mifflin, 1977.	Eastern and Midwestern edible plants guide.
Foster, Steven, James A. Duke, and Steven Foster. <i>A Field Guide to Medicinal Plants and Herbs of Eastern and Central North America</i> . Boston: Houghton Mifflin, 2000.	Eastern and Midwestern medicinal plants guide.
ONLINE RESOURCES	
National Museum of the American Indian Collections Database; Smithsonian Institute	http://www.americanindian.si.edu/searchcollections/home.aspx
Native American Ethnobotany Database; Daniel Moerman; University of Michigan	http://herb.umd.umich.edu/
Library of Congress; Ethnobotany of the Americas	http://www.loc.gov/rr/scitech/tracer-bullets/ethnobotanytb.html

APPENDIX III: Ecoregions of the United States

There are different levels of ecoregional organization, as well as different methods of classifying ecoregions. This curriculum uses a classification system developed by the Commission for Environmental Cooperation (CEC) and the Environmental Protection Agency (EPA), which uses three different nested scales, or levels, of ecoregion division. This curriculum uses two different levels of ecoregional divisions: the broadest divisions, level I, which splits the United States into thirteen ecoregions.* Each of these broad ecoregions can be divided into subsequently smaller and smaller units for more detailed study. To help students gain an understanding of their local environment, this curriculum also includes study of level III ecoregions.

*Note: The state of Hawaii represents the thirteenth ecoregion, classified by the Nature Conservancy as the Hawaiian High Islands Ecoregion. Hawaii is not included in the CEC ecoregion classification system.

The Commission for Environmental Cooperation (CEC) is an international organization whose members are Canada, Mexico and the United States. The CEC was created under the North American Agreement on Environmental Cooperation (NAAEC) to address regional environmental concerns, help prevent potential trade and environmental conflicts and promote the effective enforcement of environmental law.

Level I Ecoregions:

Eastern Temperate Forests



Physical Setting:

This humid ecoregion is mostly low in elevation, with the Appalachian Mountains running north-south reaching elevations of over 2,000 meters. The north is glacially influenced. Perennial streams, large watercourses, lakes, and wetlands are abundant.

The climate changes along the latitudinal gradient from cool, continental to subtropical. The climate is generally warm, humid and temperate, with hot summers and mild to cool winters.

Average annual temperatures:	4°C - 22°C
Average summer temperatures:	27°C - 32°C
Average winter temperatures:	-12°C - 4°C
Average annual precipitation:	100 cm to 150 cm

Characteristic Native Plants:

This ecoregion has a wide diversity of native broadleaf trees, including many species of oak, maple, beech, hickory, ash and elm. Forests are often mixed conifer-deciduous, with a variety of pine species being common. Black cherry, yellow poplar, sweet gum, basswood, hackberry, persimmon, eastern red cedar and flowering dogwood are also common here.

Characteristic Native Wildlife:

Common mammals include gray squirrel, eastern chipmunk, raccoon, porcupine, gray fox, bobcat, white-tailed deer and black bear. These forests host an incredibly rich diversity of bird, amphibian, reptile, and fish species.

This heavily populated ecoregion covers much of the eastern United States, from the Great Lakes to the Gulf of Mexico and from the farm country of Iowa, Oklahoma, and Texas east to the Atlantic Coast. The forests have a dense canopy of mixed deciduous trees and needle-leaf conifers.

Adapted from: North American Terrestrial Ecoregions Level I.
Commission for Environmental Cooperation, Montreal, Canada.
<http://www.cec.org>

APPENDIX III: Ecoregions of the United States

Marine West Coast Forests



This ecoregion stretches along the Pacific Coast from Alaska to northern California. The landscape is dominated by mountains and fringed by coastal plains. These are North America's temperate rainforests, the wettest and among the most productive forests in the nation.

Adapted from: North American Terrestrial Ecoregions Level I. Commission for Environmental Cooperation, Montreal, Canada. <http://www.cec.org>

Physical Setting:

The landscape is dominated by volcanic and glacially influenced mountains, with some glacially influenced coastal plains. Heavy rainfall has resulted in leached, nutrient-poor soils throughout much of the forests.

The climate is moderated by the adjacent Pacific Ocean, decreasing seasonal temperature extremes. The region is heavily influenced by high annual precipitation.

Average annual temperatures:	5°C - 9°C
Average summer temperatures:	10°C - 16°C
Average winter temperatures:	-1°C - -3°C
Average annual precipitation:	150 cm - 300 cm, with extremes of 500 cm along the northern coast.

Characteristic Native Plants:

Coastal rainforests: Western red cedar, western hemlock, Douglas-fir, Sitka spruce, California redwood. **Drier valleys:** Garry oak, Pacific madrone, Douglas-fir. **Sub-alpine:** Mountain hemlock, amabilis fir. **Alpine:** shrubs, forb, mosses and lichens.

Characteristic Native Wildlife:

Black-tailed deer, black and grizzly bear, elk, wolf, otter, raccoon, quail, marbled murrelets, cormorants, gulls, mures, petrels and puffins, and northwestern crows.

Great Plains



The Great Plains stretch from far north in Alberta south into Mexico, and is comprised of vast grasslands. These vast grasslands were maintained by climate, grazing ungulates, and fire. The topography is relatively flat and open. Much of this ecoregion has been converted to agriculture.

Adapted from: North American Terrestrial Ecoregions Level I. Commission for Environmental Cooperation, Montreal, Canada. <http://www.cec.org>

Physical Setting:

The topography is relatively flat and open. The northern reaches are dotted with glacially influenced wetlands. Tablelands, plateaus, and rolling hills are shaped by erosive winds and water. The Great Plains grasslands were characterized by deep, fertile soils, much of which have been damaged by intensive agriculture.

The climate varies from north to south along the latitudinal gradient. Western grasslands, in the rainshadow of the Rocky Mountains, are drier. Precipitation increases toward the east, where native vegetation is taller and more lush.

Average annual temperatures:	1.5°C - 25°C
Average annual precipitation:	25 cm - 115 cm

Characteristic Native Plants:

The ecoregion was dominated by a wide diversity of grasses, especially grama, wheat, bluestem, fescue, spear, and buffalo. Forbs were also diverse here, especially in the families Asteraceae and Fabaceae. Shrubby areas include fringed sage, sagebrush, mesquite and yucca. Treed areas include aspen, cottonwood, hickory, and oak.

Characteristic Native Wildlife:

Water bodies are important grounds for migrating waterfowl. Huge herds of bison and pronghorn antelope once grazed here. Coyotes, grizzly bear, wolves, deer, and elk were also once common.

APPENDIX III: Ecoregions of the United States

North American Forests



Physical Setting:

The topography of the North American Forests is extremely varied, from rolling hills, to the basin and range of the Great Basin, to high plateaus, tablelands, canyon country, and rugged mountains. Soils are dry, lacking organic matter and fertility, and high in calcium carbonate. Streams are often ephemeral.

While temperatures vary greatly, all of these areas are characterized by low precipitation and seasonal temperature extremes. Most precipitation falls in the winter, though some also experience a wetter "monsoon" season in the late summer.

Average annual temperatures: 0°C - 25°C

Average annual precipitation: 13 cm - 38 cm

Characteristic Native Plants:

Low growing shrubs and grasses dominate in this ecoregion. Common shrubs are sagebrush, creosote bush, shadscale, greasewood, and juniper. Cacti species are abundant, as are yucca, ephedra and agave. Many areas host a wide diversity of ephemeral annuals.

Characteristic Native Wildlife:

Mule deer, pronghorn antelope, coyotes, bobcats, jackrabbits, kangaroo rats, mice, and bats are among the common mammals. Birds and reptiles are abundant and diverse here.

The North American Forests include the hot, arid lands of the southwest, but also arid shrublands stretching north into British Columbia. Trees are scarce, with the vegetation being dominated by grasses, shrubs, and cacti which have unique adaptations to survive their harsh environment.

Adapted from: North American Terrestrial Ecoregions Level I.
Commission for Environmental Cooperation, Montreal, Canada.
<http://www.cec.org>

Mediterranean California



Physical Setting:

This ecoregion is located along the interface between the North American tectonic plate and the Pacific tectonic plate and includes many active faults. The topography is comprised of a series of linear mountain ranges which separate broad valleys.

This ecoregion has a Mediterranean climate, characterized by hot, dry summers and mild winters. Precipitation varies greatly from year to year. Most precipitation falls in the winter, often in the form of fog.

Average annual temperature: 6°C - 19°C

Average annual precipitation: 20 - 100 cm

Characteristic Native Plants:

The region is dominated by chaparral communities, which consist of tough, evergreen shrubs such as chamise, ceanothus, and manzanita, which are adapted to frequent fires. Scrub oak, coast live oak, valley oak, and various sagebrush species are common. Many small forbs are fire-adapted as well, and bloom in carpets following wildfire.

Characteristic Native Wildlife:

Mule deer, bobcat, coyote, cougar, kangaroo rats, and pocket mice are characteristic mammals. Ground nesting birds like quail are common, and reptiles, amphibians, and fish are diverse.

This small ecoregion is located along the Pacific Coast from Southern Oregon to the Baja Peninsula. The area is agriculturally productive and densely populated. Vegetation here is a mixture of chaparral shrublands, grasslands, and oak savannas.

Adapted from: North American Terrestrial Ecoregions Level I.
Commission for Environmental Cooperation, Montreal, Canada.
<http://www.cec.org>

APPENDIX III: Ecoregions of the United States

Southwestern Semi-Arid Highlands



Physical Setting:

This ecoregion forms a bridge between the Rocky Mountains and the Sierra Madres. It is characterized by "sky islands," isolated mountains which rise out of dramatically different lowland basins.

The climate is arid, with hot summers and moderate winters. Much of the precipitation falls during late summer "monsoon" season thunderstorms.

Average annual temperature: 12°C - 20°C

Average annual precipitation: 30 cm - 60 cm

Characteristic Native Plants:

The grass and shrub dominated basins include grama grasses, tobosa grass, mesquite, ephedra, sotol, yucca, ocotillo, cacti, and agave. A diversity of oaks, juniper, pinyon pines, chaparral species, and pines are common on the mountain slopes.

Characteristic Native Wildlife:

Common wildlife include mule deer, cougar, jaguar, coyote, bobcat, antelope, jackrabbit, Mexican fox squirrel, hawks, ravens, turkey vulture, canyon wrens, roadrunners, elf owl, acorn woodpecker, and a variety of reptiles including western diamondback rattlesnake and gila monsters.

This ecoregion extends through central Mexico to Arizona and New Mexico in the United States. The hills and plains of this ecoregion are dominated by grasslands, with scrub-shrublands in the transition zones. Livestock grazing is the dominant human activity here.

Adapted from: North American Terrestrial Ecoregions Level I.
Commission for Environmental Cooperation, Montreal, Canada.
<http://www.cec.org>

Temperate Sierras



Physical Setting:

The terrain here features steep foothills and mountains, canyons, and deeply eroded plateaus. Streams here are often ephemeral.

The climate varies with elevation, but in general is arid and warm. Summers are hot and winters are mild. Moisture is split between late summer thunderstorms and late winter precipitation.

Average annual temperature: 3°C - 19°C

Average annual precipitation: 27 cm - 100 cm

Characteristic Native Plants:

At lower elevations, chaparral, pinyon-juniper and oak woodlands are found, featuring Madrean oaks in the south. Higher elevation vegetation communities consist of ponderosa pine forests along with Douglas-fir, southwestern white pine, white fir, and aspen.

Characteristic Native Wildlife:

Mule deer, bighorn sheep, cougar, Mexican gray wolf, coyote, bobcat, ring-tail cat, kit fox, black-tail jackrabbit, tassel-eared squirrel, Cooper's hawk, red-tailed hawk, turkey vulture, canyon wren, and Gila trout are found here.

This ecoregion covers the major mountain ranges of Mexico. In the United States, it includes disjunct mountainous areas of Arizona, New Mexico, and West Texas. Much of the land in this ecoregion is public. Arid shrub and woodlands dominate here.

Adapted from: North American Terrestrial Ecoregions Level I.
Commission for Environmental Cooperation, Montreal, Canada.
<http://www.cec.org>

APPENDIX III: Ecoregions of the United States

Northwestern Forested Mountains

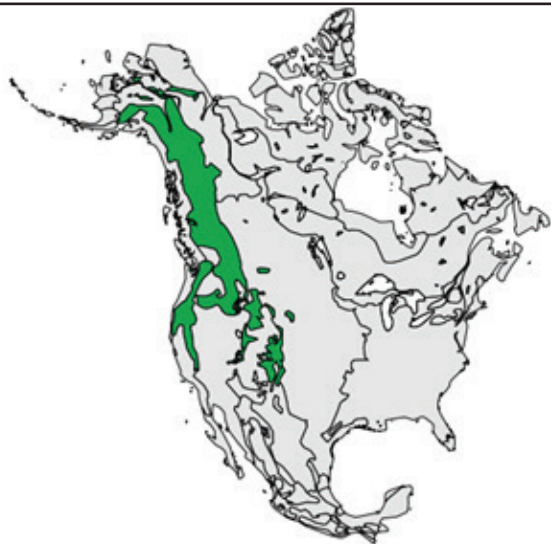

Physical Setting:

The mountains and plateaus of this ecoregion are connected by wide, arid plains. In the mountain slopes, soils are shallow and nutrient-poor, while in the plains soils are better developed and often suitable for agriculture. Higher elevations are cold and range from humid to dry. The plains are often influenced by the rainshadows of adjacent mountains, and are generally arid or subarid.

Average annual temperatures:	-6°C - 10°C
Average summer temperatures:	10°C - 21°C,
Average winter temperatures:	-23°C - 0°C.
Average annual precipitation:	260 cm in the coastal mountains 40 cm in other mountainous areas, to 25 - 50 cm in the plains.

Characteristic Native Plants:

Alpine: small forbs, lichens, and shrub associations. **Sub-alpine:** lodgepole pine, subalpine fir, Engelmann spruce. **Lower mountains:** ponderosa pine, Douglas-fir, lodgepole pine, quaking aspen, western red cedar, western white pine. **Northern Plateaus:** white spruce and black spruce. **Interior Plains:** big sagebrush, rabbitbrush, antelope brush, various bunch grasses.

Characteristic Native Wildlife:

Mule deer, elk, moose, mountain goat, bighorn sheep, coyote, black and grizzly bear, hoary marmot, and pika.

This ecoregion is comprised of chains of mountains that stretch from Alaska south through California and Nevada. It is an system of extremes, ranging from alpine tundra at the peaks of North America's highest mountains to vast conifer forests and dry sagebrush steppes.

Adapted from: North American Terrestrial Ecoregions Level I.
Commission for Environmental Cooperation, Montreal, Canada.
<http://www.cec.org>

Northern Forests



Physical Setting:

The exposed bedrock here forms thin, coarse, and nutrient-poor soils. Some areas of fine-textured soils do occur, and peatlands are extensive in certain areas. Glacial activity has left a legacy of moraines and numerous lakes. Many large river systems are headwatered here.

Summers tend to be short and warm, with long, cold winters. Most precipitation falls during the cool months.

Average annual temperature:	-4°C - 5°C
Average annual precipitation:	40 cm - 100 cm

Characteristic Native Plants:

Conifers including white and black spruce, jack pine, balsam fir, white and red pine, red spruce, and tamarack dominate. Common deciduous trees include white birch, aspen, balsam poplar, sugar maple, and various oaks.

Characteristic Native Wildlife:

Representative mammals include the woodland caribou, white-tailed deer, moose, black bear, raccoon, marten, fisher, striped skunk, lynx, bobcat and eastern chipmunk. Common birds are the boreal owl, great horned owl, ravens, blue jays and many waterfowl.

This large, forested ecoregion is for the most part sparsely populated. It is located on the Canadian Shield, a swath of exposed Precambrian bedrock with thin soil. The ecoregion is comprised of extensive boreal forests, which are dense and primarily evergreen.

Adapted from: North American Terrestrial Ecoregions Level I.
Commission for Environmental Cooperation, Montreal, Canada.
<http://www.cec.org>

APPENDIX III: Ecoregions of the United States

Taiga



Physical Setting:

The topography of this ecoregion is heavily glacially influenced. Thousands of lakes dot the landscape along with rocky glacial deposits. Peat and permafrost cover most lowland areas.

Summers are short and cool with long days, while winters are long and very cold with short days. Precipitation is limited and in many areas of Alaska's taiga falls primarily in the late summer.

Average annual temperature: $-10^{\circ}\text{C} - 0^{\circ}\text{C}$

Average annual precipitation: 20 cm - 50 cm

Characteristic Native Plants:

Lichens and mosses are key parts of these ecosystems, as well as sedges and dwarf shrubs including birches, willows, Labrador tea, and bearberry. Trees, too, are often stunted. Common species are white and black spruce, jack pine, alder, aspen, tamarack, and lodgepole pine.

Characteristic Native Wildlife:

Characteristic mammals include moose, woodland caribou, barren ground caribou, wolves, black bear, marten, lynx, snowshoe hare, arctic fox and arctic ground squirrel. This is an important area for migrating waterfowl. Other common birds are bald eagles, ravens, gray jays, northern shrikes, and sharp-tailed grouse.

The taiga includes the northernmost forest systems in the world, stretching around the globe through Siberia, Scandinavia, Canada, and Alaska. Much of Alaska is taiga, which is comprised primarily of coniferous forests. The landscape is scattered with lakes, bogs, and wetlands. Plants are often dwarfed to adapt to the cold climate.

Adapted from: North American Terrestrial Ecoregions Level I. Commission for Environmental Cooperation, Montreal, Canada. <http://www.cec.org>

Tundra



Physical Setting:

The topography of this ecoregion is heavily glacially influenced. Thousands of lakes dot the landscape along with rocky glacial deposits. Peat and permafrost cover most lowland areas. Much of the area is vast rolling grasslands and mesas.

Summers are short and generally cool with long days, while winters are long and very cold with short days. Precipitation is limited and many areas of Alaska's tundra are classified as desert.

Average annual temperature: $-1.5^{\circ}\text{C} - 6^{\circ}\text{C}$

Average annual precipitation: 10 cm - 50 cm

Characteristic Native Plants:

Lichens, heaths, and mosses are key parts of these ecosystems, as well as sedges and dwarf shrubs including birches and willows. Plants become more dwarfed toward the north.

Characteristic Native Wildlife:

Characteristic mammals include large herds of migratory barren-land and woodland caribou. Also present are grizzly bear, musk oxen, Arctic fox, Arctic hare, polar bear, wolf, moose, Arctic ground squirrel and lemming. Migratory birds are very important to the area, and a diversity of species, especially waterfowl, nest here in the summer months.

The tundra includes the northernmost reaches of the United States and Canada. Short summers and long winters characterize this northern ecoregion. Permafrost is common and much of the landscape is inhabited by dwarfed plants.

Adapted from: North American Terrestrial Ecoregions Level I. Commission for Environmental Cooperation, Montreal, Canada. <http://www.cec.org>

APPENDIX III: Ecoregions of the United States

Tropical Humid Forests



This ecoregion includes very little of the United States, consisting of the Everglades region of Southern Florida from Lake Okeechobee to Key West. In Mexico, the ecoregion includes most of the Yucatan Peninsula and Gulf coast. Abundant wetlands are a defining characteristic here.

Adapted from: North American Terrestrial Ecoregions Level I. Commission for Environmental Cooperation, Montreal, Canada. <http://www.cec.org>

Physical Setting:

This ecoregion is comprised of flat alluvial plains. It is dominated by wet soils, marshland, and swamps. Soils here tend to be rich in organic matter and underlain by porous limestone. Historically, natural wildfires have been frequent and important in maintaining the Everglades ecosystem. Humans have drained large areas of wetlands for development.

It is generally hot and humid here, with a humid subtropical to tropical savanna climate. The short dry season occurs in the winter, while thunderstorms are common throughout the rest of the year. Summers are hot and humid and winters are cool.

Average annual temperature: 22°C - 25°C

Average annual precipitation: 125 cm - 165 cm

Characteristic Native Plants:

Extensive sawgrass marshes are a primary component of the everglades ecosystem, interspersed with tree-islands of slash pine, gumbo limbo, live oak, strangler fig, and royal palm. Pigeon plum, laurel oak, scrub oak, sand pine, and saw palmettos are common. The southern coast and associated islands are comprised of mangrove swamps.

Characteristic Native Wildlife:

The wildlife here is unique and diverse, with alligators, American crocodiles, Florida panther, Key deer, white-tailed deer, manatee, brown pelicans, woodstork, ibis, and herons being characteristic.

Hawaiian Islands



This ecoregion covers the Hawaiian archipelago in the Pacific Ocean. These volcanically formed islands are home to a diverse array of endemic species. The isolation of the islands has led to the evolution of many unique lineages. This ecoregion is distinctly different from any other in the United States.

Adapted from: North American Terrestrial Ecoregions Level I. Commission for Environmental Cooperation, Montreal, Canada. <http://www.cec.org>

Physical Setting:

These islands are highly diverse in elevation, ranging from sea level to over 4,000 meters. While the older islands are marked by steep, eroded topography, the younger islands are comprised largely of fresh volcanic material that continues to be colonized by living organisms.

The tropical/sub-tropical climate here is also highly variable. Both precipitation and temperature vary wildly from one location to the next.

Average annual precipitation: 20 cm - 1000 cm

Characteristic Native Plants:

The Hawaiian Islands vegetation zones include everything from grasslands to tropical forests to montane and alpine habitats. Shrublands are dominated by guava, lantana, koa haole, klu, cacti, and pili grass. Koa, kukui, mamani, ohia lehua, and algarroba are common trees of forested areas, where they grow along with thick ferns, vines, and often epiphytes. Plants adapted to mostly bare lava flows include 'Ōhelo 'ai and 'a'ali'i.

Characteristic Native Wildlife:

Hawaii's only native terrestrial mammal is the Hawaiian hoary bat.

Appendix IV

Make your Own Quadrat Frame

Option 1:

- ◆ 4 – 1 meter x ½ inch PVC tubing pieces
- ◆ 4 right angle elbows
- ◆ PVC adhesive

Build a one-meter-square quadrat frame using PVC tubing. Affix one elbow to each 1-meter piece with PVC adhesive. Transport frame as 4 pieces. Assemble the frame at monitoring site by joining the 4 pieces into a square.

Option 2:

- ◆ 4 – 1 meter sticks or lath
- ◆ 4 screws with wing nuts

Overlap the meter sticks at the end in a right angle. Have someone hold while you drill through both sticks. Insert screw and wing nut, attaching the two. Repeat for the other two meter sticks. Now overlap the ends of the two pieces and drill making a square. Wing nuts can be loosened to fold up the square for easier transporting.

Option 3:

- ◆ 2 – 1 meter x ½ inch PVC tubing sleeves
- ◆ 4+ meters of non-stretch twine or light rope
- ◆ 1 small snap

Thread the two tubing sleeves onto the twine and tie a small loop in the end of the twine. Measure 4 meters of twine, plus 3-5 cm more, and cut. Tie the snap onto this end. The final length of your twine should measure 4 meters from the end of the loop to the end of the snap. Attach the snap to the small loop of twine to make an overall 4-meter loop. Stretch the loop using the tubing, making a square shape, and lay on the ground. This is best used with stakes or flags to secure the corners into a rigid square. (Hint: double check twine measurement after tying; you may need to adjust your knots to make a 4-meter loop)

Using your quadrat frame:

Make sure that your quadrat can be taken apart or folded up for carrying. It is best to leave one corner of the quadrat unattached so you can unfold the quadrat and slide it under the vegetation into place. If all four sides are fixed, you must place the quadrat over the vegetation, which can be difficult with tall plants, shrubs, or trees.



PROJECT BOTANY

Check out additional ecoregion-based curricula
created by the Institute for Applied Ecology
in partnership with the Bureau of Land Management



From Salmonberry to Sagebrush:
Exploring Oregon's Native Plants

From Ponderosa to Prickly Pear:
Exploring the Native Plants of New Mexico

Look for our upcoming Colorado native plant curriculum,
to be published in 2017.

For more information, visit
www.appliedeco.org

