

EDITORS

JOHN TRIMBLE

AMIRA OSMAN

BRIAN STEPHENSON

GADA KADODA

+ KNOWLEDGE  
EXCHANGE  
DIFFUSION  
INNOVATION  
COMMUNITY  
+ EMPOWERMENT  
FORUM  
NETWORKING  
CREATIVE IDEATORS

**9  
T  
H** **INTERNATIONAL CONFERENCE  
ON APPROPRIATE TECHNOLOGY**  
**NOVEMBER 2020**

**I  
C  
A  
T** **TSHWANE UNIVERSITY  
OF TECHNOLOGY, PRETORIA**

**TECHNOLOGY EXCHANGE  
AND EMPLOYMENT CREATION  
FOR COMMUNITY EMPOWERMENT:  
CROSS-POLLINATING  
INNOVATIVE MODELS**



Tshwane University  
of Technology  
*We empower people*

**( 9 T H I C A T )**

# TECHNOLOGY EXCHANGE AND EMPLOYMENT CREATION FOR COMMUNITY EMPOWERMENT: CROSS-POLLINATING INNOVATIVE MODELS

9th International Conference on Appropriate Technology

November 2020

Tshwane University of Technology, Pretoria

Technology Exchange and Employment Creation for Community  
Empowerment: Cross-Pollinating Innovative Models

## Editors

John Trimble

Amira Osman

Brian Stephenson

Gada Kadoda

## Design and layout

Andrea Jonker

Publisher © Tshwane University of Technology

ISSN: 978-0-9870163-7-9

ISBN: 978-0-9993666-8-4

a) All rights reserved. No part of this publication may be reproduced in any form without the written permission of the copyright holder.

b) Applications for the copyright holder's written permission to reproduce any parts of this publication should be addressed to the INAT.

c) No responsibility is assumed by the publishers or the authors of individual papers for any damage to property or persons as a result of operation or use of this publication and/or the information enclosed herein.

d) The views expressed in this publication are not necessarily those of the publishers and editors, neither do they endorse or guarantee any claims made by the authors of the 9TH ICAT abstracts and proceedings. The reader should therefore verify the applicability of the information or particular situations and check the references prior to any reliance thereupon.

## DISCLAIMER

While every effort is made to ensure accuracy in this publication, the publishers and editors make no representation, express or implied, with regard to the accuracy of the information contained in these proceedings and cannot accept any legal responsibility or liability in whole or in part for any errors or omissions that may be made.

## DECLARATION

All the full papers published in this book were double-blind peer reviewed by the 9<sup>th</sup> ICAT/INAT Programme Committee. This process entailed detailed reading of the abstracts, reporting of comments to authors. All full papers were copy edited. The authors of submitted abstracts (those that were accepted by the reviewers) were further invited to submit full papers for consideration for the Proceedings Book. The full papers included in the Proceedings Book are the only ones to have been successfully accepted through the two-tiered, double-blind peer reviewed process.

# TABLE OF CONTENTS

The Contents is active, meaning that each title on the contents page is an active link that enables you, when clicked on, to jump to that particular paper.  
Easily search this document by pressing Ctrl-F (WinPC) or Cmd-F (MacOS)

A Word From The Editors	8
The Peer Review Process	9
Welcome	10
Welcome From The Chair And Co-Chair Of The 9th ICAT Local Organising Committee (LOC)	12
9th ICAT Endorsement	13
9th ICAT Sponsors	16
9th ICAT Sponsors	17
9th ICAT Partners	20
9th ICAT Programme Partners	21
9th ICAT Keynote Speakers	28
9th ICAT Book Editors	32
9th ICAT Programme Committee/Panel Of Reviewers	34
9th ICAT Support Staff And Assistants	47

## CITIES AND SPACES

A Sustainability Specification For Emergency Housing	56
Synergistic Interventions For Sustainability Improvement	68
Evaluation Of Counterhegemonic Technologies: A Case Study Of Self-Managed Social Housing Production In Belo Horizonte, Brazil	78
Improved Grey Models IN Vehicular Co2 Emission Modelling And Forecasting To Decarbonize Urban Areas - Sustainable Environment	88
Insights On Floating Agriculture Approach: A Case Study Of Al-Kalakla Al-Qubba - Khartoum, Sudan	102
Infusing Circular Economy In African Smart Cities	108
The Development Of Homefarm, A Hydroponic Cultivation System Suited To Local Manufacture	120
Community School: An Inclusive Participatory Vision For Social Capital Building From Below	130
Data Analytics For Improved Indoor Air Quality	142

## CONSTRUCTION AND INFRASTRUCTURE

Sanitation Demand, Condition And Coverage In Zithobeni Extension 8 Informal Settlement, City Of Tshwane	156
Appropriate Renewable Energy For Education Infrastructure In Rural South Africa: The Cofimvaba Science Centre Model	168
'Low-Tech' As A Method Of Forging New Gender Archetypes In The Design Of A Male Children's Village In Marabastad, Pretoria, South Africa	178
The Potential Contribution Of Industry 4.0 To The Construction Industry	188
The Integration Of Agri-Tecture With Pre-School Technologies For Sustainable Education	198

A Review Of Critical Project Management Tools For Improving Construction SMEs Project Performance	206
An Overview Of A Sustainable Adoption Support Framework For Optimising Prefabrication Adoption Among Private Developers In The Nigerian Housing Industry	216

## ENERGY AND MATERIALS

A Review Of Cooking Systems And Energy Efficiencies	230
Investigating The Effect Of Yeast On The Anaerobic Digestion Of Cow Dung	240
Investigation Of Water Recycling In An Anaerobic Digester	254
Effect Of Injection Parameters On Cavity Pressure, Tensile And Microstructural Properties Of Plastic Reinforced Composites	266
Advancement Of Polymeric Materials As High Thermal Conductivity And Energy Storage Dielectric Materials Using Graphene Nanosheets: A Review	274
Insiza District Biogas Baseline Survey	282
Manicaland And Mashonaland Biogas Baseline Survey	290
Simulation Study For Potential Use Of Eutectic Plates In South African Medium Refrigerated Transport Vehicle	298
Integrated Rodent Control Strategy For South African Townships: A Systems And Sustainable Urban Development Approach	314
Comparative Thermal Performances Of Different Envelope Wall Designs For Sustainable Solar Cooling	330
Toward An Energy Threshold Hypothesis Model For Social Benefit And Household Energy Usage	346
Simulating The Passive Indoor Environmental Impact Of Three Roof Insulation Types On Urban Residences In Lagos, Nigeria	356
The Retrofitted Gari Roasting Stove: Concept, Design And Analysis	372
Environmental Health Baseline Assessment In The Mangaung Metropolitan Municipality: Rodent Control At Joe Slovo Square Township	384
Feasibility Study Of A Hybrid Photovoltaic-Micro Hydropower System For: A Case Study For Mutema Clinic In Zimbabwe	396

## ENVIRONMENT AND AGRICULTURE

The Use Of Open Source Platforms In The Development Of An Appropriate Irrigation System For Small-Scale Farmers In Johannesburg	410
Incidence Of Brucellosis In Livestock: The Case Of South Africa Between 2010-2019	420

## GREEN ECONOMY AND INNOVATION

Beegining: The Implementation Of Appropriate Beekeeping Technology	432
Integration Of Technology In Communities To Enhance Circular Economy Ideologies Through Waste To Energy Activities - A Peets Approach	446
The Development Of A Desktop Rotational Casting Machine For Increasing Small-Scale Manufacturing Capabilities	454
Household Biogas Digester For Slums, Idps And Refugees Camps: Case Study Of Kass South Darfur, Sudan	466
Food Waste Management In Hospitals	478
Whive Io: Blockchain Protocol For Sustainable And Equitable Token Distribution In Africa	486
Implementation Of Innovative Building Technologies In South Africa - A Review Of Product Performance	494
The Advent Of Cross-Laminated Timber Construction In South Africa	508
Synthesis Of A Novel Heterogeneous Basic Catalyst For Production Of Biodiesel From Waste Oil	518
A Novel Method Of Siloxane Removal From Biogas Process Using A Fixed Bed Digester	528

## HEALTH

Symba: An Exploration Of Appropriate Medical Device Design For The South African Context	544
A Narrative Review Of Lead Poisoning And Anti-Social Behaviour In Sub-Saharan African Countries	558
Qualitative Versus Quantitative Fit-Testing Of Two Commonly Used Respirators In Resource-Limited Healthcare Facilities	570
Not The "Regular" Fit: A Socio-Technical Systems Approach To Designing Eyewear In South Africa	586
Water Supply Systems Assessment And Wash Profile Of Primary Healthcare Centres In Parts Of Southwest Nigeria	596
Evaluation Of Indigenous Technology For Cast Aluminium Cookware Production In Nigeria: A Case Study Of User Health Risks From Cookware Made In Saki	606
The Use Of Technology And Its Influence On The Obesity Epidemic In South Africa	620
Public Health Services Delivered Through The Mobile Phone In The Greater Accra Region Of Ghana- A Qualitative Study	632
Promotion Of Indigenous Foods Consumption For Non-Communicable Diseases Management: A Challenge For South Africa In The 4th Industrial Revolution Context	644
Adaptation To The Impact Of Drought On Water Availability In Communities: A Review	650

## JOB CREATION

663

Product Innovation As A Catalyst For Job Creation - The Case Of Botswana's Small, Micro And Medium Enterprises (SMMEs)	664
--	-----

## KNOWLEDGE AND TECHNOLOGY

Learning From The Ground Up: Community-Driven Renovations Of An Occupied Building In Johannesburg, South Africa	676
The Significance Of Maturity Models Application In Manufacturing Towards Adaptation Of Industry 4.0: A Review	690
Analytical Review Of Technology Transfer In Construction In Developing Countries - A Perspective From Sudan	698
Translating Authorship In Architecture	710
Radical Innovation And Taboo: How To Encourage The Acceptance Of A New Menstrual Product In South Africa Through Behavioural Design	720
Re-Illustrating Old Storybooks For Modern Day Readers	734
Technology Transfer, Human Capital Development And Capacity Building: The Songhai Leadership Model	746
Development Of A Fire Detection And Extinguishing Robot	754
Community Engagement, Knowledge And Technology Exchange: Academic Reflections On A Project At Bertrams, Johannesburg	762
Statistical Modelling Of A High Entropy Alloy Clad Geometry For Aerospace Applications	774
Knowledge Literacy On Fourth Industrial Revolution: A Scientometric Analysis Of Research Outputs From The Ecowas Region In Africa	782
A Community-Informed Concept Of A Rainwater Harvesting Design With Potential To Reduce Water Scarcity In Rural South Africa	796
Open Quintuple Helix Model And Competitive Industrial Performances: Analysis Using The Innovation Synergy Index	810

## POLICY STANDARD AND ETHICS

Africana Ethics: A Key To Sustainable Development Through Appropriate Technology	824
--	-----

## SECURITY AND SAFETY

Accessible Rail Station Platform Independent Gap Filler For Persons With Reduced Mobility	836
---	-----

## SERVICES INDUSTRY

Trip Distribution Analysis Under Demand Uncertainty In Freight Rail Operations	862
Application Of Internet Of Postal Things (Iopt) For Community Development: An Appropriate Technology And Sustainability Development Perspective	870
Application Of Artificial Bee Colony (Abc) Algorithm In A Big-Box Store Or Retail Facility	888

## TECHNOLOGY RESEARCH AND DEVELOPMENT

Development Of Solar-Powered Water Purification Systems	900
Development Of An Automated Coconut Scraping Machine	920
Development Of A Modular Pick And Place Robot/Automated Guided Vehicle (Agv)	934
Prospects Of 3d Printing Of Houses In South Africa	948
Design And Implementation Of A Torque Augmented Mobility Aid	966
Hadoop Cluster Using Raspberry Pi	978

## WATER AND SANITATION

A-Frame Work For Groundwater Quality Monitoring Based On A Participatory Approach, In Sudan	984
---	-----

## A WORD FROM THE EDITORS

**JOHN TRIMBLE**  
**AMIRA OSMAN**  
**BRIAN STEPHENSON**  
**GADA KADODA**

We received a total of 165 abstract submissions and, once we launched the call for full paper submissions based on the outcome of the abstract review process, we received 99 full papers in draft form.

Of the 165 abstracts originally received, only 76 papers were accepted for inclusion in the proceedings, representing an acceptance rate of 46%. The papers published in the final book are from the following countries: Zimbabwe, USA, UK, Sudan, South Africa, Nigeria, Kenya, Ghana, Brazil, Cameroon and Brazil.

This task would simply not have been possible without the commitment, professionalism and support of the Programme Committee, 42 academics and professionals, who volunteered their services to ensure the success of the process. We salute them!

The process we followed has guaranteed the academic quality of scholarship delivered at the Conference and that which is published in the Proceedings. All abstracts have been double-blind peer reviewed. Authors of accepted abstracts were invited to submit full papers, which were then also double-blind peer reviewed.

This is to comply with the requirements for subsidy and accreditation by the South African Department of Higher Education of South Africa.

This process demands a rigorous peer review of papers submitted.

In this book we present you with the accepted papers which were double-blind, peer-reviewed. This process entailed detailed reading of the abstracts/ editing by the Editors as well as the 9TH ICAT Programme Par All full papers were copy edited. It is only the full papers in the Proceedings Book (digitally available) that have successfully been accepted through the complete two-tiered, double-blind, peer-reviewed process.

The sections of the Proceedings book are based on the sub-themes of the conference. The authors selected the themes/topics as part of their submission process.

## THE PEER REVIEW PROCESS

The process followed by the 9<sup>TH</sup> ICAT LOCAL ORGANISING COMMITTEE (LOC) and the PROGRAMME COMMITTEE/PANEL OF REVIEWERS helped guarantee the academic quality of what is delivered at the event and what was published in the Proceedings. An international PROGRAMME COMMITTEE/PANEL OF REVIEWERS with expertise aligned with the sub-themes of the Conference, were appointed. All abstracts were double-blind, peer reviewed. Authors of accepted abstracts were then invited to submit full papers, which were also double-blind, peer reviewed. This process was followed to comply with the requirements for subsidy and accreditation by the South African Department of Higher Education of South Africa. All submitted abstracts and papers were required to adhere to a format provided in the document titled: INSTRUCTIONS FOR AUTHORS. These papers were reviewed by the 9<sup>TH</sup> ICAT EDITORS, who checked them against the themes of the conference. They were then sent to the language editors and returned to the authors for a final check before included in the proceedings book.

This process assured the quality of the conference proceedings and complies with the requirements for subsidy by the South African Department of Higher Education (DHET), a rigorous paper management process was implemented. Each abstract received was double-blind peer reviewed in terms of:

- Relevance to conference theme and objectives
- Originality of material
- Academic rigour
- Contribution to knowledge and
- Research methodology

Authors whose abstracts were accepted after the Stage One review process was completed were provided with anonymous reviewers' comments and requested to submit their full papers, noting and addressing these comments. Evidence was required relative to the action taken by authors regarding the comments received. These resubmitted papers were at least twice blind reviewed again in terms of the same criteria above, including: Critical current literature review.

Authors were included in the Conference Presentation Programme and the Conference Proceedings book only after evidence was provided that all comments were appropriately responded to.

None of the reviewers were involved in the review process related to their own authored or co-authored papers. This process was managed fully online on EASYCHAIR and authors who are also members of the 9<sup>TH</sup> ICAT PROGRAMME COMMITTEE/PANEL OF REVIEWERS could not see their own papers.

### THE INTERNATIONAL NETWORK ON APPROPRIATE TECHNOLOGY STEERING COMMITTEE

C. Bedney, USA; J. Bemley, USA; P. Bofah, USA; H. Carwell, USA; M. Castro, Puerto Rico; T. Dalgety, Guyana; J. Gwamuri, Zimbabwe; G. Kadoda, Sudan; K. Madzima, RSA; K. Mpofo, RSA; M. Muchie, RSA; A. B. Nyoni, Zimbabwe; K. Ngige, Kenya; M. Poe, USA; A. Segla, Benin; D. Soumonni, RSA; B. Stephenson, USA; J. Tharakan, USA; J. Trimble, RSA; C. Verharen, USA.

### THE 9TH ICAT SOUTH AFRICAN LOCAL ORGANISING COMMITTEE

Chair Prof Amira Osman, TUT; Co-Chair Prof Patricia Popoola, TUT; INAT Liaison Prof John Trimble, TUT; Mr Isaac Tlhabadira, TUT; Mr Simon Phuluwa, TUT; Mr Tshifhiwa Nenzhelele, TUT; Dr T Adenuga, TUT; Mr Pule Sekano, TUT; Prof Mammo Muchie, TUT; Prof Khumbulani Mpofo, TUT; Prof Diran Soumonni, WITS Business School; Prof Ilesanmi Daniyan, WITS; Prof Mokgok, TUT; Ms Tsholofelo Queen Mokolopo, TUT; Ms Zanele Sibiyi, TUT; Mr Kgabo Mokgohloa, UNISA; Dr Grace Mukondeleli Katumba, UNISA; Dr. Jabu Mtsweni, CSIR.

*All communications to be directed to Prof Amira Osman @ osmanaos@tut.ac.za or 0027(0)832874006*

# WELCOME TO THE 9TH INTERNATIONAL CONFERENCE ON APPROPRIATE TECHNOLOGY

on behalf of the International Network on Appropriate Technology (INAT),  
we welcome all the participants to our first virtual conference.

The theme for the 9<sup>th</sup> ICAT is *“Technology Exchange and Employment Creation for Community Empowerment: Cross-pollinating innovative Models”*. Our host is Tshwane University of Technology (TUT).

The 1<sup>st</sup> ICAT was held in July 2004, in Bulawayo Zimbabwe, hosted by the National University of Science and Technology (NUST). The theme was *“A Knowledge Management Approach to the Development of Appropriate Technology, with a focus on sustainable land-based projects”*. Two years later, in 2006, we again hosted ICAT through NUST in Bulawayo. Health in underdeveloped countries was addressed with the theme *“Sharing the Knowledge from Research and Practice in Appropriate Technology, with a focus on Health-related projects”*. The 3<sup>rd</sup> ICAT took place in downtown Kigali Rwanda, in November 2008. The theme was *“Promoting Research and Practice in Appropriate Technology: Energy Solutions in the Era of Climate Change”*. The success of the 3<sup>rd</sup> ICAT was in large part due to the strong support from the Rwandan Ministry of Science and Technology under the leadership of Prof. Romain Murenzi. For the 4<sup>th</sup> ICAT, we crossed over to West Africa and held the conference in Accra, Ghana in 2010. Our theme that year, *“Appropriate Technology for Water and Sanitation: Solutions for a Thirsty Planet”*, extended our conference efforts to link appropriate technology to critical basic needs globally. Two years later, we returned to southern Africa, hosting the 5<sup>th</sup> ICAT in Pretoria, South Africa in November 2012, with strong support from the Department of Science and Technology (DST) in South Africa. The theme *“Linking Research, Education and Practice to Inform Policy”*, linked all areas of appropriate technology with a call for policy development that is truly people-centered. Our 6<sup>th</sup> ICAT was hosted by Kenyatta University in Nairobi, Kenya in 2014. It featured several new workshops, including for the first time: a 3D printing workshop and a Raspberry Pi workshop. The theme of the 6<sup>th</sup> ICAT *“Appropriate Technology for the 21st Century: Technological Innovation to Empower Africa”*, served to highlight the importance of innovation in advancing technology in general, and AT in particular.

The theme of the 7<sup>th</sup> ICAT, *“Sustainable Technologies to Empower Communities - Bridging Theory with Practice”*, served to highlight the importance of the practice of appropriate technology being guided by sound theory. It was hosted by NUST at Victoria Falls. Our most recent ICAT, the 8<sup>th</sup> one, was held in Benin and hosted by the Songhai Center with the theme of *“Endogenous Knowledge, Appropriate Technology and Innovation: Linking the Past and the Future”*. The Songhai Center was an excellent model of a blend of appropriate technologies that are providing comprehensive community support.

INAT defines appropriate technology (AT) as technology that is culturally sensitive, yet ecologically sound and economically sustainable. To fully embrace AT, one must be driven by compassion for humankind and Mother Earth. To fully embrace AT, one must be philosophically rooted in the belief that humanism, collectivism and egalitarianism are abiding human characteristics that heighten a collective conscience across human society. To fully embrace AT, one must be committed to organising for AT to replace unproductive and war centered technologies. This process will move AT from the pronouncement of the goal of AT advocates, to a reality where appropriate technology dominates in all realms of science, technology and education.

The 9<sup>th</sup> ICAT is hosting an innovative virtual Technology Fair that we opened to university projects and startups as well as small to large enterprises and agencies and non-profit organisations as well. We continue with workshops on 3D printing and Raspberry Pi and added new workshops including ones on Virtual Reality programming and AT and medium scale farming, too.

The 9<sup>th</sup> ICAT could not be possible without the support of our Local Organising Committee under the leadership of Professors Osman and Popoola as well as the support of TUT and the National Research Foundation (NRF) of South Africa.

## WELCOME FROM THE CHAIR AND CO-CHAIR OF THE 9TH ICAT LOCAL ORGANISING COMMITTEE (LOC)

Prof Amira Osman (CHAIR)  
Prof Patricia Popoola (CO-CHAIR)

From the end of 2019, we started planning for 2020. We started the year with confidence and with great ambitions for the 9th ICAT. Then COVID-19 came and the shutdown started. And for a few weeks, we were forced to be still and reflect. It was scary. And it made us re-think many things. COVID-19 changed everything.

This crisis hit us hard at so many levels. We had to map a way forward for the conference that was very different from what we had envisioned plan. However, this has also been a great opportunity to harness technology and to make connections we would otherwise not have considered. We would like to think that we are not just recovering or returning to what was, but rather to emerging stronger from the crisis.

Our various communities, including our professional community, are being re-structured and re-configured. Despite the difficulties, this crisis has been an incredible opportunity to innovate. We created new online platforms and our conversations have evolved.

We present you with the product of months of hard work represented in this proceedings book. In all of this, it is important to remember the purpose of this event and our thinking about Appropriate Technology. In revisiting old texts, we are reminded that, in many contexts globally, and to align with the socio-economic conditions of developing countries, strategies towards technology need to consider inclusivity, to be broad-based and at a scale that is accessible to a large portion of the population. These kinds of strategies are crucial for development projects to have real impact and to

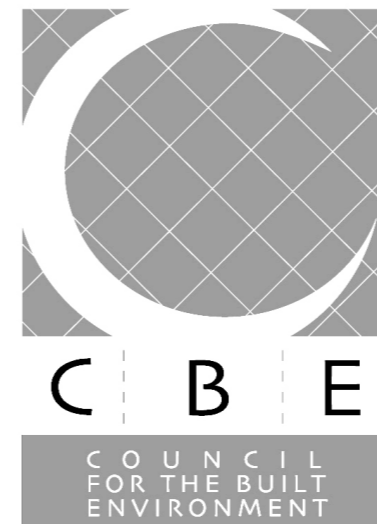
be truly embedded in the context, which they are to serve. Indeed, Schumacher wrote in 1973, in a belief that: “The primary causes of extreme poverty are immaterial. They lie in certain deficiencies in education, organization and discipline.”

Many of Schumacher’s principles in his definitive work “Small is Beautiful” express the importance of how “everybody should produce something” as opposed to ‘a few people should produce [producing] a great deal’. Schumacher believed that this is “a dynamic situation capable of generating growth.” Development according to Schumacher, cannot be an “act”; it is rather described as evolution and a process which cannot be comprehensively planned. Development, according to Schumacher, is about ownership of the education, organization and discipline required to achieve progress by the whole society.

Skills shortages constrain investments and growth; the key is access in education and training to ensure a high quality of service to our communities. A vibrant and sustainable future is achievable through innovation, since it carries the potential to add value to lives and achieve the objectives of socio-economic, cultural, environment and financial sustainability. At the centre of all our efforts are people and communities. Innovation needs to be harnessed towards support people, communities and their livelihoods.

We hope that this conference helps us reflect further on these matters. Welcome to this valuable dialogue on Appropriate Technology across cities, countries, continents and disciplines!

## 9TH ICAT ENDORSEMENT



Council For The Built Environment

### CBE ENDORSEMENT OF THE 9TH INTERNATIONAL CONFERENCE ON APPROPRIATE TECHNOLOGY (ICAT)

The Council for the Built Environment (CBE) is an overarching, statutory body that coordinates the six Councils for the Built Environment Professions with the vision of an intelligent, inclusive, adaptive and thriving Built Environment. Our mission is to lead, regulate, advise and coordinate professions and their councils to meet the National Built Environment and Transformation Future of the industry.

This aligns with the values, vision and mission of International Network on Appropriate Technology (INAT) and the theme of the 9th International Conference on Appropriate Technology (TECHNOLOGY EXCHANGE AND EMPLOYMENT CREATION FOR COMMUNITY EMPOWERMENT: CROSS POLLINATING INNOVATIVE MODELS). The conference provides an opportunity to explore appropriate technology solutions suitable for the socio-economic context of South Africa.

We are convinced that the dissemination and exchange of knowledge of current challenges from an appropriate technology perspective will make a positive contribution to not only the built environment but will also contribute to job creation and empowerment of the entire society in South Africa and the African continent.

We share in your belief that the conference can contribute to a more pluralistic, multi-centric, equitable, sustainable and ultimately more peaceful global community.

The CBE wishes to express its support to the conference and grants INAT permission to display the CBE logo on appropriate platforms to demonstrate our endorsement of the 9th International Conference on Appropriate Technology to be held from the 23rd to the 27th of November 2020 in Pretoria, South Africa.

Chief Executive Officer



# GIBELA RAIL TRANSPORT CONSORTIUM

Gibela Rail Transport Consortium was established in 2013 and contracted by PRASA to deliver 3600 train sets in a period of ten years. The company has established a Research Chair in Manufacturing and Skills Development at the Tshwane University of Technology. The chair seeks to develop local manufacturing technologies with the associated skills development. The goal of enterprise development is embedded in both the DNA of Gibela and the research chair through the Incubator that has been established to support entrepreneurs supporting technology development and commercialisation.



## PASSION OF HOPE INTERNATIONAL

ENTREPRENEURSHIP

FOOD SECURITY & NUTRITION

COMMUNITY HEALTH

SOCIAL ENTERPRISE INVESTMENT

WATER, SANITATION, HYGIENE



HOUSING

ECOLOGICAL RESTORATION

COMMUNITY ENERGY

RURAL EDUCATION

AGRICULTURE LIVESTOCK

### Tackling the Dimensions of Poverty

Am I my brother's keeper? The answer is absolutely yes. We are our sisters' and brothers' keeper. Their burden is our burden. Their struggle is our struggle. Their liberation is our liberation. Their well-being is our well-being.

Passion of Hope International (PHI) recognizes the legacy of greed as manifested by colonialism and unbridled capitalism to be major factors which shape the present landscape of global poverty on the African continent. Tackling poverty in any community must include reversing the ecological deficit inherited from the past. It must dissolve defeatist attitudes which are like hardened plaque formed in the arteries. It must overcome long-standing barriers which have led to crippled livelihoods, poor health, and low education. PHI tackles the challenge of poverty with a multi-dimensional approach. You can support us!

Eighty-five percent of each contribution to PHI goes directly to poverty alleviation. We invest in the poor and help them solve their own problems. Our approach is relational. We are embedded within each community and we build together over the long term. Ours is an investment, not a handout. Our standard is to excel at the triple bottom line: People, Profit, and Planet (social, financial, and environmental). A little donation will go a long way.

Passion of Hope International is the proud sponsor of the 2020 9th International Conference on Appropriate Technology Pretoria, South Africa

PASSION OF HOPE INTERNATIONAL  
[www.passionofhope.org](http://www.passionofhope.org)



## 9TH ICAT SPONSORS



### GIBELA, SOUTH AFRICA

Gibela was formed as a consortium to replace South Africa's outdated rolling stock and will deliver 600 state-of-the-art passenger trains into the South African rail network over the next 10 years. Fully empowered, Gibela is conscious of its role as a catalyst for economic development and the creation of new skills through its majority shareholder, Alstom. In a contract signed in 2013, the Passenger Rail Agency of South Africa (PRASA) assigned Gibela the task of replacing its rolling stock with new trains.

The Gibela Research Chair was established in 2016 where parties agreed on an MOU to fund a Research Chair in manufacturing and skills development for a period of five years.

The founding steering committee members consist of the Director of the Gibela Economic Development, Gibela Manufacturing Director, Gibela Training Manager, Tshwane University of Technology Dean of Engineering and the Built Environment, Tshwane University of Technology, Curriculum Development Practitioner, Tshwane University of Technology, Industrial Engineering Head of Department (2015-2016), and a Train Expert from France.

The vision of the Research Chair is to pioneer cutting edge research in manufacturing technology development and manufacturing value chain skills development geared for the revitalisation of the South African railway manufacturing sector.

The Research Chair focuses on manufacturing in rail specific learning programmes, research and development on rail.

## 9TH ICAT SPONSORS



### PASSION OF HOPE INTERNATIONAL

**"Empowering livelihood, well-being, and appropriate development in marginalized communities through social enterprise investment."**

The question. After murdering his brother Abel, Cain's response to the Lord was, "Am I my brother's keeper?" Sometimes, simply by looking the other way or clicking to another channel, we say a resounding, "No! I am not my brother or sister's keeper". Passion of Hope International (PHI) is an affirmative response to that question and an attempt to love our neighbor as ourselves. When our neighbor hurts, we also hurt. It's important to do something.

PHI is a registered non-profit corporation based in the United States of America. We are in our first year of operation. Our efforts are directed towards community empowerment for poverty alleviation. Where communities have been historically marginalized, we step in to help lift them out of the poverty trap; to walk beside as partners; to strengthen through social enterprise investment; to listen, giving a controlling voice in their journey and opening up new horizons for a better future. Our focus is in sub-Saharan Africa, where many of the poorest rural households are located.

We seek to understand the multi-dimensional poverty trap; a trap manifested by extended seasons of economic, environmental, social, and psychological deprivation; even bondage. Lacking adequate access or control to processes and natural resources marginalized communities are impaired to provide for their minimum nutrition, health, shelter, education, security, leisure, and other aspects of life. Unable to provide for their own, they are unable to be a resource to their neighbors.

We place a priority on addressing rural poverty where environmental factors are responsible for almost a quarter of the entire disease burden of developing countries; unsafe water, inadequate sanitation and waste disposal, and air pollution are major problems. Rapid deforestation and biodiversity losses have deprived people of valuable forest resources, such as fuelwood, food and medicine. Soil degradation remains a major threat to the livelihoods of 1 billion people.

Our approach is relational. We come as partners to sow seeds of hope where there is despair. We invest in education, in community infrastructure, and in access to health care. Strengthening capacity in these areas helps to secure the future of the next generation while benefiting the present.

Ours is an investment, not a handout. By providing essential seed funds to under-resourced entrepreneurs (individuals or covenant groups) given an approved but simplified business plan, the entire community benefits. Our standard is for triple bottom line entrepreneurial success: People, Profit, and Planet (using social, financial, and environmental metrics). As commerce and ecological health increases, so does quality of life.

PHI is currently active in the following region: Gilgil Sub-county, Nakuru (Kenya). New relationships are under development in the town of Tori-Bossito (Benin) and our home city of Baltimore, Maryland (USA).



### PROF. J TRIMBLE

**Niche area - Operations and Engineering Management, Tshwane University of Technology**

In creating a Niche in Operations and Engineering Management we create synergy across two Faculties that are engaged in research on techniques and technologies relating management practices linked to engineering decisions and industry operations such as supply chain management, operations research, project management and system dynamics.

We are drawing on the structured Masters program in Engineering Management that is part of the Industrial Engineering department. This program is unique in that it draws students from all fields of engineering and engages staff as research advisors from the different engineering departments in the Faculty of Engineering and the Built Environment. We are also drawing on the research masters programs in both Industrial Engineering and Operations Management. There is an advantage to connecting the two departments with the common techniques and practices. We will focus our work on these commonalities.

The specific research projects will address:

- 1) Supply chain management - issues that relate to supply chains and how reconfigurable technology implementation impacts the thinking around the supply chain for better responsiveness; decision support systems for demand forecasting and inventory planning; facility location and distribution linked to mail delivery.
- 2) Operations Research - technology used in improving productivity in operations and associated human factor issues that may negatively or positively affect the manufacturing or service organisation; multi-criteria optimisation problems addressing manufacturing and service delivery.
- 3) Discrete Simulation - permutation of various scenarios to optimise production in a production setting whilst adapting to new technology; simulation of service delivery to assist decision makers; learning factory simulation.
- 4) Business dynamics and system dynamics - questions of how various factors can impact the state of a system as it evolves through the generations; use of system dynamics to assist in planning for smart cities.
- 5) Project management - project management in particular skills transfer in small and micro enterprises to ensure cost effective, timely and delivery on expected quality; Project management practices to mitigate risks due to various constraints
- 6) Life cycle management - the holistic thinking in design of systems considering their entire life from cradle to grave to aid decision makers arrive at optimal decisions; replacement models and demanufacturing in the life cycle.
- 7) Quality management- in manufacturing and service offerings how will adaptable product thinking affect the quality of delivery of both products and services; Statistical Quality control; the role of quality circles, Lean manufacturing and quality standards.



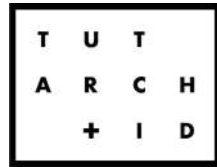
### PROF P. POPOOLA

**Leader Of The Advanced Engineering Materials And Surface Technologies, Tshwane University of Technology, TUT, Pretoria, South Africa**

Emphasis has been placed on the development of engineering materials to address the challenges involved in technological development in our society. The emergence of new materials and techniques speed up transformative advances in civilization and can propel the establishment of new industry. TUT Advanced Engineering Materials and Surface Technologies Group is focussed on the creation of new processes, products or systems through the development of advanced multifunctional materials, with different properties from those of the base material, which might be impossible to obtain by means of traditional methods.

We developed numerous innovative materials that can be applied in various applications such as biomedical materials, aerospace materials, automobile materials, electrical materials, thermal barrier coatings, anti-corrosion and anti-wear materials, and so on. New materials include composites, nano-composites, bio-composites and advanced coatings. We provide functional formulations for the fabrication of multifaceted alloys through incorporation of particulates into metallic matrices for the improvement of mechanical, chemical and tribological performances for small, medium and micro-enterprises. We make use of emerging state-of-the-art technologies to design and fabricate novel materials. These consist of new methods of manufacturing existing products, and the manufacture of new products by means of advanced technologies. For Example: Laser Manufacturing which includes surface modification and additive manufacturing or 3D printing. Laser welding, Spark Plasma Sintering and etc.

## 9TH ICAT PARTNERS



APPROPRIATE  
ARCHITECTURE  
FOR AFRICA [A3]



## 9TH ICAT PROGRAMME PARTNERS



### ANGUS DONALD CAMPBELL

(9TH ICAT Programme Partner As DSD DESIS LAB, University Of Johannesburg)

ANGUS DONALD CAMPBELL is the Head of Department and Senior Lecturer in the Department of Industrial Design, Faculty of Art, Design and Architecture (FADA) at the University of Johannesburg (UJ). He is also a founder and steering committee member of the Design Society Development DESIS Lab, based in the Faculty. Campbell is a qualified industrial designer with a Master's degree and over 15 years of university lecturing, research and freelance design experience. His design research focuses on sustainable innovation at the nexus of social, technological and ecological systems within the complex South African context. For more information: [www.angusdonaldcampbell.com](http://www.angusdonaldcampbell.com)

### THE DESIGN SOCIETY DEVELOPMENT (DSD) DESIS LAB

The Design Society Development (DSD) DESIS Lab is a multi-disciplinary community of practice, based at the Faculty of Art, Design and Architecture (FADA) at the University of Johannesburg (UJ). The DSD DESIS lab seeks to better understand how design can best serve the emerging needs of broader society, specifically in the face of staggering inequality and rapid change in Gauteng, South Africa. Our lab is currently focused on challenging the ethnocentric view of the world brought about through modernization, and hence pays particular interest to our local context, cultural diversity and local needs. For more information: [www.designsocietydevelopment.org](http://www.designsocietydevelopment.org)



### DENISE MORADO

PRAXIS-EA/UFMG Research Group

DENISE MORADO is Professor at School of Architecture (Graduation Course and Post-Graduation Program), Universidade Federal de Minas Gerais (UFMG), Belo Horizonte, Brazil, coordinator of the PRAXIS-EA/UFMG research group, a post-doctorate scholar in Geography (UFMG), a PhD in Information Science (UFMG), holds the degree of Master in Architecture (York University, England), and graduated in architecture and urbanism (FAMIH).

### PRAXIS

PRAXIS-EA/UFMG is a CNPq research group (National Council for Scientific and Technological Development), headquartered by the Projects Department and the PostGraduation Program in Architecture and Urbanism of School of Architecture, Universidade Federal de Minas Gerais (UFMG, Belo Horizonte, Brazil). It aims to critically investigate the contemporary conditions of design, production and use of urban space, to critically map aspects of the socio-spatial dynamics of Brazilian cities and to develop shared practices through the mediation between technology, design, construction, information, experience and creativity around the agents involved in these processes. PRAXIS-EA/UFMG brings together researchers from UFMG and other institutions, undergraduates and postgraduates, with the common goal of investigating urban space as a structured and structuring medium of everyday life.

(9TH ICAT)



## INNOCENT MUSONDA

Centre For Research And Innovation In The Built Environment (CARINBE), University Of Johannesburg

INNOCENT MUSONDA holds a PhD in engineering management and qualifications in construction management and civil engineering. He is professionally registered as a civil engineer, construction manager, member of the chartered institute of building and the International Council for research and Innovation in Building and Construction (CIB). He has worked in both the public and private sector in Southern Africa. He is currently a researcher, invited speaker, founder and director of the Centre for Applied Research and Innovation in the Built Environment (CARINBE) based at the University of Johannesburg. He has served as a chairperson of an international conference series on infrastructure development and investment in Africa from its inception in 2014. Prof Musonda is also a roaming scholar at the University of Toronto on the Engineering Education for Sustainable Cities in Africa Project (EESC-A).

## UNIVERSITY OF JOHANNESBURG



Vibrant, multicultural and dynamic, the University of Johannesburg (UJ) shares the pace and energy of cosmopolitan Johannesburg, the city whose name it carries. Proudly South African, the University is alive down to its African roots, and well-prepared for its role in actualising the potential that higher education holds for the continent's development. With a student population of over 50 000, UJ is one of the largest contact universities in South Africa. The vision of UJ is to be an international university of choice, anchored in Africa, dynamically shaping the future. Its mission is to inspire its community to transform and serve humanity through innovation and the collaborative pursuit of knowledge. For more information: [www.uj.ac.za](http://www.uj.ac.za)

## DITSELA PLACE

The research activities at the Department of Industrial Engineering of the Tshwane University of Technology have expanded tremendously over the past decade since its birth from the Department Mechanical Engineering. The department was established in 2009 with a core of three staff members by Dr GM Kanakana-Katumba with Mr T Nenzhelele and Mr G De Clercq. In 2011 Prof K Mpfu joined the department and the first taught Masters in Technology Management was launched in 2012. An NRF Thuthuka grant as a rating track was the first research grant that sowed the seeds of the intense research activities in the department. The first patent was registered in 2014, the first research chair supported by merSETA was initiated leading to the Gibela Research Chair in Manufacturing and Skills Development in 2016. It became evident that the space needs were no longer sufficient for the research ambitions of the department as an enterprise incubator programme and one of three flagship centres in the country funded by the NRF was established. A variety of spaces at the Tshwane Business School of Society, the CSIR and other private spaces were explored and in weighing the options the Ditsela place was identified as an ideal location.

The mandate of Higher Education Institutions is primarily the provision of education services at a tertiary level to society. Ditsela plays this role not only at the postgraduate and post-doctoral level but also at the undergraduate level. With the coming of the new Higher Education Qualification Sub-Framework (HEQSF) the twelve-month period of Work Integrated Learning (WIL) is gradually being phased out. Seeing that this will deprive students from the University of Technology the advantage of a foot in the door they have made, Ditsela thus provides a critical platform for simulated WIL. Several undergraduate students from other universities have been granted an opportunity to receive work experience.

## CIB W104 Open Building Implementation

### DR. JIA BEISI

#### CIB 104 Open Building Implementation

Born in 1963. DR. JIA BEISI holds a Bachelor of Architecture from Nanjing Institute of Technology (NIT China) and Postgraduate Diploma of the Swiss Federal Institute of Technology (ETH Zurich). He obtained a PhD in architecture history and theory in 1990 through a joint programme of NIT and ETH Zurich. His post-doctoral research projects in Zurich include a survey of housing projects in Switzerland, the result of which was published in a book, Housing Adaptability Design.

Since January 1996, he has been a tutor, lecturer and coordinator of programmes of Bachelor of Art in Architectural Study of the school. Besides design studio, he teaches courses in the history of Chinese architecture and housing in the Department of Urban Development in his school. He is a supervisor of MPhil and PhD students. His students have won more than 30 national and international student design competitions, including 1998/99 Dupont Benedictus Awards, and in exhibitions, such as UIA XXII World Congress of Architecture 2005. He has been an invited guest and visiting professor to Ball State University in the US; the University of Montreal in Canada; Southeast University in China; Universiti Teknologi Malaysia, and so forth.

He is the joint coordinator of W104-Open Building Implementation in the International Council for Research and Innovation in Building and Construction (CIB). He has participated in organising international conferences on open building and student competitions almost annually since 2003, in Zurich, Beijing, Durban, Boston, Paris, Bilbao in the last few years, to name but a few of these events. Since 1996 he has completed several research projects in housing adaptability and housing for sustainable development, based in China and Hong Kong. Jia Beisi has published 4 books and about 53 papers in international and/or national journals including Open House International, Landscape Research and Habitat International. He has been guest editor for issues of the journal Open House International, reviewer and organizer of journals and conferences.

He is also the director and partner of architectural design office of Baumschlager Eberle Hong Kong Ltd., and led and/or participated in 12 major projects and competition winning projects since 2008 including housing, shopping mall, institutional buildings, urban design and hotel.



## **KHUMBULANI MPOFU**

**(9TH ICAT Sponsor As Gibela And Ditesela Place, Member Of The Local Organising Committee)**

PROF KHUMBULANI MPOFU is an established NRF rated researcher with an unstoppable appetite for industrialisation of his activities, who has graduated over 5 doctoral and 20 Masters students in the last ten years. In the past years he has had work published in excess of 30 journals, more than 75 conference papers and 10 book chapters, while to date, 4 patents have been published and registered to him. He has given over thirty presentations at conferences, guest lectures, locally, regionally continentally and globally. He has also been recognised 6 times at national awards (National Science and Technology Forum, Southern African Institute of Industrial Engineers, Standard Bank-Rising Star) and more than five times in the university, for research excellence, since the beginning of his career. To date he has been award funding to the tune of over R50 million rand (~US\$5 million) for research, innovation, incubation and commercialisation activities.

## **GIBELA, SOUTH AFRICA**

Gibela was formed as a consortium to replace South Africa's outdated rolling stock and will deliver 600 state-of-the art passenger trains into the South African rail network over the next 10 years. Fully empowered, Gibela is conscious of its role as a catalyst for economic development and the creation of new skills through its majority shareholder, Alstom. In a contract signed in 2013, the Passenger Rail Agency of South Africa (PRASA) assigned Gibela the task of replacing its rolling stock with new trains.

The Gibela Research Chair was established in 2016 where parties agreed on an MOU to fund a Research Chair in manufacturing and skills development for a period of five years.

The founding steering committee members consist of the Director of the Gibela Economic Development, Gibela Manufacturing Director, Gibela Training Manager, Tshwane University of Technology Dean of Engineering and the Built Environment, Tshwane University of Technology, Curriculum Development Practitioner, Tshwane University of Technology, Industrial Engineering Head of Department (2015-2016), and a Train Expert from France.

The vision of the Research Chair is to pioneer cutting edge research in manufacturing technology development and manufacturing value chain skills development geared for the revitalisation of the South African railway manufacturing sector.

The Research Chair focuses on manufacturing in rail specific learning programmes, research and development on rail.



## **AKRAM ELKHALIFA**

**University Of Khartoum**

DR. AKRAM ELKHALIFA is an assistant professor and Dean of the Faculty of Architecture, University of Khartoum. He has about 20 years' experience in teaching, research and practice in the field of architecture. He is a co-founder and the general manager of "OPTIMA for Consultancy, Real Estate Valuation, and Management". He is also a member of a number of editorial boards and a reviewer for some local and international journals. He has had many articles published in international journals and in international conference proceedings.

- BSc Architecture: Faculty of Engineering & Architecture, University of Khartoum.
- MSc Real Estate Management: KTH Royal Institute of Technology, Sweden
- PhD Architecture: University of Camerino, Italy

and postgraduates, with the common goal of investigating urban space as a structured and structuring medium of everyday life.

## **UNIVERSITY OF KHARTOUM FOA BIO**

The Faculty of Architecture (FoA), University of Khartoum is the first specialized educational institute that teaches architecture in Sudan. On the 22nd of August 2007, the Department of Architecture (established in 1957) was upgraded to the Faculty of Architecture. The FoA has four Departments: Architectural Design, Construction Management & Economics, Housing, and Physical Planning and Urban Design.

The main objective of our faculty is to pursue architecture as a humanistic and professional discipline. The faculty achieves its objectives through teaching, learning, research, professional practice, and service. The FoA aspires to offer widely recognized and highly valued design and planning undergraduate and postgraduate programs that promote a respectful, collegial, interdisciplinary culture of teaching and service within the University and beyond.

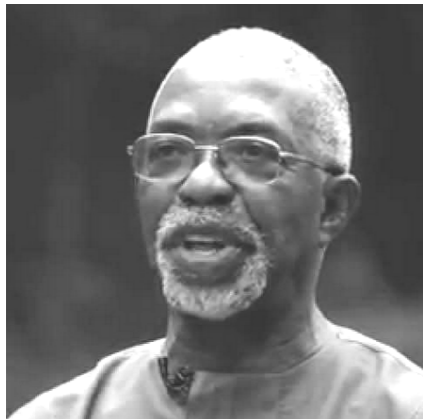
**9TH ICAT**

## 9TH ICAT KEYNOTE SPEAKERS



### PROF. DENISE MORADO NASCIMENTO

Denise Morado Nascimento is a professor at the School of Architecture and the Graduate Program in Architecture and Urbanism at the Federal University of Minas Gerais (UFMG), Belo Horizonte, Brazil. She is a Resident Professor at the Institute for Advanced Transdisciplinary Studies/UFMG. Graduated in Architecture and Urbanism from Faculties Izabela Hendrix, Master in Architecture from the University of York (England), PhD in Information Science from the School of Information Science/UFMG and Post-Doctor in Geography from the Institute of Geosciences/UFMG. Coordinator of the PRAXIS-EA/UFMG research group and researcher of CNPq. Investigations about contemporary production of urban space, exclusion system in cities, shared and/or collaborative design and production processes, technical assistance to low-income dwellers and social movements, strategies and impacts in the formation of the State-Capital corporation and occupations, removals, evictions and resistance to the processes of production of cities.



### FATHER DR GODFREY NZAMUJO

Father Dr Godfrey Nzamujo is the founder and director of the *Songhai Center*, a pioneering farm, training and research center in Porto-Novo, Benin. Begun in 1985 on a single hectare of land, the

Songhai Center has expanded to at least 17 sites in Africa, including eight in Benin and others in Nigeria, Uganda, Sierra Leone, Liberia, among other countries. With the motto 'Commitment to Excellence', Songhai symbolizes Nzamujo's belief that Africa's ecological characteristics are advantages for a regenerative agricultural and developmental paradigm, rather than impediments.

Father Nzamujo holds doctorates in electrical engineering and in philosophy, advanced specializations in microbiology and in the management sciences, and maintains affiliations with the University of California, Irvine, and Loyola Marymount University as a Professor of Engineering. He was awarded the Hunger Project's Africa Prize for Leadership in 1993, and is the author of two books: "*Songhai: Quand l'Afrique relève la tête*" (available in English as "*Songhai: When Africa lifts up its head*") and "*Songhai: l'Afrique maintenant*". Highly influenced by the Appropriate Technology movement, Father Nzamujo also advances the concept of "Authentic Technology", which is rooted in a systemic and holistic worldview, rather than a mechanistic one, and is informed by the principles of biomimicry rather than bio-arrogance.



### MR. ARMOOGUM PARSURAMEN

Mr. Armoogum Parsuramen is a well-known international figure in the field of education, and is the founder and president of the Global Rainbow Foundation in Mauritius, a non-profit organization that is devoted to helping to level the playing field for differently-abled individuals. The organization constructs low-cost prosthetic limbs for those who have lost theirs, offers them associated therapy, and ultimately restores their dignity as fully-functioning members of society.

Mr. Parsuramen has served as Minister of Education, Arts, Culture and Science in Mauritius from 1983 to 1995. He then joined the World Bank (1997-1998) as a "Senior Advisor" in Washington D.C. before taking the post of Director at UNESCO offices in France, Senegal, and India (1998-2011). He has also been conferred an Honorary Doctorate by the Governor of Tamil Nadu and Chancellor of Tamil University for his contributions to the field of education. Mr. Parsuramen is first and foremost, a man of faith and spiritual maturity, he feels a profound gratitude for what he has received in life, and wishes to give back those gifts by serving humanity. In 2019, he was chosen as an ambassador for the Rise & Shine European Union campaign, and was nominated as the Regional Representative for Africa by the Commonwealth of Learning (COL) Board of Governors. Highly humbled by these nominations, Mr. Parsuramen believes that the platforms will allow him to further consolidate his mission to serve the most vulnerable.



### DR. LYNN A. KEAYS

A creative visionary and strategist, Dr. Keays is enthusiastic about the importance of building the project management skills across Africa and achieving positive organizational and societal impact. A former diplomat with US Agency for International Development and international consultant, Dr. Keays draws on 30 years of experience in adaptive and emergent strategy, portfolio, program and project management, benefits co-creation and organizational leadership in the international and sustainable development field.

A pracademic (melding academics with practice), she is adjunct faculty at the Skema Business School, Paris Campus, is a visiting research fellow at the Project Management Group, WU Vienna University of Economics and was part-time faculty, Boston University Metropolitan College Master's program in project management from 2014- 2017. She is a published author and international conference presenter. An academic journal reviewer, she is a member of the Editorial Board of the International Journal of Project Management. Since 2016, She is the President, South Africa Chapter of the Project Management Institute since November 2016. She is a lover and collector of African art, likes the outdoors, enjoys a sports challenge and loves creating in her vegetable garden, when she finds the time. She is a film buff, especially of old cinema and independent films, which will keep her talking for hours.



## AMBASSADOR JOSEFA LEONEL CORREIA SACKO

Ambassador Josefa Leonel Correia Sacko, an Angolan national, is a leading African Agronomist. She is the Commissioner for Rural Economy and Agriculture of the African Union Commission. Prior to her election, she was Special Adviser to two Ministers in Angola. Firstly, the Angolan Minister of Environment where she also served as Ambassador responsible for Climate Change. And secondly, advisor to the Minister of Agriculture. Ambassador Josefa Sacko oversaw Food Security, Eradication of Hunger and Poverty Reduction.

Ambassador Josefa Sacko was also the former Secretary General of the Inter African Coffee Organization (IACO) for 13 years in Cote D'Ivoire where she oversaw the coffee economy of 25 African Coffee producing countries. During her tenure, she successfully advocated for the empowerment of small scale coffee farmers across the continent by setting up Regional Centres of Excellence for Capacity Building of Member States, on Genetic Material Conservation, Coffee Quality Improvement and Cup Tasting Liquor in Cote d'Ivoire, Uganda, Cameroon and Zambia.

Madam Sacko has built up her international profile and reputation by either consulting or working with several Regional, and Global Institutional on Agriculture including the World Trade Organization (WTO), African Union (AU), International Coffee Organization (ICO), African Development Bank (AfDB), African Export Import Bank (AFREXIMBANK), (FAO), UNECA, NEPAD etc.

As a strong advocate of gender empowerment and strengthening the role of small farmers in Africa, she has over the years worked with Regional Economic Communities (RECS), such as SADC, COMESA, ECOWAS and EAC, to address the challenges encountered by small scale farmers in Africa, and ensuring that they remain a central focus in regional and national policy making.

Madam Sacko is fluent in five languages. She speaks Portuguese, French, English, Spanish and Lingala.



## MR. JOSEPH MUDAU

Mr. Joseph Mudau is the Head of Training and Organizational Development at Gibela Rail Transport Consortium known as Gibela. A black economic empowerment (BEE) consortium comprising Alstom, Ubumbano Rail and New Africa Rail, a company that was awarded a contract by the Passenger Rail Agency of South Africa (PRASA) to build 600 new passenger trains.

He holds IT qualifications and Masters In Business Administrations from Tshwane University of Technology. He is also a Doctoral candidate at the same university. Mr Mudau started his career as an IT Professional and academic, and later moved to Strategic Human Capital specializing in strategy development, training and development, Operations and Project management. He has worked for local and international companies, to name just a few; Thyssenkrupp, Bombardier and others.

He is the current chairperson of the board for Rail Manufacturing Centre for Entrepreneurship Rapid Incubator (RMCERI NPC). The enterprise Incubation Programme is aimed at converting research projects to established micro / small enterprises. Mr Mudau is also the chairperson of the Gibela Research Chair Steering Committee, established between Gibela and Tshwane University of Technology. The research chair's focus is on special research project, masters and PhD supervision including the development of short learning programmes aimed at assisting industries to resolve industry specific challenges.

Mr Mudau is also an established Author, Brand Strategist and Speaker who travels across the country and abroad to inspire young people with the message of hope. He is a regular guest for SABC radios, Commercial and Community Radios; he has appeared on several TV programs.

Mr Mudau's philosophy is that "We all have a seed of greatness regardless of our background or level of education, Life has Great Possibilities". He also subscribes to values of Respect, Excellence, Teamwork and Time Management.



## 9TH ICAT BOOK EDITORS



### JOHN TRIMBLE

(9th ICAT Sponsor - And Member Of The Local Organising Committee And Member Of The 9th ICAT International Organising Committee)

JOHN TRIMBLE is currently the Flagship Professor at TUT with an appointment in industrial engineering. Before that, he served two years as a Fulbright professor with the industrial Engineering department at TUT. He has worked in industry for over 12 years and as an academic for over 30 years. He has served as HOD and Dean of ICT. He has taught at universities in Rwanda, Zimbabwe, South Africa and the USA. He has published extensively in engineering and computer science. Prof. Trimble is the founding director of the International Network on Appropriate Technology (INAT) and has coordinated eight international conferences on appropriate technology, all of them in Africa, dating back to 2004. He holds BS and MS degrees in engineering, a PhD in 'Industrial and Systems Engineering' from Georgia Institute of Technology and a Masters in Computer Science from Stanford University (all from USA).



### AMIRA OSMAN

(Member Of The 9th ICAT Local Organising Committee Chair)

AMIRA OSMAN is a Sudanese/South African Professor of Architecture at the Tshwane University of Technology. She currently holds the position of SARCHI: DST/NRF/SACN Research Chair in Spatial Transformation (Positive Change in the Built Environment) and is the Joint Coordinator of the international group CIB W104 Open Building Implementation. She is also the Chair of the Local Organising Committee (LOC) for the 9<sup>th</sup> International Conference on Appropriate Technology (ICAT), to be held in Pretoria, November, 2020. Amira obtained a BSc in 1988 and an MSc in 1996, both from the University of Khartoum in Sudan. She obtained a diploma from the Institute for Housing Studies in Rotterdam (IHS) in 1992 and a PhD in Architecture from the University of Pretoria in 2004. Amira hosted and convened the World Congress on Housing in 2005 at the University of Pretoria as well as the Sustainable Human(e) Settlements: The Urban Challenge conference in 2012, at the University of Johannesburg. She served as UIA 2014 Durban General Reporter and as head of the Scientific Committee for the International Union of Architects (UIA) and the South African Institute of Architects (SAIA).



### BRIAN A. STEPHENSON

(Member Of The 9th ICAT Local Organising Committee Chair)

BRIAN STEPHENSON, PE, is the founder and President of Qodesh CM, a civil and structural engineering consulting practice based in Baltimore, Maryland (USA). He is an advocate for sustainable and appropriate development strategies in Africa and the Caribbean. In his capacity as Professional Engineer, Mr Stephenson has been in charge of the engineering design and construction of numerous building and infrastructure projects in the United States for forty years. He is the Executive Director of Passion of Hope International, a non-profit organisation actively engaged in rural community empowerment and appropriate development in Africa. An advocate and practitioner of sustainable and appropriate development in Africa, the Caribbean, and Latin America, his association with the International Network on Appropriate Technology dates back to its beginning in 2003. In addition, Mr. Stephenson has served as professional mentor to students at Howard University, Engineers Without Borders Chapter, for more than a decade.



### GADA KADODA

(Member Of The 9th ICAT Local Organising Committee Chair)

GADA KADODA is Founding President and current head of the Board of Directors of the Sudanese Knowledge Society. She is Sudan's representative for the Barefoot College, committee member of the International Network on Appropriate Technology, and founding member of the International Network on Gender, Social Justice & Praxis.

Kadoda received her PhD in Software Engineering in 1997 from Loughborough University (UK), her MSc in Information Systems and Technology in 1993 from City University (UK), and, in 1991, a BSc in Computer Science from the University of Khartoum. Her work experience includes research and teaching posts in the UK, Barbados and Sudan. She has published on software development as well as on interdisciplinary areas, such as knowledge production, ICT for development, innovation systems, ethics of appropriate technology, social media and activism. More recently, she has been engaged in publishing with Sondra Hale, e.g. their co-edited book on *Networks of Knowledge Production in Sudan: Identities, Mobilities, and Technologies* (2017), and their upcoming book on *Capturing Cultural Capital: Sudanese Intellectuals in the Global Milieu*. She is a certified knowledge manager and futures thinking practitioner. Kadoda was 2010's African Scholar Guest of the annual programme at the University of South Africa, and was on UNICEF's list of nine innovators to watch in 2014. She received the Sudanese Women in Science Organization Award in 2015 and came fourth in the list of "30 Sudanese Women You Should Know" in 2016, as well as being selected by the BBC for their 100 Women List in 2019.

(The editors are also members of the 9<sup>th</sup> ICAT Programme Committee/Panel Of Reviewers)

## 9TH ICAT PROGRAMME COMMITTEE/ PANEL OF REVIEWERS



**AKRAM ELKHALIFA**

(9TH ICAT Programme Partner)

DR. AKRAM ELKHALIFA is an assistant professor and Dean of the Faculty of Architecture, University of Khartoum. He has about 20 years' experience in teaching, research and practice in the field of architecture. He is a co-founder and the general manager of "OPTIMA for Consultancy, Real Estate Valuation, and Management". He is also a member of a number of editorial boards and a reviewer for some local and international journals. He has had many articles published in international journals and in international conference proceedings.

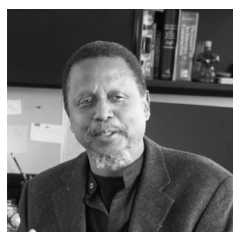
- BSc Architecture: Faculty of Engineering & Architecture, University of Khartoum.
- MSc Real Estate Management: KTH Royal Institute of Technology, Sweden
- PhD Architecture: University of Camerino, Italy



**ANGUS DONALD CAMPBELL**

(9TH ICAT Programme Partner As DSD DESIS LAB, University Of Johannesburg)

ANGUS DONALD CAMPBELL is the Head of Department and Senior Lecturer in the Department of Industrial Design, Faculty of Art, Design and Architecture (FADA) at the University of Johannesburg (UJ). He is also a founder and steering committee member of the Design Society Development DESIS Lab, based in the Faculty. Campbell is a qualified industrial designer with a Master's degree and over 15 years of university lecturing, research and freelance design experience. His design research focuses on sustainable innovation at the nexus of social, technological and ecological systems within the complex South African context. For more information: [www.angusdonaldcampbell.com](http://www.angusdonaldcampbell.com)



**BRADFORD C. GRANT**

BRADFORD C. GRANT is a full professor of Architecture in the Department of Architecture of the College of Engineering and Architecture at Howard University, Washington DC. He has been in leadership roles at Hampton and Howard Universities as Chairperson, Director, Associate Dean and Interim Dean. As a registered architect and a distinguished educator he has extensive experience in community design and contemplative practices through drawing in design education and environmental justice in architecture. His community design work, research on the role of African American architects and his teachings on "Drawing as Meditation" has earned him the Virginia Downtown Development Association Award, the American Institute of Architects (AIA) Education Honor Award, the AIA Institute Honor for Collaborative Achievement and the Center for Contemplative Mind in Society's

Contemplative Practice fellowship. Professor Grant has served as past President of the Association of Collegiate Schools of Architecture (ACSA), Humanities DC, and the Center for Contemplative Mind in Society (Cmind). He is currently president of the board of the Healthy Building Network (HBN) and is the co-founder of the "Directory of African American Architects", the first comprehensive survey, analysis and report on the numbers and roles of the African American Architect. He is appointed as the inaugural "Instagram Artist in Residence" at the Smithsonian National Portrait Gallery. Grant completed his graduate degree at the University of California Berkeley and the undergraduate degree from California Polytechnic State University, San Luis Obispo.



**CADENA BEDNEY**

(Member Of The 9th ICAT Local Organising Committee)

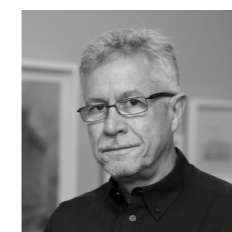
CADENA BEDNEY is a nurse in Los Angeles, California, USA. She received her BSN in nursing at California State University, Los Angeles and is a Nurse Consultant at Homes for the Multiple Handicapped in El Monte, California, USA. She currently does volunteer work as a Court Appointed Special Advocate (CASA) for the Los Angeles Children's Court and is also on the board of Directors of Special Advocate Audition Performance Preparatory Academy (SAPPA), which provides music education and opportunities for youngsters in underserved communities. She is a newly appointed INAT Board member, having been involved with and supportive of INAT since 2010.



**CHARLES VERHAREN**

(Member Of The 9th ICAT Local Organising Committee Chair)

CHARLES VERHAREN is a full professor in the Philosophy Department at Howard University in Washington, DC. and is now serving in his 53rd year at Howard. His primary research areas are African and African American philosophy, philosophy of education, environmental ethics, philosophy and technology as well as philosophy and culture. His research team currently covers agroecology movements in Africa and India. He has additionally co-edited volumes on contemporary Ethiopian Philosophy with Professor Bekele Gutema of the University of Addis Ababa and on Contemporary Ethics in Malawi, with Professor Grivas Kayange of Chancellor College at the University of Malawi. He has published a volume on rationality in philosophy and science as well as numerous articles in such journals as *Science and Engineering Ethics*, *Ethics and Education*, *Educational Philosophy and Theory*, *Phronimon Journal of Oromo Studie*., *Philosophia Africana*, *Journal of Black Studies*, *Western Journal of Black Studies*, *Présence Africaine*, *Philosophical Forum* and the *African Journal of Science, Technology, Innovation and Development*.



**CHRISTO VOSLOO**

CHRISTO VOSLOO holds architectural qualifications including a PhD from the Universities of Pretoria and Cape Town, an MBA from Nelson Mandela University and a Certificate in Arbitration from the South African Association of Arbitrators. He has published locally and internationally and has presented papers at a number of international conferences on the subject of entrepreneurship, entrepreneurship education, urban development and sustainability in architecture. He has served and still serves as reviewer for various South African and international journals and conferences. He is an Associate Professor at the University of Johannesburg's Graduate School of Architecture in the Faculty of Art Design and Architecture



### DIRAN SOUMONNI

**(Member Of The 9th ICAT Local Organising Committee Chair and 9th ICAT Local Organising Committee)**

DR DIRAN SOUMONNI is a Senior Lecturer in Innovation Policy and Management and Programme Director of the Master of Management in Innovation Studies at the Wits Business School, University of the Witwatersrand, South Africa. He is a Steering Committee Member of the International Network on Appropriate Technology (INAT) and serves on the scientific board of the African Network for the Economics of Learning, Innovation and Competence Building Systems (AFRICALICS).

Dr Soumonni holds a PhD in Public Policy (Innovation Studies and Energy Policy) and a Master's degree in Materials Science and Engineering from the Georgia Institute of Technology, USA. His undergraduate degrees in Physics and Mathematics are from Tuskegee University, USA.



### ELVIS PULE SEKANO

**(Member Of The 9th ICAT Local Organising Committee)**

ELVIS PULE SEKANO is an academic in Industrial Engineering at Tshwane University of Technology. His research is focused on development of a production ramp-up plan considering operational aspects to prepare for future disturbances using a hybrid model that combines Discrete Event Simulation, Agent-Based simulation and System Dynamics. This research includes the use of the specification of process driven and data driven models, formal optimisation techniques, model based system analysis and methods for decision making under deep uncertainty.



### ERİYETI MURENA

ERİYETI MURENA is currently a Doctoral Researcher in the Department of Industrial Engineering, at Tshwane University of Technology, South Africa, working in the area of product design and manufacture of rail parts. Her focus is on web-based process planning for reconfigurable machines.

In 2010, Eriyeti obtained a BEng in Industrial and Manufacturing Engineering from the National University of Science and Technology (NUST), Zimbabwe, followed in 2014 by MEng in Manufacturing Engineering and Operations Management. Eriyeti has worked with CNC machines (milling/turning) as a CAD/CAM technician, and has gained experience in computer aided design (CAD), computer aided manufacturing (CAM) and Engineering Drawing. She works as a Lecturer in the Department of Industrial and Manufacturing Engineering at NUST and is a member of the Zimbabwe Institute of Engineers, Women in Energy in Zimbabwe and SAIIE.



### HUMBULANI SIMON PHULUWA

**(Member Of The 9th ICAT Local Organising Committee)**

MR. HUMBULANI SIMON PHULUWA received his M-Tech in Industrial Engineering from Tshwane University of Technology (TUT) in South Africa. Simon has worked on several projects in diverse areas at TUT, including rural support programmes and collaboration with international universities on technology transfer. Mr. Phuluwa, in partnership with many blue-chip companies in South Africa, has placed many students into the labour market. He has made several contributions

to advanced manufacturing concepts and product life cycle management publications and is a board member of the J.B. Phuluwa Foundation through which rural communities are assisted with career guidance, school fees, and other social needs. He is also involved in mentoring and coaching young children in diverse areas, including engineering, farming, and business. He strongly believes in equality and excellence towards defeating the state of poverty in which many South Africans live and also as a way to ensure success for disadvantaged students. Before joining TUT, he worked in, and completed major projects at Absa Bank, Eagle Ottawa (SA), Ernest & Young, and Transnet. He has more than 16 years' experience of working in a range of areas, including press tool manufacturing, business process reengineering modelling, de-manufacturing systems, 3D printing and management systems development.

### ILESANMI AFOLABI DANIYAN

**(Member Of The 9th ICAT Local Organising Committee)**

ILESANMI AFOLABI DANIYAN obtained a Doctor of Philosophy (PhD) and Master's degrees in engineering (MEng) in mechanical engineering (production engineering option) from the Federal University of Technology, Akure, Nigeria in 2012 and 2017, respectively. He also obtained a Bachelor of Technology Degree (BTech) in chemical engineering from Ladoke Akintola University of Technology, Ogbomoso, Nigeria in 2008. At present, he is a postdoctoral research fellow at the Department of Industrial Engineering, Tshwane University of Technology in Pretoria, South Africa, where he, as a member of a research team, focuses on the development of indigenous technology for advancing the railcar manufacturing industry in South Africa. Prior to this, he was a senior lecturer in the Department of Mechanical and Mechatronics Engineering at Afe Babalola University in Ado Ekiti, Nigeria, where he taught courses relating to fluid dynamics and mechanics, strength of materials, mechanical vibrations and control, systems engineering and control, production engineering, engineering thermodynamics, maintenance management, electromechanical machines and turbomachinery at both undergraduate and postgraduate levels. During 7 years of service at the institution, he was rated the best lecturer in the Department of Mechanical & Mechatronics Engineering for the year 2015-2016 and 2016-2017. He is a registered member (Professional Engineer Cadre) of the Council for the Regulation of Engineering in Nigeria (COREN) and an associate member of the Southern African Institute of Industrial Engineering (SAIIE). He was a finalist of the SAIIE prestigious award for the best industrial engineering practitioner in 2019 and successfully completed the supervision of 18 students at undergraduate level and 3 students at post-graduate level. He has published extensively in both local and international peer reviewed for journals and conferences. He has served meritoriously in several administrative and academic capacities locally and internationally. His teaching and research interests include production engineering and advanced manufacturing as well as automation and robotics.





## JABU MTSWENI

(Member Of The 9th ICAT Local Organising Committee)

DR JABU MTSWENI is head of the Cyber and Information Security Centre at the Council for Scientific and Industrial Research (CSIR), research fellow at University of South Africa, and board member at the Directorate of Information Warfare in the Department of Defence. Dr Mtsweni has been involved in leading, supporting, and implementing large and complex cybersecurity projects locally and internationally, including projects in large state owned enterprises (in South Africa and Africa), government departments and the military. His research interests and technical expertise are in the areas of digital security, digital transformation, cybersecurity, and cybercrime. He regularly speaks at various local and international conferences on cybersecurity issues and has over 17 years of academic and industry experience, working with different local, regional and international industries and partners on various ICT projects. He has published over 70 peer-reviewed conference and journal articles with a number of collaborators. He also continues to supervise Masters and PhD Students from different universities in South Africa. He is passionate about youth development, mentoring, and positive living. He completed his first Comrades Marathon in 2019.

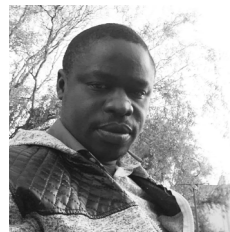


## JAKO NICE

(9th ICAT Programme Partner as CSIR)

DR. JAKO NICE is senior researcher and professional architect at the CSIR with 15 years' experience. Dr Nice specialises in Healthy Building Design (HBD), healthcare infrastructure, architecture and engineering approaches to infection control for surface and airborne contagion in the built environment, as well as the microbiology of the built environment (MoBE). Furthermore, he is involved in Alternative building Technologies (ABT) implementation and sustainable buildings planning and construction.

He has worked both in South Africa and internationally as an architect on a broad range of projects which include residential, commercial, hospitality, healthcare and religions building typologies. He is an author of numerous norms and standards guidelines for healthcare infrastructure, peer reviewed publications and an invited conference speaker. He is a Masters' year student supervisor in architecture and holds a doctorate in architecture at the University of Pretoria in MoBE, investigating building microbiomes and architecture through applied spatial analytics aimed at reducing Healthcare-Associated Infections (HAI).



## JEGEDE OLUSEYE

(Member Of The 9th ICAT Local Organising Committee)

DR. OLUSEYE O. JEGEDE is a specialist researcher at the South African Research Chair in Entrepreneurship Education, College of Business and Economics at University of Johannesburg. He is honorary research associate at the Centre for Science, Technology and Innovation Indicators (CeSTII), Human Science Research Council (HSRC), South Africa.

Dr. Jegede bagged his PhD in Technology Management (R&D and Innovation Management option) in 2015. His main areas of research include innovation management, entrepreneurial ecosystem, small

business management and economic geography. He is currently associate editor with the African Journal of Science, Technology, Innovation and Development (AJSTID) published by Taylor and Francis Group, UK.

Currently, Dr. Jegede is a member of the scientific board of the Global Network for the Economics of Learning, Innovation and Competence Building Systems (GlobeLICS), a pioneer member of the African Network for the Economics of Learning Innovation and Competence Building System (AfricaLICS) and head of research activities at the Nigerian Network for the Economics of Learning, Innovation and Competence Building Systems (NigeriaLICS). Dr Jegede is a research collaborator with the Open African Innovation Research (AIR) Network on informal sector innovation. He served as a member of the scientific council of the recently conducted African Innovation Summit II.



## JEPHIAS GWAMURI

(Member Of The 9th ICAT International Organising Committee)

PROF JEPHIAS GWAMURI holds a PhD in materials science & engineering and has over 14 years of research and university teaching. He has been awarded several research grants and has successfully worked/collaborated as a PI and co-PI of different projects. Notable among them: the AFRA Regional project RAF/8/040 International Atomic Energy Agency (IAEA) and the RAEIN Africa Zimbabwe-Mutoko biofuels project. Additionally, he has more than three years' experience of running his company, Integrated Solar Solutions for Africa (ISSA PVT, LTD) in Zimbabwe. Prof Gwamuri has consulted on several renewable energy technologies projects, both locally and internationally. As a recently appointed director of research and innovation, Prof Gwamuri has extensive hands-on experience in research and business management, coupled with strong leadership qualities.



## JOHN THARAKAN

(Member Of The 9th ICAT International Organising Committee)

DR. JOHN THARAKAN is Professor of Engineering at Howard University and Visiting Professor at SCMS College of Engineering and Technology, Karakutty, Kerala. Before Howard, he was a research scientist at the American Red Cross. His research expertise is in environmental engineering and biotechnology, bioprocessing, appropriate technology development and education, and sustainable development. His bioenvironmental engineering research has focused on the use of biological technologies for the remediation of contaminated environmental media. He was Fulbright Senior Research Scholar to India in 2006-07, and in 2015-16 he was Fulbright-Nehru Senior Research Scholar to India, with both appointments thematically centred on appropriate technology, where his research focused on water, renewable energy and resource recovery, while his scholarly work considers the ethics and philosophy of technology. As faculty adviser to the student chapter of Howard University's Engineers Without Borders, he has worked on appropriate water, sanitation and energy technology implementation in Senegal and Kenya (<http://www.howard.edu/Kenya>). Dr. Tharakan received his undergraduate education from the Indian Institute of Technology, Madras (BTech 1982) and his graduate education at the University of California, San Diego (MS, Fluid Mechanics, 1983; PhD, Engineering Science, Biochemical Engineering, 1986). His research has been published in *The Journals of: Biotechnology and Bioengineering, the Life Sciences, Chromatography, Immunological Methods, Environmental Science and Engineering, Engineering Education, Service Learning in Engineering, Science and Engineering Ethics, Engineering Education Transformation, and The African Journal of Science, Technology, Innovation and Development.*



## KGABO MOKGOHLOA

**(Member Of The 9th ICAT Local Organising Committee)**

KGABO MOKGOHLOA, is a proactive, solution and output driven, dynamic professional with considerable process engineering, project engineering, programme, and facilitation experience acquired in research and development, manufacturing and service fields. An innovative strategist and tactician, capable of directing successful initiatives aimed at achieving positive outcomes in accordance with requirements and expectations, he possesses exceptional interpersonal and group dynamics skills used to great effect in overcoming initial resistance to change, influencing decisions and forging strategic alliances nationally and internationally. A motivational and inspirational leader who thrives in highly pressurised and challenging working environments, he has exceptional conceptual, analytical, lateral thinking, negotiation and persuasion skills as well as strategic thinking skills and thrives on setting goals and reaching them.

A facilitator, researcher, author and process engineer, Kgabo Mokgohloa is passionate about learning and imparting knowledge to those who can benefit from it. He is a seasoned professional with zeal for human development, with a deep interest in “changing landscapes” ushered in by the Fourth Industrial Revolution (4IR), focussing on lean engineering/thinking, sustainability of Planet Earth, Value Engineering, Thinking Systems (TS) and firm advocate for a culture of continuous improvement.

Kgabo Mokgohloa holds various technical qualifications in Chemical Engineering, Industrial Engineering and Environmental Engineering and is currently pursuing a PhD in Science, Engineering and Technology with the topic “System Dynamics Approach to digital transformation in the postal sector in Southern Africa”.



## KHUMBULANI MPOFU

**(9th ICAT Sponsor As Gibela And Member Of The Local Organising Committee And Member Of The 9th ICAT International Organising Committee)**

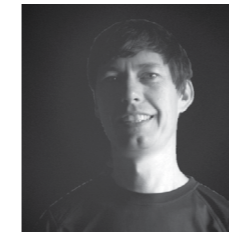
PROF KHUMBULANI MPOFU is an established NRF rated researcher with an unstoppable appetite for industrialisation of his activities, who has graduated over 5 doctoral and 20 Masters students in the last ten years. In the past years he has published in excess of 30 journal papers, more than 75 conference papers and 10 book chapters, while to date, 4 patents have been published and registered to him. He has given over thirty presentations at conferences, guest lectures, locally, regionally continentally and globally. Since the beginning of his career, he has been recognised 6 times for research excellence and at national awards (National Science and Technology Forum, Southern African Institute of Industrial Engineers, Standard Bank-Rising Star) and more than five times at the Tshwane University of Technology (where he is based). To date he has been award funding to the tune of over R50 million rand (~US\$5 million) for research, innovation, incubation and commercialisation activities.



## KYLE BRAND

KYLE BRAND is an Industrial Designer, lecturer and researcher. He has eight years of experience in teaching and mentoring students in different industrial design courses as well as developing and demonstrating the application of skills like critical thinking, human-centred design, social innovation, prototyping, creativity, systems thinking and so forth. Kyle Brand has spoken at academic and non-academic, local, and international conferences presenting research and projects. He has participated and led within transdisciplinary teams, working on complex real-world

projects. These include being the design manager for the solar car project, designing and overseeing construction of two complete solar cars and currently busy with a third car, and the design and development of an artificial nest for the southern ground hornbill in partnership with the Mabula Ground Hornbill Project. As a constantly curious individual who enjoys diversity within his work, Kyle Brand is interested in many different topics.



## LEON PIENAAR

LEON PIENAAR studied at the Tshwane University of Technology, where he obtained an MTech Architecture professional degree in 2004. He has lectured at Tshwane University of Technology and the University of Pretoria’s Department of Architecture since 2008. Leon is a professional architect registered with the South African Council for the Architectural Profession (SACAP). As a lecturer at the Tshwane University of Technology, he coordinates the information technology programme, serves as a design mentor for Master’s degree students and assists in the IT technologies implemented by the Department of Architecture.

Leon is heading a research field which focusses on the making of architecture as being thoroughly entangled with the development of digital and mechanical technologies. Leon believes that craftsmanship remains essential. To support this, a new, making laboratory and assembly workshop, known as the m<sup>2</sup>LAB, has been established in the Faculty of Engineering and the Built Environment (FEBE) that forms part of his portfolio.

The m<sup>2</sup> LAB is based on the principles of the MIT Fablab, and it gives students access to advanced manufacturing equipment while fostering a culture of interdisciplinary collaboration in design. Craftsmanship takes place in a digital environment to realise their design ideas.



## MARCEL J. CASTRO-SITIRICHE

**(Member Of The 9th ICAT Local Organising Committee)**

MARCEL J. CASTRO-SITIRICHE is an associate professor of Electrical Engineering and co-director of the Center for Hemispherical Cooperation in Research and Education in Engineering and Applied Science (CoHemis) at the University of Puerto Rico in the Mayagüez Campus, *Recinto Universitario de Mayagüez* (UPRM-RUM). His research efforts include academic, educational and service activities. Some of his areas of interest include appropriate technology, bottom-up microgrids, renewable energy systems, rural electrification, power electronics, and responsible wellbeing. Marcel is the principal investigator of a National Science Foundation funded project that combines most of his research interests based in the concept of responsible wellbeing. The five-year project title is “Cultivating Responsible Wellbeing in STEM: Social Engagement through Personal Ethics” and it is expected to end in 2020.

Since 2015 he has also been also an adjunct professor at the Nelson Mandela African Institution of Science and Technology (NM-AIST) in Arusha, Tanzania. Marcel spent the 2014-2015 at NM-AIST as a Fulbright Scholar researching the impacts that access to electric energy has on human wellbeing, particularly through rural microgrids. Ongoing research includes alternative resilient power for remote rural communities that are cost effective and aligned with a long-term energy sovereignty vision.



## OLUKOREDE ADENUGA

(Member Of The 9th ICAT Local Organising Committee)

DR. OLUKOREDE ADENUGA is a technically-savvy and highly analytical engineer with interest in areas of research in the Fourth Industrial Revolution (4IR), manufacturing, industrial process optimisation, process engineering, policy and regulation, automation and control systems. Olukorede has over two decades of training and maintenance experience, working in the academic, automotive, food and bottling industries, oil and gas exploration and production as well as in the building and construction industry. He has worked for local and international companies, including Volkswagen, Shell Exploration and Production, and others.

Dr. Adenuga holds PhD and Master's degrees in Industrial Engineering (IE) from Tshwane University of Technology (TUT) in South Africa and a Bachelor of Engineering in Electronics and Electrical Engineering from the University of Sunderland, United Kingdom. He is currently a post-doctoral fellow in Energy Efficiency in Manufacturing in the context of Fourth Industrial Revolution (2018 to date) at the Rail Manufacturing Centre for Entrepreneurship Rapid Incubator (RMCERI NPC). The enterprise's Incubation Programme is aimed at converting research projects to become established micro/small enterprises. The Research Chair's focus is on special research projects and Masters and PhD supervision, as well as the development of short learning programmes aimed at assisting industries to resolve industry specific challenges.

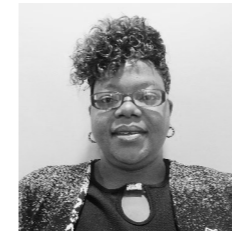
Dr. Olukorede Adenuga is an associate member of Industrial Engineering and Operations Management (AMIEOM); associate member of the South African Institute of Industrial Engineers (AMSAIIE); corporate member of Nigerian Society of Engineers (MNSE), and senior award holder from City and Guilds of London Institute (LCGI). He is a representative of The Centre for Advanced Systems Research and Education (CASRE) and holds a certificate in lean enterprise systems programs (LESP) from the Department of Industrial and Systems Engineering at the University of Tennessee-Knoxville, United State of America.



## PATRICIA POPOOLA

(9th ICAT Sponsor - As The Advanced Engineering Materials And Surface Technologies, TUT - And Co-Chair Of The Local Organising Committee, LOC)

PROF PATRICIA POPOOLA obtained her BSc (Honours) degree in Metallurgical and Materials Engineering from Obafemi Awolowo University, Ile-Ife, Nigeria and her Master's and doctoral degrees in Metallurgical Engineering at Tshwane University of Technology, Pretoria, South Africa. Patricia is an NRF rated researcher (C3-category) with research focus in advanced engineering materials. Patricia has over 400 publications (journals and conference papers), apart from book chapters, to her name. As a researcher, her publications have shown dedication to research and development in the engineering field, which is an indication of her ability to work independently. To date, Patricia has made a great deal of impact with her publications, which have been acknowledged both locally and internationally. Refer to Google scholar citation - (h-index 27, i10-index 105, citation 3288). Currently, she has graduated twenty-seven Masters' and thirteen doctoral graduates. Patricia and her students are recipients of numerous academic excellence awards. Prof Popoola continues to network with numerous national and international scientists, while mentorship of students remains her prime objective.



## RACHEL CHIKOORE

RACHAEL CHIKOORE is a passionate researcher, reviewer, consultant and lecturer at the Harare Institute of Technology (Zimbabwe). She is pursuing a doctorate in computer science and data processing and holds an MTech degree in Information Networks from Tshwane University of Technology, Pretoria, South Africa and a BSc (Hons) degree in Computer Science from Midlands State University, Zimbabwe. She has a genuine passion for research, teaching and administration. She has extensive knowledge in machine learning, database administration, SQL server administration, Linux, Weka, MATLAB and Protégé as well as having supervised numerous undergraduate and post graduate projects. She has written and published work in the field of computing and her areas of interest are machine learning, data mining and data warehousing, design and analysis of algorithms and software project management. She has collaborated actively with researchers in several other disciplines of computer science, particularly software engineering on solving software project and quality management related problems. She is a professional member of FAWEZI (Forum for African Women in Education, Zimbabwe).



## SARAH KHALIFA

MS. SARAH KHALIFA has been a renewable energy engineer since 2014, at the Ministry of Infrastructure and Urban planning - Northkordofan, Sudan. Her primary job functions include planning solar energy projects, capacity building for staff and targeted communities as well as monitoring and evaluation of solar system projects. She won the State Governor's Prize for creating and presenting a digital map of solar system projects and a solar water pump system's transformation map for water security. Over the period 2008-2011 she was the supervisor for the solar project. She is known for her contribution to the development of communities and environmental conservation by promoting renewable energy solutions for providing energy access in rural areas with fewer CO<sub>2</sub> emissions. Sarah has been recognised for her passion for her commitment to empowerment of communities. She holds a Master of Technology degree in electronics engineering from the Indian Institute of Technology, Banaras Hindu University (IIT-BHU). She received her BSc in electronics engineering from University of Gezira. Sarah is a member of the Sudanese Knowledge Society and Nafeer Charity Organisation (North Kordofane State).



## SUZETTE VAN DER WALT

SUZETTE VAN DER WALT is a South African architect who graduated with a Master's degree in architecture in 2016. She has since worked as a project architect on affordable housing developments in the Johannesburg inner city and as project manager for a socio-technical non-profit organisation working in informal settlements and unauthorised building occupations in Johannesburg.

She is an early career academic and her research explores interactions between the state, private sector and human rights organisations in the negotiations over housing and service delivery in South Africa.

Suzette also teaches at the University of Johannesburg where she facilitates the learning of tools and methods of engagement with the Masters of Architecture programme students. She also works for Tshwane University of Technology as a researcher facilitating the Community Engagement Project that forms part of a multi-year collaboration between TUT and ItoI Agency of Engagement, a non-profit social enterprise.

Currently, she is involved in the facilitation of a support programme for residents living in a building under conditions of unauthorised occupation; her role includes documenting their spaces using GIS and BIM. In addition, this entails assisting the residents to develop community action plans and refurbishment plans to improve their immediate livelihoods while they negotiate with the State around adequate inclusive housing opportunities.



### TAURAI MUTANDA

DR. TAURAI MUTANDA is a lecturer and researcher at the Mangosuthu University of Technology. He holds a PhD from Rhodes University. He has extensive experience as a postdoctoral fellow, research associate and honorary research fellow. He has been recognised by the NRF as an emerging researcher (2013). His research interests are microbiology and biochemistry involving microalgal ecophysiology, microalgal biotechnology, microalgal bioprospecting, biofuels and renewable energy as well as phyco-remediation of industrial and municipal wastewaters, algal biomolecules and value-added products, enzymatic synthesis of prebiotics, carbohydrate and lipid biochemistry, protein purification and carbohydrate biochemistry. He has an h-index of 12, i10-index of 14 and RG score of 24.14. He has published 33 research papers including 5 book chapters and his work is highly cited with a cumulative citation total of 2809 (September, 2020). He has supervised 2 PhD, 6 MSc and several honours postgraduate students. Dr. Mutanda is a prolific author and reviewer for prestigious journals. He has reviewed numerous research papers for high impact journals, and has been recognised by several publishers for this scholarly engagement. He serves on the NRF and WRC panels of research project reviewers. Dr. Mutanda has presented his research work at numerous national and international conferences.



### WAFAA NADIM

DR. NADIM is an associate professor in Architecture and Building Technology at the German University in Cairo (GUC), Egypt. She received her PhD and MSc degrees from the University of Salford, Manchester UK, and her BSc degree in architecture from Cairo University in Egypt. Dr. Nadim joined the €10 mill EU-funded Integrated Research Project on Open Building Manufacturing/Manubuild (2004-2009) where she was responsible for developing training and education packages including a VR training demonstrator. She authored or co-authored several refereed journal papers and book chapters on the innovative uptake of offsite construction in the UK and Europe. Recently, as the principle investigator, Dr. Nadim completed a project funded by the Science and Technology Development Fund (STDF) with the title *Affordable and adjustable living and mobility for an integrated urban system in Egypt (AL<sup>2</sup>MOBILIUS)* investigating the potentials of open building for social housing in Egypt.

Dr. Nadim supervises MSc and PhD scholars concerned with improving architecture and construction practices in Egypt, with emphasis on housing, covering topics such as BIM, VR, PPP, daylighting, natural ventilation, flexibility, aesthetics and so forth. Dr. Nadim was also the coordinator for SB13 Cairo Conference, and SBE16 Cairo conference in 2013 and 2016 respectively as part of the international conference series: “Sustainable Built Environment” organised by the CIB, FIDIC, iiSBE, UNEP. Dr. Nadim is also a Hubert Humphrey alumna in construction technology policy and management at Rutgers University in the USA. She has further practical experience in construction project management in multinational construction projects ranging from £100Mil - £170Mil.



### AUROBINDO OGRA

AUROBINDO OGRA is a Professional Planner with more than 18 years of international professional experience in multidisciplinary areas of urban and regional sectors. He acquired his Bachelor of Construction Technology in 2000, Master’s in Urban and Regional Planning in 2002, and his Master’s in Business Economics in 2009. He is currently finishing his doctoral research in e-Governance at the University of Johannesburg.

Aurobindo is active in consulting engagements in industry and has provided expert consulting inputs in urban sector project assignments at national and international levels in the capacity of Team Leader, as an Urban Infrastructure/ Tourism Planning Expert. During the last two decades he has worked on several multi-sectoral urban projects underwritten by bilateral and multilateral donor agencies, including ADB,

World Bank, JBIC and USAID as well as on National, Provincial and Local Government projects. His key expertise and research interest areas span multidisciplinary domains of urban sectors like Smart Cities, Urban and Regional Planning, Urban Infrastructure, Urban Development and Management, Local Government, Urban Financial Management, Metropolitan and City Regions, e-Governance, Geographic Information Systems, Urban/Spatial Analytics, Innovation and Technology Integration, Tourism, and Industrial Parks Development.

At an institutional/ industry level, he has provided technical inputs at various levels in the capacity of an Expert Panel Member, Working Commission Member, Scientific Committee Member, Editorial Board Member, Reviewer, and Session Chair as well as a Keynote Speaker. His current teaching responsibilities at postgraduate level include Sustainable Urban Infrastructure and Smart Cities Development (SUSC019), and Land, Infrastructure and Transport Planning (ULT8X00) and research supervision of postgraduate students.

Aurobindo is also active in research and has published and presented over 50 articles in journals, book chapters and peer reviewed conference proceedings. His areas of research supervision include focusing on areas of Smart cities, Digital Transformation, Industry 4.0, Special Economic Zones and Industrial Parks Development, Spatial Planning and Industrialisation, Integrated Waste Management Systems as well as other thematic areas of the built environment sector.



### CHIOMA OKORO

DR CHIOMA SYLVIA OKORO is a Senior Lecturer in the Department of Finance and Investment Management, College of Business and Economics at the University of Johannesburg, South Africa. She holds PhD (Engineering Management) and MTech (Construction Management) from UJ and BSc (Estate Management) from the University of Nigeria, Nsukka. Her professional and teaching experience centres on real estate development, valuation, and management. She has worked for private and public entities. She has published research on construction health and safety, facilities management and infrastructure planning and sustainability, in accredited journals and peer-reviewed conference proceedings, some of which have won the Best Paper Award. She heads the research unit within her current department. She is a member of the organizing committee for the International Conference on Infrastructure Development and Investment - Strategies for Africa since 2014 and a reviewer for international and national journals and conferences.

### HATTIE CARWELL

HATTIE CARWELL is a founding Board member of the International Network on Appropriate Technology. She co-founded the Coalition of Hispanic, African and Native Americans for the Next Generation of Engineers and Scientists, Executive Director of the Museum of African American Technology (MAAT) Science Village in Oakland, California, and co-founded and chairs the Development Fund for Black Students in Science and Technology (DFBSST), a national endowment fund located in Washington, DC that awards scholarships to African American students pursuing technical degrees at Historically Black Colleges and Universities.

During her 36+-year technical career, she worked nationally and internationally for the U.S. Department of Energy and the International Atomic Energy Agency as a health physicist and nuclear safeguards group leader.



**DR HERMIE DELPORT**

DR HERMIE DELPORT has been involved in architectural education for the past twenty years. She was at the Cape Peninsula University of Technology for approximately 20 years where she taught various courses, led design-build projects, was involved in curriculum development and design and acted as Head of the Department of Architectural Technology and Interior Design.

Hermie is currently with STADIO Higher Education Institution where she is the Project Leader for the development of STADIO's future School of Architecture and Spatial Design. Her research focuses on architectural curriculum and education as well as community engagement, with a specific interest in live and design-build projects as sites of learning. She believes the marriage between the inherent hands-on context of architectural education and the online learning environment provides interesting opportunities for future learning scenarios and experience

**MJUMBE POE**

Mjumbe has been developing civic technology since 2010. He endeavors to use technology to build the capacity of individuals and communities to shape their cities, their neighborhoods, and their own lives.

In addition to working as a Data Engineer at Betterment, Mjumbe is co-founder and CTO of Stepwise, a company dedicated to leveraging open data to help people make smarter, more impactful investments in the built environment. Prior to joining Stepwise in 2016, Mjumbe served as a Digital Services Architect at the City of Philadelphia's Office of Open Data and Digital Transformation . In 2012, he started at OpenPlans , where he worked on projects that encouraged city residents to get involved in planning for the future of their cities .

In 2011, he was an inaugural Code for America Fellow. The perspective of technology as a means for social empowerment guides Mjumbe's professional and extracurricular development. In addition to volunteering with Coded by Kids as an instructor and a board member, he is a member of the planning committee for the biannual International Conference on Appropriate Technology .

- MUJAHID H. KHALIFA**
- KUDAKWASHE MADZIMA**
- DENA MCMARTIN**
- KINYUA NGIGE**
- TAPIWA MURAMBIWA**
- JESSE BEMLEY**
- ALFAYO ONGERI**

## 9th ICAT support STAFF AND ASSISTANTS

With special thanks to



**TSHOLOFELO QUEEN MOKOLOPO**

**Conference management**

TSHOLOFELO QUEEN MOKOLOPO'S current job title is the Gibela Research Chair Administrative Assistant, with involvement in several projects similar to the Gibela Research Chair, namely: merSETA, NRF Flagship, SARCHI Chair and the RMCERI Incubator. She was part of the conference administrative team that hosted the 30t CIRP Design Conference that took place earlier in the year and is actively involved on the 9th ICAT Conference.

Tsholofelo obtained her B-Tech in Office Mangement and Technology, currently completing her Masters in Office Management of Technology, at the Tshwane University of Technology.

**Assistants**

- DR OT ADENUGA**
- DR IA DANIYAN**
- MR EP SEKANO**
- MR GM MONZAMBE**
- MS FRANCINE**
- MR CN MUPIER**
- MR BT SHIHUNDLA**

- LERATO MOTSHABI**
- FRANCINE VAN TONDER**
- CARLA SCHMIDT**



## TECHNOLOGY EXCHANGE AND EMPLOYMENT CREATION FOR COMMUNITY EMPOWERMENT: CROSS-POLLINATING INNOVATIVE MODELS

The 9th ICAT will:

- Promote Knowledge-Based Technology Exchange and the related diffusion of innovation to support the practice of Appropriate Technology (AT)
- Identify, initiate and combine AT contributions based on both pre-modern and modern knowledge exchange in a manner that is rooted in community empowerment
- Provide a forum for networking and debating AT solutions for the 21st century and facilitating the cross-pollination of innovative thinking in AT; bringing together a diverse group of creative ideators in the field of AT
- Allowing for the recognition, valorisation and re-appropriation of innovative and appropriate technologies Allowing an opportunity to explore AT at all levels human activity and through the investigation of the diverse range of carefully compiled sub-themes

**Technology is never neutral. Decisions about technology are based on deeply embedded belief and value systems. As professionals and educators, we are constantly taking a position through technical decision-making, and the content and process of our teaching. This was evident in the spiritual and intellectual transformation that led to the emergence of the appropriate technology movement.**

Creativity, innovation and technology transfer ecosystems motivate entrepreneurial minds, both tacit and codified, and are one of the most reliable bases for long term, sustainable development. Unfortunately, much of this knowledge transfer remains under-recognised and undervalued, due to non-exposure to new perspectives, the dearth of innovative ideas or lack of improvement on previous ones. At present, large numbers of people in the Global South, particularly in Africa, still lack access to clean water, sanitation, clean energy, reliable food and nutrition, and safe transportation, among other challenges. Yet in those same societies, some people have adopted time-tested, demonstrable approaches to resolving them, while others are engaged in cutting-edge scientific research and technological development. All of these efforts, to the extent that they are informed by contextually-relevant needs and priorities, represent the exchange of knowledge for Job Creation and Community Empowerment.

However, refining, upgrading, applying and diffusing this knowledge in the form of improved products, services and practices also requires the dissemination of lessons and experiences between similarly-motivated actors from a broad cross-section of any given society.

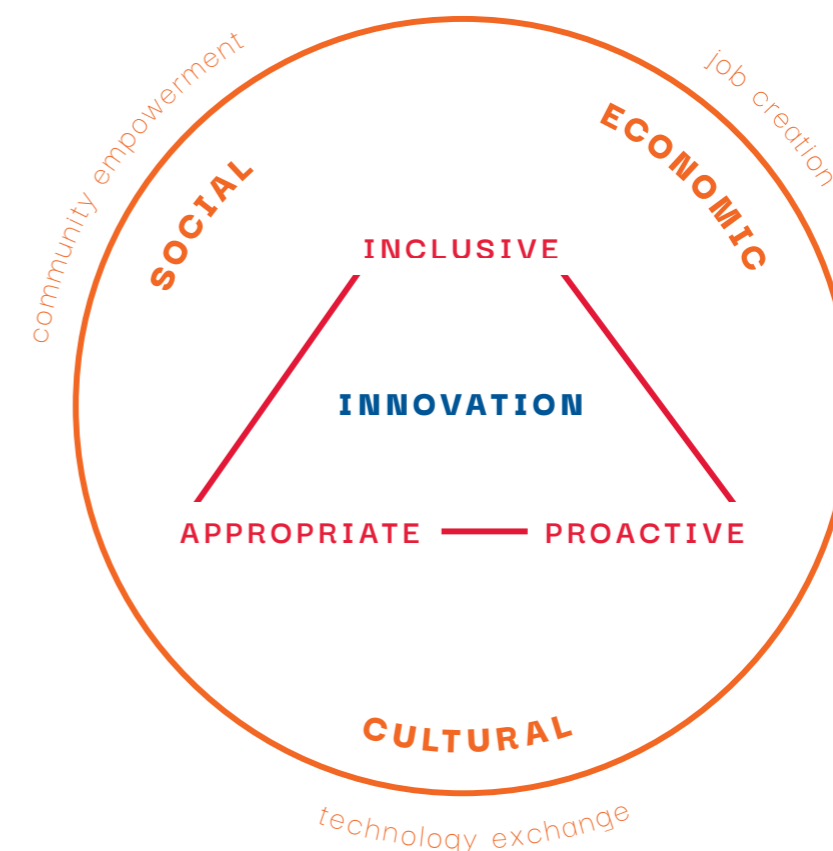
In exploring various local challenges together from an Appropriate Technology perspective, we believe that we can contribute to a more pluralistic, multi-centric, equitable, sustainable - and ultimately - more peaceful global community.

Appropriate Technology (and its manifestations) is a movement, which encompasses technological choices and applications that are decentralised, energy-efficient, environmentally sustainable, and locally autonomous. Although Dr. E.F. Schumacher is generally credited as the first to articulate the concept of “appropriate technology” in his 1973 book, “Small is Beautiful”, the INAT has significantly revised and expanded those ideas since its inception. Thus, rather than being limited to basic tools and machines, the INAT has embraced the idea of Endogenous Knowledge, which offers a framework for integrating useful and locally-grounded knowledge with cutting-edge science and technology, where relevant. Furthermore, the INAT endorses the notion of “Authentic Technology”, as advanced by Fr. Dr. Godfrey Nzamujo<sup>2</sup> of the Songhai Centre<sup>3</sup>, which is one that leverages ecological knowledge for the design of human technologies, thereby moving from “bio-arrogance to bio-mimicry”. In alignment with its continuing conceptual development and practical commitment, INAT developed an “Appropriate Technology Declaration” which is posted on its website.<sup>4</sup>

**This quote captures INAT’s core mission:**

**We declare that a primary goal of the ‘Appropriate Technology movement’ is to use science and technology research, development, deployment, implementation and policy to work toward worldwide egalitarianism. We envision – a social reality where all women, men and children of our planet have equal access to resources to meet their basic needs and a controlling voice in how resources are to be distributed and technology is to be developed.”**

**This image graphically presents the intentions and themes of the conference.<sup>5</sup>**



<sup>1</sup> Leondard, R., 2018, E. F. Schumacher and Intermediate Technology, Document de Travail/Working Paper, No. 2018-22, ESG Recherche, University of Quebec Montreal, available at [https://economie.esg.uqam.ca/wp-content/uploads/sites/54/2018/05/2018-22\\_docdt\\_eco.compressed.pdf](https://economie.esg.uqam.ca/wp-content/uploads/sites/54/2018/05/2018-22_docdt_eco.compressed.pdf), accessed 05.07.2019, 09.50

<sup>2</sup> [https://www.icwe-secretariat.com/icwe\\_webprojects\\_cms/preview/profile\\_popup.php?bioid=1284](https://www.icwe-secretariat.com/icwe_webprojects_cms/preview/profile_popup.php?bioid=1284)

<sup>3</sup> <http://www.songhai.org/index.php/en/home-en>

<sup>4</sup> INAT, Declaration of Appropriate Technology, available at [http://www.appropriatetech.net/media/attachments/2017/12/05/declaration\\_of\\_at.pdf](http://www.appropriatetech.net/media/attachments/2017/12/05/declaration_of_at.pdf), accessed 05.07.2019, 09.39

<sup>5</sup> Inspired by Drosou, N., Soetano, R., Hermawan, F., Chmutina, K., Boshier, L., Hatmoko, J. U. D., 2019, Key Factors Influencing Wider Adoption of Blue-Green Infrastructure in Developing Cities, in Water 2019, 11(6), 1234, available at <https://www.mdpi.com/2073-4441/11/6/1234/htm>, accessed 05.07.2019, 09.39

PAPER CATEGORIES	SOME SUGGESTED TOPICS	
GREEN ECONOMY AND INNOVATION	<p>Smart Manufacturing, small scale industry, mining and mineral processing, socially relevant computing, economics of technology, textile technology, recycling, social business/social entrepreneurship, appropriate technology innovation, ecological economics.</p> <p>Maximise awareness of technologies; Moving towards a sustainable, eco-friendly and pollution-free world; Opportunities to fully integrate new forms of manufacturing, prototyping and representation; Creating an interface between places of living and the technologies made possible with the developments of the 4th Industrial Revolution.</p>	<p>Environmental impact, irrigation projects, forestry &amp; wildlife, agricultural technology, climate change, air quality, remediation of contaminated environments.</p> <p>Climate change will impact the poorest countries and their people the hardest. Curtailing harmful climate change and eradicating poverty requires sustainable and ecologically sound solutions. Many have inadequate access to safe water, lack basic sanitation, have no access to a stable, reliable energy and many more access to the internet and the information and opportunities that this may offer. Eliminating poverty and improving the quality of life requires increased agriculture, industry and transport productivity, which is possible via improved water, energy and information utilisation.</p>
ENERGY AND MATERIALS	<p>Hydro power projects, alternative energy systems, renewable energy, distributed power, rural electrification, hydrogen fuel cells, Compressed Natural Gas, solar and energy efficiency.</p>	<p>Appropriate technology for small-scale urban agriculture. Including urban agriculture in all urban planning. We view urban agriculture as being an integral part of every urban project in the near future - we would like to explore opportunities for the use of roof tops, gaps between buildings and forgotten and neglected spaces in the city fabric.</p>
WATER AND SANITATION	<p>Water supply, storage and sanitation, water scarcity, water quality, water stress and recycling, toilets, waste management.</p> <p>How do we deal with landfill sites in innovative ways?</p>	<p>Education and training, knowledge engineering, knowledge management, community development, indigenous knowledge, people's science. Collaboration between academics, policy makers, users and society at large.</p>
HEALTH	<p>Indigenous medical technologies, food preparation/processing, technologies addressing malaria/TB/HIV/AIDS related issues, pharmaceuticals and Universal Health Care (UHC). Public health and human productivity require technology practices that address basic community needs.</p>	<p>Decolonisation of knowledge. The promotion of design for social innovation in higher education institutions so as to generate useful knowledge and to create meaningful social changes in collaboration with other stakeholders.</p>
CONSTRUCTION AND INFRASTRUCTURE	<p>Appropriate architecture, appropriate construction, appropriate transportation, sustainable building materials. Passive systems, locally-available materials and existing skills must be considered with regards to appropriate technology and building practice; the creation of environments that are healthy and beautiful, where social acceptance and environmental appropriateness are taken into consideration; affordability and durability. Small, medium and large scale construction enterprises can be considered in this process of investigating appropriate technology. Glass and steel, air-conditioned towers emerging are not only problematic in environmental terms, but they have implications by focusing on "big capital" and "big players"; in order for future developments to be inclusive of small and medium construction enterprises, the design and building heights need careful consideration. We need to consider materials that can be sourced locally, transported easily on smaller vehicles, carried by a maximum of two people, easily installed by unskilled labourers and easily dismantled and reused if the need arises. Inspired by the new Future Africa Campus the University of Pretoria, the conference sets out to explore these concepts in more detail.<sup>6</sup> This is in direct opposition to a building like the Leonardo that is just about to be opened in Sandton.<sup>7,8</sup></p> <p>Appropriate Architecture for Open Building<sup>9</sup>: The conference subscribes to a view of using an infrastructure model of the built environment based on levels of intervention and the separation of design tasks, polycentric rather than centralised governance and innovations by means of agreed interfaces between levels. It also considers the resilience of the whole built environment with change and transformation of its components.<sup>10</sup></p>	<p>Combining 'learning goals' and 'community service' in a manner that aims towards 'knowledge exchange' as opposed to 'knowledge transfer', and to encourage a search for design and technical solutions through deeper understanding of people, place and context, rather than deriving solutions in isolation, using abstract theories that may not have relevance to communities.</p> <p>Establishing long term partnerships with communities and gearing teaching programmes towards problems that are of high relevance to the socio-economic conditions of the contexts where we practice. Global approaches to social innovation. The conference will explore how communities can achieve more awareness of their agency, influence and decision-making capacity in the built environment. Activism through 'service learning' and in providing documentation, design and/or building services with the intention of achieving education, empowerment for communities.</p> <p>Skills gaps; Appropriate technology adoption for a various industries; Barriers in the job market; Nature of tasks in various industries; Desirability of automating or augmenting tasks; The production of goods and services; Opportunities growth and productivity.</p>

6 <https://web.facebook.com/andre.eksteen.754/posts/2645710785438900>, <https://www.ewarch.co.za/post/3096/futureafrica/>.  
7 <https://www.iol.co.za/preTORIA-news/leonardo-in-sandton-will-be-africas-tallest-building-33385524>  
8 <https://mg.co.za/article/2019-10-11-00-after-45-years-africa-has-a-new-tallest-building>  
9 <http://open-building.org/about/objectives.html>  
10 [https://councilonopenbuilding.org/?fbclid=IwAR1fMc82LSoxGNSVvMMloEsBJiwukOJ5XH-TqvvQocV89\\_t\\_XegiVxifHEQ](https://councilonopenbuilding.org/?fbclid=IwAR1fMc82LSoxGNSVvMMloEsBJiwukOJ5XH-TqvvQocV89_t_XegiVxifHEQ)

## CITIES AND SPACE

Cities as hubs of innovation and experimentation; Technology in the service of the African city of the future. Current debates about the environment, the realities about our cities and our practice will influence our understanding of technology.

The “segmentation of critical thought about cities, urban and architectural space into non-communicating subspecializations”<sup>11</sup> is challenged. It is believed that innovations in technology for our future cities will be found at the interface of various professions.

In South Africa, with the president’s recent State of the Nation address and the call for the development of a new, smart city, there is much to be debated with regards to the technologies that could serve this vision. “Cities are by definition contextual creatures. The greatest cities in history and in our era are those who work with their soil, local cultures, endogenous knowledge, appropriate technology, and in the process become hubs of experimentation and innovation. Such cities are also marked by a celebration of diversity and openness—the lifeblood of creativity.”<sup>12</sup>

Buildings, space and communities in cities: this conference being positioned in Tshwane is significant. Firstly, Tshwane has an exciting innovation strategy and intends becoming the “innovation capital of Africa”. The City of Tshwane has a particular interest in innovation eco-systems. Secondly, the city has the largest number of students between all other South African cities; the inter-university innovation challenge between the three universities in the metro encourages the students to become involved in imagining exciting futures for the future of Tshwane.

## TECHNOLOGY R&D

Investment in technology; Research and Development agendas; Economic viability and appropriate technology;

“Making” as a strong theme at TUT: some of our key projects are the TUT solar car and the Architecture Department’s “Maker Space”. We are involved in numerous community engagement projects that revolve around innovations in materials and technology. Through this event, we are seeking new partnerships and showcasing projects.

This is aligned with the City of Tshwane’s innovation statement says: “To embed the creation and implementation of new ideas within the City’s core activities for the efficient and effective delivery of basic services, enhanced democracy, and to create a platform for a sustainable knowledge economy.” The conference will support the activities of the Tshwane Innovation Zone.

## POLICY, STANDARDS AND ETHICS

Technology policies, technology standards, ethics, culture, quality assurance, responsible wellbeing.

Identify a process of infusing AT in technology policy on national and international levels. We must hold our governments, private enterprises, scientific organisations, NGOs and communities accountable for technologies that impact peoples’ health and wellbeing and the ecological balance of the planet.

Ethics of teaching and practice in community contexts.

## SERVICES INDUSTRY

Optimisation of service delivery such as water, energy or postal services (Internet of Postal Things). Innovation in service industries particular state run services. Community engagement in service improvements.

## SECURITY AND SAFETY

In the emerging world of the 4th Industrial Revolution, where digital technology and automation are central, the aspects of security and safety cannot be an after-thought. As such, the security and safety becomes paramount across the digital ecosystems.

The conference will explore appropriate technologies that enhance safety and security systems, build safer communities and empower citizens by ensuring their security and safety in a digital domain.

## CATEGORIES OF PARTICIPATION AT THE CONFERENCE

There are several categories of participation at this event.

**FULL ACADEMIC PAPER PUBLICATION AND PRESENTATION:** This group of participants submitted full papers for review and inclusion in both THE CONFERENCE PROCEEDINGS (digital publication only). The author, in this case, is also allocated a time slot in the OFFICIAL CONFERENCE PROGRAMME.

**CONFERENCE PROGRAMME PARTNERS:** One aim of the conference is to further and develop new collaborations around AT research and implementation. The Conference Partners have been instrumental in expanding the scope of the conference. These partnerships aimed to use the event as a platform for furthering conversations around the Conference Themes. They have therefore been initiated with a focus on enhancing and supporting the academic aspects of the Conference. They have assisted in the development of the Conference Programme and Content. The Programme Partners have served as advisors to the LOCAL ORGANISING COMMITTEE and the PROGRAMME COMMITTEE.

**POSTER PRESENTATIONS:** Poster presentations from both professionals and student participants are a key aspect of the academic portion of the Conference.

**SPECIAL STUDENT SESSION:** The special student session allows postgraduate students to present their research and seek advice from international experts. A PhD colloquium will also be hosted by the Africana Post Graduate Academy (APGA).

**WORKSHOPS:** Special sessions, before, during and after the Conference will provide hands-on experience with appropriate technology, such as the 3D printing workshop. Other special themes such as Open Building and its relationship to Appropriate Technology have been included. Submissions for workshops were reviewed and selected by the INAT Steering Committee.

## THE INTERNATIONAL NETWORK ON APPROPRIATE TECHNOLOGY (INAT) IS SUPPORTED BY THE LOCAL ORGANISING COMMITTEE (LOC) BASED IN PRETORIA, SOUTH AFRICA.

The INAT AND LOC are supported by PROGRAMME PARTNERS/PANEL OF REVIEWERS who have been instrumental in expanding the scope of the conference. The conference platform has been harnessed to further conversations around the conference themes and to explore potential future collaborations.

The Scientific Paper Process would not have been possible without the support of the Programme Committee, Editors and Support Staff.

### EDITORS

- Amira Osman
- Brian Stephenson
- Gada Kadoda
- John Trimble

9TH INTERNATIONAL CONFERENCE ON APPROPRIATE TECHNOLOGY

# CITIES AND SPACES

# A SUSTAINABILITY SPECIFICATION FOR EMERGENCY HOUSING

J. Gibberd, CSIR, South Africa, itshose@gmail.com

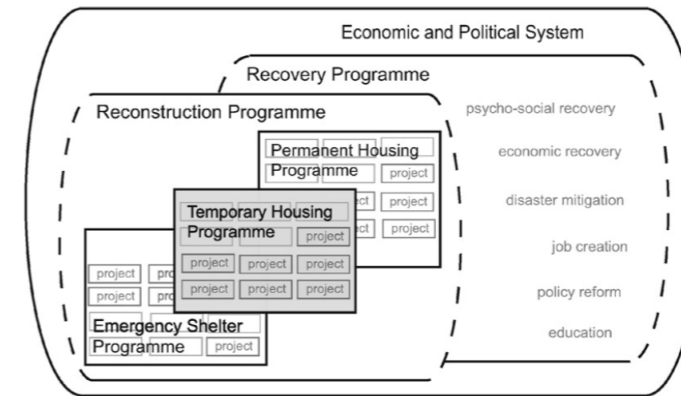
## Abstract

*There is a need to provide emergency accommodation for households in the event of a disaster such as flooding. In South Africa, this is catered for in the National Housing Code developed by the Department of Human Settlements in 2009. Since 2009 there has been an increasing requirement for human settlements and housing to address issues such as climate change, sustainable development, and more recently, COVID-19. This study aims to understand these requirements and how they can be met in emergency housing. It uses the Sustainable Building Assessment Tool (SBAT) to review current provision for emergency housing in the Housing Code. This provides the basis for proposing sustainability specifications which incorporate appropriate technologies for emergency housing. These are critically evaluated and discussed to develop conclusions and recommendations. The study identifies measures that could be incorporated into emergency housing to make a contribution to improving the quality of life of occupants as well as enhancing the sustainability performance of the housing.*

**Keywords:** appropriate technology, emergency housing, estimating tools, South Africa, sustainability

## INTRODUCTION

Emergency housing is a response to disasters and aims to accommodate displaced households and enable them to restart their lives as soon as possible after an event. Emergency housing, however, is often controversial and criticised for being too expensive, too late and for having negative impacts on local environments (Johnson, 2007). Quarantelli (1995) shows how emergency housing is catered for after a disaster. Initially, emergency shelter, as an immediate response, is provided and this may include temporary accommodation in a hall, school or under plastic sheeting. This is followed by temporary shelters such as tents which are used for a few weeks after the disaster and include the provision of food and medical care. The third stage is emergency or temporary housing which enables occupants to return to normal daily activities such as going to work, school and shopping for food. This accommodation is normally in the form of prefabricated houses. Finally, there is permanent housing, when occupants return to their former homes after reconstruction or move to new homes. These stages may not happen in all cases and there may be situations where occupants move directly from temporary shelters to permanent housing. This study focusses on the third stage, where temporary or emergency housing is provided and where occupants may live for three to five years (Johnson, 2007; Department of Human Settlements, 2009).



**Figure 1:** Temporary and emergency housing as part of a system (Johnson, 2007).

Johnson (2007) shows that it is important to consider temporary housing as part of a wider reconstruction effort which includes disaster mitigation, economic recovery, policy reform, job creation and education (see Figure 1). By placing temporary housing within a larger context, Johnson (2007) argues that the success of an emergency housing programme is linked to these wider systems and, in turn, the success of these efforts at a local level is dependent on the nature and quality of the emergency housing.

In South Africa, the growth of vulnerable informal settlements combined with natural disasters attributed to climate change such as flooding or the outbreak of disease such as the COVID-19 pandemic has resulted in the growing importance of effective emergency housing strategies (Department of Human Settlements, 2020; National Treasury, 2020). Emergency housing in South Africa is catered for the National Housing Code developed in 2009 (Department of Human Settlements, 2009).

This paper reviews the provision for emergency housing contained in the Housing Code within a context where it is becoming increasingly important to address sustainable development, climate change and COVID-19. The review draws on a sustainable building assessment tool, the Sustainable Building Assessment Tool, to identify ways the existing provision could address sustainability, climate change and COVID-19 more comprehensively and proposes outline specifications for emergency housing that aim to achieve this. These specifications are critically reviewed to ascertain their value in supplementing existing guidance, and conclusions and recommendations are proposed.

## Methodology

The methodology is based on the following steps:

1. The Emergency Housing Programme in the Housing Code is introduced and described.
2. The Sustainable Building Assessment Tool (SBAT) is described and the evaluation criteria listed.
3. Results from applying the SBAT to assess the Emergency Housing Programme are provided.
4. Results from the SBAT assessment are used to propose an alternative sustainable emergency housing specification.
5. This specification is critically reviewed.
6. Conclusions and recommendations are developed.

## Emergency Housing Programme

The Emergency Housing Programme is Part 3 of the National Housing Code (Department of Human Settlements, 2009). The Programme was developed to support the right to adequate housing enshrined in the South African Constitution. It addresses the needs of households that have had their existing accommodation destroyed or damaged and need immediate shelter. The programme provides grants to municipalities to enable them to respond rapidly to emergencies and can fund land acquisition, settlement planning, basic municipal engineering, the construction of temporary shelters (or the materials for this) and the cost of consumption of water, sanitation, refuse collection and street lighting for up to three years.

Minimum performance requirements for housing provision outlined in the Programme are summarised below:

- Water: the provision of access to a water point or tap for every 25 families.
- Sanitation: temporary sanitary facilities must be provided. Where conditions permit the use of Ventilated Improved Pit Latrines (VIP toilets) must be provided as a first option. An acceptable standard is one VIP toilet per five families.
- Access, roads, and stormwater: a main access road and open lined stormwater management system must be provided.
- Electricity: the programme will only fund the provision of high-mast lighting in special circumstances.
- Temporary shelters: these should be basic, simple in form and easy to construct. The floor area of shelters should be at least 24m<sup>2</sup> and may vary up to 30m<sup>2</sup>. The temporary shelter should be appropriate for the specific environment and as far as possible be acceptable to beneficiaries.
- Construction: shelters can be provided through the supply of materials to beneficiaries on-site to construct their own shelters or to be constructed for them, depending on the exceptional nature of the situation. The preferred option for the provision of shelter is the supply of prefabricated units. Where beneficiaries have supplied their own materials, advice and assistance can be offered with regard to the construction of the shelters.
- Roof covering: this should be trafficable and waterproof, to suit purlin spacing.
- Side cladding: this should meet OHS Act requirements and be safe, sustain normal weather conditions as well as provide adequate resistance to water penetration. The minimum height should be 2.2 m.
- Column footings: these should be concrete.
- Door: these must be framed, lockable and hinged.
- Windows: a minimum 5% of floor area must be framed and glazed.
- Flooring: this should be level, solid on compacted fill and 150 mm above ground.
- Thermal efficiency: this should suit the roofing material and local conditions.
- Settlement density: up to 5 shelters (per ordinary stand of 250m<sup>2</sup>) could be considered.
- Ownership: the ownership of temporary shelters to be provided under the Programme should be vested in the provincial department.

The Programme also provides drawings (see Figure 2) and a set of criteria that can be used to measure the performance of emergency housing projects. These are as follows:

- Where applicable, the temporary facilities should be converted into permanent sustainable housing facilities. Where the facilities are not transformed into permanent housing facilities, they should be re-used when future emergency circumstances arise.
- A beneficiary satisfaction survey should be conducted to determine the impact of the development on their lives.
- The willingness and ability of residents to pay for facilities as demonstrated by increased local government revenues and the willingness and ability of government agencies to maintain and operate public infrastructure developed through emergency housing projects should be ascertained.
- The environmental impact of emergency housing projects should be determined.
- Improvements in living conditions should be measured through:
  - Health indicators (particularly a decline in waterborne diseases and infant mortality rates, where these indicators have been recorded and are available);
  - Access to water and sanitation (households having access to “improved” drinking water and sanitation).

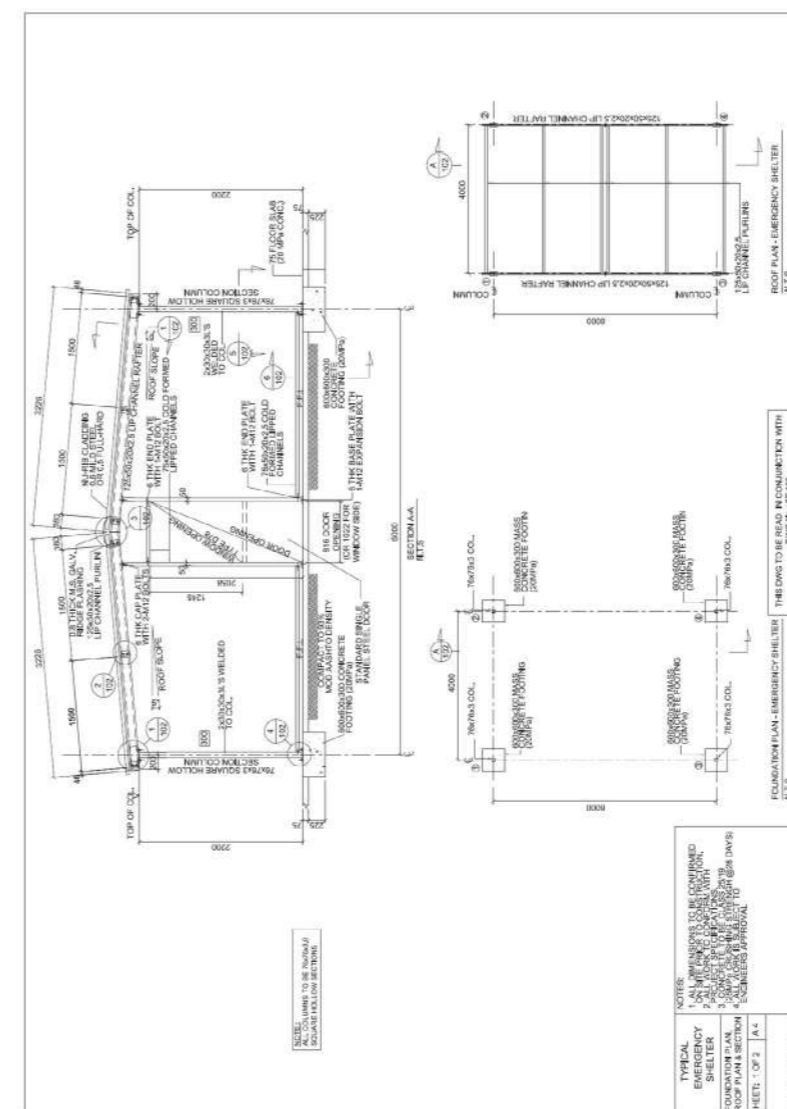


Figure 2: Drawings of typical emergency housing (Department of Human Settlements, 2009).

The performance requirements, performance criteria and drawings of emergency housing in the Code are reviewed using the Sustainable Building Assessment Tool.

## The Sustainable Building Assessment Tool

The Sustainable Building Assessment Tool (SBAT) or Residential tool was developed by the author to assess the sustainability performance of housing as well as their immediate neighbourhoods (Gibberd, 2002; 2020). This tool is based on an approach that indicates that buildings and environments are not sustainable in themselves but must enable and encourage sustainable living and the working patterns of their occupants. The tool, therefore, measures the capability of the built environment (characteristics and facilities) which enables users (occupants) to live sustainably. The tool is suitable for developing country contexts and has an equal weighting between environmental, social and economic sustainability performance. The tool explicitly addresses issues such as health, education and employment which are not addressed by green building rating tools. The benefits to the local economy of locally developed, maintained and appropriate technologies for sustainability are

recognised in the tool which weights these significantly more heavily than imported technologies which are inappropriate for local conditions.

The tool consists of an Excel-based spreadsheet and manual. Buildings are assessed in terms of 15 criteria which measure the environmental, economic and social sustainability performance of the building. Results of the assessment are presented in a report with a spider diagram shown in Figure 3. Performance in each area is reflected in a score from 0 to 5, with 5 indicating excellent sustainability performance; and 0 no performance.

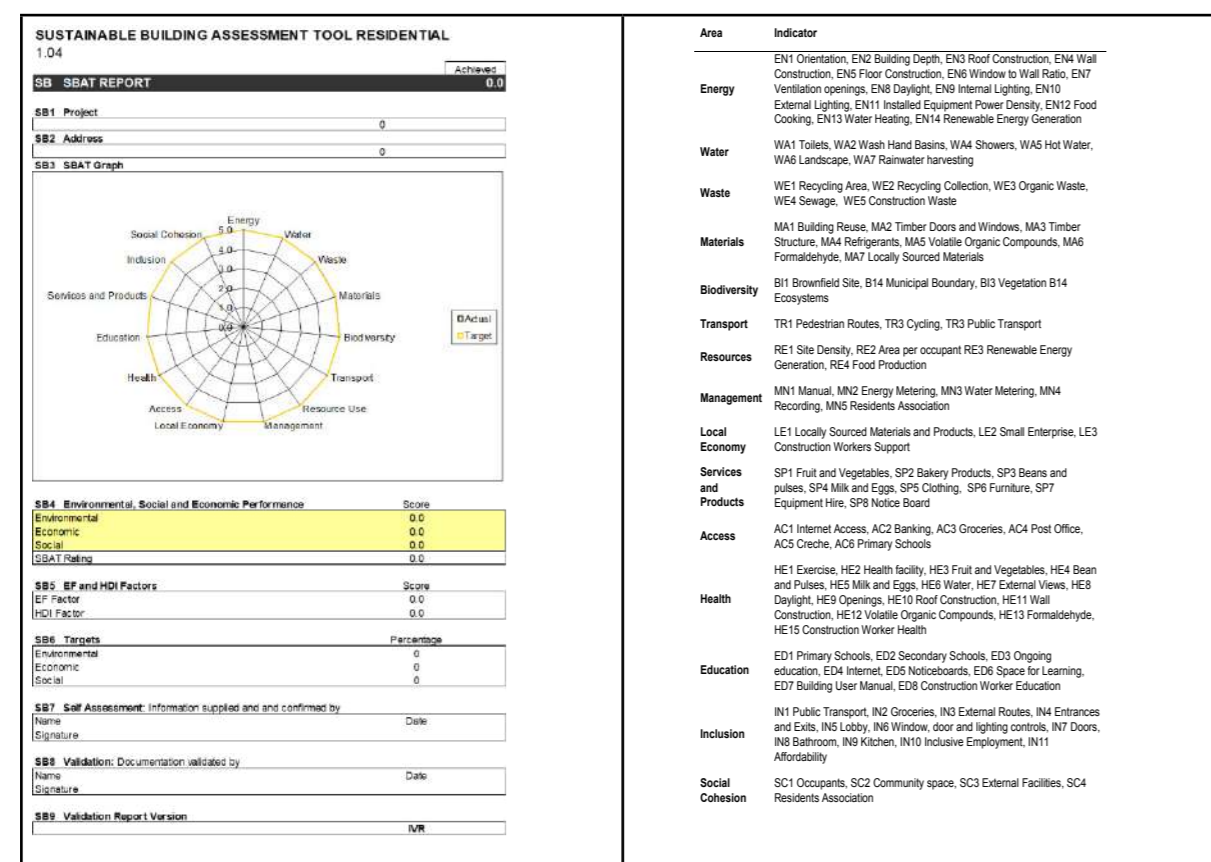


Figure 3: The Sustainable Building Assessment Tool and Criteria

## Results

A review of the results indicates that the provisions in the Emergency Housing Programme meet the following SBAT criteria: Energy EN10 External lighting; Materials MA1 Building reuse; MA4 Refrigerants; MA6 Formaldehyde; Water WA1 Toilets; Resource Use criteria RE1 Site Density and RE2 Area per occupant; and Health HE5 Water. For other SBAT criteria, these are either not met, or the criteria cannot be assessed because the issue is not addressed in the documentation provided in the Code.

Figure 4 provides shows an extract from the SBAT report of the assessment. This shows that environmental sustainability performance is 1.1 out of 5, the economic sustainability performance is 0.6 out of 5 and social sustainability is 0.3 out

of 5. These results indicate low levels of performance. This is attributed mainly to a lack of detail within the Code. This is understandable, as guidance in the Code may only have been provided in outline deliberately, with the intention that detailed decisions would be made by government officials and professionals on the ground. While this may work well in areas where there are strong institutional systems and officials and built-environment professionals with relevant experience and skills, it may not be adequate in situations where there is limited capacity. In these cases, more comprehensive guidance may be valuable in supporting effective local decision-making. This may be particularly important in disaster situations where emergency housing needs to be put in place rapidly and there is limited time to undertake research or consult. This study, therefore, proposes specifications for emergency housing that addresses sustainability more comprehensively. As an input to these specifications, the SBAT assessment of the provision in the Housing Code identifies the following areas where further detail could be provided:

- Energy: energy in the buildings should be addressed as the buildings may be used for up to three years and families will need energy for lighting and cooking.
- Water: washing facilities need to be addressed especially as washing hands is seen as a key precaution against infection during pandemics such as COVID-19.
- Waste: waste should be managed to avoid potential environmental health issues developing.
- Materials: the provision appears to favour a prefabricated steel frame and cladding systems. Other materials such as timber, cellulose insulation and bio-based cladding systems should be also considered. These may have better environmental and thermal performance, be cheaper and support local industries and small entrepreneurs.
- Biocapacity: biocapacity and planting should be addressed as trees can create shading and more comfortable environments. Vegetables can also be planted for food.
- Transport: provision for walking, cycling and public transport should be addressed as it is likely that people in emergency housing are likely to rely on walking and non-motorised transport more than on private vehicles.
- Resource use: the provision emphasises spatial efficiency but does not include a requirement to make use of leftover/available space for food production and the generation of energy. Both of these activities could provide valuable local employment as well as other benefits such as reduced carbon emissions and increased food security, so should be included.
- Management: there is an indication that the government would cover the costs for services such as water, sanitation, refuse collection, and street lighting for emergency housing for up to three years. If these services are not managed they may not be used efficiently and as a result, could place a heavy economic burden on the local municipality. Therefore, the inclusion of management of services should be addressed. Involving occupants in the design and management of the temporary housing and settlement also has other benefits such as the development of housing layouts that are more culturally appropriate, and the speeding up of the reconstruction processes (Turner, 1972, 1976; UNDRO, 1982).
- Local economy: support for the local economy is not addressed. Local content procurement requirements can be used to support local small enterprises and are an important part of government policy.
- Products and services: products and services such as food are likely to be one of the chief concerns of people moving into emergency housing. It is, therefore, important to address this issue.
- Access: facilities such as schools and the internet that may need to be accessed regularly by occupants should be included.
- Health: issues required to support health, comfort and productivity should be addressed to ensure that the health of vulnerable households moving into emergency housing is supported.
- Education: as households moving into emergency housing may include children and unemployed people seeking employment, this issue must be addressed.
- Inclusiveness: displaced households may include vulnerable people such as those with disabilities and old and ill people. It is, therefore, important that facilities are inclusive, safe and easy to use.
- Social cohesion: as households moving into emergency housing are likely to have experienced a disruptive event and be cut off from their normal social networks, it is important that people can interact with their neighbours and form new social networks. Facilities to support social cohesion should, therefore, be provided.

The Outline Specifications for Emergency Housing include the next aim in the issues identified in this review.

### SUSTAINABLE BUILDING ASSESSMENT TOOL RESIDENTIAL

1.04

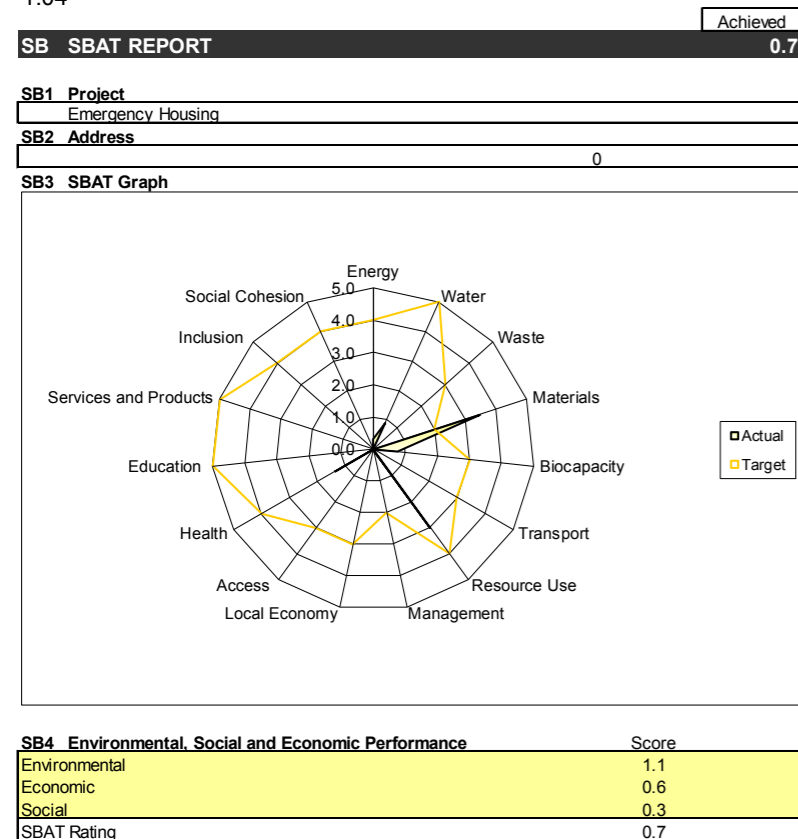


Figure 4: The Sustainable Building Assessment Tool report on emergency housing provision.

### Proposed Outline Specifications for Emergency Housing

The following proposed outline specifications for emergency housing aim to address key issues identified through the SBAT assessment of the provision for emergency housing.

#### Site

The site should be within 2km of social infrastructure such as creches, schools, clinics and recreational facilities. It should also be within 2km of locations where affordable, healthy food can be purchased, where there are opportunities for employment and where affordable public transport can be accessed.

#### Housing layouts

Housing layouts should be developed and discussed with prospective occupants. These should ensure that all houses have good access to daylight and ventilation and therefore housing should be at least 3m apart where there are doors and windows (not

party walls). The long face of buildings should be orientated within 15 degrees of north. Densities achieved should be at least 150 persons per ha and building occupancy densities should be 10-19m<sup>2</sup> per person. Layouts should include provision for small businesses, retail, recycling, recreation facilities and creches (Gibberd, 2019). Safe walking routes should be provided between housing, the main facilities and neighbouring areas. Where social facilities such as clinics and schools are not available within 2km, provision for these should be made within the development (Johnson, 2014).

#### Water

A clean, reliable water supply must be provided within 50m of houses. Designs and management systems should ensure that the supply is as reliable as possible and periods without water should be avoided. Local onsite water supplies from rainwater harvesting should be considered to reduce costs and improve the resilience of supply.

#### Sanitation

Mains sewage, ecological sanitation or a container-based composting toilet system should be provided for the development. Effective management and maintenance systems must also be put in place.

#### Electricity

Sufficient electricity to power LED lighting and a radio/computer/tv should be provided for each house. As a minimum, this should consist of a photovoltaic system with batteries, 3 LED lights and 2 sockets for a TV/radio/computer. The system should be guaranteed for at least three years.

#### Stormwater

Stormwater for the settlement should be designed to avoid any standing water around housing and minimise the risk of flooding.

#### Building design

Yard and internal house layouts should be prepared and tested for suitability with the intended occupants. These should show facilities for washing, cooking, food preparation, social spaces, homework, sleeping and toilets and ensure that they are safely catered for.

#### Washing

A private washing space should be provided. This should be drained and provided with cold and hot water. Each house should have at least one facility where hands can be washed easily. Minimum provision should include a 20l container with a tap and soap on a stand 1m off the ground near the entrance of the house. Greywater from washing should be collected to be used for irrigation.

#### Toilets

Toilet facilities should be provided in the house or yard. If these are outside, lighting should be provided.



### **Food preparation and cooking**

A space for food preparation and cooking should be provided. This should include a working surface, storage area and cooking equipment. Support for clean, affordable, safe cooking equipment should be provided as far as possible. This could include gas, solar cookers, ethanol gel cookers or electrical equipment (where there is sufficient power) such as microwave ovens, or a combination of these.

### **Social space**

Social spaces should be provided for occupants and visitors to eat and socialise together.

### **Homework and administration**

A space for homework and simple administrative tasks should be provided. This should have a workspace, good daylighting and electrical lighting.

### **Sleeping**

Sleeping spaces suitable for the household should be provided. This may include a space for parents and a space for children.

### **Building structure**

The building structure should be designed to meet potential loadings and comply with SABS 0160. The structure could be steel or timber and be designed to enable it to be disassembled and reassembled easily.

### **Building foundations**

Building foundations can be concrete where housing is intended to be permanent, while moveable precast concrete or timber footings can be used where buildings may be relocated.

### **Roof**

A durable smooth roof material suitable for reuse and rainwater harvesting should be used (Centre for Affordable Water and Sanitation Technology, 2011). The roof construction should achieve a minimum total R-value of 2.7 K•m<sup>2</sup>/W and have a light-coloured external surface with a solar absorbance of 0.55 or less, to minimise heat gains.

### **Wall construction**

Wall construction should have a minimum R-value of 1.9 K•m<sup>2</sup>/W.

### **Floors**

Floors should have a high thermal mass, or if suspended, should have an R-value of 1.9 K•m<sup>2</sup>/W.

### **Materials**

The length of time that emergency housing is required should be used to inform the choice of materials. For example, if emergency housing is required for under three years, a frame-based approach with bio-based cladding may be preferable to steel and masonry products as this will be more cost-effective and have a lower environmental impact (Johnson, 2014). Local materials and products should be used for construction and the value of local content should be 100%. No materials that are harmful to health should be used. Materials such as timber products, paints and varnishes that include Formaldehyde and Volatile Organic Compounds should be avoided.

### **Ventilation**

Windows should be provided on opposite walls and an opening size of at least 10% of the floor area should be provided to enable effective cross-ventilation and cooling.

### **Daylight**

Windows should be located to provide a 2% daylight factor in the house.

### **Electrical lighting**

LED or similarly efficient electrical lighting should be provided inside the house. This should provide at least 200lux on kitchen and homework work surfaces. Where washing, cooking or toilets are provided in the yard of house (outside), external lighting should be provided.

### **Food gardens**

Within the yard or nearby, there should be provision for growing vegetables. This could be irrigated with greywater.

### **Construction**

Where possible, houses should be assembled or built by occupants or by local people to support local development and reconstruction. Designs should ensure that the construction of units is easy and can be carried out by non-skilled people. Designs should ensure that materials and components can be reused if houses need to be moved.

### **Procurement**

Where possible and economically competitive, materials, components, prefabricated systems and construction services should be procured from local manufacturers, suppliers and contractors to support local reconstruction and economic development (Johnson, 2014).

### **Ownership**

The ownership of houses, materials and components should, over time, revert to occupants if they wish to purchase these. This ensures that houses are cared for and costs can be recovered from occupants through low-interest loans (Johnson, 2014).

## Discussion

The proposed Outline Specifications for Emergency Housing aim to ensure that emergency housing addresses sustainability more effectively. The specifications, however, should be tested and developed before being applied on a large scale to ensure that unforeseen consequences are avoided. In addition, they should also be reviewed against the latest standards and regulations as these are being updated.

In their current form, aspects may also be difficult to implement. For instance, they require that activities such as washing, cooking, socialising, homework and sleeping are to be shown on the site and building layouts. If there are more than two occupants in a 24m<sup>2</sup> house, it may be difficult to fit in all of these activities. This highlights a difficulty with the existing provisions which do not appear to take into account daily activities such as cooking, washing, socialising and doing homework. It also identifies the need to have a range of house types to accommodate different-sized households, from individuals and couples to families with children.

The inclusion of the sample house plans within the Code is useful because it indicates what sort of provision would meet requirements. This approach should also be expanded with the proposed specifications and sample drawings provided to show how the proposed specifications could be realised. The process of developing these sample plans could also be used to test and refine the specifications and improve their applicability and practicality.

## Conclusions and recommendations

The study reviews the provisions for emergency housing in the Department of Human Settlements National Housing Code using the Sustainable Building Assessment Tool. The review indicates that it may be useful to supplement existing provisions with specifications that address sustainability more comprehensively. To this end, the Proposed Outline Specifications for Emergency Housing are developed. A critical analysis of the proposed specifications indicates that these may play a valuable role in ensuring sustainability is addressed in emergency housing. It, however, suggests that the specifications should be tested and refined through an iterative design process and piloting.

## LIST OF REFERENCES

- Centre For Affordable Water and Sanitation Technology. 2011. *Introduction to household rainwater harvesting*. [Online] Available from: [Wedc-knowledge.lboro.ac.uk](http://wedc-knowledge.lboro.ac.uk), (2020).
- CAWSTRWH\_Manual\_2011-11\_en.pdf [Accessed 12/5/2020].
- Department of Human Settlements, 2009. *The national housing code*. Pretoria: Government Printer.
- Department of Human Settlements. 2020. *Minister Lindiwe Sisulu on government's response to Coronavirus COVID-19 pandemic* [ONLINE] Available at: <https://www.gov.za/speeches/minister-lindiwe-sisulu-government%E2%80%99s-response-coronavirus-covid-19-pandemic-29-apr-2020> [Accessed 14/6/2020].
- Gibberd, J. 2002. *The Sustainable Building Assessment Tool: Assessing how buildings can support sustainability in developing countries*. Built Environment Professions Convention, Johannesburg, South Africa, 1–3 May 2002.
- Gibberd, J. 2019. *Using onsite service enterprises to improve housing affordability and sustainability*. Southern African Energy Efficiency Confederation, Farm Inn, Pretoria, 14-15 November 2019.
- Gibberd, J. 2020. *Applying the Sustainable Building Assessment Tool*. Available at <https://jeremygibberd.com/2020/05/20/new-online-course-on-the-sustainable-building-assessment-tool/>.
- Johnson, C. 2007. Impacts of prefabricated temporary housing after disasters: 1999 earthquakes in Turkey. *Habitat International*, 31(1),36-52.
- National Treasury. 2020. *Division of Revenue Act: Transfers for provincial emergency housing grant to Eastern Cape for heavy rain and flooding related relief* [ONLINE] Available at: [https://www.gov.za/sites/default/files/gcis\\_document/202001/42967gon42.pdf](https://www.gov.za/sites/default/files/gcis_document/202001/42967gon42.pdf) [Accessed 14/6/2020].
- Quarantelli, E. L. 1995. Patterns of shelter and housing in US disasters. *Disaster Prevention and Management*, 4(3),43–53.
- Turner, J. 1972. Housing as a verb. In: J. Turner & R. Fichter (eds). *Freedom to build* (148–175). New York: Macmillan.
- Turner, J. 1976. *Housing by people: Towards autonomy in building environments*. London: Marion-Byers.
- UNDRO. 1982. *Shelter after disaster: Guidelines for assistance*. New York: UNDRO.

# SYNERGISTIC INTERVENTIONS FOR SUSTAINABILITY IMPROVEMENT

J. Gibberd, CSIR, South Africa, itshose@gmail.com

## Abstract

*The International Panel on Climate Change (IPCC) indicates that ‘multiple synergies will be required to achieve the goals of sustainable development, including climate adaptation and mitigation, poverty eradication and reducing inequalities’. This paper explores what ‘multiple synergies’ may mean for neighbourhoods. Sustainability analysis of an existing neighbourhood in Pretoria, South Africa is undertaken using the Built Environment Sustainability Tool (BEST). This is used as the basis to propose, and test, interventions. These interventions are evaluated using the BEST to understand their impact and ascertain whether they support multiple ‘multiple synergies’. The study finds that the interventions identified and tested created multiple impacts across several areas, which can be regarded as synergistic. These synergistic interventions are analysed to understand these in more detail and identify their characteristics and commonalities. The paper contributes to an understanding of how ‘multiple synergies required to achieve goals of sustainable development and climate change and adaptation’ can be derived in built environments and neighbourhoods.*

**Keywords:** BEST, built environment, neighbourhoods, sustainability tool, synergistic

## INTRODUCTION

Developing countries are experiencing multiple challenges that must be simultaneously addressed. On one hand, they have to achieve global environmental commitments on issues such as responding to climate change and biodiversity and on the other hand, having to address urgent local, social and economic development priorities linked to education, health, employment and infrastructure backlogs. Increasing the exposure of vulnerable communities to climate change and associated natural disasters mean that time frames are limited and Butler (2014) estimates that a window of just three decades remains to build the adaptive capacity required to cope with projected climate change impacts.

The IPCC proposes place-specific climate change adaptation pathways as a means of addressing this situation (Roy, *et al.* 2018). These pathways should include a diversity of options based on people’s values. Structured, inclusive and participatory methodologies are needed to identify ‘synergistic and transformative strategies’ that maximise climate change and sustainable development impacts (Butler, 2014). Sustainable development challenges must be met while by-passing environmental impacts.

Butler describes this approach as ‘leap-frogging the Sustainable Development Goals’ and proposes the following principles:

- Climate change must not be addressed in isolation but needs to be considered as a part of a dynamic social and ecological system.
- Climate change adaptation needs to recognise competing values and goals of different stakeholders and negotiate shared solutions.
- Proposed systems must span spatial scales, jurisdictional levels and sectors.
- Planning processes must design and implement approaches which tackle systemic causes of disadvantage.

This paper explores what a synergistic, leapfrogging approach may mean for built environments. In particular, it develops a methodology that can be used to explore and analyse synergistic interventions for a neighbourhood. Proposed interventions are critically analysed to ascertain whether these may achieve the ‘multiple synergies’ referred to by the IPCC. The study finds that some of the interventions identified appear to meet the requirements set out by the IPCC and proceeds to identify characteristics and commonalities of these types of intervention.

## METHODOLOGY

The methodology for the study is as follows. First, the Sustainable Development Goals and climate change targets are introduced. This is followed by a description of the case study neighbourhood and the Built Environment Sustainability Tool (BEST).

The assessment process using the BEST is then described and the tool applied to assess the case study neighbourhood and ascertain ‘Existing’ sustainability performance. The results of this assessment are used to identify interventions for sustainability improvement, and these are described. This leads to the second BEST assessment that takes into account the proposed interventions to reflect the performance of a ‘Proposed’ neighbourhood.

The results of these assessments are analysed and discussed to develop conclusions and recommendations for the paper. These reflect on the Sustainable Development Goals, climate change targets, the BEST, the case study neighbourhood, the proposed interventions and IPCC’s proposed ‘multiple synergy’ solutions.

## Sustainable Development Goals

The Sustainable Development Goals (SDGs) are goals developed by the United Nations to supersede the Millennium Development Goals, which expired at the end of 2015 (United Nations, 2015). UN member countries are expected to adopt the Sustainable Development Goals and use them to guide the development of national targets, policy and strategy. Table 1 lists the SDGs.

**Table 1:** The Sustainable Development Goals (United Nations, 2015).

Goal 1. End poverty in all its forms everywhere
Goal 2. End hunger, achieve food security and improved nutrition and promote sustainable agriculture
Goal 3. Ensure healthy lives and promote wellbeing for all at all ages
Goal 4. Ensure inclusive and equitable quality education and promote lifelong learning opportunities for all
Goal 5. Achieve gender equality and empower all women and girls
Goal 6. Ensure availability and sustainable management of water and sanitation for all
Goal 7. Ensure access to affordable, reliable, sustainable and modern energy for all
Goal 8. Promote sustained, inclusive and sustainable economic growth, full and productive employment and decent work for all
Goal 9. Build resilient infrastructure, promote inclusive and sustainable industrialisation and foster innovation
Goal 10. Reduce inequality within and among countries
Goal 11. Make cities and human settlements inclusive, safe, resilient and sustainable
Goal 12. Ensure sustainable consumption and production patterns
Goal 13. Take urgent action to combat climate change and its impacts
Goal 14. Conserve and sustainably use the oceans, seas and marine resources for sustainable development
Goal 15. Protect, restore and promote sustainable use of terrestrial ecosystems, sustainably manage forests, combat desertification, and halt and reverse land degradation and halt biodiversity loss
Goal 16. Promote peaceful and inclusive societies for sustainable development, provide access to justice for all and build effective, accountable and inclusive institutions at all levels
Goal 17. Strengthen the means of implementation and revitalize the Global Partnership for Sustainable Development.

### Climate Change Targets

Goal 13 of the Sustainable Development Goals is addressed by the United Nations Framework Convention on Climate Change through international agreements. An example of this is COP21, also known as the Paris Agreement (UNFCC, 2015). This agreement aims to ensure that greenhouse gas emissions are reduced to a level that will limit global average temperatures to a rise of below 2°C, compared to pre-industrial levels (UNFCC, 2015).

This target was determined as temperature increases of over 2°C were regarded as likely to result in climate change that would be highly dangerous for life on earth. The agreement requires countries to set emission targets and ensure that these are achieved. Significant funding has been made available to developing countries to help reduce their emissions (UNFCC, 2015).

### Case Study Neighbourhood

The case study neighbourhood is Groenkloof in Pretoria (-25° 46' 30.39" S 28° 13' 4.65" E) and is shown in Figure 1.

The neighbourhood largely consists of houses between 200-400 m<sup>2</sup> on sites of around 1,000 m<sup>2</sup> (indicated in blue). One side of the neighbourhood abuts a fenced municipal park and the other sides have busy roads. Businesses line these busy roads and are located one site deep (indicated in red). There is a small shopping centre with offices, restaurants, hardware, grocery, supermarket, linen, pet food, pharmacy and butchery retail (indicated in yellow). In the south of the neighbourhood, there is a park and fenced wild area (indicated in green). This neighbourhood was identified as it represented a middle-class neighbourhood in a South African city and data on the site was readily available.

### Built Environment Sustainability Tool

The Built Environment Sustainability Tool (BEST) was developed by the author as a tool for assessing the sustainability of neighbourhoods (Gibberd, 2014; 2020). It includes a facility in which the impact of interventions can be tested to understand their potential impact. This supports decision-making and the development of plans to integrate and address sustainability in neighbourhoods. Figure 2 shows the tool and assessment criteria.

Figure 2: Built Environment Sustainability Tool and assessment criteria (Gibberd, 2014)

The 'Existing' column (A) is used to report on the performance of an existing neighbourhood or design of a new neighbourhood. Column C is used to test up to six interventions that have been identified to improve sustainability.



Figure 1: Case study neighbourhood: Groenkloof, Pretoria, South Africa.

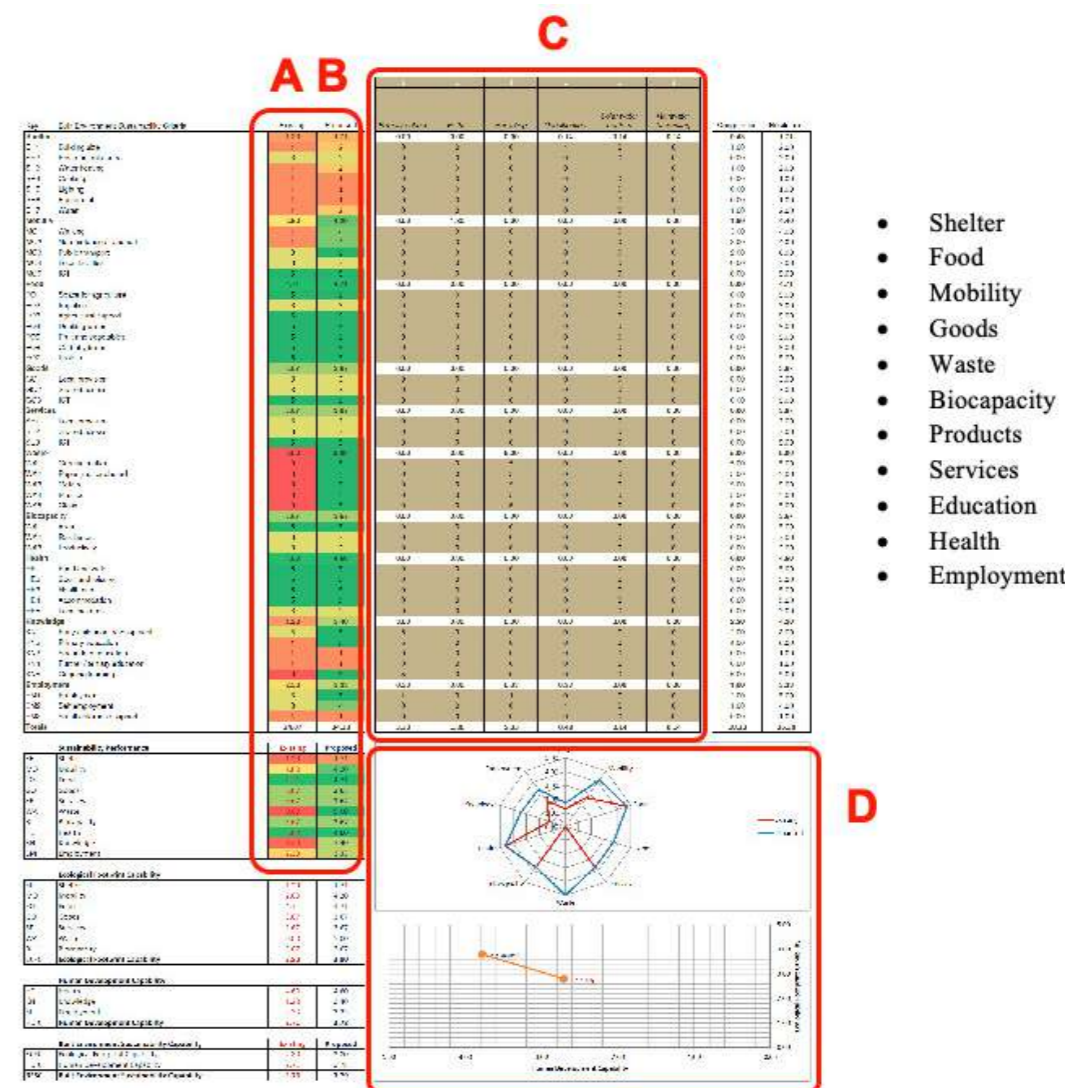
Performance of interventions is reflected in column B (the 'Proposed' performance). The colours of the 'Existing' and 'Proposed' columns reflect performance, with high scores being reflected as a green and a low score as a red. The tool includes two graphs that show the impact of the interventions (D). In the spider diagram, the red line indicates the existing performance and the blue, the proposed performance. Similarly, in the line graph, the red text 'Existing' and blue text 'Proposed' performance. Comparing the columns in A and B and reviewing the graphs in D can be used to understand the impacts of different interventions on the overall sustainability performance of the neighbourhood.

### RESULTS

#### Existing Neighbourhood Performance

The assessment of the existing neighbourhood is shown in Figure 3 (red line). This indicates that built environment sustainability capability is 0.92 and is low. Performance is particularly low in the following areas: Shelter, Goods, Waste, Education and Employment. Scores in Biocapacity, Health, Mobility, Services and Food are better.

Figure 3: The BEST report for the case study neighbourhood showing 'Existing' and 'Proposed' performance.



#### Proposed Interventions

An analysis of an existing situation, 'Existing', can be used to identify weakness in current performance and propose interventions. These interventions aim to improve the Built Environment Sustainability Capability of the neighbourhood and therefore support the achievement of the Sustainable Development Goals and climate change targets. These proposed interventions are described below.

### Intervention 1: Education Hub

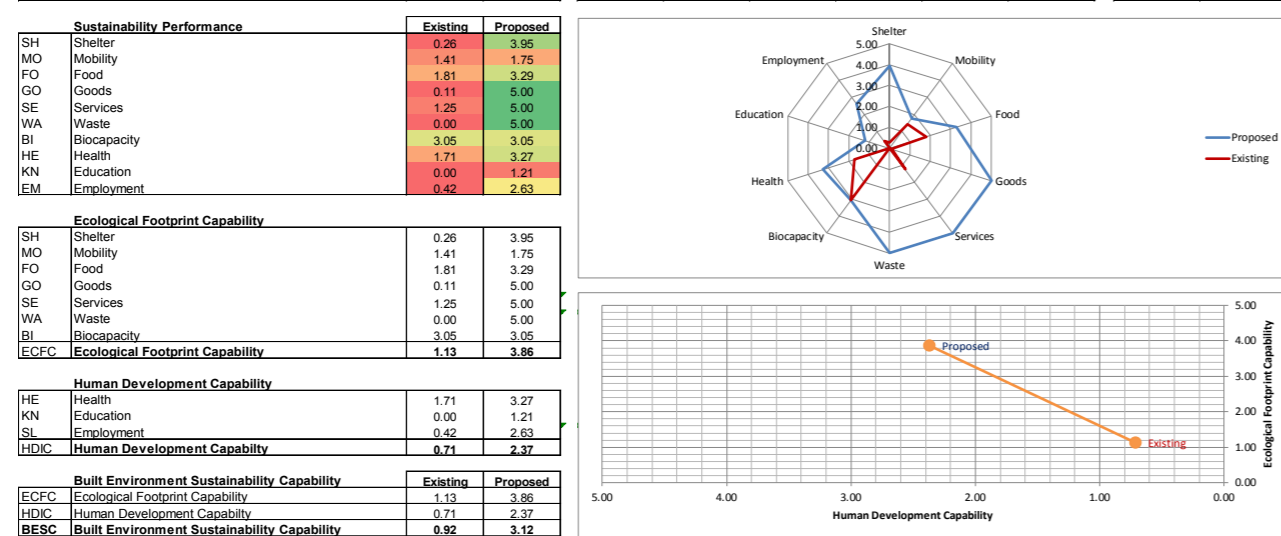
This intervention proposes an education hub that includes the following components and number of learner places: Early Childhood Development (60), Primary School (420), Secondary School (300) and an Adult Education facility (150). School infrastructure would be designed to be multi-use and so would accommodate adult learning in the evening and at weekends. The Education Hub would be located at A. in Figure 1 and use up some of the existing park.

### Intervention 2: Food Hub

The Food Hub consists of intensive vegetable gardens and a food market that would be managed by small enterprises. The market would sell locally produced vegetables as well as affordable locally grown low ecological footprint food. It would be located at B in Figure 1 and would take up a portion of the existing park.

### Intervention 3: Work Densification

Work Densification would consist of demolishing some existing work units in a block indicated as C in Figure 1 on the site and replacing these with higher density work units to meet the BEST density criteria. A condition of the new development would be the inclusion of affordable units to meet the BEST affordability criteria and the addition of businesses that meet BEST criteria in the area of affordable Goods, Services and Health. This proactive targeting of specific business types and facilities that are required in the neighbourhood to meet sustainability criteria is referred to as ‘conditional development’.



New facilities would also be designed and managed to meet all of the BEST Shelter criteria.

### Intervention 4: Residential Densification

The residential densification intervention would demolish a block of existing low-density residential units in location D and replace this with high-density housing that met BEST criteria for density and sustainability performance. New accommodation would be designed and managed to meet all of the BEST Shelter criteria. The accommodation would be highly serviced and provide facilities for self-employed people so would also contribute to local employment and enterprise development.

### Intervention 5: Energy Microgrid

This intervention would promote building energy-efficiency measures and develop a local microgrid based on photovoltaic systems installed on roof spaces, battery banks and a local power network so that all buildings would have access to renewable energy. It would also include solar hot water systems so that all buildings had water heated from solar energy. These systems and the grid would be managed and maintained by small enterprises and building owners would be paid rent for the use of space used by renewable systems. Electricity and hot water consumption from these systems would be metered and charged for, to create a resilient self-financing system. Research in 2019 indicated that energy costs to users for systems like this could be the same or only slightly higher than costs charged by the municipality (Gibberd, 2019). It also showed that the revenue generated by these systems could employ between 10 and 20 people per 1,000 occupants in a mixed-use

neighbourhood. The intervention would cover all the existing buildings in the neighbourhood as well as new buildings constructed as part of the Residential and Work Densification and the Education and Food Hub interventions.

### Intervention 6: Recycling Scheme

This intervention would develop recycling depots at the two retail centres in the neighbourhood. There would also be a wide-scale programme to ensure that all existing and new buildings recycled all of their waste. Recycling systems would be managed by small enterprises and revenue from the recycling material would be used to sustain the system and enterprises. Gibberd (2019) shows that the waste disposal costs, combined with the revenue from recycled materials, could employ between 10 and 20 people per 1,000 occupants in a mixed-use neighbourhood.

### Proposed Neighbourhood performance

A review of the ‘Proposed’ column and graphs in the BEST report shown in Figure 3 indicates that the proposed interventions have been able to improve the Built Environment Sustainability Capability of the neighbourhood from 0.92 for ‘Existing’ to 3.12 for ‘Proposed’. In particular, significant improvements have been made in the areas of Goods, Service, Waste and Health. Improvements in other areas are smaller and in some areas such as Shelter, Mobility and Biocapacity, are negligible.

### Impact of Synergistic Interventions

An analysis of the BEST results can be used to calculate the individual contributions of each intervention to the improved Built Environment Sustainability Capability found in the ‘Existing’ performance. These are shown in Table 2.

Table 2: Impacts of synergistic interventions on BEST performance.

Synergistic Interventions	Number of BEST Areas impacted	Contribution to the Built Environment Sustainability Capability improvement (%)
Education Hub	6	6
Food Hub	4	6
Work Densification	8	38
Residential Densification	6	19
Energy Microgrid	2	14
Recycling Scheme	2	18

Table 2 shows that Work Densification impacts 8 of the BEST areas and contributes to 38% of the sustainability capability improvement. The Recycling Scheme, Energy Microgrid and Residential Densification make between 10 and 20% contribution to improved sustainability capability performance. The Education and Food Hub intervention make the lowest contribution to sustainability capability improvement at around 6%.

## DISCUSSION

The following questions can be used to discuss the methodology and results. Firstly, is the BEST methodology and tool a suitable way of measuring capacity or capability for achieving Sustainable Development Goals and climate change targets? Secondly, does the tool provide a useful methodology for identifying place-specific interventions? Thirdly, what insights do the results offer in terms of identifying high impact synergistic interventions?

### Progress towards achieving Sustainable Development Goals

To ascertain whether the BEST methodology and tool are a suitable way of measuring capacity and capabilities for achieving the Sustainable Development Goals, these can be mapped to BEST criteria. This is shown in Table 3.

**Table 3:** Alignment between BEST criteria and the Sustainable Development Goals.

BEST Criteria	Sustainable Development Goals
Shelter	1, 3, 6, 7, 10, 11, 13, 15
Mobility	1, 3, 10, 11, 13, 16
Food	1, 2, 3, 8, 9, 10, 11, 12, 13, 15
Goods	1, 8, 9, 10, 11, 12, 13, 15
Services	8, 9, 10, 11, 13
Waste	11, 12, 13
Biocapacity	11, 13, 15, 16
Health	1, 2, 3, 10, 11, 13
Knowledge	1, 10, 11, 13, 16
Employment	1, 4, 8, 10, 11, 13, 16

Table 3 shows that all of the SDGs are addressed by BEST criteria other than SDG 5 (“Achieve gender equality and empower all women and girls”), SDG 14 (“Conserve and sustainably use the oceans, seas and marine resources for sustainable development”) and SDG 17 (“Strengthen the means of implementation and revitalize the Global Partnership for Sustainable Development”). This analysis suggests that the BEST criteria provide a good indication of the extent to which the characteristics and facilities within a neighbourhood support the achievement of the Sustainable Development Goals.

A review of the alignment between BEST criteria and SDG 13 (“Take urgent action to combat climate change and its impacts”) indicates that all of the BEST criteria support this. Therefore, it could be said that the BEST tool provides a good indication of the extent to which characteristics and facilities within a neighbourhood support the achievement of climate change targets.

#### Place Specific Interventions

The BEST methodology requires an initial assessment of the existing neighbourhood. The results of this assessment are used to propose interventions. The effectiveness of these interventions in addressing the shortcomings of the existing neighbourhood is then ascertained and the methodology allows a range of options to be tested to identify an ‘optimum fit’ for the neighbourhood. In this way, the methodology provides an effective way of understanding the ‘place’ (the neighbourhood) and developing interventions that respond to its sustainability deficits. Therefore, it could be said that the methodology is effective at identifying and testing ‘place-specific’ interventions, plans and ‘pathways’ for achieving Sustainable Development Goals and climate change targets.

#### Synergistic Impacts

The study identifies 6 possible interventions for improving the extent to which the neighbourhood addresses the SDGs and climate change targets. As can be seen in Table 3, some of these interventions are more effective than others in developing characteristics and facilities that support the achievement of SDGs and climate change. The ‘Work Densification’ intervention provides for 38% of the improvement and affects performance in 8 BEST areas. This performance is achieved by developing high density, high-performance buildings that comply with BEST criteria. The new accommodation provides increased employment which also helps address BEST criteria. Finally, the ‘conditional development’ requirement that requires the new development to include small businesses that meet the ‘Goods’ and ‘Services’ criteria and health facilities that meet the ‘Health’ criteria and make a substantial contribution to increased built environment sustainability capability.

The Recycling Scheme, the Education Hub, the Food Hub and the Energy Microgrid similarly affect several BEST areas. The Recycling Scheme reduces waste, vehicular transportation and creates jobs and small enterprises. The Education Hub creates improved awareness and affordable education locally, reduces vehicular transportation and creates jobs. The Food Hub provides affordable, healthy, low ecological-footprint food, reduces vehicular transportation and creates small enterprises and jobs. The Energy Microgrid provides low carbon energy to power the neighbourhood and creates local jobs and enterprises. The Residential Densification provides additional housing which meet all of the BEST sustainability performance requirements.

The review, therefore, suggests the interventions identified have *significant, multiple impacts* across some BEST areas and therefore could be said to be examples of the ‘multiple synergies’ referred to by the IPCC. A review of these synergistic interventions can be used to distil the following distinguishing features:

- **Meeting Everyday Requirements:** Synergistic interventions increase local access to facilities, goods and services required for everyday life. By doing this they also support non-motorised transport and reduce the need for vehicular transportation
- **Conditional Development:** Synergistic interventions proactively structure future development through requirements. These include targeting specific types of enterprises and facilities that support improved local sustainability capability
- **Creating Employment and Enterprises:** Synergistic interventions create local jobs and enterprises
- **Multi-use Infrastructure:** Synergistic interventions increase impacts by ensuring that infrastructure supports multiple uses
- **Local Governance:** Synergistic interventions rely on effective local governance to ensure that development prioritises local needs and are inclusive by addressing issues such as accessibility and affordability.

#### CONCLUSIONS AND RECOMMENDATIONS

The study describes how the Built Environment Sustainability Tool can be used to assess neighbourhoods to support the achievement of the Sustainable Development Goals and climate change targets. It establishes that the BEST methodology provides an effective way of identifying responsive ‘place-specific’ interventions which improve the sustainability performance of neighbourhoods. Finally, the study identifies interventions which have multiple impacts and appear to be able to improve the performance of the neighbourhood in terms of both Sustainable Development Goals and climate change targets. The study, therefore, argues that these ‘synergistic interventions’ are examples of the ‘multiple synergies required to achieve the goals of sustainable development, including climate adaptation and mitigation, poverty eradication and reducing inequalities’ identified by the IPCC (Roy *et al.*, 2018;447).

The study identifies and describes features of these synergistic interventions including Creating Employment and Enterprises, Meeting Everyday Requirements, Multi-use Infrastructure, Local Governance and Conditional Development. The paper provides valuable insight into how neighbourhoods can be developed to ‘leap-frog the Sustainable Development Goals’ as described by Butler (2014: 83). Further development and application of the methodology are therefore recommended.

## LIST OF REFERENCES

- Butler, J.R.A., Bohensky, E.L., Suadnya, W., Yanuartati, Y., Handayani, T., Habibi, P., Puspadi, K., Skewes, T.D., Wise, R.M., Suharto, I. and Park, S.E., 2016. *Scenario planning to leap-frog the Sustainable Development Goals: An adaptation pathways approach*. *Climate Risk Management*, 12, 83-99.
- Gibberd, J., 2014. Measuring capability for sustainability: The Built Environment Sustainability Tool (BEST). *Building Research & Information*, 43(1)49-61.
- Gibberd, J., 2020. *Applying the Built Environment Sustainability Tool to assess and improve neighbourhoods*. Available from <https://jeremygibberd.com/2017/08/18/applying-the-built-environment-sustainability-tool-to-assess-and-improve-neighbourhoods/>
- Roy, J. P., Tschakert, H., Waisman, S., Abdul Halim, P., Antwi-Agyei, P., Dasgupta, B., Hayward, M., Kanninen, D., Liverman, C., Okereke, P.F., Pinho, K., Riahi, and A.G. Suarez Rodriguez, 2018. Sustainable development, poverty eradication and reducing inequalities. *In: Masson-Delmotte, V., Zhai, P., Pörtner, H-O., Roberts, D., Skea, J. Shukla, P.R., Pirani, A., Moufouma-Okia, W., Péan, C., Pidcock, R., Connors, S., Matthews, J.B.R., Chen, Y., Zhou, X., Gomis, M.I., Lonnoy, E., Maycock, T., Tignor, M. and Waterfield T. (eds.). *Global Warming of 1.5°C. An IPCC Special Report on the impacts of global warming of 1.5°C above pre-industrial levels and related global greenhouse gas emission pathways, in the context of strengthening the global response to the threat of climate change, sustainable development, and efforts to eradicate poverty* [ONLINE] Available at: [https://www.ipcc.ch/site/assets/uploads/sites/2/2019/02/SR15\\_Chapter5\\_Low\\_Res.pdf](https://www.ipcc.ch/site/assets/uploads/sites/2/2019/02/SR15_Chapter5_Low_Res.pdf) [Accessed 4/6/2020].*
- UNFCCC, 2015. *Adoption of the Paris Agreement, Conference of the Parties Twenty-first session*, Paris, 30 November to 11 December, 2015. Paris: United Nations Framework Convention on Climate Change, pp?
- United Nations, 2015. *Resolution adopted by the General Assembly on 19 September 2016. A/RES/71/1*, 3 October 2016 (The New York Declaration) New York, UN.

# EVALUATION OF COUNTERHEGEMONIC TECHNOLOGIES: A CASE STUDY OF SELF-MANAGED SOCIAL HOUSING PRODUCTION IN BELO HORIZONTE, BRAZIL

Giselle O. Mascarenhas, Universidade Federal de Ouro Preto e Universidade Federal de Minas Gerais, Brazil, [mascarenhas.giselle@gmail.com](mailto:mascarenhas.giselle@gmail.com)

Roberto E. dos Santos, Universidade Federal de Minas Gerais, Brazil, [ro1234ro@gmail.com](mailto:ro1234ro@gmail.com)

## Abstract

*This paper deals with small housing estates produced under a self-management regime in the city of Belo Horizonte, capital of the state of Minas Gerais, Brazil, from 1996 to 2009. 16 estates comprising about 1,700 housing units were produced in total. Although originating from different initiatives and public programmes, these projects all have in common appropriate housing and easy access to the city to a greater or lesser extent, achieved by means of popular participation through inclusive and democratic practices. Such housing estates provide a broad field for analysis and diagnosis of the counter-hegemonic technologies used. By 'counter-hegemonic' we are referring to alternative technologies situated in the discourse of Socio-technical Adequacy and Critical Social Technology. Socio-technical Adequacy is part of the so-called alternative technologies in the context of the Solidarity Economy Network, popular cooperatives and social organisations and has its origin in the Appropriate Technology movement. Critical Social Technology, on the other hand, radically questions the fundamentals of technological development and places collective autonomy as a precondition for confronting social relations of domination. Thus, based on the case study conducted in one of the housing estates, this paper presents and discusses an interface developed for the analysis of self-managed housing production in Belo Horizonte. Among other aspects, the interface provides tools for the critical perception of housing production arrangements, focusing on the quality of space and construction. Thus, we seek to demonstrate the history of the residents' involvement in social housing movements; their degree of autonomy in decisions about productive arrangements (planning, design and execution of works); opportunities for professional qualification and community action following the construction process.*

**Keywords:** Brazil, critical social technology, housing estates, popular participation, self-management

## INTRODUCTION

Ferro [1976 (2006)] points out that in what concerns popular housing produced in underdeveloped (or developing) countries, such as Brazil, is safeguarded the low organic composition of capital. Thus, there is less investment in machinery than in labor. For the author, this is what would define civil construction as an activity based on the exploitation of the worker and on the generation of surplus value necessary for the maintenance of capital. Strategies that we recognize in conventional technologies. In this perspective, the architectural project is also an important instrument of hierarchy, since the constructive technology of manufactures, unlike that contained in artisanal production, promotes dependence on formalized/ academic knowledge external to the worker. For this reason, the production of affordable housing in Brazil proposes, both quantitatively and qualitatively, an insufficient model to its residents. This ends up being reflected in a production defined by the following factors: exclusion of beneficiary families in the decisions of the design and construction process of their homes; heteronomous, fragmented and alienating construction arrangements; architectural inflexibility; imposition of peripheral location, as seen in housing estates far from public services and facilities; and great environmental impact throughout its production chain. Furthermore, this production treats as marginal and even criminal the autonomy contained in the massive informal production of slums (favelas), agglomerations and spontaneous urban occupations. This is the scenario of hegemonic housing production in Brazil.

Belo Horizonte is the capital of the state of Minas Gerais, Brazil, a metropolitan region in which approximately four million inhabitants live. From 1996 to 2009, 1,700 housing units distributed in 16 housing estates were built. This period coincides with the rule of moderate leftist governments. The production of these units occurred under several productive arrangements and were funded by various sources, but they all had in common popular participation through inclusive and democratic practices that resulted in appropriate housing. In this way, we believe that Appropriate Technologies were used, possibly even Social Technologies, both in the management of the project as well as in the construction itself. Producing 1,700 units for the needs of a city of two and a half million inhabitants may seem a negligible amount and indeed it is. Nevertheless, these cases provided an opportunity to test the implementation of many ideas and concepts not previously experienced in Belo Horizonte including socio-technical adequacy, critical social technology, solidarity economy and collective autonomy. To the practices and methods alternative to the hegemonic production of social housing, exposed before, that is, those aligned with the Critical Theory of Technology (Feenberg, 2005), in which Social Technologies (ST) and Sociotechnical Adequacy (STA) are located, we attribute the name of 'counter-hegemonic production'.

This paper discusses the preliminary results of doctoral research the main purpose of which is to evaluate how closely these cases demonstrated such ideas and concepts. The process of constructing these housing estates (henceforth called *conjuntos*), is described, narrated from the points of view of all agents who participated in its conception as a public policy as well as in its planning, design, building sites, and management. In this paper we focus on just one of these 16 housing estates – *Conjunto Villaregia*. We selected this case to construct what we call an *evaluation interface*, that is, an instrument able to assess the production arrangements in a critical way, focusing on the quality of construction as a technological activity in itself as well as in the spaces' resultant quality. Our aim is to present an account of the inhabitants' engagement in their struggle to obtain housing, the degree of autonomy in decisions about these productive arrangements (planning, design and building site); the opportunities for professional qualification, the changes in uses and general involvement in the housing project as well as post-occupancy community actions, as shown in Figure 1 below. That said, we emphasize that the analysis and evaluation of social technologies must be done in the context of their application and with the involvement of those who were directly affected by them, the residents. Thus, for the joint construction of the interface, we adopted the recommendations of the action research methodology defined by Michel Thiollent (2011), based on the understanding that the active role of the group of researchers in the community is necessary to elucidate social and technical problems.

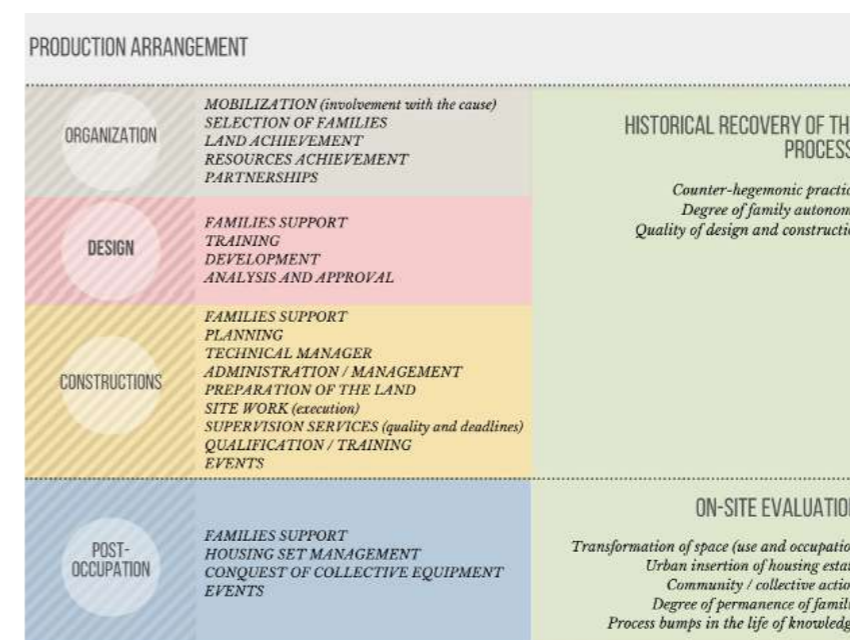


Figure 1: Model for the evaluation interface. Fonte: Giselle Mascarenhas (2020)

## Self-management housing in Belo Horizonte

More than 20 years after the implementation of policies that favoured so-called self-management in housing production, it seems opportune and pertinent to recover its history as well as to contrast self-management production to traditional production of social housing implemented after 2009 in the realm of a large housing programme conducted by the Federal Government. It seems important to us to address the context that preceded the origin of democratic public housing policies.



The period between the late 1970s and 1990s was marked by re-democratisation of Brazil in which there was an “intense social mobilization led, in large part, by leftist parties and urban social movements, including the movement for urban reform and housing” (Bedê, 2005:41). In Minas Gerais, this period was marked by several movements in the fight for housing, often linked to peripheral neighbourhoods and slums. Bedê (2005) states that government actions in slum areas in Belo Horizonte were decentralised and progressively replaced by municipal public policies throughout the 1980s. She also points out that, parallel to social mobilisation, there was low investment in social public policies by the federal government. The decentralisation of public management has led to greater autonomy in the municipal realm as it has allowed the strengthening of democratic practices and innovations based on social learning.

The election of a coalition Municipal Government (Frente BH Popular) was favoured by a series of factors, among which we highlight the creation of the Federal Constitution (1988), the Municipal Organic Law (1990) and the support of political activism and social mobilisation, including the fight for housing. Frente BH Popular stayed in power from 1993 to 1996. The Workers’ Party’s mayor, Patrus Ananias, rescued the urban reform’s agenda combining a strong articulation between population and technical frames. The most important outcome of this political project was the increasing of resources for housing programmes and urbanisation projects of social interest as well as the creation of the Participatory Housing Budget (OPH), marked by open, popular participation.

However, the Participatory Housing Budget (OPH) was born out of a troubled context, in which the financial resources were severely limited. That was a consequence of the neglect of State and Federal Governments for years. The *Associação de Moradores Sem Casa* (ASCA), an association of homeless people, promoted a systematic campaign of mobilisation, bringing together about 500 families. In view of this situation, the Urbanization and Housing Company of Belo Horizonte (URBEL) and the Municipal Planning Secretariat created the OPH, with the allocation of exclusive resources for housing construction intended for the homeless.

The OPH was driven by the municipal administrative technical staff whose support was essential to implement the participatory housing agenda. Altogether, in the period from 1996 to 2000, OPH made possible seven *conjuntos*, having constructed 759 housing units. In addition to the public budget, since 2005 the *Crédito Solidário* Programme (CSP), has enabled a new standard of operation in production by self-management of popular groups in BH.

### Evaluation interface under construction

Counter-hegemonic technology embraces practices aligned with STA and Critical Social Technology (CST). We believe that self-management in building construction is potentially able to redraw social technologies, going against the current of formal market production, in other words, to use technoscience for social purposes with representative gains for vulnerable communities. Originating in the Appropriate Technology movement, both ST and STA seek not only to generate alternative technologies to conventional technologies, but also development alternatives in the context of solidarity economy networks, popular cooperatives and self-management experiences, as is the case of the example that will be described here.

Based on Feenberg’s (2005) comprehension that technology has potentials that are suppressed under capitalism, we share here the understanding that hegemonic power structures influence technology, its use and the knowledge that surrounds it. Therefore, technology is both political and socially constructed. This is a position contrary to the notion of technological neutrality that, erroneously, disregards the interference of social factors and economic, political, cultural relations in the development and use of technologies.

The ST are defined as “products, techniques and replicable methodologies developed from the interaction with the community and they represent effective solutions for social transformation” (Kapp & Cardoso, 2013:94). In Brazil one can recognize three ST types, namely: conservative, engaged and critical. Although they are not exactly contradictory, there are important differences between them that cannot be discussed here. In order to construct the evaluation interface we adopted CST because it radically questions the fundamentals of technological development and places collective autonomy

as a precondition, standing up to social relations of domination. In the words of Kapp & Cardoso (2013:96), it aims at “emancipation from social relations of domination and the construction of social relations of cooperation”.

The STA, on the other hand, refers to a concept that aims to operationalize TS. Therefore, STA refers to the procedure in which conventional technology and the scientific knowledge surrounding it undergo changes inherent to its implementation context, that is, it proposes alternative technoscience to that formulated by and for private companies (Dagnino, Brandão & Novaes, 2004). Included amongst the premises of STA are “Democratic participation in the work process meeting requirements related to the environment [...], the health of workers and consumers and their self-management capacity” (Dagnino, Brandão & Novaes, 2004:52-53).

Therefore, STA and ST can be understood as strategies that seek alternatives to development based on the intrinsic relationship between Science, Technology and Society. These perspectives contribute to the understanding that it is possible and necessary to use “the technoscientific potential” (Dagnino, 2019: 47) to combat typical problems of the countries of the Global South, such as underdevelopment, income inequality, informality, discrimination, among many others.

In an attempt to assess the extent to which BH self-managed housing estates converge to these aspects, we created an original interface (still under test), composed of four research phases (Figure 2): 1. *Preliminary explorations*, composed of exploratory interviews with technical advisors, public authorities and / or community leaders. This phase is supported by the collecting of complementary data from the sets, such as photos, design documents, work diaries, reports, etc. This material subsequently subsidises the elaboration of a set dossier; 2. *Recognition*, which is the first visit to the *conjunto Villaregia* with the accompaniment of one or more agents who participated in the process of its construction (community leaders, consultants or state technicians); 3. *Workshop*, an exhibition of photos and drawings collected in Phase 1, followed by a conversation with several residents. At this stage, we encourage the residents to talk about their memories of the production process; 4. *Individual Survey*, based on a survey structured for different profiles of residents (people external to the process, workers or community leaders).

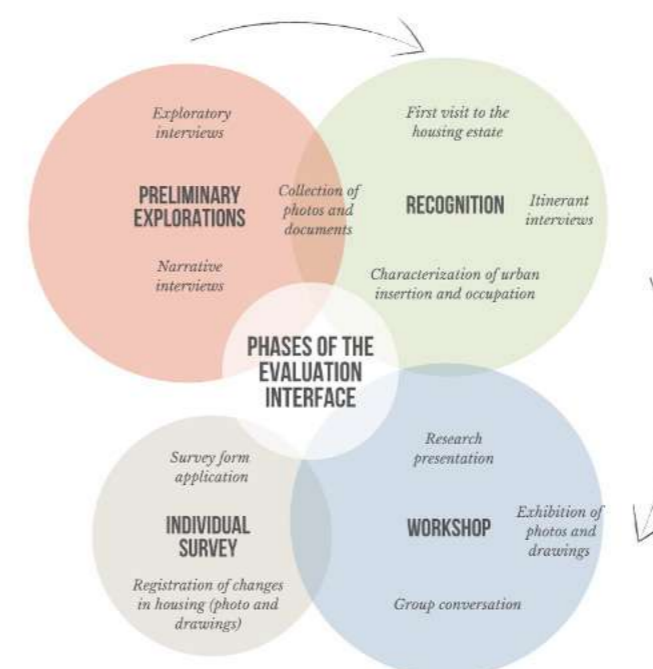


Figure 2: The four phases of evaluation interface. Fonte: Giselle Mascarenhas (2020)

## Case Study: Villaregia

The first contact with the *Conjunto Villaregia* took place with the architect in charge during the first phase of construction. She provided several project documents, and put us in contact with the architect responsible for the design process and with the former leadership of a movement which fought for housing. The *Associação de Moradores Sem Casa* (ASCA) was the entity responsible for the mobilisation of people.

The first phase of our interface started with exploratory statements followed by narratives. As a reference to the interview methods, we used the statements of Kapp (2020). As we were unaware of the reality assessed, this initial phase included conversations and exploratory statements that “aim to obtain information that respondents in general already have, different from the views or perceptions constructed during the interview itself. The attempt is that them to say what they consider important about a situation, a process, a space (Kapp, 2020: 13). Subsequently, in order to build a narrative and highlight the issues that interest us, we prepared a specific interview script for technical advisors and another for leaders. In the advisory script, we point out, for example, issues such as the type of involvement of this agent with the self-management process; how the design and construction process took place; what the results of this work are and how satisfied they are with the self-management proposal. For the leaders, among others, we anticipate open questions about their involvement with the cause of the struggle for housing; its relationship with the group and with resident families and the necessary actions to make the group viable with evidence for the participation of residents in each phase. Based on this script, we asked the interviewees to give a brief account of their experience in the process, in order to deepen the history of the group and its agents. At this stage, we were also able to raise new documents about the set, mainly photos that show different moments of its construction.

From the preliminary exploration based on photos, texts, and conversations with social agents, we made the first visit to observe the space and construction of the *conjunto Villaregia* (*second phase*). On this first visit we were accompanied by local leadership who participated in the whole process, including design and construction. This process was inspired by a housing experience which occurred shortly before, in Ipatinga, an industrial city in Minas Gerais. The leftist government of Chico Ferramenta (from *Partido dos Trabalhadores*, that is, the workers’ party) had been supported by movements fighting for housing. It produced a number of low-income housing developments from 1989 to 1992 (*Mutirões Nova Conquista*, São Francisco and Novo Jardim). Among them was the *Mutirão Primeiro de Maio* in which, besides the construction itself, the professionalisation of the participants in many specialities related to construction and management took place. It is worth emphasising that the working arrangements included significant female labour force participation, which is uncommon in Brazilian construction sites.

During the 1990s the examples of self-management housing that took place in Ipatinga gained recognition and encouraged self-management initiatives in Belo Horizonte (BH). Since the inauguration of participative public budgets (OP) in 1994, families organized by ASCA started to request funds for self-production of housing. Construction started in 1997, three years after the land was acquired with the support of the same architect who had conducted the abovementioned experience of Ipatinga. Both technologies of self-management and construction were “imported” from there. This kind of production arrangement is called *mutirão* in Brazil. They are something like a collective, voluntary task force of self-builders. People who work in this way are called *mutirantes*. Among them, the so-called *Remunerated Work Fronts* (RWF) that had some experienced workers trained in Ipatinga as instructors in the construction site, stand out. In the architect’s words, the incorporation of experienced labour from other self-managed construction sites helped not only in the training of new professionals and in strengthening the potential of self-management, but, more importantly, “they reflected the understanding that, ultimately, the associates of different entities for housing integrate, in solidarity, the same front of fight for the constitutional right to housing” (Silva, 2013: 217).

In an interview held on December 7, 2019, a former ASCA’s secretary said that the work on *Conjunto Villaregia* was mostly carried out by RWF (approximately 90%) during the week, while on Saturdays, Sundays and holidays the work was performed by *mutirantes*, composed basically of female labour. According to her, 99% of them were female workers. Due to the composition of this predominantly female construction site, the day nursery centre emerged as a fundamental facility. Also, according to the interviewee, the day nursery enabled women to work with peace of mind, as they knew their children were close by and well taken care of. It is important to mention that a prior agreement between the *mutirantes* required each family to have at least one member working on the construction sites, all the time. The more individuals in a family were working, the more points they had in the ranking that gave them, for example, the power to choose the position of the

house. Their functions were distributed according to their preferences and individual skills. In this arrangement, for example, older women or those with some limitations took charge of the daycare activities, while others worked on the separation of materials or organisation of the construction site. This strategy meant that the two-year work schedule was carried out in a year and a half. On this point, the interviewee commented that even in advance “no one did a bad job” and all were committed to the project (Souza, 2019. Verbal Communication), as they did not know which house they would live in.

In an interview, held on May 23, 2019, the architect of *Villarégia* revealed several aspects that could be characterised as counter-hegemonic. She pointed out that the cost reduction had an impact, increasing possibilities of expansion of the units’ area, commenting that: “if it were in the traditional way of construction this would not have happened”. She also pointed out the advantage that “the development of a spirit of solidarity and cooperation among the workers” came about, in addition to “income generation [...] labor training, and the very work helped families to learn how to do it [...] And their own organization, to make a decision and have an understanding” (Schmidt, 2019. Verbal Communication).

Among the obstacles in the construction process, the architect reported the difficulties in dealing with the *mutirão*, which on the one hand “helps to lower costs but it is also something suffered, it is a battle, because it is hard to be able to lower costs on top of this effort”, and the irregularity in resource transfers, which resulted in several work stoppages. However, for her, the biggest problems occurred in the final phase of construction, when the work was almost completed. When they moved in, many of the family members who had not participated in the process, being unaware of the design and construction decisions, started pointing out various technical problems in the houses and in the layout and organisation of the estate’s housing space and construction. According to the architect, such problems were of little importance. For her, this situation could have been minimised with social action in the post-occupation stage.

The *third phase* was based on an exhibition of photos and a slide show, images that were collected during the early phases. This event offered a favourable opportunity to present the objectives of our research and to introduce ourselves to the local community. We attempted to approach ordinary residents in a way that would ensure receptivity to individual interviews in the next phase. It also served to measure families’ attitudes to collective events and support the evaluation of neighbourhood relations. In addition, the photos helped to evoke the residents’ memories and to start a collective debate about the production processes of the housing.

We showed images that we had considered to be representative moments of each stage of the process – meetings, celebrations, working groups in action (food, day nursery, cleaning, carrying materials), workers skilled in construction techniques etc. This was followed by a conversation round that encouraged all those present to talk about the photos. The workshop also set up a display of printed copies of the same projected photos, which residents could take as souvenirs (Figure 3). Our aim was to explore, above all, the items related to mobilisation and construction of the site’s project.



**Figure 3:** Residents gathered around the table with printed copies identical to the projected photos. Source: Giselle Mascarenhas (2019).

In addition, we served snacks and soft drinks as a strategy to relax participants and increase participation. The workshop took place on a Thursday, at 7pm, in an inside square. The day and time were suggested by a resident who was a former social advisor hired by ASCA during construction. According to him, this was an ideal time just when people were returning from work, thus facilitating mobilization of interested people. Despite prior notification, however, there was not a very large attendance at the event. We estimate that approximately 30 people attended (including children). This relatively small number of participants appears to have been the result of a combination of factors: rain throughout the day; Christmas prayers promoted by several residents and a soccer match at exactly the same time as the workshop. We emphasized that children who were playing at the square were fundamental in promoting the workshop, calling their parents and other relatives.

The photos provoked a lot of interest among those present. Their participation, however, was relatively limited to recognition of friends and relatives (Figure 4). There were no spontaneous comments beyond these acknowledgements. Those present were encouraged to comment on the photos, but even so they did not make many comments. More precise comments were made by the former social advisor. In our understanding, his presence was a factor in the present behaviour of the residents, but not because of any deliberate action on his part. It seemed as though the residents needed to have been encouraged to talk or it was as if they felt it was not their place to talk about what had happened. We attributed this situation to the social advisor's superior status over those present, but this aspect needs further investigation.

When asked, many aspects were mentioned by those present, specially the way the day nursery and kitchen worked. They said they had worked every Saturday, Sunday and holidays, except Mother's Day, Good Friday, and Christmas. Throughout the construction process many of them started to work in the RWF, reaching 80% of the construction workforce. They told us that most people were trained for work on Saturdays and Sundays in a learning-by-doing way. The former social advisor told us about an electricians' training course sponsored by Missionary Nuns. On this point, the Catholic Church's presence in the ASCA's actions was remarkable. Many masses and prayer meetings were registered in the photos. The very name of the housing came from a Catholic source.



**Figure 4:** Residents gathered in front of a photo projection screen. Source: Giselle Mascarenhas (2019).

The *mutirão Villaregia* ritual was also remembered by those present: on Saturdays a handmade "newspaper" with the news of the week was distributed, followed by a "moment of reflection" and discussion of the day's schedule. The newspaper was written by the ASCA leaders with the objective of disseminating the results of the work and encouraging the workers. Some of the women present made it clear that the female workforce was larger and more effective than the male one. It was not clear how the frequency control was determined, but it was mentioned that some people who were represented in the photos were not the beneficiaries of the programme, but family members or friends who were taken to help in the *mutirão* and thus increase the score of the registered family, which, later on, influenced the choice of house (the scoring system was created by ASCA). We identified that the sporadic workforce of friends and family of the beneficiaries would hardly be recognised in the photos. In general, we noticed that those who stayed until the end of the workshop were only those residents who actively participated in the *mutirão*. At the end of the event, many people seemed to be grateful for the photo exhibition, hugged us and thanked us for the event. Furthermore, the attempt at self-identification in the photos showed that the process brought back good memories. We felt certain that the photos were in fact a special point of interest; they worked very well as a factor in participation and memory recall, while the snacks were a good way to "break the ice" and attract children. We understood that in addition to collecting information in-depth, the workshop established itself as an important "exposure moment" to the group, since those present were very receptive and supportive, agreeing to the application of the survey of the fourth phase. We realized that interviewing each family in their residential units, separated from the group, would be fundamental for a complete understanding of the process and its transformation over time.

In the *fourth* and final phase, the survey delves into particular issues of the moments of organization, design, work and post-occupation. Aiming at a dialogue with the production of the PMCMV-Entidades (self-managed housing program of the federal government), the proposed survey form has several issues in common with the survey of the publication: "Social Production of Housing in Brazil: Current Panorama and Trails for self-management practices" (BURGUIÈRE, *et al.*, 2016). The first part of the survey form covers all residents and raises general data such as profession, age, connection of the person with the group (participant resident, non-participating resident or local leadership), number of residents of the dwelling, location and situation of the previous dwelling aspects dealing with neighborhood relations and community actions undertaken over time. There are also about current links with entities and movements, constructive and social problems identified in the set and various items on urban insertion and mobility. With the help of the architectural plan of the housing unit, we asked the residents to also tell us about the modifications made to the dwellings, how this process went (difficulties encountered) and whether further changes were made. In this item, many of the residents insisted on guiding us around the house and explaining, in detail, the additions made, this was registered with drawings above the original plan and photographic report.

In the fourth phase we conducted 30 interviews, corresponding to over 37% of families. The tabulation of the answers has not yet been completed, but it is already possible to identify that the survey, even though it needs minor adjustments, manages to bring out the strengths and weaknesses of such a process. In the interviews, it is evident that most of the original families remained and that spaces and collective actions were achieved due to this arrangement. The low dropout rate of residents is indicative of their strengthening in the area, which may point to other potential benefits of this organization and for the development of ST and STA processes.

In this last phase, important issues were also highlighted, such as the difficulties encountered during the *mutirões*; the vulnerabilities of families before and during the fight for housing; and the existing equipment and services in the area. We emphasised displacement and appropriation of the area; the capacity to transform socio-spatial relationships and the quality of space and construction in the changes to the houses. Based on the experience that involved the application of the four phases that make up this evaluation interface, we believe it is possible to present an approximate picture of the process of construction on the sites, placing them critically in the discourse of counter-hegemonic production.

### Concluding remarks

Over the more than 20 years since the beginning of so-called ‘self-management’ projects, one can note remarkable changes in the way public housing policies have been implemented in the city of Belo Horizonte. In the 1990s, for example, despite the scarcity of municipal resources, the experiences of the OPH proved to be quite adequate for the purpose of expanding democratic processes in popular housing production. However, it is surprising that the early 2000s, did not prove fertile for popular building projects based on collective autonomy, despite being granted plentiful resources by Federal Programmes (PCS and PSH).

From the scenario of heteronomous design and construction arrangements that are nowadays commonplace in Brazilian society, we understand that the initial self-management experiences in Belo Horizonte represent an important attempt to implement counter-hegemonic housing production. These actions proved that it is possible for the homeless and their respective movements to obtain resources for housing in a productive arrangement radically different from those oriented towards capitalism only. However, these initiatives did not constitute structural changes, remaining as exceptions in local contexts.

Furthermore, we suggest the hypothesis that self-management seemed to serve more as a means to gain housing rather than the end of establishing new social structures. We believe that is essential for social restructuring based on collective autonomy of the community to take place. After all, the supposed beneficiaries are subordinates in the structural inequalities in Brazil and it is their fight for a place to live that has stimulated their efforts, rather than the construction of a different model of production and socio-spatial management. They are largely unaware of the political and economic aspects of the process itself; in other words, although it built the houses and to some extent has promoted professional training, the process has not improved their political awareness or understanding of their poor economic and social situation.

It is our hope that our “under construction interface” could succeed in demonstrating the capacity of this productive design and construction model to develop Social Technologies guided by the principles of Sociotechnical Adequacy. From the four phases presented here – preliminary information, the recognition of the group, the collective workshop and the individual research – we seek to highlight the perspectives of the different actors, in order to build an expanded narrative of self-management as an alternative process in space production.

### ACKNOWLEDGEMENTS

Our thanks to the Programa de Pós-Graduação em Arquitetura e Urbanismo (NPGAU) of the Universidade Federal de Minas Gerais as well as the Universidade Federal de Ouro Preto (UFOP), for supporting this research.

### LIST OF REFERENCES

- Bedê, M. 2005. *Trajatória da Formulação da Implantação da Política Habitacional de Belo Horizonte 1993/ 1996*. Unpublished (Master’s degree) thesis. Belo Horizonte: Universidade Federal de Minas Gerais. [Online] Available from: <https://repositorio.ufmg.br/handle/1843/MPBB-6YGLGE> [Accessed: May 10, 2020].
- BURGUIÈRE, E. et al. 2016. *Produção Social da moradia no Brasil: Panorama recente e trilhas para práticas autogestionárias*. Rio de Janeiro: Letra Capital.
- Dagnino, R. 2019. *Tecnociência Solidária: um manual estratégico*. Marília: Lutas Anticapital.
- Dagnino, R., Brandão, F. & Novaes, H. 2004. Sobre o marco analítico-conceitual da tecnologia social. In: Jr. Lassance, A, et al. (eds.) *Tecnologia Social: uma estratégia para o desenvolvimento*. Brasília: RTS.
- Feenberg, A. 2005. *Critical Theory of Technology: an overview*. Tailoring Biotechnologies.
- Ferro. S. 2006. *Arquitetura e Trabalho Livre*. São Paulo: Cosacnaify.
- Kapp, S. & Cardoso, A.L. 2013. Marco teórico da Rede Finep de Moradia e Tecnologia Social- Rede Morar T.S. *Risco Revista de Pesquisa em Arquitetura e Urbanismo*. 17/07: 27. [Online] Available from: <http://www.revistas.usp.br/risco/article/view/83050/86094> [Accessed: May 12, 2020].
- Kapp, S. Entrevistas na pesquisa sócio-espacial. *Revista Brasileira de Estudos Urbanos e Regionais*. 13/02:21. [Online]. Available from: <https://rbeur.anpur.org.br/rbeur/article/view/6067> [Accessed: August 17, 2020].
- Kapp, S.; Cardoso, A.L. 2013. Marco teórico da Rede Finep de Moradia e Tecnologia Social- Rede Morar T.S. *Risco Revista de Pesquisa em Arquitetura e Urbanismo*. 17/07: 27. [Online] Available from: <http://www.revistas.usp.br/risco/article/view/83050/86094> [Accessed: May 12, 2020].
- Schmidt, A. 2019. Verbal communication with the author on 23 May. Belo Horizonte. (Transcript/notes/recording in possession of the author).
- Souza, M. 2019. Verbal communication with the author on 7 December. Belo Horizonte. (Transcript/notes/recording in possession of the author).
- Thiollent, M. 2011. *Metodologia da Pesquisa-Ação*. São Paulo: Cortez.
- 1 The research is in progress at NPGAU-EAUFMG (Postgraduate Center in Architecture and Urbanism of the School of Architecture at the Federal University of Minas Gerais), conducted by Giselle Oliveira Mascarenhas (M.Sc.) under the supervision of Prof. Dr. Roberto E. dos Santos.
- 2 This *mutirão* was conducted by Margarete Maria de Araújo Silva, the same architect who was responsible for *conjunto* Villaregia.
- 3 The name of the *conjunto* is a tribute to a missionary community in Villa Regia, Italy, in which the ASCA coordinator took part. The Church’s connection with the fight of the homeless was driven by the 1993’s Fraternity Catholic Campaign “Onde Moras?”. The funds to purchase the land came from that missionary community.

# IMPROVED GREY MODELS IN VEHICULAR CO<sub>2</sub> EMISSION MODELLING AND FORECASTING TO DECARBONIZE URBAN AREAS – SUSTAINABLE ENVIRONMENT

Vincent Birundu Getanda

Department of Electrical and Electronic Engineering  
School of Electrical, Electronic and Information  
Engineering, Jomo Kenyatta University of Agriculture  
and Technology, Nairobi, Kenya  
getandav@yahoo.com/getandav@kisiipoly.ac.ke

Peterson Kinyua Hinga

Department of Electrical and Electronic Engineering  
School of Electrical, Electronic and Information  
Engineering, Jomo Kenyatta University of Agriculture  
and Technology, Nairobi, Kenya  
pkhinga@gmail.com

Peter Kamita Kihato

Department of Electrical and Electronic Engineering  
School of Electrical, Electronic and Information  
Engineering, Jomo Kenyatta University of Agriculture  
and Technology, Nairobi, Kenya  
pkihato@jkuat.ac.ke

Hidetoshi Oya

Department of Computer Science  
Tokyo City University, Tokyo, Japan  
hide@tcu.ac.jp

## Abstract

*Global warming is one of the contentious environmental issues mainly caused by carbon dioxide (CO<sub>2</sub>) emissions into the atmosphere. Carbon dioxide impacts negatively on the climate and public health. Moreover, air pollution by CO<sub>2</sub> emission from the transport sector is an issue in contemporary society. Modelling and forecasting of CO<sub>2</sub> emissions constitute a vital step towards clean sustainable transport and better public health. In this paper we compare a data grouping-technique (DGT) and modification of initial condition (MIC) in improving the accuracy of the original grey model (OGM(1,1)). Consequently, we propose two improved grey models, namely the grouped grey model (GGM(1,1)) and the modified initial condition grey model (MICGM(1,1)) for modelling and forecasting CO<sub>2</sub> emissions as a method of decarbonizing our cities and improving air quality. We utilize vehicular CO<sub>2</sub> emission time-series data to model and forecast CO<sub>2</sub> emission by these models and the results validate our claim that the GGM(1,1) has excellent accuracy and hence is acceptable in CO<sub>2</sub> emission modelling and forecasting. This result could be implemented in intelligent transportation systems (ITSs) to proactively forecast CO<sub>2</sub> emissions and this can be important in decision-making to decarbonize urban areas and develop clean sustainable transportation systems across the world, thereby curtailing harmful climate change and air pollution.*

**Keywords:** Clean and sustainable transport, CO<sub>2</sub> emission, decarbonizing road transport, forecasting grey model, modelling.

## INTRODUCTION

Global warming, climate change and acid rain are among the most contentious issues caused by emission of greenhouse gases (GHGs) such as CO<sub>2</sub> into the atmosphere (Ahmed, 2016; Zhou, Guang and Gao, 2017). With fast-growing populations and economies of the world, emissions from the transport industry are rising. Road transport, emits 73 percent of the European Union (EU) transport sector's emissions (Tagliapietra and Zachmann, 2018) and in the United States transportation is a major emitter of greenhouse gases (Schipper, Saenger and Sudardshan, 2011; Ramseur, 2017). In addition to environmental pollution CO<sub>2</sub> emissions have accelerated global warming (Ahmed, 2016; Li, Song, Yao and Xiao, 2018; Lin, He and Liu, 2018). Motorized transport is a major source of air pollution, particularly from congested busy urban areas with increased CO<sub>2</sub> emissions (Miller and Façanha, 2014; Kunda and Phiri, 2017). This has adverse effects on human health and the ecosystem as a whole (Ahmed, 2016). To achieve a low-carbon society, modelling and forecasting of CO<sub>2</sub> emission is important in aiding planners to set policies and measures to enhance sustainable urban transport. Therefore in this paper we propose accuracy-improved grey models for modelling and forecasting CO<sub>2</sub> emissions. High-quality and accurate CO<sub>2</sub> emission data can be valuable and reliable in making decisions in the transport sector to mitigate environmental pollution.

## LITERATURE REVIEW

Many scholars in the past have predicted and forecast CO<sub>2</sub> emissions by various methods. For instance Abdullah and Pauzi (2015), investigated and ranked the methods for forecasting CO<sub>2</sub> emissions. In this work the neural network (NN) method was ranked the most popular followed by the grey model (GM) used for modelling and estimating grey systems. A grey system is a system whose information is partially known and partially unknown. Otherwise, a system is either black, meaning its information is completely unknown, or white, meaning that its information is completely known (Li and Lin, 2014). Other studies include those by

- Libao, Tingting, Jielian, Guicai, Yanfen and Xiaoqian (2017), who predicted CO<sub>2</sub> emission based on multiple linear regression analysis,
- M. Li, Wang, De, Ji and Tan (2018), who forecast CO<sub>2</sub> emissions based on GM and the Support Vector Machine-Extreme Learning Machine (SVM-ELM) model,
- (X. Li *et al.*, 2018), who adopted the co-integration approach in forecasting CO<sub>2</sub> emissions for energy consumption,
- Nyoni and Mutongi (2019), who modeled and forecast CO<sub>2</sub> emissions using Autoregressive Integrated Moving Average (ARIMA),
- Ozceylan (2016), who used particle swarm optimization (PSO) and artificial bee colony (ABC) techniques to present estimated CO<sub>2</sub> emissions, based on socio-economic indicators and finally,
- a grey neural network model (GNNM) as a combination of the grey model (GM) and back propagation neural network (BPNN) has been established to forecast CO<sub>2</sub> emissions (Zhou *et al.*, 2017).

The negative implication of CO<sub>2</sub> emissions in the environment calls for the need to model and forecast CO<sub>2</sub> emissions (Ozceylan, 2016). The previously used methods, mentioned above, in forecasting CO<sub>2</sub> emissions require huge amounts of data and in addition these methods are complex in their analysis (Lin *et al.*, 2018). Furthermore, accurately forecasting future CO<sub>2</sub> emission levels is a complex and challenging endeavour (Ramseur, 2017). Therefore, there is an urgent need to establish effective and accurate models for modelling and forecasting trends of CO<sub>2</sub> emissions so that decision makers in the transport sector and other stakeholders can make timely and appropriate policies to decarbonize this sector to achieve a clean sustainable transport system. Thus in this paper we propose and present improved grey models in CO<sub>2</sub> emission modelling and forecasting for clean growth and development of the transport sector. The grey model requires less data (Zhou *et al.*, 2017; Lin *et al.*, 2018) and it is a simple method, easier for researchers to use.

In improving the original grey model's precision many scholars have put forth several approaches. Madhi and Mohamed (2017) categorized these research approaches into three classes, namely grey derivative enhancement, background value reconstructing and initial condition modification. We realize from this work that the new information prior using principle is not adequately addressed by the initial condition method. This principle takes advantage of new pieces of information from the time-series raw data. In other words the new information is given priority by dropping the old information as the new information is engaged in modelling (Getanda, Kihato, Hinga and Oya, 2019; Mahdi H. and Mohamed, 2017a). See the discussion on "data grouping technique" in this paper. Therefore, in this paper we use the data grouping technique (DGT) which adequately makes use of this principle to improve the accuracy of the original grey model. We further compare the DGT with the modification of initial condition (MIC) method to validate the DGT's performance in reducing the precision errors inherent in the conventional GM(1,1).

## THE ORIGINAL GREY MODEL

### The grey system theory

The grey theory as presented by Deng (1989) finds the law governing a grey system through processing raw data to establish its corresponding mathematical model (M. Li *et al.*, 2018). Thus the future conditions of the grey system can be determined scientifically. GM(1,1) is a popular model used by scholars and it consists of a first-order differential equation that contains only one variable and requires small amount of data to estimate a system. The G in GM(1,1) represents grey, the M represents model, and GM(1,1) represents first order, one variable differential equation model (Zeng, Luo and Liu, 2018). The process of the original grey model consists of grey generating operations as follows (Getanda, Kihato, Hinga and Oya, 2019).

The original non-negative raw data series is presented as:

$$X^{(0)} = \{x_{(1)}^{(0)}, x_{(2)}^{(0)}, x_{(3)}^{(0)}, \dots, x_{(m)}^{(0)}\} \quad (1)$$

where  $m$  is the total number of data points. Accumulating this series by:

$$X_{(r)}^{(1)} \triangleq \left\{ \sum_{i=1}^r x_{(i)}^{(0)} \right\}, r = 1, 2, \dots, m \quad (2)$$

results to:

$$X^{(1)} \triangleq \{x_{(1)}^{(1)}, x_{(2)}^{(1)}, \dots, x_{(m)}^{(1)}\} \quad (3)$$

This generating operation can be denoted as:

$$AGO\{X^{(0)}\} = X^{(1)} \quad (4)$$

Which is the Accumulated Generating Operation (AGO) and is vital in grey modelling, and  $AGO\{\}$  denotes an operator. Thus by an Inverse Accumulated Generating Operation (IAGO) we have:

$$IAGO\{X^{(1)}\} = X^{(0)} \quad (5)$$

Note that IAGO (inverse AGO) re-models the original series, and  $IAGO\{\}$  means IAGO operator.

Another grey generating concept is the Mean value Generating Operation (MGO) given as (Deng, 1989):

$$z_{(k)}^{(1)} = 0.5(x_{(k)}^{(1)} + x_{(k-1)}^{(1)}), k = 1, 2, \dots, m \quad (6)$$

This is the mean generation of adjacent neighbours of the AGO which yields the background value  $z_{(k)}^{(1)}$  and the "weight" equals 0.5.

### Grey modelling

Deng (1989) inferred that grey modelling is based on the generating series rather than on the raw one. He also asserted that a grey derivative and a grey differential equation are required to build a grey differential model (GM).

In grey modelling a single variable first order differential equation prediction model is given as (Luo, Zeng, and Liao, 2013; Guo-Dong, Yamaguchi and Nagai, 2006):

$$\frac{d}{dt} X^{(1)}(t) + aX^{(1)}(t) = b \quad (7)$$

where  $X^{(1)}(t)$  is a background grey value at time  $t$ ,  $a$  and  $b$  are the developing coefficient and grey input respectively, obtained by the least square method as outlined below (Getanda, Oya and Kubo, 2017).

The time response function of (7) is deduced as:

$$\hat{x}_{(r+1)}^{(1)} \triangleq \left( x_{(1)}^{(0)} - \frac{b}{a} \right) e^{-ar} + \frac{b}{a}, r = 0, 1, 2, \dots, m-1 \quad (8)$$

where  $\hat{x}_{(r+1)}^{(1)}$  is the prediction of the data sequence of (3).

And from (1) and (4) the equation (Z. Zhang, Xu, and Wang, 2017):

$$x_{(k)}^{(0)} + a z_{(k)}^{(1)} = b, k = 1, 2, \dots, m \quad (9)$$

is a grey differential model, called GM(1,1). Where:  $z_{(k)}^{(1)}$  is as given by (6),  $x_{(k)}^{(0)}$  is a grey derivative and GM(m,n) stands for  $m$ -th order differential equation of  $n$  variables (Deng, 1989).

To recover the original series the IAGO is applied and this is given by:

$$\hat{x}_{(r+1)}^{(0)} = \hat{x}_{(r+1)}^{(1)} - \hat{x}_{(r)}^{(1)}, \hat{x}_{(1)}^{(0)} = \hat{x}_{(1)}^{(1)}, r = 1, 2, \dots, m-1 \quad (10)$$

### The least square method

From the existing result (Getanda *et al.*, 2017) we can best estimate the parameters  $a$  and  $b$  of (8) by this method:

$$\begin{bmatrix} a \\ b \end{bmatrix} = \left[ A^T A \right]^{-1} A^T y \quad (11)$$

where  $A$  is the data matrix and  $y$  is the measured vector and these two are given as:

$$A = \begin{bmatrix} -z_{(2)}^{(1)} & 1 \\ -z_{(3)}^{(1)} & 1 \\ \vdots & \vdots \\ -z_{(m)}^{(1)} & 1 \end{bmatrix} \text{ and } y = \begin{bmatrix} x_{(2)}^{(0)} \\ x_{(3)}^{(0)} \\ \vdots \\ x_{(m)}^{(0)} \end{bmatrix} \quad (12)$$

## PROPOSED IMPROVED GREY MODELS

In this paper we improve the Original GM(1,1)'s precision by, firstly, grouping CO<sub>2</sub> emission data and establishing a Grouped Grey Model abbreviated as GGM(1, 1) (Getanda *et al.*, 2017). Secondly, we introduce MIC (Madhi and Mohamed, 2017b) to establish a Modified Initial Condition Grey Model which we denote as MICGM(1,1). These improvements on the Original GM(1,1)'s precision are discussed in detail in the research methodology section of this paper. So we propose to model and forecast CO<sub>2</sub> emission by these improved grey models.

## RESEARCH METHODOLOGY

From the above discussion, the rationale behind this paper is to compare the new approach of DGT and the previous MIC method in improving the prediction accuracy of the OGM(1,1) in order to validate the DGT's ability in enhancing the grey model. These techniques are discussed as follows.

### Data grouping technique (DGT)

In (Getanda *et al.*, 2017) three categories of data grouping techniques are discussed, namely no grouping (NG), weak grouping (WG), and strong grouping (SG). The no grouping technique corresponds to the OGM (1,1) and in this paper we adopt the SG technique because it is the most accurate.

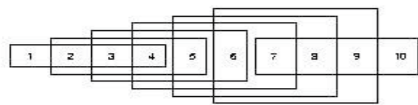


Figure 1: Strong grouping (SG).

We review the SG technique as follows. For any particular data set in SG the number of groups is given by:

$$N = n - [k - 1] \quad (13)$$

where  $N$  is the number of groups,  $n$  is the total number of data points used, and  $k$  is the number of group data points. This technique is illustrated in Figure 1. With 10 sample points, we form 7 groups of 4s. The first group includes elements 1 to 4 and the last group is composed of elements 7 to 10. Observe that the SG technique is based on the “new information prior using” principle as it takes advantage of the new pieces of information in the original data (Mahdi H. and Mohamed, 2017a). Hence, every group formed after the first group drops an element as it accommodates a new element from the series to maintain the number of group data points.

### Modification of the initial condition (MIC)

As in (Madhi and Mohamed 2017b) MIC is accomplished as follows. From (10) the restored value of the original sequence can as well be given by:

$$\hat{x}_{(r)}^{(0)} = \hat{x}_{(r)}^{(1)} - \hat{x}_{(r-1)}^{(1)}, r = 2, 3, \dots, m \quad (14)$$

Substituting (8) in (14) we obtain:

$$\hat{x}_{(r)}^{(0)} = (1 - e^a) \left( x_{(1)}^{(0)} - \frac{b}{a} \right) * e^{-ar} * e^a \quad (15)$$

Let  $C$ , that is the initial condition of the traditional GM(1,1), be expressed as:

$$C = \left( x_{(1)}^{(0)} - \frac{b}{a} \right) * e^a \quad (16)$$

So that (15) becomes:

$$\hat{x}_{(r)}^{(0)} = C * (1 - e^a) * e^{-ar} \quad (17)$$

Therefore, from the discrete form of (8) we have:

$$\hat{x}_{(r)}^{(1)} \triangleq C * e^{-ar} + \frac{b}{a}, \quad (18)$$

By applying IAGO on  $\hat{x}_{(r)}^{(1)}$ , the restored (predicted) value of the raw data is given as follows:

$$\begin{aligned} \hat{x}_{(r)}^{(0)} &= \hat{x}_{(r)}^{(1)} - \hat{x}_{(r-1)}^{(1)} \\ &= C * (1 - e^a) * e^{-ar} \\ &= C * (e^{-ar} - e^a * e^{-ar}) \\ &= C * (e^{-ar} - e^{-a(r-1)}), r = 2, 3, \dots, m \end{aligned} \quad (19)$$

### Optimization of the initial condition

Minimizing the sum of the squared error from the predicted values can optimize the initial condition. A function of  $CC$  is constructed as follows (Madhi and Mohamed, 2017b):

$$f(C) = \sum_{r=2}^m [\hat{x}_{(r)}^{(0)} - x_{(r)}^{(0)}]^2 \quad (20)$$

Substituting (19) into (20) yields:

$$\begin{aligned} f(C) &= \sum_{r=2}^m [C * (e^{-ar} - e^{-a(r-1)}) - x_{(r)}^{(0)}]^2 \\ f(C) &= \sum_{r=2}^m [C * (e^{-ar} - e^{-a(r-1)}) - x_{(r)}^{(0)}]^2 \end{aligned} \quad (21)$$

Now, we differentiate (21) with respect to  $CC$  and let the derivative be equal to zero. Then as in (Madhi and Mohamed, 2017b) the optimized  $CC$  is given as:

$$C = \frac{\sum_{r=2}^m (e^{-ar} - e^{-a(r-1)}) * x_{(r)}^{(0)}}{\sum_{r=2}^m (e^{-ar} - e^{-a(r-1)})^2} \quad (22)$$

Therefore, the process of prediction by the Modified Initial Condition Grey Model is outlined in four steps which include:

- Calculation of the background value from the AGO sequence of (3) by (6)
- Computation of the developing coefficient and grey input parameters by (11)
- Computation of the optimized value of  $CC$  by (22)
- Computation of the restored (predicted) values by equation (19)

### Evaluating the accuracy of the improved grey models

Measures of model performance, namely, Mean Absolute Percentage Deviation (MAPD) and the Mean Absolute Error (MAE) are adopted to evaluate the accuracy improvement of the proposed grey models. These indicators are computed as in Getanda *et al.* (2017).

## DATA SOURCE, EMPIRICAL EXAMPLE AND RESULT ANALYSIS

### Data Source

Simulated CO<sub>2</sub> emission output data sequences as obtained from a microscopic traffic simulator (MITRAM) are used in this paper to illustrate an empirical example (Getanda *et al.*, 2017). The data was as recorded in Table I. For more

details about the MITRAM simulator see Ishikawa, Honda and Kazama (2005) and Mori, Tada, Idu and Oya (2013). The data in Table I were used in modelling and forecasting CO<sub>2</sub> emissions and the empirical results are presented in the following paragraphs. The first 22 data points were used in modelling and the remaining three data points were used in forecasting the CO<sub>2</sub> emissions. In other words the 22 data points were used as historical data and the three as the future data to be forecast.

### Vehicular CO<sub>2</sub> Emission Modelling Empirical Results

By application of the AGO, IAGO and MGO operations on the original data sequence we modelled CO<sub>2</sub> emission and the OGM(1,1)'s parameters were obtained as  $aa = -0.0692$  and  $bb = 100.1470$ . Thus the structure of the OGM(1,1) from (8) was found to be:

$$\hat{x}_{t+1}^{(0)} = 1,447.2110 e^{0.0692r} - 1,447.2110, \quad r = 0, 1, 2, \dots, m-1 \quad (23)$$

The fitting values computed from (23) were tabulated in Table II. The fitting accuracies based on MAE and MAPD calculations were found to be 52.3927% and 76.4233% respectively. See Table III. Figure 2 shows the OGM(1,1)'s actual, fitted (predicted) and residual curves. The residual is the fitting deviation (model error).

For the MICGM(1,1) the computed parameter values were  $aa = -0.0692$  and  $bb = 100.1470$  and the optimized initial condition value,  $CC = 1.2827e+03$ . Therefore the resulting modified initial condition model structure of the grey model from (19) is given as:

$$\hat{x}_{(r)}^{(0)} = 1.2827 * e^3 * (e^{0.0692r} - e^{0.0692(r-1)}), \quad \hat{x}_{(r)}^{(0)} = 1.2827 * e^3 * (e^{0.0692r} - e^{0.0692(r-1)}), \quad r = 2, 3, \dots, m \quad (24)$$

The fitting values computed from (24) were tabulated in Table II and the corresponding fitting accuracies were found to be 56.0674% and 78.2432% from MAE and MAPD calculations respectively, as in Table III. Figure 3 is an indication of how well the actual and predicted values of the MICGM(1,1) fit onto each other and the residual curve.

For the GGM(1,1) the parameters  $aa$  and  $bb$  are different for each formed group and therefore the model structures are also different. Note that in this model and from (13) nineteen groups are formed. Hence this will result in nineteen model structures of the GGM(1,1) with nineteen different values of  $aa$  and  $bb$ . Hence this model involves a lot of computations but with MATLAB software it is easier to superimpose the simulations and show that this model has excellent accuracy. In this paper the fitting accuracies obtained were 91.2501% and 95.6668% as obtained from MAE and MAPD computations respectively, as shown in Table III. In Figure 4 we see that GGM(1,1)'s actual and predicted curves fit onto each other with a high accuracy compared with those of OGM(1,1) and MICGM(1,1). Moreover, the residual curve indicates that the fitting deviation is low.

### Vehicular CO<sub>2</sub> Emission Forecasting Empirical Results

The models developed in this paper are extrapolated to forecast future trends of CO<sub>2</sub> emissions with an assumption that the models fits a "best curve" to the historical data and that the future will follow that curve. The extrapolation in this context constitutes short-term forecasting of CO<sub>2</sub> emission.

Future forecasts of CO<sub>2</sub> emissions for the original grey model are found by extrapolating the model of (23), three points beyond  $mm$ . Figure 5 shows the forecasting at time samples  $t = 23, 24, 25$ . The future CO<sub>2</sub> emissions were obtained and recorded in Table II. These are the last three values of the OGM(1,1) column and the forecasting accuracy was 69.1399% as per the MAPD error indicator, see Table III.

Similarly, Figure 6 shows the forecasting at time samples  $t = 23, 24, 25$  as a result of extrapolating

the model of (24). The three future forecast values as recorded in Table II for the MICGM(1,1) were obtained with a forecasting accuracy of 72.0238%, based on the MAPD error indicator as seen in Table III.

For the GGM(1,1) all the nineteen models are extrapolated and the simulations superimposed in MATLAB to obtain three forecasts of CO<sub>2</sub> emissions at time samples  $t = 23, 24, 25$ , as recorded in Table II and plotted in Figure 7. Here the forecasting accuracy as computed by MAPD error indication was 76.7674%, as shown in Table III.

Table I Vehicular CO<sub>2</sub> Emission

Time of day	6:00	6:05	6:10	6:15	6:20	6:25	6:30	6:35	6:40
CO <sub>2</sub> [g]	0.00	13.62	56.06	67.88	83.08	96.13	84.74	181.12	128.72
Time of day	6:45	6:50	6:55	7:00	7:05	7:10	7:15	7:20	7:25
CO <sub>2</sub> [g]	132.58	249.10	311.93	300.76	271.66	331.52	250.40	275.48	311.09
Time of day	7:30	7:35	7:40	7:45	7:50	7:55	8:00		
CO <sub>2</sub> [g]	321.01	258.03	338.53	378.92	174.47	330.33	339.23		

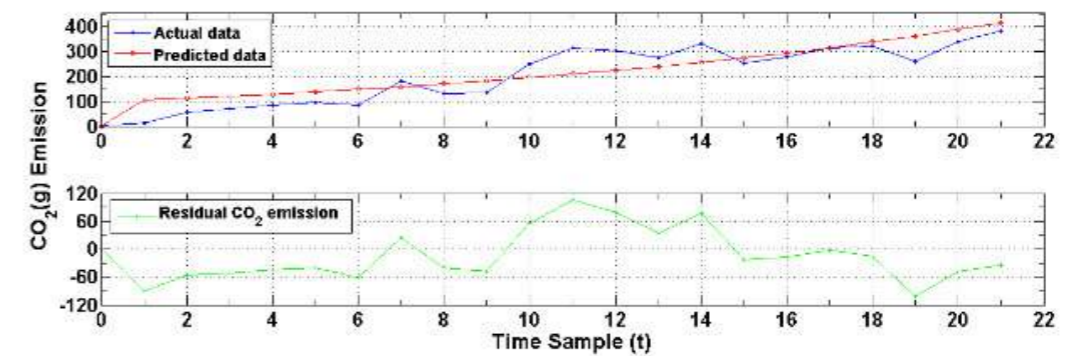


Figure 2: OGM(1,1) CO<sub>2</sub> emission modelling.

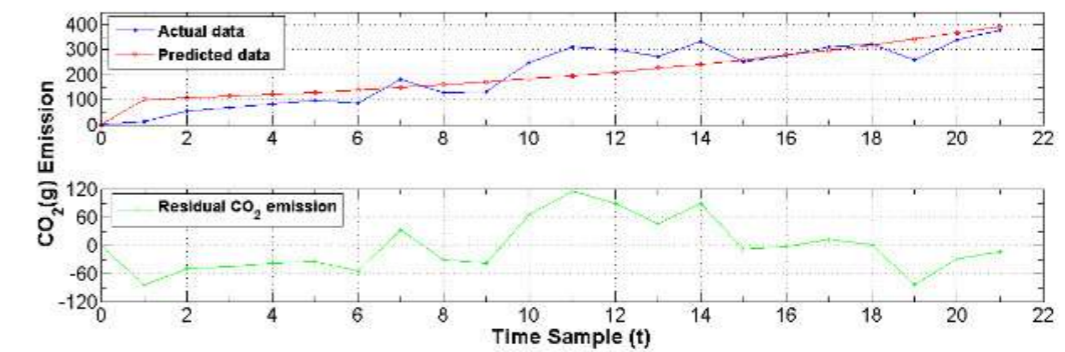


Figure 3: MICGM(1,1) CO<sub>2</sub> emission modelling.



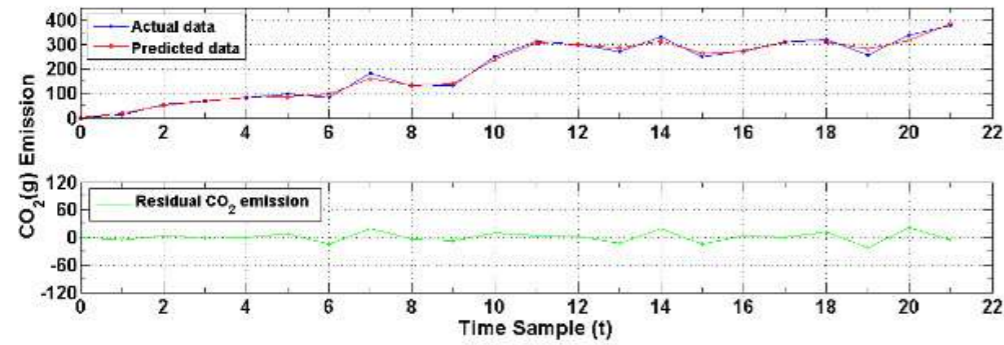


Figure 4: GGM(1,1) CO<sub>2</sub> emission modelling.

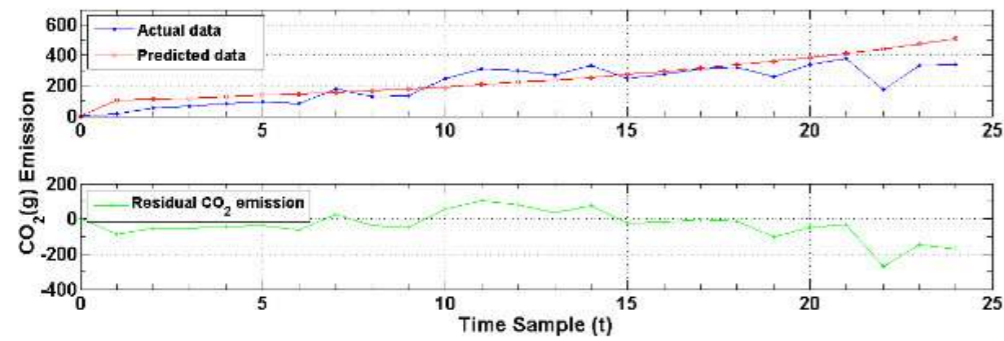


Figure 5: OGM(1,1) future CO<sub>2</sub> emission forecasting.

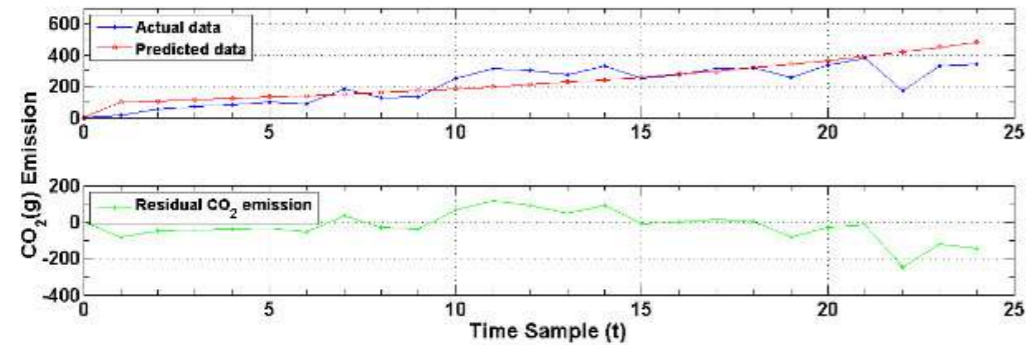


Figure 6: MICGM(1,1) future CO<sub>2</sub> emission forecasting.

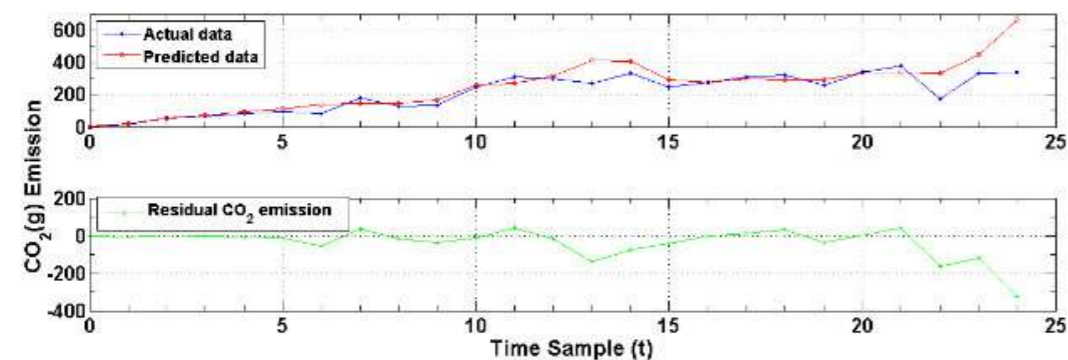


Figure 7: GGM(1,1) future CO<sub>2</sub> emission forecasting.

Table II Original and Improved Grey Models' Fitting and Forecasting Values

Raw Data		Traditional GM		Improved GM
K	Actual	OGM	MICGM	GGM
<b>Historical Data</b>		<b>Model Values</b>		
1	0.0	0.0	0.0	0.0
2	13.62	103.6935	98.4937	19.6619
3	56.06	111.1233	105.5509	51.6320
4	67.88	119.0854	113.1138	69.1628
5	83.08	127.6181	121.2186	83.5470
6	96.13	136.7621	129.9041	88.2273
7	84.74	146.5614	139.2119	98.9877
8	181.12	157.0627	149.1866	162.1046
9	128.72	168.3165	159.8761	132.4549
10	132.58	180.3766	171.3315	140.4709
11	249.10	193.3009	183.6076	240.3059
12	311.93	207.1512	196.7634	307.5334
13	300.76	221.9939	210.8618	298.0975
14	271.66	237.9001	225.9704	285.4907
15	331.52	254.9461	242.1615	312.2848
16	250.40	273.2133	259.5128	264.6029
17	275.48	292.7895	278.1073	272.3879
18	311.09	313.7683	298.0341	311.2325
19	321.01	336.2503	319.3887	309.5854
20	258.03	360.3432	342.2734	281.5715
21	338.53	386.1624	366.7978	318.0301
22	378.92	413.8315	393.0795	384.5836
<b>Future Data</b>		<b>Forecast Values</b>		
23	174.47	443.4832	421.2442	335.5412
24	330.33	475.2594	451.4271	449.5600
25	339.23	509.3125	483.7725	663.1573

Table III CO<sub>2</sub> Emission Error Evaluation

Error Indicator	Grey Model		
	Traditional GM(1,1)		Improved GM(1,1)
	OGM	MICGM	GGM
<b>Modeling</b>			
MAE	47.6073	43.9326	8.7499
MAPD	23.5767	21.7568	4.3332
<b>Forecasting</b>			
MAE	65.2554	59.1572	49.1267
MAPD	30.8601	27.9762	23.2326

**Table IV** Criteria for MAPD and RMSPE

MAPD and RMSPE	Forecasting power
Less than 10%	High accuracy
10 to 20%	Good
20 to 50%	Reasonable
More than 50%	Inaccurate

#### ERROR ANALYSIS

The performance of the grey models were evaluated by the MAE and MAPD error indicators and the errors were tabulated in Table III. Note that the GGM(1,1) has high fitting accuracy with reasonable forecasting accuracy. See the criteria for MAPD in Table IV (Getanda, *et al.*, 2017; Lotfalipour, Falahi and Bastam, 2013; T. Zhang, Wang and Zhang 2015).

#### CONCLUSION

Among the proposed grey models in this paper the GGM(1,1) has the highest modelling accuracy with reasonable forecasting accuracy. Thus these results show and validate the claim that the DGT is a reliable technique in improving the precision of the OGM(1,1) as opposed to MIC. The OGM(1,1) has, generally, low accuracy in modelling and forecasting CO<sub>2</sub> emissions.

In this era of rapid urbanization and industrialization policy makers will find it useful to adopt the GGM(1,1) model in advancing intelligent transportation systems (ITSs) so as to proactively decarbonize the transport sector. ITSs can anticipate vehicle flow of a particular road and so allow planners to redirect vehicles to less congested routes. Consequently, this reduces traffic congestion which in turn mitigates CO<sub>2</sub> emission. Thus incorporation of the proposed model in ITSs can concurrently forecast vehicle flow and its associated CO<sub>2</sub> emissions by some simulation processes. Therefore, the high accuracy of the GGM(1,1) will be valuable in deeper understanding of a transport sector's past CO<sub>2</sub> emission path in order to make a reliable prediction of its future emission. Furthermore, if successfully implemented, the GGM(1,1) has the potential to mitigate environmental impacts on air quality and health and GHG emissions. This is useful in developing a clean and sustainable transport sector. Moreover, modelling and short-term forecasting of CO<sub>2</sub> emissions is important for climate change policy formulation and decision making processes.

#### ACKNOWLEDGEMENT

We wish to acknowledge the African Development Bank and the JKUAT management authority for the financial support that ensured the success of this research.

#### LIST OF REFERENCES

- Ahmed, A. H. 2016. Forecasting CO<sub>2</sub> Emissions level in Saudi-Arabia (2014-2018) using Zeytun Time Series Statistical Software, *International Research Journal of Environment Sciences*, 5(3)27-36.
- Abdullah, L. and Pauzi, H. M. 2015. Methods in forecasting carbon dioxide emissions: a decade review, *Jurnal Teknologi*, 75(1)6782.
- Deng, J. L. 1989. Introduction to Grey System Theory, *The Journal of Grey System*, 1(1)1-24.
- Getanda, V. B., Oya, H. and Kubo, T. 2017. Improving the Accuracy of the GM(1,1) by Data Grouping Technique and Its Application to Forecast Vehicle Volume and CO<sub>2</sub> Emission in Tokushima City, Japan. In *Proceedings of the 36th IASTED International Conference on Modeling, Identification and Control (MIC 2017)*, Innsbruck, Austria, February 20-21, 2017, pp. 39-46.
- Getanda, V. B., Kihato, P. K., Hinga, P. K. and Oya, H. 2019. *Improved Grey Model, GM(1,1), in Short-Term Traffic Flow Forecasting: Smart Transportation Systems*, Paper presented at the IEEE AFRICON 2019 Conference, Accra, Ghana, September 25-27, 2019, 9 pages.
- Guo-Dong, L., Yamaguchi, D. and Nagai, M. 2006. *Non-Equidistance Grey Model Based on Grey Interval Weighting Accumulated Generating Operation*. In Proceedings of the 2006 International Conference on Machine Learning; models, Technology and Applications, MLMTA 2006, Las Vegas, Nevada, USA, June 26-29, 2006, pp. 180-188.
- Ishikawa, R., Honda, N. and Kazama, H. 2005. The Wide-Area Road Traffic Analysis by Microscopic Road Traffic Simulator MITRAM. *IPSS Transactions on Mathematical Modelling and Its Applications*, 46(SIG17)46-55.
- Kunda, D. and Phiri, H. 2017. An Approach for Predicting CO<sub>2</sub> Emissions using Data Mining Techniques, *International Journal of Computer Applications*, 172(13)7-10.
- Li, M., Wang, W., De, G., Ji, X. and Tan, Z. 2018. Forecasting carbon emissions related to energy consumption in Beijing-Tianjin-Hebei region based on grey prediction theory and extreme learning machine optimized by support vector machine algorithm, *Energies*, 11(9)2475.
- Li, Q. and Lin, Y. 2014. Review paper: A Briefing to Grey Systems Theory, *Journal of Systems Science and Information*. 2(2)178-192.
- Li, X., Song, Y., Yao, Z. and Xiao, R. 2018. Forecasting China's CO<sub>2</sub> Emissions for Energy Consumption Based on Cointegration Approach, *Discrete Dynamics in Nature and Society*, 2018(Article ID 4235076). View at: [Publisher Site](#) | [Google Scholar](#)
- Libao, Y., Tingting, Y., Jieliang, Z., Guicai, L., Yanfen, L. and Xiaoqian, M. 2017. Prediction of CO<sub>2</sub> emissions based on multiple linear regression analysis, *Energy Procedia*, 105(2017)4222-4228.
- Lin, C. C., He, R. X. and Liu, W. Y. 2018. Considering multiple factors to forecast CO<sub>2</sub> emissions: A hybrid multivariable grey forecasting and genetic programming approach, *Energies*, 11(12)3432.
- Lotfalipour, M. R., Falahi, M. A. and Bastam, M. 2013. Prediction of CO<sub>2</sub> emissions in Iran using grey and ARIMA models, *International Journal of Energy Economics and Policy*. 3(3)229-237.
- Luo, Y., Zeng, B. and Liao, D. 2013. Non-equidistant GRM(1,1) generated by accumulated generating operation of reciprocal number and its application, *International Journal of Computer Science Issues*. 10(2)119-123.
- Mahdi, M. H. and Mohamed, N. 2017. Optimized GM(1,1) model based on the modified initial condition, *Journal of Applied Sciences*. 17(2)90-96.
- Madhi, M. and Mohamed, N. 2017. An Initial condition optimization approach for improving the prediction precision of a GM (1, 1) model, *Mathematical and Computational Applications*. 22(1)21.
- Miller, J. D. and Façanha, C. 2014. The state of clean transport policy, *Washington, DC: International Council on Clean Transportation*. Retrieved January, 30, p. 2015.
- Mori, S., Tada, K., Idu, R. and Oya, H. 2013. *Traffic jam analysis and CO<sub>2</sub> emission models in Tokushima City via MITRAM*, in (in Japanese) Proc. of 2013 Annual Conf. of Electronics, Information and Systems Society, I.E.E. of Japan, Kitami Institute of Technology, Hokkaido, Japan, September 4-6, 2013, pp. 1046-1051.
- Nyoni, T. and Mutongi, C. 2019. *Modeling and forecasting carbon dioxide emissions in China using Autoregressive Integrated Moving Average (ARIMA) models*, [Online] Available from: <https://mpr.ub.uni-muenchen.de/id/eprint/93984> [Accessed: 10/31/2019].

- 
- Ozceylan, E. 2016. Forecasting CO<sub>2</sub> emission of Turkey: Swarm intelligence approaches, *International Journal of Global Warming*, 9(3)337-361.
- Ramseur, J. L. 2017. US carbon dioxide emissions trends and projections: Role of the clean power plan and other factors. CRS Report No. R44451; Washington, DC: *US Congressional Research Service*. pp. 5-6.
- Schipper, L., Saenger, C. and Sudardshan, A. 2011. Transport and Carbon Emissions in the United States: The Long View, *Energies*, 4(4)563-581.
- Tagliapietra, S. and Zachmann, G. 2018. Addressing Europe's failure to clean up the transport sector. Brussels, Belgium: Bruegel Policy Brief, Issue 2, 2018.
- Zeng, Y., Luo, M. and Liu, Y. 2018. Future energy consumption prediction based on grey forecast model, *arXiv:1804.01777*.
- Zhang, T., Wang, K. and Zhang, X. 2015. Modelling and analyzing the transmission dynamics of HBV epidemic in Xinjiang, China, *PloS One*. 10(9)e0138765.
- Zhang, Z., Xu, X. and Wang, Z. 2017. Application of grey prediction model to short-time passenger flow forecast, *AIP Conference Proceedings*, 1839(1), p. 020136. AIP Publishing LLC.
- Zhou, J., Guang, F. and Gao, Y. 2017. Prediction of CO<sub>2</sub> emissions based on the analysis and classification of decoupling, *Polish Journal of Environmental Studies*, 26(6)2851-2860.

# INSIGHTS ON FLOATING AGRICULTURE APPROACH: A CASE STUDY OF AL-KALAKLA AL-QUBBA - KHARTOUM, SUDAN

Malaz Seif Elislam Ahmed, University of Khartoum.  
Sudan malaz.saif.eng@nu.edu.sd

## Abstract

The urban land-use mosaic is influenced by three simultaneous factors: historic-ethnic interaction; government land policies; and economic forces. Despite this, current land use for many African cities is not a consequence of genuine urban growth, but more often a product of urban policies by colonial governments to serve their interests of domination and exploitation. Post-colonial states inherited such socio-economic structures, resulting in a paradoxical society with a combination of traditional, pre-capitalist roots and a capitalist-oriented post-colonial economy. Khartoum City has developed according to this dualistic pattern, comprising: (i) an integration process with the modernised system which followed this historical transformation; (ii) a dramatic expansion of marginalised and impoverished urban communities or informal settlements. This paper attempts to highlight the interrelationships between the massive urban extent and the eventual loss of agricultural lands needed to ensure food security. Finally, it advocates the use of 'smart floating agriculture techniques' to compensate for the loss of potential farmland in al-Kalakla al-Qubba, one of the oldest settlements in Khartoum, in existence since the 1600s, which has experienced a rapid increase in urban areas as a result of political and economic transformation.

Keywords: floating agricultural technology, spatial political economy, Sudan, urban regulatory settings

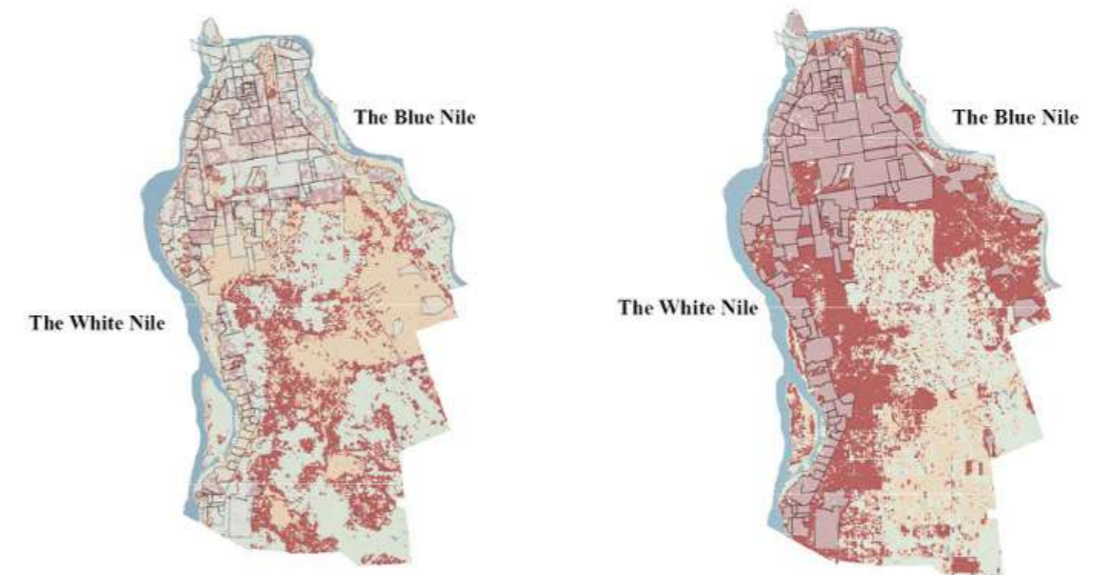
## INTRODUCTION

The current Sustainable Development Goals (SDGs) shed light on the direct linkage between urbanisation and deterioration in natural resources, food insecurity, poverty and sustainable development (Abu Hatab, Cavinato, Lindemer & Lagerkvist, 2019:129). However, in developing countries, the dramatic demographic change has created an obstacle to developing the food production system to satisfy the demand and needs of people living in urban areas (Szabo, 2015:29). Correspondingly in Sudan, according to Sudan Humanitarian Response Plan 2020, 22 per cent of its total population (43 million) including Khartoum require humanitarian support in 2020, whereas 6.2 million people who are food insecure and could worsen with the adverse economic impacts of COVID-19 (WFP, 2020).

Food security is defined as the "situation that exists when all people, at all times, have physical, social and economic access to sufficient, safe and nutritious food that meets their dietary needs and food preferences for an active and healthy life" (Szabo, 2015:29), which is influenced by the aggregation of food availability; food access; food utilisation; and food stability (WFP, 2007:18). On the other hand, the urban food security system relied on the efficiency of the food supply system, which consists of large scale food production and processing, supermarkets, urban agriculture and imports; besides the potential of rural production (Wenban-Smith, Faße & Grote, 2016:1).

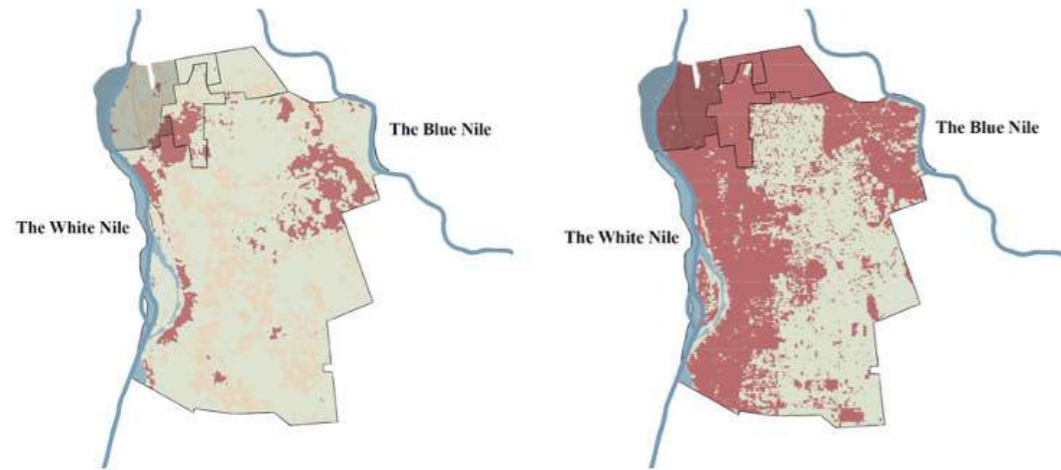
Consequently, this paper starts with tracing the spatial evolution of Khartoum, which has reduced the domain of much-needed agriculture. Then, it highlights the main features of 'smart floating agriculture technology' as a means of closing the gap left by the loss of agricultural areas, in order to ensure food security for the capital's most vulnerable inhabitants.

## Urbanisation: A casual factor associated with food insecurity



**Figure 1:** Detection of the change in the urban area (in red) the agricultural areas (in green) of Khartoum between 1978 and 2018. Source: Author's analysis of satellite images from the U.S.Geological Survey Website, 2019

The dramatic changes that passed through *Bilad es Soudan* (بلاد السودان) since the beginning of the nineteenth century changed the characteristic of Khartoum from a hereditary religious system under the command of khalifa (خليفة) and mainly had depended on cultivating (Burckhardt, 1819:264-5; Walkley, 1935:225), into gaining comparative importance as the administrative and commercial heartland (Walkley, 1935:227). On the other hand, after the independence of Sudan from the Anglo-Egyptian Condominium in the mid-1950s, the capital faced with considerable momentum of migration from rural Sudan (El-Bushra & Hijazi, 1995:507) because of the concentration of political power, administrative authority and financial control in the city (Collins, 2008:238). By the 1980s, the large-scale exodus of the rural population on account of political and economic crises that expanded the gap between the prosperous heartland and peripheral regions besides the catastrophic environmental and natural disasters, shaped the spatial fabric of the city with a "black belt" of squatter settlements and continuous illegal subdivision in the agricultural lands of the old villages alongside the Blue and White Niles banks (El-Bushra & Hijazi, 1995:507). As shown in Figure 1, such dramatic urban extend has accompanied by a massive decrease in agricultural land. On the other hand, the critical situation of food security system in Sudan has influenced by climate extremes and insecurity; land productivity, security and market access; and poverty, poor access to water and sanitation and high disease prevalence (WFP, 2007:18).

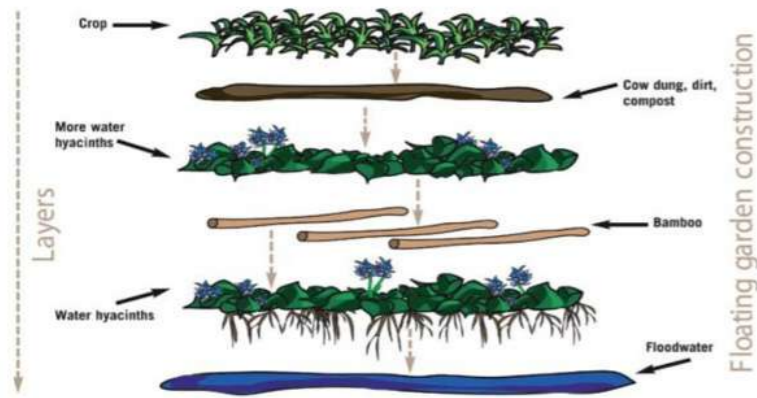


**Figure 2:** Detection of the change in the urban area (in red) and the agricultural areas (in green) of al-Kalākla between 1978 and 2018. Source: Author's analysis of satellite images from the U.S. Geological Survey Website, 2019

### Urban food security system in Khartoum: Prospect of floating agriculture

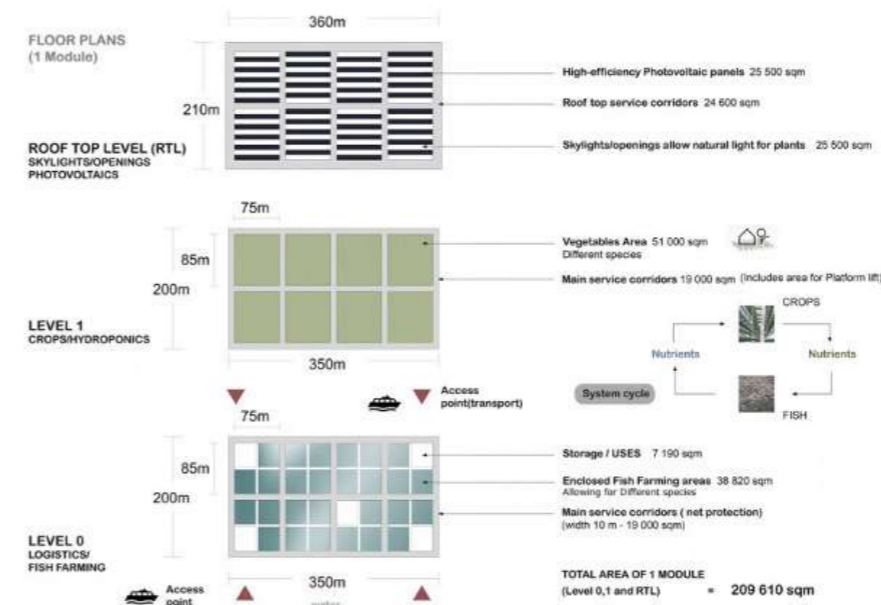
Though urban agriculture can improve remarkably the system of food security in urban areas through generating income and supply food to urban residents, yet, the rapid pattern of urbanisation has reduced the available land for agriculture (Wenban-Smith *et al.*, 2016:979). In such a situation, the study assumes 'the floating agriculture' technology, which is defined as a crop production practice in soilless floating bed to cope with the problem of unavailable cultivating lands (Hasan, Mohammad, Ghosh & Khalil, 2017:2). The study proposition takes place in old villages of *Jabal Awlyā'a* locality (جبل أوائل), which had supplied the centre markets of Khartoum since the time of *al-Turkīya* (Ahmed, 1963:450) witnessed a remarkable increase of the areas classified as urban by 400 per cent between 1978 and 2018 and the drastic simultaneous decrease in its agricultural areas (Figure. 2).

The 'soil-less cultivation' refers to the hydroponics technique, which used to cultivate plants and vegetables in a nutrient-rich solution of water (Barman, Islam & Banu, 2016:1). This technique has been used in developing countries like Bangladesh for more than two centuries to plant any vegetable and seedling (Islam & Atkins, 2007:131; Barman *et al.*, 2016:1-2). As shown in (Figure. 3) the traditional 'floating agriculture' platform is consists of decomposing heaps of water hyacinth, an upper surface layer of ash, coconut fibre and sometimes, soil, to allow plants for penetration and spread (*ibid.*).



**Figure 3:** Schematic of a traditional floating island. Source: Barman *et al.*, (2016:5)

Recently, the 'smart floating farm' has been developed to compose three primary levels: ground-level for aquaculture and desalination technologies; the first floor for hydroponic crop cultivation; and a rooftop level covered with solar panels, skylights and rainwater collectors (Figure. 4) (Wang, 2015). The single unit of this system could produce tons of vegetables and 1.703 tons of fish annually (*ibid.*).



**Figure 4:** A 'Floating Farm' model. Source: Wang, 2015

In the absence of the ability to control the course of political-economic events that have moulded the spatial fabric of Khartoum throughout the last two centuries, we conclude that using this kind of alternative technology is an attempt to adapt to the accelerated pace of urbanisation, providing a suitable solution to the scarcity of agricultural lands that have created the current food security problem. Apart from addressing the inadequate supply of agricultural produce, such technology could also help to create a vibrant urban environment for Khartoum.

## LIST OF REFERENCES

- Abu Hatab, A., Cavinato, M., Lidemer, A., Lagerkvist, C. (2019). Urban sprawl, food security and agricultural systems in developing countries: A systematic review of the literature. *Cities*, 94(2019):129-142. [online] Retrieved from: [https://www.researchgate.net/publication/333843994\\_Urban\\_sprawl\\_food\\_security\\_and\\_agricultural\\_systems\\_in\\_developing\\_countries\\_A\\_systematic\\_review\\_of\\_the\\_literature?enrichId=rgreq-93532c4c6f255f7338c2ea92e30a6d4a-XXX&enrichSource=Y292ZXJQYWdlOzMzMzgz0Mzk5NDtBUzo3NzEwNjk5ODQxMjQ5MjhAMTU2MDg0ODgxODIzNw==&el=1\\_x\\_3&\\_esc=publicationCoverPdf](https://www.researchgate.net/publication/333843994_Urban_sprawl_food_security_and_agricultural_systems_in_developing_countries_A_systematic_review_of_the_literature?enrichId=rgreq-93532c4c6f255f7338c2ea92e30a6d4a-XXX&enrichSource=Y292ZXJQYWdlOzMzMzgz0Mzk5NDtBUzo3NzEwNjk5ODQxMjQ5MjhAMTU2MDg0ODgxODIzNw==&el=1_x_3&_esc=publicationCoverPdf) [Accessed: 27 August 2020].
- Ahmed, A. 1963. Tārīkh madīnat al-Khartūm taht al-hukm al-Masrī min sanat 1820 elā sanat 1885 (*History of Khartoum City under the Egyptian condominium from c. 1820 into c. 1885*) (in Arabic). In: Ramadan, A.(ed.) Series of Egyptian History.
- Barman, N., Hasan, M., Islam, M. & Banu, N. (2016). A review on present status and future prospective of hydroponics technique. *Plant Environment Development*, 5(2):1-7. [online] Retrieved from: [https://www.researchgate.net/publication/320299106\\_A\\_review\\_on\\_present\\_status\\_and\\_future\\_prospective\\_of\\_hydroponics\\_technique](https://www.researchgate.net/publication/320299106_A_review_on_present_status_and_future_prospective_of_hydroponics_technique) [Accessed: 9 November 2020].
- Burckhardt, J. L. 1819. *Travels in Nubia*. London: John Murray.
- Collins, R. (2008). *A history of modern Sudan*. Cambridge: Cambridge University Press.
- El-Bushra, E. & Hijazi, N. 1995. Two million squatters in Khartoum urban complex: The dilemma of Sudan's national capital. *GeoJournal*, 35(4):505-515.
- Hasan, S., Muhammad, A., Ghosh, M. & Khalil, M. (2017). Assessing of farmers' opinion towards floating agriculture as a means of cleaner production: A case of Barisal District, Bangladesh. *British Journal of Applied Science & Technology*, 20(6):1-14. [online] Retrieved from: [https://www.researchgate.net/publication/317014216\\_Assessing\\_of\\_Farmers'\\_Opinion\\_towards\\_Floating\\_Agriculture\\_as\\_a\\_Means\\_of\\_Cleaner\\_Production\\_A\\_Case\\_of\\_Barisal\\_District\\_Bangladesh/citations](https://www.researchgate.net/publication/317014216_Assessing_of_Farmers'_Opinion_towards_Floating_Agriculture_as_a_Means_of_Cleaner_Production_A_Case_of_Barisal_District_Bangladesh/citations) [Accessed: 8 November 2020].
- Islam, T. & Atkins, P. (2007). Indigenous floating cultivation: a sustainable agricultural practice in the wetlands of Bangladesh. *Development in Practice*, 17(1):130-136. [online] Retrieved from: <https://www.tandfonline.com/doi/abs/10.1080/09614520601092733> [Accessed: 7 November 2020].
- Szabo, S. (2015). Urbanisation and food insecurity risks: Assessing the role of human development. *Oxford Development Studies*, 44(1):28-48. [online] Retrieved from: <https://www.tandfonline.com/doi/full/10.1080/13600818.2015.1067292> [Accessed: 9 November 2020].
- Walkley, C. 1935. *The story of Khartoum*. Sudan Notes and Records, XVIII:221-241.
- Wang, L. 2015. *Could solar-powered floating farms provide enough food for the entire world?* [Online] Retrieved from: <https://inhabitat.com/could-solar-powered-modular-floating-farms-be-an-answer-to-global-food-self-sufficiency/> [Accessed: 11 October 2020]
- Wenban-Smith, H., Fase, A. Grote, U. (2016). Food security in Tanzania: The challenge of rapid urbanisation. *Food Sec.*, 8: 973-984. [online] Retrieved from: <https://link.springer.com/article/10.1007%2Fs12571-016-0612-8> [Accessed: 8 November 2020].
- World Food Program (2007). *Sudan: Comprehensive food security and vulnerability analysis*. [Online] Retrieved from: [https://reliefweb.int/sites/reliefweb.int/files/resources/4B8B207E7E1CC7354325757D0041B862-Full\\_report.pdf](https://reliefweb.int/sites/reliefweb.int/files/resources/4B8B207E7E1CC7354325757D0041B862-Full_report.pdf) [Accessed: 7 November 2020]
- World Food Program (2020). Sudan. [Online] Retrieved from: <https://www.wfp.org/countries/sudan> [Accessed: 17 August 2020].

# INFUSING CIRCULAR ECONOMY IN AFRICAN SMART CITIES

John Trimble, Tshwane University of Technology, South Africa, trimbleja@tut.ac.za

Humbulani Phuluwa, Tshwane University of Technology, South Africa, phuluwaHS@tut.ac.za

## Abstract

*Transforming cities into smart cities is seen as the solution to many of the problems facing growing and aging metropolitan areas around the world. Africa faces unique problems with the fastest-growing urban areas, a bulging youth sector and high unemployment in the formal sectors. The use of forward-thinking planning and a range of new technologies provide the opportunity for Africa to turn its rapid urban growth into an advantage. Concern over waste generation, pollution and climate change requires that any urban transformation addresses the life cycle of its technologies, industries, services and infrastructure. Historically, technologies have been developed with a linear life cycle with little regard to what happens at the end of it. Technological advances have led to a massive increase in products and consumption. This in turn has led to more waste and complex infrastructures that have reached the end of their lives. These circumstances are most pronounced in dense, highly populated cities. Circular economy (CE) calls on a new view of design and deployment of technology, which promotes a continuous life cycle that avoids waste and system degradation and optimises utilisation of energy and other resources. CE is being addressed by many researchers both on the micro-level with individual enterprises and industries, and on the national level with government policies. Some multi-national corporations are addressing the CE across their global supply chains. This research focuses on the CE of the African city as it plans to transform into the smart city (SC) of the future. Knowledge management is used as a methodology to employ the knowledge structures associated with CE and SCs to develop a framework for approaching the development of CE-based SCs across supply chains.*

**Keywords:** Africa, appropriate technology, circular economy, smart cities, technology policy

## INTRODUCTION

Cities have been central to human existence for thousands of years. Urban congestion has led to extensive urban waste resulting from the linear production life cycle, which has been central to the legacy of the city. Comparing discards in the marketplace of ancient Rome and modern Tokyo, Smith (2019:3) declares that “it’s the act of discard that provides the most telling evidence of urban activity, whether it’s a broken potsherd from two thousand years ago or a fragment of a plastic crate that was shattered this morning. ... an urban obsession with trash is everywhere, and once you start to look, you won’t be able to stop seeing it.” The parts of ancient pots found in Rome make for interesting finds for archaeologists. The exponentially growing tons of plastic waste spell disaster for modern cities and the world. Smith (2019:20) observes that cities have been around for over six thousand years. Since their inception they have been the centres of commerce and industry as well as the centres of military and political leadership of nation states. The city has been the common space for cultural and intellectual development and the setting for the expression of political views and revolutionary demands from Paris to Washington DC and from Cairo to Cape Town. As Harvey (2012:73) points out, “Syntagma Square in Athens, Tahrir Square in Cairo, and the Plaza de Catalunya in Barcelona were public spaces that became an urban commons as people assembled there to express their political views and make demands”. As more of the world’s population shifts to cities and cities grow in size, their significance socially, politically and economically increases. According to O’Keefe (2020:48), “the world’s urban population was 746

million in 1950, or about 30% of the total. Today some 4 billion people, more than 50% of the global population, live in cities. And by 2050, the UN projects, 68% of people will reside in urban areas”. One could forecast a decline in the appeal to move to cities given the complications growing cities have, from public health issues, transportation congestion, excessive waste generation and social upheaval. However, in reality, we find the opposite situation. Smith (2019:258) explains:

So, the idea of urban collapse is a good story line for a movie but is hardly a blueprint for the eventual fate of our own urban areas. ... Many parts of our current cities are already quite dystopian, especially from the perspective of people living in slums, but the steady influx of people to these areas of abject poverty demonstrates that even when city life is very unattractive, there’s still plenty that draws people in. Their calculations to stay in cities despite urban disadvantages are logical moves, given that cities attract a disproportionate amount of resources when things do go bad.

The development of the city requires the effective employment of technologies and people management to counter the social and economic challenges. The transition to smart cities (SC) is seen as an appropriate approach to meet these challenges. While many cities are expanding geographically, the very nature of the city reflects a closed system. As a closed system the city has a need to address a circular economy (CE) approach. In this context we examine the African city.

## African cities

It is crucial to address the development of the African city in the context that is particular to Africa. In 1890 there were only two cities with populations of over 2.5 million people. Due to the massive modern agro-industrial revolution, by 1900 there were seventy-four of that size or larger (Belich, 2009:2). This was not the case in Africa. Most of Africa had a unique urban transition, particularly in comparison to developed countries. Pieterse and Parnell (2014:3) observe that “[a]t the point of colonial independence, most of Africa was predominantly rural ... urban centres that did exist were either small colonial towns or traditional villages”. The colonial state largely neglected the rural areas. Upon independence, new governments inherited this state apparatus of rural neglect. The difficulties associated with redirecting the state mechanisms have contributed to continued neglect and migration from rural areas. Advances in communication and transportation, coupled with an increase in literacy, have motivated even more people to move to the cities. By 2020, three cities in Africa had populations over 7 million: Cairo, Lagos and Kinshasa, while an additional twenty-five cities had populations over 1.5 million people. A far greater number of smaller cities emerged across Africa. Africa’s plans for urban development must address cities and towns of all sizes. As pointed out by Ford (2015:17): “Unlike in China and much of Southeast Asia, sub-Saharan Africans are not flocking to vast manufacturing centres in the cities. Most African migration is from rural areas to small towns, from small towns to big towns; and from big towns to cities. ... As a result, much more attention needs to be paid to the development of smaller African towns.”

## Smart cities

Cities have always been linked to the various development agendas of the United Nations (UN). It is imperative to link tomorrow’s smart cities to the United Nations’ current 2030 Agenda for Sustainable Development and its 17 goals (Zheng, Kwok, Aquaro and Qi, 2019). There are various perspectives on what a smart city consists of and how to develop them. Patel and Doshi (2019) believe smart cities connect resources, government, organisations (including companies), citizens and visitors through smart devices and smart environments and that smart city applications can be viewed in eight categories: governance, energy, buildings, mobility, infrastructure, technology, healthcare and citizens. This approach to smart cities could assist international formations from the World Trade Organisation (WTO) to the World Economic Forum (WEF) in implementing their objectives. Dorofeeva, Rodionov and Velichenkova (2019) contend that the smart city of today is a collection of decisions and policies for municipal and regional authorities to implement and improve urban system efficiency. They studied 486 smart city projects and categorised the projects. The categories and frequency of projects in each category are listed in Table 1. In this instance this information gives some idea of the national priorities placed on projects of different types.

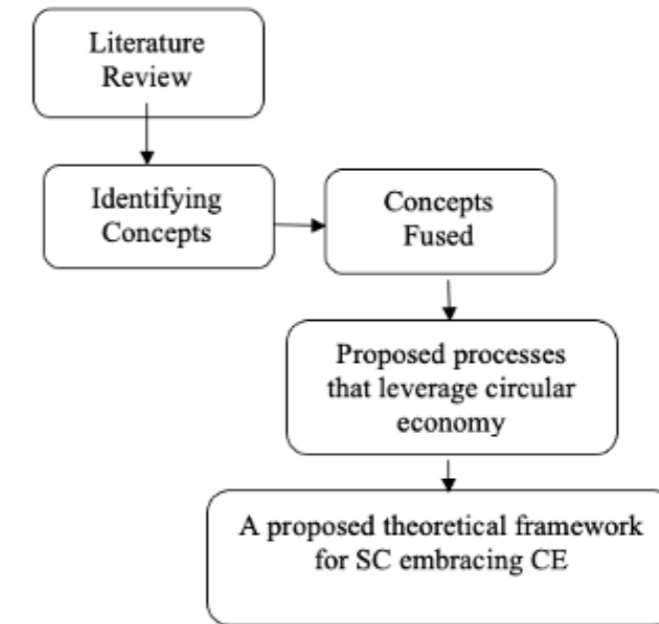
**Table 1 – Frequency of smart city categories**

Project Category	# of projects
Energy Efficiency	90
Information city and systems	263
Safety	40
Transport	47
Water Supply	17
Ecology	10
Energy Supply	8
Heat Supply	5
Waste	3
Building Construction	3

In addition to converting existing cities to smart cities there is a drive to create whole new cities as smart cities. This eliminates many problems with existing city infrastructures and processes. “In Africa, proposals abound to build new cities – with explicit smart characteristics – as offshoots of existing megacities. A number of satellite smart cities have emerged in countries such as Kenya (Konza), Nigeria (Eko Atlantic and Centenary) and South Africa (Waterfall City)” (Slavova & Okwechime 2016:12). South Africa’s particular focus on smart cities is led by its largest and most industrialised city, Johannesburg. “The city of Johannesburg has stepped-up strategic efforts aimed at rebranding itself as a smart city and overall competitive city at the centre of innovation toward improved life experiences. ... Out of the realization for the need to develop smart city initiatives, many South African cities, such as Durban, Cape Town, and Port Elizabeth, have jumped onto the bandwagon for designing smart city projects driven by the local contextual setting” (Bwalya, 2019:408). Williams, Webster and Leleux (2019) start by examining conflicting views on the concept of a smart city. They then focus on conceptualising the sustainable smart city (SSC) that “points to new relations being formed around the use of new technologies with an aspiration that local governance and services will be enhanced at the same time as facilitating more sustainable futures” (Williams, Webster & Leleux, 2019:240).

**Methodology**

This study employs knowledge management (KM) as a methodology. It is used to link the constructions of smart cities, circular economy and supply chain management in an effort to create new knowledge. Johannessen (2019) addresses knowledge management as different theories and pays particular attention to the creation of new knowledge for innovation. KM can be implemented as a seven-step strategy: 1) assess environment; 2) survey and facilitate existing KM activities; 3) plan KM initiatives; 4) implement KM initiatives; 5) perform change management; 6) implement KM governance; and 7) socialise, share and collaborate (Hunter, 2016). Our approach is to link the three constructs of smart cities, circular economy and supply chain management through knowledge representation constructs. The resulting collection of knowledge representation constructs can serve as a decision support mechanism in the innovative implementation of smart cities in Africa. Knowledge management was used as a tool to employ the knowledge structures associated with CE and SCs to develop a framework for approaching the development of CE-based SC across supply chains. Defining the data required in the study and what needs to be done is highlighted in Figure 1.



**Figure 1: The process flow followed in the study.**

The concepts are fused with urban concepts to propose a manner in which African cities might leverage circular economy principles to achieve the smart cities goals. This could accelerate development, specifically in developing economies.

**Table 2: Smart city development categories adapted from (Alexopoulos, Charalabidis, Pereira and Madrid 2019)**

Category	Examples
ICT infrastructure	Implementation of free wi-fi in public areas and municipal buildings; fibre to the home network, city operation and management centre
Environment and agriculture	Installation of rain level and light level measurement sensors; garbage collection sensors; urban agricultural consulting
Transportation – mobility	Smart stops for public transportation; vehicle fleet management; collision avoidance sensors
Health	Tele-monitoring to support vulnerable groups; telemedicine on citizens and medical records archive; establishment of Health Centres
Waste management & water resources	Online quality measurement of drinking water; online monitoring of pumping stations; citizen tele-education on recycling
Energy – sustainable development	PV installation in buildings & ports; construction of wind farms; smart meters for energy consumption
Tourism – culture	Electronic local tourist guide; tourism content applications for mobiles; digitization of museum content
Economy – development	Promoting entrepreneurship on municipal websites; contactless fare payment system; crypto-currencies adoption
Security	Early warning system of fires, floods, etc.; monitoring weather for agricultural purposes; event & crowd management
E-government	Electronic voting; access to open data by public agencies and individuals; metrics to evaluate government performance



## Knowledge management

The drastic change in smart cities since the 1990s is due to advances in technology that have contributed significantly to new forms of everyday interaction (Moustaka, Vakali & Anthopoulos, 2018). This provides the rationale for applying a knowledge management approach to promoting the further development of smart cities. The accelerating speed of technology development makes knowledge management essential in most complex efforts. The categorising of practices and identification of best practices are essential components of a knowledge management approach. Defining knowledge structures, knowledge capture and knowledge utilisation are also essential. “Knowledge management seems to be a relevant framework for smart cities, as it focuses on the actions of a given organization instead of relying on the analysis of its vision and mission” (Cantuarias-Villessuzanne & Weigel, 2020:842). One study applying the knowledge management perspective to smart cities identified three research themes: 1) sociotechnical approaches to smart cities, 2) integrating knowledge-sharing perspectives and 3) developing organisational learning capabilities (Israilidis, Odusanya & Mazhar, 2019). A taxonomy of smart city initiatives was developed based on 85 smart cities actions drawn from Europe, Asia, North and South America. It divided developments into the ten categories, listed in Table 2 (Alexopoulos, *et al.*, 2019).

## Circular economy

The concept of circular economy (CE) has emerged as a practice that will address the problems arising from expanding production of a linear nature in a closed system. The linear life cycle produces waste and the planet’s capacity to deal with waste is limited, while a city’s capacity is even more limited. The expanded use of a linear life cycle means non-renewable resources are being lost forever at an alarming rate. Different attempts are made to define and structure CE (Farooque, Zhang, Thuer, Qu and Huisinsh, 2019). In an effort to utilise the knowledge management approach, this research starts with the following definition of circular economy from a production-consumption nexus:

CE is a sustainable development initiative with the objective of reducing the societal production-consumption systems’ linear material and energy throughput flows by applying materials cycles, renewable and cascade-type energy flows to the linear system. CE promotes high value material cycles alongside more traditional recycling and develops systems approaches to the cooperation of producers, consumers and other societal actors in sustainable development work (Korhonen, Nuur, Feldman, and Birkie, 2018:547).



Figure 2: Different manufacturing economies - Source: RLI (2015)

According to van Buren (2016), the recovery of raw materials from products in order to retain them in the economy longer can result in job growth in the region due to the greater regional demand for reuse, repair, remanufacture and reclamation of raw materials. Figure 2 shows three approaches to the manufacturing economy. The historically popular ‘linear’ approach does not consider the sources of raw materials or the locations of waste. The economy with ‘feedback loops’ recognises the externality associated with raw materials and waste, while identifying recycling feedback. The ideal is the closed-loop system represented by the circular economy diagram. The definition of CE is important in identifying the role of circular economy in saving the environment and meeting social needs. Central to this definition is a systems approach that requires the cooperation of stakeholders to promote sustainable development. This requires long-range thinking and a clear understanding of the drivers in place when shifting toward CE. Thirteen motivational drivers that fall into five clusters

are identified. The five clusters are: policy and economy; health; environmental; society; and product development. Table 3 identifies the drivers by cluster and indicates related stakeholders (Govindan & Hasanagic, 2018).

## Supply chain management

Supply chain management (SCM) is concerned with optimising the operations of production and distribution for all suppliers and consumers. This requires coordination and cooperation among the multiple organisations engaged with the various aspects of production and distribution. Generally, SCM is addressed by a major player in the production chain that, then deals with both upstream and downstream processes as well as the processes central to their organisation. The development of a smart city must engage the major private and public sector organisations involved in delivering goods and services. Their collaboration with government in SCM is central to effectively implementing any smart city plan. To best guide this smart city agenda, stakeholders must understand the role of the different supply chain drivers. Table 4 highlights the different drivers and the unique decision components of each driver. All six drivers have metrics that must be tracked to optimise performance. The ‘Information’ driver plays a particularly significant role in the way it engages all the other drivers. It has additional significance in city planning by assisting in decision management across governmental and non-governmental organisations. Information as a driver motivates the use of knowledge management in actualising CE in the various smart city projects that would make up the city-planning portfolio.

Table 3: Circular economy drivers, their clusters and stakeholders (\*added by authors)

Cluster	Drivers	Stakeholders
Policy and economy	1. Keep within laws and policies of waste management	- Organisation - Supplier
	2. Economic growth implementing CE in SC	- Organisation - Supplier
Health	3. Public health pays for overconsumption of resources	- Society
	4. Animal health pays for overconsumption of resources	- Society
Environmental protection	5. CE importance due to climate change due to waste & greenhouse gas emissions (GHG)	- Society* - Government
	6. Modern agriculture over-consumes resources	- Society
	7. As demand for renewables increases, renewable resources should be protected	- Government
Society	8. Demand on resources due to global population growth drives need for CE in SC	- Government
	9. Urbanisation’s negative impact on environment	- Government
	10. Job creation potential with CE in SC	- Organisation - Supplier
	11. Environment awareness pressures industry	- Consumer
Product development	12. Improve materials & energy efficiency	- Organisation - Supplier
	13. Increase products’ value by increasing quality	- Organisation

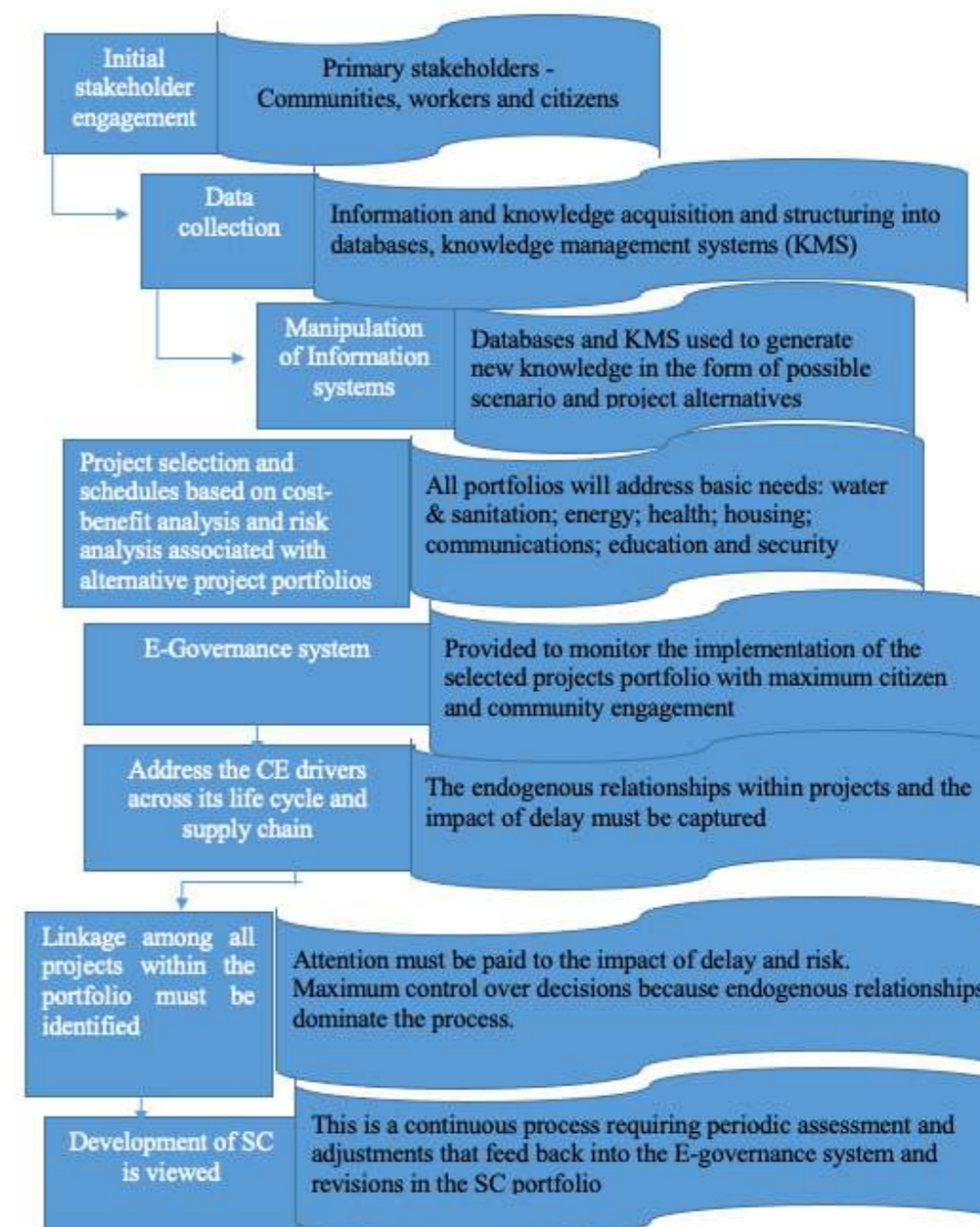
**Table 4:** SCM drivers and their unique decision components (Chopra & Meindl, 2016)

<b>Logical drivers</b>	<b>Facilities</b> – role; location; capacity	<b>Inventory</b> – cycle, safety and seasonal inventory; level of product availability	<b>Transportation</b> – design of network; choice of mode
<b>Cross-functional drivers</b>	<b>Information</b> – push vs. pull processes; coordination and information sharing; sales and operations planning; enabling technologies	<b>Sourcing</b> – in-house or outsource; supplier selection; procurement	<b>Pricing</b> – pricing and economies of scale; everyday low pricing vs. high-low pricing; fixed price vs. menu pricing

City planning that takes on an agenda of enhancing the CE must focus on the role of information. Inevitably this approach merges SCM, CE and SC into a management model for development. Employing CE as a management model to promote sustainable development requires: 1) strengthening social capital; 2) establishing a system of preferences for managing resources in a circular way, in order to weaken the competitive advantage of linear management models; 3) promoting cooperation between suppliers and receivers and manufacturers and consumers towards a collaborative sharing economy; 4) establishing and executing regulations to protect the natural environment; 5) determining/controlling recycling rates of various waste and product quality standards (Skawinska & Zalewski, 2018). Information and communication technology (ICT) is central to fulfilling all four of these management requirements and also to the application of CE to rethinking products and services and the processes of developing and distributing them. These digital technologies of ICT can be viewed in three architectural layers in the implementation of the CE-oriented smart city. The bottom layer comprises data collection and includes the use of radio frequency identification devices (RFIDs) and the Internet of Things (IoT). The middle layer deals with data integration and includes different database structures, database handling systems and product lifecycle management (PLM). The top layer involves data analysis, where machine learning and other Big Data analytics are utilised to get the most out of information collected (Pagoropoulos, Pigosso, & McAloone, 2017). The key is how widely and deeply city stakeholders are willing and able to embrace this CE-SCM approach to smart city development. Esposito, Tse and Soufani (2018:7) point out that “[c]ircular economic activity includes reuse, repair, recycling, ecodesign, sustainable supply, and responsible consumption”. CE has five fundamental traits: design out waste; build resilience through diversity; work toward energy from renewable sources; think in systems; and think in cascades. The last two traits – thinking in systems and cascades – can be linked with the other three traits and applied to all six of these activities.

### African smart cities

This study recognises the differences African urbanisation faces when compared to developed countries. Particular challenges are placed on African governments and organisations engaged in smart city development. Successful African smart city development must start with an understanding of the current drivers of urban failure in Africa. This is captured best by Pieterse (2014). In Africa the drivers of urban failure are: 1) governmental attitude that urbanisation is undesirable leading to the neglect of many urban dwellers; 2) political elites desiring to control local neighbourhoods and preventing the empowerment of local stakeholders; 3) limited public funding for urban programmes restricting urban development; and 4) weakness of civil society institutions limiting their ability to organise the poor or to pressure the state for resources. Government must demonstrate a commitment to African SC development that reduces inequality while improving the quality of life for the city’s population. It must strengthen the democracy in the city while empowering local communities. As indicated, the effective use of technology, particularly ICT, is key to a sustainable journey toward a comprehensive SC that embraces CE across its various supply chains. Figure 3 presents a graphical framework that can serve as a guide in this endeavour, showing that the engagement of stakeholders is critical to the success of each SC effort. The framework prioritises community and worker involvement in all projects. This is consistent with the position that appropriate technology is technology to empower people and communities, and critical if the urban failure drivers mentioned above are to be addressed and overcome.



**Figure 3:** Framework for SC embracing CE

### Conclusions

The framework presented in Figure 3 is a starting point for linking CE and SCM in the development of smart cities. Central to the framework is the engagement of the city’s citizens in their workspace and their communities. Communities as the primary stakeholders must take ownership of data collection and the manipulation of information systems. This can set the tone for project selection that focuses on addressing communities’ basic needs. Communities will be the benefactors of the new smart city and they will also be the key implementers.

ICT plays a strong role in this framework. The implementation of a comprehensive E-governance system is critical to citizen engagement and tracking the implementation and effectiveness of the different SC projects. The E-governance system will link the different government entities responsible for different aspects of the various projects. This will provide transparency, facilitate communication and expedite necessary actions. The transparency will encourage citizen engagement and support. A key aspect of the E-governance system is the ability for citizens' inputs to be considered and addressed. This will result in stronger citizen support and continued engagement.

The CE-SCM approach to smart city development is an urban development arena ripe for future research efforts. Farooque *et al.* (2019) provide direction for potential research in circular supply chain management (CSCM) in identifying five highly important areas that have critical potential impact and are considered very urgent: 1) design for circularity; 2) biodegradable packaging; 3) circular supply chain collaboration and coordination; 4) identifying drivers and barriers of CSCM; and 5) product liabilities and producers' responsibility. Our research team will continue to expand the framework presented in Figure 3. It is hoped that further effort will lead to constructing a more robust knowledge management system associated with our smart cities research. The E-governance component is of critical importance and can be linked to continued developments in the Internet of things (IOT) that allow collection of more information across various supply chains, as well as the swift implementation of decisions. A particular emphasis will be placed on constructing a portfolio of projects that emphasises basic services such as public healthcare, housing, education, energy needs, security, communications, water and sanitation. Our future research will also address the construction of mixed mode simulation (agent-based, continuous and discrete models) to study the potential benefits of different SC projects and portfolios.

#### Acknowledgements

We, the authors, acknowledge the support of our department and fellow researchers in our research project. We also acknowledge the contributions that the International network on appropriate technology (INAT) makes to this broad field and extend our appreciation for considering our contribution to the 9<sup>th</sup> ICAT.

#### LIST OF REFERENCES

- Alexopoulos, C., Charalabidis, Y., Pereira, G. V. & Madrid, L. 2019. A taxonomy of smart cities initiatives. *Proceedings of the 12th international conference on theory and practice of electronic governance (ICEGOV2019)*, (281-290). Melbourne, Australia (Accessed: 20 September 2020).
- Belich, J. 2009. *Replenishing the Earth*. Oxford, UK: Oxford University Press.
- Bwalya, K. J. 2019. The smart city of Johannesburg, South Africa. In Anthopoulos L (ed). *Smart City Emergence: Cases from around the World* (pp. 407-419). Amsterdam: Elsevier.
- Cantuarias-Villesuzanne, C. & Weigel, R. 2020. Mapping of smart cities in order to understand the cities' sustainability. *Companion proceedings of the web conference 2020, (WWW '20 Companion)* (842-843). Taipei, Taiwan: ACM.
- Chopra, S. & Meindl, P. 2016. *Supply chain management strategy, planning and operation*. Boston: Pearson.
- RLI. Council for the environment and infrastructure. 2015, June. *Circular economy: From wish to practice*. Retrieved May 24, 2020, from Council for the environment and infrastructure: [https://en.rli.nl/sites/default/files/advice\\_rli\\_circular\\_economy\\_interactive\\_def.pdf](https://en.rli.nl/sites/default/files/advice_rli_circular_economy_interactive_def.pdf)
- Dorofeeva, L., Rodionov, D. & Velichenkova, D. 2019. Infrastructure potential of creating "Smart Cities". *Proceedings of Peter the Great St. Petersburg Polytechnic University International Scientific Conference on innovation in digital economy* (1-7). Saint Petersburg, Russia: ACM.
- Esposito, M., Tse, T. & Soufani, K. 2018. Introducing a circular economy: New thinking with new managerial and policy implications. *California Management Review*. 60(3),5-19.
- Farooque, M., Zhang, A., Thurer, M., Qu, T. & Huisingh, D. 2019. Circular supply chain management: A definition and structured literature review. *Journal of Cleaner Production*, 228 (2019), 882-900.
- Ford, N. 2015, January. Crunch time for African cities. (A. Versi, ed.). *African Business*. (January 2015 Issue 415),16-22.
- Govindan, K. & Hasanagic, M. 2018. A systematic review on drivers, barriers, and practices towards circular economy: A supply chain perspective. *International Journal of Production Research*. 56(1-2)278-311.
- Harvey, D. 2012. *Rebel cities from the right to the city to the urban revolution*. London: Verso.
- Hunter, B. 2016. *The Power of KM: Harnessing the Extraordinary Value of Knowledge Management*. San Francisco: Spirit Rising Productions.
- Israilidis, J., Odusanya, K. & Mazhar, M. U. 2019. Exploring knowledge management perspectives in smart city research: A review and future research agenda. *International Journal of Information Management*, <https://doi.org/10.1016/j.jinfomgt.2009.07.015>
- Johannessen, J. 2019. *Knowledge management as a strategic asset: An integrated, historical approach*. Bingley, UK: Emerald Publishing Limited (Emerald Points). Available at: <http://0-search.ebscohost.com.tkplib01.tut.ac.za/login.aspx?direct=true&AuthType=ip,url,cookie,uid&db=e000xww&AN=1887133&site=eds-live> (Accessed: 20 September 2020).
- Korhonen, J., Nuur, C., Feldmann, A. & Birkie, S. E. 2018. Circular economy as an essentially contested concept. *Journal of Cleaner Production*, 175 (2018) 544-552.
- Moustaka, V., Vakali, A. & Anthopoulos, L. G. 2018. A systematic review for smart city data analytics. *ACM Computing Surveys*. 51(5)103-144.
- O'Keefe, B. 2020, March. Plotting the rise of the megacity. (C. Leaf, ed.) *Fortune*, 181(3) 48-49.
- Pagoropoulos, A., Pigosso, D. C., & McAloone, T. C. (2017). The emergent role of digital technologies in the Circular Economy: a review. *The 9th CIRP Conference: Circular Perspectives on Product/Services-Systems*. 64 (2017), pp. 19-24. Elsevier.
- Patel, Y. & Doshi, N. 2019. Social implications of smart cities. *2nd International Workshop on Recent advances on Internet of Things: Technology and applications approaches (IoT-T&A2019)*. (155) 692-697. Halifax, Canada: Elsevier, Procedia Computer Science.

- 
- Pieterse, E. 2014. Filling the void: An agenda for tackling African urbanisation. In Pieterse E. & Parnell S. (eds). *Africa's urban revolution* (200-220). London: Zed Books.
- Pieterse, E. & Parnell, S. 2014. Africa's urban revolution in context. In Pieterse E.& Parnell S (eds). *Africa's urban revolution* (1-17). London: Zed Books.
- Skawinska, E. & Zalewski, R. I. 2018. Circular economy as a management model in the paradigm of sustainable development. *Management*, 22(2),17-233.
- Slavova, M. & Okwechime, E. 2016. African smart cities strategies for Agenda 2063. *Africa Journal of Management*, DOI: 10.1080/23322373.2016.1175266, (assessed 20 November, 2020).
- Smith, M. L. 2019. *Cities: The First 6,000 years*. London: Simon & Schuster.
- Van Buren, N., Demmers, M., Van der Heijden, R. & Witlox, F. 2016. Towards a circular economy: The role of Dutch logistics industries and governments. *Sustainability* 2016, 8, 647.
- Williams, C., Webster, R. & Leleux, C. 2019. Searching for the real sustainable city? *International Journal of Government & Democracy in the Information Age 2019* (24). 229-244.
- Zheng, L., Kwok, W. M., Aquaro, V. & Qi, X. 2019. Digital government, smart cities and sustainable development. *Proceedings of the 12th International Conference on Theory And Practice of Electronic Governance (ICEGOV2019)* (291-302). Melbourne, Australia: ACM.

# THE DEVELOPMENT OF HOMEFARM, A HYDROPONIC CULTIVATION SYSTEM SUITED TO LOCAL MANUFACTURE

Mr Martin Bolton, University of Johannesburg, South Africa, mbolton@uj.ac.za

Mr Michael Currin, University of Johannesburg, South Africa, michael@pixelblueinnovations.com

## Abstract

*PixelBlue is a local South African Technology startup which develops, manufactures and commercialises technology in the indoor hydroponic farming sector. PixelBlue views the role of hydroponics as critical in transforming urban spaces into productive farming environments, whether it be in buildings, on rooftops, or in abandoned spaces. Hydroponic technology enables farming without the need for arable land, is not climate dependent, is highly water efficient and can be done vertically, which makes it perfect for use within cities. By adopting hydroponics, cities can become self-reliant through a network of decentralised farming nodes which service their surrounding populations. Through this organised co-operative system, the fresh produce grown can also be traded via the open market, thereby stimulating the economy of the city. Our research and development over the past four years has led us to develop a highly versatile and scalable hydroponic technology which can be deployed in systems ranging from consumer devices to large-scale commercial systems. This followed a standard product development process within the Tech Startup landscape which brought with it many hurdles. Currently we have an ever increasing catalogue of crops, which the system has been proven able to grow, all sourced from local organic and heirloom variety seed suppliers. The first commercial product of our technology exists in the form of the Homefarm product; a consumer indoor farming appliance, enabling urban dwellers to grow their own food from the comfort of their home, all year round. This was developed to suit accessible manufacturing capabilities within Johannesburg, and the outcome is suited to local distribution.*

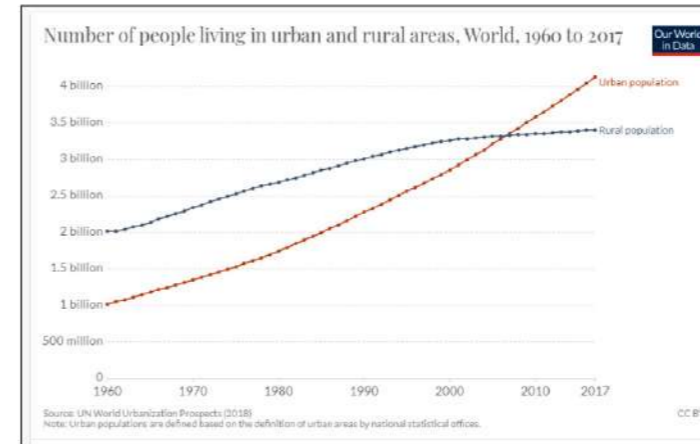
*This paper will contextualise the food supply problem and present an opportunity for developing an appropriate local solution. This will allow for the illustration of appropriate methodologies which were utilised in the development of the Homefarm product and can inform future product development.*

**Keywords:** industrial design, hydroponics, urban agriculture

## INTRODUCTION

Our existing food and agricultural systems are in crisis. South Africa is urbanising rapidly, with 63 percent of its population already living in urban areas and this number set to rise to 71 percent by 2030. By 2050, eight in ten people in South Africa will be living in urban areas (Parliamentary Monitoring Group, 2020). This is not only a local trend. The UN predicts that by 2050, 88 per cent of high-income-country populations will be living in urban areas, while 50 per cent of low-income-country populations will be living in urban areas (United Nations, 2018).

Based on these shifting and growing populations, existing global food systems and supply chains are having to feed over four billion urban dwellers globally (Figure 1). This food is brought in from farms far away and sometimes even from different countries. Before reaching urban consumers, their food has been grown, processed, transported, distributed, packaged and then retailed (Figure 2).



**Figure 1:** Urban Population Increase (Our world in data, 2020).

The impact created by each step on the food supply chain is creating an immense negative impact on the environment. At present our agricultural practices are completely unsustainable. Our soils, freshwater, oceans, forests and biodiversity are all being rapidly degraded as a result of agricultural practices.



**Figure 2:** Modern Fresh Produce Supply Chains. A comparison. (Sandia Seed Company, 2020.)

## LITERATURE REVIEW

According to information reported by the Global Forest Resource Assessment, agriculture (cropland and pasture) is by far the largest direct cause of deforestation. According to their estimations between 70% and 80% of forest conversion in Africa is due to agriculture (UN FAO, 2020). In addition, our growing population and demand has meant that the global per capita availability of arable land has shrunk from 1 578 m<sup>2</sup> in 1965 to less than 650 m<sup>2</sup> today (Agritecture. 2020). The quality of existing arable land is also in decline. Six years ago, the United Nations' Food and Agriculture Organization said soil degradation was proceeding at such a rate that the world may only have 60 harvests left, noting that it takes up to 1,000 years to build 3 inches of topsoil (Dobberstein, 2020). Finally, climate change is placing further pressure on the world's supply of food. Currently, South Africa remains a relatively food-secure nation and is a net exporter of agricultural goods, including maize, with a 25% export share in all agricultural goods in 2018. However, studies suggest the aggregate impact of climate change on crops in Southern Africa will be negative. Maize yields are projected to decline on average by 18% by mid-century (Zinyengere, Crespo, Hachigonta, 2013). A profound change of the global food and agricultural system is needed if we are to avoid irreversible eco-system degradation, biodiversity loss and still be able to nourish today's 815 million hungry as well as the additional 2 billion people, expected by 2050 (United Nations. 2020).

The relationship between agriculture and technology goes back to the dawn of agriculture. In fact, it could be argued that agriculture itself is a form of technology (Figure 3). Today, advancements in agriculture are being driven by big data, genetics, AI, surveillance, increased automation and mechanisation and hydroponics – including artificial climate control and fertigation to name a few. While most of these technologies are being applied to agriculture on a commercial scale, many of them could be applied to bring advanced methods of farming into smaller residential communities and people's homes.

### Hydroponics, an appropriate technology.

Hydroponics, as one of the identified technologies, is an Appropriate Technology to create a movement and revolution in home-based farming. It is an agricultural technology which involves the efficient and precise delivery of a nutrient-rich water-based solution to the roots of the plant without the need for arable land as a 'Grow Medium'. Hydroponic farms can be arranged vertically because the components which make up these systems can be configured in various ways, allowing for the optimisation of floor space. With the addition of energy-efficient artificial lighting, hydroponic farms can be built indoors, allowing for the use of Controlled Environment Agriculture or CEA. This makes hydroponic farming climate-agnostic and applicable in almost any environment or setting, including the built environment. Urban farms have become a familiar feature in major cities around the globe. From rooftops, to underground tunnels, to abandoned car parks, hydroponic farms have the potential to become seamless and permanent features in the urban landscape.

Our particular interest and focus is within the context of the home, and how hydroponic technologies which have been developed for large, sophisticated and expensive commercial farms can be made accessible to the average citizen.

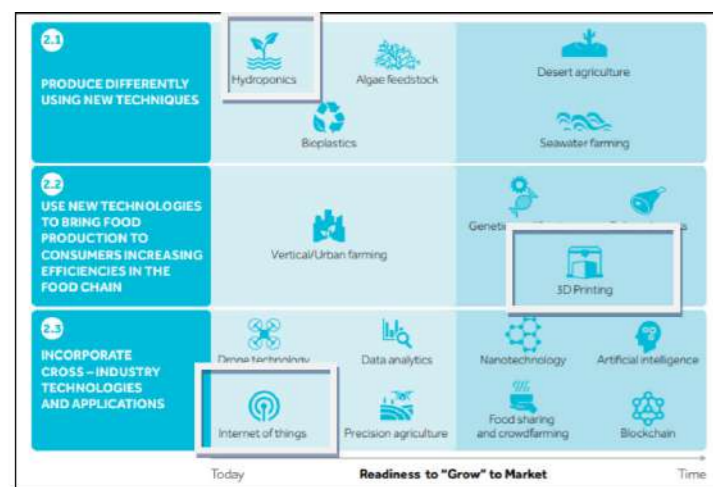


Figure 3: Various Agricultural Technologies and their readiness to 'grow' to market (Oliver Wyman, 2018).

## RESEARCH QUESTION

In order to frame the project, the following can be stated as an overarching research question:

Can an appropriate hydroponic appliance be developed to suit the local South African manufacturing landscape?

A suitable secondary research question would be to ask, what methods can successfully be applied in the development of new agricultural technology products, intended for the South African market and production?

### Pixelblue, the company

Our mission is to empower urban dwellers to grow their own fresh produce by providing an automated, productive food farm to homes across South Africa and the world. We have identified three important criteria which form the centre of our design methodology as follows and steers much of our developmental decision-making:

- The products that we develop need to be **affordable** within our local context
- The products and technology need to be as **accessible** as possible.
- What we develop needs to best suit those who use it: **usability** is key.

**Affordability** is relative and in many ways subjective. The price of something is what determines its affordability within the context of a particular socio-economic sector. While the concept of value is less tangible than price, it is a key determinant for how we perceive price. If the value proposition makes sense to the right user at the right price, this is referred to as product-user fit. While affordability is the determinant for **accessibility** from a financial standpoint, in this instance we use accessibility to refer to marketing and distribution channels. How does one get the product to the user, and how does one then continue to service the needs of that user? **Usability** refers to the relationship between the product and the user. Has the product been designed in such a way as to make it usable: is it easily understandable, intuitive and reliable in its performance. It is our ultimate goal to develop a technology which meets all three of these criteria, and which can contribute to our stated mission. To realise our mission we established PixelBlue in 2016. PixelBlue's first product to market is Homefarm – a fully automated food growing appliance for the home. Homefarm is the manifestation of 3 years' research and development to bring food farming into homes via a mainstream appliance.

### Homefarm, the product.

The Homefarm product is a countertop automated hydroponic growing appliance which is able to take the guess-work out of growing microgreens (Figure 4).

With the Homefarm product, we have developed a technology which can grow a variety of over 30 different organic and pesticide-free crops including microgreens, herbs, sprouts, grasses and leafy greens, using its automated hydroponic system. The product features include:

- A closed controlled environment.
- Automatic watering.
- Full spectrum automated grow lights.
- Humidity control.
- Temperature regulation.
- A touch screen and backlit interface with audio haptic response.
- Internet connectivity
- An App which guides the user through their growing journey, provides incentives and inspiration.
- Crops grown on single use bio-degradable hemp 'mats', with hemp that has been grown using a process that has a zero-carbon footprint.

Homefarm is essentially a mini indoor hydroponic food garden (Figure 5). It employs many of the same technologies found in larger, high tech commercial farms and packages them into a small, user friendly, home appliance. Because it controls the plants' environment, the product is able to produce consistent yields all year round. It is also able to grow microgreens, which need be grown in a controlled, or at very least, an indoor environment.



Figure 4: Homefarm appliance growing micro herbs and microgreens.

For us it was important that Homefarm grow microgreens, due to their very high nutrient density, and for the fact that they grow very quickly (seed to harvest in 12-14 days), making them perfect for home-farming. Microgreens are the young leaves of vegetables and leafy greens. They are harvested before the first 'true leaves' of the plant start to grow – typically after two weeks. When planted, their seeds are sown densely to create a 'mat' of greens which are harvested by cutting them at the base of the stems. People have long suspected the health benefits of microgreens. But only recently have scientific studies been conducted to confirm this theory and to understand the relative advantage of microgreens. In a study by the United States Department of Agriculture in 2013, results showed that different microgreens provide the vitamins A, C, E, and K1, and found that generally they have significantly higher concentrations of these phytonutrients in comparison with mature leaves from the same plant species (Lester, Xiao, Luo, Wang, 2013). In a report in the American Chemical Society's Journal of Agricultural and Food Chemistry, claims that for mice on a high-fat diet, red cabbage microgreens helped lower their risk factors for developing cardiovascular disease and reduce their weight gain and it did so more effectively than the mature red cabbage plant (Science Daily, 2016).

In an article which appeared in *The Daily Maverick*, in September 2019, about Homefarm, Gabriel Eksteen, a senior lecturer in nutrition at the University of Cape Town's Division of Human Nutrition stated "There is definitely some merit in exploring the health benefits of microgreens more (Nortier, C). They are something you can cultivate a little bit more easily at home. Growing fruit and herbs at home is often not very attainable for most people. The amount you need to grow of a crop to make a significant contribution to your diet is not something most people can do in a small back garden or flat. With microgreens, there is that possibility." The relative advantages of growing microgreens and why they are particularly well suited to home-farming is demonstrated in the diagram (Figure 6) and table (Table 1) below:



Figure 5: Homefarm appliance growing micro herbs and microgreens.

Table 1. Why microgreens are suitable to home growing

Microgreens	Mature Vegetables
- All Year Round	- Seasonal
- 2 week harvest cycles	- 3 month crop cycles
- 3 m <sup>2</sup> Crop Area per 1 m <sup>2</sup> footprint	- 1 m <sup>2</sup> Crop Area per 1 m <sup>2</sup> footprint
- Many multiples more nutritional content	

Although Homefarm has only one level for growing – multiple homefarm units can be stacked atop each other to create a vertical farm (Figure 6).

Homefarm has a loyal base of customers who clearly agree that the product does increase the intake of fresh nutritious produce in a household. The initial customers who purchased units became expert users of sorts, and they were able to provide important input regarding product refinement throughout the months and years after purchase.

What follows is the method which was followed for the product development of the Homefarm product, and the manner in which the product is suited to available manufacturing capabilities.

## METHODS

The methods followed during the development of the Homefarm product included those within the field of Industrial Design, but also methods present in the Tech Startup scene. These can be broadly stated to be an Iterative, Rapid, and Frugal Product Development Methodology, guided by User Centred Design and Design for Manufacture and this in turn allowed for the outcome to suit the local manufacturing capabilities relating to the batch quantities. Within the tech startup scene the Lean Startup Methodology is suitable methodology and it will be linked to the Industrial Design process.

As Industrial Design is product-oriented it is three-dimensional, and relies heavily on sketches, mock-ups, models, and physical prototypes (Kookiness, I., Zimmerman, J., Binder, T., Redstrom, J., Wensveen, S., 2011). In order to engage with a developmental prototype, various methods of fabrication (of the physical product) and coding (its software component) need to be ready simultaneously. Within the Homefarm team there has been a collection of engineering, coding and industrial design expertise which allowed for this to all be undertaken concurrently. This design process is a creative activity, the aim of which is to establish the multi-faceted qualities of objects, processes, services and their systems in whole life cycles (Kookiness et

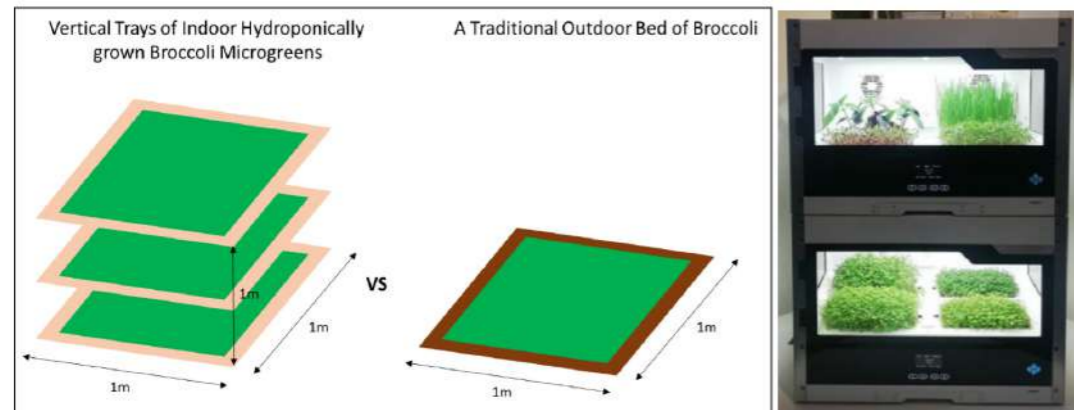


Figure 6: Vertical trays vs traditional outdoor bed. Image by author.

al. 2011). The problem with undertaking new development is that the cost implications can be uncertain and might imply a serious drain on company resources. For the development of many of the prototyping components of the Homefarm product this was undertaken with low cost material, available hardware components, and using re-usable material for developmental components. Additional to this, as much physical prototype fabrication as possible was done in-house using available tools, empowering the team to be in control of the process. The benefit of this was twofold: it kept costs low, and allowed the team to be in control of timelines. Being creative with prototyping and development in an innovative and thrifty manner allowed the work to carry with as little disruption as possible.

Perfection cannot be achieved in one single developmental sequence, and multiple iterative cycles are required. This is the heart of the Iterative Design Research Process, as explained in 'Research methods for product design' which explains our process very effectively (Figure 7).

The process of iterative product design generally involves four distinct stages prior to project implementation. This implementation, however, also provides a starting point for ongoing iterative cycles of additional refinement, narrowing down to a final implementable outcome (Milton, A., & Dodgers, P., 2013). The four stages include Understand, Observe, Visualise, Review. These stages cycle over and over until the outcome is at a point ready for implementation. This method of product design is explained in a Lean Startup Methodology where initially the company focuses on releasing a Minimal Viable Product (MVP) where the basic product is developed that should be built at first, after which additional features and functionality can be applied (Borowy, M. 2019). This is easier with smart products where the firmware installed on the device is able to be updated remotely without the product needing to be moved from its home. This method of development is very useful and has proven effective for Homefarm's development as it helped validate the team's expectation that the product makes sense to users and provided valuable insight into additional product improvements. This Lean Startup Methodology saves time and money and allows the development team to focus on building only the most beneficial part of the product, without attempting to develop a full featured product with all the bells and whistles (Borowy, M. 2019). Because no single specific method is followed throughout the developmental process, the team needs to be adaptable to various circumstances ranging from problems with material supply to financial difficulties.

## FINDINGS and DISCUSSION

### Methods of appropriate production

South Africa has an extremely broad array of manufacturing capabilities. These range from artisans making objects by hand, through to extreme mass production. This is all logistically within reach, but not financially viable, considering the resources of a small startup company.

The method of manufacture that relies on CNC cutting tools and injection moulding offers production at the lowest cost, but

not if high quantities of products are required. This method of tooling is extremely costly and does not allow much room for error during product refinement. We chose to use low-fidelity patterns made from MDF (Medium Density Fibre) wooden board, thermosetting resins, and nylons. These were not used for injection moulding, but rather for vacuum-forming, where a thin sheet of plastic is heated till it is flexible and pliable, and then formed over the low-fidelity pattern while the air is extracted and the plastic forms over the pattern. This is a more time-intensive process, but the cost of patterns and machinery is much lower, and the process allows for smaller batches of components to be made. This process is suitable for as few as 5 components at a time, as opposed to the requirement of thousands needed to justify injection moulding.

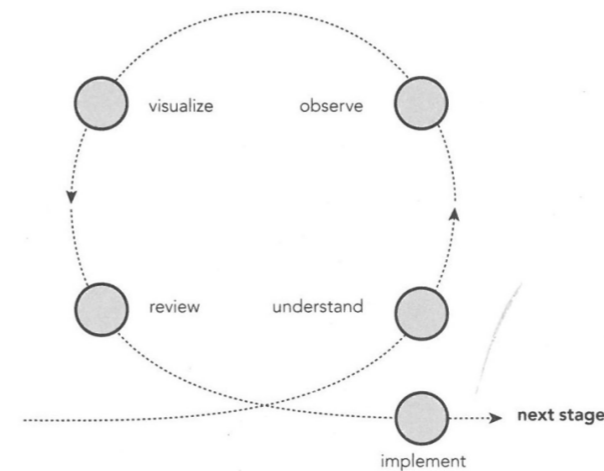


Figure 7: The iterative product design cycle (Milton, A., & Dodgers, P., 2013).

Homefarm is a proudly South African product, designed and manufactured in South Africa. One of PixelBlue's most critical and valued partners over the past 4 year has been the University of Johannesburg's Department of Industrial Design. The department has provided us with access to facilities as well as students, who regularly undertake work experience with the Homefarm team (Figure 8).

### Our challenges and scope for improvement and greater impact

The current version of the Homefarm product costs R8 500. While there is a market in South Africa at this price point, it does keep the product out of reach for most South Africans.

We believe that a product like Homefarm, at the right price, has the potential to create massive impact. As our business grows, we plan to invest in the manufacture of the product to bring the cost of manufacture down, and thereby generate higher demand in order to manufacture greater quantities, thereby bringing the cost down again. In the future, climate change may increase the price of fresh produce, which would in turn increase the value of Homefarm, as perceived relative to its price. We may also develop a Homefarm 'lite' product as part of our product range, which we could sell at a more affordable price in order to get it into more homes. With the support of strategic partners, and evidence that the potential impact could justify the investment, we could keep the margins on a Homefarm 'lite' very low and plan to get it into millions of households. We will therefore need to invest in education and marketing and we will need to think of creative ways to create awareness, understanding and incentives to change the behaviour and consumption patterns amongst consumers. As our first product, Homefarm serves Pixelblue as a platform for research and development and will continue to be an engine for innovation and intellectual property within the business. We will continue to pursue commercial success with the Homefarm product and its spin off products which, before the end of 2020, will include a larger commercial version for restaurants, schools and corporate cafeterias as well as a modular technology product for the construction of large commercial indoor farms.

In our philosophy we are inspired by the company Dyson, which says of itself, "...indeed, Dyson wants consumers to stop thinking of it as a mere vacuum company and start thinking of it as a problem-solving technology company, one that spends billions of dollars on research and development and has the wherewithal and brand power to open physical stores and tackle the biggest challenges, such as trying to build an electric vehicle from scratch in about four years." (Financial Post, Jan 22, 2018).



## CONCLUSION

The need to feed a growing, largely urban-based population, combined with climate change and the unsustainable food systems in place are putting our ability to feed ourselves in the future and look after the planet at risk. Modern agriculture employs a wide range of technologies which optimise output and protect crops from climatic variations, pests and disease. However, arable land is becoming increasingly scarce and the supply chain involved in getting our food from where it is grown to where it is consumed is highly problematic. Technology will continue to play a critical role in driving the future of agriculture forward. One such Appropriate Technology application we have identified - which addresses the arable land and supply chain conundrums - is hydroponic farming. In particular, we have noted its potential to bring fresh produce farming into the home. Hydroponics is very well suited to food farming within the urban environment. While large hydroponic farms have become a feature in cities around the globe, we believe there is an opportunity to adapt this technology to bring a mainstream food growing product into homes across South Africa and the world.

Our research, and the subsequent technology we have developed, has shown this to be possible. We are able to offer a product which can grow a significant amount of nutrient-dense, organic and pesticide-free produce, all year round, from within the user's home. And without the need for arable soil.

More work needs to be done to develop our solution to make it more affordable and accessible, in order to make a greater impact on society at large. Our work provides evidence that there are appropriate methodologies in South Africa which can be utilised in the development of more appropriate products intended for local manufacture, without needing to depend on solutions that require sourcing and importing from beyond our shores.



Figure 8: Homefarm team: design, development, manufacture all under one roof.

## LIST OF REFERENCES

- Leslie, J. (2020) *Agriecture 2020: Vertical Farm Systems with John Leslie*. [Online] Available at: <https://www.youtube.com/watch?v=QFg6j0m6wvk>. date accessed?
- Borowy, M. 2019. 4 Popular Types of Product Design Methodologies. [Online] Available from: <https://www.merixstudio.com/blog/product-design-methodology/> 18 April 2020
- Dobberstein, J. 2020. Do We Still Only Have 60 Harvests Left? [Online] Available from: <https://www.no-tillfarmer.com/blogs/1-covering-no-till/post/9569-do-we-still-only-have-60-harvests-left> 25 March 2020.
- Financial Post. 2018. *Beyond the vacuum: Dyson banks on brand power; R&D in effort to transform into tech powerhouse*. [Online] Available from: <https://business.financialpost.com/technology/personal-tech/beyond-the-vacuum-dyson-banks-on-brand-power-rd-in-efforts-to-transform-into-tech-powerhouse> 15 April 2020.
- Kookiness, I., Zimmerman, J., Binder, T., Redstrom, J., Wensveen, S., 2011. *Design research through practice: From the lab, field, and showroom*. Waltham USA, Morgan Kaufman Publishing.
- Lester, G. Xiao, Z., Luo, Y., Wang, Q. 2013. Microgreens: Assessment of Nutrient Concentrations [Online] Available from: [https://www.researchgate.net/publication/267354000\\_Microgreens\\_Assessment\\_of\\_Nutrient\\_Concentrations](https://www.researchgate.net/publication/267354000_Microgreens_Assessment_of_Nutrient_Concentrations). 6 April 2020
- Milton, A., Rodgers, P., 2013. *Research Methods for Product Design*. London, Laurence King Publishing.
- Nortier, C. 2019. Intelligent Food? SA start-up grows artificial intelligence in urban home farming. [Online] Available from: <https://www.dailymaverick.co.za/article/2019-09-27-intelligent-food-sa-start-up-grows-artificial-intelligence-in-urban-home-farming/> 14 March 2020
- Wyman, Oliver. 2018. Agriculture 4.0 – the future of farming technology. [Online] Available from: <https://www.oliverwyman.com/our-expertise/insights/2018/feb/agriculture-4-0--the-future-of-farming-technology.html>, 26 March 2020
- Anon. *How urban is the world*. Our World In Data 2020. [Online] Available from: <https://ourworldindata.org/how-urban-is-the-world>. 25 February 2020
- Parliamentary Monitoring Group (PMG), 2020. *Urbanisation*. [Online] Available from: <https://pmg.org.za/page/Urbanisation>. 27 March 2020
- Sandia Seed Company. 2020. Shorten Your Food Chain. [Online]. Available from: <https://www.sandiaseed.com/blogs/news/shorten-your-food-chain-infographic>. 19 March 2020
- Science Daily. 2016. Red cabbage microgreens lower 'bad' cholesterol in animal study. [Online] Available from: <https://www.sciencedaily.com/releases/2016/12/161214115112.htm>. 2 March 2020
- United Nations, 2018. *World Urbanization Prospects. The 2018 Revision*. [Online] Available from: <https://population.un.org/wup/Publications/Files/WUP2018-Report.pdf>. 25 March 2020
- United Nations. 2020. *Sustainable Development Goal 2: End Hunger, achieve food security and improved nutrition and promote sustainable agriculture*. [Online] Available from: <https://sdg-tracker.org/zero-hunger>. 14 April 2020
- United Nations Food and Agriculture Organisation (UNFAO). 2020. Global Forest Resource Assessment; Agriculture. [Online] Available from: <http://www.fao.org/forest-resources-assessment/en/>. 30 March 2020
- Zinyengere, N., Crespo, O., Hachigonta, S. 2013. Crop response to climate change in southern Africa: A comprehensive review. *Global and Planetary Change*. Volume 111 (2013) 118-126. Elsevier.

# COMMUNITY SCHOOL: AN INCLUSIVE PARTICIPATORY VISION FOR SOCIAL CAPITAL BUILDING FROM BELOW

Zeinab Alsadig Alsiddig Abdelrahman, National Ribat University, Khartoum, Sudan, zeelmahti@gmail.com

## Abstract

*The purpose of this paper is to identify new approaches for dealing with the presence of children in the urban streets of Khartoum, in Sudan, who work in marginal activities or beg. The neighbourhoods on the peripheries of the city, from whence these children originate, suffer largely from deprivation and poverty. The manifestation of this is a problem that requires innovative intervention, especially from a human rights perspective.*

*For the purposes of the paper, an underprivileged and diverse area known as Naivasha, in the Darassalam-Umbadda locality, 22 km north west of the centre of Khartoum, is selected. The reason for this selection is because of its high percentage of children who cannot attend school and instead need to work to support their families.*

*The paper considers how grassroots activism, as a mobilising agent in the area – represented by the neighbourhood committee called the Naivasha Change and Services Association (NCSA) – can mitigate exclusion through increasing participation and through building social capital by means of networking and increased connection to social resources.*

*The paper focuses on developing participatory tools in collaboration with local urban governance authorities, as well as the community, to reduce the rate of children who drop out of school in Naivasha. To this end, the development of an innovative model for a community school project is suggested, so as to provide a venue and a means for multi-options education.*

*The methods used are unstructured interviews and critical reviews from previous research, in addition to implications from community school models in the USA and an activism practices in Poland.*

*The conclusion of this paper focuses on considering grassroots activism roles that link with practice. Moreover, it provides guidelines for adopting an education model to work as a prevention strategy for the phenomenon of street children.*

## Spatially:

- *The approach of openness, multi-use and self-management of a public building reduces running costs; and*
- *Provides a space for networking and activism, which therefore enriches social capital.*

**Keywords:** urban, street children, grassroots activism, social capital, community school.

## INTRODUCTION

The spatial separation, or apartheid, between centres and peripheries is created in capitalism. Under the neoliberal dynamics of competition, the notion of accumulation is leading capitalist state systems to create deprivation, exclusion and social cracks in the urban space. Urban resistance movements have developed along these cracks or disparities as mechanisms that seek urban restructuring and renewal. Castelle points out that “they react against the exploitation-alienation-oppression that the city has come to represent” (Castelle, 1983:330). This emerging activism is organised to create new grassroots urbanism (Merrifield, 2014:31).

In 2019, contemporary grassroots activism – known as the Resistance Committees – played a pivotal role in a large-scale political change in Sudan. These activist committees had been forming underground since 2013 among the residential blocks of Khartoum, where people knew and trusted each other, and reached critical mass in 2019 when the movement achieved true political change. According to an ensuing government order, the work of the movement was to be categorised as a partnership in league with the new political establishment. As a result, change and services associations were established under the supervision of the Resistance Committees.

The new transitional system inherited an economic crisis with huge foreign debts, with the hope that innovative solutions would materialise.

This paper discusses the role of grassroots urbanism at a neighbourhood level, framed within the new atmosphere of collaboration with urban governance authorities and under the challenging conditions of services shortages and poverty. The paper emphasises inclusive participation as a condition for linking excluded groups to social recourses, as well as the building of social capital and, thereafter, financial capital. The paper, therefore, concentrates on the role that grassroots activism plays in providing access to services for excluded groups, bringing the phenomenon of street children into focus, which is largely a manifestation of the center/periphery paradox and the multi-faceted nature of marginalisation issues.

With these aspects in mind, the geographical context of the peripheries of Khartoum is selected for the development of guidelines involving participatory tools to engage youths of the community, who are not in school, with an aim to reintegrate them into social networks through access to education. This approach may provide opportunities to these youths that help them to escape the only alternative: the streets. Additionally, it can have a socio-economic and spatial impact on the local community, and the proposed model for community schooling can be accommodated to fit differing contexts.

One of the methods used in this paper is that of unstructured interviews with three activists. The first of these interviews was conducted on 15 April 2020 with Faris Alnoor, who works with street children in Khartoum. The interview took place in his office in Rhyad, Khartoum. The second of these interviews was conducted in Omdurman on 18 April 2020 with Amira, who works for CAFA, a non-governmental organisation (NGO), which is active in Naivasha. The third interview was also conducted in Omdurman on 18 April 2020 with Amjed Hakim, a local activist from the Resistance Committees of Umbadda. Although the intention was to consider a greater role for primary data sources, it was not possible owing to health hazards and a lockdown of Khartoum.

The paper also applies a critical review of books and research on debated issues surrounding the role of urban activism, which remains contested and yet greatly related to local conditions, as well as books and research on the concept of social capital, which is not yet well defined. Finally, implications based on case studies are also used. One such case study is that of an urban activism project in Poland that looked into community engagement in services as a prospected role of activism. The resulting model uses suggestions from different models of community schools. For example, the USA model includes all children in quality education, especially in disadvantaged areas, while the Egyptian model is aimed at increasing the attendance of girls in remote rural areas. These models are applied in addition to the traditional and historical norm of religious education being conducted in Sudan, and an education project for street children conducted in Khartoum.

The conclusion of this paper focuses on engagement roles. The transformation should be seen as making a material impact on the lives of people through inclusion and participation being treated as human rights.

## STREET CHILDREN: AN APARTHEID PHENOMENON

In the United Nations (UN) Special Session of 2002, a commitment to “a world fit for children” was declared. The phenomenon of street children was emphasised as a global problem of scale with an estimated 100-million to 17-million youths between 5 and 18 years old spending most, if not all, of their time on the streets of urban centres. These youths suffer from a lack of nutrition, a lack of access to health services and a lack of decent shelter. Although these youths share common attributes such as not having any meaningful place within society and an accompanying lack of any kind of adult support, there are many variations among them. Child care organisations such as the United Nations Children’s Fund (UNICEF) draws a distinction between two categories of street children. One category is known as ‘children of the street’, which are those youths who make the streets their home. A second category is known as ‘children on the street’, which are youths who spend all day on the streets but have some kind of a family home to return to at night (Panter-Brick, 2002:150). However, there is a high degree of mobility between the two categories.

Since the turn of the century, the discourse regarding street children has shifted in focus from the place of the street to the subject of the child. In other words, the shift in focus has highlighted the importance of considering the full rights of these youths as capable citizens who should be engaged in development (Panter-Brick, 2002:155). Scholars now focus more on the priority of developing effective participatory methods to advocate for these rights of children with regards to social inclusion, within the context of urban movement (Mingione, 1999). In summation, attention is increasingly moving beyond a sole focus on street children as the phenomenon is merely the tip of the iceberg. It is a manifestation of a much deeper problem of poverty and social exclusion.

In the case of Khartoum, the presence of street children known as Shammaasa (children of the sun) is noticeable in the urban centres, particularly at street intersections and traffic lights. A study conducted by a group of researchers concluded that the main reasons for the phenomenon of street children were push factors such as poverty, war, drought and family dysfunction, as well as pull factors such as peer pressure. According to the study, the number of street children is as high as 35 000. Of these, 18% are completely homeless, while 82% of them alternate between the street and family homes within the peripheries of the city. Some of these children attend schools. Despite the fact that 61% of the street children are within school age (7 to 14 years), the study found that 64% have either never been to school or have dropped out of school owing to financial incapability. Most of these youths need to work instead of attending school, so as to support their poor families. In conclusion, the research report suggested management strategies such as the provision of innovative education approaches that include training and income generating activities, in addition to the flexibility school of entrance requirements and school fee reductions as preventative intervention strategies (Kurdati et al., 2001).

Prior to 2018 (during the previous political regime), street children were haunted by stigma. They were threatened and chased by security forces who would capture and keep them in specialised government shelters. They would also sometimes punish them. A high proportion reported to have been arrested at least once by the police (Kurdati et al., 2001).

Nonetheless, during the famed sit-in of the Sudanese revolution from 6 April 2019 to 3 June 2019, the presence of street children gained high visibility and attention in the space owing to their unique participation in the ‘repertoires of contention’ of the revolution. They occupied a railway fly-over (‘Nafag’ in Arabic) and were thus dubbed the ‘children of the Nafag Republic’. The altered attitude towards these youths was also due to the collective spirit of the sit-in, in addition to significant initiatives of inclusion conducted by the activists of the social movement.

Despite the credibility garnered through the activism approach, as well as the efforts made during the sit-in, among other similar initiatives, the issue of street children still exists owing to the exacerbation of push factors and the continued lack of accessibility within services structures. This is in addition to the absence of support from the children’s local communities, as most of these initiatives dealt with the children in the central streets, as opposed to the peripheries from whence they come.

The problem is a manifestation of vulnerability, isolation and a lack of networks (Figure 1). An approach for building links to expand social safety nets is needed. This is discussed in the next section.

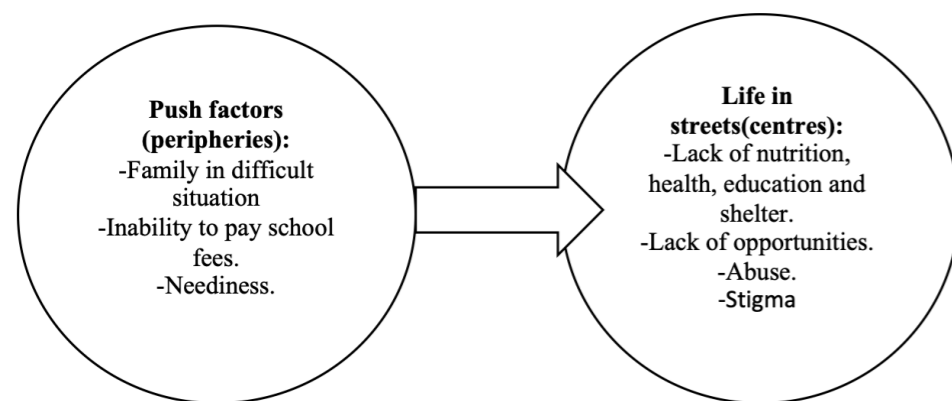


Figure 1. Hardship in the peripheries leads to a difficult life on the streets.

Source: the author.

## SOCIAL MOVEMENTS APPROACH

Contemporary models of development have not proven to be capable of achieving equitable methods for achieving accessibility. In third world countries, the International Monetary Fund has forced policies of structural adjustment models on those economies incapable of servicing their debt. These policies have been unable to operate effectively or reach out to the majority. Therefore, new forms of popular power are needed to steer from the grassroots up (Zaalouk, 2004:8).

The enterprise of social movements is defined as a very diverse network of organisations and social groups at a grassroots level. The range of activities of these groups varies from abstract political claims to the addressing of economic and social problems and processes outside of the formal institutional framework, being developed and institutionalised as a permanent form of grassroots activism (Martinez-Alier et al., 2014). When focusing on specific socio-economic problems instead of abstract political claims, the activity of social movements should manifest technical or academic knowledge, along with attractive solutions based on understanding the local social, cultural and spatial conditions (de Souza, 2006). In other words, if local authorities fail to manage the city effectively or fail to provide services appropriately, urban social movements can fill the gap through active participation by the residents. Therefore, growing urban problems such as poverty, unemployment and a lack of service delivery has led to the pursuit of innovative solutions through grassroots activism. Hence, antagonistic relations between grassroots activism and urban governance have shifted towards becoming cooperative relations between authorities and various urban movements (Mayer, 2013).

This approach to achieving change and transformation is more sustainable. It also offers an opportunity to develop participatory tools for the inclusion of more residents in urban governance. The excluded groups suffering deprivation from civil rights and institutional channels, such as homeless and street children, can voice their concerns and complaints through participation in these bottom structures that provide alternative networks.

## ACTIVISM, SOCIAL CAPITAL AND HUMAN CAPITAL

The postulation that networks are valuable is acknowledged in the definition of social capital. Scholars such as Bourdieu have argued that social capital is the sum of resources available for individuals through their membership to groups, which he describes as “the aggregate of the actual and potential resources which are linked to possession of a durable network” (Bourdieu, 1986:248). In other words, networks and connections to others who can make resources available are critical for acquiring social capital. Although Bourdieu favoured neo-liberalist connections, he introduced the notion of social resources, which were later elaborated on by Coleman. The James Coleman model of 1995 highlighted the role of social capital, which is based on trust and social relations in the development of social organisation and as a source of everyday information, which subsequently creates human capital.

Jacobs (1961), in her book titled *The Death and Life of Great American Cities*, discussed the existence of social networks in old mixed areas, forming a kind of social capital that works effectively in initiatives that bypass formal institutions. While Jacobs based her observations on mixed urban areas in New York, the poor residential neighbourhoods of Khartoum show that trust, when embedded in the structures and relations of the people, plays a great role in cooperation and support initiatives. Hence, the activities of urban movements can invest in trust relations and horizontal social networks within such deprived neighbourhoods so as to increase social capital, which will enable the achievement of certain ends.

In this sense, each community has its own social relations and social structures that could also be built and developed through social organisations such as neighbourhood associations that work to improve living standards at the residential area level (Ruef & Kwon, 2016:2). This level is where these organisations operate as social capital development agents (ibid:4).

According to social capital theory, resources such as information and amenities are better accessed and used through social structures of residency (Figure 2). The link between social capital and urban activism, as represented in neighbourhood associations, is empirically provided through increased civic engagement and a stronger sense of communities (ibid:5). Therefore, the role of grassroots activism in creating social capital, which can then be converted to other forms of capital, is theoretically plausible. To this extent, activism, through community mobilisation and increased participation, will contribute to obtaining social capital. This can then be transformed to human capital, which provides skills and capacities, which in turn creates financial capital by default. The cutting-edge measurement of effectiveness would be the extent of inclusion that extends to the most excluded groups in the community, and the practical tools for dealing with the needs of those groups.

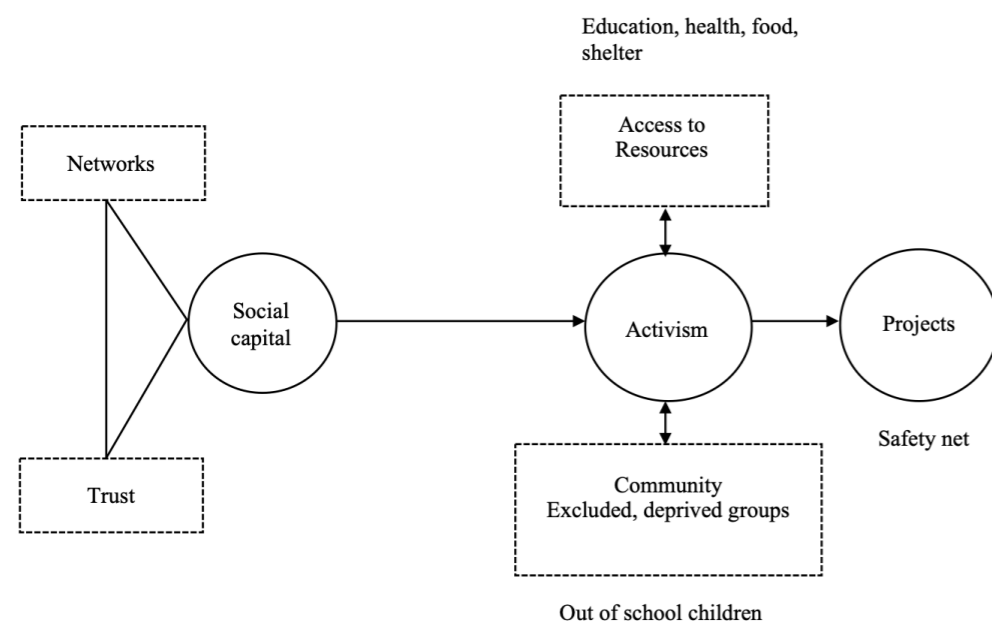


Figure 2. Social capital and activism.

Source: the author.

Therefrom, an area in the peripheries of Khartoum is selected with a motivation to study the factors that push the youth and children out of their natural environments and into the urban centres. The next section consists of a brief description of the selected area.

## NAIVASHA AS A GEOGRAPHICAL CONTEXT

Naivasha is a disadvantaged settlement on the western side of Darassalam-Umbadda. Umbadda is the largest (220,194 km<sup>2</sup>) and most populated (1 177 244) of the seven localities in Khartoum. The triad capital city is composed of Khartoum, Omdurman and Khartoum North. Originally, the area was a military camp for an old state in about 1883. It was extended as part of Omdurman and became a separate locality since 1989. Umbadda is located 22 km North West of the centre of Khartoum, and is the first to receive waves of immigrants and displaced people escaping war, famine and desertification. As such, the locality has grown in size, with increasingly poor service delivery and growing poverty.

Darassalam (meaning 'dwelling of peace') is one of the three localities of Umbadda, developed originally from displacement camps to ultimately become slum habitation under planning processes. It consists of six out of the eighteen administration units of Umbadda. The area is deprived of the basic services of electricity supply, water supply and roads. The residents of Naivasha, which is the North Umbadda unit, are living in dreadful conditions. For this reason, as it was stated by Amira from CAFA, which is a national NGO working in Naivasha, that many national and international NGOs target the area for different development projects (Amira [CAFA] pers. comm., 18 April 2020).

According to Idrees (2017), the diverse population of these areas suffers from a lack of service delivery, insufficient income and insufficient opportunities, no support from the government and poor access to health and education. Based on data from a study sample that targeted war displaced communities, 80% of the targeted communities had lost their financial capital of farms and cattle, with 62.5% lacking any alternative resources or skills. Therefore, the majority (78.3%) were found to not have sufficient money for living. About 64.1% of the population was found to be youth aged 7 to 18 years old, with 45% of them aged 7 to 12 years old. As a result, more than three quarters, about 79.2%, of the population cannot afford to take their children to school, and only half of them can access health services. The vast majority of these communities do not receive any school fees reductions, health insurance or access to loans and housing (Idrees, 2017:164-232). Kudrati *et al.* (2001) found that factors such as poverty and hardship were the most prominent reasons behind pushing children into the streets. Triangulation of the data along with the findings from the two above-mentioned studies suggests that the more disadvantaged the area, the more likely it is to be associated with the phenomenon of street children.

Naivasha suffers from either poor-quality services or a complete lack thereof. Moreover, where services are available, they are often neither affordable nor accessible owing to the rigidity of service delivery programmes and timeframes. Therefore, expanding the safety net to include excluded groups implies connecting them to social networks that can mobilise the community to develop more open and flexible structures.

## Grassroots activism in the area

Grassroots activism organisations (change and services committees) of Umbadda have proven to be efficient and showed good performance in supporting communities, most notably during the recent health hazard of the Covid-19 pandemic. These support activities are implemented by volunteers at the level of residential quarters, including 236 planned blocks plus 18 slums, in coordination with three central networks, or centralities, within the three localities of Umbadda. The organisation of the support activities reflects the urban governance structure, yet the capability to deliver support is related to the culture of revolutionary activism, horizontality, independence, and bottom level formation. There are local committees at the block level, followed by centralities in each administrative division, up to the city level (F. Hakim [Umbadda Resistance and Change Committees] pers. comm. 18 April 2020). This type of popular mobilisation is an advantage, as it is considered to be a precondition for the accomplishment of social movements (Zaalouk, 2004:7).

Porte (1998) identified three types of social networking that are necessary for creating social capital: (1) close-knit community, (2) parental support, or (3) networks beyond the family. In the case of Naivasha, being a community that suffers from fragmentation and difficult familial situations, networks beyond the family can be activated through grassroots mobilisation.

Thus, as a result of the transition from political resistance in a totalitarian system to a liberal diverse reality, the change and services committees can create innovative solutions to local problems by creating social capital in poor communities on the basis of community and services integration.

## Local examples of community and services engagement

The objective is to demonstrate a strategy for developing a model of community and services integration that utilises all community resources so as to benefit from synergy and smart partnership. For instance, an urban movement in Gdansk, Poland, collaborated with a research club to create a model solution for redeveloping the courtyards in the quarters of the historical buildings. The project gained interest and funding, which allowed the redevelopment of several courtyards (Badach *et al.*, 2018).

According to the discussion above, two local illustrations are briefly demonstrated by prior experiences that may inform the required development:

### 1) The Maseed

Al-Maseed is a type of religious school that began in Sudan centuries ago by Muslim immigrants. It was founded as a cooperative institution that combined the function of education with worship and residing. It provided students with shelter and food, in addition to Quranic education. Maseeds have a unique traditional culture that helps to

organise their systems of admission, education and community support. Maseeds are built through cooperative efforts. They accept children from five years old to stay there on a weekly basis until they finish learning The Quran. Food subsidies, called ‘karama’, and money donations, called ‘sharafa’, are given by families and the community to the single teacher, called the ‘Sheikh’. The Sheikh divides the students into groups, and assigns leaders from among the senior students (Altayeb, 2005).

## 2) The Open School Model

The open school is a project implemented by the Mugadidoon NGO in Khartoum. The NGO started in 2017 as an initiative for distributing breakfast meals in schools for poor children, whereafter it shifted its focus onto feeding homeless children who are out on the streets all day, and who very often spend the night in sewage pipes. In 2019, the NGO launched its Open School Project, which provided a free-to-attend open-air type of school that aimed to educate street children. They were offered food for attending classes, which were held in the streets they stay in, so they could return to their marginal work activities or even beg as soon as they finished attending classes. Moreover, they were enticed to attend classes through the offering of quality food and access to known restaurant, as well as sports activities. To empower the children and change the way they were viewed by others, they were dubbed the Heroes of the Streets. The open school project succeeded in changing many views about street children. Meanwhile, the children themselves were empowered and many managed to change their lives either by thereafter attending regular schools, or by finding opportunities for different types of support. Some of them even abandoned the illegal activities they used to commit (F. Alnoor [Khartoum social worker] pers. comm., 15 April 2020).

## COMMUNITY SCHOOL AS AN ENGAGEMENT MODEL

The idea of community schooling is old. A proverb that is attributed to African culture says that “it takes a village to raise a child”. This implies that the community has a great role to play in the development of a child. Community schooling, as a modern model of education, was developed in the twentieth century. Variable models of community schools have been applied in different parts of the world. These models all seek to generate efficient education. As a result, they share common characteristics such as openness, fusion, sharing, collaboration, democratisation, curricula innovation, lifelong education and self-financing production units.

In the USA, for instance, a popular model known as the full services community school (FSCS) was developed to achieve effectiveness in a neo-liberal system that focused on standardisation, following an act of congress: No Child Left Behind of 2002. The FSCS has a holistic approach that emphasises the implementation of community services integration in mainly disadvantaged urban areas. To illustrate, the rationale of the FSCS:

- Focuses on student learning, not education;
- Addresses students’ basic needs according to Maslow’s hierarchy of needs, such as shelter, clothes, food, mental care and health care;
- Promotes family engagement through parent resource centres;
- Adds vitality to community through involvement;
- Collects more resources by reducing demand on school staff;
- Provides academic and non-academic learning opportunities; and
- Offers opportunities to families and all community members to build social capital.

(Min *et al.*, 2017).

## The Development of the Model in the Geographical Context

In light of the aforementioned discussion, this is a proposal for a community services initiative model that deals with the multi-faceted dimensions of the youth and children who lack support, and aims to offer an alternative to life on the streets. Below is a matrix for the development of some guidelines for the model, within the geographical context of Naivasha:

	<b>Strengths</b>	<b>Weaknesses</b>
	<ol style="list-style-type: none"> <li>1. Popular mobilisation</li> <li>2. Grassroots organisations with well-defined structures and self-autonomy.</li> </ol>	<ol style="list-style-type: none"> <li>1. Families lack financial resources</li> <li>2. Lack of skills</li> <li>3. Lack of basic services</li> <li>4. Young majority unable to pay or access schools.</li> </ol>
<b>Opportunities</b> <ol style="list-style-type: none"> <li>1. Closeness to a huge market connected to export.</li> <li>2. NGOs are active in the area.</li> </ol>	<b>Community participation and self-management</b>  <b>Conjunction of different development activities that include production and marketing</b>  <b>Building partnerships with NGOs.</b>	<b>Clean water provision</b>  <b>Holistic approach to education</b>  <b>Open learning programs</b>  <b>Parent education</b>  <b>Training</b>  <b>Income generating activities</b>  <b>Community kitchen</b>  <b>Health unit</b>  <b>Registration office.</b>
<b>Threats</b> <ol style="list-style-type: none"> <li>1. Rigidity of policies.</li> <li>2. Non-participation.</li> </ol>	<b>Partnership with urban authorities</b>  <b>Flexibility, gratuitousness and openness</b>	<b>Cooperation</b>  <b>Facility to be self-built</b>

**Figure 3.** Matrix of the development of the model.

Source: the author.

Considering the guidelines in the matrix (Figure 3), the model can be developed as a pilot scheme in Naivasha through a process of community participation. All community members should be involved in developing a model for a community school according to the above guidelines, with the notion of “no child is left behind” and the principle of “earn while you learn” embedded within.

### Bottom-up approach

The needs will be defined by community members through meetings and discussions that seek to identify the various components and priorities. These meetings are to be planned and organised by the Services and Change Committee as an existing grassroots structure.

### Partnership and stakeholders

The Change and Services Committee of Naivasha, the local community, the community members living abroad, the local authorities, as well as various national and international organisations will be involved in identifying which needs they can collectively fulfil. They will endeavour to provide formal recognition and training. An example of a similar partnership is the community school movement in Egypt, which succeeded in increasing school entries of girls in the remote rural areas of Upper Egypt. The project was performed as a joint venture between the Egyptian Ministry of Education, UNICEF and the local community (Zaalouk, 2004).

### Programme components

#### 1. Open learning:

Open-entry school that tailors an innovative mix of nomadic school curriculum with craftsman training for children of school age (7 to 12 years old).

Flexible school hours.

Special education that offers multiple options for education and training of parents and community members.

#### 2. Services:

Well for clean water.

Public health unit that provides basic services for all community members.

Formal unit for urban governance to provide services such as a judiciary and registration.

#### 3. Common space (core):

Social events venue.

Community garden.

Theatre for traditional culture and tribal arts.

Outlet market to sell community crafts.

### Spatial guidelines

Building is constructed through community participation with local materials such as earth blocks.

Open building with multi-use spaces to be used all day, seven days a week, all year round, to reduce running costs.

### Community ownership

The space will be self-managed and controlled.

The following matrix illustrates an example of some expected impacts by using two indicators: inclusion and capital (social, human or financial).

Stakeholders	Indicator	Inclusion	Capital
Children		Innovative curriculum Fees reduction/free Shelter/services	Jobs Accessibility Social support
NCSA		Advocacy Participatory tools	Networks Trust
Parents and community		Illiteracy/training Services (such as health)	Skills/products Strong relations
NGOs and diaspora		Finance, experience, knowledge	Trust
Local authorities		Legislations, protection, legitimacy.	Partnership

**Figure 4.** Community school matrix.

Source: the author.

## CONCLUSION

In conclusion, it is apparent that there are several benefits from integrating community participation with services to increase inclusion and accessibility. The first is that linking deprived children to resources is viewed as a priority from a human rights perspective. Also, as a consequence, it works as a prevention strategy for keeping youths from being connected to street life. In addition, it benefits the community in general through providing education options, and through building social and human capital. Consequently, this builds financial capital.

The model of community schooling, as a proposed community hub that uses synergy to optimise the social safety net, can be modified according to local conditions and transferred to various communities. The way forward for implementation relies on partnerships to help with the open curriculum, teacher training and the skills development of community members. Spatially, the design and development of open building models that make use of local materials and expertise, along with multi-use furniture, will also offer smart solutions.

Finally, the aim of this attempt to foster participation and increase the effectiveness of grassroots activism is to build strong cooperative relations with the local governance authorities, while also building the community. In so doing, the idea serves to optimise democracy and urbanism through a bottom-up approach, as imagined by Merrifield, who described it as “the new urban question, from below, answered from below, answerable to the below” (Merrifield, 2014:34).

## LIST OF REFERENCES

- Altayeb, M. A. (2005). *Al Maseed*. Khartoum: Dar Azza Publication Press.
- Badach, J. Stasiak, A. Baranowski, A. J. (2018). *The role of urban movements in the process of local spatial planning and the development of participation mechanisms*. Available at: <http://doi.org/10.2478/mgrsd-2018-0036> [Accessed: 28 February 2020].
- Bourdieu, P. (1986). *The forms of capital*. Available at: [http://instructure-uploads.s3.amazonaws.com/account\\_18750000000000001/](http://instructure-uploads.s3.amazonaws.com/account_18750000000000001/). [Accessed: 28 February 2020].
- Idrees, M. (2017). *Armed conflict in Nuba Mountains and its impact on families, displaced in Khartoum State (Case Study)*. Available at: <http://repostory.sustech.edu/handle/123456789/15623> [Accessed: 14 March 2020].
- Merrifield, A. (2014). *The new urban question*. London: Pluto Press.
- Castelle, M. (1983). *The city and the grassroots*. Berkeley, California: University of California Press.
- Miniogione, E. (1999). *Introduction to Immigrants Informal Economy in European Cities*. Available at: <http://doi/10.1111/1468-2427.00191> [Accessed: 4 March 2020].
- Jacobs, J. (1961). *The death and life of great American cities*. Manhattan: Random House Press.
- Kurdati M. Plummer, M.L. Elhag Yousif, N.D. (2001). *Children of the Sug: a study of the daily lives of street children in Khartoum, Sudan*. Available at: <http://pascal-francis.inist.fr/vibad/index.php?action=getRecordDetail&idt=20341746> [Accessed: 20 March 2020].
- Martinez, J. A. Anguelovski, I. Bond, P. Del Bene, D. (2014). Between activism and science: grassroots concepts for sustainability. *Journal of Political Ecology*, 21(11):19-60. Available at: DOI: 10.2458/v21i1.21124 [Accessed: 30 March 2020].
- Min, M. Anderson, J. Chen, M. (2017). *What do we know about Full-Services Community Schools: integrative research review with NVivo*. Available at: <files.eric.ed.gov> [Accessed: 24 May 2020].
- de Souza, A.S. (2006). Social movements as critical urban planning agents. Available at: <journals.sagepub.com> [Accessed: 28 February 2020].
- Mayer, M. (2013). *First world urban activism*. Available at: <http://doi.org/10.1080/13604813.2013.757417> [Accessed 2 March 2020].
- Panter-Brick, C. (2002). Street children, human rights and public health: a critique and future directions. *Annual Review of Anthropology*, Vol.31:147-171 October 2002. Available at: <https://doi.org/10.1146/annurev.anthro.31.040402.08535> [Accessed: 30 March 2020]
- Ruef, M. & Kwon, S. (2016). *Neighbourhood association and social capital*. Available from: <http://sf.oxfordjournals.org> [Accessed: 2 February 2020].
- Zaalouk, M. (2004). *The pedagogy of empowerment*. Cairo: The American University in Cairo Press.

# DATA ANALYTICS FOR IMPROVED INDOOR AIR QUALITY

Ashvin Manga<sup>1</sup> and Christopher Allen<sup>2</sup>

Department of Construction Management, Nelson Mandela University, School of the Built Environment, Port Elizabeth, South Africa, ashvinmanga@gmail.com

## Abstract

*Ventilation is critical to healthy indoor environments. The World Health Organization (WHO) revealed that nine out of 10 people on this planet breathe air with high levels of pollutants, resulting in seven million deaths every year. The Environmental Protection Agency highlighted that indoor levels of air pollutants may be as much as five times as high as outdoor levels. However, many modern office buildings are designed to be reliant on sometimes ineffective, energy demanding mechanical ventilation systems. Therefore, the aim of this research was to understand the impact a natural ventilation retrofit would have on the indoor air quality of a mechanically ventilated office building.*

*Using a quantitative experimental design methodology employing a medical grade indoor air quality monitor, the researchers were able to capture data on the indoor air quality before and after openable windows were retrofitted to the office building. The research showed that retrofitting a mechanically ventilated office building with openable windows had a significant impact on indoor air quality and occupant well-being. Following the installation, the indoor particulate matter (PM) 2.5 concentrations decreased by 22% whilst Indoor (PM) 10 concentrations decreased by 17%. Office hours in which CO<sub>2</sub> exceeded 1000 parts per million reduced from 36 hours to zero. Recommendations include making use of an indoor air quality monitor as a first step to quantify the indoor air quality and that for natural ventilation retrofits to be effective and have a return on investment, they must be holistically designed and include considerations such as building location, climate, wind patterns, outdoor air quality and occupant usage.*

**Keywords:** natural ventilation, retrofit, indoor air quality and office environment.

## INTRODUCTION

As the world endures the Coronavirus Pandemic, we have been forced to reconsider all that we have previously accepted as normal and to rapidly adapt to a new normal. Indoor air quality and ventilation may profoundly impact the spread of disease within our built environment and there has thus been much discussion concerning the importance of this in our buildings. Can an aspect like indoor humidity levels significantly increase virus transmission? According to Rettner (2013), an indoor relative humidity level of 23 percent results in 70 to 75 percent of flu virus particles being able to cause an infection an hour after coughing. However, when humidity levels were increased to 43 percent, only 14 percent of the virus particles had the ability to infect. Research in the area of indoor air quality concludes that the air we breathe within our built environment must be managed and as Peter Drucker famously said, “You cannot manage what you cannot measure” (Fisher, Lauria & Chengalur-Smith, 2011).

Today technology allows us to take control of our indoor environments by providing accurate and affordable indoor air quality monitors. An indoor air quality monitor is the first step to understanding and improving the quality of air occupants are exposed to. The aim of this case study of a commercial office building window retrofit was to understand the impact a natural ventilation retrofit would have on indoor air quality of a mechanically ventilated office building. To achieve this, the researchers purchased an Airvisual node, a medical grade air quality monitor that offers real-time air quality measurement. This study quantified the change in air quality of an office building before and after the office façade was retrofitted with openable windows. The retrofitted windows converted the office space from an office with only mechanical ventilation to a hybrid ventilated office utilising mechanical and natural ventilation as desired by the occupants. This research consolidates current public sentiment on the importance of indoor air quality providing a sustainable ecological solution to quantifiably improve that quality by data analytics and natural ventilation.

## REVIEW OF LITERATURE

### Particulate matter 2.5 (PM2.5)

Exposure to ambient fine particulate matter (PM2.5) is identified as a major concern affecting human health worldwide (Martin *et al.*, 2019) with associated annual global welfare costs of trillions of dollars. Examined within is the ability of current data to answer a basic question about PM2.5, namely the location of the city with the highest PM2.5 concentration. The ability to answer this basic question serves as an indicator of scientific progress to assess global human exposure to air pollution and as an important component of efforts to reduce its impacts. Despite the importance of PM2.5, we find that insufficient monitoring data exist to answer this basic question about the spatial pattern of PM2.5 at the global scale. Only 24 of 234 countries have more than 3 monitors per million inhabitants, while density is an order of magnitude lower in the vast majority of the world’s countries, with 141 having no regular PM2.5 monitoring at all. The global mean population distance to nearest PM2.5 monitor is 220 km, too large for exposure assessment. Efforts to fill in monitoring gaps with estimates from satellite remote sensing, chemical transport modeling, and statistical models have biases at individual monitor locations that can exceed 100 µg m<sup>-3</sup>. Progress in advancing knowledge about the global distribution of PM2.5 will require a harmonized network that integrates different types of monitoring equipment (regulatory networks, low-cost monitors, satellite remote sensing, and research-grade instrumentation). The PM2.5 is an airborne pollutant with the diameter of each particle below 2.5 micro metres (µm). Particulate matter is of interest as gravity tends to act on particles greater than 30 µm resulting in rapid disposition, PM2.5 particles remain suspended for extended time and, as a result of transport by wind, can travel far from their sources and remain in the air for a long time (Martins & Carrilho da Graça, 2018) combined with internal sources (e.g. indoor combustion, particle re-suspension). The relationship of indoor and outdoor PM2.5 concentrations can be multifaceted, and may be strongly associated with chronic lung disease, respiratory symptoms and public mortality (Deng *et al.*, 2015). New evidence emerged when researchers from Harvard University’s T.H. Chan School of Public Health revealed that air pollution has intensified the Covid-19 Pandemic (Gardiner, 2020). The study analysed data on PM2.5 levels and COVID-19 deaths from 3,000 U.S. counties covering approximately 98% of the population. Counties that averaged just one microgram per cubic meter more PM2.5 in the air had a COVID-19 death rate that was 15 percent higher.

Information about the global distribution of PM2.5 has improved significantly over the last decade (Martin *et al.*, 2019) with associated annual global welfare costs of trillions of dollars. Examined within is the ability of current data to answer a basic question about PM2.5, namely the location of the city with the highest PM2.5 concentration. The ability to answer this basic question serves as an indicator of scientific progress to assess global human exposure to air pollution and as an important component of efforts to reduce its impacts. Despite the importance of PM2.5, we find that insufficient monitoring data exist to answer this basic question about the spatial pattern of PM2.5 at the global scale. Only 24 of 234 countries have more than 3 monitors per million inhabitants, while density is an order of magnitude lower in the vast majority of the world’s countries, with 141 having no regular PM2.5 monitoring at all. The global mean population distance to nearest PM2.5 monitor is 220 km, too large for exposure assessment. Efforts to fill in monitoring gaps with estimates from satellite remote sensing, chemical transport modeling, and statistical models have biases at individual monitor locations that can exceed 100 µg m<sup>-3</sup>. Progress in advancing knowledge about the global distribution of PM2.5 will require a harmonized network that integrates different types of monitoring equipment (regulatory networks, low-cost monitors, satellite remote sensing, and research-grade instrumentation).



with research having identified that indoor PM2.5 predominantly originates from outdoor sources. Indoor and outdoor sources of PM2.5 are subject to factors such as wind speed and direction, outdoor particle source characteristics, air intake location, air leakage rates, heating ventilation and air conditioning (HVAC) systems, indoor air exchange rates, indoor particle deposition and re-suspension, the activities of people smoking and cooking indoors (Deng *et al.*, 2015). Premature deaths attributable to PM2.5 are projected to have an annual global welfare cost rise from US\$3 trillion in 2015 to US\$18–25 trillion in 2060 (Martin *et al.*, 2019) with associated annual global welfare costs of trillions of dollars. Examined within is the ability of current data to answer a basic question about PM2.5, namely the location of the city with the highest PM2.5 concentration. The ability to answer this basic question serves as an indicator of scientific progress to assess global human exposure to air pollution and as an important component of efforts to reduce its impacts. Despite the importance of PM2.5, we find that insufficient monitoring data exist to answer this basic question about the spatial pattern of PM2.5 at the global scale. Only 24 of 234 countries have more than 3 monitors per million inhabitants, while density is an order of magnitude lower in the vast majority of the world's countries, with 141 having no regular PM2.5 monitoring at all. The global mean population distance to nearest PM2.5 monitor is 220 km, too large for exposure assessment. Efforts to fill in monitoring gaps with estimates from satellite remote sensing, chemical transport modeling, and statistical models have biases at individual monitor locations that can exceed 100 µg m<sup>-3</sup>. Progress in advancing knowledge about the global distribution of PM2.5 will require a harmonized network that integrates different types of monitoring equipment (regulatory networks, low-cost monitors, satellite remote sensing, and research-grade instrumentation). Research conducted in the field of epidemiology revealed that lasting exposure to ambient PM2.5 is related to increased morbidity and premature mortality (Zhu *et al.*, 2019) the first American Heart Association scientific statement on "Air Pollution and Cardiovascular Disease" concluded that exposure to particulate matter (PM.

## Carbon dioxide

Carbon dioxide (CO<sub>2</sub>) is a colourless, tasteless, odourless, and non-flammable gas that is heavier than air and may accumulate at lower spaces, causing a deficiency of oxygen (Azuma *et al.*, 2018). Carbon dioxide is naturally present in the earth's atmosphere as a trace gas and a product of cellular respiration or fossil fuel burning. The normal outdoor CO<sub>2</sub> concentrations are approximately 380 ppm, although in urban areas these have been reported to be as high as 500 ppm because of the increased human activity (Azuma *et al.*, 2018).

The main source of CO<sub>2</sub> in the non-industrial indoor environment is human metabolism. Additionally, the global need to reduce energy consumption provides an incentive for low rates of ventilation, leading to higher indoor CO<sub>2</sub> concentrations. The indoor CO<sub>2</sub> concentration is an indicator of indoor air quality acceptability, air flow exchange suitability, and whether there is sufficient fresh air in indoor spaces in buildings. The typical average indoor CO<sub>2</sub> concentration ranges from 800 to 1000 ppm, with an upper limit of 1000 ppm for CO<sub>2</sub> concentrations in commercial buildings. Ventilation with ambient air is often used for reducing indoor CO<sub>2</sub> concentration (Azuma *et al.*, 2018).

An experimental study conducted on 355 university students of four classrooms suggested that a 100 ppm increase in indoor CO<sub>2</sub> concentration (range 674–1450 ppm) was significantly associated with headaches, and this association was independent from other related indoor environmental factors, including temperature, relative humidity, and air exchange rate (Azuma *et al.*, 2018). Research also indicated that for every 100 ppm decrease in the differential between indoor and outdoor carbon dioxide concentration (dCO<sub>2</sub>), office workers experienced fewer SBS symptoms, including 60% fewer reports of sore throat and 70% fewer reports of symptoms of wheezing. It has been reported that CO<sub>2</sub> affects decision making at thresholds of 600 ppm, which is below the normally accepted comfort range of 1000 ppm (Park *et al.*, 2019).

Although physiological studies have shown that CO<sub>2</sub> raises the respiration rate above the level required for gas exchange, imposing an additional load on the respiratory system at concentrations higher than 5000 ppm. In 1881, Pettenkofer and Flügge proposed that 700–1000 ppm should be considered as the permissible indoor CO<sub>2</sub>. A study of human subjects stated that inhalation exposure to 1000 ppm CO<sub>2</sub> for a short term caused marked variations in respiratory movement amplitude, peripheral blood flow increases, and the cerebral cortex functional state (Azuma *et al.*, 2018).

## Sick building syndrome (SBS)

Outbreaks of building-related illnesses, collectively termed sick building syndrome (SBS) among building occupants have been reported in recent decades (Nag, 2019). The SBS presents symptomatically as the complex spectrum of ill health complaints, such as mucous membrane irritation (rhinorrhoea, nasal congestion, sore throat, eye irritation), asthma symptoms (chest tightness, wheezing), neurotoxic effects (a headache, fatigue, irritability), gastrointestinal disturbance, skin dryness, and sensitivity to odours. These symptoms may present among occupants in office buildings, schools, public buildings, hospitals, and recreational facilities. Building-related sicknesses have been observed as being pervasive in modern high-rise buildings. These buildings are designed to be airtight based on energy-saving considerations such as windows remaining sealed, deprivation of natural ventilation and daylighting, and HVAC systems re-circulating the air in the building, with a minimal replacement of fresh air. Concerns about human health due to deteriorating indoor environmental quality are gradually increasing with a public outcry among the building occupants as well as challenging lawsuits to redress grievances. Acknowledging that the incidences of SBS symptoms are straightforward, its characterisation and linkages to an indoor exposure require more in-depth analysis (Nag, 2019). An impediment of this effort is to determine whether the problem is primarily chemical, biological, physical, or psychogenic. Typically, maintaining allowable IAQ in office buildings depends on whether effective ventilation systems are in operation. Ineffective or inadequate ventilation systems result in inefficient removal of pollutants from indoor air and display signs of SBS among the occupants (Nag, 2019).

## Natural ventilation system

Natural ventilation essentially describes the air movement created by naturally occurring pressure differences created either by wind or temperature differences (Alatalo, 2016; Khatami, 2014). The term 'natural ventilation' here, refers to supplying fresh air to an indoor space and removing aged air from that space using natural forces such as the momentum of wind (wind-driven ventilation), the indoor-outdoor temperature difference (buoyancy-driven ventilation), and a combination of wind and buoyancy (Weerasuriya *et al.*, 2019). Proper utilisation of natural ventilation can provide large ventilation rates without the consumption of energy. As natural ventilation is driven by wind or buoyancy, the used natural ventilated building form includes wind-driven ventilation form, buoyancy-driven ventilation form, and the combination of those two (Wang & Zhai, 2018).

When wind hits a building, positive pressure is created on the windward side and a negative pressure on the leeward side of the building (Alatalo, 2016). This forces air into the building from the windward side and out from the leeward side, creating cross-ventilation through the building. Natural ventilation is an increasingly popular green-building technology that has proven to be an effective solution to lower building cooling energy and to improve indoor air quality in various climates and types of building (Chen *et al.*, 2019).

As natural ventilation is affected by external environmental factors which vary, estimating the air flow rate using analytical methods are very complex. Experimental methods such as tracer gas or measurements of air velocity through the openings are applied to measure the ventilation rate in a building. In this situation, naturally ventilated buildings in terms of environmental variables such as CO<sub>2</sub> or air temperature that are affected by the flow rate can be used to assess the effectiveness of natural ventilation. Increasing the flow rate in naturally ventilated buildings helps to increase the mixture of outdoor and indoor air. Since the outside temperature and the CO<sub>2</sub> level is lower than the inside temperature and CO<sub>2</sub> level, mixing indoor and outdoor air helps to reduce the internal temperature and CO<sub>2</sub> level. Therefore, these parameters can be used as indicators of air flow rate in naturally ventilated buildings (Khatami, 2014).

## Hybrid ventilation systems

Ventilation plays a critical role in improving indoor environments whilst hybrid ventilation is an effective means of minimising ventilation energy and improving indoor climate (Meng *et al.*, 2019). It has been found that air-conditioners are often operated for 6 to 12 hours at a time, consuming electricity at a rate of 40–45 kWh/m<sup>2</sup> (Weerasuriya *et al.*, 2019). Although previous studies have indicated crucial role air-of conditioning in creating indoor thermal comfort during the hot and humid summers, air-conditioners are not the only means to achieve acceptable indoor thermal conditions. In buildings with hybrid ventilation, system transition spaces such as corridors with motorised inlets have more flexible thermal comfort limits than office spaces and can thus be used to bring in cooler outdoor air and thus increase cooling energy savings (Yuan *et al.*, 2018). Natural ventilation, in lieu of air-conditioning, can also effectively keep an indoor environment at an acceptable thermal level (Weerasuriya *et al.*, 2019).

External wind and thermal buoyancy are the two major driving forces for natural ventilation. Thermal buoyancy is produced by the difference between the outdoor air density and the indoor air density (Yang & Li, 2015). In addition to providing thermal comfort, natural ventilation has the advantage of improving indoor air quality, reducing energy consumption in buildings, and eliminating what is known as the “sick building syndrome”. From an economics perspective, natural ventilation can reduce the capital cost of a building by about 10–50%, compared to an air-conditioned building of similar dimensions. A building’s potential for natural ventilation not only depends on its dimensions and architectural features but also relates to climatic parameters (e.g. wind speed, direction, outdoor temperature, solar radiation), characteristics of the neighbourhood (e.g. geometry and orientation of buildings) and the behaviours of residents (Weerasuriya *et al.*, 2019).

## Office environments

Conventionally, an office is described as a place-dependent workplace (buildings), which is interchangeably expressed as a workplace, workspace, private/public space, built environment or physical environment (Nag, 2019). During the twentieth century, the office building and workplace floor plans in the USA, Europe, and rapidly emerging Asia-Pacific regions were greatly influenced by technological advances, sociocultural values, prevailing environmental conditions, and applicable building regulations (Nag, 2019). The idea of what an office is has rapidly progressed, supplemented by the explosion of the Information and Communication Technology (ICT) (Nag, 2019).

Indoor Air Quality (IAQ) of the workplace is strongly linked with the health, comfort and satisfaction of the occupants. To maintain the good IAQ of buildings, Post-Occupancy Evaluation (POE) is often jointly performed with environmental measurements to holistically survey existing performance conditions in relation to the satisfaction of occupants. Indoor air quality in the workplace is vital for the health and productivity of the occupants (Park *et al.* 2019). Conventionally, sensory perception immediately reflects the perceived air quality of office users (Park *et al.*, 2019). Sixty seconds after a change in air quality, there will be an immediate response such as sneezing or yawning if it is uncomfortable. However, occupants cannot easily detect certain pollutants, among which a threshold is assumed; if the exposure falls below the threshold level, no response is expected. Given that CO<sub>2</sub> is odourless and colourless, people cannot easily distinguish the concentration level, which could exert a strong impact on the health of the occupants. For instance, the higher the concentration level, the higher the rate of sick building syndrome symptoms (Park *et al.* 2019).

Sustainability efforts are mainly focused on environmental aspects and economic aspects. The sustainability efforts in built environment have not emphasised the design and operational implications of any built space on human productivity, well-being and behaviour. The economic aspects are largely focused on reducing building energy cost by using efficient design, material and operating systems. However, there is low interest in improving the operation cost besides the energy cost of the building, especially in commercial buildings. The operation cost of an organisation includes personnel costs, material costs, financial

costs and building related costs. A study highlights that 25 years of the personnel costs of companies represent 85% of the total operational cost. A nationwide study in the UK indicated that good office environment could help to increase productivity up to 20%, the equivalent to £135 bn per year. The indoor environment has a significant impact on health and well-being of the occupants. Healthy and conducive buildings lead to happy and productive occupants (Al Horr, Arif, Kaushik, *et al.* 2017: 477) (Al Horr, Arif, Kaushik, *et al.*, 2017: 477)(Al Horr *et al.*, 2017:477). Research directs that good indoor environment air quality in a workplace can help to reduce employee absenteeism, staff turnover and increase occupant productivity and satisfaction (Al Horr *et al.*, 2017).

## FINDINGS

### Research method

The primary data for this research effort was obtained from a case study building. The building selected represents a typical modern open-planned office building in Port Elizabeth. A quantitative experimental approach was used to analyse the impact of retrofitting openable windows would have on the indoor air quality of the office. The independent variable was the installation of openable windows controlled by employees. The dependent variables being measured were as follows:

- PM2.5 in micro cubic metre (µm<sup>3</sup>);
- Carbon dioxide in parts per million (ppm);
- Humidity in relative percentage (RH).

The dependent variables were measured using a medical grade indoor air quality device by IQAir. The air quality device remained in the office for 14 weeks from 18 June to 24 September 2019. The total number of working days amounted to 69 working days (552 hours based on an 8-hour workday). The openable windows were retrofitted and in use by employees from the 16 August 2019, resulting in a 9-week pre-openable window period and a 5-week post-openable window period in which air quality data was captured in real-time. The air quality data were exported from the monitor as a CSV file and imported into Microsoft Excel for analysis.

## RESEARCH FINDINGS

### Carbon dioxide levels

Carbon dioxide (CO<sub>2</sub>) is considered a critical parameter in assessing indoor IAQ and ventilation efficiency (Nag, 2019). A building space that has insufficient fresh air ventilation can contribute to an increase in the level of CO<sub>2</sub>. Research findings have indicated that worker productivity is improved in buildings with low CO<sub>2</sub> levels, a characteristic of naturally ventilated buildings where the occupants have control over their environment using openable windows (Carrilho & Linden, 2016). An increase in the ventilation rate improves the effectiveness in providing clean air and reducing CO<sub>2</sub> concentrations in the building.

### Normal CO<sub>2</sub> Levels

The effects of CO<sub>2</sub> on adults at good health can be summarised as:

normal outdoor level: 350 - 450 ppm;

acceptable levels: < 600 ppm;

complaints of stiffness and odours: 600 - 1000 ppm;

ASHRAE and OSHA standards: 1000 ppm;

general drowsiness: 1000 - 2500 ppm; and

adverse health effects may be expected: 2500 - 5000 ppm.



Figure 2. Before retrofit

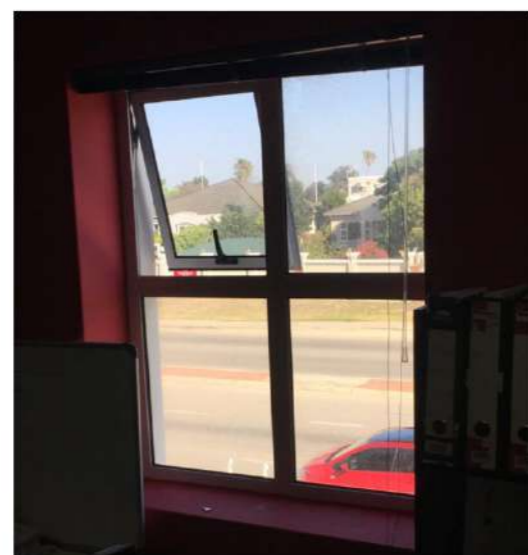


Figure 3. After retrofit

An analysis of the 14-week real-time data revealed that the pre-openable window period had 12 incidents in which office carbon dioxide levels exceeded 1000 ppm. The office carbon dioxide level exceeded 1000 ppm for a total of 36 hours. On average, office carbon dioxide levels would exceed 1000ppm twice to three times a week.

Once the openable windows were in use, the office carbon dioxide level did not exceed 1000 ppm for the remainder of the experiment. Openable windows, controlled by employees, effectively reduced >1000 ppm carbon dioxide incidents to zero.

### Particulate matter

Table 1 indicates the change in mean PM<sub>2.5</sub> office concentrations before and after the intervention of a natural ventilation retrofit by openable windows.

Table 1: Final PM<sub>2.5</sub> results

Mean indoor PM <sub>2.5</sub> concentrations (ug/m <sup>3</sup> )		
Mean	PM <sub>2.5</sub>	Comment
Before openable windows	2.89	PM <sub>2.5</sub> concentrations improved by 23%
After openable windows	2.23	
Change %	-22.8%	

The natural ventilation retrofit decreased the mean office PM<sub>2.5</sub> concentrations by 22.84%. It is noteworthy to mention that although the office building is located on a main road, and vehicles are a main source of PM<sub>2.5</sub>, the office PM<sub>2.5</sub> levels did not increase.

Table 2 indicates the change in mean PM<sub>10</sub> office concentrations before and after the intervention of a natural ventilation retrofit by openable windows.

Table 2: Final PM<sub>10</sub> results

Mean indoor PM <sub>10</sub> concentrations (ug/m <sup>3</sup> )		
Mean	PM <sub>10</sub>	Comment
Before openable windows	4.03	PM <sub>2.5</sub> concentrations improved by 18%
After openable windows	3.31	
Change %	-17.9%	

The natural ventilation retrofit decreased the mean office PM<sub>10</sub> concentrations by 18%. The decrease is both PM<sub>2.5</sub> and PM<sub>10</sub> indicates the importance of adequate ventilation. In addition, the research findings indicate the importance of IAQ data in building management systems, specifically informing data heating-ventilation-air-conditioning systems with IAQ to operate more efficiently.

### Humidity

In Table 3, the indoor humidity levels for 3 weeks before and 3 weeks after openable windows were installed, are compared.

Table 3: Humidity results

Office humidity		
	Mean	
	Indoor	Outdoor
3 weeks before openable windows	51.22	66.92
3 weeks after openable windows	51.16	62.39
Change %	-0.1%	-6.8%

The openable windows did not significantly impact the office humidity levels even with outdoor humidity levels decreasing by 6.8%.

## CONCLUSIONS

This research identified that it is essential to measure indoor air quality in office buildings no matter the age or quality of their construction, even more so in a post Covid-19 environment. It is estimated that sick building syndrome costs the United States \$30 billion annually (Paragon Controls Incorporated, 2020). Today, medical grade air quality monitors are affordable and have increased in accuracy, enabling all businesses to collect meaningful data on the quality of their work environment. This research demonstrates that even modern office buildings can be subject to poor indoor air quality and monitoring of workplace air quality should thus be a priority for all businesses in order to maximise the return on their most expensive investment, their staff. Furthermore, the need to reduce operating costs in office buildings has driven a movement to increase the use of natural ventilation as a mechanism to achieve this. Unfortunately, the perceived poor quality of outdoor air has been seen as a barrier to greater implementation of this. Port Elizabeth has healthy outdoor air and predominant wind patterns that provide the opportunity to utilise natural ventilation successfully. From the data collected, it is evident that improving ventilation significantly improves indoor air quality. Natural ventilation retrofits with openable windows can be used to improve indoor air quality and occupant satisfaction as well as reduce operational costs of existing mechanically ventilated office buildings. The literature indicates that human subjects who are exposed to 1000 ppm CO<sub>2</sub> for a short term experienced marked variations in respiratory movement amplitude, peripheral blood flow increases, and the cerebral cortex functional state (Azuma *et al.*, 2018). This study revealed the beneficial impact of a natural ventilation retrofit by measuring the indoor air quality. The cost of the retrofit was a once-off capital expenditure of R25 000. Since employees control the openable windows, there is no ongoing operational expenditure but rather, with ongoing benefits derived from the natural ventilation retrofit.

## RECOMMENDATIONS

- Facility managers need to manage indoor air quality in order to provide safe and healthy working environments. A first step to improving the management of indoor air quality is to utilise an air quality device to collect data on those environments. A medical grade air quality device should be used to ensure accurate measurements.
- Existing office buildings can improve indoor air quality by promoting or retrofitting natural ventilation solutions. The outdoor air quality in most South African cities is clean (SAPeople, 2016) and this affords our local built environment the opportunity to utilise natural ventilation solutions, sustainable solutions in the long term.
- Indoor air quality data can be used to inform building management systems or HVAC systems to optimise energy efficiency and improve occupant health and satisfaction.
- The climate and site conditions in which the building is located should be thoroughly investigated using various digital devices and accessible online weather / air quality data sources. Factors such as outdoor air pollution and noise can limit the effectiveness of a natural ventilation retrofit and therefore data on this needs to be considered in any proposal.

## LOST OF REFERENCE

- Alatalo, E. 2016. Enhancing the building performance of low- cost schools in Pakistan A study of natural ventilation , thermal comfort and moisture safety.
- Azuma, K., Kagi, N., Yanagi, U. & Osawa, H. 2018. Effects of low-level inhalation exposure to carbon dioxide in indoor environments: A short review on human health and psychomotor performance. *Environment International*. 121(August):51–56.
- Brook, R.D., Rajagopalan, S., Pope, C.A., Brook, J.R., Bhatnagar, A., Diez-Roux, A. V., Holguin, F., Hong, Y., et al. 2010. Particulate matter air pollution and cardiovascular disease: An update to the scientific statement from the American Heart Association. *Circulation*. 121(21):2331–2378.
- Carrilho, G. & Linden, P. 2016. Ten questions about natural ventilation of non-domestic buildings. *Building and Environment*. 107:263–273.
- Chen, Y., Tong, Z., Samuelson, H., Wu, W. & Malkawi, A. 2019. Realizing natural ventilation potential through window control: The impact of occupant behavior. *Energy Procedia*. 158:3215–3221.
- Deng, G., Li, Z., Wang, Z., Gao, J., Xu, Z., Li, J. & Wang, Z. 2015. Indoor/outdoor relationship of PM 2.5 concentration in typical buildings with and without air cleaning in Beijing. *Indoor and Built Environment*. 26(1):60–68.
- Fisher, C., Lauria, E. & Chengalur-Smith, S. 2011. *Introduction to Information Quality*. AuthorHouse.
- Gardiner, B. 2020. Pollution made COVID-19 worse. Now, lockdowns are clearing the air. *National Geographic*. (April). [Online], Available: [https://www.nationalgeographic.com/science/2020/04/pollution-made-the-pandemic-worse-but-lockdowns-clean-the-sky/?cmpid=org=ngp::mc=crm-email::src=ngp::cmp=editorial::add=SpecialEdition\\_20200410&rid=33E96907C35DC2CC2F196F2FFFF0B14D](https://www.nationalgeographic.com/science/2020/04/pollution-made-the-pandemic-worse-but-lockdowns-clean-the-sky/?cmpid=org=ngp::mc=crm-email::src=ngp::cmp=editorial::add=SpecialEdition_20200410&rid=33E96907C35DC2CC2F196F2FFFF0B14D).
- Al Horr, Y., Arif, M., Kaushik, A., Mazroei, A., Elsarrag, E. & Mishra, S. 2017. Occupant productivity and indoor environment quality: A case of GSAS. *International Journal of Sustainable Built Environment*. 6(2):476–490.
- Khatami, N. 2014a. Retrofitted natural ventilation systems for a lightweight office building. 253.
- Khatami, N. 2014b. Retrofitted natural ventilation systems for a lightweight office building. 253.
- Martin, R. V., Brauer, M., van Donkelaar, A., Shaddick, G., Narain, U. & Dey, S. 2019. No one knows which city has the highest concentration of fine particulate matter. *Atmospheric Environment: X*. 3(April):100040.
- Martins, N.R. & Carrilho da Graça, G. 2018. Impact of PM2.5 in indoor urban environments: A review. *Sustainable Cities and Society*. 42(May):259–275.
- Meng, X., Wang, Y., Xing, X. & Xu, Y. 2019. Experimental study on the performance of hybrid buoyancy-driven natural ventilation with a mechanical exhaust system in an industrial building. *Energy & Buildings*. 109674.
- Nag, P.K. 2019. *Office Buildings: Health, Safety and Environment*. Springer.
- Paragon Controls Incorporated. 2020. *Cost of Poor IAQ*. [Online], Available: [http://www.paragoncontrols.com/leed\\_green\\_CostOfPoorIAQ.aspx](http://www.paragoncontrols.com/leed_green_CostOfPoorIAQ.aspx) [2020, April 16].
- Park, J., Loftness, V., Aziz, A. & Wang, T.H. 2019. Critical factors and thresholds for user satisfaction on air quality in office environments. *Building and Environment*. 164(July):106310.
- Pope, C.A., Turner, M.C., Burnett, R.T., Jerrett, M., Gapstur, S.M., Diver, W.R., Krewski, D. & Brook, R.D. 2015. Relationships between fine particulate air pollution, cardiometabolic disorders, and cardiovascular mortality. *Circulation Research*. 116(1):108–115.
- SAPeople. 2016. *South Africans (Although Not All) Breathe About the Cleanest Air in Africa*. [Online], Available: <https://www.sapeople.com/2016/10/01/south-africans-although-not-breathe-cleanest-air-africa/> [2020, May 18].

- Wang, R. & Zhai, X. 2018. *Handbook of energy systems in green buildings*.
- Weerasuriya, A.U., Zhang, X., Gan, V.J.L. & Tan, Y. 2019. A holistic framework to utilize natural ventilation to optimize energy performance of residential high-rise buildings. *Building and Environment*. 153(November 2018):218–232.
- Yang, D. & Li, P. 2015. Natural ventilation of lower-level floors assisted by the mechanical ventilation of upper-level floors via a stack. *Energy and Buildings*. 92:296–305.
- Yuan, S., Vallianos, C., Athienitis, A. & Rao, J. 2018. A study of hybrid ventilation in an institutional building for predictive control. *Building and Environment*. 128(October 2017):1–11.
- Zhu, G., Hu, W., Liu, Y., Cao, J., Ma, Z., Deng, Y., Sabel, C.E. & Wang, H. 2019. Health burdens of ambient PM 2.5 pollution across Chinese cities during 2006–2015. *Journal of Environmental Management*. 243(May):250–256.
- Alatalo, E. 2016. Enhancing the building performance of low-cost schools in Pakistan A study of natural ventilation, thermal comfort and moisture safety.
- Azuma, K., Kagi, N., Yanagi, U. & Osawa, H. 2018. Effects of low-level inhalation exposure to carbon dioxide in indoor environments: A short review on human health and psychomotor performance. *Environment International*. 121(August):51–56.
- Brook, R.D., Rajagopalan, S., Pope, C.A., Brook, J.R., Bhatnagar, A., Diez-Roux, A. V., Holguin, F., Hong, Y., et al. 2010. Particulate matter air pollution and cardiovascular disease: An update to the scientific statement from the American Heart Association. *Circulation*. 121(21):2331–2378.
- Carrilho, G. & Linden, P. 2016. Ten questions about natural ventilation of non-domestic buildings. *Building and Environment*. 107:263–273.
- Chen, Y., Tong, Z., Samuelson, H., Wu, W. & Malkawi, A. 2019. Realizing natural ventilation potential through window control: The impact of occupant behavior. *Energy Procedia*. 158:3215–3221.
- Deng, G., Li, Z., Wang, Z., Gao, J., Xu, Z., Li, J. & Wang, Z. 2015. Indoor/outdoor relationship of PM 2.5 concentration in typical buildings with and without air cleaning in Beijing. *Indoor and Built Environment*. 26(1):60–68.
- Fisher, C., Lauria, E. & Chengalur-Smith, S. 2011. *Introduction to Information Quality*. AuthorHouse.
- Gardiner, B. 2020. Pollution made COVID-19 worse. Now, lockdowns are clearing the air. *National Geographic*. (April). [Online], Available: [https://www.nationalgeographic.com/science/2020/04/pollution-made-the-pandemic-worse-but-lockdowns-clean-the-sky/?cmpid=org=ngp::mc=crm-email::src=ngp::cmp=editorial::add=SpecialEdition\\_20200410&rid=33E96907C35DC2CC2F196F2FFFF0B14D](https://www.nationalgeographic.com/science/2020/04/pollution-made-the-pandemic-worse-but-lockdowns-clean-the-sky/?cmpid=org=ngp::mc=crm-email::src=ngp::cmp=editorial::add=SpecialEdition_20200410&rid=33E96907C35DC2CC2F196F2FFFF0B14D).
- Al Horr, Y., Arif, M., Kaushik, A., Mazroei, A., Elsarrag, E. & Mishra, S. 2017. Occupant productivity and indoor environment quality: A case of GSAS. *International Journal of Sustainable Built Environment*. 6(2):476–490.
- Khatami, N. 2014a. Retrofitted natural ventilation systems for a lightweight office building. 253.
- Martin, R. V., Brauer, M., van Donkelaar, A., Shaddick, G., Narain, U. & Dey, S. 2019. No one knows which city has the highest concentration of fine particulate matter. *Atmospheric Environment: X*. 3(April):100040.
- Martins, N.R. & Carrilho da Graça, G. 2018. Impact of PM2.5 in indoor urban environments: A review. *Sustainable Cities and Society*. 42(May):259–275.
- Meng, X., Wang, Y., Xing, X. & Xu, Y. 2019. Experimental study on the performance of hybrid buoyancy-driven natural ventilation with a mechanical exhaust system in an industrial building. *Energy & Buildings*. 109674.
- Nag, P.K. (2019). *Office Buildings: Health, Safety and Environment, Design Science and Innovation Series*. Netherlands: Springer. [Online]. Available: <https://doi.org/10.1007/978-981-13-2577-9> [Accessed 4 December].
- Paragon Controls Incorporated. 2020. *Cost of Poor IAQ*. [Online], Available: [http://www.paragoncontrols.com/leed\\_green\\_CostOfPoorIAQ.aspx](http://www.paragoncontrols.com/leed_green_CostOfPoorIAQ.aspx) [2020, April 16].
- Park, J., Loftness, V., Aziz, A. & Wang, T.H. 2019. Critical factors and thresholds for user satisfaction on air quality in office environments. *Building and Environment*. 164(July):106310.
- Pope, C.A., Turner, M.C., Burnett, R.T., Jerrett, M., Gapstur, S.M., Diver, W.R., Krewski, D. & Brook, R.D. 2015. Relationships between fine particulate air pollution, cardiometabolic disorders, and cardiovascular mortality. *Circulation Research*. 116(1):108–115.
- SAPeople. 2016. *South Africans (Although Not All) Breathe About the Cleanest Air in Africa*. [Online], Available: <https://www.sapeople.com/2016/10/01/south-africans-although-not-breathe-cleanest-air-africa/> [2020, May 18].
- Wang, R. & Zhai, X. 2018. *Handbook of energy systems in green buildings*.
- Weerasuriya, A.U., Zhang, X., Gan, V.J.L. & Tan, Y. 2019. A holistic framework to utilize natural ventilation to optimize energy performance of residential high-rise buildings. *Building and Environment*. 153(November 2018):218–232.
- Yang, D. & Li, P. 2015. Natural ventilation of lower-level floors assisted by the mechanical ventilation of upper-level floors via a stack. *Energy and Buildings*. 92:296–305.
- Yuan, S., Vallianos, C., Athienitis, A. & Rao, J. 2018. A study of hybrid ventilation in an institutional building for predictive control. *Building and Environment*. 128(October 2017):1–11.
- Zhu, G., Hu, W., Liu, Y., Cao, J., Ma, Z., Deng, Y., Sabel, C.E. & Wang, H. 2019. Health burdens of ambient PM 2.5 pollution across Chinese cities during 2006–2015. *Journal of Environmental Management*. 243(May):250–256.

9TH INTERNATIONAL CONFERENCE ON APPROPRIATE TECHNOLOGY

# CONSTRUCTION AND INFRASTRUCTURE

# SANITATION DEMAND, CONDITION AND COVERAGE IN ZITHOBENI EXTENSION 8 INFORMAL SETTLEMENT, CITY OF TSHWANE

Renay Helouise Van Wyk, Department of Environmental Health, Faculty of Health Sciences, University of Johannesburg, South Africa, renayvw@uj.ac.za  
Crescentia Netshieneulu, Department of Environmental Health, Faculty of Health Sciences, University of Johannesburg, South Africa, CrescentiaN@Tshwane.gov.za  
Tobias George Barnard, Water and Health Research Centre, Faculty of Health Sciences, University of Johannesburg, South Africa, tgbarnard@uj.ac.za

## Abstract

*People living in informal settlements are faced with a number of challenges, including lack of basic services and infrastructure, poverty and overcrowding. To address the inequalities, infrastructure such as shared chemical toilets are provided to informal settlements as the best practical alternative. Shared facilities are only acceptable when they meet the standards for accessibility, safety, hygiene and maintenance. Mixed methods research was employed to investigate the sanitation demand in an informal settlement by examining the perceptions of households and their receptiveness to the use of chemical toilets. In addition, the condition of selected chemical toilets in the settlements were visually appraised and evaluated by means of an observation checklist.*

*The results showed that 95% of the main study and 80.6% of the pilot study report that the chemical toilets were being used. According to the study, 7.6% of the households in both study sites did not use the chemical toilets all the time. Alternatives included private pit latrines in their yards, buckets and open defecation in a nearby field. Those households practising open defecation indicated that poor hygiene of the toilets was the main reason for this. It is evident from data collected that the use and acceptance of sanitation facilities is determined by the state of cleanliness or lack thereof. The dissatisfaction of the households could be associated with the lack of doors in some of the toilets to provide much needed privacy and that their dignity was not maintained when using the toilet.*

*Results of the chemical toilet observations showed unsatisfactory cleanliness (83.3%) and poor structural conditions (76.7%), which can be attributed to the user's behaviour and hygiene practices. The provision of sanitation facilities in informal settlements should be inclusive of health and hygiene education aimed at empowering communities to take accountability for their health and wellbeing.*

**Keywords:** sanitation demand, informal settlement, chemical toilet

## INTRODUCTION

The rapid growth of informal settlements in South Africa makes it difficult for the government to ensure the provision of adequate infrastructure; hence, the use of temporary or interim sanitation facilities that often do not meet the sanitation needs of households.

According to the household service delivery survey, 22.3% of the households in South Africa are non-formal dwellings and that 22.1 % do not have access to improved sanitation facilities (Stats SA, 2013). Improved sanitation facilities are defined as those that hygienically separate human excreta from human contact (UNICEF, 2017). According to the Joint Monitoring

Programme, shared toilets are not regarded as improved sanitation facilities as they fail to meet the requirements of improved sanitation. Due to expanding urbanisation, providing satisfactory sanitation infrastructure in informal settlements is becoming a challenge and residents are forced to share the few available facilities as the best practical alternative (Simiyu, Swilling, Cairncross & Rheingans, 2017). The main barriers to the provision of sanitation facilities in informal settlements are the lack of land ownership, the nature of land tenure, and formal demarcation (Department of Human Settlements, 2013).

According to Simiyu (2016), the lack of household sanitation facilities necessitated the introduction of communal or shared sanitation facilities in informal settlements as a means to increase access to and use of sanitation facilities. The challenge of providing household sanitation means that many countries include shared, community and public toilets in their national strategies to meet global goals (Foggitt, Cawood, Evans & Acheampong, 2019). However, little is known about the use and effectiveness of communal or shared sanitation facilities. Serious health risks associated with inadequate sanitation systems have not yet been provided with a strong motivation to address growing sanitation needs in many areas.

The National Sanitation Policy proposes moving away from treating informal settlements as temporary and emergency environments to treating them as established communities that require long-term planning and permanent structures (Department of Water and Sanitation, 2016). According to The City of Tshwane Metropolitan Municipality's Integrated Development Plan (2017-2021), basic water and sanitation services will be provided to informal settlements through the formalisation process, without specified timeframes (Department of Provincial and Local Government, 2001).

## MATERIALS AND METHODS

### Study area

The study was conducted in the Zithobeni Extension 8 informal settlement, located in Bronkhorstpruit, City of Tshwane Metropolitan Council (CoT). According to the City of Tshwane Informal Settlement Region 7 Report (2016), the settlement has a population of 12 000, 3000 households and 129 chemical toilets. The City of Tshwane is still in the process of formalising the settlement and therefore delivering limited basic services.



**Figure 2.** Chemical toilets (left) supplied in Zithobeni Extension 8 Informal Settlement and communal taps (right).

Sanitation services are provided by the municipality appointing a contractor to supply chemical toilets. In addition, households have built other types of toilet structures such as pit latrines, most of which are not well built with concrete slabs, they have no ventilation pipes or toilet seat lids and the toilet structures made of plastic material or the structures are screened by blankets and clothing material.

The water is predominantly supplied via communal taps provided in the streets of the settlements. The water pressure is very poor in some parts, and sometimes the flow is intermittent. As water is not available within the home environment, storage of drinking water in containers is the most common practice in the settlement.

## Data collection

Mixed methods research was employed to determine the hygiene practices of chemical toilet users through microbiological testing for the presence of *E. coli* on the toilet seats. Quantitative research design was utilised to gather numerical data from the chemical toilet observation checklists and a household survey. All chemical toilets (total of 129) were selected using a random sampling procedure. An observation checklist was used to evaluate the cleanliness of the chemical toilets by means of visual appraisal. Each chemical toilet was allocated a number which was marked on the toilet roof for tracking purposes.

The questionnaire was piloted in Phumzile informal settlement to identify any shortcomings of the tool before it was administered in the main study. The household questionnaire results were sorted and presented into sub-themes, namely demographics, household's toilet use and experience, chemical toilet cleanliness, perception and receptiveness.

The pilot study performed in Phumzile Informal Settlement had a 100% response rate with all 31 households responding to all questions in the questionnaire. A total of 140 households from Zithobeni Extension 8 Informal Settlement were recruited for the main study. Out of the 140, only 133 (95%) households responded to all the questions in the questionnaire.

## RESULTS

The results indicated that 95% of the main study, and 80.6% of the pilot study reported using the chemical toilets (**Table 1**). According to the study, 7.6% of households from the study sites did not use the chemical toilet all the time; they used other alternatives for toilet activities, which included private pit latrines in their yards, buckets and open defecation in a nearby field. Those practising open defecation exhibited poor hygiene as the main reason.

Antwi-Agyei, Dwumfour-Asare, Adjei, Kweyu and Simiyu (2020) state that approximately 673 million people practice open defecation, and the situation is worse in Southern Asia and Sub-Saharan Africa. There is a need to recognise the significance of communal toilets as a viable alternative to open defecation; otherwise, households could revert to open defecation practices if the facilities are inaccessible or unclean. It is evident at the study sites that the use and acceptance of sanitation facilities is determined by the state of cleanliness or lack thereof.

**Table 1** Percentage response regarding chemical toilet use and experience

Characteristic	Study site	Percentage response				
		Often	Rarely	Never	Yes	No
Households using chemical toilets	Main <sup>1</sup>				95	5
	Pilot <sup>2</sup>				80.6	19.4
Do you ever have to wait to use the toilet	Main	54.9	36.1	9		
	Pilot	16	48	36		
Bad odour from chemical toilet	Main	85.7	13.5	0.8		
	Pilot	71.4	25	3.6		
Flies present	Main	83.5	13.5	3		
	Pilot	71.4	25	3.6		
Washed hands after toilet use	Main	93.2	6	0.8		
	Pilot	82.8	17.2	0		
Water close to toilet for hand washing	Main				4.5	95.5
	Pilot				3.6	96.4

<sup>1</sup>Main study site was Zithobeni Ext. 8; n=140 households

<sup>2</sup>Pilot study site was Phumzile informal settlement; n=31 households

Bad odour from the chemical toilets was reported from both study sites with 71.4% in the pilot study compared with 85.7% recorded in the main study. The presence of the bad odour suggests unsatisfactory cleanliness of the toilets which may result in households not using the chemical toilets as desired. The results are consistent with the findings by Windh and Holmlund (2018) that informal settlement residents do not have a problem using the toilet facilities during the day except for the smell. The presence of bad odour could also be attributed to the lack of ventilation pipes in most of the toilets as a measure to control the smell.

The presence of flies was reported at both study sites, with 71.4% of the toilets at the pilot study site and 83.5% at the main study site. The results suggest that inadequately cleaned chemical toilets can be a breeding site for flies as they are attracted to the odour. When comparing the results regarding the presence of flies and bad odour, the percentages are almost similar. The slight similarities of the percentages suggest a significant association between dirty toilet surfaces and the breeding of flies. Another contributing factor for the presence of flies could be that the doors did not close properly; in the study, 73.8% of door levers were found to be dysfunctional. The presence of flies could also be caused by the lack of ventilation pipes in most of

the toilets. Ventilation pipes with fly screens act as a control measure for the movement of flies to minimise the risk of human exposure to foodborne pathogens.

The observations are consistent with the findings by Yalli, Sambo, Lawal and Tukur (2017) that the presence of flies indicate sanitary deficiency and unhygienic conditions in an environment. The reported number of runny tummy cases could also be associated with the presence of flies, as they are known as reservoirs of various human pathogens and mechanical vectors in the spreading of diarrheal diseases. A number of fly species such as the common housefly or *Musca domestica* have adapted to life in human settlements, and feed on human foodstuffs and waste. The presence of flies suggests that the provided chemical toilets do not act as a barrier which helps in eradicating disease transmission.

The study found that there were no hand washing facilities provided near to the chemical toilets in both study sites. Despite not having access to hand washing facilities, 82.8% of households from the pilot study site reported washing hands after using the toilet as compared to 93.2% of households from the main study site. Access to water in both settlements was by means of communal taps, located in the streets of the settlements with the common practice of participants collecting the water storing it in containers at home.

The reliance on self-reporting for hand washing practices is a limitation of this study and may introduce bias. Seimetz, Slekiene, Friedrich, and Mosler (2017) found that several studies have shown that self-reporting overestimates hand washing behaviour when compared to observed frequencies. Household hand washing practices were not observed in the study.

Burns, Maughan-Brown and Mouzinho (2018) states that the regular washing of hands is a cheap and effective way to reduce communicable diseases and related child mortality in developing countries. Hand washing is known as an effective way to reduce disease. Recent evidence suggests that instilling a habit of washing hands at critical times continues to present a challenging task in communities.

**Table 2** shows that households from the pilot study site were not sure of the frequency of cleaning the toilets, while households from main study site indicated that the chemical toilets are cleaned twice per week by the contractor.

**Table 2** Chemical Toilet Cleanliness Characteristics

Characteristic	Study site	Percentage response					Do not know
		Contractor	Household	Other	Daily	Weekly	
Who cleans the toilet?	Main <sup>1</sup>	65.1	33.3	14.3			
	Pilot <sup>2</sup>	13.6	4.5	86.4			
How often is the toilet cleaned?	Main				6.9	80	13.1
	Pilot				0	83.3	16.7
Supply of the toilet paper	Main	7	93				
	Pilot	56	44				

<sup>1</sup>Main study site was Zithobeni Ext. 8; n=140 households

<sup>2</sup>Pilot study site was Phumzile informal settlement; n=31 households

According to the households in both study sites, the contractor primarily empties the toilet rather than cleaning the entire toilet structure. The inadequate cleaning can be attributed to the lack of a cleaning schedule set by the municipality as part of the contractual conditions for the contractor. Cleaning of toilet facilities should be clearly defined and appropriately carried out (Ibhafidon-Momodu, 2016). This can be associated with the fact that municipalities put greater effort into increasing sanitation facilities while neglecting the operation and maintenance of such facilities (DWS, 2016).

Findings at both the sites under study indicated that certain households sometimes clean the toilets themselves as they are often dirty. This implies that some households are benefitting from using the chemical toilet but put little or no effort into keeping them clean. This could be due to the toilets remaining dirty since the contractor does not clean them. Literature on the recommended cleaning frequency of shared chemical toilet facilities is lacking. In this study the frequency of cleaning is insufficient as most of the chemical toilets were dirty and full on most of the days during the study period.

The dirtiness of the chemical toilets also suggests negligence, lack of accountability and little or no sense of ownership by the households. According to Simiyu, Swilling, Rheingans and Cairncross (2017) the quality of the cleanliness of toilet facilities decreases as there is an increase in the number of households sharing the toilet facility. These observations are similar to the findings of the study on shared toilets conducted in informal settlements in Uganda (Tumwebaze & Mosler, 2014).



A notable inconsistency at both the study sites is the supply of toilet paper. Households at the pilot study site indicated that the contractor supplied toilet paper while the households at the main study site reported that they supplied their own toilet paper. Despite the supply of toilet paper by the contractor, 46% of the households at the pilot study indicated that they provided the toilet paper themselves because it is often not available. This may suggest that the households keep the provided toilet paper for themselves rather than sharing it with the other households.

Households at both study sites reported dissatisfaction with the chemical toilets (Table 3). Households (70.4%) at the pilot study site felt that their privacy is not maintained while 88.8% of the main study site households also felt this way. The dissatisfaction of the households could be associated with the lack of doors for some of the toilets which would provide much needed privacy. Similar findings were made by Ibhafidon-Momodu (2016) that some people avoid the shared toilet because it is unpleasant, dirty, smelly, not private enough, and they lack basic hand washing and drying facilities.

Households at both the study sites indicated dissatisfaction with the chemical toilets as they felt that their dignity was not maintained when using the toilet. This may be associated with the poor cleanliness of the chemical toilets, bad odour and flies. Cleanliness appears to play a critical role in the usage and acceptance of the chemical toilets. According to Appiah-Effah, Duku, Azangbego, Aggrey, Gyapong-Korsah and Nyarko (2019), some of the concerns of the households did not use the shared toilets were the distances involved in accessing such facilities, the lack of maintenance and the unhygienic nature of these facilities since shared toilets were usually accessed by many people.

**Table 3:** Perception, receptiveness and safety characteristics

Characteristic	Study site	Percentage response				
		Satisfied	Dissatisfied	Not sure	Yes	No
Feeling privacy is maintained when using chemical toilet	Main <sup>1</sup>	9.8	88.6	1.5		
	Pilot <sup>2</sup>	22.2	70.4	7.4		
Feeling dignity is maintained when using chemical toilet	Main	9.2	88.5	2.3		
	Pilot	22.2	70.4	7.4		
Feeling safe using the toilet at night	Main				18.9	81.1
	Pilot				28	72
Means of lighting at night	Main				20.6	79.4
	Pilot				7.1	92.9
Households experienced criminal activities	Main				13.6	86.4
	Pilot				27.6	72.4

<sup>1</sup>Main study site was Zithobeni Ext. 8; n=140 households

<sup>2</sup>Pilot study site was Phumzile informal settlement; n=31 households

The second most frequent reason for households choosing not to use the chemical toilet was the threat of criminal activity. This can be attributed to the chemical toilets being located outside the yards of the households, thus posing a threat of criminal activity. On the contrary, the study results revealed lower levels of criminal activities experienced by households than expected. Approximately 27.6% of households from the pilot study reported to have experienced criminal activities as compared to 13.6% from the main study site. The reported criminal activities at both study sites included rape, physical assault, being locked inside the toilet and robbery.

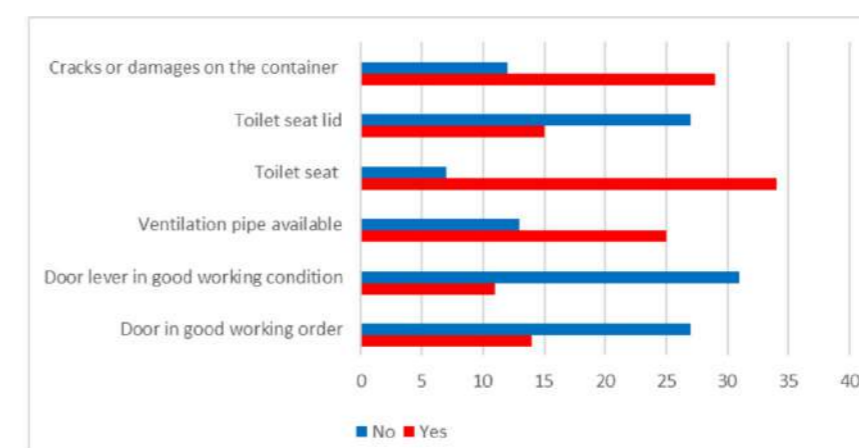
A study conducted by Jacobs (2017) found that using a toilet in an informal settlement is regarded as one of the most dangerous activities for residents as they are frequently robbed, raped, assaulted and murdered. Similar findings were reported by Hangulu and Akintola (2017) that people using shared sanitation systems and toilets far from the house refuse to go to the toilet because they are afraid of being assaulted or robbed on their way to the facilities. As much as shared communal toilets pose safety risks for every user, women are at greater risk of being attacked. Women spend approximately 97 billion hours per annum looking for a safe place to relieve themselves and to manage their menstrual cycles with privacy and dignity; in the process they risk shame, disease, harassment and even attack because they have no safe toilets (Reddy, Raghavan & Vedala, 2019).

The lack of proper lighting at night was reported by households at both study sites. Households reported not feeling safe using the chemical toilets at night due to criminal activities, suggesting a significant association between the lack of lighting and criminal activity, consequently discouraging the use of chemical toilets at night. The possibility of criminal activity at night could lead to households using other toilet alternatives such as containers or open defecation.

#### Chemical toilet observations

A chemical toilet observation checklist was used to evaluate the cleanliness of selected chemical toilets at the main study. Observations included structure, hygiene, environment and accessibility characteristics of the chemical toilet. The findings indicate that (76.7%) of the chemical toilets had cracks or were damaged, 65.9% of the doors were not in good working condition, 73.8% of the door levers were not working, and 65.8% had no ventilation pipes. The results indicated poor maintenance of the toilet facilities, with some technical aspects that need attention, as highlighted above.

The unwillingness of households to clean the toilet facilities could be associated with lack of ownership and accountability; hence, they fail to keep the facility clean and functional. According to Mels, Castellano, Braadbaart, Veenstra, Dijkstra, Meulman, Singels, and Wilsenach, (2009), conflicts amongst households on the maintenance of the sanitation facility often lead to vandalism, damage, and destruction of the systems. The structural conditions may be due to sanitation often not being a priority; hence, the budget allocated for their maintenance by municipalities or decision makers is insufficient. These findings could also be attributed to the households not prioritising sanitation as a need as they would for housing, water and electricity.

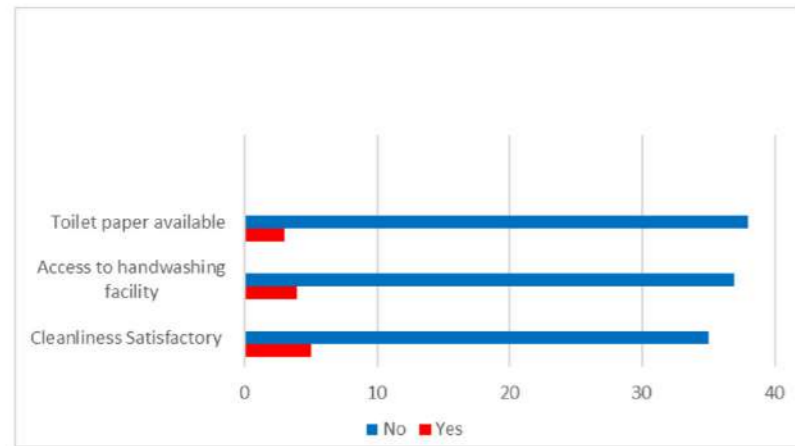


**Figure 3:** Results of the chemical observation checklist related to general maintenance of the toilets.

According to Simiyu *et al.* (2017), sanitation is a basic service often lacking in informal settlements, a situation attributed to lack of government funding. Similar findings were made by Mjoli (2010) that most municipalities do not allocate a budget for the long-term sustainability of sanitation facilities. The reluctance of government to allocate funds may also be due to most informal settlements being located on private land without proper ownership by occupants. The other contributing factor for government not providing sustainable sanitation facilities to informal settlements is the nature of their establishment, that is, they mushroom without any planning. These results are consistent with the definition of informal settlements, described as an unplanned dwelling on land which has not been surveyed or proclaimed as residential (Stats SA, 2016).

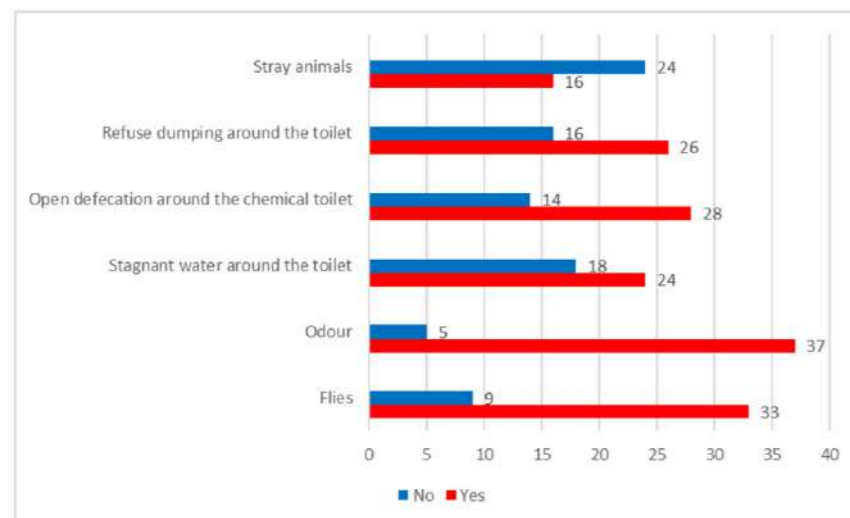
The illegality and informality of the settlements render it impossible for the government to invest in informal settlements. Therefore, lack of tenure or title deeds not only discourages sanitation agencies from providing services but also discourages households from investing in good sanitation facilities because of their fear of being moved to other locations (DWS, 2016). Shared sanitation is described as a 'limited' sanitation service. Donors and governments are reluctant to invest in sanitation as this does not count towards achieving the SDG target 6.2 (Evans, Hueso, Johnston, Norman, Pérez, Slaymaker & Trémolet, 2017).

**Figure 3** depicts the chemical toilet hygiene conditions as observed in the selected chemical toilets (n=42). According to the observations, cleanliness was unsatisfactory in 83.3% of the chemical toilets, and 90.5% had no toilet paper. The majority (90.5%) of the chemical toilets had no access to hand washing facilities and only a few of the toilets were located close to the communal taps.



**Figure 4.** Results from the chemical observation checklist related to the availability of hygiene facilities for the toilets.

The results revealed unsatisfactory environmental hygiene with the presence of flies (78.6%), bad odour (88.1%) and open defecation (66.7%) (**Figure 5**). The unsatisfactory environmental hygiene conditions may be associated with the location of the toilet facilities. The chemical toilets are located on the street boundaries, resulting in the lack of ownership and accountability by households. Poor environmental conditions such as illegal refuse dumping within the surroundings of the chemical toilets were also observed. This can be attributed to municipal waste trucks unable to gain access to some parts of the informal settlements owing to the narrow roads. The presence of refuse dumps suggests the absence of environmental health awareness aimed at changing behaviour and little or no promotion of creating a healthy environment.



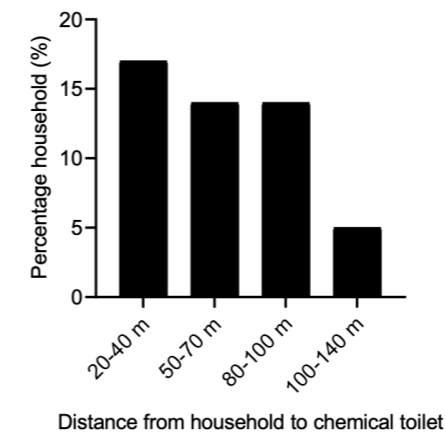
**Figure 5:** Results of the chemical observation checklist related to the environmental hygiene of the toilets.

The presence of stagnant water was observed around the chemical toilets. This could be attributed to the lack of storm water drainage in the settlement. The presence of stagnant water causes a foul odour, attracts flies, and could also encourage stray animals to seek water.

Evidence of open human or animal defecation was observed on the surrounding ground of the chemical toilets. Open defaecation may indicate dysfunctional and inadequate sanitation facilities which drive residents to open defaecation. Tumwebaze *et al.* (2014) found that poor-quality sanitation facilities may prohibit their use and encourage open defaecation. According to Nelson, Karver, Kullman and Graham (2014), perceived cleanliness appears to play an important role in satisfaction regarding sanitation facilities.

The average walking distance from households to the chemical toilet was observed and estimated in terms of metres; the results are presented in Figure 6.

The study found that the furthest distance from the household to the chemical toilet is less than 140 m. The findings fall in line with the trends reported in 2009. An estimated 88% of households resided less than 200 metres away from the outside-yard toilet facility, whereas in 2015 the percentage increased to 94% (Stats SA., 2016).



**Figure 6:** Average walking distance from households to chemical toilet facility.

## DISCUSSION

The study revealed a decrease in the walking distance from the households. A 2015 study indicated that, at that time, the average distance from the households was furthest, that is, 200 metres (Stats SA, 2016). The reduction in walking distance from households to toilet facilities may be attributed to efforts by municipalities to decrease the backlogs (DWA, 2003). The improvement in the walking distance attests to the effort of government to provide better sanitation services to informal settlements to realise the SDG sanitation goal by 2030 (WHO, 2015). According to Gonsalves *et al.* (2015), the average walking time to and from a toilet was estimated to be 2.5 minutes. Future research studies to assess the average acceptable travel time per trip to the toilet are recommended. Besides spending time walking to the toilet facility, households indicated that they also have to wait to use the toilet as it is shared with other households.

The results showed that households were dissatisfied with the chemical toilets provided. The households felt that their dignity is not maintained when using the chemical toilets. Dissatisfaction was found to be clearly connected to poor hygiene, flies, bad odour and lack of privacy. It can be concluded that poor cleanliness is associated with lower levels of household satisfaction. This further suggests that facility cleanliness may play an important role in reducing open defecation.

Chemical toilets do not provide the necessary privacy and dignity. Shiras, Cumming, Brown, Muneme, Nala and Dreibelbis (2018) indicated that participants who experienced privacy-related stressors and embarrassment complained of poorly constructed toilet infrastructure made similar findings. The damages in the chemical toilet structure may suggest possible vandalism and negligence by households. According to Duncker (2014), sanitation technology and its acceptance by the users were key factors that will impact the sustainability of such technology.

The study found that households felt insecure using the chemical toilet at night due to criminal activities (robbery, physical assault, being locked inside the toilet, rape, etc.) Lack of adequate lighting in the settlement is a contributor. Poor lighting could be due to the non-formalisation process of the settlement as stated in the municipal IDP document that basic services will be provided after the formalisation process.

The study suggests that there is an association of the availability of means of lighting with the use of chemical toilets at night. Consistent findings were also made by Belur *et al.* (2017) that the absence of lighting, poor design and inconsiderate siting of toilets, and a lack of police presence in the informal areas are facilitators of violence, especially against women.

## CONCLUSION

The study provides evidence that the current practice of providing ‘temporary’ sanitation facilities, which end up becoming ‘permanent’ services, is unsustainable. Sanitation facilities were generally available but the conditions were unhygienic with some technical aspects that needed attention, for example, vent pipes that were too short, missing toilet seat lids, and doors that do not close properly, if they are present.

Households expect local authorities to keep the facilities clean and are not actively engaged in their maintenance. They do not take ownership of the facilities since they offer a shared service. Sanitation facilities were subjected to incorrect maintenance and misuse. The findings of the study confirm that behavioural and environmental factors interact with the determination of the hygiene status in communities.

Providing sustainable and improved toilet facilities would increase human health in informal settlements and contribute to reaching the SDGs. Government needs to acknowledge that informal settlements are established communities, which require long-term sanitation solutions rather than treat them as a temporary and emergency environment. The study finds that most of these facilities do not count as basic sanitation based on the indicators such as the compromised safety, privacy, dignity, and cleanliness. There is a high demand for sanitation in informal settlements and effort by the government to address the sanitation needs. The households often reject the facilities provided. Consistent findings by Vijay Panchang (2019) indicate that an increased demand for sanitation facilities does not always translate into increased use of sanitation facilities.

## LIST OF REFERENCES

- Antwi-Agyei, P., Dwumfour-Asare, B., Adjei, K.A., Kweyu, R. & Simiyu, S. 2020. Understanding the barriers and opportunities for effective management of shared sanitation in low-income settlements: the case of Kumasi, Ghana. *International Journal of Environmental Research and Public Health*, 17:12.17(12), 4528. <https://doi.org/10.3390/ijerph17124528>
- Appiah-Effah, E., Duku, G. A., Azangbego, N. Y., Aggrey, R. K. A., Gyapong-Korsah, B. & Nyarko, K. B. 2019. Ghana’s post-MDGs sanitation situation: an overview. *Journal of Water, Sanitation and Hygiene for Development*, 9(3): 397-415
- Belur, J.P., Daruwalla, N., Joshi, R. and Fernandes, R., 2017. Perceptions of gender-based violence around public toilets in Mumbai slums. *International Journal of Comparative and Applied Criminal Justice*, Vol.41, 63–78. <https://doi.org/10.1080/01924036.2016.1240094>
- Bloomfield, S. F., Exner, M., Nath, K. J., Signorelli, C. & Scott, E. A. 2012. The chain of infection transmission in the home and everyday life settings, and the role of hygiene in reducing the risk of infection. *International Scientific Forum on Home Hygiene*. <http://www.ifhomehygiene.org/IntegratedCRD.nsf/111e68ea0824afe1802575070003f039/9df1597d905889868025729700617093?OpenDocument>
- Burns, J., Maughan-Brown, B. and Mouzinho, Â. (2018) Washing with hope: evidence of improved handwashing among children in South Africa from a pilot study of a novel soap technology. *BMC Public Health*, Vol.18, no.1.
- City of Tshwane Metropolitan Council. 2016. *Region 7 Report on Informal Settlements*, Pretoria, South Africa.
- Duncker, L.C. 2014. Sanitation: User perceptions and acceptance. *Alive2green*. The Green Building Handbook, CSIR, Pretoria, South Africa. Vol.6. <http://www.alive2green.com> (Accessed on 26 September 2018).
- Erb, S., D’Mello-Guyett, L., Malebo, H.M., Njee, R. M., Matwewe, F., Ensink, J., Hinic, V., Widmer, A. & Frei, R. 2018. High prevalence of ESBL-Producing *E. coli* in private and shared latrines in an informal urban settlement in Dar es Salaam, Tanzania. *Antimicrobial Resistance and Infection Control*, 7:3. DOI: 10.1186/s13756-017-0292-y.
- Evans, B., Hueso, A., Johnston, R., Norman, G., Pérez, E., Slaymaker, T. and Trémolet, S., 2017. The role of shared sanitation in the 2030 Agenda for Sustainable Development. *Journal of Water, Sanitation and Hygiene for Development*, 7 (3): 349–351. <https://doi.org/10.2166/washdev.2017.023>
- Foggitt, E., Cawood, S., Evans, B. & Acheampong, P. 2019. Experiences of shared sanitation: towards a better understanding of access, exclusion and ‘toilet mobility’ in low-income urban areas. *Journal of Water, Sanitation and Hygiene for Development*, 9(3): 581–590. <https://doi.org/10.2166/washdev.2019.025>
- Gonsalves, G.S., Kaplan, E.H., Paltiel, A.D., 2015. Reducing Sexual Violence by Increasing the Supply of Toilets in Khayelitsha, South Africa: A Mathematical Model. *PLoS ONE* 10(4): e0122244. doi:10.1371/journal.pone.0122244
- Gupta, T., Jain, A. & Jain, S. 2018. Screening of various surface areas of student’s restrooms for pathogenic microbial flora in tertiary care hospitals. *Indian Journal of Applied Research*, 8(5):34-36.
- Hangulu, L. & Akintola, O. 2017. Perspectives of policy-makers and stakeholders about health care waste management in community-based care in South Africa: a qualitative study. *BMC Health Services Research*. 17, 290 (2017). <https://doi.org/10.1186/s12913-017-2236-x>
- Ibhafidon-Momodu, G. O. 2016. Impact of shared sanitation toilets on candidiasis infection among females in Auchi Community, Edo state, Nigeria. MSc Dissertation, Kwame Nkurumah University of Science and Technology (KNUST), Kumasi, Ghana <http://hdl.handle.net/123456789/9100>
- Jacobs, B. L. 2017. Gendered Lived Experiences in Urban Cape Town: Urban Infrastructure as Equal Opportunity, Social Justice, and Crime Prevention. *Journal of Comparative Urban Law and Policy*: Vol. 1: Iss 1, Article 10. <https://readingroom.law.gsu.edu/jculp/vol1/iss1/10>
- Kabugo, D., Kizito, S., Ashok, D.D., Kiwanuka, A.G., Nabimba, R., Namunana, S., Kabaka, R.M., Achan, B. & Najjuka, F. C. 2016. Factors associated with community-acquired urinary tract infections among adults attending assessment centre, Mulago Hospital Uganda. *African Health Sciences*, 16(4): 1131-1142. doi: 10.4314/ahs.v16i4.31. PMID: 28479906; PMCID: PMC5398460.

- Kabugo D, Kizito S, Ashok DD, Graham KA, Nabimba R, Namunana S, Kabaka MR, Achan B, Najjuka FC. Factors associated with community-acquired urinary tract infections among adults attending assessment centre, Mulago Hospital Uganda. *Afr Health Sci.* 2016 Dec;16(4):1131-1142. doi: 10.4314/ahs.v16i4.31. PMID: 28479906; PMCID: PMC5398460.
- Mels, A., Castellano, D., Braadbaart, O., Veenstra, S., Dijkstra, I., Meulman, B., Singels, A. & Wilsenach, J. A. 2009. Sanitation services for the informal settlements of Cape Town, South Africa. *Desalination*, 248(1-3): 330-337.
- Mjoli, N. (2010) Review of sanitation policy and practice in South Africa. WRC Report No. 1741/1/09. Technical Report. Water Research Commission, Pretoria, South Africa.
- Nelson, K.B., Karver, J., Kullman, C., Graham, J.P., 2014. User perceptions of shared sanitation among rural households in Indonesia and Bangladesh. *PLoS One.* 4;9(8):e103886. doi: 10.1371/journal.pone.0103886. PMID: 25090096; PMCID: PMC4121202.
- Ogwezzy-Ndisika, A. O. and Solomon, T. 2019. Knowledge, attitude and practice of hand washing among mothers of children 0-59 months of age in Lagos Nigeria. *Universal Journal of Public Health* Vol. 7(2): 52 – 58. doi: 10.13189/ujph.2019.070202
- Reddy, Y. M., Raghavan, S. & Vedala, S. C. 2019. A narrative exposition on public toilet usage by women: a study from Warangal. *Indian Journal of Gender Studies*, 26:1-2.
- Seimetz, E., Slekiene, J., Friedrich, M.N. and Mosler, H.J. (2017) Identifying behavioural determinants for interventions to increase hand washing practices among primary school children in rural Burundi and urban Zimbabwe. *BMC research notes*, Vol.10, no.1. 280. <https://doi.org/10.1186/s13104-017-2599-4>
- Shiras, T., Cumming, O., Brown, J., Muneme, B., Nala, R., and Dreibelbis, R. 2018. Shared latrines in Maputo, Mozambique: exploring emotional well-being and psychosocial stress. *BMC International Health Human Rights* 18, 30. <https://doi.org/10.1186/s12914-018-0169-z>
- Simiyu, S. 2016. Determinants of usage of communal sanitation facilities in informal settlements of Kisumu, Kenya. *Environment and Urbanization*, 28(1): 241-258. doi:10.1177/0956247815616732.
- Simiyu, S. Swilling, M. Cairncross, S. & Rheingans, R. 2017. Determinants of quality of shared sanitation facilities in informal settlements: case study of Kisumu, Kenya. *BMC Public Health*, 17(1): 68. <https://doi.org/10.1186/s12889-016-4009-6>
- South Africa. Department of Human Settlements. 2013. *Gauteng: Informal Settlement Status Research Report*. Government Printers, Pretoria, South Africa
- South Africa. Department of Provincial and Local Government (DPLG). 2001. *IDP General Guidelines*. Government Printers, Pretoria, South Africa
- South Africa. Department of Water and Sanitation. 2016. *National Sanitation Policy*. Government Printers, Pretoria, South Africa
- South Africa. Department of Water Affairs. 2003. *Strategic Framework for Water Services*, DWA, Government Printers, Pretoria, South Africa
- Statistics South Africa. 2013. *Household Service Delivery Statistics*. [Online] Available from: <http://www.statssa.gov.za> [Accessed 16 February 2019].
- Tumwebaze, I. K. & Mosler, H. 2014. Shared toilet users' collective cleaning and determinant factors in Kampala Slums, Uganda. *BMC Public Health*, 14(1): 1260 (2014). <https://doi.org/10.1186/1471-2458-14-1260>
- United Nations Children's Fund. 2017. *Improved sanitation*. New York. [Online] Available from: <https://www.unicef.org/publications/files/UNICEF> [Accessed 19 November 2017].
- Vijay Panchang, S. 2019. Demand for improved sanitation in an urban informal settlement in India: role of the local built environment. *International Journal of Environmental Health Research*, 29(2): 194-208. doi: 10.1080/09603123.2018.1533530. Epub 2018 Oct 12. PMID: 30311768
- World Health Organisation, 2015. Progress on sanitation and drinking water: 2015 update and MDG assessment. World Health Organisation, Geneva, Switzerland
- Yalli, A.A., Sambo, S., Lawal, H.M. and Tukur, U., 2017. Study of Bacteria on the Body Surfaces of House Flies (*Musca Domestica*) In Some Homes within Sokoto Metropolis. *Journal of Advancement in Medical and Life Sciences*. V5I4.03 DOI: 10.5281/zenodo.1000685

# APPROPRIATE RENEWABLE ENERGY FOR EDUCATION INFRASTRUCTURE IN RURAL SOUTH AFRICA: THE COFIMVABA SCIENCE CENTRE MODEL

Jako Albert Nice, Council for Scientific and Industrial Research (CSIR), South Africa, jnice@csir.co.za

## Abstract

*The Council for Scientific and Industrial Research (CSIR) has embarked on an innovation investigation through a ministerial initiative brought by the Department of Science and Technology Innovation (DSI). The Cofimvaba Science Centre was envisioned, planned and is currently in construction to build and test theory with regard to the efficacy of multiple innovations in the supply and delivery of building construction projects in South Africa. This is in response to the target set by the National Development Plan (NDP 2011:288) of 2030 for energy efficiency in building standard SANS 204 to achieve 'zero carbon' buildings.*

*There is a need for alternative teaching platforms for maths, science and technology. At the same time, there is a need for rapid construction of infrastructure with sustainable ongoing power supply in rural areas in South Africa. The innovations could lead to improved teaching outcomes and quality of instruction, as well as improvement in the rate of construction and service delivery, with the added benefit of future economy creation downstream. The building has been constructed by alternative construction methods and materials, with five different energy sources regulated through a microgrid system delivering a planned net zero carbon building. A multiyear building performance analysis will be conducted to gather evidence for future application and appropriateness. A pre-construction investigation of available building technologies was done, and during construction assessments of renewable energy sources and the financial viability of the project continued. Post-construction assessment of the building's performance will be conducted covering materiality, thermal performance, indoor air and sound quality, energy, water and waste use. The alternative building construction method has yielded rapid construction time. However, a slow administrative process has delayed the completion date. Nevertheless, the project suggests that net zero energy can be achieved for Government and private buildings in rural South Africa.*

**Keywords:** appropriate technologies, building performance, construction, net zero, , renewable energy, .

## INTRODUCTION

The Department of Science and Innovation (DSI), in collaboration with the Department of Basic Education (DBE) and the Eastern Cape Department of Education (ECDE), is leading an initiative that seeks to examine whether the introduction of innovative and tested technologies would improve the quality of learning and teaching in the Cofimvaba Schools District, Eastern Cape. The initiative includes the development of a science centre and virtual remote science and technology teaching for both student and educator. The Cofimvaba Science Centre (CSC), located on Main Road, Cofimvaba, is a 1 369 m<sup>2</sup> Science Centre and educational facility to assist and encourage learners in the district with the study of science and technology. The location is considered strategically placed, given its centrality to schools in the broader community intended to benefit from the Science Centre programmes. To advance the mission and drive the building industry, the CSIR developed the CSC to demonstrate how 'deep green' buildings are designed, contracted, constructed, and occupied, aimed at both creating an education facility and establishing a living laboratory to test appropriate technologies, appropriate contracting and procurement methods for application in rural South Africa.

The CSC aims to advance the goals and objectives of the DSI-led campaign to promote public awareness of, and engagement in, science, and contribute to the development of a skilled and capable workforce particularly with high-level scarce skills in science, engineering and technology (SET) to support an inclusive growth path. In that context, the envisaged CSC will have four strategic focus areas, namely science engagement, Mathematics, Science and Technology (MST), curricular support, SET career education and talent nurturing. The actual design of the programmes under these focus areas is shaped by the needs and expectations of the DSI, the DBE and the ECDE.

The design and planning of the Science Centre itself will contribute to the SET areas through construction using Innovative Building Technologies (IBT) in support of a Cabinet Resolution of 2013 in this regard. The building is designed and planned to be off-grid, meaning that it will be independent of outside services such as water, energy and sewerage. The technologies adopted to achieve this will provide a live working example of the application of IBTs and related technologies. In addition to Solar Photo Voltaic Panels, building-scale wind turbines and hydrogen fuel cells managed by a microgrid system contribute to the net zero carbon energy target. Rainwater harvesting is supported by a constructed reedbed for recycling of grey water, and the treatment of sewerage will be done on site using an Agrément certified bio-based toilet. DSI and the Department of Environmental Affairs with the CSIR embarked on an investigation to conserve a potential ruined natural wetland as a further SET exhibit. However due to seasonal climatic factors and the degraded state of the wetland area, a reconstructed wetland and onsite educational intervention is currently underway.

The Science Centre is very similar programmatically to a school, where the school hall becomes an exhibition centre. This hall is supported by classrooms, laboratories (chemistry, physics and computer) and a multi-purpose lecture theatre that doubles as a planetarium (in support of the Square Kilometre Array or SKA, a project strongly supported by DST). The Science centre is intended to serve as a "living laboratory" in which the methods of design, contracting, construction, commissioning and operation, and the lessons learnt in the process, could be shared and potentially replicated. The CSIR's experience will therefore serve as a practical model to inform these aspects of future buildings and thereby reduce the buildings' contribution to the climate crisis.

## METHODOLOGY, DISCUSSION AND EVALUATION

### The socio-economic context

The town of Cofimvaba falls under the Intsika Yethu municipality and is situated in the Chris Hani District Municipality, a district in the centre of the Eastern Cape. The Chris Hani node is one of four Integrated Sustainable Rural Development Strategy (ISRDS) nodes in the Eastern Cape.

The Chris Hani District Municipality (CHDM) covers approximately 37 294 km<sup>2</sup>, with a total population of 840 058 (CHDM, 2018:). The total number of households is estimated at 218 000 in 2016 (CHDM, 2018), with an average family size of 4.8 (CHDM, 2018). The majority of the population is young people between the ages of 0 to 24 (55.9%) (CHDM, 2011). These are largely children of school-going ages. About 39 % of the population in the district is below 15 years of age (CHDM, 2011) and more than half the population is below 20 years of age. The majority of people live in rural areas, townships and informal settlements. The levels of poverty within the district remain high with over half of the district population (52.9%) living in poverty (CHDM, 2011). Due to the high rates of unemployment there is a high dependence on grants and remittances as the main source of household income.

The human development index for the district is below 0.50 (CHDM, 2011). The district is comparatively poor in terms of poverty measures such as Human Development Index (HDI) (0.559); poverty gap and the number of people living in poverty (75.4%) (CHDM, 2011). More than 75% of the economically active age groups are unemployed (CHDM, 2011). Matriculants struggle to further their studies due to financial constraints.

Agriculture is regarded as the backbone of the economy of the district as the largest portion of land is utilised for agricultural purposes. Managing the available resources in a sustainable manner is therefore a priority. The Chris Hani Regional Economic Development Strategy (REDS) has endorsed 4 specific clusters or sectors for prioritisation namely: Agriculture, Agro-processing and Forestry, Manufacturing, Construction and Mining, Tourism and Hospitality and Services, Retail and Logistics (CHDM, 2018). The strategy notes that local beneficiation is key to the district, water infrastructure backlogs must be eradicated, energy security needs to be addressed and transport linkages need to be maximized (CHDM, 2011). The strategy has identified 4 major development corridors. The corridors are seen as key infrastructure to strengthen and enhance potential value chains as they may relate to the strategic economic clusters or sectors.

At an estimated 153 000 people, Cofimvaba has the highest population in the district, with youth being in the majority. Its population is projected to grow at an average rate of 0.6% from 153 000 in 2016 to 158 000 in 2021 (ECSECC, 2017). Its main economic sectors are community services (52%), trade (14.8%) and agriculture (14.6%). The working-age population in Intsika Yethu in 2016 was 84 200. The top five employment sectors in 2016 were Community services (4 910), Trade (3 110), Construction (2 400), Households (1 170) and Finance (1 130) (Ibid). However, the number of people without any schooling decreased from 2006 to 2016 with an annual rate of -4.87% while the number of people within the ‘matric only’ category increased from 5 380 to 10 000 (CHDM, 2011). A total of 66 700 individuals within the municipal area were considered functionally literate in 2016, equivalent to 67.01% of the population, while illiteracy rate decreased on average by -2.58% annually from 2006 to 2016 (CHDM, 2011).

The public sector dominates the region’s economy with a limited production base and limited private sector investment growth. The area is largely rural which negatively influences the ability to provide health services. The provision of services such as education, youth development and development projects remain a challenge for government. Consequently the region is challenged with a higher demand for basic services as well as housing and infrastructure. More than 75% of households in the district do not have proper and safe forms of sanitation and electricity, while access to social infrastructure is restricted (CHDM, 2011).

A survey undertaken in the node in June 2003 found a rising death rate among the youth due to HIV/Aids together with other common diseases such as cholera and diarrhoea due to the unavailability of purified water and proper sanitation (CHDM, 2011).

### The infrastructure problem and appropriate technology opportunity

In 2016 the majority of households used ventilated improved pit toilets (VIPs) at 14 300, followed by no toilet (9 790); pit toilet (9 760); flush toilet (3 430); and bucket system (108). In 2016 Intsika Yethu Local Municipality had a total number of 4 320 (or 9.31%) households with piped water inside the dwelling, 8 900 (19.17%) with piped water inside the yard, and 16 500 (35.59%) had no formal piped water. When looking at the water backlog (number of households below RDP-level) over time, it can be seen that in 2006 the number of households were 28 300, but this had decreased annually at -2.5% to 21 800 in 2016. The number of households in 2016 with electricity for lighting purposes only totalled 4 990 (11.84%); for lighting and other purposes this was 28 200 (66.86%) while 8 980 (21.29%) did not use electricity.

The data reflect the urgent need for alternative technologies in rural areas that could be localized and sustainable. The CSC was designed and planned to test the appropriateness and longevity of such interventions. As the building construction comes to a close (in 2020), the post-occupancy evaluation and five years’ of building assessment will provide insight into the successful application and implementation of these technologies in responding to the real needs in community and civil buildings.

### Innovative technology options for Cofimvaba Science Centre Project

The core design factors outlined in Table 1 were considered to achieve an appropriate building method and appropriate technologies for the social and economic environment of Cofimvaba. This town in many ways represents a large percentage of rural South Africa. The final selected applications had to support the net zero- energy and net zero-water aspirations, but also support the concept of the living laboratory for teaching purposes.

What are “net zero energy” buildings?

‘A [net zero energy building is a] building that is highly energy-efficient, and the remaining energy use is from renewable energy, preferably on-site but also off-site where absolutely necessary, so that there are zero net carbon emissions on an annual basis (Net Zero), or if the energy from renewable energy results in more energy being produced than what is used on site (Net Positive).’ (GBCSA, 2020).

A net zero water building harvests and reuses as much water on-site as it consumes annually. The design and construction of the CSC has ventured to achieve net zero efficiency for both energy and water, and in doing so aims to be one of only a few such buildings in South Africa, and set a standard for state buildings.

### Appropriate technology solutions

In reference to Table 1 potential technologies that were considered. However, not all the technologies have been incorporated, due to either cost and/or eventual viability. After collaborative investigation by the project design team, a large number have been applied, as presented in Table 2. The collective application of several systems is a collaborative intervention that will achieve the intended result more effectively.

Table 1 Design requirements

Category	Technology Option	Technology Applied	Comment
Electricity	Photovoltaic Panels	Photovoltaic Panels	Individual roof mounted
	Hydrogen Fuel Cell	Hydrogen Fuel Cell	External
	Solar water heaters	Solar water heaters	Hot water radiators
	Solar water space heating	Solar water space	Automated energy management
	Heat pumps	Energy Management System	
	Energy Management System application	Microgrid Wind turbine	
Sanitation	Bio toilets	Bio toilets	Combination of technologies
	Composting toilet	Low flush	Specification of fittings
	Low flush	Reed bed	
	Reed bed		
Water	Rain water harvesting system	Rain water harvesting system	Irrigation purposes
	Sustainable Urban Drainage	Sustainable Urban Drainage	Collection and treatment of surface water
	Grey water recycling	Grey water recycling	Two-pipe drainage system
	Water Management System	Reconstructed wetland Retention landscaping	Automated management Monitor internal reticulation
Building	IBT System	IBT System	Not brick and mortar
	Heat reflective roof	Heat reflective roof	Painted roof sheets
	Attic ventilation	Attic ventilation	Extract vents
	Vented window frames		Reduce risk of condensation
Road surfaces	Permeable paving	Permeable paving	Part of Sustainable drainage system
	Ultra-thin AC pavement	Solar radiation pavement	
	Ultra-thin CRC		
	Solar radiation pavement		
	Air purifying pavement blocks		
External lighting	Solar street lighting	Solar street lighting	Mast lighting
	Solar external lights	Solar external lights	Building lighting
Waste	Recycling facility	Recycling facility (future)	Bins and sorting
Urban agriculture	Communal plots		
Green walls	Solar screens		Vertical planting

### Integrated design and delivery solutions

Achieving a high-performance ‘deep green’ building requires an Integrated Design and Delivery Solution (IDDS). Integrated Design and Delivery Solutions (IDDS) are aimed at

“... transforming the construction sector through the rapid adoption of new processes, such as Integrated Project Delivery (IPD), together with Building Information Modelling (BIM), and automation technologies, using people with enhanced skills in more productive environments” (CIB 2009:3).

Integrated Design and Delivery Solutions use

“... collaborative work processes and enhanced skills, with integrated data, information, and knowledge management to minimize structural and process inefficiencies and to enhance the value delivered during design, build, and operation, and across projects” (CIB 2009:3).

Table 2 is summary of the design strategies and the passive feature they provide. The CSC has been developed as a totally passive project with only split conditioning units installed in two internal spaces.

**Table 2** CSC Applied design strategies

Design Strategy	Applied technology	Passive Design Features Achieved
Insulation: Insulation plays a significant role in passive design because it allows the building to operate optimally regardless of the external environmental conditions. Insulation keeps the heat out in summer while retaining any heat generated inside the building in winter	The Science Centre external walls are insulated concrete formwork (ICF) and light steel frame (LSF) providing a U-value of x and 0.37 (R-value of 2.68) respectively. SANS 204 requires a U-value of 0.52 for Zone 2 (a total R-value of 1.9). The Science Centre therefore exceeds code requirements. The roof makes use of reflective paint on the roof sheets and 70 mm rigid polyurethane board insulation having a U-value of 40 in the ceiling (R-value of 0.025). SANS 204 requires a roof assembly U-value of 0.31 (R-value of 3.2). External doors and windows are double glazed PVC frames with low e glass with an overall U-value of 2.1 (R-value of 0.47).	Highly insulated building envelope
Capture solar heat gain in winter	The window shading devices are designed to allow solar heat gain in the winter. In addition, heat built up in winter in the passive ventilation towers is captured and forced into the classrooms and administration offices.	Shading devices allow ingress of winter solar heat gain. Passive ventilation towers collect winter solar heat which is forced into the classrooms and administration offices.
Restrict solar heat gain in summer	Shading devices (overhangs, deciduous trees) on the north and west elevations are designed to shield the sun from solar heat gain.	Shading devices on north and west elevations. No fenestration on the east elevation.
Natural ventilation	The Science Centre relies on natural ventilation. The classrooms cross ventilate from openable windows to a passive vertical tower driven by a solar heat source at the discharge level. The administration office relies on a Trombe wall to drive cross ventilation. The exhibition space relies on displacement ventilation with low level air entry on the south elevation and high level exhausts on the east and west gables of the saw-tooth roof.	Provide natural ventilation using passive ventilation towers, Trombe wall, and displacement ventilation.
Reduce temperature swings with thermal mass floors	The Science Centre uses an uncovered concrete thermal mass floor slab to store any internal heat energy in summer and winter.	Thermal mass floor
Use of daylight as a primary light source	The Science Centre relies on daylight as a primary lighting source. The window area, narrow floor plate for the classrooms and administration offices, orientation, and the saw tooth roof allow the building to be entirely daylight, reducing the need for energy-intensive internal lighting. The daylighting also increases productivity and reduces stress. If and where necessary, artificial task lighting will be used. The exhibition centre uses a south facing saw tooth roof for lighting. The classrooms and administration offices make use of fenestration for daylighting.	Use daylight as the primary light source

Air tightness	The Science Centre relies on strict construction detailing to avoid leakage.  The building is constructed from ICF and LFS which both provide the dual benefit of high performing insulation and air tightness. Two coats of tape and air barrier material is applied to the joints of the LSF to ensure tight seals between the boarding. The joints between the fenestration frame and the wall are sealed by a purpose-made rubber sealing strip. Opening sections have a rubber seal between the opening edge and the frame (windows and doors).	Sealing of all gaps
External views	The Science Centre makes use of a narrow floor plate for the classrooms and the administration offices together with controlled fenestration opening to ensure external views. The saw tooth roof of the exhibition hall provides external views of the sky, while strategically positioned windows allow external views to the east and the south.	Maximize external views
Sanitation	Smart San system & Reed bed, utilising a combination of technologies Specification of fittings	Re-use of water and pre-cycling of black and grey water
Water	Rain water harvesting system Sustainable Urban Drainage Grey water recycling Water Management System	On site re-use
Electricity	Photovoltaic Panels Wind turbine Hydrogen Fuel Cell Solar water heaters Energy Management System application (Microgrid)	Automated energy management using national grid as backup

Due to limits on this paper’s length, only the energy technologies and construction systems applied in the CSC will be discussed.

### IBT structure & insulated concrete insulation

Light steel frame construction can be described as an off-site method of construction since a lot of the manufacturing takes place in a factory, and the components transported to and assembled on site. This method is also known as ‘dry construction’ as no wet materials, such as cement, are used during the erection process. This speeds up construction as workers do not have to wait for the wet materials to dry and/or cure, and it also reduces the consumption of water, a scarce resource in South Africa. Light steel frame building consists of structural wall panels and/or trusses, assembled using cold-formed steel sections made from thin gauge high-strength galvanised steel sheet. Sections are joined together – typically in a factory – using rivets or self-tapping screws, to form structural wall panels and/or roof trusses which are then transported to site for erection on foundations and floor slabs. The wall frames are clad externally and internally on site with a range of cladding materials, with the services (data, electrical and plumbing conduits) and insulation material installed in the wall cavity. A wide range of exterior and interior cladding is available, and a number of insulation materials may be used including fibre thermal insulation mats, loose fill thermal insulation, reflective foil laminates, flame retardant grade expanded or extruded polystyrene, and rigid polyurethane foam and poly-isocyanurate.

Light steel frame building can either be erected in accordance with the South African National Standard SANS 517:2013 ‘Light steel frame building’, or by rational design prepared by a competent person. The vertical steel sections of the wall panels are at 400 mm centres and the horizontal sections are at 1 200 mm centres. The steel frames are clad externally with 18 mm timber shutter board and finished with cement fibre boards. Internally the steel frame is clad with gypsum board. Insulation is inserted into the steel frame cavities. Typically light steel frame can be used for up to double story building with a maximum height of 6 m, thereafter additional structural support is required (SASFA 2007).

Insulated concrete composite (ICC) generally comprises two external skins of reinforced, high-strength concrete and an inner core of insulation. Various insulation materials are used, including fibreglass, rock wool and polystyrene, although extruded polystyrene (XPS) and expanded polystyrene (EPS) are most commonly used. The sheet size can vary according to the project requirements and window and door openings made in the sheet prior to delivery to site. Generally EPS sheets are erected on site and supported by structural light gauge steel framing inserted into the centre of the insulation sheet. A steel or fibre mesh is attached to the sheet and a 22 Mpa concrete layer about 25 mm thick is sprayed onto the mesh. Typically R-values of 5.0 (U-value of 0.20) can be achieved. Once erected, the ICC wall panels are sprayed on both sides with a high density, fibre-cement technology, called Fibrecote. The combination of Neopor, the *in situ* reinforced substructure, and Fibrecote acts as a composite member, providing load bearing or non-load bearing walls with unparalleled strength with the look, feel, and durability of masonry construction, while offering far superior insulation and STC values, reduced construction time and all at an affordable cost. The Imison 3 Building System (Agrément Certificate) is used on the CSC and comprises:

- concrete surface bed with thickened foundation beams
- a galvanised light gauge, cold rolled structural steel frame
- core infill panels made up of:
  - expanded polystyrene (EPS) with a density of 16 kg/m
  - galvanised steel reinforcing mesh cladding to both sides of the wall panel
  - alkali resistant woven fibreglass reinforcing mat to both sides of the wall panel
  - spray applied fibre reinforced plaster 25 mm thick
  - light gauge steel trusses
  - light weight roof cladding

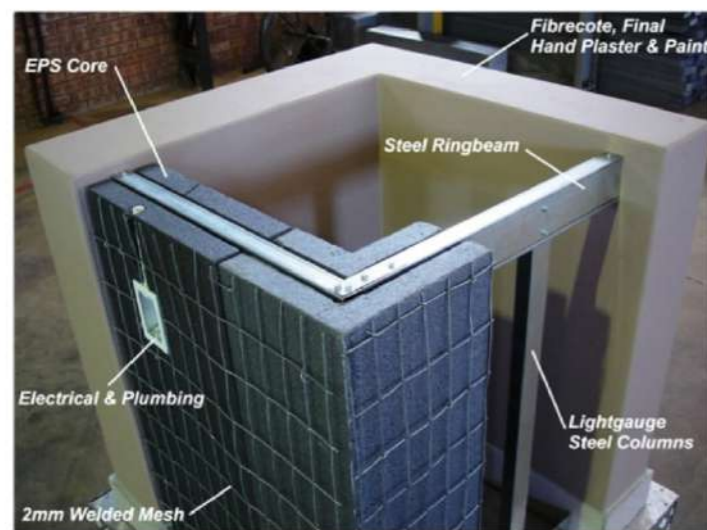
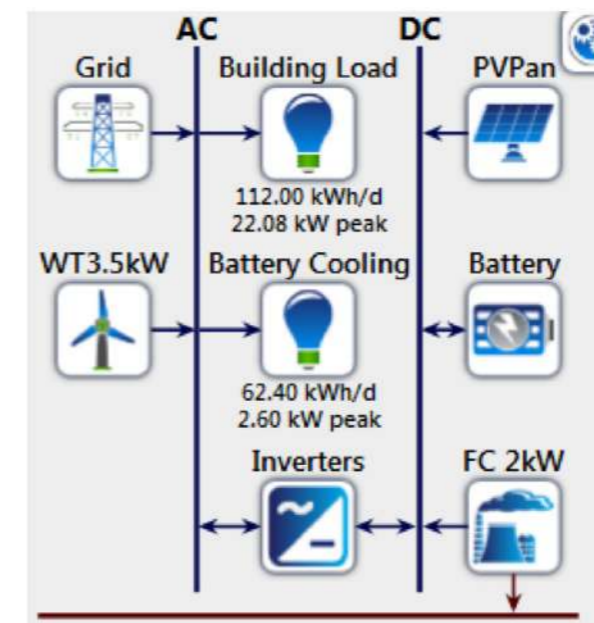


Figure 1 Typical system detail (Imison 2019)

### Energy Generation and Storage

The passive design strategies employed for the Science Centre has resulted in a lower energy demand enabling the Science centre to produce enough energy through the solar panels on the rooftop and the small scale wind turbines to power the building. The Science Centre is also an example of a grid asset: due to the on-site energy generation under circumstances when the building is not consuming all of its energy, the surplus can be fed back into the grid. Based on a comparable science centre the projected energy demand is estimated at 110 000 kWh/year. The power provision of the Cofimvaba Science Centre is unique as it relies on multiple energy sources. It consists of the fuel cell, battery, PV, wind and grid supply with solar water heaters to reduce energy demand. This also introduces complexity into the control system, which is discussed later. The fuel cell system is a PEM (proton exchange membrane) type which is regarded as highly efficient and designed to produce clean energy; in the system chemical energy is converted to electricity (Jian et al. 2015).

The energy efficiency from a fuel cell stack can be as high as 80% (Emanuelsson & Persson, 2007). In the design of the system, two options were considered for providing hydrogen, namely stored hydrogen and an electrolysis process. Renewable energy sources should power the electrolyser, which, in conjunction with battery storage, gives a hybrid energy system with increased reliability and security. This system represents the favoured approach to decarbonized hybrid microgrid systems (Mohammed et al. 2014).



Microgrid generation dispatch merit order:

- 1) Solar PV, wind
- 2) Battery storage
- 3) Hydrogen fuel cell
- 4) Eskom utility grid

Eskom utility grid function:

- Energy reserve
- Backup supply

Requirements

- Stable standalone grid, strong DC bus
- Complies to SMA design rule
- Cost effective solution
- Single load bus controller
- Seamless synchronisation of Eskom voltage and frequency

Figure 2 Electrical System design layout (excluding the HFC) (Element Consulting Engineers & CSIR, 2019)

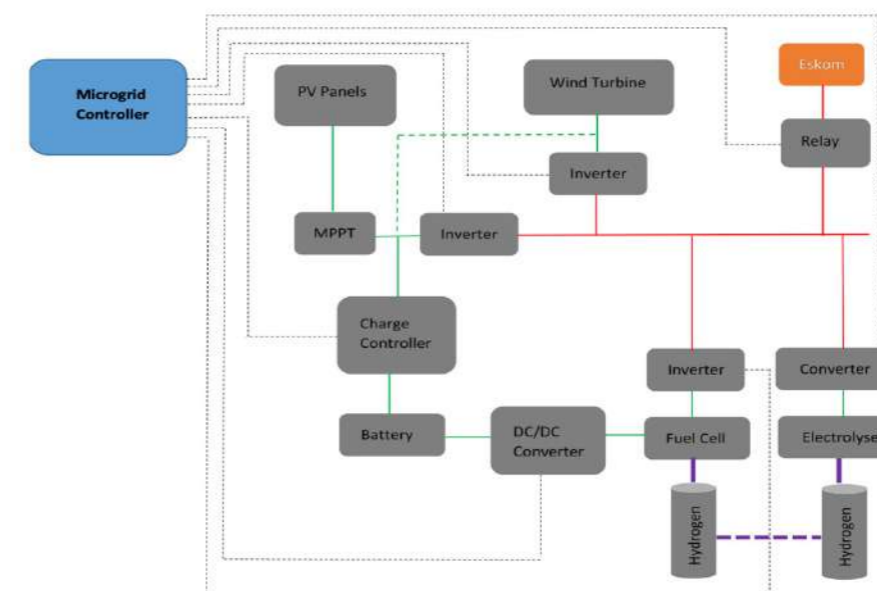


Figure 3 Electrical system Phase 2 control architecture including the HFC (Element Consulting Engineers & CSIR, 2019)



The design of hybrid microgrid systems including fuel cells has been undertaken by a number of authors (Mohammed 2014, Taklimi & Hosseini, 2011, Méziane, Khellaf and Chellali, 2012). These systems are composed of renewable energy sources (photovoltaic panels and wind turbines) and battery backup and storage systems. In such systems the grid is limited to less than 10 000 kWh per annum.

The system at the Cofimvaba Science Centre will use stored hydrogen at 200 bar, to provide 112 kWh per day. The fuel cell system does increase the cost of the system, the number of operations of the system with fuel cell increases significantly. When stored hydrogen is used the fuel cell is expected to operate for 755 hours per annum. Data on the annual generation and load profiles will be used to develop the controller. With the cost of hydrogen expected to decline, this system has the potential to demonstrate the viability of small scale decarbonised hybrid systems, inviting wider adoption of this technology.

### CONCLUSION

The selection and application of appropriate technologies will be an ongoing point of debate. However, when considering the rural built environment of South Africa, solutions are needed. Not only for households but in delivering services. New and innovative approaches are required to deal with old problems and new educational needs. The CSC presented an opportunity to combine cutting edge science and technologies combined with practical passive solutions. The following five years' worth of building performance data will support the next generation of IBT and sustainable technologies for rural environments in South Africa. It goes without saying that the success of any project lies in administrative and procurement efficiency. The technologies applied will improve consumption, demonstrate rapid construction and will reduce lifecycle cost. However, the fiduciary climate and financial controls currently in place for infrastructure procurement in the public sector does not support the gains achieved in this project.

The CSC project will provide educational support to numerous young minds, will broaden and stimulate the future thinkers of the Eastern Cape and serve as a prototype for future civic buildings, net zero government infrastructure and a new model for education and educator support. The building serves as a living laboratory for science and technology, to incorporate curriculum teaching through the building systems as practical aspects. The virtual online streaming and teaching hosted from the SCS site to in excess of 80 rural schools is a 1<sup>st</sup> for the South African schooling system.

### ACKNOWLEDGEMENT

The author acknowledges the financial support provided by CSIR, and investments by the Department of Science and Innovation (DSI) and the Department of Basic Education and Eastern Cape Department of Education (ECDoE). The extensive project team over the past few years (CSIR and consultants) who have contributed to this project, and in particular a former colleague Llewelyn van Wyk, who envisioned and developed this project.

### LIST OF REFERENCES

- Chris Hani District Municipality. 2018. *2018-2020 Draft IDP Review*. Chris Hani District Municipality. Queenstown. [Online] Available from: <http://www.chrishanidm.gov.za/about-us/> [Downloaded: 11 July 2018].
- Emanuelsson, S. and J Persson, J. 2007. *Design of a fuel cell system*. Master's Thesis. Chalmers University of Technology, Sweden.
- Green Building Council South Africa. 2020. *Net Zero* [Online] Available at: <https://gbcsa.org.za/> [Accessed 20 May 2020].
- Hlatshwayo, M. 2020. *Energy Modelling – Cofimvaba Science Centre Microgrid. Report - CSIR\_EC\_ESY\_RPT ('E) March19* Energy Modelling – Cofimvaba Science Centre Microgrid\_[Draft]1.1B. CSIR. South Africa.
- Jian, Q., Zhao, Y., and Wang, H. 2015. An experimental study of the dynamic behaviour of a 2 kW proton exchange membrane fuel cell stack under various loading conditions. *Energy*, 80:740–745.
- Méziane, F., Khellaf, A. and Chellali, F. 2012. Study and dimensioning of a Wind-Electrolyzer-Fuel cell system for the power supply of an isolated site, *Revue des Energies Renouvelables SIENR'12 Ghardaïa*, Algeria, 381–391.
- Mohammed, O.H. 2014 *Optimal Design of a PV / Fuel Cell Hybrid Power System for the City of Brest in France* To cite this version: HAL Id: hal-01023490 Optimal Design of a PV / Fuel Cell Hybrid Power System for the City of Brest. City of Brest, France.
- National planning commission. 2011. *National Development Plan*. South African National Press, 2011:288.
- Southern African Light Steel Frame Building Association. 2007. *SASFA Code for Low Rise Light Steel Frame Building*. Southern African Light Steel Frame Building Association.
- Taklimi, A. and Hosseini, S.R. 2011. *Demonstration Project of the Solar Hydrogen Energy System Located on Taleghan-Iran : Technical-Economic Assessments Demonstration project of the solar hydrogen energy system located on Taleghan-Iran: Technical-economic assessments*. World Renewable Energy Congress-Sweden 2011, 8-13 May, Sweden.

# 'LOW-TECH' AS A METHOD OF FORGING NEW GENDER ARCHETYPES IN THE DESIGN OF A MALE CHILDREN'S VILLAGE IN MARABASTAD, PRETORIA, SOUTH AFRICA

Lourina Grobler, Tshwane University of Technology - Department of Architecture and Industrial Design  
Pretoria, South Africa, lalie28.grobler@gmail.com / 213218239@tut4life.ac.za

## Abstract

This article focusses on homeless boys, and how low-tech housing could go some way towards counteracting the adverse effects of their social situation. It is argued that involving young boys in the development in their living environment could create an incentive for participation and generate a sense of ownership. Alternative construction methods that facilitate this level of engagement could be explored. This study focusses on rammed earth as a building material that can contribute achieve a high level of involvement and as being appropriate for a participatory process aimed at homeless boys aged twelve to eighteen. The project is conceptualised as providing a place of acceptance within the context of Marabastad in the city of Pretoria, South Africa. Preliminary investigations have revealed that suitable spaces for the care and accommodation of homeless children are mostly missing within the current fabric of the inner city. It is believed that a low-tech building prototype could provide a sense of permanence and stability for homeless boys – and it could help create a place of belonging and permanence for those that live very nomadic lives. The use of rammed earth in housing in general, and for the homeless specifically, offers a grounded approach that will be explained in this article.

After collaborating with Asaduru Stabilised Rammed-earth Walling Systems Specialists (Asaduru a, 2020 and b, n.d.), it was apparent to the author that this method of construction is straightforward and easy to understand and construct. It requires minimal skill levels – only a few hours of instruction and some ongoing consultation is needed. Both the sand and cement, the key components needed in this construction technique, can be easily transported and locally sourced. It requires minimal labour but can provide an opportunity for inclusive community engagement. In a country like South Africa, with its high unemployment figures, this method of construction could do more than create just a beautiful environment in which homeless boys could live; this technology could be taught to the boys who reside in a proposed children's village, providing skills, empowerment and making a contribution towards lowering the future rate of unemployment in the area.

The programme proposed goes beyond mere building however: it aims at re-adjusting the focus on and education of homeless boys. In time, this could result in a reduction in the crippling cycle of gender-based violence (GBV) and criminality that such boys are at risk of falling into. Without remedial interventions such as this, many boys could become victims of the same 'broken' cycle that currently exists.

**Keywords:** activism, community engagement, low-tech housing, rammed earth, stability

## INTRODUCTION

The word *appropriate* is taken from Late Latin *appropriatus*, meaning, to “take possession of, take exclusively”. *Technology* is from the Greek *tekhnologia*, meaning, “systematic treatment of an art, craft, or technique”. It originally referred to grammar, from *tekhnō-*, combining *tekhnē* “an art, a system or method of making or doing,” from the root *text-* “to weave,” also “to fabricate.” Lastly the suffix *-logy* – that is a word-forming element meaning “a speaking, discourse, treatise, doctrine, theory, science,” from Greek *-logia*.

Appropriate technology is thus *fabricating exclusive methods to speak*. As architects, we design buildings so that they convey our intended architectural language to the users, the surrounding community and stakeholders. Every building project has a narrative and sentiment that communicates within the craft of its materiality and construction. In this case, it is suggested that a building project could be presented as a method to address social ills through participative construction techniques. It is asked: could the intense layers and folds of masculinity be unpacked, understood and remedied through the layers of rammed earth construction? Could the process of making, working by hand and responding to the qualities of the material engender healing and the alleviation of the stresses that generate social friction?

*Asaduru* (ibid) promote a particular approach to rammed earth construction and it is the chosen low-tech systems approach adopted for this project. This is discussed in more detail alongside some of the theoretical similarities extracted from the literature and from case studies – such as the example of the eco-lodge in Figures 1 and 2.



**Figure 1&2:** Eco-lodge designed by GLH Architects, Free State, South Africa (Cooke, 2020)

In Figure 3, I have attempted to draw parallels between the layers of the context of the study, including the unpacking of the concepts of “gender” and “masculinity”, and the layers of a rammed earth construction. There are several possible critiques of the approach presented in this paper which I will address in this section. Firstly, in the existing context of Marabastad, Pretoria, rammed-earth as a building material seems out of place. It does not relate to the construction methods and physical qualities of the surrounding neighbourhood fabric which tends to be brick structures with IBR roof sheeting. Rammed-earth in itself is currently not a popular choice of construction in South Africa but is slowly becoming more prominent as the focus shifts toward sustainability. It is perceived mostly as a niche method of construction but is actually an established, age-old building technique and perhaps the stigma attached to it needs to be addressed – and this proposed project is one way to do that.

Secondly, it might be argued that we should be advocating for girls. I argue that dedicated spaces for boys are critically needed within the Pretoria Central Business District (CBD). Within the context of the greater Tshwane metropolitan area, social housing for boys is almost non-existent. There is no shelter for boys between the ages of twelve and eighteen (Tlhabye, 2018). The numbers of homeless boys, however, particularly noted in Marabastad, are difficult to pinpoint, as was indicated in an interview with Wayne Renkin of the Tshwane Leadership Foundation (Renkin, 2020). Therefore, a proposed location for a Male Children's Village in Marabastad is crucial, as most homeless people appear to congregate on the periphery of the CBD between Boom and Bloed Streets. Female shelters only accept boys until the age of twelve, due to privacy and spatial limitations; teenagers who are accommodated cannot be within the same space shared with their mother if another female is accommodated in the same shared room. The age of twelve is a legal requirement that is informed by the experience of social workers within the shelters (Renkin, 2020). Unfortunately, this creates a gap and older boys, separated from their mothers, have to integrate into a male shelter. They mostly end up having to fend for themselves on the street.

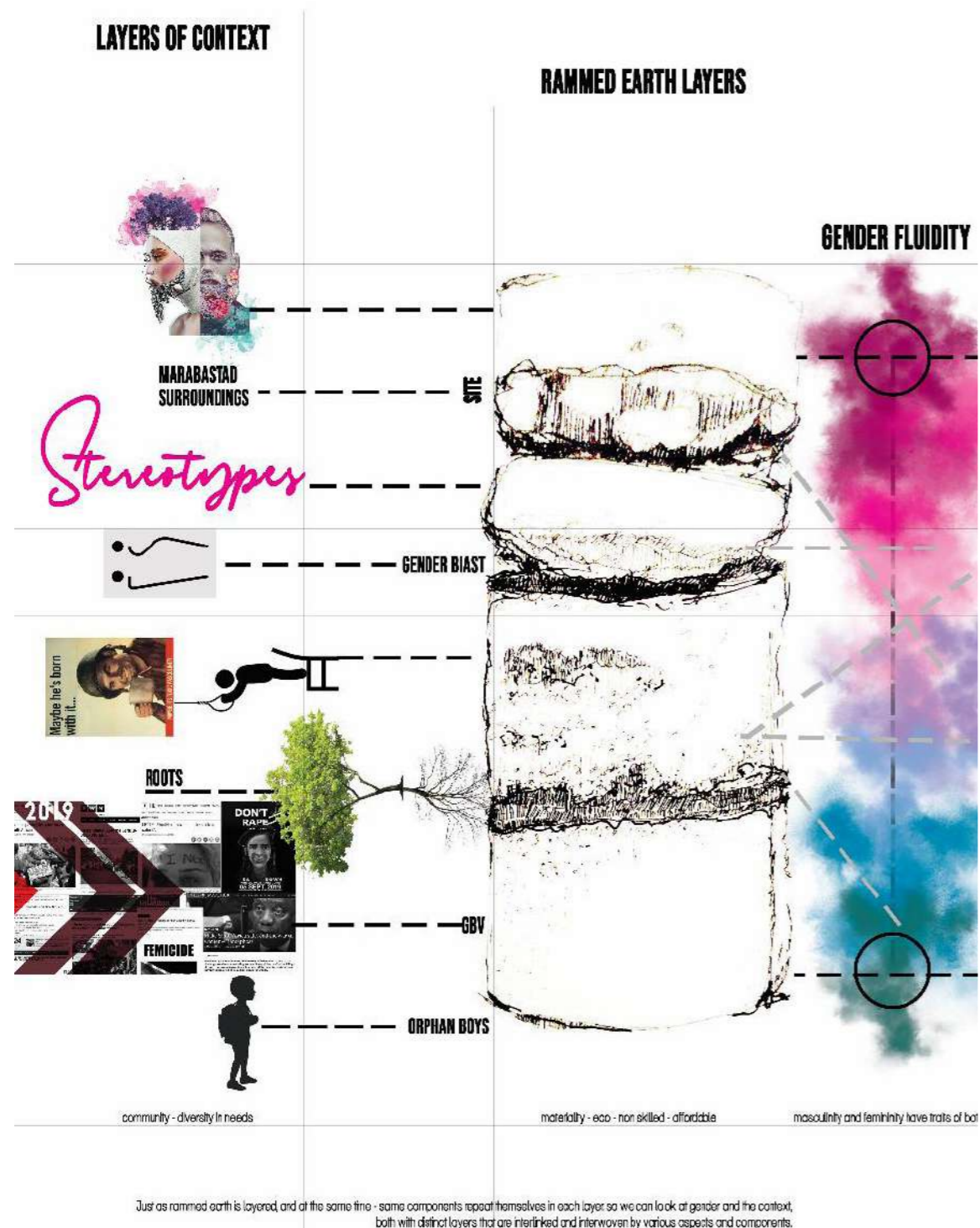


Figure 3: Graphic by the author to illustrate comparisons of community, rammed earth and masculinity.

A study conducted through the Consortium for Street Children (CSC) supports this reality. During 2014, it found that most street children are male African boys around the age of 13. Multiple sources, including the CSC (2014) and (Ward & Seager, 2010) indicate that more often than not, intolerable home situations are reasons for such boys leaving their homes. These unbearable situations include parental abuse and violence, poverty, alcohol and drug abuse, issues at school or even their own bad behaviour. Some instances are due to the death of one or both parents, in which case the family cannot support the child.

In order to re-adjust the focus towards education and provide for homeless boys in Marabastad, this paper sets out, through an example of appropriate technology, to contribute positively to, what I have called, the ‘broken man’ conversation, by empowering communities in South Africa that are crippled so often by Gender-Based Violence (GBV) and criminality. As an indicator, during the first week of the 2020 COVID19 lockdown (27 March until 31 March) in South Africa, over 2 300 cases of GBV were reported, according to Police Minister Bheki Cele. The figure is even more extreme when looked at from January 2020 until 31 March when it stood at 15 924. GBV Command Centre reported that in 2019, the number stood at 87 920 (IOL Staff Reporter, 2020).

GBV brings to the fore issues relating to women, girls, gender and gender-specific design. The use of public buildings is always characterised by fluidity – with a multitude of users during a typical day. This fluidity is addressed in two ways. Firstly, through colour psychology and addressing of stereotypes; pink is mostly associated with girls/women. The colour itself is associated with unconditional love, empathy and understanding. The effects can range from calming emotions to warmth and tenderness. Different shades offer different sentiments; orchid relates to non-conformist views; fuchsia inspires confidence; and blush is non-threatening. (Empowered by colour, n.d.). It is suggested that the use of pink used in relation to both sexes can perhaps be comforting to girls/women while also breaking stereotypes and encouraging changes in behaviour.

*“Without a doubt, pink for me is something that has been weaponised against women,” she says. Girls get pink toys, pink clothes, pink play kitchens; the fact that the colour is absent from traditional corporate suites “is tied into who belongs in the workplace,” Lee from The wing Soho, a women-only workplace and social club founded in 2005 (Krichels, 2018)*

The second observation is that the focus on masculinity is deeply rooted in feminism and its overall assumed basis of gender equality. How could this understanding of equality translate into architectural space and form? It is believed that gender-specific spatial design which focusses on boy-orientated programmes could help establish this parity.

### COMMUNITY

The word ‘community’ in this context refers to the direct neighbouring citizens in Marabastad. This neighbourhood is also where locally sourced materials are acquired — sand and cement may be transported easily. *Asaduru* does, however, use the internationally sourced *Peri* formwork, which should be adjusted to a locally produced *Marine-ply* formwork, similar to concrete shuttering methods that are standard in South Africa. Locally-sourced materials provide an overall lower carbon footprint to the project but also open the door for transformation in the larger community of *Marabi* (a colloquial phrasing used instead of Marabastad). The implied relationship between the context and the building material is explored in this study.

There can now be an active transfer of knowledge and skills initiated by the construction method. During an independent study conducted in 2017, Sing hypothesised that the majority of residents in the survey had familiarity with earth construction and were willing to learn more and use it to construct their own houses. The survey, conducted in the Iterileng township, aimed to establish if earth construction done by residents themselves could replace existing methods of low-cost housing to improve living conditions in informal settlements. It could also provide a faster way of building to address the severe backlog of low-cost housing provided by the South African government. Sing also indicated that there was a negative connotation to earth construction, but that demonstrations and discussions could change the perception of users (Sing, 2017:117-119). The research indicated that rammed earth could also be appropriately used within *Marabi*.

Additionally, labourers from within the community may be empowered through the acquisition of skills, thus rendered more employable in the construction industry. The design of a male children’s village intends to collaborate with, and uplift the local community; this project exposes the harsh reality of the lack of similar spaces within the study context. Uplifting areas and dedicated spaces for boy children were found to be absent during preliminary site investigations in 2019. This expansive community uplifting scheme could be made possible with this children’s village programme that forms the basis for a tight-knit community.

## LAYERING

The idea of ‘tight-knit’ families and family groupings could be linked to rammed-earth as a layered, tightly-packed or compound. This ramming of the earth to compact it, also done by hand, and not necessarily with pneumatic compactors; this provides an additional quality of handcrafted-ness. Each wall is different; each segment has character. There is no mass production: no factory precast rammed-earth walls; different soils, adding pigment or cement, various stones and layer thicknesses, contributes to the resultant individuality.

‘Precast’ is currently the institutional system standard known as foster care. A family unit, on the other hand, works similarly to rammed-earth; every family is unique, just as every wall is unique. The programme is aimed at doing the same, provide family instead of an institution that does not take into consideration each individual. On a national scale, a prominent case study would be *Girls and Boys’ Town (GBT)*, South Africa. It is functioning as educator, institution and family at various levels for different situations and children. Using the S.H.I.N.E.® acronym as a departure point for their approach to helping vulnerable youth establishes the appropriateness of it as a case study. S.H.I.N.E.® stands for Significance – Home – Independence – Nurture and lastly, Education (GBT-About, s.a.).

If each boy that comes through the doors of the anticipated village could feel important within a family and educated towards independence with the guidance of proper male role models, the hypothesis would be successful. These boys would then be able to re-invest in future generations as better-acclimatised male adults.

What archetype (prototype/template/ possible outcome, one configuration of potential)? provides space for these layers of social interactions and educational consulting based on family dynamics (i.e. mother types, and or, father types) and provides space for these proper role models to also interact with the community. This design proposal offers room for positive role models to interact with, and positively influence, homeless boys.

This article aims to then, critically, understand the role appropriate architectural technology can play in the provision of gender-shaping platforms and the unearthing of a new archetypal process of design that can contribute to better-acclimated societies. Therefore, there is a pursuit of provocative conversation that promotes new versions of envisioned reality. The use of pink integrated into rammed earth walls strengthens this archetype, an appropriate application for gender shaping platforms. By doing so, we can contribute to the new versions of reality as stated above – through establishing a space for equality. Rammed earth, also, in its forgiving handcrafted presence, becomes a metaphor for space itself being a gracious space for children seeking redemption and betterment.

## Place-making

Rammed earth is a solid mass; it emits warmth and sturdiness, groundedness, stability – an element that can support everything that lies on it. There is also an unfinished roughness and brutishness about rammed earth that resonates with the intended focus group; boys that are mostly in unstable environments – all qualities that can cause great insecurity and vulnerability.

The programme proposed aims to design a building harnessing the good qualities of rammed earth and launching a platform for social innovation at an unimposing scale to these boys. Using the fine grain of *Marabi* as a launchpad, a stable home life is argued to be key towards children thriving and becoming thoughtful, responsible adults. Children need a home where they can feel valued, loved and important. This becomes the scale to operate at – smaller, intentional, available, invested, secure, inviting, warm and homely.

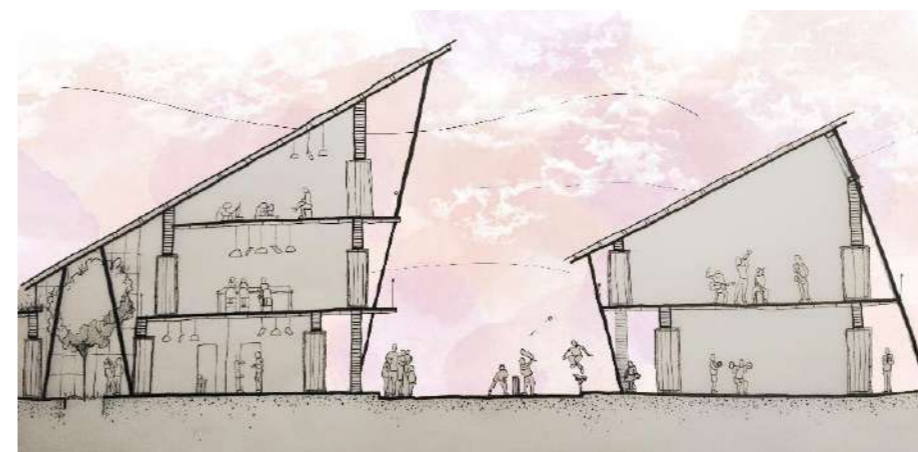
The intended deliverable results are a stable home for a usually disregarded boy. The proposed environment would provide investment in boys’ futures, with a drop-in centre that can initiate relationship and trust. With additional elements of counselling, education, hobby exploration as well as skills development, spaces could be created that could ensure a successful and fruitful future.

On a simple level, architecture can provide environments where skills for traditional and non-traditional roles can be developed – not only for these boys but also for adult males that seek to improve or reinvent themselves. It is interesting to note that in Tshwane, women-headed households are becoming more evident and in 2011, made up 35% of households (Africa, 2011). An example then for one of these multifunctional spaces that boys use during the day could be a dedicated space for cooking

classes at night. This would be intended for househusbands, but not exclusively, who have now taken up this newly reinvented role out of necessity. To address the current social practices and beliefs that are generating warped values, it is suggested that architecture could serve as a platform for the construction, and adoption, of new societal values.

This article investigates new sets of understanding gender archetypes that can help move the conversation forward within an appropriate architectural and technological solution. The concept of place-making can be explored through the materiality of the building and a technology that may be perceived as being as solid as the earth itself. This meaning attributed to particular structures and materials may have an impact on broadening our perception of social conditions. This metaphor has been explored through a series of design experiments.

Figure 4 shows how the concept of “place-making” is explored in a section drawing. In this drawing the author showcases the relationship of people to space and how decisions can be made with regards to space, scale, enclosure and boundary that could be appropriate to the context and the programme of the building.



**Figure 4:** Design exploration – An active exploration of place-making in a section.

## Methodology

While it is not possible to delve deeply into related concepts in this paper, it is acknowledged that the problem presented here needs to be understood in the context of theories of race and gender history in South Africa. Critical theory, as Judith Butler describes the research movement, is an appropriate approach, specifically within gender in architecture, thereby, responding appropriately to the current day and age. Butler, a gender theorist, has influenced more than just gender; she has also looked at feminism, queer-, literary- and political theory as well as ethics. Butler seeks to transform and overcome a wide range of oppressions and inequalities in society, as she discussed in an interview with *The New Yorker* (Gessen, 2020).

The research issues a series of sketches, writings and diagrams that intend to provide insight into how each theory critically influences the resulting design. The initial literature reviews included several studies on gender theory, masculinity, homelessness and specifically boy activism. It aims to establish a way forward for architectural interpretation through more than just the shell that houses function as.

All of the explored concepts influence and inform the complex language of masculinity allowing the researcher a better understanding of designing gender-specific housing and how it may help generate a tectonic and architectural language appropriate to the surrounding built fabric and for the focus group of homeless boys.

A mixed methodology approach is formulated to incorporate a broader approach to the project. A combination of the above mentioned, along with Critical theory and Constructivist methodology establishes the process.

Figure 5 is a mind map by the author to tie together the different conceptual aspects of the proposed project. Figure 6 is a representation of some explorations made into the technology in the TUT Architecture Maker Space.

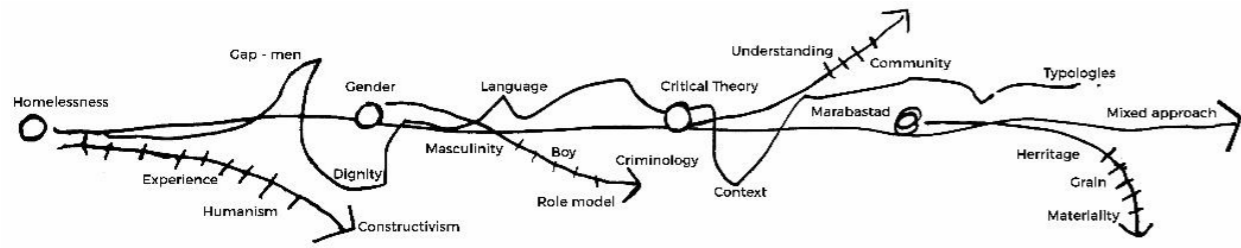


Figure 5: Methodology approach explained in a mind map.

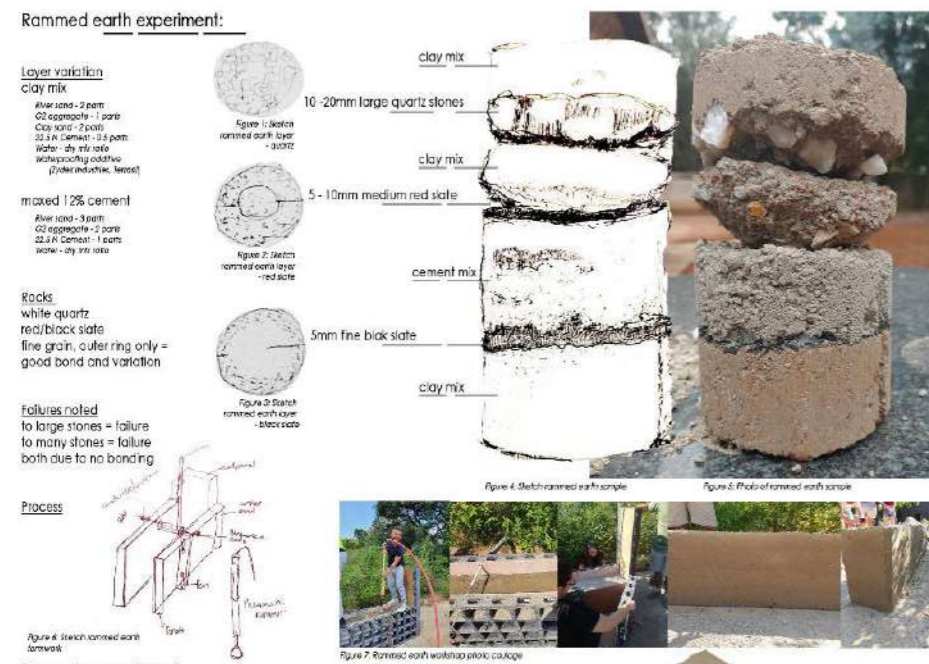


Figure 6: Graphic showcasing the author's explorations at the TUT Architecture Maker Space.

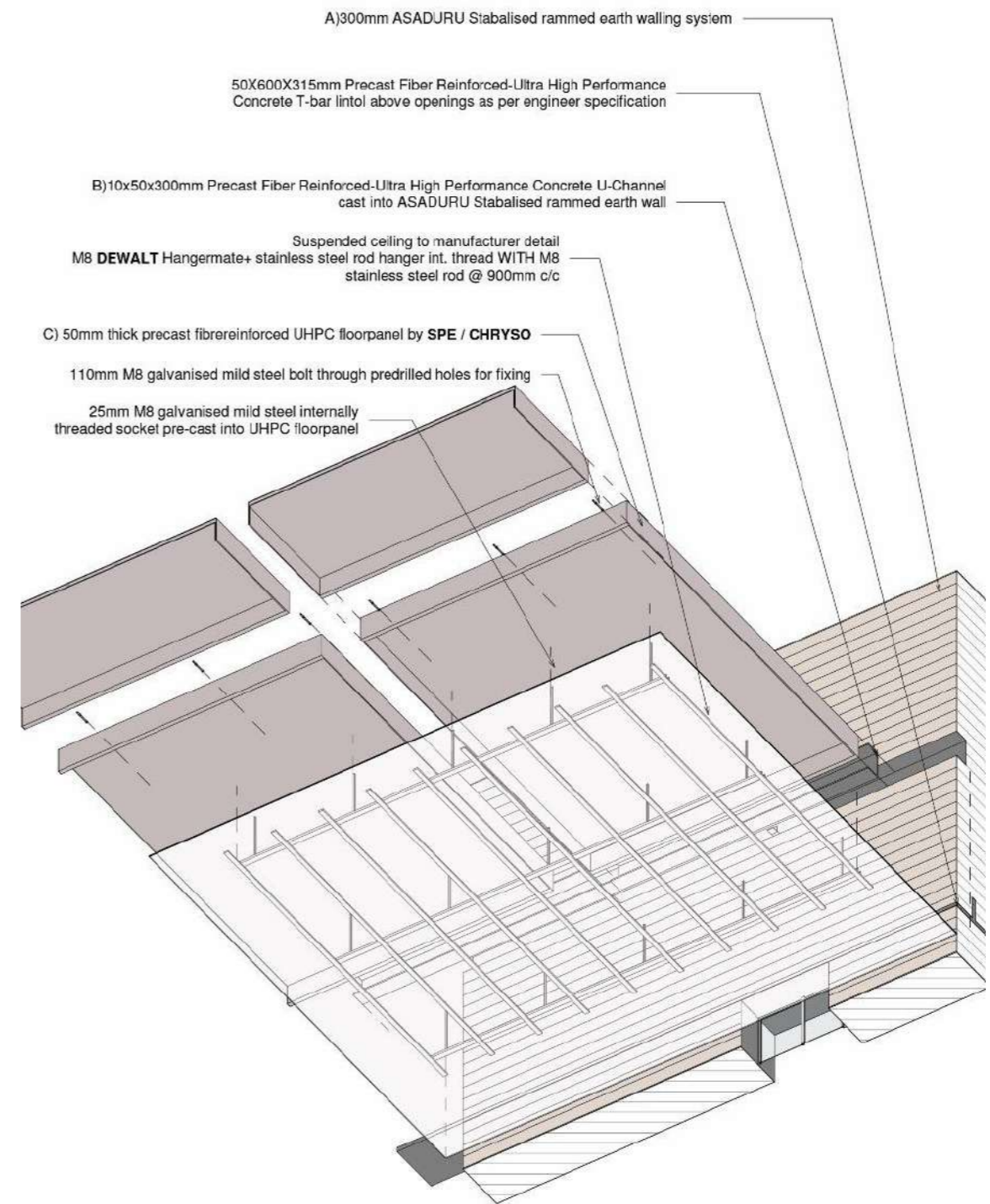


Figure 7: Technical exploration - Exploded 3D from below; Scale 1:25 @A1.

## CONCLUSION: MOTIVATING FOR STABILITY

The elemental quality of rammed-earth gives it its stability, and this has been used as a metaphor in this article to establish a relate-ability between the deliberate and purposeful selection of a building material and technique and the programmatic purpose of a building. It is believed that this technology could help in the creation of space that is intentionally warm, forgiving in its hand-crafted imperfections, that can establish solid boundaries and structure, and – above all – provide dignity and value to those that typically go unnoticed.

The South African Constitution is one of only a few in the world that directly addresses dignity and the restoration thereof to its people. It is described in *Chapter One – The founding provisions* but also in *Chapter Two – The bill of rights (SA Constitution, 1996)*.

Chapter One indicates the founding values of “*Human dignity, the achievement of equality and the advancement of human rights and freedoms.*” (SA Constitution, 1996:2). Chapter Two cites ‘*human dignity*’ and states that “*Everyone has inherent dignity and the right to have their dignity respected and protected.*” (SA Constitution, 1996:6)

The conclusion is that at this specific point in time – the year 2020 in this country - that is South Africa within the community that is Marabastad, Pretoria, there is no dignity afforded to the homeless, and even less equality towards homeless boys in particular.

This conclusion is grounded in a local case study that incorporates various articles in 2019 that indicate the gap in the social housing structure within South Africa. The following are extracts:

### Plea for plight of homeless boys

“Renkin said there were many families on the streets with their children, because by law many shelters were not legally allowed to accept boys older than 12. Men and boys were historically never on the radar, he said, and even getting government funding for them was a challenge. ‘I honestly feel having this kind of preferential treatment is what perpetuates the cycle of violence; there is no place or nothing that stops that cycle of violence and it continues and grows,’ Renkin said.” (Tlhabye, 2018).

### Treatment of homeless people in the spotlight

“‘He said homelessness could be linked to poverty, mental health, crime, human trafficking, drug addiction and women and child abuse.’ Wayne Renkin, of the Tshwane Leadership Foundation.” (Mahlokwane, 2019)

It is this lack of dignity and equality that needs to be addressed and advocated for by providing stability for the vulnerable with a construction method that in itself advocates for change.

## LIST OF REFERENCES

- Asaduru (a), 2020. Verbal communication with the author on 9 March. Studio 55, Krugersdorp. (Transcript/notes/recording in possession of the author).
- Asadura (b), n.d., available at <https://www.asaduru.com/>, [Accessed: 2020, October 14]
- Baldwin, Eric. 2018. *Children Village by Aleph Zero and Rosenbaum Wins 2018 RIBA International Prize*. [Online] Available from: <https://www.archdaily.com/906258/children-village-by-aleph-zero-and-rosenbaum-wins-2018-riba-international-prize> [Accessed: 2020, May 03].
- Cooke, Luciana. 2020. *Witklipfontein eco-lodge by GLH architects emerges from the earth in South Africa*. Designboom [Online] Available from: <https://www.designboom.com/architecture/witklipfontein-eco-lodge-glh-architects-south-africa-03-09-2020/> [Accessed: 2020, May 20].
- CSC. 2014. *Street Children in South Africa: Findings from interviews on the background of street children in Pretoria, South Africa*. CSC. [Online] Available from: <https://www.streetchildren.org/resources/street-children-in-south-africa-findings-from-interviews-on-the-background-of-street-children-in-pretoria-south-africa/> [Accessed: 2020, August 18].
- Dauids, Lorenzo. 2019. #changethestory: *The lives of street people have not improved*. IOL, 30/07. [Online] Available from: <https://www.iol.co.za/capeargus/opinion/changethestory-the-lives-of-street-people-have-not-improved-30059725> [Accessed: 2020, May 11].
- Funderstanding. 2011. *Constructivism | Philosophy of Learning | Funderstanding: Education, Curriculum and Learning Resources*. [Online] Available from: <https://www.funderstanding.com/theory/constructivism/> [Accessed: 2020, February 25].
- GBT. s.a. *About*. [Online] Available from: <https://www.girlsandboystown.org.za/about/> [Accessed: 2020, May 18].
- Gessen, M. 2020. *Judith Butler Wants Us to Reshape Our Rage*. *The New Yorker*, 09/02. [Online] Available from: <https://www.newyorker.com/culture/the-new-yorker-interview/judith-butler-wants-us-to-reshape-our-rage> [Accessed: 2020, February 27].
- Krichels, Jennifer. 2018. *Architecture of Gender*. *Oculus-magazine*. [Online] Available from: <https://www.aiany.org/membership/oculus-magazine/article/winter-2018/architecture-of-gender/> [Accessed: 2020, August 24].
- Mahlokwane, James. 2019. *Treatment of homeless people in the spotlight*. IOL, 02/07. [Online] Available from: <https://www.iol.co.za/pretoria-news/treatment-of-homeless-people-in-the-spotlight-28416404> [Accessed: 2020, May 11].
- Online Etymology Dictionary. s.a. [Online] Available from: <https://www.etymonline.com/word/technology> [Accessed: 2020, May 13].
- Renkin, W. 2020. Verbal communication with the author on 7 September. Tshwane Leadership Foundation Office, Pretoria. (Transcript/notes/recording in possession of the author).
- Singh, Sanisha. 2017. *Using earth construction in informal housing to achieve sustainable informal settlements: A case study in Itireleng, Tshwane*. Unpublished (Masters in Architecture) thesis. Tshwane University of Technology. [Online] Available from: <http://tutvital.tut.ac.za:8080/vital/access/manager/Repository/tut:4286> [Accessed: 2020, August 23].
- Staff Reporter. 2020. *Cele welcomes drop in crime, but gender-based violence cases still high*. IOL, 05/04. [Online] Available from: <https://www.iol.co.za/news/south-africa/cele-welcomes-drop-in-crime-but-gender-based-violence-cases-still-high-46262416> [Accessed: 2020, May 15].
- Statistics South Africa. 2011. *Female-headed households*. [Online] Available from: [http://www.statssa.gov.za/?page\\_id=993](http://www.statssa.gov.za/?page_id=993) [Accessed: 2020, March 01].
- South African Government. 1996. *The SA Constitution*. [Online] Available from: <https://www.justice.gov.za/legislation/constitution/chp01.html> [Accessed: 2020, January 10].
- Tlhabye, Goitseman. 2018. *Plea for plight of homeless boys*. *Pretoria News*, 16/04. [Online] Available from: <https://www.iol.co.za/pretoria-news/plea-for-plight-of-homeless-boys-14466665> [Accessed: 2019, December 15].
- Ward, C.L. & Seager, J.R. 2010. South African street children: a survey and recommendations for services, Human Sciences Research Council (HSRC) in *Development Southern Africa*. 27(1):85–100.

# THE POTENTIAL CONTRIBUTION OF INDUSTRY 4.0 TO THE CONSTRUCTION INDUSTRY

John Shaidi and John Smallwood, Nelson Mandela University, South Africa.  
john.smallwood@mandela.ac.za

## Abstract

*The aim of this study was to determine the perceived potential of Industry 4.0 to contribute to improved productivity, quality, and time performance.*

*A quantitative research approach was adopted, which entailed a web-based questionnaire and the sending of personalised e-mails to construction industry professionals in the City of Port Elizabeth, South Africa. Statistics, which included frequencies and a measure of central tendency, are used to discuss the findings.*

*It was found that the factors that contribute to poor performance can be considered to do so to a major, as opposed to a minor, extent. It was also found that Industry 4.0 interventions were perceived to be able to mitigate the factors that contribute to poor performance due to the late completion of projects, compromised quality and poor productivity to a major, rather than minor, extent.*

*The conclusion was that the adoption of Industry 4.0 technologies afforded an opportunity for the South African construction industry to improve its performance in terms of productivity, quality, and time performance.*

*It was recommended that the level of awareness of Industry 4.0 technologies should be raised, that tertiary built environment education should include Industry 4.0 in the respective curricula, and that built environment practices and contractors should implement Industry 4.0 technologies on their projects, while documenting the benefits of doing so.*

**Keywords:** construction, improvement, Industry 4.0, performance.

## INTRODUCTION

Delays in the completion of construction projects are a recurring problem in the construction industry and occur on a global scale (Enshassi, Al-Najjar, & Kumaraswamy., 2009). A global study determined that only 25% of construction projects over the past three years were completed within 10% of their original deadlines (Autodesk & Chartered Institute of Building (CIOB), 2019). The World Economic Forum (WEF) (2016) states that the overall productivity in the construction industry has remained nearly flat for the past 50 years, adding that, in the United States of America, labour productivity in the construction industry has actually fallen over the past 40 years.

Within the context of South Africa, the Construction Industry Development Board (cidb) (2016) highlighted a range of performance issues. These performance issues were as follows: clients were neutral or dissatisfied with the performance of contractors on 18% of the projects surveyed; clients were neutral or dissatisfied with the construction schedule performance of contractors on 26% of the projects; approximately 13% of the projects surveyed had levels of defects which were regarded as inappropriate; and there was a noticeable increase in the levels of defects over the period of 2012 to 2015.

The manufacturing, automobile and banking sectors have already tapped into the future by adopting a fully digital approach to the fourth industrial revolution, commonly referred to as Industry 4.0, in their everyday business. This, therefore, contributes to their productivity, accuracy, efficiency and improved client satisfaction (Osunsanmi, Aigbavboa & Oke, 2018). However, the construction industry is still dominated by a paper-based communication system for relaying information. The construction industry needs to adopt a similar approach to the manufacturing, automobile and banking sectors so as to improve its performance by enhancing its ability to monitor construction projects during the design, construction and in-use phases, so as to deliver enhanced productivity (Osunsanmi *et al.*, 2018).

The concept of Construction Industry 4.0 is based on the principles of creating a smart construction site, simulations and the virtual storage of data. This enables construction firms to arrange and evaluate data from not only different stages of construction projects, but also from end users after completion. The aim of this is to deliver faster, more flexible construction projects to meet quality requirements and reduce costs. However, despite the advantages and benefits of applying Industry 4.0 concepts to construction projects, limited studies have been conducted in South Africa towards examining the awareness of construction industry practitioners in terms of the application of Industry 4.0 in the construction industry (Oesterreich & Teuteberg, 2016).

According to the Construction Industry Training Board (CITB) (2018), the construction industry has vast potential for improving materials handling, productivity, efficiency, quality, mitigating material wastage, and improving client satisfaction through the implementation of digitalisation, innovative technologies and new construction techniques. The rapidly emerged augmented reality, drones, 3D scanning and printing, building information modelling (BIM), autonomous equipment and advanced building materials, all of which have reached market maturity, are all potential contributors.

Autodesk & CIOB (2019) refer to the number of new technologies and their potential, on an individual basis, to change one or more aspects of the construction industry. They also highlight how the synergy between the technologies causes an even greater impact by transforming how buildings and structures are designed, constructed and operated. They contend that these changes are about to transform the industry by radically improving productivity, quality, health and safety, while also reducing environmental impact and changing business models.

Given the general level of performance of the South African construction industry, the advent of Industry 4.0 and the limited research that has been conducted relative thereto, a study titled ‘The Potential Contribution of Industry 4.0 to the Construction Industry’ was conducted. The objectives, relative to this paper – which reports on a component of the study – were to determine the extent to which:

- factors contribute to the late completion of projects, quality non-conformances and poor productivity; and
- Industry 4.0 interventions could mitigate factors that contribute to the late completion of projects, quality non-conformances and poor productivity.

## REVIEW OF THE LITERATURE

### Causes of delays

Research conducted on the causes of delays among large construction projects by Haseeb, Bibi and Rabbani (2011) identified the most influential factors as: improper planning of the project; poor site management and coordination; inappropriate coordination of information; and lack of experience among workers. Dolo, Sawhney, Iyer and Rentala (2012) investigated the factors influencing project delays on construction projects by surveying construction professionals. Factor analysis identified the most influential factors as: absence of project personnel commitment; improper site management; poor communication; and substandard contracts.

### The potential of Industry 4.0 to mitigate delays

Sørensen, Olsson and Landmark (2016) reported on the use of drones to monitor construction progress. Drones automatically survey and inspect a site, collecting video footage daily. This footage is then converted into a 3D view of the site, which is fed into BIM software that compares it against computerised architectural plans, as well as the construction work plan, showing when each element should be completed. The BIM software may also assist by indicating to designers and contractors how the project is progressing, and may automatically highlight activities that may be falling behind schedule. This enables contractors to take timeous remedial measures so that the project may proceed according to schedule (Sørensen *et al.*, 2016).

### Causes of quality non-conformances

The cidb (2011) report titled *Construction quality in South Africa: A Client perspective* reviewed the state of quality in South African construction. A study conducted specifically for the report identified the top ten barriers to the achievement of quality. These barriers were: poor site management (planning, organising, leading, controlling, and coordinating); lack of contractor quality expertise; corruption; inadequate resourcing by contractors; lack of understanding of quality; level of subcontracting; inadequate information; detail; focus on cost by contractors; and poor constructability.

### The potential of Industry 4.0 to mitigate quality non-conformances

Big data and BIM models change a passive situation. Whereas projects managed in the traditional manner rely on paper documentation or personalised network communication to deliver project information, the use of Internet technology can now enable participants to understand the progress of the project in real-time, allowing them to search for the latest, most accurate and most complete project data. It reduces quality problems caused by the inefficiencies that result from low collaboration, and it is an important way to realise the modification and information management of the construction industry (Wang, Fan, Fu & Zhang, 2018).

### Causes of poor productivity

According to the cidb (2015) report, employers identified the five most influential factors affecting labour productivity in the construction industry of South Africa. These factors were identified as: wages; transport; morale of workers; employee benefits; and absenteeism. Moswane, Aigbavboa & Mewomo (2018) state that four groups of factors have the greatest impact on labour productivity in South African construction. These factors are: management in the form of poor communication and absence of a motivation programme; unavailability of material and ineffective equipment; labour-related factors in the form of a shortage of resources and experience; and technical-related factors such as the complexity of projects and poor organisation.

### The potential of Industry 4.0 to mitigate poor productivity

Mobile and Internet of things (IoT) technologies may be applied to automate productivity reporting in near real-time, as immediate feedback allows workers to comprehend how they are performing. This causes a shift in how firms operate by enabling them to improve their businesses in near-real-time (Shomberg, Clemmons, Anderson & Ramanathan, 2018). Further, through the application of BIM, construction firms can plan, coordinate and design with an integrated approach, which is one of the many benefits of improved productivity (Aripin, Zawawi & Ismail, 2019). The CITB (2018) cites the use of automated autonomous vehicles to undertake repetitive tasks such as laying roadways and conducting excavations to improve productivity.

### Achieving digital transformation

Ho (2019) advocates focusing on three core pillars, namely technology, people and process, to achieve successful digital transformation. In terms of technology, full-scale digital transformation requires integrated, cohesive systems, as opposed to siloed data and technology. To successfully achieve this, firms must focus on resolving problems rather than on just installing the latest most popular digital solution. In terms of people: given that construction is a 'people' industry, firms must focus their attention on who they involve in both the purchasing and the implementation process. Doing so will prevent a disconnection between people and the technology. In terms of process, to increase the likelihood of successful digitalisation, it is important that firms first identify operational changes that will improve performance, and then define the digital standards, which include the process change, required enablers and the expected benefits.

## RESEARCH

### Research method and sample stratum

A quantitative research method was adopted and a web-based questionnaire survey was conducted in the building sector of the construction industry in the city of Port Elizabeth, South Africa. The questionnaire consisted of 26 questions, most of which were five-point Likert scale-type questions. The link to the questionnaire and the cover letter, which explained the purpose of the study and instructions regarding how the questionnaire should be completed, was e-mailed to the sample stratum.

The questions, the responses to which are reported on, were:

- On a scale of 1 (minor) to 5 (major), to what extent do the following factors contribute to poor performance in the form of the late completion of projects?
- On a scale of 1 (minor) to 5 (major), to what extent do the following factors contribute to poor performance in the form of compromised quality / non-conformances?
- On a scale of 1 (minor) to 5 (major), to what extent do the following factors contribute to poor performance in the form of poor productivity?
- On a scale of 1 (minor) to 5 (major), to what extent could the following interventions mitigate the factors contributing to poor performance in the form of late completion of projects?
- On a scale of 1 (minor) to 5 (major), to what extent could the following interventions mitigate the factors that contribute to poor performance in the form of compromised quality / non-conformances?
- On a scale of 1 (minor) to 5 (major), to what extent could the following interventions mitigate the factors that contribute to poor performance in the form of poor productivity?

Of the 60 registered construction professionals who were requested by means of an e-mail to participate in the study, 30 responded, which equates to a response rate of 50.0%.

### Research findings

Of the respondents, 56.7% were construction project managers, and 43.3% were construction managers; 90.0% of the respondents were male, and 10.0% were female; 23.3% of respondents were  $\leq 40$  years of age, and 76.7% were  $> 40$  years of age; 13.3% of respondents had  $\leq 10$  years of work experience; and 86.7% had  $> 10$  years of work experience. Lastly, 40.0% of the respondents possessed a master's degree, 20.0% a bachelor of technology / honours degree, 30.0% a diploma / bachelor's degree, and 9.9% a national certificate or less.

Table 1 indicates the extent to which 23 factors contribute to the late completion of projects in terms of the percentage of responses to a scale of 1 (minor) to 5 (major), and a mean score (MS) ranging between 1.00 and 5.00, with the midpoint being 3.00. It is notable that all the MSs are  $> 3.00$ , which indicates that, in general, the factors contribute to the late completion of projects to a major, rather than a minor, extent.

Only 3 out of 23 (13.0%) MSs are from  $> 4.20$  to  $\leq 5.00$ , which indicates the factors that contribute between a near-major extent to a major / major extent to the late completion of projects. These factors are rework, poor decision making and late provision of information.



**Table 1:** Extent to which factors contribute to the late completion of projects.

Factor	Response (%)						MS	Rank
	Un-sure	Minor .....Major						
		1	2	3	4	5		
Rework	3.3	0.0	0.0	10.0	33.3	53.3	4.45	1
Poor decision making	0.0	0.0	6.7	3.3	33.3	56.7	4.40	2
Late provision of information	0.0	0.0	3.3	10.0	46.7	40.0	4.23	3
Poor site management	0.0	6.7	3.3	6.7	30.0	53.3	4.20	4
Poor coordination of subcontractors	0.0	0.0	6.7	6.7	46.7	40.0	4.20	5
Underestimation of the complexity of the work	0.0	3.3	6.7	0.0	46.7	43.3	4.20	6
Inappropriate coordination of information	0.0	0.0	3.3	10.0	50.0	36.7	4.20	7
Poor site supervision	0.0	6.7	3.3	10.0	23.3	56.7	4.20	8
Inadequate planning	0.0	0.0	10.0	10.0	33.3	46.7	4.17	9
Poor communication	0.0	0.0	6.7	10.0	43.3	40.0	4.17	10
Late ordering of materials	0.0	0.0	13.3	10.0	26.7	50.0	4.13	11
Poor coordination on site	0.0	0.0	10.0	6.7	43.3	40.0	4.13	12
Impractical allocation of resources	0.0	6.7	6.7	6.7	33.3	46.7	4.07	13
Slow to give instructions	0.0	3.3	3.3	16.7	43.3	33.3	4.00	14
Incomplete documents	0.0	0.0	3.3	23.3	43.3	30.0	4.00	15
Poor logistic management	0.0	0.0	16.7	3.3	43.3	36.7	4.00	16
Late delivery of materials	0.0	3.3	6.7	23.3	23.3	43.3	3.97	17
Design changes	0.0	0.0	3.3	30.0	33.3	33.3	3.97	18
Shortage of materials	0.0	6.7	3.3	13.3	40.0	33.3	3.93	19
Change of scope	0.0	0.0	6.7	23.3	43.3	26.7	3.90	20
Poor procurement strategies	0.0	0.0	20.0	0.0	56.7	23.3	3.83	21
Shortage of plant and equipment	0.0	3.3	10.0	13.3	53.3	20.0	3.77	22
Transportation delays	0.0	3.3	10.0	26.7	43.3	16.7	3.60	23

The remaining 20 of the 23 (87.0%) MSs are  $> 3.40 \leq 4.20$ , which indicates that the factors contribute between some extent to a near-major / near-major extent to the late completion of projects. However, 5 out of 20 (25.0%) MSs are 4.20, which is the upper limit of the range. These were poor site management, poor coordination of subcontractors, underestimation of the complexity of the work, inappropriate coordination of information, and poor site supervision. Further, 4 out of 20 (20.0%) factors fall within 0.07 of 4.20 (4.13), namely inadequate planning, poor communication, late ordering of materials, and poor coordination on site. These are followed by a further seven factors whose MSs fall within 0.10 of 4.13 (3.93). These are impractical allocation of resources, slow to give instructions, incomplete documents, poor logistic management, late delivery of materials, design changes, and shortage of materials. The MS range of the remaining four factors falls between 3.90 and 3.60. These are change of scope, poor procurement strategies, shortage of plant and equipment, and transportation delays.

Table 2 indicates the extent to which twenty factors contribute to quality non-conformances on projects, in terms of percentage responses to a scale of 1 (minor) to 5 (major), and a MS range of between 1.00 and 5.00, the midpoint of which is 3.00. It is notable that all the MSs are  $> 3.00$ , which indicates that the factors generally contribute to the late completion of projects to more of a major than a minor extent.

Only 2 out of 20 (10.0%) MSs are from  $> 4.20 \leq 5.00$ , which indicates that the factors contribute between a near-major extent to a major / major extent to quality non-conformances on projects. These factors are inappropriate / poor design, and poor site supervision.

**Table 2:** Extent to which factors contribute to quality non-conformances.

Factor	Response (%)						MS	Rank
	Un-sure	Minor .....Major						
		1	2	3	4	5		
Inappropriate / poor design	0.0	3.3	0.0	6.7	36.7	53.3	4.37	1
Poor site supervision	0.0	6.7	3.3	0.0	36.7	53.3	4.27	2
Poor decision making	3.3	6.7	3.3	3.3	36.7	46.7	4.17	3
Poor site management	3.3	6.7	10.0	0.0	33.3	46.7	4.07	4
Improper construction methods implemented by the contractor	0.0	6.7	3.3	6.7	43.3	40.0	4.07	5
Poor coordination of subcontractors	0.0	6.7	6.7	16.7	23.3	46.7	3.97	6
Poor coordination on site	0.0	6.7	3.3	13.3	46.7	30.0	3.90	7
Inadequate planning	0.0	6.7	10.0	10.0	36.7	36.7	3.87	8
Inadequate project management system	0.0	10.0	6.7	10.0	33.3	40.0	3.87	9
Incomplete documents	0.0	3.3	10.0	13.3	43.3	30.0	3.87	10
Late provision of information	0.0	10.0	6.7	10.0	33.3	40.0	3.87	11
Poor material handling	0.0	13.3	3.3	3.3	43.3	36.7	3.87	12
Rework	3.3	13.3	0.0	16.7	23.3	43.3	3.86	13
Impractical allocation of resources	0.0	6.7	13.3	6.7	36.7	36.7	3.83	14
Inappropriate coordination of information	0.0	13.3	0.0	10.0	43.3	33.3	3.83	15
Poor communication	0.0	6.7	10.0	16.7	30.0	36.7	3.80	16
Use of incorrect material	0.0	10.0	10.0	16.7	26.7	36.7	3.70	17
Change of scope	0.0	13.3	3.3	16.7	40.0	26.7	3.63	18
Design changes	0.0	16.7	3.3	16.7	30.0	33.3	3.60	19
Damage of materials during transportation to site	0.0	13.3	6.7	23.3	26.7	30.0	3.53	20

The remaining 18 out of 20 (90.0%) MSs are from  $> 3.40 \leq 4.20$ , which indicates that the factors contribute between some extent to a near-major / near-major extent to quality non-conformances on projects. 13 out of 18 (72.2%) MSs fall within the upper part of the range, from  $> 3.80 \leq 4.20$ . These are poor decision making, poor site management, and improper construction methods implemented by the contractor predominate, followed by poor coordination of subcontractors, poor coordination on site, inadequate planning, inadequate project management system, incomplete documents, late provision of information, poor material handling, rework, impractical allocation of resources, and inappropriate coordination of information. The remaining 5 out of 18 (27.8%) MSs fall within the lower part of the range, from  $> 3.40 \leq 3.80$ . These are poor communication, use of incorrect material, change of scope, design changes, and damage of materials during transportation to site.

Table 3 indicates the extent to which 25 factors contribute to poor productivity on projects in terms of percentage responses to a scale of 1 (minor) to 5 (major), and a MS range of between 1.00 and 5.00, with the midpoint being 3.00. It is notable that all the MSs are > 3.00, which indicates that, in general, the factors contribute to poor productivity of projects to more of a major than a minor extent.

Only 5 out of 25 (20.0%) MSs are from > 4.20 to ≤ 5.00, which indicates that the factors contribute between a near major-extent to major / major extent to poor productivity on projects. These factors are poor decision making, rework, improper construction method implemented by contractor, late provision of information, and poor site supervision.

**Table 3:** Extent to which factors contribute to poor productivity.

Factor	Response (%)					MS	Rank	
	Un-sure	Minor .....Major						
		1	2	3	4			5
Poor decision making	0.0	3.3	0.0	6.7	43.3	46.7	4.30	1
Rework	0.0	3.3	3.3	10.0	30.0	53.3	4.27	2
Improper construction method implemented by contractor	0.0	3.3	3.3	6.7	36.7	50.0	4.27	3
Late provision of information	0.0	3.3	0.0	13.3	36.7	46.7	4.23	4
Poor site supervision	0.0	6.7	3.3	3.3	33.3	53.3	4.23	5
Poor communication	0.0	3.3	0.0	16.7	33.3	46.7	4.20	6
Inadequate planning	0.0	3.3	6.7	0.0	46.7	43.3	4.20	7
Poor coordination of subcontractors	0.0	6.7	0.0	13.3	33.3	46.7	4.13	8
Impractical allocation of resources	0.0	6.7	3.3	6.7	40.0	43.3	4.10	9
Poor site management	0.0	6.7	3.3	6.7	43.3	40.0	4.07	10
Inappropriate coordination of information	0.0	3.3	10.0	0.0	50.0	36.7	4.07	11
Late delivery of materials	0.0	3.3	3.3	16.7	40.0	36.7	4.03	12
Poor site coordination	0.0	6.7	6.7	6.7	36.7	43.3	4.03	13
Slow to give instructions	0.0	3.3	3.3	10.0	53.3	30.0	4.03	14
Underestimation of complexity of the work	0.0	6.7	3.3	6.7	50.0	33.3	4.00	15
Inappropriate and poor design	0.0	6.7	3.3	16.7	33.3	40.0	3.97	16
Change of scope	0.0	6.7	6.7	3.3	50.0	33.3	3.97	17
Shortage of materials	0.0	10.0	3.3	10.0	36.7	40.0	3.93	18
Late ordering of materials	0.0	6.7	3.3	16.7	40.0	33.3	3.90	19
Shortage of plant and equipment	0.0	6.7	10.0	6.7	40.0	36.7	3.90	20
Design changes	0.0	6.7	6.7	6.7	50.0	30.0	3.90	21
Poor logistics management	0.0	10.0	3.3	6.7	50.0	30.0	3.87	22
Poor procurement strategies	0.0	10.0	6.7	6.7	56.7	20.0	3.70	23
Poor material handling	0.0	16.7	0.0	13.3	43.3	26.7	3.63	24
Transportation delays	0.0	10.0	6.7	16.7	46.7	20.0	3.60	25

The remaining 20 out of 25 (80.0%) MSs are from > 3.40 to ≤ 4.20, which indicates that the factors contribute between some extent to a near-major / near-major extent to poor productivity on projects. A total of 17 out of 20 (85.0%) MSs fall within the upper part of the range, between > 3.80 and ≤ 4.20. Poor communication and inadequate planning predominate because their MSs of 4.20 each fall within the upper limit of the range. They are followed within a range of 0.20 by poor coordination

of subcontractors, impractical allocation of resources, poor site management, inappropriate coordination of information, late delivery of materials, poor site coordination, slow to give instructions, and underestimation of complexity of the work. The remaining factors within this upper part of the range are inappropriate and poor design, change of scope, shortage of materials, late ordering of materials, shortage of plant and equipment, design changes, and poor logistics management. The 3 out of 20 (15.0%) MSs that fall within the lower part of the range from > 3.40 to ≤ 3.80 are poor procurement strategies, poor material handling, and transportation delays.

Table 4 provides a comparison of the perceived extent to which 11 Industry 4.0 interventions could mitigate the factors that contribute to poor performance in the form of late completion, quality non-conformances, and poor productivity on projects, in terms of MSs based upon percentage responses to a scale of 1 (minor) and 5 (major). A mean MS was computed based on the three forms of poor performance. It is notable that all the MSs are > 3.00, which indicates that, in general, Industry 4.0 interventions are perceived to be able to mitigate the factors that contribute to poor performance on projects to more of a major than a minor extent. It is notable that no MSs fall within the range of > 4.20 to ≤ 5.00, which indicates that the interventions are perceived to be able to mitigate the factors between a near-major extent to major / major extent.

Only 1 MS out of 11 (9.1%) is between > 3.40 and ≤ 4.20, which indicates that BIM is perceived to be able mitigate the factors contributing to poor performance on projects between some extent to a near-major / near-major extent.

The remaining 10 out of 11 (90.9%) MSs are > 2.60 ≤ 3.40, which indicates that the Industry 4.0 interventions are perceived to be able to mitigate the factors contributing to poor performance on projects between a near minor to some extent / some extent. A cluster of interventions in the form of implementing a smart construction site, 3D printing of building components technology, augmented reality, and the use of radio frequency identification and IoT technology for monitoring, fall within a range of 0.07 of 3.40, which is the upper limit of the range. The remaining six out of 10 (60.0%) interventions fall within the upper half of the range, which is > 3.00. These interventions are autonomous vehicles that deliver materials, automation and robotic technology to replace workers involved in physically demanding work, use of drones to conduct inspections and monitoring, virtual reality, big data technology, and cloud computing.

The overall MS is 3.28. Then, in terms of the perceived potential of Industry 4.0 interventions to mitigate the factors contributing to poor performance per category, late completion is ranked first (3.35), followed by poor productivity (3.26), and then quality non-conformances (3.25). All four MSs fall between > 2.60 and ≤ 3.40, which indicates that, overall, and in terms of categories, the Industry 4.0 interventions are perceived to be able to mitigate the factors contributing to poor performance on projects between a near-minor to some extent / some extent.

**Table 4:** Comparison of the perceived extent to which 11 Industry 4.0 interventions could mitigate the factors contributing to poor performance on projects.

Intervention	Late completion		Quality non-conformances		Poor productivity		Mean	
	MS	Rank	MS	Rank	MS	Rank	MS	Rank
BIM	3.71	1	3.41	2	3.54	1	3.55	1
Implementing a smart construction site	3.50	3	3.15	8	3.46	2	3.37	2=
3D printing of building components technology	3.46	4	3.46	1	3.19	8	3.37	2=
Augmented reality	3.54	2	3.17	7	3.28	5	3.33	4=
Use of radio frequency identification and IoT technology for monitoring	3.37	5	3.28	4	3.33	4	3.33	4=
Autonomous vehicles that deliver materials	3.28	6	-	-	3.22	6	3.25	6
Automation and robotic technology to replace workers involved in physically demanding work	3.13	10	3.38	3	3.20	7	3.24	7
Use of drones to conduct inspections and monitoring	3.14	9	3.07	10	3.42	3	3.21	8
Virtual reality	-	-	3.23	6	3.16	9	3.20	9
Big data technology	3.21	7	3.23	5	3.04	11	3.16	10
Cloud computing	3.15	8	3.13	9	3.04	10	3.11	11
Mean	3.35		3.25		3.26		3.28	

## CONCLUSIONS

Given the size of the sample stratum, the response rate, and the fact that the potential of Industry 4.0 interventions to mitigate the factors contributing to poor performance on projects is perception based, the findings cannot be considered definitive in any way, but rather indicative.

The empirical study determined the extent to which factors contribute to the late completion of projects, quality non-conformances and poor productivity, and the perceived extent to which Industry 4.0 interventions could mitigate these factors. However, the study relied on the literature in terms of quantifying the potential of Industry 4.0 technologies to mitigate the factors. Therefore, the objectives of the study were achieved.

Given the extent to which factors contribute to the late completion of projects, quality non-conformances and poor productivity, it can be concluded that performance relative to the three parameters is poor, the factors are largely common, and the empirical findings reflect those identified in the literature. Further, the factors that contribute to poor performance relative to parameters do so indirectly via other parameters. For example, rework contributing to quality non-conformances is the immediate link. However, by so doing so, rework contributes to poor productivity and late completion of projects.

Given the perceived extent to which 11 Industry 4.0 interventions could mitigate the factors that contribute to poor performance on projects, it could be concluded that there is potential to improve performance relative to the identified three parameters. Further, it could be concluded that Industry 4.0 technologies are perceived to possess the potential to contribute to such improvement and to do so simultaneously relative to all the parameters. Lastly, the empirical findings reflect those identified in the literature.

## RECOMMENDATIONS

The level of awareness relative to Industry 4.0 technologies should be raised. Industry and professional associations, statutory built environment councils, and the cidb are ideally positioned to do so. These associations and councils should promote and present continuing professional development to their members and registered persons, respectively.

Tertiary built environment education should include Industry 4.0 in the respective curricula and should contextualise such inclusion. Professional associations and statutory built environment councils should include Industry 4.0 in their educational frameworks, and their accreditation panels should interrogate whether Industry 4.0 is embedded in the respective programmes.

Given the potential benefits indicated by the literature and research findings, built environment practices and contractors should implement Industry 4.0 technologies in their projects, and document the benefits of doing so in the form of case studies.

Moreover, a range of interventions are required to realise effective digitalisation of construction. A strategy is necessary to avert piecemeal implementation of technologies, to optimise synergy between the technologies. Employees need to be upskilled to consider how they can use technologies to address the issues that arise in the form of the factors that contribute to poor performance, as opposed to using the technologies. In essence, acknowledgement of the problems is a prerequisite for resolving the problems; hence, the questions that were posed during the study. However, employees will need to be upskilled in terms of embracing and interacting with the technologies. Problem solving skills are also a priority.

## LIST OF REFERENCES

- Aripin, I.D.M., Zawawi, E.M.A. & Ismail, Z. 2019. Factors influencing the implementation of technologies behind Industry 4.0 in the Malaysian construction industry. *MATEC Web of Conferences*. Paris, France. 16–18 May:1–6.
- Autodesk and Chartered Institute of Building (CIOB). 2019. *Discussion Paper Reimagining construction: The vision for digital transformation, and a roadmap for how to get there*. London: CIOB.
- Construction Industry Development Board (CIDB). 2011. *Construction quality in South Africa: A Client perspective*. Pretoria: CIDB.
- Construction Industry Development Board (CIDB). 2016. *The CIDB Construction Industry Indicators Summary Results:2015*. Pretoria: CIDB.
- Construction Industry Training Board (CITB). 2018. *Unlocking construction's digital future: A skills plan for industry*. Peterborough, United Kingdom: CITB.
- Doloi, H., Sawhney, A., Iyer, K.C. & Rentala, S. 2012. Analysing factors affecting delays in Indian construction projects. *International Journal of Project Management*, 30(4):479–489.
- Enshassi, A., Al-Najjar, J. & Kumaraswamy, M. 2009. *Journal of Financial Management of Property and Construction*, 14(2):126-151.
- Haseeb, M., Bibi, A. & Rabbani, W. 2011. Problems of projects and effects of delay in the construction industry of Pakistan. *Australian Journal of Business and Management Research*, 1(5):41-50.
- Ho, S. 2019. Technology, people, and process: 3 pillars of construction digital transformation. [Online] Available from: <https://constructionblog.autodesk.com/construction-digital-transformation> [Accessed: 4 September 2020].
- Moswane, D., Aigbavboa, P. C. & Mewomo, M. 2018. An investigation of motivational and demotivation factors affecting labour productivity in the Northwest Province of South Africa, In: *Proceedings of the World Congress on Engineering*. London, United Kingdom. 4–6 July: 1–6.
- Oesterreich, T. D. & Teuteberg, F. 2016. Understanding the implications of digitisation and automation in the context of Industry 4.0: a triangulation approach and elements of a research agenda for the construction industry. *Computers in Industry*, 83(1):121–139.
- Osunsanmi, T. O., Aigbavboa, C. & Oke, A. 2018. Construction 4.0: The future of the construction industry in South Africa. *International Journal of Civil and Environmental Engineering*, 12(3):206–212.
- Shomberg, M., Clemmons, J., Anderson, D. & Ramanathan, R. 2018. *Building a sustainable world: How to survive and thrive in a digital construction economy*. Pennsylvania: SAP Digital Engineering, Construction, and Operations.
- Sørensen, A. Ø., Olsson, N. & Landmark, A. D. 2016. Big data in construction management research. In: Saari, A. & Huovinen, P. *Proceedings of the CIB World Building Congress*. 2016. Volume III - Building up business operations and their logic. *Shaping Materials and Technologies*. Tampere, Finland. 30 May – 3 June:405–416.
- Wang, D., Fan, J., Fu, H. & Zhang, B. 2018. Research on optimization of big data construction engineering quality management based on RNN-LSTM. *Complexity*, 2(1):1–16.
- World Economic Forum (WEF). 2016. *Shaping the future of construction: a breakthrough in mindset and technology. Prepared in collaboration with the Boston Consulting Group*. Geneva: WEF.

# THE INTEGRATION OF AGRI-TECTURE WITH PRE-SCHOOL TECHNOLOGIES FOR SUSTAINABLE EDUCATION

Katlego Tshimologo Lebethe, Tshwane University of Technology, South Africa, kt.lebethe@gmail.com

## Abstract

*This paper presents integration strategies for sustainable agri-tecture education in pre-school facilities, in order to assist in practical wisdom transference from adult caregivers, facilitators and community elders to pre-school children in South Africa. The design strategies aim to encourage environmentally-conscious behaviour in children by interaction with architectural and agricultural objects and spaces via play/experimentation.*

*Long-term objectives include increasing the farming population, improving rural livelihoods, and food sovereignty. This can be achieved by education in agri-tecture which is morphologically demonstrated in architectural form.*

*In South Africa, as a sub-Saharan country, the farming population is dwindling. This, together with climate change, which is accelerating the decline of productive farmers, leaving the remaining farmers to re-skill themselves in agro-ecological farming practices for increased yield. The imbalance is deepened by urban environments, which have their roots in agricultural production, and import the majority of their food from rural farming areas. This model is now considered to be unsustainable, partly because children have been left out of the design process.*

*A mixed-methods approach is used to develop the pragmatic research paradigm. Ethnographic studies will be used in combination with case studies and analytical experimentation to develop a viable set of guidelines for use in the design of pre-school learning sites, in the rural and urban environments of South Africa.*

*This paper argues that pre-school education, together with the re-introduction of agriculture as part of the built environment, could improve sustainability and resiliency within these systems. This approach offers an alternative to current practices.*

**Keywords:** Agriculture, architecture, education, pre-school, South Africa, sustainability

## INTRODUCTION

It is widely accepted that current unsustainable systems of resource management are having a detrimental effect on children as well as future generations. If human civilisation is to continue, thought should be given to successive generations, along with the environments in which they will reside.

At an event for Early Childhood Development (ECD), United Nations secretary, Ban Ki-Moon stated that early childhood development can be used to drive sustainable development goals for an extended period of time (2015). The premise is that much is currently known about the influences of nutrition, stimulation, protection and loving care in the healthy development of children. Complementary to Ki-Moon, Cyril Ramaposa (2020) reassured South Africans that in the transition to a sustainable society, he would ensure that the African child is not abandoned. In support of Article 6 of the United Nations Convention on the Rights of the Child (OHCHR, 2020:3) which states: 'Children have the right to live a full life and governments should ensure that children survive and develop healthily', along with

Article 24 of the same document: 'Children have the right to good quality healthcare, clean water, nutritious food and a clean environment so that they will stay healthy'(OHCHR, 2020:6-7), several strategies will need to be explored.

In order for children in current and future generations to grow appropriately and realise their own needs through their lifetime, they need mentorship and skills to accomplish these objectives (Center on the Developing Child at Harvard University, 2017:2). Children also need to be encouraged in creative thinking, problem solving and change creation. In the current context of climate change, knowledge exposure has to embrace sustainable living techniques. This includes re-adapting historic indigenous practices based on sustainable living (Mollison, 2002:2), within early childhood developmental facilities.

## Community

Kgabalatsane View was chosen as the site for this study because of the variety of challenges that the locality and site presents. It is a new developing location, which extends from the neighbouring Kgabalatsane village. The Greenfield site belongs to a local church and presents an opportunity to re-establish the public educational role of churches and other religious institutions in the area and within South Africa.

Like most impoverished areas in South Africa, the exodus of the patriarchs from the family unit (South Africa, 2011:25) has caused a significant intergenerational gap which in turn has sparked a massive decline in subsistence farming (The Conversation, 2019). The ancient Bantu agricultural and architectural knowledge which enabled migration from the Congo Basin (Mokhtar, 1981:537-538) has diminished with the youth being attracted to urban work which is less physically demanding. The resulting poverty, along with broken families and community structures, has contributed to the delayed establishment of quality ECD facilities in many disadvantaged societies, leaving children unaware of their power to effect sustainable environmental change.

## Literature

According to the Association for Vertical Farming (2017), Agri-tecture is the art, science, and practice of incorporating agriculture into the built environment. Farming real estate can be designed into the building elements internally and externally to capitalise on the generated microclimates. This food generation method, in agreement with Bill Mollison's permaculture philosophy (Mollison, 2002:1), which serves to reunite people with their ecological environments, can be taught to children at an early age to encourage the diversification of local food systems in their communities over time. For instance, Westberg (2019:9) states that preschool children can be taught new food habits when provided with the appropriate environment.

According to Friedrich Froebel's kindergarten model (cited in Scott 2010:7) it is vital for children to engage in meaningful activities which encourage discovery and learning through enjoyable experimentation. Activities such as cooking, gardening, looking after animals, recycling and creative expression, etc., immerse children in kinaesthetic learning experiences. Froebel and Montessori concur that when children are inspired to think independently, they can develop good risk assessment skills and undertake responsibilities. This is based on the understanding that children know their own needs well. Scott (2010:7, 11) states that the design of a prototype facility should encourage children to move around safely and freely while engaging in self-sufficient activities.

The Montessori Method engages the inquisitive mind, which draws from the environment, culture and language. This method develops the mind, promoting abstract thought and imagination from ages six to twelve (Scott 2010:11). Involving caregivers and community elders in the day-to-day activities of the pre-school can impart linguistic knowledge of the community to the children while providing an indigenous perspective (Mollison, 2002:2) for ecological preservation. Maria Montessori (1946:3) concludes:

Scientific observation then has established that education is not what the teacher gives; education is a natural process spontaneously carried out by the human individual, and is acquired not by listening to words but by experiences upon the environment.

## Hypothesis

As discussed, numerous Early Childhood Development experts agree that children learn very well by doing (Scott, 2010:7, 10, 13). In most cases the unstructured activity is referred to as 'play'; however, in this paper the term 'experimentation' will also be used to highlight the way children engage in experimentation to resolve gaps in their practical information. The question is: how can one integrate play with experimentation in the form of agri-tecture with pre-school technologies for sustainable education?

**Condition the mind along with the body**



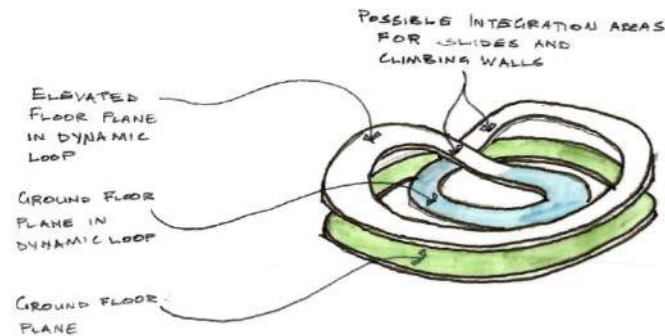
**Figure 1:** Elastic band in circular shape (courtyard possible). (Image by author 2020.)



**Figure 2:** Elastic band in elongated shape to increase North light exposure of courtyard. (Image by author 2020.)



**Figure 3:** Elastic band twisted to form interior/ dynamic loop. (Image by author 2020.)



**Figure 4:** Integration of dynamic loop into interior courtyard. (Image by author 2020.)

The concept allows an oval shape (Figure 2) to be generated from a circle (Figure 1) for the core facility and a dynamic running loop (Figure 3 and 4) to be interwoven through the facility. We can use the elastic band principles to introduce flexibility to the design of the movement paths in the facility. This would enable children to run independently through the unencumbered obstacle course. The loop provides security internally by containing the children in a courtyard and, externally, through the creation of the different horizontal planes which are primarily accessible from that courtyard. The internal courtyard encloses two deciduous trees, which provide shade and evaporative cooling for the courtyard. The tree trunks provide opportunities for experimental constructions. The variation in view, from the variety of horizontal planes, could be used to highlight the key elements of the site and the neighbourhood, allowing children to see diverse views including the horizon. The obstacle course contains child-only spaces, encouraging children to rely on one another for support during challenges. Some of the spaces could perhaps isolate children during play-time, while others provide physical seclusion in small groups. However, these small spaces should remain visually accessible to adult supervision.

The facility further incorporates architecture for indoor and outdoor cooking and gardening activities, wherein the fixed furniture and architecture are designed to allow side-by-side accessibility for both children and adults. Each learning space will have an instruction platform enabling the facilitator to provide knowledge to all participants simultaneously. This will encourage good group communication and responsiveness; reinforce-adult-to child behavioural modelling patterns, and serve-and-return interactions between children and their elders or caregivers during structured activities.

Furthermore, the internal courtyard could accommodate a large sand pit to encourage adult-child serve-and-return model building activities. This area would embrace the use of sand in play and allow for experiments to evolve toward practical architectural design applications in 3D modelling and in sketching. In addition, animal enclosures could be designed to allow visual access to animals from the various play and learning areas during the day. By incorporating unconventional animal accommodation structures, preconceived ideas of architecture through structured child-to-animal interactions would be challenged.

A pre-modern technological viewpoint includes the notion of *Letsema*<sup>1</sup> and could be used to further reinforce community ties in the collection of free and low-cost local materials. In the site context, locally-available construction materials can be used (i.e. sand, stone, and recycled plastic waste). The same *Letsema* could be used to construct the building using simple transferable methods, drawn from history, which the locals can use outside of the site.

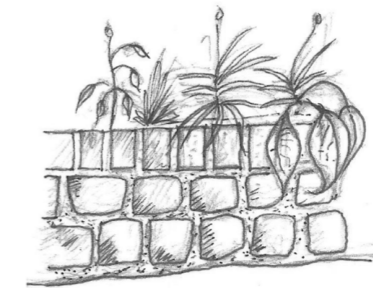


**Figure 5:** Many hands make light work. (Image by author 2020.)

From a modern technological viewpoint, space provision could be made for pretend play, where interactive exploration of a child-sized petrol station with a grocery store, a micro-sized kitchen, a kinetic energy experimentation area, and a farming simulation area, could be experienced. An indoor area for child construction is provided for giant Lego, recycled cardboard play along with architecture and urban design model making. The application of this typology to a network of preschools could allow for some of the pretend play sets and props to be rotated, in order that the children may explore a greater variety of environments simulating real life.



**Figure 6 (left):** Ruins-Great-Zimbabwe-palace. (Hoskins, C., n.d.) [Online] Available at <https://www.britannica.com/place/Great-Zimbabwe> [Accessed 11 May 2020]



**Figure 7 (right):** Concept of a contemporary stone planter or retaining wall. (Image by author, 2020.)

<sup>1</sup> *Letsema*: Tswana term for a large community effort to achieve a communally beneficial goal.

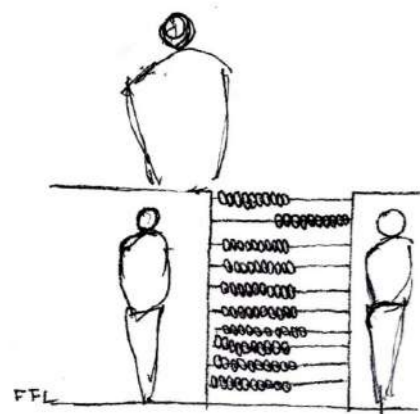
It is this integration of a pre-modern notion (i.e. *Letsema*) and modern technological concepts (i.e. Lego) that could become the kind of technology that would ensure sustainability appropriate for pre-school education in Kgalabatsane View. A common story can unite and instil pride in a community. Thus agri-tecture could passively narrate the history of the locals and their area.

In a journey in which a community of people migrated from the Congo Basin and reached South Africa, the African proverb which states: ‘If you want to go fast, go alone. If you want to go far, go together,’” was demonstrated. The use of technologies that were acquired on the journey can be commemorated in the daily lives of the locals in their adaptation of different skills, for instance, stone expertise, into their living systems.

### Methodology

Drawing from Bantu architectural history which includes historical monuments such as the great Zimbabwe and Mapungubwe ruins, the design can include contemporary interpretations inspired by vernacular architecture (see Figures 6 and 7).

On the other hand, drawing from mathematical knowledge (i.e. pattern recognition, problem recognition, conflict resolution, risk calculation and programming, etc.) can aid in various problem identification and solving abilities for a child. These include numeracy programmes, for example the use of an abacus and “noughts and crosses”, which have the power to interest children in mathematics. Integrating several large-scaled interactive abacuses and ‘Noughts and crosses’ games for peer learning can assist in accelerating the recognition of mathematical principles.



**Figure 8:** Abacus gate scaled to allow accessibility to multiple children during number experimentation. (Image by author, 2020.)

### Results

The processes of seasonal food growing can alert children to the natural cycles of life and the seasons. The food cycle can be explored in its entirety, from seed, soil preparation, seedling production and nurturing, watering and water conservation, transplanting, plant care, harvesting, to food preparation and consumption. The inclusion of composting facilities where children can see various processes which turn food waste back into earth along with the animals and insects that facilitate this process, may allow children to establish the knowledge connections needed for nurturing the environment.

Moreover, responsive relationships between children and adults can improve brain development. Both children and adults can benefit from interdependent assistance, hope and assurance. An environment which can support good, responsive, serve-and-return interactions between adults and children, and positive relationships between facilitators and participants, can promote children and community health while elevating child and adult life skills (Center on the Developing Child at Harvard University, 2017:3).

Finally, providing collaborative learning environments for children can accelerate the development of a collective intelligence. Learners’ experiences are supplemented by one another’s. The increase in the collective intelligence can also increase long-term strategic abilities such as: cooperation, social networking knowledge, information management and self-directed learning.

Agri-tectural spaces are provided which are designed to accommodate children for conversation, improvisation, prototyping and tinkering (Bevan, Bell, Stevens, Razfar., 2013:100).

### CONCLUSION

This paper contends that, in the development of alternative technologies, multiple approaches can be of great benefit. The integration of ancient indigenous wisdom along with modern technologies may allow for the adoption of a dynamic, community-centred approach to add value to the establishment of sustainable resource management systems. Ensuring that children are at the centre of well-designed learning environments for ecological sustainability can improve local resilience and anchor the structure of the succession of human civilisation.

The investigation explored the design of new facilities which can be applied in rural and urban environments; however, it does not cover the integration of strategies into existing ECD buildings. Further investigation could allow for the enhancement of facilities to nurture ecological preservation unconsciously in children and provide a diversity of options for the implementation of sustainable earth-care systems.

This paper has demonstrated that agri-tecture as an alternative technology can possibly instil local pride and a spirit of camaraderie, while providing technological skills development which children and locals could use for personal off-site applications.

In addition, the paper aims to illustrate passive and active ways of developing positive lifestyle changes by illustrating resource-efficient, food-resilient living systems. This ensures that children become familiar with positive living changes, while providing a focused environment wherein deep engagement can reinforce the practice/ implementation of these proposed solutions. Furthermore, the objective is to provide an environment which can divert energy from destructive living systems toward the construction of beneficial systems in support of a sustainable social order.

## LIST OF REFERENCES

- Association for Vertical Farming, 2017. *Vertical farming academy: Introduction to Agritecture*. [Online]  
Available at: <https://academy.vertical-farming.net/intro-to-agritecture/> [Accessed 25 February 2020].
- Bevan, B., Bell, P., Stevens, R. & Razfar, A., 2013. *LOST Opportunities : Learning in Out-of-School Time*. London: Springer
- Center on the Developing Child at Harvard University, 2017. *Three Principles to Improve Outcomes for Children and Families*. [Online] Available at: [https://46y5eh11fhgw3ve3ytpwxt9r-wpengine.netdna-ssl.com/wp-content/uploads/2017/10/HCDC\\_3PrinciplesPolicyPractice.pdf](https://46y5eh11fhgw3ve3ytpwxt9r-wpengine.netdna-ssl.com/wp-content/uploads/2017/10/HCDC_3PrinciplesPolicyPractice.pdf) [Accessed 25 February 2020].
- Ki-Moon, B., 2015. *Secretary-General's remarks at event on Investing in Early Childhood Development as the Foundation for Sustainable Development [as delivered]*. [Online]  
Available at: <https://www.un.org/sg/en/content/sg/statement/2015-09-22/secretary-generals-remarks-event-investing-early-childhood> [Accessed 13 May 2020].
- Mokhtar, G., 1981. *General history of Africa, II: Ancient civilizations of Africa*. California: Heinemann: UNESCO
- Mollison, B., 2002. *Permaculture - A designer's manual*. 2nd ed. Tyalgum: Tagari Publications.
- Montessori, M., 1946. *Education for A new World: The Montessori*. 1st ed. Adyar: Kalakshetra.
- OHCHR, 2020. *Convention on the Rights of the Child*. [Online] Available at: <https://www.ohchr.org/en/professionalinterest/pages/crc.aspx> [Accessed 15 May 2020].
- Ramaphosa, C., 2020. *President Cyril Ramaphosa: 2020 State of the Nation address*. [Online]  
Available at: [https://www.justice.gov.za/m\\_speeches/2020/20200213-SONA.pdf](https://www.justice.gov.za/m_speeches/2020/20200213-SONA.pdf) [Accessed 14 February 2020]
- Scott, S., 2010. *Architecture for children*. Camberwell: Acer Press.
- South Africa, 2011. *Green Paper on families promoting family life and strengthening families in South Africa*. [Online]  
Available at: [https://www.gov.za/sites/default/files/gcis\\_document/201409/34692gen756a0.pdf](https://www.gov.za/sites/default/files/gcis_document/201409/34692gen756a0.pdf)  
[Accessed 27 February 2020].
- The Conversation, 2019. *Smallholder crop farming is on the decline in South Africa – Here's why it matters*. [Online]  
Available at: <https://www.thesouthafrican.com/lifestyle/smallholder-crop-farming-decline-south-africa/>  
[Accessed 05 February 2020].
- Westberg, J., 2019. Designing preschools for an independent and social child: Visions of preschool space in the Swedish welfare state. *Early Years*, DOI: 10.1080/09575146.2019.1608426

# A REVIEW OF CRITICAL PROJECT MANAGEMENT TOOLS FOR IMPROVING CONSTRUCTION SMES PROJECT PERFORMANCE

Chijioke Emere, Department of Construction Management and Quantity Surveying, Faculty of Engineering and the Built Environment, University of Johannesburg, South Africa. [cjmere4real@gmail.com](mailto:cjmere4real@gmail.com)

Innocent Musonda, Department of Construction Management and Quantity Surveying, Faculty of Engineering and the Built Environment, University of Johannesburg, South Africa. [cjmere4real@gmail.com](mailto:cjmere4real@gmail.com)

Chioma Okoro, Department of Finance and Investment Management, College of Business and Economics, University of Johannesburg, South Africa. [chiomao@uj.ac.za](mailto:chiomao@uj.ac.za)

## Abstract

*The use of project management tools is known to be linked with performance efficiency and effectiveness. Literature suggests that the inability to fully utilise the essential tools for meeting project deliverables is part of the reason for poor project performance, especially among construction small and medium enterprises (SMEs). Hence, the primary objective of this paper is to review the critical project management tools for achieving project deliverables efficiently and effectively, particularly for construction SMEs in South Africa. The study is based on previous literature on the project performance of construction SMEs and their use of project management tools. The review of the literature was based on both the international and South African context. The study revealed that a Gantt chart, project charter, control chart, decision tree, check sheet, cause and effect diagram, Pareto chart, progress report, and network diagram were the most commonly occurring project management tools in the sampled literature. Findings from this study could aid construction stakeholders in selecting key project management tools for performance improvement among SMEs.*

**Keywords:** construction projects, performance, project management tools, SMEs.

## INTRODUCTION

Project success is a by-product of efficiency and effectiveness regarding achieving desirable performance in terms of time, cost, and quality (Dweiri & Kabian, 2006; Shenrar & Dvir, 2010). Patah (2010) asserts that project success can be evaluated by how well the project adds to the accomplishment of the vital goals of an organisation, as well as how well the project was conducted to maximise output. According to Dweiri and Kabian (2006), efficiency can be reached through the actualisation of project objectives of time, cost and quality, while effectiveness can be measured based on the degree to which those project objectives are achieved. Hence, the usage of project management tools is vital to the achievement of these outcomes (Kerzner, 2010). Successful management of a project is actualised when targets and other project objectives are met while simultaneously using resources viably and productively (Shenrar & Dvir, 2010). This aligns with Kerzner (2017:7), who characterised project success as “the completion of activity within the imperative of time, cost and performance with acceptance by users/customers”. Besides this, Kerzner (2010) affirmed that adequate knowledge and implementation of project management

best practices, including the use of tools, are inevitable when improving the efficiency and effectiveness of an organisation (Kerzner, 2010). Construction SMEs, therefore, are required to take advantage of the available vital tools for meeting project deliverables effectively and efficiently. This is because the traditional approach to managing projects is insufficient for tackling the myriad issues surrounding construction (Chou & Yang, 2012). Project management and the usage of its tools are therefore inevitable if performance is to be improved.

That being said, literature informs that the performance of construction SMEs is negatively affected partly by an inability to maximise the use of vital project management tools for meeting project deliverables (Moilwa, 2013; Ihesiene, 2014). Hence, problems such as inefficiency, poor budgetary issues, improper planning, scheduling and control in terms of project execution are prevalent (Construction industry development board (CIDB), 2011; Moilwa, 2013; Ihesiene, 2014). Therefore, the improvement of project performance requires the conscientious adoption of tools that are critical for efficiency and effectiveness. Project management tools include software, documents or design, used in connection with or without techniques for achieving project deliverables (Fox & Murray, 2003; Shina, 2014). The adequate usage of the relevant tools will improve the performance of construction SMEs, which make up about 78% of the companies in South Africa, accounting for about 10% of the gross domestic product (Statistics South Africa (Stats SA), 2011; 2014). Moreover, construction SMEs contribute to job creation and thus mitigate the South African unemployment rate of about 27.7% (Shakantu, 2012; Stats SA, 2017). Therefore, the performance of SMEs is of paramount concern.

However, construction SMEs in South Africa, like in developing countries, still experience tremendous problems. These problems can contribute to project failure, including *inter alia* project management deficiency (Price Waterhouse Coopers (PWC), 2014). This is in line with findings of the CIDB (2011), which show that, in Gauteng, the building activity of SMEs decreases because of poor project management and a lack of skilled labour. According to Marx (2011), more than 50% of building contractors lack adequate management skills. Further, the project and business failure rate among SMEs including that of the construction sector in South Africa is about 71% to 75% (Monk, 2010; Moloi, 2013; Burger, 2016). This makes research on project management tools to improve performance important.

Although research has been conducted on project management tools, previous related literature seemed to use the terms “tools” and “techniques” synonymously and interchangeably (Patanakul, Iewwongcharoen & Milosevic, 2010; Chou & Yang, 2012). Several authors discussed the use of the Gantt chart for aiding with project management scheduling by graphically showing each task as a horizontal bar, the length of which is proportional to the time needed for its completion (Abbasi & Al-Mharmah, 2000; Bresner & Hobbs, 2008; Burke, 2013; Kerzner & Kerzner, 2017). Other studies mentioned the use of the project charter for integrations management by defining the statement of scope, objectives, and participants in a project (Milosevic, 2003; Bresner & Hobbs, 2008; Chou & Yang, 2012). The control chart, decision tree, checklist, cause and effect diagram, progress report, network diagram, milestone chart and project management software are among the vital tools focused on by several authors. This indicates that good evaluation and the use of project management tools for meeting project targets are essential (Abbasi & Al-Mharmah, 2000; Newell, 2002; Bresner & Hobbs, 2008; Patanakul *et al.*, 2010; Burke, 2013; Ferreira, Tereso, Ribeiro, Fernandes & Loureiro, 2013; Kerzner & Kerzner, 2017).

The current study seeks to identify the tools that are essential for meeting project deliverables and increasing performance efficiency in construction. The following segments of the paper present an overview of the strategy utilised in conducting the investigation, the findings, and the conclusions drawn from those findings.



## RESEARCH METHOD

The study sought to identify critical tools for meeting project deliverables and improving performance. A literature review was conducted to achieve the objective of the study, which was part of the research for a master's degree. Therefore, the findings from a review of the literature on the tools are presented. Various sources, including journals, conference proceedings, dissertations, and theses, were consulted. Databases such as Science Direct, Ebscohost, Google and Google Scholar were used. The materials were chosen based on the presence of relevant keywords, which included 'project management', 'performance', 'SMEs', 'success', 'construction industry', and 'tools'. Frequency of occurrence was used to rank the identified tools among the sampled studies. The literature review findings are subsequently presented.

## FINDINGS AND DISCUSSION

Many authors have identified a plethora of tools that are essential in aiding project teams to achieve project deliverables and improve project performance. These tools are tailored especially for construction project management, as presented in Table 1.

**Table 1:** Project management tools for specific outcome

Project outcome	PM Tools	Source
Time management	Gantt chart, milestone chart, and network diagram	Newell (2002) Bresner & Hobbs (2008) Burke (2013) Ferreira <i>et al.</i> (2013) PMBOK (2013) Radujkovic & Sjekavica (2017)
Managing quality	Control charts, Pareto diagram, cause and effect diagram, checklist, and flow chart	Chou & Yang (2012) Stojcetovic, Mistic & Zivce (2013) PMBOK (2013)
Project risk management	Checklist and decision tree	Newell (2002) Milosevic (2003) Bresner & Hobbs (2008) Chou & Yang (2012) Ferreira <i>et al.</i> (2013)
Management of project human resources	Organisational chart and issue log	Abbasi & Al-Mharmah (2000) Ferreira <i>et al.</i> (2013) PMBOK (2013) Golini, Kalchschmidt, & Landoni (2015)
Communication	Progress report	Miosevic (2003) Patanakul <i>et al.</i> (2010) PMBOK (2013)
Procurement	Statement of work	Bresner & Hobbs (2008) Ferreira <i>et al.</i> (2013)
Integration and scope management	Project charter	Patanakul <i>et al.</i> (2010) Chou & Yang (2012) Radujkovic & Sjekavica (2017)
Managing cost	Bill of quantities/materials used	Michael, Deepak, Venishri & Siow (2014)
Project management	Microsoft Project and Primavera software	Maserang (2002) White & Fortune (2002) Michael <i>et al.</i> (2014)

Further, in order to demonstrate the consensus among the sampled studies on the critical tools, the frequency of occurrence was assessed. Findings indicated that the most cited tools were the Gantt chart, project charter, control chart, and decision tree, check sheet, cause and effect diagram, Pareto chart, progress report, and network diagram (Table 2). Some of these are further discussed hereunder.

## Gantt chart

The project manager uses this tool to present the project's schedule in a chart format easy to understand. "It is a graphical representation of a project that shows each task as a horizontal bar whose length is proportional to its time of completion" (Burke, 2013). It is widely used in planning and controlling of documents and it effectively presents information in an accurate and precise manner (Milosevic, 2003; Bresner & Hobbs, 2008; Burke, 2013). The specific areas where this tool has been successfully used by previous studies included the conceptual, planning, and execution phases of the project life cycle. Patanakul *et al.* (2010) revealed that the Gantt chart was mostly used at the conceptual phase and execution phase for achieving the required project deliverables, and that the project was successful overall. Additionally, a study conducted by Murphy and Ledwith (2006) identified the Gantt chart as the most used tool among high-tech SMEs in Ireland for achieving the required deliverables at the planning phase. Moreover, Agumba (2006) identified the Gantt chart as one of the key tools used during the design/planning stage of projects among construction SMEs in South Africa. This tool was also among the top-ranked tools that were identified by Bresner and Hobbs (2008) and Tereso, Ribeiro, Fernandes, Loureiro and Ferreira (2019) as being used during the planning phase of projects.

## Project charter

This tool is mostly used in project integration (PMBOK, 2013). It refers to a statement of objective that sets out detailed project goals, roles and responsibilities, and identifies the main stakeholders (Bresner & Hobbs, 2008; Ferreira *et al.*, 2013; PMBOK, 2013). Having a project charter improves communication among project parties to a great extent and allows progression to be aimed at attaining industry best practices (Ferreira *et al.*, 2013). Studies conducted by Bresner and Hobbs (2008), Patanakul *et al.* (2010), Ferreira *et al.* (2013) and Tereso *et al.* (2019) identified the project charter as a major tool for achieving project objectives at the initiation or conceptual phase, as well as at the planning phase of the project life cycle. Hence, the appropriate use of this tool at this stage ensures that the project goals, roles and responsibilities are properly integrated early enough to ensure overall project performance improvement.

## Control chart

This is a graph used to study how a process changes over time, so as to control and improve the process (Newell, 2002; Chou & Yang, 2012; Stojcetovic *et al.*, 2013). It is one of the essential quality tools. Its function also includes the control and monitoring of cost and schedule variances, volume and frequency of scope changes, as well as errors in the project document (Agumba, 2006). Agumba (2006) identified this tool as one of the more efficient tools to be used during the construction phase of the project life cycle among construction SMEs for meeting quality objectives and maintaining good project control. Additionally, Chou & Yang (2012) found this tool to be one of the more effective tools for achieving an outcome of construction project quality in Taiwan. This view was shared by Bresner and Hobbs (2008).

## Decision tree

This tool is vital for project risk management (Bresner & Hobbs, 2008). It portrays decisions and their possible consequences in a tree-like model including chance event outcomes, resource costs, and utility (Karimi & Hamilton, 2010). It helps to determine the worst, best and expected values for different scenarios (Karimi & Hamilton, 2010; Kaminski, Jakubczyk & Szufel, 2017). This tool is advocated during the conceptual and execution/construction phases of projects (Milosevic & Lewwongcharoen, 2004; Bresner & Hobbs, 2008; Ferreira *et al.*, 2013).

## Check sheet/list

This tool is used for the collection of data and the collected data may provide a platform for subsequent analysis (Bresner & Hobbs, 2008; Burke, 2013). A checklist can help translate opinions into facts. Moreover, they are easy to understand. They can be customised in terms of design to serve a specific purpose. In Patanakul *et al.* (2010), the use of a checklist was found to be significant in influencing project success, particularly during the conceptual and execution phase.

### Cause and effect diagram

The cause and effect diagram is valuable for investigating all the potential factors that may cause or add to a specific issue, or have any impact (PMBOK, 2013). It is mostly used for brainstorming, particularly when managing complex issues. It can also be used in conjunction with the Pareto diagram. This tool was largely found to be used towards the attainment of project success at both the planning phase and execution phase of the project life cycle (Patanakul *et al.*, 2010).

### Pareto diagram/chart

This is a graphical tool that assists with the breaking down of a major problem so as to pinpoint the most significant parts. It is a bar graph with data arranged in descending order of significance (Michael *et al.*, 2014). This tool is used significantly at the execution phase for meeting project objectives (Patanakul *et al.* 2010). It was also mentioned in Bresner & Hobbs (2008) as a key tool for meeting quality objectives.

### Progress report

This report clarifies, in detail, the activities and tasks that have been undertaken and the milestones that have been reached towards the completion of a project (Milosevic, 2003; Balmaceda, 2018). By viewing the current status of progress, the project manager can monitor and control the project to detect cost, scheduling or quality-related problems early on. In Tereso *et al.* (2019), this tool was significantly used for the monitoring and controlling process of a project across various phases.

### Network diagram

This tool calculates the critical path method. With the aid of this tool, the start and finish times, as well as the sequence for all the project activities, can be determined. The sequence of activities that form the critical path can also be determined (Burke, 2013). It is one of the more vital time management tools (Patanakul *et al.*, 2010; Ferreira *et al.*, 2013). This tool is key during the project planning/design phase of a project (Milosevic & Iewwongcharoen, 2004; Bresner & Hobbs, 2008). It was also identified as a prerequisite to the critical path method in Agumba (2006).

### Milestone chart

This chart focuses on planned critical events that are scheduled to happen at specific times in the programme. Such events could be the inception or fruition of a particularly important activity, equipment deliveries, reviews, or perhaps approval dates (Verzuh, 2008). This chart is similar to the Gantt chart in the sense that it uses symbols on a schedule to provide information about planned and actual finishing dates, as well as any modifications to the milestone plan (Newell, 2002). A milestone chart can be used at the planning and execution phases of the project life cycle for actualising project success (Patanakul *et al.*, 2010; Tereso *et al.*, 2019).

### Organisational chart

This is a diagram that graphically demonstrates the connection between the task members, together with characterising their obligations, duties and specialisations (Agumba, 2006; Burke, 2013). Through the picture that this chart presents, a complete overview of an organisation can be viewed. This tool is best used at the design/planning phase of a project because it comprises the organisational breakdown structure. Hence, it is important for meeting project objectives during project design and planning, and it has been used among SMEs (Agumba, 2006; Golini *et al.*, 2012).

### Project management software

According to PMBOK (2013), project management software is widely used to assist with schedule development. These software products automate the calculation of mathematical analyses and resource levelling, thus enabling the rapid

consideration of many schedule alternatives. Project management software creates room for quick calculations to be performed, which are shown on a spreadsheet where changes can be handled very quickly – unlike hand calculations, which would be very laborious (Burke, 2013). Additionally, editing is swift once the database has been built up. Some of the popular software products that can be used include Microsoft Project and Primavera (Maserang, 2002; White & Fortune, 2002; Michael *et al.*, 2014). The importance of these software products at the monitoring and control phase of projects was demonstrated in Bresner & Hobbs (2008) and Tereso *et al.* (2019).

Other notable tools included in Table 2 (not discussed above) were best used at certain project phases. For instance, the use of a scope statement is crucial at the conceptual phase and planning phase for proper definition and control of a project (workwise) to ensure that activities were not deviated from but rather tailored to achieve the desired project goals and to meet objectives (Milosevic & Iewwongcharoen, 2004; Patanakul *et al.*, 2010; Tereso *et al.*, 2019). The statement of work was revealed in Agumba (2006) to be used among construction SMEs at the design/planning phase. The issue log was found to be relevant at the execution phase in Tereso *et al.* (2019) for the provision of structured information on how to resolve obstacles that can deter the achievement of project goals. The risk log was shown to be relevant at the execution phase in Milosevic and Iewwongcharoen (2004) for identifying uncertain events that may significantly influence project performance. The flow chart was significantly used in Patanakul *et al.* (2010) at both the planning phase and execution phase for achieving the project deliverables. Likewise, a performance report was used at the execution phase in both Patanakul *et al.* (2010) and Milosevic and Iewwongcharoen (2004). The activity list and PERT chart were found to be crucial for improving project performance during the planning phase in Tereso *et al.* (2019) and Milosevic and Iewwongcharoen (2004) respectively. Drawing/design software and a bill of quantities/materials were found to be relevant in Michael *et al.* (2014) throughout the project life cycle, and can be used at the conceptual, design/planning and execution phases.

In summary, the above-discussed tools are not exhaustive. However, it is noteworthy that the tools can enhance project performance and are thus crucial for SMEs in their efforts to improve project performance (Agumba, 2006; CIDB, 2011; Moilwa, 2013; Ihesiene, 2014).

Table 2: Project management tools.

Tools	Source															Total					
	Abbassi & Al-Mharmah (2000)	Agumba (2006)	Bresner & Hobbs (2008)	Burke (2013)	Chou & Yang (2012)	Ferreira <i>et al.</i> (2013)	Golini <i>et al.</i> (2012)	Kerzner & Kerzner (2017)	Maserang (2002)	Michael <i>et al.</i> (2014)	Milosevic (2003)	Milosevic & Iewwongcharoen (2004)	Newell (2002)	Patanakul <i>et al.</i> (2010)	Radujkovic & Sjekavica (2017)		Stojcetovic <i>et al.</i> (2013)	PM <sup>2</sup> Guide (2016)	PMBOK (2012)	White & Fortune (2002)	
Gantt/Bar Chart	X	X	X	X	X	X	X	X	X	X	X	X	X	X	X	X	X	X	X	X	15
Project Charter			X	X	X	X	X	X	X	X	X	X	X	X	X	X	X	X	X	X	9
Control Chart																					9
Decision Tree			X	X	X	X	X	X	X	X	X	X	X	X	X	X	X	X	X	X	9
Checklist																					8
Cause and Effect Diagram			X	X	X	X	X	X	X	X	X	X	X	X	X	X	X	X	X	X	7
Pareto Diagram/chart			X	X	X	X	X	X	X	X	X	X	X	X	X	X	X	X	X	X	7
Progress Report			X	X	X	X	X	X	X	X	X	X	X	X	X	X	X	X	X	X	6
Network Diagram			X	X	X	X	X	X	X	X	X	X	X	X	X	X	X	X	X	X	6
Scope statement																					5
Milestone Chart																					5
Issue Log																					5
Organisational Chart or OBS	X	X	X	X	X	X	X	X	X	X	X	X	X	X	X	X	X	X	X	X	5
Flow Chart																					5
Planning Software (Microsoft project/Primavera)	X																				4
Statement of Work		X	X	X	X	X	X	X	X	X	X	X	X	X	X	X	X	X	X	X	4
Performance Report																					4
Activity list			X	X	X	X	X	X	X	X	X	X	X	X	X	X	X	X	X	X	3
Project Closure																					3
Documentation			X	X	X	X	X	X	X	X	X	X	X	X	X	X	X	X	X	X	2
PERT Chart																					2
Risk Log																					2
Drawing/Design Software (eg. AutoCAD/Staadpro)																					1
Bill of Quantities/Materials																					1

## CONCLUSION

The study identified the project management tools mostly mentioned in existing literature concerning construction. It was revealed that the Gantt chart, project charter, control chart and decision tree were the most frequently occurring project management tools among the sampled literature. Other notable tools included a checklist, milestone chart, Pareto chart, progress report and network diagram. The diligent usage of these tools by construction SMEs, in conjunction with project management techniques, will go far in guaranteeing the achievement of project deliverables and will improve performance efficiency and effectiveness. Additionally, the achievement of project objectives leads to an increase in productivity. Productivity, in turn, impacts business growth and sustainability. This, therefore, contributes to the overall economic abundance of the nation.

Because the study is based on a literature review and is thus not comprehensive, further research is necessary with the use of primary data to determine the critical tools used among construction SMEs to improve project performance across the project life cycle.

## LIST OF REFERENCES

- Agumba, J. N. 2006. *Evaluating the use of project management techniques in infrastructure delivery by South African small and medium-sized contractors*. [Unpublished Master's dissertation]. Johannesburg: University of Johannesburg. South Africa.
- Balmaceda, K. 2018. *Progress report: how to write, structure, and make it visually attractive*. [Online] Available from: <https://piktochart.com/blog/progress-report/#:~:text=a%20progress%20report%3F%E2%80%9D-,What%20is%20a%20progress%20report%3F%C3%A0%2Dvis%20your%20project%20plan> [Accessed: 29 August 2019].
- Bresner, C. & Hobbs, B. 2008. Project management practice, generic or contextual: a reality check. *Project Management Journal*, 39(1):16-33.
- Burke, R. 2013. *Project management: planning and control techniques*. 4th Edition. New Jersey, USA: John Wiley & Sons Publishing.
- Burger, T. (2016). Failure of Businesses in South Africa is No Joke. [Online]. Available from: <https://jtbconsulting.co.za/the-failure-rate-of-businesses-in-south-africa-is-no-joke/> [Accessed: 04 November 2020].
- Dweiri, F. T. & Kablan, M. M. 2006. Using fuzzy decision making for the evaluation of the project management internal efficiency. *Decision Support Systems*, 42(2):712-726.
- Chou, J. S. & Yang, J. G. 2012. Project management knowledge and effects on construction project outcomes: *An Empirical Study*. *Project Management Journal*, 43(5):47-67.
- Construction Industry Development Board (CIDB). 2011. *Construction quality in South Africa: a client's perspective*. Pretoria, South Africa: CIDB.
- Construction Industry Development Board (CIDB). 2011. *SMEs Development*. [Online] Available from: [www.info.gov.za/View/DownloadFileAction?id=68205](http://www.info.gov.za/View/DownloadFileAction?id=68205) [Accessed: 27 April 2018].
- Ferreira, M., Tereso, A., Ribeiro, P., Fernandes, G. & Loureiro, I. 2013. Project management practices in private Portuguese organizations. *Procedia Technology*, 9:608-617.
- Fox, J. & Murray, C. 2003. Conducting research using web-based questionnaires: practical, methodological, and ethical considerations. *International Journal of Social Research Methodology*, 6(2):167-180.
- Golini, R., Kalchschmidt, M. & Landoni, P. 2015. Adoption of project management practices: The impact on international development projects of non-governmental organizations. *International Journal of Project Management*, 33(3):650-663.
- Ihesiene, U.C. 2014. A Survey-based study of project management problems in small and medium scale enterprises (SME) in Nigeria. *European Scientific Journal*, 10(25):1857-7881.
- Kamiński, B., Jakubczyk, M. & Szufel, P. 2017. A framework for sensitivity analysis of decision trees. *Central European Journal of Operations Research*, 26 (1):135-159. [Online] Available from: [doi:10.1007/s10100-017-0479-6](https://doi.org/10.1007/s10100-017-0479-6). PMC 5767274. PMID 29375266 [Accessed: 10 June 2020].
- Karimi, K. & Hamilton, H.J. 2010. Generation and interpretation of temporal decision rules. *ArXiv preprint arXiv:1004.3334*. Available from: <https://arxiv.org/ftp/arxiv/papers/1004/1004.3334.pdf>. [Accessed: 11 May 2020].
- Kerzner, H.R. 2010. *Project management-best practices: Achieving global excellence*. 2nd edition. Hoboken, USA: John Wiley & Sons.
- Kerzner, H. & Kerzner, H. R. 2017. *Project management: a systems approach to planning, scheduling, and controlling*. 10th Edition. New Jersey, USA: John Wiley & Sons Publishing.
- Marx, H. J. 2011. Construction Industry Development Board. Construction industry indicators. *An International Journal*, 1:93-117.
- Maserang, S. 2002. Project management: Tools & Techniques. Retrieved November, 15, p.2013. Available from: [http://www.umsl.edu/~sauterv/analysis/488\\_f02\\_papers/ProjMgmt.html](http://www.umsl.edu/~sauterv/analysis/488_f02_papers/ProjMgmt.html) [Accessed: 30 May 2020].
- Michael, J., Deepak, T., Venishri, P. & Siow, Y.T. 2014. Ranking the factors that influence the construction project management success-Malaysian perspective. *Civil and Environmental Research*, 6(1):80-88.
- Milosevic, D. Z. 2003. *Project Management toolbox*. New York: John Wiley and Sons.
- Milosevic, D. & Iewwongcharoen, B. 2004. *Project management tools and techniques: the contingency use and their impacts on project success*. Paper presented at PMI Research Conference Innovations, London, 14 July 2004. Newtown Square, PA: Project Management Institute.
- Molwa, S. 2013. *Factors constraining the development of professional project managers in small and medium-size construction enterprises in South Africa*. [Unpublished Masters thesis]. Johannesburg: University of Witwatersrand.
- Moloi, N. 2013. *The sustainability of construction small-medium enterprises (SMEs) in South Africa* (Unpublished Master's dissertation). Johannesburg: University of the Witwatersrand.
- Monks, P. 2010. *Sustainable growth of SMEs*. [Unpublished Masters research report]. Port Elizabeth: Nelson Mandela Metropolitan University.
- Murphy, A. & Ledwith, A. 2006. *Project management tools and techniques in high-tech SMEs in Ireland*. High Technology Small Firms Conference 2006, Enterprise Research Centre University of Limerick, Limerick Ireland.
- Newell, M. W. 2002. *Preparing for the project management professional (PM) certification exam*. New York: AMACOM.
- Patah, L. A. 2010. *Aviação da relação do uso de métodos e treinamentos em gerenciamento de projetos no sucesso dos projetos através de uma perspectiva contingencial: uma análise quantitativa*. [PhD in Production Engineering Dissertation] – Universidade de São Paulo, São Paulo.
- Patanakul, P., Iewwongcharoen, B. & Milosevic, D. 2010. An empirical study on the use of project management tools and techniques across project life-cycle and their impact on project success. *Journal of General Management*, 35(3):41-66.
- PwC. 2014. *Trends, challenges, and future outlook. Capital projects and infrastructure in East Africa, Southern Africa, and West Africa. SA construction*. [Online] Available from: [www.pwc.co.za/infrastructure](http://www.pwc.co.za/infrastructure) [Accessed: 26 June 2018].
- Project Management Body of Knowledge (PMBOK). 2013. *A Guide to the project management body knowledge*. 2nd edition. Project Management Institute. [Online] Available from <http://www.pmi.org> [Accessed: 22 April 2018].
- Radujković, M. & Sjekavica, M. 2017. Project management success factors. *Procedia Engineering*, 196:607-615.
- Shakantu, W.M. 2012. *Contractor Development*. In: G. Ofori (ed.) *New perspectives on construction in developing countries*, 1st ed. New York: Spon Press.
- Shenrar, A. & Dvir, D. 2010. Project success: a multidimensional strategic concept. *Long Range Planning*, 34(6):699-725.
- Shina, S.G. 2014. *Engineering project management for the global high-technology industry*. New York: McGraw-Hill.
- Statistics, S.A. 2011. *Formal census*. Pretoria: Statistics South Africa. [Online] Available from: [http://www.statssa.gov.za/census/census\\_2011/census\\_products/Census\\_2011\\_Census\\_in\\_brief.pdf](http://www.statssa.gov.za/census/census_2011/census_products/Census_2011_Census_in_brief.pdf) [Accessed: 5 April 2018].
- Statistics, South Africa. 2014. *Gross domestic product: Second quarter: Statistical Release PO441*. Pretoria: Statistics South Africa. [Online] Available from: <http://www.statssa.gov.za/publications/P0441/P04413rdQuarter2014.pdf> [Accessed: 6 April 2018].
- Statistics, South Africa. 2017. *Gross Domestic Product: Fourth Quarter 2017*. [Online] Available from: [www.statssa.gov.za](http://www.statssa.gov.za) [Accessed: 9 November 2019].
- Stojcetovic, B., Mistic, M. & Sarkocecic, Z. 2013. *Quality tools in project quality in project*. In 7th International Quality Conference. May 24th, 2013: 153-158. Centre for Quality, Faculty of Engineering, the University of Kragujevac Bojan.
- Tereso, A., Ribeiro, P., Fernandes, G., Loureiro, I. & Ferreira, M. 2019. Project management practices in private organizations. *Project Management Journal*, 50(1):6-22.
- Verzuh, E. 2008. *The Fast Forward MBA in project management* (3rd ed.). Hoboken, NJ: John Wiley.
- White, D. & Fortune, J. 2002. Current practice in project management - an empirical study. *International Journal of Project Management*, 20(1):1-11.

# AN OVERVIEW OF A SUSTAINABLE ADOPTION SUPPORT FRAMEWORK FOR OPTIMISING PREFABRICATION ADOPTION AMONG PRIVATE DEVELOPERS IN THE NIGERIAN HOUSING INDUSTRY

Enitan Oloto, University of Lagos, enlegacy@gmail.com  
Kayode Adebayo, University of Lagos, akay.adebayo@gmail.com

## Abstract

*According to the report of the Vision 2020 National Technical Working Group on housing in Nigeria, one of the five stated issues that needs to be resolved for the adequate provision of housing is the optimisation of appropriate design and technology for housing supply. One such technology suggested by this paper is the prefabrication system, which incorporates advantages such as economies of scale, labour savings and lowered cost. The unavailability of housing stock is a daunting global phenomenon that plagues most developing countries, such as Nigeria. Despite several mitigation attempts by the government and by the private sector, Nigeria still faces a deficit of more than 17-million houses. Equally, in the face of the current Covid-19 pandemic, which has further exposed the housing challenges faced by developing countries, it has become of utmost importance to evaluate the current level of adoption of appropriate technologies such as prefabrication, which offers the benefit of rapid production. This paper adopts a qualitative research approach by presenting an overview of an Adoption Support Framework (ASF), which was developed using a mixed research methodology. It is framed by the Innovation Diffusion Theory (IDT) and the Technology Acceptance Model (TAM) for optimising prefabrication adoption among private developers in the Nigerian housing industry. The ASF was developed based on an extensive review of literature and analysed data collected from 400 respondents in Lagos and The Federal Capital Territory, Abuja. These respondents are private developers and members of the Real Estate Developers Association of Nigeria (REDAN). Semi-structured interviews were also conducted with housing experts. The ASF is diagrammatic, showing the relationship between identified variables for increased adoption rate, while also showing the importance of improving these situations through a holistic and synergised research and development (R&D) collaborative approach within the housing industry. The ASF is discussed under three criteria: applicability; comprehension; and theoretical generalisation, while recommending areas for improvements.*

**Keywords:** adoption support framework, housing, prefabrication, technology, REDAN

## INTRODUCTION

In the face of the current Covid-19 pandemic, it has become most important to evaluate the current level of adoption of appropriate technologies such as prefabrication. This offers benefits such as rapid production, so as to continuously chart the course towards a sustainable and holistic transition from conventional construction methods that are currently impeding national and global housing goals, to technologies that provide adequate and affordable housing. The current pandemic has further exposed housing challenges faced by developing countries. Estimates of the United Nations (UN), as well as national counts (where they exist), suggest that the vast majority of the 1.1-billion people deemed homeless live in developing countries. This number includes inadequately housed people and street sleepers (Speak, 2019:1). Given the on-going impacts

of climate change, war, civil unrest, global economic uncertainty and the current Covid-19 pandemic, it is likely that these numbers will continue to increase. Therefore, it is expedient for stakeholders within the housing industry to proffer strategies for optimising the adoption of fast construction methods such as prefabrication, with a view to creating increased housing stock that is affordable and accessible.

This study presents an overview of an ASF developed for the optimisation of prefabrication adoption. The framework was developed on the premise of two theories: the IDT (Rogers, 2003) and the TAM (Davis, 1989). A conceptual framework developed from a combination of the two theories was used to develop survey tools used to gather data used to establish the ASF. The framework highlighted the independent variables that influence the rate of adoption, while findings from the analysis showed that four internal variables displayed the strongest predictor of adoption rate. It also showed the proposed relationship between stakeholders identified in the study. A previous framework developed by Pour-Rahimiana, Goulding, Akintoye and Kolo (2017:512) was also reviewed, which exposed the vagueness of the proposed roadmap towards adoption. In this study, the ASF is discussed under three criteria: applicability; comprehension; and theoretical generalisation. It provides a holistic and sustainable strategy towards prefabrication adoption, suggesting a procedure for tackling the housing shortage in the Nigerian housing industry and all developing countries.

## OVERVIEW OF HOUSING CHALLENGES IN NIGERIA

In Nigeria, neither the government nor the private sector provide sufficient housing units for the masses that need and demand it. Formal housing production is at approximately 100 000 units per year, which is highly inadequate because at least 1 000 000 units are needed yearly to bridge the 17-million to 20-million unit housing deficit by government's own target date of 2033, presuming the population continues at its annual growth rate of 3.5%. It is estimated that it will cost US\$363-billion to curb the current housing deficit. This number is expected to keep growing (CAHF, 2018:215). Those most affected by this housing shortage are the poor and vulnerable.

The Covid-19 pandemic has further exposed the evidence of insufficient housing units. According to Farha (2020:1), housing has become the frontline defence against Covid-19, where governments worldwide have invoked orders to stay home, self-isolate, physically distance from others and wash one's hands. These policies were implemented to flatten the pandemic curve and decrease infection rates of Covid-19. Unfortunately, according to Farha (2020:1) achieving these policies has been a challenge both globally and in developing countries, as these policies are predicated on the assumption that everyone has a home with adequate sanitation services. For over 800 million homeless people globally, this is not the case (Farha, 2020:1). The pandemic has reemphasised the need to embrace more sustainable and innovative approaches to housing delivery that can provide affordable homes through rapid construction methods.

In Lagos State, adequate housing has always been a challenge given the rapid urbanisation. In recent years, the housing deficit has increased to about 5-million, representing 31% of the estimated national housing deficit of 18-million. This has resulted in an acute shortage of housing for the teeming population (Oshodi, 2010). The phenomenon of rapid urban growth and demand for housing availability in Lagos is witnessed equally in the federal capital city Abuja. Iman, Mohammed, Wilson and Cheeseman (2008:469) revealed that records from the Abuja Master Plan indicated that the city was planned for a capacity of 3.2 million people. However, projected population figures for Abuja predict a massive growth of 5.8 million people by 2026. Unfortunately, the population has exploded even though less than 50% of the planned development has been attained. Abdullahi and Aziz (2010) say that the growth rate of Abuja is 9.3% and that housing development is a major challenge for the government.

When housing development approaches become innovative and sustainable, they can bridge the housing gap currently facing

developing cities globally. Industrial approaches save costs and time by moving critical construction processes off-site or by using advanced on-site techniques that make construction more like manufacturing. One of the most effective approaches is the use of prefabricated parts, such as pre-cast structural elements. It is therefore ironic that, despite the existence of such innovative yet not-so-new construction methods, which have the potential to enhance efficiency and rapid housing delivery, developers in both the public and private sectors have ignored their potential to reduce the housing deficit plaguing the country.

### EARLIER STUDIES OF PREFABRICATION IN THE HOUSING INDUSTRY OF NIGERIA

Literature provides research that addresses the issue of prefabrication adoption. Table 1 is a summary of research based on the adoption of prefabrication in the housing construction industry, based on a comprehensive literature review. However, within the Nigerian context, none of this research was based on models and theories that address the issue of system or product implementation in all areas.

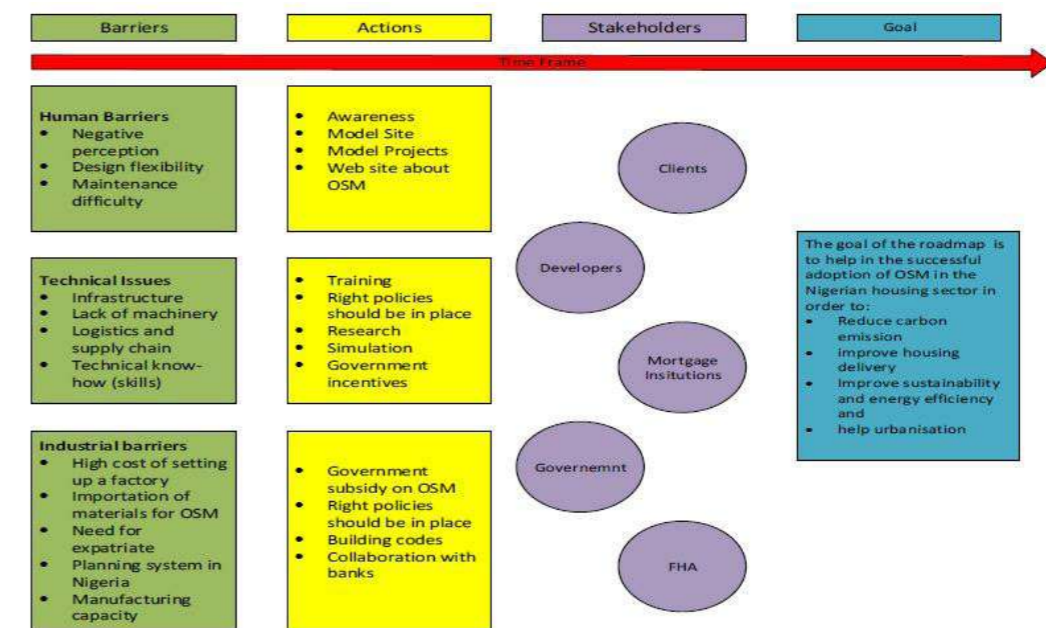
**Table 1:** Summary of previous research on prefabrication in the Nigerian housing industry.

Research	Country	Theory	Scope	Findings	References
Developers' perception of prefabricated housing methodology in Nigeria: A study of Lagos state	Nigeria	Nil	Lagos	Developers had very good knowledge of prefabrication but very little application.	(Adebayo & Dixon-Ogbechi, 2017a)
Urban mass housing in Lagos metropolis Nigeria – The potentials and marketability of prefabricated housing system	Nigeria	Nil	Lagos	Academia agreed on the prefabrication methodology marketability; optimistic about future adoption; academia within the built environment were knowledgeable of prefabrication; system not present in curriculum institutions.	(Adebayo & Dixon-Ogbechi, 2017b)
Housing Stakeholders' Perspective on Offsite Manufacturing in Nigeria	Nigeria	Nil	Nigeria	Notable benefits are less wastage on site, faster construction time, quality improvements and reduction in wet trades.	(Kolo, Rahimian & Goulding, 2015)
Offsite manufacturing construction: a big opportunity for housing delivery in Nigeria	Nigeria	Nil	Nigeria	Barriers include: negative local perception of the construction method; client's resistance to change and innovation; lack of infrastructure and skills shortage. Recommendation for adoption: sensitisation; collaboration and encouragement from government.	(Kolo, Rahimian & Goulding, 2014)
Review of Motivations, Success Factors, and Barriers to the Adoption of Offsite Manufacturing in Nigeria	Nigeria	Nil	Nigeria	Development of framework towards the adoption of prefabrication in Nigeria.	(Pour-Rahimiana et al., 2017)
Prefabrication Method of Building Construction in Lagos State, Nigeria: Prospects and Challenges	Nigeria	Nil	Lagos	Majority of the prefabricated home occupants (63.1%) were aware of prefabrication; Awareness was garnered from personal interest and research by occupants (13.1%).	(Ogunde, Selekere, Joshua, Kukoyi & Omuh, 2016)

### FRAMEWORKS TOWARDS SUCCESSFUL ADOPTION OF PREFABRICATION

Frameworks towards prefabrication adoption have been presented in several research studies globally. However, a recent framework within the Nigerian context, though vague and lacking a robust research approach towards its development, was developed by Pour-Rahimian *et al.* (2017:512). A proposed roadmap towards adoption was generated based on the findings of a substantial literature review that investigated the needs and barriers of adopting prefabrication in Nigeria. It also looked at seminal literature elaborating on prefabrication and the Nigerian housing industry, and provided an additional understanding of prefabrication in Nigeria based on expert opinions.

Figure 1 presents a framework based on the findings from Pour-Rahimian *et al.* (2017:517). The roadmap, which is the first step towards capturing variables that increase adoption, summarises the barriers associated with the adoption of prefabrication in Nigeria. This was initially developed from literature and refined with the engagement of principal stakeholders from Nigeria. The research identified five stakeholders. According to Pour-Rahimian *et al.* (2017:517), no literature had developed a framework specifically focusing on barriers, drivers, stakeholders and goals, particularly within the context of Nigeria. This was a commendable output because no literature had, until this study, illustrated a framework within the Nigerian context with regards to the stakeholders and their opinions on the barriers and drivers of prefabrication for housing construction. However, Pour-Rahimian *et al.* (2017:519) agreed that the framework was considered to be a starting point for future studies. One could consider the framework to be vague, showing no clear relationship between barriers or actions among the identified stakeholders. The framework failed to identify the various communication channels for effective diffusion of innovation. Although the barriers to prefabrication or offsite construction adoption in Nigeria were derived from expert opinions (Pour-Rahimian *et al.* 2017), the relationships between the barriers, actions and stakeholders were not specified, but rather generalised.



**Figure 1:** Outline roadmap for the adoption of prefabrication in the Nigerian housing development sector (Pour-Rahimian et al., 2017).

## THEORETICAL FRAMEWORK

The abovementioned study identified the concepts and theories that informed the reflections, analysis, and evaluation of this study selected for this claim. They were identified through a process of reflection in the writing of the researcher's claim, and are introduced here as an overview. Two theories that have informed the reflections, analysis, and evaluation of this study are the IDT and the TAM. In the IDT, Rogers (2003) argues that diffusion is the process by which an innovation is communicated over time among the participants of a social system. The origins of the IDT are varied and span multiple disciplines. As seen in Figure 2, the research identifies measurable variables (level of awareness, attributes of innovation and category of adopters) within the IDT theory. These measurable variables influence the rate of adoption of prefabrication among private developers, but limit the scope of investigation within the first two stages of the five-stage model. The researcher also drew upon the TAM of Davis (1985), as illustrated in Figure 3. The TAM introduces two measurable independent variables: the perceived usefulness (PU) and perceived ease of use (PEoU) of new technology (Steinhardt & Manley, 2016:30).

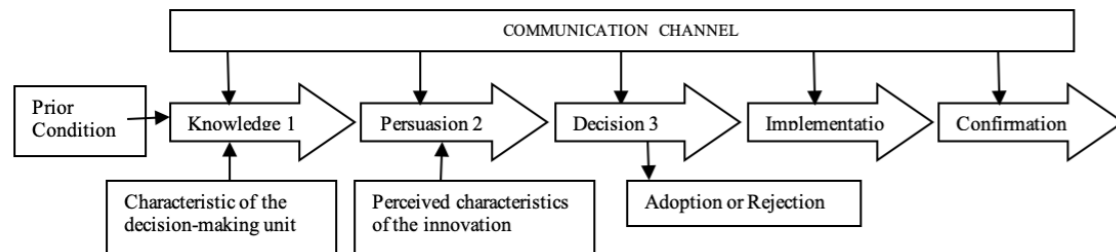


Figure 2: The innovation-decision process, adapted from Rogers (2003).

The theoretical and predictive validity of these constructs has been established across a range of disciplines (Bagozzi, 2007:245). PU is underpinned by the quality of outputs associated with the new technology, the resulting image of adopters, as well as the effect on the complexity and efficiency of processes. The PEoU is underpinned by the level of frustration and ease with which new technologies can be adopted (Venkatesh & Bala, 2008). The PEoU is theoretically tied to the perceived capabilities of the adopter to facilitate adoption, as the construct was originally built on the concept of individual self-efficacy, or perceived incapacity to undertake a behaviour (Davis, 1989:320).

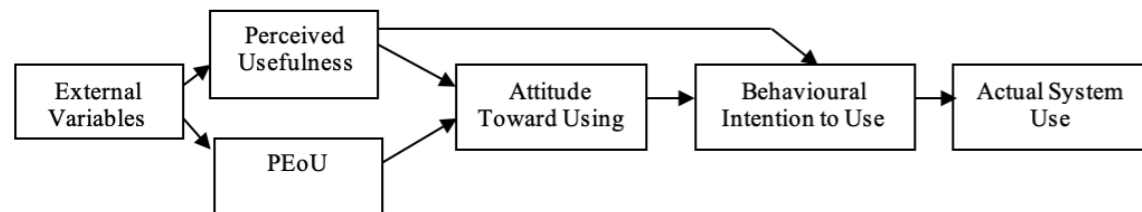


Figure 3: TAM. Adapted from Davis (1989).

## CONCEPTUAL FRAMEWORK

The conceptual framework was developed from merging two theoretical frameworks, the IDT and the TAM. These two theoretical frameworks shared variables with similar characteristics and a common dependent variable identified at the third stage of the innovation-decision process and at the last phase of the TAM respectively, namely adoption and actual usage. The scope of the research was limited to measuring the variables identified in stage 1 and stage 2 of the IDT (knowledge/level of awareness and persuasion), and stage 1 of the TAM (PU and PEoU). The independent variables identified were measured to determine the rate of adoption and to provide explanations behind this phenomenon. The diagram in Figure 3 is a synthesis of the IDT and the TAM theories.

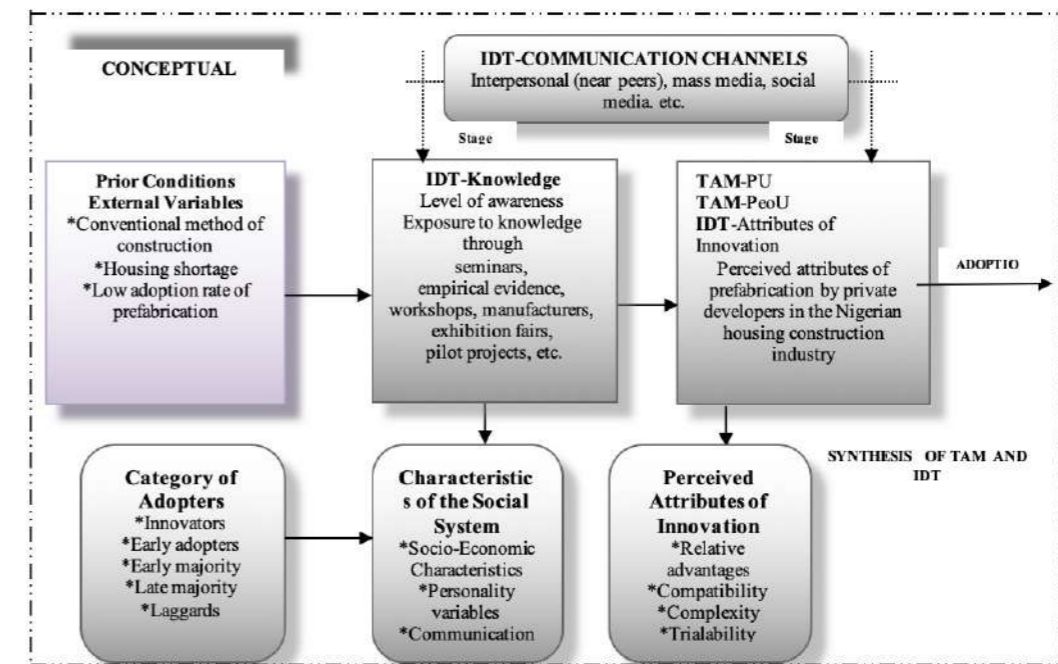


Figure 4: Conceptual Framework-Synthesis of IDT and TAM (Author, 2020).

## RESEARCH METHOD

This study adopted a quantitative and qualitative research approach. It involved an analysis of relevant literature, the conducting of a survey among 400 private developers under REDAN, and the conducting of in-depth interviews with experts who are directly involved in housing delivery. There were three main phases included throughout the study stages that employed different research methods. These included: literature search/review; data collection/analysis; and the development of the ASF. Questionnaire, which was developed on the premise of the theories employed (TAM and IDT) and was based on the data collected.

## THE ASF

The sustainable ASF towards the optimisation of prefabrication adoption in the Nigerian housing development industry, based on the findings of recent studies, is presented in Figure 5. This ASF summarises the steps towards achieving sustainable prefabrication adoption among private developers in Nigeria. The ASF identifies prior conditions of the phenomenon. This includes: low housing supply and low adoption of prefabrication; a diagrammatic relationship between these prior conditions; the level of awareness and current applications pre-diffusion among developers; as well as the importance of improving these current levels of awareness and application through a defragmented and collaborative R&D approach among stakeholders identified within the industry, such as private developers, manufacturers, academia and government professional bodies. The ASF shows that a continuous and sustainable collaboration of R&D, including the active dissemination of findings, provides empirical evidence that can be diffused through appropriate communication channels. This would foster a rapid adoption rate of any innovative technology, including prefabrication. It is important to note that all these activities exist within identified social systems that must exist in an integrated form in order to achieve effective information dissemination of technologies that need to be adopted, such as prefabrication.

This was initially developed from literature, as well as from findings from data that were gathered and analysed in recent studies. The ASF is novel because it specifically focuses on barriers, actions, stakeholders and goals within the context of Nigeria. However, it has the potential to be generalised to suit the contexts of other developing countries. This can be achieved against the backdrop of a combination of two technology acceptance theories (IDT and TAM), which were used to identify and measure variables that influenced the phenomenon of prefabrication adoption.

The ASF was developed based on an extensive review of literature, analysed survey data and in-depth semi-structured interviews. Regression analysis showed that observability, which is one of the independent variables in the conceptual framework, was a strong predictor of prefabrication adoption. According to Rogers (1983:232), observability is the degree to which the results of an innovation are visible to potential adopters. In this case, these are private developers. The results of some ideas are easily observed and communicated to some, whereas some innovations are difficult to describe to others. The observability of innovation – which in this case is prefabrication – as perceived by private developers and other stakeholders of the housing development industry, is positively related to its rate of adoption. The easier it is for individuals to see the results of an innovation such as prefabricated housing projects, the more likely they are to adopt it. Visible results reduce uncertainty and also stimulate peer discussion of a new idea as friends and neighbours of an adopter often request information about it (Abdullahi, Gbaje & Mohammed, 2015:85). Observability is also a form of advertising or marketing of a new technology. The development of a highly visible pilot project experience can catch the eyes of potential users and stakeholders in the housing development sector such as private developers, which will, in turn, spark interest, drive conversation and raise awareness. This would optimise the adoption rate of prefabrication.

The ASF was evaluated by experts in related fields for its clarity, accuracy, relevance, and appropriateness. This was done using communicative validation. Communicative validation includes returning to the study subjects to confirm whether that which was elaborated on corresponds to that which they experienced, both concerning the content and the relationships proposed (Souza & Silva, 2011:779). The evaluation criteria were fit, comprehension, and theoretical generalisation. This was to ascertain whether that which the private developers and experts experienced, now no longer in speech, was expressed in the developed ASF, as well as in the interpretation of the data that led to the development of the ASF, thereby expressing a higher level of abstraction. Thus, the rationale for the choice of communicative validation was based on verifying whether the ASF encompassed the entire experience of the private developers with the pre-existing conditions in the housing development industry and their relationship to prefabrication; whether the relationships of the phenomena converged; whether the ASF represents the identified social structures (such as REDAN, manufacturers, academia, among others) involved within the social system; and whether the variables were referred to in the same manner in which the researchers had categorised them. The evaluation of the ASF was performed with ten experts and professionals within the housing development industry.

Summaries of results from the evaluation exercise were presented based on the criteria of applicability; comprehension; and generalisation. Experts in housing development (EHD) were identified.

#### **First Criterion: Applicability/Fit**

This criterion was intended to verify whether the ASF was true to the on-going housing deficit in the Nigerian housing development industry, the insisted usage of conventional methods of construction, and the low rate of prefabrication adoption as an innovative approach to increasing housing supply among the private developers. It was also intended to verify whether it was suited to the interactive processes of the social support structure and system, and could express the reality experienced by the private developers. When describing the ASF, the experts showed an interconnection between components in a multi-directional manner, which included the cycle of the experiences with prefabrication. The categories presented were considered to be representative of each stage of this cycle and reflected the various stages of the conceptual framework developed in the research literature. The experts all expressed agreement, using examples and comparisons with their own experiences, with that which was described in the framework, in the sense that the included categories reflect the stages that they experience or had experienced. The description of the ASF was literal. The dynamics of the ASF and the design of its process were also highlighted, showing the connections that occur, as evidenced by the following statement:

*This framework is truly relevant and fits /expresses the current reoccurring conditions within the housing development industry. It also shows a clear progressive scenario indicating proposed action plans along the process. (EP1)*

The framework was therefore considered appropriate for current conditions within the housing development sector. This was because the experts thought that what was represented in the framework expressed their personal experience, as well as the knowledge gained through professional practice, current conditions with regards to housing, and the adoption of innovative approaches to solving housing inadequacy. In this criterion, no changes to the framework were suggested by the experts or resulted from the analysis performed by the researchers.

#### **Second Criterion: Comprehension**

In this phase, the ASF was evaluated to see if it represented the reality of the housing development industry, if its relationship to prefabrication was comprehensible, and if it made sense to the professional experts selected for the process. The ASF was considered to be understandable, which was evidenced by their descriptions and explanations of what they were observing in the diagram. These descriptions and explanations were analysed regarding their internal logic. They were also compared with the interpretations that the researchers had performed to create each of the categories, thus verifying the correspondence between these descriptions and the proposed theoretical design. All the experts reported that they comprehended the ASF presented.

*...the framework shows clearly a repetitive reoccurring interactive process suggested by the diagram, within the social system amongst the social structure. This interactive process in the network makes me understand that there are a series of elements, activities in the network, people, organizations, flows, which converges towards facilitating the optimization of any innovation adoption, like prefabrication, in this scenario. To me, it is in reality, total feedback and iterative process. (EP3)*

The analysis of the process was based on the fact that a theory denotes a set of well-constructed categories, themes, and concepts, which are related in a systematic way to form a theoretical framework to explain a social phenomenon. It was considered that the findings of the investigation exceeded the conditions of the mere conceptual organisation, establishing their relationships, as expressed by the experts. Thus, regarding the comprehension criterion, the framework was considered comprehensible, showing the results of the measurable variables (dependent and independent).

#### **Third Criterion: Theoretical Generalisation**

In this stage, the level of applicability was evaluated in different contexts of the ASF. In this criterion, what was considered was whether the ASF presented the capacity for abstraction and theoretical generalisation, and whether it was capable of also being used for the comprehension of other related innovation adoption situations experienced, as well as for other social structures within the housing development industry. This evaluation emphasises the scope and power of generalisation, because the ASF has the potential to be adapted to other conditions.

*I see this framework can be applied in other areas within the housing development industry, where other phenomena relating to housing delivery i.e. a shift from a conventional approach of housing delivery, whether administrative, decision-making processes, operational, to more modern approaches, can apply this approach in increasing adoption of any process desired and perceived as dimmed fit for the sustainable growth of the industry. The framework is therefore considered sustainable from my observation and can be modified over a period as scenarios and conditions improve or decline. New and relevant variables may need to be evaluated. The framework though developed in the context of Nigeria's housing development, can be adopted in the housing development industries of other developing countries (EP6)*



In the theoretical generalisation criterion, the ASF was considered valid, insofar as the experts considered the ASF abstract enough, having sufficient variation to apply it to other similar contexts. Although the outcome of the evaluation process was positive, continual revisions will be needed, along with improvements to its analysis. The process enabled a level of confidence and security for the ASF to be applied in practice. The application of the ASF will give rise to new ideas, provide other perspectives and, thus, lead to cognitive advances. This will enable reciprocal movements between theory and practice.

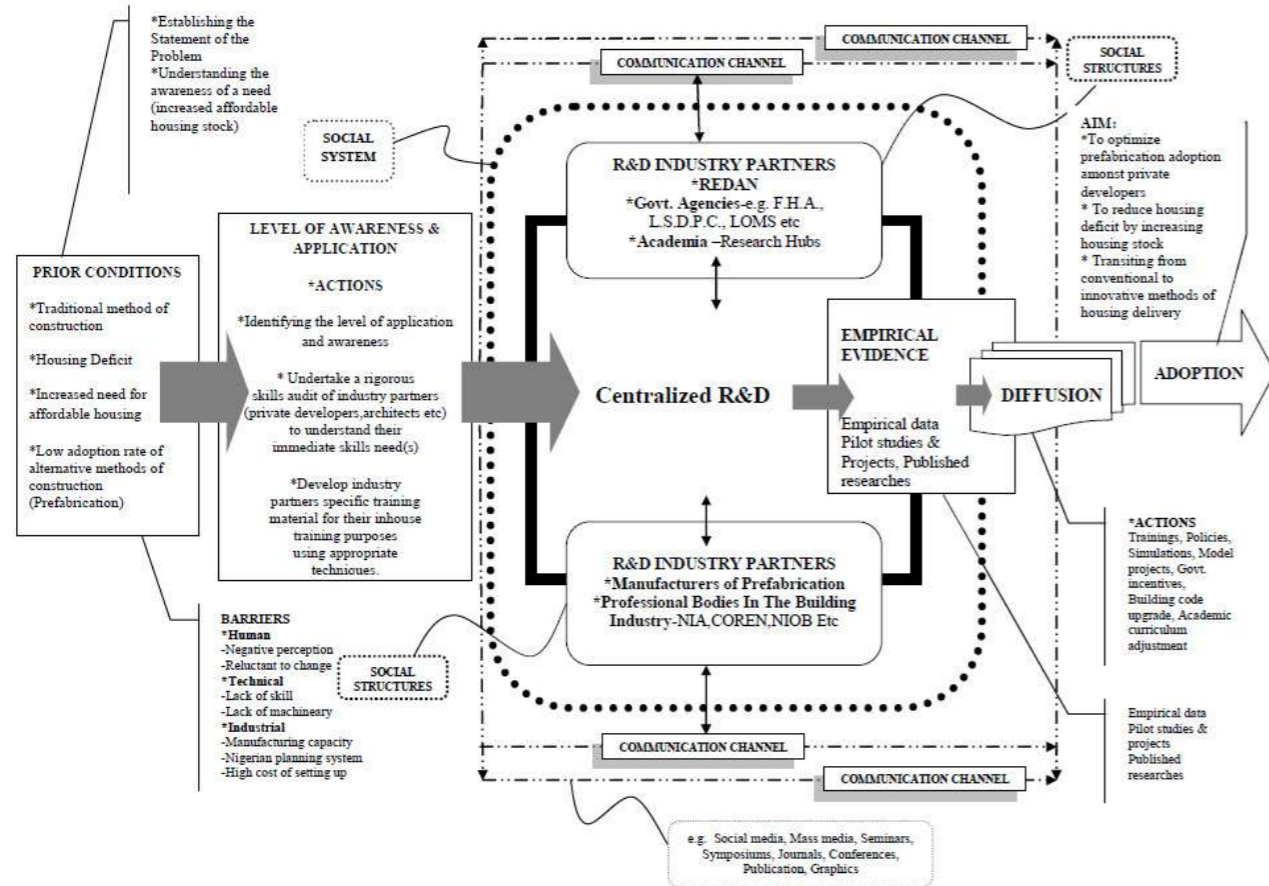


Figure 5: Sustainable ASF for optimising the use of prefabrication among private developers in Nigeria (Author, 2020).

## CONCLUSION

This study indicates that, although there is still a large housing deficit in Nigeria, there are currently no significant measures being implemented to address this challenge. However, prefabrication has been identified as a potential solution. Although the potential for positive changes exist in the form of numerous innovations such as sustainable adoption, they are not always adopted. If the innovation does not meet the perceived needs, it is naturally abandoned. The paper presented a brief overview of the Adoption Support Framework, which was discussed under three criteria: applicability; comprehension; and theoretical generalisation. Based on findings from analysed data, which was gathered from housing experts, the framework is conclusively applicable and fits the current housing scenario with regards to prefabrication. It can be easily interpreted and understood among stakeholders of the housing industry, and can be used in other scenarios within the housing industries of other developing countries. However, a research agenda focused on potential pre- and post-implementation interventions is recommended after subjection to further expert viewing. The aim of this would be to minimise bias and generate more valuable insights towards sustainable adoption.

## LIST OF REFERENCES

- Abdullahi, B. C. & Aziz, W. A. 2010. *Nigeria's housing policy and public private partnership (PPP) strategy: Reflections in achieving home ownership for low income group in Abuja, Nigeria*. Paper presented at the 22nd International housing Research Conference. Istanbul. 4-7 July.
- Abdullahi, I. M., Gbaje, S. E. & Mohammed, F. M. 2015. Perceived attributes of diffusion of innovation theory as a theoretical framework for understanding the non-use of digital library services. *Journal of Information & Knowledge Management*, 5(9):84-87. [Online] Available from: [https://www.researchgate.net/publication/309479883\\_Perceived\\_Attributes\\_of\\_Diffusion\\_of\\_Innovation\\_Theory\\_as\\_a\\_Theoretical\\_Framework\\_for\\_understanding\\_the\\_Non-Use\\_of\\_Digital\\_Library\\_Services](https://www.researchgate.net/publication/309479883_Perceived_Attributes_of_Diffusion_of_Innovation_Theory_as_a_Theoretical_Framework_for_understanding_the_Non-Use_of_Digital_Library_Services) [Accessed on Apr 08 2020].
- Adebayo, A. K. & Dixon-Ogbechi, B. N. 2017. Developers' perception of prefabricated housing methodology in Nigeria: a study of Lagos state. *Journal of Strategic and International Studies*, 12(4):54-68.
- Adebayo, A. K. & Dixon-Ogbechi, B. N. 2017. Urban mass housing in Lagos metropolis Nigeria-The potentials and marketability of prefabricated housing system. *Journal of Strategies and International Studies*, 12(1):25-30.
- Bagozzi, R. 2007. The legacy of the technology acceptance model and a proposal for a paradigm shift. *Journal of the Association for Information Systems*, 8(4):244-254.
- Centre for Affordable Housing Finance in Africa (CAHFA). 2018. Yearbook: housing finance in Africa: a review of some of Africa's housing finance markets. [Online] Available from: <http://housingfinanceafrica.org/> [Accessed on 13 July 2019].
- Davis, F. D. 1985. *A technology acceptance model for empirically testing new end-user information systems: theory and results*. Unpublished (Doctoral) thesis. Massachusetts: Massachusetts Institute of Technology. Sloan School of Management. [Online] Available from: <https://www.worldcat.org/title/technology-acceptance-model-for-empirically-testing-new-end-user-information-systems-theory-and-results/oclc/14927137> [Accessed on 17 May 2017].
- Davis, F. D. 1989. Perceived usefulness, PEOU, and user acceptance of information technology. *MIS Quarterly*, 3(13):319-340. [Online] Available from: <http://www.jstor.org/stable/249008> [Accessed on 12 April 2018].
- Farha, L. 2020. *Covid-19 guidance note protection for those living in homelessness*. [Online] Available from: [http://www.unhousingrapp.org/user/pages/07.press-room/Guidance%20Note%20Homelessness%20Actual%20Final%20%20April%202020%202\].pdf](http://www.unhousingrapp.org/user/pages/07.press-room/Guidance%20Note%20Homelessness%20Actual%20Final%20%20April%202020%202].pdf) [Accessed on 5 April 2020].
- Iman, A., Mohammed, B., Wilson, D. C. & Cheeseman, C. R. 2008. Solid waste management in Abuja, Nigeria. *Waste management*, 28:468-472.
- Kolo, S. J., Rahimian, F. P. & Goulding, J. S. 2014. Offsite manufacturing construction: a big opportunity for housing delivery in Nigeria. *Procedia Engineering*, 85:319-327. [Online] Available from: <https://doi.org/10.1016/j.proeng.2014.10.557> [Accessed on 8 February 2017].
- Kolo, S. J., Rahimian, F. P. & Goulding, J. S. 2015. *Housing stakeholders' perspective on offsite manufacturing in Nigeria*. Paper presented at the International Conference on Innovative Production and Construction (IPC). Perth. Western Australia. Australia. 28-31 July:179-182. [Online] Available from: <http://www.lcia.org.au/construct15/program/proceedings/> [Accessed on 7 March 2018].
- Ogunde, A., Selekere, T. E., Joshua, O., Kukoyi, P. O. & Omuh, I. O. 2016. Prefabrication method of building construction in Lagos state Nigeria: prospects and challenges. *International Journal of Engineering Technology and Computer Research (IJETCR)*, 4(1):88-100. [Online] Available from: <https://ijetcr.org/index.php/ijetcr/article/download/298/295/> [Accessed on 6 April 2020].
- Oshodi, L. (2010). *Housing, population and development in Lagos, Nigeria*. *International development and urban governance*. [Online] Available from: <https://oshlookman.wordpress.com/2010/11/24/housing-situation-in-lagos-nigeria/> [Accessed on 2 July 2012].

- Pour-Rahimiana, F., Goulding, J., Akintoye, A. & Kolo, S. 2017. Review of motivations, success factors and barriers to the adoption of offsite manufacturing in Nigeria. *Procedia Engineering*, 196:512- 519. [Online] Available from: <https://doi:10.1016/j.proeng.2017.07.232> [Accessed on 17 September 2019].
- Rogers, E. M. 1983. *Diffusion of innovations*, 3<sup>rd</sup> ed. New York: The Free Press. [Online] Available from: <https://teddykw2.files.wordpress.com/2012/07/everett-m-rogers-diffusion-of-innovations.pdf> [Accessed on 12 September 2018].
- Rogers, E. M. 1995. *Diffusion of innovations*, 4<sup>th</sup> ed. New York: The Free Press.
- Rogers, E. M. 2003. *Diffusion of innovations*, 5<sup>th</sup> ed. New York: The Free Press.
- Sloan School of Management. Massachusetts Institute of Technology. [Online] Available from: <https://dspace.mit.edu/handle/1721.1/15192> [Accessed on 20 October 2019].
- Souza, S. D. S. D. & Silva, D. M. G. V. D. 2011. Validation of a theoretical model: knowing the interactive processes within the support network for people with tuberculosis. *Acta Paulista de Enfermagem*, 24(6):778-783. [Online] Available from: <http://dx.doi.org/10.1590/S0103-21002011000600008> [Accessed on 15 February 2020].
- Speak, S. 2019. *The state of homelessness in developing countries*. Paper presented at the Expert Group Meeting on Affordable Housing and Social Protection Systems for all to Address Homelessness. United Nations, Nairobi, Kenya. 22–24 May. [Online] Available from: [https://www.un.org/development/desa/dspd/wp-content/uploads/sites/22/2019/05/SPEAK\\_Suzanne\\_Paper.pdf](https://www.un.org/development/desa/dspd/wp-content/uploads/sites/22/2019/05/SPEAK_Suzanne_Paper.pdf). Accessed on 8 March 2020.
- Steinhardt, D. & Manley, K. 2016. Exploring the belief of Australian prefabricated house builders. *Construction Economics and Building*, 16(2): 27-41. [Online] Available from: <http://dx.doi.org/10.5130/AJCEB.v16i2.4741> [Accessed on 19 July 2018].
- Venkatesh, V. & Bala, H. 2008. Technology acceptance model 3 and a research agenda on interventions. *Decision Sciences*, 39(2):273-315. [Online] Available from: <http://dx.doi.org/10.1111/j.1540-5915.2008.00192.x> [Accessed on 16 June 2018].

9TH INTERNATIONAL CONFERENCE ON APPROPRIATE TECHNOLOGY

# ENERGY AND MATERIALS

# A REVIEW OF COOKING SYSTEMS AND ENERGY EFFICIENCIES

Hesborn R. Ayub, Kenyatta University, Kenya, hesborn.rasugu@egerton.ac.ke  
Willis J. Ambusso, Kenyatta University, Kenya, ambusso.willis@ku.ac.ke  
Franklin Manene, Egerton University, Kenya, manenef@egerton.ac.ke  
Daudi M. Nyaanga, Egerton University, Kenya, dmnyaanga@egerton.ac.ke  
Department of Energy Technology, Kenyatta University - Kenya.

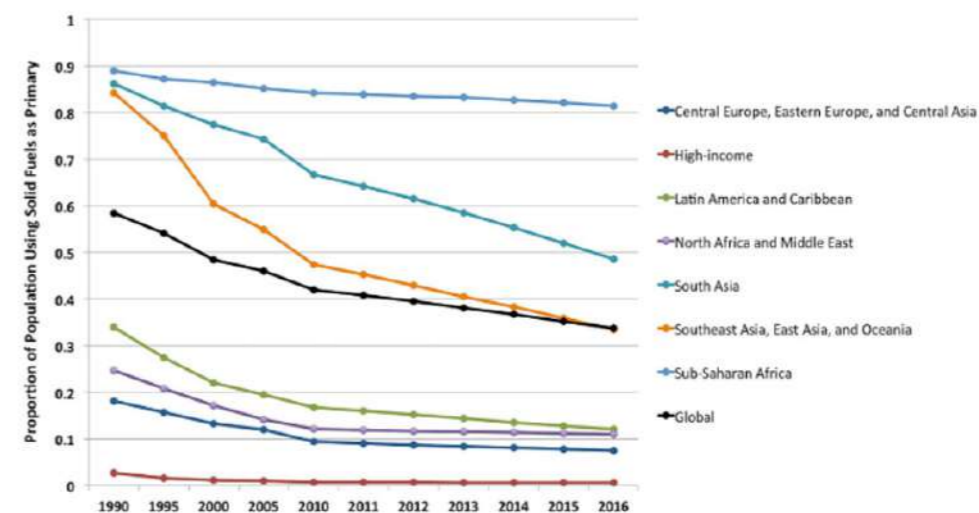
## Abstract

*This review examines the energy resources available in the world and their use in cooking. The review also looks at challenges in the ways they are used, and possible solutions to such problems. The study was done through a literature search using key words. Then 40 most relevant publications were read, analysed and synthesized. The major challenges found were low efficiencies, high cost, un-sustainability and indoor house pollution affecting about 3 billion people in the world. The new trends in energy use which might overcome these challenges are combustion-less cooking, using solar, hydrogen and electrical systems to overcome indoor pollution. The pressure-cooking concept improves energy efficiencies in boiling operations. The study found the following overall efficiencies: electrical induction heating at 90%, gas at 45-60%, traditional cooking stove 10%, fuel wood stove at 23-40% and electrical resistive heating at 75%. Induction cooking was found to be both faster and more efficient than gas, while electrical energy systems as a whole were found to be the cleanest, offering ease of control and versatility. Other energy efficiency improvement techniques in cooking that were found in literature were insulation, containment of escaping steam while cooking and automating the cooking vessel with a micro-controller. The study proposes research into combining of a micro-controller automated insulated pressure cooker which prevents exit of steam by cutting power supply using a relay, to work with an induction cooker. This combination is likely to improve overall energy efficiency in cooking. When successful it will help reduce pressure on cooking energy resources. Zero emission release during cooking will reduce indoor pollution significantly. With electrical cooking, from renewable energy sources, fewer trees will be cut for fuel wood, meaning lower carbon dioxide emission while leaving more trees to capture carbon dioxide which will have a double effect in mitigating climate change.*

**Keywords:** clean cooking, cooking efficiency, indoor pollution, induction cooker, pressure cooker.

## INTRODUCTION

Thermal energy is essential in human life: cooking is essential for feeding humankind, and boiled water is needed to fight infections, (Nogueira, I., Legrand, M., & Lecuona-neuman, 2018:p404). Energy for cooking comprises about 90% of all the domestic energy need in a country, and this is about 40% of its total energy consumption. Biomass sources, which are agricultural wastes and trees from forests, comprise of 80% of cooking energy in sub-Saharan Africa (Van der Plas R., 2007:p7). Other cooking energy sources are LPG, natural gas, electricity and kerosene. The choice of resource depends on the availability, affordability, ease of control and level of cleanliness.



**Figure 1.** Global and regional trends in population use of solid fuels as primary fuel (Baumgartner, 2019:p2)

The constant use of biomass in poorly ventilated households has led to indoor pollution and to respiratory diseases. This has led to newer and improved forms of renewable energy use, especially biomass gasification and biogas production.

From Figure 1, we see that solid fuel use is declining with time, due to the dangers associated with solid fuels, such as indoor pollution, and due to the improvement of the economic position of people. Despite this, world energy demand grows by 8.1% annually as the world population grows. This emphasizes the need to make available energy resources sustainable.

## METHODOLOGY

This study was conducted through a review of papers selected from Google Scholar using the five search terms “induction cooker”, “pressure cooker”, “cooking efficiency”, “clean cooking” and “cooking energy”. Two hundred papers were opened online and the 40 most relevant papers were selected and downloaded. The choices were based on the content as per their abstracts, data figures and their keywords. These selected papers were read, analysed and synthesized. The resulting review paper exposed the existing research gaps in the academic literature and also pointed the way to an energy-efficient cooking system.

## FINDINGS

### Cooking energy

The diagram in Figure 2 was developed from the literature to show the range of sources of energy used in cooking systems. Biomass and fossil fuel are the ones used in their raw forms for combustion-based cooking while most sources get converted into electricity first, for it to be used for combustion-less cooking.

Renewable energy resources are used either directly to cook or indirectly to generate electricity. The sun is the major source of renewable energy. It is the source of energy for systems using wind, hydro power, biomass, wave and OTEC (Ocean Thermal Energy Technology). Such systems include, for example, parabolic cookers, box cookers and Scheffler cookers.

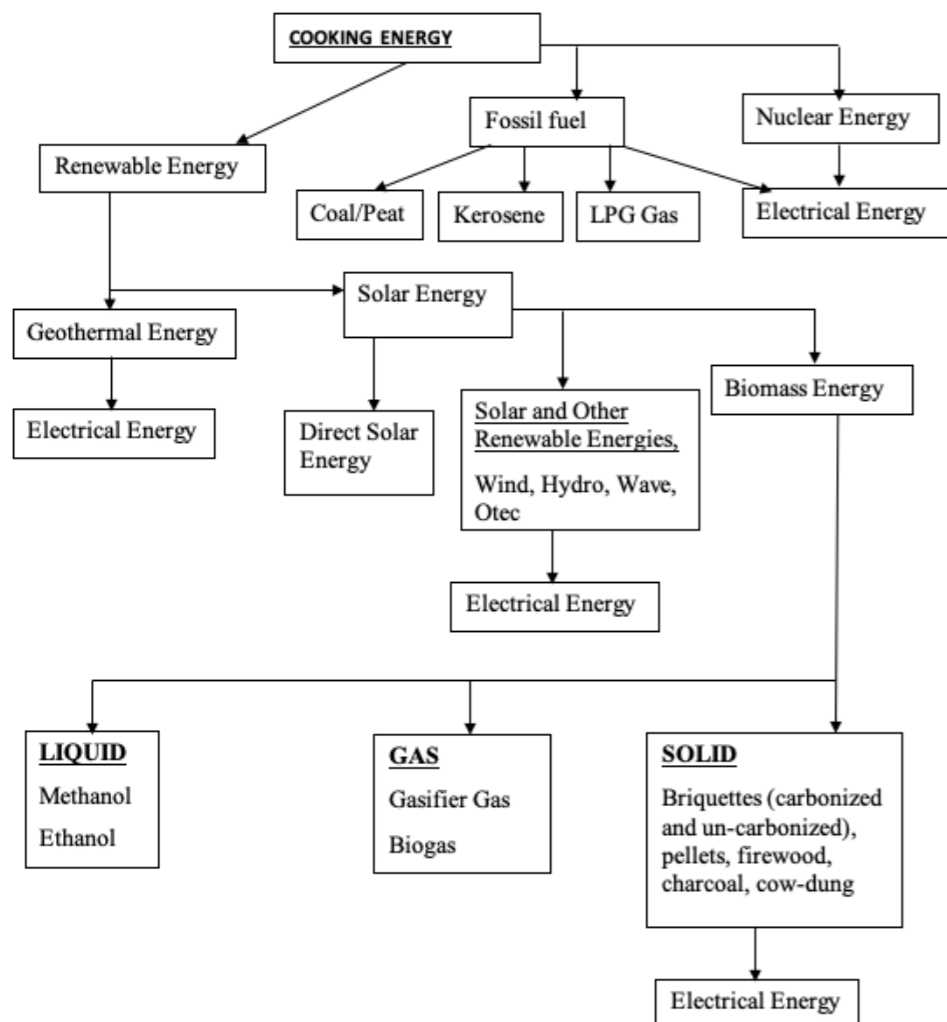


Figure 2: A cooking energy tree diagram.

Prabhu, A. V., Jeba, P., Babu, R., & Kumar, P. S. S. R., (2018:p27) argued for solar as a means of cooking and Indora S. & Kandpal T.C. (2018:p133) also supported solar for institutional cooking. Banerjee, M., Prasad, R., Rehman, I. H., & Gill, B., (2016: p166) proposed the use of solar induction stoves that are very efficient and an option for clean cooking. These new methods of using solar energy directly are more sustainable for cooking.

#### Cooking energy and cleanliness

Most fuels are hydrocarbons. When these hydrocarbons burn, they produce CO<sub>2</sub>, CO, H<sub>2</sub>O, N<sub>2</sub> and traces of NO<sub>2</sub> and SO<sub>2</sub>. Carbon dioxide gas is produced by combustion of fossil fuels and biomass, causes ozone layer depletion leading global warming and climate change including affecting rainfall patterns which often threatens food production and security

About 3 billion people in the world rely on solid fuels and kerosene for their cooking needs. Exposure to household air pollution from burning these fuels accounts for approximately 3 million premature deaths each year (Kumar & Igdalsky, 2019:p190), (Mazorra, J., Sánchez-jacob, E., De, C., Fernández, L., & Lumbreras, J. 2020:p1) and (Quinn, A. K., Bruce, N., Puzzolo, E., Dickinson, K., Sturke, R., Jack, D. W., Rosenthal, J. P., 2018:p2), and different illnesses such as heart disease, childhood pneumonia, chronic respiratory diseases, eye disease, cardiovascular disease, cancers, burns and cataracts ( Jewitt, S., Atagher, P., & Clifford, M., 2020:p2) and (Puzzolo, E., Pope, D., Health, P., & Kingdom, U., 2017:p291). World Health Organisation (WHO, 2014: p6) puts annual premature deaths due to respiratory complications at 7 million annually, but an

even higher figure is noted in other publications. This data emphasizes the need to substitute solid fuels with cleaner options. There has thus been a decline in global use of solid fuel and kerosene stoves for daily household energy needs (see Figure 1) (Baumgartner, 2019:p2).

Generally, women do most of the cooking in homes and, therefore are disproportionately affected by household air pollution caused by the inefficient burning of solid biomass cooking fuels ( Bloomfield, E., & Malla, M. B., 2014:p7) and (Ihalainen, M., Schure, J., & Sola, P., 2020:p2&3). Despite several existing efficient and clean cooking energy systems, households generally do not prefer them (Das, K., Pradhan, G., & Nonhebel, S., 2019:p157) and (Ihalainen et al., 2020:p5). The reason could be the high initial cost of purchase and reluctance to drop their traditional cooking methods. Charcoal and firewood will remain the main sources of cooking fuel for the next three decades. Corresponding energy policies are needed that set proper priorities and improve the sustainability of the biomass energy sector, ( Batchelor, S., Brown, E., Leary, J., Scott, N., & Leach, M., 2017:p259). The use of efficient cooking stoves can potentially save fuel and reduce the health risks of smoke in the kitchen ( Njenga, M., Iiyama, M., Jamndass, R., Helander, H., Larsson, A., Leeuw, J. De, Sundberg, C., 2016:p5). The introduction of new biomass technologies like Improved Cooking Stoves (ICS), despite having a chimney for emptying smoke to outside and avoiding indoor pollution, have a low rate of adoption. The majority of households use traditional biomass for cooking due to lack of knowledge. Therefore, mechanisms should be designed to promote clean cooking systems to teach the public about health effects of traditional cooking energy sources (Geremew, K., Gedefaw, M., Dagne, Z., & Jara, D., 2014:p3). The access to clean cooking fuels and technologies is essential for achieving the Sustainable Development Goals (SDGs), particularly in developing countries, to minimize impacts on human health and environment (Mikhail, J., Gallego-schmid, A., Stamford, L., & Azapagic, A., 2020:p3).

A shift to clean fuel like LPG and other gas stoves can bring significant health and environmental benefits, but only with proper and consistent use. Gas cooking is an important source of airborne fine particulate matter indoors. Exposure to cooking-derived fine particulate matter can lead to adverse human health impacts on non-smokers, especially in poorly-ventilated residential homes ( Sharma, R., & Balasubramanian, R., 2020:p4). The World Health Organization (WHO, 2018:p1) recommends carbon-free combustion methods such as solar, electric and hydrogen cooking. Solar cooking has reliability issues while hydrogen cooking is a new concept. Electric cooking (or e-cooking) is very clean and combustion free. The major challenges to electrical cooking are the high cost of electrical power and low electrification rates in some developing countries.

Table 1: Summary table of cooking energy in cleanness aspect.

Level of Clean Cooking	Forms	Effects
Unclean Cooking	fuel wood, cow dung, coal, peat, kerosene, pellets	Most undergo incomplete combustion thus producing fine black carbon, carbon monoxide, carbon dioxide and chlorofluorocarbons that cause respiratory problems.
Clean cooking	Improved cook stoves and charcoal, biogas, Smokeless biomass gasifier and LPG* burners	They undergo complete combustion but produce carbon dioxide and carbon aerosols that cause respiratory problems.
Cleanest cooking	solar, electrical and hydrogen cooking.	Hydrogen undergoes combustion but produces water, no carbon compounds. Other sources don't undergo combustion hence no gases emitted. This is the cooking method recommended by WHO.

Key: \*LPG = liquefied petroleum gas

Table 1 shows three categories of cleanliness of fuel as per their effect in indoor pollution. Biomass and fossil fuels undergo incomplete combustion, releasing particulate matter and emissions that are dangerous to life (Clancy, J., 2004:p12). Hydrogen undergoes clean combustion to release water, while electricity is combustion-less and clean.

Efforts have been made to reduce indoor pollution by replacing kerosene lanterns with solar lighting kits. This is a good move but because lighting accounts for only 10% of indoor pollution, the problem of pollution from cooking has to be solved. WHO recommends cooking by combustion of hydrogen or, if carbon sources are used, the flue gases must be expelled from indoor air.

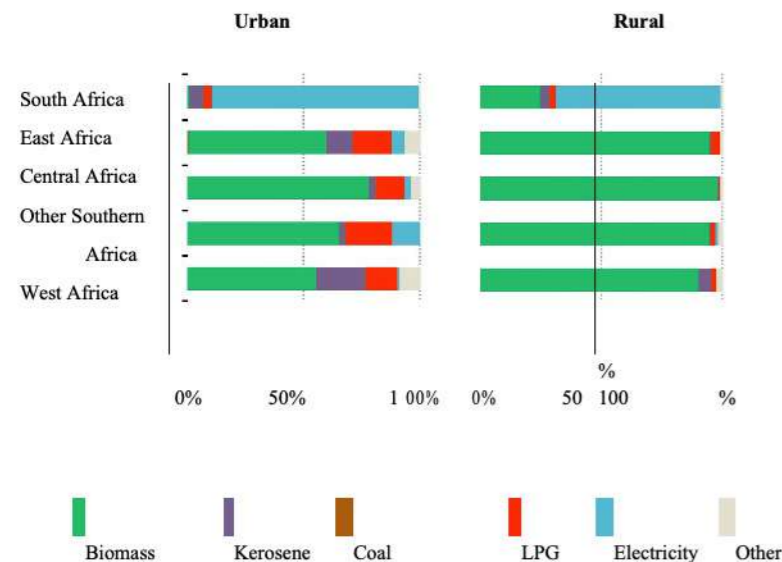


Figure 3: Cooking fuels in Africa, Source: (International Energy Agency, IEA, 2017:93).

In South Africa people use electricity for cooking in about 80% of urban homes and in 60% of rural areas. This is due to high grid connectivity in South Africa. Other east, west, central and southern African states use biomass for cooking in about 80% of rural and 60% of urban areas (IEA, 2017:p94). This shows surely that electrical cooking is a reality and can be achieved. The major challenges in Africa are the low electrification rates, poor grid connection and low power generation.

The annual electrical energy consumption for cooking per household is 3232 kWh which means about 9 kWh per day. With an efficiency improvement on the vessel side this daily energy use can be supplied by using solar PV (Bandile I. Sibiya, and Chitra Venugopal, 2017:p148) as supported by Watkins, T., Arroyo, P., Perry, R., Wang, R., Arriaga, O., Fleming, M., Stone, I., (2017:p52) that reported that small food quantities cook well for a family by incorporating insulation to the cookers. The authors recommend that the cooker can be fitted with a gas or battery back-up in non-grid areas to overcome major electrical challenges of cost and availability. Sibiya, Bandile Innocent., (2017:p147) proved that solar PV can support an induction cooker which can have a battery back-up for night cooking.

### COOKING SYSTEM ENERGY EFFICIENCIES

The efficiency of a cooking system is the ratio of energy output at the cooking vessel to the energy from source at the input side. When the efficiency is low, more energy input is required for the same amount of food to be cooked, compared to a more efficient cooking system. The lower the efficiency the more the need for energy. This situation leads to overexploitation of the available energy resources, and so efficiency improvements are needed for systems to be sustainable.

Our meta-study concluded that the efficiencies of cooking systems such as traditional 3-stone fires was about 10%, of ICS improved cook stoves 23-40% as per (Zhang, J., K. R. Smith, Y. Ma, S. Ye, F. Jiang, W. Qi, P. Liu, M. A. K. Khalil, R. A. Rasmussen, and S. A. Thorneloe., 2000:p4538). Efficiency for gas cooking is 45-60% and of electrical resistive cooking about 75% (Sunil Malla and Govinda R Timilsina, 2014:p8). Efficiency of inductive cooking systems was about 90% as per (Sadhu Pradip Kumar, Nitai Pal, Atanu Bandopadhyay and Sinha Dola, 2010:p652). While according to (Anozie, A. N., Bakare, A. R., Sonibare, J. A., & Oyebisi, T. O., 2007:p1286) the consumption efficiencies when boiling water were reported as 25%, 46%, 73%, 79%, 66% and 90% for fuel wood, kerosene, gas, electric immersion coil, electric heating coil and electric hot plate, respectively. The electric hot plate with its resistive element is 90% efficient according to Anozie et al. (2007:p1286), provided that the vessel is larger than the hot plate. When they are equal in size you will get about 75% efficiency. The induction cooker has a constant efficiency of 90% because it has sensors to determine the size of the cooking vessel and it adjusts the area that it magnetises. Induction cooking is thus widely used for its high efficiency and safety (Cao, L., Yin, T., Jin, M., & He, Z., 2019:p2) and (Yung, W. K. C., Muthu, S. S., & Subramanian, K., 2018:p136). Induction cookers heat pots cook faster than gas, as has been proven by both Sadhu et al., (2010:p652) and (Martínez-gómez, J., Ibarra, D., Villacis, S., Cuji, P., & Cruz, P. R., 2016:p101). The major challenge for their adoption in domestic use is initial high cost and the need to replace cooking vessels to ferromagnetic compliant ones.

### ATTEMPTS TO IMPROVE COOKING EFFICIENCY

There are three types of energy losses in cooking systems:

- Heat loss to the environment by both the cooking vessel and heat source, through basic heat transfer mechanisms of radiation, convection and conduction, resulting to poor heat transmission.
- Escape of heated steam in boiling, which will lower the internal energy of the water.

Any improvement in cooking efficiency reduces the energy input, thus decreasing demand on energy resources in the world, hence reducing the carbon footprint (Cimini A. & Moresi M., 2017:p22). We discuss three approaches to improvement found in the literature, namely insulation, pressure cooking and automation.

#### Insulation

Insulating materials reduce heat transfer losses from the vessel's or oven's side to the environment. Examples of insulating materials used are air, vacuum in a thermos flask, and rock wool. The fireless cooker is a good example of an almost adiabatic state with almost zero heat loss to the environment: according to (Watkins et al., 2017:p52), food can be brought to boiling point and then put in the very well-insulated fireless cooker, where it cooks without any extra energy. Also (Kumaresan, G., Vigneswaran, V. S., Esakkimuthu, S., & Velraj, R., 2016:p78) in solar cooking utilized insulation to achieve effective energy storage. Employing this insulation technology in an ordinary induction pressure cooker vessel can result in significant energy savings.

#### Pressure cooking

This entails cooking by boiling hard grains in a closed vessel at high temperature with steam at 120 °C and a pressure of 1.5 bar; the high pressure forces steam into the hard grains, hence cooking them faster (Karl, A., Singh, D., & Zerriffi, H., 2018:p4). There is energy loss from the food when the pressure-valve opens for safety, which escapes with energy according to Date D D, Tated R G. (2018:p2388). From the review we conclude that a new approach is needed for the pressure cooker where the cooking is done in a well-insulated pressure cooker powered by an induction cooker without release of steam, with the safety valve in its closed position.

#### Automating

The pressure cooker can be automated with the use of a micro-controller which switches an electric cooker off just before steam escapes through the safety valve. Pressure sensors control a relay that switches the heating device on and off, which conserves energy by preventing steam escape. Svosve C., & Gudukeya, L. (2020:p142) have demonstrated an automated stove which prevents the burning of food and powers off when it senses that there is no food to cook. (Das, T., Subramanian, R., Chakkaravarthi, A., Singh, V., Ali, S. Z., & Bordoloi, P. K., 2006:p158) agreed that automation will control energy input and bring energy economy. Sibiya & Bandile Innocent, (2017:p146) find the same results in their smart induction cooking system using solar energy.

### CONCLUSION

This study has successfully explored cooking systems for their cleanliness, efficiencies and sustainability, which was the main aim of the review paper. Electrical cooking was found to be clean, with induction heating giving the fastest and most efficient cooker. Electrical energy for cooking is clean with ease of control, and can support other domestic uses. Hence the need to make it more available, affordable, and sourced from renewable energy.

The pressure cooker offers energy savings by avoiding steam release, by switching power off and on, using a micro-controller. This study then proposes further research into systems that combine induction cooking technology with an insulated pressure cooker which is automated with a micro-controller for steam containment. This will prevent most energy losses to the environment, cut indoor pollution and reduce carbon dioxide emissions from combustion. The use of less energy in cooking from electrical renewable resources will help reduce demand for unsustainable energy resources, such as forests, around the world. This will have a double effect in mitigating climate change, which is SDG 13.

## RECOMMENDATIONS

From the findings the following suggestions are made to improve cooking energy efficiency, emission, cost and sustainability. Un-exploited renewable energy resources should be turned into electrical energy at an economical cost to make electrical energy cheaply available. This is in combination with good grid electrification will promote electrical cooking. Countries without natural and LPG gas should consider electrifying their country and then provide subsidies to support electrical induction cooking. This will lead to clean cooking and avoid unnecessary foreign expense to buy gas. This will help build and develop their own country and create jobs. Especially the sub-Saharan African countries with plenty of un-exploited renewable energy resources should follow South Africa's example in electrical cooking.

## ACKNOWLEDGEMENTS

The authors acknowledge the financial support for the scholarship from DAAD, which is funded by the Federal Republic of Germany.

## LIST OF REFERENCES

- Anozie, A. N., Bakare, A. R., Sonibare, J. A., & Oyebisi, T. O. 2007. Evaluation of cooking energy cost, efficiency, impact on air pollution and policy in Nigeria. *Energy*, 32, 1283–1290. <https://doi.org/10.1016/j.energy.2006.07.004>.
- Banerjee, M., Prasad, R., Rehman, I. H., & Gill, B. 2016. Induction stoves as an option for clean cooking in rural India. *Energy Policy*, 88, 159–167. <https://doi.org/10.1016/j.enpol.2015.10.021>.
- Batchelor, S., Brown, E., Leary, J., Scott, N., & Leach, M. 2018. Solar electric cooking in Africa: Where will the transition happen first? *Energy Research & Social Science*, 40(March), 257–272. <https://doi.org/10.1016/j.erss.2018.01.019>.
- Baumgartner, J. 2019. *Household Energy Solutions in Low and Middle Income Countries. Encyclopedia of Environmental Health, 2nd Edition* (2nd ed.). Elsevier Inc. <https://doi.org/10.1016/B978-0-12-409548-9.11784-1>.
- Bloomfield, D.E., & Malla, M. B. 2014. *Gender and Livelihoods Impacts of Clean Cook stoves in South Asia*. Global Alliance for Clean Cook stoves. Retrieved May 16, 2018, from <https://cleancookstoves.org/binary-data/RESOURCE/file/000/000/363-1.pdf>
- Cao, L., Yin, T., Jin, M., & He, Z. 2019. Flexible circulated-cooling liquid metal coil for induction heating. *Applied Thermal Engineering*, 162, 114260. <https://doi.org/10.1016/j.applthermaleng.2019.114260>.
- Cimini, A., & Moresi, M. 2017. Energy efficiency and carbon footprint of home pasta cooking appliances. *Journal of Food Engineering*. <https://doi.org/10.1016/j.jfoodeng.2017.01.012>.
- Clancy, J. 2004. *Enabling urban poor livelihoods policy making: understanding the role of energy services*. UK Department for International Development (DFID) Inception Report, 2004.
- Das, K., Pradhan, G., & Nonhebel, S. 2019. Human energy and time spent by women using cooking energy systems: A case study of Nepal. *Energy*, 182, 493–501. <https://doi.org/10.1016/j.energy.2019.06.074>.
- Das, T., Subramanian, R., Chakkaravarthi, A., Singh, V., Ali, S. Z., & Bordoloi, P. K. 2006. Energy conservation in domestic rice cooking. *Journal of Food Engineering*, 75, 156–166. <https://doi.org/10.1016/j.jfoodeng.2005.04.005>.
- Date D D, Tated R G; 2018. Pressure cooker lid – Literature review. *International Journal of Advance Research, Ideas and Innovations in Technology (IJARIIT)*.2018;4(3):2388-96.
- Geremew, K., Gedefaw, M., Dagne, Z., & Jara, D. 2014. Current Level and Correlates of Traditional Cooking Energy Sources Utilization in Urban Settings in the Context of Climate Change and Health, Northwest Ethiopia: A Case of Debre Markos Town. *BioMed Research International*, 2014, 1–10. <https://doi.org/10.1155/2014/572473>
- IEA International Energy Agency 2017. *World Energy Outlook-2017*, OECD/IEA, Paris.
- Ihalainen, M., Schure, J., & Sola, P. 2020. Where are the women? A review and conceptual framework for addressing gender equity in charcoal value chains in Sub-Saharan Africa. *Energy for Sustainable Development*, 55, 1–12. <https://doi.org/10.1016/j.esd.2019.11.003>
- Indora, S., & Kandpal, T. C. 2018. Institutional cooking with solar energy: A review. *Renewable and Sustainable Energy Reviews*, 84(December 2017), 131–154. <https://doi.org/10.1016/j.rser.2017.12.001>
- Jewitt, S., Atagher, P., & Clifford, M. (2020). “ We cannot stop cooking ”: Stove stacking, seasonality and the risky practices of household cookstove transitions in Nigeria. *Energy Research & Social Science*, 61, 1–10. <https://doi.org/10.1016/j.erss.2019.101340>
- Kar, A., Singh, D., & Zerriffi, H. 2018. Has India's Ujjwala Program enabled millions to shift to Liquefied Petroleum Gas as a primary cooking fuel? Available online: <http://erdelab.forestry.ubc.ca/2018/04/hasindiasujjwalaprogramenabledmillionstoshifttoliquefiedpetroleumgasasprimarycookingfuel/> [Accessed 08/05/2019].
- Kumar, P., & Igdalsky, L. 2019. Sustained uptake of clean cooking practices in poor communities: Role of social networks. *Energy Research & Social Science*, 48(August 2018), 189–193. <https://doi.org/10.1016/j.erss.2018.10.008>
- Kumaresan, G., Vigneswaran, V. S., Esakkimuthu, S., & Velraj, R. 2016. Performance assessment of a solar domestic cooking unit integrated with thermal energy storage system. *Journal of Energy Storage*, 6, 70–79. <https://doi.org/10.1016/j.est.2016.03.002>

- Martínez-gómez, J., Ibarra, D., Villacis, S., Cuji, P., & Cruz, P. R. 2016. Analysis of LPG, electric and induction cookers during cooking typical Ecuadorian dishes into the national efficient cooking program. *Food Policy*, 59, 88–102. <https://doi.org/10.1016/j.foodpol.2015.12.010>
- Mazorra, J., Sánchez-jacob, E., De, C., Fernández, L., & Lumbreras, J. 2020. A comprehensive analysis of cooking solutions co-benefits at household level: Healthy lives and well-being, gender and climate change. *Science of the Total Environment*, 707, 135968. <https://doi.org/10.1016/j.scitotenv.2019.135968>
- Mikhail, J., Gallego-schmid, A., Stamford, L., & Azapagic, A. 2020. Environment Environmental sustainability of cooking fuels in remote communities: Life cycle and local impacts. *Science of the Total Environment*, 713, 136445. <https://doi.org/10.1016/j.scitotenv.2019.136445>
- Njenga, M., Iiyama, M., Jamndass, R., Helander, H., Larsson, A., Leeuw, J. De, Sundberg, C. 2016. Gasifier as a cleaner cooking system in rural Kenya. *Journal of Cleaner Production*. <https://doi.org/10.1016/j.jclepro.2016.01.039>
- Nogueira, I., Legrand, M., & Lecuona-neumann, A. 2018. Photovoltaic Cooking. In *Advances in Renewable Energies and Power Technologies* (pp. 403–427). <https://doi.org/10.1016/B978-0-12-812959-3.00013-7>
- Prabhu, A. V., Jeba, P., Babu, R., & Kumar, P. S. S. R. 2018. A Review of Solar Based Induction Cooker using Different Topologies. *International Journal of Scientific Research and Review*, 7(10), 26–30.
- Primc, K., & Slabe-erker, R. 2020. Social policy or energy policy? Time to reconsider energy poverty policies. *Energy for Sustainable Development*, 55, 32–36. <https://doi.org/10.1016/j.esd.2020.01.001>
- Puzzolo, E., Pope, D., Health, P., & Kingdom, U. 2017. *Clean Fuels for Cooking in Developing Countries. Encyclopedia of Sustainable Technologies* (Vol. 4). Elsevier. <https://doi.org/10.1016/B978-0-12-409548-9.10153-8>
- Quinn, A. K., Bruce, N., Puzzolo, E., Dickinson, K., Sturke, R., Jack, D. W., ... Rosenthal, J. P. 2018. Energy for Sustainable Development: An analysis of efforts to scale up clean household energy for cooking around the world. *Energy for Sustainable Development*, 46, 1–10. <https://doi.org/10.1016/j.esd.2018.06.011>
- Sadhu Pradip Kumar, Nitai Pal, Atanu Bandopadhyay and Sinha Dola, 2010. *Review of induction cooking - A health hazards free tool to improve energy efficiency as compared to microwave oven*. Conference: Computer and Automation Engineering (ICCAE), 2010 The 2nd International Conference on Volume: 5, p 650-654, IEEE. DOI:10.1109/ICCAE.2010.5451317.
- Sharma, R., & Balasubramanian, R. 2020. Evaluation of the effectiveness of a portable air cleaner in mitigating indoor human exposure to cooking- derived airborne particles. *Environmental Research*, 109192. <https://doi.org/10.1016/j.envres.2020.109192>
- Sibiya, Bandile I., & Venugopal, C. 2017. Solar Powered Induction Cooking System. *Energy Procedia*, 117, 145–156. <https://doi.org/10.1016/j.egypro.2017.05.117>
- Sibiya, Bandile Innocent. 2017. *Smart Induction Cooking System Using Solar Energy*. University of KwaZulu-Natal. Unpublished Master's Thesis p.15, <https://researchspace.ukzn.ac.za/handle/10413/18113>.
- Sunil Malla, & Timilsina, G. R. 2014. *Household Cooking Fuel Choice and Adoption of Improved Cookstoves in Developing Countries a Review. A World Bank Policy review paper, June 2014*. <https://doi.org/10.1596/1813-9450-6903>
- Svosve, C., & Gudukeya, L. 2020. A Smart Smart Electric Electric Cooking Cooking Stove Stove. *Procedia Manufacturing*, 43(2019), 135–142. <https://doi.org/10.1016/j.promfg.2020.02.127>
- Van der Plas R. Haiti: (2007). Strategy to alleviate the pressure of fuel demand on national wood fuel resources. Republic of Haiti Ministry of Environment, Bureau of Mines and Energy, Energy Sector Management Assistance Program technical paper no. 112/07; 2007.
- Watkins, T., Arroyo, P., Perry, R., Wang, R., Arriaga, O., Fleming, M., ... Stone, I. 2017). Insulated Solar Electric Cooking – Tomorrow's healthy affordable stoves? *Development Engineering*, 2(December 2016), 47–52. <https://doi.org/10.1016/j.deveng.2017.01.001>
- WHO. 2014. Indoor Air Quality Guidelines: Household Fuel Combustion. Geneva: World Health Organization.
- WHO. 2018. Burden of disease from household air pollution for 2016. [https://www.who.int/airpollution/data/HAP\\_BoD\\_results\\_May2018\\_final.pdf](https://www.who.int/airpollution/data/HAP_BoD_results_May2018_final.pdf) [Accessed 21/03/2019]
- Yung, W. K. C., Muthu, S. S., & Subramanian, K. 2018. Carbon Footprint Analysis of Personal Electronic Product Induction Cooker. In *Environmental Carbon Footprints* (pp. 113–140). Elsevier Inc. <https://doi.org/10.1016/B978-0-12-812849-7.00005-2>
- Zhang, J., K. R. Smith, Y. Ma, S. Ye, F. Jiang, W. Qi, P. Liu, M. A. K. Khalil, R. A. Rasmussen, and S. A. Thorneloe. 2000. “Greenhouse gases and other airborne pollutants from household stoves in China: a database for emission factors.” *Atmospheric Environment* 34 (26):4537-4549. [https://doi.org/10.1016/S1352-2310\(99\)00450-1](https://doi.org/10.1016/S1352-2310(99)00450-1)



# INVESTIGATING THE EFFECT OF YEAST ON THE ANAEROBIC DIGESTION OF COW DUNG

Zelda Z. Rasmeni	Bongeka N. Magwaza	Daniel M. Madyira	Anthony N. Matheri
Department of Mechanical Engineering	Department of Mechanical Engineering Science	Department of Mechanical Engineering Science	Department of Chemical Engineering
UJ-PEETS	University of Johannesburg	University of Johannesburg	UJ-PEETS
University of Johannesburg Johannesburg, South Africa	University of Johannesburg Johannesburg, South Africa	University of Johannesburg Johannesburg, South Africa	University of Johannesburg Johannesburg, South Africa

\*Corresponding Author:  
zrasmeni@uj.ac.za

## Abstract

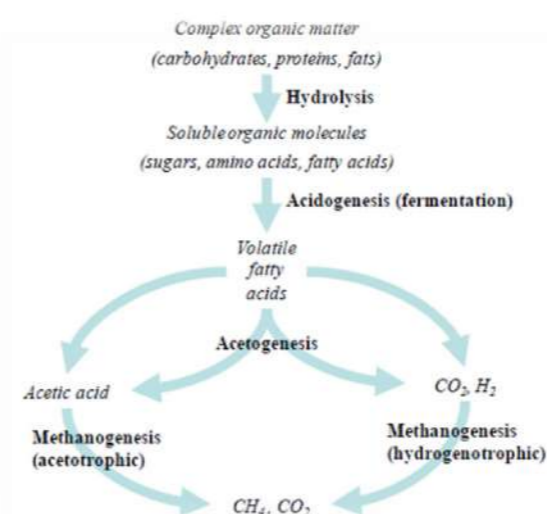
Concerns that the world faces include the depletion of natural resources, imbalance in the ecosystem, the risk of human health, and environment considerations. Anaerobic digestion presents an opportunity to minimise these concerns and to provide biogas for heating and cooking, as well as fertilisers for agricultural purposes. The main driving forces behind the production of biogas through anaerobic digestion is the prevention of pollution, energy generation and for agricultural uses. This promotes an energy-food nexus; hence, sustaining the environment through recycling and a bio-economical approach. The largest resource available in farming and rural communities, for the production of biogas, is animal manure. A major challenge in producing biogas through anaerobic digestion is the low biogas yield due to the diluted nature of substrates. This makes the process undesirable in terms of household use and commercial application. This paper aims to investigate the effect of yeast on the biomethane (bio  $\text{CH}_4$ ) yield of an anaerobic digester using cow dung feedstock. This is done in an attempt to improve the quality and quantity of biogas, thereby promoting its use as a sustainable energy solution. A biochemical methane ( $\text{CH}_4$ ) potential (BMP) test was conducted on three different substrates for the production of bio  $\text{CH}_4$ . The results obtained for the digestion of yeast alone indicated that a higher yield of biogas was obtained when a small amount of yeast was added to the substrate. Moreover, it indicated that the addition of yeast on the anaerobic digestion of cow dung improves the yield of biogas, with the optimum biogas yield occurring at a ratio of 1:2 (yeast to cow dung).

**Keywords:** anaerobic digestion, biogas yield, cow dung, yeast.

## INTRODUCTION

Biogas is an energy-rich gas produced from anaerobic digestion. It is composed mainly of  $\text{CH}_4$  and carbon dioxide ( $\text{CO}_2$ ). This gas is formed from the anaerobic degradation of organic substances, such as animal manure, wastewater, food waste and many other organic substrate (Perella & Gidarakos, 2016). Anaerobic digestion is the process of breaking down organic matter through the use of microbial associations in an oxygen-free environment. During anaerobic digestion, the organic portion of organic waste is broken down into biogas through the metabolism of microorganisms. Anaerobic digestion is considered to

be an option for managing organic waste and producing energy, while simultaneously reducing pollution (Choi, Kim, Lee & Lee, 2018; Bharathiraja, Sudharsana, Jayamuthunagai, Praveenkumar, Chozharendhan & Iyyappan, 2018). Another benefit of anaerobic digestion is that the process is performed at a low energy requirement. The biogas produced helps to reduce the amount of wood and fossil fuels used, thus reducing greenhouse emissions. Ekpeni, Nkem-Ekpeni, Benyounis, Aboderheeba, Stokes and Olabi (2014) break down the stages that constitute the production of biogas into four – as presented in Figure 1. The first stage is hydrolysis, which involves the breakdown of organic matter into simpler molecules in the presence of water. The second stage is acidogenesis, which involves the transformation of simpler molecules into acids (Chadwick, D., Sommer, S., Thorman, R., Fanguero, D., Cardenas, L., Amon, B. and Misselbrook, T., 2011). Acetic acid is produced during the third stage, which is known as acetogenesis. The last stage is methanogenesis wherein  $\text{CH}_4$  is produced. The resulting biogas product is composed of mainly  $\text{CH}_4$  and  $\text{CO}_2$  (Bassey, James, Bassey & Matthew, 2013).



**Figure 1:** Biochemical steps of anaerobic digestion [4].

Several researchers (Igliński, Buczkowski and Cichosz, 2015; Lindkvist & Karlsson, 2018; Hagos, Zong, Li, Liu & Lu, 2017; Appels, L., Lauwers, J., Degreève, J., Helsen, L., Lievens, B., Willems, K., Van Impe, J. and Dewil, R., 2011) have reported that one of the major challenges in producing biogas through anaerobic digestion is the low biogas yield due to the diluted nature of substrates. This makes the process undesirable for commercial applications. Also, on a large industrial scale, this process is not attractive economically. Yeast is believed to improve the biogas yield in an anaerobic digester (Bharathiraja *et al.*, 2018). This might depend on the type of feedstock used and on other process parameters.

Anaerobic digestion presents an opportunity for economic growth of communities. One of the economic benefits of anaerobic digestion systems includes the reduction of fossil fuel expenditure for waste management systems, which is achieved by using the energy produced in the form of biogas for electricity and heat. This could generate revenue through the selling of excess energy and through the reduction of fertiliser inputs and associated costs, while simultaneously improving soil fertility for agricultural purposes. However, the economics of the anaerobic digestion systems globally are affected by variations in the type and composition of feedstock, scale of digester, operating conditions, government incentives, and potential use of products. For instance, an anaerobic digestion system on a farm can generate income by making use of the energy products from the anaerobic digestion system and by charging dumping fees for accepting solid wastes. It can also generate income from co-products such as compost or organic fertiliser. The synergistic management of an anaerobic digestion plant and a farm could allow for shared resources such as labour and machinery, thereby contributing toward the positive economics of these systems (Vasco-Correa, Khanal, Manandhar & Shah, 2018; Achinas, Achinas & Euverink, 2017) and of the community. This highlights the importance of bio  $\text{CH}_4$  potential testing and improvements as being essential to growing the biogas sector. Also, depending on the geographic area and the season, the energy required to maintain the anaerobic digestion systems temperature varies significantly (Achinas *et al.*, 2017).

In an attempt to improve the biogas quantity and quality, continuous research has gained traction over the past few years. For instance, in the food industry, the need for clean fuel is important. Increased demand for high quantities of good quality bio

CH<sub>4</sub> could arise in further applications. For example, demand may increase in catering, industrial kitchens, bakeries and the food industry in general, wherein instantaneous, continuous heat and fast regulation are needed (Fagerström, Al Seadi, Rasi & Briseid, 2018).

### Factors Affecting Anaerobic Digestion and the Yield of Biogas

#### Temperature

According to (Liu, C., Wachemo, A.C., Tong, H., Shi, S., Zhang, L., Yuan, H. and Li, X., 2018) anaerobic digestion can occur in four different temperature conditions where microorganisms can develop. These conditions are: psychrophilic (T < 20 °C); mesophilic (20 °C < T < 45 °C); thermophilic (45 °C < T < 60 °C); and hyper-thermophilic (T > 60 °C). The operating temperature of the biogas digester is one factor that affects the performance of the anaerobic digestion process. In most cases, biogas plants are operated under mesophilic temperatures (Kuo & Lai, 2010). High-temperature operation is advantageous in that it allows for the enhancement of hydrolysis and reduces odour. On the other hand, mesophilic operation is less energy intensive and the operation is not susceptible to shock loading. Also, it is beneficial to degrade various organic matter under mesophilic conditions because there is a lower probability of inhibiting ammonia (Liu, C., Wachemo, A.C., Tong, H., Shi, S., Zhang, L., Yuan, H. and Li, X., 2018).

#### Hydraulic Retention Time

Aramrueang, Rapport and Zhang (2016) researched the effect of hydraulic retention time during the anaerobic digestion of *Spirulina platensis*. During the experiment, a completely stirred tank reactor was operated at different hydraulic retention times, varying from 10 days to 25 days. Based on the results they obtained, a greater yield of biogas and CH<sub>4</sub> was achieved through a longer retention time and lower organic loading rate. During longer hydraulic retention times, mesophilic conditions are viable. Hydraulic retention time has been recognised as one of the most important parameters that affect the continuous digestion of organic waste. Hydraulic retention time is the average time that input organic matter stays inside the digester before it is pushed out of the vessel as a digestate.

#### Organic Loading Rate

The organic loading rate is the amount of digestible material that is fed into the digester in kg of chemical oxygen demand (COD) per m<sup>3</sup> of digester and per day (El Achkar, J.H., Lendormi, T., Salameh, D., Louka, N., Maroun, R.G., Lanoisellé, J.L. and Hobaika, Z., 2018). Estevez, Linjordet & Morken (2012) experimented on the effect of organic loading rates on the biogas yield. According to Comino, Rosso & Riggio (2010), increasing the organic loading rate from 4.45 g to 5.15 g volatile solids (VS)/Ld during the co-digestion of crop silage and manure caused an increase of 5% on the yield of CH<sub>4</sub>. However, further attempts to increase the organic loading rate resulted in a decrease of biogas yield.

#### pH

Due to unregulated pH levels during the anaerobic digestion of cow dung, an increased concentration of ammonia nitrogen occurred, which was assumed to impede the process (Abubakar & Ismail, 2012). It was reported by Chen, Cheng & Creamer (2008), as well as by Fuchs, Wang, Gabauer, Ortner & Li (2018) that a high concentration of ammonia nitrogen is toxic to anaerobes, which will decrease the efficiency of the digestion and upset the process. The optimum pH value for the process of anaerobic digestion is slightly neutral to slightly basic (between 6.5 and 7.5) (Chen *et al.*, 2008).

#### Substrate (Cow Dung)

Cow dung is believed to have a high carbon to nitrogen ratio. Cow dung has a very good buffering capacity, such as the quantitative measure of its resistance to pH changes and the fact that it acts as a source of different micro-organisms that are required for anaerobic digestion (Bharathiraja *et al.*, 2018). Cow dung was mixed with rumen fluid at a ratio of 3:2 in an experiment conducted by (Choi, G., Kim, J., Lee, S. and Lee, C., 2018). A retention time of 42 days was used, while the temperature was taken with the aid of a mercury thermometer. The results obtained by Choi, G., Kim, J., Lee, S. and Lee, C., 2018) showed that the biogas yield contained 57.98% CH<sub>4</sub>, which was the highest percentage in the composition of biogas.

### Yeast Properties and its Effects on the Yield of Biogas

Baking yeast plays an important role in metabolising sugars to produce CO<sub>2</sub> and ethanol. The performance of yeast is prohibited by natural fungicides which may exist in plant materials, medium-chain fatty acids and other common

preservatives (Ruttarattanamongkol, Wagner & Rizvi, 2011). Zupančič, Škrjanec & Marinšek Logar (2012) investigated the possibilities of using waste yeast as an energy substrate to increase biogas production in brewery-wastewater treatment. In animal feed, baking yeast is used as a protein supplement. It allows for a fast breakdown of organic substances and it increases the number of cellulolytic bacteria in the rumen of cows, having no effect of the concentration of hydrogen and CH<sub>4</sub> (Epeni *et al.*, 2014; Suwannarat & Ritchie, 2015; Akin & Rigsby, 1987).

### METHODOLOGY

This paper aimed to investigate the effect of yeast on the bio CH<sub>4</sub> yield of an anaerobic digester using cow dung feedstock. This was done in an attempt to improve biogas quality and quantity, thereby promoting its use as a sustainable energy solution.

#### Specimen Preparation and Characterisation

The physical-chemical characterisation method was used to determine the moisture content, total solids (TS), VS and ash content of the substrates. What follows is the standard procedure that was followed during the characterisation of substrates, according to the American Public Health Association (Jenkins, 1982).

#### Equipment Description

The AMPTS II equipment was used to conduct BMP tests and analysis. Figure 2 presents the AMPTS II setup. The BMP test was carried out using batch digesters at a temperature of 37 °C. The substrates were divided into three parts: cow dung alone; yeast alone; and a digestion of a mixture of cow dung and yeast.



Figure 2: BMP test (AMPTS II).

#### Experimental Procedure

##### Substrates

Cow dung was digested alone, which was followed by the digestion of yeast alone and, finally, the co-digestion of cow dung and yeast mixed at different proportions. pH tests were performed on the substrates to ensure that they were operating at optimum pH levels. Nitrogen gas was used in the AMPTS II to remove oxygen and to ensure anaerobic conditions.

##### Inoculum

The inoculum – the starting fluid used in the biogas digester – was obtained from an active biogas digester. This inoculum is produced from food waste and animal manure. The inoculum used during the experiments was extracted from an active biogas digester operating at 37 °C.

##### Reactors

Fifteen glass bottles of 500 ml each were used as reactors. The reactors were fed with substrates of different volumes and incubated at a mesophilic temperature range, which is approximately 37 °C. Before the AMPTS II was allowed to run, information was loaded into the computer. This information included the percentage of flush gas for the concentration of CO<sub>2</sub>, which was set at 10%, the mixer time, which was 60 seconds, and the mixer speed adjustment, which was kept at 60% during the entire digestion process. The digestion process was analysed based on the volatile solids (VS) other than the chemical oxygen demand (COD). The headspace volume for all the digesters was kept at 100 ml and the assumed CH<sub>4</sub> content was 60%.

## BMP Assays

The CO<sub>2</sub> absorbing unit had 15 glass bottles containing a volume of up to 100 ml. 3M sodium hydroxide (NaOH) solution was used to remove the CO<sub>2</sub> from the gas produced in the incubating unit. The digesters were connected to the 100 ml glass bottles, which were filled with 75 ml of NaOH solution. After exiting the CO<sub>2</sub> absorbing unit, the gas was allowed to flow into the third unit wherein the volume of bio CH<sub>4</sub> was determined. The gas produced was analysed using the gas chromatography device, which was also used to determine the bio CH<sub>4</sub> composition.

## RESULTS AND DISCUSSIONS

### Bio CH<sub>4</sub> Potential Test for Cow Dung Alone

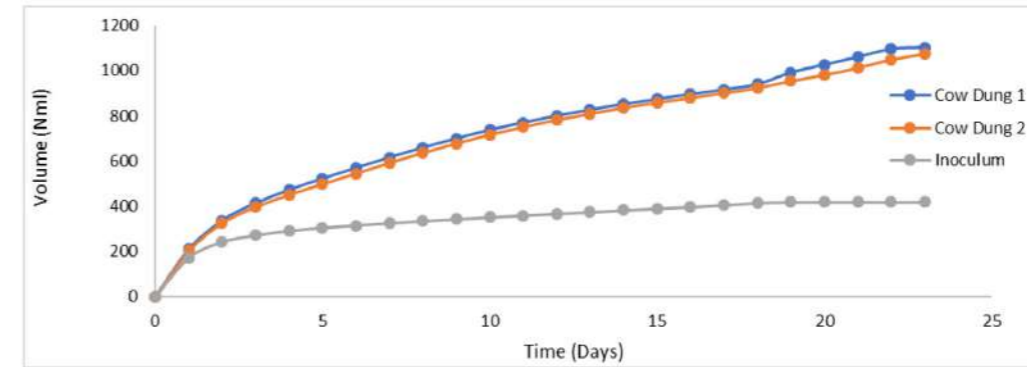
The digestion for cow dung alone ran for 23 days. Table 1 summarises the results obtained from the digestion of cow dung. Table 1 shows that the volume of biogas produced from the samples containing cow dung was 364.29 Nml Biogas/g VS. For inoculum, the volume of biogas produced was 157.60 Nml Biogas/g VS. Since the concentration of CH<sub>4</sub> was assumed to be 60%, the volume of CH<sub>4</sub> produced was 218.574 Nml CH<sub>4</sub>/g VS and 94.56 Nml CH<sub>4</sub>/g VS for cow dung and inoculum samples respectively.

**Table 1:** BMP Results for cow dung alone.

Parameters	Results
Physical observation	Semi-solid
Preparation	The sample was thoroughly mixed and randomly drawn
TS or dry matter (DM)	17.60%
VS (% VS of TS)	87.61%
Ash (% Wet)	2.81%
pH of the wet substrate	7.54
Adjusted pH before the run	Not Adjusted
Operating temperature	37 °C
Inoculum to substrate ratio	2 (on VS basis)
BMP (Nml Biogas/g VS) GB21- Cow dung sample GB7- Inoculum sample	Average duplicate 364.29 157.60
CH <sub>4</sub> concentration (%)	60 %

Figure 3 presents an accumulated volume of biogas for cow dung. The inoculum in Figure 3 started to produce biogas from the first day of digestion – the same as the cow dung did. The reason for this is that the inoculum was extracted from an active bioreactor and the oxygen was flushed before initiating the digestion, thus creating an anaerobic environment. Based on Figure 3, it can be stated that there was no increase in the volume of biogas produced after day 23. Hence, a constant, straight curve is presumed from day 23 onwards. Units for the volume of biogas produced are normalised because the AMPTS II

measured the volume of biogas at standard temperature and pressure.



**Figure 3:** Accumulated volume of biogas for cow dung.

### Bio CH<sub>4</sub> Potential Test for Yeast Alone

Table 2 summarises some of the characteristics of, and the maximum accumulated biogas yield obtained from, yeast samples. It can be seen from Table 2 that there was a volume of 678.68 Nml Biogas/g VS and 673.37 Nml Biogas/g VS for sample 1 and 2 respectively. The concentration of CH<sub>4</sub> was assumed to be 60%. Hence, from the yield of biogas produced, the volume of CH<sub>4</sub> produced from both samples was 407.2 Nml CH<sub>4</sub>/g VS and 404.02 Nml CH<sub>4</sub>/g VS.

**Table 2:** BMP results for yeast alone.

Parameters	Results
Physical observation	
The accumulated volume of inoculum	Dry granular sample
Preparation	The sample was thoroughly mixed and randomly drawn
TS or DM	92.90%
VS (% VS of TS)	90.06%
Ash (%Wet)	9.23%
pH of the wet substrate	7.91
Adjusted pH before the run	Not adjusted
Operating temperature	37 °C
Inoculum to substrate ratio	2 (on VS basis)
BMP (NI Biogas/kg VS) GB12 GB7	678.68 673.37

The accumulated biogas production was calculated from the daily production of biogas. The results obtained are illustrated in Figure 4.

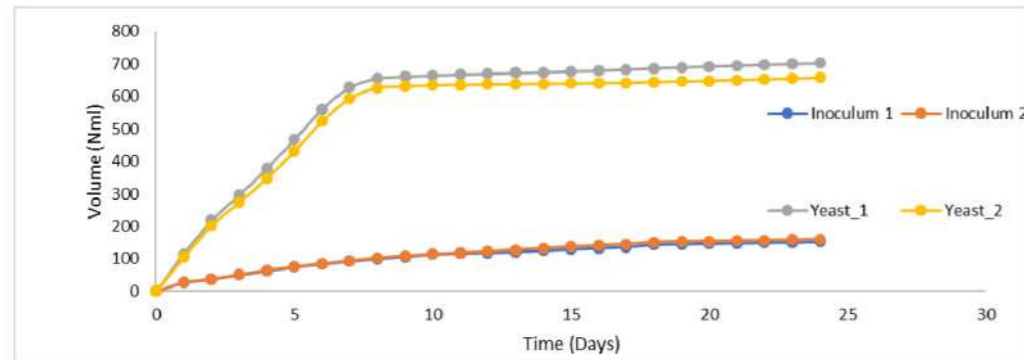


Figure 4: The accumulated amount of gas for all samples.

Figure 4 presents the samples with inoculum and yeast. The accumulated biogas increased rapidly for the first seven days; hence, the slopes of the curves are very steep. After that, the biogas production increased slowly. This implies that the digestion of yeast occurred very fast within the first few days of anaerobic digestion. Also, it can be observed that the anaerobic digestion process and the formation of biogas occurred immediately from day 1, reaching a maximum volume of 676.025 Nml Biogas/g VS.

The curves representing inoculum samples were expected to be similar to curves shown in Figure 4, since the same amount of inoculum was used for both samples. On the other hand, there is very little difference between the two yeast samples. The difference in the volume of biogas produced was about 45.4 Nml, which can be approximated to 6.45%. This variation was 0.03 g.

#### Bio CH<sub>4</sub> Potential Test for Cow Dung and Yeast

The results obtained were generated and are summarised in Table 3, Table 4 and Table 5.

Table 3: BMP results for cow dung and yeast – 5g yeast and 25g cow dung.

Sample	Cow Dung and Yeast
The accumulated volume of mixed inoculum & substrate (Nml)	569.1
The accumulated volume of inoculum	189.7
Mass of mixed inoculum and substrate VS (sample + substrate)	3.01
Mass of inoculum VS (g VS inoculum)	3.01
Mass of substrate VS (g VS substrate)	1.5
Total solid of a wet substrate (%)	33.92%
Volatile Solid (% VS of wet)	29.75%
Volatile Solid (% TS)	87.71%
Ash	4.16%
BMP (Nml CH <sub>4</sub> /g VS)	252.93
CH <sub>4</sub> concentration (%)	60%
Volume of biogas (Nml biogas/g VS) or (Nm <sup>3</sup> /ton VS) or (Nl/kg VS)	421.56
Volume of biogas (Nm <sup>3</sup> /kg VS)	0.4216
Volume of biogas per ton wet substrate (Nm <sup>3</sup> /ton wet substrate)	125.41
Volume of CH <sub>4</sub> per ton wet substrate (Nm <sup>3</sup> /ton wet substrate)	75.24767

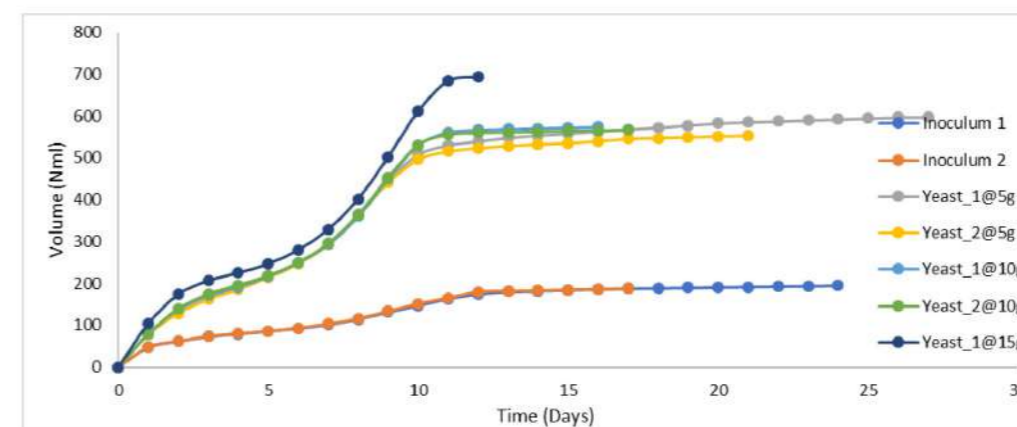
**Table 4:** BMP results for cow dung and yeast – 10g yeast and 20g cow dung.

Sample	Cow Dung and Yeast
The accumulated volume of mixed inoculum and substrate (Nml)	570.6
The accumulated volume of inoculum	189.7
Mass of mixed inoculum & substrate VS (sample + substrate)	3.01
Mass of inoculum VS (g VS inoculum)	3.01
Mass of substrate VS (g VS substrate)	1.5
Total solid of a wet substrate (%)	46.13%
Volatile Solid (% VS of wet)	40.90%
Volatile Solid (% TS)	88.66%
Ash	5.23%
BMP (Nml CH <sub>4</sub> /g VS)	253.93
CH <sub>4</sub> concentration (%)	60%
Volume of biogas (Nml biogas/g VS) or (Nm <sup>3</sup> /ton VS) or (Nl/kg VS)	423.22
Volume of biogas (Nm <sup>3</sup> /kg VS)	0.4232
Volume of biogas per ton wet substrate (Nm <sup>3</sup> /ton wet substrate)	173.10
Volume of CH <sub>4</sub> per ton wet substrate (Nm <sup>3</sup> /ton wet substrate)	103.8587

**Table 5:** BMP results for cow dung and yeast – 15g yeast and 15g cow dung.

Sample	Cow Dung and Yeast
The accumulated volume of mixed inoculum and substrate (Nml)	429.1
The accumulated volume of inoculum	189.7
Mass of mixed inoculum and substrate VS (sample + substrate)	3.01
Mass of inoculum VS (g VS inoculum)	3.01
Mass of substrate VS (g VS substrate)	1.5
Total solid of a wet substrate (%)	58.46%
Volatile Solid (% VS of wet)	50.52%
Volatile Solid (% TS)	86.42%
Ash	7.93%
BMP (Nml CH <sub>4</sub> /g VS)	159.60
CH <sub>4</sub> concentration (%)	60%
Volume of biogas (Nml biogas/g VS) or (Nm <sup>3</sup> /ton VS) or (Nl/kg VS)	266.00
Volume of biogas (Nm <sup>3</sup> /kg VS)	0.2660
Volume of biogas per ton wet substrate (Nm <sup>3</sup> /ton wet substrate)	134.38
Volume of CH <sub>4</sub> per ton wet substrate (Nm <sup>3</sup> /ton wet substrate)	80.62992

Figure 5 shows the plots for the accumulated production of biogas for the mixture of cow dung and yeast. The results obtained from the accumulated production of biogas were determined from the daily production of biogas.



**Figure 5:** Accumulated production of biogas for cow dung and yeast.

An increasing trend for the accumulated volume of biogas can be observed in Figure 5. The results obtained show that the maximum volume of biogas produced was 694.1 Nml, which was produced from the mixture with the yeast of 15 g. In addition,

the curve for the yeast of 15 g shows that the digestion process ended at day 12. This implies that the yeast was used up during the first 12 days of the digestion period. Other samples continued with digestion; however, not all of them reached the last day of the digestion period. The curve representing the accumulated amount of biogas produced from the mixture of cow dung with 15 g yeast shows that the anaerobic digestion stopped at day 12. This implies that the substrate was used up. Therefore, it could not produce biogas anymore. It can also be observed in Figure 5 that the more yeast added to the mixture, the quicker the anaerobic digestion.

#### Mono- and Co-Digestion Bio CH<sub>4</sub> Production

This section compares the results obtained from the BMP tests. Figure 6 indicates the accumulated production of biogas for all the samples.

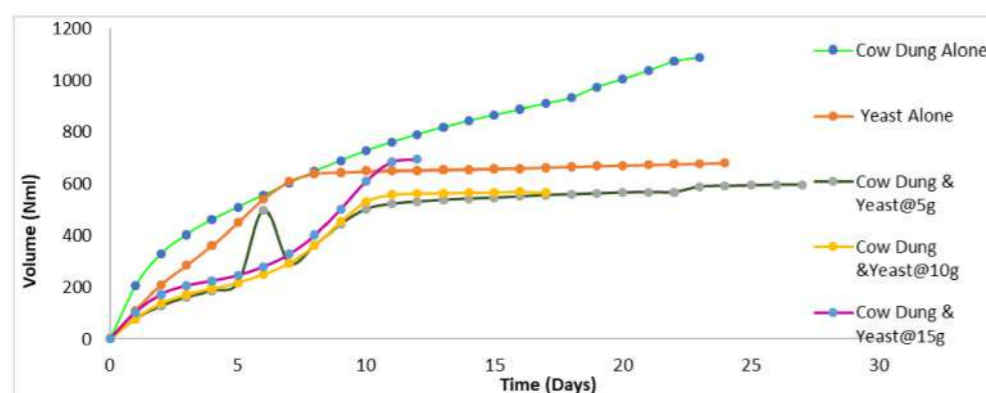


Figure 6: Accumulated biogas production for all samples.

Based on Figure 6, it is evident that the digestion of cow dung alone produced a higher yield of biogas when compared with all the other substrates, followed by the mixture of cow dung and 15 g of yeast. The reason that cow dung produced a much higher yield of biogas was because of the large amount of cow dung that was used during the digestion. Further, what is noted from the graph in Figure 6 is that the mixture of cow dung and 5 g of yeast produced a higher yield of biogas between day 5 and day 7. In addition, with a low amount of yeast added to the cow dung substrate, the digestion process continued, with biogas being produced up to the last day – even though the yield of biogas was constant towards the end.

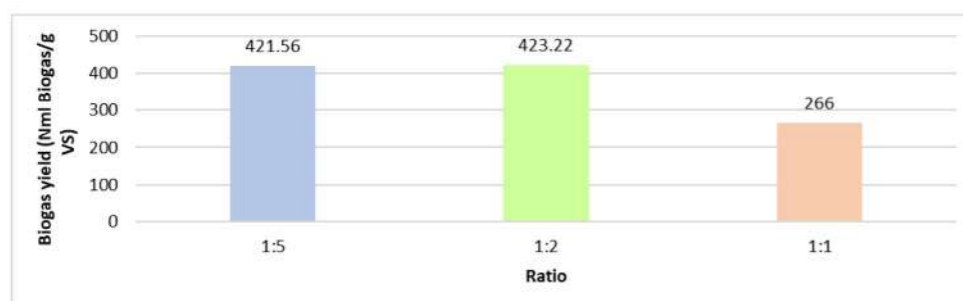


Figure 7: Comparison of biogas yield obtained from the mixtures in terms of ratios.

Figure 7 shows a bar graph that compares the yield of biogas obtained from the three different mixtures of biogas in terms of ratios. The ratio of 1:5 represents the mixture of cow dung and 5g of yeast. The ratios of 1:2 and 1:1 represent the mixture of cow dung and yeast of 10g and 15g respectively. From this figure, it can be observed that the optimum biogas yield was achieved at the ratio of 1:2.

#### CONCLUSIONS AND RECOMMENDATIONS

Based on the results obtained from the experiments, the following conclusions are made:

The BMP of cow dung alone was determined to be 364.29 Nml Biogas/g VS. The BMP of yeast alone was determined to be 675.97 Nml Biogas/g VS. The BMP of the mixture with 5g of yeast was determined to be 421.56 Nml Biogas/g VS. The BMP of the mixture with 10 g yeast was determined to be 423.22 Nml Biogas/g VS. The BMP of the mixture with 15 g yeast was determined to be 266.0 Nml Biogas/g VS. The yield of biogas increased as the mass of yeast added to the substrates increased. The more yeast was added to cow dung, the earlier the anaerobic digestion process ended. The maximum biogas produced was observed on the second day of anaerobic digestion for all the experiments. The results obtained for the digestion of yeast alone indicated that a higher yield of biogas was obtained when a small amount of yeast was added to the substrate. Finally, the addition of yeast to the anaerobic digestion of cow dung improved the yield of biogas, with the optimum biogas yield occurring at the ratio of 1:2 (yeast to cow dung). It is recommended that the impact of yeast be evaluated based on different substrates and in co-digestion. Other types of baking yeast should also be considered. This will accommodate a larger community than just the farming community, which also has food waste or any other organic waste to use as feedstock for anaerobic digestion. In addition, it is recommended that the ratio of feed to inoculum be evaluated so as to optimise the production process.

#### ACKNOWLEDGMENT

The authors wish to acknowledge Process Energy and Environment Station (UJ-PEETS) and the University of Johannesburg.

## LIST OF REFERENCES

- Fagerström, A., Al Seadi, T., Rasi, S. and Briseid, T., 2018. The role of anaerobic digestion and biogas in the circular economy. IEA Bioenergy.
- Asikong Bassey, E., James, E., Agbo Bassey, E., Antai, E.E. and Eja Matthew, E., 2013. Four potentials of biogas yield from cow dung-CD. *European Journal of Experimental Biology*, 3(3), pp.273-282.
- Bharathiraja, B., Sudharsana, T., Jayamuthunagai, J., Praveenkumar, R., Chozhavendhan, S. and Iyyappan, J., 2018. Biogas production—A review on composition, fuel properties, feed stock and principles of anaerobic digestion. *Renewable and Sustainable Energy reviews*, 90(C), pp.570-582.
- Igliński, B., Buczkowski, R. and Cichosz, M., 2015. Biogas production in Poland—Current state, potential and perspectives. *Renewable and Sustainable Energy Reviews*, 50, pp.686-695.
- Abubakar, B.S.U.I. and Ismail, N., 2012. Anaerobic digestion of cow dung for biogas production. *ARPN journal of engineering and applied sciences*, 7(2), pp.169-172.
- Liu, C., Wachemo, A.C., Tong, H., Shi, S., Zhang, L., Yuan, H. and Li, X., 2018. Biogas production and microbial community properties during anaerobic digestion of corn stover at different temperatures. *Bioresource technology*, 261, pp.93-103.
- Akin, D.E. and Rigsby, L.L., 1987. Mixed fungal populations and lignocellulosic tissue degradation in the bovine rumen. *Applied and Environmental Microbiology*, 53(9).
- Chadwick, D., Sommer, S., Thorman, R., Fanguero, D., Cardenas, L., Amon, B. and Misselbrook, T., 2011. Manure management: Implications for greenhouse gas emissions. *Animal Feed Science and Technology*, 166, pp.514-531.
- Lindkvist, E. and Karlsson, M., 2018. Biogas production plants; existing classifications and proposed categories. *Journal of Cleaner Production*, 174, pp.1588-1597.
- Comino, E., Rosso, M. and Riggio, V., 2010. Investigation of increasing organic loading rate in the co-digestion of energy crops and cow manure mix. *Bioresource technology*, 101(9), pp.3013-3019.
- Pellera, F.M. and Gidarakos, E., 2016. Effect of substrate to inoculum ratio and inoculum type on the biochemical methane potential of solid agroindustrial waste. *Journal of environmental chemical engineering*, 4(3), pp.3217-3229.
- .Choi, G., Kim, J., Lee, S. and Lee, C., 2018. Anaerobic co-digestion of high-strength organic wastes pretreated by thermal hydrolysis. *Bioresource technology*, 257, pp.238-248.
- Zupančič, G.D., Škrjanec, I. and Logar, R.M., 2012. Anaerobic co-digestion of excess brewery yeast in a granular biomass reactor to enhance the production of biomethane. *Bioresource technology*, 124, pp.328-337.
- Suwannarat, J. and Ritchie, R.J., 2015. Anaerobic digestion of food waste using yeast. *Waste management*, 42, pp.61-66.
- Vasco-Correa, J., Khanal, S., Manandhar, A. and Shah, A., 2018. Anaerobic digestion for bioenergy production: Global status, environmental and techno-economic implications, and government policies. *Bioresource technology*, 247, pp.1015-1026.
- El Achkar, J.H., Lendormi, T., Salameh, D., Louka, N., Maroun, R.G., Lanoisellé, J.L. and Hobaika, Z., 2018. Anaerobic digestion of grape pomace: Effect of the hydraulic retention time on process performance and fibers degradability. *Waste Management*, 71, pp.137-146.
- Hagos, K., Zong, J., Li, D., Liu, C. and Lu, X., 2017. Anaerobic co-digestion process for biogas production: Progress, challenges and perspectives. *Renewable and Sustainable Energy Reviews*, 76, pp.1485-1496.
- Ruttarattanamongkol, K., Wagner, M.E. and Rizvi, S.S., 2011. Properties of yeast free bread produced by supercritical fluid extrusion (SCFX) and vacuum baking. *Innovative Food Science & Emerging Technologies*, 12(4), pp.542-550.
- Appels, L., Lauwers, J., Degreè, J., Helsen, L., Lievens, B., Willems, K., Van Impe, J. and Dewil, R., 2011. Anaerobic digestion in global bio-energy production: potential and research challenges. *Renewable and Sustainable Energy Reviews*, 15(9), pp.4295-4301.
- Ekpeni, L.E., Nkem-Ekpeni, F.F., Benyounis, K.Y., Aboderheeba, A.K., Stokes, J. and Olabi, A.G., 2014. Yeast: a potential biomass substrate for the production of cleaner energy (biogas). *Energy Procedia*, 61, pp.1718-1731.
- Estevez, M.M., Linjordet, R. and Morken, J., 2012, July. Organic loading rate effect on anaerobic digestion: Case study on co-digestion of lignocellulosic pre-treated material with cow manure. In *International conference of agricultural engineering-CIGR-AgEng*.
- Aramrueang, N., Rapport, J. and Zhang, R., 2016. Effects of hydraulic retention time and organic loading rate on performance and stability of anaerobic digestion of *Spirulina platensis*. *Biosystems Engineering*, 147, pp.174-182.
- Achinas, S., Achinas, V. and Euverink, G.J.W., 2017. A technological overview of biogas production from biowaste. *Engineering*, 3(3), pp.299-307.
- Jenkins, S.H., 1982. Standard Methods for the Examination of Water and Wastewater. *Water Res.*, 16, pp.1495-1496.
- Kuo, W.C. and Lai, W.L., 2010. Treatment of kitchen waste using a mobile thermophilic anaerobic digestion system. *Renewable Energy*, 35(10), pp.2335-2339.
- Fuchs, W., Wang, X., Gabauer, W., Ortner, M. & Li, Z. 2018. Tackling ammonia inhibition for efficient biogas production from chicken manure: status and technical trends in Europe and China. *Renewable and Sustainable Energy Reviews*. [Online] Available from doi: 10.1016/j.rser.2018.08.038.
- Chen, Y., Cheng, J. J. & Creamer, K. S. 2008. Inhibition of anaerobic digestion process: a review. *Bioresource Technology*. [Online] Available from doi: 10.1016/j.biortech.2007.01.057.
- Choi, G., Kim, J., Lee, S. and Lee, C., 2018. Anaerobic co-digestion of high-strength organic wastes pretreated by thermal hydrolysis. *Bioresource technology*, 257, pp.238-248.

# INVESTIGATION OF WATER RECYCLING IN AN ANAEROBIC DIGESTER

Zenzile Rasmeni, University of Johannesburg, South Africa, zrasmeni@uj.ac.za  
Daniel Madyira, University of Johannesburg, South Africa, dmadyira@uj.ac.za  
Veli Nkutha, University of Johannesburg, South Africa  
Matheri Anthony, University of Johannesburg, South Africa, anthonym@uj.ac.za

## Abstract

Anaerobic digesters (ADs) are important biogas production units that convert waste to energy. In this paper, water recycling in the digestate of ADs will be investigated as a way to utilise this scarce resource. Mostly, the digestate is discharged into a dry bed to allow the water to evaporate and the solid bio-fertiliser to be recovered. This paper focuses not only on extracting of the solid content, but also on capturing the water so that it can be reused in the anaerobic digestion system. The tests that were performed included accumulated mass, water quantity, and water quality tests. The most suitable filtration material was found to be the 60  $\mu\text{m}$  stainless steel mesh. This material was found to have a separation efficiency of 44% while recycling 77% of the water from liquid digestate. The properties of the material were high durability, high corrosion resistance, and high strength. This made the material long lasting and efficient for real-world applications. Further, due to its low corrosion, the recycled water does not have material impurities. The filtered water can be fed back into the digester while the filtrate can be used as a fertiliser.

**Keywords:** anaerobic digestion, water recycling, liquid digestate, waste to energy.

## INTRODUCTION

Anaerobic digestion is a collection of processes that break down biodegradable materials in an oxygen-free environment. During this process, organic materials are disintegrated into simpler chemical constituents through hydrolysis, acetogenesis, acidogenesis and methanogenesis processes (Monnet, 2003; National Non-Food Crops Centre, 2011). The anaerobic digester is used to achieve two possible goals, which are to treat biodegradable waste and to produce saleable products (heat/energy and soil amendments) as shown in Figure 1 (Monnet, 2003). The organic waste to be treated includes farm waste, sewage sludge, solid wastes, industrial organic wastes and botanic wastes (Monnet, 2003). Energy crops can also be grown and used in the anaerobic digester, where high gas yields and good quality soil amendments are required (Monnet, 2003). The by-products of the anaerobic digester are biogas and digestate, the quality of which is dependent on the feedstock and level of contamination. The biogas and digestate can be further treated for special purposes, such as the composting of digestate (Monnet, 2003).

The process of anaerobic digestion can be divided into four phases: pre-treatment; digestion; gas upgrading; and digestate treatment (Figure 1). Relevant pre-treatment is performed on the organic waste before it is fed into the biodigester to ensure proper mixing of different feedstocks, water addition, and removal of undesired items. The pre-treatment is performed to avoid failure during the digestion process, to enable better digestion efficiency, and to improve the digestate grade (Monnet, 2003). The type of feedstock also influences the level of pre-treatment required in the system. For instance, manure requires mixing, while municipal solid wastes undergo sorting and shredding as a pre-treatment.

The digestion stage occurs in the digester, which is characterised according to temperature, several stages, mixing devices, and the water content in the feedstock. Digestion can be dry or wet, based on the kind of solid content involved. The feedstock is mixed with water and other suitable liquid wastes, such as sewage slurry or re-circulated liquid from the effluent of the digester (Monnet, 2003). There are two types of digesters – namely thermophilic and mesophilic – which operate at average temperatures of 55 °C and 35 °C respectively (Monnet, 2003). Mesophilic digesters have lower operational costs and less complexity but have a lower production efficiency than thermophilic digesters. The various stages of digestion are separated into a multi-stage process, which allows for better process control while simultaneously maximising digestion (Monnet, 2003).

The biogas produced during the digestion phase is treated by removing carbon dioxide to produce fuel quality gas for energy production (Fuchs & Drosig, 2013). The biogas is also upgraded by removing contaminants such as hydrogen sulphide and water vapour, which can damage engines or boilers. The digestate can be dried and used as a fertiliser or can be treated for higher quality uses such as compost (Fuchs & Drosig, 2013; Monlau, 2015).

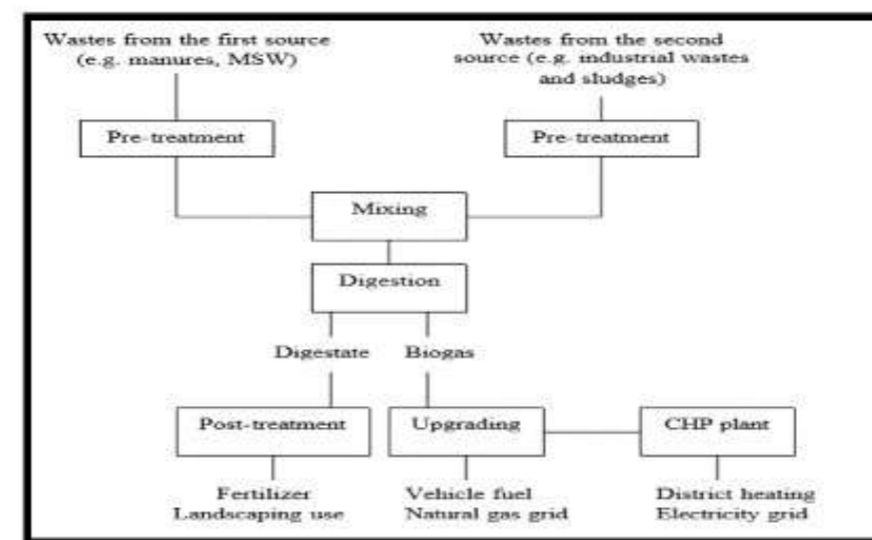


Figure 1: General process of an AD digestion plant (Fuchs & Drosig, 2013).

## Investigations on Anaerobic Digesters

Studies and experiments have been performed to improve the AD process by considering factors such as methane emissions, type of feedstock, amount of water used and gas yield. Flesch, Desjardins & Worth (2011) investigated fugitive methane emissions, and concluded that lower emissions from a biogas plant enabled more biogas production. Shar, Mahmood, Rashid, Perves & Raja (2015) investigated biogas optimisation using key techniques of co-digestion, pre-treatment and digester design. However, this project is based on investigating water recycling in an anaerobic digester, since water is a scarce resource that should be used sparingly.

Water scarcity has become a drawback in the use of ADs in many regions of the world. Smith, Goebel & Blignaut (2014) investigated whether ADs were feasible in rural South Africa given the current low availability of water. A study was conducted in Bergville, in KwaZulu Natal, to assess a household AD. The study concluded that the AD was not feasible due to the low availability of water and insufficient infrastructure, such as boreholes and wells, in the area. A study on the applicability of ADs in sub-Saharan Africa was also performed by Bansal, Tumvesege & Smith (2016), where it was concluded that 72% of the countries required water recycling in order to be able to run an AD. The study looked into recycling water from aquaculture, rainfall, and domestic water – which included drinking, cooking, bathing, and laundry water (Nyong & Kanaroglou, 1999). Bansal *et al.* (2016) found, as shown in Figure 2, Figure 3 and Figure 4, that there is water scarcity in sub-Saharan Africa and there is limited water that can be recycled. Figure 2 shows the amount of water required for anaerobic digestion in various countries.



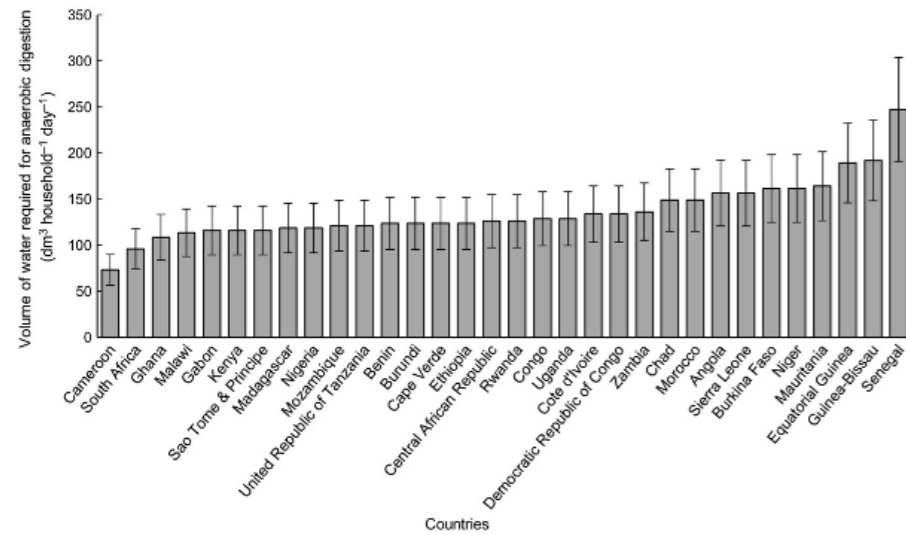


Figure 2: Volume of water required for anaerobic digestion (Wire Cloth, n.d.).

The volume of water available for recycling is shown in Figure 3, which indicates that South Africa has potential because there is enough water to recycle.

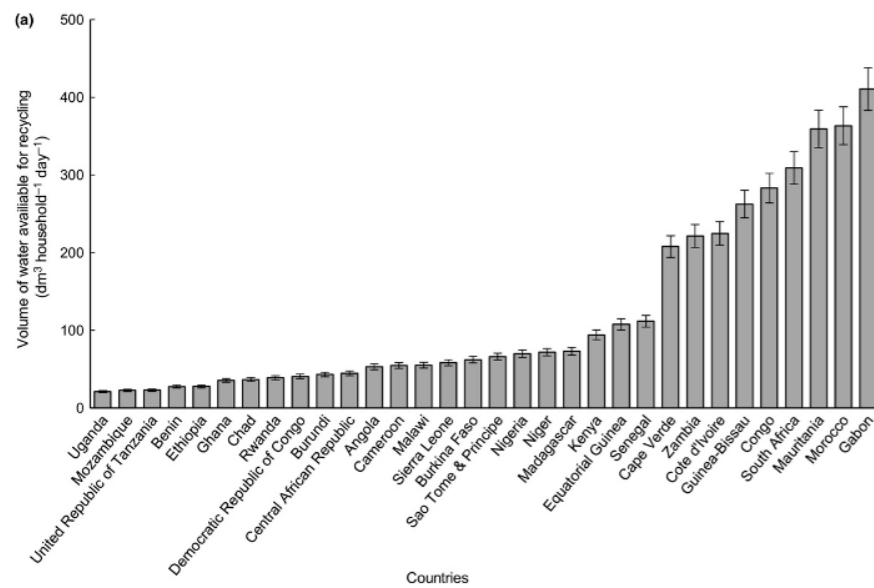


Figure 3: Volume of water available for recycling (Bansal et al., 2016).

Figure 4 shows that water recycling can be effective in South Africa. Recycled water can then be fed into anaerobic digestion systems.

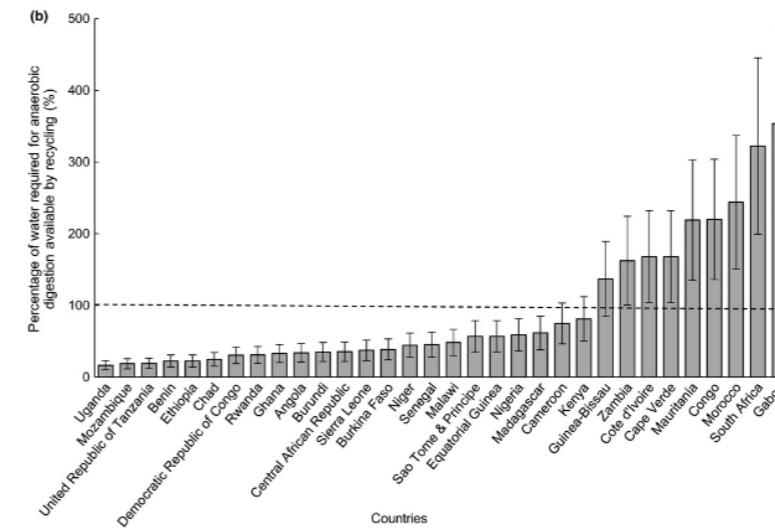


Figure 4: Percentage of water required to be available by recycling for anaerobic digestion (Bansal et al., 2016).

Figure 2 shows that water recycling is imperative and much needed in most of Africa. Figure 3 also shows that there are limited supplies of water available for recycling, according to the methods suggested by (Bansal *et al.*, 2016). The percentage of water required for ADs is excessively high for most African countries, making the technology unsustainable in most of the countries shown. Further, underdeveloped countries cannot recycle as much domestic water as developed countries can, owing to inadequate infrastructure, which is not as advanced in terms of water transporting and handling. Thus, a more general method is required to recycle water, one which would not be dependent on the infrastructure. This general method should be simple, energy-efficient, and low cost in terms of maintenance and usage.

#### Characteristics of Slurry

To be able to recycle the digestate from an AD, a clear understanding of the nature of the slurry or digestate is required. The digestate is generally a liquid with a dry matter (DM) content that ranges from 4% to 10%. This can vary depending on storage time and pre-treatments [15]. If the slurry has been stored at high temperatures for a long time, this can result in particle size reduction, organic compound mineralisation, and a decrease in separation efficiency (Cocolo, 2013). The main physical characteristics of slurry are moisture content, particle size, and viscosity. The sum of all solids contained in the slurry is the DM, which consists of suspended solids and dissolved solids. The total solid content also influences the density and viscosity of the slurry (Cocolo, 2013). Equation 1 below represents the density of the slurry, whereby the density of the slurry is dependent on the DM content. The slurry used in this project is based on cow dung, hence the density of the slurry is calculated based on cow dung (Cocolo, 2013).

$$\rho_{slurry} = \frac{DM + 236}{0.24}$$

$$\rho_{slurry} = \frac{DM + 279}{0.28}$$

Viscosity is the measure of a fluid's resistance to flow, which is driven mainly by shear stresses. Viscosity influences the movement and transport of the slurry in a porous media such as sand (Cocolo, 2013). The viscosity of slurry can be computed using the viscosity equation for cattle dung-based slurry.

$$\mu_{slurry} = 4.10^{-5} \cdot DM^{4.4671}$$

One of the main parameters that influence solid-liquid separation treatment is particle size and distribution. The animal species involved in producing the manure has a significant influence on the particle size of the manure, the type of housing, and the feeding system. The particle size is usually larger in cow dung slurry. According to (Marcato *et al.*, 2009). The particle size can be as small as 0.025 mm. Particle size distribution is affected by factors such as feed composition, diet, animal category, storage time and temperature. According to Marcato, Pinelli, Pouech and Guiesse (2009), ADs lead to the modification of particle size distribution, resulting in a reduction of small particles and the forming of larger particle size distributions. Nutrients generally have a small particle size, especially nitrogen (N) and phosphorus (P). In fact, 70% of undissolved N and P have particle sizes ranging between 0.45  $\mu\text{m}$  to 250  $\mu\text{m}$  (Marcato *et al.*, 2009).

## METHODOLOGY

### Materials Description

In this experiment, reinforced non-woven materials were used for testing since they possessed superior strength, stability and the ability to repel liquid. Since liquid digestate was passed through the filter fibres, it was imperative to use materials of various pore sizes, such that a relationship could be determined between pore size and filtration (Marlin Steel, 2017). What follows is a description of each of the materials used. Coarse polyester 30  $\mu\text{m}$  material is commonly used for air and liquid filtration purposes through the application of a driving force or vacuum to pass liquid through the material (Textile Learner, 2018). Nylon 30  $\mu\text{m}$  fabric is a highly abrasion-resistant material that is used in the filtration of abrasive dust or wet abrasive solids at low temperatures (Christensen, 2018). Stainless steel 60  $\mu\text{m}$  mesh is a high-quality wire cloth used for filtration in a variety of applications, such as mining (Wire Cloth, 2019). Air-laid polyester 30  $\mu\text{m}$  material is used for thermal insulation or for air filtration purposes (Singh, 2018), while polypropylene 120  $\mu\text{m}$  material has similar properties. Benzene toluene xylene (BTX) 200  $\mu\text{m}$  material has a high strength and large pore sizes, which permits large pore size digestate filtration (Singh, Verma, Rai & Singh, 2015). Lastly, Box 340 micrometer material was the heaviest material and most costly out of all materials compared. This material is commonly used in mines as a belt material (Singh *et al.*, 2015).

### Specimen Preparation

The filtering materials were initially checked for any visible cracks or impurities, such as gaps and tears. After visual inspection, a piece was cut and marked, and then used to cover the opening of the beaker. This was done to ensure that the material was efficiently close to the opening of the beaker so as to ensure that no liquid digest could pass into the beaker without being filtered under gravity conditions.

### Experimental Setup

Two testing methods were used to accomplish filtration due to the difference in the pore size of the materials. The two testing methods were natural filtration, and forced filtration using a vacuum. All the test materials were first passed through natural filtration to assess if the method was suitable. The materials were then passed through forced filtration. The filtration method and the materials to be tested through the method are given as follows: i) natural filtration by gravity; and ii) forced filtration using a vacuum.

#### Natural filtration by gravity

1. XT21 Coarse Polypropylene 30  $\mu$
2. XT63 Coarse Polyester 30  $\mu$
3. XT23 Coarse Nylon 30  $\mu$

#### Forced filtration using a vacuum

1. Steel Filter 60  $\mu$
2. Polyethene
3. PP120 Polypropylene 120  $\mu\text{m}$
4. Box 335b 200  $\mu\text{m}$
5. Box 1004 340  $\mu\text{m}$

## Experimental Procedure

### Experiment 1: Gravity Conditions

Gravity filtration testing was performed simply and systematically. An evaluation of the equipment was done to ensure that all testing equipment was calibrated. Further, the beakers and the graduated beaker to be used were checked to ensure that they did not leak and were not broken. The filtering materials were sized and cut carefully to cover the beakers. They were marked for ease of identification. The masses of the empty graduated beaker, filter membranes, and that of the empty disposable glass vials were measured. After the masses were recorded, the opening of the glass beaker was covered with the filter material and fastened using an elastic band. The digestate from the storage bottle was poured into glass beaker 2, and 10 ml of the digestate from glass beaker 2 was carefully poured into the graduated beaker using a glass funnel. The mass of the graduated beaker and its contents was measured and recorded. The digestate from the graduate beaker was poured through the filtering fibre into the empty glass beaker. When the filtration was complete, the rubber band was removed and the filtering material was extracted. The filtrate was collected and disposed of into a disposable vial. The mass of the disposable vial with its contents was measured and recorded. The filtering fibre was placed into the oven to dry, which was set to 100  $^{\circ}\text{C}$ . The mass of the filtering membrane and its contents was measured using a weighing scale. The filtering material was taken to an optical microscope, which was used to examine the average particle size of the filtrate. The pH of the filtrate in the disposable vial were tested using a pH meter. The same set of procedures was done for other materials that were tested using gravity.

### Experiment 2: Vacuum Conditions

Vacuum filtration testing was performed simply and systematically. An evaluation of equipment was done to ensure that all testing equipment was calibrated. Further, the vacuum was also checked to ensure that the vacuum tap was operating with enough vacuum. Proper evaluation of the vacuum apparatus, Buchner flask and funnel was done to ensure they were not broken or cracked, and that the rubber seal was not broken. The setup of the Buchner vacuum filter apparatus was done by inserting the Buchner funnel into the rubber seal and the Buchner flask, and then by connecting the rubber tubing to the vacuum valve, with the large side on the Buchner flask arm and the smaller side on the vacuum valve. The valve was not opened yet. The filtering materials were sized and cut to fit in the Buchner funnel using scissors, and they were marked for ease of identification. The mass of the empty graduated beaker, filter membranes, and that of the empty disposable glass vials were measured. After the masses were recorded, the filtering membrane was fitted onto the Buchner funnel. It was balanced by placing the balancing piece to prevent air ingress. The digestate from the storage bottle was poured into the glass beaker, and 10 ml of the digestate from the glass beaker was carefully poured into the graduated beaker using a glass funnel. The mass of the graduated beaker and its contents was measured and recorded. The vacuum valve was opened to create a vacuum in the Buchner funnel and the digestate from the graduated beaker was poured into the Buchner funnel to allow for vacuum filtration. The Buchner funnel was covered with material to minimise air ingress, using an elastic band to secure it. The filtrate was collected and disposed of into the disposable vial, and the mass of the disposable vial with its contents was measured and recorded. The filtering fibre was placed into the oven to dry, which was set to 100  $^{\circ}\text{C}$ . The mass of the filtering membrane and its contents was measured using a weighing scale. The filtering material was taken to an optical microscope, which was used to examine the average particle size of the filtrate. The pH and the TDS of the filtrate in the disposable vial were tested using a pH meter. The same set of procedures was done for other materials that were tested using a vacuum.

## RESULTS AND DISCUSSIONS

### Solid Content Trapped

The number of solids trapped by the various filter fibres gave an indication of how suitably the filter material performed in restoring the solid content in the digestate. The material that trapped the largest quantity of material was not necessarily considered the best filter material. However, it was considered a viable option when fertiliser production was the main driving factor. Figure 5 shows the accumulated mass of each material from a 10 ml digestate sample.

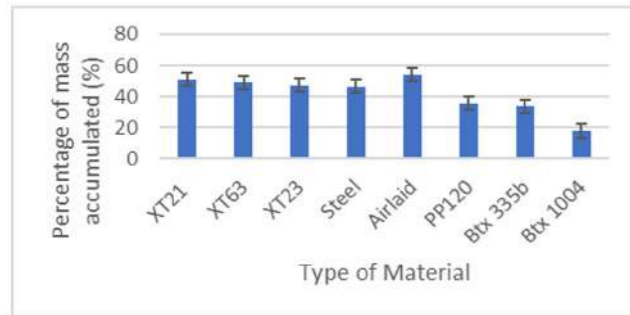


Figure 5: Accumulated mass versus material.

From Figure 5, it can be understood that air-laid polyester trapped the most solid contents for an equal digestate amount of 10 ml. The 30  $\mu$ m filtering materials follow air-laid polyester in the order: XT21, XT63, and XT23. The next material is steel 60  $\mu$ m. The last three materials in terms of mass accumulation are PP120 followed by Box 335b, with the least mass accumulating material being Box 1004.

According to Wegner (2018), materials with smaller pore sizes collect more solids than materials with bigger pore sizes. This trend is true for all materials besides air-laid polyester, which has the highest mass accumulation. This is due to its spongy appearance and texture, which enables it to trap the most solids. However, air-laid polyester has the disadvantage of trapping solids within its layers, thereby making it difficult to clean the material or extract the trapped solids. The other materials used do not have this disadvantage, besides clogging, which happens easily with the 30  $\mu$ m materials. Materials with excessively large pore sizes can allow small particle solids to pass through, which is a disadvantage if a large number of solids need to be trapped.

Careful considerations of grain size and porosity must be considered when selecting a suitable material for any filtration application. In terms of trapping solids and extracting them, it can be seen in the results that the steel 60  $\mu$ m filter material is the most suitable for the application, since it ensures that solids can be easily extracted and it does not require vacuum, unlike the 30  $\mu$ m materials. The least favourable material for application in this investigation is air-laid polyester, since solids are difficult to extract. Box 1004 is the least suitable, since it trapped a low number of solids due to its large pore size.

#### Amount of Water Recycled

The amount of filtrate obtained from using the various filter membranes and 10 ml of digestate gave an indication of the amount of water recycled (see Figure 6). This was imperative since the filtrate should be fed back into the anaerobic digestion system.

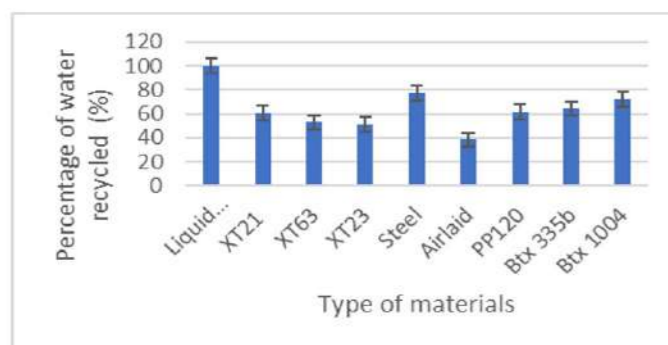


Figure 6: Mass of filtrate versus material used.

Raw digestate prior to filtration had a mass of 9.73 g for a 10 ml sample (Figure 6). It was expected that the use of filtration membranes to trap the solid particles required for fertilisers would provide the filtrate with a volume less than that of the raw

digestate. The steel 60  $\mu$ m filter had the highest mass of filtrate at 7.51 g, resulting in 77% water recycling. This material had the largest volume of filtrate recycled. This was due to its non-fibrous nature, which meant that it absorbed less water while filtering than its fibrous competitors. Box 1004 was the second-most effective water recycling material, recycling at a rate of 72%. The third-most effective water recycling material was Box 335b, which recycled at a rate of 64%.

The least effective water recycling materials were the vacuum tested materials: XT21, XT63, and XT23, which had 30  $\mu$ m pore sizes. These materials recycled 60%, 53%, and 51% water respectively. Small pore sizes make it difficult for the filtrate to pass through the material, which results in faster clogging when compared with the larger pore size fibrous materials. The material with the lowest amount of water recycled was air-laid polyester at 38%. This was due to its cotton wool-like texture, which resulted in a high degree of water absorbance.

#### Quality of the Water Recycled

In the previous section, the amount of water recycled was investigated and compared graphically. This was to understand which filtering fibre recycled the largest amount of water and which recycled the least. In this section, a further step was taken towards understanding the composition of the water, in terms of the total diluted solids, so as to determine the quantity of solids left in the filtrate. The pH of the digestate and of the filtrates were measured to determine any changes introduced by the filtration materials. Figure 7 shows the TDS in the filtrate after filtration, whereas Figure 8 shows the pH of the resulting filtrates.

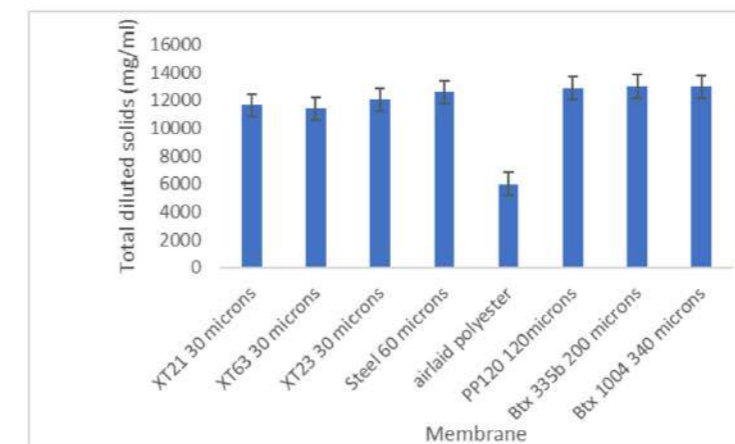


Figure 7: TDS for various filtrates.

It was expected that the material that trapped the larger amount of solid content would result in infiltration with lower a TDS. In this experiment, this expectation was satisfied because air-laid polyester filtrate had the lowest TDS. This was caused by its high degree of absorbance and because it had multiple layers to trap solids, leading to an extremely low TDS level of 6 009 mg/ml, when compared with the other filtrates. Other filtering membranes with low TDS levels were the XT21, XT63 and XT23, having TDS levels of 11 643 mg/ml, 11 423 mg/ml and 12 045 mg/ml respectively. These low values of TDS were the result of small pore sizes, which allowed the materials to remove most of the passing liquid. However, clogging occurs quickly. Materials with the highest TDS levels were steel 60  $\mu$ m, PP120, Box 335b and Box 1004. These materials had TDS values of 12 587 mg/ml, 12 871 mg/ml, 12 994 mg/ml and 12 976 mg/l respectively. This was due to the large grain sizes. The grain sizes allowed for small particles to pass through the grains even though they were not as prone to clogging as the 30  $\mu$ m materials, and not as absorbent as air-laid polyester.

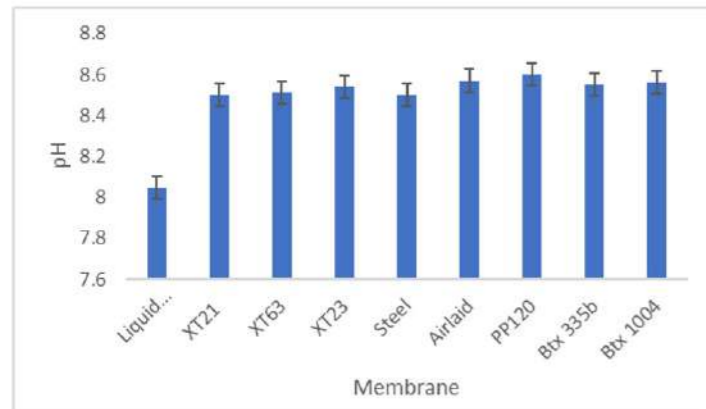


Figure 8: pH of the filtrate obtained from different membranes.

Figure 8 shows the pH of the filtrates obtained from the various materials. The pH was seen to increase by filtration for all filter membranes used. The filtering materials used caused this. It can be understood that through filtration, the removal of the solid particles resulted in a slightly more basic solution. This slight increase in pH from 8.05 does not present any hazard, thus the filtrate can be recycled back into the AD without any harm. The material that resulted in the highest pH increase of 8.6 was PP120, the second-highest was air-laid polyester at 8.57, followed by Box 1004 at 8.56. Box 335 had a pH value of 8.55 which is slightly less than that of Box 1004. The material with the least pH was XT23, followed by the steel filter 60  $\mu\text{m}$ .

#### The Separation Efficiency of the Materials

The separation index (Et), which expresses the distribution of a specific compound between a solid and liquid fraction, is important when considering infiltration techniques because it is a performance indicator. The Et is expressed as the mass of the solid trapped by the filtering material from the digestate.

$$Et(x) = m(x) \text{ solid} / m(x) \text{ slurry}$$

The Et of the various filtering materials is shown in Figure 9. It can be seen that the values range from 0.26% to 0.78%. The best performing material was determined to be air-laid polyester, with a separation index of 0.78%, followed by the 30  $\mu\text{m}$  materials. These materials were XT23, XT63 and XT21, which had separation indexes of 0.73%, 0.70% and 0.68% respectively. Steel 60  $\mu\text{m}$  was the next most efficient material with an efficiency of 0.67%. The third least efficient material was PP120, having an efficiency of 0.51%, followed by Box 335b at 0.48%. The least efficient material was Box 1004 at 0.26%. Figure 9 shows the visual comparison of the various Ets of the materials, in terms of the accumulated solid content trapped from the mass of liquid digestate.

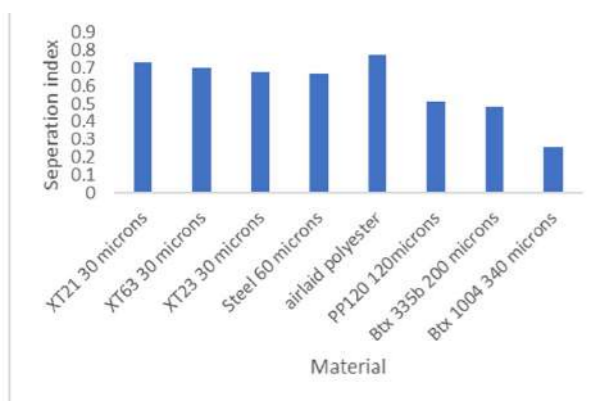


Figure 9: Separation efficiency of tested materials.

#### CONCLUSIONS AND RECOMMENDATIONS

From the results obtained, the mass of the solid content in the raw digestate was determined to be 0.14 g, which was achieved by evaporating the liquid fraction using a furnace. From filtration tests it was determined that the material that collected the largest mass of solids was air-laid polyester, which captured 53.92%. The materials that collected the next largest mass of solids were the 30  $\mu\text{m}$  materials: XT21, XT63, and XT23. These materials captured 50.93%, 48.93% and 47.36% of solids respectively. The Steel 60  $\mu\text{m}$  came next, which captured 46.43% of solids. From a solid content removal point of view, it was deduced that air-laid polyester was the most suitable material. However, it did not satisfy the main goal of this project, which was to trap the solids so that they could be reused. This disadvantage was due to the high absorbance and multilayer form of the material, which made the extraction of solids difficult. This left the 30  $\mu\text{m}$  materials and the steel 60  $\mu\text{m}$  material as the most viable options.

When the focus was shifted to the other major requirement of this project, which was to recycle a good quantity of water that was sufficiently filtered, it was concluded that the 60  $\mu\text{m}$  steel recycled the most amount of water at a rate of 77.18%. The second most effective water recycling method was Box 1004, which recycled 72.05% of water. The 30  $\mu\text{m}$  materials recycled between 51% and 60% of water. From a water recycling perspective, it was determined that the steel 60  $\mu\text{m}$  material recycled the most amount of water. When the solid mass accumulation was compared with water recycling, it was concluded that the steel 60  $\mu\text{m}$  was the most suitable material for this project.

In terms of the total suspended solids, the 60  $\mu\text{m}$  material was found to have a TDS of 12 587 mg/ml, with an uncertainty of 41.72 mg/ml. This material resulted in the fifth most cleaned water. The top four water-cleaning materials were the air-laid polyester and the 30  $\mu\text{m}$  materials (XT21, XT63, and XT23). Concerning the pH, polypropylene 120  $\mu\text{m}$  and steel 60  $\mu\text{m}$  filtered recycled water with the least increase in pH of 8.5. Considering all the tests, it was concluded that the steel 60  $\mu\text{m}$  filter was the most suitable material for water recycling in an anaerobic digester. Moreover, the material was found to be well suited for the project since it had desired properties, such as corrosion resistance, durability, and high strength.

#### ACKNOWLEDGMENT

The authors wish to acknowledge the Process Energy and Environment Station (UJ-PEETS) and the University of Johannesburg for funding and provision of research resources.

## LIST OF REFERENCES LIST OF RELISLISLIST OF REFERENCES

- Bansal, V., Tumvesege, V. & Smith, J. U. 2016. Water for small-scale biogas digesters in sub-Saharan Africa. *GCB Bioenergy*, (10):1-18.
- Christensen, D. 2018. Nylon's properties & uses. *Sciencing*. [Online] Available from: <https://sciencing.com/nylons-properties-uses-8627049.html>. Accessed on 24 August 2019.
- Cocolo, G. 2013. *Assessment of different solid-liquid separation techniques for livestock slurry*2. Milan: University of Milan.
- Flesch, T. K., Desjardins, R. L. & Worth D. 2011. Fugitive methane emission from an agricultural biodigester. *Biogas and Bioenergy*, (35):3927-3935.
- Fuchs, W. & Drosch, B. 2013. Assessment of the state of the art of technologies for the processing of digestate residue from anaerobic digesters. *Water Science*, (67):1984-1993.
- Marcato, C. E., Pinelli, E., Pouech, P. & Guisresse, M. 2009. Particle size and metal distributions in anaerobically digested pig slurry. *Bioresource Technology*, (99):2340-2348.
- Marlin Steel. 2018. *7 Need-to-Know polypropylene material properties*. Marlin steel wire products LLC. [Online] Available from: <https://www.marlinwire.com/blog/7-need-to-know-polypropylene-material-properties> [Accessed: 24 August 2019].
- Monlau, F. 2015. New opportunities for agricultural digestate valorization. *Energy Environment Science*, (8):2600-2621.
- Monnet, F. 2003. An introduction to anaerobic digestion. Scotland: Remade.
- National Non-Food CROPS CENTRE. 2011. *NFFC renewable fuels and energy factsheet. 22:11*. [Online] Available from: <http://www.nnfcc.com>. [Accessed: 18 February 2019].
- Nyong, A. O. & Kanaroglou, P. S. 1999. Domestic water use in semiarid Africa: a case study of Katarko village in northeastern Nigeria. *Human Ecology*, (27):537-555.
- Shar, F. A., Mahmood, Q., Rashid, Q., Perves, A. & Raja, I. A. 2015. Co-digestion, pretreatment and digester design for enhanced methanogenesis. *Renewable and Sustainable Energy Reviews*, (42): 627-648, 2015.
- Singh, R. 2018. Textile Learner, *Airlaid web formation technique*. [Online] Available from: <http://textilelearner.blogspot.com/2013/07airlaid-web-formation-technique.html?m=1> [Accessed: 25 August 2019].
- Singh, S., Verma, J., Rai, B. N. & Singh, R. S. 2015. Biodegradation of vapour phase benzene, toluene and xylene (BTX) using compost-based modified biofilter medium, *Indian Journal of Biotechnology*, (14):216-220.
- Smith, M. T., Goebel, J. L. & Blignaut, J. N. 2014. The financial and economic feasibility of rural household digesters. *Waste Management*, (34):352-362.
- Textile Learner. 2018. Polyester Fibre: Characteristics and uses, *Textile Learner*. [Online] Available from :[http://textilelearner.blogspot.com/2011/07/polyester-fiber-characteristics-of\\_11.html?m=1](http://textilelearner.blogspot.com/2011/07/polyester-fiber-characteristics-of_11.html?m=1). Accessed on 24 August 2019.
- Wegner, K. 2018. Separations II: Solid-Gas Systems. In *Micro- and Nanoparticle Technology*. Zurich. Swiss Federal Institute of Technology.
- Wire Cloth. 2019. Stainless steel mesh. *Wire Mesh Manufacturers*. [Online] Available from: <https://www.wire-cloth.net/stainless-steel-mesh/>. Accessed on 25 August 2019.

# EFFECT OF INJECTION PARAMETERS ON CAVITY PRESSURE, TENSILE AND MICROSTRUCTURAL PROPERTIES OF PLASTIC REINFORCED COMPOSITES

Adefemi Omowole Adeodu<sup>1\*</sup>, Mukondeleli Grace Kanakana-Katumba<sup>1</sup>, Rendani Maladzh<sup>1</sup>  
Ilesanmi Afolabi Daniyan<sup>2</sup>

<sup>1</sup>Department of Mechanical and Industrial Engineering, University of South Africa, Florida, South Africa

<sup>2</sup>Department of Industrial Engineering, Tshwane University of Technology, Pretoria, South Africa

Email of Corresponding Author: engrcharles520ca@gamil.com

## Abstract

*The injection moulding process is among the most efficient processes for mass production of polymer products with complex geometry at minimal cost. This study investigates the effect of injection parameters on the mold cavity pressure, tensile and microstructural properties of plastic-reinforced composites. The two polymer composite materials used for this work are low-density polyethylene reinforced with aluminium powder (LDPE/Al) and low-density polyethylene reinforced with carbon black (LDPE/CB) at 250 and 200°C injection temperature, respectively. The mould cavity is cylindrical with constant 24 mm diameter. The cavity pressure is measured against time with pressure Kistler sensor at different injection moulding cycles. The results indicate that the cavity pressure increases with an increase in the injection pressure but decreases with increase in the injection time for the two analysed polymer composites. The effect of varying injection pressure on the tensile and microstructural properties of the composites shows an increasing order of tensile strength and microstructural orientation due to homogenous distribution of the reinforcements within the polymer matrix and due to inhomogeneous shear flow experienced during molding, respectively. The study shows that process parameters affects cavity pressure, mechanical and microstructural properties of LDPE/Al and LDPE/CB. Also, it indicates the buildup of pressure inside the mould cavity during the injection moulding cycles.*

**Keyword:** carbon black, injection, low-density polyethylene, microstructure, tensile strength

## INTRODUCTION

Injection moulding is a complex polymer processing technique whereby polymeric materials are made to pass through a cylindrical channel connected with heating bands to melt the materials and allow solidification within the cavity of a design mould to form a specific shape. This processing technique is widely accepted to produce plastic products and components. Its application is found in many industrial as well as household consumer products due to certain reasons such as high efficient-fast production, ability to handle the design of complex parts, enhanced strength and flexibility of the finished product, good surface finish of the product, fewer scraps and the relatively low cost of the process (Shakurahmed, 2013; Singh, Pradhan & Verma, 2015). It is well adopted for processing of polymer as well as polymer composites. The quality of parts produced by injection moulding is a function of plastic material, part geometry, mould structure, and process conditions (Tang, Kong, Sapuan, Samin, R. & Sulaiman, 2006; Crawford, 1987). The plastic injection moulding process is a cyclic process. It begins with feeding the resin and the appropriate additives with polymer material from the hopper to the heating system of the injection moulding machine and then, the mould cavity which is filled with the hot polymer melt at injection

temperature (filling stage). After the cavity is filled, additional polymer melt is packed into the cavity at a higher pressure than during the packing stage (that is, the post-filling stage) to compensate for the expected shrinkage when the polymer solidifies. This is followed by the “cooling stage” where the mould is cooled until the part is sufficiently rigid to be ejected. The last step is the ejection stage where the mould is opened and the part is ejected. The mould is then closed again to begin the next cycle (Hassan, Regnier, Le Bot & Defaye, 2010; Bozdana & Eyercioglu, 2002). The quality of the final moulded part, which may be characterised in terms of dimensional stability, appearance, and mechanical properties, is highly dependent on the processing variables (Bozdana & Eyercioglu, 2002). Defects in the products, such as warpage, shrinkage, sink marks, and residual stress, are caused by many factors during the production process. These defects are detrimental to the quality and accuracy of the products. Therefore, it is of critical importance to effectively control the influencing factors during the moulding procedure (Hussan *et al.*, 2010). During the injection processing, there is a strict correlation between process parameters and the quality of the resulting product. For instance, improper settings of process parameters will induce defects on the products, for example, warpage, shrinkage; sink mark, and residual stress (Tsai, Hsieh, & Chun Lo, 2009; Hassan, Nicolas & Defaye, 2009). The cavity pressure profile and its repeatability remarkably influence the quality of the moulded part, especially on its mass, dimensional stability, mechanical behaviour, and the surface quality (Huang, 2007). Injection moulding pressure is one of the key processing parameters mentioned in several research works. Zhang, Edirisinghe & Evans. (1989) showed that the cavity pressure would gradually decay and vanish eventually if the temperature of the mould is low enough. The pressure drop (the difference between injection pressure and cavity pressure) is due to the solidification of feedstock and the friction at the mould surface. In addition, several material properties change as the cavity pressure increases. They found that the higher the holding pressure is, the greater the cavity pressure will be. The cavity pressure is influenced by the temperature of the mould and increases as the temperature of the mould increases. The effects of injection pressure and holding time on the properties such as dimension, surface fatness, green density and sintering density of injection moulded parts was studied by Wei, Rong-Yuan & Ho, (2000). The results reveal that the pressure–time traces where the gate pressure is increased from 22 to 117 MPa, and the holding time up to 75 sec illustrates the trend of the property changes under these pressures. High holding pressures and longer holding time would be favoured to increase moulded dimension and to decrease the surface sinking of green pieces. The data also show that the pressures and holding time exert no significant influence on the bulk density of green parts. The study of the effect of reprocessing cycle on shrinkage and mechanical properties of acrylonitrile-butadiene-styrene was conducted by Rahimi, Esfahanian, & Moradi, (2014). It was discovered that there is an inverse relationship between reprocessing cycle and shrinkage, while tensile and flexural properties are directly related to reprocessing cycle. In a similar experiment conducted by Pareek and Bhamniya (2013) on polycarbonate material, the analysis shows that process parameters such as melting temperature and injection pressure have a direct relationship on the tensile strength of the material. The rationale of this study is drawn from other works carried out by certain authors such as Hassan (2012), who performed experimental work on the effect of injection moulding parameters on the polymer pressure inside the mould cavity and the final product weight. The work considered a good number of processing parameters such as packing pressure, packing time, injection pressure, time and temperature. The work is limited to homogeneous materials of polystyrene (PS) and low-density polyethylene (LDPE). Singh *et al.* (2015) carried out an experimental design using Taguchi’s orthogonal array to determine the effect of the injection process parameters on tensile strength. The work established the optimum process parameters to determine the quality of the product in terms of strength alone and was limited to a single homogeneous material, polypropylene (PP). An investigation of the effect of microscopic structures on the shrinkage of the macroscopic product was carried out by Wu *et al.* (2018). Flat specimens with and without microstructures were used to determine the in-plane shrinkage via the optical method. Wu, Gong, Cha & Park, (2018) also investigated the effect of the injection pressure and packaging pressure on electrical and microstructural properties of carbon black filled polymer composite. The authors established the basis for an improvement in quality of the final products based on their appearance and mechanical properties. Other quality parameters such as dimensional stability can still be examined. This work studied the effect of injection pressure and time on the mold cavity pressure, tensile and microstructural properties of low density polyethylene (LDPE) mixed with aluminium and low-density polyethylene (LDPE) mixed with carbon black powders at 250 and 200°C injection temperature, respectively, in order to establish the quality of the final product in terms of strength and appearance.

## MATERIALS AND METHOD

The materials considered in the study are low density polyethylene (LDPE) mixed with aluminium (pyro powder) and carbon black (thermal black) powder separately. The LDPE was supplied by General Polymer Thermoplastic Materials, LLC, Auburn Hills, MI while the aluminium and carbon black powder were supplied by Haojian Chemical Technology Co.Ltd, China. Tables 1-3 show the properties of LDPE, aluminium and carbon black powder respectively. The injection moulding machine was locally developed in the Engineering Workshop of Afe Babalola University, Ado-Ekiti, Nigeria. The experimental set-up is presented in Figure 1 which consist of the following:

Injection molding machine: it is constructed of steel 40 C MD consisting of movable and non-movable parts. The movable part consist of a cylindrical injection screw shaft of length 385 mm, diameter of 25 mm and pitch length of 20 mm. The non-movable part consist mainly of cylindrical barrel through which the injection screw shaft pushes the molten material into the mould. The length of the barrel is 260 mm with internal diameter of 70 mm. a steel mould was constructed as an attachment to the injection machine with mould cavity located at the movable of the mould in a form of rectangle with dimension of 50 x50 mm.

Amplifier (Kistler 5039A): it is used to convert the electrical charge of the pressure sensor signals yielded by piezoelectric into proportional voltages. The outputs of the amplifier were transferred to the center of acquisition system and universal indicator respectively. The output signals from the amplifier are 0-10 DC voltages.

Universal Indicator: this is used to display the different measurement signals in an output indicator.

Acquisition data: Data output from the amplifier is collected using a Hewlett-Packard (Hp) 3852 A data acquisition system equipped with two Hp 44711 24-channel.

Computer: it is used to record the output reading of the acquisition system through an interface cart by the help of lab view programme.

Kistler 6159 A: this is used to measure the cavity pressure in the mould via a quartz sensor with diameter 1 mm at the front. The pressure transducer has a sensitivity of  $\pm 2.5$  bar and capable of registering changes of the pressure as a function of time with a resolution up to 0.01 seconds. The pressure acting directly on the entire front of the sensor is transferred to the quartz measuring element which produces an electrical charge proportional to the pressure.

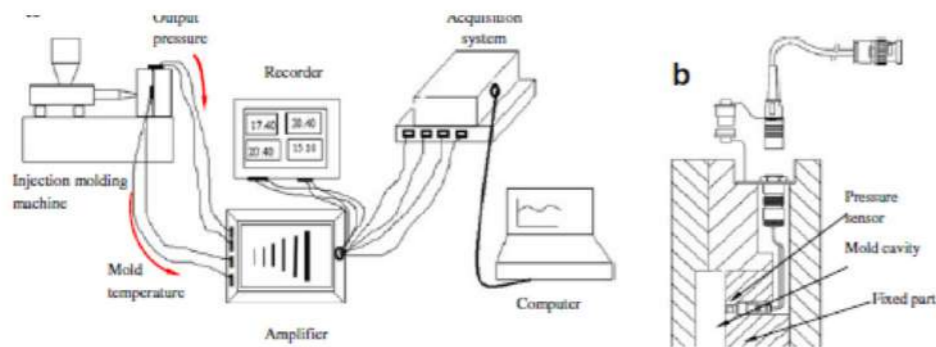


Figure 1 Experimental set-up

### Fabrication of the Polymer Composite Pellets

The polymer composite pellets are produced by mixing 25 % weight fraction of aluminium and carbon black powder separately with 150 grams of Low-Density Polyethylene (LDPE) to make 200 grams of each polymer composite. The mixing was carried out with a mixer (ME100LA) at a temperature of 190°C for 20 minutes at a speed of 200 rpm. After the mixing was done, the mixtures were passed into a twin screw plastic pelletizer, and later fed into the injection moulding machine

### Description of Injection Process

The modified polymer material is fed through the hopper and moved through the screw shaft into the injection cylinder (barrel) of the machine, which is first preheated to the melting temperature of the material. By the rotation movement of the screw shaft, the material is conveyed through the barrel, mixed to the proper molten state, compressed to the proper density and forced into the mould cavity through the runner and gate. The hot plastic material inside the mould is allowed to cool via surrounding air. The cooled material is removed from the mould to start a new cycle. The cavity pressure was measured for various injection moulding cycles. Table 1 presents the design parameters of the machine.

Table 1. Design Parameters of the Injection Molding Machine

S/N	Parameter	Value
1	Injection Pressure (max)	100Mpa
2	Injection time	1.6 sec
3	Injection velocity	30 mm/s
4	Rotational velocity	100 rpm
5	Injection temperature (max)	500°C

### Tensile Property Test of the Product

Two (2) tensile specimen samples for each of the polymer composite were prepared by varying the injection pressure between 40 and 80 MPa according to the design given by ASTM D 638M. The dimension of the specimen is shown in Figure 2.

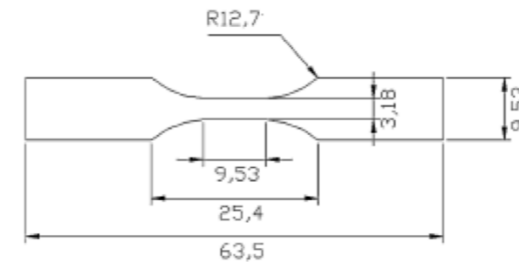


Figure 2 Tensile Test Specimen

### Microstructural Analysis of the Product

A sample each of LDPE/Aluminium and LDPE/Carbon black subject to an injection pressure of 80 MPa where planed along the flow direction into two layers with the thickness of layers removed to be 0.1 and 0.2 mm. The microstructure of the two layers for each composite were analyzed using Scanning Electron Microscopy (JOEL-JSM 7600F).

## RESULTS AND DISCUSSION

The condition of polymer composite materials in terms of quality and orientation are determined by process condition (Hassan, 2012). Defects in quality such as surface roughness, a decrease in dimensional precision and high cost are the results of poor process parameters. Therefore, optimal moulding parameters are essential.

### Effect of Injection Pressure on Mould Cavity Pressure

Figure 3 shows the relationship between injection pressure and mold cavity pressure of LDPE/Al and LDPE/CB at 250 and 200 °C respectively. A direct relationship was observed between cavity pressure and injection pressure in both materials. Between the ranges of 35 – 75 MPa injection pressure, a steep slope increase in cavity pressure of 37 MPa was observed for LDPE/CB at 200 °C injection temperature and cavity pressure of 42 MPa was observed for LDPE/AL at 250 °C injection temperature. This was due to increase in the specific volumes of the polymer composite materials at low viscosity (Hassan, 2012). At above 40 MPa injection pressure, there was gradual increase in the cavity pressure in both materials. Also, in Figure 3, it was observed that 53 % increase in the injection pressure of LDPE/AL caused the cavity pressure to increase by 52 %, while 53 % increase in the injection pressure of LDPE/CB caused the cavity pressure to increase by 51 %. Hence, the degree

of responsiveness to injection pressure by LDPE/Al is higher compared to that of LDPE/CB. These results can be traced to the injection temperature difference between the two materials and thus impact more on the quality of LDPE/AL than LDPE/CB. An increase in the value of injection temperature, brought about increase in the specific volume and decrease in the viscosity of the samples (Hassan, 2012). Hence, there is increase in fluidity of LDPE/Al compared to LDPE/CB. Comparing the work with the work reported by Shojacia, Ghaffarions & Karimianc. (2003) using PS and LDPE, it was agreed that higher injection pressure decreases the mold filling time, however, it may cause material deformation and fiber washout (Shojacia *et al.*, 2003). The effect of the injection pressure on the cavity pressure for different injection temperatures in the case of PS and LDPE showed that the increase of the injection pressure increases the cavity pressure, which is more prevalent in case of LDPE compared to PS. It also shows that the cavity pressure increases with increasing the injection temperature because the increase of the injection temperature increases the specific volume and decreases the viscosity of the polymer. Hence, the fluidity of the polymer to enter the mold cavity increases (Leo & Gevellez, 1996; Jassen, Van Dijk & Husselman, 1998). For injection temperature of 220 °C, the increase of injection pressure of 60 % increases the cavity pressure by 36 % in case of PS and 90 % in the case of LDPE

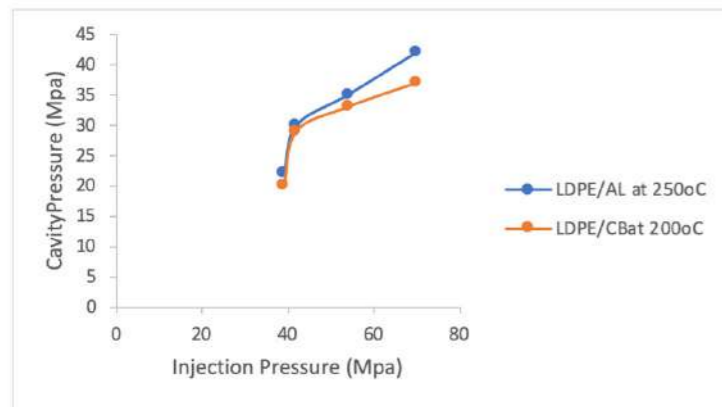


Figure 3. Effect of injection pressure on cavity pressure

#### Effect of Injection Time on Mould Cavity Pressure

Injection time largely determines the prevailing flow and thermal conditions during filling stage in injection moulding process (Papathansiou, 1995), which invariably determines the performance of the entire moulding process. In Figure 4, there was an inverse relationship between injection time and cavity pressure for LDPE/Al and LDPE/CB at 250 and 200°C respectively. However, at 50 % increase in the injection time, 38 % decrease in the cavity pressure was observed for LDPE/CB while 48 % decrease in the cavity pressure was observed for LDPE/Al due to variations in the injection pressure and temperature (Hassan, 2012). The injection time is one of the major factors to determine the efficiency of the injection moulding process (Boldzar & Kubat, 1986). The effect of the injection time on the cavity pressure at different injection temperatures for PS and LDPE was considered by (Shojacia *et al.*, 2003). During injection moulding process, the increase of the injection time was followed by decreasing the injection pressure to have the same mass input to the mold cavity during injection stage. Hence, the cavity pressure decreases with an increase in the injection time due to the decrease of injection pressure. According to Shojacia *et al.* (2003), the effect of injection temperature on the cavity pressure in the case of LDPE was greater compared to PS especially at low injection time. This is due to the shrinkage in the case of LDPE which is greater than that of PS. The increase of the injection time in case of LDPE by about 83 % decreases the cavity pressure by 23% at injection temperature of 235 °C and 36 % at injection temperature of 240 °C. Also, the increase of the injection time by 83 % decreases the cavity pressure about 23 % at injection temperature 220 °C for PS. The research concluded that the increase of injection time decreases the cavity pressure, but it has no great effect on the cavity pressure profile for all polymer materials analyzed. It also shows that the increase of the injection time decreases the total cycle time.

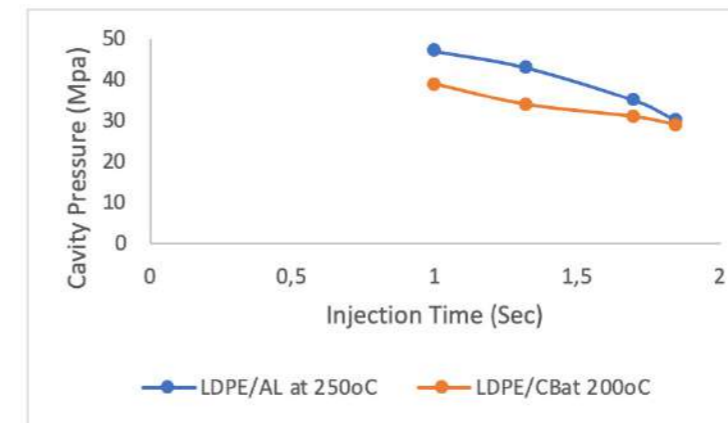


Figure 4 Effect of injection time on cavity pressure

#### Effect of Injection Pressure on Tensile Strength

Figure 5 shows the relationship between injection pressure and tensile strength for LDPE/Al and LDPE/CB at 250 and 200°C respectively. A direct increase relationship was observed between injection pressure and tensile strength for both materials. These show a good agreement with (Azuddin, Chaudhury & Taha, 2014). In Figure 5, the effect of injection pressure on tensile strength for LDPE/CB is higher compared to LDPE/Al. This can be traced to the higher fluidity on LDPE/Al (Azuddin *et al.*, 2014) and also, the higher loading and particle distribution of aluminium powder within the polymer phase due to higher surface area of aluminium powder compared to carbon black (Shimpi, Verma & Mishra, 2010; Abdolmohammadi, Siyamak, Ibrahim, Yunus, Rahman, Azizi & Fataehi, 2012)

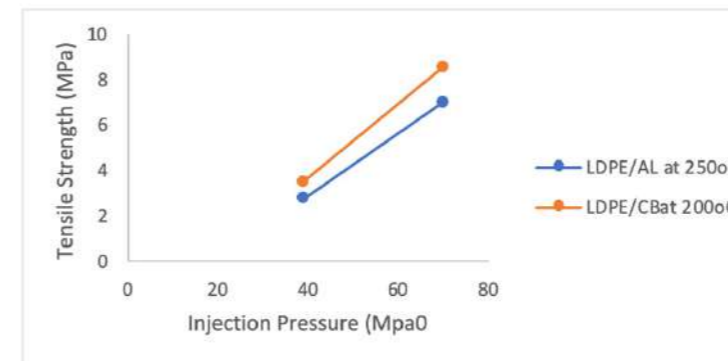


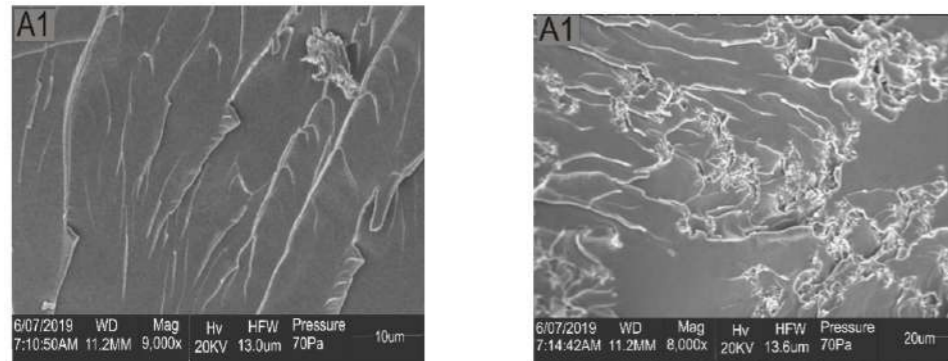
Figure 5 Effect of Injection Pressure on Tensile Strength

#### Effect of Injection Pressure on Microstructural Property

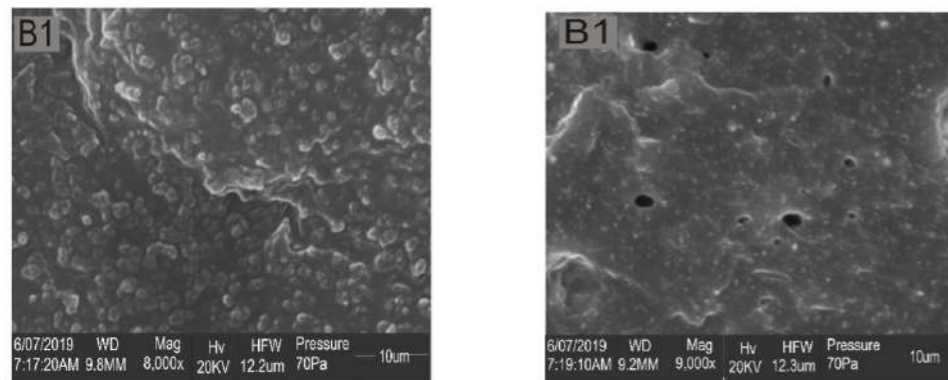
Figures 6 a-d show the microstructural analysis of LDPE/Al and LDPE/CB samples fabricated under injection pressure of 80 MPa for different layers of 0.1 and 0.2 mm, respectively. The analysis was based on the effects of injection pressure on orientation of the microstructures (Morphology). It was observed that orientation of microstructure within the polymer composites increases towards the area close to the middle plane due to inhomogeneous shear flow experienced during molding (Zhang, Jiang, Liu, Wu & Zou, 2012). Also, there was significant deformation in the particle distribution due to high injection pressure moulding flow especially in the region close to the surface of the moulded samples (Zhang *et al.*, 2012).



Comparing LDPE/Al and LDPE/CB, there were significant differences in morphology and level of deformation in the particle distribution in LDPE/CB due to higher crystallinity of carbon black particles (Zhang *et al.*, 2012). Generally, carbon black particles move from region of higher shear stress to the region of lower shear stress (Zhang *et al.*, 2012).



**Figure 6 (a) Microstructure of LDPE/Al of 0.1mm Layer (b) Microstructure of LDPE/Al of 0.2mm Layer**



**Figure 6 (c) Microstructure of LDPE/CB of 0.1mm Layer (d) Microstructure of LDPE/CB of 0.2mm Layer**

## CONCLUSIONS

In this study, the effects of injection pressure and time on cavity pressure are investigated. Two polymer composites are considered in this work: LDPE/Al and LDPE/CB at 250 and 200 °C, respectively. The direct relationship between the injection pressure and cavity pressure for both LDPE/Al and LDPE/CB at their respective injection temperatures exhibits good evolution of the cavity pressure inside the mould cavity at different injection pressures. The inverse relationship between the injection time and cavity pressure is a function of the injection parameters which goes a long way towards determining the mechanical and microstructural properties of the products. This would assist composite manufacturers to determine the optimum injection parameters for the production of polymer products.

## LIST OF REFERENCES

- Abdolmohammadi, S., Siyamak, S., Ibrahim, N. A., Yunus, W. W., Rahman, M. Z., Azizi, S. & Fataehi, A. 2012. Enhancement of Mechanical and Thermal Properties of Polycaprolactone/Chitosan Blend by Calcium carbonate Nanoparticles. *International Journal of Molecular Science*. 2013, 4508-4522.
- Azuddin, M., Chaudhury, I. A. & Taha, Z. 2014. Development and Performance Evaluation of a Low-Cost Custom made Vertical Injection Moulding Machine. *Journal of the Brazilian Society of Mechanical Science and Engineering* Doi.10.1007/1540430-014-0145-z.
- Boldzar, A. & Kubat, J. 1986. Measurement of Cycle Time in Injection Moulding of Filled Thermoplastic. *Polymer Engineering & Science* 26(12): 877-885.
- Bozdana, A. T. & Eyercioglu, O. 2002. Development of an expert system for the determination of injection moulding parameters of thermoplastic materials: EXPIMM. *Journal of Materials Process Technology*, 128:113-122.
- Crawford, R. J. 1987. *Rubber and plastic engineering design and application*. Butterworth-Heinemann limited London: Applied, p 110.
- Hassan, H., Nicolas, R. N. & Defaye, G. 2009. 3D Study on the effect of process parameters on the cooling of polymer by injection molding. *Journal of Applied Polymer Science*, 114:2901-2914.
- Hassan, H., Regnier, N., Le Bot, C. & Defaye, G. 2010. 3D Study of cooling system effect on the heat transfer during polymer injection molding. *International Journal of Thermal Sciences*, 49:161-169.
- Hassan, H. 2012. An experimental work on the effect of injection moulding parameters on the cavity pressure and product weight. *International Journal of Advanced Manufacturing Technology*. 67:675-686.
- Huang, M. S. 2007. Cavity pressure based grey prediction of the filling-to-packing switchover point for injection molding. *Journal of Materials Process Technology*, 183:419-424.
- Jassen, K. M. B., Van Dijk, D. J. & Husselman, M. H. 1998. Effect of Processing Conditions on Shrinkage in Injection. *Polymer Engineering Science*, 38: 843-846.
- Leo, V. & Gevellez, C. 1996. The Effect of the Packing Parameters, Gate, Geometry and Mold Elasticity on the final Dimensions of a Mold part. *Polymer Engineering Science*, 36(5): 1961-1971.
- Papathansiou, T. D. 1995. Modeling of injection mould filling effect of under cooling on polymer crystallization. *Chemical Engineering Science*. 50 (21):3433-3442.
- Pareek, R. & Bhamniya, J. 2013. Optimization of injection moulding process using Taguchi and ANOVA. *Journal of Scientific and Engineering Research*, 4(1): 1- 6
- Rahimi, M., Esfahanian, M. & Moradi, M. 2014. Effect of reprocessing on shrinkage and mechanical properties of ABS and investigating the proper blend of virgin and recycled ABS in injection moulding. *Journal of Materials Processing Technology*, 214(11):2359-2365.
- Shakurahmed, S. S. 2013. *Design and fabrication of injection moulding machine for small scale industries*. Summer Report. Department of Mechanical Engineering, University of Pune. India
- Shimpi, N. G., Verma, J. & Mishra, S. 2010. Dispersion of nano CaCO<sub>3</sub> on PVC and its influence on mechanical and thermal properties. *Journal of Composites Materials*. 44, 211-219.
- Shojacia, A., Ghaffarions, S. R. & Karimian, S. H.M. 2003. Simulation of the three Dimensional Non-Isothermal Mold Filling Process in Resin Transfer Molding. *Composites Science and Technology*, 63:1931-1948.
- Singh, G., Pradhan, M. K. & Verma, A. 2015. Effect of injection moulding process parameter on tensile strength using the Taguchi Method. *International Journal of Mechanical, Aerospace, Industrial, Mechatronics and Manufacturing Engineering*, 9(10):1-6.
- Tang, S. H., Kong, Y. M., Sapuan, S. M., Samin, R. & Sulaiman, S. 2006. Design and thermal analysis of plastic injection mould. *Journal of Materials Processing Technology*, 171:259-267.
- Tsai, K. M., Hsieh, C. & Chun Lo, W. 2009. A study of the effects of process parameters for injection molding on surface quality of optical lenses. *Journal of Materials Processing Technology*, 209:3469-3477.
- Wei, W. C. J., Rong-Yuan, W. & Ho, S. J. 2000. Effects of pressure parameters on alumina made by powder injection moulding. *Journal of European Ceramic Society*. 20:1301-1310.
- Wu, Y. Gong, Y., Cha, K. J. & Park, J. M. 2018. Effect of microstructures on the shrinkage of injection moulding product. *Journal of Mechanical Science*. 33(3):1357-1363.
- Zhang, J. G., Edirisinghe, M. J. & Evans, R. G. 1989. The control of sprue solidification time in ceramic injection moulding. *Journal of Materials Science*, 24:840-848.
- Zhang, B., Jiang, A., Liu, D., Wu, H. & Zou, J. 2012. Microstructural effect of injection moulded nano-particle polymer composites on their resistivity. *Advance Materials Research*, Vol. 472-475, pg1059-1062.

# ADVANCEMENT OF POLYMERIC MATERIALS AS HIGH THERMAL CONDUCTIVITY AND ENERGY STORAGE DIELECTRIC MATERIALS USING GRAPHENE NANOSHEETS: A REVIEW

Uyor, U.O.1, Popoola, A.P.I.1, Popoola, O.M.2 & Aigbodion, V.S.<sup>1,3</sup>  
Private Bag X680. Pretoria, South Africa.  
3Africa Centre of Excellence on Sustainable Power and Energy Development, University of Nigeria, Nsukka, Private Bag 0004 Nsukka Enugu- State Nigeria.  
1Department of Chemical, Metallurgical and Materials Engineering, Tshwane University of Technology, Pretoria West, Private Bag X680. Pretoria, South Africa.  
2Department of Electrical Engineering, Tshwane University of Technology, Pretoria West,  
Corresponding Author: UyorUO@tut.ac.za

## Abstract

*Electrostatic dielectric capacitors are extensively used in modern electronic technology. Although ceramic materials are used for such applications, polymeric materials are more desired due to their excellent properties such as their light weight, chemical resistance, flexibility, easy processing and low cost. Some of the challenges associated with polymeric dielectric energy storage materials are low dielectric constant, low energy density and poor thermal management. However, the recent discovery of graphene nanosheets (GNs) has paved the way for enhancing the dielectric and thermal properties of polymeric materials for advanced engineering applications. The introduction of GNs in the polymer matrix has been demonstrated with improved properties, resulting from the excellent properties of such nanofillers. Although high dielectric loss and poor dielectric breakdown strength are the main shortcomings of such nanodielectric composites, there have been advancements towards addressing these challenges. Therefore, this review investigated the advancement of polymeric materials as high thermal conductivity and energy storage materials using GNs. Further, it discussed the challenges facing such nanocomposites for high dielectric energy storage applications. Recommendations to address such shortcomings were also outlined in this review. Therefore, it is believed that this paper will aid in advancing research in this area to further improve polymeric materials for high temperature and dielectric applications.*

**Keywords:** polymeric materials, graphene nanosheets, thermal conductivity and energy storage.

## INTRODUCTION

Polymer dielectric materials are essential materials used in the fabrication of dielectric capacitors for energy storage and other related applications. They are preferred over ceramic dielectric materials because of their distinct properties. However, the dielectric constant or permittivity of polymer dielectric film is relatively low. For instance, it is less than 5 for non-ferroelectric polymers and below 15 for ferroelectric polymers. The low dielectric constant often results in low capacitance and energy storage density (ESD) of polymeric dielectric film capacitors. This is because capacitance and ESD have direct relationships with the dielectric constant of a material, as is shown in Equation 1 and Equation 2 respectively. High capacitance and energy storage capacity of dielectric materials are required in various advanced electronic and electrical applications. Notably, an increase in the dielectric constant of a dielectric material results in an increase in the capacitance and ESD of such materials. This is demonstrated in the following equations:

$$C = \epsilon \epsilon_0 A/d \quad (1)$$

$$ESD = 0.5E^2\epsilon^l\epsilon_0 \quad (2)$$

In these equations:  $\epsilon_0$  and  $\epsilon^l$  are the permittivity of free space ( $8.85 \times 10^{-12}$  F/m) and dielectric material respectively; A is the area of the electrode ( $m^2$ ); d is the thickness (m) of the dielectric material; and E is the breakdown strength (V/m).

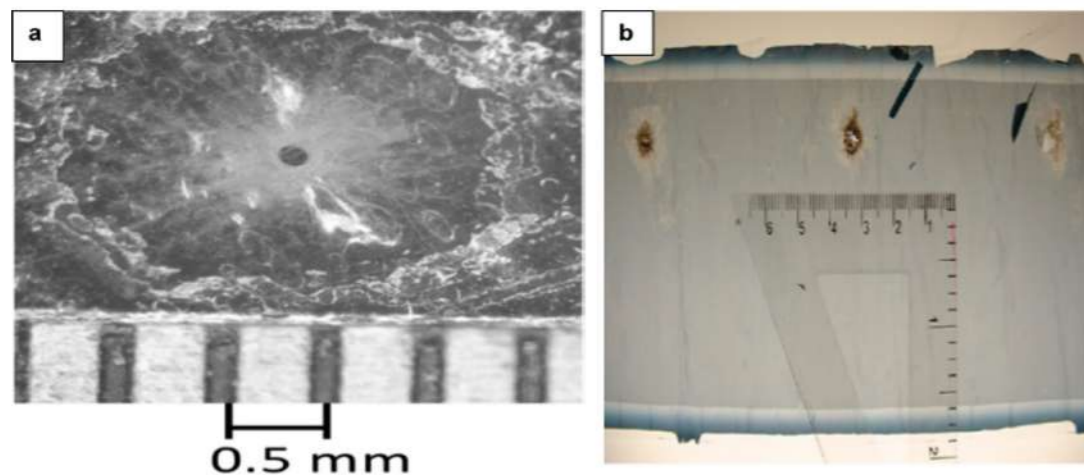
An increase in the dielectric constant of polymeric materials can also result in further miniaturisation of electronic components. For instance, the width and length of a patch antenna are inversely proportional to the dielectric constant, as shown in Equation 3 and Equation 4 respectively (Glatkowski & Arthur, 2004). These equations are used in the design of a patch or microstrip antenna. With a high dielectric constant, the width and length of a patch antenna can be significantly reduced, as demonstrated with Equation 3 and Equation 4. This signifies the importance of high dielectric constant materials in electronic applications (Glatkowski & Arthur, 2004). Polymers with high dielectric properties are also required for other applications, such as electromagnetic shielding and electronic packaging. It is difficult to obtain the dielectric constant required for advanced applications and next-generation dielectric materials in single materials, such as in pure polymers or ceramics (Dang *et al.*, 2012). Naturally, it is difficult to obtain all the required properties for advanced engineering applications in pure materials. Therefore, improved dielectric constants of polymeric materials for capacitors, electromagnetic shielding, and other engineering applications have been obtained using organic fillers (Daniel-Mkpume *et al.*, 2019; Omah *et al.*, 2018; Patrick, Aigbodion & Hassan, 2012) and ceramic fillers (Kim *et al.*, 2009; Li *et al.*, 2010; Li *et al.*, 2009). Although positive results have been obtained with these fillers in polymer matrices, their dielectric constant is still low when compared with what is required for advanced engineering applications.

$$W = c/(2f_r) * (2/(\epsilon^l + 1))^{1/2} \quad (3)$$

$$L = c/(2f_r(\epsilon^l)^{1/2}) \quad (4)$$

In these equations:  $f_r$  is the resonant frequency ( $s^{-1}$ ); c is the speed of light ( $3 \times 10^8$   $ms^{-1}$ ); and W and L are the width (m) and length (m) of a patch antenna, respectively. On the other hand, high thermal conductivity is also a necessity for miniaturisation of electronic components. This is a challenge with regard to polymers due to their low thermal properties (Huang, Jiang & Tanaka, 2011). For instance, an increase in power density of polymer dielectric materials is often associated with high power loss density and operating temperature, especially with regard to miniaturised devices. There is often a challenge in the dissipation of generated heat within such materials, due to poor thermal management and an inability to dissipate heat quickly. This leads to localised burnt surfaces or hotspots on the dielectric films, as is shown in Figure 1 (Zhang *et al.*, 2015a).

However, the recent discovery of GNs has paved the way for a high dielectric constant, high ESD and high thermal properties of polymer based materials (Chiu & Chen, 2015) at a low percolation threshold (Fan *et al.*, 2012; Maity, Mandal & Nandi, 2015; Wu *et al.*, 2015). Polymer/graphene nanocomposites show a huge amount of dielectric constant near the percolation threshold (Uyor *et al.*, 2018a; Weng, Wang & Liu, 2017). A percolation threshold is a point of insulation to conduction transition in percolative polymer nanocomposites. At this point, such nanocomposites indicate a large dielectric constant and electrical conductivity outputs (Deepa, Gopika & James, 2013; Panwar, Sachdev & Mehra, 2007). Various reports have claimed that the high dielectric constant of polymer/graphene nanocomposites is the result of micro-capacitor formation in the polymer matrix (Chu *et al.*, 2013; Li *et al.*, 2008). The micro-capacitors are formed when adjacent conductive fillers are separated by insulative thin layers of a polymer matrix (Fan *et al.*, 2012; He *et al.*, 2009; Uyor, Popoola & Aigbodion, 2018). Although this class of polymer nanocomposites is faced with the challenges of high energy dissipation and poor dielectric breakdown capability, their significant increase in dielectric constant and ESD have made them promising materials for various engineering applications (Uyor *et al.*, 2019a). Therefore, this review focused on the positive contribution of GNs on the advancement of dielectric constant and thermal conductivity of polymers. It went further to look at the challenges associated with such nanomaterials and possible solutions for advanced engineering applications. This review provided insight for further research to address the challenges faced by this class of polymer nanocomposites. Since this class of polymer nanocomposites remains at a research level, it is expected that this review will facilitate the industrial production of engineering components made with such nanocomposites, which have superior characteristics. This class of polymer nanocomposites will be beneficial to various engineering fields, especially electronic and electrical applications, particularly in the design of advanced dielectric capacitor materials, patch antennas, electromagnetic shielding, electronic packaging and various other miniaturised electronic components.



**Figure 1:** Image of a: (a) breakdown site on a polymer film (Boggs, Ho & Jow, 2010); and (b) metalised capacitor film, showing burnt spots with poor self-clearing (Ho & Greenbaum, 2018).

#### EFFECTS OF GRAPHENE NANOSHEETS ON THE THERMAL CONDUCTIVITY OF POLYMERIC MATERIALS

A GN is a 2D material bonded in a sp<sup>2</sup> honeycomb structure and hexagonally interconnected by Van der Waals force (Xu *et al.*, 2013). It is a large aspect ratio and large surface area nanomaterial. Its high thermal, electrical and mechanical properties distinguish it from conventional nanofillers (Garzón & Palza, 2014). When such a nanofiller is incorporated into amorphous or semi-crystalline polymeric materials, their thermal properties are significantly enhanced. This is due to the introduction of charge carriers with high mobility in the matrix, which helps in the transferring of heat within and out of the materials. The various reported superior thermal properties of nanocomposites made with GNs can also be credited to the high thermal conductivity of such a nanofiller. Due to the high aspect ratio and large surface area of GNs, there are significant changes to the morphological and microstructural properties of polymeric materials, even at a low concentration, along with the formation of conductive network structures in the matrix near percolation threshold (Uyor *et al.*, 2018b). With the interconnected GNs in the polymer matrix, there is easy and fast mobility of free electrons, or charge carriers, from one graphene sheet to another, which increases the conductivity of such material (Wen *et al.*, 2013). To achieve this, high exfoliation and dispersion of GNs in the polymer matrix are required. This often results in some challenges in practical applications due to the restacking nature of GNs.

From the ongoing discussion, various studies have investigated the advantages of GNs in improving thermal conductivity of various polymeric materials (Ashenai Ghasemi, Ghorbani & Ghasemi, 2017; Chiu & Chen, 2015; Uyor, 2019). For instance, Zhang *et al.* (2015b) recorded improved thermal conductivity of about 0.95 W m<sup>-1</sup> K<sup>-1</sup> by introducing 1 wt% graphene oxide in poly (vinylidene fluoride) (PVDF)/10 wt% carbon nanotubes composite. The achieved result is about 332% increase when compared with pure PVDF, which had thermal conductivity of about 0.22 W m<sup>-1</sup> K<sup>-1</sup>. The improved property was because of dense network structures that formed in the matrix with the incorporation of graphene oxide. A similar study, carried out by Huang, Zhi and Jiang (2012), recorded thermal conductivity of 6.31 W m<sup>-1</sup> K<sup>-1</sup> when 20 vol% graphene nanoplatelets was added into epoxy/20 vol% carbon nanotubes, which is significantly higher compared with that of pure epoxy. At 10 wt% graphene sheets in the PVDF matrix, thermal conductivity of approximately 0.58 W m<sup>-1</sup> K<sup>-1</sup> (152% increase) was measured, compared with about 0.23 W m<sup>-1</sup> K<sup>-1</sup> for pure polymer (Jinhong *et al.*, 2011). The enhancement was attributed to the bridging of amorphous regions in the polymer matrix by graphene sheets, which improved the conduction of the polymer. Uyor (2019) measured thermal conductivity of about 1.003 W m<sup>-1</sup> K<sup>-1</sup> by incorporating 6.67 wt% functionalised graphene nanoplatelets in the PVDF matrix, which is about a 295% increase when compared with the pure PVDF. Even at a low graphene content in a polymer matrix, high thermal conductivity has also been recorded. Lian *et al.* (2016) achieved 2.13 W m<sup>-1</sup> K<sup>-1</sup> with epoxy/0.92 vol% graphene composites, which is about a 1 231% increase compared with pure epoxy (0.16 W m<sup>-1</sup> K<sup>-1</sup>). The authors also reported an increase in glass transition temperature ( $T_g$ ) with the addition of graphene in the polymer matrix.  $T_g$  measures the temperature at which a polymeric material changes from rigid to soft due to the initial mobility of its molecular chains with application of heat. It is useful for the determination of the polymer working temperature. Improving such properties of polymers using GNs implies the promotion of a working temperature of such materials.

A thermal conductivity increase of about 66% has been obtained with polystyrene/10 wt% graphene composite (0.244 W m<sup>-1</sup> K<sup>-1</sup>) when compared with pure polystyrene (0.147 W m<sup>-1</sup> K<sup>-1</sup>) (Ding *et al.*, 2015). Also, about a 1 000% increase in thermal conductivity has been reported for polyethylene/13 wt% graphene nanocomposites at 300% applied strain (Tarannum *et al.*, 2020). Meanwhile, Li *et al.* (2020) measured through-plane thermal conductivity of about 10 times higher than that of pure epoxy resin by incorporating highly oriented graphite of 1.75 wt% in the epoxy matrix. Since most polymers have low thermal conductivity in the range of 0.5 W m<sup>-1</sup> K<sup>-1</sup> (Tarannum *et al.*, 2020), the high percentage of variation in thermal conductivity of polymer/graphene nanocomposites, as recorded by various researchers, is not due to the use of different polymer matrix, but rather as a result of different GN concentrations, GN particle sizes, GN orientation in the matrix, degree of GN dispersion in the matrix and fabrication method. Various other authors such as Ding *et al.* (2014), Araby *et al.* (2014), Hamidinejad *et al.* (2018b), Zabihi and Araghi (2016), Imran, Lou and Shivakumar (2018), Clausi *et al.* (2020), among others, have shown an increase in the thermal properties of polymeric materials using GNs. The enhanced thermal properties recorded with polymer/graphene nanocomposites is essential in both high temperature applications and in the miniaturisation of electronic components.

#### CONTRIBUTION OF GRAPHENE NANOSHEETS ON DIELECTRIC PROPERTIES OF POLYMERIC MATERIALS

Various studies have used GNs to significantly enhance the dielectric constant or permittivity and ESD of polymers. Dielectric permittivity measured in thousand-folds have been reported by adding GNs in the polymer matrix (Chu *et al.*, 2013; Guan *et al.*, 2017; Sun *et al.*, 2014). It is believed that GNs form micro-capacitors in the polymer matrix (Chu *et al.*, 2013) as a result of their large surface areas of about 2 630 m<sup>2</sup>/g to 2 600 m<sup>2</sup>/g (Stankovich *et al.*, 2006; Stoller *et al.*, 2008). This is possible when adjacent GNs, which act as conductive electrodes, are separated by thin layers of polymer in the matrix, especially in the case of well exfoliated and dispersed GNs. The high surface area and electrical conductivity of GNs give them an edge over conventional nanofillers in the formation of micro-capacitors with a high number of dielectric permittivity outputs. Therefore, various studies have measured high dielectric permittivity and energy density with polymer/graphene nanocomposites. For instance, Yousefi *et al.* (2014) obtained dielectric permittivity of about 14 000 (2 800 times higher than pure epoxy) at 1 kHz by adding 3 wt% reduced graphene oxide (rGO) to an epoxy matrix of dielectric constant 5. The significant result achieved was due to a high accumulation of charge carriers on epoxy-rGO interfaces. Also, high dielectric permittivity of about 38 418 (4 268.7 folds higher than pure PVDF) at 100 Hz has been recorded with 6.67 wt% functionalised graphene nanoplatelets in a PVDF matrix (Uyor *et al.*, 2018a). Chu *et al.* (2013) reported dielectric permittivity of about 4 500 at 1 kHz by incorporating 3.19 vol% functionalized few layers graphene in a PVDF matrix of dielectric constant of around 10.

Guan *et al.* (2017) measured dielectric permittivity of about 5 400 at 100 Hz, which is about a 40 809% increase, by adding 2 wt% ionic liquid modified graphene oxide into a PVDF matrix of dielectric constant 13.2. Dielectric permittivity of approximately 2 360 at 1 kHz has also been measured by the incorporation of MnO<sub>2</sub>-decorated graphene sheets into a PVDF matrix (Sun *et al.*, 2014). While Li *et al.* (2017) developed polypropylene/functionalised graphene by melt compounding with the aid of polypropylene-grafted maleic anhydride as a compatibiliser. The study obtained dielectric permittivity of approximately 170 at 100 Hz for 0.99 vol% loading. This can be estimated as an 7 627.3% increase compared with that of pure polypropylene matrix, which is usually around 2.2. Other authors such as Wang *et al.* (2012), Zheng *et al.* (2018), Hamidinejad *et al.* (2018a), and Deshmukh *et al.* (2017), among others, have also reported improved dielectric properties of polymers using GNs. The enhanced dielectric permittivity reported by various studies with polymer/graphene nanocomposites is not only important for the fabrication of polymer dielectric film capacitors with high ESD, but also essential for the fabrication of miniaturised electronic components, electromagnetic interference shielding and electronic packaging. However, there is still a need for further studies to optimise the fabrication process of such nanocomposites and the dispersion state of GNs in the polymer matrix for practical applications.

#### POLYMER/GRAPHENE DIELECTRIC NANOMATERIALS: CHALLENGES AND RECOMMENDATIONS

Despite the promising features of graphene nanosheets (GNs) for improving the dielectric permittivity, energy storage capacity and thermal response of polymers, fabrication challenges remain. These challenges include high agglomeration and incompatibility with polymer systems. Due to the positive impact of well-dispersed GNs on the dielectric, energy and thermal behaviour of polymers, various approaches have been adopted for addressing the challenges of agglomeration and incompatibility of GNs with the polymer matrix. This has been achieved through covalent (Maity, Mandal & Nandi, 2015; Wang *et al.*, 2012) and non-covalent (Bai *et al.*, 2009; Li *et al.*, 2015a) modifications of GNs.

In addition, high dielectric loss, energy dissipation and poor dielectric breakdown behaviour (Al-Saleh, 2018; Han *et al.*, 2013; Li *et al.*, 2015b) are also barriers for the practical application of polymer/graphene nanocomposites. These shortcomings associated with such dielectric nanomaterials for high dielectric energy storage application are due to high current leakage, release of electrons from graphene, high mobility of charge carriers in the polymer matrix, direct contact of GNs in the matrix, conductive network structures formation in the matrix, hopping of electrons from one graphene sheets to another in the matrix, high electrical conductivity of such nanocomposites, and poor distribution of GNs in the matrix.

Various efforts have been made to address these challenges associated with polymer/graphene dielectric nanomaterials. For instance, various studies have shown that physical insulation of GNs with some ceramic powders (Uyor *et al.*, 2019b; Uyor, Popoola & Aigbodion, 2018; Wang *et al.*, 2013) and organic materials (Li *et al.*, 2015b; Wang *et al.*, 2012) can reduce the high dielectric dissipation and enhance the dielectric breakdown behaviour of such nanocomposites. Notwithstanding the results achieved so far by various authors, further work still needs to be done to fully actualise the practical applications of these promising dielectric nanomaterials as high thermal management and dielectric energy storage materials. Some of the ways to further address the shortcomings of polymer/graphene nanocomposites have been outlined in our previous study (Uyor *et al.*, 2019a). Typically, the prospective techniques include: (i) coating of multiple insulative layers on GNs to ensure optimal prevention of release of  $\pi$ -orbital electrons from GNs; (ii) the use of hybrid nanofillers such as 1D and 2D nanoparticles to promote the formation of 3D network structures in the polymer matrix for high energy storage outputs; and (iii) the use of a control method for insulating GNs so as to avoid the destruction of its conjugal structures, and the deterioration of its excellent energy, electrical, thermal and mechanical properties.

## CONCLUSION

Graphene nanosheets (GNs) have shown great future potential for advancing the dielectric energy storage and thermal properties of polymeric materials for various engineering applications. This review has been able to look at the contribution of GNs on the thermal and dielectric behaviour of polymeric materials. It was noted that such nanofiller can effectively improve the properties of polymers for various advanced engineering applications. The review went further to outline the current challenges associated with the practical applications of polymer/graphene nanocomposites as high dielectric energy storage and thermal management materials. It was recommended that further work still needs to be done in this area, so as to further overcome the challenges and realise the practical applications of the promising polymer/graphene dielectric nanomaterials in advanced dielectric energy storage applications and in the miniaturisation of electronic components. Some prospective routes towards addressing the current hurdles faced by this class of polymer nanocomposites were outlined for research, as well as for practical and industrial consideration. The future use of this class of polymer nanocomposites for advanced electronic applications cannot be over-emphasised. These materials will facilitate a high degree of electronic component miniaturisation. Such flexible polymer nanocomposites, with high thermal conductivity and dielectric properties, will find various advanced technological applications in the design of flexible battery electrodes, capacitor materials, patch or microstrip antennas, electromagnetic shielding materials, electronic packaging, as well as high thermal management materials, among others.

## ACKNOWLEDGEMENT

We appreciate the Faculty of Engineering and the Built Environment and the Centre for Energy and Electric Power, Tshwane University of Technology, South Africa, for their support.

## LIST OF REFERENCES

- Al-Saleh, M.H. 2018. Carbon-based polymer nanocomposites as dielectric energy storage materials. *Nanotechnology*, 30(6):1-14.
- Araby, S., Meng, Q., Zhang, L., Kang, H., Majewski, P., Tang, Y. & Ma, J. 2014. Electrically and thermally conductive elastomer/graphene nanocomposites by solution mixing. *Polymer*, 55(1):201-210.
- Ashenai Ghasemi, F., Ghorbani, A. & Ghasemi, I. 2017. Mechanical, thermal and dynamic mechanical properties of pp/gf/xgnp nanocomposites. *Mechanics of Composite Materials*, 53(1):131-138.
- Bai, H., Xu, Y., Zhao, L., Li, C. & Shi, G. 2009. Non-covalent functionalization of graphene sheets by sulfonated polyaniline. *Chemical Communications*, (13):1667-1669.
- Boggs, S.A., Ho, J. & Jow, T.R. 2010. Overview of laminar dielectric capacitors. *IEEE Electrical Insulation Magazine*, 26(2):7-13.
- Chiu, F.-C. & Chen, Y.-J. 2015. Evaluation of thermal, mechanical, and electrical properties of pvd/gnp binary and pvd/pmma/gnp ternary nanocomposites. *Composites Part A: Applied Science and Manufacturing*, 68:62-71.
- Chu, L., Xue, Q., Sun, J., Xia, F., Xing, W., Xia, D. & Dong, M. 2013. Porous graphene sandwich/poly(vinylidene fluoride) composites with high dielectric properties. *Composites Science and Technology*, 86:70-75.
- Clausi, M., Grasselli, S., Malchiodi, A. & Bayer, I.S. 2020. Thermally conductive pvd-graphene nanoplatelet (GNP) coatings. *Applied Surface Science*, 1-10.
- Dang, Z.-M., Yuan, J.-K., Zha, J.-W., Zhou, T., Li, S.-T. & Hu, G.-H. 2012. Fundamentals, processes and applications of high-permittivity polymer-matrix composites. *Progress in Materials Science*, 57(4):660-723.
- Daniel-Mkpume, C., Ugochukwu, C., Okonkwo, E., Fayomi, O. & Obiorah, S. 2019. Effect of luffa cylindrica fiber and particulate on the mechanical properties of epoxy. *The International Journal of Advanced Manufacturing Technology*, 1-6.
- Deepa, K.S., Gopika, M.S. & James, J. 2013. Influence of matrix conductivity and coulomb blockade effect on the percolation threshold of insulator-conductor composites. *Composites Science and Technology*, 78:18-23.
- Deshmukh, K., Ahamed, M.B., Sadasivuni, K.K., Ponnamma, D., Almaadeed, M.A.-A., Pasha, S.K., Deshmukh, R.R. & Chidambaram, K. 2017. Graphene oxide reinforced poly (4-styrenesulfonic acid)/polyvinyl alcohol blend composites with enhanced dielectric properties for portable and flexible electronics. *Materials Chemistry and Physics*, 186:188-201.
- Ding, P., Su, S., Song, N., Tang, S., Liu, Y. & Shi, L. 2014. Highly thermal conductive composites with polyamide-6 covalently-grafted graphene by an in situ polymerization and thermal reduction process. *Carbon*, 66:576-584.
- Ding, P., Zhang, J., Song, N., Tang, S., Liu, Y. & Shi, L. 2015. Anisotropic thermal conductive properties of hot-pressed polystyrene/graphene composites in the through-plane and in-plane directions. *Composites Science and Technology*, 109:25-31.
- Fan, P., Wang, L., Yang, J., Chen, F. & Zhong, M. 2012. Graphene/poly(vinylidene fluoride) composites with high dielectric constant and low percolation threshold. *Nanotechnology*, 23(36):1-8.
- Garzón, C. & Palza, H. 2014. Electrical behavior of polypropylene composites melt mixed with carbon-based particles: effect of the kind of particle and annealing process. *Composites Science and Technology*, 99:117-123.
- Glatkowski, P.J. & Arthur, D.J. 2004. Nanocomposite dielectrics. *Google Patents*.
- Guan, J., Xing, C., Wang, Y., Li, Y. & Li, J. 2017. Poly (vinylidene fluoride) dielectric composites with both ionic nanoclusters and well dispersed graphene oxide. *Composites Science and Technology*, 138:98-105.
- Hamidinejad, M., Zhao, B., Zandieh, A., Moghimian, N., Filleter, T. & Park, C.B. 2018a. Enhanced electrical and electromagnetic interference shielding properties of polymer-graphene nanoplatelet composites fabricated via supercritical-fluid treatment and physical foaming. *ACS Applied Materials & Interfaces*, 10(36):30752-30761.
- Hamidinejad, S.M., Chu, R.K., Zhao, B., Park, C.B. & Filleter, T. 2018b. Enhanced thermal conductivity of graphene nanoplatelet-polymer nanocomposites fabricated via supercritical fluid-assisted in situ exfoliation. *ACS Applied Materials & Interfaces*, 10(1):1225-1236.
- Han, K., Li, Q., Chen, Z., Gadinski, M.R., Dong, L., Xiong, C. & Wang, Q. 2013. Suppression of energy dissipation and enhancement of breakdown strength in ferroelectric polymer-graphene percolative composites. *Journal of Materials Chemistry C*, 1(42):7034 - 7042.
- He, F., Lau, S., Chan, H.L. & Fan, J. 2009. High dielectric permittivity and low percolation threshold in nanocomposites based on poly(vinylidene fluoride) and exfoliated graphite nanoplates. *Advanced Materials*, 21(6):710-715.
- Ho, J.S. & Greenbaum, S.G. 2018. Polymer capacitor dielectrics for high temperature applications. *ACS Applied Materials & Interfaces*, 10(35):29189-29218.

- Huang, X., Jiang, P. & Tanaka, T. 2011. A review of dielectric polymer composites with high thermal conductivity. *IEEE Electrical Insulation Magazine*, 27(4):8-16.
- Huang, X., Zhi, C. & Jiang, P. 2012. Toward effective synergetic effects from graphene nanoplatelets and carbon nanotubes on thermal conductivity of ultrahigh volume fraction nanocarbon epoxy composites. *The Journal of Physical Chemistry C*, 116(44):23812-23820.
- Imran, K.A., Lou, J. & Shivakumar, K.N. 2018. Enhancement of electrical and thermal conductivity of polypropylene by graphene nanoplatelets. *Journal of Applied Polymer Science*, 135(9):1-11.
- Jinhong, Y., Xingyi, H., Chao, W. & Pingkai, J. 2011. Permittivity, thermal conductivity and thermal stability of poly(vinylidene fluoride)/graphene nanocomposites. *IEEE Transactions on Dielectrics and Electrical Insulation*, 18(2):478-484.
- Kim, P., Doss, N.M., Tillotson, J.P., Hotchkiss, P.J., Pan, M.-J., Marder, S.R., Li, J., Calame, J.P. & Perry, J.W. 2009. High energy density nanocomposites based on surface-modified batio<sub>3</sub> and a ferroelectric polymer. *ACS Nano*, 3(9):2581-2592.
- Li, C.-Q., Zha, J.-W., Long, H.-Q., Wang, S.-J., Zhang, D.-L. & Dang, Z.-M. 2017. Mechanical and dielectric properties of graphene incorporated polypropylene nanocomposites using polypropylene-graft-maleic anhydride as a compatibilizer. *Composites Science and Technology*, 153:111-118.
- Li, H., Chen, Z., Liu, L., Chen, J., Jiang, M. & Xiong, C. 2015a. Poly (vinyl pyrrolidone)-coated graphene/poly (vinylidene fluoride) composite films with high dielectric permittivity and low loss. *Composites Science and Technology*, 121:49-55.
- Li, J., Khanchaitit, P., Han, K. & Wang, Q. 2010. New route toward high-energy-density nanocomposites based on chain-end functionalized ferroelectric polymers. *Chemistry of Materials*, 22(18):5350-5357.
- Li, J., Seok, S.I., Chu, B., Dogan, F., Zhang, Q. & Wang, Q. 2009. Nanocomposites of ferroelectric polymers with tio<sub>2</sub> nanoparticles exhibiting significantly enhanced electrical energy density. *Advanced Materials*, 21(2):217-221.
- Li, M., Liu, J., Pan, S., Zhang, J., Liu, Y., Liu, J. & Lu, H. 2020. Highly oriented graphite aerogel fabricated by confined liquid-phase expansion for anisotropically thermally conductive epoxy composites. *ACS Applied Materials & Interfaces*.
- Li, Q., Xue, Q., Hao, L., Gao, X. & Zheng, Q. 2008. Large dielectric constant of the chemically functionalized carbon nanotube/polymer composites. *Composites Science and Technology*, 68(10):2290-2296.
- Li, Y., Fan, M., Wu, K., Yu, F., Chai, S., Chen, F. & Fu, Q. 2015b. Polydopamine coating layer on graphene for suppressing loss tangent and enhancing dielectric constant of poly(vinylidene fluoride)/graphene composites. *Composites Part A: Applied Science and Manufacturing*, 73:85-92.
- Lian, G., Tuan, C.-C., Li, L., Jiao, S., Wang, Q., Moon, K.-S., Cui, D. & Wong, C.-P. 2016. Vertically aligned and interconnected graphene networks for high thermal conductivity of epoxy composites with ultralow loading. *Chemistry of Materials*, 28(17):6096-6104.
- Maity, N., Mandal, A. & Nandi, A.K. 2015. Interface engineering of ionic liquid integrated graphene in poly(vinylidene fluoride) matrix yielding magnificent improvement in mechanical, electrical and dielectric properties. *Polymer*, 65:154-167.
- Omah, A., Aigbodion, V., Madu, S., Oji, E., Uyor, U. & Ude, S. 2018. Experimental correlation between the production parameter and mechanical properties of functional epoxy-cow bone particulate composites. *The International Journal of Advanced Manufacturing Technology*, 101(9-12):2465-2474.
- Panwar, V., Sachdev, V.K. & Mehra, R.M. 2007. Insulator conductor transition in low-density polyethylene-graphite composites. *European Polymer Journal*, 43(2):573-585.
- Patrick, S., Aigbodion, V. & Hassan, S. 2012. Development of polyester/eggshell particulate composites. *Tribology in Industry*, 34(4):217-225.
- Stankovich, S., Dikin, D.A., Dommett, G.H., Kohlhaas, K.M., Zimney, E.J., Stach, E.A., Piner, R.D., Nguyen, S.T. & Ruoff, R.S. 2006. Graphene-based composite materials. *Nature*, 442(7100):282.
- Stoller, M.D., Park, S., Zhu, Y., An, J. & Ruoff, R.S. 2008. Graphene-based ultracapacitors. *Nano Letters*, 8(10):3498-3502.
- Sun, J., Xue, Q., Guo, Q., Tao, Y. & Xing, W. 2014. Excellent dielectric properties of polyvinylidene fluoride composites based on sandwich structured MnO<sub>2</sub>/graphene nanosheets/MnO<sub>2</sub>. *Composites Part A: Applied Science and Manufacturing*, 67:252-258.
- Tarannum, F., Muthaiah, R., Annam, R.S., Gu, T. & Garg, J. 2020. Effect of alignment on enhancement of thermal conductivity of polyethylene-graphene nanocomposites and comparison with effective medium theory. *Nanomaterials*, 10(7):1-12.
- Uyor, U.O., Popoola, A., Popoola, O. & Aigbodion, V. 2018. Mechanically insulated graphene/polymer nanocomposites with improved dielectric performance and energy storage capacity. *Polymer Science, Series A*, 60(6):875-885.
- Uyor, U.O., Popoola, A., Popoola, O. & Aigbodion, V. 2018a. Enhanced dielectric performance and energy storage density of polymer/graphene nanocomposites prepared by dual fabrication. *Journal of Thermoplastic Composite Materials*, 33(2):270-285.
- Uyor, U.O., Popoola, A., Popoola, O. & Aigbodion, V. 2018b. Energy storage and loss capacity of graphene reinforced poly (vinylidene fluoride) nanocomposites from electrical and dielectric properties perspective: A Review. *Advances in Polymer Technology*, 37(8):2838-2858.
- Uyor, U.O., Popoola, A., Popoola, O.M. & Aigbodion, V. 2019. Enhanced thermal and mechanical properties of polymer reinforced with slightly functionalized graphene nanoplatelets. *Journal of Testing and Evaluation*, 47(4):2681-2692.
- Uyor, U.O., Popoola, A., Popoola, O. & Aigbodion, V. 2019a. Advancement on suppression of energy dissipation of percolative polymer nanocomposites: A Review on Graphene Based. *Journal of Materials Science: Materials in Electronics*, 30:16966-16982.
- Uyor, U.O., Popoola, A., Popoola, O. & Aigbodion, V. 2019b. Microelectrostatic simulation of insulated graphene-polymer nanocomposites using comsol multiphysics. *Journal of Thermoplastic Composite Materials*, 1-15.
- Wang, D., Bao, Y., Zha, J.-W., Zhao, J., Dang, Z.-M. & Hu, G.-H. 2012. Improved dielectric properties of nanocomposites based on poly (vinylidene fluoride) and poly (vinyl alcohol)-functionalized graphene. *ACS Applied Materials & Interfaces*, 4(11):6273-6279.
- Wang, D., Zhou, T., Zha, J.-W., Zhao, J., Shi, C.-Y. & Dang, Z.-M. 2013. Functionalized graphene-BaTiO<sub>3</sub>/ferroelectric polymer nanodielectric composites with high permittivity, low dielectric loss, and low percolation threshold. *Journal of Materials Chemistry A*, 1(20):6162-6168.
- Wen, B., Cao, M.-S., Hou, Z.-L., Song, W.-L., Zhang, L., Lu, M.-M., Jin, H.-B., Fang, X.-Y., Wang, W.-Z. & Yuan, J. 2013. Temperature dependent microwave attenuation behavior for carbon-nanotube/silica composites. *Carbon*, 65:124-139.
- Weng, L., Wang, T. & Liu, L. 2017. A study on the structure and properties of poly(vinylidene fluoride)/graphite micro-sheet composite Films. *Journal of Composite Materials*, 51(27):3769-3778.
- Wu, Y., Lin, X., Shen, X., Sun, X., Liu, X., Wang, Z. & Kim, J.-K. 2015. Exceptional dielectric properties of chlorine-doped graphene oxide/poly (vinylidene fluoride) nanocomposites. *Carbon*, 89:102-112.
- Xu, C., Xu, B., Gu, Y., Xiong, Z., Sun, J. & Zhao, X. 2013. Graphene-based electrodes for electrochemical energy storage. *Energy & Environmental Science*, 6(5):1388-1414.
- Yousefi, N., Lin, X., Shen, X., Jia, J., Dada, O.J. & Kim, J.K. 2013. *Electrical properties of self-aligned in-situ reduced graphene oxide/epoxy nanocomposites*. In: ICCM International Conferences on Composite Materials, held at Montreal, Canada, 8019- 8025.
- Zabihi, Z. & Araghi, H. 2016. Effect of functional groups on thermal conductivity of graphene/paraffin nanocomposite. *Physics Letters A*, 380(45):3828-3831.
- Zhang, N., Ho, J., Runt, J. & Zhang, S. 2015a. Light weight high temperature polymer film capacitors with dielectric loss lower than polypropylene. *Journal of Materials Science: Materials in Electronics*, 26(12):9396-9401.
- Zhang, W.-B., Zhang, Z.-X., Yang, J.-H., Huang, T., Zhang, N., Zheng, X.-T., Wang, Y. & Zhou, Z.-W. 2015b. Largely enhanced thermal conductivity of poly(vinylidene fluoride)/carbon nanotube composites achieved by adding graphene oxide. *Carbon*, 90:242-254.
- Zheng, X., Yu, H., Yue, S., Xing, R., Zhang, Q., Liu, Y. & Zhang, B. 2018. Functionalization of Graphene and dielectric property relationships in PVDF/graphene nanosheets composites. *International Journal of Electrochemical Science*, 13:1-13.

# INSIZA DISTRICT BIOGAS BASELINE SURVEY

Garikai Kajau and Daniel M. Madyira

Department of Mechanical Engineering Science, University of Johannesburg, Johannesburg, South Africa

gkajau@gmail.com, dmadyira@uj.ac.za

## Abstract

*This study was a demand driven initiative, as a response to the growing desire for biogas technology. The study was carried-out in a district called Insiza (Zimbabwe). The aim of the study was to carry out a baseline survey of the status of bio-digesters in Insiza district. In this district, non-governmental organisations were responsible for promoting and funding the construction of bio-digesters. Therefore, the non-governmental organisations were instrumental in assisting the research team with the location of bio-digesters. Literature estimates that 400 bio-digesters have been installed in Zimbabwe. All the known digester sites in the district were visited and 100% of the digesters were found to be either non-functional or abandoned. The research managed to highlight main reasons why the digesters were not functioning, including; (a) lack of substrate (b) lack of water, and (c) oversized bio-digesters. It was also noted that the Carmatec and the Indian type digesters were the most common designs installed in the district. Furthermore, most of the digesters in Insiza ranged in size from 15m<sup>3</sup> -30m<sup>3</sup>. These were largely fed with cow dung. It was apparent that due to overdependence on one form of substrate, most of the bio-digesters in Insiza district stopped functioning when the substrate availability ran low. It was concluded that for future sustainability, there is need to widen the variety of substrates that can be used in the digesters.*

**Keywords:** traditional biomass, substrate, carmatec, bio-digester

## INTRODUCTION

Zimbabwe has initiated a journey towards the adoption of alternative energy sources to replace traditional fossil fuels. It has, therefore, recently become more and more attractive due to the high energy demand, the limited resources of fossil fuel, and environmental concerns as well as a strategy to survive post-fossil fuel economy era. This study was conducted in Insiza District which is situated in the rural part of Zimbabwe. The district is in climatic natural region 5 of the country. The natural regions are the agro-ecological regions that Zimbabwe is divided into (Ovincent *et al*, 1960). This region experiences low rainfall patterns of about 450-650 mm per year with periodic seasonal droughts and severe dry spells during the rainy season. Due to its location and the energy deficit in Zimbabwe, most people in Insiza rely on biomass as a source of energy. The World Health Organisation (2017), notes that most of the rural population in Sub Saharan Africa rely on cow dung, fuelwood, charcoal and crop residues for energy as the electrification rates are very low, in the range of about 11%. This is also supported by Mwirigi *et al* (2014). According to the International Energy Agency (2014), countries such as Zimbabwe will continue using biomass for energy purposes for the foreseeable future and this will follow the rate of population growth. In Zimbabwe, the available biomass includes industrial wastes, municipal wastes and agricultural wastes (Jingura, *et al* (2013). Biomass theoretical availability has been estimated to be 409PJ (Hemstock and Hall, 1995). It is critical to note that there is traditional biomass and improved traditional biomass. Traditional biomass involves the direct burning of the various forms of solid biomass material (Karekezi *et al*, 2006). On the other hand, improved traditional biomass refers to the improved and more efficient technologies for direct combustion (Karekezi *et al*, 2006). Karekezi (1994) indicated that the traditional

biomass which people rely on, leads to stoves which are inefficient, leading to major greenhouse emissions. Furthermore, these emissions lead to health complications for people (especially women and children) who spend prolonged hours exposed to the smoke. Married to that, is the fact that over reliance on wood also causes massive deforestation. Equally important is the fact that this has serious implications on gender equality. This is because in most cases it is the girl child who carries the burden of looking for firewood in the family. Miranda *et al* (2014), remark that the combustion of  $CH_4$  can be used to produce heat energy and electricity. Biogas as a source of  $CH_4$  is one of the renewable energy alternatives that can be pursued in order to migrate from over relying traditional biomass and also to ameliorate the effects of national energy deficit in Zimbabwe. According to Ziuku *et al* (2014), by the end of 2013, Zimbabwe produced 1500MW of energy against a national demand of 2400 MW. With an installed capacity of 1940 MW, the country will still have challenges in meeting its energy demand Ziuku *et al* (2014). It becomes imperative to introduce other energy sources such as biogas to meet demand. However, the benefit of installing biogas digesters has not been fully realised. This study of the biogas baseline conditions in Insiza district managed to highlight the state of bio-digesters in the district. The survey also highlighted key parameters, which affected the success of the initial biogas program with a view to improve performance in the future. Jingura *et al* (2013), note that Zimbabwe has about 400 bio-digesters and their capacities vary from 3- 16m<sup>3</sup> m<sup>3</sup>. However, what is worrying is that biogas has been utilised at only 8% of the potential in Zimbabwe (Makonese, 2016). This journey has been slow, and this research is basically a baseline survey of the adoption of biogas technology in Insiza. This was one of the many ways of documenting the baseline conditions with regards to the uptake of biogas technology in the district. Baseline scenarios are important in that they are the lens which guide the roll out of the implementation program. Parawira (2009), pointed out that small scale biogas digesters have been constructed in Africa but only a few are operational. Moreover, Jingura *et al* (2008), opine that there has been little documentation regarding the performance of bio-digesters in Africa. This study is a way of providing documentation regarding the existence and performance of bio-digesters in Insiza district. Beyond offering energy, biogas technology also offers other benefits. Hakawati *et al* (2017), chronicle that biogas offers multifaceted benefits as compared to other renewables such as wind, solar and hydroelectricity. Cheng *et al* (2014) and Bond and Templeton (2011) asserts that biogas control organic waste, can produce fertiliser, carbon dioxide for the food industry, heat and methane. Musyoki and Tinarwo (2015) point out that rural women tend to benefit from a reduction in the time spent collecting firewood, making charcoal and even cooking in dangerous fumes and this overall improves the quality of life through improvement in health and sanitation.

## AIM OF THE INVESTIGATION

The aim of this work was to conduct a baseline survey of the uptake of biogas technology in Insiza district.

## RESEARCH PROCEDURE

An institution called Africa 2000 which funded the construction of bio-digestors provided useful information regarding the location of bio-digesters in the district. A questionnaire was handed to bio-digester owners and in cases where the owner was not available, the eldest member of the family was subsequently given the questionnaire to complete. From the literature survey, it was observed that Insiza district biogas digesters were either classified as Indian Type (Floating drum) and the Carmatec fixed dome.

The data collection tool that was used for this study focused on the following aspects summarized in Table 1.

**Table 1:** Data collection tool collection focus areas

Type of biogas digester	Energy uses of biogas
District digester is located	Feeding intervals
Size of digester	Use of slurry
Year of construction	Quantity of substrate per feeding
Business model	Owner's opinion on functionality
Type of substrate	Distance from water source
Number of livestock at the household	Distance of digester from user
Status of biogas digester	GPS Coordinates
Mode of feeding	Feeding intervals
Operational problems	Experiences and lessons on design

All the bio-digesters in Insiza district were visited and every bio-digester owner was interviewed. All the bio-digester owners interviewed managed to give feedback.

## RESULTS AND DISCUSSION

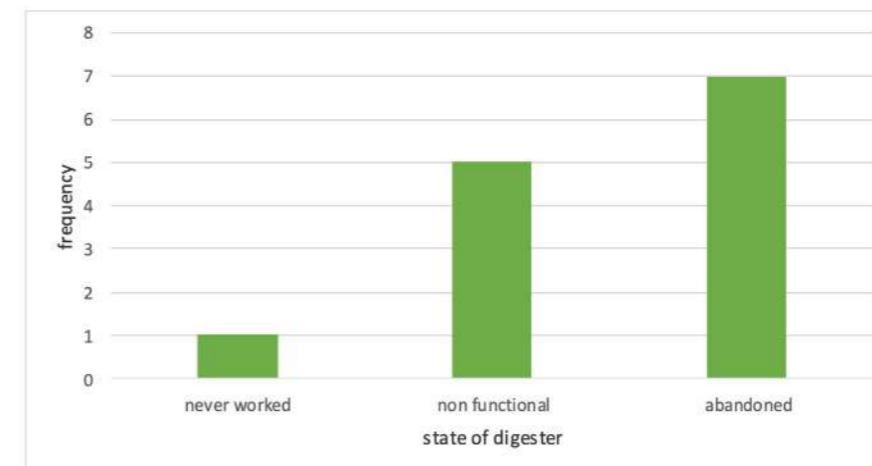
A total of 13 biogas digesters were identified and visited in Insiza district to check the baseline conditions with regards to the uptake of biogas technology in the district. All the biogas digesters were found not to be working. The digesters were built with the assistance of a non-governmental organization. Each family that constructed a biogas digester was given a heifer as a motivation and to boost the source of substrate. The family, upon receiving the heifer, were supposed to keep it until it had given birth upon which they would hand it over to the next family. This was meant to grow the head of cattle to provide enough cow dung for the bio-digester and to improve livelihoods. Table 2 shows the size of biogas digesters in the district and some key parameters, which affect biogas production.

**Table 2:** Important biogas parameters in Insiza district

Size of digester (m <sup>3</sup> )	Distance to water source (km)	Number of livestock
30	1	2
30	1	4
15	0.2	4
30	1	10
15	1	2
25	0.01	1
30	0.5	2
30	1	2
15	1.2	2
30	1	8
30	1.5	2
30	1.6	2
30	1.6	2

The study found out that there are two types of bio-digesters that were built in Insiza district. These were the Carmatec type and the Indian type. 15% of the bio-digesters were Carmatec and 85% were Indian type.

Figure 1 summarizes the status of biogas digesters in Insiza district. There was one digester which had never worked, 5 nonfunctional and 7 abandoned.



**Figure 1.** The status of biogas digesters in Insiza district

As can be seen from the graph above, all the visited digesters were not working. One of the constructed digesters never worked. 53% of the biogas digesters were abandoned by the owners. Figures 2(a)-(f) shows the status of some of the visited bio-digesters showing the general lack of repair and maintenance.



**(a)** abandoned digester



**(b)** Indian type digester



**(c)** abandoned digester



**(d)** abandoned digester



(e) digester with steam trap



(f) abandoned digester

**Figure 2:** The photographic presentation of sited biogas digesters in Insiza district (a- abandoned digester, b -indian type digester, c-abandoned digester, d-abandoned digester, e-digester with steam trap and f–abandoned digester)

Zimbabwe is an agro-based country and the main activity in Insiza district is communal farming. The district is mainly in a dry area. The following types of substrate are available for use in biogas production. Table 3 shows the available crops in Insiza district that could be used as substrate in Insiza district.

**Table 3:** Available crops and residues in Insiza district.

Crop	Residue
Maize	Cobs, Stover
Sorghum	Stover, Threshed heads
Groundnuts	Hulls, Halms
Cotton	Stalks, husks, Hulls
Sunflower	Heads, hulls

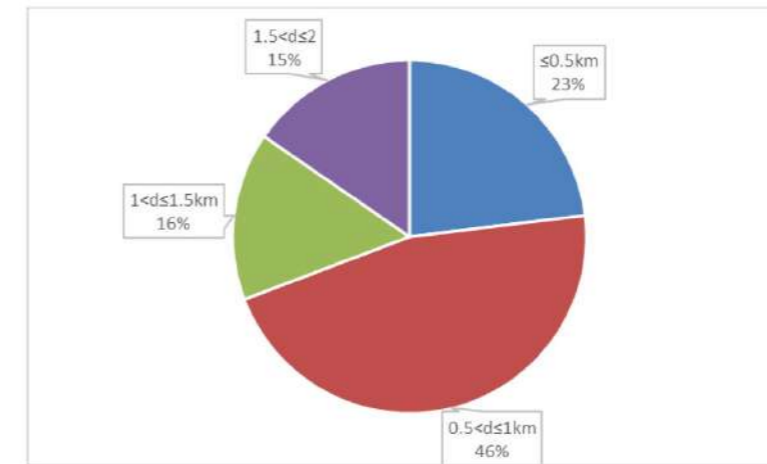
The people of Insiza also practice animal husbandry at a communal level which results in the following forms of substrate being available as for biogas production as shown in Table 4.

**Table 4:** Available livestock in Insiza district.

Animal	Substrate
Cattle	cow dung
Pig	pig manure
Poultry	chicken droppings
Donkey	donkey manure

All visited families indicated that they were using cow dung as a substrate before the abandonment or the malfunctioning of the biogas digesters. Weiland (2010) observed that in more and advanced regions, biogas owners mix livestock manure with other substrates such as food/crop waste for improved bio-digester performance. This could have assisted the challenge of substrate availability in Insiza district, given the overreliance on cow dung. It was also noted that most households lacked enough cows to feed the biogas digesters.

Access to water is very important in anaerobic digestion. Water creates the anaerobic environment in which biomass digestion takes place to create biogas. The availability of water or lack of it can be a game changer in the way in which a biogas digester operates. In general, the district of Insiza experiences low total rainfall of about (450-650 mm), periodic seasonal droughts and severe dry spells during the rainy season. Figure 3 shows the distance to the water source for the digesters in the district.

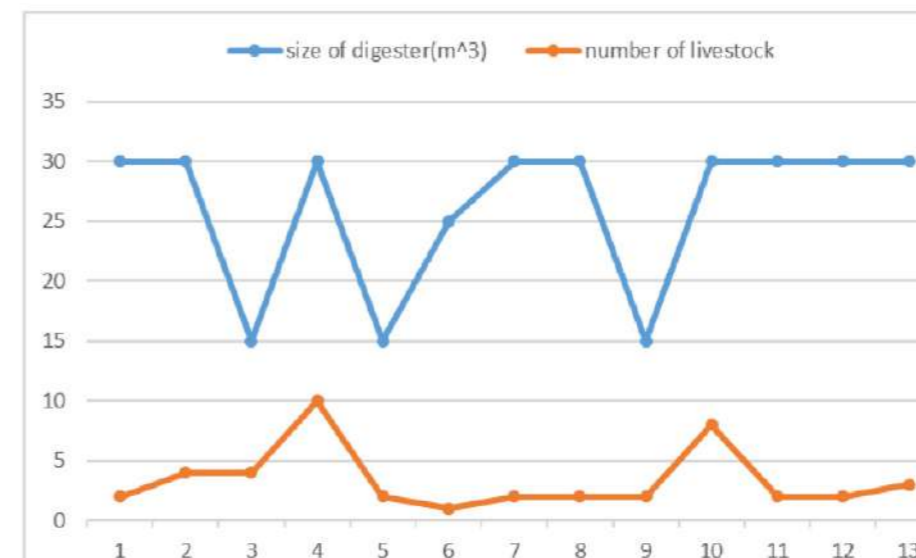


**Figure 3.** The distance to the water source

12/13 families indicated lack of water as a major setback in the functioning of their biogas digester. They highlighted that getting water at communal water points was a very tedious process, which led many people to have a negative attitude about biogas technology.

Another very important feature is the size of biogas digesters that were built in Insiza district. Most of the biogas digesters constructed in the district are of the order of  $30m^3$  and this is contrary to the available number of cattle to feed those types of digesters. It was observed that 9/13 bio-digesters that were visited had an individual capacity of  $30m^3$ . Figure 4, shows the size of biogas digesters and the number of livestock in Insiza district.

**Figure 4:** Individual capacity.



When sizing biogas digesters it is very important to take into consideration the amount of livestock that the family has as this affects the availability of substrate required to feed the biogas digester. In Insiza district they practice free range subsistence farming with regards to their cattle during the dry season from May to October and this has a serious impact on the availability of the amount of cow dung collected. As can be seen from the graph most families have less than 4 cattle and these were required to provide substrate for biogas of the size of the order of  $15m^3$ - $30m^3$ .



The families that were interviewed indicated that they used the biogas for cooking and lighting. All the families that were interviewed indicated that they intended to use the biogas for heating and lightning. 10/13 families also indicated that they intended to use the slurry as organic manure in their agricultural fields, with 3/13 also stating that they hoped to sell the slurry to other villagers.

#### CONCLUDING REMARKS

A comprehensive study of the baseline status of biogas digesters was conducted in Insiza district. A total of 13 biogas digesters were identified and all of them were visited. Based on the results obtained, the following conclusions can be made:

- 1) Overreliance on one form of cow dung was the main reason why biodigesters were not functioning in Insiza district.
- 2) Availability of other forms of energy also played a role in people not pursuing biogas technology
- 3) The two types of digesters that are common in Insiza district are the Carmatec and Indian
- 4) The main type of substrate that is used in Insiza district is cow dung.
- 5) All the visited digesters were not working

#### LIST OF REFERENCES

- Bond, T. & Templeton, M., 2011. History and future of domestic biogas plants in the developing world. *Energy for Sustainable development*, Volume 15(4), pp. 347-354.
- Cheng, S., Li, Z., Mang, H.P., Neupane, K., Wauthelet, M. and Huba, E.M., 2014. Application of fault tree approach for technical assessment of small-sized biogas systems in Nepal. *Applied energy*, 113, pp.1372-1381.
- Hakawati, R., Smyth, B.M., McCullough, G., De Rosa, F. and Rooney, D., 2017. What is the most energy efficient route for biogas utilization: heat, electricity or transport? *Applied Energy*, 206, pp.1076-1087.
- Hemstock, S.L. and Hall, D.O., 1995. Biomass energy flows in Zimbabwe. *Biomass and Bioenergy*, 8(3), pp.151-173.
- International Energy Agency, 1998. *World Energy Outlook 1996*. Paris. IEA/OECD
- Jingura, R.M. and Matengaifa, R., 2008. The potential for energy production from crop residues in Zimbabwe. *Biomass and Bioenergy*, 32(12), pp.1287-1292.
- Jingura, R.M., Musadamba, D. and Kamusoko, R., 2013. A review of the state of biomass energy technologies in Zimbabwe. *Renewable and Sustainable Energy Reviews*, 26, pp.652-659.
- Karekezi, S., 1994. Disseminating renewable energy technologies in sub-Saharan Africa. *Annual review of energy and the environment*, 19(1), pp.387-421.
- Karekezi, S., Lata, K. and Coelho, S.T., 2006. Traditional biomass energy: improving its use and moving to modern energy use. *Renewable Energy—A Global Review of Technologies, Policies and Markets*, 1, pp.231-261.
- Miranda, N.D., Chicol, A. and McCulloch, M., 2014, October. Potentials of biogas production and GHG mitigation in Guatemalan dairy farms. In *IEEE Global Humanitarian Technology Conference (GHTC 2014)* (pp. 491-498). IEEE.
- Makonese, T., 2016, March. Renewable energy in Zimbabwe. In *2016 International Conference on the Domestic Use of Energy (DUE)* (pp. 1-9). IEEE.
- Musyoki, A. and Tinarwo, D., 2015. A pro-poor strategy for the emerging green economy: a case study of Marubini multi-purpose women's co-operative biogas project in Maila, Limpopo, South Africa. *Journal of Public Administration*, 50(1), pp.143-156.
- Mwirigi, J., Balana, B.B., Mugisha, J., Walekhwa, P., Melamu, R., Nakami, S. and Makenzi, P., 2014. Socio-economic hurdles to widespread adoption of small-scale biogas digesters in Sub-Saharan Africa: A review. *biomass and bioenergy*, 70, pp.17-25.
- Ovincent, V., Thomas, R.G. and Staples, R.R., 1960. An agricultural survey of Southern Rhodesia. Part 1. Agro-ecological survey. *An agricultural survey of Southern Rhodesia. Part 1. Agro-ecological survey*.
- Parawira, W., 2009. Biogas technology in sub-Saharan Africa: status, prospects and constraints. *Reviews in Environmental Science and Bio/Technology*, 8(2), pp.187-200.
- World Health Organization, 2017. *Burden of disease from household air pollution for 2012*. Geneva. Switzerland
- Weiland, P., 2010. Biogas production: current state and perspectives. *Applied microbiology and biotechnology*, 85(4), pp.849-860.
- Ziuku, S., Seyitini, L., Mapurisa, B., Chikodzi, D. and van Kuijk, K., 2014. Potential of concentrated solar power (CSP) in Zimbabwe. *Energy for Sustainable Development*, 23, pp.220-227.

# MANICALAND AND MASHONALAND BIOGAS BASELINE SURVEY

Garikai Kajau and Daniel M. Madyira

Department of Mechanical Engineering Science, University of Johannesburg, Johannesburg, South Africa

gkajau@gmail.com, dmadyira@uj.ac.za

## Abstract

*Access to reliable and modern energy sources is very important for improving the living conditions at household level. Therefore, this study analyzed the status of anaerobic bio-digesters in Manicaland and Mashonaland West Provinces of Zimbabwe. The research was also undertaken out of the realization that there has been little documentation regarding the existence and performance of bio-digesters in Zimbabwe. The two provinces are mostly rural. Most rural populations in Zimbabwe rely on traditional fuels such as firewood for cooking and paraffin for lighting. Due to extensive deforestation, some communities burn dried cow dung for cooking. The aim of this study was to carry out a baseline survey of the status of bio-digesters in Manicaland and Mashonaland West Provinces of Zimbabwe. The survey managed to quantify the number of bio-digesters in the two provinces. More importantly is the fact that the study was able to identify bio-digesters which were operational and those which were not operational. Of the visited digesters, only 14% of the digesters were found to be functional. The two main reasons for non-functionality were found to be (a) easy availability of other sources of energy and (b) absent users. A total of 29 bio-digesters were visited. Most of the digesters that were built in Mashonaland and Manicaland provinces were the Carmatec, Indian and bi-latrline digesters.*

**Keywords:** traditional biomass, bi-latrline digester, substrate, carmatec, bio-digester

## INTRODUCTION

The baseline survey was a demand driven initiative, which sought to unearth the uptake of biogas technology in Manicaland and Mashonaland West Provinces of Zimbabwe. The baseline survey sought to study the status of the existing bio-digesters in the provinces. The two provinces have average temperatures (20-31°) that are favorable to the anaerobic digestion process. The findings of this research would therefore provide a good reference point for stakeholders involved in biogas programs in the visited provinces. Jingura *et al* (2009), noted that biogas technology has been embraced in Zimbabwe and 400 bio-digesters have been installed nationwide. This study covered the rural and urban parts of the two provinces. A literature survey was conducted to gain an in-depth understanding of the different sources of energy that were currently used in the two provinces. The study also managed to outline the areas where the bio-digesters were located and the institutions responsible for their construction. The author contacted churches, non-governmental organizations and government departments that were responsible for the promotion and construction of bio-digesters in the two provinces. This study was conducted over a period of three months, within which all relevant information from the stakeholders was gathered. It is worrying to note that there is massive energy poverty in Zimbabwe (Kalia *et al* (2004). This energy shortage is there against a total biomass theoretical potential of about 409Pj Hemstock *et al* (1995). Amidst this potential, only 8% biomass is utilized as reported in literature. According to Amigun *et al* (2011), public health and environmental problems are mitigated if organic material is used for biogas production. Biogas production has the advantage of being simple to construct and operate at large or small scales Mwirigi *et al* (2014). This overreliance on traditional biomass has obvious negative health implications as outlined above. Traditional biomass involves people directly burning the various forms of solid biomass material Karekezi *et al* (2006). Though there is no consensus amongst scholars about the link between the use of fuelwood to deforestation in Zimbabwe, it

should be noted that the low efficiencies of fuelwood ultimately lead people to cutting more trees Jingura *et al* (2013). The survey managed to quantify the number of bio-digesters in the district. More importantly, this survey managed to highlight the number of bio-digesters that were functional and non-functional. Of those that were non-functional, this survey managed to posit the reasons why they were not functioning. This is undesirable as it ultimately results in the negative perception concerning the biogas technology.

## PROBLEM STATEMENT

This research was carried out in Manicaland and Mashonaland provinces of Zimbabwe. According to agro-ecological regions in Zimbabwe, the two provinces fall in Natural Region 3. This region receives moderate rainfall patterns ranging from 500-750mm per year and the region is characterized by mid-season dry spells and high temperatures. The inhabitants of this region rely heavily on traditional biomass which includes firewood and dry cow dung. It is estimated that Zimbabweans in the rural areas consume over 6 million tonnes of wood per annum Jingura *et al* (2013). Overreliance on wood as a source of fuel ultimately lead to massive deforestation which has serious negative impact on the environment. It is the intention of this study to document the contribution of biogas technology in the energy mix of the two provinces. Due to the existence of many players in the biogas technology in Zimbabwe there is a challenge of lack of documentation regarding this technology. Jingura *et al* (2008) point out that there has been little documentation regarding the performance of bio-digesters in Africa in general. Mistakes in the area of biogas technology are often repeated because of lack of performance reporting Jingura *et al* (2008). In view of that, documenting the type and performance of bio-digesters in the two provinces will help future projects of a similar nature in the two provinces.

## AIM OF THE INVESTIGATION

The aim of this work is to conduct a baseline survey of the uptake of biogas technology in Manicaland and Mashonaland provinces of Zimbabwe.

## METHODOLOGY

A quantitative research methodology was employed in this study. Literature was used to inform the researchers the geographical position of known digesters in the two provinces. The researcher subsequently visited the bio-digester plants in the two provinces. Data collection was done through questionnaires. The respondents were chosen from the visited digesters and where the owner was not available the oldest person with the required knowledge was interviewed.

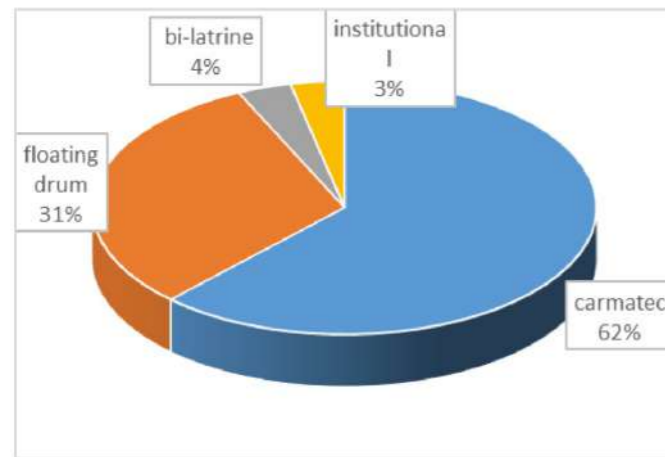
Below is a table that shows the data collection tool that was used in this study.

**Table 1:** Data collection tool

Technological Issues	Operational Issues	Ownership issues
Type of bio-digester	Distance from water source	District digester is located
Size of digester	Feeding intervals	Year of construction
Experiences and lessons on design	Use of slurry	Business model
Energy uses of biogas	Quantity of substrate per feeding	Number of livestock at the household
Mode of feeding	Distance of digester from user	Owner's opinion on functionality
Type of substrate	Operational problems	Bio-digester Location (GPS Coordinates)
Status of biogas digester		

## RESULTS AND DISCUSSION

A total of 29 biogas digesters were surveyed. Below are the results of the surveyed biogas digesters. The two provinces had different types of biogas digesters. Figure 1 shows the types of bio-digesters that were found in the visited provinces.



**Figure 1:** Proportions of the different types of bio-digesters in the two provinces

The graph shows that there are four types of biogas digesters in the two provinces. One of the digesters is an institutional biogas digester. Institutional bio-digesters were built by big institution such as tertiary institutions and municipalities. It can be observed that the floating drum is the second most popular digester in the two provinces. Figures 2 (a) - (d) shows the types of bio-digesters that are common in the two provinces.



(a) Bi-latrine



(b) Institutional plant



(c) Floating drum



(d) Carmatec design

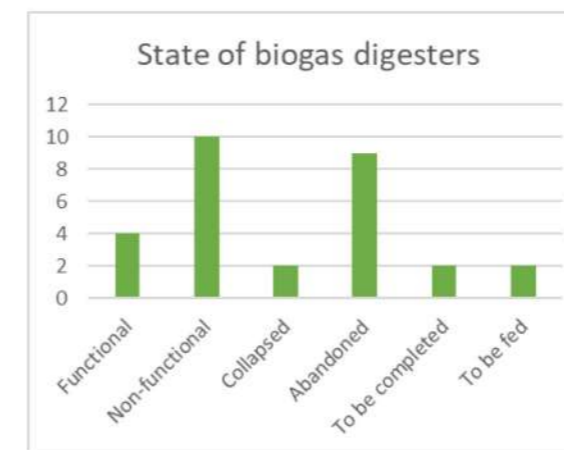
**Figure 2:** Different bio-digester designs (a – Bi-latrine, b – Institutional plant and c – Floating drum, d- Carmatec design)

In these two provinces, the study also managed to document the existence of bi-latrine digesters. When using bi-latrine digesters, it is critical to limit the water used for cleaning to 0,5-1,0 litre per bowl in order to regulate the amount of water mixing with the human excreta Kossmann *et al* (1999). However, the users indicated that the cleaning was random and there was no measurement regarding the water that was used. The World Health Organization (2006), also indicate that the human excreta that undergoes mesophilic anaerobic digestion are not suitable for use as manure. Handling of the slurry after the digestion process was a significant social issue that emerged during the information gathering. This issue was more prominent when dealing with bi-latrine digesters as opposed to other designs. This resulted in most people favoring other types of designs as opposed to the bi-latrine design.

Figure 3 shows the state of the surveyed biogas digesters.

These two provinces provided a glimmer of hope in terms of the uptake of biogas technology in that, 4 of the visited bio-digesters were working. Abandoned bio-digesters referred to those digesters that were completed in terms of construction but showed signs of not being used for a period of more than two years. Non-functional digesters were those digesters that were fully constructed, fed but not producing any gas. Two bio-digesters had not been completed 15 years after the owners had started construction and this period is very long when dealing with domestic bio-digesters. When the biogas installer or promoter does not train the biogas user or owner, many such biogas systems can collapse or be abandoned Kranert *et al* (2012), Njoroge (2002), Huba *et al* (2007), Joanne *et al* (2011). It is therefore important for biogas promoters to train bio-digester owners if biogas technology is to be embraced and successful.

The funding behind the construction of a biogas digester is very important in the sustainability of the digester. Figure 4 depicts the institution/s or individual/s behind the construction of biogas digester in the two provinces.



**Figure 3:** State of biogas digesters

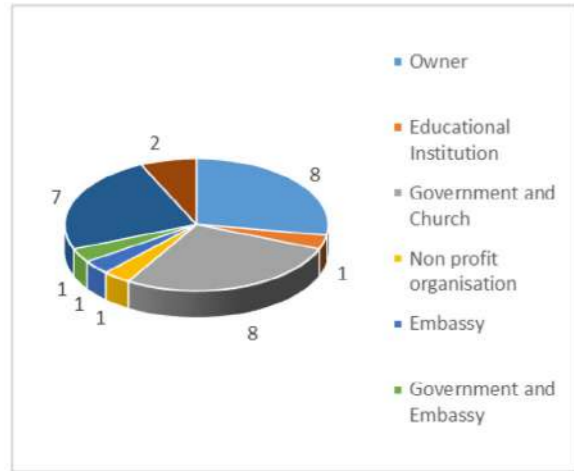


Figure 4: Institution responsible for the funding of construction

These two provinces provided interesting information in that many institutions were responsible for the construction of biogas digesters. The government, non-profit organizations, embassies, churches and bio-digester owners were responsible for the construction of bio-digesters. This shows that the biogas owners were also intrinsically motivated to pursue the biogas technology. The diverse nature of organizations responsible for the promotion of biogas technology indicates interest in the uptake of biogas technology from the various stakeholders.

The study also found a diverse use of the biogas produced. Figure 5 shows the diverse applications of the biogas in these provinces.

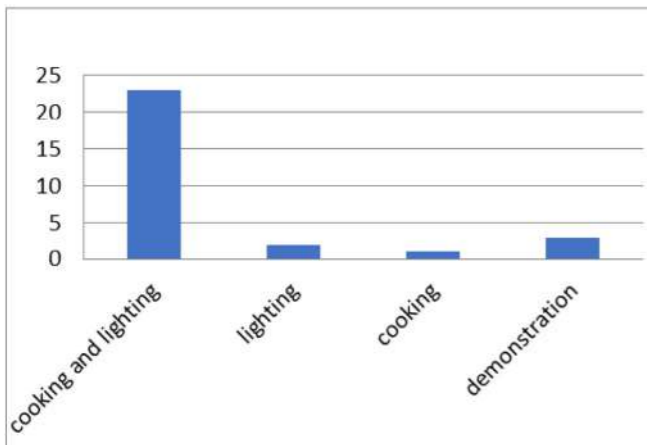


Figure 5: Intended use of biogas by users.

As can be seen, most of the bio-digester owners used the biogas for cooking and lighting. Equally important is the fact that some institutions constructed biogas digesters which were mainly for demonstration purposes only. Figures 6a-c are pictorial representation of the various implements used to combust the biogas in the areas visited.



Figure 6: Biogas use (a) Biogas stove (b) Biogas light and (c) Biogas light

25 out of 29 biogas digesters were not functioning in the two provinces. Figure 7 shows the reasons supplied by the owners why the bio-digesters were not functioning in the two provinces. The reasons why bio-digesters were not functioning this provide an important reference point for anyone who wants to take up biogas projects in the future. Digestate disposal, biogas production, operator's manual, biogas distribution systems, the biogas utilization equipment and the structural components are some of the problems which have been observed to affect the efficient operation of small-scale biogas digesters Cheng *et al* (2014). There is no performance monitoring and reporting of most of the biogas digesters and this often results in the prevalence of the same mistakes and this ultimately leads to a negative perception about the technology and even abandonment Jingura *et al* (2009). Figure 7 shows the main reasons for bio-digester failure.

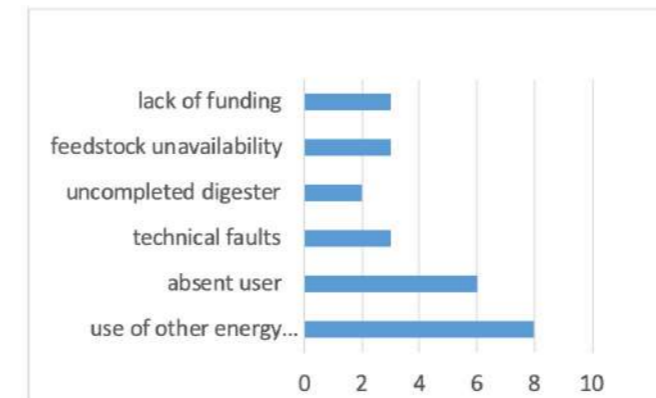


Figure 7: Reasons for digester failure

It can be observed from the graph above that most people abandoned the use of biogas technology due to the availability of other forms of energy. In urban and peri-urban areas, people shifted to the use of electricity and in rural areas people resorted to the use of traditional biomass such as firewood and solar. Figure 8a-Figure 8c, show some of the sources of energy that were observed to be used in rural areas.



(a) Firewood stove



(b) Solar panel



(c) Solar lamp

**Figure 8:** Sources of energy observed to be used in rural areas (a – Firewood, b – Solar panel and c – Solar lamp)

Chopra (1991) note, that the use of biogas reduces the people's overdependence on fuelwood and there are also added benefits of using the digested slurry for agricultural purposes. However, what is worrying is that people resorted to continued use of traditional biomass even though they had livestock to feed the biogas digesters. Kaila *et al* (2004) reports that rural households who have 2-5 cattle can have an average of 22kg of manure which they can subsequently be used to feed biogas digesters. Karekezi (1994) argues that the traditional biomass which people rely on, leads to stoves which are inefficient, which also exacerbates greenhouse gas emissions. This also causes people to develop health complications due to the prolonged exposure to smoke. Jingura *et al* (2009) also notes that the availability of water and feedstock also plays an important role in the success of a biogas program. It is very critical to note that this study found out that the availability of water was not an issue in the two provinces.

## CONCLUDING REMARKS

A comprehensive study of the status of bio-digesters in Manicaland and Mashonaland provinces in Zimbabwe was conducted on a total of 29 digesters. 15 bio-digesters were visited in Manicaland and 14 were visited in Mashonaland province. Based on the results obtained, the following conclusions can be made:

1. The three types of digesters that are common in the two provinces are the Carmatec, Indian and bio latrine
2. Only 14% of the surveyed digesters are functional
3. The main reason why people abandoned biogas technology is the availability of alternative sources of energy such as solar and firewood.
4. Most biogas owners intended to use the technology for heating, cooking and lighting.

## LIST OF REFERENCES

- R. Jingura and R. Matengaifa, "Optimization of biogas production by anaerobic digestion for sustainable energy development in Zimbabwe," *Renewable and Sustainable Energy Reviews*, vol. 13(5), pp. 1116-1120, 2009.
- A. Kalia and S. Singh, "Development of a biogas plant," *Energy sources*, vol. 26(8), pp. 707-714, 2004.
- S. Hemstock and D. Hall, "Biomass energy flows in Zimbabwe," *Biomass and Bioenergy*, vol. 8(3), pp. 151-173, 1995.
- B. Amigun, J. Musango and W. Stafford, "Biofuels and sustainability in Africa," *Renewable and sustainable energy reviews*, vol. 15(2), pp. 1360-1372, 2011.
- J. Mwirigi, B. Balana, J. Mugisha, P. Walekhwa, R. Melamu, S. Nakami and P. Makenzi, "Socio-economic hurdles to widespread adoption of small-scale biogas digesters in Sub-Saharan Africa: A review," *Biomass and Bioenergy*, vol. 70, pp. 17-25, 2014.
- S. Karekezi, "Disseminating renewable energy technologies in sub-Saharan Africa," *Annual review of energy and the environment*, vol. 19(1), pp. 387-421, 1994.
- R. Jingura, D. Musademba, Kamusoko and R., "A review of the state of biomass energy technologies in Zimbabwe," *Renewable and Sustainable Energy Reviews*, vol. 26, pp. 652-659, 2013.
- R. Jingura and R. Matengaifa, "The potential for energy production from crop residues in Zimbabwe," *Biomass and Bioenergy*, vol. 32(12), pp. 1287-1292, 2008.
- S. Karekezi, K. K. Lata and S. Coelho, , "Traditional biomass energy: Improving its use and moving to modern energy use," *Renewable Energy—A Global Review of Technologies, Policies and Markets*, vol. 1, pp. 231-261, 2006.
- W. Kossmann, U. Pönitz, S. Habermehl, T. Hoerz, P. Krämer, B. Klingler, C. Kellner, T. Wittur, F. von Klopotek, A. Krieg and H. Euler, "Biogas-Application and Product Development. Information and Advisory Service on Appropriate Technology (ISAT)," in *Biogas Digest Volume 11*, Eschborn Germany, 1999.
- World Health Organisation, "Greywater Use in Agriculture," in *Guidelines for the safe use of wastewater, excreta and greywater*, Geneva, Switzerland, 2006.
- M. Kranert, S. Kusch, J. Huang and K. Fischer, "Anaerobic digestion of waste," *Waste to Energy*, Vols. Springer, London, pp. 107-135, 2012.
- D. Njoroge, "Evolution of biogas technology in South Sudan; current and future challenges," in *Proceedings from biodigester workshop*, 2002.
- E. Huba, O. Fall, O. Sanogo, G. Kabore and P. Bracken, "Feasibility study for a national domestic biogas programme in Burkina Faso," in *Eschborn: Deutsche Gesellschaft fuer Technische Zusammenarbeit (GTZ) GmbH*, 2007.
- S. Joanne, V. Tumwesige and L. Avery, "Small-scale biogas digester for sustainable Energy production in Sub-Saharan Africa," 2011.
- S. Cheng, Z. Li, H. Mang, K. Neupane, M. Wauthélet and E. Huba, "Application of fault tree approach for technical assessment of small-sized biogas systems in Nepal," *Applied energy*, vol. 113, pp. 1372-1381, 2014.
- N. Chopra, "Biogas digested slurry boosts crop yield: economics of slurry application," *Indian Farming*, vol. 40(4), pp. 35-36, 1991.

# SIMULATION STUDY FOR POTENTIAL USE OF EUTECTIC PLATES IN SOUTH AFRICAN MEDIUM REFRIGERATED TRANSPORT VEHICLE

T.B Radebe<sup>a</sup>, Z Huan<sup>b</sup>, J Baloyi<sup>c</sup>

<sup>a</sup>Thandiwe Bongani Radebe, Tshwane University of Technology, South Africa, bongz.rt@gmail.com

<sup>b</sup>Zhongjie Huan, Applied Refrigeration and Thermal Energy Systems, Tshwane University of Technology, South Africa, huanz@tut.ac.za

<sup>c</sup>Jeffrey Baloyi, CSIR, Pretoria, South Africa, jbaloyi@csir.co.za

## Abstract

*South Africa is one of the less-developed countries in Africa, in that it has a high degree of biological spoilage of livestock products, fish, fruit and vegetables due to lack of refrigeration. Refrigerated transport plays an important role in presenting perishable foodstuffs and non-food goods to consumers while maintaining safety and high-quality during transportation between distant locations. This paper presents the potential application of eutectic water-salt solutions – Phase Change Materials (PCMs) – fitted inside eutectic plates to serve as an alternative refrigeration system for medium-distance refrigerated transport vehicles of South Africa. This paper numerically investigates the characteristics of PCM eutectic plates applied at low-temperature ranges. Physical and mathematical models for three-dimensional (3D) transient natural flow were developed as proposed by Xiaofeng and Zhe. Using the governing equation of mass, momentum and energy conservation, three eutectic plate configurations were modelled and simulated in Ansys Fluent for 5 hours. A uniform heat transfer inside a refrigerated compartment was predicted using the Reynolds Stress Model (RSM). The three configurations showed great potential for the system to function in the South African climate. They had an even temperature distribution across the compartment, showing that the system could be ideal for medium-distance refrigerated transport vehicles delivering perishable foodstuffs or non-food goods.*

**Keywords:** Phase change material; eutectic plate; refrigerated transport vehicle; Reynolds Stress Model; natural convection.

## INTRODUCTION

Africa comprises less-developed countries in terms of food management, including South Africa. As the population increases, the country should focus on proper management of natural resources, which includes labour, land, clean water, oil and agricultural inputs to avoid civil strife and starvation. If post-harvest food losses are minimised, resources can be conserved and would lead to improved human well-being. Well-developed countries, such as the United States of America and the United Kingdom, can prolong shelf life of a product through extensive and effective cold chains. Less-developed countries in Africa have high degrees of biological spoilage of livestock products, fish, fruit and vegetables due to a lack of refrigeration (Hodges, Buzby & Bennett, 2011).

Refrigerated transport plays an important role in the cold chain. It presents perishable foodstuffs and non-food goods to consumers with a prolonged shelf life, which increases safety and ensures high quality during transportation between distant locations (Adekomaya, Jamiru, Sadiku & Huan, 2016). These products include goods such as flowers, plants, pharmaceuticals or chemical products. Glouannec (2014) reported that about 4 million refrigerated transport vehicles are in use throughout the world and predicted that this number would rapidly increase. In terms of proportions, 30% of refrigerated transport vehicles

are trailers, 30% are large trucks, and the last 40% are trucks and vans. Medium-distance vehicles deliver between the producer of goods and the store or from one store to another. They are normally 6 m to 8 m long and use a mechanical compression refrigerated system.

This paper presents the potential application of eutectic water-salt solutions as Phase Change Materials (PCMs) fitted inside Eutectic plates to serve as an alternative refrigeration system for medium-distance refrigerated transport vehicles of South Africa. Previously, this system has been used on small-distance refrigerated transport vehicles (Xiaofeng, Xuelai & Munyalo, 2017; Zhe, Yonggang & Jinjin, 2013). This study extends it to medium-distance refrigerated transport vehicles (Zhao, Zhang & Xu, 2019). This study focuses on numerically finding the optimum eutectic plate configuration needed to determine the temperature range for preserving agricultural products using Computational Fluid Dynamics (CFD) techniques.

## Refrigerated Transport Vehicles

It is reported that 40% of all foods produced in the world require refrigeration and, as a result, 15% of electricity consumption is due to refrigeration (Meneghetti & Monti, 2015). The term ‘cold chain’ refers to the process of food handling and distribution. This is where the product is maintained at a certain temperature from harvesting, throughout the cooling process, to the point where it is sold. Factors such as transportation, different types of storage facilities, as well as where and how the food is displayed within the market can play important roles (Hundy, Trott & Welch, 2016).

Refrigerated transport vehicles are divided into three groups, namely short-distance delivery transport, medium-distance transport, and long-distance transport. Short-distance vehicles make use of the eutectic plates system. They deliver between the last refrigerated stores to the display cabinets in a supermarket, food shop or even directly to a home. Medium-distance vehicles deliver between the producer of goods and the store, or from one store to another. They are normally 6 m to 8 m long and use a mechanical compression refrigerated system. Long-distance transports are 13.6 m long and use a truck to hoist the refrigerated compartment. They have multiple delivery points along their journeys, which can be long or medium distances (Evans, 2008).

The main purpose of refrigerated transport is to maintain a certain temperature during transportation. All goods that are loaded on these systems are precooled to match the carriage temperature. The refrigerated transport vehicle is fitted with a thermally insulated compartment. The thermal heat load is removed by a refrigeration system or a cooling agent (Francis, Evans, Davies & Maidment, 2017). Certain goods such as bananas and citrus fruit, are excluded, since they require an appropriate cooling regime. Each transport mode is fitted with specialised refrigeration equipment to provide temperature control. These systems not only cool, but can provide heat if needed, all in the attempt to maintain the desired transport temperature, especially for chilled goods in cold climates (International Institute of Refrigeration, 2003).

Transport refrigeration units must be robust and reliable to withstand vibrations and shocks. They must also overcome three major obstacles that are not encountered by other refrigeration units. Firstly, these units must operate in a wide range of ambient temperature ranges. Secondly, they must operate under extremely variable weather conditions, including exposure to solar radiation, rain and other factors that contribute to or are caused by the weather. Thirdly, these units must carry a wide range of cargoes with differing temperature requirements (International Institute of Refrigeration, 2003).

The improvements to transport-refrigerated systems make it difficult to minimise the energy consumption and the overall environmental impact of these systems. To do so, one must compromise the temperature control and other ambient conditions, such as the relative humidity. Innovations and strategies that seek to optimise the vehicle design and the performance of the refrigeration system reveal that, by improving the efficiency, 50% of the energy could be saved (Francis *et al.*, 2017). When designing these systems, one of the aims is to maximise the cargo space and keep the system as lightweight as possible (Galos, Sutcliffe, Cebon, Piecyk & Greening, 2015).

## Preservation of Goods

Temperature is a major parameter that affects product quality deterioration, the ripening rate and the shelf life of a product. For fruit and vegetable quality to be maintained at a high level, rapid removal of the field heat after harvest should be done through cooling. By maintaining the optimum product temperature throughout the postharvest supply chain, high quality can be maintained and this would reduce production losses (Defraeye, Wu, Prawiranto, Fortunato, Kemp, Hartmann, Cronje, Verboven & Nicolai, 2017).

The South African parastatal organisation named the Perishable Products Export Control Board (PPECB) monitors pulp temperature data to determine the compliance of cargo with cold treatment protocols. These cold treatments are designed to kill specific phytosanitary organisms such as fruit flies or false codling moths. The cold treatment protocol emphasises that the fruit and vegetable temperatures be maintained below a specific level for a certain amount of time. This protocol is applicable not only to moving cargo but also to land-based treatments. Studies show that customers are willing to pay higher prices and purchase larger quantities of fruit when the quality of the cargo is accurately monitored (Defraeye *et al.*, 2017). The properties of these goods are listed in Table 1. Hundy *et al.* (2016) mentioned that these kinds of figures would differ slightly depending on the location of the product, the variety and the type of breed.

**Table 1:** Specific and latent heats of foodstuffs (typical values) (Hundy *et al.* 2016).

Product	Specific Heat Capacity Above Freezing	Highest Freezing Point (°C)	Latent Heat of Freezing	Specific Heat Capacity Below Freezing
Apples	3.65	-1.1	280	1.89
Bananas	3.35	-0.8	250	1.78
Beer	3.85	-2.2	-	-
Cabbage	3.92	-0.9	-	-
Carrots	3.79	-1.4	294	1.94
Celery	3.99	-0.5	-	-
Dairy products				
Milk	3.75	-0.6	-	-
Butter	1.37	Down to -20	53	1.04
Ice Cream	2.95	-6	210	1.63
Cheese	2.1	-13	125	1.3
Dried fruits	1.8	-2	-	-
Eggs, shell	3.05	-2.2	220	1.67
Fish, white	3.55	-2.2	270	1.86
Blue	2.9	-2.2	210	1.63
Meats, bacon	1.5	-2	64	1.07
Beef	3.2	-2	230	1.7
Ham	2.7	-2	188	1.55
Lamb	3	-2	215	1.65
Pork	2.6	-2.5	125	1.3
Poultry	3.3	-2.8	246	1.77
Melons	3.95	-0.9	310	2
Mushrooms	3.89	-0.9	304	1.98
Onions	3.8	-0.9	295	1.95
Oranges	3.75	-0.8	-	-
Pears	3.62	-1.6	-	-
Potatoes	3.5	-0.7	265	1.84
Tomatoes	3.98	-0.5	-	-

### Eutectic plate

Latent Heat Cold Storage (LHCS) is a kind of energy storage system consisting of eutectic solutions that can change phase at low temperatures. This could be a change from solid to liquid, or from liquid to gas. Eutectic systems are constructed into hollow tubes, beams or plates, which are then fitted with a eutectic solution, as well as a PCM to store and release energy. Although they operate differently from conventional refrigeration systems that use a direct expansion of refrigerant gas, they can reach the same results (Tassou, De-Lille & Ge, 2009).

Eutectic plates have some advantages over other refrigeration systems that set them apart. Some drawbacks have been encountered with these systems as well. In a study conducted by Brown (2012), eutectic plates were seen as an alternative technology to the vapour compression system. Their coefficient of performance was rated as 40% to 50% efficient.

Eutectic plates do not contain any moving parts while they are in operation, which makes them more mechanically reliable than other refrigeration units. Moreover, no noise is produced, making them ideal for use in situations requiring silence. Due to the PCM solution inserted inside the plates, they can maintain a constant temperature inside a refrigerated compartment. This temperature is maintained even when the plates are exposed to the ambient air while goods are loaded and offloaded on the

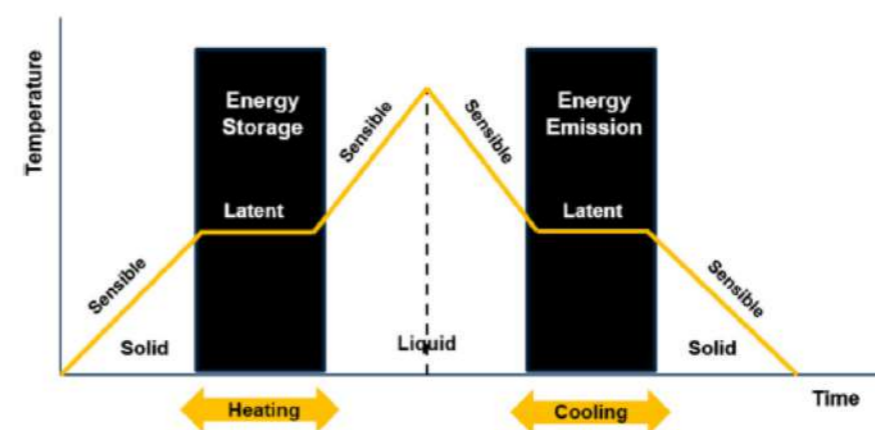
truck. Eutectic plates can be used in places where there is no electricity grid, as they can be charged before use. With eutectic plates, frost build-up does not greatly affect the heat transfer as it does on cooling gills. When considering the life span of eutectic plates, they have great durability and also have a low maintenance cost when compared with ventilated systems (FIC, 2019).

Different PCM compounds used inside eutectic plates can be very corrosive. To avoid this, the choice of steel used for both the evaporator coils and plate should be selected according to the mixture properties of the PCM. Corrosion occurring between the PCM and the casing is one of the reasons for insufficient long-term stability of eutectic plates (Zalba, Marín, Cabeza, & Mehling, 2003).

When the PCM changes from liquid to solid, the molecules inside the solution tend to become rigid and the PCM expands as it freezes. Because of expansion during the freezing process, some of the plates suffer leakages. To avoid this, the coils of the evaporator are designed to allow the freezing of the solution from the perimeter towards the centre of the plate. The manufacturer also rounds all the edges and eliminates any sharp areas so as to generate a high resistance to forces created during the expansion process (FIC, 2019).

Another disadvantage of PCMs is that they tend to reduce working performance. This means that they tend to break down after several cooling cycles – changing from solid to liquid, then back to solid again. This instability depends on the type of PCM group used – organic or inorganic PCM (Liu, Saman & Bruno 2012a; Zalba *et al.*, 2003). In most studies, it has been shown that the PCM storage costs were higher than traditional storage options (Du, Calautit, Wang, Wu & Liu, 2018).

### Thermal Energy Storage



**Figure 1:** Phase change transition (Du *et al.* 2018; Wen *et al.* 2018).

Eutectic systems make use of Thermal Energy Storage (TES) systems. TES is the process of holding thermal energy temporarily in another medium to make use of it at a later stage. Figure 1 illustrates the process of energy storage and energy emission. During the charging process of this medium, the cold thermal energy is accumulated, and during the discharging process, the stored cold thermal energy is retrieved for use (Veerakumar & Sreekumar, 2016). The substance used in eutectic plates is known as a PCM.

A PCM is a substance that can store or release large amounts of energy per unit mass while undergoing a melting or a solidifying process. This is due to the high heat of fusion of the material (Liu, Saman & Bruno, 2014). Therefore, when choosing a material to be used for a PCM, there are desirable thermos-physical kinetic and chemical properties that must be observed. Properties such as the melting temperature of a PCM should be within the range of the operating temperatures. An ideal PCM must have a high latent heat of fusion, a high thermal conductivity and a high density. It must also have a low volume change during phase change, have a low degree of supercooling, low degradation, and be less corrosive to the construction materials. A PCM must be chemically stable, non-toxic, non-flammable, easily available and cost-effective (Veerakumar & Sreekumar, 2016).

Several desirable properties have been stated in a study by Liu, Saman & Bruno (2012b). One of these is that a PCM should melt congruently to avoid irreversible segregation of components. Further, it should be chemically stable to provide a reasonable life span. For eutectic plates to maintain a refrigerated compartment at a constant temperature, the melting point of the eutectic should be lower than the desired temperature. To minimise the cost of operation, since the eutectic plate needs to be charged, the melting point should not be too much lower than the required temperature. If this occurs, the refrigeration unit will be expensive to operate and will not be efficient (Liu *et al.*, 2012a).

Li, Hwang, Radermacher and Chun (2013) performed a comparison between eutectic water-salt solutions, non-eutectic water-salt PCMs and the ideal common PCMs shown in Figure 2. It should be noted that there are no ideal common PCMs. However, six thermal properties are crucial when determining the type of PCM to be used.

In Figure 2, six thermal properties are compared on a radar chart. Three advantageous thermal properties (thermal conductivity, fusion heat and density) are compared with three disadvantageous properties (corrosion, supercooling and flammability). Performance is shown to improve in the direction that the shaded area extends along the arrow. However, Li *et al.* (2013) further elaborated that these diagrams are not according to scale but are designed to provide a general idea of the kind of ideal common PCMs needed.

From Figure 2, eutectic water-salt solutions have higher thermal conductivity, fusion heat and density. They are less flammable but are very corrosive and undergo supercooling when compared with other categories. Non-eutectic water-salt PCMs have less thermal conductivity and fusion heat. However, alcohol solutions have relatively high fusion heat and high density, while different kinds of paraffin have fewer supercooling effects and are less corrosive (Li, Hwang & Radermacher, 2012; Li *et al.*, 2013).

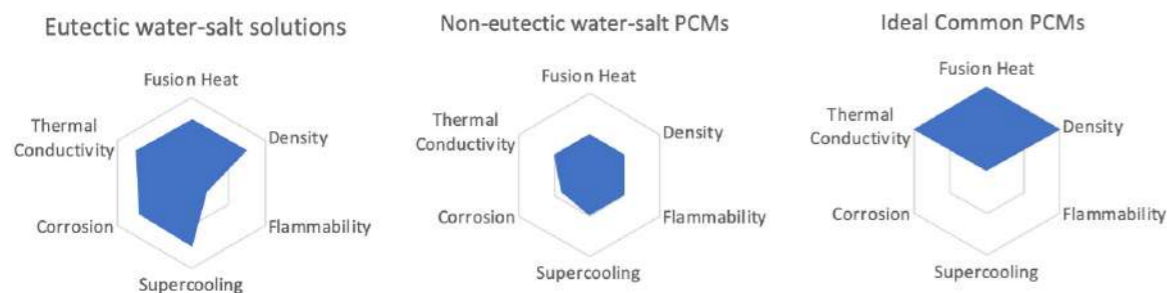


Figure 2: Thermal property comparison of common PCMs (Li *et al.* 2013).

Inorganic PCM (eutectic water-salt solutions)

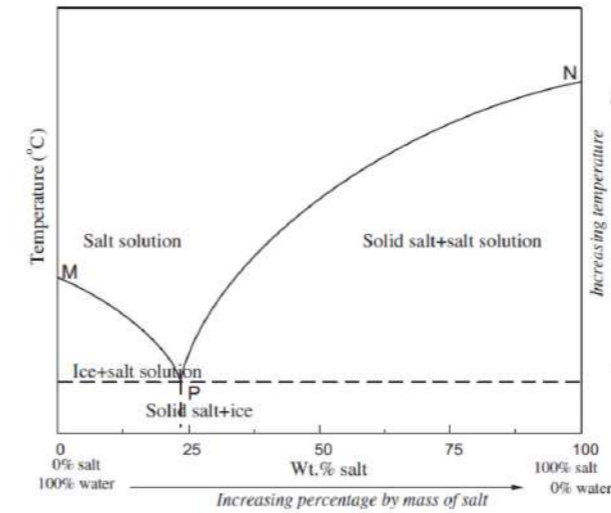


Figure 3: Phase diagram for eutectic water-salt solutions (Li *et al.* 2013).

As mentioned above, eutectic water-salt solutions have a high fusion heat and a suitable phase change temperature range. As a result, much research is focused on them. Figure 3 clearly illustrates that pure water has a freezing point of 0 °C, turning from liquid to solid at Point M. For the solution to reach sub-zero temperatures, salt is added to the water. As more salt is added to the mixture, the temperature declines further until the solution reaches a eutectic point at Point P. Due to the mixture of salt and water, the solutions may not freeze from a pure liquid state to a solid-state immediately. Only pure water will freeze out of the solution and the salt particles will remain intact. However, when the salt content added reaches the eutectic point, the salt and water freeze out of the solution, meaning that the mixture of the frozen material becomes the same as that of the solution. At the same time, the solution will store large amounts of energy. When the melting process begins, the PCM changes phase and releases large amounts of energy that maintains a constant temperature. If more salt content is added beyond the eutectic point, which is the 25% mark (25% salt and 75% water), then the freezing temperature will start to increase at Point N (Li *et al.* 2013). Thermal properties of eutectic water-salt solutions are shown in Table 2 and Table 3.



**Table 2:** Thermal properties of eutectic water-salt solutions (Li *et al.*, 2013; Ndanduleni, Huan, Design, Huan, Ndanduleni & Huan, 2019; Phase Change Material Products Limited, 2019; Zalba *et al.*, 2003).

PCM	Salt % in Water	Phase Change Temperature (°C)	Fusion Heat (kJ/kg)
ZnCl <sub>2</sub> /H <sub>2</sub> O	0.51	-62	116.84
FeCl <sub>3</sub> /H <sub>2</sub> O	0.331	-55	155.52
CaCl <sub>2</sub> /H <sub>2</sub> O	0.298	-55	164.93
CuCl <sub>2</sub> /H <sub>2</sub> O	0.36	-40	166.17
K <sub>2</sub> CO <sub>3</sub> /H <sub>2</sub> O	0.396	-36.5	165.36
MgCl <sub>2</sub> /H <sub>2</sub> O	0.171	-33.6	221.88
Al(NO <sub>3</sub> ) <sub>3</sub> /H <sub>2</sub> O	0.305	-30.6	207.63
Mg(NO <sub>3</sub> ) <sub>2</sub> /H <sub>2</sub> O	0.346	-29	186.93
Zn(NO <sub>3</sub> ) <sub>2</sub> /H <sub>2</sub> O	0.394	-29	169.88
NH <sub>4</sub> F/H <sub>2</sub> O	0.323	-28.1	187.83
NaBr/H <sub>2</sub> O	0.403	-28	175.69
KF/H <sub>2</sub> O	0.215	-21.6	227.13
NaCl/H <sub>2</sub> O	0.224	-21.2	228.14
MgCl <sub>2</sub> /H <sub>2</sub> O-2	0.25	-19.4	223.10
(NH <sub>4</sub> ) <sub>2</sub> SO <sub>4</sub> /H <sub>2</sub> O	0.397	-18.5	187.75
NaNO <sub>3</sub> /H <sub>2</sub> O	0.369	-17.7	187.79
NH <sub>4</sub> NO <sub>3</sub> /H <sub>2</sub> O	0.412	-17.35	186.29
Ca(NO <sub>3</sub> ) <sub>2</sub> /H <sub>2</sub> O	0.35	-16	199.35
NH <sub>4</sub> Cl/H <sub>2</sub> O	0.195	-16	248.44
K <sub>2</sub> HPO <sub>4</sub> /H <sub>2</sub> O	0.368	-13.5	197.79
Na <sub>2</sub> S <sub>2</sub> O <sub>3</sub> /H <sub>2</sub> O	0.3	-11	219.86
KCl/H <sub>2</sub> O	0.195	-10.7	253.18
MnSO <sub>4</sub> /H <sub>2</sub> O	0.322	-10.5	213.07
NaH <sub>2</sub> PO <sub>4</sub> /H <sub>2</sub> O	0.324	-9.9	214.25
BaCl <sub>2</sub> /H <sub>2</sub> O	0.225	-7.8	246.44
ZnSO <sub>4</sub> /H <sub>2</sub> O	0.272	-6.5	235.75
Sr(NO <sub>3</sub> ) <sub>2</sub> /H <sub>2</sub> O	0.245	-5.75	243.15
KHCO <sub>3</sub> /H <sub>2</sub> O	0.1695	-5.4	268.54
NiSO <sub>4</sub> /H <sub>2</sub> O	0.206	-4.15	258.61
Na <sub>2</sub> SO <sub>4</sub> /H <sub>2</sub> O	0.127	-3.55	284.95
NaF/H <sub>2</sub> O	0.039	-3.5	314.09
NaOH/H <sub>2</sub> O	0.19	-2.8	265.98
MgSO <sub>4</sub> /H <sub>2</sub> O	0.19	-3.9	264.42
KNO <sub>3</sub> /H <sub>2</sub> O	0.097	-2.8	296.02
Na <sub>2</sub> CO <sub>3</sub> /H <sub>2</sub> O	0.059	-2.1	310.23
FeSO <sub>4</sub> /H <sub>2</sub> O	0.1304	-1.8	286.81
CuSO <sub>4</sub> /H <sub>2</sub> O	0.119	-1.6	290.91

**Table 3:** Thermal properties of commercial eutectic water-salt solutions (Li *et al.* 2013).

PCM type	Content	Phase Change Temperature (°C)	Latent Heat (kJ/kg)	Liquid Density (kg/m <sup>3</sup> )	Appearance
HS 37N	Inorganic salts	-37 to -39	60 (minimum)	-	Light white/grey/blue
HS 26N	Inorganic salts	-25 to -26	205	1200	Light blue to dark
HS 23N	Inorganic salts	-22 to -26	200	1180	Light white/grey
HS 7N	Inorganic salts	-7 to -5	230	1120	Light white/grey

Physical configurations and casing material

After performing a thermal cycling test, Porisini (1988) concluded that stainless steel – among carbon steel, aluminium alloys and copper – was the most corrosion-resistant metal when used with salt hydrates. Table 4 lists the properties of these materials. Although copper showed spots of corrosion, it did not react further for a long period. Initially, PCMs were poured into the respective casing in their liquid form before they were frozen to the desired temperature. Poor stability and corrosion between the container and the PCM limit the use of these materials, especially for food applications (Sharma, Tyagi, Chen & Buddhi 2009; Zalba *et al.*, 2003).

**Table 4:** Thermophysical properties of various container materials for PCMs (Sharma *et al.*, 2009).

Material	Density (kg/m <sup>3</sup> )	Thermal Conductivity (W/mK)	Specific Heat (kJ/kg°C)
Copper	8954	389	0.383
Aluminium	2707	204	0.896
Aluminium mixed	2659	137	0.867
Tin	7304	64	0.226
Stainless steel	8010	7.7	0.500
Glass	2700	0.78	0.840

## METHODOLOGY

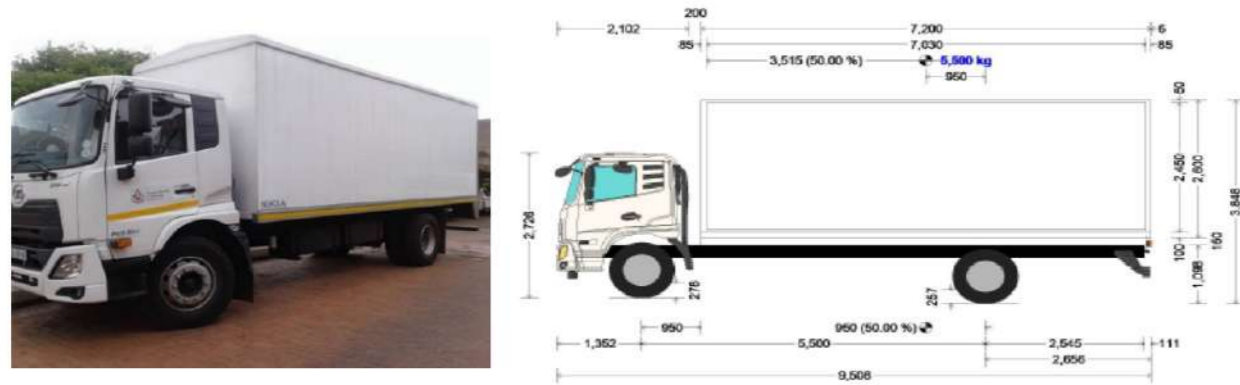
### Model assumption

Hypothesis conditions and model assumptions:

- Constant latent heat energy is supplied by the PCM, and the effects of phase change remain constant for 5 hours.
- The thermophysical properties of the eutectic plate are assumed to be constant, with the plate maintaining a constant temperature.
- Contact thermal resistance between the PCM and eutectic plate casing is ignored.

- The thickness of the eutectic plate casing is ignored.
- Air infiltration in the refrigerated compartment is ignored because the compartment is closed for the simulation time.

### Physical model



**Figure 4:** UD Croner PKE250 (H29) truck.

A UD Croner PKE250 truck, which is a medium refrigerated transport vehicle, as displayed in Figure 4, was used for research. The majority of studies are carried out on small vans. This study explores the possibility of eutectic plates maintaining the same performance as in small vans. The truck was also selected for its availability during the study. The total width of the truck was 2 600 mm. The refrigerated compartment measured 7 030 mm x 2 450 mm x 2 450 mm (length x width x height) for the inner walls, with a polyurethane thickness of 85 mm on the sidewalls. The eutectic plates selected were ERT from FIC, measuring 1 740 mm x 690 mm x 53 mm (length x width x thickness). Stainless steel was used as the case covering for the PCM, while polyurethane was used for the insulation of the refrigerated compartment. The air inside the refrigerated compartment was also assumed to behave as a Newtonian fluid at room temperature. The properties of the PCM were not listed, as the solidification and melting feature was not used in the simulation.

**Table 5:** Properties of materials.

Material	Density (kg/m <sup>3</sup> )	Specific Heat (J/kg K)	Thermal Conductivity (W/m K)
Air	1.225	1006	0.02435
Polyurethane	35	1380	0.024
Stainless steel	8030	502.48	16.27

### Mathematical model

Computer Fluid Dynamics (CFD) was originally developed by Richardson, Courant, Friedrichs and Lewy (Badia-melis, Carthy, Ruiz-garcia, Garcia-hierro & Villalba, 2018). It is a simulation tool used for modelling fluid-flow problems by instigating fluid motions with numerical techniques. These simulations are based on fundamental governing equations of fluid dynamics, conservation of mass, momentum and energy. Over the years, CFD has had many applications across different industries by following a five-step process of determining the geometry, generating a mesh, pre-processing, solving the governing equations and post-processing (Bahramian, 2019). The refrigeration industry makes use of CFD to optimise technology, develop equipment, and process strategies for cooling and packaging improvements. This includes ambient

precooling, airspeed influence during precooling and gas fumigation in cold rooms. CFD still has some drawbacks, especially with regards to the accuracy of the solution. Traditional measuring methods are still needed to verify the accuracy, which will disturb the packaging arrangements (Badia-melis *et al.*, 2018). The mass, momentum and energy conservation Equations 1, 2, and 3 respectively were adopted from Mills (1999b), while the RSM Equation 4 was adopted from Ansys Fluent Guide (2013).

#### Mass conservation

$$\frac{D\rho}{Dt} = \frac{\partial\rho}{\partial t} + \mathbf{v} \cdot \nabla\rho \text{ (Mills, 1999).} \quad \text{Equation 1}$$

#### Momentum conservation

$$\rho \frac{Dv}{Dt} = -\nabla P + \mu \nabla^2 v + \rho g \text{ (Mills, 1999).} \quad \text{Equation 2}$$

In the above,  $\rho$  is the density in (kg/m<sup>3</sup>),  $v$  is the velocity component for  $u$ , and  $v$  and  $w$  were measured in (m/s). Also,  $P$  is the pressure force in (N/m<sup>2</sup>),  $g$  is the gravitational acceleration in (m/s<sup>2</sup>) and the del-operator  $\nabla$  denotes the three components  $x$ ,  $y$ , and  $z$ .

#### Reynolds Stress Transport Equations

$$\begin{aligned} \frac{\partial}{\partial t} (\rho \overline{u'_i u'_j}) + \frac{\partial}{\partial x_k} (\rho u_k \overline{u'_i u'_j}) = & - \frac{\partial}{\partial x_k} \left[ \overline{\rho u'_i u'_j u'_k} + p' (\delta_{kj} u'_i + \delta_{ik} u'_j) \right] + \\ & \frac{\partial}{\partial x_k} \left[ \mu \frac{\partial}{\partial x_k} (\overline{u'_i u'_j}) \right] - \rho \left( \overline{u'_i u'_k} \frac{\partial u'_j}{\partial x_k} + \overline{u'_j u'_k} \frac{\partial u'_i}{\partial x_k} \right) - \rho \beta (g_i \overline{u'_j \theta} + g_j \overline{u'_i \theta}) + \\ & p' \left( \frac{\partial u'_i}{\partial x_j} + \frac{\partial u'_j}{\partial x_i} \right) - 2\mu \frac{\partial u'_i}{\partial x_k} \frac{\partial u'_j}{\partial x_k} - 2\rho \Omega_k (\overline{u'_j u'_m} \varepsilon_{ikm} + \overline{u'_i u'_m} \varepsilon_{jkm}) + \frac{S_{user}}{\rho} \end{aligned} \quad \text{Equation 4}$$

(Inc. ANSYS 2013)

#### Energy conservation

$$\rho c \frac{DT}{Dt} = \nabla \cdot k \nabla T + \mu \Phi + \dot{Q}_v''' \text{ (Mills, 1999).} \quad \text{Equation 3}$$

The above solves for incompressible flow, where  $\dot{Q}_v'''$  is the heat generated and is measured in [W/m<sup>3</sup>]. Also,  $\rho$  is density in (kg/m<sup>3</sup>),  $t$  is time in (s),  $k$  is thermal conductivity measured in [W/(m·K)] or [W/(m·°C)]  $\mu\Phi$  is viscous dissipation, and  $T$  is the temperature measured in K.

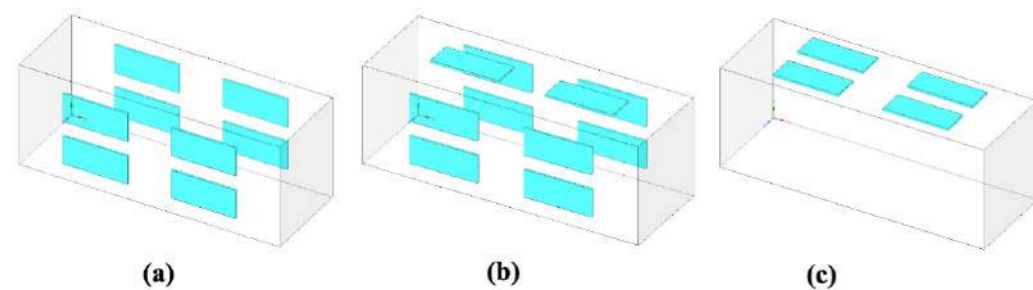
#### Boundary conditions

The eutectic plates with stainless steel casing were set at a temperature of -18°C, while a temperature of 25 °C were set along the entire wall of the refrigerated truck. The initial temperature assumed for the goods is 15°C, as proposed by Xiaofeng *et al.*, (2017). The outer walls of the refrigerated compartment were initially assumed to be at room temperature when the eutectic plate was placed inside the compartment. The walls were 85 mm thick, were assumed to have no heat leakages, and were simulated as stationary walls with no-slip conditions for the shearing. A standard roughness model was chosen, with a sand

grain roughness constant of 0.5. These effects between the PCM and the casing were ignored. A hybrid initialisation was used for the simulation, with a time step of 1 second for 5 hours. Initially, 20 iterations per time step were used, but this was later changed to 10 iterations per time step because the model converged after 4 interactions on some simulations.

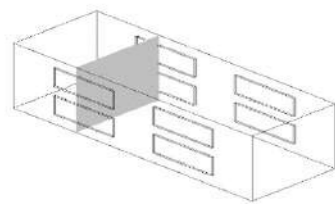
### Configurations setup

In refrigerated transport vehicles, a series of eutectic plates are placed on the roof, sides or middle of the refrigerated compartment. Figure 5 illustrates the three configurations used in the study. However, there are different configurations, such as plastic tubes fitted with PCM (Evans, 2008). Xiaofeng *et al.* (2017) and Zhe *et al.* (2013) placed the eutectic plates at the sides of the truck.



**Figure 5:** Three different eutectic configurations inside the refrigerated compartment: (a) 4 eutectic plates placed on the side walls (configuration 1); (b) 6 eutectic plates, 4 placed on the sidewalls and 2 on the roof (configuration 2); (c) 4 eutectic plates placed on the roof (configuration 3).

## RESULTS AND DISCUSSION



**Figure 6:** Sketch map of plane position through the eutectic plates.

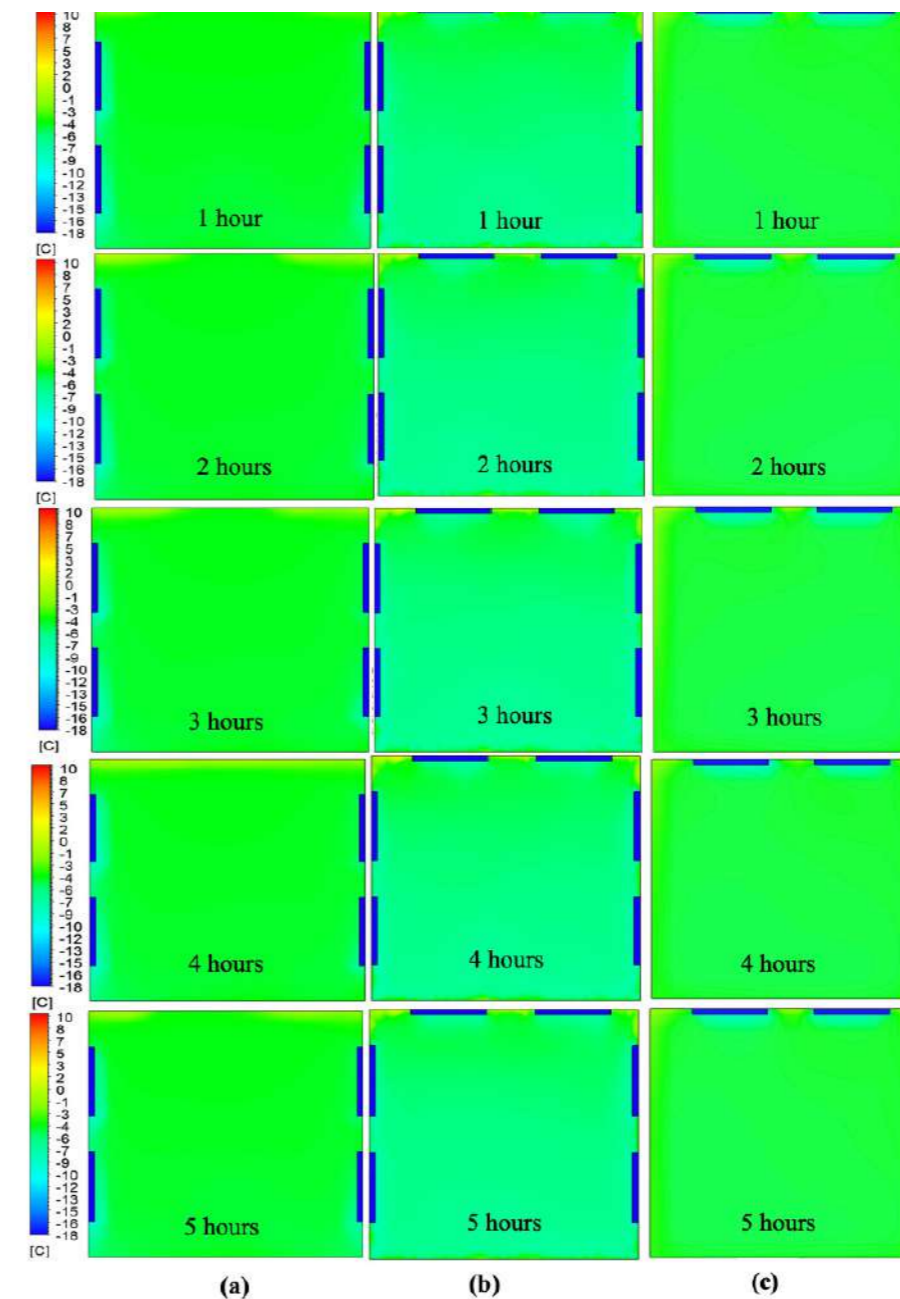
Figure 6 illustrates the plane from which the results of the simulation were read. The plane is situated in the middle of the eutectic plates.

### Incompressible ideal gas

In these simulations, the air was treated as an incompressible ideal gas. These simulations aimed to determine the optimal temperature range within the refrigerated compartment that agricultural goods should be stored at. The plates in configuration 2 were later changed because high-temperature zones were detected at the corners of the compartment.

For transient flows, the temperature was measured against time. In the 5 hours that the eutectic plates maintained a temperature of  $-18^{\circ}\text{C}$ , the temperature was distributed inside the compartment. Between the three configurations, a comparison was made to find the best configuration that will distribute the temperature in the time given for the temperature range. A range from

$-18^{\circ}\text{C}$  to  $10^{\circ}\text{C}$  was used to determine which configuration optimised the temperature. The results are displayed in Figure 7. From the three configurations presented, configuration 1 maintained a temperature of  $-3^{\circ}\text{C}$  for the 5 hours simulated. Agricultural products can be maintained for that time duration. However, the temperature at the top tended to increase over time. Configuration 2 shows the set-up that would maintain the lowest temperature of close to  $-12^{\circ}\text{C}$  for 5 hours. Frozen products can be stored within this configuration. Configuration 3 resembled the same results as configuration 1. Therefore, the same food products can be stored inside it. An in-depth study by Radebe, Huan and Baloyi (2020) illustrated that configuration 2 promoted higher airflow conditions. Placing the eutectic plates at the top contributed greatly to the buoyancy effect for natural convection, thereby promoting airflow patterns within the refrigerated compartment.



**Figure 7:** Transient temperature distribution on plane 1: (a) configuration 1; (b) configuration 2; (c) configuration 3.

## CONCLUSION

To ensure agricultural goods remain fresh, sub-zero temperatures are ideal in the refrigerated compartment. The use of eutectic plates at a temperature range of -18 °C is good because it compensates for the precooling of the goods. If goods are placed inside the refrigerated compartment at 15 °C and the ambient air surrounding the compartment is 25°C, then the temperature will be maintained at sub-zero temperatures. In the 5 hours that the eutectic plates maintained a temperature of -18°C, the temperature was distributed inside the compartment. From the three configurations presented, configuration 1 maintained a temperature of -3 °C for the 5 hours simulated. Agricultural products can be maintained for that time duration. However, the temperature at the top tended to increase over time. Configuration 2 showed that it would maintain the lowest temperature of close to -12 °C over 5 hours. Frozen products can be stored within this configuration. Finally, configuration 3 resembled the same results as configuration 1 and the same food products can be stored inside it.

## ACKNOWLEDGMENTS

This study was funded by the Tshwane University of Technology.

## LIST OF REFERENCES

- Adekomaya, O., Jamiru, T., Sadiku, R. & Huan, Z. 2016. Sustaining the shelf life of fresh food in cold chain: a burden on the environment. *Alexandria Engineering Journal*, 55(2):1359–1365. doi: 10.1016/j.aej.2016.03.024.
- ANSYS Inc. 2013. *ANSYS FLUENT Theory Guide Release 18.2*:15317. doi:/10.1016/0140-3664(87)90311-2.
- ANSYS Inc. 2013. *ANSYS FLUENT Theory Guide Release 18.2*:15317(November):373–464. doi: 10.1016/0140-3664(87)90311-2.
- Badia-melis, R., Carthy, U. M., Ruiz-garcia, L., Garcia-hierro, J. & Villalba, J. I. R. 2018. New trends in cold chain monitoring applications: a review. *Food Control* 86:170–182. doi: 10.1016/j.foodcont.2017.11.022.
- Bahramian, A. 2019. Simultaneous effects of mesh refinement, grid configuration and wall boundary condition on prediction of pressure gradients and velocity profiles of microparticles in a conical fluidized bed. *Particuology*. doi: 10.1016/j.partic.2018.04.003.
- Brown, D. R., Stout, T. B., Dirks, J. A. & Fernandez, N. 2012. The prospects of alternatives to vapor compression technology for space cooling and food refrigeration applications. *Energy Engineering*, 109(6):7–20. doi: 10.1080/01998595.2012.10554226.
- Defraeye, T., Wu, W., Prawiranto, K., Fortunato, G., Kemp, S., Hartmann, S., Cronje, P., Verboven, P. & Nicolai, B. 2017. Artificial fruit for monitoring the thermal history of horticultural produce in the cold chain. *Journal of Food Engineering*, (215):51–60. doi: 10.1016/j.jfoodeng.2017.07.012.
- Du, K., Calautit, J., Wang, Z., Wu, Y. & Liu, H. 2018. A review of the applications of phase change materials in cooling, heating and power generation in different temperature ranges. *Applied Energy*, 220(February):242–273. doi: 10.1016/j.apenergy.2018.03.005.
- Evans, J. 2008. *Frozen food science and technology*. In: A. J. Evans, FIC 2019. *Eutectic Plates - accumulation systems for transport refrigeration*. Italy: Blackwell Publishing. Oxford
- Francis, C., Evans, J., Davies, G. & Maidment, G. 2017. *Overview of sustainable refrigerated road transport systems reference module in food science*. Elsevier. doi: 10.1016/B978-0-08-100596-5.21245-6. incomplete?
- Galos, J., Sutcliffe, M., Cebon, D., Piecyk, M. & Greening, P. 2015. Reducing the energy consumption of heavy goods vehicles through the application of lightweight trailers: fleet case studies. *Transportation Research Part D*, 41:40–49. doi: 10.1016/j.trd.2015.09.010.
- Glouannec, P., Michel, B., Delamarre, G. & Grohens, Y. 2014. Experimental and numerical study of heat transfer across insulation wall of a refrigerated integral panel van. *Applied Thermal Engineering* 73(1):196–204. doi: 10.1016/j.applthermaleng.2014.07.044.
- Hodges, R.J., Buzby, J. C. & Bennett, B. 2011. Postharvest losses and waste in developed and less developed countries: Opportunities to improve resource use. *Journal of Agricultural Science* 149(S1): 37–45. doi: 10.1017/S0021859610000936.
- Hundy, G. F., Trott, A. R. & Welch, T. C. 2016. Cold storage and refrigeration load estimation, in *Refrigeration, Air Conditioning and Heat Pumps*, 229–251. doi: 10.1016/b978-0-08-100647-4.00015-2.
- International Institute of Refrigeration. 2003. *Refrigerated transport: progress achieved and challenges to be met*, 5–7. INCOMPLETE
- Li, G., Hwang, Y. & Radermacher, R. 2012. Review of cold storage materials for air conditioning application. *International Journal of Refrigeration*, 35(8):2053–2077. doi: 10.1016/j.ijrefrig.2012.06.003.
- Li, G., Hwang, Y., Radermacher, R. & Chun, H. H. 2013. Review of cold storage materials for subzero applications. *Energy*, 51:1–17. doi: 10.1016/j.energy.2012.12.002.
- Liu, M., Saman, W. & Bruno, F. 2012a. Development of a novel refrigeration system for refrigerated trucks incorporating phase change material. *Applied Energy*, 92:336–342. doi: 10.1016/j.apenergy.2011.10.015.

- Liu, M., Saman, W. & Bruno, F. 2012b. Review on storage materials and thermal performance enhancement techniques for high temperature phase change thermal storage systems. *Renewable and Sustainable Energy Reviews*, 16(4):2118–2132. doi: 10.1016/j.rser.2012.01.020.
- Liu, M., Saman, W. & Bruno, F. 2014. Computer simulation with TRNSYS for a mobile refrigeration system incorporating a phase change thermal storage unit. *Applied Energy*, 132:226–235. doi: 10.1016/j.apenergy.2014.06.066.
- Meneghetti, A. & Monti, L. 2015. Greening the food supply chain : an optimisation model for sustainable design of refrigerated automated warehouses. *International Journal of Production Research*, 7543:1–17. doi: 10.1080/00207543.2014.985449.
- Mills, A. F. 1999. The general conservation equations in B. Stenquist (ed.), *Basic Heat and Mass Transfer*. 2nd ed. 428–440. Prentice Hall. United States of America.
- Ndanduleni, C., Huan, Z., Design, I., Huan, P. Z., Ndanduleni, C. & Huan, Z. 2019. Review on phase change materials for sub-zero temperature application in transport refrigeration, 1–10. *Phase Change Material Products Limited 2019, PlusICE Eutectic (E) Range*. [Online]. Available from: <http://www.pcmproducts.net/> [Accessed on 1 January 2019].
- Porisini, F. C. 1988. Salt hydrates used for latent heat storage: corrosion of metals and reliability of thermal performance. *Solar Energy*, 41(2):193–197. doi.org/10.1016/0038-092X(88)90136-3.
- Radebe, T. B., Huan, Z. & Baloyi, J. 2020. Simulation of eutectic plates in medium refrigerated transport. *Journal of Engineering, Design and Technology*. doi: 10.1108/JEDT-02-2020-0065.
- Sharma, A., Tyagi, V. V., Chen, C. R. & Buddhi, D. 2009. Review on thermal energy storage with phase change materials and applications. *Renewable and Sustainable Energy Reviews*, 13(2):318–345. doi: 10.1016/j.rser.2007.10.005.
- Tassou, S.A., De-Lille, G. & Ge, Y.T. 2009. Food transport refrigeration - Approaches to reduce energy consumption and environmental impacts of road transport. *Applied Thermal Engineering* 29(8–9):1467–1477. doi: 10.1016/j.applthermaleng.2008.06.027.
- Veerakumar, C. & Sreekumar, A. 2016. Phase change material based cold thermal energy storage: Materials, techniques and applications: a review. *International Journal of Refrigeration*, 67:271–289. doi: 10.1016/j.ijrefrig.2015.12.005.
- Wen, R., Zhang, W., Lv, Z., Huang, Z., & Gao, W. 2018. A novel composite phase change material of stearic acid/carbonized sunflower straw for thermal energy storage. *Materials Letters*, 215:42–45. doi: 10.1016/j.matlet.2017.12.008.
- Xiaofeng, X., Xuelai, Z. & Munyalo, J. M. 2017. Simulation study on temperature field and cold plate melting of cold storage refrigerator car. *Energy Procedia*, 142:3394–3400. doi: 10.1016/j.egypro.2017.12.476.
- Zalba, B., Marín, J. M., Cabeza, L. F. & Mehling, H. 2003. Review on thermal energy storage with phase change: materials, heat transfer analysis and applications. *Applied Thermal Engineering*, 23:251–283. doi: 10.1016/S1359-4311(02)00192-8.
- Zhao, Y., Zhang, X. & Xu, X. 2019. Application and research progress of cold storage technology in cold chain transportation and distribution. *Journal of Thermal Analysis and 8*. doi: 10.1007/s10973-019-08400-8.
- Zhe, Z., Yonggang, G. & Jinjin, T. 2013. Numerical simulation and experiment of temperature field distribution in box of cold plate refrigerated truck. *Transactions of the Chinese Society of Agricultural Engineering*, 18–24. doi:10.3969/j.issn.1002-6819.2013z1.003.

# INTEGRATED RODENT CONTROL STRATEGY FOR SOUTH AFRICAN TOWNSHIPS: A SYSTEMS AND SUSTAINABLE URBAN DEVELOPMENT APPROACH

Kgomotso Lebelo, Central University of Technology, Free State, South Africa, KLebelo@cut.ac.za

## Abstract

*The International Health Regulations of 2005 makes provision for vector control to curb the spread of diseases across national borderlines. To this day, developing nations are largely affected by the manifestation of pests in urban centres and densely populated townships. Rodent infestation in the townships of South Africa is an unsightly reality and it requires urgent sustainable interventions that require a multi-stakeholder approach. Rodents in densely populated communities are known to spread diseases, damage property, and threaten food security. Not only is this a financial burden, but it changes the character of townships to inhabitable spaces. This paper proposes a model based on the three pillars of sustainable development (social, economic, and environmental). This model is based on the premise that rodents can be controlled through the manipulation of environmental factors, spatio-planning, law enforcement, community engagement, surveillance, Environmental Health systems design, and monitoring. The present review focuses on the impact of low-cost appropriate technologies and socially acceptable interventions through organised efforts of the communities as the driving factors towards an integrated rodent control model suited to the South African context.*

**Keywords:** rodent control, environmental health, sustainability.

## INTRODUCTION

The study of rodents and the factors affecting their population dynamics is imperative in public health and ecological studies. Rodents maintain a balance in the food chain but can be a nuisance in large numbers. Not only do they affect the agricultural sector, but they also burden the public health system by promoting the use of limited funds for treating diseases. Rodents have been used extensively in laboratory experiments over the years. Rats are known for their ability to mimic behaviour from older rats (Douglas & Bce, 2018). They can navigate their way around rodent traps and poison once they have learned by observation and the use of tactile sensing. Moreover, Douglas and Bce (2018) assert that rodents have shown neophobia towards new objects. Essentially, they are likely to avoid new food when placed in familiar territory.

Rodents cause structural damage in dense settlements where there are close associations with humans. Rodents living in walls can also cause damage to circuit boards and wiring. By tunnelling, rodents weaken the ability of insulation to absorb heat flow in buildings. New York City was found to have the greatest rodent infestation due to old and aging buildings (Almeida, Corrigan & Sarno, 2013). A study conducted in South Africa revealed that rodents were a major problem in the households of people living in informal settlements (Jassat, Naicker, Naidoo & Mathee, 2013).

The provision of sanitation and garbage collection services is an important and yet challenging issue in the rapidly growing cities of developing countries, with significant human health and environmental sustainability implications (Abubakar, 2017; Parrot, Sotamenou & Dia, 2009). Uncollected garbage is a serious environmental hazard for all, especially in areas where the roads are not accessible for waste collection, deteriorating the aesthetic quality of the city. Uncollected or improperly managed solid wastes can reduce the aesthetic quality of the environment and cause health and safety risks (Ablo & Yekple, 2018). Thus, the health situation of such a community is under serious threat. Improper waste disposal has resulted in poor hygiene and a

lack of access to clean water and sanitation in such a city, particularly among the urban poor (Mohammed, Elias, Science & Ababa, 2017). This problem is increasing because of rapid population growth, low technical capacity, and financial constraints that have overloaded the public sector (Ablo & Yekple, 2018). Although waste management responsibilities primarily lie with cities and municipalities, the key to success is to collaborate with the private sector, local communities and, in some cases, the informal sector (Mohammed *et al.*, 2017). Many towns and cities in developing countries have a mixture of on- and off-site sanitation facilities and services, some provided by householders, some by private developers, and some by the municipality or utility (Hawkins *et al.*, 2013). According to Hawkins *et al.*, (2013), the established low-income settlements usually don't lack sanitation facilities totally. The problem lies with improper management of resources, inadequate supply of equipment, and blocked drains (Hawkins, Blackett, Heymans, Perez, Moulik, Gambrill, Ginnekin, Kolsky, Gomez & Ravikumar, 2013).

## METHODOLOGY

This review was conducted through searching Internet search engines and database libraries such as Google scholar/browser, Web of Science, Pubmed, and ScienceDirect. The library searches were carried out using the terms "rodents control", "sustainable rodent control", "integrated pest control", "nature-based rodent control solutions", "rodent infestation and diseases", and "systems approach to rodent control". Only studies published in English were considered. The searched results were analysed and arranged according to themes of importance, such as health implications of rodent infestation, integrated pest control and rodent control models. Articles in this review needed to meet the following criteria: firstly, be published after January 1999 and before June 2020; and secondly, the articles had to be available as reviews, meta-analyses, newspaper articles, letters and original research.

## RESULTS

A total of 2 009 articles or records were searched in various article search engines and databases. A significant portion of the articles was derived from electronic sources. After accounting for duplication, the articles were further screened by title (n = 750). The remaining articles were screened for relevance and availability of full text (n = 301). The next procedure included discarding articles according to the quality of written text and analysis, of which only 82 (n = 82) of the articles were included in the review.

## DISCUSSION

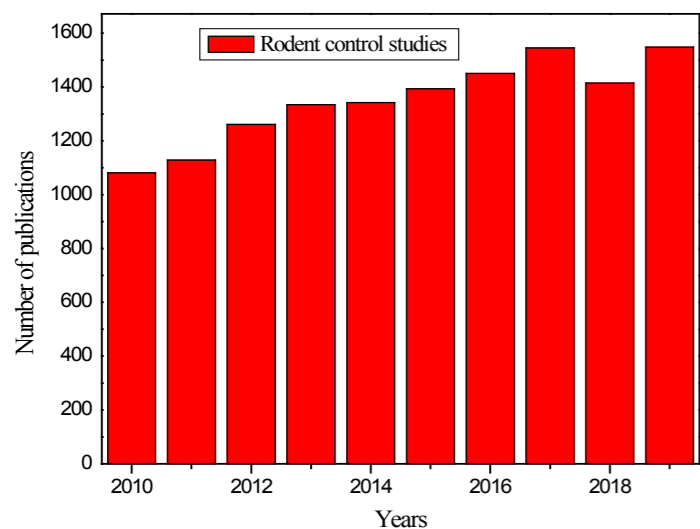
### LOCATION AND TRANSMISSION OF DISEASES

Over the years, certain rodent species have been associated with catastrophic diseases such as plague and leptospirosis. In Uganda, the plague is endemic along the West Nile River. Also, the *rattus rattus*, which is prevalent in the households near the river, is known to harbour the causative agents (*yersnia pestis* species) for the plague (Boegler, Atiku, Enscore, Apangu, Mpanga, Acayo, Kaggwa, Mead, Yockey, Kugeler, Schriefer, Horiuchi, Gage & Eisen, 2018). Infections are presumed to be a result of rodents dying and subsequently forcing the infectious fleas to find alternate hosts, which are humans in most cases. Plague control is found to be effective when using methods such as residual spraying and the use of insecticide tubes in areas where increased exposures occur (Boegler *et al.*, 2018). The high number of rodent populations in Uganda has made other viable methods ineffective. Strategies such as lethal trapping, cat ownership and using rodenticides have proven to be ineffective due to a lack of sustainable resources. In the quest to alleviate and prevent further infections in the community, researchers found community engagement and human behavioural measures to be transformative tools in reducing the number of infections through integrated surveillance activities (Boegler *et al.*, 2018; Mariën, Borremans, Kourouma, Baforday, Günther, Magassouba & Leirs, 2019).

Lassa fever is caused by the Lassa arenavirus. This haemorrhagic fever thrives in rural villages and agricultural habitats (Mariën *et al.*, 2019). The transmission route is similar to that of the plague in terms of the exposure routes. A survey revealed that from 1987, it was estimated that between 100 000 and 300 000 infections could occur each year. Moreover, a fatality rate of 1% to 2% could be estimated (Mariën *et al.*, 2019). Another fatal disease is leptospirosis. It is zoonotic and is transmitted through an animal reservoir either by direct contact or through environmental means such as water and soil (Minter, Diggle, Costa, Childs, Ko & Begon, 2018; Munõz-Zanzi, Mason, Encina, Gonzalez & Berg, 2014). Leptospirosis is estimated to account for 58 000 deaths globally per annum. According to Minter *et al.* (2018), these figures may be an underestimate, considering the unreported data in underdeveloped countries.

Figure 1 shows that there has been a consistent gradual increase in rodent control studies in terms of the number of published studies since the year 2010. The graph below shows the number of published studies from 2010 to August 2019 as recorded by the Web of Science database when searching with the phrase “rodent control”.

**Figure 1:** Published studies on “rodent control”. Data analysis completed using the Web of Science search system on 04 August 2020.



Rodent species are specific to their respective habitats. Species such as the *rattus norvegicus* (Norwegian rats) are mainly found in residential areas and are reported to be the main vectors for rural and urban zoonotic diseases (Shiels, Bogardus, Rohrer & Kawelo, 2019; Xiao, Tong, Huang, Gao, Hu, Li, Gao & Zheng, 2018). The main attractors for some rodent species are humid, food-rich and warm environments (Mariën *et al.*, 2019; Natrass, Stephens, Loubser & Town, 2019; Xiao *et al.*, 2018). These conditions are prevalent among human populations, which sets the precedent for rodent-human interaction. Essentially, the diseases will be transmitted via several media: contaminated food and food products; water; the saliva of infected rodents; and aerosolised urine and faeces (Mariën *et al.*, 2019; Saez, Haidara, Camara & Fichet-calvet, 2018; Xiao *et al.*, 2018).

In developing countries, leptospirosis is an emerging health problem affecting urban slum communities. Annual epidemics of the disease usually occur throughout periods of seasonal rainfall. Deficiencies in sanitation infrastructure such as open sewage systems and poor waste collection services, provide conditions for the proliferation of rats, which are the main reservoir for leptospirosis in urban settings (Costa, Ribeiro, Felzemburgh, Santos, Reis, Santos, Fraga, Araujo, Santana, Childs, Reis & Ko, 2014). As mentioned, the Norway rat is an important reservoir for urban leptospirosis, which is a life-threatening zoonotic disease. In urban settings, leptospirosis transmission occurs primarily in the peri-domiciliary environment of the slums. Rodent control is one of the most frequent strategies to prevent leptospirosis, but the identification of domiciles that are at higher risk of transmission is challenging (Costa *et al.*, 2014; Minter *et al.*, 2018).

#### RODENT CONTROL AS A FUNCTION OF ENVIRONMENTAL HEALTH

In South Africa, environmental health practitioners (EHPs) are entrusted with the responsibility of carrying out the surveillance and control of vectors. This can happen in collaboration with other stakeholders. The regulations governing the scope of practice for environmental health, as promulgated under the Health Act 61 of 2003 (National Department of Health, 2004), succinctly outline the role of EHPs in vector control. Environmental Health Practitioners must take control of their areas of jurisdiction to forecast and design suitable strategies specifically for their communities (Lebelo & van Wyk, 2019). The functions below summarise the functions of EHPs in vector control:

- Identify vectors, their habits and breeding places.
- Remove or remedy the conditions resulting from or favouring the prevalence or increase of rodents and residually spray

the premises and surroundings.

- Investigate zoonotic diseases and other vector-borne diseases in the working and living environment.
- Conduct serological tests of rodents, dogs and other pests.

#### PEST CONTROL AND SURVEILLANCE

Surveillance is imperative in any local authority that endeavours to protect the livelihoods of its residents. The main purpose of public health surveillance is to determine and evaluate factors adverse to human health (Lee, 2017). Moreover, specific activities include the collection, analysis, and distribution of essential data to relevant stakeholders to make informed decisions. In the context of vector control and management, various surveillance methods can be applied according to the suitability and availability of resources. According to Ford, Miller, Cawthorne, Fearnley & Kirk (2015), methods such as event-based surveillance can be used where resources are scarce and platforms such as social media can be used. In terms of rodent control, this can be applicable where members of the community can use social media platforms to record and report incidents and the manifestation of environmental nuisances.

Another method is common indicator-based surveillance. This method is the most favoured because it pools from the already existing routine surveillance data. Additional models in surveillance can include complex integrated systems that use data from various sources. In vector control, the data sources will most likely be from the relevant department of health, public works, horticulture or waste management. All these departments contain elements or measurable variables in the manifestation of vectors in communities. Integrated systems are usually expensive and require sustainable resources (Ford *et al.*, 2015). Moreover, Ford *et al.* (2015) recommend a tiered approach, where the benefits of multiple surveillance systems are combined into one for a greater effect. However, systems will have to be in place to support big data mining and rapid analysis. Human resources and budgetary constraints will need to be accounted for in order to run such systems on digital platforms (Lee, 2017). In South Africa, there are notable vector-borne diseases such as plague. These are diseases that must be clinically diagnosed and reported by health authorities. Rapid detection and reporting leads to the timeous identification of outbreaks and the control thereof (Ford *et al.*, 2015; Tchatchouang, Fri, De Santi, Brandi, Schiavano, Amagliani & Ateba, 2020).

#### GEOGRAPHIC INFORMATION SYSTEMS IN INTEGRATED SURVEILLANCE

Rodent species have different categories, and thus can be distinguished geographically. In public health, a variety of studies are published on the methods of surveillance and disease spatio-planning. This is to determine the geographic location of diseases and their causative factors (Lee, 2017). By implication, the same principle can be applied when determining the location of rodents, their breeding rates, and their conducive environments in communities. This can be achieved by using geographic information systems (GISs). Multiple authors assert that a GIS serves the purpose of editing, drawing, organising, and optimally presenting spatial data (Abdul Rasam & Mohd Noor, 2012; Chang, 2019; Childs, Klein & Glass, 2019; Lee, 2017; Moore & Carpenter, 1999). Essentially, such a system can be combined with the town and regional planning to allocate resources for species mapping, the determination of risk factors, and surveillance (Nadi, Abedi, Isazadeh, Rostami, Siamian, Hosseini & AsadiAliabadi, 2016).

Geographic Information Systems are known to be capable of retaining large volumes of data (Kirby, Delmelle & Eberth, 2017), therefore more data from various departments within local government can be used to make informed decisions regarding the control of rodents and environmental factors. Other studies have reported the use of this technology in determining the scarcity of food (Chang, 2019). The same system design can be used for tracking rodent populations over time through spatial mapping. Essentially, the population density and movement of rodent species can be classified under cold or hot spots. Ultimately, this type of design will be beneficial for allocating resources equitably (Ali, Zaidi, Hira, Adnan & Ullah, 2018; Le, Pardo, Claster, Liu, Cheng, Li, Cao, Wu, Shi, Masinde, Bagula, Nzioka Muthama, Baquero, Santana, Chiaravalloti-Neto, Duncan, Keedwell, Dragan Savić, Wang & Xiao, 2018; Samarasundera, Walsh, Cheng, Koenig, Jattansingh, Dawe & Soljak, 2012). In support of using thematic maps, other scholars (Andreo, Neteler, Rocchini, Provencal, Levis, Porcasi, Rizzoli, Lanfri, Scavuzzo, Pini, Enria & Polop, 2014) have reported an improvement in terms of rodent control and surveillance system when using GIS technology in some cities of Argentina. Researchers (Traweger & Slotta-Bachmayr, 2005) assert that applied management of rodents should no longer be based on rodenticides, but should rather be a result of an in-depth knowledge and understanding of ecology and spatial planning. Essentially, models of rat distribution will assist in the design of sustainable control measures that are supported by appropriate technology.

## WASTE AS A CONTRIBUTOR TO INCREASED RODENT POPULATIONS

Rodents, in particular, thrive under specific conditions. Municipal solid waste serves as a vehicle and haven for rodents to feed on and breed and hide in. The impact of waste in most municipalities is undeniable and local authorities have been devising strategies to alleviate the effects of waste without compromising the balance of the ecosystem. Literature shows that the combination of environmental pollutants and organic species can adversely affect humans (Aleluia & Ferrão, 2016; Guerrini, Carvalho, Romano, Cunha Marques & Leardini, 2017; Vallero & Shulman, 2019). It is estimated that the quantity of municipal waste globally is roughly between 1.3-billion tonnes and 1.9-billion tonnes annually (Leal Filho, Brandli, Moora, Kruopiene & Stenmarck, 2016). This suggests a link between human population growth and food waste production, which could potentially be linked to increased rodent numbers in communities.

In the quest for municipalities or local authorities to deliver basic sanitation services, several factors must be taken into consideration. These factors include using the most appropriate technology that is economically viable, safe and promotes the global agenda of sustainable development (Kawai & Tasaki, 2016; Vallero & Shulman, 2019). Ultimately, this will ensure that the least damage is caused to the environment (Zhang, Huang & He, 2014). Unsanitary environmental factors serve as breeding grounds for rodents and related pests. The provision of basic services in poor countries is of utmost importance for solving challenges in rapidly growing cities (Vallero, 2019). Polluted environments are not only unsightly but affect the safety of communities. As a result, poor civilians are hit the hardest (Ablo & Yekple, 2018; Abubakar, 2017).

The lack of capacity in low-income countries is far-reaching in that there is usually a challenge in the implementation of policies and systems (Aparcana, 2017; Kasinja & Tilley, 2018). Improper waste disposal results in poor hygiene, especially in high-density areas. Therefore, the cumulative effect of poor drainage, inadequate septage and improper waste collection exacerbates the impact of rodents in poor communities (Ablo & Yekple, 2018; Kawai & Tasaki, 2016). The ever-expanding human populace rapidly increases the demand for food production and thus increases exposure and rodent infestation. The food waste predominantly found in poorly serviced landfill sites or illegal dumping spots provides shelter and nutrition for the different species of pests (Coban, Ertis & Cavdaroglu, 2018; Mohammed *et al.*, 2017). This calls for local authorities to use unconventional remediation strategies to control the rodent population dynamics without disturbing the ecosystem (Coban *et al.*, 2018).

Municipal solid waste management and environmental control at large depend on several factors. According to Ma and Hipel (2016), policy and stakeholder participation are imperative. Comprehensive strategies can be designed and executed in communities that need interventions the most. The strategies must be partnered with social, economic and psychological dynamics, and not merely technological innovation (Blackie, Mackay, Allen, Smith, Barrett, Whyte, Murphy, Ross, Shapiro, Ogilvie, Sam, Macmorran, Inder & Eason, 2014). The downside to this approach is that countries usually use a strategy that is economically viable according to their needs and financial strength (Enitan, Enitan, Odiyo & Alhassan, 2018; Letcher & Slack, 2019; Ma & Hipel, 2016; Seyring, Dollhofer, Weißenbacher, Bakas & McKinnon, 2016). Municipal solid waste, like pest manifestation, is majorly affected by several factors such as geography, climatic variation, population dynamics and socio-cultural practices (Al-Jarallah & Aleisa, 2014).

## CLIMATE CHANGE AND THE MANIFESTATION OF RODENTS

Rodent populations fluctuate with several variables. One of several variables is climate variation. Climate variations influence the growth of some microorganisms, rodent habitats and affect the nutrition cycle of rodents by making food such as crops grow (Stuart, Kong, Then, Joy & Sathya, 2019). Therefore, meteorological features are constantly studied by researchers to understand the relationships between pathogens and living organisms. Rodents can potentially harbour pathogenic microbes. These microbes thrive under favourable conditions and are also distributed in outdoor environments. Hellberg and Chu (2016) reported that microbes are dispersed according to their epidemiologic nature. Also, they are distributed according to the nature of the environment they will survive in (Smith & Fazil, 2019). Further, the infrastructure, anthropogenic activities and the behaviour of other living things in the ecosystem can influence the manifestation of pathogens.

## INTEGRATED PEST/RODENT CONTROL STRATEGY

An integrated pest/rodent control strategy should yield high returns in terms of decreased pest population numbers. This can occur by applying an intervention simultaneously throughout the entire region to ensure maximum benefits. The purpose of

such a robust intervention is to deny pests food and breeding nests. This intervention model is supported by Connor, Courtney and Yoder (2000), who reported that the extinction rate increases as the ratio between birth rate and death rate for an individual population decreases. Moreover, Makundi, Oguge and Mwanjabe (1999) assessed the need for synchronised activities where they found that the climate influenced rodent numbers. In their study, they determined that high rainfall increased vegetation growth, thus increasing food for rodents, leading to enough nutrition for breeding. All these factors ultimately increased rodent numbers. A comprehensive strategy encompasses the following synchronised activities: biological and chemical control, which includes ecologically friendly poisons (Boegler *et al.*, 2018; Capizzi, Bertolino & Mortelliti, 2014); as well as environmental manipulation in the form of waste management activities, regional planning, horticulture and water resource management (Figure 2). All of these management actions can make conditions less favourable for the breeding of rodents (Saez *et al.*, 2018). Last, but not least, administrative functions such as environmental inspections and education, play an important role in a comprehensive rodent control strategy (Roomaney, Ehrlich & Rother, 2012).

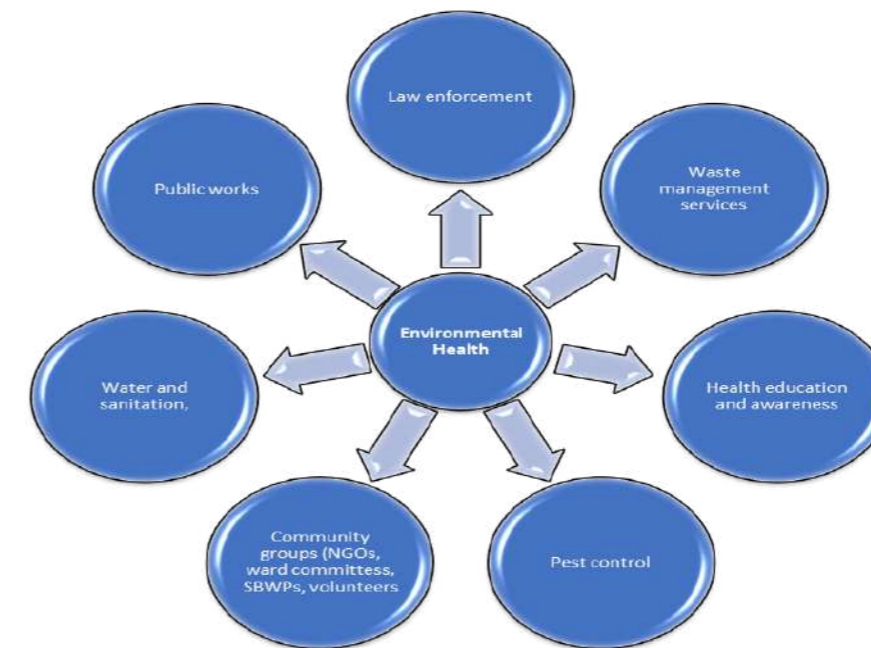


Figure 2: Concept rodent control model, adapted from Taylor, Arntzen, Hayter, Iles, Frean, & Belmain (2008).

## RODENT CONTROL STRATEGIES

Rodents are responsible for substantial damage to food, cash crops and structures, as well as industrial and domestic property. They are also reservoirs and carriers of zoonotic diseases, which in some areas of East Africa have claimed the lives of many victims (Kao & Eisenberg, 2018; Maikudi Usman, Dadrasnia, Tzin Lim, Fahim Mahmud & Ismail, 2016). Digging, trapping, flooding, netting, rat drives and physical barriers are the norm for rodent control in rice fields in most developing countries (Magassouba, Leirs, Marie & Fichet-calvet, 2018; Meerburg, Singleton & Kijlstra, 2009). There are numerous rodent control strategies. Trapping and poisoning require human exploitation of the land through planting unpalatable plant species for diet-specific rats. However, everything should be done within economically feasible limits.

Minimising the area-to-perimeter of rodent-suitable patches will reduce the likelihood of rodent outbreaks in the region (Brooks & Matta, 2019). Further, it is recommended that the rodent-suitable patch should have a low carrying capacity and that the intervention should vary in time and in space. Spatial and regional planning is required in control programmes where landscapes and the availability of rodent habitats are concerned (Dehghani, Vazirianzadeh, Asadi, Akbari & Moravvej, 2012; Edut & Eilam, 2003). Designing a management strategy requires the knowledge of rodent cycles to avoid rodent outbreaks. Current strategies focus on reducing rodent density due to conservation-influenced-environmental laws, so as not to disturb ecological cycles. However, it is reported that these rodents can serve as vectors for diseases.



The City of Johannesburg, in its endeavour to deal with appalling conditions caused by increased rodent numbers, misapplied Levine's model for insect pest species by introducing a project as part of their biological control programme. Levine's model of population dynamics considers that the existence of a high density of a certain species can potentially cause damage over a short period. As a result, the municipality introduced predator species in high density – using the barn owl (*tyto alba*) and the eagle-owl (*bubo Africanus*) – in the hope that the rodent population would decrease in that certain area of study (Eye Witness News 702, 2014). The municipality attempted an innovation that used appropriate technology but disregarded the critical element of economic feasibility and cultural acceptance. This method highlights the appropriate use of existing technology and resources to reinforce the industrious capacities of local communities and to create jobs (Moon & Hwang, 2018). However, the municipality overlooked a few confounders, which skewed the results and potentially caused community unrest. According to media reports (Eye Witness News 702, 2014; Samuels, 2014), the following were notable challenges in the project:

- The owls threatened the already existing pigeon population numbers with regards to space and food.
- The community held misconceptions and superstitions regarding the association of owls with witchcraft, possibly due to low education levels and non-consultation processes. This led to the decapitation of owls.
- The rodent population decreases could not be enumerated.
- The intervention was not applied across the board, thus causing low variation.
- The use of rat poisons by the community indirectly affected the owls that consumed the poisoned rats.

A study was conducted by Roomaney *et al.* (2012) on the acceptability of rat trap use over pesticides for rodent control in two poor urban communities in South Africa. In this study, participants received an intervention in the form of two high-quality rodent traps. The results revealed that, of the respondents who were followed up (n=175), 88% used the rat traps, as opposed to 35% that continued using pesticides after they were provided with rodent traps. The study concluded that the rat traps were acceptable as an alternative to toxic pesticides for rodent control when introduced to poor urban communities. However, further research is needed to determine the sustainability of the use of rat traps. Moreover, the cost-benefit of such an intervention needs to be studied further.

Another study was carried out by Juneau, Gillett-kaufman & Leppla (n.d.) to test options for university housing. This study focused on rodent control options such as baiting and using the buildings as elements of integrated pest management (IPM). IPM incorporates a variety of methods to control pests, ranging from human behavioural changes to the use of biological controls and least-toxic pesticides. The goal of an IPM is to reduce pest and pesticide risks to humans and the environment. The study identified the primary pest and described its ecology. Further, it aided in identifying appropriate pesticides to use for different rodent types in a manner that is humane and does not pose health problems to the people and the environment.

A study on the delivery of environmental health services to Ducats informal settlements assessed the available service against the required standards, which are set out in the relevant government policies and statutory documentation (Sompani, 2003). The results showed that the service delivery was not appropriate and not up to the standards mentioned in the government policies. Moreover, in the informal settlement, poor service delivery was identified as the leading factor for high levels of rodent infestation.

**Table 1:** Specific sustainable rodent control initiatives.

Activity	Relevant departments/ stakeholders	References
<b>Community engagement:</b> Health and environmental education.	Community development workers and environmental health department.	(Roomaney <i>et al.</i> , 2012; Saez <i>et al.</i> , 2018)
<b>Trapping and poisoning:</b> A combination of approved eco-friendly biological and chemical substances.	Health departments, agriculture department, trained households and trained private contractors.	(Boegler <i>et al.</i> , 2018; Motro, 2019; Shiels <i>et al.</i> , 2019)
<b>Administrative control:</b> Environmental inspections and law enforcement.	Environmental health department, waste management and community-based forums.	(Natrass <i>et al.</i> , 2019; Roomaney <i>et al.</i> , 2012; Saez <i>et al.</i> , 2018)
<b>Environmental manipulation:</b> Urban and rural cleansing, urban planning, and horticulture services,	Public works departments in municipalities.	(Brooks & Matta, 2019; Saez <i>et al.</i> , 2018)
<b>Building control:</b> Closure of burrows, walls, and roof using approved materials (rodent proofing).	Municipal building control authorities and individual households.	(Douglas & Bce, 2018; Saez <i>et al.</i> , 2018; Xiao <i>et al.</i> , 2018)
<b>Natural predators:</b> Cats and dogs (vaccinated animals to prevent another burden on the public health system).	Individual households and veterinary departments.	(Saez <i>et al.</i> , 2018)
<b>Waste and water management:</b> Improve waste collection services, clear illegal dumping spots, and fix damaged pipes and drains, thus denying rodents shelter and food.	Municipal waste control departments, water and sanitation, environmental activists, community-based organisations and private contractors.	(Roomaney <i>et al.</i> , 2012; Saez <i>et al.</i> , 2018)

## RODENTICIDES AND TRAPS

Rodenticides and baiting traps can be used in dry months in households. It is assumed that rodents aggregate in households in dry months to search for food and shelter (Campbell, Beek, Eason, Glen, Godwin, Gould, Holmes, Howald, Madden, Ponder, Threadgill, Wegmann & Baxter, 2015; Mariën *et al.*, 2019). To effectively reduce the spiking of rodent numbers over a long period of time, there should be continuous density control. This is achieved through the continual distribution of rodent traps and rodenticides in households. A study undertaken in Upper Guinea discovered that the Lassa virus could be extinct if the rodent populations were reduced by 30% in 10 years. This mathematical model was completed assuming that the extinction probability strongly depended on the assumed transmission-density coefficient (Mariën *et al.*, 2019).

The complete removal of all invasive rodents where people live is not possible. However, to protect natural resources, rodent suppression by trapping, baiting and poisoning is the most viable option in most regions (Natrass *et al.*, 2019; Shiels *et al.*, 2019). Therefore, Shiels *et al.* (2019) recommended a targeted intervention whereby only invasive species would be trapped to protect the ecosystem from further harm. Other interesting findings on rodent traps were that they needed to be tailored to a specific species and adjusted according to the season, since rodent populations fluctuate (Motro, 2019). Several published studies (Mariën *et al.*, 2019; Motro, 2019; Saez *et al.*, 2018) have noted that rodents tended to quickly return a few months after the area had been treated with rodenticides or baiting traps. The rapid growth of the population may be attributed to the following: the breeding of the surviving population and thus the recolonising of habitats; the porosity of the walls and roofs in households; the lack of predators such as dogs and cats; poor house-keeping and waste management; and untreated surrounding gardens and fields.

In recent years, there has been technological innovation on how rodents are controlled in industries and households. More notably, devices for the electrocution of rodents have been introduced, which are meant for customers who are afraid of rodents (Goode, 2018). Moreover, there are also rodent control devices that are operated by mobile devices. Basically, after sensing the activity in the rodent trap, the customer receives notification through their mobile device. Goode has reported another technology that uses a single dose of toxin in the trap. The mechanism of the trap is that it attracts the rodent into the device, then automatically sprays the toxin on the rodent. The toxin is known to penetrate the skin and target the bloodstream where it causes damage to the rodent. This device is reported to be safe for pets, humans and the environment. However, further exploration must be made on the affordability and sustainability of the device for normal households.

## EFFECTS OF RODENTICIDES AND OTHER PEST CONTROL CHEMICALS

Rodenticides are classified as pesticides (Kumar, Chand & Shah, 2018; Zikankuba, Mwanyika, Ntwenya & James, 2019). Generally, rodenticides consist of harmful compounds, which do not only affect rodents but could also be detrimental to the environment. Moreover, rodenticides can contain heavy metals such as arsenic (Antoniadis, Golia, Liu, Wang, Shaheen & Rinklebe, 2019). The rodenticides used in controlling rodent pests in agriculture can contaminate water sources and potentially pose a threat to food security (Al-Othman, Ali, Al-Othman, Ali & Habila, 2016; Panti-May, Sodá-Tamayo, Gamboa-Tec, Cetina-Franco, Cigarroa-Toledo, Machain-Williams, del Rosario Robles & Hernández-Betancourt, 2017; Rai, Lee, Zhang, Tsang & Kim, 2019; Serieys, Bishop, Okes, Broad, Jean, Poppenga, Viljoen, Wayne & Riain, 2019; Stuart *et al.*, 2019). Essentially, polluted environments in communities compound the problem of disease and poor aesthetics in various geographic regions. Therefore, pesticides are majorly used to control pests and are applied in various industries, as well as for personal use in ordinary households (Zikankuba *et al.*, 2019).

The irresponsible use of some of these pesticides results in adverse effects on the environment and humans due to their capability to travel across national boundaries (Taiwo, 2019). The chemicals used in rodent control can leach into food sources and cause harm when ingested by humans. This is dangerous in households where there are children exposed to hazardous chemical substances. Further, there is an ongoing concern regarding the accidental poisoning of other living organisms as a result of rodenticides. This debate is spearheaded by environmentalists and animal rights activists who also advocate for more humane methods or controlling rodents (Natrass *et al.*, 2019). This debate is best described by a scenario in the City of Cape Town, South Africa, whereby EHPs opted for a method of rodent control that was classified as inhumane by opposing councils. Essentially, it was a choice between trapping and drowning rodents, as opposed to the generally accepted method of poisoning. This caused an ethical problem and conflicted narratives because none of the options were deemed fit by the opposing parties, even though one of the methods (poisoning and traps) was endorsed by legislation (Natrass *et al.*, 2019). Globally, the core argument remains: “What constitutes the humane control of rodents, and what are the merits of choosing one method over the other, since poisoning, snap-trapping and drowning can inflict pain?”.

## SYSTEMS APPROACH TO RODENT CONTROL (CAUSAL LOOP)

Rodent population dynamics can be best explained using a causal loop diagram (Figure 3). New developments, such as residential properties or informal settlements, can stimulate the growth of human populations, especially migrant workers and others looking for better opportunities. This rapid rise in population numbers puts a strain on municipal resources such as water and sanitation, waste management, town planning initiatives, health resources and staffing (Mariën *et al.*, 2019; Minter *et al.*, 2018; Stuart, Kong, Then, Flor & Sathya, 2019). All these factors contribute to the growth of rodents when not managed properly. Food waste, leaking pipes, municipal drains, overgrown grass, illegal dumping spots and redundant appliances are all factors that contribute to a rise in rodent numbers (Quinn, Kenmuir & Krueger, 2019). The local authorities, in turn, need to develop systems to cope with the pressure exerted on limited resources. Sustainable solutions will need to be devised in the form of baiting stations, least harmful chemical products, as well as major investment in technologies and human resources for the monitoring and implementation of systems (Natrass *et al.*, 2019).

Figure 4 depicts a workflow in a system where there is stakeholder collaboration. Constant monitoring and the identification of factors for risk communities are vital in rodent control. This includes a synergistic approach towards municipal service delivery. This approach should encompass the health department, environmental control department and community-based organisations. Therefore, to remediate polluted environments and restore dignity to regions where people reside, joint efforts are necessary for addressing environmental challenges that may be detrimental to human health.

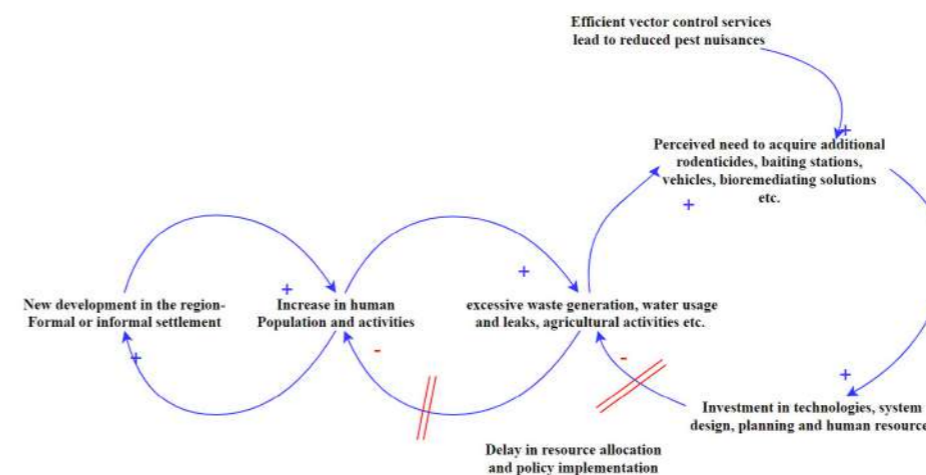


Figure 3: Causal loop diagram: increase in rodent population numbers and an increase in waste output.

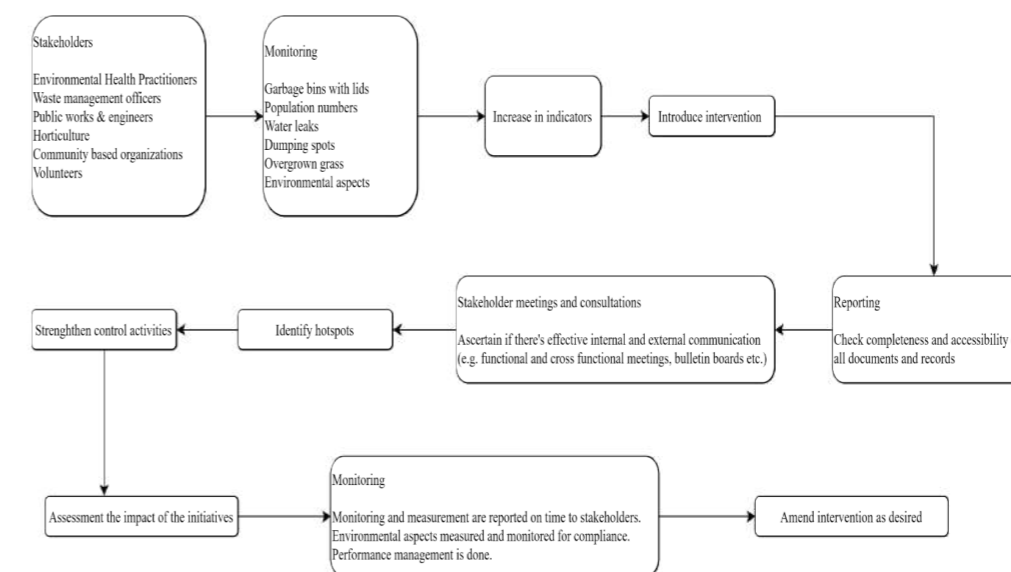


Figure 4: Schematic diagram demonstrating possible intervention pathways for rodent control service delivery through stakeholder consultation.

## CONCLUSION AND RECOMMENDATIONS

A comprehensive and sustainable rodent control model can be summarised by the graphic below (Figure 5). A sustainable model essentially means that the activities will transcend the test of time and will cause the least possible harm to the environment and to surrounding populations. It is a known fact that municipalities have challenges with regard to budget allocation for environmental control initiatives. In addition, anthropogenic factors also contribute to the state of the environment and largely influence the aesthetics of human environments.

To comply with Section 24 of the South African Constitution, which speaks of the right to a clean and healthy environment, the following must be done: control the environment through partnerships (municipality, community and private enterprises); document and monitor risks inherent to exposed population groups; implement legislative measures to non-complying households and businesses; apply approved environment-friendly substances in rodent control; train stakeholders on rodent risk factors and use the power of multimedia to run educational campaigns.

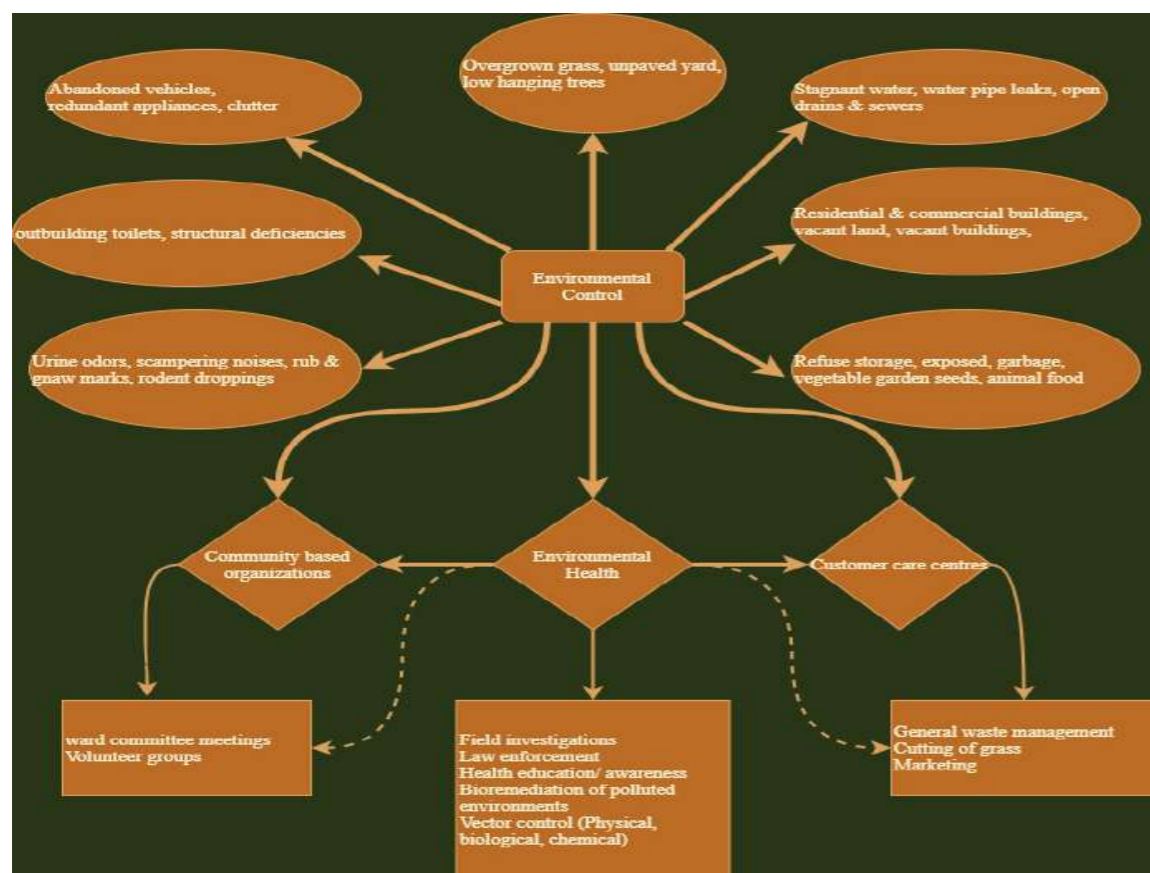


Figure 5: Integrated pest and rodent control design.

## LIST OF REFERENCES

- Abdul Rasam, A.R. & Mohd Noor, A.M. 2012. Contribution of GIS and remote sensing technologies for managing foodborne diseases in Malaysia. *Proceedings - 2012 IEEE Control and System Graduate Research Colloquium, ICSGRC 2012, Icsgrc*, 258–261. [Online] Available from: <https://doi.org/10.1109/ICSGRC.2012.6287172> [Accessed: 17 May 2020].
- Ablo, A.D. & Yekple, E.E. 2018. Urban water stress and poor sanitation in Ghana: perception and experiences of residents in the Ashaiman Municipality. *Geo Journal*, 83(3):583–594. [Online] Available from: <https://doi.org/10.1007/s10708-017-9787-6> [Accessed: 01 February 2020].
- Abubakar, I.R. 2017. Household response to inadequate sewerage and garbage collection services in Abuja, Nigeria. *Journal of Environmental and Public Health*. [Online] Available from: <https://doi.org/10.1155/2017/5314840> [Accessed: 02 February 2020].
- Al-Jarallah, R. & Aleisa, E. 2014. A baseline study characterizing the municipal solid waste in the State of Kuwait. *Waste Management*, 34(5):952–960. [Online] Available from: <https://doi.org/10.1016/j.wasman.2014.02.015> [Accessed: 13 December 2019].
- Al-Othman, Z. A., Ali, R., Al-Othman, A.M., Ali, J. & Habila, M. 2016. Assessment of toxic metals in wheat crops grown on selected soils, irrigated by different water sources. *Arabian Journal of Chemistry*, 9:S1555–S1562. [Online] Available from: <https://doi.org/10.1016/j.arabjc.2012.04.006> [Accessed: 04 April 2020].
- Aleluia, J. & Ferrão, P. 2016. Characterization of urban waste management practices in developing Asian countries: A new analytical framework based on waste characteristics and urban dimension. *Waste Management*, 58:415–429. [Online] Available from: <https://doi.org/10.1016/j.wasman.2016.05.008> [Accessed: 06 June 2020].
- Ali, A., Zaidi, F., Hira, S., Adnan, M., & Ullah, S. 2018. *Spatial modeling of rat bites and prediction of rat infestation in Peshawar valley using binomial kriging with logistic regression*.
- Almeida, A., Corrigan, R., & Sarno, R. 2013. The economic impact of commensal rodents on small businesses in Manhattan's Chinatown: trends and possible causes. *Suburban Sustainability*, 1(1). [Online] Available from: <https://doi.org/10.5038/2164-0866.1.1.2> [Accessed: 06 June 2020].
- Andreo, V., Neteler, M., Rocchini, D., Provencal, C., Levis, S., Porcasi, X., Rizzoli, A., Lanfri, M., Scavuzzo, M., Pini, N., Enria, D., & Polop, J. 2014. Estimating hantavirus risk in Southern Argentina: A GIS-based approach combining human cases and host distribution. *Viruses*, 6(1):201–222. [Online] Available from: <https://doi.org/10.3390/v6010201> [Accessed: 04 April 2020].
- Antoniadis, V., Golia, E.E., Liu, Y.T., Wang, S.L., Shaheen, S.M. & Rinklebe, J. 2019. Soil and maize contamination by trace elements and associated health risk assessment in the industrial area of Volos, Greece. *Environment International*, 124(January):79–88. [Online] Available from: <https://doi.org/10.1016/j.envint.2018.12.053> [Accessed: 04 April 2020].
- Aparcana, S. 2017. Approaches to formalization of the informal waste sector into municipal solid waste management systems in low- and middle-income countries: Review of barriers and success factors. *Waste Management*, 61: 593–607. [Online] Available from: <https://doi.org/10.1016/j.wasman.2016.12.028> [Accessed: 02 February 2020].
- Blackie, H.M., Mackay, J.W.B., Allen, W.J., Smith, D.H.V., Barrett, B., Whyte, B.I., Murphy, E.C., Ross, J., Shapiro, L., Ogilvie, S., Sam, S., Macmorran, D., Inder, S. & Eason, C.T. 2014. Innovative developments for long-term mammalian pest control. *Pest Management Science*, 70(3):345–351. [Online] Available from: <https://doi.org/10.1002/ps.3627> [Accessed: 17 May 2020].
- Boegler, K.A., Atiku, L. A., Ensore, R.E., Apangu, T., Mpanga, J.T., Acayo, S., Kaggwa, J., Mead, P.S., Yockey, B.M., Kugeler, K.J., Schriefer, M.E., Horiuchi, K., Gage, K.L. & Eisen, R.J. 2018. *Rat Fall Surveillance Coupled with Vector Control and Community Education as a Plague Prevention Strategy in the West Nile Region, Uganda*. 98(1):238–247. [Online] Available from: <https://doi.org/10.4269/ajtmh.17-0502> [Accessed: 06 June 2020].
- Brooks, D. & Matta, J. 2019. *Spreading of Rodent Infestations Through a City*. 6:1–17.
- Campbell, K. J., Beek, J., Eason, C.T., Glen, A.S., Godwin, J., Gould, F., Holmes, N.D., Howald, G.R., Madden, F.M., Ponder, J.B., Threadgill, D.W., Wegmann, A.S. & Baxter, G.S. 2015. The next generation of rodent eradications: Innovative technologies and tools to improve species specificity and increase their feasibility on islands. *Biological Conservation*, 185:47–58. [Online] Available from: <https://doi.org/10.1016/j.biocon.2014.10.016> [Accessed: 07 June 2020].
- Capizzi, D., Bertolino, S. & Mortelliti, A. 2014. Rating the rat: Global patterns and research priorities in impacts and management of rodent pests. *Mammal Review*, 44(2):148–162. [Online] Available from: <https://doi.org/10.1111/mam.12019> [Accessed: 06 June 2020].
- Chang, K. 2019. Geographic information system technology. In: Wiley, J., & Sons. *The International Encyclopedia of Geography*:1–10. Sons, Ltd. [Online] Available from: <https://doi.org/10.1002/9781118786352.wbieg0152.pub2> [Accessed: 02 February 2020].

- Childs, J.E., Klein, S.L. & Glass, G.E. 2019. *A Case study of two rodent-borne viruses: Not always the same old suspects*. [Online] Available from: <https://doi.org/10.3389/fevo.2019.00035> [Accessed: 7 March 2020].
- Coban, A., Ertis, I.F. & Cavdaroglu, N.A. 2018. Municipal solid waste management via multi-criteria decision making methods: A case study in Istanbul, Turkey. *Journal of Cleaner Production*, 180:159–167. [Online] Available from: <https://doi.org/10.1016/j.jclepro.2018.01.130> [Accessed: 02 February 2020].
- Connor, E.F., Courtney, A.C. & Yoder, J.M. 2000. Individuals-area relationships: The relationship between animal population density and area. *Ecology*, 81(3):734–748. [Online] Available from: [https://doi.org/10.1890/0012-9658\(2000\)081\[0734:IAR TRB\]2.0.CO;2](https://doi.org/10.1890/0012-9658(2000)081[0734:IAR TRB]2.0.CO;2) [Accessed: 06 June 2020].
- Costa, F., Ribeiro, G.S., Felzemburgh, R.D.M., Santos, N., Reis, R.B., Santos, A. C., Fraga, D.B.M., Araujo, W.N., Santana, C., Childs, J.E., Reis, M.G. & Ko, A. I. 2014. Influence of household rat infestation on leptospira transmission in the urban slum environment. *PLoS Neglected Tropical Diseases*, 8(12). [Online] Available from: <https://doi.org/10.1371/journal.pntd.0003338> [Accessed: 17 June 2020].
- Dehghani, R., Vazirianzadeh, B., Asadi, M.A., Akbari, H. & Moravvej, S.A. 2012. Infestation of rodents (Rodentia: Muridae) among houses in Kashan, Central Iran. *Pakistan Journal of Zoology*, 44(6):1721–1726.
- Douglas, B. & Bce, G. 2018. *Science-Based Rodent Solutions for Rodents The Outside-In Approach*, 1–13.
- Edut, S. & Eilam, D. 2003. Rodents in open space adjust their behavioral response to the different risk levels during barn-owl attack. *BMC Ecology*, 3:1–16. [Online] Available from: <https://doi.org/10.1186/1472-6785-3-10> [Accessed: 15 June 2020].
- Enitan, I.T., Enitan, A.M., Odiyo, J.O. & Alhassan, M.M. 2018. Human health risk assessment of trace metals in surface water due to leachate from the municipal dumpsite by pollution index: A case study from Ndawuse River, Abuja, Nigeria. *Open Chemistry*, 16(1):214–227. [Online] Available from: <https://doi.org/10.1515/chem-2018-0008> [Accessed: 03 February 2020].
- Eye Witness News 702. 2014. *Cultural clashes over Owl Box project*. [Online] Available from: <http://www.702.co.za/articles/497/has-the-alexandra-community-embraced-the-owls> [Accessed: 06 June 2020].
- Ford, L., Miller, M., Cawthorne, A., Fearley, E. & Kirk, M. 2015. Approaches to the surveillance of foodborne disease: A review of the evidence. *Foodborne Pathogens and Disease*, 12(12):927–936. [Online] Available from: <https://doi.org/10.1089/fpd.2015.2013> [Accessed: 18 June 2020].
- Goode, S. 2018. Pest control innovation in the rodent sector. *International Pest Control*, 60(4):212–213.
- Guerrini, A., Carvalho, P., Romano, G., Cunha Marques, R. & Leardini, C. 2017. Assessing efficiency drivers in municipal solid waste collection services through a non-parametric method. *Journal of Cleaner Production*, 147:431–441. [Online] Available from: <https://doi.org/10.1016/j.jclepro.2017.01.079> [Accessed: 04 May 2020].
- Hawkins, P., Blackett, I., Heymans, C., Perez, E., Moulik, S.G., Gambriell, M., Ginnekin, M. Van Kolsky, P., Gomez, B. & Ravikumar, J. 2013. Poor-inclusive urban sanitation: An overview. *Water and Sanitation Program (WSP)*, August: 1–24.
- Hellberg, R.S. & Chu, E. 2016. Effects of climate change on the persistence and dispersal of foodborne bacterial pathogens in the outdoor environment: A review. *Critical Reviews in Microbiology*, 42(4):548–572. [Online] Available from: <https://doi.org/10.3109/1040841X.2014.972335> [Accessed: 04 May 2020].
- Jassat, W., Naicker, N., Naidoo, S. & Mathee, A. 2013. Rodent control in urban communities in Johannesburg, South Africa: From research to action. *International Journal of Environmental Health Research*, 23(6):474–483. [Online] Available from: <https://doi.org/10.1080/09603123.2012.755156> [Accessed: 13 June 2020].
- Juneau, K.J., Gillett-kaufman, J.L. & Leppla, N. Martin, K. Walker, W. *Integrated Pest Management Policy and Treatment Options for University Housing*. University of Florida.
- Kao, Y. & Eisenberg, M.C. 2018. Practical unidentifiability of a simple vector-borne disease model : Implications for parameter estimation and intervention assessment. *Epidemics*, 25(October 2017):89–100. [Online] Available from: <https://doi.org/10.1016/j.epidem.2018.05.010> [Accessed: 17 June 2020].
- Kasinja, C. & Tilley, E. 2018. Formalization of informal waste pickers cooperatives in Blantyre, Malawi: A feasibility assessment. *Sustainability (Switzerland)*, 10(4):1–17. [Online] Available from: <https://doi.org/10.3390/su10041149> [Accessed: 06 February 2020].
- Kawai, K. & Tasaki, T. 2016. Revisiting estimates of municipal solid waste generation per capita and their reliability. *Journal of Material Cycles and Waste Management*, 18(1):1–13. [Online] Available from: <https://doi.org/10.1007/s10163-015-0355-1> [Accessed: 07 February 2020].
- Kirby, R.S., Delmelle, E. & Eberth, J.M. 2017. Advances in spatial epidemiology and geographic information systems. *Annals of Epidemiology*, 27(1):1–9. [Online] Available from: <https://doi.org/10.1016/j.annepidem.2016.12.001> [Accessed: 04 April 2020].
- Kumar, M., Chand, R. & Shah, K. 2018. Mycotoxins and pesticides: Toxicity and applications in food and feed. *In Microbial Biotechnology*, 2. [Online] Available from: [https://doi.org/10.1007/978-981-10-7140-9\\_11](https://doi.org/10.1007/978-981-10-7140-9_11) [Accessed: 07 May 2020].
- Le, T., Pardo, P., Claster, W., Liu, Z., Cheng, K., Li, H.H., Cao, G., Wu, D., Shi, Y., Masinde, E.M., Bagula, A., Nzioka Muthama, P., Baquero, O.S., Santana, L. M.R., Chiaravalloti-Neto, F., Duncan, A.P., Keedwell, E.C., Dragan Savić, P., Wang, J. & Xiao, G. 2018. Dengue forecasting in São Paulo city with generalized additive models, artificial neural networks and seasonal autoregressive integrated moving average models. *PLoS ONE*, 13(4): 1–8. [Online] Available from: <https://doi.org/10.1371/journal.pone.0195065> [Accessed: 17 June 2020].
- Leal Filho, W., Brandli, L., Moora, H., Kruopiene, J. & Stenmarck, Å. 2016. Benchmarking approaches and methods in the field of urban waste management. *Journal of Cleaner Production*, 112:4377–4386. [Online] Available from: <https://doi.org/10.1016/j.jclepro.2015.09.065> [Accessed: 07 February 2020].
- Lebelo, K. & van Wyk, R. 2019. Communicable disease surveillance in the City of Ekurhuleni: Environmental Health Practitioners perceptions. *2019 Open Innovations Conference*. [Online] Available from: <https://doi.org/10.1109/OI.2019.8908191> [Accessed: 02 February 2020].
- Lee, B. 2017. Foodborne disease and the need for greater foodborne disease surveillance in the Caribbean. *Veterinary Sciences*, 4(3). [Online] Available from: <https://doi.org/10.3390/vetsci4030040> [Accessed: 19 October 2019].
- Letcher, T.M. & Slack, R. 2019. Chemicals in waste: Household hazardous waste. *In Waste* (2nd ed.). Elsevier Inc. [Online] Available from: <https://doi.org/10.1016/b978-0-12-815060-3.00017-7> [Accessed: 06 February 2020].
- Ma, J. & Hipel, K.W. 2016. Exploring social dimensions of municipal solid waste management around the globe – A systematic literature review. *Waste Management*, 56:3–12. [Online] Available from: <https://doi.org/10.1016/j.wasman.2016.06.041> [Accessed: 07 February 2020].
- Magassouba, N.F., Leirs, H., Marie, J. & Fichet-calvet, E. 2018. *Movement Patterns of Small Rodents in Lassa Fever-Endemic Villages in Guinea*. [Online] Available from: <https://doi.org/10.1007/s10393-018-1331-8> [Accessed: 06 June 2020].
- Maikudi Usman, M., Dadrastia, A., Tzin Lim, K., Fahim Mahmud, A. & Ismail, S. 2016. Application of biosurfactants in environmental biotechnology; remediation of oil and heavy metal. *AIMS Bioengineering*, 3(3):289–304. [Online] Available from: <https://doi.org/10.3934/bioeng.2016.3.289> [Accessed: 02 February 2020].
- Makundi, R.H., Oguge, N.O. & Mwanjabe, P.S. 1999. Rodent pest management in East Africa - an ecological approach. *Ecologically-Based Rodent Management*, 460–476.
- Mariën, J., Borremans, B., Kourouma, F., Baforday, J., Günther, S., Magassouba, N. F., & Leirs, H. (2019). *Evaluation of rodent control to fight Lassa fever based on field data and mathematical modelling*, 1751. [Online] Available from: <https://doi.org/10.1080/22221751.2019.1605846> [Accessed: 05 May 2020].
- Meerburg, B.G., Singleton, G.R. & Kijlstra, A. 2009. Rodent-borne diseases and their risks for public health Rodent-borne diseases and their risks for public health. *In Critical Reviews in Microbiology*, 35(3). [Online] Available from: <https://doi.org/10.1080/10408410902989837> [Accessed: 04 June 2020].
- Minter, A., Diggle, P.J., Costa, F., Childs, J., Ko, A.I. & Begon, M. 2018. A model for leptospire dynamics and control in the Norway rat (*Rattus norvegicus*) the reservoir host in urban slum environments. *Epidemics*, 25(September 2017):26–34. [Online] Available from: <https://doi.org/10.1016/j.epidem.2018.05.002> [Accessed: 05 May 2020].
- Mohammed, A., Elias, E., Science, E. & Ababa, A. 2017. Solid waste management environmental impacts in Addis Ababa city. *Journal of Environment and waste management*, 4(1):194–203.
- Moon, Y. & Hwang, J. 2018. Crowdfunding as an alternative means for funding sustainable appropriate technology: Acceptance determinants of backers. *Sustainability (Switzerland)*, 10(5). [Online] Available from: <https://doi.org/10.3390/su10051456> [Accessed: 06 June 2020].
- Moore, D.A. & Carpenter, T.E. 1999. Spatial analytical methods and geographic information systems: Use in health research and epidemiology. *Epidemiologic Reviews*, 21(2):143–161. [Online] Available from: <https://doi.org/10.1093/oxfordjournals.epirev.a017993> [Accessed: 04 December 2019].
- Motro, Y., Ghedler, Y. Muller, Y. Goldin, Y. Chagina, O. Rimon, A. Harel, Y. Motro, U. 2019. A comparison of trapping efficacy of 11 rodent traps in agriculture. *Mammal Research*, 64(3): 435–443.
- Munõz-Zanzi, C., Mason, M., Encina, C., Gonzalez, M. & Berg, S. 2014. Household characteristics associated with rodent presence and Leptospira infection in rural and urban communities from Southern Chile. *American Journal of Tropical Medicine and Hygiene*, 90(3):497–506. [Online] Available from: <https://doi.org/10.4269/ajtmh.13-0334> [Accessed: 06 June 2020].
- Nadi, A., Abedi, G., Isazadeh, K., Rostami, F., Siamian, H., Hosseini, M. & AsadiAliabadi, M. 2016. Epidemiologic investigation of dysentery in North of Iran: Use of geographic information system (GIS). *Materia Socio Medica*, 28(6):444. [Online] Available from: <https://doi.org/10.5455/msm.2016.28.444-448> [Accessed: 06 June 2020].
- South Africa. National Department of Health. 2004. *National Health Act, No. 61 of 2003*. Government printer.
- Nattrass, N., Stephens, J., Loubser, J. J. & Town, C. 2019. *Animal Welfare and Ecology in the Contested Ethics of Rodent*

- Control in Cape Town Rats, Poison and Policy Contestation in*, 1–10. [Online] Available from: <https://doi.org/10.1093/jue/juz008> [Accessed: 04 April 2020].
- Panti-May, J.A., Sodá-Tamayo, L., Gamboa-Tec, N., Cetina-Franco, R., Cigarroa-Toledo, N., Machaín-Williams, C., del Rosario Robles, M. & Hernández-Betancourt, S.F. 2017. Perceptions of rodent-associated problems: an experience in urban and rural areas of Yucatan, Mexico. *Urban Ecosystems*, 20(5):983–988. [Online] Available from: <https://doi.org/10.1007/s11252-017-0651-8> [Accessed: 05 May 2020].
- Parrot, L., Sotamenou, J. & Dia, B.K. 2009. Municipal solid waste management in Africa: Strategies and livelihoods in Yaoundé, Cameroon. *Waste Management*, 29(2):986–995. [Online] Available from: <https://doi.org/10.1016/j.wasman.2008.05.005> [Accessed: 02 February 2020].
- Quinn, N., Kenmuir, S. & Krueger, L. 2019. *A California Without Rodenticides: Challenges for Commensal Rodent Management in the Future*. 13(2):212–225.
- Rai, P.K., Lee, S.S., Zhang, M., Tsang, Y.F. & Kim, K.H. 2019. Heavy metals in food crops: Health risks, fate, mechanisms, and management. *Environment International*, 125(November 2018):365–385. [Online] Available from: <https://doi.org/10.1016/j.envint.2019.01.067> [Accessed: 05 May 2020].
- Roomaney, R., Ehrlich, R. & Rother, H.A. 2012. The acceptability of rat trap use over pesticides for rodent control in two poor urban communities in South Africa. *Environmental Health: A Global Access Science Source*, 11(1):1–7. [Online] Available from: <https://doi.org/10.1186/1476-069X-11-32> [Accessed: 18 November 2019].
- Saez, A.M., Haidara, M.C., Camara, A. & Fichet-calvet, E. 2018. *Rodent control to Fight Lassa Fever: Evaluation and Lessons Learned from a 4-Year Study in Upper Guinea*. 1–16. [Online] Available from: <https://doi.org/10.6084/m9.figshare.5545267> [Accessed: 03 December 2020].
- Samarasundera, E., Walsh, T., Cheng, T., Koenig, A., Jattansingh, K., Dawe, A. & Soljak, M. 2012. Methods and tools for geographical mapping and analysis in primary health care. *Primary Health Care Research & Development*, 13(1):10–21. [Online] Available from: <https://doi.org/10.1017/S1463423611000417> [Accessed: 07 March 2020].
- Samuels, S. 2014. Alex residents kill owls because they are used for ‘Witchcraft.’ *Alex News*. [Online] Available from: <https://alexnews.co.za/35417/owl-project-under-scrutiny/> [Accessed: 18 November 2019].
- Serieys, L.E.K., Bishop, J., Okes, N., Broad, J., Jean, D., Poppenga, R.H., Viljoen, S., Wayne, R.K. & Riain, M.J.O. 2019. *Science of the Total Environment Widespread Anticoagulant Poison Exposure in Predators in a Rapidly Growing South African city*. 666:581–590. [Online] Available from: <https://doi.org/10.1016/j.scitotenv.2019.02.122> [Accessed: 05 May 2020].
- Seyring, N., Dollhofer, M., Weißenbacher, J., Bakas, I. & McKinnon, D. 2016. Assessment of collection schemes for packaging and other recyclable waste in European Union-28 Member States and capital cities. *Waste Management and Research*, 34(9):947–956. [Online] Available from: <https://doi.org/10.1177/0734242X16650516> [Accessed: 17 June 2020].
- Shiels, A., Bogardus, T., Rohrer, J. & Kawelo, K. 2019. Effectiveness of Snap and A24-Automated Traps and Broadcast Anticoagulant Bait in Suppressing Commensal Rodents in Hawaii. *Human-Wildlife Interactions*. 13(2): 226–237.
- Smith, B. & Fazil, A. 2019. How will climate change impact microbial foodborne disease in Canada?. *Canada Communicable Disease Report*, 45(4):108–113. [Online] Available from: <https://doi.org/10.14745/ccdr.v45i04a05> [Accessed: 17 June 2020].
- Sompani, T.M. 2003. *Delivery of Environmental Health Services to Ducats informal settlement*. Unpublished Master’s degree in Environmental Health. Cape Town: Cape Technikon.
- Stuart, A.M., Kong, P., Then, R., Joy, R. & Sathya, K. 2019. Tailor-made solutions to tackle rodent pests of rice through community-based management approaches in Cambodia. *Crop Protection*, January. [Online] Available from: <https://doi.org/10.1016/j.cropro.2019.01.023> [Accessed: 05 May 2020].
- Taiwo, A.M. 2019. A review of environmental and health effects of organochlorine pesticide residues in Africa. *Chemosphere*, 220:1126–1140. [Online] Available from: <https://doi.org/10.1016/j.chemosphere.2019.01.001> [Accessed: 04 April 2020].
- Taylor, P.J., Arntzen, L., Hayter, M., Iles, M., Freen, J. & Belmain, S. 2008. Understanding and managing sanitary risks due to rodent zoonoses in an African city: beyond the Boston Model. *Integrative Zoology*, 3(1):38–50. [Online] Available from: <https://doi.org/10.1111/j.1749-4877.2008.00072.x> [Accessed: 07 March 2020].
- Tchatchouang, C.D.K., Fri, J., De Santi, M., Brandi, G., Schiavano, G. F., Amagliani, G. & Ateba, C.N. 2020. Listeriosis outbreak in south africa: A comparative analysis with previously reported cases worldwide. *Microorganisms*, 8(1). [Online] Available from: <https://doi.org/10.3390/microorganisms8010135> [Accessed: 07 July 2020].
- Traweger, D. & Slotta-Bachmayr, L. 2005. Introducing GIS-modelling into the management of a brown rat (*Rattus norvegicus* Berk.) (Mamm. Rodentia Muridae) population in an urban habitat. *Journal of Pest Science*, 78(1):17–24. [Online] Available from: <https://doi.org/10.1007/s10340-004-0062-5> [Accessed: 04 April 2020].
- Vallero, D.A. 2019. Waste Governance. In *Waste* (2nd ed.). Elsevier Inc. [Online] Available from: <https://doi.org/10.1016/b978-0-12-815060-3.00033-5> [Accessed: 02 February 2020].
- Vallero, D.A. & Shulman, V. 2019. Introduction to waste management. *Waste*, 3–14. [Online] Available from: <https://doi.org/10.1016/b978-0-12-815060-3.00001-3> [Accessed: 02 February 2020].
- Xiao, H., Tong, X., Huang, R., Gao, L., Hu, S., Li, Y., Gao, H. & Zheng, P. 2018. *Landscape And Rodent Community Composition Are Associated With Risk of Hemorrhagic Fever With Renal Syndrome In Two Cities in China, 2006 – 2013*:1–10. [Online] Available from: <https://doi.org/10.1186/s12879-017-2827-5> [Accessed: 05 May 2020].
- Zhang, Y., Huang, G.H. & He, L. 2014. A multi-echelon supply chain model for municipal solid waste management system. *Waste Management*, 34(2):553–561. [Online] Available from: <https://doi.org/10.1016/j.wasman.2013.10.002> [Accessed: 02 February 2020].
- Zikankuba, V.L., Mwanyika, G., Ntwenya, J.E. & James, A. 2019. Pesticide regulations and their malpractice implications on food and environment safety. *Cogent Food & Agriculture*, 5(1). [Online] Available from: <https://doi.org/10.1080/23311932.2019.1601544> [Accessed: 07 March 2020].

# COMPARATIVE THERMAL PERFORMANCES OF DIFFERENT ENVELOPE WALL DESIGNS FOR SUSTAINABLE SOLAR COOLING

Osamuyi Obadolagbonyi, Dr. Ben Oni\*, Dr. Mandoye Ndoye, Tuskegee University, Tuskegee AL, USA  
\*boni@tuskegee.edu

## Abstract

Countries in hot climate areas of the world have an abundance of sunshine. While the heat component of the sunshine, along with humidity, produces ambient discomfort, the visible light component has a high potential for cooling applications and improved indoor thermal comfort. In this study, a traditional building practice in sub-Saharan Africa (SSA) that involves the use of cement blocks was reviewed. Novel strategies aimed at reducing the radiant heat transmission from outdoors to indoors were investigated. Work by others in similar studies has mostly focused on increasing concrete insulation with admixtures. The work presented in this study seeks to identify the wall envelope design that offers the highest thermal resistance to radiant heat ingress into the building interior, and therefore makes solar cooling more feasible. Scaled down versions of building envelope walls were constructed using cement blocks, as traditionally used in SSA. A traditional single-wall envelope was constructed for reference. Double walls of varying spacing and configurations between external and internal walls were also constructed for comparison with the reference. The study analysed the wall envelope thermal performance for ambient temperatures above 75 °F (23.9 °C). The results of the study show that a double-wall configuration with vent holes on the exterior reduced the amount of thermal energy stored in the building interior by up to 47% over a 24-hour period, compared with the traditional reference single wall envelope.

**Keywords:** building envelope wall, cooling with solar, double envelope walls, efficient solar cooling, radiant heat flow.

## Introduction

Building envelopes (walls and roofs) play a critical role in controlling indoor temperature. The envelopes serve to protect the interior from environmental elements. The envelopes also serve as thermal comfort buffers from ambient temperatures. The focus of this paper is to assess how different designs and configurations of envelope walls affect the thermal energy build-up in building interior. The objective is to identify the configuration that best facilitates the use of solar energy for cooling. The conventional process of mitigating heat build-up in the interior of a building is through building insulation. In parts of the world where insulation materials are readily accessible and affordable, a typical solution to the issue of internal heat build-up is to incorporate an appropriate level of insulation within the envelope. There are, however, many hot climatic regions of the world, for example, SSA, where building insulations are neither readily available nor affordable for the average homeowner. Further, the traditional building construction practice in SSA does not include insulation with the cement block typically used in envelope wall constructions. A typical home in the SSA is made of a single cement wall envelope without insulation, and metal roofing with minimal or no insulation as well.

## works by others in similar topical areas

The authors, in their previous study titled “Comparative Thermal Performances of Different Envelope Roof Designs

for Sustainable Solar Cooling” reported that air spacing in envelope roof covers reduced attic temperatures by 12.26 °F (6.81 °C). The major research activities aimed at reducing thermal conductivity to building interiors have, however, mostly focused on increasing concrete insulation with admixtures (Brick Industry Association, 2016). Sadineni, Srikanth & Boehm (2011) have re-echoed the fact that cement blocks have a high thermal mass. This characteristic implies that the non-insulated cement wall functionally behaves as a thermal energy storage structure. Al-Jabri, Hago, Al-Nuaimi & Al-Saidy (2005) therefore conclude that concrete blocks with high thermal insulation properties have become a necessity in hot environments to mitigate electrical energy usage. This realisation has motivated research interests to seek to minimise the radiant heat transmittance from the exterior to interior environments. Ng and Low (2010) investigated thermal conductivity of newspaper sandwiched between aerated lightweight concrete panels. They reported a reduction of 18.0% to 20.7% in the thermal conductivity because of the materials used. Sukontasukkul (2009) used crumb rubber in a pre-cast concrete panel to reduce sound and thermal conductivity. For the given range of rubber aggregate that was used, the author reported a reduction in thermal conductivity of between 20% and 50%, compared with plain concrete. Demirboga (2007) investigated the impact of mineral admixtures added to regular concrete. The minerals experimented with included silica fume, class C fly ash, and blast furnace slag. The author reported a maximum of 23% reduction in thermal conductivity with 30% fly ash admixture. Al-Jabri *et al.* (2004) used leca, polystyrene foam, vermiculite and aluminium powder mix to construct cement blocks. The authors recorded a moderate reduction in thermal conductivity in many of the mixes, compared with regular cement blocks.

There have also been small-scale research activities exploring cement block design, cement block fabrication methods, and envelope wall construction configurations to minimise thermal conduction. In this regard, Al-Jabri *et al.* (2004) explored the option of constructing double-skin walls using ordinary blocks and then inserting polystyrene sheets between them. The authors also explored the fabrication of new cement block designs with multiple staggered cavities. The observations indicated the potential for a reduction in thermal conductivity through envelope walls.

## RESEARCH DESIGN METHOD AND EXPERIMENTAL SETUP

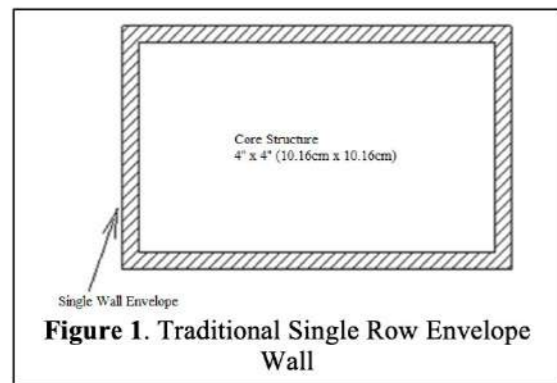
The work reported in this paper compares different envelope wall configurations using existing cement blocks. Temperature sensors installed at different locations of the constructed envelope walls provided data for the analysis presented in the paper. Budaiwi, Abdou and Al-Homoud (2009) and Lstiburek (2002) allude to the impact of humidity on thermal conductivity. They state that humidity tends to reduce the transmission of radiant energy due to absorption and scattering, and that the value of the thermal conductivity of a particular material is subject to variation due to changes in both moisture content and temperature. Humidity data were not considered in this paper for the primary reason that the research seeks relative information as to how different envelope wall designs and configurations impact ambient heat ingress into building interiors. Further, the different test envelope walls were constructed at the same location and exposed to common humidity conditions.

The prospect that current building materials and construction practices in SSA will change in the near future is a matter of extreme optimism. Given the absence of building insulation materials and the lack of availability of cement blocks with insulating admixtures in SSA, this study explores options to reduce interior thermal energy build-up within the scope of pre-existing construction practices and available materials to facilitate the use of solar energy for cooling. The typical blockhouse construction envelope is a single row of a block wall. This type of construction transmits radiant heat to the interior, which is minimally obstructed only by a decrement factor and time lag associated with the wall constituent materials. The time lag only delays the time it takes for the heat to reach the interior, but does not prevent it from happening. Duffin and Knowles (1984), Asan (2006) and Xing, Zhang, Cao and Wang (2012) defined time lag as the time it takes for the temperature wave from the outer surface to propagate into the inner surface of a wall. They also defined the decrement factor as the decreasing ratio of the temperature amplitude during the wave propagation process through the wall. Further, the works of Duffin and Knowles (1984), Asan (2006) and Xing *et al.* (2012), as well as other previous studies on these topics, provide detailed explanations of the heat transfer process from the envelope exterior to the interior.

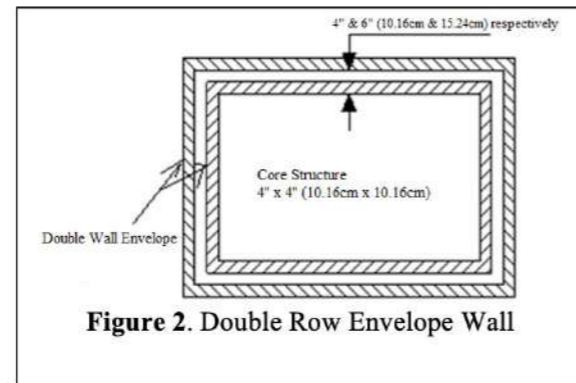
In this study, envelope wall designs and configurations were investigated to determine the best option for reduced thermal transmission to interior environments. Specifically, the following designs and configurations were investigated:

- (a) Single row envelope wall (Figure 1 and Figure 3);
- (b) Double row envelope wall with 4 “ (10.16 cm) and 6 “ (15.24 cm) air spaces in-between the walls, (Figure 2 and Figure 3);

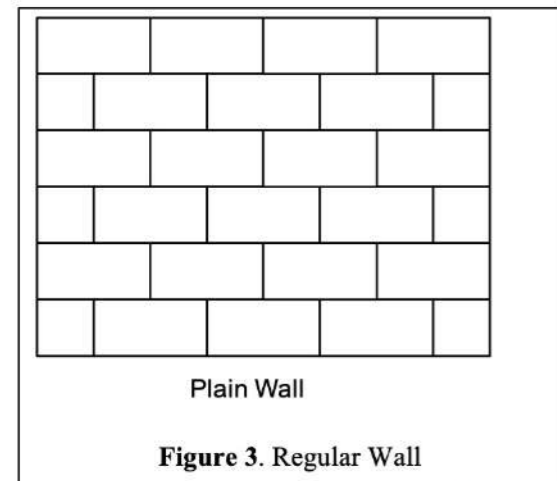
- (c) Double envelope wall with a 4" (10.16 cm) air space in-between the walls, with staggered vent holes on the exterior wall (Figure 2 and Figure 4); and
- (d) Double-wall envelope with a 4" (10.16 cm) air space in-between walls, with radiant foil wrap around the interior wall (Figure 5).



**Figure 1. Traditional Single Row Envelope Wall**

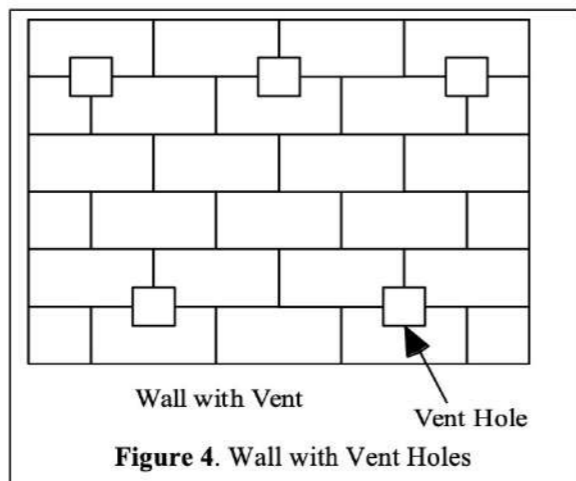


**Figure 2. Double Row Envelope Wall**



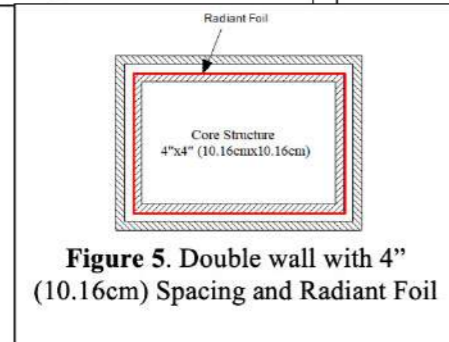
Plain Wall

**Figure 3. Regular Wall**



Wall with Vent

**Figure 4. Wall with Vent Holes**



**Figure 5. Double wall with 4' (10.16cm) Spacing and Radiant Foil**

### Experiment setup

The study approach centres on comparing the relative thermal performances for the different configurations constructed. It was therefore essential that all configurations and constructions were exposed to identical conditions – structurally and environmentally. In this regard, the considerations listed below were embraced.

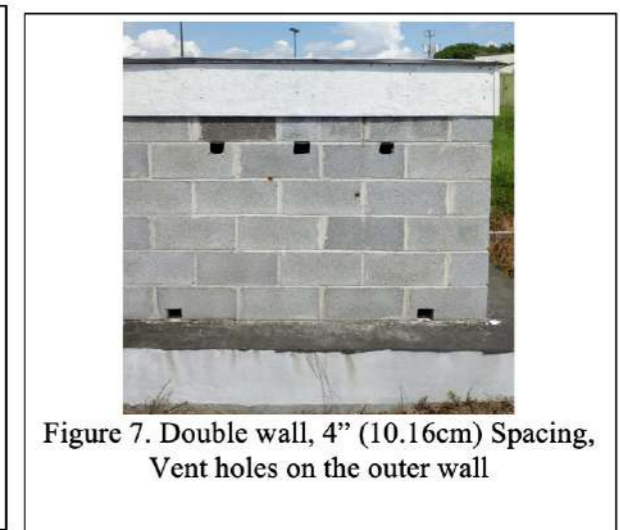
u

### DESIGN CONFIGURATIONS

The design configurations used in this study comprised a core envelope structure measuring 4' x 4' x 4' (1.2 m x 1.2 m x 1.2 m). The core structure was replicated in all the design configurations. In the double-wall design configurations, the core structure represented the inner envelope wall. Representative physical structures are depicted in Figure 6, Figure 7, Figure 8 and Figure 9.



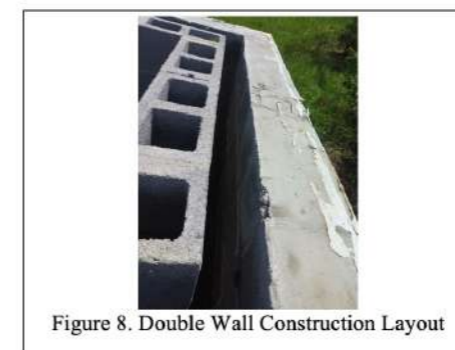
**Figure 6. Single wall Configuration - Reference**



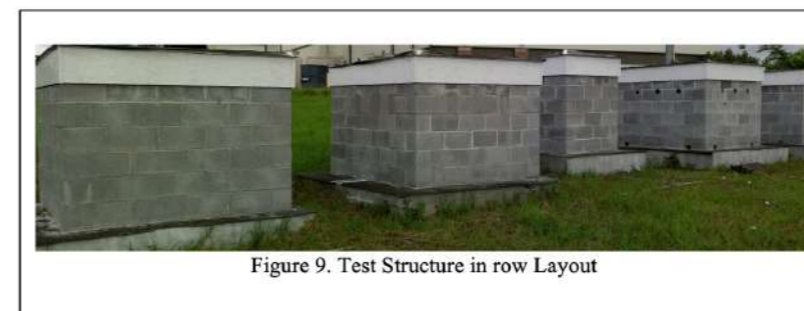
**Figure 7. Double wall, 4' (10.16cm) Spacing, Vent holes on the outer wall**

### ORIENTATION

All structures were placed in a north-south straight row. With this orientation, no structures cast any shadows on other structures, and the rising sun impacted all the structures uniformly.



**Figure 8. Double Wall Construction Layout**



**Figure 9. Test Structure in row Layout**

## ROOF STRUCTURES

The roof cover for the structures was designed, constructed and installed identically. The design aim of the roof cover was to provide significant insulation to support the assumption that all the heat recorded in the interior space of the structures was mostly due to the radiant heat transmitted through the envelope wall only.

## SENSOR LOCATIONS

All temperature sensors in the core envelope structures were mounted at identical locations. This was at the midpoint of the north-facing wall and at the midpoint of the interior space, as shown in Figure 10 and Figure 11.

## SENSOR TYPE

All temperature sensors and wires were identical. The wires ran through conduit pipes to a common data acquisition point. The sensors used were uniformly the Watlow Ring Terminal Thermocouple, Type J.

## Experiment data

The experiment was designed using the LabVIEW software and the National Instrument (NI) data acquisition devices. The LabVIEW software was programmed to collect data at the rate of one data point every 30 seconds for each sensor connected to the data acquisition device. Temperature data points from all the sensors were acquired concurrently. Sensors were located in each structure as shown in Figure 11. The data collection device used in the experiment was the NI Wireless Sensor Network (WSN) 3212. The WSN device was located at the construction site. It wirelessly transmitted the sensor data to an Ethernet gateway, the NI WSN 9791, connected to an Internet network. The temperature data were collected and stored on a dedicated computer in the laboratory.

## Results

The study examined the temperature profile in hourly intervals on a 24-hour basis. Since temperature data for each sensor were captured every 30 seconds, the hourly data were computed as the average of the data captured over 60 minutes (hourly average). The study analysed daytime temperatures of 75 °F (23.9 °C) and above, which are typical of SSA regions. In this regard, the hourly-averaged data was further averaged over a seven-day data period to obtain weekly average data, as illustrated in Table 1. A typical profile of ambient temperature sensor and wall sensor outputs for the single wall configuration (the reference structure) is graphically illustrated in Figure 12.

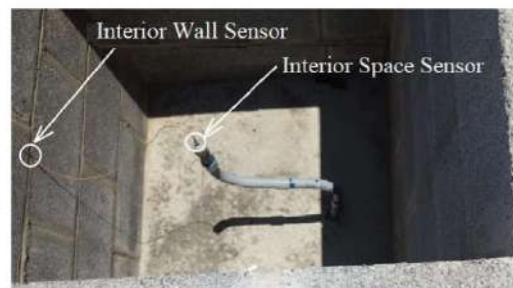


Figure 10. Sensor locations in the inner wall

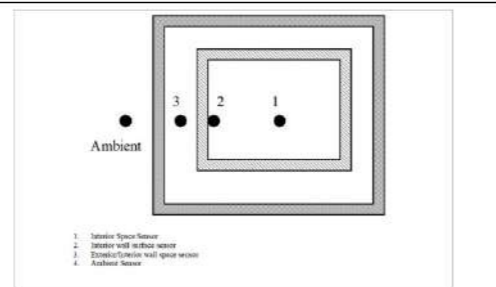


Figure 11. Temperature Sensor Locations

Table 1 – Sample Average Temperature data (°F) (Hourly and Weekly)

	12-Jun	13-Jun	14-Jun	15-Jun	16-Jun	17-Jun	18-Jun	Week	Week
	Avg.	Avg.	Avg.	Avg.	Avg.	Avg.	Avg.	Avg. Sensor	Avg. Ambient
5:00 AM	78.58	80.68	81.15	80.63	81.78	82.44	78.18	80.49	68.27
6	78.10	80.22	80.61	80.32	81.48	82.10	77.81	80.09	70.00
7	77.82	79.70	80.19	79.99	81.24	81.89	77.71	79.79	73.59
8	77.98	79.56	79.87	79.78	81.16	81.64	78.44	79.78	77.29
9	78.63	79.95	80.30	79.66	81.34	81.47	79.56	80.13	80.70
10	79.62	80.64	81.21	79.76	81.70	81.42	80.74	80.73	83.99
11	80.60	81.34	81.99	80.42	82.74	81.45	81.97	81.50	85.27
12:00:PM	81.77	82.52	82.45	81.18	84.09	81.25	83.15	82.35	86.68
1	83.22	83.55	83.38	82.26	85.21	80.91	84.38	83.27	87.41
2	84.51	84.62	83.99	83.53	86.21	80.58	85.33	84.11	88.04
3	85.86	85.56	84.97	84.78	87.16	80.49	86.14	84.99	87.53
4	86.92	85.70	85.52	85.64	87.22	80.75	86.97	85.53	86.57
5	86.70	86.51	85.85	86.09	87.46	81.25	87.89	85.96	84.40
6	86.67	86.75	85.83	86.30	87.65	81.52	89.07	86.26	81.47
7	86.64	86.47	85.51	86.12	87.68	81.93	90.20	86.36	77.05
8	86.28	85.95	85.02	86.03	87.43	82.22	90.28	86.17	74.42
9	85.60	85.30	84.42	85.58	86.84	81.88	89.71	85.62	73.36
10	84.96	84.75	83.83	85.03	86.24	81.38	88.99	85.03	72.45
11	84.35	84.18	83.31	84.59	85.66	80.92	88.25	84.47	71.57
12:00:AM	83.66	83.67	82.78	84.07	85.09	80.45	87.59	83.90	70.71
1	83.00	83.17	82.25	83.50	84.47	79.96	86.86	83.32	70.26
2	82.40	82.67	81.79	82.96	83.90	79.50	86.11	82.76	69.88
3	81.80	82.18	81.37	82.50	83.42	79.06	85.41	82.25	69.44
4	81.24	81.67	80.99	82.11	82.97	78.63	84.74	81.77	69.13
5:00 AM	80.95	81.41	80.79	81.94	82.57	78.39	84.38	81.49	69.21

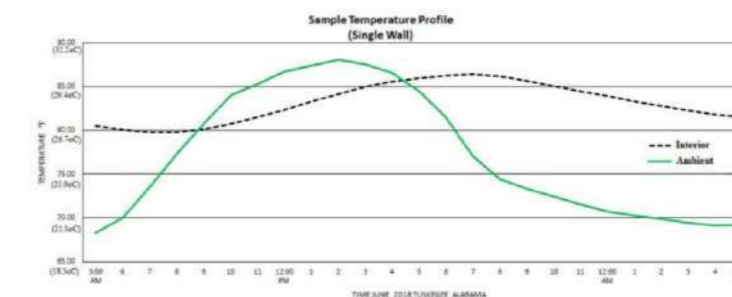


Figure 12. Sample Temperature Profile for Single Envelope Wall Structure – Ambient vs. Interior Space

A typical temperature profile for the double-wall envelope construction is illustrated in Figure 13. The figure shows the relative temperature profile at locations as per Figure 11.



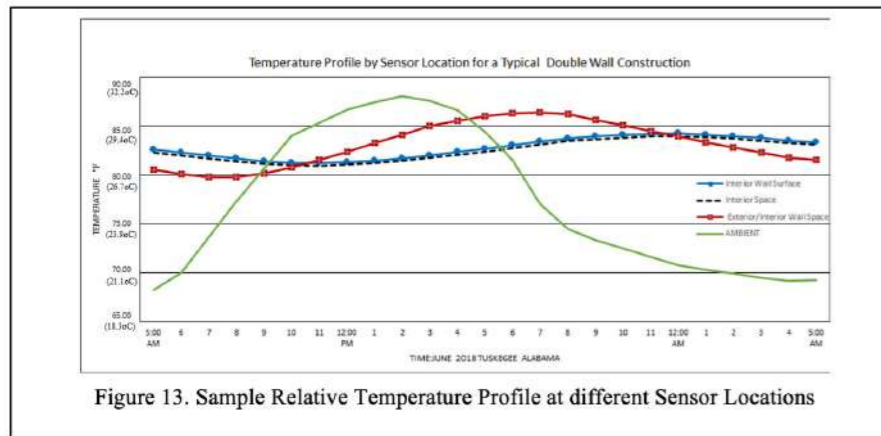


Figure 13. Sample Relative Temperature Profile at different Sensor Locations

Figure 14 shows the relative level of thermal energy stored in the interiors of the structures over 24 hours under common environmental and atmospheric conditions across all of the different construction configurations examined in this study.

From Figure 14, it appears that the best thermal performing configuration (the configuration that allowed the least amount of heat to be transmitted to the interior of the structure over 24 hours) was the double envelope wall, which had 4" (10.16 cm) of air space between the exterior and interior walls, along with staggered vent holes in the exterior wall (Figure 2 and Figure 4). Al-Jabri *et al.* (2004) adopted the staggered hole design in their experiments so as to attain elongation of the heat flow path through the wall. The principle for the staggered arrangement in this study is that the thermal energy stored in the exterior and interior wall mass would heat the air in the space. Consequently, the heated air would rise by convection and exhaust through the top row of vents, while cooler air from the bottom vents would replace the heated air. Through this process, some of the thermal energy that would otherwise flow to the interior space is instead ferried out of the air space.

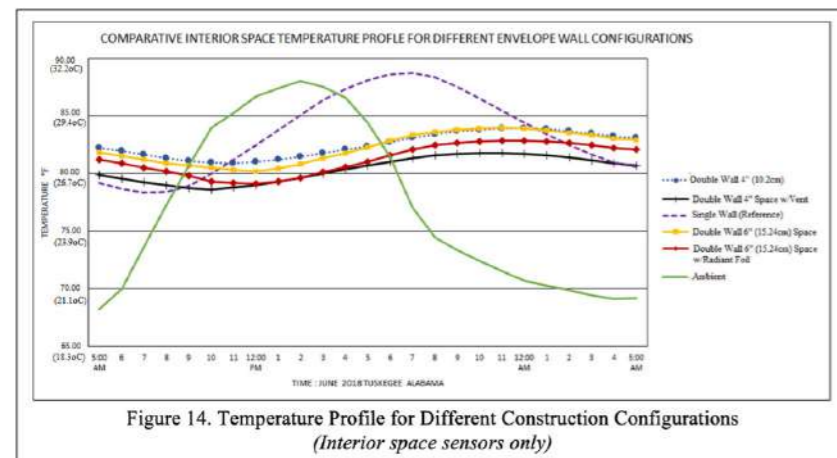


Figure 14. Temperature Profile for Different Construction Configurations (Interior space sensors only)

The second best performing configuration was the double-wall, which had 6" (15.24 cm) of air space between the walls, with the interior wall wrapped in radiant barrier foil. Radiant barrier foil is a reflective thermal material that reflects radiant energy instead of absorbing it. Although radiant barrier foils are mostly used for attic thermal insulation, the results from this study confirm that they are also effective as an envelope wall thermal insulator.

The results of the 4" (10.16 cm) and 6" (15.24 cm) spaced walls suggest that the size of the space between the exterior and interior envelope walls is limited concerning the extent to which the space distance can impact on the amount of heat flow to the interior space. The results show that there was no marked difference in thermal performance between the 6" (15.24 cm) spaced double wall envelope without a vent and the 4" (10.16 cm) spaced double wall without a vent. The only trivial difference observed between the two is that the double wall with a 6" (15.24 cm) space had an expectedly

slight thermal flux time lag behind the 4" (10.16 cm) spaced double wall in the early hours of the day. However, this lag ultimately aligned with the 4" (10.16 cm) double-wall later in the day as the heat build-up in the walls increased. The lag may be attributed to the larger air volume in the 6" (15.24 cm) space, which provided slightly higher thermal resistance to the heat flux compared with the 4" (10.16 cm) space. Nonetheless, all of the double-wall configurations performed better than the single reference wall construction over 24 hours.

## Discussions

The outcome sought in this study was a representative indication of the relative costs to cool a home with solar energy under different envelope-wall design configurations. The traditional single wall envelope was compared with the double wall envelope designs. The costs considered in the analysis included the following:

- Solar panels and cooling equipment (materials and installation);
- Walls (materials and installation); and
- Operational costs.

Finally, the analysis provided an estimated break-even point for the double-wall envelope configuration, when compared with the traditional single-wall envelope.

## assumptions

The performance results presented above were based on a core structure with dimensions of 4' x 4' x 4' (1.22 m x 1.22 m x 1.22 m). Assumptions were adopted to interpolate the results obtained to the typical size of homes in the climatic region identified in this study. These assumptions were:

- Total block surface area of home = 800 ft<sup>2</sup> (74.32 m<sup>2</sup>).
- The thermal performance of the experimental 16 ft<sup>2</sup> (2.44 m<sup>2</sup>) space will linearly translate to the 800 ft<sup>2</sup> (74.32 m<sup>2</sup>) space.
- Prevailing environmental and ambient conditions of the 800 ft<sup>2</sup> (74.32 m<sup>2</sup>) space are similar to conditions in the 16 ft<sup>2</sup> (2.44 m<sup>2</sup>) space.

Additional assumptions are presented as encountered in the analysis.

## preliminary computations

### preliminary computations

In this analysis, the heat to be removed from the internal environment space was first computed. The number of solar panels required to remove the stored heat was computed. Additional assumptions in this phase included:

- Internal reference comfort temperature = 75 °F (23.9 °C).
- Cooling units and solar panels are designed for 25% above the peak load.
- Seasonal energy efficiency ratio (SEER) = 13 for cooling units.
- The heat in the interior environment to be removed by the cooling unit is due to the 800 ft<sup>2</sup> (74.32 m<sup>2</sup>) cement block walls only.

- The convective heat coefficient for the wall surface is:  $h_c = 1.46 \text{ Btu}/(\text{ft}^2\text{h}^\circ\text{F})$  (15.72 Btu/(m<sup>2</sup>h°F)) (Yunus, 2006).

The heat stored in the interior environment is:  $q = h_c A \Delta T$

(1)

where:

$q$  = heat transferred per unit of time (Btu/hr.);

$A$  = heat transfer area of the surface (ft<sup>2</sup> or m<sup>2</sup>);

$h_c$  = convective heat transfer coefficient of the process (Btu/(ft<sup>2</sup>h°F) or Btu/(m<sup>2</sup> h °F)); and

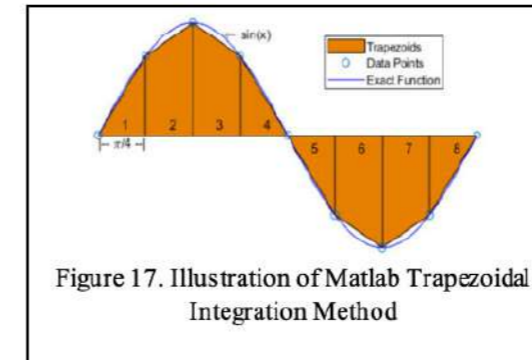
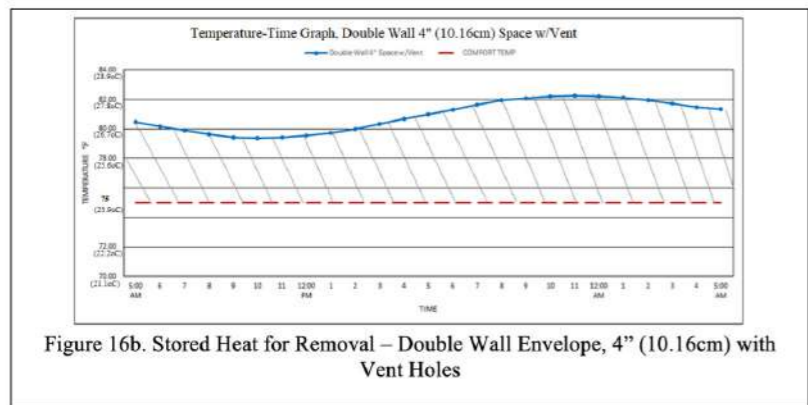
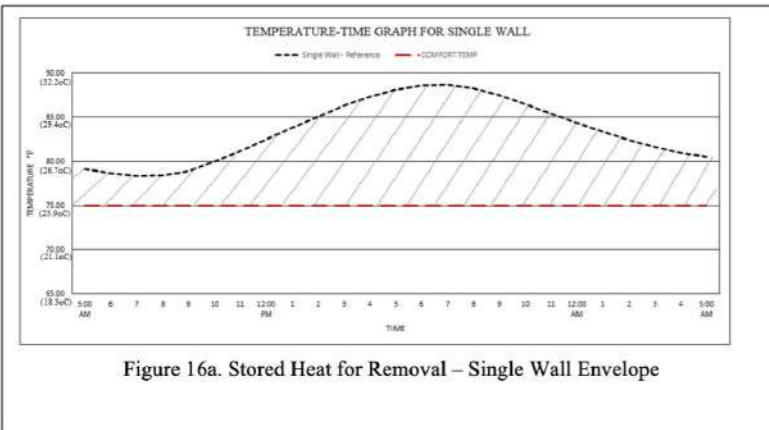
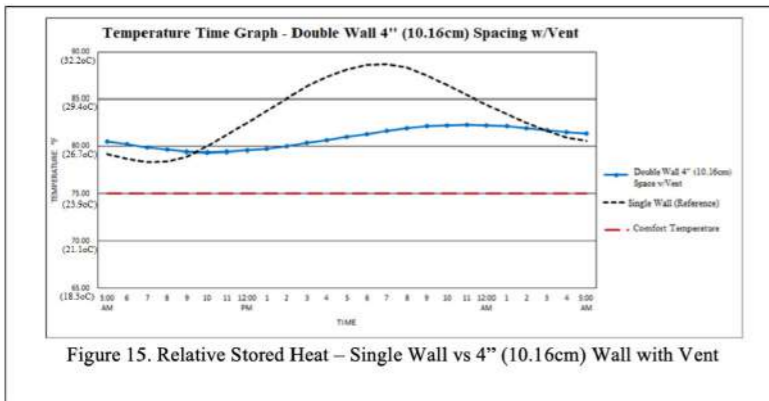
$\Delta T$  = temperature difference between the surface and the bulk air (°F).

## Summing up the heat over time

The integration of the temperature profile over a 24-hour period is represented as "h·°F". The profile of a single envelope wall and a double envelope wall with vent holes spaced at 4" (10.16cm) is shown in Figure 15 for the purpose of visual comparison. The figure is separated into individual profiles as illustrated in Figure 17 (a) and Figure

17(b) for illustration. The stored heat to be removed is bound by the temperature profile and the 75 °F (23.9 °C) comfort line, as indicated by the hatch lines.

From Figure 17a and Figure 17b, the areas under the curves were computed using the Matlab trapezoidal function. Mathworks (2019) indicates that the trapezoidal function – *trapz()* – performs numerical integration via the trapezoidal method. This method approximates the integration over an interval by breaking the area down into trapezoids with more easily computable areas, as illustrated in Figure 17.



The function may be mathematically represented as:

$$\int_a^b f(x)dx \approx \frac{b-a}{2N} \sum_{n=1}^N (f(x_n) + f(x_{n+1})) \int_a^b f(x)dx \approx \frac{b-a}{2N} \sum_{n=1}^N (f(x_n) + f(x_{n+1})) \quad (2)$$

$$= \frac{b-a}{2N} [f(x_1) + 2f(x_2) + \dots + 2f(x_N) + f(x_{N+1})] \frac{b-a}{2N} [f(x_1) + 2f(x_2) + \dots + 2f(x_N) + f(x_{N+1})] \quad (3)$$

In these equations, the spacing between each point is equal to the scalar value (b-a)/N. In the 24-hour period used in this computation, a = 0, b = 24 and N = 24.

The output of the computation is the product of hour and temperature (h.°F) as presented below:

	dT (°Fh)
Single Wall (Reference)	329
Double Wall 4''(10.16cm) Space with Vents	174
Double Wall 4''(10.16cm) Space w/out Vents	214
Double Wall 6''(15.24 cm) Space	215
Double Wall 6''(15.24 cm) Space w/Radiant Foil	189

With this data, the thermal energy (BTU) over a 24-hour period to be removed from the interior environment is computed as outlined in Table 3.

#### computing the number of solar panels

The computations in Table 3 are summarised as follows:

- The total heat gain (*q*BTU) above 75 °F (23.9 °C), transferred to and stored in the interior space for the 24-hour period is calculated per heat gain relationship as expressed in Equation 1.
- The heat gain per hour is computed in Btu/hr. and converted to Watts based on a SEER = 13.
- The factor of 1.25 used in the computation of maximum Btu [*Q<sub>max</sub>*] represents an engineering design allowance of 25%.
- With the stored energy to be removed computed in Watts, the number of solar panels necessary to power a cooling unit is computed using the relationship:

$$\text{Number of solar panels} = \frac{\text{Daily Watt-hour}}{\text{Wattage of solar panel} \times \text{sun-hours per day}}$$

Assumptions:

- a. Solar panel Wattage/panel = 150 W.
- b. Average sun hours per day = 6 hours.

The results in Table 3 show that the traditional single cement block envelope wall will require 41 solar panels compared with 22 solar panels for the double envelope wall with a 4" (10.16 cm) space and vent holes to maintain the internal space temperature at 75 °F (23.9 °C).

$Q = hc A \Delta T$ ( $hc = 1.46$ )	Single Wall (Reference)	Double Wall 4" (10.16cm) Space with Vents	Double Wall 4" (10.16cm) Space w/out Vents	Double Wall 6" (15.24 cm) Space	Double Wall 6" (15.24 cm) Space w/Radiant Foil
$\Delta T$ (°F h)	329	174	214	215	189
Heat Gain (24Hr.) = $Q$ (BTU) = $1.46[A(\Delta T)] = 1.46[800(\Delta T)$ (°F h)]	384,272	203,232	249,952	251,120	220,752
Heat Gain/hr. = $Q/24$ (BTU/hr.)	16,011	8,468	10,415	10,463	9,198
With 25% Design allowance, $Q$ (max) = $1.25 * Q$ (BTU/Hr.)	20,014	10,585	13,018	13,079	11,498
Design Power (Watts) of cooling unit based on 13 SEER = $[Q$ (BTU/Hr.) / 13 (W.Hr)] (Watts)	1,540	814	1,001	1,006	884
Watts/Solar Panel (Watts)	150	150	150	150	150
Sun-hr./day (Hrs)	6	6	6	6	6
Number of Solar Panels=(Daily watt.hr.)/[Watt/solar Panel*Sun-hr./day]	41	22	27	27	24

#### Fixed costs

This study partitions the cost comparison between the single wall envelope and double wall envelopes into two sections – fixed cost and operating cost respectively. The fixed cost includes solar panels, air-conditioning unit and installed wall costs respectively. Table 4 summarises the fixed costs calculations. Data used for the computation were provided by local vendors. Vendors provided installed costs as are customary in their respective trades. Installed costs, as specified by the vendors, included material and labour costs combined. The cost data used in the calculation per Table 4 are:

- i. Solar panel installed cost rate = \$3.42/Watt
- ii. Cooling unit installed cost rate = \$0.20/Btu
- iii. Wall installed cost rate = \$11/ft<sup>2</sup> (\$118.4/m<sup>2</sup>)

The cost computed was the product of the installed cost rate for the item and the quantity of the item. The fact that the double-wall area is slightly more than twice the single wall area (depending on the wall spacing) is reflected in the computation. The framework for computing the operating cost was that houses with the different envelope wall configurations are in the same location and were presumed to be cooled to 75 °F (23.9 °C), 24 hours/day, 365 days/year. The electricity rate data used in the computation was \$0.2747/KWh. This rate was chosen to reflect the relatively higher electricity rates anticipated in high-temperature regions of the world, including the target of SSA. Table 5 summarises the computation.

In Table 6, the fixed costs and operating costs were combined and projected into the future so as to identify the breakeven point for the different envelope wall configurations evaluated in this study. The premise was that the internal environment would be maintained at 75 °F (23.9 °C) consistently into the future.

Table 4. Fixed Cost Computation

Fixed Costs	Single Wall (Reference)	Double Wall 4" (10.16cm) Space with Vents	Double Wall 4" (10.16cm) Space w/out Vents	Double Wall 6" (15.24 cm) Space	Double Wall 6" (15.24 cm) Space w/Radiant Foil
<b>Solar Panel Installed Costs</b>					
Solar Panel - Material Installed cost rate: (\$/watt) (\$)	3.42	3.42	3.42	3.42	3.42
Total Watts to be supplied by Solar Panel (W)	1,540	814	1,002	1,006	884
Solar Panel Installed Costs=Installed Cost rate*Total Watts (\$)	5,267	2,784	3,427	3,441	3,023
<b>A/C Unit Costs</b>					
A/C Unit Installed Rate: Costs/Btu (\$/Btu)	0.18	0.18	0.18	0.18	0.18
Total Heat Energy to be removed by cooling unit (Btu/hr.)	20,017	10,585	13,023	13,082	11,490
A/C Unit Installed Costs = Installed Cost Rate*Total Btu	3,603	1,905	2,344	2,355	2,068
<b>Wall Installed Costs</b>					
Installed Cost Rate (\$/sqft)	11	11	11	11	11
Approx. Wall Area	800	1622	1622	1952	1952
Total Wall Costs	8,800	17,842	17,842	21,472	21,472
<b>Total Fixed Costs</b>	<b>17,670</b>	<b>22,531</b>	<b>23,613</b>	<b>27,267</b>	<b>26,563</b>

Table 5. Operating Cost Projection Computation

Annual Operating Cost	Single Wall (Reference)	Double Wall 4" (10.16cm) Space with Vents	Double Wall 4" (10.16cm) Space w/out Vents	Double Wall 6" (15.24 cm) Space	Double Wall 6" (15.24 cm) Space w/Radiant Foil
Electricity Rate (\$/KWH) \$	0.2747	0.2747	0.2747	0.2747	0.2747
Operating Hours/yr = 2*Yr+4hr/dy*365dys (Hr.)	8,760	8,760	8,760	8,760	8,760
Watts Consumed by A/C Unit (kW)	1.540	0.814	1.002	1.006	0.884
Operating Cost/Yr.=[Operating Hrs*A/C Watt *Electricity Rate] (\$)	3,706	1,959	2,411	2,421	2,127

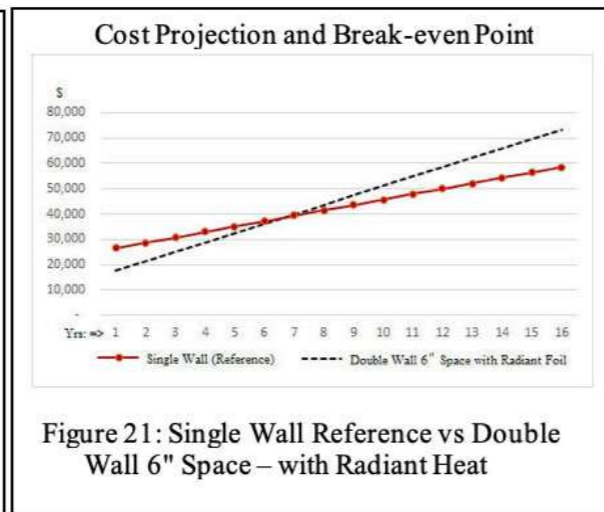
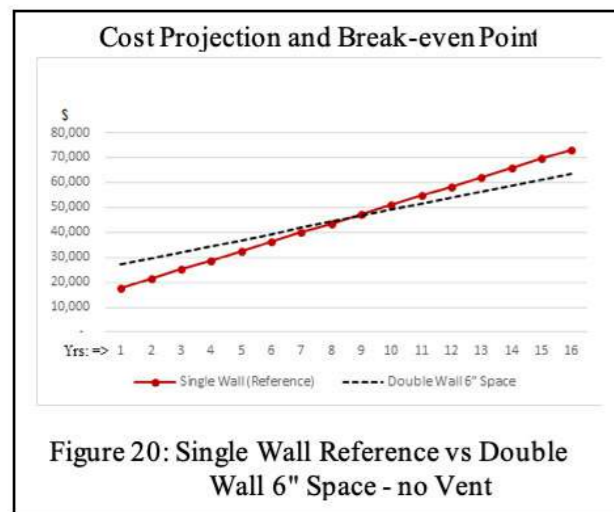
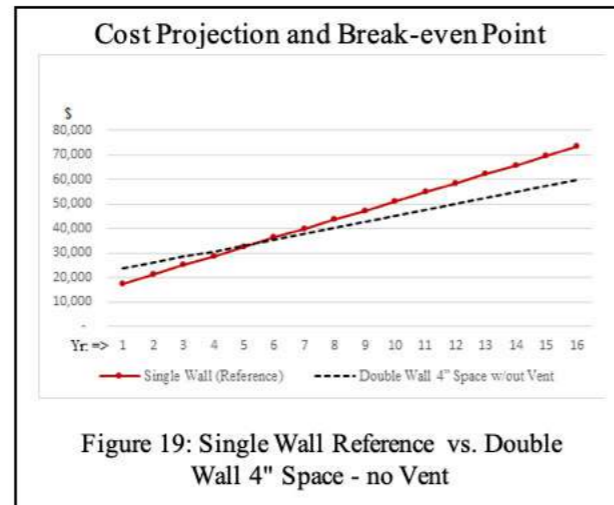
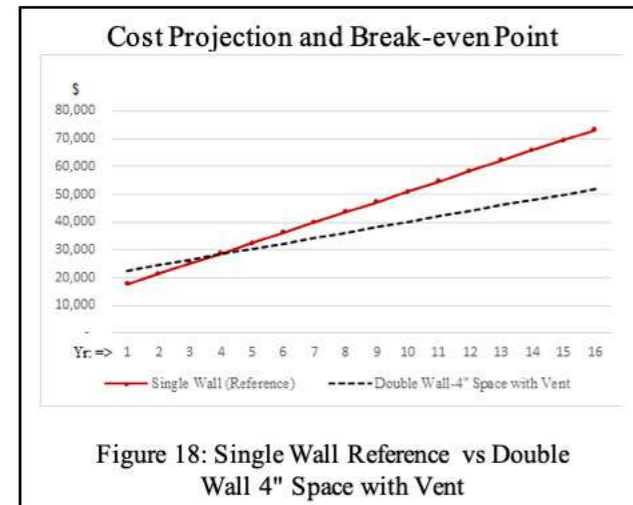
Table 6. Cost Projection Computation

Cost Projection Fixed Costs + Variable costs(t)	Single Wall (Reference)	Double Wall 4" (10.16cm) Space with Vents	Double Wall 4" (10.16cm) Space w/out Vents	Double Wall 6" (15.24 cm) Space	Double Wall 6" (15.24 cm) Space w/Radiant Foil
Fixed Costs=(Wall+A/C+Solar Panel) Installed \$	17,669	22,352	23,612	27,268	26,563
Variable Costs= Electrical Energy Operating Costs(t) \$	3,705	1,959	2,411	2,421	2,127
Cost Projection y(t) = Fixed Cost (\$)+Energy Cost* [t=time in years] \$	17,669+3,705t	22,352+1,959t	23,612+2,411t	27,268+2,421t	26,563+2,127t

The projection combined initial costs and operating costs over time and computed them as follows:

$$\begin{aligned} \text{Single cement wall envelope (reference)} & \quad \$ (17,669 + 3,705 t) & (5) \\ \text{Double cement wall envelope, 4" space with vent holes:} & \quad \$ (22,532 + 1,959 t) & (6) \end{aligned}$$

Double cement wall envelope, 4 “space with no vent holes:  $\$(23,612 + 2,411 t)$  (7)  
 Double cement wall envelope, 6 “ space:  $\$(27,268 + 2,421 t)$  (8)  
 Double cement wall envelope, 6 “ space with radiant heat foil:  $\$(26,563 + 2,127 t)$  (9)  
 In the above,  $t$  = number of years.  
 The equations are plotted in Figure 18 to Figure 22 for comparison.



## Conclusion

This paper recognised the long-standing tradition of building structures with cement blocks in urban and suburban areas of sub-Saharan Africa. The lack of availability and lack of use of insulation in the building practices gives rise to energy-inefficient structures that do not lend themselves to the use of solar energy for cooling. Given the very dim prospect that the building materials and practices will change or that insulation materials, if available and affordable, can be incorporated into the traditional cement-block construction practices, this paper explored options within these constraints for new envelope wall designs that will make cooling with solar energy more feasible. While the heat component of sunshine can produce ambient discomfort, the visible light component can produce energy for ambient cooling if the amount of heat in the environment to be cooled is reduced. A companion study carried out for a double-roof envelope showed that the attic temperature of a home could be reduced by about 12.26 °F (6.81 °C) when compared with a single-roof envelope. Experimental data

from this study for a double-wall envelope show a reduction in heat transmitted to the building interior of up to 47%. This is possible if the single wall envelope is replaced with a double wall envelope with staggered vent holes in the exterior wall. The study focused on environmental temperatures of 75 °F (23.9 °C) and above. The cost analysis conducted shows that the breakeven point for the double wall envelope with a 4 “ (10.16 cm) space with staggered vents is about 3.5 years if a solar-powered air-conditioning unit is implemented.

## ACKNOWLEDGMENT

This study forms a part of the grant activities funded by the Department of Energy (DOE), Division of the National Nuclear Security Agency, (NNSA) Minority Serving Institutions Program Workforce Planning and Outreach Branch, Office of Human Capital Management. Funding support is designed to enhance STEM education and research at Tuskegee University under FAMU Project No. 004599 contract # C-4317. The authors are grateful to DOE/NNSA for the support

## LIST OF REFERENCES

- Al-Jabri, K.S., Hago, A.W., Al-Nuaimi, A.S. and Al-Saidy, A.H., 2005. Concrete blocks for thermal insulation in hot climate. *Cement and Concrete Research*, 35(8), pp.1472-1479.
- Asan, H. 2006. Numerical computation of time lags and decrement factors for different building materials. *Building and Environment*, 41(5):615-620.
- Al-Homoud, M.S., Abdou, A.A. and Budaiwi, I.M., 2009. Assessment of monitored energy use and thermal comfort conditions in mosques in hot-humid climates. *Energy and Buildings*, 41(6), pp.607-614.
- Brick Industry Association. 2016. Introduction to energy performance of brick masonry. *Technical Notes on Brick Construction*, 1-16.
- Duffin, R.J. and Knowles, G., 1984. A passive wall design to minimize building temperature swings. *Solar Energy*, 33(3-4), pp.337-342.
- Xing, J., Zhang, X., Cao, Y. & Wang, G. 2012. Thermal performance evaluation of the wall using heat flux time lag and decrement factor. *Energy and Buildings*, 47:369-374.
- Lstiburek, J. Relative humidity. 2002. *Building Science Corporation online*. [Online] Available from: [www.buildingscience.com/resources/moisture/relative\\_humidity\\_0402.pdf](http://www.buildingscience.com/resources/moisture/relative_humidity_0402.pdf). [Accessed: 2018].
- Mathworks. 2019. Trapezoidal Numerical Integration, R2019b. [Online] Available from: <https://mathworks.com/help/matlab/trapz.html> [Accessed: 2019]
- Obadolagbonyi, O., Oni, B., Dr. Mandoye, N. 2020. Comparative thermal performances of different envelope roof designs for sustainable solar cooling. *I-Manager's Journal on Civil Engineering (JCE)*, 10(1).
- Sukontasukkul, P. 2009. Use of crumb rubber to improve thermal and sound properties of pre-cast concrete panel. *Construction and Building Materials*, 23:1084-1092.
- Demirboga, R. 2007. Thermal conductivity and compressive strength of concrete incorporation with mineral admixtures. *Journal of Building and Environment*, 42:2467-2471.
- Ng, S.C. and Low, K.S., 2010. Thermal conductivity of newspaper sandwiched aerated lightweight concrete panel. *Energy and Buildings*, 42(12), pp.2452-2456.
- Sadineni, S.B., Srikanth, M. & Boehm, R.F. 2011. Passive building energy savings: A review of building envelope components. *Renewable and Sustainable Energy Reviews*, 15(8): 3617-3631.
- Yunus, A.Ç. 2006. *Heat and mass transfer: A practical approach*. 3<sup>rd</sup> Edition. Asia: McGraw Hill.

# TOWARD AN ENERGY THRESHOLD HYPOTHESIS MODEL FOR SOCIAL BENEFIT AND HOUSEHOLD ENERGY USAGE

Samira Ortiz, University of Puerto Rico Mayagüez, Puerto Rico, samira.ortiz@upr.edu

Mandoye Ndoye, Tuskegee University, Tuskegee, AL, USA, mndoye@tuskegee.edu

Marcel Castro-Sitiriche, University of Puerto Rico Mayagüez, Puerto Rico, and Nelson Mandela African Institution of Science and Technology, Tanzania marcel.castro@upr.edu

## Abstract

*A strong positive relationship between quality of life and electricity consumption in impoverished countries can be found in many studies. However, previous work has presented that the positive relationship does not continue beyond a certain electricity consumption threshold. Consequently, there is a need to explore the possibility for communities to live with sustainable levels of energy consumption without sacrificing their quality of life. Our proposed method introduces the energy satisfaction (ES) model from the concept of quantifiable user satisfaction, which is then used to propose the power satisfaction (PS) model. Social value obtained from daily-used electric devices is evaluated through an efficiency metric: the relative social value of energy (RSVE-ES). A preliminary scenario is shown in results for the use of lights, since they are one of the most important daily-used devices. PS, ES and RSVE-ES are analysed in the experiment. The model proposes a penalisation of consumption excess, and results show that energy consumption beyond a certain threshold value leads to a lower RSVE-ES.*

**Keywords:** energy satisfaction, power satisfaction, relative social value of energy, responsible wellbeing.

## INTRODUCTION

There is a close relationship between the quality of life and level of electrification (Pasten & Santamaria 2012). More specifically, consumer comfort and satisfaction are intrinsically linked to electric power use levels, thus becoming crucial aspects of power systems. However, there remains 1.1-billion people without electric power. For many years, the approach to development projects has been to transfer technology designed for a wealthy urban context and to remote rural villages and impoverished countries. Since 70% of the world's poor live in rural villages (WEO I 2017), it is important to change the direction of the paradigm by designing appropriate technology for smart rural villages, and by exploring innovation opportunities in the context of building smart cities. As such, it is imperative to consider technology in an appropriate fashion by using the small-scale innovative potential derived from decentralised, energy-efficient, environmentally sustainable, and locally autonomous technology applied to smart villages.

The present research offers a methodology to properly measure satisfaction on a small-scale, since the amount of available energy in many rural communities is limited. Also, it could be applied in urban areas' households after a power outage resulting from a natural disaster or power failure. The methodology could be extended to any household. However, in the abovementioned situations, it is even more critical to ensure that quality of life and satisfaction requirements are met. This novel approach of directly exploring the granular contribution that each kWh of energy use has during each hour of the day is unique in its potential application in real time, as well as the inclusion of the detrimental impact that excess consumption could have on quality of life.

Consumer satisfaction usually means minimum cost for maximum comfort (Khalid, Khan & Javaid 2019), and is traditionally connected to studies on price reduction, utility stability and network reliability. Some researchers have been working on comfort management applied to different areas such as thermal comfort (Kim, Hong, Jeong, Koo & Jeong,

2016; Godina, Rodrigues, Poursmaeil, Matias & Catalão, 2018), visual comfort (Kwong, 2020), air quality (Al horr *et al.*, 2016) and residential user satisfaction (Ogunjuyigbe, Ayodele & Akinola, 2017). A level of user comfort is ensured in the work developed by Godina *et al.* (2018), where a customer is required to consume additional energy to meet the fixed enjoyable level of comfort from an air conditioner.

There is still the matter of quantifying the satisfaction of the customer, which could be defined in terms of how much the expectation of the customer is met (Shahzad *et al.*, 2017; Ogunjuyigbe *et al.*, 2017). The most state-of-the-art methodologies tackle the aspect of comfort/satisfaction/welfare as an indirect measure, derived from another variable. For example, Yang, Tang and Nehorai (2012) compute satisfaction by finding the difference between the nominal user demand and the actual demand. The present work develops a direct measure for satisfaction based on the actual perception of the user. It is developed in such a manner that it can be included in common optimisation problems that seek to reduce costs.

Ogunjuyigbe *et al.* (2017), on the other hand, developed a cost per unit satisfaction index. This cost is minimised for specific energy use patterns and compared to the desired consumption pattern. They developed a table describing a rating from 0 to 1 for each electrical device by hour, as well as the per-hour operational cost of use for each appliance. While this approach minimises cost, our proposed algorithm maximises satisfaction while averting an increase in energy consumption.

Similarly, the proposed approach introduces the concept of a quantifiable user satisfaction metric, and proposes the concepts of PS and ES. The developed model emulates the extensively known terms of electric power and energy. The PS is an hourly-based metric and ES is a 24-hour metric that results from the summation of the hourly-based PS values. This has not been previously explored. We are proposing a more accurate tool that can translate different energy usages into user satisfaction. It is common to see how much energy is consumed for each use, but not how this energy usage is affecting the everyday experiences of people. Another key feature in this work is the inclusion of time dependent-satisfaction for each energy use. By knowing how much benefit is derived from the energy consumed by each device, those devices that bring the most satisfaction can be prioritised, thereby improving quality of life for people and increasing the social value.

Subjective wellbeing research includes top-down and bottom-up theoretical approaches. The former is based on the Kantian perspective, where the most important factor is how someone reacts to daily moments. The latter is more reductionist in the sense that subjective wellbeing is built upon the sum of daily moments of positive experience. Both approaches have plenty of research evidence to sustain them. It has been recognised that "both formulations may be partly true. The challenge is to uncover how top-down or internal factors and bottom-up molecular events interact" (Diener, Suh, Lucas & Smith, 1999). This research uses the bottom-up approach when introducing the concept of PS. It intends to capture how each specific energy use contributes to the construction of the quality of life in real time during the day. The concept of ES sums up the PS into a tangible and subjective daily measure of wellbeing. While the ES is defined for each energy use, the overall ES for a household is determined by the average value. However, further research is needed to better account for relative differences in the importance among various energy uses. Every user involved in energy-related daily activities in the household is directly affected as to how these activities are accomplished. Thus, introducing a satisfaction variable through these approaches ensures that users' quality of life is considered for further decisions, while also providing information to determine if the effect of energy is a positive one.

Moreover, an efficiency metric denoted as relative social value of energy (RSVE) is included (Miller, Altamirano-Allende, Johnson & Aggemang, 2015) in order to analyse how electricity contributes to having a high social value. This is done by using the ES and actual energy consumption.

Chambers (1997) proposed responsible wellbeing as a way to combine concepts of wellbeing with personal responsibility. Castro-Sitiriche and Ozik (2014) delved in the matter when considering responsible wellbeing in terms of energy consumption, defining the energy threshold hypothesis that was previously presented by Max-Neef (1995) in terms of economic growth and quality of life. Alameda-Lozada and Díaz-Rodríguez (2009) also worked on properly measuring sustainable development by using the index of sustainable and economic welfare (ISEW), which embraces socio-economic and environmental aspects.

This paper aims to develop a quantifiable satisfaction model that considers the threshold hypothesis, so that it can be used to evaluate how much social value is obtained from different energy uses. To summarise, the contributions of this paper can be highlighted as follows:

- The novel method is the introduction of the concept of quantifiable power-based user satisfaction.
- The concepts of PS and ES are also proposed.
- The concept of responsible wellbeing is introduced through a factor that allows the model to penalise consumption excess proportionally to the hours of use in two ways: (1) the number of hours a device is continuously used, and (2) the number of hours that it has been used in over the past 24-hour window. An exception is given in the case of refrigerators, for which satisfaction increases as hours of usage increases.

## SATISFACTION MODEL

Satisfaction is based on the perception of consumers and how their expectations can be fulfilled (Shahzad *et al.*, 2017). In a house, there are many devices which provide differing levels of satisfaction at different times of the day. Moreover, these devices are consuming different levels of electrical power.

### User Input Satisfaction

For user satisfaction, the following assumptions must be noted:

1. The model considered the perception of just one person per house. That person will be called the head of the household.
2. Satisfaction can be compared depending on the time of the day. This is called time-based satisfaction and is denoted by  $\Omega_i$ , as defined by Ogunjuyigbe (2017). It implies that if there is a device 1, then the satisfaction it is providing at time  $t_1, (\Omega_1(t_1))$ , can be compared with the satisfaction the same device is providing at different time  $t_2, (\Omega_1(t_2))$ .
3. Time-based satisfaction  $\Omega$  has an integer numerical value from 0 to 6, where 6 means completely satisfied, 3 means neutral, and small satisfaction values, such as 0, 1 and 2, will correspond to dissatisfaction.
4. The consumption excess can be penalised proportionally to the number of hours a device is continuously used.
5. The consumption excess can be penalised proportionally to the number of hours that it has been used in the past 24-hours.
6. Three levels of time-based satisfaction are identified in accordance with these 7 scores (Table 1).

**Table 1.** Levels of satisfaction.

Level	Respondent's answer
Satisfied	4, 5, 6
Neutral	3
Unsatisfied	0, 1, 2

In other words, the head of the household is asked to score the satisfaction provided by each device at each hour of the day (time-based satisfaction). The respondent's answer can be any number from 0 to 6 – as in the American Time of Use Survey: Well-Being Module Questionnaire (Bureau of Labor Statistics, 2014), where 0 means the respondent did not experience any of the following categorised feelings: happy, tired, stressed, sad, pain or meaningful, while performing daily activities such as watching television, eating or driving home. Meanwhile, 6 means that the feelings were felt really strongly in each category while doing those same daily activities. The present work will not be using those categories – just the scale. Besides, the levels of satisfaction are identified as described in Leong *et al.* (2018), where the head of the household's subjective satisfaction was assessed on a 0/1/2 scale, where 0 represents unsatisfied, 1 represents neutral, and 2 represents satisfied.

### Power Satisfaction and Energy Satisfaction

The PS will not only depend on the user input satisfaction set by the head of the household, but also on the number of hours of continuous usage and the total length of use in a day. In order to find the PS at time  $t$ , we need to analyse the previous 24 hours. In other words, from time  $t - 24$  until  $time t - 1$ . It is suggested that PS cannot be tested based on how satisfied a person is, but it will be affected by the perception of the person regarding the last 24 hours.

### Continuous Length of Use (CLOU) and Length of Use (LoU):

The proposed model, based on the concept of responsible consumption (Castro-Sitiriche *et al.*, 2014), requires the distinction of the Continuous Length of Use (CLOU) that a device is turned 'On' immediately before time  $t$  and the total Length of Use (LoU) that a device is maintained 'On' during the previous 24 hour window. The reason to include them both is to account for the detrimental effects of too many hours of device use during one day and also account for the negative impacts of a device that is continuously used for too many hours. Through responsible consumption, the level of satisfaction could be maximised considering both, the CLOU and the LoU. The responsible CLOU and LoU are defined as  $t_u$  and  $t_r$  respectively. The actual consumption of devices CLOU and LoU, are established as  $\hat{t}_u$  and  $\hat{t}_r$ , respectively. When  $\hat{t}_u > t_u$ , the model reflects an excess in consumption, while if  $\hat{t}_u < t_u$ , the model results in poor consumption. Both scenarios will translate to poor satisfaction. Then, within one 24-hour window, the number of continuous hours ( $t_u$ ) that device  $i$  has been used will be computed, and so will be the total number of hours ( $t_r$ ) that device  $i$  has been used. For example, if the experiments start at 6:00 AM on 20 March 2018, then the following 24 hours will be needed for the PS computation. Therefore, PS can be computed at 6:00 AM of 21 March 2018, supposing the television was used from 7:00 AM to 9:00 AM, then from 12:00 PM to 5:00 PM, and again from 11:00 PM to 5:00 AM.

### Equation of Power Satisfaction

From a general viewpoint, the PS at a given time can be expressed as the function in Equation 2 below:

$$PS [t] = f(t, \hat{t}_u, \hat{t}_r, \alpha, \beta, \gamma) \quad (1)$$

$$PS[t] = f_\alpha(t, \alpha) - f_\beta(t, \hat{t}_u, \beta) - f_\gamma(t, \hat{t}_r, \gamma) \quad (2)$$

where:

$f_\alpha$  is the function for the initial satisfaction;  
 $f_\beta$  is the function for CLOU; and  
 $f_\gamma$  is the function for LoU.

The main idea is to penalise the initial satisfaction ( $\alpha$ ) according to excessive or poor consumption.  $\beta$  and  $\gamma$  depends on  $\alpha$ . They convert  $\hat{t}_u$  and  $\hat{t}_r$  into a value that can be deducted from  $\alpha$ , respectively.

$$\text{In addition } \alpha_i[t] = \frac{\Omega_i[t]}{t_{t_i}} \quad (3)$$

where  $\Omega_i$  is the time-based input satisfaction for device  $i$ . It is divided by the responsible LoU ( $t_{t_i}$ ), which means that  $\alpha$  will reach its maximum if it used the expected amount of time ( $t_{t_i}$ ) during a 24-hour period.

$\hat{t}_u$  and  $\hat{t}_r$  are defined as follows:

$$\hat{t}_u = \sum_{n=t}^{t+24} u_n + 1[u_{n-1} \neq 0]; t = k, \dots, k + 23 \quad (4)$$

$$\hat{t}_r = \sum_{n=t}^{t+24} u_n; t = k, \dots, k + 23 \quad (5)$$

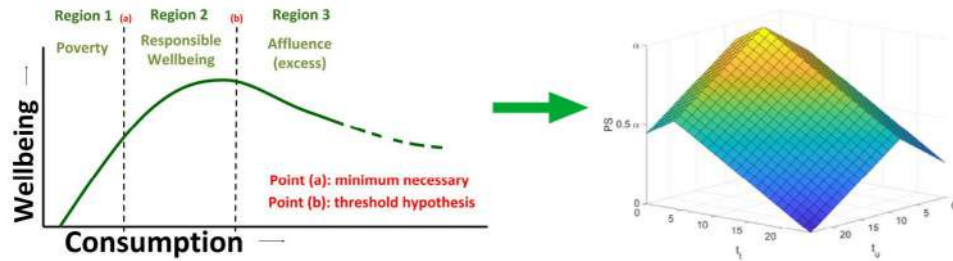
The whole experiment may last a minimum of 48 hours or may be extended for days, months or years. If  $k$  is the initial time of the experiment, then the experiment will last  $k + 47$  hours. To find PS, 24 hours of the experiment is needed. Moreover,  $\mathbf{u} = \{u_n; n = 1, 2, \dots, 24\}$  where  $u_n$  is 0 or 1. This variable is the input vector for each device and denote the 'On' or 'Off' status. It will be 1 when 'On' and 0 when 'Off'.

### Derivation Equation of Power Satisfaction.

The behaviour of wellbeing based on consumption, as proposed by Castro *et al.* (2014), was analysed. Three regions were identified: a rising-slope poverty region; the responsible wellbeing region with a peak of wellbeing; and the excess region with a negative slope as shown on the left side of Figure 1. As a result, the proposed PS is based on this concept. The proposed PS concept is a linear approximation and is depicted in Figure 1. There is a responsible consumption that can be achieved by using devices for an optimum CLoU ( $t_u$ ) and LoU ( $t_r$ ). For values under and above these optimum CLoU and LoU values, PS will decrease according to the line slope. This means that the maximum time a device can run continuously is  $t_u = t_r = 24$  hours. When this happens, the PS will reach its minimum value ( $PS^{min}$ ), which is defined in terms of the initial satisfaction ( $\alpha$ ). However, since PS decreases in cases of poor and excess consumption, the magnitude of the difference between  $t_u$ ,  $t_r$ , and  $t_u$  and  $t_r$ ,  $|t_u - t_u|$  and  $|t_r - t_r|$ , respectively, will be the independent variables.

Hence, the first point  $P_1$ :

$$P_1 = (24 - t_u, 24 - t_r, PS^{min}) \quad (6)$$



**Figure 1:** (Left-side) Responsible wellbeing and the threshold hypothesis. Adapted from Equation 4; (Right-side) PS value. Consumption in right-side plot is measured through two variables: CLoU and LoU.

For the second point ( $t_u = t_u$  and  $t_r = t_r$ ), the PS reaches its maximum ( $PS^{MAX}$ ). Hence:

$$P_2 = (0, 0, PS^{MAX}) \quad (7)$$

The direction vector  $d$  that passes both points can be expressed as:

$$d = P_1 P_2 = (24 - t_u, 24 - t_r, PS^{min} - PS^{MAX}) \quad (8)$$

Thus, the parametric equation of the line is:

$$\frac{|t_u - t_u|}{24 - t_u} = \frac{|t_r - t_r|}{24 - t_r} = \frac{PS - PS^{MAX}}{PS^{min} - PS^{MAX}} \quad (9)$$

A plane containing the above line needs to be found to establish a relationship among the different values of  $t_u$ ,  $t_r$  and  $PS$ . The equation of a plane passing through the line is:

$$\beta |t_u - t_u| + \gamma |t_r - t_r| - (PS - PS^{MAX}) = 0 \quad (10)$$

Then, the normal vector orthogonal to this plane is:

$$n = \langle \beta, \gamma, 1 \rangle \quad (11)$$

For simplicity, we will make  $\beta = \gamma$ . Then it follows that:

$$\beta |t_u - t_u| + \beta |t_r - t_r| - (PS - PS^{MAX}) = 0 \quad (12)$$

By replacing  $P_1$  from Equation 6, and since 24 is the largest number that devices can be 'On', absolute value can be removed.

Therefore:

$$\beta (24 - t_u) + \beta (24 - t_r) - (PS^{min} - PS^{MAX}) = 0 \quad (13)$$

Finding  $\beta$  is as follows:

$$\beta = \gamma = -\frac{PS^{MAX} - PS^{min}}{48 - t_u - t_r} \quad (14)$$

The PS for device  $i$  is defined as follows:

$$PS_i[t] = PS^{MAX} u_i[t] - \beta_i |t_{u_i}[t] - t_{u_i}| u_i[t] - \gamma [t] |t_{r_i}[t] - t_{r_i}| u_i[t] \quad (15)$$

The  $PS^{MAX}$  and  $PS^{min}$  values are the values of the maximum and minimum PS that can possibly be achieved. These values are  $\alpha$ -dependent.  $PS^{MAX}$  can be achieved in a scenario of responsible consumption. This is possible when the actual consumption of a device ( $t_u$  and  $t_r$ ) equals the responsible CLoU and LoU ( $t_u$  and  $t_r$ ) hours, respectively. Consequently,  $PS^{MAX}$  will be set as  $\alpha$  and  $PS^{min}$  will be set as 0 ( $PS^{MAX} = 1$  and  $PS^{min} = 0$ ).

The PS for device  $i$  is defined as in Equation 16. The equation was derived by finding the equation of the plane in 3D space, since there are two independent variables ( $t_u$  and  $t_r$ ) and a dependant variable ( $PS$ ).

Therefore:

$$PS_i[t] = (\alpha_i - \beta_i |t_{u_i}[t] - t_{u_i}| - \gamma [t] |t_{r_i}[t] - t_{r_i}|) u_i[t] \quad (16)$$

where:

$$\beta_i[t] = \gamma_i[t] = \frac{\alpha_i[t]+3}{48-t_{u_i}-t_{r_i}} \beta_i[t] = \gamma_i[t] = \frac{\alpha_i[t]+3}{48-t_{u_i}-t_{r_i}} \quad (17)$$

In Equation 15, all the terms are being multiplied by array  $u_i[t]$ , so the PS is reflecting the satisfaction of the 'use' and not of the 'no use'. Therefore, we cannot expect a negative value when the device is 'Off'. The first term  $\alpha_i$  is a function of the initial satisfaction, which depends on the time-based input satisfaction ( $\Omega$ ). The second term  $\beta_i |t_{u_i}[t] - t_{u_i}| u_i[t]$  describes the penalty value for CLoU that will be deducted from the first term, if  $t_u$  is greater or less than the responsible CLoU ( $t_u$  hours). By using the absolute value of the difference between the actual CLoU and LoU ( $t_u$  and  $t_r$ ) and the responsible CLoU and LoU ( $t_u$  and  $t_r$  hours) respectively, the magnitude of these differences can be used to compute the penalty values, depending on whether the actual CLoU and LoU are greater or less than the responsible CLoU and LoU. Consequently, the third term  $\gamma [t] |t_{r_i}[t] - t_{r_i}| u_i[t]$  describes the penalty value for LoU that will also be deducted from the first term, if  $t_r$  is greater or less than the responsible LoU ( $t_r$  hours). In the case of a refrigerator, no penalties will be applied ( $\alpha = \beta = 0$ ) since the more hours that the refrigerator is in use, the more the satisfaction.

### Energy Satisfaction Equation

Each user has a subset  $\{i: i = 1, 2, \dots, N\}$  of  $N$  participant devices. Following the well-known concept of electric energy, to find the ES in time  $t$ , the previous 24 values of  $PS$  are required. This would be:  $\dots, \{PS_i[t-24], \dots, PS_i[t-1]\}$ . To compute the first  $PS, PS_i[t-24]$ , the 24 hours prior to this time are also required. Hence, to compute ES, 48 hours worth of the experiment are required.

ES is defined as follows:

$$ES[t] = \frac{1}{N} \sum_{i \in N} \sum_{n=k}^t PS_{i,n} \quad (18)$$

The above is true where  $N$  is the number of participant devices,  $k$  is the initial time of the experiment, and  $t = k + 23$ .



## RELATIVE SOCIAL VALUE OF ENERGY

The social value of energy is used to evaluate how much social value is obtained from energy services. Miller *et al.* (2015) addressed a study wherein the social value of energy was defined in terms of the total value derived by an individual or community from energy services, including economic and non-economic value, and accounting for risks, burdens, and other negative externalities (Shyu, 2014). They developed a relative social value considering the Human Development Index (HDI) and electric power consumption (KWh per capita), normalised to the index of India. Since HDI combines life expectancy at birth, education index and gross national income (GNI), HDI may not be good metric to examine social value, because GNI can be considered as a means, not an end. We define the relative social value of energy as stated in the following:

$$RSVE = \frac{ES}{L} \quad (19)$$

The coefficient of variance of the electric power consumption ( $L$ ) is adjusted so that is equivalent to the coefficient of variance of the ES. The coefficient of variance ( $c_v$ ) is the ratio of the standard deviation ( $\sigma$ ) to the mean ( $\mu$ ) as in the following:

$$c_v = \frac{\sigma}{\mu} \quad (20)$$

As stated by Jeffrey *et al.* (2016), this adjustment is done to ensure that the social value of energy is equally sensitive to changes in ES and electric power consumption. This is done by adding a constant to the ES measure.

$$RSVE_a = \frac{ES}{L + \omega} \quad (21)$$

The above is true where  $RSVE_a$  is the adjusted  $RSVE$ . Once the coefficient of variance is computed for the ES ( $c_{vES}$ ). In addition,  $\omega$  needs to be found so that the coefficient of variance of the electric power consumption ( $c_{vL}$ ) equals the coefficient of variance of ES.

$$c_{vL} = \frac{\sigma_L + \omega}{\mu_L + \omega} \quad (22)$$

The above is true where  $\sigma_{L+\omega}$  and  $\mu_{L+\omega}$  are the standard deviation and mean, respectively, of the electric power consumption with  $\omega$  added.

## RESULTS AND DISCUSSION

A scenario where all lights in a household were considered to be a single appliance was defined to validate the proposed model. A 120-hour experiment was set up, whereupon the lights were in an 'Off' status for the first 48 hours. Data from REDD (Kolter, Batra & Andrew, 2010) has been used for 72 hours. Table 2 describes the input time-based satisfaction of the user. The input of the user has been created from common device use, in which having lights 'On' during sleeping hours would have a negative effect on the quality of life. On the other hand, lighting in 'On' status, when it is needed the most (during early morning and during the evening when there is no sunlight), will have a positive effect. Previously published works show the importance of having lighting 'On' at night (Ortiz, Ndoye, Nyari, Park & Castro-Sitiriche, 2018).

**Table 2:** Lighting time-based satisfaction

Hours	1	2	3	4	5	6	7	8	9	10	11	12	13	14	15	16	17	18	19	20	21	22	23	24
$\Omega$	0	0	0	0	0	6	6	6	1	1	1	1	1	1	1	1	1	6	6	6	6	0	0	0

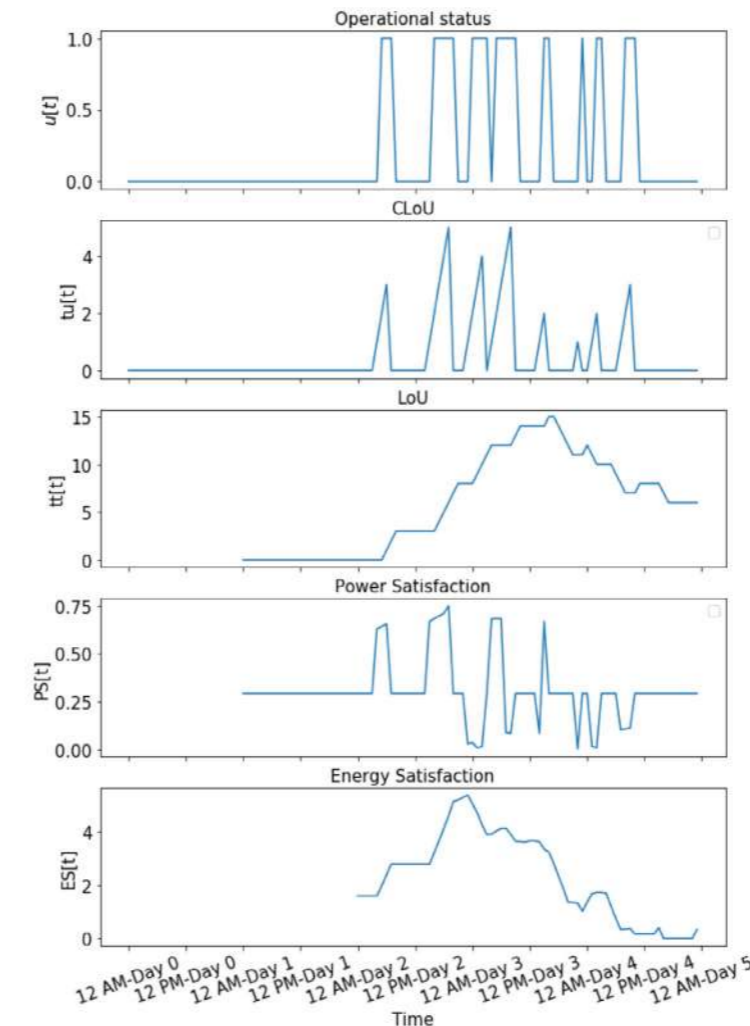
Figure 2 shows the operational status ( $u(t)$ ), CLoU and LoU, as well as PS and ES. The operational status displays the hours of the day in which lighting is mostly 'On' or 'Off'. This means that if lighting is 'On' for more than 40 minutes, it will be considered 'On' during that hour. Since the experiment is considering the first 48 hours 'Off', the value of  $u$  is 0 in the first for 48 hours. Then, from hour 49 until hour 120 of the experiment, actual data from the REDD database were used.

The second plot (CLoU) displays the number of hours that lights have been previously 'On', if it is 'On' in the current hour. For example, lighting is 'On' for the first time from hour 53 to hour 55. Hence, in time slots 53, 54 and 55, we will have a CLoU value that is different from 0, such as 1, 2 and 3 respectively.

On the other hand, LoU provides the number of hours that devices have been 'On' during the 24-hour window whether it has been continuously or not. Hence, even if lighting has been 'Off' from hour 56 to hour 63, at time slot 64, LoU is 4.

The PS provides a metric of how someone reacts to daily moments. To find the PS, 24 previous values of  $u$  are used. The ES implementation follows the bottom-up approach and quantifies the sum of these daily moments registered by the PS. To find the first ES value, 24 PS values need to be available. PS is higher if lighting is 'On' during the time slots when  $\Omega$  is higher. The ES plot in Figure 2 supports the threshold hypothesis for household consumption, where it increases at the beginning and reaches a maximum responsible wellbeing point. Then, the curve starts to decline when the number of hours of use increases, specifically if lighting is 'On' in hours where time-based satisfaction is not high. This, therefore, supports the threshold hypothesis (Max-Neef, 1995) for lighting household appliances. It is important to mention that the threshold hypothesis can be seen in most household devices. However, the case of the refrigerator is an exception because there is a general expectation of 24-hour use that would result in higher ES with maximum use LoU and CLoU. Early results from ongoing research that explores multiple devices are consistent with the results presented in this paper.

The  $RSVE$  plot (Figure 3) does not prove responsible wellbeing. However, this efficiency metric also shows how its value is the highest in its first value since it is 'Off' when making the user unsatisfied. Then, from there, it starts to decrease gradually, since for every time slot computation, the previous 24 PS values were considered and, even if having them 'On' at that time slot had a low or high  $\Omega$ , the sense of satisfaction is still recalled due to the previous states. The higher the consumption, the lower the  $RSVE = ES$ .



**Figure 2:** PS and ES computation for lighting.

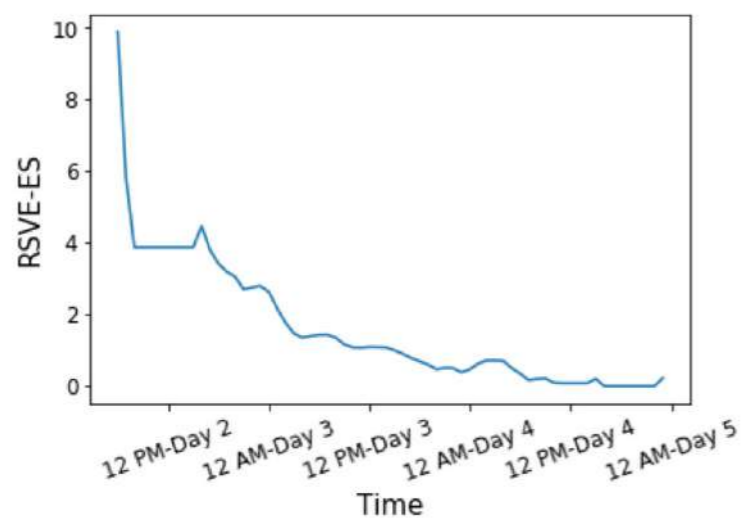


Figure 3: Time of the day versus relative social value of lighting energy consumption.

## CONCLUSIONS

For this paper, the novel Energy Satisfaction (ES) model is proposed to explore how specific energy uses contribute to the overall quality of life in a household unit. This conceptual model provides a quantifiable methodology based on user satisfaction as a bottom-up subjective wellbeing approach, with many future ramifications for the study of emerging research areas such as smart meters, Internet of things, intelligent power systems and energy data science. User satisfaction needs to be considered in the definition of complex systems problems, and not as a posteriori parameter to test the model. The concept of power satisfaction (PS) is developed to represent the temporal dependency of satisfaction, while ES grasps the summative nature of wellbeing. Results included a combination of simulated data and real data from the REDD database. The results were validated through the threshold hypothesis for household lighting consumption. Consumption was analysed through two time dimensions: number of hours of continuous usage (CLOU) and the total length of use in a day (LoU). Finally, the  $RSVE$  was determined by applying the concept of ES. This efficiency metric provides information for analysing how electricity contributes to having a higher social value. The application of this kind of work will lead to a knowledge base that can guide energy policy recommendations. Further work considering more devices will provide an important framework to study energy consumption in the context of complex socio-technical systems that better reflect the complexity of human behaviour.

## ACKNOWLEDGEMENT

This work was funded in part by the National Science Foundation through the project titled “Cultivating Responsible Wellbeing in STEM: Social Engagement through Personal Ethics”, award #1449489, at the University of Puerto Rico in Mayagüez.

## LIST OF REFERENCES

- Al horr, Y., Arif M., Katafygiotou M., Mazroei A., Kaushik A. & Elsarrag E. 2016. Impact of indoor environmental quality on occupant well-being and comfort: a review of the literature. *International Journal of Sustainable Built Environment*, 1 June, 5(1):1.
- Alameda-Lozada, J. I. & Díaz-Rodríguez. 2009. *Index of sustainable economic welfare for Puerto Rico // Index of sustainable economic welfare for Puerto Rico*. - [s.l.] : UPR, Recinto Universitario de Mayagüez: Instituto Tropical de Energía.
- U.S. Bureau of Labor Statistics. 2014. *US American Time Use Survey Well-being Module Questionnaire*. [Online] Available from: <https://www.bls.gov/tus/wbmquestionnaire.pdf> [Accessed: October 30,2020].
- Castro-Sitiriche, M. J. & Ozik, J. 2014. Rural Electrification Pathways to Wellbeing, *Appropriate Technology for the 21st Century: Technological Innovation to Empower Africa*, Knowledge and Technology Transfer Session:56.
- Chambers R. Responsible well-being—A personal agenda for development. 1997. *World development*. Nov 1;25(11):1743-54.
- Diener, E., Suh, E. M., Lucas, R. E. & Smith, H. L. 1999. Subjective well-being: Three decades of progress. *Psychological bulletin*, 125,(2):276.
- Godina, R., Rodrigues, E. M., Poursmaeil, E., Matias, J. C. & Catalão, J. P. 2018. Model predictive control home energy management and optimization strategy with demand response. *Applied Sciences*, 8(3):408.
- Jeffrey, K., Wheatley, H. & Abdallah, S. 2016. *The Happy Planet Index: 2016: a global index of sustainable well-being*. London: New Economics Foundation.
- Khalid, A., Khan, Z. A. & Javaid, N. 2018. Game theory based electric price tariff and Salp swarm algorithm for demand side management, *ITT 2018 - Information Technology Trends: Emerging Technologies for Artificial Intelligence*, IEEE:99–103.
- Kim, J., Hong, T., Jeong, J., Koo, C. & Jeong, K. 2016. An optimization model for selecting the optimal green systems by considering the thermal comfort and energy consumption. *Applied Energy*, 169, 682-695.
- Kolter, J. Z., Batra, S. & Ng, A. Y. 2010. Energy disaggregation via discriminative sparse coding. In: *Advances in Neural Information Processing Systems* 23:1153–1161.
- Kwong, Q. J. 2020. Light level, visual comfort and lighting energy savings potential in a green-certified high-rise building. *Journal of Building Engineering*, 29C:1-9.
- Leong, S., Urpelainen, J. & Jain, A. 2018. Subjective satisfaction with off-grid electricity in Rural India. Available at SSRN 3120016: <https://ssrn.com/abstract=3120016>.
- Max-Neef, M. 1995. Economic growth and quality of life: a threshold hypothesis. *Ecological Economics*, 15(2):115–118.
- Miller, C. A., Altamirano-Allende, C., Johnson, N. & Agyemang, M. 2015. The social value of mid-scale energy in Africa: redefining value and redesigning energy to reduce poverty. *Energy Research & Social Science*, 5:67-69.
- Ogunjuyigbe, A. S. O., Ayodele, T. R. & Akinola, O. A. 2017. User satisfaction-induced demand side load management in residential buildings with user budget constraint. *Applied Energy*, 187:352–366.
- Ortiz, S., Ndoye, M., Nyari, E. A., Park, E. & Castro-Sitiriche, M. 2018. Rural microgrid load profile benefit assessment, *IEEE PES/IAS PowerAfrica*:675-680.
- Pasten, C. & Santamarina, J. C. 2012. Energy and quality of life. *Energy Policy*, 49:468-476.
- Shahzad S, Brennan J, Theodossopoulos D, Hughes B, Calautit JK. 2017. Energy and comfort in contemporary open plan and traditional personal offices. *Applied Energy*, 185:1542–1555.
- Shyu, C.W. 2014. Ensuring access to electricity and minimum basic electricity needs as a goal for the post-MDG development agenda after 2015. *Energy for Sustainable Development*, 19:29–38.
- International Energy Agency. 2017. Special Report: Energy Access Outlook. *IEA WEO: Paris, France*.
- Yang, P., Tang, G. & Nehorai, A. 2012. A game-theoretic approach for optimal time-of-use electricity pricing. *IEEE Transactions on Power Systems*, 28(2):884-892.

# SIMULATING THE PASSIVE INDOOR ENVIRONMENTAL IMPACT OF THREE ROOF INSULATION TYPES ON URBAN RESIDENCES IN LAGOS, NIGERIA

Henry Odiri Igugu, Tshwane University of Technology, South Africa, henryigugu@gmail.com;  
Jacques Laubscher, Tshwane University of Technology, South Africa, laubscherj@tut.ac.za

## Abstract

The use of mechanical systems to achieve temperate indoor thermal conditions in urban residential buildings contributes significantly to energy consumption levels. The implementation of passive building techniques could reduce residential energy consumption. This paper focuses on the effects of three roof insulation materials (glass wool, extruded polystyrene and spray polyurethane foam) on indoor comfort and indoor cooling loads of urban residences. This paper presents new knowledge regarding the quantified performance of roof insulation in the Nigerian built environment. Under a contextualised and cultural response scenario defined by a temperature cooling setpoint of 16 °C, dynamic building energy modelling (BEM) simulations were conducted on a typical residential building in Lagos, Nigeria, using hourly weather data. The study developed a datum scenario to evaluate the initial cooling loads and indoor conditions. Simulations followed, using the three different roof insulation materials mentioned. The simulation results and respective construction costs attempt to balance performance and costs. The results highlight the need for roof insulation that contributes to improved comfort levels. The dynamic BEM indicates cooling loads decreasing between 38% and 39%. Based on the performance to cost comparison, glass wool insulation is the ideal material for reducing the residential energy consumption in Lagos. The results further suggest that the performance of roof insulation materials in the Nigerian context becomes disproportionate to the increase of the R-value beyond 3.0 m<sup>2</sup>K/W.

**Keywords:** building energy modelling, BEM, cooling load, roof insulation, Lagos, Nigeria.

## INTRODUCTION

Buildings account for 30% to 40% of all energy use through their lifecycles (Filippin, Larsen & Ricard, 2018:399; International Energy Agency (IEA), 2018). Several studies have acknowledged that the operational phase of a building accounts for approximately 70% to 90% of its lifecycle consumption (Tumminia, Guarino, Longo, Ferraro, Cellura & Antonucci, 2018:272; Beccali, Cellura, Fontana, Longo & Mistretta, 2013:284; Cellura, Guarino, Longo & Mistretta, 2014:372). In Nigeria, energy-intensive mechanical systems such as heating, ventilation and air-conditioning (HVAC) are typically used to achieve temperate indoor thermal conditions. The built environment of Nigeria has the potential to contribute to achieving the sustainable goals Number 11 (Sustainable Cities and Communities) and Number 13 (Climate Action) of the United Nations. The projected rise in the Nigerian population and resulting floor space requirements make it imperative to reduce building energy consumption through the adaptation of passive techniques.

### Energy dynamics in the built environment of Nigeria

Ezennaya, Isaac, Okolie and Ezeanyim (2014:335) measured energy consumption in Nigeria between 2000 and 2012. Figure 1 illustrates the energy consumption of the industrial, residential and commercial sectors, which are approximately 12%, 60% and 28%, respectively. Thus, the residential sector of Nigeria is the primary energy consumer. This is significant when comparing residential consumption levels in Nigeria with a global average of approximately 25% (Pablo-Romero, Pozo-Barajas & Yñiguez, 2017:342).

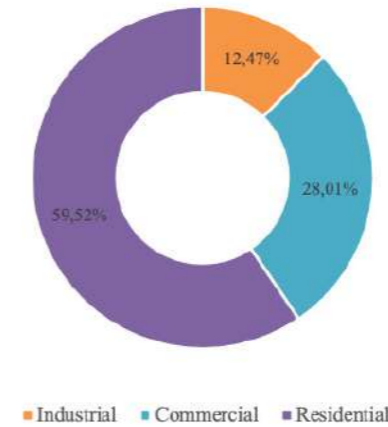


Figure 1: The average energy consumption of Nigeria by sectors between 2000 and 2012 (Ezennaya et al., 2014).

The projected increase in the energy consumption of the residential sector of Nigeria was calculated using the growth rates identified from different studies and databases. According to a report on the energy outlook for Africa, the energy demand growth in Nigeria between 2000 and 2040 will be the largest at 7.7% annually (International Energy Agency (IEA), 2014). However, the electricity consumption of Nigeria between 1990 and 2016 grew from 10.77 TWh to 26.26 TWh, representing an average annual growth rate of 5.5% (International Energy Agency (IEA), 2019). Based on the World Bank World Development Indicators, Iyke (2015:167) showed that the annual energy consumption growth rate averaged at 27.5% between 1971 and 2011, which was an increase from 2 TWh in 1971 to approximately 24 TWh in 2011.

Figure 2 compares the energy consumption growth rates (actual and projected) of the residential sector from Ezennaya et al. (2014:336) (scenario 1) with the growth rates of 7.7% by IEA (2014) (scenario 2) and 5.5% by IEA (2019) (scenario 3) for the period of 2012 to 2030. Figure 3 illustrates the 27.5% projections by Iyke (2015:167). The projections are made from the baseline measured value of 8 350 MW as obtained from the National Bureau of Statistics and the Central Bank of Nigeria Statistical Bulletin (Ezennaya et al., 2014). By 2030, energy consumption in the residential sector will increase to 11 495 MW, 31 737 MW and 21 889 MW in scenarios 1, 2 and 3, respectively. The growth in scenarios 2 and 3 is approximately 176% and 90% higher than in scenario 1. The scenarios support the need to address energy use in residential buildings in Nigeria to facilitate a more sustainable built environment.

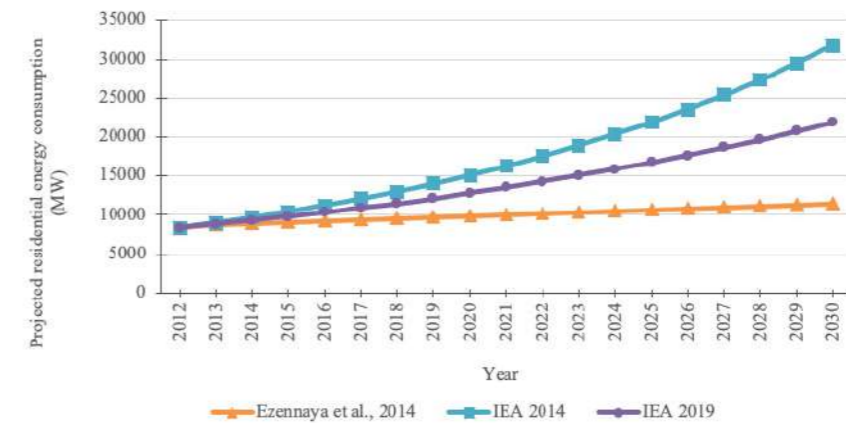


Figure 2: Comparing projected residential sector energy consumption at different growth rates.

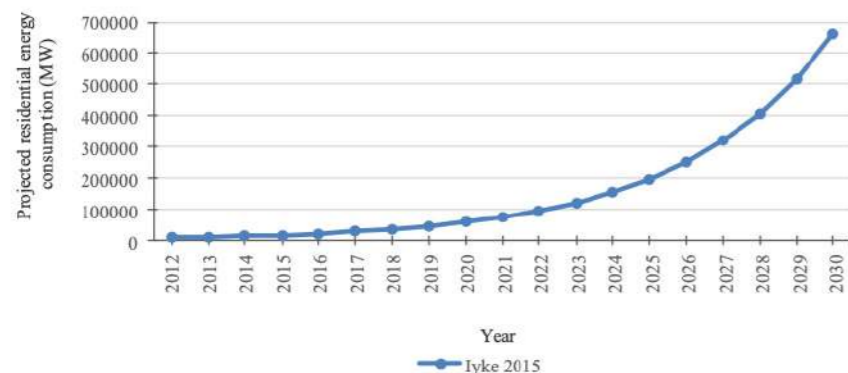


Figure 3: Projected growth in energy consumption at a 27.5% annual increase.

### Context of the study

The character of the residential sector in the city of Lagos could be described as typical of Nigeria. Population growth and improved standard of living are factors that significantly influence energy consumption growth (Siirola, 2014:96). Rupp, Vásquez and Lamberts (2015:179) suggested that the influence on energy consumption is facilitated by an increasing dependency on artificial systems creating a temperate indoor climate. Onyenokporo and Ochedi (2019:259) highlighted that 99% of Lagos residents rely on mechanical ventilation systems to achieve a temperate indoor climate.

Lagos is the fastest growing city by population in Africa, with a projected annual increase of approximately 675 000 people between 2010 and 2030 (Muggah, 2018). In an article for the World Economic Forum, Lagos was projected to be the largest megacity on the globe by 2100, with a population of approximately 88-million residents (Desjardins, 2018). These population growth trends will result in an increase in energy consumption in the residential sector. Given the current state of residential energy consumption in Lagos and the projected population growth, passive methods for contributing to a temperate indoor environment warrant investigation.

### METHODOLOGY

Although the Federal Ministry of Power Works and Housing (Housing Sector) (2017:16) specifies a minimum R-value of 1.25 m<sup>2</sup>K/W for roof insulation materials, Solid Green Consulting (2017:32) recommends an R-value increase to 2.5 m<sup>2</sup>K/W. This paper quantitatively determines the potential of reducing energy consumption in residential buildings in Lagos when installing roof insulation as a passive environmental technique.

A simulation-based experimental approach was adopted and executed through BEM. Hourly weather data for Lagos was acquired from the Lagos/Ikeja weather station (6.6 °N, 3.3 °E, 40 m) through METEONORM® software. The weather information was exported using the *energy plus weather* (.epw) format. The exported file was then uploaded into the DESIGNBUILDER® v6.1.2.9 (hereafter referred to as DESIGNBUILDER) simulation software, and it was used in the dynamic simulations.

The selected residential floor plan layout typifies a multi-family apartment building, but it was developed to be used for either single or multi-storey buildings. Within the context of Nigeria, a typical multi-family apartment building can be described as three-bedroom semi-detached apartments stacked in configurations of two to four floors (Ezema, Olotuah & Fagbenle, 2015:44144; Ilesanmi, 2012:235). Babalola, Ibem, Olotuah, Opoko, Adewale and Fulani (2020:3986) and Solid Green Consulting (2017:19) identified the semi-detached multi-family apartment residential typology as the predominant typology in Lagos. The design selected for the simulations was developed from a combination of the layouts depicted in Ezema *et al.* (2015:44144) and Solid Green Consulting (2017:20). A floor space of 231 m<sup>2</sup> and a roof area of 392 m<sup>2</sup> was achieved. The resulting floor area of the habitable spaces was 149.243 m<sup>2</sup>. The research is limited to the roof of the upper floor.

Using ENERGYPLUS™ (hereafter referred to as EnergyPlus) for the analysis, a baseline outcome of initial indoor thermal conditions and cooling loads for the apartments with no roof insulation material installed was derived. Afterwards, the different roof insulation materials were included in the roof composition and simulations were performed for each inclusion. The effects of the insulation materials on the comfort levels and cooling loads were observed. The simulation calculations were done for a typical calendar year (1 January to 31 December) and data was reported monthly. Finally, the performance of each material was

compared with their respective construction costs (as obtained from selected contractors) to make a recommendation based on the balancing of performance and cost.

### EXPERIMENTAL STUDY: DESCRIPTION OF THE SIMULATION FRAMEWORK

The setup and framework for the dynamic BEM process are described in detail below, illustrating the characteristics and performance of the residential unit in the simulation software. This section focuses on the categories, parameters and values used for the dynamic BEM. **Development of building geometry and spatial zoning**

As stated earlier, the residential floor plan layout typifies a multi-family apartment. After developing the building geometry, the internal zoning parameters were set up in DESIGNBUILDER. Figure 4 illustrates the semi-detached building layout, combining the floor plan (Section A: Grid 1-6) and the colour-coded zones from DESIGNBUILDER (Section B: Grid 6-11). The zoning constituted both habitable and uninhabitable spaces. Bathrooms, corridors, toilets and shower rooms were excluded from the calculations, being considered as uninhabitable spaces. The spaces included in the calculations were bedrooms, dining rooms and living rooms due to the possibility of them being fitted with air-conditioners.

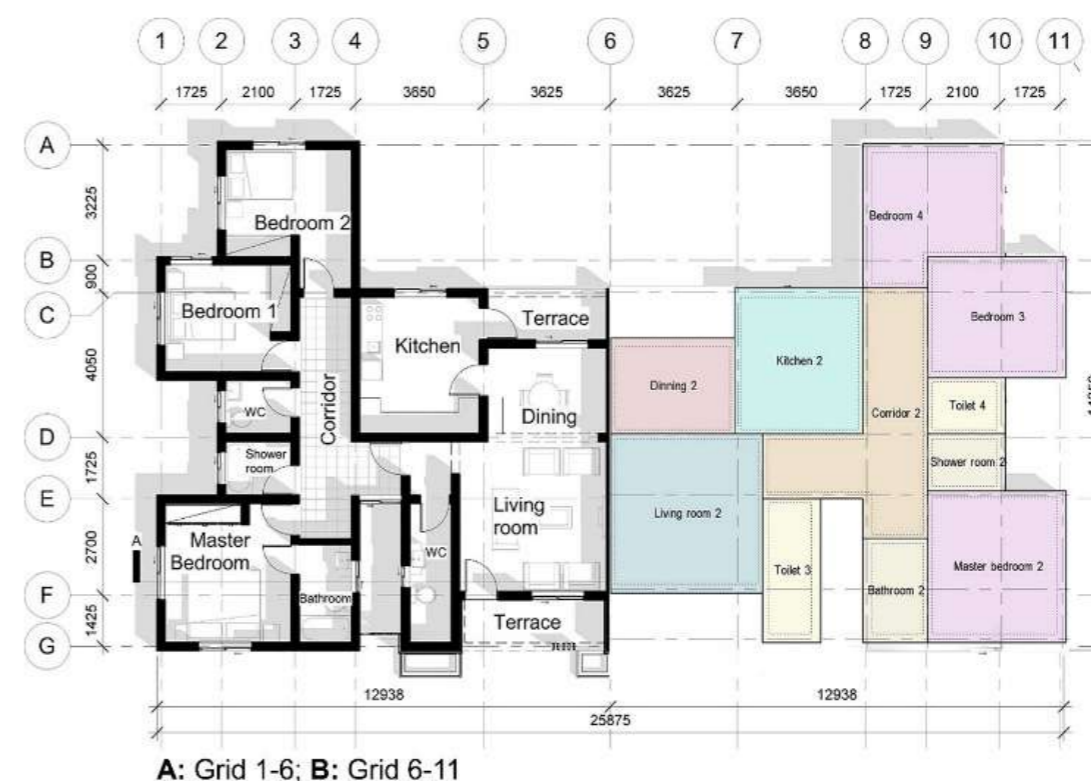
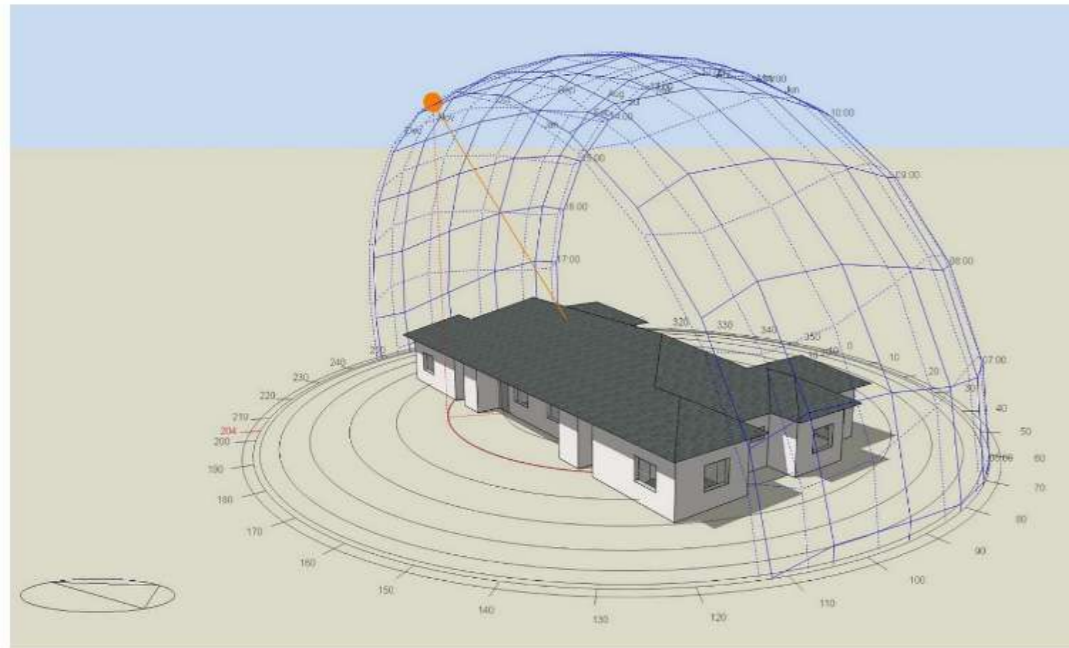


Figure 4: Building geometry developed in DESIGNBUILDER.

### Micro-climate

Nigeria can be described as a sun-rich country, receiving high levels of solar radiation throughout the year. This affects the thermal performance of buildings in the country (Qin, Zhang & Hiller, 2017:138). Using the weather data for Lagos in the simulation software, Figure 5 illustrates the typical microclimatic context of Lagos. According to Saafi and Daouas (2018:926), up to 95% of solar radiation can be absorbed by the roof surface. The absorption is primarily influenced by the roof material, its texture and its colour. Further, the roof aspect potentially accounts for 70% of total heat gain in residential buildings (Al-Obaidi, Ismail & Rahman, 2014:283). Roof insulation has the potential to aid in the reduction of heat gain (Kamal, 2012:89).



**Figure 5:** Building geometry developed in DESIGNBUILDER.

### Simulation data specifications

The data specifications are divided into three main categories, namely building envelope (construction and openings); occupancy (activity); and equipment (lighting and HVAC). These parameters were specified to accurately depict the Nigerian context under which the roof insulation materials were tested.

#### Building envelope information

Table 1 presents the specifications for the windows and building elements, including the roof, walls, floor and the windows (as openings). The roof of the simulated building consists of 25 mm-thick concrete roof tiles, at a roof pitch of 28°, with a 1555 mm air gap above the 13 mm gypsum plasterboard ceiling. An average air gap was calculated. The wall specification consists of 13 mm dense plaster applied to both sides of 225 mm concrete blocks. The floor construction includes 11 mm thick ceramic/porcelain tiles as a floor finishing on 50 mm-thick floor screed, which is on 150 mm-thick cast-*in-situ* concrete.

**Table 1:** Details of the building envelope.

Group	Data set	Parameter	Specifications
Construction	Construction template	Template	Uninsulated, medium weight
	Construction	External walls	Concrete block wall, 225 mm, uninsulated
		Pitched roof (unoccupied)	Uninsulated – medium weight
		Internal partitions	Concrete block wall, 225 mm, uninsulated
	Floors	Ground floor	Uninsulated
	Sub-surfaces	External doors	Metal door
		Internal doors	Wooden door
	Airtightness	Model infiltration	Yes
		Constant (ac/h)	1.000
		Schedule	On 24/7
Openings	Glazing template	Template	Single glazing, clear, no shading
	External windows	Glazing type	Sgl Clr 6 mm
		Layout	Preferred height 1.2m, 20% glazed
		Type	3-Preferred height
	Dimensions	Window to wall %	20.00
		Window height (m)	1.20
		Sill height (m)	0.90
		Outside reveal depth (m)	0.00
	Frame and dividers	Frame/dividers	Yes
		Construction	Aluminium window frame (no break)

#### Occupant activity information

Activities for individual zones within the habitable spaces were selected by using the activity templates. The templates specify the use of the space and occupancy hours, among other factors, for the simulations. A typical activity tab with the selected specifications is shown in Table 2. Minor adjustments to the template include changing the occupancy specifications to “Married\_Couple\_Two\_Children” for each three-bedroom apartment, the occupancy density to 0.0433 people/m<sup>2</sup>, as well as changing the number of people to 10 (five people per residential unit).

Based on the hourly weather data and using the ASHRAE Standard 55-2004 comfort model in CLIMATE CONSULTANT®, a comfort level of 22 °C was considered. This aligns with the typical comfort range of 22 °C to 25 °C, as specified by the ASHRAE standards. The ASHRAE standards have been used to investigate indoor comfort in Nigeria (Ogbonna & Harris, 2008:2; Adunola, 2014:195; Ahadzie, Ankrah, Efeoma & Uduku, 2014:396; Omonijo, 2017:101).

A challenge when using international standards such as ASHRAE, is that the standards are not contextualised and often do not take the specific cultural and environmental responses of residents into account. In a study of the air-conditioning temperature set point for Lagos, Sangowawa and Adebamowo (2012:7) concluded that the ideal comfort level in Lagos was 16 °C. To accurately depict the context of Lagos in the dynamic BEM, the cooling temperature set point was adjusted to 16 °C.

**Table 2:** Specifications regarding occupant activity.

Data group	Parameter	Specification
Activity template	Template	Domestic bedroom
	Zone type	1-Standard
	Zone multiplier	1
	Include zone in thermal calculations	Yes
	Include zone in radiance daylighting calculations	Yes
	Detailed occupancy template	Married_Couple_Two_Children
Occupancy	Occupancy density (people/m <sup>2</sup> )	0.0433
	Number of people	10
	Latent fraction	0.5000
Metabolic Heat	Metabolic rate	Bedroom (dwelling)
	Metabolic factor	0.90
	Clothing schedule	Default clothing schedule
Heating setpoint Temperatures	Heating (°C)	14.0
	Heating set back (°C)	12.0
Cooling setpoint Temperatures	Cooling (°C)	16.0
	Cooling set back (°C)	18.0

#### Equipment usage information

Table 3 highlights the data specifications for lighting and HVAC equipment used in the dynamic BEM. For lighting, the general energy code template was selected. The National Building Energy Efficiency Code of Nigeria specifies a lighting power density not more than 6 W/m<sup>2</sup> (Federal Ministry of Power Works and Housing (Housing Sector), 2017:15). The normalised power density of 3.4 W/m<sup>2</sup>-100 lux value specified by the template was adopted. The selected HVAC equipment was a “split air conditioning system without fresh air”. The operating hours for the air conditioning system were regulated by the activity templates described in section 3.2.1.

**Table 3: Details of lighting and HVAC equipment.**

Group	Data sets	Parameter	Specification
Lighting	Lighting template	Template	General energy code
	General Lighting	Normalised power density (W/m <sup>2</sup> -100 lux)	3.4000
		Luminaire type	Suspended
		Return air fraction	0.000
		Radiant fraction	0.420
		Visible fraction	0.180
	Lighting control	Working plane height (m)	0.800
		Control type	Linear
		Minimum output fraction	0.100
		Minimum input power fraction	0.100
HVAC template		Template	Split no fresh air
HVAC	Mechanical ventilation	Outside air definition method	Minimum fresh air (Sum per person + per area)
	Operation	Schedule	Dwell DomBed Occ
	Cooling	Cooled	Yes
		Cooling system	Default
		Fuel	Electricity from grid
		Cooling system seasonal coefficient of performance	1.800
	Domestic hot water	Domestic hot water	No
Natural ventilation	Natural ventilation	No	

**RESULTS AND DISCUSSIONS**

The simulations measure the impact of the preselected roof insulation material types on the indoor climatic conditions and the required cooling loads in a typical urban residential building in Lagos, Nigeria. The basis for the material selection included a minimum thermal resistivity (R-value) of 2.5 m<sup>2</sup>k/W. A variance in the thermal conductivity (k-value) and probable accessibility of the insulation materials within Nigeria were also considered. Lastly, the construction technique of the roof insulation materials was considered when selecting the materials. Table 4 summarises the characteristics of the three roof insulation materials.

**Table 4: Details of the roof insulation materials used in the dynamic simulations.**

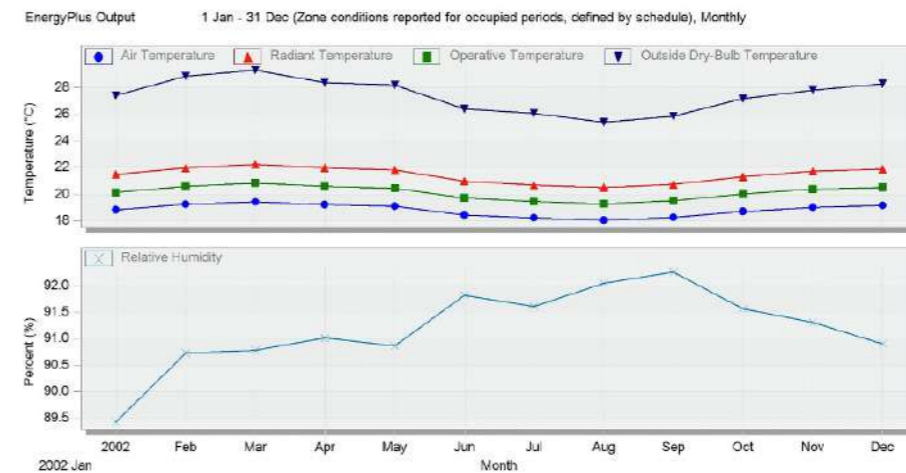
Name	Depth (mm)	k-value (W/mK)	Cost (R/m <sup>2</sup> )	Cost* (₦/ m <sup>2</sup> )	Notes
Glass wool insulation	100	0.0390	139.59	3 024.35	The overall cost is a sum of the insulation material supply cost per m <sup>2</sup> (R74.59/m <sup>2</sup> ) and the labour cost per m <sup>2</sup> (R65.00/m <sup>2</sup> ).
Extruded polystyrene (XPS)	100	0.0340	498.36	10 798.51	The cost used is a sum of the insulation material cost per m <sup>2</sup> (R437.00/m <sup>2</sup> ), the labour cost per m <sup>2</sup> (R50.00/m <sup>2</sup> ) and other fixing materials (R11.36/m <sup>2</sup> ).
Spray polyurethane foam (SPF)	100	0.0227	447.00	9 685.64	The total cost is inclusive of the insulation material cost and installation cost per m <sup>2</sup> (R447.00/m <sup>2</sup> ).

\*The exchange rate used is ZAR (R) 1.00 = NGN (₦) 21.6660 (21 May 2020). The freeware online conversion source <https://www.xe.com/currencyconverter/convert> was used for the calculations.

**Baseline scenario: uninsulated roof**

Figure 6 illustrates the outdoor temperature, the corresponding indoor temperatures and the relative humidity for January through to December for the baseline scenario. The resulting system loads (the total cooling load) are shown in Figure 7 as the sum of the sensible cooling load and the latent cooling load. The EnergyPlus output showed an average external dry-bulb temperature of 27.4 °C.

For the baseline scenario (an uninsulated roof), the results showed that the average annual operative temperature and relative humidity were 20.1 °C and 91.2%, respectively. A peak operative temperature of 20.9 °C occurred in March, which also recorded a peak external temperature of 29.3 °C. Conversely, the lowest operative temperature and lowest outside temperature were observed in August at 19.3 °C and 25.4 °C, respectively.



**Figure 6: Indoor temperature and relative humidity for the baseline scenario.**

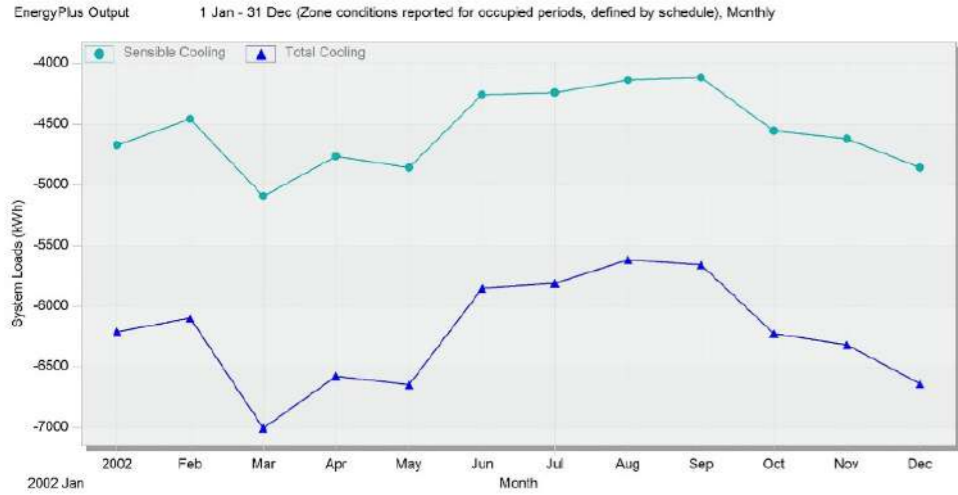


Figure 7: Sensible and total cooling loads for the baseline scenario.

The results calculated that a total cooling load of 74 670.6 kWh/year was required. Peak cooling loads were logged in March (7 004.8 kWh), while the lowest cooling loads occurred in August (5 619.0 kWh). The data indicate an outside temperature variance of 3.9 °C (the difference between the highest and lowest recorded outside temperatures). Analysing the cooling loads at March and August showed that the temperature variance of 3.9 °C resulted in a cooling load variance of 1 385.8 kWh.

### Glass wool insulated roof

Figure 8 shows the indoor temperatures and relative humidity for the building when glass wool is used as roof insulation in the baseline building. The resultant system loads required to achieve these indoor conditions are shown in Figure 9. Using a cooling temperature setpoint of 16 °C, the results indicated an annual average operative temperature of 19.2 °C at a relative humidity of 72.52%. The peak temperature occurred in March at 19.8 °C, and lowest operative temperature occurred in August at 18.5 °C.

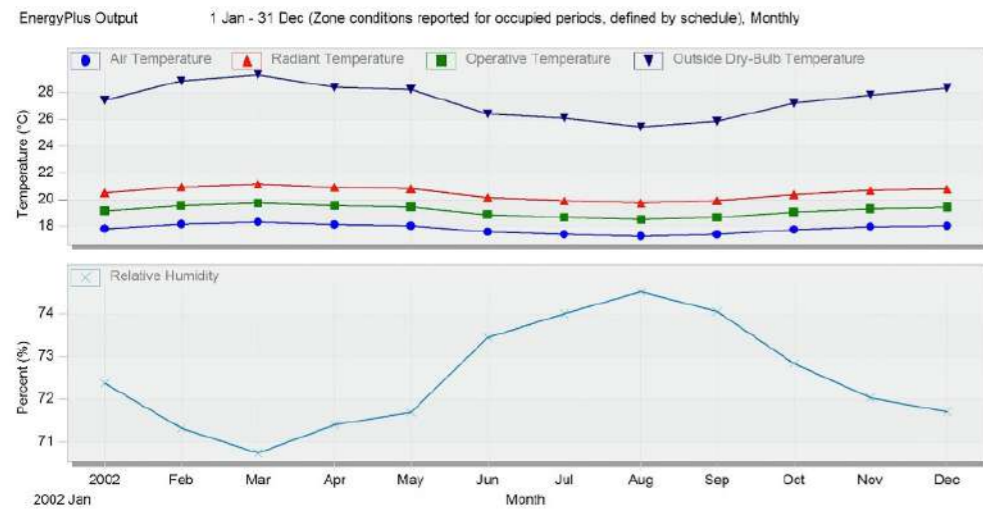


Figure 8: Indoor temperature and relative humidity for the building with glass wool roof insulation.

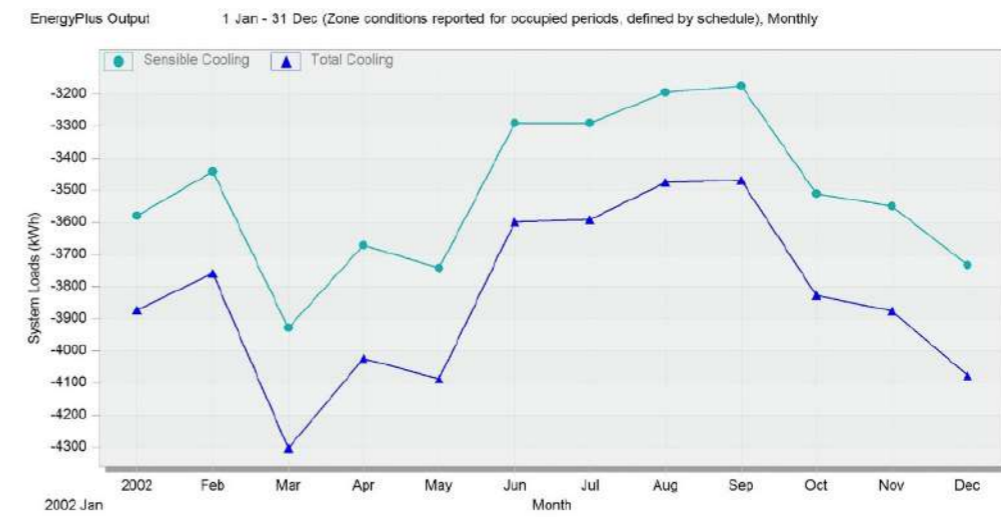


Figure 9: Sensible and total cooling loads for the building with glass wool roof insulation.

The simulation outputs indicated that, at the determined indoor conditions, the total cooling load required was 45 959.0 kWh/year. This showed a decrease of 28 711.6 kWh/year on an annual basis when compared with the total cooling load of the baseline scenario. Peak and lowest cooling loads were observed in March at 4 302.5 kWh and 3 468.4 kWh in September, respectively. The data indicate the use of glass wool roof insulation leads to an annual 38.45% reduction in cooling load.

### XPS insulated roof

Figure 10 demonstrates the indoor temperatures and relative humidity for each month of the year using 100 mm thick XPS as roof insulation. For this scenario, the 13 mm gypsum plasterboard was excluded because the XPS material also functioned as a ceiling. Figure 11 shows the resulting cooling loads at a setpoint of 16 °C. Annual average operative temperatures of 19.2 °C were indicated, while March recorded a peak operative temperature of 19.8 °C, further decreasing to its lowest value in August at 18.5 °C.

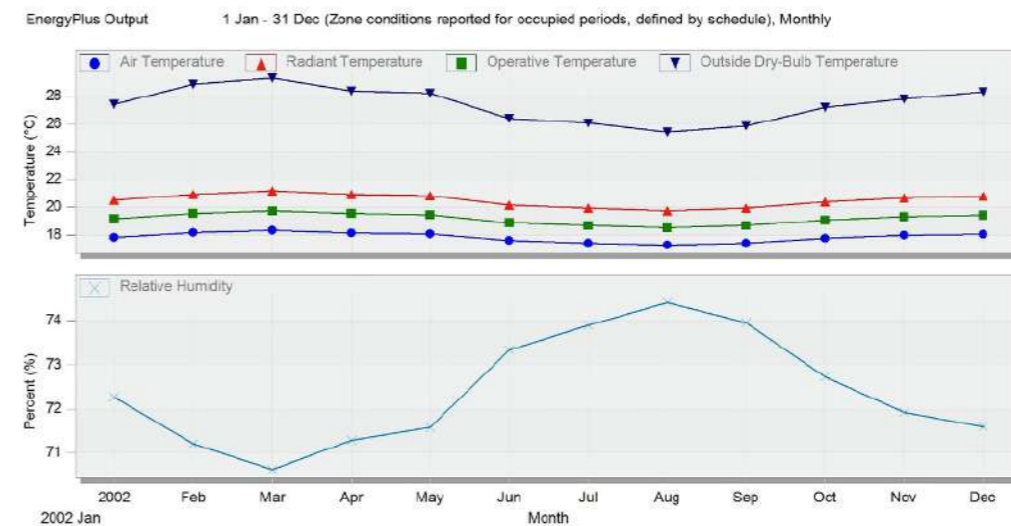


Figure 10: Indoor temperature and relative humidity for the building with XPS roof insulation.

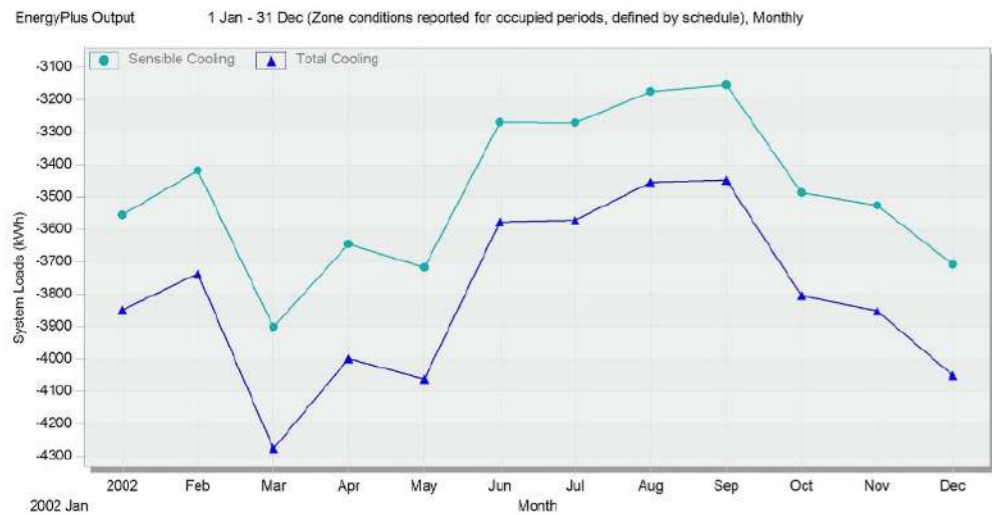


Figure 11: Sensible and total cooling loads for the building with XPS roof insulation.

The EnergyPlus output indicated that a cooling load of 45 678.9 kWh/year was needed to achieve these indoor conditions. When compared with the baseline, this translated to a reduction of 28 991.7 kWh/year. The peak cooling loads were observed in March at 4 275.9 kWh. The lowest total cooling load of 3 447.6 kWh was in September. The simulation output indicated that at a cooling temperature setpoint of 16 °C, the use of XPS roof insulation annually decreased the energy consumption for cooling by 38.83%.

#### SPF insulated roof

Figure 12 illustrates the resultant indoor temperatures and relative humidity for the building when 100 mm thick SPF is used as roof insulation at a set cooling temperature 16 °C. The system loads are shown in Figure 13. Results indicated that operative temperatures and relative humidity at 19.2 °C and 72.42% respectively were consistent with the values obtained when using other roof insulation materials. March and August recorded the highest and lowest operative temperatures at 19.7 °C and 18.5 °C respectively.

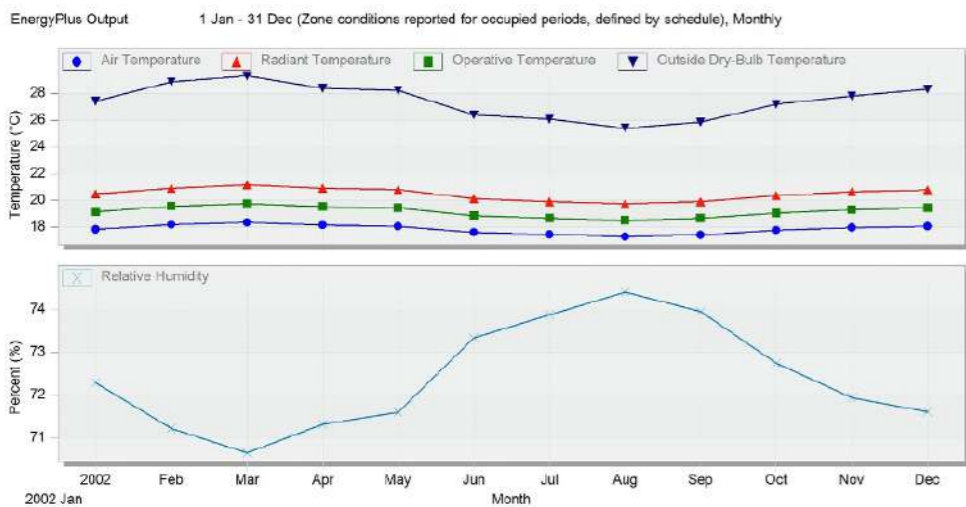


Figure 12: Indoor temperature and relative humidity for the building with SPF roof insulation.

The outcome of the simulation indicated that the total cooling load was 45 327.5 kWh/year. This was a reduction of 29 343.1 kWh/year when compared with the baseline scenario. Peak cooling loads occurred in March at 4 242.0 kWh, with September having the lowest cooling loads at 3 422.0 kWh. The data showed that, in the cultural response comfort scenario (cooling

temperature setpoint of 16 °C), the implementation of the SPF insulation resulted in a cooling load reduction of 39.30% annually.

#### Comparison of performance and cost

A comparison of the annual performance of the roof insulation materials and the associated construction costs is highlighted in Table 5. This comparison was made to determine a balance between performance and related costs. The key performance index (KPI) for energy use (in kWh/m<sup>2</sup>/year) was used to depict the performance. Lower KPIs indicated better energy efficiencies. The formula to calculate the KPI is stated as follows:

$$\text{Key Performance Index (KPI)} = \frac{\text{Total energy consumed in year}}{\text{Total floor area}}$$

In this equation, the total floor area used is the sum of the floor areas of all the habitable spaces (149.243 m<sup>2</sup>).

Table 5: Comparison of material performance and related construction costs.

INSULATION MATERIAL SPECIFICATIONS				PERFORMANCE				
Name	k-value (W/mK)	Depth (mm)	R-value (m <sup>2</sup> K/W)	Operative Temp. (°C)	Relative Humidity (%)	Total cooling loads (kWh/year)	KPI (kWh/m <sup>2</sup> /year)	Costs (₹/m <sup>2</sup> )
Uninsulated building	N/A	N/A	N/A	20.1	91.20	74 670.0	500.32	N/A
Glass wool	0.0390	100	2.56	19.2	72.52	45 959.0	307.95	3 024.35
XPS	0.0340	100	2.94	19.2	72.41	45 678.9	306.07	10 798.51
SPF	0.0227	100	4.40	19.2	72.42	45 327.5	303.72	9 685.64

As shown in Table 5, the SPF material exhibited the highest performance at 303.72 kWh/m<sup>2</sup>/year when compared with glass wool and XPS, at the cost of ₹ 9 685.64/m<sup>2</sup>. The construction costs for glass wool material was ₹ 3 024.35/m<sup>2</sup>. Using glass wool insulation would result in a performance loss of 4.23 kWh/m<sup>2</sup>/year when compared to the best-performing SPF. However, construction costs would be decreased by approximately 69% when using glass wool, as opposed to SPF.

In addition, the results show that the use of XPS instead of the SPF amounted to a performance loss of 2.35 kWh/m<sup>2</sup>/year. However, there was an increase in construction cost of 11.5% when using XPS material. The result was an additional ₹ 1 112.87/m<sup>2</sup> when compared with SPF. The R-value variance between the best performing and the least performing materials was 1.84 m<sup>2</sup>K/W. The results indicate that the variance in R-value resulted in an approximately 3.00 kWh/m<sup>2</sup>/year difference in performance. The proximity in performance values of the SPF and the XPS, when compared with their difference in R-values (4.40 m<sup>2</sup>K/W and 2.94 m<sup>2</sup>K/W, respectively), suggested a threshold of diminishing returns.



## CONCLUSIONS

The paper assessed the effect of three roof insulation materials on the cooling loads and indoor conditions of urban residential buildings in Lagos, Nigeria, using dynamic BEM simulations. A baseline scenario was developed as a reference point to quantify initial indoor conditions and cooling loads in the buildings without roof insulation. After that, simulations were conducted for three different roof insulation materials. Consideration was given to the cultural context by adapting key parameters, in particular, the temperature cooling setpoint of 16 °C.

For the baseline scenario, a key performance indicator of 500.32 kWh/m<sup>2</sup>/year at an operative temperature of 20.1 °C and a relative humidity of 91.2% was determined. The use of glass wool, extruded polystyrene and spray polyurethane foam (SPF) as roof insulation (at a cooling setpoint of 16 °C) resulted in cooling load reductions of 38.45%, 38.83% and 39.30% respectively. Operative temperatures were consistent at 19.2 °C for all three insulation materials, while the relative humidity averaged at 72.45%.

The results indicate that, by including roof insulation as a passive technique as part of the roof component in urban building design in Nigeria, the energy required to address cooling loads could be decreased by nearly 40%, while simultaneously improving indoor thermal conditions. Further advantages include reduced annual building operational costs and enhanced occupant well-being. The adoption of roof insulation as a passive technique potentially alleviates energy-related greenhouse gas emissions, thereby promoting resource efficiency and sustainability in the Nigerian built environment.

When only comparing R-value results, the SPF material was the best performer. However, when considering material performance and construction costs, the results indicated that glass wool was the best performing insulation material. The product reduces the cooling loads (with approximately 2% performance variation) at a 31% lower cost, when compared with that of the best performing material. Thus, a balance between performance and cost can be achieved at a roof insulation R-value between 2.5 m<sup>2</sup>K/W and 3.0 m<sup>2</sup>K/W.

The outcome of the research could impact on retrofitting existing residential stock, both for single storeys and the upper floor of multi-storeys. Studies focusing on thermal comfort in the built environment of Nigeria need to consider culturally contextualised practices and passive building techniques.

Future studies could investigate the use of other passive techniques for heat reduction, such as wall insulation and evaporative cooling. Further research could compare the simulation results with empirical results. The resulting environmental costs of the insulation materials and other applicable passive techniques could also be investigated in future studies. Lastly, a comparison between the performance and construction costs could also prove beneficial when considering real-world implementation.

## ACKNOWLEDGEMENTS

The authors acknowledge the financial support of the National Research Foundation South Africa, Grant no. 118690.

## LIST OF REFERENCES

- Adunola, A. O. 2014. Evaluation of urban residential thermal comfort in relation to indoor and outdoor air temperatures in Ibadan, Nigeria. *Building and Environment*, 75:190-205.
- Ahadzie, D. K., Ankrah, N. A., Effeoma, M. O. & Uduku, O. 2014. Assessing thermal comfort and energy efficiency in tropical African offices using the adaptive approach. *Structural Survey*, 32:396-412.
- Al-Obaidi, K. M., Ismail, M. & Rahman, A. M. A. 2014. Passive cooling techniques through reflective and radiative roofs in tropical houses in Southeast Asia: a literature review. *Frontiers of Architectural Research*, 3:283-297.
- Babalola, O. D., Ibem, E. O., Olotuah, A. O., Opoko, A. P., Adewale, B. A. & Fulani, O. A. 2020. Housing quality and its predictors in public residential estates in Lagos, Nigeria. *Environment, Development and Sustainability*, 22:3973-4005.
- Beccali, M., Cellura, M., Fontana, M., Longo, S. & Mistretta, M. 2013. Energy retrofit of a single-family house: Life cycle net energy saving and environmental benefits. *Renewable and Sustainable Energy Reviews*, 27:283-293.
- Cellura, M., Guarino, F., Longo, S. & Mistretta, M. 2014. Energy lifecycle approach in Net zero energy buildings balance: operation and embodied energy of an Italian case study. *Energy and Buildings*, 72:371-381.
- Desjardins, J. 2018. *By 2100 none of the world's biggest cities will be in China, the US or Europe* [Online] Available from: <https://www.weforum.org/agenda/2018/07/by-2100-none-of-the-worlds-biggest-cities-will-be-in-china-the-us-or-europe> [Accessed: 13 September 2018].
- Ezema, I., Olotuah, A. & Fagbenle, O.I. 2015. Estimating embodied energy in residential buildings in a Nigerian context. *International Journal of Applied Engineering Research*, 10:44140-44149.
- Ezennaya, O., Isaac, O., Okolie, U. & Ezeanyim, O. 2014. Analysis of Nigeria's national electricity demand forecast (2013–2030). *International Journal of Science and Technology Research*, 3:333-340.
- Federal Ministry of Power Works and Housing (Housing Sector). 2017. National Building Energy Efficiency Code. Abuja/Nigeria: Federal Ministry of Power, Works and Housing.
- Filippin, C., Larsen, S. F. & Ricard, F. 2018. Improvement of energy performance metrics for the retrofit of the built environment. Adaptation to climate change and mitigation of energy poverty. *Energy and Buildings*, 165:399-415.
- Ilesanmi, A. 2012. Housing, neighbourhood quality and quality of life in public housing in Lagos, Nigeria. *International Journal for Housing Science and Its Applications*, 36: 231-240.
- International Energy Agency (IEA). 2014. *Africa energy outlook-a focus on energy prospects in Sub-Saharan Africa*. Paris, France: Tech. rep. International Energy 807 Agency.
- International Energy Agency (IEA). 2018. *Climate Change* [Online] Available from: <https://www.iea.org/topics/climatechange/> [Accessed: 24 May 2018].
- International Energy Agency (IEA). 2019. *Key stats for Nigeria, 1990-2016* [Online] Available from: <https://www.iea.org/countries/Nigeria/> [Accessed: 08 August 2019].
- Iyke, B. N. 2015. Electricity consumption and economic growth in Nigeria: a revisit of the energy-growth debate. *Energy Economics*, 51:166-176.
- Kamal, M. A. 2012. An overview of passive cooling techniques in buildings: design concepts and architectural interventions. *Acta Technica Napocensis: Civil Engineering & Architecture*, 55:84-97.
- Muggah, R. 2018. *African cities will double in population by 2050. Here are 4 ways to make sure they thrive*. [Online] Available from: <https://www.weforum.org/agenda/2018/06/Africa-urbanization-cities-double-population-2050-4%20ways-thrive> [Accessed: 13 September 2018].
- Ogbonna, A. C. & Harris, D. J. 2008. Thermal comfort in sub-Saharan Africa: field study report in Jos-Nigeria. *Applied Energy*, 85:1-11.
- Omonijo, A. G. 2017. Assessing seasonal variations in urban thermal comfort and potential health risks using physiologically equivalent temperature: a case of Ibadan, Nigeria. *Urban Climate*, 21:87-105.

- Onyenokporo, N. C. & Ochedi, E. T. 2019. Low-cost retrofit packages for residential buildings in hot-humid Lagos, Nigeria. *International Journal of Building Pathology and Adaptation*, 37:250-272.
- Pablo-Romero, M. D. P., Barajas, R. & Yniguez, R. 2017. Global changes in residential energy consumption. *Energy Policy*, 101:342-352.
- Qin, Y., Zhang, M. & Hiller, J. E. 2017. Theoretical and experimental studies on the daily accumulative heat gain from cool roofs. *Energy*, 129:138-147.
- Rupp, R. F., Vasquez, N. G. & Lamberts, R. 2015. A review of human thermal comfort in the built environment. *Energy and Buildings*, 105:178-205.
- Saafi, K. & Daquas, N. 2018. A lifecycle cost analysis for an optimum combination of cool coating and thermal insulation of residential building roofs in Tunisia. *Energy*, 152:925-938.
- Sangowawa, T. & Adebamowo, M. 2012. The concept of thermal comfort in the built environment given the current global economic crisis: a case study of Lagos, Nigeria. The 7th proceedings of Windsor conference.
- Siiriola, J. J. 2014. Speculations on global energy demand and supply going forward. *Current Opinion in Chemical Engineering*, 5:96-100.
- Solid Green Consulting. 2017. *Development of the National Building Energy Efficiency Code (BEEC)* [Online] Available from: <http://www.pwh.gov.ng/download/1510059611415.pdf> [Accessed: 28 May 2018].
- Tumminia, G., Guarino, F., Longo, S., Ferraro, M., Cellura, M. & Antonucci, V. 2018. Life cycle energy performances and environmental impacts of a prefabricated building module. *Renewable and Sustainable Energy Reviews*, 92:272-283.

# THE RETROFITTED GARI ROASTING STOVE: CONCEPT, DESIGN AND ANALYSIS

Donald Amrago, Technology Consultancy Centre, KNUST, agoameneva@gmail.com

Alex Donyinah, SNV Ghana, AKwameDonyinah@snvworld.org

Emmanuel Appiah, SNV Ghana, immanuelkappiah@gmail.com

## Abstract

*Ever since it was introduced into West Africa by the Portuguese in the 16<sup>th</sup> Century, the cassava crop (*Manihot esculenta* Crantz) has evolved in terms of its varieties and in terms of the end products produced among the various communities in which it is grown. One such process is the turning of cassava into gari. Gari is a staple food in most parts of West Africa. It is made from grated cassava to make dough. It is pressed to squeeze out water and starch, and then roasted in shallow metal or earthenware bowls into hard and crispy granules. These granules can be stored for a long period. This paper focuses on the stoves and energy inputs used for roasting cassava dough to make gari. The traditional gari stove was compared with a retrofitted traditional stove. The study was done in Ntankoro-Kintampo in the Brong Ahafo Region of Ghana. The study proved that the retrofitted stove was a significant improvement over the traditional stove. Using a Controlled Cooking Test (CCT) model, the retrofitted stove saved 44% on firewood when compared with the traditional stove. While there was no significant change between the two stoves in terms of time taken to process gari, there were significant differences in emissions of carbon monoxide (CO) and fine particulate matter (PM<sub>2.5</sub>), where 48.22% and 39.38% were the respective results between the retrofitted stove and the traditional stove. The energising development requirement of 40% was met, which was an indication that the retrofitted stove could be adapted for gari roasting enterprises.*

**Key Words:** cassava, firewood, laterite, retrofit, stove, traditional.

## INTRODUCTION

The origin of cassava (*Manihot esculenta* Crantz) is believed to be Central America. Currently, this staple root crop is cultivated in the tropics and consumed by millions of people who use it for the preparation of various foods and many industrial applications, such as adhesives for veneer, pharmaceuticals and paper (Dufour, 1994). Cassava is a perishable commodity with a shelf life of two to three days after harvest. When cassava is processed, its stability is enhanced and value is added, thereby reducing bulkiness at the marketing stage (Phillips, Taylor, Sanni & Akoroda, 2005). The increase in urban population has necessitated the demand for more staple shelf food. Some cassava products in this category include gari, tapioca and akyeke, which are Ghanaian foods. The convenience of these cassava products has meant that they have managed to retain their markets among many urban populations. In preparing these staple cassava products, heat is required to toast and stir constantly in large but shallow metal or earthenware bowls, usually over fire. Stirring is a necessity and it is done with either a piece of gourd/calabash or with a wooden paddle until the gari is dried sufficiently to form creamy, crispy granules. A hand feel or scoops into the mouth are the standard checks performed by an experienced gari roaster to ensure that uniform batches are produced.

It is noted that cassava roots are bulky and perishable. Moreover, most varieties are unsuitable for direct consumption because of the presence of cyanogenic glucosides. The processing of cassava into gari makes it potable, reduces the toxicity and increases the shelf-life of the product (Sanni, 1995). Adebayo *et al.* (2012) added that roasting or gelatinisation therefore improves the digestibility of the gari, the dryness of which determines its crispiness and storability. Thus, gari should have a moisture content of 8% to 10%.

Over the years, roasting in West Africa has evolved through the implementation of a variety of techniques and firing processes. One technique involves local hearths being built with adobe as a fire resistant and as a means to hold the roasting bowls. This type of fireplace is slightly better than the old three-stone stove. However, they suffer heat losses through walls and other openings due to poor circulation. A major challenge is the smoke generated from the biomass fuel, which engulfs most gari roasting environments. The purpose of this paper is to provide an appropriate solution to the inefficient and environmentally unfriendly traditional gari stoves through the application of intermediate technologies. This included the use of local earth materials and building techniques, as well as the application of proven scientific findings or practices in terms of the firing processes. This is why the current traditional gari stoves were retrofitted.

## The traditional gari stoves

The stoves were made from lateritic soil and built with adobe (atakpame) by laying two or three courses to the required height. The observation of the firing of the stove was conducted over six working days. It involved watching the firing and the gari roasting processes, the reactions of the women practitioners, and several question and answer sessions (before firing, during firing and after firing the stoves). These stoves looked rectangular in shape but with one end open, acting as the entrance. The three other sides (two length sides and one width side) were made of solid wall, which was 203 mm (about 8") thick. The walls had the following dimensions: the width was 1 130 mm (about 44.5"); the length was 1 650 mm (about 65"), and the height was 1 030 mm (about 40.5"). The roasting bowls were all made with 0.6 mm to 1.2 mm thick mild steel sheets, with a depth of 112 mm to 113 mm (about 4" to 5"). They had a width of 830 mm (about 32.75") and a length 1 140 mm (about 45"). The flange was placed on the stove wall and held on with clay.

Although the women operating the gari roasting stoves routinely polished the back sides of the stoves with red earth (fine laterite or clay), after stoking with firewood several times, the fire chamber showed signs of intense scorching, leading to disintegration. The worst affected parts were the entrance and two side walls. Continued raking of charcoal and ash from the base of the fire chamber created depressions, which increased the distance between the floor and the base of the roasting bowl. The absence of smoke outlets or chimneys caused smoke and heat to escape through the entrance. This created an atmosphere of smoke and intense heat for the women roasting the gari.



**Picture 1:** A traditional gari stove in use at Akrofrom, in the Brong Ahafo region of Ghana.

### Cassava in Ghana

The Portuguese brought cassava from Latin America to feed slaves in West Africa in the 16<sup>th</sup> Century (Okogbenin, Egesi, Fregene, 2006). They were also responsible for cassava being sent to India and East Africa in the 17<sup>th</sup> and 18<sup>th</sup> Centuries respectively. It was realised that the cassava crop was tolerant of drought, low soil fertility and poor crop husbandry (Van Vark, 2013). It served as a famine-reserved crop and was also widely grown in West Africa to satisfy increased food demand during the 20<sup>th</sup> Century due to an urban population boom (Eke-Okoro & Njoku, 2012).

The cultivation of cassava in Ghana occurs in the semi-deciduous forest or the transition to forest areas (Tweneboah, 2000). It can also be found in most agro-ecological zones in Ghana due to its tolerance of poor soils with low water content and nutrients. For maximum rooting and root penetration, cassava requires loose soils – sandy to loamy soils – for better yields. This makes cassava a hardy plant, suitable for the harsh parts of tropical terrain. Cassava varieties mature within eight months to 18 months. At the peak of its maturity, cassava may rot in the soil if it is not harvested. A value-added product such as gari is an intervention for the prevention of post-harvest losses. A study of the gari roasting process was therefore a necessity.

In Ghana, the gari processing industry has seen much improvement in terms of local production and the amount of employment it has created. While some processes, such as grating, have been mechanised, the processes of gari roasting, cassava peeling, washing and up-rooting, among others, are still done manually, using traditional methods and techniques. This paper looked at the stoves and firing regimes of the gari roasting process, providing an intervention through the retrofitting of a traditional gari stove.

### Gari processing materials and equipment

Cassava dough, before it is turned into gari, is subjected to certain processes. These process stages require input materials such as cassava roots, knives for peeling them, basins and water for washing peeled cassavas, graters for grating cassava into mash (dough), sacks for fermenting the cassava mash, sieves or sifters for refining the product, fuel for roasting the gari, as well as packaging materials for packaging the finished products. Appropriate equipment is needed at each of these processing stages, such as a cassava harvester, grater, fermenting trough, press, roasting bowl, stove, gari grain sifter, sealing or stitching machine, and weighing scale.

### Toasting/roasting/garifying

Toasting and stirring is done constantly in a large, shallow cast-iron pan (or an aluminium or earthenware bowl) over a fire, using a piece of gourd or a wooden paddle, until the gari is dried enough according to hand feel. This may take 20 minutes to 30 minutes, depending on the heat intensity and quantity of sifted cake. The finished product (gari) is usually identified as such when the colour changes from white to cream (for non-palm oil fortified gari) and the hand feel of the grains or particles is crispy. Toasting can also be done mechanically through the use of an automated garifyer or other improved garifyers made of stainless steel material, using firewood or charcoal as the heat source. Tubman (1989) noted that rotating drum roasters do not produce good quality gari because the device does not mix and roast the gari well. One good reason for manual roasting is the ability of the calabash or gourd to be reversed so that the backside can be used to break up lumps during the early stages of gelatinisation, when the raw dough is placed in the roasting bowl.

### Materials and methods

All materials used for retrofitting were obtained locally (within the community where the stoves were refitted), as shown in Table 1 below.

### Material preparation

Laterite or clay was measured out (by volume). For example, measurements included tractor trailer, truck bucket and tricycle loads (locally known as aboboya or motoking). Sand, wood-ash and grog were added as shown in the table below. The rule of thumb was that the amount added depended on the plasticity of the laterite or clay soil.

**Table 1:** Composition of earth materials used to retrofit the traditional stove.

Material	High Plastic Laterite/Clay	Low Plastic Laterite/Clay
Laterite or clay soil	50%	60%
Sand	20%	20%
Wood-ash	10%	10%
Grog	20%	10%
Total	100%	100%

A basic scientific knowledge of the material is an advantage for good mixing and blending. Laterite, as identified at road construction sites, is reddish brown and sticky, with small pebbles. Some laterite does not have these pebbles and is therefore more plastic or sticky. Natural clays are more plastic than laterite.

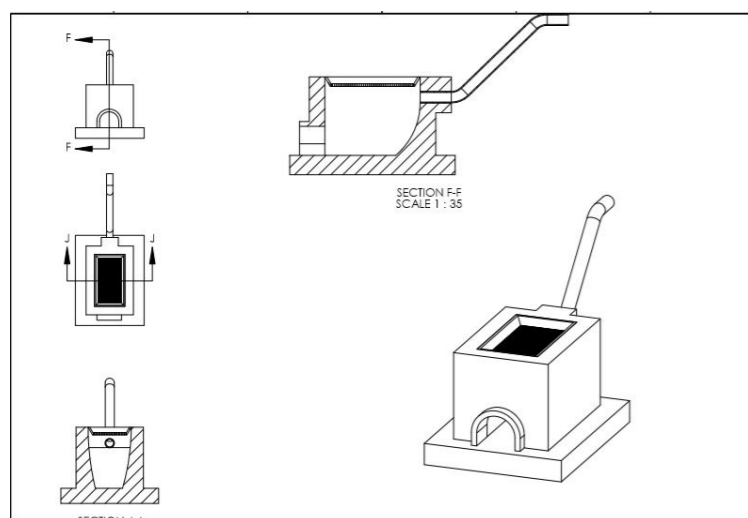
In any community, laterite can be identified by women potters or by local producers of fire hearths. Sand occurs naturally in most communities. Smooth sand is used for rendering walls, while rough sand comes from rivers. The latter is mixed with the laterite or clay. Wood-ash is collected from any wood-burned fireplace, such as bread ovens, gari roasting furnaces or chop bars (local restaurants). This needs to be collected over a period, then sieved and stored dry. Grog, which is crushed or milled, is made of an already-fired material. It can be obtained from broken bricks, such as from a brick site or from any fire chamber that was discarded and thrown away, such as a fire hearth, old stove or discarded pot. In the absence of grog, the quantity of sand can be increased. Wood ash and grog are already-fired materials and will therefore not shrink when used in materials for lining a fire chamber. Clay or laterite acts as a binder of sand, while grog stabilises the clay body to reduce instances of shrinkage and cracking. It adds to the strength of the wall.

A comparative study was done for the old traditional stove and the retrofitted stove. Real situation cooking, also known as a CCT, was done by roasting gari on both stoves, using the same quantity of cassava dough and firewood. In the field, a portable indoor air pollution (IAP) meter was attached to the cook or gari roaster in order to measure and record the possible inhalation of CO and PM<sub>2.5</sub> emissions for 60 minutes. An OHAUS R31 P30 electronic weighing scale was used for weighing the food and the firewood before and after the cooking. The firewood moisture content was determined by using a Voltcraft FM-300 moisture meter. Five random samples were taken at four different locations in the form of a bundle of firewood to determine dry basics. Later, average values were converted into wet basics. The available firewood was identified as Pepaa tree (a local name) with a calorific value of 19 200 KJ/kg (calorific value chart). It had a moisture content of 11.8%. Prevailing atmospheric conditions were determined with a THC-2 temperature, humidity and clock meter, resulting to an average temperature of 30.3 °C with a relative humidity of 57.2%.

### Concept and design

In design process, the following aspects were considered: technical performance; availability of materials; cost of materials; manufacturing processes; cost to consumer; skills required to operate; cultural suitability; and acceptance (Foley, Moss & Timberlake, 1986). Therefore, drawings were made so as to visualise the concepts for the various parts of the stove. The basic purpose was to make the retrofitting process simple by starting with a concept, progressing to visualisation, and then to construction. Being the first of its kind, it was necessary for the artisans to understand the basic principles underlining the concepts, their design and the reality of their physical construction. This philosophy facilitated artisanal capacity, skills and resourcefulness in terms of the retrofitting of the gari stove.

The design process took problem framing, concept evaluation, tools and resources into consideration. One of the interventions made for the traditional stove was the provision of a reduced firebox as an entrance to the stove. It also meant that the entrance needed to be large enough to take minimal sizes of wood, compared with a traditional stove, where all the firewood is pushed into the firebox. Provision was made for a chimney outlet to draw in heat and also to act as an outlet for smoke, so as to eliminate CO and PM<sub>2.5</sub> from the working environment. The reshaping of the fire chamber enabled good circulation of heat movement in the chamber. Another intervention was the introduction of curved and rounded corners. Further, other surfaces were provided with insulating materials, such as sawdust mixed with laterite, to line the fire chamber for improved heat retention.



**Schematic Drawing 1:** New gari roasting stove design.

#### The retrofitting process

Generally speaking, to retrofit is to repair or to put to good use an old idea or product. It is a process that involves observations and a detailed understanding of the challenges or problems that existed before. The need for understanding the principles of science and technology are paramount. When retrofitting gari roasting stoves, one needs to understand stoves, flames, biomass, fire chambers, materials, building techniques, heating mechanisms, surface lining materials, stoking techniques and the possibility of adaption to facilitate the use of other energies. The inside lining of the old stove walls were chipped away. This was done to remove all loose walls that had been over-burnt during prolonged firing. This was done with care so as to not collapse the weak walls. The fire chamber floor was also scraped out so as to remove soft, accumulated layers of ash. Moreover, the old entrance was prepared in the same manner as the other walls. All crack lines and joints were gently exposed.

Materials (laterite, wood ash and sand) were batched-out and mixed with a shovel in a dry state. Water was added to a workable consistency. Foot-trampling was done and redone (two to three times) and covered with polythene sheets for 24 to 48 hours so as to enable all the dry particles in the mixture to absorb water and dry uniformly later in the wall. With the aid of a spade, the mixture was slidded and made into balls by hand. The balls were used for forming the walls – an adobe wall forming technique. This was done one layer at a time, starting from the base and working upwards on all sides.

A clay slip – formed by soaking clay or laterite in water and then agitating it until it turns into thick fluid – was applied after first dabbing the exposed walls with water (using an old mattress foam). This was done gently to enable the walls absorb water and become soft. This was repeated three to four times in intervals of about 15 minutes, so as to allow the walls enough time to absorb the water. All the soaked walls were left to soften up overnight. This was followed by painting the surfaces with the clay slip. The viscosity (thickness) of the clay slip should be such that it looks like porridge (locally known as Kooko). A soft bristle brush was used to apply the clay slip. Two or three coatings of clay slip were applied. The purpose of this was to soften the walls and also to act as an adhesive between the old stove walls and newly applied laterite/clay body that would reinforce the walls. Worn-out areas of the stove walls were filled with the same walling material. Hand scopes were used to fill and level the walls to a uniform thickness and height.

#### Fire chamber floor

In fixing the floor of the fire chamber, consideration was given to the continuous abrasion by the firewood that occurs during stoking, as well as the collection of charcoal and wood ash. Ferricrete stones were laid on the floor of the fire chamber. Heavily worn out parts of the stove walls had ferricrete stones laid as foundations, upon which the walls were formed. All the ferricrete stones were bonded with the prepared clay body (laterite, wood ash and sand).

#### Fire Box

As per the design concept, the firebox at the entrance to the stove needed to be small when compared with the large open entrance of the old stove. The new concept had the firebox hardened with ferricrete stones, which were used to protect the

entrance from the continued wear caused by firewood stoking. Ferricrete stones are common in the community where the stove was built. They are fire resistant and are used by local households as part of their three-stone fire places. In the absence of ferricrete stones, burnt clay bricks can be used for the firebox.

A wooden rack was made into a small arch to span the firebox. Ferricrete stones were used for the two sides of the firebox and were also laid over the arch. Since the ferricrete stones were not uniform in terms of size and shape, they were chiselled into shape and bonded with the same clay mixture used for the walls. Stove walls were put in place on both sides of the firebox, until the frontage was made to be the same height as the rest of the old stove. The arch structure was left in the firebox for two to three days. During this time, checks were conducted on all the walls to observe any form of cracks. These cracks were pressed and filled in by hand, and the stove was covered with plastic sheets. This prevented excessive drying and allowed the walls (both old and new) to merge slowly into one body. Due to pressure from stove owners to resume work, retrofitted stoves could not be allowed to dry naturally, which would have required 21 to 28 days. In this instance, after five to seven days of constant checking and observing for cracks, the women were allowed to paint and polish the external surfaces of the stoves with red clay. This is a practice used for dressing traditional hearths in households. This form of coating and burnishing is a maintenance technique used to seal off cracks and to enhance the lifespans of hearths and stoves. This is typically done daily before firing starts as a routine maintenance system practised by women in rural communities. The two bodies, stove walls and hearth were all earth-based. Therefore, the clay-based coating and painting solution bonded well with the surfaces. A slow fire was then allowed to heat up the chamber for half a day. The roasting bowl was filled with water and, after firing, the entrance was closed to retain heat in the chamber. This artificial drying process expedited the drying of the stove.

#### Chimney

The retrofitted gari stove had a chimney. The wall opposite the stove entrance was perforated 6 “ (152 mm) from the top. It had a diameter of 5 “ (127 mm). An earth wall was built from the ground up to the base of the hole at the back of the stove. Since the concept was to take biomass smoke away from the users, a horizontal tunnel (slightly rising) was created by placing a 5 “ polyvinyl chloride (PVC) pipe into the hole at the back of the stove, leading out beyond the edge of the shed. The PVC pipe was smeared with oil to prevent clay from sticking to it when it was covered with clay. The PVC pipe was left for two to three days for the tunnel cover to set and harden. At the end of the horizontal tunnel, the vertical chimney was fixed. This was also done in layers until it rose above the shed. An outlet cap was formed and fixed to keep rain water away and to pass out smoke from the stove. The PVC pipe was then pulled out from the chimney hole through the fire chamber of the stove.

#### Fire chamber lining

Lining the fire chamber was the final piece of work done before the roasting bowl was placed over the retrofitted stove. A mixture of fine saw dust, clay/laterite and wood ash were added in a dry state at a volumetric ratio of 50:40:10 respectively. Water was added to a workable consistency. The mixture was covered for two days to mature. This means that it must be prepared ahead of its usage. The dressing was started by hand and completed with a trowel, which was used to smooth the surface. The purpose of the lining was to create an insulating material which would maintain the heat in the chamber without absorbing it. The stove, although rectangular on the outside, had inside corners that were filled to provide curved surfaces. The chamber floor and walls were also shaped together into a “U” formation. This enabled the fire chamber to have good flame circulation and a concentrated rise of heat towards the base of the roasting bowl. A plastic sheet was used to cover the stove so as to control the drying rate. Each morning and evening, for two to three days, observations were conducted to check for cracks. These were joined where necessary.

#### Fixing the Roasting Bowl

Before the roasting bowl was fixed on the retrofitted stove, the top sides of the open stove were checked with a spirit level instrument to ensure proper levelling. Soft clay was laid (about 1 cm thick) over the rectangular walls. The roasting bowl was then gently lowered onto the stove. Checks were conducted for proper alignment on all the sides, before pressing the roasting bowl firmly to embed itself into the clay. The uncovered parts of the stove walls were dressed smoothly and covered with plastic sheets for slow drying to take place. Smoke was generated in the chamber to check for leakages underneath the roasting bowl, which rested on the stove walls. Clay fill-ins were done where necessary.



Picture 2: The retrofitted stove in use.

### Results and Discussion

The tests were carried out at Ntankoro-Kintampo, in the Brong Ahafo Region. This community is a large gari processing area in the middle belt or transition zone of Ghana. It was therefore an appropriate community to be selected for the retrofitting of traditional gari stoves.

This comparative test was conducted during the last quarter of 2017, on the traditional stoves (T1) and retrofitted stoves (R2). Raw data, measurements and tests were recorded using CCT version 2.0. A real cooking situation was practised. In this case, gari was roasted as part of the test. The biomass fuel used was from a tree known locally as the Pepaa tree, with a calorific value of 19 200 KJ/kg (calorific value chart). An average random moisture content of 11.8% was determined. Atmospheric conditions – temperature and humidity – that prevailed during the test period were recorded as 30.3 °C and 57.2% respectively.

During the CCT, the same weight of wood fuel and sieved cassava dough were assigned to each gari stove. In order to measure the possible inhalation of emissions (CO and PM<sub>2.5</sub>), the women operating the stoves were provided with IAP meters, which were attached to them. The CCTs on the two stove types were repeated three times.

Table 2: Basic data obtained from the CCT.

CCT Results: Traditional Stove (T1)		Units	Test 1	Test 2	Test 3	Mean	St. Dev.
Total weight of food cooked	g		16 996	17 045	16 865	16 968.7	93.1
Weight of char remaining	g		2 102	2 815	2 475	2 464	356.6
Equivalent dry wood consumed	g		28 506.7	22 090.8	27 395.2	25 997.6	3 428.7
Specific fuel consumption	g/kg		1 677.3	1 296	1 624.4	1 532.6	206.5
Total cooking time	min		91	80	92	87.7	6.7
CCT Results: Retrofitted Stove (R2)		Units	Test 1	Test 2	Test 3	Mean	St. Dev.
Total weight of food cooked	g		16 888	17 019	17 042	16 983	83.1
Weight of char remaining	g		1 412	939	2 450	1 600.3	772.9
Equivalent dry wood consumed	g		14 673	15 386.8	13 654	14 571.3	870.9
Specific fuel consumption	g/kg		868.8	904.1	801.2	858	52.3
Total cooking time	min		92	81	65	79.3	13.6

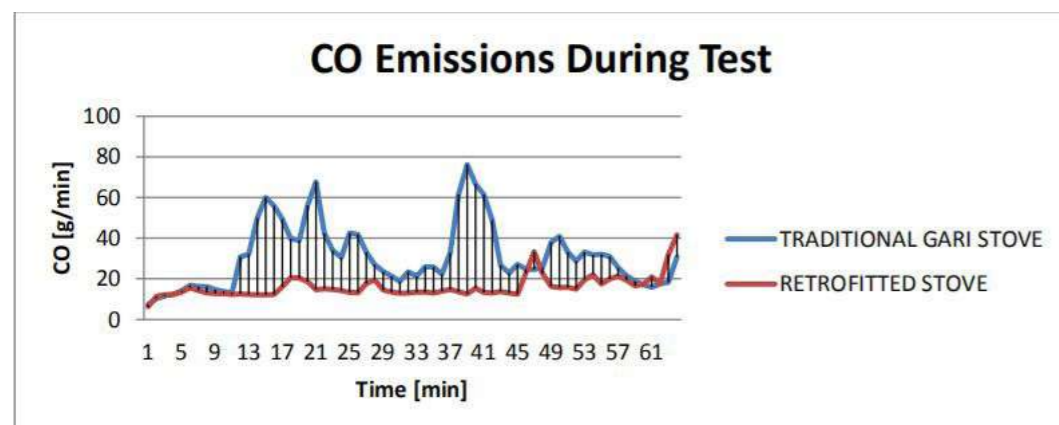
A statistical significance analysis (*t*-test) was used and the summary stove results were presented with a confidence level of 95% ( $P < .05$ ). This meant that the results were beyond reasonable doubt and were not due to chance (Mitchell & Jolley, 1996).

When comparing T1 and R2, it was observed that the temperatures of the external stove walls were 39 °C and 30 °C respectively. This implied that the walls absorbed heat and conducted it into the environment, instead of keeping the heat in the fire chamber where it was needed. Stove R2 showed a slight improvement because a local insulating material of saw dust mixed with clay was used for lining the fire chamber. Specific fuel consumed between T1 (1532.6 g/kg) and R2 (858 g/kg) indicated that there was a percentage difference of 44.01%. The processing rate of gari, measured in grams per minute, placed T1 at 193.5589 and R2 at 214.0714. However, there was no significant difference observed for the total weight of food cooked between T1 and R2, which was 16 968.7 gm and 16 983 gm respectively.

Char is what remains when firewood does not burn fully into wood ash. The weight of the char remaining after the cooking on T1 (2 464) and R2 (1 600.3) were determined and compared. There was a significant difference of 31.1% in terms of the char that remained when comparing the two different stoves. Therefore, the equivalent of dry wood that went into the CCT, as consumed by T1 and R2, was 25 997.6 g and 14 571.3 g respectively. This showed a significant difference of 43.95%. In terms of specific fuel consumed, T1 used 1 532.6 g/kg and R2 used 858 g/kg, as stated earlier. The percentage difference between the two stoves came to 44.01%. These results show that a large amount of char – not fully-burnt wood – remained in T1, indicating that T1 was also fed with more wood than R2, which burnt its wood fully to ashes, therefore having less char and less kilograms of wood consumed.

### Emissions

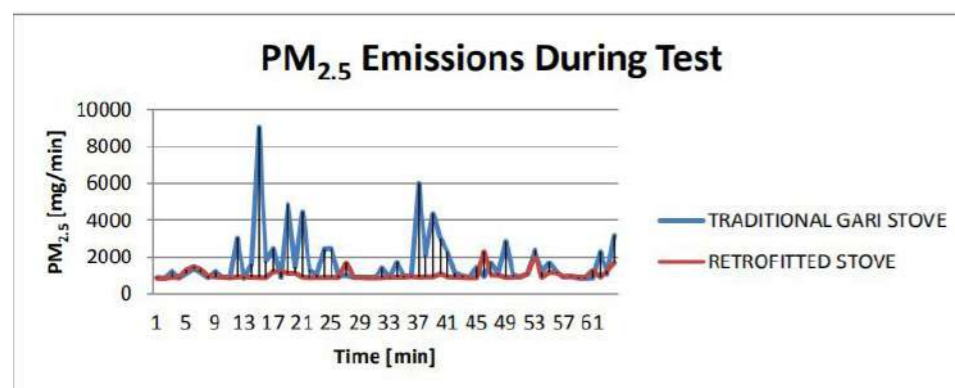
Gari roasting is carried over heat in West Africa. In Ghana, in particular, it is done over biomass stoves. These stoves emit smoke, CO and PM<sub>2.5</sub>. The CO emission from T1 and R2 were at levels of 31.15 g/min and 16.13 g/min respectively, which is a difference of 48.22%. Similarly, emissions of PM<sub>2.5</sub> from the T1 and R2 stoves reveal levels of 1 721.5 mg/min and 1 043.5 mg/min respectively. This trend can be explained by the inefficient burning of biomass in the combustion chamber of T1, resulting in carbon and soot in the fire chamber and chimney. The thorough burning of firewood emits less PM<sub>2.5</sub> and less smoke.



Graph 1: CO emission during test.

Stove	Traditional gari stove	Retrofitted stove
Carbon monoxide emission (g/min)	31.15	16.13
Significant level @95% confidence level between stoves		YES
% difference		48.22

Table 3: Figures from the CO emission test.



Graph 2: PM<sub>2.5</sub> emission test.

Stove	Traditional gari stove	Retrofitted stove
PM <sub>2.5</sub> emission (mg/min)	1721.5	1043.5
Significant level @95% confidence level between stoves		YES
% difference		39.38

Table 4: Figures from the PM<sub>2.5</sub> emission test.

## CONCLUSION

The traditional gari roasting stove was retrofitted to eliminate the drudgery and hazards associated with operating the traditional stove. A concept led to the designing and construction of retrofitted stoves, using available local materials such as laterite or clay soil, sawdust, wood ash, sand and ferricrete rocks. Using adobe construction techniques, the traditional gari stove was retrofitted with a firebox, insulated and reconfigured to have a “U”-shaped combustion chamber, as well as a chimney. Part of the concept was to save on costs. Therefore, the sizes of the stove and the roasting bowl were maintained. Using a statistically significant analysis (t-test), the results indicated that a significant difference of 44% was observable between the retrofitted stove and the traditional stove.

There was better heat retention in the fire chamber of the retrofitted stove, which was achieved by reducing heat losses through the walls and into the surrounding environment.

In terms of emissions, there was a significant difference of 48.22% for carbon monoxide and 39.38% for fine particulate matter, which was in favour of the retrofitted stove over the traditional stove. This paper establishes that the retrofitted stove proved safer and more user-friendly, while also being efficient in terms of firewood consumption. This paper therefore recommends the retrofitted stove to be promoted and used in the respective communities, not only for gari roasting but for other agro-cereals as well, such as ground nuts, beans, soya or maize. The reason for this is because the retrofitted stove met the energising development requirement of 40% fuel savings. Adapted versions could be used for round-bottom pots or scaled down for household uses. Gas can also be used in place of biomass.

## ACKNOWLEDGEMENT

The authors are grateful to the following SNV for providing funding for the testing of the retrofitted stove: to Institute of Industrial Research of CSIR for conducting the test; to Mr Yeboah and his team of artisans at Ntankro and Akrofrom (BA); and finally but not least, to the women stove owners for having the patience to wait for the retrofitting of their stoves.

## LIST OF REFERENCES

- Adjekum, A. A. 2006. *Cassava processing & marketing experiences from Ghana*.
- Taiwo, A. & Bart-Plange, A. 2016. Introduction of smokeless stove to Gari Producers at Koryire in the Yilokrobo Municipality of Ghana. *International Journal of Advanced Engineering, Management and Science*.
- Akinnuli, et al. 2015. *Design Concepts Towards Electric Powered Gari Frying*. Inter. Jour. of Scitif. & En. research
- Barnes, et al. 2012. *Cleaner hearths, better homes*. New Delhi, India: Oxford University Press.
- Barnes, et al. 1994. *Comparative Int. review of stoves programmes*. WB Tech paper (No 242). Energy series. WB Washington DC, USA.
- Bell. 2004. Doing your Research Project. *Society for tropical Root Crops - Africa Branch*:156-167. edited by Terry, E.R., Akoroda, M. & Arene, O.B. Open University Press. Owerri, Nigeria.
- Beamish & Donovan. 1989. *Village-Level brickmaking frieder*. GIZ Germany: Vieweg & Sohn Braunschweig.
- Ceballos, I., Ruiz, M., Fernandez, C., Pena, R. & Rodriguez, A. 2013. *The In Vitro mass-produced model mycorrhizal fungus, rhizophagua irregularis, significantly increases yields of the globally important food security crop cassava*. *PLoS One*, 8(8):e70633. [Online] Available from Doi: 10.1371/journal.pone.0070633
- Cocks, J. H. 1985. *Cassava: new potential for a neglected crop*. London: Boulder, Colo. Westview Press.
- Dufour, D. L. 1995. *A closer look at the nutritional implications of bitter cassava use*. In: Sponsel, L.E. *Indigenous peoples and the future of Amazonia: an ecological anthropology of an endangered world*. Tucson: University of Arizona Press.
- Eke-okoro, O. N. & Njoku, D. N. 2012. A review of cassava development in Nigeria. *Journal of Agricultural and Biological Science*, 7(1):59-65.
- FAO/IFA. 2005. Proceedings of the validation forum on the Global cassava dev. Strategy. *A Review*, 2.
- Foley, G., Moss, P. & Timberlake, L. 1986. *Stoves and Tress*. USA: International Institute for Environment and Development An Earthscan Paperback.
- Hahn, S. K., Mahungu, N. M., Otoo, J. A., Msabaha, M. A. M., Lutaladio, N. B. & Dahniya, M. T. 1987. *Cassava end African food crisis:24-29*. In: *Tropical root crops-root crops and the African food crisis*. Proceedings, Third Triennial Symposium of the International.
- Hahn, S. K. & Keyser, J. 1985. Cassava: a basic food of Africa. *Outlook on Agriculture*, 4:95-100.
- Hillocks, R. J. 2001. *Cassava in Africa*. Natural Resources Institute. Central Avenue, Chantham, Kent ME4 4TB, United Kingdom: University of Greenwich.
- Liu, A., Hamel, C., Elm, A., Costa, C., Ma, B. & Smith, D. L. 2002. Concentrations of K, Ca and Mg in maize colonized by arbuscular mycorrhizal fungi under field conditions. *Canadian Journal of Soil Science*. 82(3):272-278.
- Mitchell & Jolley. 1996. *Research design explain*. USA: Harcourt Brace College Publishers Philadelphia.
- MOFA. 2010. *Twenty Sixth USA National Farmer's Day Celebration*:16-23. Accra, Ghana: MOFA.
- Norsker & Danisch. 1991. *Forming techniques-for the self-reliant potter*. Germany: Braunschweig, GIZ.
- Norsker. 1990. *Clay materials for the self-reliant potter*, (62):32-46. Germany: Deutsches Zentrum fur Entwick/ungstechnologien, GATE.
- Oduro, I., Ellis, W. O., Dziedoave, N. T. & Nimako-Yeboah, K. 2000. Quality of Gari from selected processing zones in Ghana. *Food Control Journal*, 11:297-303.
- Okogbenin, E., Egesi, C. & Fregene, M. 2006. *Marker aided introgression of CMD resistance in Latin American germplasm for the broadening of the Genetic base of cassava in Nigeria*. NRCRI, Umudike Annual Report:2-6.
- Phillips, T., Taylor, D., Sanni, S.L. & Akoroda, M. 2004. *A Cassava industrial revolution in Nigeria*. In: *The potential for a new industrial crop*:43. Rome: IFAD/FAO.
- Rogers, E.M. 1995. *Diffusion of innovations*. (4th ed). N.Y.: The Free Press:
- Rhodes. 1981. *Kilns. Design, Construction and Operation*. USA: Chilton Books Company Radnor.
- Tweneboah, C.K. 2000. *Modern Agriculture in the Tropics with special reference to Ghana food crops*. Co-Wood Publishers.
- Van Vark, C. 2013. *Cassava can become Africa's new cash crop*. [Online] Available from: <http://www.theguardian.com/global-development-professionalnetwork/2013/mar/28/cassva-food-security-sub-sahran-africa>
- B. 1987. *Improved wood, waste and charcoal burning stoves*. In: *A Practitioners Manual*. London, UK: Intermediate Technology Publications.



# ENVIRONMENTAL HEALTH BASELINE ASSESSMENT IN THE MANGAUNG METROPOLITAN MUNICIPALITY: RODENT CONTROL AT JOE SLOVO SQUARE TOWNSHIP

\*K. Lebelo<sup>1</sup>, L.K Letsitsa<sup>1</sup>, N.A Moabi<sup>2</sup>, M.I Mokgadi<sup>1</sup>, R. Tsuinyana<sup>1</sup>, L. Sebege<sup>1</sup>, N. Jafta<sup>1</sup>, T. Makhele<sup>1</sup>, T.P Tsolo<sup>1</sup>, G.M Mosola<sup>2</sup>, B. Gqwetha<sup>2</sup>, N.F Lerothodi<sup>2</sup>, T. Mohatlane<sup>2</sup>

\*<sup>1</sup>Central University of Technology, Free State, Department of Life Sciences, South Africa, KLebelo@cut.ac.za

<sup>2</sup>Mangaung Metropolitan Municipality, Free State, Division: Municipal Health Services & Solid Waste, South Africa

## Abstract

*Rodents are the most widely dispersed mammals across different geographic locations. The ability of rodents to transmit diseases such as plague and leptospirosis is widely reported globally. It is vital to conduct environmental health baseline studies to assess environmental determinants of illness within the communities. Densely populated townships in South Africa are characterised by poor environmental conditions, such as poor waste management services, substandard housing, poorly maintained stormwater drains, and poorly maintained sewage systems. These factors are conducive to the breeding of rodent species. This paper discusses a study conducted in the Mangaung Metropolitan Municipality. The study aimed to describe the contributing factors to rodent infestation in the Joe Slovo Square township. The study revealed unsanitary living conditions, where 61.8% (n = 251) of the households had exposed garbage close to the premises, and 57% (n = 251) of the premises had active signs of recent rodent activity. Moreover, a significant majority of the residents expressed their dissatisfaction with poor housing, inadequate municipal waste collection services in the area, and a lack of rodent control tools (rodenticides and baiting equipment). The results of this baseline assessment can be used by municipal departments to improve service delivery and design management systems for the improvement of environmental conditions in and around various townships.*

**Keywords:** environmental health assessment, rodent control, community engagement, rodenticides, sustainable innovations.

## INTRODUCTION

Environmental health (EH) plays a significant role in all municipalities. Environmental health practitioners (EHPs) are mandated by legislation (Health Act 61 of 2003) to render municipal health services in the fulfilment of sections 24, 26, and 27 of the Constitution of the Republic of South Africa (Gazette, 2013; National Department of Health, 2004). Therefore, EH has various functions sub-divided into categories such as waste management, vector control, water quality monitoring, among others.

Several metropolitan municipalities in South African have embarked on rodent control initiatives over the past decade, namely: the City of Johannesburg, the City of Ekurhuleni and the City of Cape Town. The City of Johannesburg traditionally focused on rat killing/trapping and on health education. However, it has been noted that this approach does not account for other variables that affect the manifestation of rodents in the municipality, for example, house quality, sanitary services and domestic behaviour (Jassat, Naicker, Naidoo & Mathee, 2013). This argument was further addressed by the Medical Research Council of South Africa in its Health and Environment and Development Study in Johannesburg (Jassat *et al.*, 2013; Shezi *et al.*, 2019). The central message of the study was that rodent infestation required greater implementation plans with careful consideration

of social contexts. The responsibility of rodent control is shared by various stakeholders. The departments involved are: the health department, public works department, recreational department, and members of the community (Jassat *et al.*, 2013). Essentially, joint efforts will result in health education programmes and cleaner parks, as well as maintaining a good state of repair of major waste and water provision equipment.

The effectiveness of rodent control highly depends on conducting surveys. These surveys assist with information collection to implement proper control measures in certain situations. The causes of large rodent infestations in habitable environments can be investigated through surveys or environmental studies. However, surveys alone do not always provide an accurate picture of the extent of rodent infestations. There are many methods used during rodent control surveys (Rossi, Kadaouré, Godefroid & Dobigny, 2017). The trapping method assists with assessing rodent problems, but the process may take longer because rodents dislike anything unfamiliar or new. To capture rodents in a study in Italy, Longworth traps for domestic species and Havahart traps for rats were used (Vitale *et al.*, 2018). For pathological investigations of rodents, cage traps should be used during rodent surveys. The effectiveness of glue trappings highly depends on the quality of the glue used, the humidity and the ambient temperature.

## RODENT INFESTATION AND DISEASE TRANSMISSION

Poor environmental hygiene and substandard housing are among the environmental factors that cause health problems in urban cities. The following factors are significant direct or indirect contributors to the increase in rodent population numbers in most urban regions: inappropriate human behaviour, improper sanitation, dilapidated buildings, and poor waste management (Brooks & Matta, 2019; Letcher & Slack, 2019; Natrass, Stephens, Loubser & Cape Town, 2019; Weimann & Oni, 2019). When a rodent population causes significant damage to structures that costs more than the economic cost of controlling it, it is considered a pest. Significant damage to crops throughout the world is mostly caused by rodents (Singla, Babbar & Kaur, 2012). Food security is threatened by rodent outbreaks experienced worldwide.

Rodents are the most widely dispersed mammals and are the host of many types of zoonotic diseases (Tan *et al.*, 2019). Direct or indirect contact with infected rodents poses a great risk to humans, particularly agricultural workers. Rodent infestation is a public health challenge globally (Jassat *et al.*, 2013; Mathee, 2011; Roomaney, Ehrlich & Rother, 2012). Rodent infestation is a phenomenon in which rodents exist in large numbers in a particular place, often causing damage and/or disease. From an environmental health perspective, they are the source of several zoonoses. Poverty-stricken urban neighbourhoods are excessively affected because socio-economic factors promote rat infestations and rat-human contact (Lam, Byers & Himsforth, 2018). Rats thrive in urban centres where human environments provide easy access to harbourage and food. Aging infrastructure, poor sanitation, large population, high density housing and poverty have been consistently associated with urban rat infestations (Baum, 2017). Since rat infestations excessively affect populations that are already marginalised and disadvantaged, it is important to understand the full scope of potential rat-related health risks (Lam *et al.* 2018).

Rats exist in large numbers in low-income urban communities due to poor waste management and poor infrastructure (Baum, 2017). The epidemiology of rodent-borne diseases links rodents to several diseases such as plague, leptospirosis, Lassa fever, salmonellosis, rat-bite fever, viral haemorrhagic fevers and murine typhus. These diseases are transmitted by means of bites from infected rodents, contamination of food with rodent urine, or by rodents acting as vectors for other organisms such as fleas (Roomaney, *et al.* 2012). Rodents that are generally found in urban areas are the brown rodent (sometimes known as the Norway rat, sewer rat or *rattus rattus*), the black rodent and the domestic mouse (also known as *mus musculus*) (Minter *et al.*, 2018; Pini *et al.*, 2003; Terkel 1995; Tram & Aubin, 2016). For rodents to breed in nests made in burrows, lumber, rubble or secluded places within buildings, environmental lifeline factors such as water, food and shelter are required. Rodents are also known to be attracted to unhealthy environments such as exposed foodstuffs, food waste, domestic waste, garden waste, other accumulations of waste, and untidy storage (Colvin & Jackson, 1999; Jassat *et al.*, 2013). People become infected through exposure to or inhalation of infected rodent urine, droppings or saliva. The chances of infection increase when people are near spaces where rodents are actively living (Pini *et al.*, 2003).

## WASTE MANAGEMENT IN DEVELOPING REGIONS

South African townships in metropolitan areas currently face environmental challenges, considering the amount of waste disposed illegally by community members in open spaces. In developing urban areas associated with informal settlements, littering and overflowing waste bins are common. Nonetheless, the waste management problems in South African townships

are similar to those of many developing countries (Puling & Van der Merwe, 2004; Worku, 2016). The lack of waste collection services ranks high among the many issues contributing to the environmental health problem. In previous studies, municipal waste management challenges in South African informal settlements were compared against challenges in Bangladesh. The comparison looked at the lack of community involvement, negative attitude and the lack of responsibility by local waste management (Hasan, 1998). However, Puling & Van der Merwe (2004) assert that the lack of input regarding waste management by unemployed residents might be attributed to feelings of powerlessness, due to municipalities hiring private entities to render waste management services.

Solid waste management has become a significant issue among developing nations. Fast expanding populations, poor waste services, higher life-standards due to economic development and increasing urbanisation rates, increase the amount and variety of solid waste, leading to large amounts of waste being illegally dumped, burnt or disposed of in landfills (Coban, Ertis, and Cavdaroglu 2018; Dhokhikah, Trihadiningrum, and Sunaryo 2015). In such a complicated environment, municipal authorities need to develop the most effective way to deal with the consistently rising amount of metropolitan solid waste (Coban *et al.* 2018; Worku, 2016). Municipal solid waste management consists of several activities, including: collection, transportation, treatment, material recovery, energy recovery, and disposal. Municipal solid waste collection can be operated in several ways, including drop-off collection and door-to-door collection, or a combination of these (Seyring *et al.*, 2016). No unique method is used globally.

## METHODOLOGY

This study was the first of its kind undertaken in the municipality. It has the potential to become a longitudinal study that encompasses in-depth analysis and questions. The study was motivated by the perceived lack of capacity regarding rodent control activities, as well as by the lack of formal documentation regarding service standards for rodent control. The project was a descriptive quantitative study that aimed to describe possible environmental contributors to the manifestation of rodents in the area. This paper presents only the significant findings.

## RESEARCH POPULATION AND SAMPLE

This study formed part of a larger study aimed at describing service delivery challenges in the Mangaung Metropolitan Municipality. This paper focuses on a sub-section of the Joe Slovo Square township. The study population included a total population of 251 households in the Joe Slovo Square township, which is located 15 km outside the Bloemfontein city centre (29.16 ° S, 26.25 ° E). The residential area is characterised by poor environmental factors – as illustrated in Figure 1, Figure 2, Figure 3 and Figure 4. Most of the houses were built as part of the Reconstruction and Development Programme.

## DATA COLLECTION

Data were collected by means of inspection checklists and structured questionnaires designed by the researchers. The field workers included environmental health students from the Central University of Technology, across different levels of study. In addition, the Mangaung Metropolitan EHPs supervised the fieldwork and data capturing.

## DATA ANALYSIS

The researchers coded the inspection checklist and questionnaire, while data were captured via an IBM Statistical Package for Social Sciences Version 25 data file. The data were summarised in custom tables, cross tables and frequency tables. A confidence interval of 95% was used in the analysis. A chi-squared test for independence was conducted based on the responses, so as to determine the strength of association between specific variables (reported with  $p$ -values at a significance level of  $p = 0.05$ ). The qualitative data were then categorised in a thematic manner where codes were created using grounded theory.

## ETHICAL CONSIDERATIONS

Permission to conduct the study was sought and granted by the Central University of Technology, the Free State, the Department of Life Sciences, and the Mangaung Metropolitan Municipality Municipal Health Services Division. The researchers received consent from participants voluntarily. Moreover, the participants were advised on their rights to withdraw

at any stage of the study. The protection of the privacy of the participants was considered by making sure that the information collected was used for this study only.



*Figure 1: Blocked sewage system and leaking pipes.*



*Figure 2: Uncollected refuse piles and improper storage.*



Figure 3: Overgrown grass on the premises.



Figure 4: Openings in walls and signs of active rodents (rodent droppings).

## RESULTS AND DISCUSSION

Joes Slovo Square township is situated 15 kms outside of the Bloemfontein city centre. The township is predominantly characterised by multiple households per yard. This means that, on one stand, the possibility of multiple units exists, with some occupied by tenants or extended family members. This leads to increased waste generation and water usage (Awunyo-Vitor, Ishak & Seidu Jasaw, 2013; Leton & Omotosho, 2004). The township has a variety of premises classified under the following categories: residential, commercial, residential-commercial and vacant space (Figure 1). Figure 1 shows that 93.2% of the

premises in the township are primarily residential. A further 0.8% is categorised as commercial property. Some premises are zoned strictly for business use. Small enterprises, in the form of spaza shops, mini-markets and hair salons, among others, account for 5.6% of the total space while vacant spaces account for 0.4% thereof. Research indicates that the majority of municipal solid waste consists of food waste, rubble and paper, among others (Coban *et al.*, 2018). Therefore, by implication, the more commercial properties that are available in the township, the more waste will be generated as a result of purchasing power. However, the relatively low number of commercial properties in the area can be attributed to its proximity to bigger townships nearby, as well as to the city of Bloemfontein.

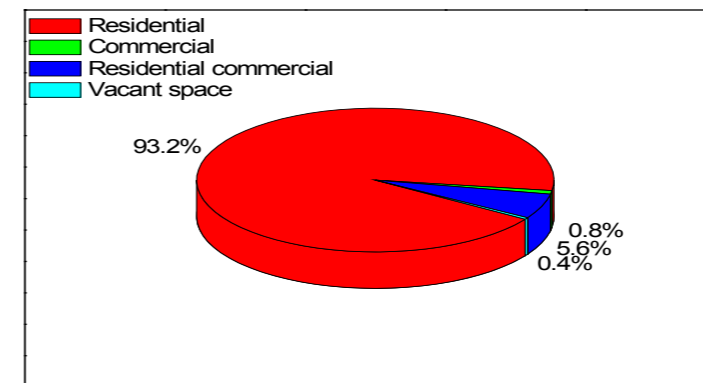


Figure 5: Types of premises.

Rodent infestation in unsanitary and densely populated areas is usually high. This can be attributed to factors such as humidity, availability of shelter and availability of food. The majority of residents (54.4%) reported that rodents caused a nuisance and were generally problematic (Figure 6). This is evident in Figure 4, where there are holes in the walls and evidence of recent rodent activity such as rodent droppings and gnaw marks. Generally, substandard housing is prone to structural deficiencies, which rodents exploit to their advantage (Azevedo *et al.*, 2011; Jassat *et al.*, 2013; Tobin & Fall, 2004). In support of the assertion that rodents are nuisances, 50.2% of the respondents strongly agreed that rodents threatened food security by damaging and contaminating foodstuffs stored on the premises. This corroborates research conducted by Singla *et al.* (2012), who reported that there were economic losses as a result of rodents damaging crops. Essentially, in a community where unemployment and poverty are high, damage to food and property is a significant loss. Food safety is also compromised due to the disease transmission capabilities of rodents.

Extensive research has been conducted on how rodents contaminate water sources and food. According to Jassat *et al.* (2013) and Pini *et al.* (2003), rodents can directly contaminate food by urinating on the food or in the water used to prepare the food. This assertion was echoed by 26.9% of the participants who agreed, and a further 55% who strongly agreed that rodents could transmit diseases, and that the municipality should come up with interventions for rodent control (Figure 8).

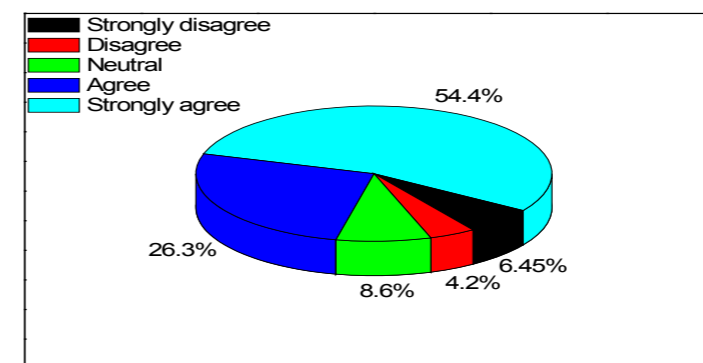


Figure 6: Views on the extent of the rodent problem in the area.

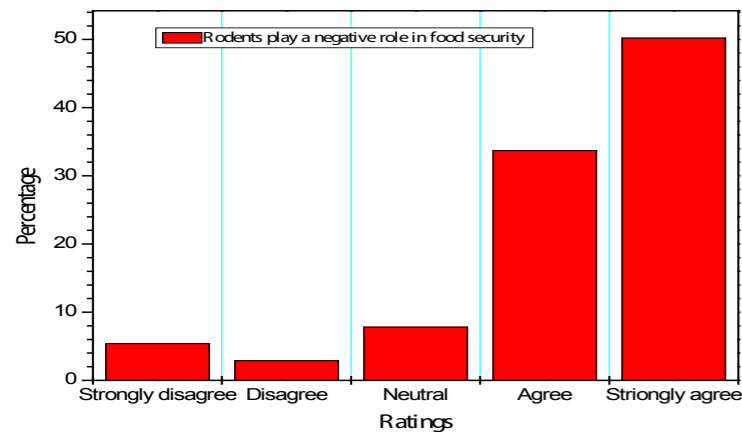


Figure 7: The negative role of rodents in food security.

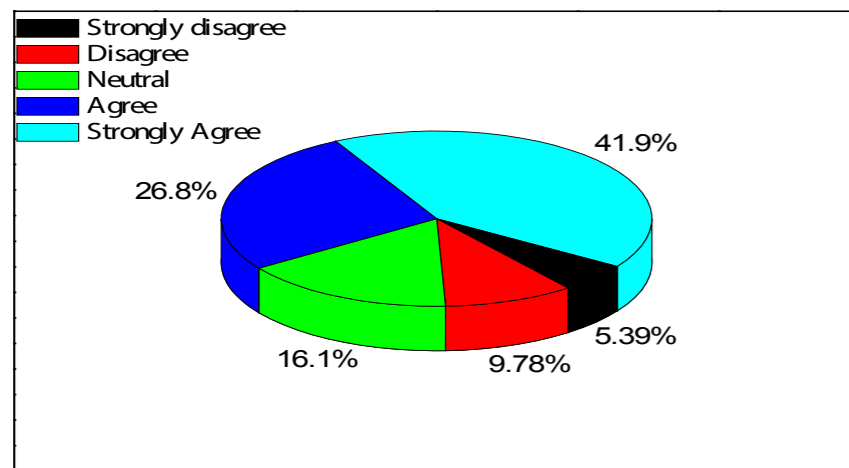


Figure 8: Rodents have a role to play in disease transmission.

As shown in Figure 9, the graph reaches the highest peak where the respondents strongly agreed that spaces such as schools and churches were prone to be used as dumping spots – which is an illegal activity in the Mangaung Metropolitan Municipality. This could be attributed to the lack of individual accountability, since no one person is responsible for maintenance. Hasan (1998) and Puling and Van der Merwe (2004) correctly stated that a “negative attitude and lack of responsibility”, exacerbated by feelings of powerlessness in terms of decision making regarding local waste management, could collectively be the result of illegal dumping spots piling up.

Generally, the community members in Joe Slovo Square township were not satisfied with the level of service delivery by the municipality (Figure 10). Further evidence is shown in Figure 2, which shows waste piles. In the words of the one participant:

*“The problem is that municipal does not collect waste on time. The municipality should give us dustbins since we do not have them.”*

This demonstrates the challenges that lead to unsanitary environmental conditions, and which ultimately promote rodent population increase.

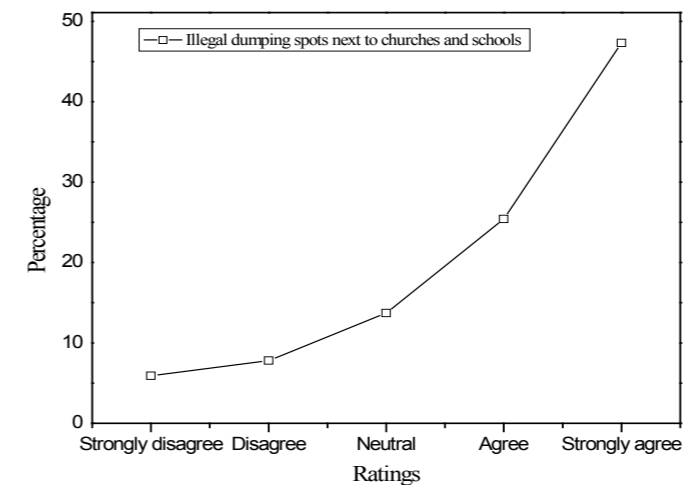


Figure 9: Churches and school corners as illegal dumping spots.

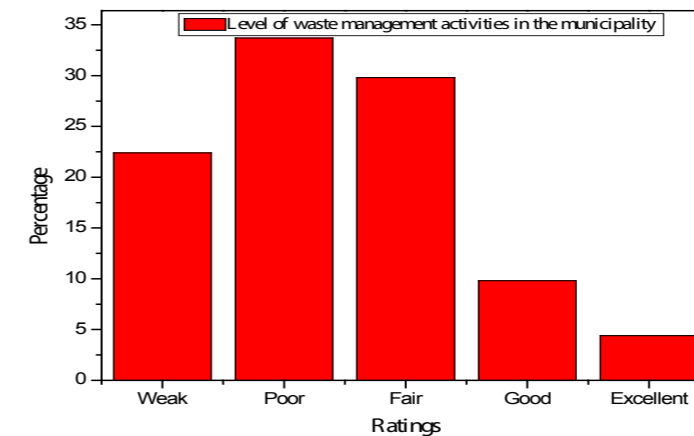


Figure 10: Level of waste management activities in the municipality.

For rodents to thrive, certain conditions must prevail, namely: food, shelter, water, humidity and favourable temperature. Figure 1 shows a blocked sewage system and leaking municipal water pipes. Table 1 shows a strong association between the availability of proper refuse storage and the visibility of active signs of rodent infestation. Table 2 presents the signs of rodent infestations and the kinds of environments rodents thrive in. Looking at the premises at a glance, 84.5% of the yards were unpaved and 30.3% of yards had overgrown grass. This enables rodents to dig burrows for shelter. Moreover, 57% of the premises had active signs of rodent infestation (gnaw marks, rodent droppings, urine stains and smell) as documented by Brooks and Matta (2019), Letcher and Slack (2019), Nattrass *et al.* (2019) and Weimann and Oni (2019), among other similar studies.

**Table 1:** The availability of proper refuse storage and the visibility of active signs of infestation.

		Are there any urine stains, trails or rodent droppings?			Cramer's V	Overall significance P-value <.05
		No	Yes	Total		
Unapproved refuse storage	No	65 60.2%	58 40.6%	123 49.0%	0.002	0.002
	Yes	43 39.8%	85 59.4%	128 51.0%		
<b>Total</b>		108	143	251		
		100.0%	100.0%	100.0%		

P <.05 = statistically significant

>.05 = strong association (Cramer's V)

**Table 1:** Rodent inspection checklist.

Variables	No	Yes	Total
Are there any open drains?	197 (78.5%)	54 (21.5%)	251
Are there any opening in pipes and wiring?	187 (74.5%)	64 (25.5%)	251
Are there any redundant appliances?	205 (81.7%)	46 (18.3%)	251
Are there any urine stains, trails, rodent droppings?	108 (43.0%)	143 (57.0%)	251
Burrows and openings in the structure	158 (62.9%)	93 (37.1%)	251
Damaged cars, stacked on bricks	223 (88.8%)	28 (11.2%)	251
Is any animal food lying around?	208 (82.9%)	43 (17.1%)	251
Is food sold on the premises ?	236 (94.0%)	15 (6.0%)	251
Is the garbage exposed (bin with no lid) ?	96 (38.2%)	155 (61.8%)	251
Is the yard paved?	212 (84.5%)	39 (15.5%)	251
Is there a garden or large seeds kept on the premises?	188 (74.9%)	63 (25.1%)	251
Is there overgrown grass, low hanging trees or a garden?	175 (69.7%)	76 (30.3%)	251
Other types of rubbish	195 (77.7%)	56 (22.3%)	251
Sewers on premises	3 (1.2%)	248 (98.8%)	251
Stagnant water	215 (85.7%)	36 (14.3%)	251
Toilet located outside the house	102 (40.6%)	149 (59.4%)	251
Unapproved refuse storage	123 (49.0%)	128 (51.0%)	251
Water leaks and pipes	206 (82.1%)	45 (17.9%)	251
Is there overgrown grass, low hanging trees or a garden?	175 (69.7%)	76 (30.3%)	251

## COMMUNITY VIEWS ON RODENTS AND SERVICE DELIVERY

The participants in the survey were asked questions regarding general service delivery, the environment, and possible solutions for the municipality. The findings were thematically arranged, transcribed and interpreted by the researchers during data analysis. The responses were given according to the personal circumstances and experiences of individuals.

### THEME 1: FOOD SAFETY AND SECURITY

A significant majority claimed to have witnessed the damage that rodents had caused in the community regarding food and related losses.

*"Rats spoil food and eat couches, clothes, shoes and vegetables and bites children..."*  
*"They move from neighbour to neighbour and ruin vegetable gardens."*

Food security and safety is critical globally. The damaging effects of rodents can heighten the food safety challenges that already exist in impoverished communities (Flynn *et al.*, 2019; Oelofse, Muswema & Ramukhwatho, 2018; Rai *et al.*, 2019).

### THEME 2: RODENTICIDES AND OTHER POISONS

The community members reported the challenges they were experiencing and how the municipality should respond. The main factors that were highlighted were the need for pest control operators and the provision of poisons. Three participants stated that:

*"Hire pest control, waste collection, provide yard inspection, open space must be frequently cut."*

*"Apply pesticides for rodent infestation."*

*"There are too many rodents and the government can help by supplying the community with rat poison."*

These statements show the extent of rodent concerns in the community. However, the quest for rapid intervention does not account for sustainability. There is currently a global call for nations to use less harmful rodenticides in the light of the sustainable development agenda. Pesticides can be harmful when used in large concentrations. Moreover, they are known to have fatal effects among young children and some animals (Antoniadis *et al.*, 2019; Chiesa *et al.*, 2019; Mazzi *et al.*, 2016; Mazzoni *et al.*, 2018).

### THEME 3: WASTE MANAGEMENT AS A CONTRIBUTOR TO RODENTS

The key complaints from community members, regarding factors that contributed to the aesthetically poor environment and rodent infestation, were the illegal dumping spots and poor waste management services. Community members stated the following:

*Waste collection at least twice a week, allocation of refuse bags from the municipality, provide appropriate dumping area and cut grass on open spaces.*

*The problem is that municipal does not collect waste on time. The municipality should give us dustbins since we do not have them.*

*Community face problems with bad smell nuisance caused by waste around the streets.*

The views above show a general dissatisfaction regarding waste management services in the area. The main concern is the efficiency and timeline of service provision. Waste pile-up is one of the burdensome contributors to bad aesthetics in any geographical location (Vallero & Shulman, 2019; Worku, 2016). Therefore, the waste management department needs to gain rapport with the community members regarding timeous service provision.

## CONCLUSIONS AND FUTURE WORK

Vector control is a critical function in environmental health. In this paper, the environmental determinants of rodent infestation and the community perceptions through lived experiences were assessed. This preliminary study showed the shortcomings in terms of service delivery and unsightly conditions that contributed to the increased rodent population, as perceived by the residents in the Joe Slovo Square township. The findings may not be relevant to the developed parts of the Mangaung Metropolitan Municipality. Nonetheless, the results revealed the need for sustainable interventions using appropriate technology for rodent control. The interventions, based on the findings, should include community engagement projects, health educational programmes, efficient essential service delivery, and law enforcement as a last resort to deal with non-complying households and polluters. This study has opened the doors for further research into sustainable rodent control methods through technology and innovation. These methods should encompass eco-friendly biological and chemical substances, supplemented by baiting and trapping, to reduce rodent numbers. Moreover, studies should be conducted on the behavioural patterns of rodent species that are specific to the study area. Ultimately, this type of project could create sustainable jobs while providing a service to the community through appropriate technologies.

## ACKNOWLEDGEMENTS

Special votes of gratitude are extended to the Central University of Technology, the Free State, the Mangaung Metropolitan Municipality, and the residents of Joe Slovo Square township for actively participating in the study.

## DECLARATION OF CONFLICTING INTERESTS

The authors declared there are no potential conflicts of interest concerning the research, authorship, and/or publication of this article.

## FUNDING

The authors received no financial support for the research and authorship of this paper.

## LIST OF REFERENCES

- Antoniadis, V. *et al.* 2019. Soil and maize contamination by trace elements and associated health risk assessment in the industrial area of Volos, Greece. *Environment International*, 124(January):79–88.
- Awunyo-Vitor, D., Ishak, S. & Seidu Jasaw, G. 2013. Urban households willingness to pay for improved solid waste disposal services in Kumasi Metropolis, Ghana. *Urban Studies Research*, 2013:1–8.
- Azevedo, L.F. *et al.* 2011. Como escrever um artigo científico - estruturação e redacção da secção de métodos. *Revista Portuguesa de Pneumologia*, 17(5):232–38.
- Baum, P.E. 2017. *The effect of microenvironment on rat population in association with urban health in candidacy*. Unpublished Master's degree of Public Health. New Haven: Yale University.
- Brooks, D. & Matta, J. 2019. Spreading of rodent infestations through a city. *Applied Network Science*, 6:1–17.
- Chiesa, L. M. Zanardi, E. Nobile, M. Panseri, S. Ferretti, E. Ghidini, S. Foschini, S. Ianieri, A. Arioli, F. 2019. Food risk characterization from exposure to persistent organic pollutants and metals contaminating eels from an Italian lake. *Food Additives and Contaminants - Part A Chemistry, Analysis, Control, Exposure and Risk Assessment*, 36(5):779–88.
- Coban, A., Ertis, I. F. & Cavdaroglu, N. A. 2018. Municipal solid waste management via multi-criteria decision making methods: a case study in Istanbul, Turkey. *Journal of Cleaner Production*, 180:159–67.
- Dhokhikah, Y., Trihadiningrum, Y. & Sunaryo, S. 2015. Community participation in household solid waste reduction in Surabaya, Indonesia. *Resources, Conservation and Recycling*, 102:153–62.
- Flynn, K. Villarreal, B. P. Barranco, A. Belc, N. Björnsdóttir, B. Fusco, V. Rainieri, S. Smaradóttir, S. E. Smeu, I. Teixeira, P. Jörundsdóttir, H. Ó. 2019. An introduction to current food safety needs. *Trends in Food Science and Technology*, 84:1–3.
- Hasan, S. 1998. Problems of municipal waste management in Bangladesh: an inquiry into its nature. *Habitat International*, 22(2):191–202.
- Jassat, W., Naicker, N., Naidoo, S. & Mathee, A. 2013. Rodent control in urban communities in Johannesburg, South Africa: From research to action. *International Journal of Environmental Health Research*, 23(6):474–83.
- Lam, R., Byers, K. A. & Himsworth, C. G. 2018. Beyond zoonosis: the mental health impacts of rat exposure on impoverished urban neighborhoods. *Journal of Environmental Health*, 81(4):8–12.
- Letcher, T. M. & Slack, R. 2019. *Waste chemicals in waste: household hazardous waste*. 2nd ed. Elsevier Inc.
- Leton, T.G. & Omotosho, O. 2004. Landfill Operations in the Niger Delta Region of Nigeria. *Engineering Geology*, 73(1–2):171–77.
- Mathee, A. 2011. Environment and health in south africa: gains, losses, and opportunities. *Journal of Public Health Policy*, 32(SUPPL.1):S37–43.
- Mazzi, A. Toniolo, S. Mason, M. Aguiari, F. Scipioni, A. 2016. What are the benefits and difficulties in adopting an environmental management system? The opinion of Italian organizations. *Journal of Cleaner Production*, 139 (September 2015):873–85.
- Mazzoni, M. Boggio, E. Manca, M. Piscia, R. Quadroni, S. Bellasi, A. Bettinetti, R. 2018. Trophic transfer of persistent organic pollutants through a pelagic food web: The case of Lake Como (Northern Italy). *Science of the Total Environment*, 640–641:98–106.
- Minter, A. Diggle, P. J. Costa, F. Childs, J. Ko, A. I. Begon, M. 2018. A model for leptospire dynamics and control in the Norway Rat (*Rattus Norvegicus*) the reservoir host in urban slum environments. *Epidemics*, 25:26–34.
- Natrass, N., Stephens, J. & Loubser, J.J. 2019. Animal welfare and ecology in the contested ethics of rodent control in Cape Town rats, poison and policy contestation. *Journal of urban ecology*, 5 (1): 1–10 .
- Oelofse, S., Muswema, A. & Ramukhwatho, F. 2018. Household food waste disposal in South Africa: a case study of Johannesburg and Ekurhuleni. *South African Journal of Science*, 114(5–6): 40–46.
- Pini, N. Levis, S. Calderón, G. Ramirez, J. Bravo, D. Lozano, E. Ripoll, C. St. Jeor, S. Ksiazek, T. G. Barquez, R. M. Enria, D. 2003. Hantavirus infection in humans and rodents, Northwestern Argentina. *Emerging Infectious Diseases*, 9(9): 1070–76.
- Puling, L. & Van der Merwe, J. H. 2004. *Solid waste management in developing urban areas: Case study of Lwandle Township*. Unpublished MSc Geography and Environmental Studies. Stellenbosch: University of Stellenbosch.
- Rai, P. K. Lee, S. S. Zhang, M. Tsang, Y. F. Kim, K. H. 2019. Heavy metals in food crops: health risks, fate, mechanisms, and management. *Environment International*, 125(November 2018):365–85.
- Roomaney, R., Ehrlich, R. & Rother, H. A. 2012. The acceptability of rat trap use over pesticides for rodent control in two poor urban communities in South Africa. *Environmental Health: A Global Access Science Source*, 11(1):1–7.
- Rossi, J., Kadaouré, I., Godefroid, M. & Dobigny, G. 2017. Landscape epidemiology in urban environments: The example of rodent-borne Trypanosoma in Niamey, Niger. *Infection, Genetics and Evolution*. 63 (October 2017): 307-315
- Seyring, N. Dollhofer, M. Weißenbacher, J. Bakas, I. McKinnon, D. 2016. Assessment of collection schemes for packaging and other recyclable waste in European Union-28 member states and capital cities. *Waste Management and Research*, 34(9):947–56.
- Shezi, B. Mathee, A. Siziba, W. Street, R. A. Naicker, N. Kunene, Z. Wright, C. Y. 2019. Environmental health practitioners potentially play a key role in helping communities adapt to climate change. *BMC Public Health*, 19(1):1–8.
- Singla, N., Babbar, B.K. & Kaur, J. 2012. Farmers' participatory research on rodent control in Punjab State: survey, education, impact assessment and sustainability. *Crop Protection*, 34:25–31.
- South Africa. Department of Health. 2013. *Norms and Standards for Environmental Health in South Africa*. Government printer
- South Africa. National Department of Health. 2004. *National Health Act, No. 61 of 2003*. Government printer
- Tan, Z. Yu, H. Xu, L. Zhao, Z. Zhang, P. Qu, Y. He, B. Tu, C. 2019. Virome profiling of rodents in Xinjiang Uygur autonomous region, China: Isolation and characterization of a new strain of Wenzhou Virus. *Virology*, 529(November 2018):122–34.
- Terkel, J. 1995. *24 Advances in the study of behavior. Cultural transmission in the black rat: pine cone feeding*. Tel aviv. Elsevier Masson SAS.
- Tobin, M. E. & Fall, M. W. 2004. *Pest control: rodents. II*. DigitalCommons. Lincoln Pest control: University of Nebraska.
- Tram, E. & Aubin, L. 2016. *Environmental Factors Associated with Increased Rat Populations : A Focused Practice Question*.
- Vallero, D.A. & Shulman, V. 2019. Introduction to waste management. *Waste*, 3–14.
- Vitale, M. *et al.* 2018. Human leptospirosis cases in Palermo Italy. The role of rodents and climate. *Journal of Infection and Public Health*, 11(2):209–14.
- Weimann, A. & Oni, T. 2019. A systematised review of the health impact of urban informal settlements and implications for upgrading interventions in South Africa, a rapidly urbanising middle-income country. *International Journal of Environmental Research and Public Health*, 16(19):1–17.
- Worku, Z. 2016. Predictors of efficiency in municipal waste management in Tshwane Municipalities, South Africa. *Environmental Economics*, 7(3):45–51.

# FEASIBILITY STUDY OF A HYBRID PHOTOVOLTAIC-MICRO HYDROPOWER SYSTEM FOR: A CASE STUDY FOR MUTEMA CLINIC IN ZIMBABWE

John Tonderai Matewe, National University of Science and Technology, john.tewex@gmail.com,

## Abstract

The inaccessibility of the national grid to some remote medical centers in Zimbabwe has resulted in vaccine spoilage, limitations in the use of essential medical equipment, lack of standard lighting for medical procedures and lack of communication for education and health information exchanges. To that end, it is therefore smart to explore every possible way of generating more energy. Renewable energies have become the best option for electrification especially for remote areas and to meet relatively small load. This study investigates the feasibility of a hybrid photovoltaic-micro hydropower system to meet the energy requirements of a typical remote medical center in Zimbabwe. It was carried out using the Hybrid Optimization of Multiple Energy Resources (HOMER 2) sizing tool to assess the feasibility of the hybrid system against other supply options such as the use of diesel generators. Stream-flow data of Popoteke River, the intended site for installation of the hydro plant, was obtained from the Zimbabwe National Water Authority (ZINWA) and solar irradiance data was obtained from the National Renewable Energy Laboratory (NREL) database. To obtain an optimal design of the hybrid system, capital costs, net present costs (NPC) and Levelized Cost of Energy (LCOE) of various configurations were analyzed. The hybrid system consisting of 19 kW PV, 9.83 kW hydro, 8kW converter and 100 battery strings was found to be the most economic one with a total NPC of \$USD 97 396 and an LCOE of 0.542\$/kWh.

**Keywords:** remote rural, hybrid, photovoltaic, hydropower, HOMER

## INTRODUCTION

Across the globe, electricity remains a fundamental tool for national as well as international development agendas that encompass affordable and clean energy, sustainable cities and communities and climate action. The inaccessibility of the national grid by some remote areas has been cited as a major hindrance towards an improved healthcare system for most developing countries (Rohani, et al., 2013). Without electricity, health clinics cannot store vaccines for children, the distribution of other cold-chain dependent drugs, as well as global push to deliver antiretroviral drugs and services to HIV patients worldwide becomes a futile exercise (Olatomiwa, Mekhilef, & Olayinka, 2015).

Zimbabwe currently has a national electrification rate of 32.3%. Almost 11 million people have no access to electricity (Anon, Zimbabwe, 2020). Currently, the state-owned utility Zimbabwe Electricity Supply Authority (ZESA) is producing about 1 250 MW against a projected national demand of 2 200 MW (current demand is 1 600MW due to deindustrialization) and an installed capacity of approximately 2 210 MW. ZESA is currently importing power from South Africa's Eskom (300 MW) and Mozambique's Hydro Cahora Bassa (50 W) to compensate for the 350 MW shortfall (ZPC, Generation Stats, 2019). The high cost of importation is one the greatest problem being encountered by the Zimbabwe Power Company (ZPC). Another point to take note of is the age of all the power plants. Most of the power generation stations were established in the '80s to support the then population of 7 million people (ZPC, Stations, s.a). Currently, the population of Zimbabwe is almost 17 million and is estimated to be 20+ million by 2030, which put a lot of strain on the current energy generation and distribution infrastructure.

In order to cope with the increasing electric consumption trend, it is therefore smart to explore every possible way of generating more energy. The use of diesel generators has been considered for a long time as the best solution for the pre-electrification of remote areas, rural medical clinics included. However, with policies such as the 2030 Agenda for Sustainable Development and the National Energy Policy, in place, power generation using renewable and environmentally friendly energy sources seems to be the only viable option (Kusakana, Munda, & Gimoh, 2009).

Studies on the planning and application of hybrid renewable systems have already been carried out. (Getnet & Shunki, 2017) discussed the optimization and operational strategy of hybrid renewable energy system for Jimma zone in Ethiopia. They found out that where renewable energies are available in abundance, developing a hybrid power system is more cost effective and suitable for rural communities than grid extension. (Syahputra & Indah, 2020) also investigated the possibility of hybrid micro-hydro and photovoltaic systems for rural areas in Indonesia. The authors proposed the use of irrigation channels for installation of micro hydro plants. The authors used the HOMER software to design an optimized PV and micro hydro system.

## METHODOLOGY

### Description of case

A case study of Mutema clinic, a remote health center in the Gutu district in Masvingo Province of Zimbabwe was considered. The clinic is located on co-ordinates 19°52.7' S, 31°59.3' E and close to the Popoteke River, a tributary to Lake Mutirikwi. Mutema clinic is part of the national health center with no access to the main electricity grid. Poor torches and candles are available for lighting. The clinic counts an outpatient department, the clinical head's office, the labour ward and kitchen. The clinic further runs the female ward and the male ward which houses three beds in each room. In addition, three rooms are reserved for nurses and nurse aids. An estimate of household appliances and medical equipment load data was obtained from another typical health center in the same province (Mucheke clinic) with access to the main grid as shown in Table 1 and Table 2.

*Table 1: An estimate of household appliances*

Device/Appliance	Wattage/W	Quantity	Power Consumption/kWh		
			Morning 0700-1759	Evening 1800-2159	Night 2200-0659
Lighting (LED)	9	6	54	162	378
TV (LG 32inch)	55	3	0	495	165
Refrigerator	50	3	750	150	300
Radio	2	3	6	12	18
Kettle	1200	3	0	1200	1200
Iron	950	3	0	4275	0
DSTV Decoder	18	3	0	162	54

**Table 2:** An estimate of medical equipment load data

Equipment to be used	Wattage/W	Quantity	Power Consumption/kWh		
			Morning (0700-1759)h	Evening (1800-2159)h	Night (2200-0659)h
Vaccine Refrigerator	160	1	800	240	480
Refrig [non-medical]	240	1	960	240	720
Sterilizer(MOST T Series)	2600	1	5200	0	0
Oxygen concentrator	625	2	6250	1250	5000
Kwiksol Solar Water Heater	3000	1	27000	0	0
Portable X-Ray	800	1	2400	0	0
Lights(Metrop LED)	9	9	18	54	162
Overhead Fan	150	1	150	600	450
Suction	90	2	180	180	180
Vital signs monitor(BP)	70	3	210	105	210
TV (Sony Bravia-40inch)	180	1	1260		
Submersible screw solar pump	500	1	1250	0	0
Incubator (Shinva)	400	1	3600	800	800
Operating lamp (Shinva)	90	1	90	90	180
Desktop computer	200	1	800	0	0
Wi-Fi Router	6	1	30	18	0
<b>Total</b>			48 608	10 033	10 297

(Mucheke clinic, 2019)

**Renewable energy resources**

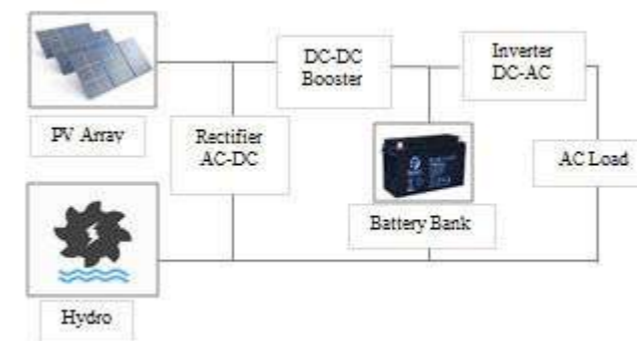
Zimbabwe is adorned with abundant sunshine resources characterized by long summers and short winters resulting in the country having an annual average of 8.3 sun hours per day\_(Kuijk, 2012). Table 3 gives the insolation data of Mutema clinic obtained from the NREL database and the stream-flow data obtained from ZINWA Runde Catchment area in Masvingo, Zimbabwe.

**Table 3:** Renewable energy resources

Month	Solar Irradiance (kwh/m <sup>2</sup> /d)	Stream flow (m <sup>3</sup> /s)
January	5.986	5.960
February	5.726	9.530
March	5.630	5.720
April	5.107	2.710
May	4.648	1.100
June	4.258	0.821
July	4.570	0.801
August	5.268	0.758
September	5.947	0.650
October	6.447	0.768
November	6.482	0.851
December	5.784	4.860

**Experimental Description**

The proposed micro grid system is a Stand-alone PV–battery–Micro hydropower hybrid renewable energy system. Hybrid Renewable Energy Systems (HRES) can be subdivided into different connecting topologies. These include the series hybrid energy systems, switched hybrid energy systems and parallel hybrid energy systems\_(Badwawi, Abusara, & Mallick, 2015). The proposed HRES depicted in Figure 1 is a parallel hybrid system with advantages of continuity and an independent nature of meeting the load by each source.



**Figure 1:** Block diagram of proposed HRES

The dispatch strategy and the methodology in general are similar to the one employed by (Kusakana et al, 2009). The AC load is met primarily by the hydroelectric unit and PV array all year round. The storage equipment is also included as part of the design to fulfill the electric load, when PV or micro hydro is not generating enough electricity. The Hydro unit selected for this design is an ultra-low head, run of river micro hydro system called STREAM. Electrical output range is between 0.5 – 44 kW from a 0.5 m net head.\_(UNIDO, s.a).

**HRES Modeling**

HOMER 2 Micro-grid Analysis Tool was used to perform an assessment of the least cost off-grid system solution for powering a remote health center in the Gutu district of Masvingo Province. HOMER 2 simulates, optimizes and performs sensitivity



analysis on proposed energy designs in a bid to find least cost system configurations (Gilman, 2004). According to (USAID, 2010), the synthetic hourly load requirements were processed the same way as those of the Health Clinic Power System Design tool developed by the United States Agency for International Development (USAID) which involves compiling the energy demand,  $E_d$  (electrical consumption of the medical equipment and household appliances) for a given period of time as can be shown in (1) by:

$$(1) \quad E_d = \frac{\sum_{b=1}^N P_b Q_b R_b}{1000} \text{ (kWh)} \quad E_d = \frac{\sum_{b=1}^N P_b Q_b R_b}{1000} \text{ (kWh)}$$

Where

$P_b$  = Power of any type of load e.g. suction, lights etc.  
 $Q_b$  = time the load/appliance is in use and  
 $R_b$  = Quantity of each type of load.

#### PV-micro hydropower hybrid system analysis and sizing

For HOMER 2 to estimate the costs of installing and operating the hybrid system under consideration over the lifetime of the project and make the comparison with other supply options, load, components and resources details must be provided (Gilman, 2004). The calculations take into account costs such as capital, replacement, and operation and maintenance.

#### Micro hydropower sizing

For the chosen site, the two important data assessed are the net head,  $h$  and the discharge,  $Q$ . The electrical power,  $E_p$  available from the water resource is given by (2).

$$E_p = \rho \times Q \times g \times h \times \eta \quad E_p = \rho \times Q \times g \times h \times \eta \quad \text{(kW)} \quad (2)$$

Where

$\rho$  = density of water  
 $\eta$  = overall efficiencies of power plant  
 $g$  = acceleration due to gravity

The capital cost, replacement cost and operation and replacement cost for the hydro unit are \$USD8 000, \$USD4 000 and \$USD2 000 respectively (Anon, JAG Seabell, 2004).

#### Photovoltaic sizing

For the sizing of the photovoltaic panel and battery bank, the following formulae and assumptions have been taken into account:

- Power consumption was separated based on seasons that is summer (September-April) and winter (May-August).
- The daily average energy demand,  $E_d$  and the average sun irradiances,  $F_s$  of respective seasons were used to calculate the power required from the PV array,  $PV_{out}$  as shown in (3).

$$PV_{out} = E_d / F_s \quad PV_{out} = E_d / F_s \quad \text{(kW)} \quad (3)$$

$$PV \text{ power output} = \frac{\text{Daily energy use (kWh)}}{\text{Daily hours of full sun (h)}} \quad PV \text{ power output} = \frac{\text{Daily energy use (kWh)}}{\text{Daily hours of full sun (h)}}$$

- PV size,  $PV_c$  was calculated based on seasons,  $PV_{out}$  and the derating factor,  $d$  as depicted in (4).

$$PV_c = PV_{out} / d \quad PV_c = PV_{out} / d \quad \text{(kW)} \quad (4)$$

Where  $d$  is a parameter that takes into account the inefficiencies of the overall system, such as soiling of the panels and imperfect electrical connections (usually 0.8 according to NREL PVWatts calculator).

The number of PV modules in the array,  $N_m$  is found from relation (5):

$$N_m = A_{PV} / A_{sm} \quad N_m = A_{PV} / A_{sm} \quad (5)$$

Where

$A_{PV}$  = the area available for PV installation and  
 $A_{sm}$  = the area of a single PV module.

According to (Statista, 2019), the cost of the PV is \$USD3/W. The replacement cost is \$USD3000/kW and operation and maintenance cost is \$USD150/kW per year.

#### Battery sizing

This study considered a battery which has nominal voltage,  $V_{bat}$  of 12 V, and a nominal capacity,  $K$  of 200Ah. The installation, replacement, operating and maintenance costs of a single battery are \$USD200, \$USD200 and \$USD7/year, respectively (Soratek, 2019). The number of batteries,  $N_b$  required is given by (6).

$$\text{Area of PV} = \frac{\text{Total DC Energy [kWh/day]}}{\text{Irradiance [kWh/m}^2\text{/day] / System Efficiency}}$$

$$\text{Area of PV} = \frac{\text{Total DC Energy [kWh/day]}}{\text{Irradiance [kWh/m}^2\text{/day] / System Efficiency}}$$

$$N_b = (E_d \times N_s) / (DOD_{max} \times V_{bat} \times K) \quad N_b = (E_d \times N_s) / (DOD_{max} \times V_{bat} \times K) \quad (6)$$

Where

$N_s$  = the number of storage days required and  
 $DOD_{max}$  = maximum depth of discharge.

## RESULTS AND DISCUSSION

#### System Analysis

The hybrid and diesel generator systems are designed using HOMER 2 micro-grid tool. A 10% day-to-day load variability was considered to make the load look more real. The daily energy consumption is 69 kWh and the peak load is 8kW for the proposed case.

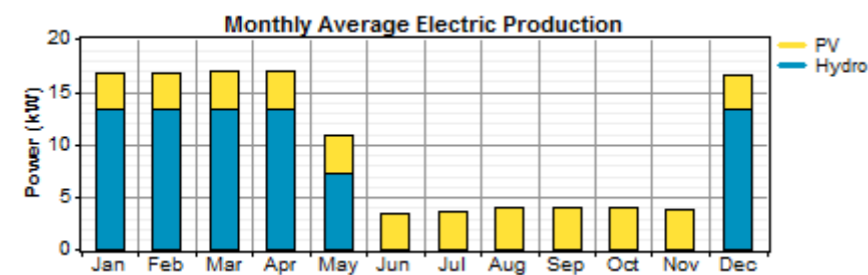
A design flow rate of 1.34 m<sup>3</sup>/s was used in the designing of the micro hydro plant. Table 4 shows a comparison of the two systems in terms of optimal design, capital cost, operating cost and the total NPC.

**Table 4: Optimized result of the two systems**

	Hybrid	Diesel Generator
Optimal design	19 kW PV, 9.83 kW hydro, 100 battery strings, 8 kW converter	10 kW auto generator
Capital cost	\$86 600	\$2 917
Operating cost	\$1 467	\$24 338
Total NPC	\$ 97 396	\$314 041

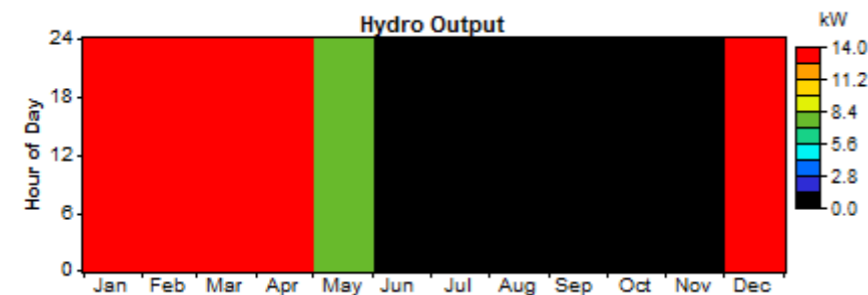
(HOMER)

The NPC (or life-cycle cost) of a component is the present value of all the costs of installing and operating that component over the project lifetime, minus the present value of all the revenues that it earns over the project lifetime. The total NPC is regarded as the primary economic figure of merit in HOMER. The optimized result from HOMER shows that the hybrid system is the most economic design with a total NPC of \$97 396 compared to the \$314 041 of the diesel generator. The contribution of each renewable energy source towards electrical power production is shown in Figure 2, Figure 3 and Figure 4.



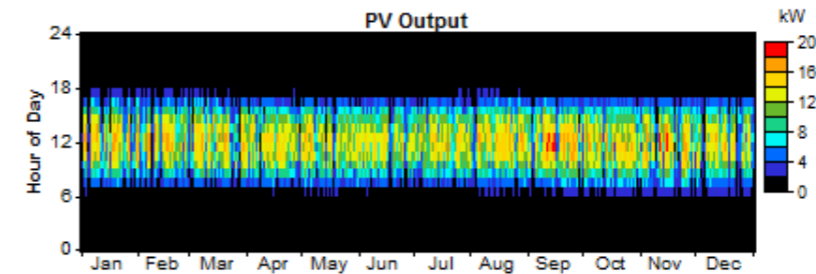
**Figure 2: Monthly electrical production of the PV and Hydro sources.**

From December to May, it can be seen that more electricity is produced from hydro power since it is the period that the area receives rainfall. From June to around November, PV is the only source because of reduction in the water resource. Micro hydropower contribution to the system is about 56% of the production while PV contributed 44% of electricity production to meet a primary AC load of 32 205 kWh/yr. The excess 37.8% electricity will be channeled towards water harvesting using sand abstraction techniques.



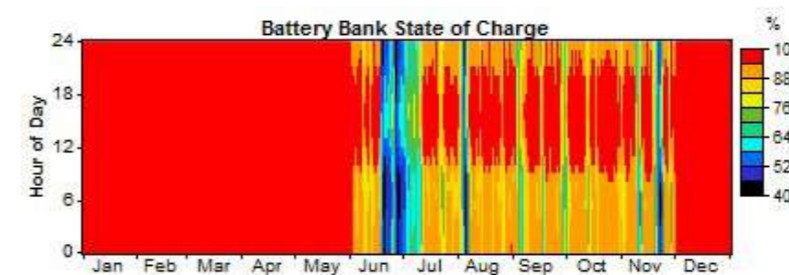
**Figure 3: Hydro Output**

The electrical power from the micro-hydroelectric unit is varying all year round as shown in Figure 3. These variations are a result of the different monthly average flows of Popoteki River. The period from June to November is observed to produce power well below 1.4 kW since it is winter season when rainfall is well below average. The LCOE for the hydroelectric unit of \$0.0419/kWh is lower than that of the PV system since the operating costs and repairing costs of the unit are low.



**Figure 4: Hourly PV Output of the array**

Figure 4 clearly shows that the solar resource is available only during the day from around 7am to 5pm. The PV unit is responsible for meeting the load when there is inadequate or no hydro resource and also channeling the excess power to charge the batteries. During periods of peak demand and during the night, an inverter can be used to convert DC power from the batteries to AC power to meet a certain load.

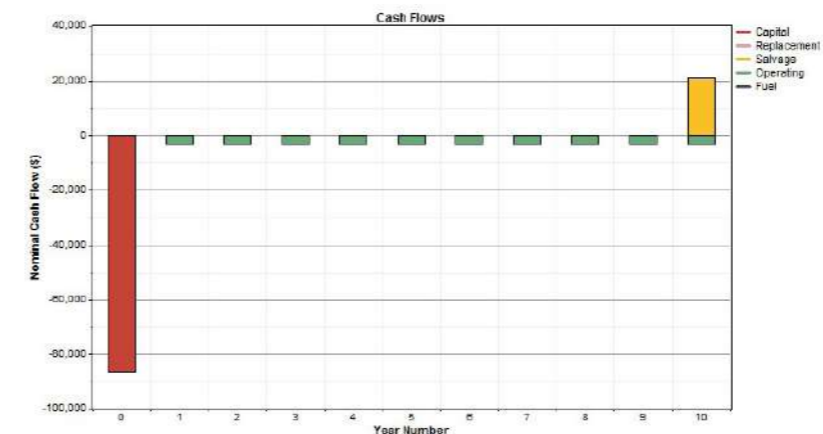


**Figure 5: Hourly State of Charge of the Battery Bank**

As can be observed from Figure 5, the battery state of charge is usually a maximum from December to May since the hydro power resource is in abundance. The contribution of PV is therefore low since it can only be used to charge batteries which are used during the night for the vaccine refrigerators and for lighting. However, the period from June to November is a different one. Since it is a winter season, water availability starts to decrease. Hence power from the PV system together with stored power in the batteries step up to meet the load.

### Cost Summary

The results from HOMER on cash flows were analyzed to evaluate which of the two systems is cost-effective. Each bar in the graph represents either a total inflow or total outflow of cash for a single year. Figure 6 displays the cash flow for the hybrid system whilst Figure 7 displays that of the diesel generator.



**Figure 6: Cash flow trend of the hybrid system for the entire lifespan**

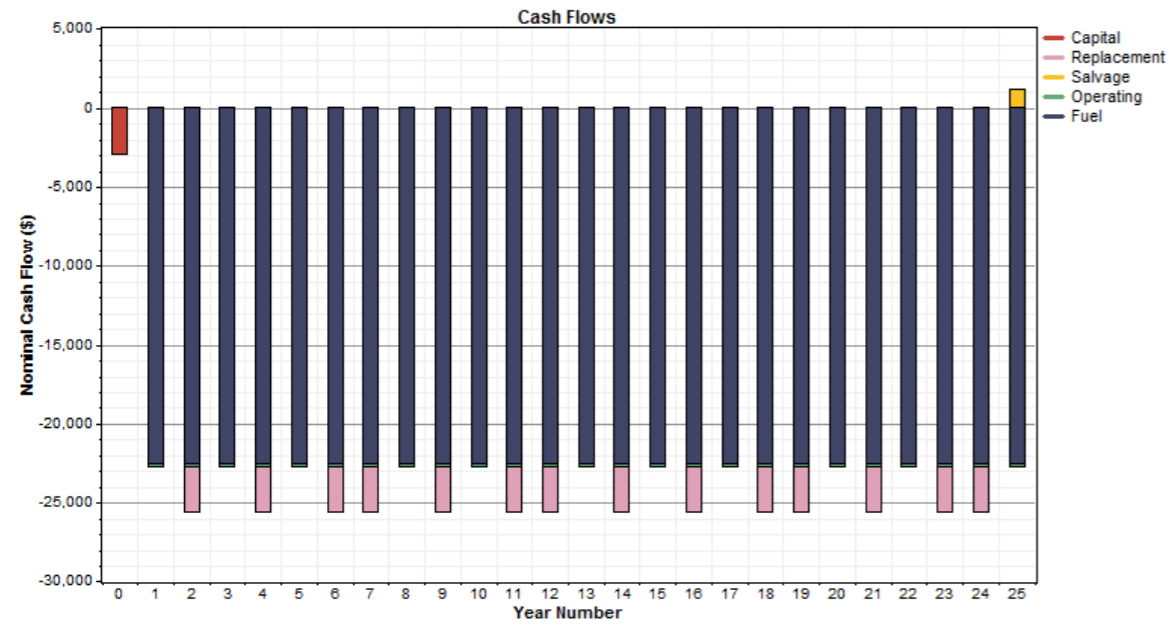


Figure 7: Cash flow trend of the diesel generator for its entire lifespan

The cash flow diagrams give a clear idea of the typical expenses associated with the different components of the two systems. The initial capital cost of the hybrid system is higher than that of the diesel generator because more equipment is needed during the period of installation. However, once the hybrid system is installed, the operating costs which include periodic servicing of the inverters and cleaning of panels and battery replacement costs are a minimum. As for the diesel generator, the operating costs are always high throughout the entire lifespan due to high fuel cost and maintenance procedures. It can also be noted that the salvage or remaining value of the hybrid systems is much greater than the diesel generator system.

#### Impacts on Environment

Table 5 displays the emission results from HOMER software if a diesel generator is chosen to meet the load.

Table 5: Diesel generator emissions

Pollutant	Emissions(kg/yr)
Carbon dioxide	39 635
Carbon monoxide	97.8
Unburned hydrocarbons	10.8
Particulate matter	7.38
Sulfur dioxide	79.6
Nitrogen oxides	873

[HOMER]

The pollutants outlined above are harmful to the environment with deadly impacts such as global warming, ozone layer depletion, cancerous diseases and many others. According to (Brander, Sood, Wylie, Haughton, & Lovell, 2011), the grid emission factor (GEF) of Zimbabwe is 0.6kgCO<sub>2</sub>/kWh. Since the proposed system is only a renewable resource-oriented system, emissions are almost zero hence a reduction in CO<sub>2</sub> emissions.

#### CONCLUSION

The main goal of this present study revolved around the idea that for an area with adequate hydro and solar resources, a hybrid system can be erected which is able to meet a certain energy demand. For the chosen area (Mutema clinic in Masvingo Province, Zimbabwe), the average irradiance of 5.49 kW/m<sup>2</sup>/day and the Popoteke river design discharge of 1.34 m<sup>3</sup>/s is sufficient enough for the development of a hybrid PV/micro hydropower system. The proposed hybrid system which consists

of 9.38 kW micro-hydro, 19 kW PV, 100 200 Ah tall tubular Lithium batteries and a 8kW system converter is able to meet the 69 kWh daily load of medical equipment and household appliances. The hybrid system has a lower NPC of \$97 396 compared with the diesel generator system making it the best viable option for low cost electricity production for remote rural clinics. Moreover, the use of a hybrid system would save around 40 tonnes of greenhouse gases every year which would be produced if a diesel generator was used. The results of this study can be used as instruments of reference for the erection of low cost stand-alone hybrid systems to supply electricity to people leaving in remote rural areas along the Zambezi river like Binga, Chete, Kanyemba parts and many others where adequate renewable energy resources are available.

#### Funding

The research received no external funding.

#### Conflicts of Interest

The authors declare no conflict of interest.

## LIST OF REFERENCES

- Anon. (2004, July 11). *JAG Seabell*. Retrieved July 25, 2020, from JAG Seabell Co.,Ltd: [www.jagseabell.jp](http://www.jagseabell.jp)
- Anon. (2020, sa sa). *Zimbabwe*. Retrieved February 12, 2020, from Powerforall: <https://www.powerforall.org/countries/zimbabwe>
- Badwawi, R., Abusara, M., & Mallick, T. (2015, January ). A Review of Hybrid Solar PV and Wind Energy System. *Smart Science*, 127-138.
- Brander, Sood, A., Wylie, C., Haughton, A., & Lovell, J. (2011). Electricity-specific emission factors for grid electricity. *Ecometrica*, 1-22.
- Getnet, Z. S., & Shunki, G. (2017). Design and Modelling of Hybrid PV-Micro Hydro Power Generation Case Study Jimma Zone. *Amerian Journal of Electrical Power and Energy Systems*, 91-98.
- Gilman, P. (2004, May 6). *HOMER help*. Retrieved April 24, 2020, from HOMER ENERGY: [support@homerenergy.com](mailto:support@homerenergy.com)
- Jones, P., Wynn, M., Hillier, D., & Comfort, D. (2017). The Sustainable Development Goals and Information and Communication Technologies. *Indonesian Journal of Sustainability Accounting and Management*, 1-15.
- Kuijk, K. (2012). *Solar PV Potential in Rural Zimbabwe*. Amsterdam: VRIJE University.
- Kusakana, K., Munda, J., & Gimoh, A. (2009). Feasibility study of a hybrid PV-Micro Hydro system for rural electrification. *IEEE* (pp. 2-6). Kenya: AFRICON.
- Olatomiwa, Mekhilef, & Olayinka. (2015). Hybrid renewable power supply for rural health clinics(RHC) in six geo-political zones of Nigeria. *Sustainable Energy Technologies and Assessments*, 60-71.
- Rohani, H., Zukor, K., Bonjour, S., Wilburn, S., Kuese, A., Hebert, R., et al. (2013). Limited electricity access in health facilities of sub-Saharan Africa: a systematic review of data on electricity access, sources, and reliability. *Glob Health Sci Pract.*, 249-261.
- Soratek. (2019, sa sa). *Batteries*. Retrieved May 7, 2019, from Soratek: <http://www.soratek.co.zw/batteries>
- Statista. (2019, sa sa). *Solar PV-Statistics & Facts*. Retrieved July 5, 2019, from Statista: <https://www.statista.com/topics/993/solar-pv/>
- Syahputra, R., & Indah, S. (2020, January 21). Planning of Hybrid Micro-Hydro and Solar Photovoltaic Systems for Rural Areas of Central Java,Indonesia. *Planning of Hybrid Micro-Hydro and Solar Photovoltaic Systems for Rural Areas of Central Java,Indonesia*, pp. 1-16.
- UNIDO. (s.a, s.a s.a). *Hydro power;Micro hydropower system(ultra low head)*. Retrieved August 21, 2020, from United Nations Industrial Development Organization: [www.unido.or.jp/en/technology\\_db/1683/](http://www.unido.or.jp/en/technology_db/1683/)
- USAID. (2010, sa sa). *Health Clinic Power System Design*. Retrieved March 2019, 2019, from PoweringHealth: [tools.poweringhealth.org](http://tools.poweringhealth.org) [Accessed :3March 2019].
- ZPC. (2018, March 21). *Power Column*. Retrieved January 13, 2019, from ZPC: [www.zpc.co.zw](http://www.zpc.co.zw)
- ZPC. (2019, sa sa). *Generation Stats*. Retrieved February 2, 2019, from ZimbabwePowerCompany: [www.zpc.co.zw](http://www.zpc.co.zw)
- ZPC. (s.a, s.a sa). *Stations*. Retrieved August 19, 2020, from zimbabwepowercompany: [www.zpc.co.zw/powerstations](http://www.zpc.co.zw/powerstations)

9TH INTERNATIONAL CONFERENCE ON APPROPRIATE TECHNOLOGY

# ENVIRONMENT AND AGRICULTURE

# THE USE OF OPEN SOURCE PLATFORMS IN THE DEVELOPMENT OF AN APPROPRIATE IRRIGATION SYSTEM FOR SMALL-SCALE FARMERS IN JOHANNESBURG

Miss Oratile R Mokgatla

University of Johannesburg, South Africa, rmokgatla@uj.ac.za

Mr Martin Bolton

University of Johannesburg, South Africa, mbolton@uj.ac.za

## Abstract

*Climate change is an ever-daunting reality for farmers, resulting in unreliable water supply and extended dry periods. There is an ever-growing need to address the sustainable use of water for these farmers, especially in the water-constrained urban areas. In agriculture, water is a scarce but valuable resource that needs proper management, and the lack of irrigation systems suitable for small-scale farming limits its sustainable use. The lack of accessible, affordable, and contextually-appropriate irrigation technology has been a barrier encountered by most small-scale farmers. Limitation of resources and the need for affordable tooling and manufacturing, therefore, drives the need for low-cost product development. The high cost of initial setup, maintenance, and training for correct use of the equipment often deters farmers from venturing out to seek solutions for their problems. This calls for contextually-appropriate innovations that allow for adoption by farmers. This project involved inputs and participation from seven urban farmers. The use of open-source manufacturing programmes enabled low-cost product development, making manufacturing more accessible to farmers. Open-source forums and platforms such as Arduino, YouTube and OpenCAD are but a few of the available open-source programmes that were utilised in the development of electrical and physical system prototypes that were able to monitor and log water use patterns for the farmers. My developed design was implemented with two of the participating farmers and this enabled further refinements as the farmers were able to advise on the efficacy of the solution. The incorporation of new technological advancements enables the development of appropriate technology that meets the requirements of the intended users, in this case, the farmers.*

**Keywords:** human-centred design, industrial design, irrigation design, open-source, small scale farming.

## INTRODUCTION

There is an ever-growing need to curb hunger in developing countries, with a great emphasis on the potential of agriculture. With an ever-growing need for expansion of food production, agriculture has been afforded the greater share of natural resources such as water. Over the past decade this allocation has been at the centre of debates on the effects of agriculture on climate change.

In South Africa, the agricultural sector is one of the most water-intensive industries, accounting for between 51-62% of

all water use (Bonthuys, 2018:26). Water, because of its direct correlation with food production, is the greatest food-limiting factor in developing countries, including sub-Saharan Africa (Wenhold, *et al.*, 2007:327). In a resource-constrained world, the sustainable use of resources is at the forefront of climate-related issues. The scarcity of water in Johannesburg is further highlighted by the fact that, apart from Birmingham in England, it is the only city that is not built on a river. This fact might explain the current rise of borehole drilling within and around the city.

There is a large literature highlighting the scarcity of water in South Africa (and in the wider context of sub-Saharan Africa), indicating the need for more rigorous resource management in order to meet growing demands for higher food production both in the urban and rural areas (Wenhold, *et al.*, 2007:331). To meet water demands, there needs to be an improvement or development of existing systems that increase efficiency in water use in the various demand sectors, thereby increasing access to water (G. M. M. Ochieng, 2004). New technological advances enable the development of appropriate technology that meets the requirements of the intended users who are, in this case, the farmers.

In the developing world, technology development in agriculture is often in the form of imported knowledge or technology from developing countries (Campbell, 2013:11). Appropriation of technology, however, is the assimilation of technological advancements for the current socio-economic context. Benefits for the users come by tailoring the solutions or equipment to the needs and wants of the users, and technology that is appropriate in this sense can make farming a viable activity for small-scale entrepreneurs. However, the availability of water has become the most serious limiting factor in agricultural production in South Africa (Zwane, 2019:562). The incorporation of technologies such as drip and sprinkler irrigation were recommended by the Limpopo Head Office (De Witt, 2010) in (Zwane, 2019:567) illustrating the willingness of the government to explore new technologies in the mitigation of water issues facing the agricultural sector.

## METHODOLOGY

### Human-centred design for appropriate technology

The farmers were at the centre of the design insights that drove the development of the irrigation system. This qualified it as a Human-Centred Design (HCD) process, where the intended end-users form part of the design process and their needs and requirements are central to the process. Through putting the needs of the farmers at the forefront, HCD ensures that all technology developed for them and with them is suited to their capacity, needs and wants, and is therefore “appropriate” for them to use. In this case, HCD and appropriate technology are seen as sister ideologies that cannot be separated. HCD has a defined user for whom a product or system is optimized (Giacomin, 2014:608) and this characteristic leads to higher efficiency in usage patterns. This is essential when agricultural technology must aid farmers in coping with future climate shocks, and this then requires the expertise and participation of these farmers in co-designing interventions. (Jew, Stephen, Andrew, David, & Peter, 2020:8).

This was a qualitative study and data collection started with interviewing the farmers, and the design process from then on always referred to the needs that had been uncovered during the initial data-gathering stage. This process ensured that the needs of the farmers are central to the development of the product and ensured product user satisfaction. Seven farmers participated in this study, all in and around Johannesburg. All but two of the framers were within 15 km of the Johannesburg city centre, with the other two farmers located in nearby communities in the outskirts of the city. This provided a wide array of different landscapes, in terms of size of the farm, profits and technology adoption and availability.

From the interviews that were carried out, a thorough needs assessment was synthesised from the thematic analysis of the findings. Table 1 is a summary of those identified needs, grouped from the common themes consistent to all farmers.

**Table 1 Needs analysis of participating farmers**

DESIGN CONSIDERATIONS	DESIGN SPECIFICATION
<b>COST &amp; AFFORDABILITY</b>	<ol style="list-style-type: none"> <li>1. The kit cost should be kept at a minimum</li> <li>2. Maintenance cost should be kept relatively low though the ability to acquire replacements locally or affordably</li> <li>3. Farmers should be equipped to carry maintenance out themselves so as to keep costs low</li> </ol>
<b>FUNCTION</b>	<ol style="list-style-type: none"> <li>4. The function should be inherent in the semantics of the product</li> <li>5. The kit assembly should be relatively easy to achieve, considerations must be made in terms of manual and setup guide.</li> <li>6. The assembly of the kit should require no specialised knowledge or equipment that is not accessible to the farmer</li> </ol>
<b>USABILITY</b>	<ol style="list-style-type: none"> <li>7. The assembly of the kit should require no specialised knowledge or equipment that is not accessible to the farmer</li> </ol>
<b>SUSTAINABILITY</b>	<ol style="list-style-type: none"> <li>8. The farmers should be able to monitor their water use</li> <li>9. The assembly of the kit should require no specialised knowledge or equipment that is not accessible to the farmer</li> <li>10. Should have the functionality to monitor the cost of water used</li> <li>11. The material used should be able to withstand prolonged exposure to the sun and other elements</li> <li>12. The kit should be easily adjustable to fit in with the different sizes and configurations of the different farms</li> </ol>

**OPEN MANUFACTURING (SOFTWARE TOOLS FOR OPEN DESIGN)**

There are many definitions and parameters of Open-source Manufacturing (or Open Manufacturing). In this paper, it simply refers to free access platforms, software and technology that aid affordable product realisation. Forums and platforms such as Arduino, YouTube and OpenCAD are but a few of the available open-source programmes. These were also utilised in the development of the electrical and physical prototypes that were able to monitor and log water use patterns for the farmers.

The specification of the need is the most important reference when starting the human-centred design process because the problems faced by the farmers are at the heart of it. Unlike commercial product development, HCD manufacturers and producers can be more accommodating to the changing needs of the user, as the users are in fact at the core of the entire process. Open manufacturing can cater to the needs of smaller groups of people and in this case, resource-poor farmers. There are no proprietary software or machinery costs that are associated with patented designs or software, allowing for the final associated costs to be kept as low as possible. This, in turn, enables the low-cost development of products and implementation of design changes in the various iterative stages of the design and prototyping process. Lastly, it allows for quick turn-around time and interactive developmental prototypes to be tested with farmers.

**FIRST PHASE OF TESTING**

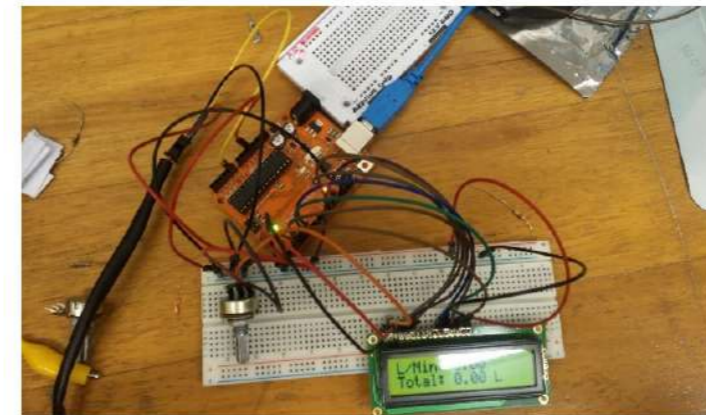
**Arduino**

Arduino is an open-source hardware and software platform that allows users to build interactive products (Arduino, 2020). The drive for the development of affordable technology through the use of open-source manufacture has been the norm for start-ups

(Wood, 2005) and small-batch manufacturers that could not afford the staggering costs of propriety software and hardware. User forums such as those provided by Arduino enable designers with limited knowledge of C++ and Python programming languages to modify the coding used in the system (Merkel, Hopf, & Müller, 2012:107). Sample codes are available on the Arduino website for a multitude of applications, including code for various electronic components and ample manipulation of sensors (Arduino, 2020). This enables beginners to also construct and test simple designs, because circuit schematics are also available on these forums.

The complexity of what was needed and what could be achieved in the time frame of this study was a hurdle, considering the designer’s limited programming and electrical engineering knowledge. As most of the farmers had cited a water management system as their most common problem, this was the dominant problem that was to be tackled. After extensive desktop research, electronic components were sourced that formed the base model of the system. The three components were (a) a flow meter that would be able to measure water output (b) an Arduino Uno Board, a computer board that reads and stored signal outputs from the flow meter and sends them to (c) an output source (in this case a computer monitor). All of these components are low cost and available from several electrical component supply stores.

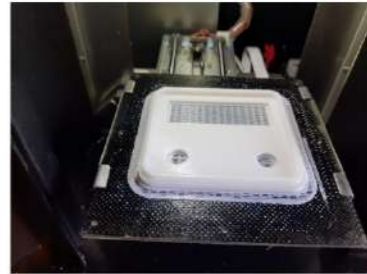
Since the author had no prior programming knowledge, other online forums such as Instructables, GitHub and the Arduino community forum were used in the development of the water management system. These websites are spaces where “makers” post their new projects and discuss the problems they face. This forms a community of people helping each other to find solutions to their technical questions. The coding for the proof of concept model was adapted from base codes and circuit schematics that had been developed by other contributors on these forums. They were a great tool in not only building the code itself but for the debugging of problems encountered as well.



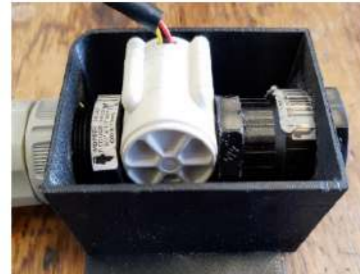
**Figure 1: Proof of concept model using the Arduino Uno**

The goal of this first proof of concept was to allow for the monitoring of water usage. The proof of concept model worked and the next stages of the development focused on adding better usability and extended functions that had been identified beforehand. A display was added and correct configuration of the new circuit was ensured before adding other components. This meant that in its rudimentary form the circuit could monitor and display rate of water output, total water output and the total cost of water without the need for an external computer and monitor.

For quick testing of the housing and the efficacy of the product, the use of additive manufacturing methods was used. The use of 3D modelling is quite essential in terms of assessing the size, volumetric assessment and aesthetics of any given product. Although all 3D modelling software gives an overall impression of the products, 3D printing can be used to represent the final form in the physical realm.



**Figure 2:** Use of a 3D printer to manufacture the enclosure for the water use logger



**Figure 3:** 3D printed enclosure with components assembled in it

The 3D files for the printing process were either modelled by the author or obtained from open source forums such as Thingiverse, which is an online library of ready-to-3D print CAD models (Alcock, Hudson, & Chilana, 2016:195). The availability of such platforms enables access to various models without the need for payment and is also available for use as a discussion forum to seek input from other “designers and makers”. Within a matter of hours, the prototyping and printing of the enclosure itself were complete.

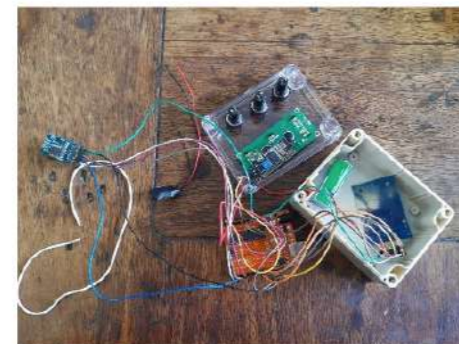
After multiple iterations of testing and consultation with experts, more functionality was added to the water monitor (a) a battery for external power supply (b) a card scanner to enable each farmer to access their individual accounts (c) external data storage card to enable extended use of the monitor without losing data (d) buttons to power the monitor and swap through between functions (e) waterproof enclosure to encase the electronic components.

## SECOND PHASE OF TESTING

Through the qualitative data gathered from the farmers, a clear need arose for an irrigation kit and they had specifically pointed to drip irrigation being the preferred method. Various drip irrigation kits and implements could already be acquired from various main hardware and landscaping shops, so further insights were necessary to understand their perceived shortcomings. Henceforth, parallel to the development of the water management system, field tests were also carried out on the efficacy of existing drip irrigation hardware, in order to note the interaction of the farmers with the installation process, and problems farmers faced during and after installation. From these insights a modified drip and misting kit, easier to install, was put together for the farmers. This was included together with the final monitor design outcome, making a package which



**Figure 4:** Components used to build the prototype



**Figure 5:** The assembled water monitor encased in a waterproof enclosure

I chose to call Thothi Water Management, meaning ‘droplet’ in Setswana, representative of micro irrigation i.e drip.



**Figure 6:** Participating small-scale farmers in Johannesburg engaged with the initial functional test prototype.



**Figure 7:** Installation of drip kit at a participant farm



**Figure 8:** The various irrigation components included in the Thothi kit

## FINAL OUTCOME

The final kit comprised both the water monitor and the drip irrigation kit. Although the components had been extensively tested separately, only one farm was able to test the kit in its entirety. The contents of the Thothi kit comprised (a) Thothi Water Monitor (b) Full Flow T-connectors and elbow connectors (c) Stop valve taps (d) Tap adapters (e) Adjustable drippers (f) Adjustable misters (g) Drip pipes

## KIT MANUAL DEVELOPMENT USING OPEN SOURCE CAD LIBRARIES

In the first consultations with the farmers, it was quite apparent that most, if not all, were quite conversant with what irrigation was, its importance and what types of irrigation systems existed, with some farmers even citing their preference. A good number of the farmers that were part of the study already had existing irrigation systems on their land, albeit not in use. This pointed to a problem far beyond just the lack of proper irrigation but the lack of maintenance abilities thereafter as well.

To ensure proper long-term use of Thothi, a manual was devised to circumvent all the above-listed problems that were additionally faced by the farmers. The manual includes a comprehensive list of all the individual items included in the kit (including quantities) and each of their uses. It also details how to install the drip irrigation to the main manifold. As some of



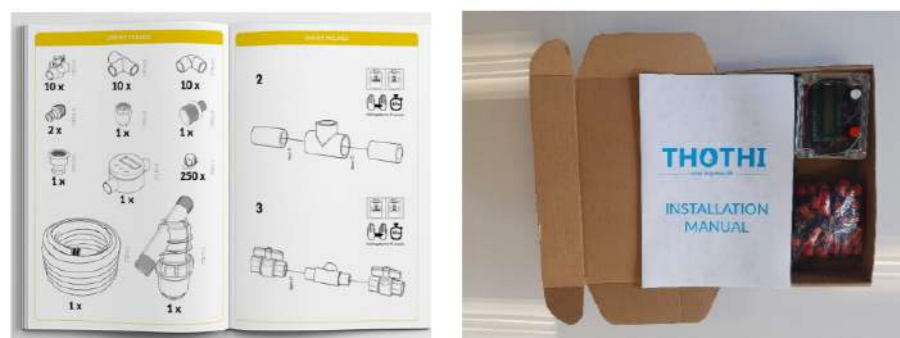
the farmers had problems with upkeep, a guide on maintenance and troubleshooting problems is also detailed in the manual. For the design of the manual, the use of Solidworks Composer and Adobe illustrator was crucial to the process. Although the mentioned software programmes are not open source, similar software is available as open-source, OpenScad and Inkscape. For the models of the actual kit items, GrabCAD was used for the download of already existing standard components such as tap connections, valves and the drip pipe. Grabcad is a free online library of 3D modelled components (GrabCAD, 2017). Preferred software (or file extension) can be specified when searching for specific components, including free CAD software.

## CONCLUSION OF FIELD TESTS

Several design changes need to be implemented for creating a final, more resolved prototype product. Although there were many more proposed changes, the time constraints of the study prevented implementing them. These following design changes will, however, be carried out as part of other research endeavours. The incorporation of participants throughout the duration of the project allowed for extremely rich data to be gathered, but with that human involvement comes a lengthy and thorough process of unpacking and understanding user needs. A rushed product may have been resolved sooner, however, it means that intended user voices would not have been heard through the process.

### Design Refinement

The way forward would be to fabricate a batch of test prototypes and implement them with participating farmers for use with an entire growing season to allow for prolonged product use and feedback. This would allow for a design to be finalised



**Figure 9:** Manual that was designed for assisting the farmers with installation and maintenance of the drip kit

and suited to a larger scale rollout. The data generated from these devices would be able to assist farmers, but also provide valuable data regarding water usage patterns by farmers.

Design refinements ought to be done to make the expansion of manufacturing suitable for batch production. Before full product rollout can be undertaken, there are plans to further the research on the long term benefits of the kit. For the design of a more compact and aesthetically pleasing enclosure, the circuitry needs to be migrated from breadboard to PCB in order to decrease the number of large-size components such as the Arduino board. The development and production of such can also be done through open-source software such as Fritzing, which is a software that enables a designer to create professional permanent electronic circuits from experimental prototypes (Knörig, Wettach, & Cohen, 2009:351).

### Cloud Data Logging

Integration of a Bluetooth or wifi module within the electronics of the product means that it would be able to undertake remote data logging. This enables also the backup of data onto an independent cloud without the need for physical interaction between the designer and the product. Thothi as it is now would only be able to log data if it was switched on and therefore a solenoid valve needs to be included in the system to ensure that whenever there is water flow, the water use is always being logged by the water flow monitor.

## Irrigation Manual Design

Although the kit included the manual, the farmers were more inclined to begin installation without first having read the manual. Reading of manuals can be daunting and a better approach needs to be taken with the design of future manuals. Farmers are more receptive to the use of visual aids than of reading through the text. Some of the text in the manual, where possible needs to be replaced with illustrations of the relevant actions. Additional exploration needs to be undertaken with the use of image, photo, video sequences of steps, with feedback being gained from users. All of this leads to the need for multiple iterative cycles of product development prior to being able to finalise a suitable product.

## RECOMMENDATIONS & CONCLUSION

Irrigation in South Africa is big business and an open-source format, therefore, interferes with the profits of companies and individuals that are in the industry. Due to the Human-Centred approach of this study, it was deemed more beneficial to work directly with only the farmers as they themselves in this regard are the users and ultimately experts in their field.

The design of appropriate technology is not one-dimensional. The availability of these technologies also depends on education, support infrastructure and a thorough design intervention for successful adoption. This was the case for this study as well. The design was only one element in solving the irrigation issue: creating tools, such as the manual, were also essential to the whole process of product development. In this design process, the “appropriateness” of the design was judged by its ability to solve the problems that had been raised by the farmers themselves, and the design process allowed for iteration or consultation between the farmers whilst making the necessary design changes. The final product was not only the product that the farmers themselves wanted but other support structures that had been put in place for proper utilisation of the system, this including a comprehensive manual, a drip kit, a misting kit and Thothi water management. The availability of many open source platforms allowed for the effective development of this system and the availability of accessible knowledge allows for an immense number of technologies to be applied in almost any field. Further research, however, needs to be done to improve the market readiness of Thothi, through testing over longer periods and on varying farming landscapes. This, with the input of the participating farmers, is likely to yield a suitable, manufacturable outcome which can be adopted by them, and able to work effectively in their settings.

## LIST OF REFERENCES

- Alcock, C., Hudson, N., & Chilana, P. K. 2016. Barriers to using, customizing, and printing 3D designs on thingiverse. *Proceedings of the 19th International Conference on Supporting Group Work*, (pp. 195-199).
- Arduino. 2020. *What is Arduino?* [Online] Available from: <https://www.arduino.cc/en/Guide/Introduction> [Accessed 11 April 2020]
- Bonthuys, J. 2018. In-depth study sheds light on irrigated farming areas, water use. *Water Wheel*, 17(4), pp. 26-29.
- Campbell, A. D. 2013. Participatory technology design for urban agriculture in South Africa. *Conference on Human-Computer Interaction* (pp. 8-16). Cape Town: Interact 2013.
- G. M. M. Ochieng, F. A. 2004. Water management tools as a means of averting a possible water scarcity in South Africa by the year 2025. *Water SA*, 30(5), 120-124.
- Giacomin, J. 2014. What is Human Centred Design? *The Design Journal*, 17(4), 606-623.
- GrabCAD. 2017. *Company GrabCAD*. [Online] Available from: <https://resources.grabcad.com/company/> [Accessed 11 April 2020]
- Jew, E. K., Stephen, W., Andrew, D. J., David, M. D., & Peter, S. 2020. Farming systems and conservation agriculture: technology, structures and agency in Malawi. *Land Use Policy*, 95(1), p. 104612.
- Knörrig, A., Wettach, R., & Cohen, J. 2009. Fritzing: a tool for advancing electronic prototyping for designers. *Proceedings of the 3rd International Conference on Tangible and Embedded Interaction*, (pp. 351-358).
- Merkel, A., Hopf, H., & Müller, E. 2012. Accelerating the innovation process with the help of open source prototyping hardware. *International Journal of Engineering*, 10(1).
- Wenhold, F. A., Faber, M., van Averbek, W., Oelofse, A., Van Jaarsveld, P., Jansen van Rensburg, W., . . . Slabbert, R. 2007. Linking smallholder agriculture and water to household food security and nutrition. *Water SA*, 33(3), 327-336.
- Wood, D. 2005. *Open source software strategies for venture-funded startups*. University of Maryland, Tech. Rep. TR-MS1287.
- Zwane, E. M. 2019. Impact of climate change on primary agriculture, water sources and food security in Western Cape, South Africa. *Jambá: Journal of Disaster Risk Studies*, 11(1), 562.

# INCIDENCE OF BRUCELLOSIS IN LIVESTOCK: THE CASE OF SOUTH AFRICA BETWEEN 2010-2019

Mpinane F. Senekane\*, Shalin Bidassey-Manilal<sup>1</sup>, Thokozani P. Mbonane<sup>1</sup>

<sup>1</sup> University of Johannesburg, Department of Environmental Health, Doornfontein Campus, P. Bag 524, Auckland Park 2006, Johannesburg, South Africa, shalinb@uj.ac.za, tmbonane@uj.ac.za

\*Corresponding author: msenekane@uj.ac.za

## Abstract

*Brucellosis remains a public health concern despite being eradicated in several developing countries such as South Africa. Recently, there have been a growing number of bovine brucellosis cases reported in different provinces within South Africa. This paper aimed to describe the incidence of brucellosis in livestock between 2010 and 2019 in different provinces of South Africa. A review of published articles between 2010 and 2019 from scientific databases Scopus, ScienceDirect, African Journals Online, AGRIS: Agricultural database, AGRICOLA: Agricultural Online Access, BioOne and SciELO were used to extract relevant scientific articles. Furthermore, grey literature and government reports were also used. The results were presented in a narrative approach. Brucella abortus outbreaks are usually reported to the government via monthly reports. However, this could be an underrepresentation of the disease as not all herds are tested and not all cases are effectively reported. Gaps in the policy implementation and operational levels in the abattoirs were identified. This study recommends monitoring of livestock on regular basis to determine the presence of brucellosis infections; isolation of sick from healthy animals, additional veterinary laboratories to support vaccination of all red meat animals to prevent the incidence of brucellosis; the involvement of government in implementing and enforcing policies on as well as funding testing procedures. The synergistic involvement of breeding farmers and public health officials in combating this re-emerging disease could be a significant approach.*

**Keywords:** Brucella abortus, brucellosis, control, infections, livestock

## INTRODUCTION

Brucellosis is one of the most common contagious diseases that causes high rates of morbidity, abortion, lifetime sterility, reduced milk production and affects both male and female livestock (Khan & Zahoor, 2018; Zhang, Zhou, Huang & Guan, 2019). It is also known as Undulant fever, Mediterranean fever or Malta fever and is a zoonotic disease that infects both humans and animals (Srivastava & Chaudhary, 2011). Brucellosis has been reported in 86 different countries worldwide and is a serious threat to global livestock (Khan & Zahoor, 2018). Brucellosis is caused by the bacteria of the genus *Brucella*, in cattle, it is usually caused by *B. abortus*, in sheep and in goats by *B. melitensis*, and in pigs by *B. suis* (Awah-Ndukum, Mouiche, Bayang, Ngu Ngwa, Assana, Feussom, Manchang & Zoli, 2018). Transmission can occur through direct contact with infected animals, their tissues, meat and meat byproducts and milk. Even though pasteurization of milk is an effective means to kill *Brucella* and prevent the spread of infection, this precaution is not commonly exercised in various communities due to lack of knowledge and in some milk sheds lack of resources (Franc, Krecek, Hasler & Gamboa, 2018). Brucellosis is a problem that affects the entire herd of livestock and is spread primarily by ingestion of contaminated material such as mucosal

contact with aborted fetuses and foetal membranes, which contain large amounts of the bacteria (Robinson, 2003 & Franc et al., 2018).

When brucellosis is detected in livestock in any country, international veterinary regulations impose stringent measures on animal movements and trade which results in huge economic losses; for this reason, programs to control or eradicate brucellosis in animals have been implemented on a global scale (Godfroid, Nielsen & Saegerman, 2010). Control of brucellosis in animals requires correct diagnosis, slaughtering of infected animals, and indefinite monitoring of brucellosis-free livestock (da Silva Mol, de Araújo França, da Paixão & Santos, 2012). Diagnosis is based on bacteriology or serology and screening of animals. Placenta from aborted fetuses and udder secretions are known to be preferred methods for culture and stained smear extraction. Serological tests are known to be efficient and cost-effective and use cheap and rapid tests which are sensitive enough to detect antibodies in whey, milk and serum from a high proportion of infected animals eg. Rose Bengal Plate Test, Elisa Test, Serum Agglutination Test and Complement Fixation Tests. Screening of milk samples by milk ring test or ELISA and intradermal testing are very useful for brucellosis surveillance (Nicoletti, 2013 & Godfroid et al., 2010). There is currently no treatment available for brucellosis but this disease can be controlled by the use of effective vaccinations available in veterinary laboratories. Positive cases are identified, infected herds are quarantined and uninfected herds are protected by good sanitation and biosecurity (The Cattle Site, 2020).

## BRUCELLOSIS CONTROL IN SOUTH AFRICA

There are several *Brucella* species present in South Africa but bovine brucellosis accounts for by far the majority of reported cases (South Africa, Western Cape Government Agriculture, 2016). In South Africa, animal brucellosis is a controlled, reportable disease, where control measures have been instituted to prevent the spread of brucellosis in the country (NICD, 2018). The country's main focus is on bovine brucellosis through the Animal Diseases Act 35 of 1984 and the Bovine Brucellosis Scheme (R.2483 of 9 Dec 1988) which is regulated by The Department of Agriculture, Forestry and Fisheries (DAFF). According to the Animal Disease Act (Section 10), it is compulsory for high-risk herds that have been confirmed or suspected of bovine brucellosis to undergo testing (Frean, Cloete, Rassouw & Blumberg, 2018; Kolo, Adesiyun, Fasina, Katsande, Dogonyaro, Potts, Matle, Gelaw, & Heerden, 2019). The participation in the scheme by the farmers is voluntary except in cases where brucellosis in an animal is suspected or confirmed. Serological tests that are submitted via the State Veterinary Services are currently being funded by the South African Government. However, there is no database available to substantiate this (DAFF, 2017). Control of brucellosis in some dairy farms has been progressing well, there is some progress noted on commercial and communal beef herds. However, brucellosis control on game farms has proved to be complex and challenging (DAFF, 2015). There is currently a paucity of information on brucellosis in livestock in South Africa (Cloete, Gerstenberg, Mayet & Tempia, 2018).

## THE IMPACT OF BRUCELLOSIS ON HUMAN HEALTH IN SOUTH AFRICA.

The impact of brucellosis on human health gains public health importance when the bacteria are transmitted to human via unpasteurized milk, meat, and animal byproducts, from infected animals (Khan & Zahoor, 2018). The signs and symptoms of brucellosis in human beings are not specific, however. Pregnant women may present with chronic and acute febrile conditions, with common recurring sequelae. The chronic condition often leads to complications and affect the leg muscles, central nervous system and the cardiovascular system (Franc et al.; 2018). Transmission of brucellosis occurs through direct transmission from animals to humans when people handle infected anatomical parts such as the placenta and foetus and foetal fluids, vaginal discharge and animal byproducts such as cheese, milk and meat (Tadesse, 2016). This explains why large numbers of health workers who specifically deal with infected animals are frequent victims of *Brucella* infection which they contract during fieldwork (Kose, Serin, Akkoçlu, Kuzucu, Ulu, Ersan & Oguz 2014).

General malaise, depression, cephalgia, profuse perspiration with a characteristic smell, weight loss, chills, arthralgia, and weakness result from commonly known asthenia and fatigue symptoms. The impact on men include disorders of the reproductive system such as orchitis and erectile dysfunction. Women are impacted by abortions and infertility, and may not show any symptoms. Women may also have their liver and spleen affected and suffer bacterial endocarditis (Dean, Crump, Greter, Hattendorf, Schelling & Zinsstag, 2012). Of the symptoms pointed out in this section, cephalgia is the most common. The recognition of brucellosis as a human disease becomes complex, precisely due to the non-specificity of symptoms. Laboratory diagnosis is necessary to rule out the infections that can reach all organs of the human body (Galińska & Zagórski, 2013). "Concerning symptomatology, the literature characterizes brucellosis as an illness of diversified clinic; among the

symptoms observed are continuous fever, asthenia, fatigue, cephalalgia, profuse sweating, weight loss and others (Dean, Crump, Greter, Hattendorf, Schelling & Zinsstag, 2012)". We conclude that the impact of brucellosis on human health is serious and it is a reason for figures showing increased occupational diseases which affect animal health workers, researchers, rural personnel and veterinarians.

### CRITICAL FACTORS FOR THE SUCCESSFUL ERADICATION OF BRUCELLOSIS.

Although there are multiple methods for the eradication of brucellosis, eradication programmes initiated by the national government seem to focus on the sanitary management of infected herds only. This is not enough, because initiatives on adequate training programmes for cattle producers should be in place and should include biosecurity, legal compliance and veterinary public health programs (GarciaDiez & Coelho, 2013). It is imperative, therefore, for veterinarians to play a leading role in ensuring that farmers in the rural areas are trained on how to prevent brucellosis and its spread because prevention of human brucellosis can be achieved through taking necessary steps to eradicate bovine brucellosis.

We have observed that no inspection is performed on rural livestock and that rural farmers do not adhere to regulations that govern livestock. Infected animals are sold to the agents at lower prices and this makes it easy to spread the disease rather than eradicating it. It should be compulsory that before animals can leave any farm, serological testing should be performed on all animals older than one year, and testing should be done to calves younger than one year before they are slaughtered. According to Cloete, Gersetsberg, Mayet, & Tempia (2019), one of the farming systems used in South Africa is communal grazing and yet there is no evidence that communities are at risk of acquiring brucellosis infection from the practice of communal grazing. We conclude that although brucellosis is transmitted from animals to human being, human beings may not be infected if the environment in which animals are grazing has not been contaminated with discharges, placenta membranes, urine and aborted foetus from infected animals. We also conclude that humans may not be infected when they slaughter animals that are infected with brucellosis if they thoroughly clean their hands and use disinfectants after slaughtering. It is important to understand the knowledge, attitude and practices in different grazing settings so that there is a better understanding of brucellosis and what are the measures needed for a successful eradication.

Based on this information, we conclude that the initial step in eradicating bovine brucellosis is to ensure that the premises are cleaned and sanitized with approved sanitizers and are subjected to veterinary inspection. The next step is to ensure that suspected infected livestock are tested and if found to be positive after tests have been completed, strict measures must be applied such as restriction of movement of animals in and out of the premises under the authority of a licence issued by the National Executive Officer of the Department of Agriculture, Forestry and Fisheries. We recommend that infected livestock should be kept in isolation until slaughtered and breeding and potential breeding livestock should be subjected to further testing; and strict measures should be imposed on all pregnant animals and animals that have calved. Furthermore, investigations of human and animal contact with contagious animals should be undertaken to determine the risk of spread of infection. It is necessary to test herds at origin, livestock on transit or other animals that are considered to be at risk. Tracing and testing of all animals which have left the infected herd since the last negative herd test can also help eradicate bovine brucellosis.

There is limited scientific information available and limited attention to brucellosis in South Africa amongst public health officials. Hence this study describes the incidence of brucellosis in livestock within South Africa.

### METHODS

We systematically reviewed the literature indexed in Scopus, ScienceDirect, African Journals Online, AGRIS: Agricultural database, AGRICOLA: Agricultural Online Access, BioOne and SciELO. Grey literature was also used to compile this article. A systematic review was conducted using guidelines including: (i) literature search to identify relevant articles, (ii) screening and (iii) data extraction (Moher, Liberati, Tetzlaff, & Altman, 2009).

#### Searching

To carry out this study one database search engine i.e. Scopus was used to extract relevant scientific articles using the keywords "Brucellosis in South Africa," Undulant Fever, Brucellosis, Mediterranean fever and Malta Fever in South Africa. A total of 97 articles appeared in the search out of this 7 were systematic review articles and 2 were books. Out of the 97 articles

located, only 50 of them were published during the period 2010-2019. Below is a breakdown indicating the number of articles published over these years on brucellosis in South Africa.

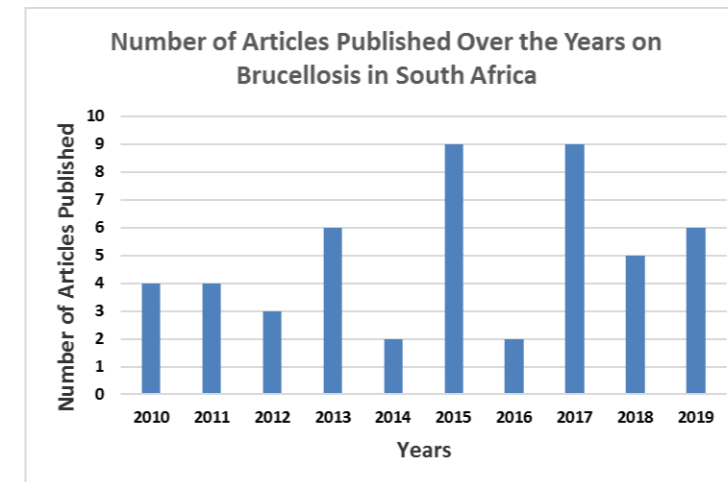


Figure 1: Number of Articles Published Over the Years 2010 to 2019 on brucellosis in South Africa

#### Selection

The articles were sorted by a team of three reviewers. All articles were classified into one of two categories, based on the abstracts:

**Category 1:** Relevant - articles related to brucellosis infections in animals (i.e. disease frequency) or cases of animal brucellosis (i.e. disease morbidity).

**Category 2:** Irrelevant - articles related to non-animal brucellosis, articles addressing topics not related to the current review, such as genetics, laboratory diagnostic tests, experimental laboratory animal studies.

#### Data screening

The retrieved articles were screened based on the following criteria:

- Cases of animal brucellosis in South Africa
- Animal brucellosis studies in South Africa
- Human brucellosis studies in South Africa
- Brucellosis studies in other countries
- Diagnosis of brucellosis in South Africa
- Literature reviews
- Books
- Not brucellosis related

#### Data Screening and Extraction

Full-text analysis for each article was carried out by the reviewers and an extraction sheet was used to draw out the following information:

- Title of the article
- Authors
- Year the study was carried out
- Country/province and study setting (rural or urban)
- Aim of the study

- Study design
- Sample population or size (which type of livestock)
- Inclusion and exclusion criteria
- Diagnostic test
- Study outcome/results
- Policies, interventions and procedures in place to deal with brucellosis
- The key conclusion of relevance to our review

## RESULTS

The database searches revealed 97 research articles and after removing duplicates and those that did not meet the eligibility criterion such as related to human brucellosis including those that did not fall within the study period between 2010 – 2019; 50 articles remained for data extraction and analysis. These included 6 articles reporting on cases or frequency and diagnosis of brucellosis in livestock in South Africa; 7 articles of brucellosis related to transboundary, KAP and brucellosis testing effectiveness and efficiency; 4 articles on human brucellosis studies and 21 articles on animal and human brucellosis incidence and prevalence in other countries. The search also located 7 literature review articles. However 4 of these concentrated on human brucellosis, 2 on brucellosis in human and animals in other countries and 1 review on an over-view of buffalo breeding projects in South Africa. Out of the 50 articles, 2 were the books on brucellosis and 3 articles were irrelevant to brucellosis.

## DISCUSSIONS

### Studies on brucellosis in South Africa

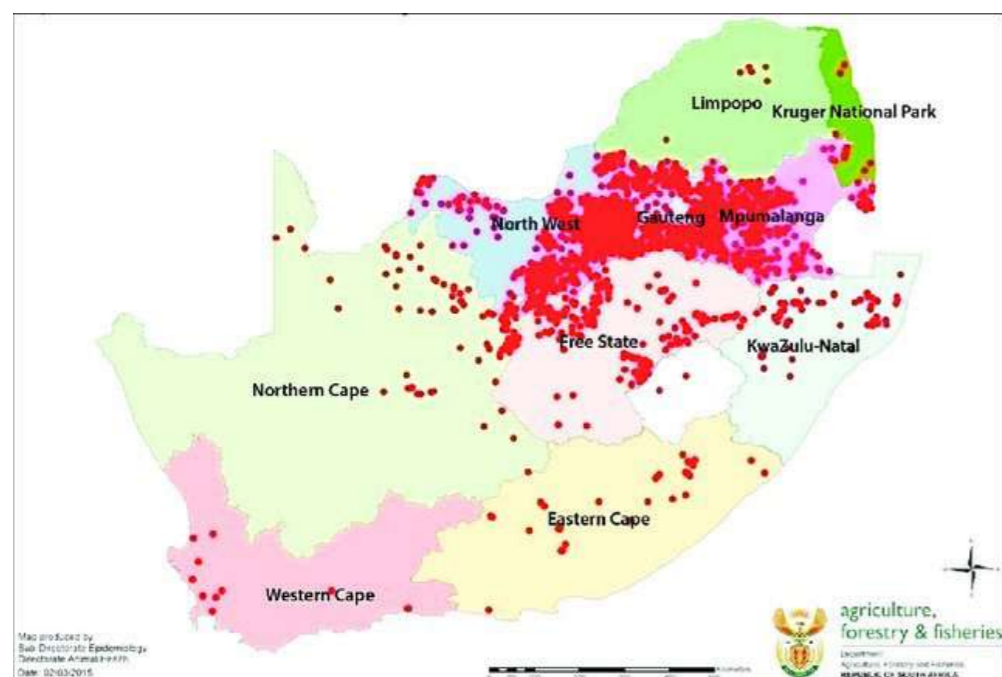
In South Africa, abattoir facilities can be used to monitor disease control policies, detect disease agents and to assess brucellosis control programmes, such as brucellosis vaccination, and early intervention can be facilitated to mitigate the epidemic loss of animals (Kolo et al., 2019). In South African laboratories, the Rose Bengal Test and complement fixation serological tests are used, because of the cost-efficacy of the test (Chisi, Marageni, Naidoo, Zulu, Akol, & Van Heerden, 2017). In South Africa, where heifer vaccination is compulsory, cattle are seen to be the highest source of outbreaks (Simpson, Marcotty, Rouille, Matekwe, Letesson, & Godfroid, 2018). In most of the articles screened, studies were mostly related to serological tests being done on livestock to determine if the animal has brucellosis. The most common studies were those reported by Chisi et al., 2017, Njiro, Kidanemariam, Tsotetsi, Katsande, Mnisi, Lubisi, Potts, Baloyi, Moyo, Mpofu, Kalake, & Williams, 2011, Simpson et al., 2018.; Gorsich, Ezenwa, Cross, Bengis, & Jolles, 2015. Government disease control practices in the country have previously focused on control of *Brucella abortus* among the infectious causes of reproductive diseases in South Africa. However based on the high seroprevalence of other reproductive diseases in this study, other infectious causes of reproductive failures also need attention (Njiro et al., 2011). A shortage of veterinary staff in the Department of Agriculture reduces the efficiency of service delivery, especially during the vaccination and testing programmes which take longer to complete (Jenjezwa & Seethal, 2014). Below is a table indicative of brucellosis frequency in livestock in South Africa. All of the studies below conducted seroprevalence (blood tests to determine if there is a pathogen) tests to determine the presence of brucellosis in cattle, buffalos and goats.

**Table 1:** Studies conducted in South Africa to determine the frequency of brucellosis in animals from the period 2010 - 2019

Author/s, (year/ref)	Study Design & Area	Species	Method Used	Observed diseases	Findings
Kolo et al., 2019	Cross-sectional study (Gauteng Province)	Cattle	serological and bacteriological tests	<i>Brucella abortus</i>	The brucellosis estimated seroprevalence and culture Prevalence among slaughtered cattle in Gauteng abattoirs is at 5.5%.
Simpson et al., 2018	Longitudinal study (Limpopo province)	Cattle	Serological tests.	<i>Brucella abortus</i>	The cases showed a rapid antibody response with 98% at 2 weeks
Simpson et al., 2017	Cross-sectional study (Limpopo Province)	<ul style="list-style-type: none"> <li>• Cattle,</li> <li>• Goats,</li> <li>• Dogs</li> </ul>	Serological tests	<ul style="list-style-type: none"> <li>• <i>Brucella abortus</i></li> <li>• <i>Brucella melitensis</i></li> <li>• <i>Brucella canis</i></li> </ul>	The results showed a 1.4 % seroprevalence in cattle and the absence of <i>Brucella</i> seropositivity in goats i.e. 1/593
Nyirenda et al., 2016	A retrospective study (North West Province)	Buffalo	Serological tests	<i>Brucella abortus</i>	Serological tests records revealed a total of 83 (0.23%) out of 365 buffalo records were found to be positive for the prevalence of <i>Brucella abortus</i> during the study period.
Gorsich et al., 2015	Longitudinal study (Mpumalanga Province)	Buffalo	serological survey	<i>Brucella abortus</i>	Annual brucellosis seroprevalence ranged from 8.7% to 47.6% increased with age until adulthood and varied by location within the Park
Njiro et al., 2011	Cross-sectional study (Gauteng Province)	Cattle	<ul style="list-style-type: none"> <li>• Serology blood sampling,</li> <li>• Sheath washes</li> <li>• Sheath,</li> <li>• Antibodies serological testing.</li> </ul>	<i>Brucella abortus</i>	The result for <i>Brucella abortus</i> is higher than the national Average i.e. Nine out of 237 samples (3.8 %) tested positive

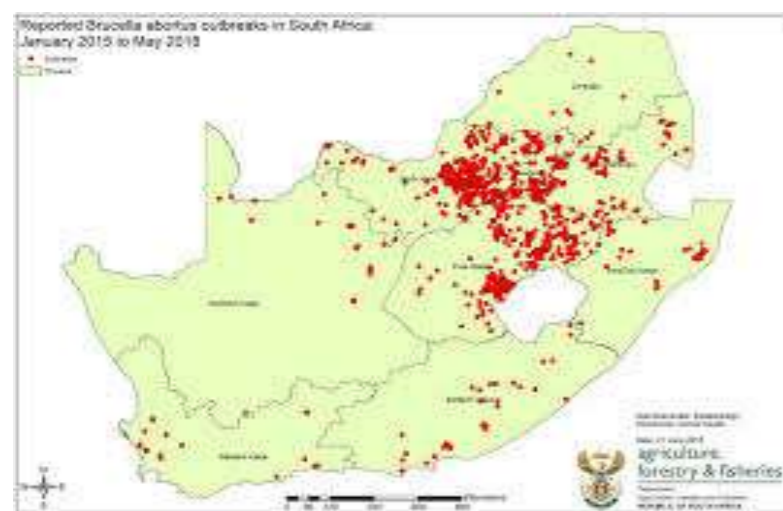
The above studies (Table 1) on brucellosis frequencies obtained their findings from conducting serological and bacteriological tests on livestock. While Kolo et al., 2019 is exceptional by focusing on brucellosis frequencies in a specific province the rest of the studies concentrated on game reserves, national parks and communities.

Due to a limitation in brucellosis case frequency studies in South Africa, grey literature was reviewed for more information.



**Figure 2:** Brucella abortus prevalence in livestock from 2010-2014 (Department of Agriculture, Forestry and Fisheries, South Africa, 2015).

Figure 2 illustrates the prevalence of Brucella abortus in livestock from 2010-2014. According to the map, it is evident that during this period brucellosis cases were more frequent in inland South Africa and more common in Gauteng, Mpumalanga, North West and varying in the Free State Province.



**Figure 3:** Reported brucellosis outbreaks in South Africa from January 2015 to May 2018 (NICD, 2018)

The map in Figure 3 illustrates brucellosis frequency in all nine provinces in South Africa from 2015 – 2018 and similar to the map above (Figure 2), results indicate the concentration of brucellosis cases in the Highveld region of the country (NICD, 2018). Although the true prevalence of bovine brucellosis is currently unknown, the disease is widespread across the country based on disease reports sent monthly by the Provincial Veterinary Authorities to DAFF (DAFF, 2019)

## CONCLUSION

Literature shows that brucellosis was most prevalent in 2015 and 2017. The number of cases was low in 2014 and 2016. Farmers must use vaccinations as an important intervention rather than testing of livestock, because some farmers are reluctant to slaughter positive animals while others decide on selling animals that are positive before they can be branded. We, therefore, conclude that effective control of brucellosis can be managed efficiently if the government can ensure that there is no shortage of brucellosis vaccines in all veterinary laboratories in South Africa.

## ACKNOWLEDGEMENT

The authors acknowledge the Department of Environmental Health in the Faculty of Health Sciences (University of Johannesburg) management for their support.

## LIST OF REFERENCES

- Abdoel, T., Dias, I.T., Cardoso, R., & Smits, H.L. 2007. Simple and Rapid Field Tests for Brucellosis in Livestock, *Veterinary Microbiology*. Volume 130, issues 3-4, 25 August 2008, pages 312-319 [Online] available at: <http://doi.org/10.1016/j.vetmic.2008.01.009>
- Awah-Ndukum, J., Mouiche, M.M.M., Bayang, H.N., Ngu Ngwa, V., Assana, E., Feussom, K.J.M., Manchang, T.K., & Zoli, P.A. 2018. Seroprevalence and Associated Risk Factors of Brucellosis among Indigenous Cattle in the Adamawa and North Regions of Cameroon. *Veterinary Medicine International*, 2018, 3468596 [Online] available at: <https://doi.org/10.1155/2018/3468596>
- Chisi, S.L., Marageni, Y., Naidoo, P., Zulu, G., Akol, G.W. & Van Heerden, H. 2017 An evaluation of serological tests in the diagnosis of bovine brucellosis in naturally infected cattle in KwaZulu-Natal province in South Africa. *Journal of the South African Veterinary Association* 88(0), a1381. [Online] available at: <https://doi.org/10.4102/jsava.v88i0.1381>
- Chisi, S.L., Schmidt, T., Akol, G.W. & Van Heerden, H. 2017 Use of *Brucella abortus* species-specific polymerase chain reaction assay for the diagnosis of bovine brucellosis. *Journal of the South African Veterinary Association* 88(0), a1433. [Online] available at: <https://doi.org/10.4102/jsava.v88i0.1433>
- Cloete, A., Gerstenberg, C., Mayet, N. & Tempia, S. 2019. Brucellosis knowledge, attitudes and practices of a South African communal cattle keeper group, *Onderstepoort Journal of Veterinary Research* 86(1), a1671. [Online] available at <https://doi.org/10.4102/ojvr.v86i1.1671>
- DAFF. 2015. Brucellosis in South Africa: Progress and challenges. [Online] available at: [https://repository.up.ac.za/bitstream/handle/2263/49187/mbizeni\\_brucellosis\\_sa2015.pdf?sequence=1&isAllowed=y](https://repository.up.ac.za/bitstream/handle/2263/49187/mbizeni_brucellosis_sa2015.pdf?sequence=1&isAllowed=y)
- DAFF. 2017. DISCUSSION PAPER ON THE REVIEW OF BOVINE BRUCELLOSIS CONTROL IN SOUTH AFRICA. [Online] available at: [https://www.daff.gov.za/vetweb/pamphlets&Information/Policy/Discussion%20paper%20on%20the%20review%20of%20bovine%20brucellosis%20control\\_Final%2005052017.pdf](https://www.daff.gov.za/vetweb/pamphlets&Information/Policy/Discussion%20paper%20on%20the%20review%20of%20bovine%20brucellosis%20control_Final%2005052017.pdf)
- DAFF. 2019. ALL for public comment on the draft document - bovine brucellosis control policy, South Africa. Draft 1\_BR Policy\_Version 1\_2019-04-01. [Online] available at: [https://www.daff.gov.za/vetweb/pamphlets&Information/Policy/Draft%20document%20-%20Bovine%20Brucellosis%20Control%20Policy,%20South%20Africa\\_V1\\_2019-04-01\\_for%20comment.pdf](https://www.daff.gov.za/vetweb/pamphlets&Information/Policy/Draft%20document%20-%20Bovine%20Brucellosis%20Control%20Policy,%20South%20Africa_V1_2019-04-01_for%20comment.pdf)
- da Silva Mol, J.P., de Araújo França, S., da Paixão, T.A., & Santos, R.M. 2012. Laboratorial diagnosis of animal brucellosis. *Revista brasileira de medicina veterinária*, 19 (3), p. 117-126. [Online] available at: <http://doi.org/10.4322/rbcv.2014.106>
- Dean, A.S., Crump, L., Greter, H., Hattendorf, J., Schelling, E & Zinsstag, J. 2012. Clinical manifestations of human brucellosis: a systematic review and meta-analysis. *PLoS Negl Trop Dis*. 2012;6(12): doi: 10.1371/journal.pntd.0001929.
- Franc, K.A.; Krecek, R.C.; Hasler, B.N & Gamboa, A.M. 2018. Brucellosis remains a neglected disease in the developing world: A call for interdisciplinary action. *BMC Public Health* volume 18, Article number: 125 (2018).
- Gorsich, E.E., Ezenwa, V.O., Cross, P.C., Bengis, R.G., & Jolles, A.E. 2015. Context-dependent survival, fecundity and predicted population-level consequences of brucellosis in African buffalo. *Journal of Animal Ecology*, 2015, 84, 999–1009. [Online] available at: doi:10.1111/1365-2656.12356
- Jenjezw, V.R. & Seethal, C.E.P. 2014. The role of the state in stock farming in rural areas: A case study of Hertzog, Eastern Cape, South Africa. *Journal of the South African Veterinary Association* 85(1), Art. #912, 7 pages. [Online] available at: <http://dx.doi.org/10.4102/jsava.v85i1.912>
- Kose, S., Serin, S.S., Akkoçlu, G., Kuzucu, L., Ulu, Y., Ersan, G. & Oguz, F. 2014. Clinical manifestations, complications, and treatment of brucellosis: Evaluation of 72 cases. *Turk. J. Med. Sci.* 2014;44:220–223. doi: 10.3906/sag-1112-34
- Moher D, Liberati, A., Tetzlaff, J., & Altman, DG. 2009. Preferred reporting items for systematic reviews and meta-analyses: the PRISMA statement. *Ann Intern Med*. 2009;151:264–9.
- Franc, K.A., Krecek, R.C., Häslar, B.N., & Arenas-Gamboa, A.M. 2018. Brucellosis remains a neglected disease in the developing world: a call for interdisciplinary action. *BMC Public Health (2018) 18:125*. [Online] available at: <https://doi.org/10.1186/s12889-017-5016-y>
- Fean, J., Cloete, A., Rassouw, J., & Blumberg, L. 2018. Brucellosis in South Africa – A Notifiable Medical Condition. National Institute of Communicable Disease, Centre for Emerging Zoonotic and Parasitic Diseases. *NICD, 13 (3)*. [Online] available at:
- <https://www.nicd.ac.za/wp-content/uploads/2018/12/Brucellosis.pdf>
- Galińska, E.M. & Zagórski, J. 2013. Brucellosis in humans-etiology, diagnostics, clinical form. *Ann Agric Environ Med*. 2013;20(2):233–238.
- GarciaDiez, J & Coelho, A.C. 2013. An evaluation of cattle farmer's knowledge of bovine brucellosis in North-East Portugal. [Online] available at: <https://doi.org/10.1016/j.jiph.2013.04.008>
- Godfroid, J., Nielsen, K., & Saegerman, C. 2010. Diagnosis of brucellosis in livestock and wildlife. *Croatian medical journal*, 51(4), 296–305. [Online] available at: <https://doi.org/10.3325/cmj.2010.51.296>
- Khan, M. Z., & Zahoor, M. 2018. An Overview of Brucellosis in Cattle and Humans, and its Serological and Molecular Diagnosis in Control Strategies. *Tropical medicine and infectious disease*, 3(2), 65. [Online] available at: <https://doi.org/10.3390/tropicalmed3020065>
- Kolo, F.B., Adesiyun, A.A., Fasina, F.O., Katsande, C.T., Dogonyaro, B.B., Potts, A., Matle, I., Gelaw, A.K and van Heerden, H. 2019. Seroprevalence and characterization of *Brucella* species in cattle slaughtered at Gauteng abattoirs, South Africa. *Veterinary Medicine Science*, 5 (4), pp. 545-555, November 2019. [Online] available at: <https://doi.org/10.1002/vms3.190>
- NICD. 2018. Brucellosis in South Africa – A Notifiable Medical Condition. Vol. 16 (2), pp. 110-117. [Online] available at: <https://www.nicd.ac.za/wp-content/uploads/2018/12/Brucellosis.pdf>
- Nicoletti, P. 2013. Brucellosis in Cattle. MSD Manual, Veterinary Manual. [Online] available at: <https://www.msdsmanual.com/reproductive-system/brucellosis-in-large-animals/brucellosis-in-cattle>
- Njiro, S.M., Kidanemariam, A.G., Tsetetsi, A.M., Katsande, T.C., Mnisi, M., Lubisi, B.A., Potts, A.D., Baloyi, F., Moyo, G., Mpofo, J., Kalake, A., & Williams, R. 2011. A study of some infectious causes of reproductive disorders in cattle owned by resource-poor farmers in Gauteng Province, South Africa. *Journal of the South African Veterinary Association*, vol. 82(4), pp. 213–218.
- Robinson, A. 2003. Guidelines for coordinated human and animal brucellosis surveillance. Food and Agriculture Organisation of the United Nations, Rome. FAO Animal Production and Health Paper, ISSN: 0254-6019. [Online] available at: <http://www.fao.org/3/a-y4723e.pdf>
- RUVASA. 2019. Disease Reports - Ruminant Veterinary Association of South Africa. [Online] available at: <https://ruvasa.co.za/disease-report-2020/>
- Simpson, G., Marcotty, T., Rouille, E., Matekwe, N., Letesson, J.J. & Godfroid, J. 2017. Documenting the absence of brucellosis in cattle, goats and dogs in a Bone Health interface in the Mnisi community, Limpopo, South Africa. *Tropical Animal Health and Production* 50:903–906. [Online] available at: <https://doi.org/10.1007/s11250-017-1495-1>
- Simpson, G.J.G., Marcotty, T., Rouille, E., Chilundo, A., Letesson, J-J. & Godfroid, J. 2018. Immunological response to *Brucella abortus* strain 19 vaccination of cattle in a communal area in South Africa. *Journal of the South African Veterinary Association* 89(0), a1527. [Online] available at: <https://doi.org/10.4102/jsava.v89i0.1527>
- South Africa, Western Cape Government, Agriculture. 2016. Epidemiology Report: Bovine Brucellosis – what is going on? *Veterinary Services*, 8 (10), October 2016. [Online] available at: [http://www.elsenburg.com/vetepi/epireport\\_pdf/October2016.pdf](http://www.elsenburg.com/vetepi/epireport_pdf/October2016.pdf)
- Srivastava, A., & Chaudhary, H.S. 2011. Brucellosis: Its Diagnosis, Prevention and Treatment. *Journal of Chemical and Pharmaceutical Research*, 2011, 3(6):912-917. [Online] available at: <https://www.researchgate.net/publication/221836441>
- Tadesse, G. 2016. Brucellosis seropositivity in animals and humans in Ethiopia: A meta-analysis. *PLoS Negl. Trop. Dis*. 2016;10:e0005006. doi: 10.1371/journal.pntd.0005006.
- The Cattle Site. 2020. Brucellosis. Cattle Disease Guide. Cattle Health, Welfare and Diseases News, England. [Online] available at: <https://www.thecattlesite.com/diseaseinfo/202/brucellosis/>
- Zhang, N., Zhou, H., Huang, D. S., & Guan, P. 2019. Brucellosis awareness and knowledge in communities worldwide: A systematic review and meta-analysis of 79 observational studies. *PLoS neglected tropical diseases*, 13(5), e0007366. [Online] available at: <https://doi.org/10.1371/journal.pntd.0007366>

9TH INTERNATIONAL CONFERENCE ON APPROPRIATE TECHNOLOGY

# **GREEN ECONOMY AND INNOVATION**



# BEGINNING: THE IMPLEMENTATION OF APPROPRIATE BEEKEEPING TECHNOLOGY

Ivan Leroy Brown, University of Johannesburg, [ivanleroybrown@gmail.com](mailto:ivanleroybrown@gmail.com)  
 Angus Donald Campbell, University of Johannesburg, [acampbell@uj.ac.za](mailto:acampbell@uj.ac.za)

## Abstract

In January, 2018 a small South African business called Beegin opened its doors to the international beekeeping industry. Three years of design research, field-testing and development at the University of Johannesburg's Department of Industrial Design resulted in a lightweight concrete beehive and a set of moulds for its distributed production. The appropriate beekeeping technology system (ABTS) produced good results in trials, however, the hardest part of any technological intervention, especially in a developing context, lies in its implementation at scale. Careful theoretical and methodological choices guided the design process through a focus on design for impact (Prestero, 2012), and learnings from the successes and failures of other appropriate technology (AT) projects (Hazeltine & Bull, 2003). This recipe became the foundation from which the delivery strategy for Beegin was planned. Two years later, Beegin has successfully delivered products to over 200 clients in 11 countries. The technology is beginning to have its intended impact, but the implementation process has been far from straightforward. Most of the early expectations were not achieved and plans had to be constantly revisited as Beegin struggled through the phases of business start-up, despite and in some ways due to, its innovative product offering. This paper will briefly document the development of the Beegin beekeeping technology system, the contextual problems it tried to address, and the theoretical framework and methods that led to its creation. The main focus of the paper is an exploration of the transition phase of the Beegin beehive as an AT intervention that took the route from a University-based research project to commercial enterprise. This is relevant for AT discourse, firstly because not much has been written on the subject, and secondly because there are useful lessons to be learnt from the practical experience of commercial implementation versus theoretical AT delivery.

**Keywords:** appropriate beekeeping technology, commercialisation, design for outcomes, industrial design, innovation, implementation, social innovation

## INTRODUCTION

Beegin started as a mini-dissertation final project in a Bachelors of Technology Degree in Industrial Design at the University of Johannesburg in 2016. Through a Human-Centred Design (HCD) approach (Brown, 2015:1), the project had the goal of developing an accessible and sustainable beekeeping system to address some of the critical issues facing existing and emergent beekeepers. The resulting prototype *appropriate beekeeping technology system* (ABTS), named *Beegin*, was then tested and refined through a two-year Masters project. Through intensive participatory design research and field testing, a novel approach to beekeeping was realised (Brown, 2017:1).

The design research was positioned within a theoretical framework which included Appropriate Technology (AT) and Designing for Impact, with the intention that any solutions developed by the project would be *feasible, viable and desirable* (IDEO - HCD, 2011:6) in the South African context. *Beegin* was deemed to be successful after field-testing

at a small scale, but fully verifying the potential success at a larger scale required the rollout of the technology (Brown, 2017:72-78). Part of this Research and Development (R&D) phase was to ensure that the ABTS was prepared for implementation through a process of iteration<sup>1</sup> and scaling towards widespread delivery (Brown, 2017:25).

With limited examples of commercialised South African university projects, particularly in the fields of Industrial Design and AT, it was difficult to select a suitable avenue of implementation. Timothy Prestero, CEO of Design that Matters<sup>2</sup>, has said that “compared to the whole process that leads to implementation - which includes **financing, manufacture and distribution, training, and adoption** - design is the least hard part” (Cooper Hewitt, 2013:24). This was evident in the *Beegin* project since navigating these areas of implementation resulted in further modifications to the ABTS. In the end, the simplest solution to implementation proved to be the most appropriate, providing an example of a viable route for similar AT projects, in similar contexts. In this paper, we will first explain the background and framework that lead to the ABTS outcome, and briefly describe the technology itself. The main focus of the paper is the roll-out of *Beegin* detailing each of the four areas of implementation as described by Prestero (Cooper Hewitt, 2013:24), extracting lessons that could be used as guidelines for similar AT projects.

## A RESPONSIBLE INNOVATION FRAMEWORK<sup>3</sup>

South Africa is faced with a problematic socioeconomic landscape – approximately half (49.2%) of the population live below the poverty line (Stats SA, 2015). In the context of a developing nation, design can, and should, be focused on solving critical humanitarian problems (Papanek, 1985:5). Developed by Fritz Schumacher (1975:3) AT was, as he saw it, the discipline of assimilating technological value towards socio-economic benefit. AT principles of ‘design for the masses’ and ‘self-reliance’ when paired with the innovative and creative aspects of design thinking “can provide people with new tools for engaging their cultural and natural environment” (Buchanan 2001:37). The theoretical framework for the *Beegin* design research project used the principles of AT as fundamental guidelines, focusing on two key aspects that were of specific value in the South African context, namely accessibility and sustainability:

- Accessible technology is affordable, ownable, operable, producible and controllable within the community it serves, and it also enhances skills and dignity (Smillie 2008:91).
- Sustainable technology is socially, economically and environmentally maintainable and non-violent, it uses natural resources, capital and labour as they are available, for the long-term (Smillie 2008:91).

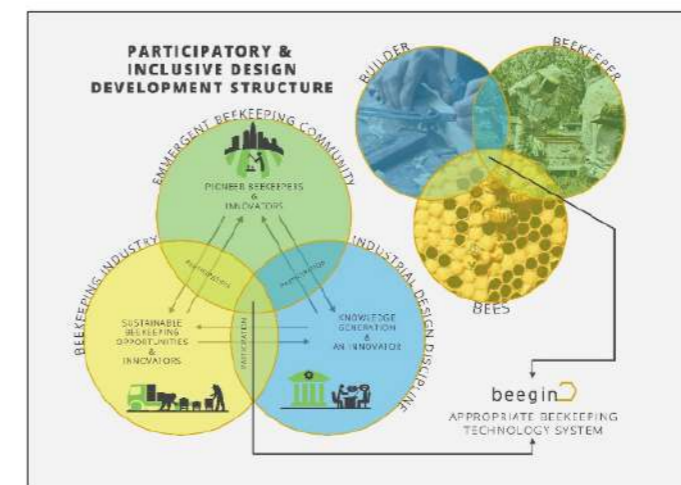


Figure 1: Participatory research collaboration in the Beegin project (Brown, 2017).

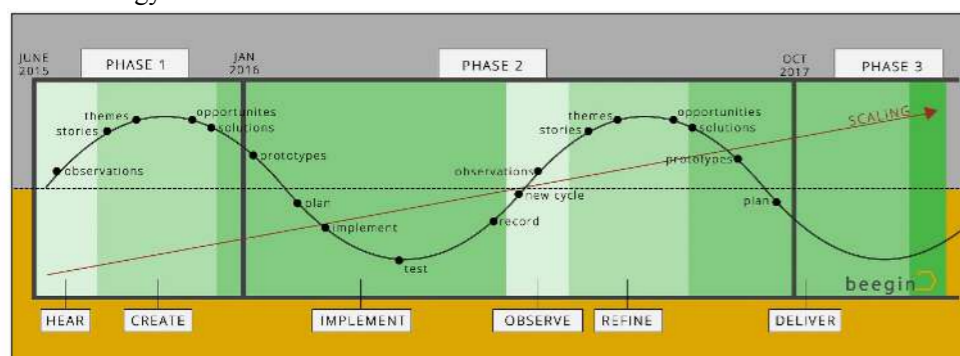
<sup>1</sup> Design iteration, or iterative design, refers to the process of repeatedly making alterations, or starting over, with some, or all, aspects of the process that resulted in the previous version (Kumar, 2013, p. 9).  
<sup>2</sup> Design that Matters is a multi-disciplinary, non-profit founded by a group of MIT students that works with social innovators in developing nations to address basic needs (DtM, 2018).  
<sup>3</sup> For more detailed unpacking of this framework please refer to Campbell & Brown (2018).

To achieve an AT solution requires genuine knowledge of the social, economic, environmental and political context surrounding the problem, which necessitates practitioners to undertake participatory research (Hazeltine & Bull, 2003:29). Human-Centred Design (HCD) is a participatory, user-inclusive approach to developing design solutions. It is carried out through any number of appropriate R&D methods, but tends to be divided into three trademark phases: “Hear (data collection), Create (design work), Deliver (implementation)” (Muratovski, 2016:190). This approach, popularised by IDEO<sup>4</sup> (2015), has become synonymous with good design by positioning end-users as experts throughout the design study. In the *Beegin* project two participant groups collaborated to develop the ABTS. As shown in Figure 1, the first group included the emergent beekeeping community, the beekeeping industry, and the academic Department of Industrial Design at UJ. The second group included the bees, the equipment manufacturer and the beekeeper (Brown, 2017, p. 26).

It is important to note that to complete the HCD process the design practitioner needs to implement the design outcome (IDEO, 2015:133). Often designers, and their design outcomes, are given credit long before implementation has ever occurred (Lisseden, Maley & Mehta, 2015:32). In academia, design researchers may develop successful outcomes or insights, but they are often shelved when the researcher completes their academic deliverable (Smith, 2012). For both these reasons, the design industry has adopted *impact* as a mode of assessing the success of design innovations (Cooper Hewitt, 2013:24).

To address the disparity between theoretical and real-world value, Presterio developed an approach to design for impact, that he calls “designing for outcomes” (Presterio, 2012). This model focuses on designing for *manufacturability, distribution, actual use* and *visual appearance* simultaneously to guarantee the products’ delivery and uptake (Presterio, 2012). In this approach, the designer is continually assessing and refining the system of delivery during the development of the product and, importantly, continually integrating the various role-players into the system (CSIP, 2007)).

The *Beegin* project adopted the HCD process in a cyclical model of R&D, implementation and scaling (Figure 2) (Brown, 2017:23). By slowly growing the scope of the project, the intention was to ensure that any AT outcomes had been properly substantiated in the real-world context and were deliverable within the limitations of available resources (Brown, 2017:27). This system of staggering growth and impact verification was, essentially, a merging of HCD and Design for Outcomes, and helped ensure that the *Beegin* project did not end before wide-scale delivery and adoption of the technology.



**Figure 2:** HCD design research process and Design for Outcomes system for the *Beegin* project (Brown, 2017)

## HEAR & CREATE

The project began by looking at opportunities to help increase the capabilities of small-scale farmers. During scoping interviews, several participants indicated their desire to raise bees and produce honey, with some participants having already set up apiaries with poor results (Brown, 2015:17). This led to further investigation through literature and

<sup>4</sup> IDEO design consultancy, the brainchild of industrial designer David Kelley, has become well-known for its HCD process and numerous collaborations and participatory design projects undertaken in developing nations (Muratovski, 2016, p. 190).

interviews of the challenges facing emerging beekeepers, professional beekeepers, development organisations, agriculturalists and pollination experts (Brown, 2017:8). It was evident that beekeeping in South Africa was under threat from several systemic issues that were not being addressed at a political/economic policy level (Brown, 2017:11), some of these include:

- Cheap honey being imported without levies was driving the local market price of honey down.
- Unregulated transport and renting of beehives for pollination was spreading diseases and parasites across South Africa.
- Criminal activity (theft and targeted vandalism) was being met with little to no police action (Figure. 3).
- Millions of dollars in aid and donor funding had been poured into beekeeping for development projects for decades with marginal impact achieved.

Other issues, particularly of a technological nature, included lack of finance, fires, weathering, maintenance (Brown, 2017:15). The standardised wooden box and removable frames used by beekeepers for over a century around the world, called a Langstroth beehive, is not an expensive or complicated piece of technology. However, to run a sustainable business, beekeepers need between 50 and 200 hives, which makes them cumulatively an expensive asset (Hilmi, Bradbear & Mejia, 2011:11). The longevity of the beehives was also limiting, with industry estimates reaching a figure of 30% annual replacement (Brown, 2015:19, TTA, 2008). These issues combined to directly impact on the profitability of beekeeping and related enterprises (pollination, equipment manufacture and so forth) and, together with the day-to-day problems that beekeepers have always faced, had become make-or-break business obstacles (Brown, 2017:15). When beekeepers attempted to minimise costs in difficult circumstances the wooden beehives, which incurred continual costs, were a technology that needed reconsideration (Brown, 2017:15). The fact that this was also a need for emerging beekeepers (Figure. 3), aligned with the initial impetus for the design research project.

To redesign the beehive, extensive reviews of existing beehives, with further feedback from expert beekeepers was undertaken to produce a set of criteria for both a user-centric and bee-centric beehive design. The design criteria included durability, weight, insulation, toxicity, manufacturing & cost/price (Brown, 2017:36). These criteria were then used to guide the “create” phase of the HCD process, which resulted in beehive prototypes that went through multiple iterative design stages to arrive at a lightweight concrete beehive and moulding tools. The concept was field-tested in partnership with a group of six expert and five emerging beekeepers over one honey-production season (Brown, 2017:37-51).

Through their extended use in the field, both successful and problematic aspects of the beehives and their moulds were carefully documented for design refinement. Aligned with the Design for Outcomes strategy, during the second iteration of design refinement, a further refinement of the design criteria was undertaken to balance and prioritise the requirements for producing an implementable outcome. The design criteria (Figure. 4) were categorised into the macro system (ABTS), material design (lightweight concrete), tool design (DIY moulds), micro system (beekeeping style),



**Figure 3:** Problem identification research found wooden beehives were regularly destroyed, impacting sustainability for beekeepers (Brown, 2017).

product design (aesthetic & functional) and business design (delivery system) (Brown, 2017:57). The ABTS was re-engineered for maximum ‘implementability’ using this hierarchical framework to refine the unresolved issues, resulting in the product outcomes of the *Bee Bunka* (final lightweight concrete beehive) and its moulds for production, branded as *Beegin* – “helping get beekeepers started and keep going” (Brown, 2017:70).

### THE BEEGIN APPROPRIATE BEEKEEPING TECHNOLOGY SYSTEM

The *Bee Bunka* is a lightweight concrete, Langstroth-style beehive. It is designed to combat the issues of theft, vandalism, pests, diseases, weathering and longevity as experienced with traditional wooden beehives. Made from a steel-reinforced, lightweight concrete mixture, the *Bee Bunka* is a strong, durable and cost-effective alternative to existing beehives. An additional benefit is that the lightweight concrete improves insulation for the bee swarm, reducing their need to heat or cool the hive and hence increases honey production (Campbell, 2019). Based on the traditional Langstroth<sup>5</sup> design, the *Bee Bunka* consists of a deep brood chamber (with a floor), a shallow super chamber and a lid (Figure. 6). The chambers take standard frame sizes and are light enough to be moved by two people. The concrete parts all interlock with one another and enable the beekeeper to place a chain/cable around the beehive to reduce theft and vandalism (Beegin, 2019).



**Figure 4:** Hierarchical framework for designing ABTS to achieve 'implementability' (Brown, 2017).

The *Bee Bunka* is made using a set of three simple, low-cost, plastic vacuum-formed moulds. The moulds make it possible for anyone, anywhere to make the beehives, without the need for technical skills or electricity. A beekeeper, farmer or entrepreneur simply needs to gather readily available materials (sand, cement, wire, lightweight aggregate) and follow a set of instructions to make a beehive - all for the same cost as a wooden hive (Beegin, 2019).

### IMPLEMENTATION ROUTE

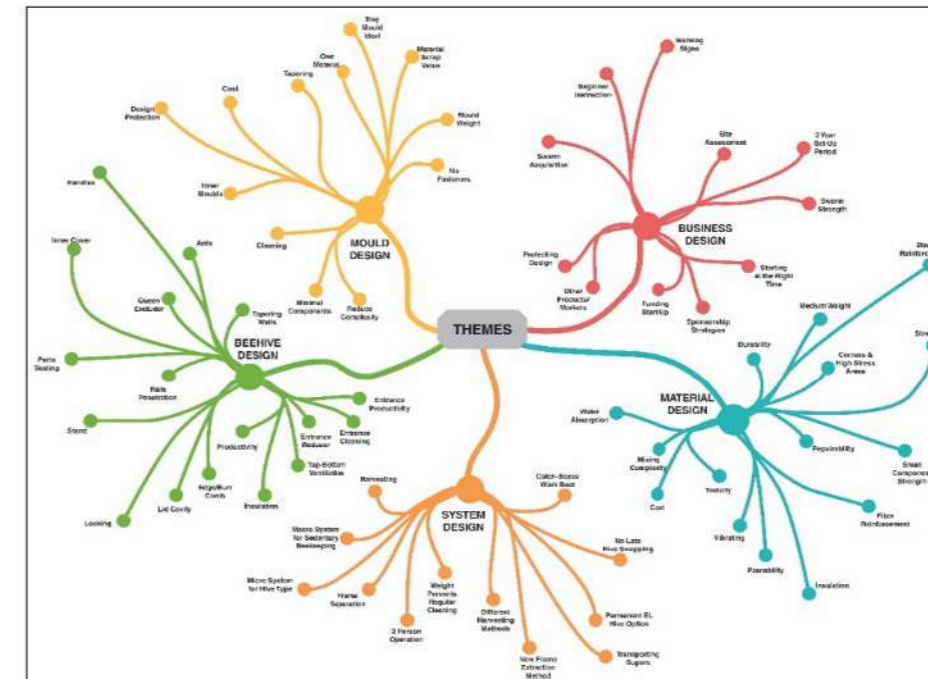
*Beegin* was registered as a Private Company in South Africa in January 2018 by the beehive designer, Ivan Brown, under license from the University of Johannesburg. This was the first step in changing the ABTS from an academic university-based project into a commercial business.

Although the project could have continued within the academic realm by accessing research funding and scaling the R&D, there were issues with this option:

- The question of whether *Beegin* could survive as a sustainable business would not be testable in such a scenario and this would make the business reliant on funding to keep operating.
- The previous testing had shown that beekeeping requires long periods to produce verifiable results (Brown, 2017:76) and the duration of the next phase of testing and iteration was unknown. Continuing to research within an academic environment would need specific deadlines, usually closely aligned with the academic year and/or research funding cycles.
- The nature of the participatory design research process meant the technology was already public knowledge. Functional and aesthetic design registrations were taken out for the beehive and moulds through the UJ Technology Transfer Office (TTO). Therefore, there was a significant risk of a competitor, copying and slightly editing some of the design innovations, and emerging in the market if the project was limited by the relatively slow launch processes within university-based commercialisation (Perkman & Salter, 2012).

The ABTS could have been sold to a private company capable of taking it to market, a common route to commercialisation (Perkman & Slater, 2012), however, the issues with this option were:

<sup>5</sup> The Langstroth beehive is a standardised system of removable frames with exact dimensions based on the honeybee’s natural comb building with vertically stacking chambers for controlling honey production and brood rearing (Johannmeier, 2001:59).



**Figure 5:** Grouping of beehive design criteria during phase 2 of the *Beegin* R&D (Brown, 2017)

- At the outset, with little data on long-term effectiveness and wide-scale market demand, the technology would be difficult to sell the technology for a fair price.
- Relinquishing control of the technology would essentially stop any further R&D within the AT framework.
- Most investors would evaluate *Beegin* based purely on economics and not on the social impact of the technology.

The ABTS could have been made Open Source<sup>6</sup>, allowing people to attempt to make the moulds themselves. However, the size and complexity of the moulds meant that the majority would not have access to the tools and skills to make them, contradicting the project’s intention for broad accessibility.

Therefore, the most suitable route to delivering the technology appeared to be to commercialise the technology and in this way deliver the ABTS to as wide a market as fast as possible. The *Field Guide to AT* by Barrett Hazeltine and Christopher Bull (2003) lists the following steps to starting a business:

1. Prepare a business plan.
2. Search for required funds.
3. Secure legal approvals.
4. Lease a structure.
5. Order items, material, equipment and/or components.
6. Get utilities.
7. Find suppliers.
8. Hire staff.
9. Install equipment.
10. Commence production.
11. Commence marketing.

Based on these guidelines, *Beegin* could relatively easily start making and selling pre-cast lightweight concrete beehives as well as the moulds for making the beehives to the South African market and potentially abroad. Steps 1, 3, 7, 10 and 11 had already been completed through the outcome requirements of the BTech project, the Master’s project and the licensing agreement with the UJ TTO. Steps 4, 6, 9 were met by the pre-existing infrastructure that Brown already had access to. Steps 2, 5 and 8 were the only outstanding items and seemed as if they could be resolved relatively quickly.

<sup>6</sup> The Open Source movement is built on Creative Commons licenses, which “were designed to give creative people the freedom to deploy copyright in a flexible manner.” (van Abel et al. 2011: 12).



Figure 6: The *Beegin* Bee Bunka - lightweight concrete beehive, (Brown, 2018).

## FINANCING

The ABTS business model arose from the responsible innovation framework, following an unconventional business model. Generally, in Industrial Design practice the ownership of moulds, which enable the reproduction of a product, symbolises intellectual property (IP) and carries the potential for anyone who has them to reverse-engineer a design. A typical approach would be for a business to retain the moulds and only sell the end-product. The reasons for *Beegin* selling the moulds were as follows:

- The precast concrete beehives are heavy and bulky, making transport expensive and requiring significant fossil fuel resources for distribution.
- Setting up satellite production facilities run by *Beegin* would be costly, and would likely struggle due to varying local demand, resulting in an over-exposed business.
- In South Africa, with significant unemployment (Stats SA, 2019), a local beehive maker would be better positioned to understand their local requirements and market. The moulds, therefore, offered the potential for localised small-scale entrepreneurship.
- Feedback from participants in the fieldwork indicated that beekeepers and farmers preferred the autonomy offered by owning their moulds.
- The way that the moulds were designed and manufactured meant that it would be hard for anyone to achieve the same quality for a similar price, and without sufficient volume, copying one or two moulds would be unfeasible.
- The moulds had a limited life span, which meant that entrepreneurs who made successful businesses out of manufacturing the hives would continue to support *Beegin* in the long-term.

The unconventional business model of the ABTS provided definite social and economic benefit to those that bought the moulds. However for *Beegin* it was a significant obstacle in receiving any form of funding. Funding applications were submitted to University (UJ), and government (TIA & DTI) and private banking business start-up funding programmes (Nedbank). Concurring with Perkman and Salter's (2012) findings, the University funding route was found to be mired in bureaucracy and, contrary to any notion of rapid deployment, some applications for funding stretched over 3 years, with no outcome.

The government and bank funding had the following hurdles:

- The funding required by *Beegin* to start up was low – under R500k, which was too low for most start-up packages.
- For government or bank support, a comprehensive business report is required. This entails the hiring of a market analyst to carry out exploratory research to calculate potential demand. Then a business expert and accountant need to be involved in the generation and signoff of aspects of the document. The cost implications of this were in themselves greater than the start-up capital required. It would have also added at least a year to the planning and then possibly another 6 months<sup>7</sup> for applications and approvals.

<sup>7</sup> From discussions with other entrepreneurs, many explained that in South Africa funding was a slow and arduous process, which severely hampered the ability for a business to get to market early.

During the participatory research into the ABTS, beekeepers and farmers showed a significant level of interest in purchasing the moulds. The research and AT outcomes were also presented at beekeeping association meetings, drawing interest and spreading the word to the wider industry. *Beegin* therefore decided to experiment with crowdfunding, running an *Indiegogo* campaign (Fig. 8) for 6 weeks to raise R480k for the first round of mould production. A survey was done amongst these potential customers, reaching out directly through phone-calls and email, to see who would be willing to pre-order the moulds through *Indiegogo*, and the results showed that *Beegin* could achieve the required capital. Time and effort were put into developing the campaign but it too did not meet with success for the following reasons:

- The ABTS was an innovative technology, not broadly tested. While some early adopters were willing to take a risk on the technology, most beekeepers desired to see evidence of long-term results, especially in diverse countries.
- Most of those who had shown interest in supporting the campaign were farmers, and not particularly tech-savvy. Many of them responded with confusion over the *Indiegogo* web-based system, which took them too far out of their comfort zones.
- The campaign was designed for the beekeepers who had already shown interest in purchasing the moulds; others who organically came across the project on the platform were alienated when they viewed the technical video that was intended to convince beekeepers to invest.
- At the time of the campaign, South African projects on *Indiegogo* could only request funding in USD (this has now changed, as seen in Fig. 8). Several South African farmers/beekeepers, therefore, refused to buy into the campaign because they believed it to be an American version of the *Beegin* project or that they would be paying extra for it – since *Indiegogo* takes ±10% of successfully funded campaigns they were not incorrect in this regard.
- Finally, again because the campaign was targeted at farmers who had shown interest in buying the moulds, there were no cheap 'gimmick' investment incentives (such as getting a *Beegin* t-shirt) designed into the campaign. Coupled with the relatively short duration of the campaign, this led to the exclusion of several funders who needed more time to raise the capital needed \$560 price tag for a complete mould set.

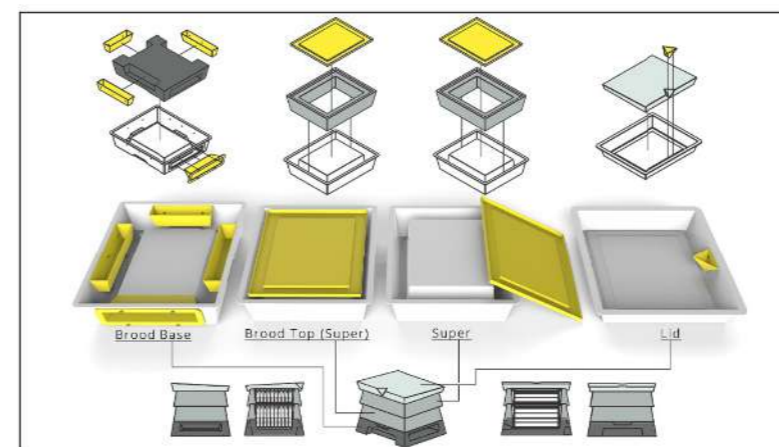


Figure 7: The *Beegin* Bee Bunka Mould Set - low-tech, DIY moulds, (Brown, 2017).

After all these avenues did not bring timeous funding, *Beegin* started making and selling precast beehives using the prototype moulds (Fig. 9). After selling a few hives, extra prototype moulds were then made to increase production capacity. With any new technology, it is difficult for enterprises to get immediate user buy-in (Rogers, 2013). The early adopters of the ABTS were few and far between, but some were willing, some sufficiently desperate, to try the beehives. The newness of the ABTS could provide no wide-scale evidence of efficacy, so the majority of early adopters opted to buy pre-cast beehives first, and moulds later (Fig. 12). This naturally worked out well for the *Beegin* business model and it is important to note that had *Beegin* offered to only sell moulds from the get-go, sales may have been non-existent.

The year spent selling hives afforded the ABTS the opportunity to be field-tested on a wider scale, providing further evidence of efficacy, and allowed the gradual accumulation of capital to fund the production of the first batch of moulds.

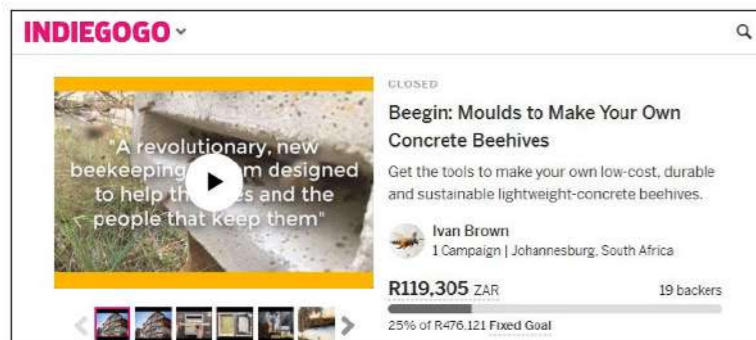


Figure 8: Indiegogo crowdfunding page for Beegin Moulds (Indiegogo, 2020).



Figure 9: Beegin Bee Bunka early production of beehives in 2018, (Brown, 2018).



Figure 10: Early sales of pre-cast beehives to local, commercial beekeepers (Brown, 2018).

Additionally, some small soft loans, largely through clients who agreed to pre-order, were used to boost capital. In the end, not waiting for funding or spending time and money on a business plan helped establish *Beegin* without any debt or loss in the integrity of the responsible innovation framework.

## MANUFACTURE

The manufacturing process for the *Beegin* beehive moulds is vacuum/thermo-forming – a simple relatively low-cost manufacturing process well suited to the low tolerances needed for moulding the concrete hives. The intention was that the moulds should be produced locally, as per most models of appropriate technology. However, after extensive engagement with the local industry, it was found that UV treated plastic sheets above a certain thickness, as required for the *Beegin* moulds, are all imported to South Africa from China and that the size of the mould parts were all too big for local manufacturers (Figure 11). *Beegin*, therefore, took the difficult decision to manufacture its moulds in China (Figure 12) with some unexpected consolations:

- *Beegin* was importing moulds, not the beehives. Moulds are considered production tools with the potential to create local employment, and therefore no duties are paid on their import.
- The moulds were designed to be stackable and therefore packed into a relatively small volume, which resulted in efficient use of container space and reduced shipping costs.

A low-priced entry of AT into the market is key to its success (Smillie, 2008); coupled with the low cost of Chinese manufacturing it seemed *Beegin* had found a suitable manufacturing route. However, after ordering and shipping two batches of moulds a few limitations were identified:

- The minimum quantities required by the Chinese manufacturer meant a large capital outlay before each order. This was more a problem with the manufacturing process itself than the Chinese manufacturer, since South African manufacturers had even larger minimum order quantities.
- The slow shipping process meant waiting up to two months for parts. Again, in comparison to local manufacture, this is still relatively swift due to the fast turn-around time in China.
- Payment in China is in USD, which was difficult to manage with ZAR exchange rate fluctuations.

## DISTRIBUTION

Distribution in South Africa through a wide distribution network of couriers across most of the country has been effective and relatively straightforward. However, there remains a problem with worldwide distribution. Although the moulds are light and have zero import/export duties, their size is costly for shipping. In the bulk order from China, this is amortised across a significant number of mould sets, but when shipping a single mould to an international destination, the costs quickly escalate, since South Africa is geographically removed from most major shipping



Figure 11: Failed attempts at making large mould parts in South Africa (Brown, 2017).



Figure 12: Chinese made mould units (Brown, 2019).

destinations. For this reason, a great deal of international interest, even from neighbouring countries, has been dissuaded. Numerous options have been explored to mitigate this issue. With a focus mainly on the USA and Australia where two big beekeeping markets exist, *Beegin* has sought options to:

- Partner with a client based in a foreign country to become a distributor. This idea has been presented to numerous clients who wish to become distributors. However, to make it feasible for the distributors, they need to earn a high enough profit on the ABTS, and thus far no reasonable agreement which keeps the end-customers' interests at heart has been arrived at.
- Local warehousing and distribution as offered by shipping companies. They offer businesses the possibility of shipping large quantities of products to a country, storing them in a warehouse and distributing them from there with each order. However, the moulds then need to be packed into individual boxes beforehand, creating a pricing problem with the bulk shipment. The storage fees are also high.

## TRAINING & ADOPTION

In the business plan, it was estimated that a large portion of *Beegin*'s business would come from Non-Governmental Organisations (NGOs) involved in beekeeping for development projects (Figure 13). There was a great deal of interest, with discussions with no less than 15 individual organisations including *African Honeybee*, *Bee Parks Trust*, *Win-Win Earth*, *Swaziland Ministries*, *UNICEF South Sudan*, and *WFP Yemen*. However, of these, only a small amount of

business (selling one or two moulds) has materialised so far. The slow, bureaucratic process of approval and funding that these organisations rely on could be to blame. But some of the NGOs are still in a process of trialling the technology, so we wait to see if their interest bears any significant fruit.

*Beegin* always expected some limits to the scale of industry adoption particularly with pollinating and migratory beekeepers<sup>8</sup> that rely on lightweight, transportable wooden beehives for their operations. However, ‘necessity is the mother of invention’ and the security benefits of the Bee Bunka seem to have trumped this. One large commercial pollination beekeeper has started testing a system where the farmer, who would usually hire their beehives, now buys the *Bee Bunkas* to be permanently installed on their farm. Then, during the flowering season, the beekeeper brings his



Figure 13: A Bee Bunka demonstration for a potential NGO client (Brown, 2018).

bees in wooden hives and transfers them to the concrete hives, so that they are safe whilst located on the farm. Another commercial, migratory beekeeper has built camps in wilderness areas using Bee Bunkas to also protect the swarms whilst in the field. Other enterprising small-scale beekeepers have teamed up to buy moulds together and share them when needed.

On this note, the results of the initial university-based field-testing of the concrete moulds to produce hives enabled the moulds to be refined to a point that currently most clients have not required additional assistance outside of the training manual provided with the moulds. *Beegin* was expecting a need for additional training would be necessary when clients bought the moulds, however, it seems most appear to enjoy finding their own way (Figs. 14-15). It may be that the type of proactive, DIY-inclined people that are attracted by appropriate technology solutions are also the type of people that will put their mind towards figuring out a way of suiting it to their own needs.

## IMPACT & SCALING

Since commercialisation in January 2018, *Beegin* has sold over 600 precast, lightweight concrete beehives. Sales have mainly been to people within 200km of the business’s location. Since starting to sell moulds in April 2019 *Beegin* has sold almost 100 sets, the majority to customers in South Africa, but sales have also been made in 11 other countries (Figure 16). Through these moulds, an estimated 3 000 beehives have been produced thus far. The feedback and reception of the technology have been overwhelmingly positive. Despite the slow process of beekeeping, which requires a year or more to establish a honey-producing swarm in a beehive, the results have shown that the ABTS outperforms traditional beehives, hence promoting business growth for beekeepers and farmers. The commercialisation phase will need to be followed by another research phase and we have kept track of *Beegin*’s users, which will enable future research on the impact of the AT. During this further research, we will explore the uptake and use of the technology and its production from a product point of view, as well as its economic impact for the beekeepers. This will lead to clearer insights into the socioeconomic and technological impacts of *Beegin*.

For *Beegin* as a company, the slow pace of beekeeping, relationships with NGOs and the search for funding has meant gradual business growth. Being unrestricted by large loan repayments, *Beegin* has managed to keep itself afloat whilst

<sup>8</sup> Migratory or pollinating beekeepers move their hives by placing them on a truck and driving them at night; they relocate them to different farms/locations during different flowering periods to diversify the source of nectar for the bees and/or to offer pollination services for fruiting crop farmers (Johannsmeyer, 2001, p.43).



Figure 14: Bee Bunka production in Lusaka, Zambia (Brown, 2019).



Figure 15: Bee Bunka production in Antigua, Antigua (Brown, 2019).



Figure 16: Beegin Bee Bunka Mould client map (Beegin, 2020).

focused on the ABTS, but at the same time limited by not being able to pursue much in the way of other technology solutions or R&D. Without users seeing a definite positive value-to-cost ratio the *Beegin* project would run aground quickly. Scaling is therefore directly linked to market acceptance, with *Beegin* relying on user feedback to guide the development of further business decisions. Where requirements are not being met and users have difficulties, the AT has to be refined. Innovations also filter back from within the user base and are then incorporated for future clients. For example, as clients report back on their own tests and trials using different concrete additives and aggregates, like Hempcrete and reinforcement-fibres, *Beegin* has added these to the instruction manuals, forwarding digital copies of new editions directly to past clients.

## CONCLUSION

*Beegin* managed to navigate the difficult areas of financing, manufacture and distribution, training, and adoption, as identified by Timothy Prester (in Cooper Hewitt, 2013:24). Nevertheless, this path to implementation was not easy. A large part was successful due to the clear orientation provided by the framework for responsible innovation developed during the research (Campbell & Brown, 2018). There is an art to balancing theory and practice in the implementation of appropriate technology, and to some degree, there is also an amount of luck/serendipity (Kaufman, 2018). There were potential avenues for commercialisation that may have resulted in fewer or no people accessing the ABTS, with *Beegin* failing to deliver the research outcomes.

In the end, it seems that *Beegin* carefully ‘muddled through’ (Lindblom, 1959) to arrive at a point of incremental scaling, which has limited the expansion of the brand, but at the same time has allowed for a more considered and appropriate technological outcome. In the current world order, such a position is tenuous, and with all the upheavals brought about through COVID-19, more consideration and luck may be needed for *Beegin* to navigate current uncertainties. If *Beegin* continues to grow, the wide and varied user base offers great potential for further research into its broader impact.

## LIST OF REFERENCES

- Beegin. 2020. *Beegin: Appropriate Beekeeping Technology*. Available at: <http://www.beegin.co.za/> [Accessed 7 April 2020].
- Boorstin, L., 2013. *The Quest for Scale*. Available at: [https://ssir.org/articles/entry/the\\_quest\\_for\\_scale](https://ssir.org/articles/entry/the_quest_for_scale) [Accessed 14 October 2017].
- Brand, K.G. & Campbell, A.D. 2014. In-context and ecology immersion for resilience: An exploration of the design of a household farming kit. *International Union of Architects World Congress: UIA 2014 Durban: Architecture Otherwhere: Resilience, Ecology, Values*. Durban, South Africa: UIA 2014 Durban, 1332-1343.
- Brown, I. 2015. *An improved beehive design to support local urban agriculture*. BTech mini-dissertation. Johannesburg: University of Johannesburg.
- Brown, I. 2017. *An appropriate technology system for emergent beekeepers: Field testing and development towards implementation*. Johannesburg: University of Johannesburg.
- Buchanan, R., 2001. Human dignity and human rights: Towards a human-centered framework for design. *Design Issues*, 17(3) 35-39
- Campbell, A.D. 2019. Keynote Address. *LENS World Distributed Conference - Designing Sustainability for All*. Cape Town: LeNS, 5 April, pp. 19-23.
- Campbell, A.D. & Brown, I.L. 2018. A potential difference model for educating critical citizen designers: The case study of the Beegin Appropriate Beekeeping Technology System. In Costandius, E. & Botes, H. (eds.) *Educating Citizen Designers in Southern Africa*. Stellenbosch: SUNMeDIA. pp. 85-104. date/s in 2018 ?
- Campbell, A.D. & Harrison, P.H. 2015. A Framework for Socio-Technical Innovation: The Case of a Human-Powered Shredder. In Collina, L., Galluzzo, L. & Meroni, A (eds.). *Proceedings of the Cumulus Conference, Milano 2015: The Virtuous Circle: Design Culture and Experimentation*. Milan: McGraw Hill, 3-7 June, pp. 211-230.
- Cooper Hewitt, 2013. *Design and social impact: A cross-sectoral agenda for design education, research and practice*. New York: Smithsonian Institution's Cooper Hewitt National Design Museum.
- CSIP (Care Services Improvement Partnership). 2007. *Designing for Outcomes*. London: Department of Health.
- Design that Matters (DtM). 2018. *Social Impact Design*. Available at <https://www.designthatmatters.org/about> [Accessed 14 April 2020].
- Hazeltine, B. & Bull, C., 2003. *Field guide to appropriate technology*. San Diego: Academic Press.
- Hilmi, M., Bradbear, N. & Mejia, D., 2011. *Beekeeping and sustainable livelihoods*. Rome: FAO.
- IDEO.org, 2015. *The field guide to human-centered design. Design Kit series*. Canada, City unknown: Publisher unknown.
- Illgner, P. M., Nel, E. L. & Robertson, M. P., 1998. Beekeeping and local self-reliance in southern Africa. *The Geographical Review* 88(3) 349-362.
- Indiegogo. 2020. *Beegin: Moulds to make your own concrete beehives*. Accessed at: <https://www.indiegogo.com/projects/beegin-moulds-to-make-your-own-concrete-beehives> [Accessed 15 April 2020].
- Johannsmeier, M., 2001. Beekeeping in South Africa. Plant Protection Research Institute Handbook No 14. Pretoria: Agricultural Research Council.
- Kaufman, S.B., 2018. The role of luck in life success is far greater than we realized. *Scientific American Blog*, March 1. Available at: <https://blogs.scientificamerican.com/beautiful-minds/the-role-of-luck-in-life-success-is-far-greater-than-we-realized/> [Accessed 27 April 2020].
- Kumar, V. 2013. *101 Design Methods: A structured approach to driving innovation in your organisation*. New Jersey: John Wiley & Sons.
- Lindblom, C.E. The science of "Muddling Through". *Public Administration Review*, 19(2)79-88.
- Lisseden, J., Maley, S. & Mehta, K., 2015. An era of appropriate technology: Evolutions, oversights and opportunities. *Journal of Humanitarian Engineering*, 3(1)pp?.
- Muratovski, G., 2016. *Research for designers: A guide to methods and practice*. London: SAGE Publications Ltd.
- Papanek, V., 1985. *Design for the real world: Human ecology and social change*. London: Thames & Hudson.
- Perkmann, M. & Salter, A.J. 2012. How to create productive partnerships with universities. *MIT Sloan Management Review*, 53(4)pp?
- Pilloton, E. 2009. *Design revolution: 100 Products that are changing people's lives*. London: Thames & Hudson.
- Prestero, T., 2012. *Design for people, not awards*. [Online] Available at: [https://www.ted.com/talks/timothy\\_prestero\\_design\\_for\\_people\\_not\\_awards](https://www.ted.com/talks/timothy_prestero_design_for_people_not_awards). [Accessed 10 January 2017].
- Resnick, E. (ed.). 2019. *The social design reader*. London: Bloomsbury Publishing Plc.
- Rogers, E.M. 2013. *Diffusion of innovations*. Fifth Edition. New York: Free Press.
- Stats SA, 2019. *Unemployment rses slightly in third quarter of 2019*. Available at: <http://www.statssa.gov.za/?p=12689> [Accessed 26 April 2020].
- Stats SA, 2015. Living Conditions Survey 2014/2015. Available at: <http://www.statssa.gov.za/?p=9473> [Accessed 7 April 2020].
- Smith, L.T. 1999. *Decolonizing methodologies: Research and indigenous peoples*. London: Zed Books.
- Smillie, I. 2008. *Mastering the machine revisited: Poverty, aid and technology*. Rugby: Practical Action Publishing.
- TTA (Total Transformation Agribusiness). 2008. Situation analysis of the beekeeping industry: Situation analysis of the beekeeping industry in Botswana, Lesotho, Malawi, Mozambique, South Africa, Swaziland, Zambia and Zimbabwe. Johannesburg: TTA.
- UNEP, 2019. Human Development Report 2019 - Beyond income, beyond averages, beyond today: Inequalities in human development in the 21st century. New York: UNEP.
- Van Abel, B., Evers, L., Klaassen, R. & Troxler, P. 2011. *Open design now: Why design cannot remain exclusive*. Amsterdam: BIS Publishers.

# INTEGRATION OF TECHNOLOGY IN COMMUNITIES TO ENHANCE CIRCULAR ECONOMY IDEOLOGIES THROUGH WASTE TO ENERGY ACTIVITIES - A PEETS APPROACH

Daniel Madyira, University of Johannesburg, South Africa, dmadyira@uj.ac.za  
 Samson Masebinu, University of Johannesburg, South Africa, smasebinu@uj.ac.za  
 Ezekiel Nyoni, Midlands State University, Zimbabwe, enyoni@waremstech.com  
 Zenzile Rasmeni, University of Johannesburg, South Africa, zrasmeni@uj.ac.za

## Abstract

*The rise in human population also means ever-increasing demands on energy supply, and since everything is either digitised or automated in the 21<sup>st</sup> century, the demand for electricity is strained to the limit. This pressure on natural resources has triggered the use of circular economy ideologies and sustainable technologies by creating value out of waste. However, in sub-Saharan Africa, socio-economic challenges in the region have to be factored in when applying these technologies and ideas. The Process, Energy and Environment Technology Station at the University of Johannesburg (UJPEETS) has managed to follow through on the application of a circular economy strategy in a Waste to Energy project. The Institution has been involved in projects with waste to energy (biogas) production, permaculture and urban logistics solutions for urban agriculture entrepreneurs. The organisation has been focusing on how these developed technologies can be used to solve socio-economic challenges in a socio-technical way. The paper highlights how waste-to-energy activities can be coupled with indigenous knowledge systems in a drive to uplift under-privileged communities through skills transfer, job creation and community development-driven projects. This is in line with spreading awareness of the circular economy concept at grassroots level for better appreciation of the concept at national policy stage and its wider implementation.*

**Key Words:** circular economy, South Africa, sustainable technology, waste to energy

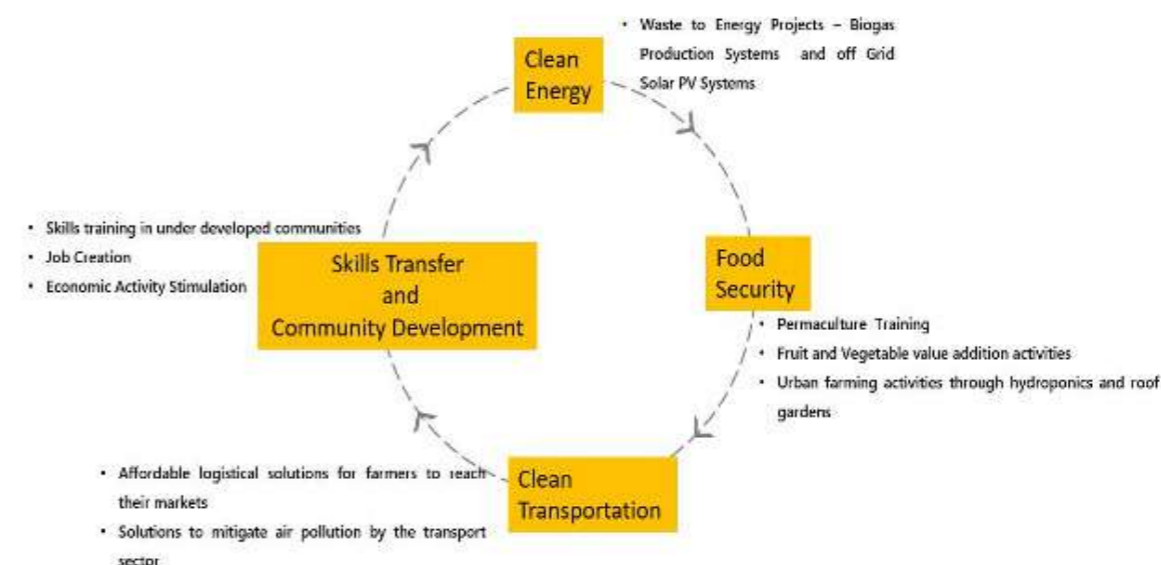
## INTRODUCTION

Currently, most systems and products are designed and manufactured using a linear economic model/paradigm. End of Life (EoL) of the products is just estimated and no plans are made for restoration of the product or material reuse (Tam,2019). Because of the excessive global warming effects on the planet's climate, there has been a rise in the promotion of the use of sustainable technologies coupled with circular economy in order to reduce the use of fossil fuels and limit the use of materials which are not biodegradable. Implementation of sustainable technologies is vital in order to preserve the earth's natural resources. As the world population increases, the demand on natural resources to provide daily necessities, mainly energy, has increased as well. This has also started the call worldwide to look at alternative energy solutions which are pro-circular economy. These are commonly known as renewable energy technologies.

China, through its central bank, introduced the circular economy in the year 2002 (Bassi,2019). In Europe the concept has started to gain momentum as the European commission has already started adopting circular economy into its

economic package (European Union, 2018). Some of the popular European countries that have adopted the circular economy policy at national level include the UK, the Netherlands, Finland and Scotland where such policies are already being implemented (Repo,2018). However, Repo, Anttonen, Mykkänen and Lammi (2018) (Repo,2018) argue that there is lack of harmony on the circular economy public policy and the understanding of this by layman citizens of the respective countries. They argue that this lack of congruence between the public policy and the perspectives of citizens towards the policy is the result of the policy not being fully accepted by the citizens with the final outcome being failure of its full implementation (Repo,2018). Repo *et al.* (Repo,2018) illustrate that the push for circular economic policies and activities needs to be driven from a local contextualisation of the ongoing social, economic and climatic challenges. This would facilitate citizen participation as the policy strategies would be actively demonstrated. This has been observed in Europe where The Netherlands (food processing), Finland (water management) and Scotland (whisky processing) have used the challenges being faced in the respective areas to push for circular economy activities as solutions (Repo,2018). Bassi and Dias (2019) in their study on how small to medium enterprises (SMEs) in the European Union (EU) use circular economy-related activities, observed that the circular economy practices by SMEs in 28 countries in the study were motivated by environmental benefits other than the financial benefits involved. The main aspects of the circular economy involved include food security; renewable energy and its efficient usage; and the reuse and sharing of assets and waste management in respect of water and recycling.

At the University of Johannesburg in South Africa, the Process, Energy and Environment Technology Station (UJPEETS) is at the forefront of using circular economy-related activities and related technologies for community development programmes as illustrated in Figure 1. UJPEETS activities are in line with all 17 of the United Nations' Sustainable Development Goals. This article considers the use of sustainable technologies and circular economy ideologies by UJPEETS towards local South African community development. The impact of these projects and how they can be explored further in a drive for circular economy policies in the country are discussed, the main activities being centred around Goal 1 (poverty alleviation), Goal 2 (Zero Hunger) and Goal 7 (affordable and clean energy).



**Figure 1:** UJPEETS Circular Economy Approach



## UJ PEETS Circular Economy applications

### Waste to Energy applications

At the core of the circular economy activities is sustainable development, focusing on the environmental impact and restoration of the natural environment (Millar, 2019). Although the potential of a circular economy being used as a tool in social equity has been discussed, the quantitative measures of how it can be used in improving social equity have not been addressed.

The role of circular economy activities in social equity is to improve human rights, which includes access to clean energy, clean water and poverty alleviation through job creation and entrepreneurial opportunities. As societies or local communities develop, the use of primary resources increases and results in more waste being generated (Somplak, 2019). Waste to energy conversion technologies have been thrown into the mix of the circular economy in incentivising people to use waste to generate energy mainly for cooking. UJPEETS has developed a model where anaerobic digestion of organic waste to generate biogas can be used to help provide access to clean, renewable energy in both rural and urban under-privileged communities.

While waste to energy technologies are already in existence, their application in underdeveloped communities has been minimal. In African communities there are indigenous knowledge systems but how these can be fully optimised by coupling them with fully developed technologies remains a challenge, as most communities have little or no knowledge of the latter. In rural Limpopo Province some communities use cow dung that is almost dry to burn as fuel instead of the traditional use of firewood. Although this practice derives from an indigenous knowledge system that has been passed down from one generation to the next for centuries, it is however, not the most efficient method of using cow dung as a resource. The already developed small scale biogas digesters can be used to far better effect, fully utilising the potential of generating energy out of the cow dung. After burning the cow dung the remaining ashes are usually thrown away, but with fully developed biogas digesters there is no waste as the remaining sludge is used as liquid fertiliser for gardening.



**Figure 2:** Zenzile Rasmeni from UJPEETS hosting a workshop on the link between biogas production and permaculture in Polokwane, Limpopo Province, South Africa

The UJPEETS Waste to Energy programme starts with training for the entire community, conscientising them on how they can fully utilise their organic waste from food leftovers, animal dung and post-harvesting waste. Some community members are then shortlisted and given free training on how to build and construct household digesters. Some are trained on the maintenance of the digesters, some are given an artisanal building background, whilst others acquire new

skills. The trained individuals are then subcontracted and paid to work in all small-scale biogas construction projects in which UJPEETS will be involved in the region or province. For efficient skills transfer across the country different teams are selected from province to province and some who show potential are further trained as instructors and are hired to be trainers for the next batch of trainees.



**Figure 3:** Kagiso Riba from UJPEETS supervising the training of builders in Leolo, Limpopo

In Limpopo Province, as shown in Figure 3. UJPEETS has managed to train eight individuals on the technical aspects of building fixed dome-shaped biogas digesters. These individuals went on to build ten digesters in two council wards. Four of the digesters are at schools where they mix organic food waste, animal waste and human waste from the toilets to provide biogas as cooking gas for the school-feeding programme. They then use the sludge as liquid fertiliser for the school garden. Teachers and caretakers of the school were part of the training and also selected students with the aim of enabling them to transfer the skills to the rest of the community members.

In Johannesburg Urban the UJPEETS Waste to Energy project has managed to install prefabricated biogas digesters at two schools, already illustrated in Figure 4. The  $1m^3 m^3$  capacity biogas digesters and burners are currently providing cooking gas for the school's feeding programmes where the gas produced is being used for an average of two hours of cooking time every day.



**Figure 4:** Pre-fab biogas digesters installed at two different schools in Johannesburg (a blanket is sometimes used to maintain a warm temperature inside the digester)

### Urban Logistics for agri-preneures

As a solution to counter the effects of unemployment in the urban areas of South Africa, some youths have turned to urban farming as a means to survival. This has led to a recent increase in urban farming activities. Although it is still a niche market, these urban farmers experience difficulties in transporting their harvested crops to their respective customers.



*Figure 5: Themba (urban farmer), Eveliene van Brakel and Mariette Dijkzeul (TU DELFT Students Netherlands) and the E-bike*

The main challenge is finding an affordable mode of transport with a capacity to deliver their produce whilst it is still fresh. The most desirable transport – either metered taxis, uber services and/or refrigerated logistics companies – is too expensive for these smallholder farmers. Cheaper modes of transport such as local minibus taxis are not suitable and safe for the delivery of fresh produce. Sometimes urban farmers are forced to throw their produce away as the quality has deteriorated by the time it reaches the customer who would reject the delivery. Therefore, there is a need for a sustainable and energy-efficient logistics solution for urban farmers in the inner city of Johannesburg. UJPEETS in collaboration with TUDELFT from the Netherlands collaborated in devising an e-mobility solution to this problem where an electrically-powered bicycle, an ‘e-bike’, was developed from an ordinary bicycle and is now used as a delivery business model for an entrepreneur. UJPEETS was responsible for the development of the e-bike prototype whilst TUDELFT developed an efficient business model for the urban farmer-entrepreneur. The initiative drew the interest of the Gauteng Department of Transport and the City of Johannesburg, and this ended in their donating 50 more bicycles for conversion into e-bikes.

### Permaculture

Permaculture training is integrated with biogas training as the two technologies complement each other. The organic waste from harvesting and post-harvesting activities in permaculture is used as input to the biogas digester. The output from the digester takes the form of biogas which is used as energy to cook, and sludge which is used as liquid fertiliser, thus creating a circular economy. This model is being used commercially at two different urban food gardens in the inner city of Johannesburg. Moreover, at schools and in communities where the UJPEETS team installed biogas digesters, food gardens are also being developed as part of the permaculture training. The community members are then left to run the systems on their own with regular check-ups being carried out on the sustainability of the projects by the UJPEETS organisation. The goal of permaculture is to create food resilience? security? in South Africa as a whole.



*Figure 6: The food garden at a local school, a blue flame from the biogas stove at Siyakhana food garden and the installation of a plug flow biodigester*

### CONCLUSION

The rise and need for environment conservation together with poverty alleviation through skills empowerment and job creation are at the heart of circular economy. UJPEETS has shown through its model that it is possible to integrate different technologies and package them into a model that serves both for-profit organisations and social entrepreneurs. The Waste to Energy project leading to the production of biogas can conscientise and incentivise citizens to use the energy potential that lies within their waste. The more people or households can engage in such activities the less need there will be for electricity for heating and cooking to be drawn from the national grid, thereby lessening the burden on electric power producers. People will always need to produce food, hence the increasing interest in urban farming. Delivery of fresh goods to consumers at much cheaper prices offers a competitive advantage over conventional methods of food procurement and distribution. Electric bicycles, coupled with a solar charging system, provide a sustainable and cheaper delivery option for urban farmers.

### ACKNOWLEDGEMENTS

University of Johannesburg, Department of Science and Technology (South Africa), Technology Innovation Agency, TU DELFT (Netherlands).

---

## LIST OF REFERENCES

- Bassi, F. & Dias, J. G. 2019. The use of circular economy practices in SMEs across the EU. *Resources, Conservation & Recycling*, 146(?)523-533.
- European Union. 2018. *Directive (Eu) 2018/851 of the European Parliament and of the Council of 30 May 2018*. . City of Publication?: Publisher EU Parliament?
- Millar, N., McLaughlin, E. & Börger, T. 2019. The circular economy: Swings and roundabouts? *Ecological Economics*, 158(?)11–19.
- Repo, P., Anttonen, M., Mykkänen J. & Lammi, M. 2018. Lack of congruence between European citizen perspectives and policies on circular economy. *European Journal of Sustainable Development*, 7(1)249-264.
- Somplak, R., Nevrlý, V., Smejkalv, V., Smidova, Z. & Pavlas, M. 2019. Bulky waste for energy recovery: Analysis of spatial distribution, *Energy*, 2019(181)827-839.
- Tam, E., Soulliere, K. & Sawyer-Beaulieu, S. 2019. Managing complex products to support the circular economy. *Resources, Conservation & Recycling*, 145124-1.

# THE DEVELOPMENT OF A DESKTOP ROTATIONAL CASTING MACHINE FOR INCREASING SMALL-SCALE MANUFACTURING CAPABILITIES

Martin Bolton

University of Johannesburg, South Africa, mbolton@uj.ac.za

## Abstract

*There is an ever-growing need for community upliftment as well as an international requirement for employment opportunities. Many people who are wanting to manufacture and sell products often cannot afford either the machines or tools due to their high cost. Furthermore, they are not able to rely on large manufacturers for the outsourcing of manufacture because of associated costs. If there were a more accessible array of machinery capable of manufacturing high quality parts at a low purchase price and running costs, this would enable more people to undertake manufacturing activities. Manufacturers who undertake small-scale manufacture would also have more control over the manufacturing processes. This could also equip manufacturers operating in the informal economy to manufacture products using methods which previously have been inaccessible. South Africa is currently experiencing an extremely high unemployment rate, which was 26.5% at the end of 2017, meaning that just over one quarter of the country's labour force is without work. This has now been exacerbated due to the economic effects of the COVID 19 pandemic. The government, recognising that manufacturing can play a pivotal role in reducing unemployment, has highlighted the urgency of promoting increased labour-intensive forms of manufacturing in a number of government policy documents. This paper presents the development of a desktop rotational casting machine which is manufactured from local available resources, and designed to be as low-cost, repairable and adaptable as possible. It forms part of a PhD. project entailing the development of various appropriate machines for the South African context and incorporates the participation of large and small-scale manufacturing industry participants. The ideal specifications of the machine, as well as the tooling and processes of its manufacture, are discussed in this paper.*

**Keywords:** machine design, manufacture, small-scale, South Africa

## INTRODUCTION

The aim of my research is the development of appropriate machinery technology for the South African small-scale manufacturing sector. If a more accessible array of machinery capable of manufacturing high quality parts at low purchase and running costs existed, more people would be able to undertake manufacturing activities in the country and this would also give manufacturers who undertake small-scale manufacture greater control over manufacturing processes. It could also equip manufacturers operating in the informal economy to manufacture products using methods which previously have been inaccessible. The SA Department of Trade and Industry (DTI) explains that although South Africa has a highly-developed co-operative sector, operating in the 'first economy', there are also co-operatives operating in the mainly informal, marginalised and unskilled economy, populated by the unemployed and those unemployable in the formal sector (DTI, 2018). South Africa currently has an extremely high unemployment rate – 26.5% at the end of 2017 – which means that just over one quarter of

the country's labour force is without work (StatsSA 2017:2). If more affordable and appropriate manufacturing equipment were readily available, there would be more opportunities for the unemployed to be able to earn an income through manufacturing and selling products, whilst at the same time contributing to the economy.

I aimed to develop a rotational machine able to meet the requirements of Johannesburg-based small-scale manufacturers who would benefit from increased manufacturing capabilities, without needing to rely on additional service providers. Participation from two large-scale manufacturers in Johannesburg allowed for the interrogation of aspects of current manufacturing limitations linked to available resources, as well as technical rule-of-thumb issues regarding manufacturing processes. I used this input together with my knowledge of industrial design, prototyping and machine development to develop a new machine able to be informed by existing open-source designs of similar small-scale manufacturing machines, existing commercial machines, and lessons learnt from manufacturing participants.

This new machine can be taken to both large-scale as well as small-scale manufacturers to interrogate and test, providing valuable input into the efficacy of the design outcome. The developed machine is to be manufactured as far as possible from local materials/components, is easy to repair and use and possibly could even be built using standard workshop tools, such as angle grinders and welders. This would fit the specifications of Hazeltine and Bull who state that appropriate technology should be small-scale, energy efficient, environmentally sound, labour intensive and controlled by the local community (2003:1). A suitable method for tackling this study would be that of Action Research, as defined by Reason and Bradbury (2001) as a participatory, democratic process concerned with developing practical know-how in the pursuit of worthwhile human purposes, grounded in a participatory worldview. This method "seeks to bring together action and reflection, theory and practice, in participation with others, in the pursuit of practical solutions to issues of pressing concern to people, and more generally the flourishing of individual persons and their communities" (Reason & Bradbury, 2001:1).

## Introduction to rotational moulding

Rotational moulding is a method of producing hollow items with the use of thin wall moulds. It is also known as rotocasting or rotomoulding and is unique amongst plastic moulding processes because the heating, shaping and cooling of the plastic all take place inside the mould with no application of pressure (Crawford, 1992:1). The process was developed in the 1940s but in the early years it attracted little attention because it was regarded as a slow process which was restricted to a small number of plastics (Crawford, 1992:1). There are many advantages to this method of manufacture which include the production of relatively complex items which are in essence stress free. Within large-scale manufacturing it provides a competitive alternative to blow-moulding and injection-moulding. The sequence with rotomoulding thermoplastic is based on the heating and cooling of an axially or biaxially rotating split-hollow cavity mould that defines the outside shape of the required product (Rosato, Rosato & Schott, 2012:140). Below is an image of a small industrial rotational moulding machine at Sasol Polymer Technology Service centre. It is evident that the two moulds are attached to an arm, which rotates in two different axes. The minor axis rotates at the end of the arm, and the major axis rotates the entire minor axis.



Figure 1: Industrial rotational moulding machine (image by author).

A predetermined charge of ambient plastic powder or pellets is placed in one half of a mould and then the mould cavity closed (Crawford, 1992:1). This rotating mould arm is then positioned inside a heating chamber or oven, and heated from the outside. This sequence is illustrated in four steps in Figure 2 below.

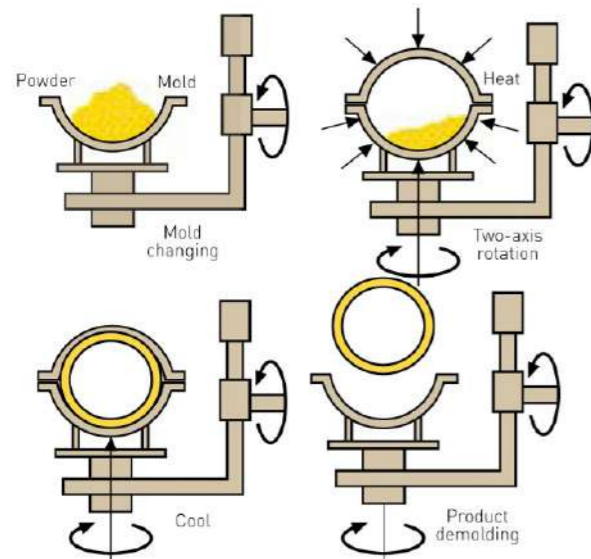


Figure 2: The rotational moulding process sequence (Roto-Industry, 2019).

The material from which the mould is made allows for the plastic within the mould to melt and begin coating the inside of the mould. As the mould rotates, gravity is attempting to pool the molten plastic at the lowest point of the mould, but the mould is continually rotating allowing the plastic to coat the entire inside surface of the mould. This is what enables hollow items to be manufactured effectively with this process.

### Different speeds for different proportions

As is clear in the Sasol rotomoulding information booklet (2007), “for different shaped articles, and positioning on the arm, the rotational will vary”. The rotational ratios between the major and minor axes vary for differently proportioned shapes (Figure 3).

Ratio	Shapes
8 to 1	Horizontally mounted straight tubes or oblongs
4 to 1	Cubes, balls, odd shapes, rectangular boxes
2 to 1	Rings, tyres, balls, round flat shapes. Any rectangle which shows two or more thin sides when run at 4 to 1
1 to 2	Parts which should run at 2 to 1, but show thin side walls
1 to 3	Flat rectangles e.g. suit cases, bin covers
1 to 5	Vertically mounted cylinders

Figure 3: Rotational ratios: major vs minor axes (Sasol booklet, 2007).

It is evident in the industrial rotational moulding process that the rotation of the major and minor axes are able to be controlled independently, associated with different product forms.

### Examples of rotational moulded products

Types of products span many different sectors and include furniture, light shades, marine accessories, material-handling bins, shipping drums, storage tanks and receptacles, surfboards and toys, to name only a few (Figure 4). Final product sizes range from small play balls up to 83000 litre tanks that can weigh at least 1½ tons (Rosato *et al.*, 2012:140). Smaller products can fall into categories such as household, garden, toys and lighting, whereas much larger products can suit industrial sectors including the civil, agricultural and marine sectors.



Figure 4: Examples of rotomoulded products (Roto-Industry, 2019).

The cycle times for rotational moulding typically range from 6 to 12 minutes and can be at least 30 minutes for large parts. The wall thickness of a part affects cycle times, but not in a direct ratio.

The benefits of rotational moulding compared to blow moulding and injection moulding include:

- low mould cost and ability to mould complex features
- the machine’s ability to accommodate different sized moulds easily
- complex moulding forms can easily be undertaken (Rosato *et al.*, 2012:140).

### Rotational casting (resins that set/cure)

In a similar manner to rotomoulding plastic, rotational casting (or rotocasting) is undertaken with thermosetting resins where the production is more suited to smaller items and tool costs are much lower than rotomoulding, as explained above. The thermosetting resin used in rotocasting is more expensive than the plastic used in rotomoulding. The huge benefit of rotocasting, however, is the ability to manufacture products without constant and extremely high energy requirements for the mould heating. The mould material also does not need to withstand high temperatures, so casting silicones make for suitable materials which can carry fine detail and surface finish. These moulds are made by casting silicone over a master pattern, which is a one-off master made to look exactly like the final product. An example of a rotocast product is seen in Figure 5 with resin costume play helmets made by Volpin Props in the US. These are finished carefully with intricate topcoat techniques, but the underlying structure is cast from a flat grey, black or white resin. Process techniques may be seen on the Volpin Props Instagram account (Volpin Props, 2020).



Figure 5: Rotational cast cosplay helmets (Volpin Props, 2018).

There are many different types of thermosetting resins available which are able to achieve similar properties to those of industrial plastics. Although resin cost is higher than that of industrial plastics, it is possible to manufacture products in much smaller batches, or even one-offs, which is not economically viable with rotational moulding using molten plastic by industrial manufacturers. The cost of manufacturing a metal mould for rotational moulding could cost tens of thousands of rands upwards, whereas the moulds used in rotational casting can be made with mould silicone and cost as little as R380/kg (AMT composites, 2020). In Figure 6 below, an industrial fabricated steel mould is presented on the left which is for rotomoulding plastic tank type forms, and on the right are several moulds for rotocasting geometric forms which were made from pink mould-making silicone, an aluminium-filled resin master (the silver form) and plaster of Paris (white).

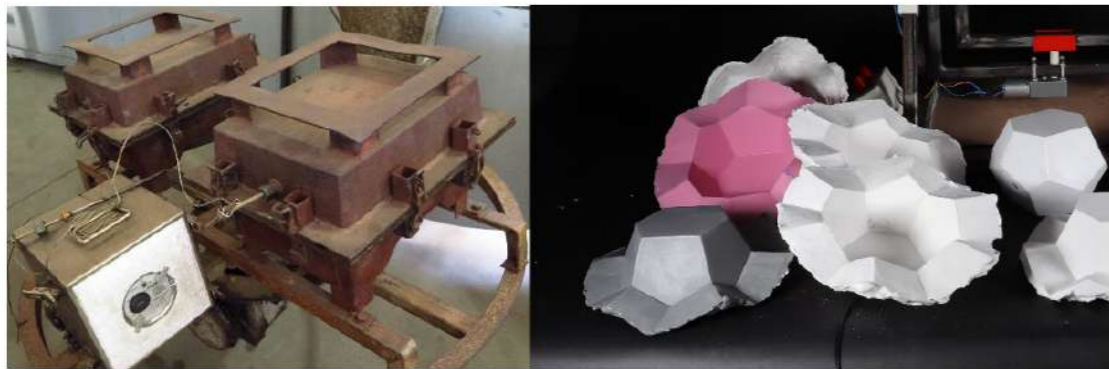


Figure 6: Industrial fabricated steel mould, small-scale silicone & plaster moulds.

#### An overview of available rotational casting machines

There are many available plans for making your own ‘DIY’ rotocasting machines which can be cranked by hand, or powered with a motor. Additionally, there are several examples of rotocasting kits which can be purchased and assembled at home. These are not manufactured locally in South Africa and can be imported. Importing kits, however, does not help the local economy, and manufacturing the machines locally is more beneficial in the long run. Very few people are sufficiently technically minded or willing to attempt to build a mechanical contraption as complex as a rotational casting machine. There are many available designs online which can be separated into the following three types: DIY systems which are the lowest cost, but where the buyer has to find all the materials and components himself. The middle range would be the ready-to-assemble kits with medium cost and medium technical complexity. The highest-cost machines would be the Plug & Play type machines with minimal to no assembly, and which require minimal technical complexity in setting up. These have been plotted in Table 1 below which illustrates the increase of cost versus the ease of assembly.

Table 1: Cost vs. ease of assembly of existing rotational casting machines.

#### Ease of assembly

		Highest Cost. <b>Plug &amp; play.</b> Minimal assembly, Minimal technical complexity.
	Medium cost, some technical know-how required. <b>Ready-to- assemble Kits</b>	
Low cost: Buy all materials and build it yourself. <b>DIY system.</b>		

#### DIY systems

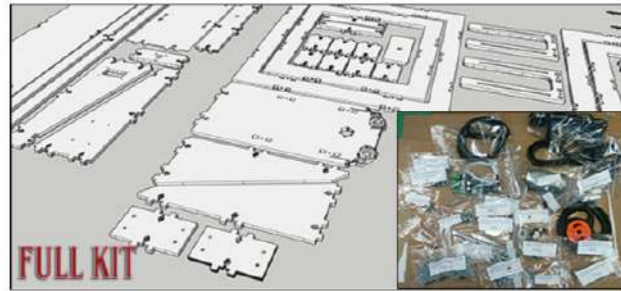
The following list includes DIY systems which are available and have a similar composition:

- Rotational Casting Machine by erjack1 (Comment on social media regarding this machine: “I’m interested in how you attach molds. I am using a cassette made from plywood but it is clumsy and takes forever to change molds.”)
- Make A Rotational Casting Machine For Under \$150 by Pseudereid
- Prototype 03 - Rotational Casting - Lasercut 3Dprinting by Henri-Goeminne
- Rotational Casting Machine (RotoCast) by DrRadium April 2017
- Rotational Casting Machine (RotoCast) by Miaviaor April 2016
- Version 2 by Miaviaor
- \$20 Rotational Casting Machine by dragoneye360 (figure 7 to the right)

All of these designs require a relatively high level of skill as well as specialised tools to fabricate the machines. And even then, the majority of these machines are dependent on hand- cranking the machine the entire time whilst the resin inside is setting.

#### Ready-to-assemble kit

The RotoMAAK machine (Figure 8) costs R14 000 and consists of a full kit and all necessary components. It is made in the United States and can be shipped internationally.



### RotoMAAK White Full Kit

Price: \$776.00

Precisely laser cut White Melamine coated MDF RotoMAAK for FULL KIT. Kit includes all hardware to make a fully functional RotoMAAK.

[Assembly Guide v1.1](#)

[RotoMAAK BOM v1.3](#)

Figure 8: RotoMAAK rotocasting machine kit (RotoMAAK, 2018).

The RotoMAAK DIY Rotational Casting machine is shipped with all the components and an electrical control system to enable construction using minimal tools. It operates with a single motor with a speed control, which is also linked to the internal frame with a pulley and drive belt. The RotoMAAK is described as “a DIY Rotational casting machine to bridge the gap between rapid prototyping and the cost of producing thousands of hollow cast parts.” The machine’s cost is \$776 which equates to R14000 (exchange rate as of 18 May 2020) and although it can be shipped internationally, shipping duties will apply. The kit is shipped “flat-pack” like many kit 3D printers, which means that the buyer must follow a sequence of assembly steps prior to operating the machine. The optimising of space for shipping requires the product to be disassembled, which is difficult and likely to cause confusion for the person who needs to decipher complex assembly instructions.

#### Plug & Play, High cost machine example

The Mannetron 2’x2’ rotational casting machine is an industry specification machine able to hold a mould 60cm by 60cm with a weight of 80kg max, and weighing 220KG (Mannetron, 2020). It is American and the purchase cost (excluding any shipping) comes to approximately R101 000 (\$5500 converted). This machine is mentioned as it allows rotational control for components of different proportions, i.e. not a fixed rotational ratio for both axes, but rather independent motor control. This is the most interesting example product due to the fact that it has a similar mechanical composition to the DIY rotocasting machines, but is an industrial machine of high cost and durability. The use of this machine is intended for very high value rotational cast items, for example, sculptural reproductions as opposed to industrial rotational moulding of plastics which generally aim at lower unit costs, but lower reproducible quality finishes.



Figure 9: Mannetron 2’x2’ rotational casting machine (Mannetron, 2020).

It is clear that there is a large playing field of existing machines and many free plans which one can follow to make one’s own machine. The machines shown vary in cost from R900 (50\$ machine) to the R14000 kit (RotoMAAK), to the powerful R101000 Mannetron machine. None of these are commercially available in South Africa.

#### Rotational machine for South African manufacture: requirements and specifications

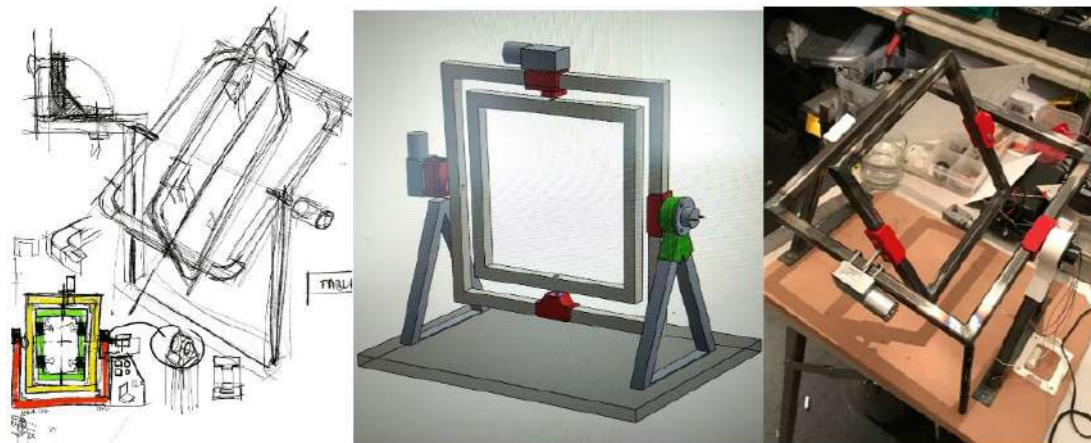
After considering all requirements for a more appropriate machine for South Africa, these were compiled into a collection of compositional, operational, and control aspects with the following requirements and specifications:

- the 2 axes should be able to be controlled independently as with industrial rotational moulding machines
- the machine should be low cost, robust, and repairable
- it should be constructed from available material and components
- it should be small enough to be transported in standard modes of transport and be placed on a worktable or work bench
- the mould size must suit the user requirements and possibly different machine frame sizes
- it should be able to accommodate various types of mould and casting materials and processes
- if the machine is to suit DIY fabrication, mechanical and structural parts must suit 3D printing on entry-level 3D printers and be constructed with minimal workshop tools.
- the machine must operate on single phase electricity.

The first machine that I developed and fabricated was a proof of concept machine, which applied as many of the abovementioned requirements as possible. From what was learnt from the comments online regarding the various available rotocasting machines, this new machine was developed where the main frame was made from a square steel tube, and main structural components 3D-printed using ABS and PLA plastic filament. Various existing standard components were utilised which included ball bearings, screws and the rotational control components. The design and development of the machine were undertaken with SolidWorks Computer Aided Design Software, which allowed for modelling the separate components with the incorporation of the standard components. The majority of the standard components and electrical control items were able to be sourced locally, however they are also available online with international shipping. Basic electrical understanding and online specification sheets allowed for the correct wiring of the different components.

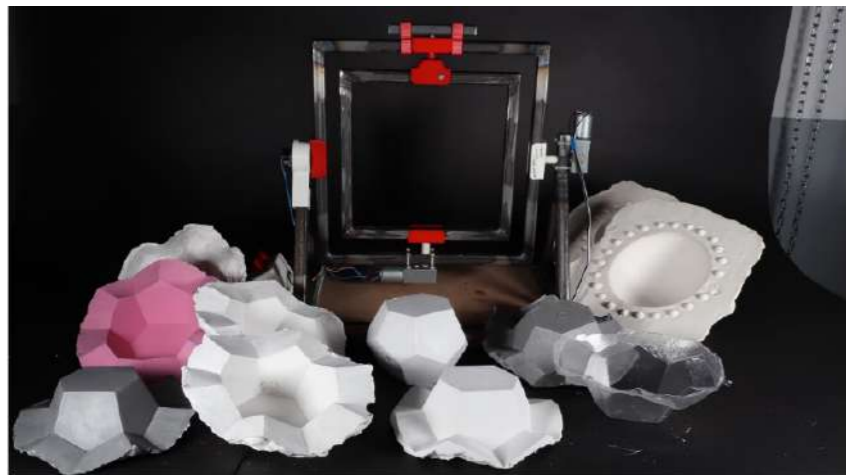
#### Low-cost independent motor control: Separate rotational control for each axis

What makes this machine stand out from all of the existing versions online, is the ability to control the rotational speed of each frame independently. This means that different proportional objects being cast can be rotated at different speeds when necessary, as explained earlier.



**Figure 10:** Development of machine 1: Sketching; Computer Aided Design; Prototype.

Version 1 prototype has been designed and fabricated as far as possible from locally available materials intended for manufacture. Several electrical and automation components were not available locally and were sourced online and imported<sup>1</sup>. Version 1 of the machine includes two geared DC motors able to provide adequate torque and speed. These are controlled with two independent motor speed controllers. The maximum object size is 150mm by 150mm by 150mm (Figures 10 & 11).



**Figure 11:** Version 1 machine prototype and test moulds.

The machine is powered with the turning of the speed controllers, and the two frames begin rotating independently or together. This machine was utilised for data generation and experimenting, as well as for the batch manufacture of various ceramic products, as illustrated below (Figure 12).



**Figure 12:** Machine testing with rotocasting ceramic, chocolate & thermosetting resins.

<sup>1</sup> These were the small 12V DC Geared Motors which you can see mounted on the frame in Figure 10.

Different moulds were used for different materials, all able to be created using 3D printing, and additive and subtractive moulding methods. The moulds tested thus far were made from 3D printed master forms, printed hollow out of plastic, using low-cost 3D printing machines. This allows for masters to be made accurately from computer models, smoothed and finished by hand and then silicone moulds made from this. Once the first silicone mould has been made, additional master moulds can be made from this accurate silicone mould. The test production samples below were all made using the moulds presented earlier in the paper (Figure 13).



**Figure 13:** Geometric planter and carafe stopper ball roto-slip-cast.

The lessons learnt from extensive testing of the small rotational machine allowed for the composition of a larger, stronger, more durable machine able to handle larger, heavier moulds as well as be suited to added manufacturing processes capabilities making use of constant rotation.

#### Overview of machine version 2: Low cost and dual axis controllable rotational machine

The presented outcome below has a useful bed size, double that of the first test machine which can handle objects up to 300mm by 300mm within its inner frame. Frame construction and modular design allow for construction with basic workshop machines, and suit disassembly, repair and replacement. The materials are all obtained from local material and component suppliers within Johannesburg, with some part of the notable components as follows:

**All structural steel:** standard 19mm mild steel square tube and frame parts can be customised for different mould bracing solutions. Standard 100mm mild steel square base plates (for motor mounts) can be customised to adapt to different motors and easily interchanged. All metal components were TIG welded where needed, and designed to be disassembled easily for repair.

**Fasteners:** Standard M4, M6 and M8 fasteners and weld nuts, and screws.

**Drive motors:** These motors are standard 12V windscreen-wiper motors available from a local Auto Spares store.

**Electrical control:** 12V power supply, motor speed control boards (pre-assembled) available at local electronics supply store.

**Housings:** Prototype housings are 3D printed (Covid-19 lockdown restriction), but standard electrical enclosures are easily able to be used.

**3D printed components:** Several components were 3D printed such as bushes, bearing holders, and the control box but will be able to be switched with more robust components once Covid-19 restrictions lift. This technology was utilised as a method to fabricate items that could not be sourced.

The final large rotational machine is presented on the right and boasts a sturdy frame and two strong motors able to be controlled independently (Figure 14). Through machine testing with various size and shape moulds, a taut stretch-cord allows for the receipt of these different-sized moulds without much difficulty or setup time. Additionally, the tension of the cord locates the mould relatively centre to the frame, allowing for the centre of mass to be suitably located. The final machine cost of



manufacture comes to a similar price as the DIY kits, at an approximation of R5000. This needs to be resolved to incorporate as many standard components as possible and will be undertaken in the next round of prototyping when a manufacture leaflet will be also be developed.

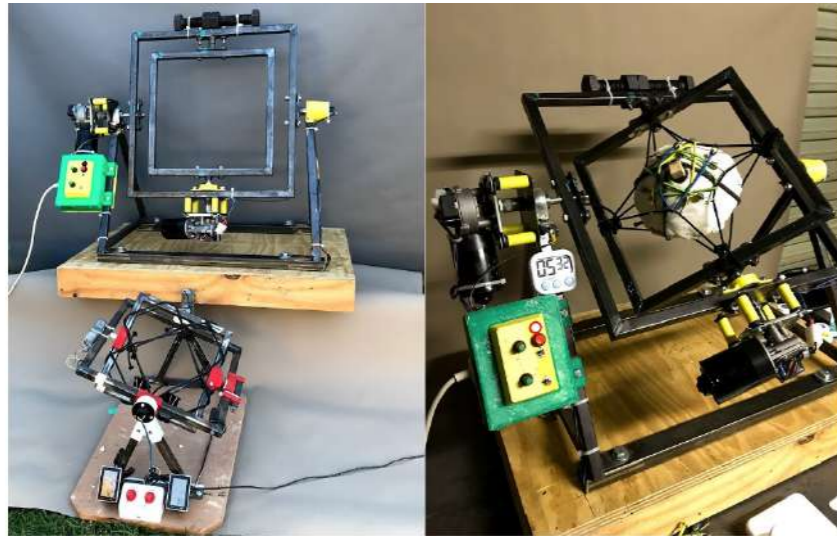


Figure 14: Two rotational machine prototypes. (Photos by author)

Various manufacture tests have been undertaken to assess the efficacy of the machines. This has been done by the logging of machine speed and duration, in order to identify appropriate settings for different proportion components. In general, the speeds required do not exceed 30RPM for either of the axes. The most success for all tested forms were with a major axis speed of 22RPM and a minor axis speed of 30 RPM, which can be decreased as the curing time nears completion (Figure 15).

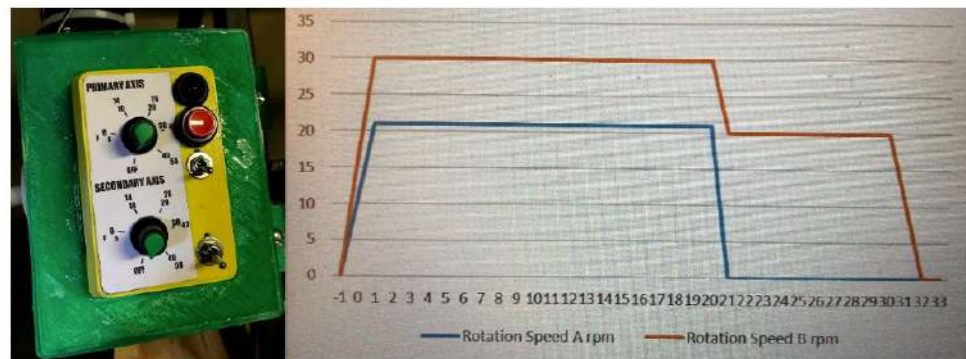


Figure 15: Rotational speed ramp cycle for roto-slip cast terracotta.

## Conclusion

Although the prototype machine has only recently been completed amidst Covid-19 lock-down restrictions, its promising capabilities are able to be shared with the maker community and will prove beneficial for manufacturing many types of small components. A larger machine, with a similar control system, bolstering larger, more powerful motors will also enable the casting of large products. Additionally, the ability to rotate a small sheet-metal hand-fabricated mould within a standard kitchen oven may have potential for making low-cost rotomoulded items from plastic. The way forward would be to make the plans more accessible so that others can attempt to replicate the design locally in Johannesburg, and possibly on social media platforms for others to critique, advise or use the design for the benefit of the community. This would also provide the space for the interrogation of the cost of machine vs. what the market would perceive as a suitable purchase / build cost. This project illustrates effective utilisation of social media as well as open source platforms to develop new technologies appropriate for different geographic and economic settings.

## LIST OF REFERENCES

- AMT Composites. 2020. Mold Max™ 30 Standard Silicone. [O] Available: <https://www.amtcomposites.co.za/product/mold-max-30-standard-1-1kg/> Accessed 6 May 2020
- Crawford, R. J. 1992. *Rotational moulding of plastics*. Somerset, Research Studies Press LT.
- DTI. 2018. Economic empowerment. [O] Available: [http://www.thedti.gov.za/economic\\_empowerment/co\\_ops.jsp](http://www.thedti.gov.za/economic_empowerment/co_ops.jsp). Accessed 17 April 2018
- Hazeltine, B., & Bull, C. 2003. *Field guide to appropriate technology*. California: Elsevier.
- Reason, P. & Bradbury, H. 2001. *Handbook of action research: Participative inquiry and practice*. London: SAGE Publications
- Rosato, D.V., Rosato, M.G. & Schott, N.R. 2012. *Plastic technology handbook*. Volume 2. New York: Momentum Press,.
- Roto-Industry. 2019. Rotomoulding manufacturing process. [O] Available: <http://www.rotomoulding.com/#tab-id-4> 15 April 2020
- Rotomaak. 2018. *The RotoMAAK*. [O] Available: <http://www.rotomaak.com/index.html>
- Sasol Polymers, 2007. An Introduction to Rotational Moulding, Sasol Polymers, Polythene business. 05 January 2020
- StatsSA. 2017b. *Statistics South Africa: Stats in brief 2017*. Pretoria: South Africa.
- Volpin Props. 2018. *Voidsteel helmet, elder scrolls online*. [O] Available: <http://www.volpinprops.com/portfolio/voidsteel-helmet-elder-scrolls-online/> 13 March 2020
- Volpin Props. 2020. Volpinprops Instagram Account [O] Available: <https://www.instagram.com/volpinprops/> 16 February 2020

# HOUSEHOLD BIOGAS DIGESTER FOR SLUMS, IDPS AND REFUGEES CAMPS: CASE STUDY OF KASS SOUTH DARFUR, SUDAN

Adam, Wini, MSc./ University of Khartoum, Sudan, weny1964@yahoo.com

Wolter, Dennis, M.Eng/E3 Development Solutions, Germany, dennis@e3solutions.rw

Azrag, Elfadil, Dr/ University of Khartoum, Sudan, elfadilazrag@yahoo.com

Ronteltap, Mariska, Dr. Senior Process Technologist at Delfland Water Authority, Netherlands, mronteltap@hhdelfland.nl

## Abstract

*Sudan witnessed a revolution in 2019 which placed technocrat ministers in position to govern Sudan through a 3 year transitional period. Although more than one year has passed, a peace agreement is still in process. The large numbers of Internally Displaced Persons (IDPs) of over 3.3 million countrywide living in camps on the outskirts of towns pose a challenge to the political stability and the country's economic and social development. Additionally, these communities have poor access to sanitation and they rely on firewood as the main source of energy for cooking. This leads to environmental degradation through groundwater pollution and high deforestation rates around the camp areas – in an area of the Sahel Zone where flora and fauna are already threatened by an expanding desert, as well as high air pollution levels and respiratory diseases caused by cooking indoors. Thus, the use of anaerobic digesters for treatment of human waste has the potential to reduce groundwater contamination and air pollution. The research investigates the feasibility of biogas technologies for people living in informal settlements. It presents a literature review of the current biogas systems nationally and internationally. Through the DGIS - IHE Delft Programmatic Cooperation DUPC2 fund, several consultation meetings, workshops and demonstration campaigns have been conducted in South Darfur to produce customized educational materials in resource recovery and human-centred biogas digester design. Biogas application in Sudan is limited, mainly due to the high capital cost of implementation ranging between 750USD for an imported plug-flow digester to 1,200USD for concrete domes. An affordable alternative could lead to greater adoption of the technology, thus reducing groundwater pollution, while offering a clean and renewable energy source. The proposed human-centred biogas digester design treats household waste to produce 1.8 m<sup>3</sup>/d of biogas. The two-stage digester's wet and dry reactors receive around 80 kg/day of kitchen waste, faecal sludge and grey water in the ratio 6.2% : 15% : 78.8 %, respectively.*

**Keywords:** anaerobic treatment, appropriate technology for cooking, household biogas, IDP, informal settlements, renewable energy.

## INTRODUCTION

After more than 30 years of military dictatorship, Sudan is undergoing significant political transformation towards a more representative political system. The transitional government in Khartoum is led by qualified technocrats who have indicated a keen interest in progressive change. However, war and political conflicts left over 3.3 million persons living in camps located in the outskirts of towns, lacking basic sanitary services as well as energy supply (Adam, Ronteltap,

Hooijmans, 2017). People have been living in these camps for over 20 years already. When pit latrines are used in densely populated camps, groundwater shows evidence of high levels of contamination in the boreholes located inside these areas (Harvey, 2007; Graham and Polizzotto, 2013).

Anaerobic processes are extensively applied in wastewater treatment, using technologies such as plug-flow reactors (PFR), continuously stirred reactors (CSTRs), up-flow anaerobic sludge blanket (UASB) reactors, anaerobic baffled reactors (ABRs) and anaerobic filters (Ronteltap, Dodane and Bassan, 2014). The technology selection depends on the waste characteristics: faecal sludge, manure, and solid waste are treated in conventional systems such as CSTRs and PFRs. Advanced technologies such as anaerobic filters and fluidised bed digesters treat soluble organic waste (Kerroum, Mossaab, and Hassen, 2012).

Countries such as China and India have national programmes for boosting biogas investments (Ramaswamy and Vemareddy, 2015). China, India and Nepal have 30, 3.8, and 0.2 million household digesters, respectively (Kerroum et al., 2012). Europe has quite a number of farm-scale digesters/reactors: 4000 in Germany, 350 in Austria, 72 in Switzerland, 65 in the UK, 35 in Denmark and 12 in Sweden (Wilkinson, 2011; Horváth, Tabatabaei, Karimi, and Kumar, 2016). This shows the advance of the technology as well as its applicability and reproducibility.

## Overview of biogas production

The biochemical methane potential (BMP) varies depending on the substrate characteristics, inoculums and reactor design. The BMP ranges between 100-711 ml/g Volatile Solids (Macias-Corral, Samani, Hanson, Smith, Funk, Yu, and Longworth, 2008; Abouelenien, Namba, Kosseva Nishio, and Nakashimada, 2014). Methane production corresponds to the organic loading rate (OLR). The lower the OLR the more methane extracted per litre of substrate, hence higher removal rates of total volatile solids (TVS) can be achieved at lower OLR.

Dry thermophilic digestion operates best at higher OLR between 8-13 gVS/L reactor volume producing 2-4 litres of methane per litre reactor volume (Fernández-Rodríguez, 2014). In contrast, wet digestion with effluent recirculation is operated at low OLR between 3.3-4 gVS/L/d achieving lower MP rates of 2-2.8 L<sub>methane</sub>/L<sub>substrate</sub>.d. However, it boasts the highest relative methane extraction rates of 630-711 ml/gVS (Hartmann & Ahring, 2005).

Moreover, the maximum organic loading rate (OLR) of animal manure is increased with the addition of other wastes such as food and greeneries. The mixing ratio of two substrates should be optimized for best biogas production, for instance, Li et al. (2014) stated optimum mixing ratio of cow manure co-digestion and straw at 1:1 mass ratio. The study of Zhang et al. (2013) co-digested food waste and cow manure at a 2:1 mass ratio, which increased OLR to 15 gVS/L.d and produced 5.8 L<sub>methane</sub>/L<sub>substrate</sub>. Research concluded that the high pH of manure buffers the digestion of food waste (ibid).

Some substrates require treatment before the digestion process; an example is poultry manure which is associated with high ammonia concentrations. The substrate is either diluted with a low-ammonia substrate (Borowski, Domański, Weatherley, 2014) or a stripping device is applied (Abouelenien et al., 2014).

Another technique to increase biogas production is staging the reactor to recycle the effluent and decouple the hydraulic retention time (HRT) from solid retention time (SRT), to make use of all available organics in the substrate. The co-digestion of municipal solid waste (MSW) leachate with (33% by volume-) of granular sludge from full-scale IC<sup>1</sup>bioreactors utilising paper mill waste showed methane generation rates of up to 11.7 L<sub>methane</sub>/L<sub>substrate</sub>.d (Luo, Zhou, Qian and Liu, 2014).

<sup>1</sup> IC: internally circulated reactors [for more information press](#)

A two-stage digester (dry and wet) which uses the leachate from the solid reactor to feed the wet reactor, and an effluent pipe connected to two up-flow anaerobic filters UAF for second stage digestion, produces 13 LMethane/LReactor/d (Macias-Corral, et al., 2008). Sharma (2000) produced 4 m<sup>3</sup> of biogas from a 1.35 m<sup>3</sup> plug flow reactor connected to a settler to recycle 50% of 120 kg/d fruit waste fed.

Additionally, reactors can operate at lower HRT (of only hours or days depending on the substrate degradability) for similar methane production rates if operated in the thermophilic phase. Blumensaat and Keller (2004) used the ADM1 model to optimise the two-stage biogas unit; the first reactor produces 180 L<sub>Methane</sub>/d of biogas from 160 L thermophilic reactor volume, connected to the second reactor (800 L mesophilic state) which produces 75 L<sub>Methane</sub>/d. The second reactor is much larger to accommodate a HRT of 20 days while the thermophilic reactor only requires a 4 day HRT to degrade the substrate.

### Co-digestion experience in Africa

Application of biogas digesters in Africa is limited. Most digesters are implemented in public buildings such as schools and universities. A children's school in Namisu Village, near Blantyre, Malawi, has an anaerobic portable digester which was installed by a UK-based brand called Flexigester. The digester material is mainly polyethylene which can be embedded into a trench or installed above the ground. However it should be protected from human and animal activities. The size of the Flexigester is approximately 18 m length, 1.5 m width and 0.5 m depth and takes up to 280 L/d, filling the digester in about 30 days. The estimated biogas output is up to 8 m<sup>3</sup>/day and the system generates up to 100 t/yr of bio-fertiliser (SOWTech, 2015).

Flexi Domestic Systems digesters have been installed in Kenya, Uganda, Rwanda and Burundi, with the largest numbers in Nairobi. The digester is prefabricated in the shape of a plug flow reactor with two sizes (6 m<sup>3</sup> and 9m<sup>3</sup>), priced at \$750 and \$900, respectively. The digester is placed above ground and receives 20 kg of waste to produce enough biogas for family of 6-8 members (Biogas International, 2019)

Alternatively, there are other digesters locally fabricated to develop rural communities in Ethiopia that have a lower cost; however, these require more operational effort since the digester is fed manually. The pipe bio-digester piloted by the ROSA project at Arba Minch University is an example of this. Its pipe is made of six 200 L drums welded together. It utilises around 8 kg of kitchen waste together with 10 kg of animal manure (cow dung), and the produced biogas is directly used for cooking in the canteen kitchen (Rosa, 2009).

### METHODOLOGY

This research project is funded by the DUPC 2 programme led by UNESCO-IHE to develop customised educational materials using a participatory approach, including consultation meetings, workshops and practical training sessions. Through the participatory approach, secondary literature obtained from the desk study is analysed and presented to service providers, the water sanitation and hygiene (WASH) sector in South Darfur and consumers (community representatives). In March 2018 several workshops were given to public health and WASH practitioners from Kass civil society. Throughout the activities, the researcher was able to collect primary data from interactive design exercises, field visits, transcripts of consultation meetings and interviews. The analysis of primary and secondary data from NGOs allows the development of a human-centred design guided by the knowledge obtained from the literature.

### RESULTS

Biogas technology was introduced to Sudan decades ago. However, the technology is not integrated into the local

market and there are few applications that are being successfully operated. Large numbers of people are challenged by the lack of services such as water, sanitation and cooking fuel, especially those who live in informal settlements. Thus waste to energy nexus will largely impact Sudanese citizen life by the reduction of firewood use and domestic waste.

### Biogas history in Sudan

In 1976 a Sudanese-German Project constructed several digesters to use Water Hyacinth as feedstock along the White Nile, Sudan. Later the Energy Research Institute supported by the ministry of finance launched a programme to encourage biogas use in Sudan, implementing 300 biogas digesters distributed as shown in the map, Figure 1. Sudan is now Sudan and South Sudan.

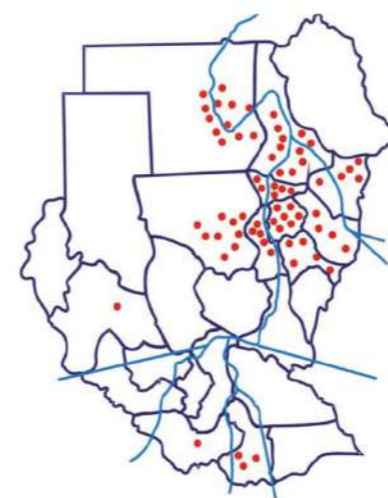


Figure 1 biogas digesters implementations in Sudan and South Sudan

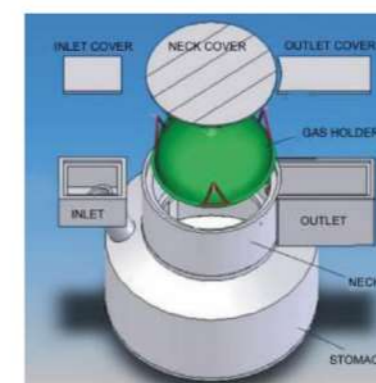


Figure 2 Drawing of the puxin digester design

The digesters were promoted for free in the beginning and later implemented at a 20–70% subsidised fee. The project developed biogas units for cooking application, but also additional uses for lights, refrigerators and combustion engines (Mohamed, 2004). Additionally, reports illustrate plans of implementing 15,000 digesters in North Kordofan under their Clean Development Mechanism CDM projects conducted by the Agricultural Technology Transfer Society<sup>2</sup>(in collaboration with CoreCarbonX, an Indian consultancy firm.<sup>3</sup>)

Another project by the World Food Program (WFP) introduced biogas digesters for school feeding programmes using animal manure as a substrate. Under this project 6-10 m<sup>3</sup> digesters made of concrete with fibreglass gas storage units from Puxin<sup>4</sup> were installed together with biogas appliances such as stoves and lights. The assessment made by ATTS concluded that the gas storage capacity of 1.2-1.6 m<sup>3</sup> is insufficient for school feeding purposes. However, the proposed modification by ATTS costs about 1,200 USD for a 10 m<sup>3</sup> digester to provide 5–6m<sup>3</sup> of biogas storage (Ahmed and Gouzoli, S.A.).

<sup>2</sup> Sudan based non-governmental organization (NGO) focus on environmental issues, [click for more information](#).

<sup>3</sup> See the [validation report](#) and [project page](#) for more information.

<sup>4</sup> [Chinese based Company](#) manufactures biogas digesters (press **A** for digester price and **B** for company website)

### Case study of Kassala, East of Sudan: Plug flow digester pilot

Practical Action Sudan piloted flexible digesters from B energy<sup>5</sup> in Kassala, East Sudan. The digester's active size is 2 m<sup>3</sup>(substrate volume) and is contained into 2x5 m<sup>2</sup> bags, which is gradually fed into the plug flow reactor with 20 kg of cow dung daily, to produce 1 m<sup>3</sup> of biogas per day. The digester is connected to a storage bag with 1.2 m<sup>3</sup> volume, lasting for 2-4 hours of cooking. The material of the bags is TUV<sup>6</sup> certified for inflammable gas storage and the greenhouse structure protects the digester from human and animal activities (Farah, 2018).



**Figure 3** The biogas digester laid above ground and protected with a greenhouse (Farah, 2018).



**Figure 4** Biogas storage bag in use outside the kitchen (Farah, 2018).

### Case study of Kass South Darfur, West of Sudan

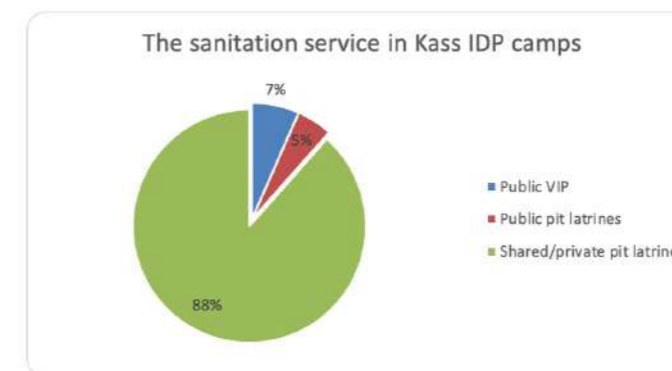
Kass is located<sup>7</sup> in South Darfur State, situated approximately 85 km Northeast of the state capital, Nyala, covering a total area of 850 km<sup>2</sup>. The total population of the locality is 365,000, of which 76,843 are internally displaced persons (ESP, 2016). Mostly they live in small mud houses built in the middle of Kass' vocational school grounds

The sanitation situation is challenging: lack of sufficient space allocated to sanitation, a high water table near valleys (*wadis*), low accountability of community-based organisations (CBOs) managing public sanitation and continuous reduction of funding for sanitation as a result of insufficient interventions (Scott, 2013). The low technical capacity of WASH experts and municipality/locality staff leads to unsustainable technical solutions. Around 60% of the coverage is private or shared, unimproved pit latrines (6012 units). Additionally, the average number of users per communal latrine is estimated at a ratio of 50:1, hence the accumulation rate of faecal sludge is very high; thus latrines are annually covered over and reallocated

<sup>5</sup> German based company, for more information [click](#)

<sup>6</sup> For more information about the TUV certification [click](#)

<sup>7</sup> Localities in Sudan are the name for administrative units equivalent to districts in other countries



**Figure 5** Sanitation service categories and latrine type in Kass (Adam, Ronteltap and Brdjanovic, 2016).

### Social acceptance of resource recovery

The local communities are looking for affordable and durable sanitation solutions that could replace simple pits with short life cycles (up to 6 years maximum) and they lack successful local examples of digesters for effective demonstration, replication and local uptake (Adam, Ronteltap, and Hooijmans, 2017). On the other hand, the Ministry of Health's Environmental and Sanitation Project (ESP), as well as the WASH partners at national and state level (South Darfur) alike, are eager to learn and adopt new approaches to tackle sanitation problems and find sustainable management schemes (Ibid).

During workshops conducted in Kass, participants showed a high interest in adopting waste recycling techniques e.g. composting, gasification, and biogas application. Other practical trainings were delivered to vocational teachers, neighbourhood volunteers from CBOs and pottery makers to demonstrate the acceptance of the community in reusing waste and collecting trash from existing dumpsites. Furthermore, the participants learned the procedure for digging a pit for composting, how to modify a barrel for gasification of solid waste and how to create a small system from jerry-can and tire tube to demonstrate micro-sized biogas models<sup>8</sup>.

<sup>8</sup> For more information on resource recovery initiatives in Kass locality, [click here](#).



**Figure 6** Gasification experiment in Kass vocational school to produce briquettes; The materials and tools applied use a locally available binder (okra powder) compacted by the use of a mechanical press



**Figure 7** Biogas experiment in Kass vocational school: 16 litres jerry-can filled with crushed goat manure



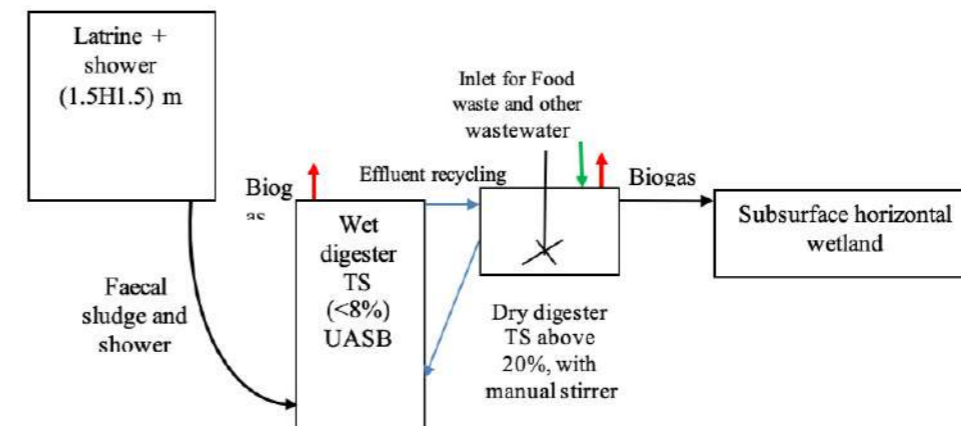
**Figure 8** Pit compost experiment in Kass vocational school: the compost after five days



**Figure 9** Women's pottery workshop: women produced gasifiers then tested the stove with solid waste derived fuel and produced biochar.

### Solution proposed

The quantities and the strength of wastewater largely vary among different economic classes due to the availability of water. The low amount of water supplied to households in slums and peri-urban areas leads to high strength wastewater (Katukiza et al., 2012). Table 2 reports the different streams of wastewater in slums and IDP households and their organic loads: kitchen waste, faecal sludge and grey water. The total COD load is 2.116 kg/d or 28 g/L that can produce 420-740 L/kg per kg COD)of methane per day. The estimated total TVS load of an average household in South Darfur's IDP camps is 2.73 kg VS/d or 34 kgVS/m<sup>3</sup>.d that can produce up to 1.8 m<sup>3</sup> of biogas per day. The substrate needs an increase in the organic load, which can be achieved with the addition of biodegradable materials such as grass and agricultural waste to ensure enough methane production rates sufficient for a family of seven people, which is around 2 m<sup>3</sup>/d. Staging the reactor by using interconnected dry and wet reactors reduces the amount of water required to digest organic waste. Manual washing of the solid substrate is achieved with water discharged from bathroom showers and after cleaning it is then passed to the wet digester after 15-20 days. In addition, the effluent of the wet digester (UASB) will be recycled through a solid waste reactor. Digester sizes are usually about 1.5 m<sup>3</sup> for dry digestion and much smaller size of UASBs (less than 0.5 m<sup>3</sup>). However, to achieve irrigation or discharge limits set by Sudanese Standards and Metrology Organization (SSMO) (which are 150 mg/L for COD and 50 mg/L for BOD), digester effluent will be further treated in horizontal wetland, growing fodder crops.



**Figure 10** Diagram explaining the biogas unit proposed for the IDP household.

Although the waste characteristics vary widely, the most common values obtained from the literature and field visits to South Darfur IDP camps, were taken as baseline for design calculations. The waste generation is rather low: around 5 kg/HH.d, 12 kg/HH.d, and 63 L/HH.d organic waste, faecal sludge, and grey water respectively. The pH of grey water can be acidic (5-6), however this can be solved by the addition of faecal sludge or manure. The sludge produced from the digester has a high value as soil conditioner and natural fertiliser. However, pathogens should first be removed (through drying) or else the fertiliser can be used for trees with inedible fruit.

**Table 1** the calculation of household waste organic load based on concentrations reported from literature, Hartmann and Ahring, (2005); Niwagaba et al. (2014); Heinss et al.(1998); Adam, (2016); Katukiza et al.(2012); Carlesen, Vad and Otoi, (2008).

Parameter	Unit	Organic waste		Faecal sludge		Greywater		Total
		Conc.	OLR g/d	Conc.	OLR g/d	Conc.	OLR g/d	
Quantity	kg/HH.d or L/HH.d	5		12		63		
pH				6.5-9		5.5-6.5		
TS	%	35-83	2891	17-30	2737	2-12	441	6069
TVS	%	30-36	954	60-70	1779			2733
TCOD	g/Kg or g/L	431	2111	20-50	416			2528
SCOD	g/L	2.3	11	16	190	5-8	0.41	202
BOD/COD	1			0.17		0.4-0.87		
Total-N	g/Kg	6.3	31			0.02-0.15	0.087	31
TKN	mg/l			3.4-5	50			50
NH4-N	mg/l					4-74		25
E.coli	Cfu/100 ml			108		4.2x10 <sup>5</sup>		

## CONCLUSION

Household scale digesters that are extensively used in China, India and Nepal have several advantages: treatment of domestic waste, supply of biogas for cooking, production of fertiliser and reclamation of irrigation water.

Literature indicates that biogas technologies are evolving rapidly, applying different techniques such as co-digestion, effluent recycling, staging of reactors and ammonia stripping. Different designs of digesters should be selected based on context, such as wet or dry digesters, thermophilic or mesophilic digesters and internally or externally circulated digesters. The treatment of solid waste leachate by recycling the effluent seems to be a promising technology producing methane of up to  $12.9 \text{ L}_{\text{methane}}/\text{L}_{\text{reactor}}$ . Biogas systems have been applied in several parts of Sudan since 1976: White Nile, North Sudan, North Kordofan and Darfur. The numbers of implemented digesters are still low due to the high capital cost, lack of financing options and lack of advances in research.

The sanitation situation in Kass is enduringly challenging, especially in IDP camps located in the middle of the town. Around 40% of the IDP population accesses public facilities where one latrine is shared by 50 or more persons. Hence, latrines have high faecal sludge accumulation rates leading to VIP latrines sludge being removed every six months within improved pit latrines being covered and reallocated annually. Workshops and practical training were delivered to Kass vocational schoolteachers, neighbourhood volunteers from CBOs and pottery makers on how to produce micro-gasifier stoves. Participants showed great interest in adopting waste recycling techniques e.g. composting, gasification, and biogas application. The current paper proposes the application of anaerobic digesters, which receive all household organic wastes from the kitchen, toilet (faecal sludge) and grey water to produce biogas for cooking. In addition to biogas, the digester reclaims water and produces soil conditioner (sludge). Both can be used in farm-fields, after ensuring the deactivation of pathogens via secondary treatment.

## LIST OF REFERENCES

- Abouelenien, F., Namba, Y., Kosseva, M.R., Nishio, N., Nakashimada, Y. (2014). Enhancement of methane production from co-digestion of chicken manure with agricultural wastes. *Bioresour Technol.* 159/80–7.
- Adam, W., Ronteltap, M., Hooijmans C.M. (2017). Sustainable Productive Sanitation Systems and Businesses for South Darfur Emergency Settlements (IDPs), Second International Resource Recovery Conference, Oral Presentation Proceedings. NYC. July, 2017. NYC. Available at <https://drive.google.com/file/d/0Bz8AUVfDFS7M041QnBYnVsTG8/view?usp=sharing> [Accessed on 4th of November 2020]
- Adam, W., Ronteltap M., and Brdjanovic, D. (2016). Sustainability assessment of productive sanitation in IDP emergency settlements. Available at: <https://un-ihe.on.worldcat.org/oclc/1110011518> [Accessed 4th of November 2020]
- Ahmed, Muna and Gouzoli, Faisal. S.A. Agricultural technology transfer (ATTS) mission to el-Fahir Available at (<http://www.sudanatts.org/collect/gamia/index/assoc/HASH016f/115e5b35.dir/fashir%20mission.pdf>) [Accessed: 15th August 2020].
- Biogas International (2019). Available at (<http://biogas.co.ke/flexi-domestic-systems/>) [Accessed: 15th August 2020]
- Blumensaat, F. and Keller, J. (2005). Modelling of two-stage anaerobic digestion using the IWA Anaerobic Digestion Model No. 1 (ADM1). *Water Research*, 39(1)171-183.
- Borowski, S., Domański, J., Weatherley, L. (2014). Anaerobic co-digestion of swine and poultry manure with municipal sewage sludge. *Waste Manage.* 34:513–21.
- Carlesen, J., Vad, J., & Otoi, S. P. (2008). Kampala City Council—A project for promoting ecological sanitation in Kampala, Uganda. *Sida Evaluation*, 44. Available at <https://www.sida.se/contentassets/96290b6861c44718975a09bc465d8df8/14687.pdf>. [Accessed 4th November 2020].
- ESP; Environment and Sanitation project South Darfur (2016). Camp profile report. Unpublished government document. Health Ministry Nyala office. South Darfur State.
- Farah, Mohamed. (2018). Verbal communication with author on 25th of September 2020. Practical Action, Khartoum.
- Farouk, H., Elobaid, M., Abdelazim, O., Salah, M., Bakheet, K., and Lang, A. (2017). Development of a household anaerobic digester for rural areas in Sudan. *International Journal of Energy Applications and Technologies*, 4(2), 53-63.
- Fernández-Rodríguez J, Pérez M, and Romero L. (2014). Dry thermophilic anaerobic digestion of the organic fraction of municipal solid wastes: solid retention time optimization. *Chem Eng J.* 251(?):435–40.
- Graham, J.P. and Polizzotto, M.L., (2013). Pit latrines and their impacts on groundwater quality: a systematic review. *Environmental Health Perspectives*, 121(5), p.521.
- Hartmann, H., and Ahring, B. K. (2005). Anaerobic digestion of the organic fraction of municipal solid waste: Influence of co-digestion with manure. *Water Research*, 39(8), 1543-1552.
- Harvey, P. (2007). Excreta disposal in emergencies: A field manual. Water, Engineering and Development Centre (WEDC) Loughborough University of Technology. If this is a Report or a Paper, then not in italics
- Heinss, U., Larmie, S. A., & Strauss, M. (1998). Solids Separation and Pond Systems for the Treatment of Septage and Public Toilet Sludges in Tropical Climates -Lessons Learnt and Recommendations for Preliminary Design. EAWAG. EAWAG/SANDEC Report. Federal research institute. Switzerland.
- Horváth, I. S., Tabatabaei, M., Karimi, K. and Kumar, R. (2016). Recent updates on biogas production: A review. *Biofuel Res. J.* 10(?), 394-402.
- Katukiza, A. Y., Ronteltap, M., Niwagaba, C. B., Foppen, J. W. A., Kansime, F. P. N. L., and Lens, P. N. L. (2012). Sustainable sanitation technology options for urban slums. *Biotechnology Advances*, 30(5), 964-978.

- Kerroum, D., Mossaab, B. L., and Hassen, M. A. (2012). Production of biogas from sludge waste and organic fraction of municipal solid waste. *Biogas*, 151.incomplete ref
- ROSA (2010). Arba Minch Town Rosa Project Booklet. Resource-Oriented Sanitation concepts for peri-urban areas in Africa (ROSA) project, Ethiopia. [Accessed 4th of November 2020]. <https://www.susana.org/en/knowledge-hub/resources-and-publications/library/details/1189>.
- Mohamed F. E. (2004). Biogas technology in Sudan: Potential, experience and future prospects at Expert Consultation on the Utilization of Agricultural Residues, Cairo, Egypt, 6-8 of June: 161-168. [http://www.fao.org/tempref/GI/Reserved/FTP\\_FaoRne/morelinks/Publications/English/EXPERT%20CONSULTATION%20AGR%20.pdf](http://www.fao.org/tempref/GI/Reserved/FTP_FaoRne/morelinks/Publications/English/EXPERT%20CONSULTATION%20AGR%20.pdf) (Accessed on 5th August 2020).
- Niwagaba, C. B., Mbéguéré, M., & Strande, L. (2014). Faecal sludge quantification, characterisation and treatment objectives. *Faecal Sludge Management-Systems Approach Implementation and Operation*. London, UK: IWA Publishing, 97-120.
- Ramaswamy, J., and Vemareddy, P. S. (2015). Production of biogas using small-scale plug flow reactor and sizing calculation for biodegradable solid waste. *Renewables: Wind, Water, and Solar*, 2(1)1-4.
- Ronteltap, M., Dodane, P. H., and Bassan, M. (2014). Overview of treatment technologies. *Faecal Sludge Management-Systems Approach Implementation and Operation*. London, UK: IWA Publishing, 97-120.
- Scott R. (2013). Sustainable WASH interventions as populations transition from relief to development. 36th WEDC International Conference. Briefing Paper 1824. Nakuru, Kenya.
- Sharma, V.K., Testa, C., Lastella, G., Cornacchia, G. and Comparato, M.P. (2000). Inclined-plug-flow type reactor for anaerobic digestion of semi-solid waste. *Applied Energy*, 65(1) 173-185.
- SOWTech (2015). Flexigester V10 Technical Specifications. Datasheet. URL: <http://www.flexigester.com/specs.html> [Last visited: 06/11/2020].
- Wilkinson, K. G. (2011). A comparison of the drivers influencing adoption of on-farm anaerobic digestion in Germany and Australia. *Biomass and bioenergy*, 35(5)1613-1622.
- Yuan X., Wen B., Ma X, Zhu W., Wang X., Chen S. et al. (2014). Enhancing the anaerobic digestion of lignocellulose of municipal solid waste using a microbial pre-treatment method. *Bioresour Technol.* 154/1–9.
- Zhang C, Xiao G, Peng L, Su H, Tan T. (2013). The anaerobic co-digestion of food waste and cattle manure. *Bioresour Technol.* 129/170–6.
- Macias-Corral, M., Samani, Z., Hanson, A., Smith, G., Funk, P., Yu, H., & Longworth, J. (2008). Anaerobic digestion of municipal solid waste and agricultural waste and the effect of co-digestion with dairy cow manure. *Bioresour technology*, 99(17), 8288-8293.

# FOOD WASTE MANAGEMENT IN HOSPITALS

Micaela Myburgh<sup>1\*</sup> & Hema Kesa<sup>1</sup>

<sup>1</sup>Food Evolution Research Laboratory, School of Tourism and Hospitality, University of Johannesburg, South Africa  
micaela.myburgh.mm@gmail.com, hemak@uj.ac.za

## Abstract

*Food waste has various negative effects on the environment, for example, wasting important resources such as water which is used during the production of food. Additionally, there are negative social effects of food waste which includes food insecurity. Therefore, it is essential to identify both the contributors and causes of food waste.*

*This paper focuses on food waste contributed by hospitals. There is a lack of existing research with regard to food waste in hospitals, especially in South Africa. Therefore, investigating the extent, causes, implications, prevention, and reduction measures currently in place would contribute essential information to existing data. This study aims to investigate these key aspects.*

*A pilot study was conducted on hospital food wastage. The study adopted the quantitative research approach, which consisted of the distribution of questionnaires to various hospital staff who are involved in the production and distribution of food within the various hospitals. The findings of the study revealed that all the hospitals involved in the study experienced food waste and identified that there are various causes of food waste in hospitals, for example, special dietary requirements by patients. The findings further identified that waste reduction measures are in place; however, large amounts of food waste are experienced irrespective of the measures put in place and that food waste experienced by hospitals has various implications such as financial losses and health and safety risks for the hospitals.*

*The outcomes of the pilot study identified and reiterated the value and significance of this study with regard to identifying the extent of food waste in private hospitals, the causes thereof, and how it can be managed and reduced. These findings contribute to the necessary data required regarding food waste in South African private hospitals.*

**Keywords:** food wastage, hospital, reduction

## INTRODUCTION

According to Hic, Pradhan, Rybski and Kropp (2016), an estimate of 1.3 billion tonnes of food produced for human ingestion is wasted worldwide each year. Marais, Smit, Koen and Lotze (2017) state that South Africa contributes more than 9 million tonnes of food waste to the overall amount of food wasted globally each year. An estimate of 50% of total waste generated in general wards of hospitals comprises food (Williams & Walton, 2011). This presents a large problem as half of the food produced for consumption in hospitals is wasted, yet masses of people around the world suffer from starvation and malnutrition daily.

The global population is increasing, which means that there is an increased need for basic resources such as food; therefore, reducing food waste is imperative to meet the need to feed the entire global population. The reduction of food waste will contribute to both the sustainability of food for the future (Bond, Meacham, Bhunnoo & Benton, 2013) and the overall food supply available for human consumption. Sustainability of food for the future is imperative as it is estimated that the total size of the population will increase by an estimate of its current 7 billion to 8–10 billion by 2050 (Lutz, Wolfgang & Samir, 2010). According to Williams and Walton (2011), only a small amount of food waste is used in a sustainable manner, for example, by composting and recycling. The majority, if not all, of the food waste generated by hospitals is discarded which presents an enormous waste of essential resources. Considering that so many people suffer from undernutrition, starvation, and poverty, we cannot afford to waste such large amounts of food while it is a scarce resource for so many.

To reduce the amount of food wasted in hospitals, the causes of food wastage need to be identified and measures need to be implemented to manage hospital food waste sustainably, reduce the amount of food waste experienced and find preventative measures to attempt to avoid as much food waste as possible.

## The purpose of the study

The purpose of this research study is to fill the gap linked to the lack of research conducted as, according to Sonnino and McWilliam (2011), it is estimated that more than 60% of hospital food might be wasted, although many hospitals have recorded wastage to be below 10% only, it is therefore important to investigate the amount of food waste in hospitals and acquire accurate statistics in order to gain more knowledge regarding food waste in hospitals and put the necessary measures in place to reduce food waste. Hospitals contribute a large amount of food wastage to the total waste stream. According to research completed by Goonan, Miroso and Spence (2014), hospitals contribute approximately 50% of waste to the overall waste stream. This paper further aims to contribute to the existing knowledge of food wastage in hospitals.

This study will further identify how hospital food wastage could be used in a sustainable manner. It is imperative to use food wastage in a sustainable manner as the notion of sustainable nutrition, which, in periods of few resources, is becoming progressively more significant with regard to the limited resources such as land, energy, water, and other possessions (Strotman, Friedrich, Kreyenschmidt, Teitscheid & Ritter, 2017).

This study will increase the knowledge and understanding concerning food wastage experienced in hospitals. This researcher examined food wastage in Gauteng private hospitals in South Africa. The study further investigated the causes of hospital food wastage including whether or not special dietary requirements by patients cause more food waste than those who do not have special dietary requirements, how food waste could be reduced, as well as the negative implications of food wastage in private hospitals. This pilot study forms part of a larger study that is currently ongoing. The quantitative research method was adopted for the pilot study. This was carried out by administering questionnaires at various private hospitals in Gauteng, South Africa, in order to gather information as well as to achieve the purpose of this study.

## LITERATURE REVIEW

Food waste can be defined as consumable food items intended for human ingestion but are rejected and therefore required to be discarded due to the food items being contaminated by vermin; these foods do not include food items which have been rejected due to defects (Bond *et al.*, 2013). The U.S. Food and Drug Administration (FDA) (2018) states that organic waste, typically food, is the second largest element of landfills which are the third biggest source of methane emissions. Methane is a large contributor to global warming due to it absorbing heat from the sun, which heats up the atmosphere. It is therefore essential to reduce food wastage in order to sustain the environment.

According to research completed by the CSIR organisation, more than nine million tonnes of food is wasted in South Africa per annum (Oelofse, Nahman & de Lange, 2013). Food wastage does not only negatively impact the environment but also has various negative social and economic implications (Goonan, 2012).



According to Papargyropoulou, Steinberger, Wright, Lozano, Padfield and Ujang (2019), the food service and hospitality industry has been recognised as an industry with momentous potential for food waste prevention. Thus, food waste from this industry has recently received increased attention in research.

Sonnino and McWilliam (2011) state that hospital food wastage is a major problem and it is believed that more than 60% of hospital food could be wasted, even though many hospitals have recorded wastage to be below 10%. Hospitals contribute a large amount of food wastage to the total waste stream. According to research conducted by Goonan *et al.* (2014), hospitals contribute about 50% of waste to the overall waste stream. Reducing the amount of food waste experienced by hospitals will create a ripple effect in the reduction of the overall food waste epidemic and contributing to the food available for human consumption.

### Types of hospital food waste

Hospital plate waste can be defined as food that has been served to patients but not consumed (Díaz & García, 2013). There are two different types of hospital food waste, trolley waste which is also known as production waste and plate waste. Trolley waste refers to food wastage that occurs during the various stages of production, including storage and over ordering or over production (Goonan, 2012). According to research conducted by Sonnino and McWilliam (2011), the amount of plate waste experienced by hospitals was lower than the trolley waste which would mean that more food wastage is experienced due to factors such as over production and over ordering rather than patients not consuming the food served.

### Causes of food wastage

Goonan (2012) identified that between 19% and 66% of food is wasted in hospitals during each meal service. There are various causes of food waste in hospitals, according to Goonan *et al.* (2014). The largest amount of food waste is produced during service due to over production and the absence of adequate portion control.

The causes of food waste include over prepared food (Cuglin, Petljak & Naletine, 2017); an irregular hospital environment, for example, the variable number of patients being admitted (Goonan *et al.*, 2014); portion sizes being too large, especially for elderly patients (Williams & Walton, 2011); the quality of service (Sonnino & McWilliam, 2011); patients ordering meals early and changing their minds during meal service (Sonnino & McWilliam, 2011); limited choice with regard to menu items (Williams & Walton, 2011); insufficient preserving temperatures (Cuglin *et al.*, 2017); food safety rules and regulations (Goonan, 2012); unsuitable menu items (Cuglin *et al.*, 2017); environmental factors such as untimely meal times and meal disruptions (Williams & Waltons, 2011); clinical factors such as special dietary requirements by patients (Williams & Walton, 2011); service factors such as difficulties related to ordering food items due to a lack of information (Williams & Walton, 2011); menu and food factors such as the quality of food, for example, under or overcooked food items (Williams & Walton, 2011); food items expiring due to them not being consumed before their expiry date (Giuseppe, Mario & Cinzia, 2014); fresh produce such as fruit and vegetables that generally have a shorter life span compared with non-perishable food items, which leads to increased food wastage (Eriksson, 2012); over-ordering (Eriksson, 2012); food rejections (Giuseppe *et al.*, 2014); and poor quality control (Giuseppe *et al.*, 2014).

It is thus evident that there are various causes of food wastage. Therefore, finding appropriate prevention and reduction measures is essential in order to combat the major problem of food waste.

### The food waste hierarchy

Eriksson (2015) states that the waste hierarchy positions waste prevention and managing choices in order of importance. The food recovery hierarchy begins with reducing the amount of excess food as the most favourable strategy and continues with feeding the hungry, using food as animal feed, manufacturing uses, composting, and the least favourable, landfilling and incineration. Based on the food waste hierarchy, the best socially correct and environmentally friendly way to use excess food is to ensure that it is used to feed the hungry and undernourished.

### Prevention and reduction of food waste

De Lange and Nahman (2015) state that approximately 81% of wasted food produced across the food supply chain could have been fit for consumption if it had been handled, distributed, or prepared differently. According to Eriksson (2015), preventing the over production of food is the most effective way to reduce food wastage; however, this is not wanted due to the issue of food security. Therefore, reducing waste is the most viable option as food waste cannot be completely prevented. Betz, Buchli, Göbel and Müller (2014) identified measures for waste reduction in various areas, specifically, efficient storage and purchasing which entails optimising storage management, for example, applying the first-in-first-out (FIFO) principle and controlling the expiration date of food times; preparation and cooking which entails developing strategies to use or store overproduced food items, for example, freezing; serving which entails presenting meals attractively; and consumers, which entails sensitising consumers to food waste and the causes of food waste for example, using posters; and the use of feedback sheets in order to survey reasons for plate waste.

Further studies have identified ways in which food wastage can be reduced. These strategies for reduction include standardising recipes and preparing ingredients in advance in order to reduce the amount of waste experienced during preparation and production (Goonan *et al.*, 2014); training employees on the effect that food waste exerts on the environment and the economy as well as the social implications; developing a standardised waste management system in order to reduce the amount of waste experienced prior to patient consumption (Goonan *et al.*, 2014). Reducing patient portion sizes (Williams & Walton, 2011) and implementing the bulk system, also known as the buffet system, allows patients to choose what they would like to eat while controlling the portion size (Williams & Walton, 2011). If the pre-plated system was in use, switching to the bulk system was found to produce 50% less plate waste (Williams & Walton, 2011). Helping patients to open packaging and encouraging them to eat (Williams & Walton, 2011) would also help to reduce waste.

It is evident that there are numerous causes of food wastage in hospitals as well as across the food supply chain. Food waste cannot be completely prevented; however, finding ways to reduce food waste is imperative not only for the sustainability of the environment, economy, and the growing population but also for the sustainability of hospital operations and the reduction of undernutrition in patients.

### Various foods cause different amounts of waste at different stages of the food supply chain

Various foods contribute different amounts of waste. Nahman and De Lange (2013) state that meat contributes 7%, fish contributes 2%, milk contributes 8%, cereals contribute 26%, roots and tubers contribute 9%, oil seeds and pulses contribute 4%, and fruit and vegetables contribute 44% to food wastage. As fruits, vegetables and cereals contributing the most waste, reducing this wastage would contribute to a decrease in the overall waste in South Africa. The WWF Organisation (2017), as well as Eriksson (2015) supports findings of Nahman and De Lange (2013), which rank fruits and vegetables as well as cereals as the most wasted foods.

According to Oelofse and Nahman (2012), the reduction of meat waste is essential in order to reduce the environmental impacts which occur during the production of meat. It is essential to identify which foods contribute the most wastage and the reason for such wastage in order to reduce the wastage.

### Implications of hospital food waste and problems related to food waste

There are three interconnected difficulties with food waste. According to Oelofse and Nahman (2012), these problems are food insecurity, greenhouse gas emissions and waste disposal.

Hic *et al.* (2016) highlight food insecurity as a major issue because food waste exerts an impact on both the economy and the environment due to 800 million people going hungry worldwide. This is regarded as an environmental and economic problem due to one third of the world being undernourished which consequently causes decreased productivity, increased disease and death, and a reduction in economic growth. Wasted food also means wasted resources owing to the production of food consisting of water, land and energy which all contribute to the dilapidation of the environment (World Wide Fund for Nature Organisation, 2017). According to the World Wide Fund for Nature Organisation (2017), the energy wasted from food production is sufficient to power Johannesburg for about 16 weeks and the water wasted due to food waste could fill more than 600 000 Olympic swimming pools.

When food is wasted it has to be disposed of, and the low-priced and most practical way to dispose of food waste in South Africa is through landfilling. This takes up land which is a resource being wasted, and it gives off greenhouse gases (Oelofse & Nahman, 2012). It also exerts a negative effect as a result of the foul odour and pests as well as air emissions and the contribution to increased traffic and accidents during transportation of the waste to landfills (De Lange & Nahman, 2015). According to Oelofse and Nahman (2012), disposing of food waste at landfills is banned in numerous countries, which has also become a priority consideration in South Africa, as landfilling of food waste contributes an estimated 4.3% of the greenhouse gas emissions in South Africa. The WWF Organisation (2017) found that, in South Africa, 90% of waste is sent to landfills. Therefore, finding substitute ways to dispose of food waste is essential for the reduction of greenhouse gas emissions.

According to Finn (2014), an estimate of 1.3 billion tons of food intended for human consumption worldwide are wasted. Hospitals contribute an estimate of 50% food waste to the total waste stream (Goonan *et al.*, 2014) and has various negative implications.

The social implications of hospital food wastage include malnutrition or undernutrition of hospital patients (Walton & Krassie, 2012), which decreases their recovery rate. This is also a concern as a large portion of the global population is starving, which is a huge social challenge faced by the world.

There are a number of negative influences of food waste on the environment. This includes land degradation, a waste of scarce and valuable resources such as water, pollution which increases the carbon footprint, and greenhouse gases that are released into the atmosphere which is the most concerning consequence as it is a major contributor to climate change and because it is caused by waste, such as food waste being disposed of at landfills (Papargyropoulou, Lozano, Steinberger, Wright & Ujang, 2016). According to Finn (2014), the amount of energy needed to make the food that is wasted each year in the United States is equivalent to 300 million barrels of oil. Finn (2014) also states that the amount of water lost due to food waste could be sufficient to provide water for nine million people who live in households. These figures clearly indicate that enormous amounts of valuable resources that are being wasted, and since water is so scarce and a limited resource for so many people, reducing the wastage could provide much needed water to millions who do not have access to this necessity.

Food waste has negative implications on hospitals as they have to cover the cost of the disposal of food waste at landfills. They further have to cut their financial losses owing to wasted resources such as food items, time spent preparing the food and costly labour (Goonan, 2012).

Food items carry pathogens which could cause foodborne illnesses such as Listeriosis. Foodborne illnesses could exert a negative impact on the economy, the environment and the population owing to food being unsafe to consume and therefore discarded, thus contributing to the food waste stream (Watson & Meah, 2012)

It is evident that there are various negative implications for food waste. The only way to reduce the impact of food waste is to reduce the amount of food waste experienced across the entire food supply chain.

It is evident that food waste cannot be completely avoided. It is therefore important to find methods to use food waste in a sustainable manner. Sustainability refers to the ability to preserve resources to ensure that there is a sufficient supply for the future (Bond *et al.*, 2013). Food waste sustainability therefore refers to identifying measures to ensure that wastage is used in the most sustainable manner to ensure that resources will be available in the future.

## RESEARCH METHODS

The pilot study conducted for this paper will inform a larger study that is currently in progress. The research conducted for this study applied the quantitative research approach. Quantitative research refers to research that is predominantly based on the collection of data which can be measured to express facts.

The research technique used in this pilot study was the survey approach adopted for quantitative research. The questionnaires were completed by various private hospitals in the Gauteng region. All the questionnaires were completed by the hospital managers, employees who handled stock and waste, food service staff, kitchen supervisors, catering managers, ward hostesses and all the kitchen staff who work with food. The questionnaire consisted of a total of 40

questions which were mostly closed ended with a few being open-ended. A total of 20 questionnaires were completed by the private hospitals. The benefit of this research tool allows the researcher to identify any gaps, differences, and similarities across the various private hospitals as well as why food wastage occurs.

The research methodology for this study required the collection of data which was analysed in order to become more knowledgeable with regard to the extent of food wastage in hospitals, the implications thereof, and the quantity of food waste generated by hospitals. Ethical clearance for this study was granted by the University of Johannesburg and permission was granted by the hospitals for this study to be conducted.

## Pilot study

A pilot study was conducted in order to determine whether all the questions were understood by respondents, whether there were any errors, and to ensure that the questions were reliable and valid in relation to the study. Thus, a pilot study increases the validity and reliability of a study. The questionnaires were distributed to hospitals that are not included in the current study. The results were analysed, and the necessary changes were made to the questionnaire. As mentioned earlier, this study is in progress, therefore, only the results of the pilot study are discussed in this paper.

## RESULTS

### The extent of food waste contributed by private hospitals in Johannesburg, Gauteng

The results of the study further indicated the need for this study. Most of the hospitals included in the pilot study stated that food waste is experienced almost every time food is prepared. All the hospitals included in this study experience both plate and trolley waste while half of the hospitals use both the plated and bulk food distribution systems and the other half use only the plated food distribution system.

The study found that hospitals experience less food waste when using the plated food distribution system which contradicts the findings of Williams and Walton (2011) in a study on plate waste. When comparing plated meal services with bulk meal service in six different hospitals, it was found that there was 50% less plate waste when the bulk service system was adopted.

### The causes of hospital food wastage, reduction, and implications thereof

The study found various reasons for food waste in hospitals. These include kitchen errors, lack of appetite by patients, an irregular hospital environment, and poor portion control. Identifying why these causes of food waste occur and finding appropriate measures to rectify this problem are essential to reduce the overall amount of food wasted in hospitals.

According to the results of this study, food waste has several implications. The environment is largely affected by landfills and waste areas filling up. The green footprint as well as the reputation of the hospital are negatively affected, and the food waste further contributes to pollution. Financial implications include additional costs in all the departments of the hospital, loss of revenue, and under-trained staff thus causing increased wastage which with rising costs. One of the social implications is that ill patients might not eat food, which could increase the risk of malnutrition while also contributing to food wastage.

The study identified that hospitals execute various food waste reduction measures. These reduction measures include standardising recipes, training employees on food waste management, and implementing food waste reduction systems. In spite of these food reduction measures, hospitals are still experiencing large quantities of food waste. It is therefore imperative to find more effective food waste reduction measures.

### Special dietary requirements by patients and the contribution to a higher rate of food wastage in private hospitals

This study found that special dietary requirements contribute to food waste in hospitals. These special dietary requirements include catering for people with allergies such as lactose intolerance, illnesses such as diabetes, and religious requirements such as kosher or halaal meals.

### The menu, quality of food, style of food service and portion sizes have an effect on hospital food wastage

The results of the pilot study found that the menu, quality of food and portion sizes exert an effect and contribute to food waste. It is therefore important to find how the menu can be adjusted to suit patients, ensure that better quality of food is served and find ways to decrease the portion sizes of the food served, especially the less popular and most wasted food items.

### Conclusion of results

The results of the pilot study reiterate the importance of this study. Hospitals have various causes of food waste and have implemented strategies to reduce and prevent the food wastage experienced. However, large quantities of food are still being wasted owing to special dietary requirements, portion sizes, menu items, the quality of food and an irregular hospital environment to name a few. Identifying suitable prevention and reduction measures are imperative in order to reduce food waste experienced by hospitals. These results further indicate that decreasing food waste would decrease the negative implications of food wastage on the environment, humankind, and hospitals in general.

### LIMITATIONS

A few limitations were experienced owing to this research being part of a pilot study which was conducted to inform the main study. Thus, the sample size was small. Further limitations include the limited number of participant hospitals in Gauteng in the pilot study because most of the hospitals are participants in the larger study. Therefore, the generalisability and reliability of the results are limited. No observations were made at the hospitals owing to the COVID-19 pandemic and the restrictions regarding access to healthcare facilities.

### CONCLUSION

Food waste poses a huge threat to the sustainability of the environment, businesses, and the human race. Minimising the amount of food wasted in the food supply chain from the beginning to end is imperative. It is the responsibility of every entity involved to attempt to reduce the amount of food wasted. This study will be beneficial to hospitals as well as healthcare organisations as it will increase the existing knowledge regarding food waste and offer information where additional knowledge is needed to reduce hospital food waste. It has social and environmental benefits with regard to identifying how the surplus of food items could be used sustainably as well as how to increase food intake by patients in order to reduce patient undernourishment and hospital food waste. Considering the literature consulted as well as the findings in this study, it is evident that food waste in South Africa is a major problem as South Africa contributes roughly 9.4 million tonnes to this food waste (Oelofse & Nahman, 2012). This wastage is fairly high especially in the light of such a large portion of the population suffering from food insecurity and poverty. Decreasing the amount of food waste that hospitals contribute to the overall food waste stream will not eradicate the food waste problem. Nonetheless, it will contribute to the decrease of the overall food waste stream.

### LIST OF REFERENCES

- Bond, M., Meacham, T., Bhunnoo, R. & Benton, T.G. 2013. Food waste within global food systems. A Global Food Security report.
- Betz, A., Buchli, J., Göbel, C. & Müller, C. 2014. Food waste in the Swiss food service industry: magnitude and potential for reduction. *Waste Management*, 35:218-226.
- Cuglin, A.M., Petljak, K. & Naletina, D. 2017. Exploratory research of food waste generation and food waste prevention in the hospitality industry: the case of Zagreb restaurants. *Business Logistics in Modern Management*.
- De Lange, W. & Nahman, A. 2015. Costs of food waste in South Africa: incorporating inedible food waste. *Waste Management*, 40:167-172.
- Eriksson, M. 2015. *Supermarket food waste*. (Vol. 2015, No. 119)
- Fda.gov. (2018). How to cut food waste and maintain food safety. [Online] Available from: <https://www.fda.gov/downloads/food/resourcesforyou/consumers/ucm529509.pdf> [Accessed: 29 March 2020].
- Finn, S. (2014). Valuing our food: minimizing waste and optimizing resources. [Online] Wiley Online Library. Available from: <https://onlinelibrary.wiley.com/doi/full/10.1111/zygo.12131> [Accessed: 7 June 2020].
- Goonan, S.L. 2013. *Getting a taste for food waste: an ethnographic exploration into the generation of hospital food waste prior to patient consumption* (Unpublished). Doctoral thesis. University of Otago.
- Goonan, S., Miroso, M. and Spence, H. 2014. Getting a taste for food waste: a mixed methods ethnographic study into hospital food waste before patient consumption conducted at three New Zealand foodservice facilities. *Journal of the Academy of Nutrition and Dietetics*, 114(1):63-71.
- Giuseppe, A., Mario, E. & Cinzia, M. 2014. Economic benefits from food recovery at the retail stage: an application to Italian food chains. *Waste Management*, 34(7):1306-1316.
- Hiç, C., Pradhan, P., Rybski, D. & Kropp, J. P. 2016. Food surplus and its climate burdens. *Environmental Science & Technology*, 50(8):4269-4277.
- Wolfgang, L. & Samir, K. C. 2010. Dimensions of global population projections: what do we know about future population trends and structures? *Philosophical Transactions of the Royal Society of London B: Biological Sciences*, 365(1554):2779-2791.
- Marais, M. L., Smit, Y., Koen, N. & Lötze, E. 2017. Are the attitudes and practices of foodservice managers, catering personnel and students contributing to excessive food wastage at Stellenbosch University? *South African Journal of Clinical Nutrition*, 30(3):60-67.
- Oelofse, S, Nahman, A. & De Lange, W. 2013. The magnitude and cost of food waste in South Africa.
- Papargyropoulou, E., Wright, N., Lozano, R., Steinberger, J., Padfield, R. & Ujang, Z. 2016. Conceptual framework for the study of food waste generation and prevention in the hospitality sector. *Waste Management*, 49:326-336.
- Papargyropoulou, E., Steinberger, J.K., Wright, N., Lozano, R., Padfield, R. & Ujang, Z. 2019. Patterns and causes of food waste in the hospitality and food service sector: food waste prevention insights from Malaysia. *Sustainability*, 11(21):6016.
- Sonnino, R. & McWilliam, S. 2011. Food waste, catering practices and public procurement: a case study of hospital food systems in Wales. *Food Policy*, 36(6):823-829.
- Strotmann, C., Friedrich, S., Kreyenschmidt, J., Teitscheid, P. & Ritter, G. 2017. Comparing food provided and wasted before and after implementing measures against food waste in three healthcare food service facilities. *Sustainability*, 9(8):1409.
- Watson, M. and Meah, A., 2012. Food, waste and safety: Negotiating conflicting social anxieties into the practices of domestic provisioning. *The Sociological Review*, 60(S2):102-120.
- Wwf.org.za. (2017). Food loss and waste: facts and futures report. [Online] Available from: [http://www.wwf.org.za/media\\_room/publications/?21641/Food-Loss-and-Waste-Facts-and-Futures-Report](http://www.wwf.org.za/media_room/publications/?21641/Food-Loss-and-Waste-Facts-and-Futures-Report) [Accessed: 06 September 2020].
- Williams, P. & Walton, K., 2011. Plate waste in hospitals and strategies for change. *European e-journal of Clinical Nutrition and Metabolism*, 6(6):e235-e241.
- Valero Díaz, A. & Caracuel García, A. 2013. Evaluation of factors affecting plate waste of inpatients in different healthcare settings. *Nutrición hospitalaria*.

# WHIVE IO: BLOCKCHAIN PROTOCOL FOR SUSTAINABLE AND EQUITABLE TOKEN DISTRIBUTION IN AFRICA

Todd Shurn , Howard University, shurn@scs.howard.edu

John Wainaina Karanja, BitHub Africa, wainaina.karanja@bithub.africa

## Abstract

The Whive protocol, also known as “Whive IO” is a cryptographically secure protocol that extends the Bitcoin blockchain protocol. The Whive protocol auxiliary chain favours token issuance to persons solving proof-of-work algorithms using low power CPUs operating in regions with a high solar reliability index. Whive IO is an open peer-to-peer protocol resistant to medium (GPU) and ASIC high scale mining.

The Whive protocol seeks to empower African, South East Asian and other developing communities globally with abundant solar energy potential. The initial Whive use case is transparently distributing decentralised solar generated electrical power. Whive, offers an open API enabling third party blockchain application developers to link Whive tokens to community renewable energy resources. Whive tokens may be used to reward decentralised solar generated power in a manner interoperable with existing electric power distribution grids.

**Keywords:** Bitcoin protocol, mining, hash based proof-of-work algorithm and proof-of-stake algorithm, auxiliary blockchain, digital tokens, solar reliability index

## INTRODUCTION

Whive, is a blockchain protocol that extends the Bitcoin protocol using a secure auxiliary chain (*AuxChain*) that will enable building applications with trustless rewards. The protocol is intended to incentivise engineers in the developing world to contribute to establishing sustainable solutions to challenges facing their communities. Solar energy is an example application that may be advanced by the Whive protocol in an equitable distributed economy that is interoperable with the mainstream economy.

The Whive token is the reward for identification of new blocks to be added to the Whive shared and distributed ledger. The Whive protocol’s process to add blocks to the chain has two guiding principles, namely proof-of-work and proof-of-stake algorithms. These principles are implemented to ensure token reward equity to miners across targeted regions.

### Proof-of-Work Algorithm

Similar to Bitcoin, Whive requires solving a proof-of-work (*PoW*) mathematical problem to identify the next block on the chain. The PoW requires a hashed consensus solution verifiable by all the nodes that include network miners. The PoW problem’s solution ensures “trust” for each Whive block transaction and makes Whive block alteration computationally infeasible.

Whive PoW deviates from Bitcoin PoW (*Nakamoto,2008*) by layering the *yespower 1.0* algorithm that favours computing hash solutions on smaller computing hardware with central processing units (CPUs) and disfavours hardware with graphics processing units (GPUs) or application-specific integrated circuit (ASIC) hardware. Yespower generates a hash that is compared with the Bitcoin PoW hash resulting in either a match or another yespower invocation until a match is achieved allowing a new block to be mined (*Yespower, 2014*).

Yespower is implemented to enable low power, less expensive computing devices containing CPUs owned by many Africans to have a greater opportunity to identify new blocks and be rewarded with Whive tokens, than more expensive, high powered hardware with GPUs. Thus, yespower may be considered a deliberate choice of a pro-CPU, anti-GPU, moderately-pro-ASIC PoW scheme. It is possible to respond to GPU hardware improvements by increasing yespower parameter values to further retard GPU Whive mining proficiency.

### Mining Bias and Reward Distribution algorithm

Whive tokens are mainly intended for African, Middle Eastern, South East Asian and developing countries with high solar reliability indices. Whive PoW has embedded components to increase likelihood of tokens being rewarded to miners in those areas. These components are:

- Miner processor type (pt)
- Miner time zone (tz)
- Miner location (loc).

Values for each component are combined to determine:

*total reward score (rs)* using the following formula

$$rs = (pt + tz + loc) / 3$$

The total reward score determines the probability that a node will be allowed to generate a viable yespower block hash on the network. If a mining node has a total reward score of 20% it will have a 20% chance of being able to generate a viable yespower block hash on the network. Indeed, nodes with favorable processors, time zones and locations will always score higher than nodes with less desired time zones and locations.

### Processor Type Component

Devices with the ARM processor architecture are rewarded with 70% of the processor type value as shown in *Table 1* below. The X86 and Windows Operating System (*OS*) receive 15% and 10% of the value respectively. Other unknown or un-identifiable architectures receive only 5% value. This value allocation scheme favors devices such as Raspberry Pi’s, Odroids, and smartphones.

**Table 1:** Processor types and values

PROCESSORS	VALUE
WINDOWS OS	10%
ARM OS	70%
X86 OS	15%

Other OS	5%
----------	----

High powered computing devices with multiple cores are heavily penalised using this formula:

$$\text{Processor score} = (\text{Processor value} \times 4) \div (\text{Number of Cores} \times 2)$$

The processor score is a percentage assigned to different processors based on architecture and processor power (*Whive Yellow Paper, 2020*).

### Time Zone Component

The protocol detects the time zone of the miner's machine using *Coordinated Universal Time (UCT)* time stamp and assigns a value shown in *Table 2*:

**Table 2:** Time zones and values

START TIME ZONE	END TIME ZONE	VALUE
Earliest African timezone (GMT -1)	Earliest European time zone (GMT 0)	30%
Earliest European time zone (GMT 0)	Latest African timezone (GMT 4)	40%
Latest African timezone (GMT +4)	Earliest Asian timezone (GMT +5)	20%
Other	Other	10%

### Location Component

An oracle (*Havilland, 2019*) will be implemented to determine location component values. The oracle will utilise a third party API that generates geo-coordinates from a mining node's Internet Protocol (IP) address.

The protocol's location component algorithm is currently on a test-network (*testnet*) with the values shown in *Table 3*:

**Table 3:** Locations and their values

LOCATIONS	VALUE
Caribbean region	25%
South American region	10%
African region	45%
Asian region	15%
Other regions	5%

### Proof-of-Stake Algorithm

The Whive protocol has implemented the proof-of-stake version 3 algorithm (*Fanti, Kogan, Viswanath, 2019*) on testnet for issuing new tokens to mining nodes that maintain a balance of Whive tokens on the network. Nodes that stake Whive tokens and maintain a balance on the network will receive 50% of the block reward using the same biasing

criteria for the mining algorithm.

This serves to ensure that:

Nodes with Whive tokens using solar energy are probabilistically rewarded

Node owners are discouraged from off-loading tokens affecting market price discovery negatively

Reduced computation is sufficient to earn tokens to further conserve energy usage.

### Mining and Staking Issuance Schedule

The Whive protocol will have a total of *100,000,000* Whive tokens mined and staked on the network using a *dis-inflationary* issuance policy similar to Bitcoin (*Nakamoto, 2008*). In particular, the Whive block reward will depreciate by half every 4 years as depicted in *Table 1* and *Figure 1*. This will ensure scarcity if and when the demand and utilisation of the Whive protocol continues to increase over time.

*18,550,000* Whive tokens may be claimed by Bitcoin holders on a *1 to 1* ratio in *quarter 2 (q2) 2020* through a claiming process hardcoded in release version 2 (*v2*).

The last Whive Mining and Staking rewards will be issued by *2040* resulting in a *20-year* Mining and Reward scheme for network nodes as shown in *Table 2*. Thereafter, nodes will earn Whive tokens exclusively from transaction fees from network utilisation.

**Table 4:** Block Reward and Whive Rewards issued

YEAR	BLOCK REWARD	TOKENS
2024	200	60,598,000
2028	100	21,024,000
2032	50	10,512,000
2036	25	5,256,000
2040	12.5	2,628,000

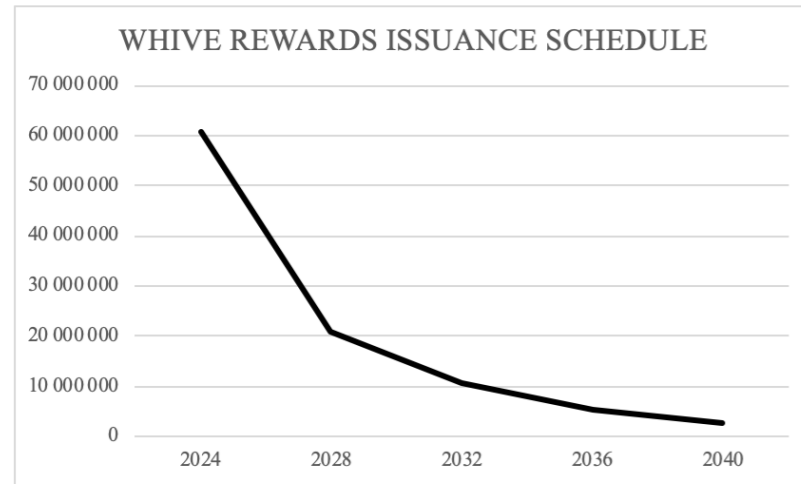


Figure 1: Whive Rewards Issuance till the year 2040

### Conclusion

The Whive protocol is designed to probabilistically reward mining and staking nodes in time zones or locations with high solar reliability indices. Additionally, processors that are commonly found in smaller mobile devices are more likely to receive new tokens than more powerful machines.

Whive protocol use of the optimised yespower algorithm ensures both sustainable and equitable distribution of tokens to Africans and other target regions. Built on robust open-source Bitcoin protocol code and integrated with the battle hardened yespower algorithm, Whive has deployed game theory, mathematical proofs and cryptography to ensure the Whive network is cryptographically secure.

The proof-of-stake algorithm and split block reward mechanism ensure tokens are earned by the smaller CPUs whilst conserving energy required to produce the optimised block hashes that secure the Whive network. These incentives should motivate adoption of renewable sources of energy notably solar in underserved regions in Africa and South East Asia.



Figure 2: Global Bitcoin Miners; China has the largest share

Whive token mining consumes much less energy compared to Bitcoin mining and achieves a more equitable mining and staking reward distribution in Africa. During the 3 months after the launch, Whive tokens were organically mined in 10 countries including Kenya in East Africa. Chinese miners have received about a third of the tokens due to the prevalence of CPU manufacturers and other computational mining devices.

Whive tokens are more fairly distributed in Africa compared to Bitcoin mining as the Chinese miners have received 2/3 of the coins mentioned in Figure 2. The Whive protocol processor biasing has been further enhanced to compensate for Chinese miner advantages in version 2 (v2) as shown the Whive roadmap in Figure 3.

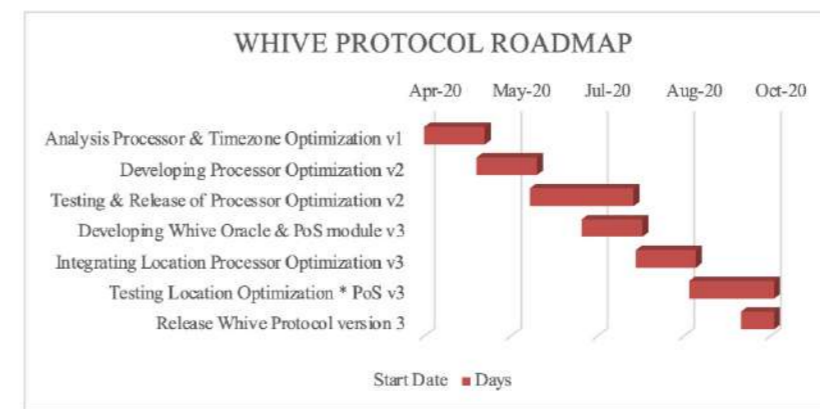


Figure 3: 2020 Whive Development Timeline

The Whive Oracle is a crucial Machine Learning (ML) component that generates data for the protocol to ensure that probability scores for time zone and location are generated dynamically. The oracle will act as a single source of truth that presents challenges of centralisation and data verification.

We propose that the threat of data centralisation could be mitigated by :

- Using data analysis to develop hard coded scores that are pre-defined in the time zone and location optimisation functions in version 3(v3) of the Whive protocol software release scheduled for *quarter 4 (q4) 2020*.
- Comparing data from multiple location services such as Google Location API and Open Location API.
- Usage of artificial intelligence (AI) to monitor the Whive network for misbehaving nodes to penalise them.

The favourability of the scores is based on computations that best approximate mobility in computer processing power and the *Solar Reliability Indices (SRIs)* for nodes on the Whive network.

This protocol implementation provides a foundation for the creation of widely distributed energy heterogeneous and community accessible regions where the rewards incentivise the transfer and utilisation of stored energy through micro-payments within micro-grid and crowd-grid ecosystems.

Whive network performance data will be continuously collected to improve the optimisation algorithms and secure the blockchain integrity. Future algorithm revisions will ensure that Whive tokens are fairly distributed to target regions in a manner that motivates sustainable renewable energy usage.

---

## LIST OF REFERENCES

- Hileman, G. & Rauchs, M. 2017. *Global cryptocurrency benchmarking study* (April 6, 2017). [Online] Available from: SSRN: <https://ssrn.com/abstract=2965436> or <http://dx.doi.org/10.2139/ssrn.2965436> [Accessed: ].
- Nakamoto, S. 2008. Bitcoin: A peer-to-peer electronic cash system. *Citeseer*. [Online] Available from: <http://bitcoin.org/bitcoin.pdf> [Accessed: ]
- Cox, B. & Felker, R. 2014, What is Yespower? [Online] Available from: <https://cvsweb.openwall.com/cgi/cvsweb.cgi/projects/yespower/README?rev=1.3>[Accessed:.....].
- de Havilland, P. 2019. *What is a blockchain Oracle?* [Online] Available from: <https://cryptobriefing.com/what-is-blockchain-oracle/> [Accessed:.....].
- Fanti, G. & Kogan, L. & Viswanath, P. 2019. Economics of proof-of-stake payment systems. [Online] Available from: <http://pramodv.ece.illinois.edu/pubs/GKV.pdf> [Accessed:.....].

# IMPLEMENTATION OF INNOVATIVE BUILDING TECHNOLOGIES IN SOUTH AFRICA – A REVIEW OF PRODUCT PERFORMANCE

J. Mahachi, University of Johannesburg, South Africa, jmahachi@uj.ac.za

## Abstract

South Africa's national building regulations allow for the use of conventional building products, which must comply with deemed-to-comply standards as provided in the South African National Standards. The regulations also make provision for products and materials, which must comply with the performance requirements of Agrément South Africa. These products, normally referred to as Innovative Building Technologies (IBT), have to undergo product certification, a process that includes structural strength and stability tests, fire tests, thermal and energy performance assessment, etcetera. Many of these IBTs have been certified and some have been commercialised and implemented in housing and other social infrastructures such as schools and clinics. Although the certificates issued by Agrément SA provide credible information to designers and contractors, there is still a gap between research, a knowledge base, and implementation of the building products. This paper attempts to present a knowledge base of IBT building walling products, which have been assessed and certified by Agrément SA. The research methodology involved collation and analysis of data from Agrément SA, analysing, and categorising the products through a stratification process that depends on building occupancy classification and performance. Some of the data on the certificates were also validated through engagements with the system owners. A review is also made to establish the reasons why some of the products have not been utilised on the ground despite being certified as meeting the requirements of the building regulations. The recommendation of the paper is the adoption of a conceptual framework that integrates research, knowledgebases, invention, government participation, and market diffusion.

**Keywords:** innovative building technologies, National Building Regulations, performance tests, Agrément certification, construction innovation

## INTRODUCTION

All over the world, there has been a concern regarding the limited uptake of innovation in the broader construction industry, and more so in housing. Although the South African regulatory environment is not prescriptive in the materials and products to be used in building construction, there has been a slow uptake of innovative building products compared to other countries. In this study, innovative building products are described as any non-conventional building products assessed and certified by Agrément South Africa and for which there are no South African National Standards to assess the performance of these products. The use of innovative building products in South Africa has important economic ramifications which include the eradication of the housing backlog, the provision of better quality housing and

construction products, a possible reduction in the life cycle cost of the product, etcetera. In other countries, Fairclough (2002) and Burger (2014) have noted that innovations have changed the way homes are made, how they are built, how they perform, who can afford them, and how well they serve their occupants. The South African housing industry is fairly large and complex, with two distinct markets, namely the bondable housing market and the government subsidised housing market.

The bondable housing market is delivered mainly through the private sector. Figure 1 presents the number of enrolments (i.e. houses provided with a warranty) by the regulatory body National Home Builders Registration Council (NHBRC, 2020) during the last ten years. The houses enrolled by the NHBRC is a good indicator of the houses to be constructed. Despite the 2009/10 economic recession, the numbers show steady but slow growth in the delivery of bondable houses. The performance of the government subsidised houses is also presented in the same figure, where it is apparent that the delivery trend is descending, with just under 100,000 houses delivered in the 2018/19 financial year (South African Government, 2020). In total, South Africa's capacity to deliver houses in both the bondable and subsidy housing markets is just under 160,000, and yet there is abundant technical capacity to deliver more. This is an indicator of serious intervention required by the government and the private developers in the home built environment. This, therefore, requires a change; an exploration of how innovation, in its broad context, can be utilised to examine the structure, characteristics, and technologies available to accelerate the delivery of houses and other social infrastructure. Advancing the uptake of housing innovation in South Africa has been slow, partly because of the limited knowledge base available regarding the technologies, the perceived "high costs", problems with social acceptability, etcetera.

Agrément SA tests, assesses and certifies construction innovative products. These products range from walling building systems, roads, and bridge joints to water and sanitation products. However, currently there is not any properly documented and stratified knowledge base of these products. Such a knowledgebase would include, but not limited to, the performance of the products as certified by Agrément SA, the actual "as-built" performance, limitations of the products, cost, capacity of manufacturing plants to local demands, etcetera.

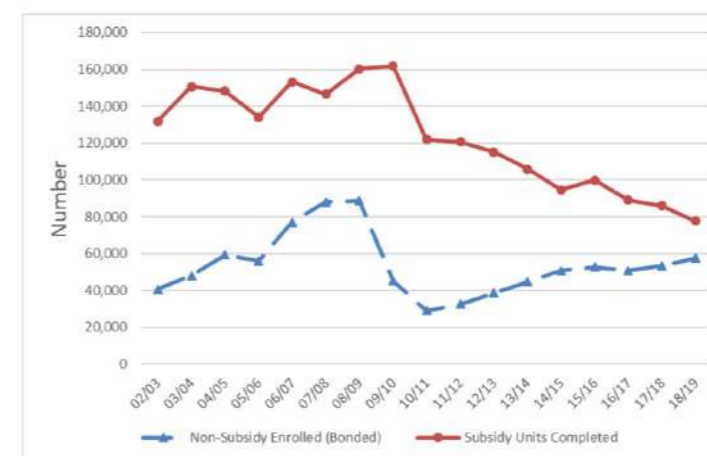


Figure 1: Delivery of houses

## AIM OF THE STUDY

The purpose of this study is to explore the literature of available walling building technologies in South Africa and the limitations in the uptake of these technologies. The study further attempts to establish the following research questions:

- What are the walling building technologies have been assessed and approved by Agrément SA?
- Do these technologies differ in terms of performance?



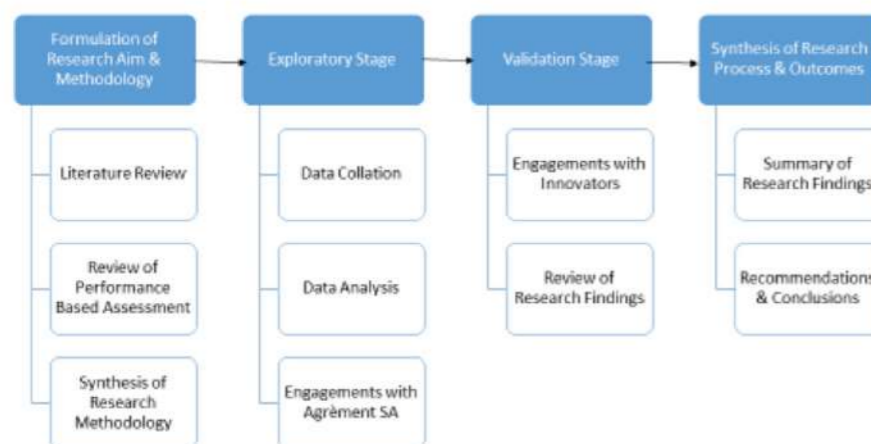
- Can the technologies be stratified in terms of their performance?
- What are the constraints in the uptake of these technologies?
- What is the role of government and what is the best implementation framework to ensure uptake of the technologies?

The research, however, is limited to the walling building technologies, and more so, to the walling products that could be available by Agrèment SA. The data researched and presented is based on what is provided on the Agrèment SA certificates, and in some cases validated by the innovators of the technologies.

## RESEARCH METHODOLOGY AND DESIGN

To achieve the aim of this research, a four-stage research methodology was employed as presented in Figure 2. The first phase established a critical review of building performance and how Agrèment SA assesses and certifies the walling building systems. The second exploratory stage drew on the walling systems available from the Agrèment SA website and discussions with the officials from Agrèment SA. A thorough critical analysis of the certificates was also performed, resulting in the stratification of the building walling systems in terms of their performance.

The third “validation stage” involved the engagement with some of the technology innovators/owners to validate or gain clarification of the information on the certificates. An attempt was made not to modify the information obtained from the certificates issued by Agrèment SA. An opportunity was also taken to gain clarification from the innovators regarding their experiences in the uptake of innovative technologies. The final stage of the research methodology was the synthesis of the data gathered from all the previous stages and consolidated into a conceptual framework.



**Figure 2: Research Methodology**

## LITERATURE REVIEW

The concept of building performance is not new but has been advanced over the last few decades, with notable work carried out by Foliente (2000), Fairclough (2002) and Hartkopf *et al.* (2008). In all the relevant literature, performance-based standards are concerned with that which a building product is required to do, rather than on how it is done. This

approach has also been adopted by the International Council for Research and Innovation in Building and Construction CIB (2003) in their definition of a performance-based building.

The South African building regulatory environment is based on a similar performance requirement. The National Building Regulations (NBR) and Building Standards Act (Act No. 103 of 1977, as amended) provides for three ways in meeting the performance requirements, which includes performance assessment carried out through Agrèment SA.

Agrèment SA is a state entity established in terms of the Agrèment SA Act (Act 11 of 2015), with a mandate to assess and certify non-standardised construction products, systems, materials, components, and processes which are not covered by South African National Standards (SANS). However, all such products must meet the performance requirements of SANS 10400 (2012), and thus Agrèment SA assessment is referred to as “Performance-Based”. On satisfying all the performance requirements, Agrèment SA issues a certificate of “fit-for-purpose”, and this certificate summarises the performance that may be expected of the product.

Hartkopf *et al.* (2008) has emphasised that there is a connection between performance-based standards and innovation and that the use of a performance-based approach in the building industry encourages innovation, allows for more competition, and supports cost-effective building. It is on this basis that this study considers innovative products as those products which have been assessed and certified by Agrèment SA as meeting the performance requirements of SANS 10400. However, the limitation of the study is only on walling building systems.

The performance aspects assessed by Agrèment SA (2010) to comply with SANS 10400 are:

- Structural performance;
- Behaviour in fire;
- The durability of materials;
- Water penetration and rising damp; and
- Thermal performance and energy use.

However, in addition to the above, Agrèment SA also assesses other aspects which do not necessarily have compliance requirements in NBR but are related to habitability, namely condensation and acoustics performance. This research was limited to only the mandatory requirements of NBR, although in practice all performance requirements would need to be covered.

## CATEGORISATION OF CERTIFIED WALLING SYSTEMS

This section reviews the active walling systems which have been assessed and certified by Agrèment SA. Active systems are those which systems whose registration status are in good standing with Agrèment SA. Due to limitations in access to all the systems, a sampling technique of the active systems was undertaken with the aid of Agrèment SA officials. The sampled products were then analysed and stratified into four main groups depending on their structural performance. It was observed that many of the walling systems show a resemblance in terms of how the product is manufactured and the performance thereof. The following classification which was used:

### 1. Sandwich Insulated Panels (SIP)

The SIPs are made up of at least three layers of materials consisting of a low-density core, which is sandwiched and bonded to thin skin layers on each side. In certain cases, the outer skins are galvanised chromadeck but usually, the inner skins are made of gypsum, silica, or magnesium plasterboard. This structural form provides the materials to act as a composite material with very high structural and energy performance.

The advantages of using sandwich panels are mainly associated with off-site (i.e. in a workshop) manufacturing. This also enables the installation of services such as plumbing and electrical conduits to be pre-fixed under factory conditions or these services can be surface mounted on the finished product.

Two main sub-groups of SIPs have been certified by Agrément SA. They comprise the insulation material, that is, polyurethane or expanded polystyrene. These sub-groups are briefly outlined below.

#### 1.1. Polyurethane Building Systems

These walling systems use insulated polyurethane as an insulation foam material. Polyurethane is a polymer composed of organic units that are joined by carbamate. It is a combustible solid and can be ignited if exposed to open fire. However, it does have many characteristics that offer advantages as a building material. This includes high insulation, significant structural strength, and the ability to resist impact load. The density of polyurethane is of about 36 kg/m<sup>3</sup>, which makes it economically viable for building systems as it has the potential to reduce other associated costs such as those of foundations. This advantage will be significant in multi-storey buildings.

#### 1.2. Expanded Polystyrene Systems (EPS)

The building systems made of EPS are similar to those made of polyurethane. In this case, the insulation material is EPS. EPS is a rigid, closed-cell, lightweight thermoplastic foam material produced from solid beads of polystyrene. This material also has a low-density in the order of 11 to 32 kg/m<sup>3</sup>. As a composite material, the density of the product is in the order of 600-800 kg/m<sup>3</sup>. The most important mechanical property of EPS is similar to polyurethane but has significant structural properties such as a very high compressive resistance which increases as the density of the material becomes higher. The insulation properties are also excellent.

### 2. Light Concrete Building Systems

This group of building systems is made of lightweight concrete. Lightweight concrete consists of lightweight aggregates or it can be Autoclaved Aerated Concrete (AAC). The light aggregates result in a very low density of the concrete in the order of 300 to 800 kg/m<sup>3</sup>. The AAC is made with fine aggregates, cement, and expansion agents, which yields about 75% entrained air in the concrete. The AAC is usually made into blocks or panels and used later to build mortared walls, similar to standard concrete walls. Although the AAC panels have been included in this group, the AAC blocks have been classified under the “Building Block Group”.

Lightweight concrete is usually poured in between external and internal fibre cement boards and may be reinforced if so required. The AAC panels are manufactured under strict quality management systems in a controlled manufacturing environment. Although the manufacturing costs may be high, both lightweight concrete and AAC offer advantages of reduced weight, an improvement in the thermal properties and fire resistance, savings in handling and transportation costs, and a reduction in the cost of formwork and propping during construction.

### 3. Polyvinyl Chloride (PVC) Building Systems

PVC is a rigid thermoplastic polymer that, if required, can be made more flexible by the addition of plasticisers such as phthalates. PVC has low greenhouse gas emissions and has the advantages of good physical and mechanical properties. When used in building, the density of PVC is very high, and has good tensile strength, easily fabricated, does not require painting, and is resistant to moisture and abrasion. PVC building systems are normally interlocking shells or modules that are filled with concrete to provide additional structural strength requirements.

### 4. Container Building Systems

A container building system is a modular steel building component, with each component connecting structurally. Vertical integration is achieved by means of steel sections that offer structural stability. Construction is based on a stable steel frame with interchangeable wall panels. Specific sizes of space are achieved by removing outer wall panels and fitting partitions.

Advantages of container building systems include easy transportation and fast installation; hence quick completion of the construction; flexible construction, and the efforts of greening in construction are supported since steel can be recycled. Internal walls are usually fitted with gypsum board “Rhino wall” encapsulating a layer of extruded polystyrene (EPS) board or mineral-wool batts. The thickness and usage of the EPS or mineral-

wool batts depend on the climatic zones (Conradie, 2014); the thickness ranges from 40 to 100 mm.

### 5. Building Blocks

Several building blocks made from various building materials were assessed and certified. These blocks consist of:

- Soil cement blocks dry stacked or laid in horizontal mortar joints; or
- Compressed earth blocks using soil-cement slurry as mortar; or
- Cement hollow blocks; or
- Hollow ribbed wood/cement blocks filled with concrete; or
- AAC blocks.

Most of these blocks, except for AAC blocks, are manufactured on-site using cheap local labour. The quality of the blocks depends on the quality and availability of the raw materials as well as the quality control systems on-site.

Based on the above, the walling building systems were grouped, analysed, and stratified as presented in Table 1 (based on the data that could be extracted at the time). The list is exhaustive, and further analysis may still be required. The building occupancies in the table are described in the next section.

**Table 1: Building Walling System Stratification Groups**

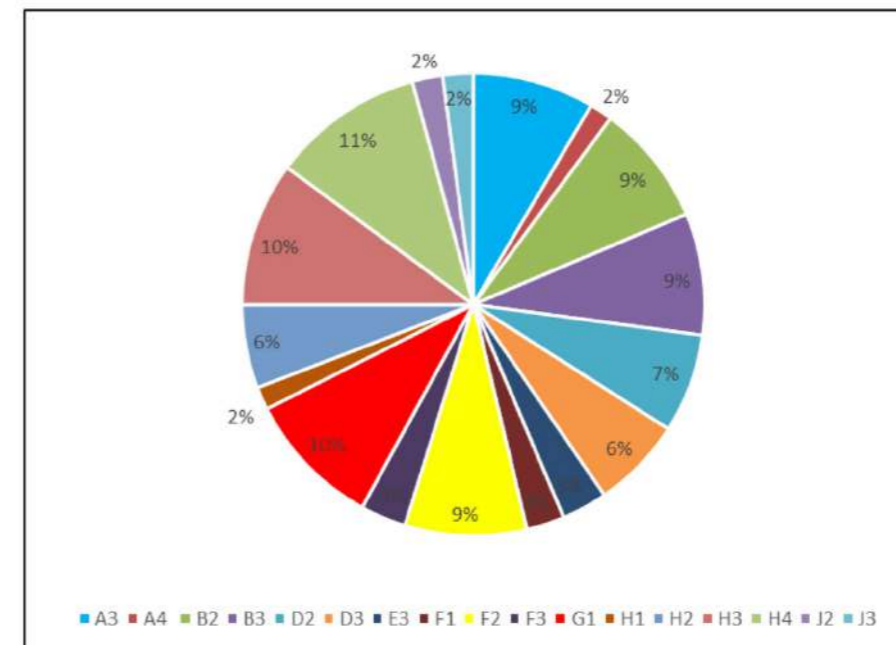
Building Groups	Names of Building Systems	Building Occupancies*
1. Sandwich Insulated Panels	a. Spaceframe 2000 Building System	A3, D2, G1, H2, H3, H4
	b. Amsa Protea Building System	H3, H4
	c. FSM Building System	A3, H2, H4
	d. Kwikspace Modular Building System	A3, D2, D3, G1
	e. MIB Building System	A3, B2, B3, D2, D3, E3, F2, G1, H3, H4
	f. SARDA Building System	A3, B2, B3, D2, D3, F2, G1, H2, H3, H4
2. Light Concrete Building Systems	a. UCO Solidwall Building System	A3, B2, B3, E3, F2, G1, H3, H4, J2, J3
	b. Robust Building System	A3, B2, B3, D2, D3, E1, E3, F1, F2, F3, G1, H2, H3, H4
	c. Tilt-up Pre-fabricated Building System	H3, H4
	d. Uvuyo Building System	B2, B3, F2, H3, H4
3. PVC Building Systems	a. Flex Building System	A3, B2, B3, F1, F2, F3, G1, H3, H4, J2, J3
	b. Luxwood Wall Panel Building System	B2, B3, D2, D3, F1, F2, F3, G1, H3, H4
	c. GHS Wall Technology Building System	A3, A4, B2, B3, C2, D2, D3, D4, E3, F2, F3, G1, H2, H3, H4, H5, J2, J3, J4
4. Container Building Systems	a. ITAS Modular Building System	G1
	b. Xtraspace Container Building System	A3, B2, B3, D1, D2, D3, F2, G1, H1, H2, H3, H4
5. Building Blocks	a. Mega Building System	A3, B3, F2, G1, H3, H4
	b. Stumelblock Building System	A3, B2, B3, D2, D3, F2, G1, H2, H3, H4
	c. Benex Masonry Building System	A3, A4, B3, D2, D3, F2, G1, H2, H3, H4
	d. Compressed Earth Building System	A3, A4, B2, B3, F2, G1, H2, H3, H4
	e. Hydraform Building System	A3, B2, B3, D2, D3, F2, G1, H2, H3, H4, J1, J2
	f. Ikhaya Brick Building System	H3, H4
	g. Izoblock Building System	A3, A4, B2, B3, D2, D3, E3, F1, F2, F3, G1, H1, H2, H3, H4
	h. Klevabrick Building System	A3, B2, B3, D2, D3, E3, F1, F2, F3, G1, H1
	i. Automapolyblock Building System	A3, B2, B3, D2, D3, F2, G1, H2, H3, H4

\*As per National Building Regulations Nomenclature

## ANALYSIS OF THE BUILDING SYSTEMS

### Occupancy Classification

National Building Regulations (NBR) classifies buildings according to the appropriate occupancy and reflects the primary function of that building. The NBR provides for thirty such classifications covering all sorts of building functionalities, including residential, commercial, hospitals, garages, schools, storage areas, etcetera. Part of the Agrément certification includes the NBR building occupancy classification depending on how the product performs (see Table 1). The distribution of the occupancy classification was then analysed and the percentage distribution of the classes are presented in Figure 3.



**Figure 3: Distribution of Occupancy Classes (Classes are as per NBR)**

The following is deduced from the data presented in Table 1 and Figure 3:

- Very few walling building systems cover the following occupancy classifications:
  - A1 Entertainment and public assembly
  - A2 Theatrical and indoor sport
  - A5 Outdoor sport
  - B1 High-risk commercial service
  - C1 Exhibition hall
  - E2 Hospital
  - E4 Health care
  - J1 High-risk storage.

The above occupancies pose a huge risk to societal health and safety and would thus require stringent compliance with the performance requirements of Agrément, and hence, the National Building Regulations. For example, Class E2 for the hospital would require an additional assessment of the health risk to the occupants and compliance with stringent performance requirements.

2. The high number of certifications are awarded for the following occupancy classes:

- A3 Places of instruction
- B3 Low-risk commercial services
- D2 Moderate-risk industrial
- D3 Low-risk industrial
- F2 Small shop
- G1 Offices
- H3 Domestic residences (2 or more units on a site)
- H4 Dwelling house (dwelling unit on its own site).

It is evident that the certification has focused more on low-risk occupancies. However, class H3 does pose a huge risk, that is, if one house has a problem, the probability of multiple failures will be very high. This will be so in low-income houses where the challenges are not only structural failures but also potential fires, poor workmanship, contractors who cut corners, limited budget by the government to deliver the houses, etcetera. This situation, therefore, requires one be able to choose a walling building system that can address these challenges. The use of SIP addresses some of these challenges, although the beneficiaries may not be in favour of such systems, perceiving that these systems may lead to a reduction of much needed local labour. The Block Building systems, as indicated earlier, provides an opportunity for local labour but requires strict on-site quality control systems.

On reviewing the uptake of these building systems on the ground, it is apparent that there are still further challenges:

- The SIP products require huge manufacturing capital outlay, although the actual cost of implementation is probably low. Many such systems have therefore not taken off the ground due to lack of funding;
- Some SIP products have the “knock-on” effect, and the material does not resemble the “brick and mortar”, and thus it is perceived as socially unacceptable; and
- The block or brick building systems have a better social acceptance due to the solid nature of the system; these systems have found applications in the H3, H4 and social infrastructure space (A3). The materials are locally available. However, the speed of construction is very slow compared to the panel SIP building systems.

With the current COVID-19 pandemic, the government and the private sector need to have social infrastructure such as clinics and temporary structures which can be implemented in the shortest possible time with a reasonable design life. The SIP building systems and the container building systems would offer such advantages for rapid implementation.

3. Only one system from the sample could be used for occupation classification E1 (Place of Detention). Places of detention would typically include correctional services; such structures require good structural strength and stability, acoustics, and energy efficiency. The system that meets this requirement is constructed using factory-produced expanded metal panels supported with additional reinforcing, to which mortar (lightweight concrete) is applied to both faces, providing a thermally efficient structure.

The H1 classification for Hotel is also met by only one system using steel containers. To successfully implement this building system requires additional checks and balances by a competent person to ensure structural strength and stability.

The systems were then further analysed in terms of energy and thermal performance. It is argued that since the energy requirements are part of SANS 10400, they, therefore, form part of the NBR requirements.

### Energy Performance

Energy usage refers to the amount of energy that is required to heat a building in winter and to cool it in summer, and thus maintain a comfortable indoor air temperature. This energy will generally include heating and cooling loads, artificial lighting, water heating, and mechanical services. Agrément makes use of building energy simulation

programmes to calculate the amount of energy required to maintain a minimum temperature of 16 °C. The energy requirement (i.e. the performance) is compared to a reference Standard Brick House (SBH). The SBH is of similar size (53m<sup>2</sup>), oriented north, has a fenestration not exceeding 15% of the floor area, and has:

- 230 mm external walls and 115 mm internal walls;
- Plastered internal wall surfaces;
- Concrete floors; and
- A sheeted roof fitted with a ceiling, and without a ceiling as per the requirements of SANS 10400XA. The ceiling is 6 mm thick gypsum plasterboard, and the insulation is 40 mm thick glass-fibre or mineral wool.

The results of the analysis of certificates based on the above performance criteria are presented in Table 2.

**Table 2: Energy Performance of Walling Building Systems**

Building Group	Name of Building System	Ceiling (No insulation)	Ceiling (with insulation)
1. Sandwich Insulated Panels	a. Spaceframe 2000 Building System	=	✓
	b. Amsa Protea Building System	✓	NA
	c. FSM Building System	NA	=
	d. Kwikspace Modular Building System	✓	✓
	e. MIB Building System	✓	NA
	f. SARDA Building System	✓	NA
2. Light Concrete Building Systems	a. UCO Solidwall Building System	NA	✓
	b. Robust Building System	NA	✓
	c. Tilt-up Pre-fabricated Building System	=	=
	d. Uvuyo Building System	NA	=
3. PVC Building Systems	a. Flex Building System	=	NA
	b. Luxwood Wall Panel Building System	=	=
	c. GHS Wall Technology Building System	✓	NA
4. Container Building Systems	a. ITAS Modular Building System	NA	=
	b. Xtraspace Container Building System	NA	✓
5. Building Blocks	a. Benex Masonry Building System	✓	✓
	b. Compressed Earth Building System	=	NA
	c. Hydraform Building System	NA	=
	d. Ikhaya Brick Building System	=	NA
	e. Izoblock Building System	NA	NA
	f. Klevabrick Building System	✓	✓
	g. Mega Building System	=	✓
	h. Stumbel block Building System	NA	=
	i. Automa polyblock Building System	=	NA

Key:

✓ Exceeds performance of SBH; = Same performance as SBH; NA Not assessed

In Table 2, it is evident that several building systems perform equal to or better than the standard brick house (SBH) when the roof has a ceiling but no insulation, and performs even better with insulation. The ability to reduce energy consumption is one of the strong functional performances of the innovative walling system. This is particularly advantageous in South Africa, where energy is scarce and very expensive. Most of the houses built with these walling systems can therefore be built with ceilings with an additional cost of the insulation if required. As might be expected,

the systems which do perform much better are those in the SIP group using EPS and polyurethane as insulation. The AAC based products and lightweight concrete products also offer better energy performance.

### Thermal Performance

The thermal performance of a building is the extent to which the materiality and construction of a building can create an internal temperature that is more comfortable than the external temperature (Conradie, 2014). Agrément SA measures thermal comfort as the maximum indoor air temperature in a 53m<sup>2</sup> Standard Brick House (SBH), where the SBH is defined the same way as for energy performance. Both size and orientation are taken into account in all the climatic regions of South Africa. The results of the comparison for the sample walling building systems are presented in Table 3.

**Table 3: Thermal Performance of Walling Building Systems**

Building Group	Name of Building System	Ceiling (No insulation)	Ceiling (with insulation)
1. Sandwich Insulated Panel	a. Spaceframe 2000 Building System	=	✓
	b. Amsa Protea Building System	✓	NA
	c. FSM Building System	NA	✓
	d. Kwikspace Modular Building System	✓	✓
	e. MIB Building System	NA	✓
	f. SARDA Building System	NA	✓
2. Light Concrete Building Systems	a. UCO Solidwall Building System	NA	✓
	b. Robust Building System	NA	✓
	c. Tilt-up Pre-fabricated Building System	✓	✓
	d. Uvuyo Building System	NA	=
3. PVC Building Systems	a. Flex Building System	✓	NA
	b. Luxwood Wall Panel Building System	NA	✓
	c. GHS Wall Technology Building System	NA	✓
4. Container Building Systems	a. ITAS Modular Building System	NA	✓
	b. Xtraspace Container Building System	NA	✓
5. Building Blocks	a. Benex Masonry Building System	NA	✓
	b. Compressed Earth Building System	NA	NA
	c. Hydraform Building System	NA	=
	d. Ikhaya Brick Building System	NA	=
	e. Izoblock Building System	NA	NA
	f. Klevabrick Building System	NA	✓
	g. Mega Building System	NA	✓
	h. Stumbelblock Building System	NA	=
	i. Automapolyblock Building System	NA	✓

**Key:** NA: Not Assessed

In Table 4, it is also observed that the walling systems compare marginally with the SBH when the ceiling is not insulated. However, with insulation, the walling systems far exceed the performance of the brick house. The performance characteristics are similar to those presented for energy performance above.

### GENERAL DISCUSSIONS

Several innovative walling systems have been analysed and stratified in terms of their performance. The benefits of using innovative building systems outweigh the disadvantages. The energy and thermal performance comparisons have indicated that innovative solutions perform better than the conventional “brick and mortar” and will therefore assist in reducing the impact of pollutants on the environment.

Interactions and discussions with system innovators have shown that innovation in construction, and the uptake thereof, can be improved by the following:

- A quicker turnaround in the testing, assessment and certification of products by Agrément SA. There is currently no knowledge base on the performance of products assessed by Agrément SA or other research organisations or universities. This results in the duplication of research efforts and resources;
- The conventional “brick and mortar” home building industry is highly competitive and fragmented. It requires low capital which makes it easy for new companies to enter and exit the market. As a result, the profit margins are very low, particularly in the government-subsidised housing market. Homebuilders are therefore reluctant to invest, learn and install any new innovative products. Be that as it may, some of the innovators have managed to create a niche market by advancing and offering their products in the social infrastructure market (schools and clinics) as energy-efficient products, with a quick turn-around delivery timeframe;
- The government offers limited support to promote construction innovation, either through technical, finance, or preferential procurement. This is despite government initiatives that go as far back as 2013 when the Cabinet Legotla resolved to use Innovative Building Technologies (IBT) for the construction of social infrastructure. At that time, the Cabinet resolved to set a target of 60% of the specific building types to be constructed from IBTs. To date (2020), no significant investment has been made using IBTs; and
- There is a general misunderstanding of the benefits of using innovative products and performance perceptions by beneficiaries, owners and the government.

It is on the above basis that an integrated delivery framework is required in the assessment, certification, and implementation of building products as proposed and presented in Figure 4. In the framework, it is proposed to have a continuous feedback loop between research and knowledge database of the performance of innovative construction products. There is currently no knowledge database that potential innovators, contractors and the government can utilise. This knowledgebase must be based on Agrément SA certificates, research, social imperatives, cost, the actual performance of the product on the ground (“as-built”), etcetera. Furthermore, in this framework, it is proposed that the government should be involved from the conceptual stages through to implementation. It must be realised that there are very few locally grown inventions in South Africa, with the majority of products being imported from other countries (“Technology Transfer”). Therefore, a feedback loop is needed for the transfer of new technology inventions and technologies between other countries and the end-users of the technologies. This would ensure that the problem of misunderstanding the benefits and perceptions are addressed during the conceptual stages. Only when all the processes have been addressed will Agrément SA provide the relevant certificate.

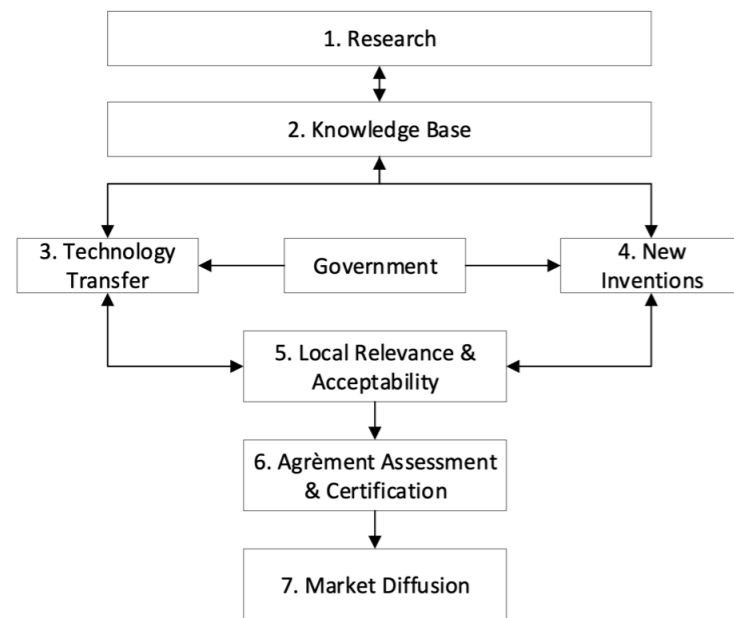


Figure 4: Integrated Delivery Framework for Innovation in Construction in South Africa

## CONCLUSION

Testing, assessment and certification of building products play a critical role in enabling innovation in construction. South Africa does have a regulatory environment that supports the use of innovative building products. Agrément SA provides a mechanism to independently, objectively and professionally test, certify and evaluate performance for compliance with National Building Regulations. Although the certificates issued by Agrément SA provide credible information to designers and contractors, there still lacks a gap between research, knowledge base, and implementation of the building products. In this research paper, a summary of the walling building products and their stratified performance have been presented. However, there is still a need to develop a comprehensive knowledge base of these products, depending on their actual performance “as-built”, the availability of local materials, the manufacturing process, social acceptance, etcetera. This knowledge base will enable the adoption of construction innovative products and hence, contribute to the economic development of the country.

## LIST OF REFERENCES

- Agrément SA. 2010. *The performance concept*. Online. Available from: <http://www.agrement.co.za>, Pretoria. Agrément South Africa. [Accessed 10 March, 2020].
- Agrément South Africa Act (Act 11 of 2015), Government Gazette 41186, 20 October 2017, Pretoria, South Africa.
- Burger, S. 2014. *Innovative building technologies can aid delivery of social infrastructure*. Creamer Media, Johannesburg, South Africa.
- International Council for Research and Innovation in Building and Construction (CIB). 2003. *Performance based building: First international state-of-the-art report*. Rotterdam: CIB Development Foundation: PeBBu Thematic Network.
- Conradie, D.C.U. 2014. The performance of innovative building technologies in South Africa’s climatic zones. In: *Green Building Handbook: The Essential Guide*, Vol 6, Edited by L van Wyk, CSIR, Pretoria, South Africa
- Foliente, G. 2000. Developments in performance-based building codes and standards. *Forest Products Journal*, 50(7/8), pp. 12-21.
- Fairclough, J. 2002. *Rethinking construction innovation and research: a review of government R&D policies and practices*. London: Department of Trade and Industry/Department of Transport, Local Government.
- Hartkopf, V., Loftness, V. & Mill, P. 2008. The concept of total building performance and building diagnostics. *Building performance: Function, preservation and rehabilitation*, American Society for Testing and Materials (ASTM) STP 901, G. Davise, Ed., 1986, Philadelphia, 1986, pp. 5-22.
- National Building Regulations (NBR). 1977. *National Building Regulations and Building Standards Act. No. 103 of 1977, as amended*. Government Gazette. Government Printers, Pretoria. South Africa.
- National Home Builders Registration Council (NHBRC), 2020, 5 March 2020. Online. Available from: [www.nhbrc.org.za](http://www.nhbrc.org.za). [Accessed 5 March 2020].
- South African Government, 2020, Department of Human Settlements Annual Report 2018-19, Online. Available from: <http://www.dhs.gov.za>. [Accessed 05 March 2020].
- South African National Standard (SANS) 10400, 2012, *The application of the National Building Regulations*, SABS, Pretoria, Republic of South Africa.

# THE ADVENT OF CROSS-LAMINATED TIMBER CONSTRUCTION IN SOUTH AFRICA

Brendan Murphy and John Smallwood, Nelson Mandela University, South Africa.  
john.smallwood@mandela.ac.za

## Abstract

*The construction industry is slow to adapt to and adopt the benefits of new technologies. The manufacture of popular construction materials traditionally utilised in the industry such as brick, concrete, and steel, generate large volumes of greenhouse gases (GHG), and negatively affect global warming, and contribute to climate change.*

*Cross-laminated timber is a prefabricated solid engineered wood panel made of at least three orthogonally bonded layers of solid-sawn lumber or structural composite lumber (SCL) that are laminated by gluing longitudinal and transverse layers with structural adhesives to form solid rectangular-shaped timber intended for roof, floor, or wall applications.*

*Embodied energy, measured in mega joules (MJ), is an important factor when determining the impact that various construction materials exert on the environment. The energy consumed in the production of construction materials is highly correlated with CO<sub>2</sub> emissions and an average of 98 tonnes of CO<sub>2</sub> per MJ are produced. Furthermore, the embodied energy of hardwood timber (air dried, rough sawn) of 388 MJ/m<sup>3</sup> is far less than that of concrete (3 180 MJ/m<sup>3</sup>) and steel (251 200MJ/m<sup>3</sup>).*

*This research study aimed to determine the viability and feasibility of CLT as an alternative, sustainable building material to substitute traditional building materials, the manufacture of which generates excessive GHGs and contributes to global warming.*

*The findings include a range of barriers in terms of the implementation of CLT in South Africa, namely perceptions with respect to 'timber' construction, limited design and construction expertise, initial cost disadvantage vis-à-vis traditional masonry construction. CLT offers environmental, construction ergonomics, construction health and safety (H&S), productivity, quality, and time benefits.*

*Recommendations include: CLT design and construction must be embedded in tertiary built environment education programmes; industry craft training must include CLT construction; the built environment must engender a paradigm shift from traditional masonry construction to 'timber' construction.*

**Keywords:** construction, cross-laminated, sustainability, timber

## INTRODUCTION

For decades, the global construction industry has been utilising deep rooted traditional construction methods and materials to achieve a specific form and function to meet the requirements of a structure and facilitate the needs of the client. Since the discovery of brick and mortar construction, there have been very few shifts in methodology and mindset to improve efficiency, waste, and functionality.

Materials such as brick, steel and concrete have been the building blocks of the global construction industry for centuries. The combination of steel and concrete is currently still being utilised as reinforced concrete (RC) in structural frames. Unfortunately, the manufacture of RC components, namely cements, aggregates, and steel, contribute a large overall percentage to the construction industry's carbon footprint. According to the Construction Industry Development Board (cidb) programme manager for construction industry performance, Dr Rodney Milford, "the impact of climate change and the demands for sustainable systems are becoming more and more apparent every day" (cidb, 2019). As stated by Diston (2018) in the Chartered Institute of Building (CIOB's) House of Commons environmental audit inquiry submission, of the total global carbon emissions produced, between 40% and 50% are generated by the built environment. The threat of global warming is no longer merely a threat. It has become a measurable reality and should more measures to reduce or even stabilise the global temperature increase not evolve, it will be detrimental to human life.

The negative environmental impacts that result from the manufacture of traditional building materials together with global warming, have urged numerous governments across the world to join the green movement and conservation of the environment. Over the past decade, South Africa's government has acknowledged the need to conform to climate change agreements that address the necessity to drastically reduce GHGs and stabilise the global temperature increase.

South Africa has ratified both the United Nations Framework Convention on Climate Change (UNFCCC) and its Kyoto Protocol in 1997 and 2002 respectively. The country submitted its first Nationally Determined Contribution (NDC) in September 2015, which contains both the country's adaptation and mitigation responses to climate change (DEA, 2018). As sustainable development policies and measures are being enforced by the UNFCCC, its Kyoto Protocol, and other agreements such as the Paris agreement, the study explored the viability of one of the current international advances in building materials, that is, reducing emissions within the industry.

With the increasing adoption and utilisation of CLT in regions of Europe, North America, Australia, and New Zealand as a sustainable structural material, its resulting benefits have been observed and discussed to determine the reasoning for the low drive of this product within South Africa.

As limited research has been conducted relative to the viability of utilising CLT as an alternative sustainable building material in South Africa, the paper focuses on the knowledge, awareness, perceptions, exposure, and perceived demand with respect to CLT as a sustainable construction material amongst architecture, engineering, and construction (AEC) stakeholders in the industry.

## REVIEW OF THE LITERATURE

### The construction industry and its impact

The manufacture and popularity of conventional construction materials utilised in the industry, for example, brick and mortar, concrete, and steel, largely contribute to the industry's Greenhouse Gas (GHG) generation which, in turn, contributes to the climate change and global warming epidemic. The concentration of the three key GHGs, namely carbon dioxide (CO<sub>2</sub>), nitrous oxide (NO), and methane (CH<sub>4</sub>), have increased beyond the observed natural range of 280 parts per million (ppm) since the arrival of the first industrial revolution in about 1750 (Ampofo-Anti, Dumani & Van Wyk, 2015).

As stated by Skullestad, Bohne and Lohne (2016), it is estimated by UN Habitat, that 3 billion people will need homes within the next 20 years. With such a volume of residential dwellings required within such a short period and the quantity of GHGs being produced by utilising traditional construction methods and materials, it is almost certain to exert a further negative impact on the environment. Ampofo-Anti (2009) indicates that the material choices made in the pre-use phase are responsible for the major environmental impacts that occur in the use phase.

## Cross-Laminated Timber (CLT)

Initially established in Switzerland in the 1990s, CLT was developed after industry-academia joint research efforts in Austria during 1996 (Crespell & Gagnon, 2019), and has since gained popularity in residential and non-residential applications in Europe, USA, Australia, and New Zealand (Karacabeyli & Douglas, 2013). Initially, utilisation progress was slow, but the early 2000s witnessed a rapid increase in CLT construction due to the green building movement, better efficiencies, amendments to building codes, and improved marketing and distribution channels (Crespell & Gagnon, 2019). In line with intensive research and development, production facilities have been established, initially on a small scale, but over the past ten years, on an industrial scale (Brandner, Flatscher, Ringhofer, Schickhofer & Thiel, 2016). The CLT is a prefabricated solid engineered wood panel made of between three and seven orthogonally bonded layers of solid-sawn lumber or structural composite lumber (SCL) that are laminated by gluing the longitudinal and transverse layers with structural adhesives to form a solid rectangular-shaped, straight, and plane timber intended for roof, floor, or wall applications (ANSI, 2018). A few of the main factors that have affected global CLT construction adoption in emerging CLT markets, include, but are not limited to, the manufacture and supply, building codes and standards, structural and building performance, serviceability, fire performance and knowledge of the product. As stated by Buchanan, Dunn, O'Neill and Pau (2018), basic guidance for mass timber construction is informed by building code requirements and design guidance from CLT manufacturers and suppliers.

## Exposure and perception of CLT as a product

Crafford, Blumentritt and Brand (2017) mention that end users of structural timber systems do not possess the relevant information to make environmentally responsible decisions when selecting the system, while manufacturers have minimal information to assist them in the reduction of environmental impacts of their processes and products. As evident by the adoption and development in the USA and Canada (Muszynski, Hansen, Fernando, Schwarzmann & Rainer, 2017), for a new building technology to gain traction within the construction industry, participants must be aware of the characteristics of the materials, the construction methods of the product, and the associated building system. The lack of information disseminated with respect to new building technologies, the study of materials and methods at tertiary institution level in South Africa also plays a large role in the lack of knowledge and basic awareness regarding CLT amongst the South African AEC industry. Low awareness, exposure and knowledge of the product hinder product specification when the final decision regarding material utilisation is made. This limitation is made evident by Hyams, Watts and Harvatt (2019) when stating that the decision is also influenced due to the greater availability of industry experience in traditional reinforced concrete frame construction.

A consumer's perception and beliefs in a new product is fundamental for the adoption of a new product and can occasionally be as important as the actual performance of the product. For this reason, determining how potential adopters, architects, and engineers perceive the characteristics and properties of CLT as a construction material is important (Lindholm & Reiterer, 2017). This is confirmed by Mallo and Espinoza (2015) who explain that the fundamental importance of the consumer's perception of products, and that their perceptions of the product can be as important as the actual performance of the product, and that creating awareness of a product existing in the target market is an important step which plays a vital role in the adoption of the product.

## Advantages and disadvantages of CLT construction

The wood utilised in manufacturing these prefabricated engineered systems sequester and store CO<sub>2</sub>, which acts as a carbon sink through the conversion of CO<sub>2</sub> to biomass in the process of bio-sequestration via photosynthesis (Lehmann, 2012). A few other advantages identified are sustainability of timber, its performance related to fire, its acoustic and insulation performances, speed of construction, good mechanical and physical properties, positive workability, hygrothermal performance, durability, stability and light material weight (Gosselin, Blanchet, Lehoux & Cimon, 2016). Compared to CLT, ability of concrete to control internal environments through thermal mass absorption, storage and dispersing the absorbed heat is greater. As CLT is a lighter material, the weight of concrete resists uplifting forces in basement construction better than CLT does (Hyams, Watts & Harvatt, 2019). The structure of a CLT lightweight frame, however, provides an advantage from a cost perspective. The lighter frame of CLT reduces the size of the foundations required to support it and therefore reduces the cost and volume of the concrete required. The erection speed when utilising CLT construction systems is one of the predominant benefits and advantages of using this construction system. Research conducted by Gosselin *et al.* (2016) includes an example of the Bridport House in London. This building was erected in 10 days using CLT construction, whereas, if the same building had been constructed utilising concrete, the estimated construction time would have been 21 weeks. This factor plays a positive

role in construction in high density areas by reducing the duration of traffic disruptions caused by construction.

## Cost

One of the most important aspects to consider when assessing a new building is the cost competitiveness when using alternative materials. This is a critical consideration for many construction projects, with low profit margins being affected, especially regarding the adoption and the increase in the market share of the material. Even though there are advantages to utilising the material, if the cost does not compete with traditional materials, the probability that clients and builders will switch to using it is very low (Smyth, 2018). A material base cost of a CLT building is estimated to be 10% - 20% more costly than the equivalent reinforced concrete structure (Smyth, 2018). Cost comparisons must take into consideration associated costs relating to the duration of the programme, the foundations, and facades. Where the material costs of superstructures utilising CLT may be slightly higher initially, they are often offset by the cost savings arising from the reduced size of the foundation and the complexity of utilising a lighter material (Hyams, Watts & Harvatt, 2019). An estimated time saving of 30% can be achieved due to the elimination of wet trades, amongst others (Smyth, 2018). With projects being completed earlier, the preliminary costs of the contractors are reduced, which increase their profits; hence, developers can acquire rental revenue sooner, thus decreasing their return on investment period to begin turning over a profit sooner.

## Building performance

A material impact of a building envelope is demonstrated in a 20-year comparative study of three homes of equal floor area designed in timber, concrete, and steel. Relative to the timber design, it was found that the respective steel and concrete designs release 24% and 47% more air pollutants, emit 34% and 81% more GHGs, and consume 26% and 57% more energy (Ampofanti, 2009). The respectable airtightness of CLT as a material of 2 - 3 m<sup>3</sup>/(m<sup>2</sup>/hr), is similar to insulated buildings constructed with conventional building materials at 2.5 - 2.9 m<sup>3</sup>/(m<sup>2</sup>/hr). This is a result of the joints between the panels being either taped closed or sealed with expanding insulation tape to provide additional airtightness. The airtightness of CLT as a material is similar to that of insulated buildings constructed with conventional building materials which promote a highly energy-efficient completed building. Apart from the excellent airtightness, CLT has high natural sound insulating properties (Smyth, 2018). The CLT structures inherently possess excellent fire-resistance due to the thick cross-sections of the components which char at a slow and predictable rate when exposed to fire. When traditional adhesives were used to laminate and glue the CLT panels, the charring rate was discovered to be the same as for solid timber and Glulam members. The manner in which CLT construction panels are manufactured typically achieves fewer air voids within the wall and floor assemblies. This also assists in reducing the risk of fire spreading throughout the structure (Pavlyukovskiy, 2012).

## Structural attributes of CLT

Building codes related to structural timber components were identified as a barrier to CLT adoption. Although timber cannot match modern high-strength concrete in compression, its strength parallel to the grain is very similar to that of reinforced concrete. For the same structural volume and capacity, the weight of timber represents only 20% of the weight of concrete. Lighter structural frames allow high-rise buildings to double in height while adding only 10% of the weight (Gosselin *et al.*, 2016). The orthogonal configuration in which CLT elements are produced, results in adjacent layers acting as reinforcement, adding dimensional stability and load carrying capabilities uni-directionally (Mallo & Espinoza, 2015). Working stresses are low due to the reinforcement effects provided by the cross-laminations and large cross-sections which also increase the splitting resistance of the CLT elements (Structural Timber Association, 2015). The mechanical properties of CLT enable a reduction in structural cost and time compared to analogous structures made from steel and reinforced concrete (Vilguts, Mieriņš & Serdjūks, 2014). The structural benefits of CLT construction are that: CLT wall components possess high axial load capacity due to the bearing area of loadbearing elements; they have high in-plane shear strength walls to resist horizontal loads, and they have intrinsic fire resistance due to their large size of the sections. During fire exposure, a charred layer forms on the surface of the CLT, which insulates the remaining CLT section, which in turn reduces the entry of oxygen and heat to the core, enabling the component to retain its loadbearing capacity, thus significantly delaying further surface spread of flames (Structural Timber Association, 2015).



## The demand for CLT

Most of the global excitement regarding CLT focuses on the construction of tall buildings whereas the majority of the CLT produced is destined for the small to medium multi-residential, public and industrial structures (Muszynski *et al.*, 2017). As noted in a research study conducted by Mallo and Espinoza (2015), the potential adopter's perception of the attributes of CLT determines the rate of diffusion, thus highlighting the importance of perceptions in the understanding and analysis of the potential adoption of a new technology. The study further indicates that the willingness to adopt CLT construction systems is positively correlated with the familiarity of the system and product and that the successful adoption of CLT construction systems is largely dependent on the information regarding the benefits of the product reaching the target audience. To increase the awareness and knowledge of CLT, it is imperative that South African statutory councils and institutional bodies distribute sufficient information and knowledge to their affiliated members. This increase in knowledge will provide industry participants with the confidence to specify CLT construction systems, increase exposure to the product and ultimately generate a higher demand for CLT construction within South Africa. According to Gosselin *et al.* (2016), the top five aspects mentioned in the motivation for the adoption of wood as a structural material selected were sustainability, the technical aspects, cost, erection speed, and aesthetics respectively. These aspects alone, once observed by industry participants, will increase the demand for CLT construction within South Africa.

## RESEARCH

### Research method and sample stratum

A qualitative approach was adopted to address the problem statement and consider the numerous variables that affect the adoption of CLT within the local industry. Insights into the problem statement were supplied by the following stakeholder groups: architects; CLT construction specialists; investors, and structural engineers. The sample was carefully selected for their knowledge of CLT construction within their individual disciplines and fields, all of whom had prior experience and knowledge of either designing with, investing in, manufacturing, or constructing with CLT construction methods. The interviewees included participants who were based in various geographical locations, namely an Italian architect; an Italian structural engineer; an Italian CLT investor in South Africa; a Czech Republican CLT project coordinator; a South African CLT specialist, and a South African CLT manufacturer. An interview protocol was used to facilitate the interviews conducted face-to-face, or telephonically, or in a self-administered manner facilitated by e-mail. In the case of face-to-face or telephonic interviews, a dictaphone was used to record the conversations.

### CLT knowledge and awareness

Most of the interviewees identified the sources of information contributing to their wealth of knowledge of CLT construction and, similarly, its benefits. Of the interviewees, 33% indicated that their basic knowledge of CLT and its characteristics originated from their tertiary education curriculum (international) and a more in-depth understanding was gained through experience of design with the timber construction system. An additional 50% did not mention tertiary education institutions as their primary source of CLT knowledge, but rather, their experience gained by designing, constructing, and working with CLT as a product throughout their careers as architects and construction project managers as well as through personal research. The remaining 17% claimed that they acquired their CLT knowledge mostly through specifying the product for projects and researching the characteristics and properties of the product as a part of their vocation. Considering the data obtained, it can be deduced that the more knowledge and experience that industry participants gain through their tertiary education degrees and working with CLT construction systems, the higher the adoption rates of CLT construction within that specific geographical region. This leads to a greater likelihood that they would gain the confidence and understanding required regarding the properties and characteristics product. It was discovered that the level of awareness and knowledge of CLT construction is low, and although knowledge and information is insufficiently distributed among local construction and design institutes, if any industry participants are actively looking for alternative building solutions, online sources would greatly assist them. For the South African construction industry to embrace the adoption of new technological advancements in building, industry participants must firstly be aware of these advancements, and secondly, possess adequate knowledge of these products and methods to sufficiently drive the adoption thereof and confidently specify these systems.

## CLT specification

An adequate level of knowledge required to provide the architect or structural engineer with the confidence to specify an unknown material relies on exposure to sufficient information and knowledge as well as exposure to projects constructed with CLT construction systems. For architects and structural engineers to be comfortable and willing to specify this alternative construction system, they require the knowledge and information related to its components and elements. Multiple interviewees highlighted that the perception of timber greatly affects the willingness to specify CLT construction systems as without adequate knowledge and exposure to this construction system, the likelihood of specifying it is low. It was also emphasised that a CLT construction system is not suited to every project and client. The historically poor timber culture within South Africa was also identified as a major issue regarding the reluctance to specify CLT as an alternative sustainable construction material. Timber is perceived to be of inferior quality when compared to conventional reinforced concrete, steel, and masonry construction. This again relates to a lack of understanding CLT as a structural building material and system. A third issue identified for the non-specification of CLT is that there is a limited number of architects and engineers in South Africa who possess the required training and experience necessary to design buildings that utilise mass timber construction. Three of the additional factors identified that could possibly delay the adoption and specification of CLT construction within South Africa are the cost of the required design software, technical approvals, and building codes.

### Structural knowledge of CLT

South Africa's historically poor timber culture plays a major role in terms of the perceptions of the structural performance of timber construction locally. This notion was labelled as a barrier to the adoption of CLT construction within South Africa. The strength of timber parallel to the grain is similar to that of reinforced concrete, and its flexibility cannot be matched by reinforced concrete. As a construction material, timber's density is lower than that of conventional structural materials such as reinforced concrete, masonry, and steel, which are efficient for long spans or tall structures. The lightweight frame of a timber structure permits reduced use of concrete in the foundations, which results in reduced project costs. Without the knowledge of the design potential of CLT, the structural elements become oversized, or include excessive amounts of steel connections, which increase the costs and deter the client from selecting a CLT construction system. It was noted that the strength of a CLT structure relies on the successful design and precision of the steel connections that attach adjoining CLT components. This is confirmed by Brander *et al.* (2016), who state that the performance of solid timber structures utilising CLT depend primarily on the applied connections because of the high level of stiffness and bearing resistance of the CLT. The general consensus of the interviewees was that the local industry is ill-equipped in terms of the skills and expertise necessary to drive the adoption of CLT construction systems. This notion could be attributed to the South African institutional bodies being identified as the source of CLT knowledge and who disseminate the least information regarding CLT as a product and construction system. This could be directly linked to the low demand and specification of CLT.

### Demand for CLT

It was emphasised that to increase the demand for CLT construction systems in South Africa, there is a dire need for basic knowledge of the product to be nurtured at tertiary built environment education institutions. There is a negative stigma attached to timber construction in South Africa as it is perceived to be of inferior quality compared with conventional construction materials such as reinforced concrete, steel, and masonry. By implementing a basic knowledge of CLT at a tertiary education level, it will increase the level of awareness of future industry participants, which in turn is likely to lead to an increase in the demand for CLT construction in South Africa once the negative perceptions of timber construction have dissipated. Forward-thinking developers must become familiar with and aware of benefits of CLT regarding decreased construction duration, reduced environmental impact, improved construction site health and safety, and a high return on investment to drive the adoption of CLT, thus increasing its exposure and ultimately increasing the demand therefore. The market sector identified as the most probable sector to embrace CLT construction systems due to its feasibility and return on investment is the commercial sector of the construction market. The demand for CLT construction systems is directly linked to the awareness, knowledge, and perception of the material as an alternative construction system to conventional construction methods. Once local industry participants obtain the required information and knowledge regarding the characteristics and properties of CLT, and they gain experience with CLT design, architects and structural engineers will possess the requisite skills to efficiently design CLT structures, increasing their feasibility, viability, and demand. The global climate crisis was also identified by both the literature reviewed and the interviewees to play a major role in the adoption of CLT as a sustainable alternative to conventional

construction materials. The approval and inclusion of CLT as a structural building material and construction system within the SANS documents, national building codes, and building regulations, removes barriers pertaining to construction material standards and regulations.

### **Exposure to CLT**

Currently, efforts are underway to gain greater exposure for CLT construction within South Africa by constructing a CLT structure on a university campus in South Africa. Due to the location of the structure and the associated high traffic, it is estimated that this would spark interest and achieve incomparable exposure. It was discovered that the local industry lacks exposure to CLT structures from a design and construction perspective, as well as the assistance required to drive the growth of knowledge and exposure to CLT structural design. The underlying reason for this issue is attributed to a historically poor timber culture within South Africa. The limited number of architects and engineers trained in mass timber construction within South Africa was again identified as a major barrier to specifying CLT construction systems and thus increasing exposure thereto. The finding that South African institutional bodies provided the least information regarding CLT as a product and construction system, is notable. This finding is cause for concern, as the local industry participants responsible for specifying structural materials and incorporating selected materials within designs are represented by these institutions.

### **Perceptions relative to CLT**

The overarching opinion obtained from the interviews is that timber construction, especially medium to large structures, is generally viewed as inferior to structures constructed using conventional building materials such as reinforced concrete and steel. The general perception regarding the structural characteristics and properties of CLT was refuted by the interviewees, as they stated that no CLT projects they had been involved with had ever had structural issues. The structural performance and versatility of CLT was proclaimed to allow designers to design numerous variations that do not limit design as much as people perceive. As CLT is an engineered timber product, the fire performance and fire resistance of the product were identified as a concern, and a barrier to the adoption of CLT construction systems. Interviewees did not exhibit any concern that the fire safety of CLT would constitute a barrier once the industry participants and the general public are more informed in this regard. It was noted that when CLT is exposed to direct fire, the natural reaction of the wood is the charring of the outer surface which preserves the inner structural core. Another acknowledged perception refers to the cost of CLT construction systems. The initial cost of a CLT construction system was found to range between 10% - 20% higher than conventional structural construction materials. The greater initial cost of CLT could usually be offset by savings from other aspects of the construction. The reduction in the weight of the structure when utilising CLT allows for smaller foundations and therefore, cost savings in terms of the required volume of concrete needed in the foundations. The financial benefits arising from constructing with CLT systems was further confirmed; thus reiterating the necessity to fully understand the design, the properties and the characteristics of CLT when designing with it. If the designers are not adequately experienced and knowledgeable, the structure will be over-designed resulting in excessive costs. The design of the structure must be optimised to achieve efficiency as complex designs could exert a major impact of up to 20% on the overall cost.

### **CONCLUSIONS**

Utilising CLT construction systems can result in a zero-carbon structure and assist in the fight against climate change by reducing the carbon footprint of the industry. Use of CLT is an environmentally friendly alternative that possesses very similar structural characteristics to conventional construction materials while mitigating negative environmental impacts. The infancy of CLT as a construction material and system within South Africa is due to the low awareness and knowledge possessed by the local AEC industry, which would enable them to specify and achieve the benefits of this construction system. Although the initial costs of utilising CLT construction systems are slightly higher than those of conventional structural materials and methods, the operational costs such as heating, ventilation, and air conditioning (HVAC) systems are reduced due to the thermal properties of the material and its biophilic nature. On-site productivity is improved because of the CLT elements being prefabricated at a manufacturing plant. The benefits of off-site manufacturing are further demonstrated by the precision and accuracy of the CLT elements which ensure a quality final product after the rapid erection of the structure.

The road to embracing the benefits of CLT is currently fraught with delays regarding approvals and inclusions in SANS documents, national building codes, and building regulations. Additional barriers exist in the form of negative perceptions and a historically poor timber culture in South Africa. Specification of and demand for this alternative construction material and system will increase as its knowledge and awareness increases.

### **RECOMMENDATIONS**

The limited adoption of CLT construction systems within South Africa is a multi-faceted issue that includes action requirements from multiple stakeholders. Drawing from the research conducted, the greatest issue facing the adoption of CLT construction systems in South Africa is the low level of awareness and knowledge regarding the product. If the local AEC industry is not aware of CLT and its benefits or does not obtain the knowledge and skills required to confidently specify CLT construction systems, the growth of this sustainable alternative construction system will stagnate, which will prevent large-scale adoption. To address this lack of awareness and knowledge at its origin, it is imperative that tertiary education institutions in South Africa implement CLT related modules within their curricula such as those for materials and methods for construction programmes, quantities / production analysis for quantity surveying programmes, and design for the architectural and structural engineering programmes. If not, this will create a void in the knowledge and understanding of the product once graduates enter the industry and may ultimately result in a further delay of the adoption of CLT construction in South Africa.

CLT manufacturers must drive demand through publicising information and knowledge to the general public as well as institutional bodies and statutory councils that represent the local AEC industry participants. Otherwise, the beliefs and perceptions of industry participants and end consumer of timber construction will not change and will further delay the adoption of CLT as a sustainable and alternative construction material within South Africa. In addition, carpentry skills programmes must be initiated to enable the local workforce to be trained, upskilled, and gain adequate experience to erect CLT structures accurately and safely. To accelerate the adoption and remove the 'red tape' of utilising CLT construction systems, SANS documents, national building regulations, and building codes need to approve and include CLT as a product and construction material.

## LIST OF REFERENCES

- American National Standards Institute. 2018. *ANSI/APA PRG 320-2018: Standard for Performance-Rated Cross-Laminated Timber*. Tacoma, WA: APA - The Engineered Wood Association.
- Ampofo-Anti, N. 2009. Environmental impacts of construction materials use: a life cycle perspective. In: *Green Building Handbook South Africa, Volume 1: A guide to ecological design*, Pretoria: Council for Scientific and Industrial Research (CSIR) Built Environment, pp. 1-9.
- Ampofo-Anti, N.L., Dumani, N. & Van Wyk, L. 2015. *Potential for reducing greenhouse gas emissions in the South African construction sector DBSA Green Fund Research and Policy Development to advance a green economy in South Africa*. Pretoria: Council for Scientific and Industrial Research (CSIR) Built Environment.
- Brandner, R., Flatscher, G., Ringhofer, A., Schickhofer, G. & Thiel, A. 2016. Cross laminated timber (CLT): overview and development. *European Journal of Wood and Wood Products*, 74(3):331-351.
- Buchanan, A. H., Dunn, A., O'neill, J. & Pau, D. 2018. Fire Safety of CLT Buildings in New Zealand and Australia. *Wood and Fiber Science*, 50:96-101.
- Construction Industry Development Board (cidb). 2011. Industry susses out sustainability tools. *cidb Concrete*. [Online] [www.cidb.org.za/News/Newsletters1/Concrete%20Issue%2011.pdf](http://www.cidb.org.za/News/Newsletters1/Concrete%20Issue%2011.pdf) [Accessed: 22 June 2019].
- Crafford, P.L., Blumentritt, M. & Brand Wessels, C. 2017. The potential of South African timber products to reduce the environmental impact of buildings. *South African Journal of Science*, 113(9-10):1-8.
- Crespell, P. & Gagnon, S. 2018. *Cross-laminated timber: a primer*. Vancouver / Quebec City, Canada: FP Innovations. [Online] [www.tboake.com/2018/CLT%20primer.pdf](http://www.tboake.com/2018/CLT%20primer.pdf) [Accessed: 18 July 2019].
- Department of Environmental Affairs. 2018. *South Africa's low-emission development strategy 2050*. Pretoria: Department of Environmental Affairs.
- Diston, J. 2018. *House of Commons Environmental Audit Select Committee – CIOB submission*. Bracknell: Chartered Institute of Building.
- Gosselin, A., Blanchet, P., Lehoux, N. & Cimon, Y. 2016. Main motivations and barriers for using wood in multi-story and non-residential construction projects. *Bio Resources*, 12(1):546-570.
- Hyams, A., Watts, S. & Harvatt, C. 2019. Cost Model: Residential Timber. *Building Magazine*, pp.1-6. [Online] [http://waughthistleton.com/media/press/1706\\_CLT\\_Cost\\_model\\_Residential\\_timber\\_Magazine\\_Features\\_Building.pdf](http://waughthistleton.com/media/press/1706_CLT_Cost_model_Residential_timber_Magazine_Features_Building.pdf) [Accessed: 27 August 2019].
- Karacabeyli, E. & Douglas, B. 2013. *CLT: Handbook cross-laminated timber*. Vancouver: FP Innovations.
- Lehmann, S. 2012. Sustainable construction for urban infill development using engineered massive wood panel systems. *Sustainability*, 4(10):2707-2742.
- Lindholm, J. & Reiterer, S.M. 2017. *Marketing innovative products in a conservative industry: a look at cross-laminated timber*. Unpublished Masters General Management. Jönköping, Sweden: Jönköping University.
- Mallo, M.F.L. & Espinoza, O. 2015. Awareness, perceptions and willingness to adopt cross-laminated timber by the architecture community in the United States. *Journal of Cleaner Production*, 94:198-210.
- Muszynski, L., Hansen, E., Fernando, S., Schwarzmann, G. & Rainer, J. 2017. Insights into the global cross-laminated timber industry. *Bio Products Business*, 52(5): 77-92.
- Pavlyukovskiy, A. 2012. *Using Cross Laminated Timber in Russia*. Double Degree Programme in Civil and Construction Engineering, Unpublished Bachelors Thesis, Lappeenranta, Finland: Saimaa University of Applied Sciences.
- Skullestad, J.L., Bohne, R.A. & Lohne, J. 2016. High-rise timber buildings as a climate change mitigation measure—a comparative LCA of structural system alternatives. *Energy Procedia*, 96:112-123.
- Smyth, M. 2018. *A study of the viability of cross laminated timber for residential construction*. Unpublished Masters, Stockholm: KTH Royal Institute of Technology.
- Structural Timber Association. 2015. *11 Structural Engineering Bulletin: cross-laminated timber construction - an introduction*. Alfoa: Structural Timber Association.
- Vilguts, A., Mieriņš, I. & Serdjuks, D. 2014. Design methodology analysis of cross-laminated timber elements subjected to flexure. *Journal of Sustainable Architecture and Civil Engineering*, 9(4):50-58.

# SYNTHESIS OF A NOVEL HETEROGENEOUS BASIC CATALYST FOR PRODUCTION OF BIODIESEL FROM WASTE OIL

Leshoboro Molapo, Tshwane University of Technology (TUT), South Africa, kkmmbaya@gmail.com  
Amos Adeniyi, Tshwane University of Technology (TUT), South Africa, AdeniyiA@tut.ac.za  
Richard Mbaya, Tshwane University of Technology (TUT), South Africa, MbayaR@tut.ac.za  
Andries Kolesnikov, Tshwane University of Technology (TUT), South Africa, KolesnikovA@tut.ac.za

## Abstract

In this work, a novel heterogeneous catalyst was synthesised using calcined magnesium aluminide (Mg/Al) hydrotalcite impregnated with potassium fluoride (KF) and used for the production of biodiesel from waste oil. The Mg/Al hydrotalcite was impregnated with KF in order to improve the morphology of the synthesised catalysts. The catalyst was characterised using Fourier transform infrared spectroscopy (FTIR), X-ray diffraction (XRD), energy dispersive spectroscopy (EDS), scan electron microscopy (SEM), Brunauer–Emmett–Teller (BET), as well as nitrogen ( $N_2$ ) adsorption and desorption techniques. The catalyst showed a high crystallinity and was found to have a pore volume and a pore diameter of  $0.72 \text{ cm}^3/\text{g}$  and  $17.73 \text{ nm}$  respectively. The enclosed space of adsorption/desorption branches was at relatively high  $P/P_0 = 0.76$ , which could be ascribed to the existence of a mesoporous structure. The transesterification of waste cooking oil was achieved through the use of the catalyst for the production of biodiesel. The biodiesel yield was 80%. This occurred at a reaction temperature of  $62 \text{ }^\circ\text{C}$ , while the effective catalyst amount was 2.5 wt% for a feed molar ratio of methanol to waste oil at 9:1.

**Keywords:** biodiesel, catalysis, heterogeneous catalyst, Mg/Al hydrotalcite, waste oil.

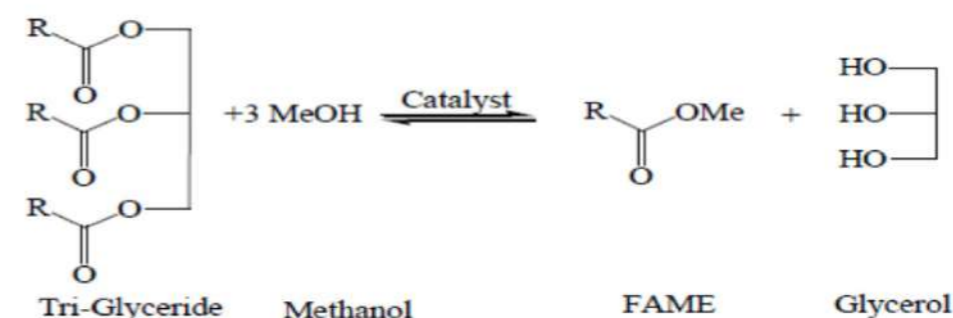
## INTRODUCTION

The demand for vitality derived from bio-renewable resources is ever-increasing due to the unpredictability of oil prices and escalating worries concerning climate change, security and energy (Owusu & Asumadu-Sarkodie, 2016). A clean-burning fuel called biodiesel can be derived from vegetable oil, from animal fat – which is obtained from renewable feedstock – or from recycled greases obtained from the food industry (Alptekin *et al.*, 2014). Not only is biodiesel biodegradable, non-inflammable and non-toxic, but its usage generates less sulphur dioxide, less carbon monoxide, and fewer unburned hydrocarbons than the petroleum-based alternative (Kralova & Sjöblom, 2010). Biodiesel has turned out to be hugely attractive because it is eco-friendly and is generated from renewable resources (Lai, 2014). Moreover, from an energy efficiency point of view, biodiesel has significant advantages over conventional diesel (Hill *et al.*, 2006). Therefore, exploring biodiesel production methods is an attractive and worthwhile proposition.

As bio-energy, biodiesel is almost carbon-neutral, meaning that the carbon dioxide ( $\text{CO}_2$ ) produced during combustion will be absorbed naturally together with the  $\text{CO}_2$  in the air, thereby recycling it and avoiding an overall net increase in the atmospheric carbon dioxide  $\text{CO}_2$  inventory. This results in an almost 0% contribution towards global warming (Cao, 2008). An important operational advantage of biodiesel is that it can be utilised directly in the majority of diesel engines without necessitating any extensive modifications (Ali & Semwal, 2014).

Biodiesel comprises a mixture of alkyl esters and fatty acids. Normally, such mixtures of methyl or ethyl esters are produced from a transesterification reaction in the presence of a catalyst, engaging triglyceride esters (vegetable oil, animal fat or waste cooking oil) and alcohol (methanol or ethanol), with glycerol as the main by-product (Lai, 2014). As the word suggests, transesterification is a reaction whereby one ester is converted into a different ester. Vegetable oils are triglyceride esters, which means that three ester molecules are bound to one glycerol molecule. During transesterification, triglycerides are split and the glycerol is removed from the triglyceride replaced by an alkyl radical from the individual alcohol used (Canakci *et al.*, 2009).

In the conventional batch process, the transesterification reaction takes place as illustrated in Figure 1.



**Figure 1:** The transesterification process reaction (Hossain *et al.*, 2008).

The reaction occurs in the presence of a homogeneous catalyst. Depending on the process, this catalyst could either be sodium (Na) or potassium hydroxide (KOH) as the basic version, and/or sulphuric acid ( $\text{H}_2\text{SO}_4$ ) as the acidic version (Thangaraj *et al.*, 2019). There are many methods or processes being researched or utilised for biodiesel production. These processes include pyrolysis, dilution and transesterification reaction (Grebermarian and Marchetti, 2017). Transesterification is a viable method for producing biodiesel (Nasreen *et al.*, 2018). Current industrial practice is for biodiesel to be manufactured mostly by homogeneous catalysed transesterification of animal fats or vegetable oil with KOH or sodium hydroxide (NaOH) as basic catalysts (Georgogianni *et al.*, 2009). Under a mild reacting condition, homogeneous base catalysts have a quick reaction rate. However, it is very difficult to eliminate or separate them from the products or from the reaction mixture. In addition, a large amount of water is required to wash them off the biodiesel (Dias *et al.*, 2008). The washing process is also responsible for the waste products of saponification and the formation of stable emulsion. Additionally, homogeneous catalysts are difficult to separate from the glycerol generated as a by-product, thus rendering its use for other downstream products as difficult or nearly impossible (Nasreen *et al.*, 2018; Komers *et al.*, 2001; Xie *et al.*, 2006a). Therefore, the substitution of liquid homogeneous catalysts with solid heterogeneous catalysts is a much better process for the production of biodiesel in a more feasible and economic way. An advantage of heterogeneous acidic or basic catalysts is the fact that they are environmentally benign, noncorrosive and present fewer disposal problems. They can be selective in that they can be designed to be more active, and they are far easier to separate from liquid products. They also have long catalytic lifetimes (Védrine, 2017).

A large number of heterogeneous catalysts of different types have been investigated for the transesterification of vegetable oils and animal fat to biodiesel over the past decade. These include alkaline earth metal oxides, rehydrated hydrotalcite, and different alkali metal compounds supported on alumina or zeolites (Xie *et al.*, 2006b). Due to the varied compositions and special structural properties of hydrotalcite, they are broadly applied for catalysis and adsorption (Ríos *et al.*, 2016), which is formed by oxide precipitation in the presence of carbonates and alkali hydroxide (Díez *et al.*, 2003) or alkali-free co-precipitation (Cantrell *et al.*, 2005). In addition, hydrotalcites appear to have gained significant attention in previous years as transesterification catalysts for biodiesel synthesis (Helwani *et al.*, 2009). Owing to the significant weaknesses and drawbacks of homogeneous catalysts – such as high cost, unsuitability for reuse, a complicated separation downstream process and unwanted soap formation – most recent publications and patents for the biodiesel production have involved a continuous process and a heterogeneous catalyst. Hence, in this work, Mg/Al hydrotalcites were synthesised and tested for the production of biodiesel. The significance of this study is that a new heterogeneous catalyst was synthesised to facilitate biodiesel production. This can serve as an alternative fuel source for most countries globally.

## MATERIALS AND METHOD

### Hydrotalcite catalyst synthesis

The hydrotalcite catalyst used in this work was formulated and synthesised using a co-precipitation method involving an aqueous solution that contained magnesium nitrate ( $\text{Mg}(\text{NO}_3)_2 \cdot 6\text{H}_2\text{O}$ ) and aluminium nitrate ( $\text{Al}(\text{NO}_3)_3 \cdot 9\text{H}_2\text{O}$ ). It was heated and stirred at a temperature of  $70^\circ\text{C}$ . The other solution was prepared to contain  $\text{Na}_2\text{CO}_3$  and was also heated to a temperature of  $70^\circ\text{C}$ . The two solutions were mixed together at the same temperature and stirred for 3 hours. The precipitated solution, which was between a pH level of 8 and 10, was cooled and washed several times until the pH level was between 7 and 8. The whitewashed sample (Mg/Al hydrotalcite) was desiccated in an oven at the temperature of  $110^\circ\text{C}$  for a period of 12 hours. The dried sample was calcined at different temperatures of  $450^\circ\text{C}$ ,  $550^\circ\text{C}$ ,  $600^\circ\text{C}$  and  $650^\circ\text{C}$ . The calcined Mg/Al hydrotalcite was tested to produce biodiesel, with the one calcined at  $550^\circ\text{C}$  being found to produce a better yield. Therefore, the Mg/Al hydrotalcite calcined at  $550^\circ\text{C}$  was the one chosen for further processing. Moreover, in order to improve the catalytic activity of the calcined Mg/Al hydrotalcite catalysts, the process of impregnation with metal halides (KF) was introduced. The calcined catalyst was impregnated with the KF solution. The white precipitate was then dried at  $65^\circ\text{C}$  overnight to obtain the catalyst, and was stored in a container.

The synthesised catalyst was characterized by the use of FTIR, XRD, EDS, SEM, BET, as well as  $\text{N}_2$  adsorption and desorption techniques (Huang *et al.*, 2009; Juárez *et al.*, 2017; Adeniyi *et al.*, 2019).

### Waste cooking oil

The waste cooking oil utilised in this research was collected from the Tshwane University of Technology cafeteria. Solid materials in the waste cooking oil were removed by filtration, with the remaining waste cooking oil ready for use in the production of biodiesel.

### Transesterification process

The hydrotalcite catalyst was tested by performing transesterification experiments in the 2L autoclave reactor. The autoclave reactor was equipped with a temperature and pressure controller and stirrer. The reactions took place under specific reaction conditions, which involved a methanol/oil ratio of 9:1, catalyst weight amount of 0.5 wt% to 6.5 wt%, reaction temperatures of between  $50^\circ\text{C}$  and  $74^\circ\text{C}$  and a transesterification reaction time of between 1.5 hours and 6.5 hours.

When the reaction was complete, the reactor was cooled to room temperature and the catalyst was recovered from the product mixer by means of filtration. The phase separation after filtering the catalysts out was comprised of methyl ester (biodiesel) at the top and glycerol at the bottom.

The two mixtures were separated. The biodiesel was analysed by gas chromatography, using a Varian CP 3800. The biodiesel yield – or fatty acid methyl ester (FAME) – in each experiment was calculated within the composition as analysed by gas chromatography. The ratio of the weight of the FAME, as determined by gas chromatography, to the weight of the entire production gives the yield. The following equation was used for calculating the volume yield and the FAME yield:

$$\text{volume yield \%} = \left( \frac{\text{volume of product}}{\text{volume of oil fed}} \right) \times 100 \quad (1)$$

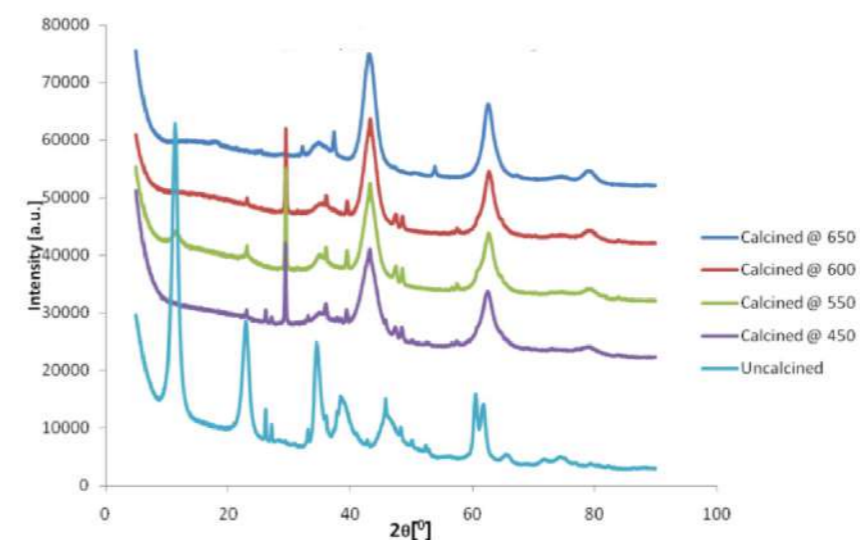
$$\text{Biodiesel yield (\%)} = (1) \times \text{FAME \%} \quad (2)$$

## RESULTS AND DISCUSSION

### Characterisation of the synthesised heterogeneous catalyst

The XRD result is as shown in Figure 2. The pattern assigned for diffraction peaks is due to  $\text{Mg}^{2+}$  and  $\text{Al}^{3+}$  that appeared for the uncalcined catalyst. For the calcined catalyst, the diffraction peaks disappear and are only feasible at diffraction angles of 29, 43 and 62. This is due to the interlayer water and carbonates. For the uncalcined catalyst, the intensity peak

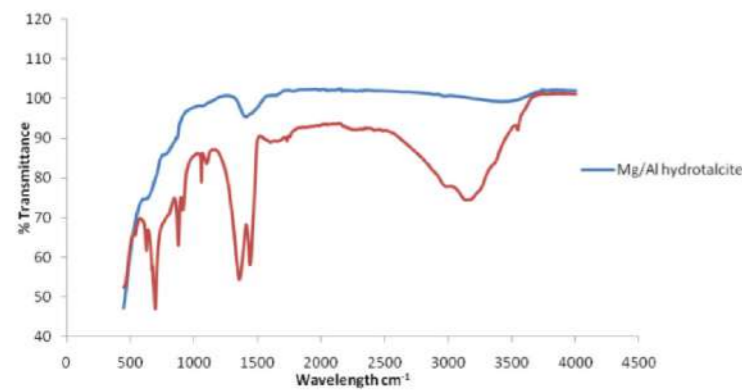
at a diffraction angle of 11 is well pronounced, which proves that the synthesised catalyst is a real hydrotalcite catalyst. The first intensity peak is formed between diffraction angles of 10 and 15. The other intensity peaks are formed at a diffraction angle of 22, corresponding to the basal plane. In addition, the intensity peak reflections on the diffraction angles between 29 and 65 are characteristic of hydrotalcite-like compounds.



**Figure 2:** The XRD plot shows the phase composition of both uncalcined and calcined catalyst. The calcination was done at various temperatures, ranging from  $450^\circ\text{C}$  to  $650^\circ\text{C}$  as shown. The results clearly indicate the presence of a crystalline phase in the materials.

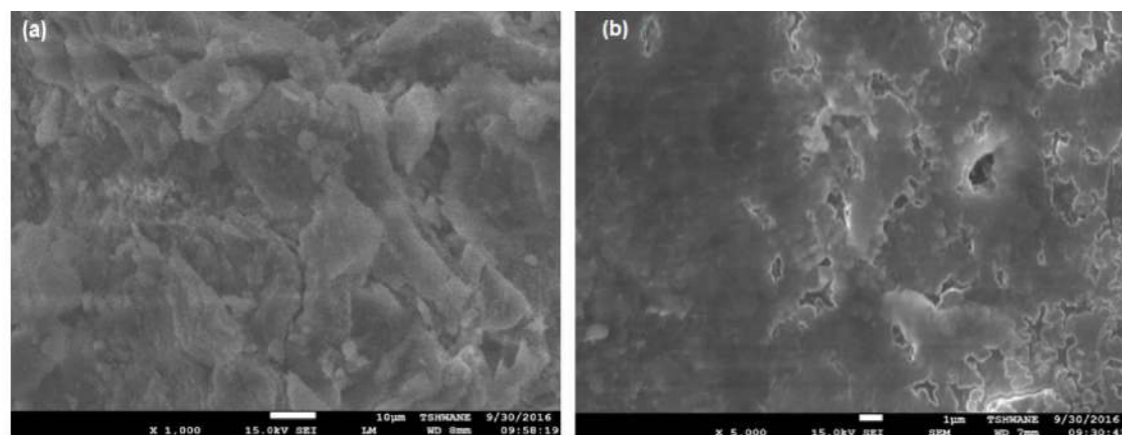
Figure 3 shows the FTIR results for the impregnated Mg/Al hydrotalcite catalysts, both uncalcined and calcined, at  $550^\circ\text{C}$ . For a calcined catalyst, the main absorption bands typically take place at  $1453\text{ cm}^{-1}$  and the other small bands were at  $665\text{ cm}^{-1}$ ,  $817\text{ cm}^{-1}$  and  $1125\text{ cm}^{-1}$ , which are attributed to asymmetric stretch (Engin *et al.*, 2006). The calcined catalysts in the study showed asymmetric and symmetric stretching vibrations that indicated a small band of carboxyl groups at  $703.87\text{ cm}^{-1}$ . The asymmetric and symmetric stretching vibrations may also be due to the pliable mode of water molecules. A broad band was visible at  $3174\text{ cm}^{-1}$  that may be the result of prolonged vibrations of the hydroxyl ions and hydroxyl groups of the intercalated water. In addition, due to the KF used, the catalyst was able to have a proper absorption band. This can also be seen in Figure 4b, which shows the SEM image of the impregnated catalysts.

The SEM has been widely used for the inspection of the morphology of catalyst surfaces (Lomić *et al.*, 2004) and was applied to examine the morphology of the catalyst synthesized in this work. The SEM images are as shown in Figure 4. The metal oxides were created to retain the flat structure of catalysts. The Mg/Al hydrotalcite has a  $\text{Mg}(\text{OH})_2$  brucite sheet, where  $\text{Al}^{3+}$  substitutes  $\text{Mg}^{2+}$  sites, which are distorted to become to periclase-like Mg-Al-O solid solutions when calcined at this temperature. The morphology suitable for the brucite sheet was preserved after calcination because it stays the same even if the temperature is being increased further. In addition, it also indicated that, through the heating of water, Mg/Al hydrotalcite and  $\text{CO}_2$  were unconfined by the creation of the mechanism rather than exfoliation, and so crystal morphology was maintained. The creation of hydrotalcite through thermal treatment was assigned to engage the substitution of the interlayer carbonate by hydroxyl group, with no extreme effect on the innovative order heaped structure of the combines (Xie *et al.*, 2006a). Furthermore, the Mg/Al hydrotalcite was impregnated with KF in order to improve the morphology of the catalysts. As can be seen in Figure 4b, the catalysts loaded with KF developed holes in the surface. These are particularly designed by metal halides to construct a great number of pores to serve as flow channels within the composition. This structure is very good at improving catalytic activity.



**Figure 3:** FTIR spectra of impregnated Mg/Al hydrotalcite (calcined at 550 °C and uncalcined) catalyst samples.

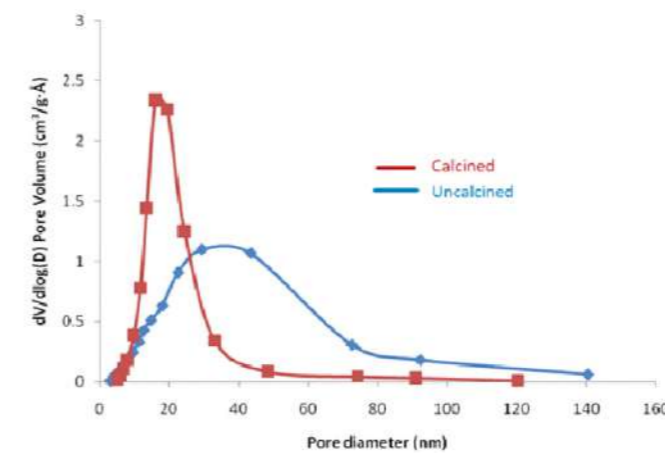
The BET surface area of the calcined catalyst is shown in Table 1 and conforms with the one in the literature (Casenave *et al.*, 2001). Thermal decomposition of hydrotalcite precursors escorted to the generation of a massive surface area, and resulted in an increase in the pore volume. The catalyst with a large surface area is used favourably in liquid phase reactions, which is advantageous because it can offer sufficient a large reaction area in the stirred reactor. Moreover, the creation of a large surface area is a significant characteristic required for catalysis. The increase in surface area during calcination at 550 °C can be attributed to the formation of a mesoporous structure owing to the expulsion of CO<sub>2</sub> and H<sub>2</sub>O from the hydrotalcite precursors (Corma *et al.*, 2005). The pore size distribution curvature of the calcined Mg/Al hydrotalcite was quite narrow, as shown in Figure 5, which indicated a mesoporous structure. Such mesoporous structures have played an important role for a metallic catalyst to prevent the agglomeration of the active phase through the restrained effect. This was also confirmed by the N<sub>2</sub> adsorption and desorption isotherms of the calcined sample, as shown in Figure 6.



**Figure 4:** (a) The SEM analysis of Mg/Al Catalyst calcined at 550 °C. (b) The SEM analysis of calcined Mg/Al hydrotalcite and impregnated with potassium fluoride (KF).

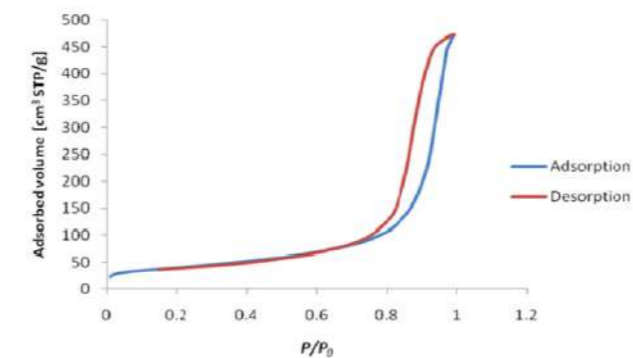
Table 1: BET data for calcined Mg/Al hydrotalcite catalyst and impregnated with KF.

Parameter	Value
Surface area	141.3451 m <sup>2</sup> /g
Pore volume	0.719143 cm <sup>3</sup> /g
Pore diameter	17.72665 nm

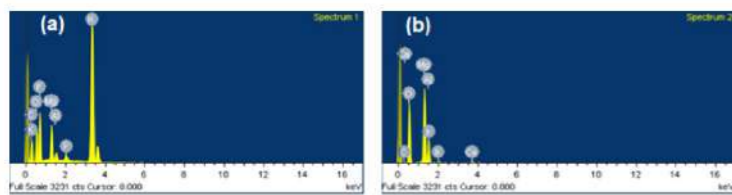


**Figure 5:** Pore size distribution curves of calcined and uncalcined Mg/Al hydrotalcite.

Figure 6 shows the adsorption and desorption isotherms, which reveal that the H3-type hysteresis with type IV sorption isotherm – at huge relative pressure – is exhibited for this catalyst, which is normal for the comprehensives of plate-like particles (Meloni *et al.*, 2008). At a relatively high P/P<sub>0</sub> of 0.76, the enclosed space of adsorption and desorption branches. This could be ascribed to the existence of a great mesoporous structure and/or some macropores. This sort of hysteresis is frequent for the proximity of open extensive pores, which authorises simple dispersion of the reactants in the course of the materials.



**Figure 6:** N<sub>2</sub> adsorption and desorption isotherms of calcined sample.

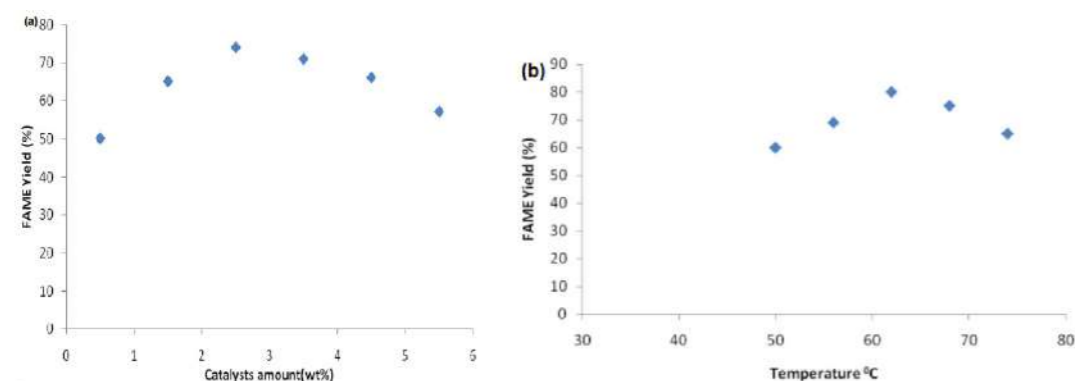


**Figure 7:** (a) The EDS spectrum of impregnated Mg/Al hydrotalcite. (b) The EDS spectrum of Mg/Al hydrotalcite calcined at 550°C.

EDS was used to measure the weight percentage of magnesium (Mg) and aluminium (Al) weight compositions. The results are shown in Figure 7. Mg was 28.55 wt% and Al was 11.04 wt%. This had happened even after calcination, which meant that Mg/Al hydrotalcite had formed properly. There were some traces of other elements in this catalyst, but the weight percentage could be negligible. The EDS was performed on the Mg/Al hydrotalcite, which was being impregnated with KF, thereby improving the catalytic activity and, hence, the performance of the catalyst. The result of the elemental analysis of prepared impregnated Mg/Al hydrotalcite showed that KF was 37 wt%. This indicated that the content of fluoride ions were relatively high, which promoted the catalytic activity of the catalysts by increasing the surface area – as was seen on the BET analysis.

#### Biodiesel production

The catalyst was tested for biodiesel production for the feed molar ratio of 9:1 for methanol and cooking oil respectively (Meng *et al.*, 2008). First, the optimum mass of the catalyst required was established as shown in Figure 8a. Consequently, the optimum reaction temperature was established as shown in Figure 8b.



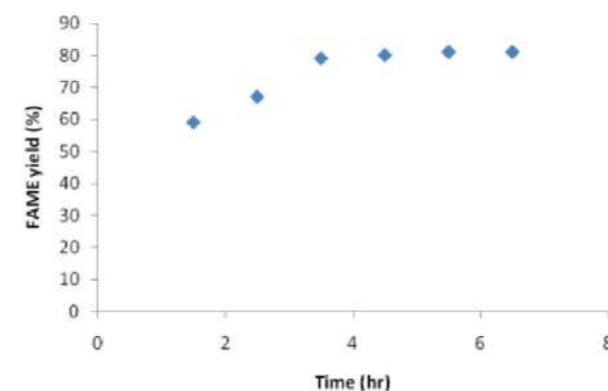
**Figure 8:** (a) The effect of catalysts amount on FAME yield. (b) The effect of temperature of the yield.

The effect of the catalyst amount on the production of biodiesel yield from waste cooking oil was investigated in this study. The catalyst amount was tested along a range from 0.5 wt% to 5.5 wt%. It was indicated that the conversion of biodiesel increased rapidly from 0.5 wt% to 2.5 wt% to produce 50% and 74% respectively. An inadequate catalyst amount resulted in fatty acid esters from an incomplete yield of the triglycerides (Leung and Guo, 2006). This was also due to the fact that catalytic activity was tremendously influenced by the number of catalyst sites. However, further increases in catalyst amounts diminished conversion gradually, which was a result of the mixing of the products, reactants and solid catalysts. Using the optimum catalyst weight percentage of 2.5 wt%, the effects of various reaction temperatures were investigated. The range of temperatures investigated fell between 50 °C and 74 °C. At a low temperature of 55 °C, the biodiesel yield was low at 60%. This proved that lower temperature resulted in less FAME conversion because fewer molecules could feasibly pass over the energy barrier (Obadiah *et al.*, 2012). It was also discovered that, when increasing the temperature, there was a reduction in the viscosity of the oil, which facilitated proper contact at the active site of the catalyst surface between the oil and the methanol (Leung and Guo, 2006). Moreover, the effect of temperature on the reaction rate can also be elaborated upon using the theory of chemical reaction kinetics. The increase in temperature will cause an upshot in the mounting

fraction of molecules that have a soaring speed and high kinetic rate (Awolu & Layokun, 2013). At the temperature of 55 °C, the yield was about 60%. This is due to the fact that methanolysis does not conduct well at low temperatures. When increasing the temperature towards the boiling point of methanol, the conversion increases rapidly because methanolysis takes place easily at these temperatures. At the temperature of 62 °C, the yield was found to be 80%, which is the highest (Xie *et al.*, 2006a). The boiling point of methanol is 64.7 °C, and to circumvent the evaporation of alcohol, reaction temperature was decreased. This was done due to the loss of some methanol at high temperatures (Wei *et al.*, 2009). It was also discovered that when the boiling point of methanol is surpassed by the reaction temperature, the methanol will vaporize and make a large number of bubbles, which serve to hold down the reaction on the three-phase interface (İlgen *et al.*, 2007).

Further experiments were carried out with a catalyst of 2.5 wt% and a reaction temperature of 62 °C. The effect of the reaction time on the yield of FAME is shown in Figure 9.

The effect of the reaction time, under the transesterification reaction for biodiesel production from waste cooking oil, was investigated. The reaction was highly dependent on reaction time, as revealed in Figure 9. The reaction was slow in the beginning, owing to the diffusion and mixing of methanol into oil (Liu and Wang, 2013). At 1.5 hours, the yield of biodiesel was found to be very small, which meant that the reaction was not yet complete. As more was given, there was a gradual increase in the biodiesel yield. At the 3.5 hours, the reaction had almost reached equilibrium. Therefore, the yield was at its highest at 80% and remained nearly constant at 6.5 hours. Moreover, a reduction in the product yield from increasing the reaction time further because of the backwards reaction had an impact on the conversion. This led to a loss of FAME, while also making more acids to form soaps (Agarwal *et al.*, 2012). Therefore, the optimum reaction in this study was found to be 3.5 hours.



**Figure 9:** The effect of reaction time on FAME yield.

#### CONCLUSION

Mg/Al hydrotalcite calcined, impregnated with KF, was successfully synthesised and used in the production of biodiesel through a transesterification reaction of waste cooking oil. The transesterification of waste cooking oil with methanol for the production of biodiesel, utilising Mg/Al hydrotalcite as heterogeneous catalysts in the batch reactor, was found to be effective. The yield increased with increases in temperature, but dropped as the temperature drew closer to the boiling point of methanol owing to evaporation of the some of the methanol in the reactor. The highest yield of 80% was achieved at a reaction temperature of 62 °C, with a catalyst weight percentage of 2.5 wt% for a feed molar ratio of 9:1 of methanol and waste oil respectively. The reaction increases with time, with the optimal time being 3.5 hours. It is recommended that the catalyst should be tried on a pilot scale to verify the laboratory study. The catalyst should be studied further for performance improvement.

#### ACKNOWLEDGEMENTS

The Council for Scientific and Industrial Research (CSIR) is acknowledged for providing facilities for the synthesis and for the experiment.

## LIST OF REFERENCES

- Adeniyi, A., Onyango, M. & Bopape, M. 2019. Impact of nodular structure in characterization of three thin film composite membranes made from 1, 2-benzisothiazol-3 (2H)-one, sodium salt. *Journal of Materials and Environmental Sciences*, 10:213-224.
- Agarwal, M., Chauhan, G., Chaurasia, S. & Singh, K. 2012. Study of catalytic behavior of KOH as homogeneous and heterogeneous catalyst for biodiesel production. *Journal of the Taiwan Institute of Chemical Engineers*, 43:89-94.
- Ali, J. & Semwal, A. 2014. Biodiesel as an alternative fuel for diesel engine: an overview. *International Journal of Applied Engineering, Research*, 9:1159-1168.
- Alptekin, E., Canakci, M. & Sanli, H. 2014. Biodiesel production from vegetable oil and waste animal fats in a pilot plant. *Waste Management*, 34:2146-2154.
- Awolu, O. O. & Layokun, S. K. 2013. Optimization of two-step transesterification production of biodiesel from neem (*Azadirachta indica*) oil. *International Journal of Energy and Environmental Engineering*, 4:39.
- Canakci, M., Ozsezen, A. N., Arcaklioglu, E. & Erdil, A. 2009. Prediction of performance and exhaust emissions of a diesel engine fueled with biodiesel produced from waste frying palm oil. *Expert systems with Applications*, 36:9268-9280.
- Cantrell, D. G., Gillie, L. J., Lee, A. F. & Wilson, K. 2005. Structure-reactivity correlations in MgAl hydrotalcite catalysts for biodiesel synthesis. *Applied Catalysis A: General*, 287:183-190.
- Cao, P. 2008. *A membrane reactor process for the production of biodiesel*. Doctoral dissertation. University of Ottawa (Canada).
- Casenave, S., Martinez, H., Guimon, C., Auroux, A., Hulea, V., Cordoneanu, A. & Dumitriu, E. 2001. Acid-base properties of Mg-Ni-Al mixed oxides using LDH as precursors. *Thermochimica Acta*, 379:85-93.
- Corma, A., Hamid, S. B. A., Iborra, S. & Velty, A. 2005. Lewis and Brønsted basic active sites on solid catalysts and their role in the synthesis of monoglycerides. *Journal of Catalysis*, 234:340-347.
- Dias, J. M., Alvim-Ferraz, M. C. & Almeida, M. F. 2008. Comparison of the performance of different homogeneous alkali catalysts during transesterification of waste and virgin oils and evaluation of biodiesel quality. *Fuel*, 87:3572-3578.
- Diez, V., Apesteguia, C. & Di Cosimo, J. 2003. Effect of the chemical composition on the catalytic performance of MgAlOx catalysts for alcohol elimination reactions. *Journal of Catalysis*, 215:220-233.
- Engin, B., Demirtaş, H. & Eken, M. 2006. Temperature effects on egg shells investigated by XRD, IR and ESR techniques. *Radiation physics and chemistry*, 75:268-277.
- Georgogianni, K., Katsoulidis, A., Pomonis, P., Manos, G. & Kontominas, M. 2009. Transesterification of rapeseed oil for the production of biodiesel using homogeneous and heterogeneous catalysis. *Fuel processing technology*, 90:1016-1022.
- Grebemariam, S. & Marchetti, J. M. 2017. *Biodiesel production technologies*. *AIMS Energy*, 5(3): 425-457. DOI: 10.3934/energy.2017.3.425
- Helwani, Z., Othman, M., Aziz, N., Fernando, W. & Kim, J. 2009. Technologies for production of biodiesel focusing on green catalytic techniques: a review. *Fuel Processing Technology*, 90:1502-1514.
- Hill, J., Nelson, E., Tilman, D., Polasky, S. & Tiffany, D. 2006. *Environmental, economic, and energetic costs and benefits of biodiesel and ethanol biofuels*. Proceedings of the National Academy of Sciences, 103:11206-11210.
- Hossain, A. S., Salleh, A., Boyce, A. N., Chowdhury, P. & Naqiuddin, M. 2008. Biodiesel fuel production from algae as renewable energy. *American Journal of Biochemistry and Biotechnology*, 4: 250-254.
- Huang, Z., Su, J. F., Guo, Y. H., Su, X.Q. & Teng, L. J. 2009. Synthesis of well-crystallized zeolite beta at large scale and its incorporation into polysulfone matrix for gas separation. *Chemical Engineering Communications*, 196:969-986.
- İlgen, O., Dincer, I., Yildiz, M., Alptekin, E., Boz, N., Canakci, M. & Akin, A. N. 2007. Investigation of biodiesel production from canola oil using Mg-Al hydrotalcite catalysts. *Turkish Journal of Chemistry*, 31:509-514.
- Juárez, L. A., Costero, A. M., Parra, M., Gaviña, P., Gil, S., Martínez-Máñez, R. & Sancenón, F. 2017. NO<sub>2</sub>-controlled cargo delivery from gated silica mesoporous nanoparticles. *Chemical Communications*, 53:585-588.
- Komers, K., Machek, J. & Stloukal, R. 2001. Biodiesel from rapeseed oil, methanol and KOH. 2. Composition of solution of KOH in methanol as reaction partner of oil. *European Journal of Lipid Science and Technology*, 103:359-362.
- Kralova, I. & Sjöblom, J. 2010. Biofuels—renewable energy sources: a review. *Journal of Dispersion Science and Technology*, 31:409-425.
- Lai, E. 2014. Biodiesel: environmental friendly alternative to petrodiesel. *Journal of Petroleum & Environmental Biotechnology*, 5:122.
- Leung, D. & Guo, Y. 2006. Transesterification of neat and used frying oil: optimization for biodiesel production. *Fuel Processing Technology*, 87:883-890.
- Liu, K. & Wang, R. 2013. Biodiesel production by transesterification of duck oil with methanol in the presence of alkali catalyst. *Petroleum & Coal*, 55(1), pp.68-72
- Lomić, G. A., Kiš, E. E., Bošković, G. C. & Marinković-Nedučin, R. P. 2004. Application of scanning electron microscopy in catalysis. *Acta Periodica Technologica* (35), 67-77.
- Meloni, D., Monaci, R., Solinas, V., Auroux, A. & Dumitriu, E. 2008. Characterisation of the active sites in mixed oxides derived from LDH precursors by physico-chemical and catalytic techniques. *Applied Catalysis A: General*, 350:86-95.
- Meng, X., Chen, G. & Wang, Y. 2008. Biodiesel production from waste cooking oil via alkali catalyst and its engine test. *Fuel processing technology*, 89:851-857.
- Nasreen, S., Nafees, M., Qureshi, L.A., Asad, M.S., Sadiq, A. & Ali, S.D. 2018. Review of catalytic transesterification methods for biodiesel production. *Biofuels: State of Development*, pp.93-119.
- Obadiah, A., Kannan, R., Ramasubbu, A. & Kumar, S. V. 2012. *Mg-Al hydrotalcite as solid base catalyst for biodiesel production from pongamia oil*. JSIR Vol. 71(02), 131-137.
- Owusu, P. A. & Asumadu-Sarkodie, S. 2016. A review of renewable energy sources, sustainability issues and climate change mitigation. *Cogent Engineering*, 3:1167990.
- Suppes, G. J., Dasari, M. A., Doskocil, E. J., Mankidy, P. J. & Goff, M. J. 2004. Transesterification of soybean oil with zeolite and metal catalysts. *Applied Catalysis A: General*, 257:213-223.
- Thangaraj, B., Solomon, P. R., Muniyandi, B., Ranganathan, S. & Lin, L. 2019. Catalysis in biodiesel production—a review. *Clean Energy*, 3:2-23.
- Védrine, J. C. 2017. Heterogeneous catalysis on metal oxides. *Catalysts*, 7: 341-365.
- ei, Z., Xu, C. & Li, B. 2009. Application of waste eggshell as low-cost solid catalyst for biodiesel production. *Bioresource technology*, 100:2883-2885.
- Xie, W., Peng, H. & Chen, L. 2006a. Calcined Mg-Al hydrotalcites as solid base catalysts for methanolysis of soybean oil. *Journal of Molecular Catalysis A: Chemical*, 246:24-32.
- Xie, W., Peng, H. & Chen, L. 2006b. Transesterification of soybean oil catalyzed by potassium loaded on alumina as a solid-base catalyst. *Applied Catalysis A: General*, 300:67-74.



# A NOVEL METHOD OF SILOXANE REMOVAL FROM BIOGAS PROCESS USING A FIXED BED DIGESTER

Victor Mhlanga, Tshwane University of Technology (TUT), South Africa, HlongwaneVT@tut.ac.za

Amos Adeniyi, Tshwane University of Technology (TUT), South Africa, AdeniyiA@tut.ac.za

Richard Mbaya, Tshwane University of Technology (TUT), South Africa, MbayaR@tut.ac.za

Lerato Tshabalala, Council for Scientific and Industrial Research (CSIR), South Africa, Ckgomari@gmail.com

## Abstract

*The overall purpose of this study was to quantify and evaluate the fate and removal performance of selected siloxane compounds derived from biogas. The work seeks to enhance the production of biogas (methane) through the optimisation of operating conditions by using a designed fixed-bed biodigester. A fixed-bed digester is an appropriate technology as it uses the skills and technology that are readily available in the locality for the treatment of biogas. The digester was fabricated and is applied for the investigation of the degradation of siloxane compounds at different bed heights, using natural zeolite as a bed. Siloxanes are inhibitory compounds that cause harm to the end-users of biogas such as boilers and generators, and must therefore be removed. The procedures included the measurement and adjustment of pH, the measurement and adjustment of the water bath temperature, feeding nutrients to the digesters, measuring the volume and composition of the biogas produced, determining the chemical oxygen demand (COD) and concentration of siloxanes. The results demonstrated that the absorption of ammonia by zeolite increases the lifespan of the microorganisms that are responsible for the degradation of siloxanes. In addition, the higher the bed height, the faster the degradation of siloxanes. The fixed-bed digester was found to be effective in the degradation of siloxanes.*

**Keywords:** siloxanes, fixed-bed, digester, zeolites, biogas.

## INTRODUCTION

The natural human environment is composed of various organic pollutants, including siloxanes found in municipal wastewater, fuel additives or antifoaming agents. These serve as a carcinogenic or mutagenic threat to human life, to living organisms, and to the environment (Baumgartner, Schauer, Ezzati, Lu, Cheng, Patz & Bautista, 2011; McLachlan & Ramzan, 2010). They are also found in cosmetics, hair products such as shampoo, paper coatings, and detergents such as soap (Sherwood, Clark, Farmer, Herrero-Davila & Moity, 2016). A variety of siloxane compounds of interest have been identified as contaminants in wastewater including octamethylcyclotetrasiloxane, hexamethylcyclopentasiloxane and decamethylcyclohexanesiloxane (Surita & Tansel, 2015). These have the capability of bioaccumulation and can act as inhibitors during biogas production. Their presence during biogas production in digesters has a negative impact, leading to a low biogas volume production.

Siloxanes are made up of a silicon–oxygen (Si–O) unit, and are both physically and chemically inert. They are resistant to oxidation, resistant to high temperatures, have low surface tension, are compressible, and are water repellent (De Arespacochaga, Valderrama, Raich-Montiu, Crest, Mehta & Cortina, 2015). Siloxanes are volatile compounds used in many industrial processes such as cosmetics manufacture, detergent manufacture and construction – whereby some of them are emitted and condensed to form wastewater sewage sludge (García-Gutiérrez, Jacquemin, McCrellis, Dimitriou, Taylor, Hardacre & Allen, 2016). Among the pollutants found in biogas, the volatile methyl siloxanes (VMSs) happen to have the most detrimental effect on biogas used for the production of energy. The VMSs found in biogas mainly result from the manufacture of building materials, cosmetics, detergents and textiles (Li, Zhang & Xu, 2014).

Silicones and siloxanes are divided into three categories, which are fluids (without cross-links), elastomers (rubbers) and resins (with cross-links) (De Arespacochaga *et al.*, 2015). These categories depend on the number of cross-links. They are used in both industrial and domestic applications. Examples include antifoaming agents, coating products for automotive care, cosmetics, textiles, personal care products such as shampoo, cosmetics, lotion, hair products, deodorants, antiperspirants and nail polishes, as well as sealants for the construction industry (Li *et al.*, 2014; Matsui & Imamura, 2010).

At low concentrations, siloxanes are not toxic to the aqueous organisms in aqueous media. However, when entering an aqueous environment, they will quickly degrade, evaporate or bind to organic-rich particulates. This limits their availability and toxicity to organisms. Liver and lung damage, endocrine disruption in laboratory animal studies, as well as disorders in connective tissues are all caused by cyclic siloxane involvement in adverse immunologic responses. Moreover, some of the damaging effects on hormone functions can lead to infertility (De Arespacochaga *et al.*, 2015).

Several Energy Conversion Systems (ECSs) for biogas energy valorisation are currently installed in wastewater treatment plants (WWTPs), including boilers, internal combustion engines, combustion turbines, micro-turbines, fuel cells and Stirling engines (De Arespacochaga *et al.*, 2015). During the combustion of digestion gas, siloxanes are converted into crystalline silica, which has similar chemical and physical properties to glass (Matsui & Imamura 2010). There is concern for the potential malfunction of equipment used for siloxane removal, which may lead to the accidental release of siloxanes into the natural gas supply system. When gas containing siloxanes is combusted through the use of home appliances such as stoves, water heaters and other appliances, it can cause harmful environmental emissions and deleterious effects on human health (Nair, Zhang, Gutierrez, Chen, Egolfopoulos & Tsotsis, 2012). During internal combustion, siloxanes decompose into silicone dioxide (SiO<sub>2</sub>) micro-particulates that pose a threat to the equipment unless adequate measures are taken to remove them from the exhaust (Nair *et al.*, 2012). The hardness of the micro-particulate residue leads to abrasion of the gas engine surfaces. It contributes to the overheating of sensitive motor parts, serving as a thermal insulator. It affects measurements in the burning chamber, depressing the function of spark plugs as electrical insulators (García-Gutiérrez *et al.*, 2016). In turbines, the silica ash is deposited onto the turbine blade and it damages the cooling system. These problems increase the maintenance cost (Matsui & Imamura, 2010). Although inadequate moisture and hydrogen sulphide removal can cause component corrosion issues, siloxanes have been identified as the most important contaminant for micro-turbines. The silica causes significant erosion of the turbine nozzle and bearings, resulting in turbine failure (De Arespacochaga *et al.*, 2015).

The treatment of siloxanes can be achieved through both biological and chemical processes. Industries use different techniques for the removal of siloxanes. These include adsorption, absorption, cryogenic condensation or condensation, membrane separation and biological degradation. Popat and Deshusses (2008) used biological treatment, such as anaerobic/aerobic biotrickling filtering, for the degradation or removal of siloxanes in wastewater. More than 30% removal was achieved. Anaerobic treatment of siloxane and the simultaneous production of biogas as a by-product has been previously investigated (Ajhar, Travesset, Yüce & Melin, 2010). The production of biogas from the sludge in sewage treatment (municipality wastewater) was investigated, since such sewage contains a large amount of greenhouse gas (methane). It was observed that the presence of siloxanes inhibits the production of methane gas as a by-product. Since these compounds have a relatively high half-life, they have a high contribution of COD in both effluent and influent (Surita & Tansel, 2014). During the degradation or oxidation process, the dissolved oxygen (DO) decreases and tends to affect the quality of the

receiving bodies. The energetic utilisation is compromised by the presence of volatile organic silicon compounds (VO-SiCs) such as siloxane. Nonetheless, the scientific community have determined that VOSiCs in biogas are produced by the degradation and/or volatilisation of organosilicon materials (Schweigkofler & Niessner, 1999).

With all these techniques reported, the most used technique is the removal of siloxanes by adsorption on activated carbon (De Arespachoga *et al.*, 2015). In adsorption, the accessibility of siloxane on the adsorbent surface is determined by the adsorbent properties. High siloxane removal can be obtained at high adsorption capacities, a large surface area, and effective pore volume (Baraldi, Damianovic, Manfio, Foresti & Vazoller, 2008; Yu, Wilson & Tay, 1998). Most reports show that activated carbon is the most used adsorbent. However, other adsorbents, such as silica gel, molecular sieves, polymer beads, zeolites and alumina, have been used (De Arespachoga *et al.*, 2015). When experiments were conducted, different adsorbents were tested before selecting activated carbon owing to its adsorption capacity (Baraldi *et al.*, 2008).

In absorption, organic solvents with high boiling points are used for the removal of siloxanes. The installation thereof includes both spray and packed columns (Soreanu, Beland, Falletta, Edmonson & Seto, 2008). Gas-liquid absorption can be used to remove all contaminants from biogas, where gaseous contaminants are transferred to liquid absorbents (Soreanu *et al.*, 2008). Absorption operates better at low temperatures. Therefore, gas is cooled before the adsorption process (De Arespachoga *et al.*, 2015).

During cryogenic condensation, a decrease in the temperature of biogas forms a condensate that contains siloxanes. Studies show that the removal efficiency of siloxanes at  $-25\text{ }^{\circ}\text{C}$  is 25.9% when cooling, whereas at  $-70\text{ }^{\circ}\text{C}$  the removal efficiency is 99.3% when freezing. This process removes water as well as other substances such as siloxanes and aromatics. This process occurs ne step before the use of activated carbon (De Arespachoga *et al.*, 2015).

The membrane separation process consists of selective siloxane permeation through dense polymeric membrane material, where methane is retained and does not pass the membrane. The process is very compact owing to small volume occupation and large surface area available for separation (De Arespachoga *et al.*, 2015; Ajhar *et al.*, 2010). Membrane systems currently in use for biogas treatment are either high-pressure membrane systems, which require pressurised gas to enable the gas to pass through the membrane, or low/atmospheric pressure membrane systems, in which molecules are separated by the diffusion of gas molecules through a selective microporous hydrophobic membrane and absorption is achieved through the use of a specific absorbent (Soreanu *et al.*, 2018).

The oxidation of siloxanes during biogas combustion results in microcrystalline  $\text{SiO}_2$ , which is a residue that has both physical and chemical properties similar to glass (Tower, 2003). Another method used to remove siloxanes was achieved through the use of a fluidised-adsorption bed, which achieved 10% to 20% of siloxane removals (Ajhar *et al.*, 2010). Nonetheless, a fixed-bed anaerobic digestion process in the presence of natural zeolite (clinoptilolite), a cost-effective system, has not yet been given attention regarding the removal of quantities of siloxane compounds produced in biogas production. The overall purpose of this study was to quantify and evaluate the fate and removal performance of selected siloxane compounds from biogas by fabricating a fixed-bed biodigester using skills and technology obtained from the locality. The work seeks to enhance the production of biogas (methane) through the optimisation of operating conditions, using a designed fixed-bed biodigester.

## MATERIAL AND METHODS

### Materials

Commercial siloxanes (D4) with a purity of 99%, glucose ( $\text{C}_6\text{H}_{12}\text{O}_6$ )/syrup glucose,  $\text{NiNO}_3$ ,  $\text{CuCl}_2$ ,  $\text{Mg}(\text{NO}_3)_2 \cdot 5\text{H}_2\text{O}$ ,  $\text{FeCl}_2$ , and  $\text{CH}_3\text{OH}$  were purchased in South Africa from Sigma-Aldrich, which is owned by Merck.  $\text{HCl}$ , sodium hydro-

gen carbonate ( $\text{NaHCO}_3$ ) and starch malt were purchased from United Scientific. South African natural zeolite called clinoptilolite was collected from Pratley Mining Co. (Pty) Ltd. Activated sludge was collected from Daspoort Wastewater Treatment Plant in Pretoria, while the cow dung was collected from the Agricultural Research Council at Sundowns Farm in Centurion, South Africa.

### Preparation of Nutrients and Siloxanes

The feed solution required nutrients to assist the microorganisms in producing biogas and the degradation of siloxanes. Two digesters were used and were tagged A and B. The following ingredients were added to both digesters: 3 g of syrup with 150 ml water; 10 g of starch malt as a nutrient; 20 ml of  $\text{CuCl}_2$  solution made up of 0.5 g cupric chloride and 100 ml water; 20 ml of  $\text{MgNO}_3 \cdot 5\text{H}_2\text{O}$  solution made up of 0.3 g magnesium nitrate and 100 ml water; and 20 ml  $\text{NiNO}_3$  solution made up of 0.1 g nickel and 100 ml water.

### Methods

The experimental framework applied in this study towards the anaerobic treatment of siloxanes in a fixed-bed biodigester is shown in Figure 1. The procedures included the measurement and adjustment of pH, the measurement and adjustment of water bath temperature, the feeding of nutrients to the biodigesters, the measurement of the volume and composition of the biogas produced, and the determination of the COD and siloxanes concentration.

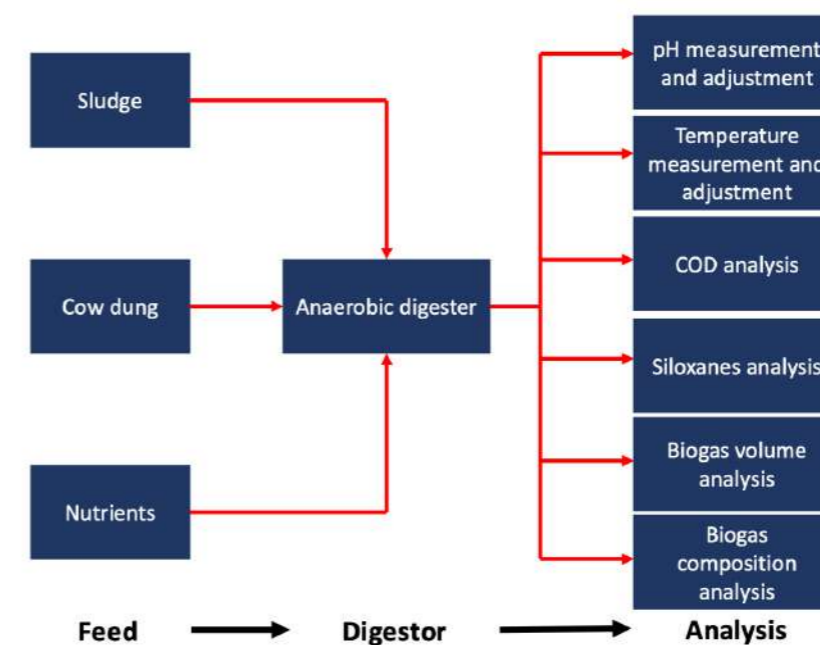


Figure 1: Summary of the experimental procedures.

### Anaerobic Digestion

A water bath, which was manufactured in-house, contained two digesters and warmed water to the desired temperature through a heating element. The respective volumes of the digesters were 4 000 ml and 3 000 ml, while borosilicate glass was used for both digesters to hold the digester solution. The water bath contained a heating element with a thermostat, which ranges from  $10\text{ }^{\circ}\text{C}$  to  $50\text{ }^{\circ}\text{C}$  as shown in Figure 2. Anaerobic digestion occurs under mesophilic conditions (from  $37\text{ }^{\circ}\text{C}$  to  $40\text{ }^{\circ}\text{C}$ ). A temperature probe was dipped into the water bath to record the exact temperature of the water.

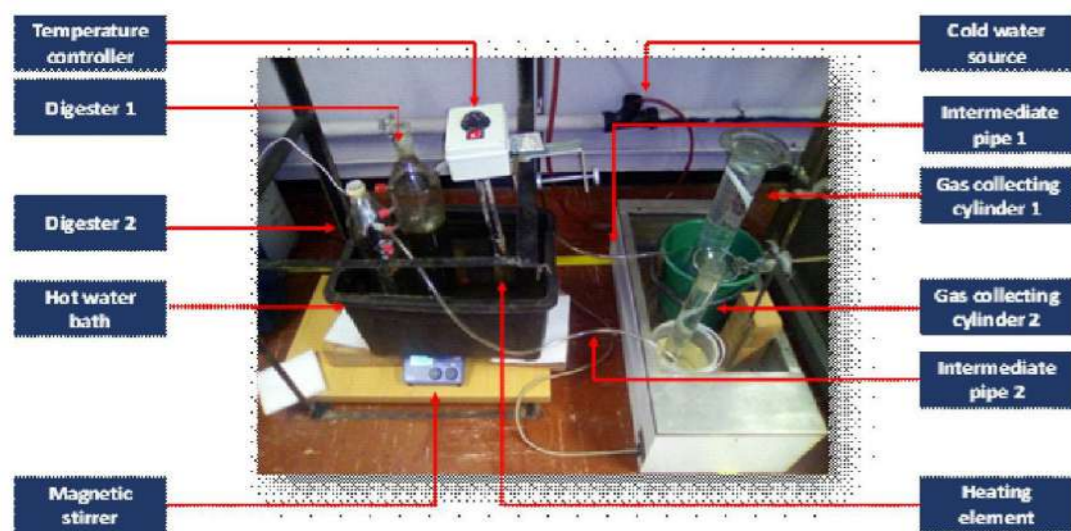
### Start-Up of Anaerobic Digestion Plant

The feed solutions were prepared respectively for both digesters. This entailed 2 000 ml of activated sludge being mixed with 200 ml of cow dung (inoculum) and 300 ml of water. Nutrients were added to the feed solution to maintain micro-organism growth and biogas production. Moreover, 150 ml of glucose syrup, 20 ml of copper chloride, 20 ml of nickel nitrate and 20 ml of magnesium nitrate were added as supporting nutrients and minerals.

Digesters A and B were immersed in the water bath and maintained under mesophilic (between 37 °C and 40 °C) conditions. Digester A was subjected to stirring at 1 500 rpm and Digester B was operated without stirring. The digesters were connected to gas-collecting apparatus for sampling, which included graduated cylinders and 20 ml syringes.

The water bath temperature was set at 38 °C for both digesters. For the uncontrolled digester, the pH was allowed to fluctuate during the testing period. For the controlled digester, the pH ranged between 6.8 and 7.8 through the adding of minerals and nutrients to the feed solution.

The pH in the anaerobic digester was determined using a pH meter. The pH meter used was an **OHAUS Starter 2100** model. The optimum pH value in the anaerobic digester had to be between 7.3 and 7.8. Adjustments were required when the recorded pH deviated from the optimum range. For high pH levels, hydrochloric acid was used, and for low pH levels, sodium bicarbonate was used to correct the pH deviation.



**Figure 2:** Anaerobic digestion plant set-up.

## Analytical methods

### COD Analysis

From each digester, 5 ml was sampled and centrifuged at 4 000 rpm for 20 minutes. After centrifuging, the sample was further filtered using 320 µm filter paper. The 1 ml from the filtered sample was extracted and diluted in 50 ml of deionised water. A 13 ml cylindrical glass vial was used to mix 2.5 ml of diluted sample, 1.5 ml of digestion solution (potassium dichromate) and 3.5 ml of 98% sulphuric acid. The mixture was placed in a thermodigester for 2 hours at 150 °C for digestion. The vial was removed from the thermodigester and left at room temperature to cool down. A spectrophotometer was used to analyse the amount of COD in the sample.

### Siloxane Analysis

A sample of 10 ml from the anaerobic digester was mixed with 10 ml of dichloromethane in a separating funnel. The separating funnel was shaken until two layers were formed. Thereafter, the bottom layer was removed. The bottom layer was taken for analysis in a gas chromatograph to determine the presence of siloxanes. A Varian CP-3800 gas chromatograph was used to analyse VMSs.

### Biogas Analysis

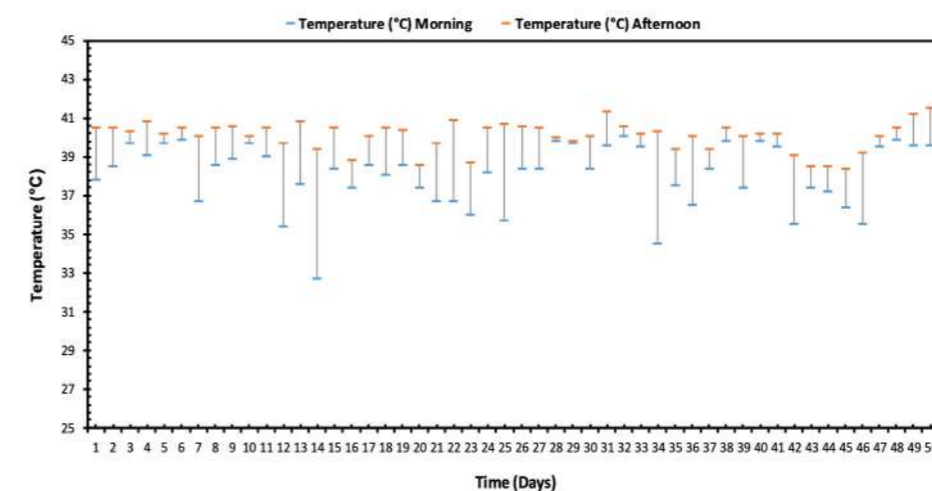
Each digester was connected to a gas collecting graduated cylinder, wherein the volume of biogas produced was determined through the water displacement method. The composition of the produced biogas was analysed using an MGA 100 portable biogas analyser, which was connected to the digester by a plastic pipe. The biogas analyser indicated the concentration of methane, carbon dioxide, oxygen and hydrogen sulfide in the biogas.

The graduated cylinders, A and B, were used to collect biogas with respective volumes of 2 000 ml and 500 ml. The MGA portable biogas analyser provided the qualitative and quantitative composition of biogas that was connected to the digesters. An Aqualitic AL800 spectrophotometer was used to measure COD. The samples to be analysed were digested for 2 hours using the thermodigester. The MFH thermodigester has the purpose of heating samples prior to COD analysis. After 2 hours, the samples were allowed to cool and then analysed for COD using the spectrophotometer.

## RESULTS AND DISCUSSION

The digestion process depends on properly controlled temperatures, as well as the degree alkaline and acidic (pH) environmental conditions for the survival of microorganisms. The environmental conditions can directly affect the product, the digestive progress and the growth rate, as well as the survival of the microorganisms (Kwietniewska & Tys, 2014; Mao *et al.*, 2015; Stamatelatu & Antonopoulou, 2016).

Temperature has a direct influence on the thermodynamic equilibrium of the biochemical reactions of anaerobic digestion. It also controls the activity, growth rate and diversity of the microorganisms (Lin *et al.*, 2008). Anaerobic digestion occurs under mesophilic conditions (between 37 °C and 40 °C), which was monitored consistently. Figure 3 presents a log of the readings captured for 50 days.



**Figure 3:** Water bath temperature as a function of time.

Temperature is one of the main factors affecting the survival of microorganisms during the anaerobic digestion process (Stamatelatu & Antonopoulou, 2016). The average temperature in the water bath was 38 °C, which is in favour of the growth rate of the methanogenesis process (Lin *et al.*, 2008). The experiment was conducted during the winter season, which resulted in ambient temperature fluctuations. Morning temperatures ranged between 35.4 °C and 40.2 °C, while afternoon temperatures ranged between 39.7 °C and 40.8 °C from day 1 to day 13. Internal forces affected the temperatures on day 14 and day 34. This included the refilling of the water bath and the malfunctioning of the thermostat. The morning temperatures on these days were read at 32.7 °C and 34.5 °C respectively, owing to the refilling of the water bath, while the afternoon temperatures were recorded at 39.4 °C and 40.3 °C respectively, which are mesophilic conditions. Any other fluctuation in temperature from day 1 to day 50, excluding day 14 and day 34, was because of external forces such as weather. Temperature fluctuation affects the growth and activity of the microorganisms inside the digester.

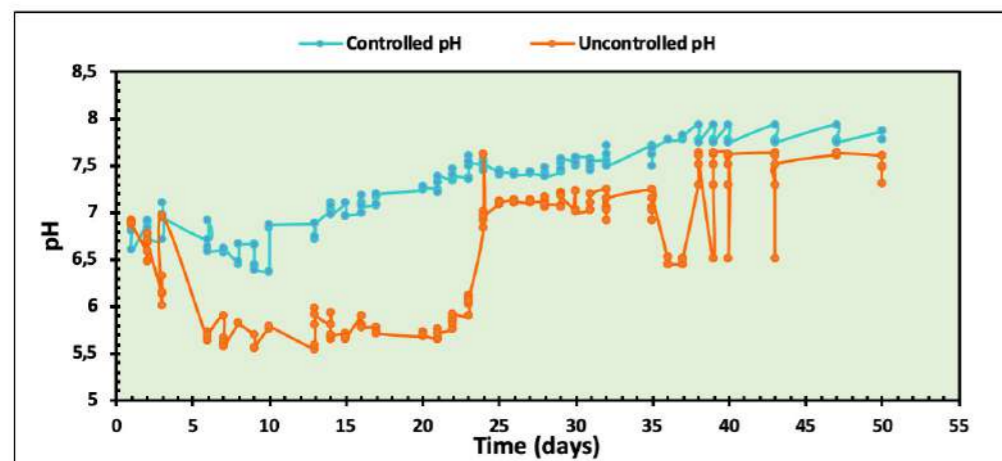


Figure 4: pH acclimatisation.

The pH in the digester was monitored in controlled and uncontrolled setups, the results of which are shown in Figure 4. The pH ranges fluctuated between 5.5 and 7.2 for uncontrolled or raw sludge, reaching a steady-state condition after 35 days. This led to favourable conditions for enhanced microbial growth during acclimatisation. The low pH of 6.0 promoted more volatile acids, which led to the inactivity of microbial growth, or methanogenesis, because acidogenesis took place at pH levels below 6.3 (Boontian, 2013). The controlled conditions were due to the addition of a buffer solution of 0.1 M NaHCO<sub>3</sub> to stabilise the pH solution medium. However, according to Mao *et al* (2015), even though there is a presence of nutrients, such as sulphate and ammonia, during the experimental run, anaerobic digestion of the secondary wastewater treatment tank also contributes to microbial growth and its activity during the anaerobic digestion process. On the other hand, the stability of controlled or acclimatised sludge maintained a steady state at a pH range of 7.2 to 7.5. At this pH, the consortium of bacteria for methanogenesis becomes active, which indicates that the anaerobic digestion process can now be used for the biodegradability of organic matter such as COD, among others.

#### Effects of pH on COD

Figure 5 shows that when the pH is low, the COD is high. It was observed that when the pH is between 6.8 and 6.4, the COD is between 4 050 mg/l and 53 450 mg/l for the first 9 days. A gradual increase in pH was observed from day 10 to day 13, with a simultaneous decrease in COD. When the pH was within the required range of between 7.3 and 7.6, the COD was within the range of 4 850 mg/l and 2 200 mg/l, which is the range required for the production of biogas. When the sludge has high levels of COD, it results in the high amount of oxidisable organic material in the sludge. This will reduce the amount of DO levels. The anaerobic conditions in the digester are favoured by the reduction in DO. According to the literature, the suggested COD range for effective biogas production has to be above 1 500 mg/l.

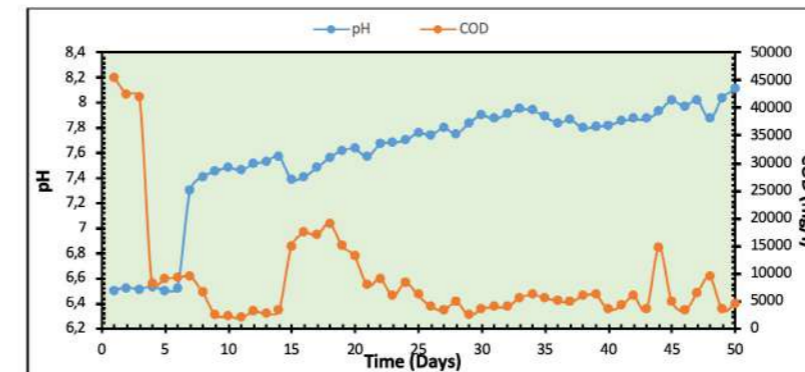


Figure 6: The effect of uncontrolled pH on COD in Digester B.

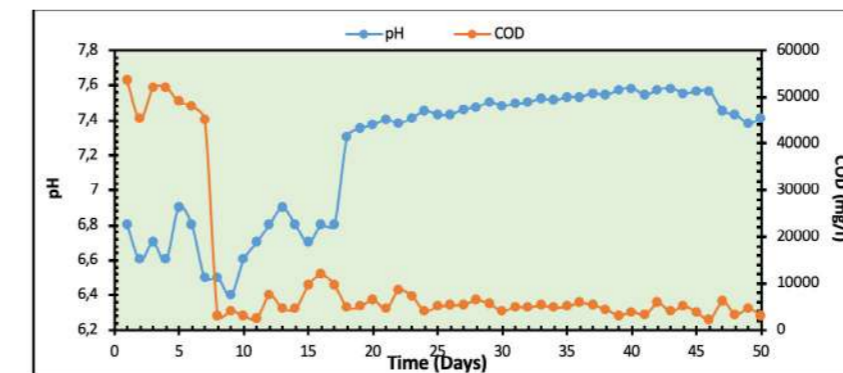


Figure 5: The effect of pH on COD in Digester A with a stirrer.

Figure 6 indicates the effect of pH on COD in Digester B. It was observed that when the pH was between 6.50 and 6.52, the COD was between 9 200 mg/l and 45 500 mg/l for the first 6 days. The drop in COD during this period was due to the unfavourable pH range. From day 7 to day 13, the pH increased and the COD decreased. From day 15, an increase in pH was observed, as well as a decrease in COD. When the pH increased from 7.39 to 8.11, the COD fell within the range of 7 800 mg/l and 4 400 mg/l for the production of biogas. The fluctuation of pH affects the COD. Higher amounts of DO and lower amounts of oxidisable organic material in the sludge leads to a decrease in the tendency for anaerobic processes to take place. At extreme variations in the COD, it will be difficult to obtain optimum biogas production.

### Effects of COD on biogas production

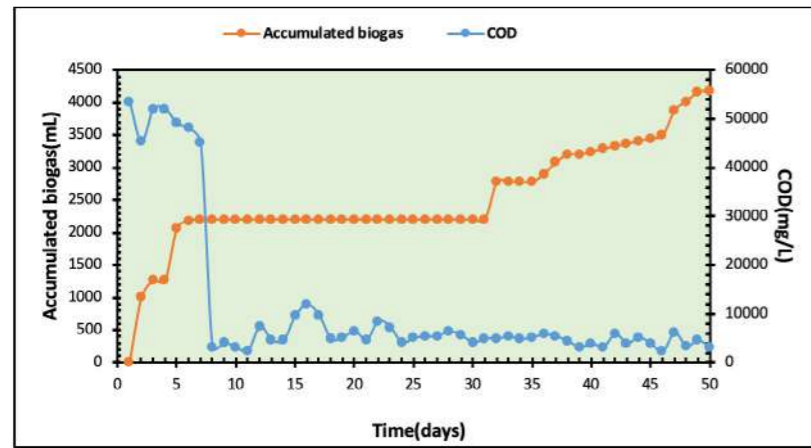


Figure 7: The effect of COD on the accumulation of biogas in Digester A with a stirrer.

The effect of COD on the accumulation of biogas production in Digester A is illustrated in Figure 7. From day one, the volume of biogas was 0 ml with a corresponding COD of 53 420 mg/l. It was observed that when the COD was extremely high, the accumulation of biogas production was low. When the COD decreased, the accumulation of biogas increased. Between day 6 and day 31, there was no biogas accumulation owing to a fluctuating COD. The fluctuation of COD resulted in an increased amount of DO and low oxidation of organic material in the digester. When the COD was within a stable range from day 32 to day 50, the conditions for anaerobic digestion were favoured, resulting in an increase in biogas accumulation.

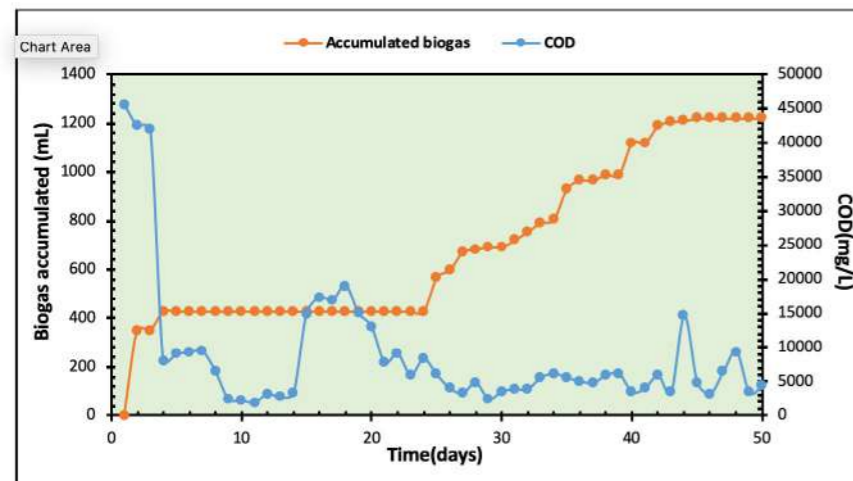


Figure 8: The effect of COD on the accumulated biogas in Digester B without a stirrer.

Figure 8 illustrates the effect of COD on the accumulation of biogas production in Digester B. From day 1 to day 4, the COD decreased and the accumulation increased. From day 5 to day 21, the COD fluctuated and there was no biogas production. The fluctuation of COD resulted in an increased amount of DO and low oxidation of organic material in the digester. Hence, zero production of biogas was observed during that period. When the COD was within a stable range from day 25 to day 43, the conditions for anaerobic digestion were favoured, resulting in an increased accumulation of biogas. An increase in accumulated biogas of 565 ml to 1 205 ml was observed from day 25 to day 43, whereas the COD decreased from 6 000 mg/l to 3 450 mg/l. The COD showed instability from day 44 to day 50, resulting in no biogas production. The amount of COD was too high for biogas production. Mitchell, Ullman, Teel, Watts and Frear (2013) state that the COD concentration must be above 1 500 mg/l for the production of biogas to take place.

### Siloxanes (D4) analysis

Figure 9 shows the degradation of siloxanes in Digester B – referred to as Reactor B – with a zeolite bed, as well as the degradation of siloxanes in Digester A – referred to as Reactor A – without a zeolite bed. The siloxanes degrade faster in Digester B with zeolite. The initial concentration of siloxanes in the zeolite bed digester was 0.0997 M from day 2, dropping to 0.0447 M on day 3 when the siloxanes were degraded to a lower concentration. The non-zeolite bed digester degraded the siloxanes at a lesser rate. The initial siloxane concentration was 0.047 M and the final siloxane concentration was 0.0449 M. The graphical trends showing the concentration of siloxanes on the zeolite bed digester and on the non-zeolite bed digester show that the degradation rate of siloxanes is greater for the zeolite bed. This is so because zeolite adsorbs ammonia, which is a strong inhibitor in the production of biogas. Ammonia is responsible for the killing of microorganisms that are responsible for the degradation of siloxanes and the production of biogas.

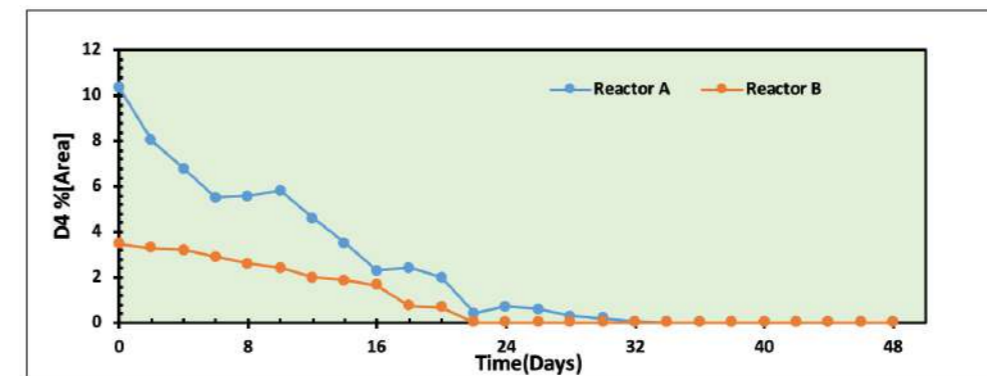


Figure 9: Siloxanes (D4) analysis.

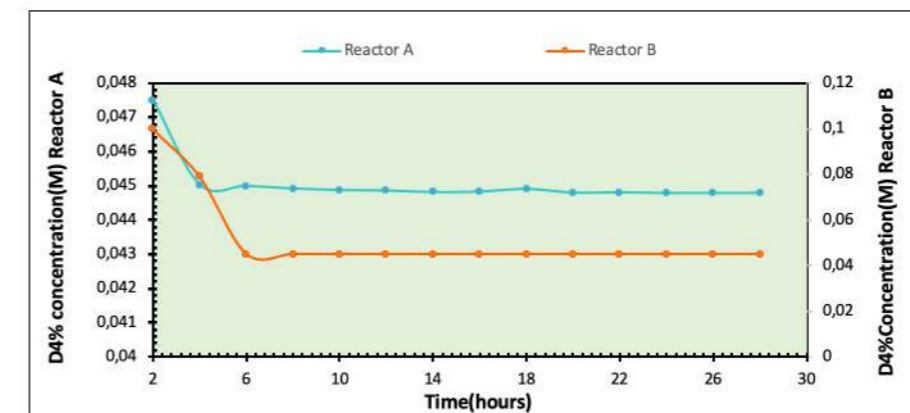


Figure 10: Siloxanes (D4) analysis for a zeolite bed.

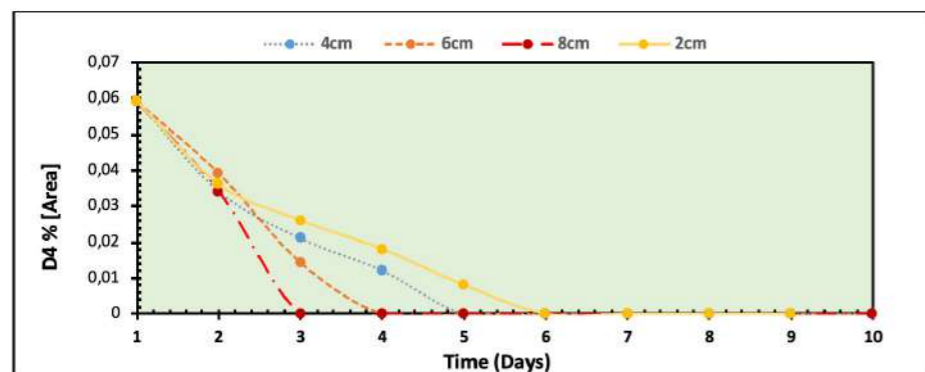


Figure 11: Siloxanes degradation (zeolite bed).

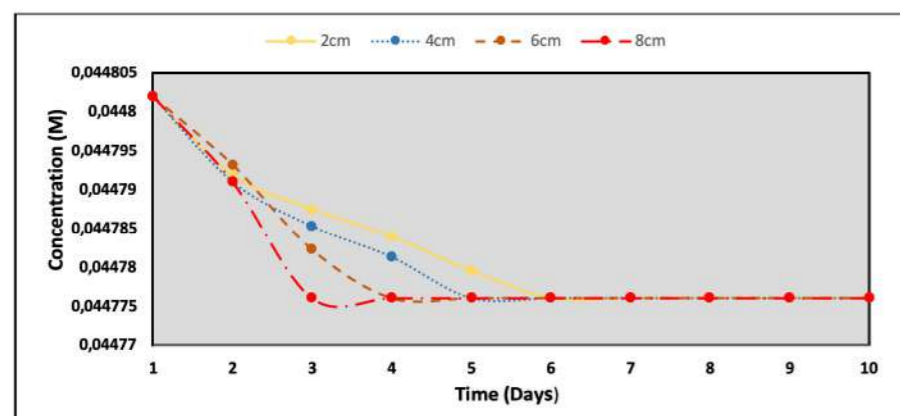


Figure 12: Siloxanes degradation (zeolite bed).

Figure 11 and Figure 12 show the degradation of siloxanes at different heights on zeolite beds. All the digesters started with a siloxane concentration of 0.0448 M, and the degradation rate of the beds was different depending on the bed height. The 8 cm bed height showed a faster degradation rate from day 1, starting at 0.0448 M, and reaching a maximum degradation point of 0.0447 M on day 3, where all siloxanes were degraded to a low concentration. It took 4 days for all siloxanes to be degraded on the 6 cm bed, 5 days on the 4 cm bed, and 6 days on the 2 cm bed before all the siloxanes were degraded to a low concentration. After 6 days of degradation, the concentration remained constant and no further degradation took place. The trend shows that the higher the zeolite bed height, the faster the rate of degradation of siloxanes. The zeolite acted as the absorbent to ammonia, which is an inhibitor to the microorganisms that are responsible for the degradation of siloxanes and the production of biogas. The degradation of siloxane in the sludge before it can escape along with the biogas, will result in less contaminated biogas being delivered to the end-user, such as boilers, generators and heaters.

## CONCLUSION

The removal of siloxane from biogas produced using sludge from a wastewater treatment plant was investigated. This was carried out using zeolite as the bed in a fixed-bed biodigester, which was designed and fabricated using appropriate technology. Different bed heights were investigated to determine the optimum height. The 2 cm bed heights took 6 days to degrade 0.04480 M of siloxanes to 0.044775 M, the 4 cm bed heights took 5 days to degrade 0.04480 M of siloxanes to 0.044775 M, the 6 cm bed heights took 4 days to degrade 0.04480 M of siloxanes to 0.044775 M, and the 8 cm bed heights took 3 days to degrade 0.04480 M of siloxanes to 0.044775 M. The rate of degradation of siloxanes proved to be faster at the 8 cm bed height. Even though the degradation did not reach zero, it can be concluded that there was a significant reduction of siloxanes from the sludge.

## LIST OF REFERENCES

- Ajhar, M., Travasset, M., Yüce, S. & Melin, T. 2010. Siloxane removal from landfill and digester gas—a technology overview. *Bioresource Technology*, 101(9):2913-2923.
- Baraldi, E.A., Damianovic, M.H., Manfio, G.P., Foresti, E. & Vazoller, R.F. 2008. Performance of a horizontal-flow anaerobic immobilized biomass (HAIB) reactor and dynamics of the microbial community during degradation of pentachlorophenol (PCP). *Anaerobe*, 14(5):268-274.
- Baumgartner, J., Schauer, J.J., Ezzati, M., Lu, L., Cheng, C., Patz, J.A. & Bautista, L.E. 2011. Indoor air pollution and blood pressure in adult women living in rural China. *Environmental Health Perspectives*, 119(10):1390-1395.
- Boontian, N. 2013. Optimization of the anaerobic digestion of biomass: A review. *Romanian Review Precision Mechanics, Optics and Mechatronics*, 43:48-54.
- De Arespacochaga, N., Valderrama, C., Raich-Montiu, J., Crest, M., Mehta, S. & Cortina, J. 2015. Understanding the effects of the origin, occurrence, monitoring, control, fate and removal of siloxanes on the energetic valorization of sewage biogas: a review. *Renewable and Sustainable Energy Reviews*, 52: 366-381.
- García-Gutiérrez, P., Jacquemin, J., McCrellis, C., Dimitriou, I., Taylor, S.R., Hardacre, C. & Allen, R.W. 2016. Techno-economic feasibility of selective CO<sub>2</sub> capture processes from biogas streams using ionic liquids as physical absorbents. *Energy & Fuels*, 30(6):5052-5064.
- Kwietniewska, E. & Tys, J. 2014. Process characteristics, inhibition factors and methane yields of anaerobic digestion process, with particular focus on microalgal biomass fermentation. *Renewable and Sustainable Energy Reviews*, 34:491-500.
- Li, Y., Zhang, W. & Xu, J. 2014. Siloxanes removal from biogas by a lab-scale biotrickling filter inoculated with *Pseudomonas aeruginosa* S240. *Journal of Hazardous Materials*, 275:175-184.
- Lin, C.Y., Wu, C.C. & Hung, C.H. 2008. Temperature effects on fermentative hydrogen production from xylose using mixed anaerobic cultures. *International Journal of Hydrogen Energy*, 33(1):43-50.
- Mao, C., Feng, Y., Wang, X. & Ren, G. 2015. Review on research achievements of biogas from anaerobic digestion. *Renewable and Sustainable Energy Reviews*, 45:540-555.
- Matsui, T. & Imamura, S. 2010. Removal of siloxane from digestion gas of sewage sludge. *Bioresource Technology*, 101(1):S29-S32.
- Mitchell, S.M., Ullman, J.L., Teel, A.L., Watts, R.J. & Frear, C. 2013. The effects of the antibiotics ampicillin, florfenicol, sulfamethazine, and tylosin on biogas production and their degradation efficiency during anaerobic digestion. *Bioresource Technology*, 149:244-252.
- McLachlan, A.J. and Ramzan, I., 2010. Misuse of formulations in the aged care setting. In *Medication Management in Older Adults* (pp. 95-104). Springer, New York, NY.
- Nair, N., Zhang, X., Gutierrez, J., Chen, J., Egolfopoulos, F. & Tsotsis, T. 2012. Impact of siloxane impurities on the performance of an engine operating on renewable natural gas. *Industrial & Engineering Chemistry Research*, 51(48):15786-15795.
- Popat, S.C. & Deshusses, M.A. 2008. Biological removal of siloxanes from landfill and digester gases: opportunities and challenges. *Environmental Science & Technology*, 42(22):8510-8515.
- Schweigkofler, M. & Niessner, R. 1999. Determination of siloxanes and VOC in landfill gas and sewage gas by canister sampling and GC-MS/AES analysis. *Environmental Science & Technology*, 33(20): 3680-3685.
- Sherwood, J., Clark, J., Farmer, T., Herrero-Davila, L. & Moity, L. 2016. Recirculation: A new concept to drive innovation in sustainable product design for bio-based products. *Molecules*. 22(1):48.
- Soreanu, G., Beland, M., Falletta, P., Edmonson, K. & Seto, P. 2008. Investigation on the use of nitrified wastewater for the

- steady-state operation of a biotrickling filter for the removal of hydrogen sulphide in biogas, *Journal of Environmental Engineering and Science*, 7(5):543-552.
- Kiran, E.U., Stamatelatu, K., Antonopoulou, G. & Lyberatos, G., 2016. Production of biogas via anaerobic digestion. In *Handbook of Biofuels Production* (pp. 259-301). Woodhead Publishing.
- Surita, S.C. & Tansel, B. 2014. A multiphase analysis of partitioning and hazard index characteristics of siloxanes in biosolids, *Ecotoxicology and Environmental Safety*, 102:79-83.
- Surita, S.C. & Tansel, B. 2015. Contribution of siloxanes to COD loading at wastewater treatment plants: Phase transfer, removal, and fate at different treatment units, *Chemosphere*, 122:245-250.
- Tower, P. 2003. New technology for removal of siloxanes in digester gas results in lower maintenance costs and air quality benefits in power generation equipment, *Proceedings of the Water Environment Federation*, (9):440-447.
- Yu, H., Wilson, F. & Tay, J.H. 1998. Kinetic analysis of an anaerobic filter treating soybean wastewater, *Water Research*, 32(11):3341-3352.

9TH INTERNATIONAL CONFERENCE ON APPROPRIATE TECHNOLOGY

# HEALTH



# SYMBA: AN EXPLORATION OF APPROPRIATE MEDICAL DEVICE DESIGN FOR THE SOUTH AFRICAN CONTEXT

Ashton Moseley, University of Johannesburg, South Africa, abullock@uj.ac.za

Angus Donald Campbell, University of Johannesburg, South Africa, acampbell@uj.ac.za

## Abstract

*Medical devices are essential for the successful delivery of almost every form of health care. The medical device industry is currently one of the fastest-growing and dynamic sectors of the global economy. However, the global market is heavily dominated by high-income countries (HICs) with low to middle-income countries (LMICs) constituting only 13% of the global market. As a result, up to 80% of medical devices in LMICs are donated or imported. A medical device needs to be appropriate for the context in which it is intended. Imported medical devices, which are manufactured for use in high-income countries, however, are often inappropriate and ineffective when used in low-resource settings. This results in approximately 40% of donated/imported medical devices being out of service, 70–90% never functioning as intended, and up to 98% broken within five years. The lack of appropriate medical devices in LMICs suggests the need for a shift towards a more human-centred, design-oriented medical device industry which promotes local manufacture. Like many LMICs, South Africa's local medical device industry is underdeveloped. Approximately 90–95% of medical devices in South African hospitals are imported/donated. However, in a 2014 World Health Organisation feasibility study, South Africa showed great capacity to support the local production of medical devices. Furthermore, recent success stories such as Jed Aylmer's Symba paediatric bed indicate that local designers and manufacturers can successfully compete with international suppliers of sophisticated equipment - highlighting an opportunity for increasing medical device design in South Africa. This paper presents the design process followed in the development of Symba in the form of a retrospective case study. The purpose of the paper is to share appropriate local design strategies which better enable local industrial designers to pursue more appropriate medical device design outcomes in the South African context.*

**Keywords:** appropriate healthcare, human-centred design, medical device design, South Africa

## INTRODUCTION

Hospital environments, designed appropriately, can promote healing and enhance operational efficiency (McAndrews, 2005:7). Medical devices (MDs) used by staff and patients in hospitals are a large contributing factor to what constitutes a 'hospital environment'. However, there is scant literature on the importance or effect of medical device development (MDD) and its effect on the hospital environment and experience. This highlights an opportunity for involving designers in the MDD industry, moving past the purely functional approach of biomedical engineers towards a more human-centred design approach.

The MD industry is one of the fastest-growing and most dynamic sectors of the global economy (Frost & Sullivan, 2017; World Health Organisation, 2010:14). Despite rapid progress within the development of medical technologies, the fact that MD innovation is mainly targeted at high-resource contexts means that the majority of the world's population lack access to MDs that are *appropriate* for their specific epidemiological needs (Cheng, 2003; World Health Organisation, 2010; World Health Organisation, 2016; Dyro, 2004).

The lack of appropriate MDs, particularly in low to middle-income countries (LMICs) suggests the need for a shift towards a more human-centred, design-oriented MD industry, which promotes local manufacture. This paper reports on a retrospective case study of the design of the Symba Paediatric Hospital bed by industrial designer Jed Aylmer, of Praestet Healthcare Design, for the Nelson Mandela Children's Hospital (NMCH) as a means to explore more appropriate medical device design (MDDes) in South Africa (SA).

## Context

### Design for healthcare

For most people, illness is a source of stress that is further aggravated when they are placed in a healthcare setting, an environment where many people experience strong emotions of fear and anxiety (Kopeck, 2012:261; Dellinger, 2009:49). Stress not only affects patients in hospitals but is also a very intense emotional experience for healthcare providers (Dellinger, 2009:48). 'Product experience' refers to the subjective experiences involved in human-product interaction (Desmet & Hekkert, 2007; Desmet, 2004). When people interact with products emotions are elicited by one's judgement of the significance of a situation in terms of benefit or harm to one's well-being (Scherer, 2001; Desmet & Hekkert, 2007). A growing body of research recognises that well-designed physical settings play an important role in making hospitals safer, more efficient, and less stressful, promoting healing for patients and improving the work environment for staff (Zimring, Augenbroe, Malone & Sadler, 2008; McCullough, 2009).

MDs are essential for the successful delivery of almost every form of health care and improvement of the health of individuals and populations (World Health Organisation, 2010). Staff and patients are exposed to and interact with MDs for most of their time in hospitals. When designed appropriately, hospital environments can reduce stress and promote healing, ultimately improving recovery time (McAndrews, 2005:7; Kopeck, 2012). Furthermore, design can enhance usability and operational efficiency while reducing the chance of human error, further improving the work experience for staff. Providing environments that help mitigate stress and enhance operational efficiency should, therefore, be a primary concern when developing and designing healthcare facilities (Kopeck, 2012:261). This suggests the importance of the appropriate design of MDs, suited to the emotional and functional needs of users.

### Technological diffusion, context and the mismatch

Not only do MDs need to be appropriate for the psychological and clinical needs of users, but they need to be appropriate for the context or setting in which they are used. One of the main barriers to the optimal use of MDs in LMICs is the 'mismatch' between the design of the device and the context in which it is ultimately used (World Health Organisation, 2010). For decades, developed countries have exported MDs from 'developed' to 'developing' settings in the form of low-cost sales or donations (Dyro, 2004). As a result, up to 80% of MDs in LMICs are donated or imported (World Health Organisation, 2011:8). In many cases, donations bypass local procurement systems of the recipient country, and as a result, actual local requirements, capabilities, and the available level of technical expertise to provide maintenance are not considered appropriately (World Health Organisation, 2011:8). It is also common for multinationals to 'strip down' devices, originally intended for High Income Country (HIC) markets, for LMICs rather than developing products specifically designed for their contexts (World Health Organisation, 2012:16). Donated MDs are rarely accompanied by ongoing maintenance, user training and technical support (Prester, 2010:86; Dyro, 2004:155). As a result, although MDs may be available in LMICs, they are often ill-suited for local conditions and therefore cannot be used effectively (World Health Organisation, 2010). As a result, approximately 40% of MDs in LMICs are out of service, 70–90% of

all donations never function as intended (Malkin & von Oldenburg Beer, 2013:1847; Chan, 2010); and up to 98% of donated medical equipment is broken within five years (Prester, 2010:86).

### Appropriate technology through local production

The WHO identifies local production as a way to increase access to appropriate MDs in LMICs (World Health Organisation, 2016:1). In a 2014 study, SA showed great capacity to support local production of MDs (World Health Organisation, 2016). Furthermore, recent success stories (Praestet, 2020; CapeRay, 2018; Lodox, 2015) indicate that local designers and manufacturers can successfully compete with international suppliers of sophisticated medical equipment. However, except for a handful of examples, SA's MD industry is still relatively underdeveloped. Most local industry is constituted of multinational subsidiaries, importers and distributors with very little local design and manufacture (Mitchell, 2017; KPMG, 2014:11-12). Like many LMICs, approximately 90-95% of MDs in South African hospitals are imported or donated (Mitchell, 2017). Local MD production consists mostly of small to medium-sized businesses combining distribution activity with manufacturing, which is limited mostly to consumables, basic hospital furniture and low technology items (SAMED). The lack of MDD in SA could be attributed to the complexities of designing for healthcare, such as navigating expensive regulatory controls and certifications (Mitchell, 2017); the myriad of end-users and stakeholders (Kopec, 2012:268; Ogrodnik, 2012); the social complexities of designing in 'developing/third-world' countries (Prester, 2012); the lack of formal MDD training in South African institutions; and finally, until June 2017, the absence of a MD regulatory framework/body in SA.

### Research design

The design and planning phase of this study involved five steps: conducting a literature review, identifying a research problem/project aim, constructing a theoretical framework, designing research questions and interview schedules, and purposively selecting the sample/case (Merriam, 1998).

### Literature review

This study began with an in-depth review of the relevant literature for the construction of the research aim and questions and theoretical framework that would guide the inquiry (Merriam, 1998). Reflecting on a body of literature, three key themes/factors/omissions were identified. Firstly, the most notable influence on MDD is the regulatory requirements<sup>1</sup> of MD development and manufacture; secondly, the complexity of the number and variety of stakeholders and/or users involved throughout the process; and thirdly, contextual considerations outside of regulatory standards or concerns were referred to by very few authors.

### Regulatory controls and context

Although the scope of this paper doesn't delve into the specific complexities of MDD controls and regulations, it is important to note that all authors refer to European (CE) and United States (FDA) regulatory requirements and processes. It is also important to note that until 2017, SA lacked its own regulatory body, and has very limited, outdated design standards related to MDs. Therefore any MDs designed or procured would have to meet the requirements of international (European/USA) standards; hence the contextual mismatch. Furthermore, the significant cost involved in getting approved by these international bodies is a potentially limiting factor to local MDD.

<sup>1</sup> The scope of this paper does not delve into the specific complexities regarding MDD controls and regulations. For more detail on this, refer to (Bullock, 2019), Chapter 2 and 7.

### Stakeholders

For a MD to be considered successful, it must be clinically effective, safe and meet the needs of the several people using and being treated by the device (Martin, Clark, Morgan, Crowe & Murphy, 2012:184; Santos, Gazelle, Rocha & Tavares, 2012). This highlights the importance of meeting user needs; however, defining who a MD user is, can be far more complicated than it seems (Teixeira, 2014:13). MD users are not a homogenous group, but rather consist of various people each with different roles and interests (Shah, Robinson & Alshawi, 2009:3). The term *user* can refer to patients, nurses, doctors, clinical specialists, carers, cleaners, maintenance staff, friends and family members (Shah, Robinson & Alshawi, 2009:3; Teixeira, 2014:13). Furthermore, other stakeholders, such as regulatory bodies, manufacturers, investors, procurement officers and hospital management also have needs, requirements and expectations which the designer and device must accommodate (Shah *et al.*, 2009:3). Various authors, therefore, stress the importance of forming multi-disciplinary project teams to identify and understand the needs of these users and to understand the system of which the device is a part (Martin *et al.*, 2012:184; Money *et al.*, 2011: 1).

### Problem identification and research aim

The synthesis and review of the existing literature identified that although various MDD process models and case studies documenting appropriate MDD have been defined, none of them describes the South African MDD regulatory landscape; and most describe the MDD process from an engineering or business perspective rather than a design point of view. As a result, 'design' is portrayed as a step in the overall development process. The absence of design-related insights in existing MDD literature coupled with the lack of documentation of local MDD outcomes and processes, informed our decision to conduct a case study documenting MDD from a designer's perspective. The aim of this study was therefore to document the design process and outcome of an appropriate South African MD as an example of how to design appropriate MDs for LMIC contexts.

### Theoretical framework

Framed within the pragmatic paradigm, the purpose of this study was to generate prescriptive/guiding design knowledge and serve as an example of best practice for the design and manufacture of appropriate MDs in LMICs (Goldkuhl, 2012:8; Zimmerman, Stolterman & Forlizzi, 2010:313). In this study, constructive knowledge was formulated and supported by the interpretivist elements of interpretation and understanding of the perceptions and lived experiences of participants, through a case study (Thanh & Thanh, 2015:25; Goldkuhl, 2012:15; Munro, 2014).

### Research objectives

Using the case study method, this study explored and analysed a local, design-led product design process and outcome of a MD to identify the:

1. challenges, shortfalls and problems faced in the process and how they were overcome
2. stakeholders/key role-players in the design process, their involvement and impact on the design process
3. design considerations and their effect on the outcome.

These objectives, informed by the literature review, guided the provisional set of interview questions (Gray, 2004).

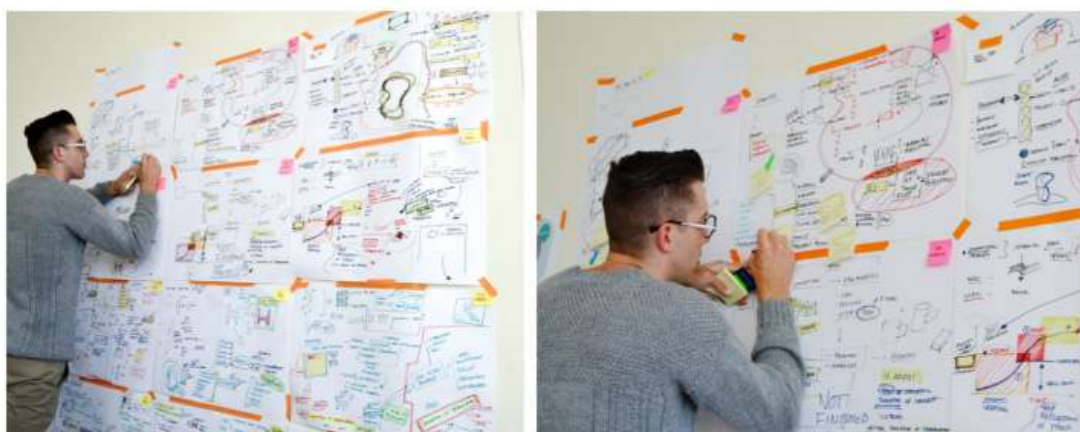
### Case selection

To ensure the gathering of valuable information, the chosen case had to meet four predetermined criteria. First, the case had to represent an industrial design-led project (not from an engineering or biomedical perspective) to provide appropriate design-related information. Second, to ensure the entirety of the design process could be documented, the case had to have been an already completed project. This was, therefore, a retrospective case study (Starman, 2013).

Third, the case had to have been documented to some extent outside of this case study to allow for fact-checking and data triangulation (Flick, 2004). Lastly, the case had to represent the correct context, therefore it had to be a South African design/product. Based on these selection criteria, Symba, the paediatric hospital bed designed and manufactured by Praestet was purposively selected for the case study.

## Methods

To enhance the rigour, credibility and validity of this research, this study adopted the strategy of triangulation of data, whereby data was gathered using multiple methods and sources (Gray, 2004; Baxter & Jack, 2008). Before conducting interviews, preliminary desktop/background research was conducted to establish a basic understanding and overview of the case and the South African MDD context (Kothari, 2004:111). In Praestet's case, the design and development of Symba were relatively undocumented. Therefore the primary data gathering tool was semi-structured interviews. This case began with an introductory interview and an overview analysis of the process. Thereafter, the in-depth retrospective visualisation of Praestet's process took place over a series of nine 'brainstorm sessions' over five months. All interviews were recorded using written notes, mind mapping (Fig. 1), audio recording and photographs, with the participants' consent (Gray, 2004; Baxter & Jack, 2008).



**Figure 1:** Aylmer's spatialisation process, 2018 (author)

Once all the data had been externalised, we began a process of classification, searching for and reviewing potential themes by rearranging the data, finding areas of similarity and clustering words related to similar concepts together or according to objectives 1-3 (Braun & Clarke, 2012; Kolko, 2010). This analysis took place in a four-hour long design session whereby the pages produced over the five months were condensed and summarised into a single page/model through a spatialisation process (Kolko, 2010). To further enhance the validity of this research, the case was interpreted from three viewpoints (summarised by the author in three visual formats: a timeline, process model and tabulated overview) providing a complete, thick case description (Gray, 2004; Baxter & Jack, 2008).

Once data collection and analysis were completed, the case was documented in an in-depth case report (Baxter & Jack, 2008). To ensure or enhance the credibility of this research, the case report and process models were reviewed by the participant to verify accuracy, completeness, terminology correctness and redundancy (Gray, 2004; Yin, 1981; Medina, Okudan Kremer & Wysk, 2013). Finally, to fully understand and accurately interpret findings, case study data were compared with published literature of existing MDD process models (Baxter & Jack, 2008) and this comparison was documented at the end of the case report.

## Case study

In 2013, Jed Aylmer was a BTech Industrial Design student at the University of Johannesburg (UJ). To complete the programme, Aylmer was required to undertake a practical final semester-long design project of his choosing; this was documented in the format of a mini-dissertation. Aylmer saw an opportunity to use his university project to design a MD for the visionary NMCH paediatric healthcare facility (Aylmer, 2017a).

A hospital bed forms the environment in which child patients spend most of their time when in hospital and it is also the object in which parents see their child during hospitalisation (Aylmer, 2013). A variety of paediatric hospital beds are available on the market, however the bed most commonly found in South African paediatric wards is the steel cot (Fig. 2), as it can be used for both young toddlers and children up to the age of five years old (Aylmer, 2013). The design and overall cage aesthetic of these cots have remained the same as beds used in the 1920s. According to Aylmer, the cage-like appearance of most paediatric beds 'subject[s] children to a psychologically disturbing micro-environment' (Aylmer, 2013). Furthermore, observations indicated that the outdated tubular steel construction acts as a hindrance to medical professionals' access to the child during respiratory procedures (Aylmer, 2013) and creates various safety hazards for nurses, with reports of the heavy steel cot side falling onto nurses' feet (Aylmer, 2017a).

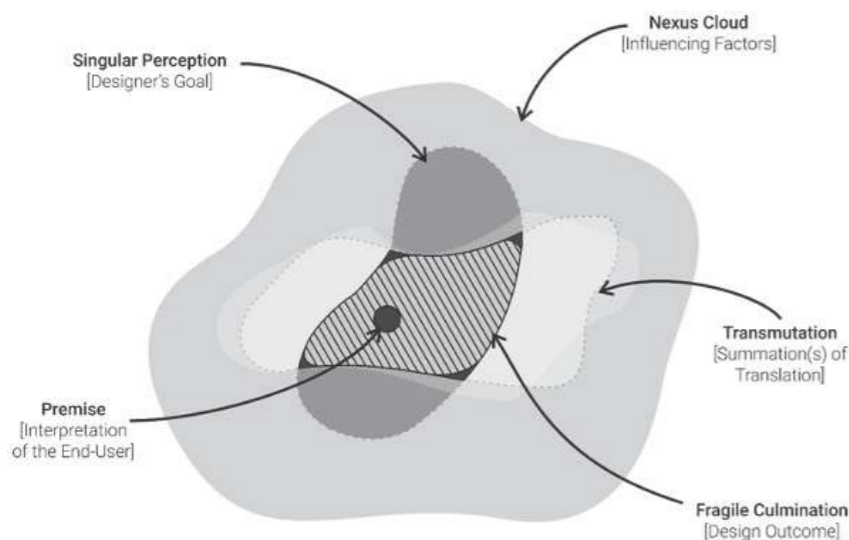


**Figure 2:** Hospital cot at Rahima Moosa Mother and Child Hospital (Aylmer, 2013)

Aylmer set out to redesign an appropriate paediatric hospital cot that offered an alternative to the cold, cage-like beds that he had observed (University of Johannesburg, 2017; Aylmer, 2013). He aimed to improve the product experience of the primary user, the child, and product usability, safety and accessibility by considering the needs and requirements of medical professionals by addressing/improving aesthetics, material choice, durability, accessibility, manufacture quality and audible properties (University of Johannesburg, 2017; Aylmer, 2013). Completing the university project in November 2013, Aylmer has since gone on to develop and manufacture his paediatric hospital bed and founded a MD design and development company, Praestet (Pty) Ltd.

## Design process model description

Various authors have attempted to visualise process models that describe the MDD landscape, however, most diagrams speak to a linear process, which fails to accurately describe the various loops, turns and stops that occur in reality (Ogrodnik, 2012:32). Aylmer described a 'plasmodial soup model' (Fig. 3), an attempt to visually depict how the design process, design thinking and design outcome are constantly changing as the designer operates within and is affected by various external influencing factors such as users, stakeholders, regulations and standards, considerations and context. According to Aylmer, this balancing act comprises five factors: the 'singular perception', the 'nexus cloud', the 'premise', 'transmutation' and the 'fragile culmination' (Aylmer, 2018i; Aylmer, 2018j).



**Figure 3:** Aylmer's plasmodial soup model summary, 2018 (author)

The 'singular perception' refers to the designer's own goals of what the product should be. Aylmer's 'singular perception' was to improve overall product experience by addressing the emotional and functional requirements of users (Aylmer, 2018b). The 'premise' represents the designer's interpretation of the end-users' needs. The 'nexus cloud' refers to all tangible (physical/written) and intangible (thought/feeling) factors (relevant and irrelevant) influencing the design process. 'Tangible factors' include standards, manufacturing constraints, market variables, context/locale and design considerations. "Intangible factors" include external influences, experiences and feelings (Aylmer, 2018i). As the process progressed, the nexus cloud grew/changed as more information became available (Aylmer, 2018i). 'Transmutation' refers to the act of translating the relevant information (identified and drawn from the nexus cloud) into a device design to best satisfy the user (Aylmer, 2018i; Aylmer, 2018j). Aylmer explained that the tensions between the internal influences of the user and designer and external influences, constantly morphed and shaped the process, resulting in various iterations. Finally, the 'fragile culmination' is the design outcome that represents the best compromise between all of the above. The 'fragile culmination' was the point of resolution that best suited the product requirements, specific to its context (the nexus) (Aylmer, 2018i; Aylmer, 2018j).

Analysis of Aylmer's description of his process identified three key categories/influences in the nexus cloud: user needs, stakeholder needs (manufacture and regulators), and financing and project management.

#### User needs

To understand the needs of users/stakeholders of a MD, one must also understand the context/s in which it operates. Aylmer consulted with and gathered insights from over 150 nurses, doctors and health professionals throughout the process through interviews, questionnaires, panel discussions, prototype testing and clinical evaluations (Aylmer, 2017a).

Symba was designed for children between the ages of six months to six years old. From a human-centred design perspective, Aylmer acknowledged that the challenge of designing for paediatrics is that the primary 'exposed' end-user cannot directly inform the process through communicating their needs, wants and feelings (Aylmer, 2017a). Therefore, Aylmer had to uncover insights using methods such as observation, looking at the way that children interact with objects, case studies and psychological research (Aylmer, 2017a). The second group of users identified by Aylmer included patients' parents or guardians, medical doctors and nurses (Aylmer, 2018k). Although these were classified as 'secondary

users', Aylmer acknowledged that this group of users were in fact also 'primary users' because they utilise the product on the outside where a child utilises the product from the inside (Aylmer, 2017a). A significant number of insights and data were collected from secondary users throughout the Symba design and development process. According to Aylmer, secondary users focused on medical functionality and operational and usability concerns (Aylmer, 2017a). Aylmer also consulted with various discipline experts including biokineticists, physiotherapists, psychologists and hospital procurement officers. Aylmer acknowledged that all users, informants and stakeholders have different perspectives and that the design process is very much about balancing those different perspectives to come to a compromise (Aylmer, 2017a).

#### Stakeholder needs

Aylmer identified regulations, standards and manufacturing considerations as a key challenge/influencing factor in the MDDes process (Aylmer, 2017a). 'The medical realm is particularly complicated because manufacture, engineering and design have to follow and work around the regulatory constraints and rules that are given and dictate how a product should be designed' (Aylmer, 2017a). Aylmer (Praestet) was both the designer and manufacturer (in the regulatory sense), working in close conjunction with local suppliers, manufacturers and a team of biomedical engineers (BMEC). Aylmer worked with approximately 16 different manufacturing suppliers who provided practical knowledge regarding the constraints and costs of manufacture (Aylmer, 2018k). The team of biomedical engineers at BMEC was responsible for assessing the stresses, strains and shear points on parts and provided guidance/assistance regarding safety and the certification procedures and requirements (Aylmer, 2018k). Aylmer's role as the designer was to balance the information coming from the biomedical engineers and the constraints of manufacture while maintaining his design intent. As part of the CE Marking application process, Aylmer elected an authorised representative (from Sweden) with whom he consulted during the compilation of the technical file (Aylmer, 2018k).

#### Financing and project management

Aylmer defined the overarching challenge as bringing the device to fruition by combining money, planning, timing and luck. Securing funding, knowing where to turn to next, knowing where in the process you are, and how to get to 'the end' were all 'massive challenge[s]'; all of which he claims to 'still face daily' (Aylmer, 2017a). Securing funding throughout the project was particularly challenging. Aylmer approached various public and private investors and funding organisations throughout the project. The two most significant donors/funding agencies involved in the product development phase of the project were the UJ Technology Transfer Office (TTO) and the Technology Innovation Agency (TIA) seed fund, which financed the building of the full-scale prototype and certification. Working as a sole-designer, manufacturer and business owner in SA, Aylmer stressed the importance of strong partnerships (Aylmer, 2017a). Aylmer identified the NMCH trust as a key partner throughout the process because, although they were not directly involved in the project, their interest and support stimulated the undertaking of the process in the first place (Aylmer, 2017a; Aylmer, 2018k). The UJ TTO was also identified as a key partner during the project, assisting with initial funding, early-stage commercialisation advice, structuring the initial stages of the business plan, intellectual property protection, and assisting with initial refinement of the product, through Resolution Circle's team of engineers (Aylmer, 2017a; Aylmer, 2018k).

#### Considerations, requirements and design outcome

Aylmer's initial four guiding design principles (based on his singular perception) were: 'cage', 'rust', 'get-in' and 'squeak'. These principles spoke to product experience, material choice/durability, safety/accessibility, and manufacture quality (2017a). While navigating the various views, insights, requirements and considerations of the role players and factors in the nexus cloud, the core design considerations can be divided into functional considerations (safety, hygiene, access, mobility, medical functionality and usability) and product experience/aesthetics (Aylmer, 2017a).

### Appropriate product experience and aesthetics

Appropriate aesthetics can reduce stress for patients and improve clinical adoption leading to more staff using it, and using it more often (Core77, 2016). According to Aylmer, MDDes is about perception (Aylmer, 2017a): ‘Hospitalisation is a horrible experience’ and his primary concern was, therefore, that of product experience (Aylmer, 2017a). Aylmer’s goals were to reduce the psychological impact of the cage-like beds on child patients through revaluating/re-approaching aesthetics and the way they appealed to the senses (Aylmer, 2017a), and to meet the needs of nurses who ‘also want to feel that they’ve got products in their ward that inspire confidence in the product and the equipment that they have’ (Aylmer, 2017a). Abandoning the heavy, cold, steel cage-like bars of existing cots, Symba’s injection- moulded clear cot side panels provide visibility (visual access) of the patient while allowing patients to feel less constrained by the cot. This also creates an environment in which the child can engage with parents, medical professionals and other patients. The soft forms and bright colours of Symba’s body ‘bring life to hospital rooms’ and create a softer, more comforting environment for children (Praestet, 2020). The high-tech, high quality aesthetic of Symba far removes it from the old, ‘basic’ aesthetic of the metal cages, which improves faith and pride in the product and its clinical efficiency. Aylmer also paid particular attention to the sound of the device (such as wheels, buttons, brakes) and the effect of these sounds on the patient environment (Aylmer, 2018b). The change in material – from cold hard metal to a warm soft plastic – drastically changes the aesthetic, tactile and sound qualities of the product (Fig. 4).

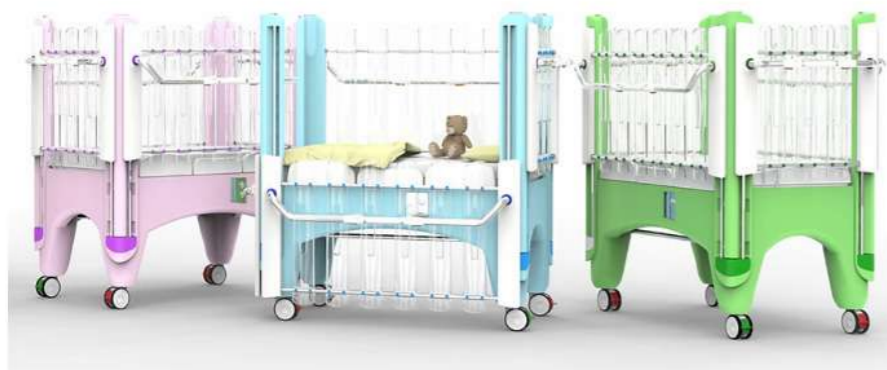


Figure 4: Symba paediatric hospital bed (Praestet, 2020)

### Appropriate functionality, safety and maintenance

The change in material, manufacture and form-giving/aesthetics not only improved product experience but also addressed the functional requirements of safety, hygiene, access, mobility, medical functionality, usability. The seamless design of the rotational moulded main components is easier to clean and reduces the chances of bacteria hiding in crevices, improving hygiene and infection control (Praestet, 2020). The individually operated cot sides are controlled using a dual-locking spring system, allowing the user to position each cot side in four safety configurations, locking properly and securely into place quickly in an emergency (Praestet, 2020). The spring system reduces strain on nurses when operating the sides and prevents risk of collapsing sides. Unlike existing cots, each cot side can be lowered, enabling access to the patient from all sides, which improved usability during respiratory procedures (Praestet, 2020). Symba has four, lockable, easy-to-manoeuvre medical-grade casters to enhance safety and ease of mobility (Praestet, 2020).

### Appropriate references

Although Symba was designed in and for the South African context, Aylmer explained that the South African Bureau of Standards (SABS) did not have a recent standard for paediatric hospital beds. According to Aylmer (2018a), the German Institute for Standardization (DIN), had the most comprehensive standard for paediatric hospital beds (DIN 32623:2009-

11) and he therefore referred to that standard when designing Symba. Furthermore, he explained that, at the time, SA had no local regulatory authority or framework in place. Aylmer, therefore, chose to pursue CE Marking certification as it would allow him to trade in Europe and made good business sense as the CE Marking is an international ‘mark of quality’ that many procurement agencies look for when choosing MDs (Aylmer, 2018a).

### Findings and discussion

#### Design is the process

When comparing Aylmer’s design process to that seen in existing literature, two similarities were identified. Firstly, Aylmer’s MDDes description of the nexus cloud links strongly to an existing MDD process description of a ‘data cloud’ (Ogrodnik, 2012:88). Both of these ‘clouds’ describe the various regulatory, market, user, IP, manufacture (and more) considerations that ‘float around’ the project and influence the design process. The difference, however, is that Ogrodnik speaks only to the data cloud when defining product specifications at the beginning of the process. Aylmer’s description differs in the sense that he described the nexus cloud as a constant undertaking at every step and within every phase of the project. Secondly, one can draw similarities between Aylmer’s ‘Plasmodial Soup Model’ and IDEOs model of innovation (Fig. 5), which describes ‘design’ as the balancing act of feasibility, viability and desirability, and achieving a balance of all three of these constraints will arrive at successful, innovative outcomes (Brown, 2009:18). Similarly, Aylmer’s model depicts the balance and alignment of the designer’s goal, the user needs, design activities and feasibility and viability concerns as defined in the nexus cloud. The overlap, the ‘fragile culmination’ refers to the design outcome that serves as the best compromise of all factors. It is interesting to note that Aylmer’s process description links to IDEOs description of design thinking (IDEO, 2015). This highlights that design and design thinking are fundamentals of the MDD (hence the new term MDDes used in this paper) process and not only a small component within the process, as is suggested in the existing literature.

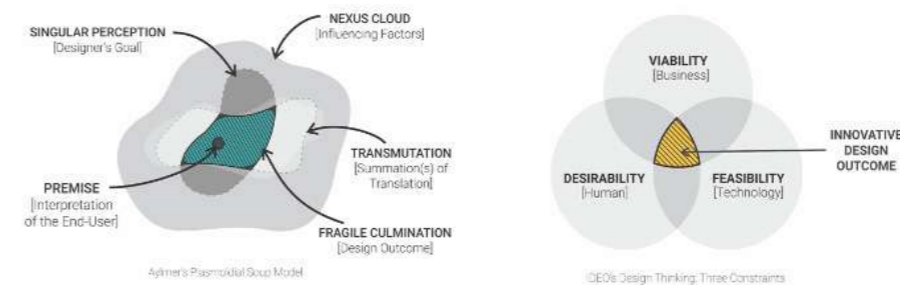


Figure 5: Plasmodial soup model and IDEO constraints model comparison, 2018 (author)

### Human-centred vs regulation-centred

User involvement in the MDDes process increases the likelihood of producing MDs that are safe, usable, compliant, clinically effective and appropriate to cultural context (Money *et al.*, 2011:3; Shah *et al.*, 2009:4; Martin *et al.*, 2012:189). The fact that the Symba project was led by an industrial designer is evident in the fact that the early phases focused mostly on desirability/human-centred concerns first (emotional and functional needs of users), then only followed by market, feasibility, and viability and regulatory concerns. The main difference between Aylmer’s case and process outlined in the literature was the significant focus on user involvement throughout the whole process with a strong focus on human factors and product experience, not only standards and regulatory controls and requirements.

### Locally suited to an international standard

Aylmer's need to pursue CE Marking certification highlighted a significant fact; that up until recently (2017) SA had no framework in place to regulate and monitor MDs. The absence of an established regulatory framework in SA may explain the limited local MDD activity. As a result, Aylmer had to refer to European standards and regulations. In a way, this served as an advantage in Aylmer's case. Unlike products that are designed to suit international standards in international contexts, designing and manufacturing a device for and within the South African context allowed Aylmer to consult frequently with local experts, with experience and valuable insight into the appropriate design of this bed. The design of Symba was informed by the South African context and local experts and experiences while meeting the quality requirements of international (European) standards and regulations. In doing so, the product is suited to local needs, while maintaining an international standard. This debunks the notion that products in LMICs should be stripped-down versions of first-world products. Furthermore, being suited to international contexts allows for exporting and industry participation. Symba has since been exported and shown at international expos, demonstrating that although this device is suited to the local context, it holds its own in international HICs as well.

### Locally trained and maintained

Symba is manufactured locally. This allows for appropriate training, maintenance, monitoring and design improvements (none of which are available when a device is donated/imported). The ability to maintain the product without waiting for months at a time for parts to be repaired or replaced, makes Symba a more appropriate solution than imported designs.

### CONCLUSION

The introduction of a new regulatory framework in SA serves as an opportunity for increased local development of MDs. This case study serves as an example of how MDs should be designed to be appropriate for users' needs, but also benefit local design and manufacture towards good quality, suitable outcomes for an LMIC context, and the world. This case study showed that, for a MD to be appropriate in LMICs, it must be design-led, human-centred, contextually-embedded, locally manufactured and supported, whilst meeting the requirements of international standards, which in turn offers the potential for international retail opportunities.

### LIST OF REFERENCES

- Aylmer, J. 2013. *The design of a user-centred paediatric hospital bed for the Nelson Mandela Children's Hospital: A study informed by the South African context*. Unpublished (BTech) thesis. Johannesburg: University of Johannesburg.
- Aylmer, J. 2017a. Verbal communication with the author on 20 November. Auckland Park. (Transcript/notes/recording in possession of the author).
- Aylmer, J. 2018a. Verbal communication with the author on 1 March. Auckland Park. (Transcript/notes/recording in possession of the author).
- Aylmer, J. 2018b. Verbal communication with the author on 27 March. Auckland Park. (Transcript/notes/recording in possession of the author).
- Aylmer, J. 2018i. Verbal communication with the author on 13 July. Auckland Park. (Transcript/notes/recording in possession of the author).
- Aylmer, J. 2018j. Verbal communication with the author on 25 September. Auckland Park. (Transcript/notes/recording in possession of the author).
- Aylmer, J. 2018k. Verbal communication with the author on 3 October. Auckland Park. (Transcript/notes/recording in possession of the author).
- Baxter, P. & Jack, S. 2008. Qualitative case study methodology: Study design and implementation for novice researchers. *The Qualitative Report*, 13(4),544-556.
- Braun, V. & Clarke, V. 2012. Thematic analysis. In Cooper, H. (ed.), *APA Handbook of Research Methods in Psychology* (Vol. 2). *Research designs: Quantitative, qualitative, neuropsychological, and biological*. American Psychological Association.
- Brown, T. 2009. *Change by design: How design thinking transforms organizations and inspires innovation*. New York: HarperCollins Publishers.
- Bullock, A. M. 2019. *Defining a design process model for paediatric medical device design in the South African context*. Unpublished (MA Design) thesis. Johannesburg: University of Johannesburg.
- CapeRay. 2018. *A revolution in breast imaging*. [Online] Available from: <http://www.caperay.com> [Accessed: 2018].
- Chan, M. D. 2010. Medical devices: An area of great promise. *Opening Address at the global Forum on Medical Devices*. [Online] Available from: [http://www.who.int/dg/speeches/2010/med\\_device\\_20100909/en/](http://www.who.int/dg/speeches/2010/med_device_20100909/en/).
- Cheng, M. 2003. *Medical device regulations: Global overview and guiding principles*. Geneva: World Health Organisation.
- Core77. 2016. *Firefly infant phototherapy*. [Online] Available from: <http://designawards.core77.com/Design-for-Social-Impact/50550/Firefly-Infant-Phototherapy>. [Accessed: November 01, 2017].
- Dellinger, B. 2009. Healing environments. In McCullough, C. S. (ed.), *Evidence Based Design for Healthcare Facilities* (pp. 45-79). Indianapolis: Sigma Theta Tau International.
- Desmet, P. M. 2004. *Design and Emotion*. In McDonagh, D., Hekkert, P., van Erp J. & Gyi, D. (eds.) London: Taylor & Francis.
- Desmet, P. & Hekkert, P. 2007. Framework of product experience. *International Journal of Design*, 1(1),57-66.

- Dyro, J. 2004. *Clinical engineering handbook*. New York: Academic Press.
- Frost & Sullivan. 2017. *Transformation of medical device industry*. [Online] Available from: <https://ww2.frost.com/frost-perspectives/transformation-medical-device-industry1/> [Accessed: June 26, 2018].
- Goldkuhl, G. 2012. Pragmatism vs interpretivism in qualitative information systems research. *European Journal of Information Systems*, 21(2),135-146.
- Gray, D. E. 2004. *Doing research in the real world*. London: Sage Publications.
- IDEO. 2015. *The field guide to human-centered design* (1st ed.). IDEO.org.
- Kolko, J. 2010. Abductive thinking and sensemaking: The drivers of design synthesis. *Design Issues*, 61(1),15-28.
- Kopec, D. 2012. *Environmental psychology for design*. New York: Fairchild.
- Kothari, C. R. 2004. *Research methodology: Methods and techniques*. New Delhi: New Age International Publishers.
- KPMG. 2014. *Industry overview and economic impact for the South African medical technology industry*. [Online] Available from: SAMED: <http://www.samed.org.za/DynamicData/LibraryDownloads/173.pdf> [Accessed: 2018].
- Lodox. 2015. *Lodox Full-Body, High-Speed Digital Radiology*. [Online] Available from: <http://lodox.com/> [Accessed: 2017].
- Malkin, R. & von Oldenburg Beer, K. 2013. Diffusion of novel healthcare technologies to resource poor settings. *Annals of Biomedical Engineering*, 41(9),1841-1850.
- Martin, J. L., Clark, D. J., Morgan, S. P., Crowe, J. A. & Murphy, E. 2012. A user-centred approach to requirements elicitation in medical device development: A case study from an industry perspective. *Applied Ergonomics*, 43,184-190.
- McAndrews, L. A. 2005. Introduction. In Komiske, B. K. (ed.), *Designing the World's Best Children's Hospitals 2: The Future of Healing Environments* (p. 7). Victoria: Images Publishing.
- McCullough, C. S. 2009. Evidence based design. In McCullough, C. S. (ed.), *Evidence Based Design for Healthcare Facilities* (pp. 1-18). Indianapolis: Sigma Theta Tau International.
- Medina, L. A., Okudan Kremer, G. E. & Wysk, R. A. 2013. Supporting medical device development: A standard product design process model. *Journal of Engineering Design*, 24(2),83-119.
- Merriam, S. 1998. *Qualitative research and case study applications in education*. San Francisco: Jossey-Bass Publishers.
- Mitchell, L. 2017. *The supply and manufacture of medical and surgical equipment and orthopaedic appliances*. [Online] Available from: Who Owns Whom: <https://www.whoownswhom.co.za/store/info/4504?segment=Healthcare> [Accessed: May 06, 2018].
- Money, A. G., Barnett, J., Kuljis, J., Craven, M. P., Martin, J. L. & Young, T. 2011. The role of the user within the medical device design and development process: Medical device manufacturers' perspectives. *BMC Medical Informatics and Decision Making*, 11(15).
- Munro, A. 2014. *Research methods in the arts: A guiding manual*. Tshwane: Tshwane University of Technology. Tshwane: Tshwane University of Technology.
- Ogrodnik, P. J. 2012. *Medical device design: Innovation from concept to market*. London: Academic Press.
- Praestet. 2020. *Symba paediatric hospital bed*. [Online] Available from: <https://www.praestet.com/symba-manual> [Accessed: 2018].
- Prestero, T. 2010. Better by design: How empathy can lead to more successful technologies and services for the poor. *Innovations*,79-93.
- Prestero, T. 2012. *Design for people, Not awards. TEDx Boston*. [Online] Available from: [https://www.ted.com/talks/timothy\\_prestero\\_design\\_for\\_people\\_not\\_awards](https://www.ted.com/talks/timothy_prestero_design_for_people_not_awards) [Accessed: April 04, 2017].
- SAMED. (n.d.). *The South African medical device industry - facts*. [Online] Available from: <http://www.samed.org.za/DynamicData/LibraryDownloads/224.pdf> [Accessed: April 23, 2018].
- Santos, I. C., Gazelle, G. S., Rocha, L. A. & Tavares, J. M. 2012. *An ontology model for the medical device development process in Europe*. [Online] Available from: <https://repositorio-aberto.up.pt/handle/10216/62387>. [Accessed: April, 2013].
- Scherer, K. R. 2001. Appraisal considered as a process of multi-level sequential checking. In Scherer, K. R., Schorr, A., Johnstone T., Scherer, K. R., Schorr, A. & Johnstone, T. (eds.), *Appraisal process in emotion: Theory, methods, research* (pp. 92-120). New York: Oxford University Press.
- Shah, S. G., Robinson, I. & Alshawi, S. 2009. Developing medical device technologies from users' perspectives: A theoretical framework for involving users in the development process. *International Journal of Technology Assessment in Healthcare*, 25(04),514-521.
- Starman, A. B. 2013. The case study as a type of qualitative research. *Journal of Contemporary Educational Studies*,28-43.
- Teixeira, M. B. 2014. *Design controls for the medical device industry* (2nd ed.). Boca Raton: CRC Press, Taylor and Francis Group.
- Thanh, N. C. & Thanh, T. T. 2015. The interconnection between interpretivist paradigm and qualitative methods in education. *American Journal of Educational Science*, 1(2),24-27.
- University of Johannesburg. 2017. *UJ Graduate designs innovative bed for Nelson Mandela Children's Hospital*. [Online] Available from: <https://www.uj.ac.za/newandevents/Pages/UJ-Graduate-designs-innovative-bed-for-Nelson-Mandela-Children%E2%80%99s-Hospital.aspx>.
- World Health Organisation. 2010. *Medical devices; Managing the mismatch: An outcome of the priority medical devices project*. Geneva: World Health Organisation.
- World Health Organisation. 2011. *Medical device donations: Considerations for solicitation and provision*. Geneva: World Health Organisation.
- World Health Organisation. 2012. *Local production and technology transfer to increase access to medical devices*. Geneva: World Health Organisation.
- World Health Organisation. 2016. *Towards improving access to medical devices through local production*. Geneva: World Health Organisation.
- World Health Organisation. 2016. *Towards improving access to medical devices through local production, Phase 2: Report of a case study in four Sub-Saharan countries*. Geneva: World Health Organisation.
- Yin, R. K. 1981. The case study as a serious research strategy. *Knowledge: Creation, Diffusion, Utilization*, 3(1),97-114.
- Zimmerman, J., Stolterman, E. & Forlizzi, J. 2010. *An analysis and critique of research through design: Towards a formalization of a research approach. Proceedings of the 8th ACM conference on designing interactive systems*. New York: Association for Computing Machinery.
- Zimring, C., Augenbroe, G. L., Malone, E. B. & Sadler, B. L. 2008. Implementing healthcare excellence: The vital role of the CEO in evidence-based design. *Health Environments Research & Design Journal*,1(3).

# A NARRATIVE REVIEW OF LEAD POISONING AND ANTI-SOCIAL BEHAVIOUR IN SUB-SAHARAN AFRICAN COUNTRIES

Thokozani P. Mbonane

The University of Johannesburg, Department of Environmental Health, Doornfontein Campus,  
P. Bag 524, Auckland Park 2006, Johannesburg, South Africa  
tmbonane@uj.ac.za

## Abstract

*Epidemiological studies show that there is an association between environmental lead exposure and antisocial and criminal behaviour. This ultimately has detrimental effects on society in general. The objectives of this review are to describe studies that have investigated correlations between environmental lead levels and anti-social behaviour in low and middle-income countries (LMIC) and its implications for public health and crime intervention. The literature was searched using academic and scientific search engines and a research articles database for studies covering the period from January 2000 to March 2020. The search selected studies that focused on associations between blood lead levels and anti-social behaviour. This review identified 11 articles globally: three (36%) were conducted in low-and-middle-income-countries (LMIC) while seven (64%) were from rich countries. Six focused on societal mis-behaviour: delinquent, violent, aggressive, anti-social and destructive behaviours. Five focused on criminal behaviour in early adolescence. We based our review on three studies that were conducted in sub-Saharan African countries. There is a dearth of information on the association of environmental lead exposure with antisocial behaviour in the LMIC, especially in African countries. Elsewhere, studies have sought to determine the relationship between long-term lead exposure and anti-social behaviour. Studies are focusing on vulnerable communities where there is evidence of anti-social behaviour. There is a need for analytical and intervention research in LMIC to describe human lead level distribution amongst exposed and vulnerable groups and its association with anti-social behaviours.*

**Keywords:** blood lead levels, environmental health, lead exposure, lifetime exposure.

## INTRODUCTION

Anti-social behaviour is a growing public health challenge globally, especially in under-resourced countries due to its resulting effects such as injuries, disability and death (Hammerton, Mahedy, Murray, Maughan, Edwards, Kendler, Hickman, & Heron, 2017). Anti-social behaviour includes aggression, violent criminal activities, risky behaviour and delinquency. Behaviour is influenced by biological, psychological, social, economic and environmental factors (Weiss and Bellinger, 2006; Tchounwou, Yedjou, Patlolla & Sutton, 2012; Tuvblad and Beaver, 2013). Environmental exposure to pollutants such as lead (Pb) are preventable yet have detrimental health effects and behavioural outcomes on children and later in young adulthood (Weiss and Bellinger, 2006; Mazumdar, Bellinger, Gregas, Abanilla, Bacic & Needleman, 2011).

Lead is a toxic metal that affects the brain and nervous system, with adverse consequences such as antisocial and violent criminal behaviour (Menon, George, E., Osterman, M. and Pecht, M. 2015). Lead is a naturally occurring heavy metal and is used in many industries due to characteristics such as its low melting point, its resistance to corrosion and its malleability (Shukla, Shukla and Tiwari, 2018, (Meyer, Brown and Falk, 2008). Human exposure to lead arises from contact with paint (including paint on children's toys), vehicle exhaust gases, industrial activities, solder in canned foods, water in old pipes, cottage industries (Montgomery and Mathee, 2005; Mathee, Röllin, von Schirnding, et al., 2006; Mathee, Röllin, Levin & Naik, 2007; Sweeney, Yu, Parker, & Dummer, 2017; Tirima, Bartrem, von Lindern, von Braun, Lind, Anka, & Abdullahi,

2018). Furthermore, the pathways are contaminated air, soil, household dust, domestic water, food and road dirt (Olowoyo, van Heerden, Fischer, & Baker, 2010; Zolaly, Hanafi, Shawky, el-Harbi & Mohamadin, 2012). Exposure to lead in the environment is via water, soil, and food or being inhaled from the atmosphere (Semlali, Dessogne, Monna, Bolte, Azimi, Navarro, Denaix, Loubet, Chateau & van Oort, 2004; Laidlaw, Pingitore, Clague, Devlin & Taylor, 2014). It can also be passed from a mother to an unborn child through the placenta (Schell, Denham, Stark, Gomez, Ravenscroft, Parsons, Aydermir & Samelson, 2003; Rudge, Röllin, Nogueira, Thomassen, Rudge, & Odland, 2009) or by the dermal route (Lin *et al.*, 2011).

Environmental lead exposure risk factors include the proximity of industries that emit lead in the atmosphere (Stroh, Lundh, Oudin, Skerfving & Strömberg, 2009) second-hand smoking due to the presence of smokers in the house (Taylor, Golding, Hibbeln and Emond, 2013), regular consumption of leaded-canned foods (Zolaly *et al.*, 2012), hand-to-mouth activities (Mathee, Naicker, Kootbodien, Mahuma, Nkomo, Naik & de Wet, 2014), melting of lead (Brown, Kim, Yomai, Meyer, Noonan & Flanders, 2005; Mathee, Khan, Naicker, Kootbodien, Naidoo & Becker, 2013), use of traditional (ayurvedic) medicine which contains lead (Gunturu, Nagarajan, McPhedran, Goodman, Hodsdon & Strout 2011; Breeher, Gerr and Fuortes, 2013; Mathee, Naicker and Teare, 2015) lead-containing skincare powder, Chinese traditional/herbal medicine (Lin *et al.*, 2011) Parents' educational level correlates with children's accidental exposure to lead (Cao, Li, Wang, Yu & Yan, 2014).

In rich countries, estimates show that lead-related annual health cost is about \$50 billion (Gould, 2009) and €22.7 billion while in poorly-resourced countries estimates are around \$134.7 billion (Attina and Trasande, 2013). Lead affects most systems and organs of the body while the kidney, brain, and heart are the most affected. Absorbed lead is mostly stored in the bones (Flora, Flora and Saxena, 2006). Lead exposure impacts the central nervous system leading to brain problems, intellectual impairment, attention problems, reduced cognitive abilities and anti-social behaviour (Sciarillo, Alexander and Farrell, 1992; Washerman, Staghezza-Jaramillo, Shrout, Popovac & Graziano, 1998; Lanphear, Dietrich, Auinger & Cox, 2000; Mazumdar *et al.*, 2011; Chen, Wu, Liu, Parvez, Lofacono, Gibson, Kioumourtoglou, Levy, Shahriar, Uddin, Islam, Lomax, Saxena, Sanchez, Santiago, Ellis, Ahsan, Wasserman & Graziano, 2019). Globally, there is growing scientific evidence that childhood exposure to lead can result in antisocial behaviour such as delinquent, aggressive and violent acts and may predict future criminal behaviour (Needleman, Riess, Tobin & Biesecker & Greenhouse, 1996; Nevin, 2007; Wright *et al.*, 2008; Nkomo, Mathee, Naicker, Galpin, Richter & Norris, 2017; Nkomo, Naicker, Mathee, Galpin, Richter & Norris, 2018). Most rich countries have implemented numerous interventions to minimize and control exposure to lead, but only a few LMIC in sub-Saharan Africa have removed lead from petrol/gasoline and legislated lead levels in paint (Mathee, 2014).

This narrative review describes the current evidence for environmental lead exposure and anti-social behaviour amongst the most affected populations and its implication on public health in poorly resourced countries in sub-Saharan Africa.

## METHODS

Search for literature

To compile this narrative review article, search engines such as Google Scholar, PubMed, Scopus, Science Direct and SciELO were used to access scientific studies that associated bone and blood lead levels and anti-social behaviour, especially in LMIC. The search included the following terms: "blood lead", "bone lead", "lead exposure and antisocial behaviour", "childhood lead exposure", "lifetime or short-term lead exposure" lead exposure and violent behaviour", "lead exposure and aggressive" and "lead exposure and criminal behaviour". The review also considered other behavioural issues associated with childhood lead exposure amongst teenagers, youths, and young adults. The results of epidemiological studies on lead exposure and anti-social behaviour worldwide are tabulated in Table 1. Only three studies were used in the review conducted in sub-Saharan Africa.

## Data screening, extraction, and synthesis

Preferred Reporting Items for Systematic Reviews and Meta-Analyses (PRISMA) was used to extract, synthesize, and present information in a flow diagram (Figure 1). The studies were extracted and a synthesis was conducted by two researchers (TPM & PCR). One was the author of this paper and the other an independent colleague who did not take part in the drafting of the review paper. We agreed on the search parameters and then searched independently. Thereafter, the identified articles were compared and merged and duplicated search results were identified. Once duplicated papers were removed, we screened the abstracts to check the eligibility of the study to be included in the review. Only papers that met the criteria in terms of the topic of interest were included and noted. These papers were assessed to check the year the study was conducted, the type of study



(ecological or cross-section), country and outcome measure studied.

### Study eligibility

The studies that were included in the review were conducted in Sub-Saharan Africa from January 2000 to March 2020. There were no studies in the other parts of the sub-Saharan African region that determine a link between elevated lead levels and any form of anti-social behaviour. The review excluded case studies, review papers, and other papers based on commentaries. Furthermore, papers based on occupational lead exposure did not form part of the review. The review focused only on environmental lead exposure.

### RESULTS

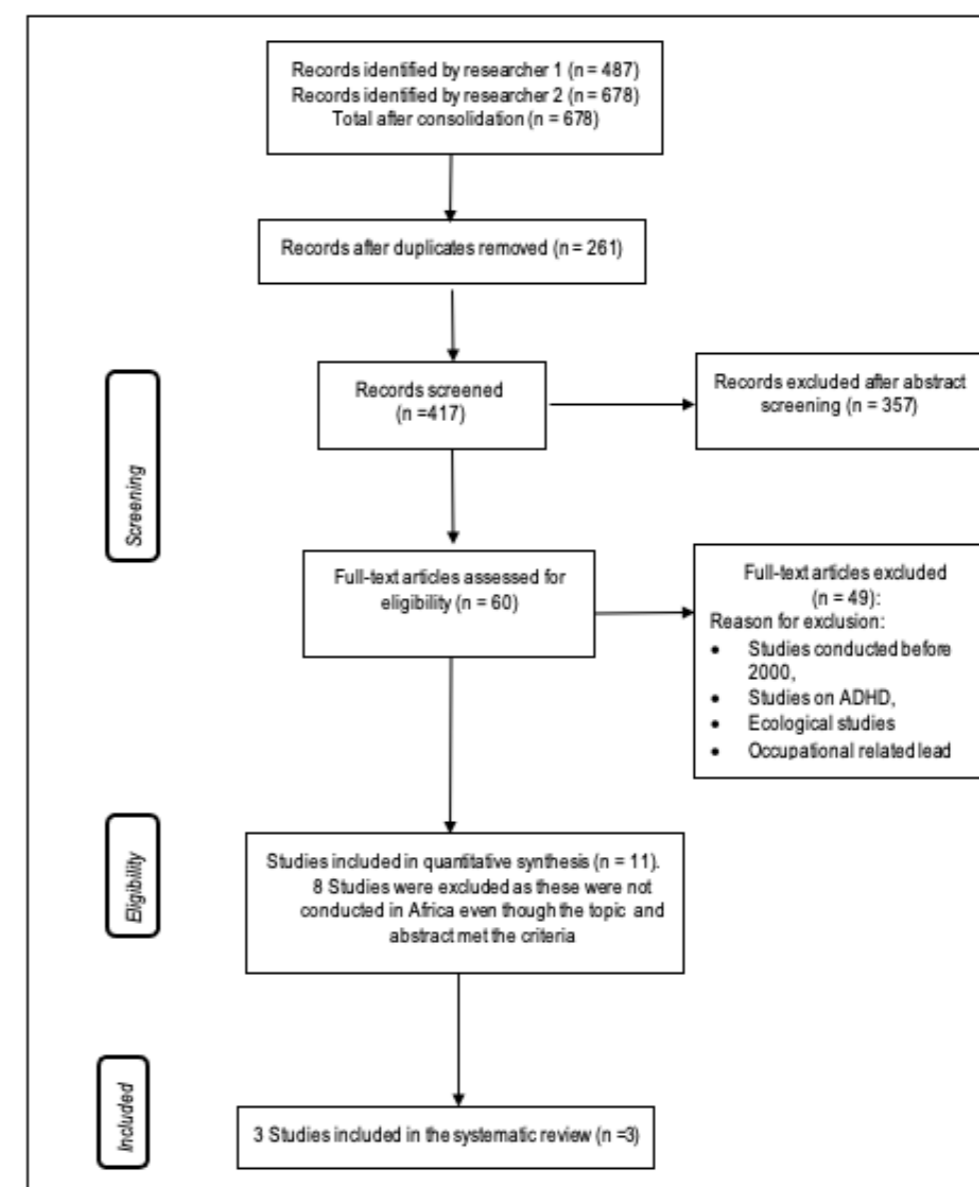
In this review, we found that there was limited scientific evidence in sub-Saharan Africa about correlations between environmental lead exposure and behavioural problems. The few studies we found for southern Africa had been conducted in one country (South Africa). Studies included in the review were conducted in 20-2018. From the total extracted data, 11 articles met the search criteria in terms of keywords, title and abstract (Table 1). However, only three studies were included in the narrative review, as shown in Table 2.

**Table 1.** Epidemiological studies on lead exposure and antisocial behaviour

Author/s, year	Population No. of participants Age (Age Mean )	Country
(Dietrich <i>et al.</i> , 2001)	Teenagers: 195, 15-17 years	USA
(Needleman <i>et al.</i> , 2002)	Youths: 340, 12-18 years	USA
(Wright <i>et al.</i> , 2008)	Youths: 250, 19-24 years	USA
(Fergusson, Boden and Horwood, 2008)	Young adults: 1 265, 14-21 years	New Zealand
(Olympio <i>et al.</i> , 2010)	Youths: 173, 14-18 years	Brazil
(Naicker <i>et al.</i> , 2012)	Teenagers: 1 041, 13 years	South Africa
(Nkomo <i>et al.</i> , 2017)	Adolescents: 1 332, 15-16 years	South Africa
(Beckley <i>et al.</i> , 2018)	Teenagers: 1041, 13 years	New Zealand
(Nkomo <i>et al.</i> , 2018)	Adolescents: 1 086, 14-15 years	South Africa
(Sampson and Winter, 2018)	Adolescents: 202, 9-18 years.	USA

### Epidemiological studies on lead exposure and antisocial behaviour

Three studies have linked environmental lead exposure and behavioural problems in the Southern African region (Naicker, Richter, Mathee, Becker & Norris, 2012; Nkomo *et al.*, 2017, 2018). All these studies were cross-sectional analytical studies, with collected data from the same population (Birth Twenty Cohort-B20t). The total population from these studies was 3 459 (males 1 643; females 1 816). Data were collected at different ages 13 (Naicker *et al.*, 2012), 14-15 (Nkomo *et al.*, 2018) and 15-16 (Nkomo *et al.*, 2017). The age range was 13-16 years, and the mean age was 14.5 years.



**Figure 1.** PRISMA flow diagram

**Table 2.** Studies included in the narrative review

Author	Type of Study	Measure Outcome (MO)	Lead levels measurement	Tool for MO	Adjusted confounding factors	Key findings
Naicker et al.	Cross-sectional	Socio-adjustment behaviour	Blood <sup>1</sup>	YSR <sup>2</sup>	Socio-economic factors	Elevated blood lead levels contribute to anti-social and destructive behaviour in boys during early teens
Nkomo et al.	Cross-sectional	Aggression behaviour	Blood	YSR	Ethnicity Gender Maternal education at birth Maternal age at birth Parents marital status SES <sup>3</sup>	Environmental lead exposure contributes to severe violent behaviour in the late adolescence
Nkomo et al.	Cross-sectional	Violent behaviour	Blood	YSR	Gender Maternal education at birth Maternal age at birth Parents marital status SES	Elevated blood lead levels are associated with direct and indirect violent behaviour in late teens

<sup>1</sup>Blood lead levels were measured by collecting venous blood

<sup>2</sup>YSR-Youth Self-Reported

<sup>3</sup>SES-Socio-economic status

**Biomarkers and blood lead levels**

Globally, numerous biomarkers such as leg bone and surface dental enamel have been used to assess lifetime lead levels and associate them with behavioural problems. For bone measurement, most studies measure the tibia or patella on the left using a lab-based K X-ray fluorescence (KXRF), while there is a growing number of researchers that have used Handheld X-ray fluorescence (Nie, Sanchez, Newton, Grodzins, Cleveland & Weisskopf, 2011). See Figure 2 and 3 for the difference in the two techniques. In the three studies used in this review, all studies analysed for short-term lead exposure using blood as the media analysed.

The blood samples were collected at age 13 in all three studies. Blood lead levels were reportedly grouped into three

categories according to Table 3, and < 5 µg/dL was used as the reference level in all three studies (Table 3). The studies reported blood lead levels ranging from 1.0 to 28.1 µg/dL, with a median of 5.4 µg/dL and the geometric mean of 5.2 µg/dL. Males show higher blood lead levels compared to females in all studies included in the review.

**Table 3.** Blood lead levels classification according to categories.

Blood lead levels	Classification
<5 µg/dL	Low risk
5–9.99 µg/dL	Intermediate risk
≥10 µg/dL	Very high risk

**Risk factors associated with lead exposure and behavioural problems**

To determine risk factors, most of the researchers used an international adopted questionnaire tested in previous studies elsewhere. Environmental risk factors associated with behavioural problems in South African studies are socio-demographic factors at pre-natal and post-natal (shown in Table 4).

**Table 4.** Risk Factors for high blood lead levels.

Risk factors
Gender
Maternal education at birth
Maternal age at birth
Maternal status at hospital
Hospital of birth
Socio-economic factors
Ethnicity

**Measurement of antisocial, aggression and violent behaviour**

The Youth Self-Reported tool was used in the three studies. The YSR is a self-report questionnaire comprising 112 items assessing behavioural competency and problems of children and adolescents aged 11 to 17. It assesses behavioural problems such as aggressive and oppositional behaviour attention seeking, as well as psychotic and impulsive behaviour and social interaction and conduct problems, among others (Achenbach and Rescorla, 2001).

**Association between environmental lead exposure and antisocial behaviour**

Studies in this review found an association between environmental lead exposure and different types of antisocial behaviour (see Table 2). One study found an association with anti-social and destructive behaviour. The other two determined an association with violent behaviour and aggression respectively. In 2018, a study conducted in Johannesburg looking at two types of behavioural problems, namely direct and indirect aggression (Nkomo *et al.*, 2018).

**DISCUSSION**

The review aimed to describe current evidence on the link between environmental lead exposure and anti-social behaviour in Sub-Saharan Africa. Most of the studies conducted in this country have focused on children’s environmental exposure and blood lead distribution. Few studies have described lead levels in the environment such as in children’s playgrounds (Mathee, Singh, Mogotsi, Timothy, Maduka, Olivier & Ing, 2009), soil and vegetables (Olowoyo *et al.*, 2010), areas near mines (von Schirnding *et al.*, 2003; Yabe, Nakayama, Ikenaka, Yohannes, Bortey-Sam, Oroszlany, Muzandu, Choongo, Kabalo, Ntapisha,

Mweene, Umemura & Ishizuka, 2015; Bello, Naidu, Rahman Liu and Dong, 2016), painted objects (O'Connor, Hou, Ye, Zhang, Ok, Song, Coulon, Peng, & Tian, 2018) and environmental lead affected communities (Mbongwe *et al.*, 2010; Mathee *et al.*, 2013; Monebenimp, Kuepouo, Chelo, Anatole, Bissek & Gottesfeld, 2017). Despite growing evidence in rich countries that have shown an association between lead exposure and different types of anti-social behaviour such as violent, aggression and criminal behaviour (Stretesky and Lynch, 2001; Boutwell Nelson, Emo, Vaughn, Schootman, Rosenfiel & Lewis, 2016; Boutwell, Nelson, Qian, Vaughn, Wright, Beaver, Barnes, Petkovsek, Lewis, Schootmoon & Rosenfeld, 2017; Taylor, Forbes, Opekin, Parr & Lanphear, 2016), there is a lack of ecological studies that have associated lead exposure with anti-social behaviour in LMIC countries. Studies in rich countries have found an association with elevated lead levels and anti-social behaviour.

#### **Comparing levels between LMIC and rich-countries**

The studies included in the review provide clear evidence that blood lead distributions in Southern African children have started to decline following the introduction of unleaded petrol (Mathee, Röllin, Von Schirnding, *et al.*, 2006), certain groups continue to be exposed to environmental lead (Mathee *et al.*, 2007; Mathee and Street, 2020) from multiple sources. Surprisingly, the blood lead distributions from the three studies used in the review were similar when compared to a recent study from rich-countries countries (Beckley Caspi, Broadbent, Harrington, Houts, Poulton, Ramrakha, Reuben & Moffitt 2018). It is important to note that the researchers used young offenders as their sample population while all three Sub-Saharan African studies used general population. However, the blood lead levels were higher when compared to non-offenders in other countries (Roy *et al.*, 2009). However, blood lead levels in South Africa were lower than other LMIC like China (He, Wang and Zhang, 2009).

#### **Risk factors associated with lead exposure and behavioural issues**

The review shows that most risk factors are closely related to the living standards of the participants. These were similar to other studies conducted elsewhere. However, a cohort study conducted in Dunedin did not find a correlation in childhood lead exposure and anti-social behaviour (Beckley *et al.*, 2018). Most Sub-Saharan Africans living in low-and-middle-income communities suffer social ills such as poverty, unemployment, illiteracy and mostly those that are situated next to lead permitting industries and activities.

#### **Epidemiological studies on lead exposure and antisocial behaviour**

The paucity of research examining the links between environmental lead exposure and anti-social behaviour is unexpected given the strong evidence that childhood lead exposure is linked to a variety of socio-behavioural problems that are precursors for severe societal misbehaviour (Naicker *et al.*, 2012; Nkomo *et al.*, 2018). Epidemiologic studies conducted in Sub-Saharan Africa show that environmental lead exposure impacts on society (Naicker *et al.*, 2012), especially through violent and aggressive behaviour (Nkomo *et al.*, 2017, 2018). Studies conducted as early as the 1980s and early 2000s showed that Sub-Saharan African children had blood lead levels higher than recommended international studies (Deveaux, Kibel, Dempster, Pocock & Formenti, 1986). In 2011, Naicker *et al.* found that boys, when compared with girls, were likely to show anti-social and destructive behaviour (attacking people in particular) when they have higher blood lead levels compared to their peers (Naicker *et al.*, 2012). In 2018, a cross-sectional study found that elevated blood lead levels were associated with aggression in adolescence (Nkomo *et al.*, 2018). Furthermore, boys aged 14-15 with high blood lead levels were prone to direct aggression such as physically harming someone. In contrast, girls at the same age showed tendencies to verbal abuse. Nkomo and colleagues conducted a study in an urban setting, studying the association between lead levels and violent behaviour among adolescents (Nkomo *et al.*, 2017). This study found that high blood lead levels in early adolescence were associated with violent behaviour in the late stages of adolescences. Especially young male adults were at risk of committing brutal, violent acts.

From the review of the three studies, it shows that being a male is associated with behavioural problems. Those teenage males who struggle with behaviour issues were at risk of causing harm (violently) to others in their young adult life.

#### **Public health implication for Sub-Saharan Africa**

In most African countries, violence is the most likely cause of injury and rates of violent crime are among the highest in the world (Norman, Matzopoulos, Groenewald & Bradshaw, 2007). Risk factors such as family problems, socio-economic, psychosocial and biological factors are well-linked to violent crimes. Environmental pollution (especially exposure to heavy metals) has not been considered as a risk factor contributing to the nature of the crime or criminal activities. This has an implication for public health policy, as there is a need to screen children for lead levels for preventive purposes.

Researchers have shown that exposure to even low lead levels can lead to anti-social and societal activities later in life. Other implication to the public health system is the non-existence or lack of policies that address societal issues such as violent criminal behaviour. Action on lead exposure prevention in Sub-Saharan Africa is limited and there are no community-based programmes. To consider the socio-economic imperatives, effective action by governments may constitute an act of socio-environmental justice, necessary to allow all to reach their full potential, and to decrease the inequality gap in the country. There is a need for further research to understand the causal relationship between environmental lead exposure and violent criminal behaviour in Sub-Saharan Africa and other similar LMIC. From the review, we can assume that this phenomenon has an impact on their public health systems as well as the criminal justice systems and the general safety of citizens or communities. Notable intervention to minimize lead exposure includes the introduction of unleaded petrol and a ban on leaded paint in homes. This is not enough to combat lead cases or poisoning due to other emerging or re-emerging lead sources. Furthermore, no policies are in place to address lead exposure or other environmental issues as a risk factor to crime, especially violent crimes. There is no routine surveillance to ensure that exposure to low lead levels is monitored or standards for action to be taken, such as treatment. Yet there is evidence that exposure to low lead levels in Sub-Saharan African children has been associated with anti-social, destructive, aggressive and violent behaviour.

#### **Limitation**

The limitation of this review was the lack of epidemiological studies on lead levels and violent criminal behaviour in Sub-Saharan Africa and poorly-resourced countries (Mbonane, Mathee, Swart, Naicker 2019).

#### **CONCLUSIONS**

The review shows that children in poorly-resourced countries continue to have lead levels above recommended international standards. It has indicated that poor countries still struggle with antisocial, aggressive and violent behaviour, while there are no clearly defined public health policies to address such phenomena. On the other hand, biological, social and psychological risk factors that predict violent behaviour are well-researched. Evidence from this exercise shows a lack of studies that determine causal relationships between environmental heavy metals exposure and violent criminal behaviour. Findings from Sub-Saharan African epidemiological studies show that childhood environmental lead exposure is likely to impact anti-social behaviour trends in youth, especially males. Hence, we propose ecological studies that will address these research gaps to guide public health and the criminal justice sector in fighting violent criminal behaviour as a public health issue.

## LIST OF REFERENCES

- Achenbach, T. M. and Rescorla, L. 2001. Manual for the ASEBA school-age forms & profiles: An integrated system of multi-informant assessment. Aseba Burlington, VT.
- Attina, T. M. and Trasande, L. 2013. Economic costs of childhood lead exposure in low- and middle-income countries., *Environmental health perspectives*, 121(9), pp. 1097–102. doi: 10.1289/ehp.1206424.
- Beckley, A. L. Caspi, A., Broadbent, J., Harrington, H., Houts, H. Poulton, R.M., Ramrakha, S., Rueben, A. and Moffitt, T.E. 2018. Association of childhood blood lead levels with criminal offending., *JAMA pediatrics*, 172(2), pp. 166–173. doi: 10.1001/jamapediatrics.2017.4005.
- Bello, O. Naidu, R., Rahman, M.M., Liu, Y. and Dong, Z.2016. Lead concentration in the blood of the general population living near a lead-zinc mine site, Nigeria: Exposure pathways, *Science of the Total Environment*, 542. doi: 10.1016/j.scitotenv.2015.10.143.
- Boutwell, B. B., Nelson, E.J., Emo, B., Vaughn, M.G., Schootman, M, Rosenfiel, R. and Lewis, R. 2016. The intersection of aggregate-level lead exposure and crime, *Environmental research*. Elsevier, 148(July), pp. 79–85. doi: 10.1016/j.envres.2016.03.023.
- Boutwell, B. B. Nelson, E.J., Qian, Z., Vaughn, M.G., Wright, J.P., Beaver, K.M., Barnes, J.C., Petkovsek, M., Lewis, R., Schootman, M. and Rosenfeld, R. 2017. Aggregate-level lead exposure, gun violence, homicide, and rape., *PLoS one*, 12(11), p. e0187953. doi: 10.1371/journal.pone.0187953.
- Breeher, L., Gerr, F. and Fuortes, L. 2013. A case report of adult lead toxicity following use of Ayurvedic herbal medication, *Journal of Occupational Medicine and Toxicology*, 8(1), p. 26. doi: 10.1186/1745-6673-8-26.
- Brown, L. M., Kim, D., Yomai, A., Meyer, P.A, Noonan, D, H. and Flanders, W.D2005. Blood lead levels and risk factors for lead poisoning in children and caregivers in Chuuk State, Micronesia, *International Journal of Hygiene and Environmental Health*, 208(4), pp. 231–236. doi: 10.1016/j.ijheh.2005.01.028.
- Cao, J.,Li, M., Wang, Y., Yu, G. and Yan, C. 2014. Environmental lead exposure among preschool children in Shanghai, China: blood lead levels and risk factors., *PLoS ONE*, 9(12), p. e113297. doi: 10.1371/journal.pone.0113297.
- Chen, Y., Wu, F., Liu, X., Parvez, F., Lolocono, N.J., Gibson, E.A., Kioumourtoglou, M., Levy, D., Shahriar, H., Uddin, M.N., Islam, T., Lomax, A., Saxena, R., Sanchez, T., Santiago, D., Ellis, T., Ahsan, H., Wasserman, G. and Graziano, J.H. 2019. Early life and adolescent arsenic exposure from drinking water and blood pressure in adolescence, *Environmental Research*, 178(June), p. 108681. doi: 10.1016/j.envres.2019.108681.
- Deveaux, P., Kibel, M.A., Dempster, W.S., Pocock, F and Formenti, K. 1986. Blood lead levels in preschool children in Cape Town, *South African Medical Journal*, 69(7), pp. 421–4. [Online] Available at: <https://www.ncbi.nlm.nih.gov/pubmed/3961631>.
- Dietrich, K. N., Douglas, R.M., Succop, P.A, Berger, O.G. and Bornschein, R.I.2001. Early exposure to lead and juvenile delinquency, *Neurotoxicology and Teratology*. doi: 10.1016/S0892-0362(01)00184-2.
- Fergusson, D. M., Boden, J. M. and Horwood, L. J. 2008. Dentine lead levels in childhood and criminal behaviour in late adolescence and early adulthood, *Journal of Epidemiology and Community Health*, 62(12), pp. 1045–1050. doi: 10.1136/jech.2007.072827.
- Flora, S. J. S., Flora, G. and Saxena, G. 2006. Environmental occurrence, health effects and management of lead poisoning, in *Lead*. doi: 10.1016/B978-044452945-9/50004-X.
- Gould, E. 2009. Childhood lead poisoning: conservative estimates of the social and economic benefits of lead hazard control., *Environmental Health Perspectives*, 117(7), pp. 1162–7. doi: 10.1289/ehp.0800408.
- Gunturu, K. S., Nagarajan, P., McPhedran, P., Goodman, T. R., Hodsdon, M. E. and Strout, M. P. 2011. Ayurvedic herbal medicine and lead poisoning, *Journal of Hematology and Oncology*. BioMed Central Ltd, 4(1), p. 51. doi: 10.1186/1756-8722-4-51.
- Hammerton, G. Mahedy, L. Murray, J., Maughan, B., Edwards, A. C., Kendler, K. S., Hickman, M. and Heron, J.2017. Effects of excessive alcohol use on antisocial behavior across adolescence and early adulthood, *Journal of the American Academy of Child and Adolescent Psychiatry*. Elsevier Inc, 56(10), pp. 857–865. doi: 10.1016/j.jaac.2017.07.781.
- He, K., Wang, S. and Zhang, J. 2009. Blood lead levels of children and its trend in China, *Science of the Total Environment*. Elsevier B.V., 407(13), pp. 3986–3993. doi: 10.1016/j.scitotenv.2009.03.018.
- Laidlaw, M. A. S., Zahran, S., Pingitore, N., Clague, J., Devlin, G. and Taylor, M.P. 2014. Identification of lead sources in residential environments: Sydney Australia, *Environmental Pollution*, 184, pp. 238–246. doi: 10.1016/j.envpol.2013.09.003.
- Lanphear, B. P.,Dietrich, K., Auinger, P. and Cox, C. 2000. Cognitive deficits associated with blood lead concentrations < 10 µg/dL in US children and adolescents, *Public Health Reports*, 115(6), pp. 521–529. doi: 10.1093/phr/115.6.521.
- Lin, S. H. et al. 2011. Lead powder use for skincare and elevated blood lead level among children in a Chinese rural area., *Journal of exposure Science & Environmental Epidemiology*. Nature Publishing Group, 22(2), pp. 198–203. doi: 10.1038/jes.2011.46.
- Mathee, A., Röllin, H., von Schirnding, Y., et al. 2006. Reductions in blood lead levels among school children following the introduction of unleaded petrol in South Africa., *Environmental Research*, 100(3), pp. 319–22. doi: 10.1016/j.envres.2005.08.001.
- Mathee, A., Röllin, H., Von Schirnding, Y., et al. 2006. Reductions in blood lead levels among school children following the introduction of unleaded petrol in South Africa, *Environmental Research*. doi: 10.1016/j.envres.2005.08.001.
- Mathee, A., Röllin, H., Levin, J. and Naik, I. 2007. Lead in paint: three decades later and still a hazard for african children?, *Environmental Health Perspectives*, 115(3), pp. 321–322. doi: 10.1289/ehp.9575.
- Mathee, A., Singh, E., Mogotsi, M., Timothy, G., Maduka, B., Olivier, J. and Ing, D. 2009. Lead-based paint on playground equipment in public children’s parks in Johannesburg, Tshwane and Ekurhuleni., *South African medical journal = Suid-99*(11), pp. 819–21. [Online] Available at: <http://www.ncbi.nlm.nih.gov/pubmed/20218484>.
- Mathee, A.,Khan, T., Naicker, N., Kootbodien, T., Naidoo, S. and Becker, P. 2013. Lead exposure in young school children in South African subsistence fishing communities, *Environmental Research*, 126, pp. 179–183. doi: 10.1016/j.envres.2013.05.009.
- Mathee, A.,Naicker, N., Kootbodien, T., Mahuma, T., Nkomo, P., Naik, I. and de Wet, T. 2014. A cross-sectional analytical study of geophagia practices and blood metal concentrations in pregnant women in Johannesburg, South Africa, *South African Medical Journal*, 104(8), pp. 568–73. doi: 10.7196/samj.7466.
- Mathee, A. 2014. Towards the prevention of lead exposure in South Africa: Contemporary and emerging challenges, *NeuroToxicology*. Elsevier B.V., 45, pp. 220–223. doi: 10.1016/j.neuro.2014.07.007.
- Mathee, A., Naicker, N. and Teare, J. 2015. Retrospective investigation of a lead poisoning outbreak from the consumption of an ayurvedic medicine: Durban, South Africa., *International Journal of Environmental Research and Public Health*, 12(7), pp. 7804–7813. doi: 10.3390/ijerph120707804.
- Mathee, A. and Street, R. 2020. Recycled aluminium cooking pots: a priority for the unfinished agenda of lead exposure reduction in poorly resourced countries, *Current Opinion in Toxicology*. Elsevier B.V. doi: 10.1016/j.cotox.2019.12.005.
- Mazumdar, M., Bellinger, D.C., Gregas, M., Abanilla, K., Bacic, J. and Needleman, H. L. 2011. Low-level environmental lead exposure in childhood and adult intellectual function: A follow-up study, *Environmental Health: A Global Access Science Source*, 10(1), pp. 1–7. doi: 10.1186/1476-069X-10-24.
- Mbonane, T. P., Mathee, A., Swart, A. and Naicker N. 2019. A study protocol to determine the association between lifetime lead exposure and violent criminal behaviour in young males in conflict with the law, *BMC Public Health*. BMC Public Health, 19(1), p. 932. doi: 10.1186/s12889-019-7025-5.
- Mbongwe, B. et al. 2010. Exposure to lead among children aged 1-6 years in the city of Gaborone, Botswana. *J Environ Health Res*, 10(1), pp. 17–26.
- Menon, S.,George, E., Osterman, M. and Pecht, M. 2015. High lead solder (over 85 %) solder in the electronics industry: RoHS exemptions and alternatives, *Journal of Materials Science: Materials in Electronics*. Springer US, 26(6), pp. 4021–4030. doi: 10.1007/s10854-015-2940-4.

- Meyer, P., Brown, M. and Falk, H. 2008. Global approach to reducing lead exposure and poisoning, *Mutation Research/ Reviews in Mutation Research*, 659(1–2), pp. 166–175. doi: 10.1016/j.mrrev.2008.03.003.
- Monebenimp, F., Kuepouo, G., Chelo, D., Anatole, P. C., Bissek, A. Z. K. and Gottesfeld, P. 2017. Blood lead levels among children in Yaoundé Cameroon., *Frontiers in public Health*, 5(July), p. 163. doi: 10.3389/fpubh.2017.00163.
- Montgomery, M. and Mathee, A. 2005. A preliminary study of residential paint lead concentrations in Johannesburg., *Environmental Research*, 98(3), pp. 279–83. doi: 10.1016/j.envres.2004.10.006.
- Naicker, N., Richter, L., Mathee, A., Becker, P. and Norris, S. A. 2012. Environmental lead exposure and socio-behavioural adjustment in the early teens: The birth to twenty cohort, *Science of The Total Environment*, 414, pp. 120–125. doi: 10.1016/j.scitotenv.2011.11.013.
- Needleman, H. L., J A Riess, J. A., Tobin, M. J., Biesecker, G. E and Greenhouse J. B. 1996. Bone lead levels and delinquent behavior, *Journal of the American Medical Association*. doi: 10.1001/jama.275.5.363.
- Needleman, H. L., McFarland, C., Ness, R. B., Fienberg, S. E. and Tobin, M. J. 2002. Bone lead levels in adjudicated delinquents. A case control study., *Neurotoxicology and Teratology*, 24(6), pp. 711–7. doi: 10.1016/S0892-0362(02)00269-6.
- Nevin, R. 2007. Understanding international crime trends: The legacy of preschool lead exposure, *Environmental Research*, 104(3), pp. 315–336. doi: 10.1016/j.envres.2007.02.008.
- Nie, L. H., Sanchez, S., Newton, K., Grodzins, L., Cleveland, R.O. and Weisskopf, M. G. 2011. In vivo quantification of lead in bone with a portable x-ray fluorescence system—methodology and feasibility, *Physics in Medicine and Biology*, 56(3), pp. N39–N51. doi: 10.1088/0031-9155/56/3/N01.
- Nkomo, P., Mathee, A., Naicker, N., Galpin, J., Richter, L. M. and Norris, S. A. 2017. The association between elevated blood lead levels and violent behavior during late adolescence: The South African Birth to Twenty Plus cohort, *Environment International*. Elsevier, 109(February), pp. 136–145. doi: 10.1016/j.envint.2017.09.004.
- Nkomo, P., Naicker, N., Mathee, A., Galpin, J., Richter, L. M. and Norris, S. A. 2018. The association between environmental lead exposure with aggressive behavior, and dimensionality of direct and indirect aggression during mid-adolescence: Birth to Twenty Plus cohort, *Science of the Total Environment*. Elsevier B.V., 612, pp. 472–479. doi: 10.1016/j.scitotenv.2017.08.138.
- Norman, R., Matzopoulos, R., Groenewald, P. and Bradshaw, D. 2007. The high burden of injuries in South Africa, *Bulletin of the World Health Organization*. doi: 10.2471/BLT.06.037184.
- O'Connor, D., Hou, D., Ye, J., Zhang, Y., Ok, Y. S., Song, Y., Coulon, F., Peng, T. and Tian, L. 2018. Lead-based paint remains a major public health concern: A critical review of global production, trade, use, exposure, health risk, and implications, *Environment International*. Elsevier, 121(July), pp. 85–101. doi: 10.1016/j.envint.2018.08.052.
- Olowoyo, J. O., van Heerden, E., Fischer, J. L. and Baker, C. 2010. Trace metals in soil and leaves of *Jacaranda mimosifolia* in Tshwane area, South Africa, *Atmospheric Environment*. Elsevier Ltd, 44(14), pp. 1826–1830. doi: 10.1016/j.atmosenv.2010.01.048.
- Olympio, K. P. K., Oliveira, P. V., Naozuka, J., Cardoso, M. R. A., Marques, A. F., Günther, W. M. R. and Bechara, E. J. H. 2010. Surface dental enamel lead levels and antisocial behavior in Brazilian adolescents, *Neurotoxicology and Teratology*. Elsevier Inc., 32(2), pp. 273–279. doi: 10.1016/j.ntt.2009.12.003.
- Olympus 2018. Handheld XRF Analyzers. [Online] Available at: <https://www.olympus-ims.com/en/xrf-xrd/xrf-handheld/> (Accessed: September 12, 2018).
- Rudge, C. V., Röllin, H. B., Nogueira, C. M., Thomassen, Y., Rudge, M. C. and Odland, J. Ø. 2009. The placenta as a barrier for toxic and essential elements in paired maternal and cord blood samples of South African delivering women, *Journal of Environmental Monitoring*. doi: 10.1039/b903805a.
- Sampson, R. J. and Winter, A. S. 2018. Poisoned development: assessing childhood lead exposure as a cause of crime in a birth cohort followed through adolescence, *Criminology*, 56(2), pp. 269–301. doi: 10.1111/1745-9125.12171.
- Schell, L. M., Denham, M. Stark, A. D., Gomez, M. Ravenscroft, J. Parsons, P. J., Aydermir, A. and Samelson, R. 2003. Maternal blood lead concentration, diet during pregnancy, and anthropometry predict neonatal blood lead in a socioeconomically disadvantaged population, *Environmental Health Perspectives*.
- Sciarillo, W. G., Alexander, G. and Farrell, K. P. 1992. Lead exposure and child behavior, *American Journal of Public Health*, 82(10), pp. 1356–1360. doi: 10.2105/AJPH.82.10.1356.
- Semlali, R. M., Dessogne, J. B., Monna, F., Bolte, J., Azimi, S., Navarro, N., Denaix, L., Loubet, M., Chateau, C. and van Oort, F. 2004. Modeling Lead Input and Output in Soils Using Lead Isotopic Geochemistry, *Environmental Science and Technology*. doi: 10.1021/es0341384.
- Shukla, V., Shukla, P. and Tiwari, A. 2018. Lead poisoning, *Indian Journal of Medical Specialities*. Indian Journal of Medical Specialities Trust, 9(3), pp. 146–149. doi: 10.1016/j.injms.2018.04.003.
- Stretesky, P. B. and Lynch, M. J. 2001. The relationship between lead exposure and homicide, *Archives of Pediatrics and Adolescent Medicine*, 155(5), pp. 579–582. doi: 10.1001/archpedi.155.5.579.
- Stroh, E., Lundh, T., Oudin, A., Skerfving, S. and Strömberg, U. 2009. Geographical patterns in blood lead in relation to industrial emissions and traffic in Swedish children, 1978–2007, *BMC Public Health*. doi: 10.1186/1471-2458-9-225.
- Sweeney, E., Yu, Z. M., Parker, L. and Dummer, T. J. B. 2017. Lead in drinking water: a response from the Atlantic PATH study, *Environmental Health Review*. doi: 10.5864/d2017-002.
- Taylor, C. M., Golding, J., Hibbeln, J. and Emond, A. M. 2013. Environmental factors predicting blood lead levels in pregnant women in the UK: the ALSPAC study., *PloS One*, 8(9), p. e72371. doi: 10.1371/journal.pone.0072371.
- Taylor, M. P., Forbes, M. K., Opeskin, B., Parr, N. and Lanphear, B. P. 2016. The relationship between atmospheric lead emissions and aggressive crime: An ecological study, *Environmental Health: A Global Access Science Source*. *Environmental Health*, 15(1). doi: 10.1186/s12940-016-0122-3.
- Tchounwou, P. B., Yedjou, C. G., Patlolla, A. K. and Sutton, D. J. 2012. Heavy Metal Toxicity and the Environment, in *EXS*, pp. 133–164. doi: 10.1007/978-3-7643-8340-4\_6.
- Tirima, S., Bartrem, C., von Lindern, I., von Braun, M., Lind, D., Anka, S. M. and Abdullahi, A. 2018. Food contamination as a pathway for lead exposure in children during the 2010–2013 lead poisoning epidemic in Zamfara, Nigeria, *Journal of Environmental Sciences (China)*. Elsevier B.V., 67, pp. 260–272. doi: 10.1016/j.jes.2017.09.007.
- Todd, A. C. 2018. Bone Lead Test. [Online] Available at: <https://labs.icaahn.mssm.edu/toddlab/bone-lead-test/> (Accessed: September 12, 2018).
- Tuvblad, C. and Beaver, K. M. 2013. Genetic and environmental influences on antisocial behavior, *Journal of criminal Justice*, 41(5), pp. 273–276. doi: 10.1016/j.jcrimjus.2013.07.007.
- Washerman, G. A., Staghezza-Jaramillo, B., Shrout, P., Popovac, D. and Graziano, J. 1998. The effect of lead exposure on behavior problems in preschool children, *American Journal of Public Health*, 88(3), pp. 481–486.
- Weiss, B. and Bellinger, D. C. 2006. Social Ecology of Children's Vulnerability to Environmental Pollutants, *Environmental Health Perspectives*, 114(10), pp. 1479–1485. doi: 10.1289/ehp.9101.
- Wright, J. P., Dietrich, K. M., Ris, M. D., Hornung, R. W., Wessel, S. D., Lanphear, B. P., Ho, M. and Rae, M. N. 2008. Association of Prenatal and Childhood Blood Lead Concentrations with Criminal Arrests in Early Adulthood, *PLoS Medicine*, 5(5), p. e101. doi: 10.1371/journal.pmed.0050101.
- Yabe, J., Nakayama, S. M. M., Ikenaka, Y., Yohannes, y. B., Bortey-Sam, N., Oroszlany, B., Muzandu, K., Choongo, K., Kabalo, A. N., Ntapisha, J., Mweene, A., Umemura, T. and Ishizuka, M. 2015. Lead poisoning in children from townships in the vicinity of a lead-zinc mine in Kabwe, Zambia, *Chemosphere*. doi: 10.1016/j.chemosphere.2014.09.028.
- Zolaly, M. A., Hanafi, M. I., Shawky, N., el-Harbi, K. and Mohamadin, A. M. 2012. Association between blood lead levels and environmental exposure among Saudi schoolchildren in certain districts of Al-Madinah., *International Journal of General Medicine*, 5, pp. 355–64. doi: 10.2147/IJGM.S28403.

# QUALITATIVE VERSUS QUANTITATIVE FIT-TESTING OF TWO COMMONLY USED RESPIRATORS IN RESOURCE-LIMITED HEALTHCARE FACILITIES

Katekani Ngobeni, Department of Environmental Health, Faculty of Health Sciences, University of Johannesburg, South Africa; kngobeni@csir.co.za

Martha Chadyiwa, Department of Environmental Health, Faculty of Health Sciences, University of Johannesburg, South Africa, mchadyiwa@uj.ac.za

Nontembeko Dudeni-Tlhone, The Council for Scientific and Industrial Research, South Africa, NDudeniTlhone@csir.co.za

Renay Helouise Van Wyk, Department of Environmental Health, Faculty of Health Sciences, University of Johannesburg, South Africa, renayvw@uj.ac.za

## Abstract

*The transmission of airborne infections such as Tuberculosis is a critical public health problem. While fit-testing of respirators is widespread, its implementation has been difficult, particularly in resource-constrained settings. This study aimed to compare fit-test results from the qualitative fit-test (QLFT) and quantitative fit-test (QNFT) methods with Halyard Health N95-respirators, models 46827 and 46727, in resource-limited healthcare settings in South Africa. This cross-sectional study was conducted at two district hospitals in Tshwane, South Africa. Ninety-nine HCWs were recruited through a non-probability, convenience sampling method and underwent sequential QLFT and QNFT fit-tests. To ascertain the degree of agreement between the two fit-tests, a Kappa (K) statistic was used. QNFT was more proficient in detecting failures than the corresponding QLFT for both types of N95-FFRs tested, with 80% of the HCW tested being more likely to pass a QLFT than a corresponding QNFT. The 95% confidence interval showed that HCWs were up to almost seven times more likely to pass a QLFT test than a corresponding QNFT. With respect to the sensitivity of the fit-tests, the proportion of HCWs obtaining a pass in both tests was roughly 45%. Furthermore, results indicated that the fit-test methods consistently disagreed ( $K=-0.02$ ). With respect to the effect of the N95-FFR model, an overlap in the confidence intervals indicated that there was no statistically significant difference in fit-test outcomes between the two N95-FFRs. These results indicate that while fit-test results may differ between QLFT and QNFT, the type of respirator model may not influence outcomes. Due to its stringent nature, the QNFT emerged as the method of choice. Findings in this study set a standard against which future efforts in this field can be measured; they demonstrated the need for convenient but more efficient and reliable fit-test methodologies that could be applied in low to middle-income countries.*

**Keywords:** Fit-testing, Quantitative fit-test, Qualitative fit-test, Respirators

## INTRODUCTION

Healthcare-associated infections (HAIs) account for a substantial burden of disease among patients and healthcare workers, especially in resource-limited settings (Harries, Zachariah, Tayler-Smith, Schouten, Chimbwandira, Van Damme, and El-Sadr, 2010).

HAI transmission of TB amongst patients and Healthcare Workers (HCWs) is of great concern. Poor airborne infection control procedure, which is a driver of HAI, is further worsened by the HIV epidemic as well as the emergence of multi-drug-resistant tuberculosis (MDR-TB) and extensively drug-resistant TB (XDR-TB) in high burdened *Mycobacterium Tuberculosis (mTB)* and human immunodeficiency virus (HIV) settings (Churchyard, Mametja, Mvusi, Ndjek, Hesselning, Reid and Babatunde, 2014; Engelbrecht, Van Rensburg and Van Rensburg, 2016, Harries et al. 2010; Pillay and Sturm, 2010).

A joint commission of the World Health Organization (WHO) and the US Centers for Disease Control and Prevention (CDC), in collaboration with the International Union of Tuberculosis and Lung Disease (IUATLD), released guidelines for the control of airborne infections in both developed and resource-limited countries (Bock, Jensen, Miller and Nardell, 2007). The suggested levels of control measures by the WHO and CDC details a three-layered hierarchical approach, which includes both administrative and environmental controls, as well as personal respiratory protection measures (Bock et al 2007; Granich Binkin, Jarvis, Simone, Rieder, Espinal, Kumaresan, and World Health Organization, 1999).

Respiratory protection comprises the use of PPE in circumstances that pose a high risk for exposure to different airborne pathogens including TB (Rim and Lim, 2014). An increased risk of TB has been documented among all categories of healthcare personnel (including facility staff, community health workers and volunteers) compared to the general population (Tudor, Van Der Walt, Margot, Dorman, Pan, Yenokyan and Farley, 2014).

The use of respiratory protection can reduce the risk of HCWs and other individuals being exposed to infectious TB droplet nuclei expelled into the air (Rim and Lim, 2014). The WHO requires that HCWs wear respirators as their PPE when treating suspected and confirmed TB patients (Bock et al. 2007; WHO 2019).

According to US federal regulations enforced by the Occupational Safety and Health Administration (OSHA), the employer must ensure that these individuals are provided with the correct type and size of the respirator to suit their specific facial features (OSHA, 2006). In addition, the respiratory protection programme must be managed by a competent administrator and include written procedures governing respirator use at that site (OSHA, 2012).

A critical element of a comprehensive respiratory protection programme is ensuring that a respirator fits an individual user. According to the OSHA, fit-testing is primarily done to ensure that the respirator a wearer is expected to use is suitable and accommodates his or her specific facial features (OSHA, 2006). Minimum accepted practices for occupational respirator use in South Africa require fit-testing to be conducted on the user (SABS, 2018).

There are two basic types of fit-testing methods for N95-FFRs: a qualitative fit-test (QLFT) or a quantitative fit-test (QNFT) (ANSI, 2001). Qualitative fit-testing relies on the participant's senses to detect face-seal leaks. The QLFT method is simply a pass/fail test that demonstrates the level of performance of the respirator with a measurable result for a particular mask on a particular individual (OSHA, 2006). On the contrary, QNFT uses instrumentation to measure leakage without dependence on a test participant's voluntary or involuntary response to the challenge agent (Janssen et al. 2002). Quantitative fit-testing in this study was conducted using the TSI 8038 PortaCount® Pro+ Respirator Fit-tester (TSI, St Paul, MN, USA). Distinct differences exist between the two methods; these will be elaborated on in the next chapter.

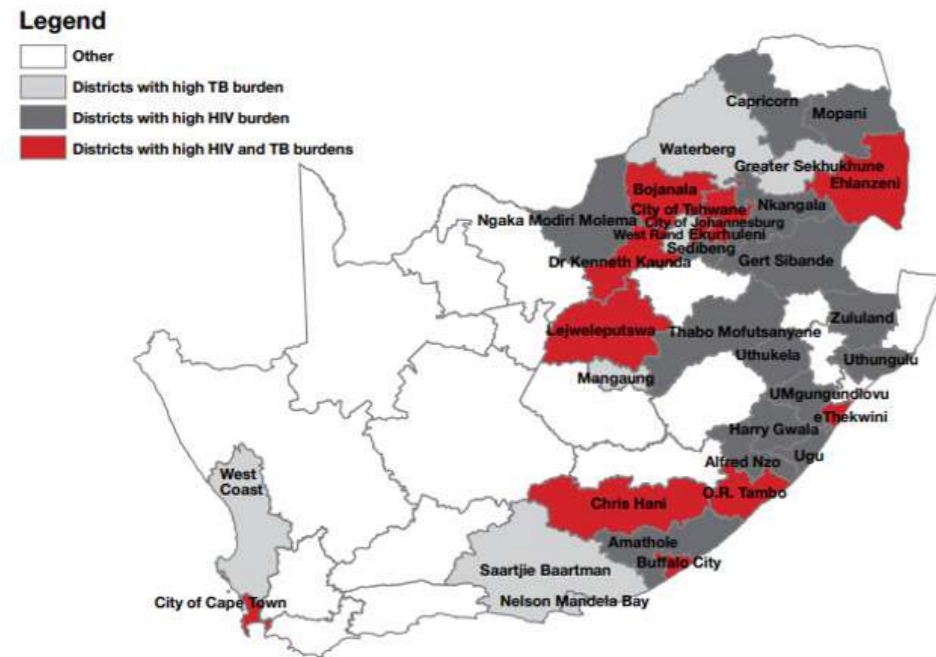
Respiratory protection is vital for protecting workers' health. Therefore, it is critical that mask-based respiratory protective devices (RPDs) can only be used after the adequate fit has been demonstrated.

## METHODS

The research was a correlation non-experimental cross-sectional study. Data from participants was collected after having tested two groups of variables. While testing the first group of variables, each participant was assigned a respirator and underwent sequential QLFT and QNFT fit-tests and the results (either pass or fail) were recorded. For the second group of variables, data was collected to determine whether the model impacted the fit-test results.

The study was conducted in Gauteng Province in the Tshwane health district in two hospitals. Tshwane district has one of the highest incidences of TB and HIV in South Africa (Figure 1). According to the South African National Strategic Plan (NSP) 2017-2022, this district is prioritised to ensure the scaling up of interventions to combat HIV and TB (SANAC, 2017). A convenience sampling method was used. All participants gave informed consent and the Research Ethics Committee of the University of Johannesburg approved all aspects of the study.

**Figure 1: Districts with high TB burdens.** Tuberculosis is a major cause of morbidity and mortality in South Africa. South Africa currently has one of the highest TB and HIV burdens in the world, with TB being the leading cause of death (SANAC, 2017).



The Tshwane health district has the same geographical boundaries as the metropolitan municipality and is situated in the northern part of Gauteng Province (Figure 2). The district is divided into seven health sub-districts which are aligned with the administrative demarcation of the Metro (Tshwane Municipality, 2012).

#### Sampling size

A total sample of 99 consenting participants were enrolled. These consenting participants were fit-tested using both the qualitative and quantitative method.

#### Data Collection

A structured questionnaire was administered in person prior to conducting a fit-test to collect primary data. The purpose of the questionnaire was to establish whether there might be any factors rendering the participant unsuitable to participate in the study. The questions were designed to address the physiological fitness of individuals to determine whether they could detect the test solution, were healthy enough to participate in the process and didn't have physical attributes that would hinder the correct fit of a respirator.

#### Data collection process

The data collection process was initiated with a training session for the people designated to conduct fit-testing and those who were fit-tested. Data was collected in two phases. Healthcare facility staff ranging from nurses to cleaners were given the opportunity to participate in the study following the training session. Post the training, the QLFT was conducted, followed by the QNFT.

#### Qualitative fit-testing

The QLFT protocol consists of two parts, namely a threshold check and a fit-test. In this study the artificial sweetener Saccharin (Macfarlan Smith Ltd, Edinburgh, U.K.) was used as the threshold check solution against N95-respirators, models 46827 and 46727 (Figure 3). Figure 3 describes the fit-test steps which includes the threshold check.



**Figure 2: Tshwane district demarcated in regions.** (Tshwane Municipality 2012)

The threshold check is performed prior to conducting QLFT and is done without wearing a respirator. The test is intended to determine whether the individual being tested can detect the taste agent or threshold check solution. During sensitivity testing, as well as during fit-testing, participants were instructed to wear a hood to cover the head and shoulders. A qualitative fit-test kit, was used in accordance with the fit-testing protocol described by OSHA 29CFR1910.134 and the respirator fit-test manual. Briefly, participants were asked to wear a hood to cover the head and shoulders. Using a clearly marked nebuliser, the test conductor then sprayed the threshold check solution into the enclosure, with the nozzle directed away from the nose and mouth of the person. To produce the aerosol, the nebuliser bulb was firmly squeezed so that it collapsed completely, then released and allowed to fully expand. Ten squeezes were repeated rapidly and then it was recorded whether the test participant could taste saccharin or not. The taste threshold was noted as ten regardless of the number of squeezes completed. However, the test conductor took note of the number of squeezes required to solicit a taste response. This was then repeated for negative responses and if the saccharin was not tasted after thirty squeezes (step 10), the test participant was deemed to be unable to taste saccharin and excluded from performing the saccharin fit-test. Throughout the sensitivity test participants were asked to breathe through their slightly open mouth with tongue extended (Figure 3).

#### Fit-test procedure using saccharin solution

The participants were asked not to eat, drink (except plain water), smoke or chew gum for 15 minutes before the test. The fit-test was conducted in the same hood as used for the sensitivity solution. The participants donned the enclosure while wearing the N95-respirators, properly adjusted and equipped with a particulate filter. The nebuliser was then inserted into the hole in the front of the enclosure and an initial concentration of saccharin fit-test solution was sprayed into the enclosure using the same number of squeezes as noted in the sensitivity test. After the aerosol had been generated, the participants performed exercises as instructed by the conductor. Currently, fit-test protocols require the test participant to perform a series of eight 60-second exercises meant to simulate workplace motions: (i) normal breathing, (ii) talking out loud, (iii) deep breathing, (iv) head side to side, (v) bend and touch toes (or jog in place), (vi) head up and down and (vii) normal breathing. The aerosol concentration was then replenished every 30 seconds using half of the number of squeezes used initially (e.g. 5, 10 or 15). The participants indicated to the test conductor whether the taste of saccharin was detected at any time during the fit-test. If the test participant did not report tasting the saccharin, the test was passed. The fit-test was deemed to be a fail if the participant detected the taste of saccharin and the test was recorded as failed. The entire procedure (taste threshold screening and fit-testing) was then repeated with a different respirator model.

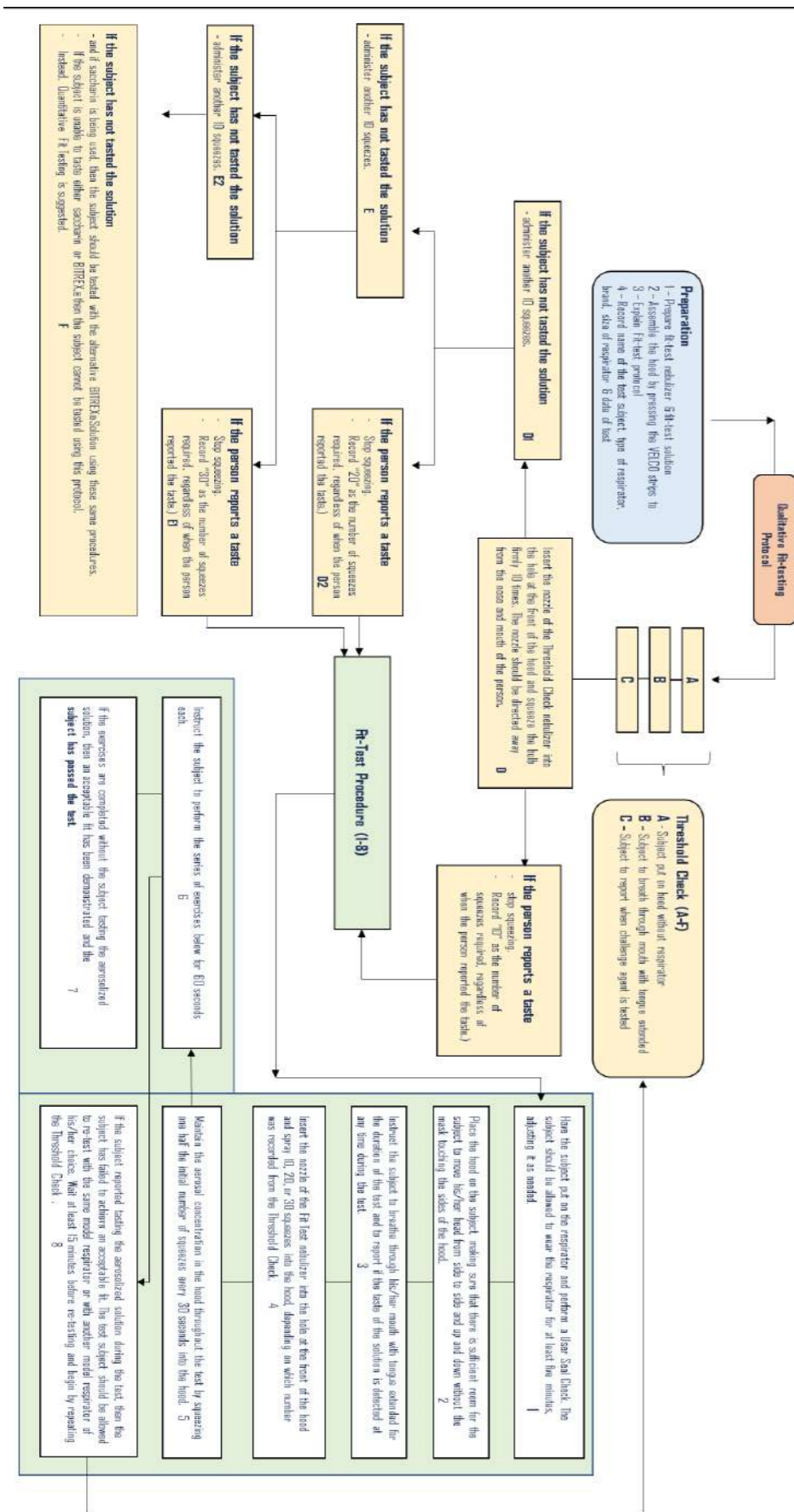


Figure 3: The QLFT fit-test flow chart

### Quantitative fit-testing

Quantitative fit-testing was conducted on N95-respirators, models 46827 and 46727, using a PortaCount® PRO+. Model 8038, according to OSHA fit-testing protocol 29CFR1910.134 and as prescribed in the TSI Respirator Fit-Test Manual (Figure 4).

### PortaCount® fit-test requirements

Briefly, the respirator was checked to ensure that the sampling probe and line were properly attached to the facepiece and that the respirator was fitted with a particulate filter capable of preventing significant penetration by the ambient particles used for the fit-test (e.g. NIOSH 42 CFR 84 series 100, series 99, or series 95 particulate filter) per manufacturer’s instruction. The person to be tested was then instructed to don the respirator for five minutes before the fit-test started, to make certain the respirator was comfortable. In addition, this allowed purging the ambient particles trapped inside the respirator. These participants had already been trained on how to wear the respirator properly.

The following conditions for the adequacy of the respirator fit were checked: chin properly placed; adequate strap tension, not overly tightened; fit across nose bridge; respirator of the proper size to span distance from nose to chin; tendency of the respirator to slip and finally, self-observation in a mirror to evaluate fit and respirator position. The person wearing the respirator was then asked to do a user seal check, determining if there was any form of leakage. The manufacturer’s instructions for operating the PortaCount® were implemented and the test proceeded. The test conductor checked with the test participant concerning the comfort of the respirator upon completion of the protocol and whether it was necessary for another model of the respirator to be tried (Figure 4).

### PortaCount® test instrument.

The PortaCount® automatically stopped and calculated the overall fit factor for the entire set of exercises. The overall fit factor is what counts. The pass or fail message indicated whether or not the test was successful. If the test was a pass, the fit-test had been completed. Since the pass or fail criterion of the PortaCount® is user programmable, the test operator ensured that the pass or fail criterion, as stated in the protocol above (Figure 4), met the requirements for minimum respirator performance. The record containing the test participant’s name, overall fit factor, make, model, style, and size of respirator used and the date of the test was then kept on file.

### RESULTS

#### Characterisation of study participants

One hundred and fifteen (115) healthcare workers were recruited for this study. All the participants were from the Tshwane district in Gauteng province and attended the pre-requisite respiratory protection training (Figure 5).

#### Response rate

Ninety-nine (99) of 115 (86%) HCWs agreed to participate in this study; 16 of 115 (13.9%) participants were excluded from the study due to non-consent. All the study participants were over the age of 20 years (median age of 40.0 years, range 32-50).

#### Fit-test results for QLFT and QNFT methods

Each participant was assigned a respirator and 89 of 99 (89.9%) HCWs undertook the QLFT method while 45 of 99 (45.5%) HCWs were fit-tested using the QNFT method; the results (either pass or fail) were recorded (Table 1).



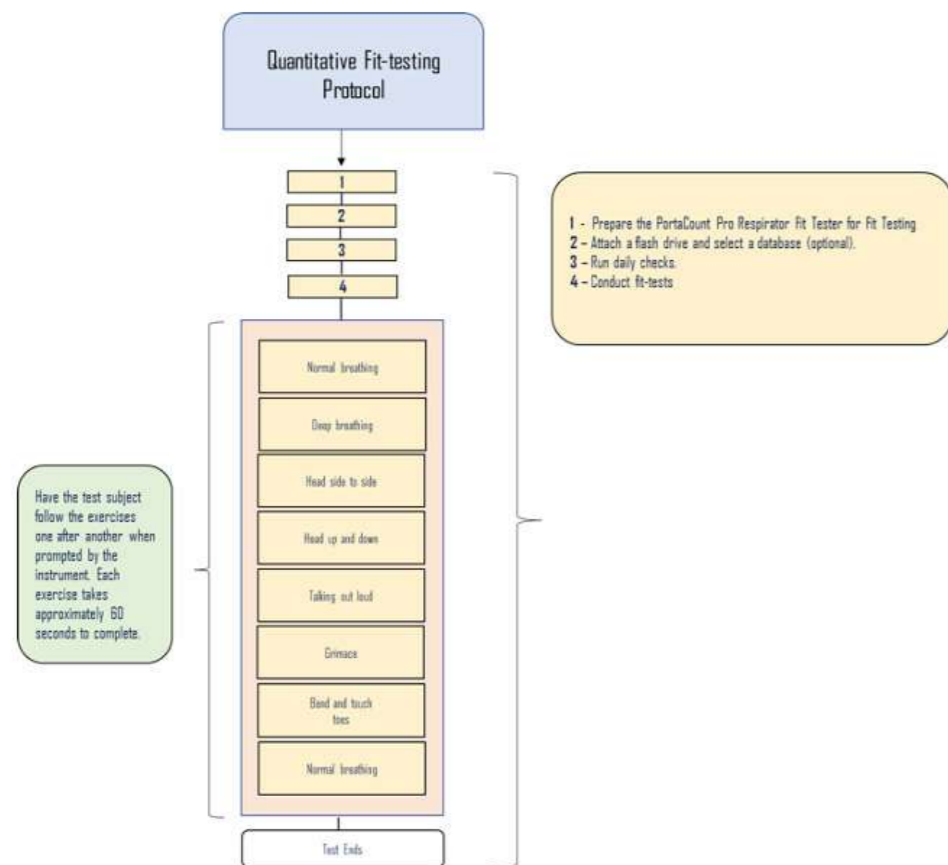


Figure 4: The QNFT fit-test flow chart.

Table 1: Number of successful fit-test conducted per model including matched tests

Facility	Qualitative fit-testing	Quantitative fit-testing	Sequentially fit-tested for both methods
Odi Hospital	53	15	14
Kalafong Hospital	36	20	23
Total	89	45	37

Thirty-seven out of 99 (37.4%) of HCWs underwent sequential QLFT and QNFT. This subset of HCWs with corresponding data for both methods was the one that was used for further comparisons throughout the study (Table 2-7).

**Comparison of pass/fail results**

A participant was considered to have failed the QLFT if at any time during the test he or she could detect the test agent while donning the respirator. A QNFT was considered a failure if the user was unable to attain an overall fit-factor of at least 100 while wearing the respirator, as prescribed by OSHA guidelines (OSHA, 2006).

The QLFT fail-pass results and the QNFT pass-fail results were tabulated and data analysed was presented regardless of the respirator model. Overall, 33 of 37 (89.2%) HCWs passed the QLFT while 4 (10.8%) HCWs failed. Furthermore, 17 of 37 (45.9%) passed that QNFT versus 20 (54.1%) participants that failed. Looking at the majority of HCWs that passed the QLFT, 18 of 33 (54.5%) failed that corresponding QNFT method (Table 2); on the contrary, only 2 of 17 individuals (11.8%) who passed the QNFT failed the corresponding QLFT. Generally, the results were biased in favour of QLFT rather than QNFT.

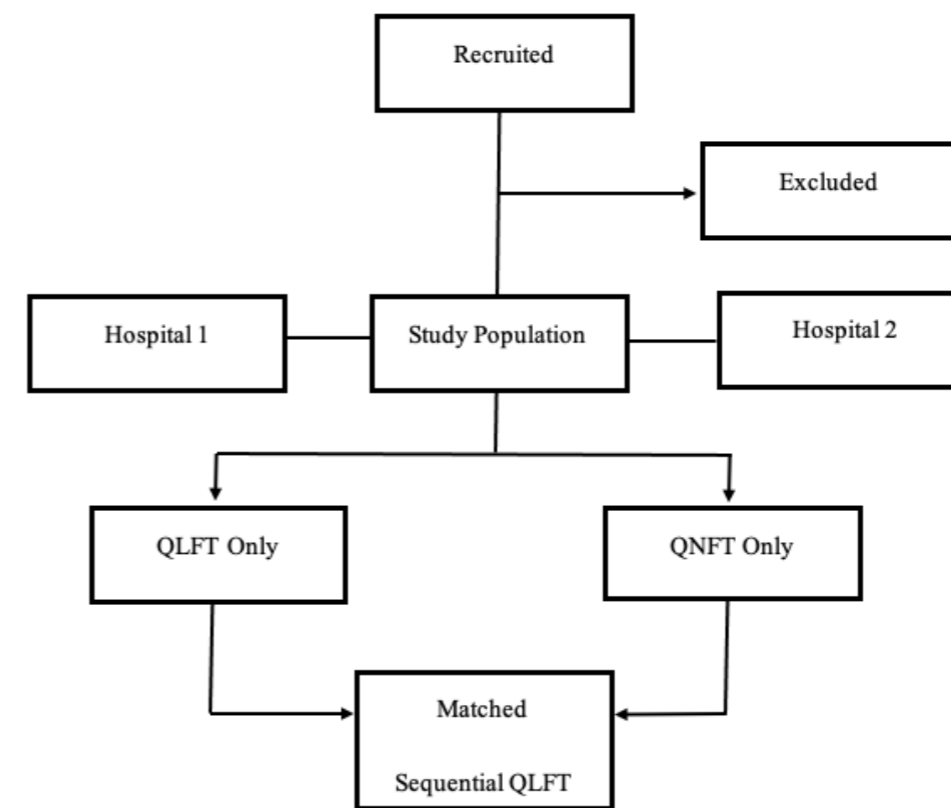


Figure 5: Characterisation of the study's population.

**Table 2: Sequential fit-testing results**

Participant ID (n=37)	Age	Gender	Job title	Overall QLFT Score	Overall QNFT Score
OD02	36	Female	Counsellor	Pass	Fail
OD09	57	Female	Nurse	Pass	Fail
OD11	57	Female	Professional Nurse	Pass	Pass
OD14	33	Female	Physiotherapist	Pass	Fail
OD26	N/A <sup>a</sup>	Female	IPC Nurse	Pass	Pass
OD28	42	Female	Laundry worker	Pass	Fail
OD29	27	Female	EHP	Pass	Pass
OD31	24	Female	Councillor	Pass	Pass
OD34	38	Female	Nurse	Fail	Pass
OD42	55	Female	Professional Nurse	Pass	Pass
OD44	49	Male	Coordinator	Pass	Pass
OD46	33	Female	Admin Trainee	Pass	Fail
OD49	52	Female	Nurse	Pass	Pass
OD54	55	Female	IPC coordinator	Pass	Fail
KL01	31	Female	Student Nurse	Pass	Fail
KL02	38	Female	Professional Nurse	Pass	Fail
KL03	30	Female	Nurse	Pass	Fail
KL07	45	Female	Cleaning Supervisor	Pass	Pass
KL08	30	Female	ENA	Pass	Pass
KL09	42	Female	Nurse	Fail	Fail
KL12	56	Female	Operational Manager	Pass	Fail
KL13	29	Female	Nursing Assistant	Pass	Pass
KL15	40	Female	Counsellor	Pass	Fail
KL17	39	Female	IPC Officer	Pass	Fail
KL18	N/A	Female	Professional Nurse	Pass	Pass
KL19	41	Female	Kitchen staff	Pass	Pass
KL21	29	Female	Professional Nurse	Pass	Fail
KL22	38	Female	Enrolled Nurse	Pass	Fail
KL23	32	Male	Cleaner	Pass	Fail
KL26	34	Female	Enrolled Nurse	pass	Pass
KL29	58	Female	Enrolled Nurse	Pass	Fail
KL33	26	Female	Counsellor	Fail	Fail
KL34	48	Female	Enrolled Nurse	Pass	Fail
KL35	36	Female	Counsellor	Fail	Pass
KL38	34	Female	Radiographer	Pass	Fail
KL41	23	Female	Nurse	Pass	Pass
KL43	55	Female	Cleaning Supervisor	Pass	Pass
Median	38 (31-49)	-	-	-	-
Total Pass	-	-	-	33	17
Total Fail	-	-	-	4	20

<sup>a</sup> N/A denotes Not Available

**Overall fit-test pass-fail contingency matrix analysis**

To determine the effect of the respirator on fit-test outcomes, the overall sequential fit-test results (**Table 3**) were further simplified into a 2x2 fit-test pass-fail contingency matrix regardless of the respirator model. This is a more simplified but robust way of determining the degree of agreement (Cohen's *Kappa* statistic) between the fit-test methods than simple percentage agreement calculation as *K* takes into account the possibility of the agreement occurring by chance (Landis and Koch, 1977). As described by Hon et al. (2017), the QLFT fail-pass results and the QNFT pass-fail results were organised into four categories, as follows: **A** — passed both fit-test methods (QNFT<sub>pass</sub> QLFT<sub>pass</sub>); **B** — passed the QNFT but failed

the QLFT (QNFT<sub>pass</sub> QLFT<sub>fail</sub>); **C** — passed the QLFT but failed the QNFT (QLFT<sub>pass</sub> QNFT<sub>fail</sub>) and **D** — failed both fit-test methods (QNFT<sub>fail</sub> QLFT<sub>fail</sub>) (Hon et al. 2017) [**Table 3**].

In order to ascertain the degree of agreement between the two fit-tests, Cohen's *Kappa* statistic (*K*) was then calculated as described by ANSI Z188.10. The *Kappa* coefficient is a statistical measure of inter-rater reliability (sometimes called inter-observer agreement) that is used to assess qualitative items and determine the agreement between two raters (in this instance method) (Landis and Koch, 1977). This inter-rater reliability usually happens when a data rater (collectors) provide a similar score to the same data set. According to ANSI a *K value* greater than 0.70 is recommended and suggests agreement between two fit-tests. The formula used to calculate Cohen's *Kappa* is:

Where:

$\mathcal{P}_o\mathcal{P}_o$  = the relative observed agreement among raters.

$\mathcal{P}_e\mathcal{P}_e$  = the hypothetical probability of chance agreement

The *Kappa* statistic varies from 0 to 1, where, 1 = perfect agreement.

<i>0 = agreement equivalent to chance.</i>	<i>0.1 – 0.20 = slight agreement.</i>	<i>0.21 – 0.40 = fair agreement.</i>
--	---------------------------------------	--------------------------------------

$$\text{Equation 1: } \mathcal{K} = \frac{\mathcal{P}_o - \mathcal{P}_e}{1 - \mathcal{P}_e} = 1 - \frac{1 - \mathcal{P}_o}{1 - \mathcal{P}_e}$$

<i>0.41 – 0.60 = moderate agreement.</i>	<i>0.61 – 0.80 = substantial agreement.</i>	<i>0.81 – 0.99 = near perfect agreement</i>
--	---	---

It is possible for  $K$  to be negative; it serves as an indication of a decline in the probability.

**Table 3:** Overall sequential fit-testing results and contingency matrix scores.

Participant ID (n=37)	Age	Gender	Job title	Overall QLFT Score	Overall QNFT Score	QNFT(Pass) QLFT (Pass)-A	QNFT (Pass) QLFT(Fail)-B	QLFT(Pass) QNFT (fail)-C	QLFT(Fail)- QNFT(Fail)-D
OD02	36	Female	Counsellor	Pass	Fail	-	-	C <sup>c</sup>	-
OD09	57	Female	Nurse	Pass	Fail	-	-	C	-
OD11	57	Female	Professional Nurse	Pass	Pass	A <sup>a</sup>	-	-	-
OD14	33	Female	Physiotherapist	Pass	Fail	-	-	C	-
OD26	N/A <sup>e</sup>	Female	IPC Nurse	Pass	Pass	A	-	-	-
OD28	42	Female	Laundry worker	Pass	Fail	-	-	C	-
OD29	27	Female	EHP	Pass	Pass	A	-	-	-
OD31	24	Female	Counsellor	Pass	Pass	A	-	-	-
OD34	38	Female	Nurse	Fail	Pass	-	B <sup>b</sup>	-	-
OD42	55	Female	Professional Nurse	Pass	Pass	A	-	-	-
OD44	49	Male	Coordinator	Pass	Pass	A	-	-	-
OD46	33	Female	Admin Trainee	Pass	Fail	-	-	C	-
OD49	52	Female	Nurse	Pass	Pass	A	-	-	-
OD54	55	Female	IPC coordinator	Pass	Fail	-	-	C	-
KL01	31	Female	Student Nurse	Pass	Fail	-	-	C	-
KL02	38	Female	Professional Nurse	Pass	Fail	-	-	C	-
KL03	30	Female	Nurse	Pass	Fail	-	-	C	-
KL07	45	Female	Cleaning Supervisor	Pass	Pass	A	-	-	-
KL08	30	Female	ENA	Pass	Pass	A	-	-	-
KL09	42	Female	Nurse	Fail	Fail	-	-	-	D <sup>d</sup>
KL12	56	Female	Operational Manager	Pass	Fail	-	-	C	-
KL13	29	Female	nursing Assistant	Pass	Pass	A	-	-	-
KL15	40	Female	Counsellor	Pass	Fail	-	-	C	-
KL17	39	Female	IPC Officer	Pass	Fail	-	-	C	-
KL18	N/A	Female	Professional Nurse	Pass	Pass	A	-	-	-
KL19	41	Female	Kitchen staff	Pass	Pass	A	-	-	-
KL21	29	Female	Professional Nurse	Pass	Fail	-	-	C	-
KL22	38	Female	Enrolled Nurse	Pass	Fail	-	-	C	-
KL23	32	Male	Cleaner	Pass	Fail	-	-	C	-
KL26	34	Female	Enrolled Nurse	pass	Pass	A	-	-	-
KL29	58	Female	Enrolled Nurse	Pass	Fail	-	-	C	-
KL33	26	Female	Counsellor	Fail	Fail	-	-	-	D
KL34	48	Female	Enrolled Nurse	pass	Fail	-	-	C	-
KL35	36	Female	Counsellor	fail	Pass	-	B	-	-
KL38	34	Female	Radiographer	Pass	Fail	-	-	C	-
KL41	23	Female	Nurse	Pass	Pass	A	-	-	-
KL43	55	Female	Cleaning Supervisor	Pass	Pass	A	-	-	-
Median	38 (31-49)	-	-	-	-	-	-	-	-
Total Pass	-	-	-	33	17	15	2	18	-
Total Fail	-	-	-	4	20	-	2	18	2

<sup>a</sup> QNFT Pass/QLFT Pass, <sup>b</sup> QNFT Pass/QLFT Fail, <sup>c</sup> QNFT Fail/QLFT Pass, <sup>d</sup> QNFT Fail/QLFT Fail, <sup>e</sup> Denotes Not Available

**Table 4:** Contingency matrix for QLFT and QNFT outcomes

	QLFT - Pass	QLFT - Fail	Total	Kappa Statistic
QNFT - Pass	15 (40.5%) - A	2 (5.5%) - B	<b>17</b>	
QNFT - Fail	18 (48.6%) - C	2 (5.5%) - D	<b>20</b>	
Total	<b>33</b>	<b>4</b>	<b>37</b>	
Kappa				-0.02
ASE				0.10
95% CI				-0.20 – 1.17

Fifteen of 37 (40.5%) HCWs passed both methods, while 2 (5.5%) individuals failed both methods. The majority of HCWs that passed the QLFT, 18 of 37 (48.6%), failed the corresponding QNFT, as shown on quadrants B and C. If both methods were passing or failing the HCWs in the same way (agreement), all values would lie along the diagonal and there would be zeros elsewhere in the matrix. Using this data, the  $K$  value of -0.02, which was well below the 0.7 value recommended by ANSI, suggests disagreement between the methods. In addition, although the obtained  $K$  value was within the resulting 95% confidence interval, this interval includes a zero which confirms that the fits-tests were statistically different, even though they seem to consistently disagree on the either passing or failing the respirators.

**Overall fit-test agreement plot for QLFT and the QNFT**

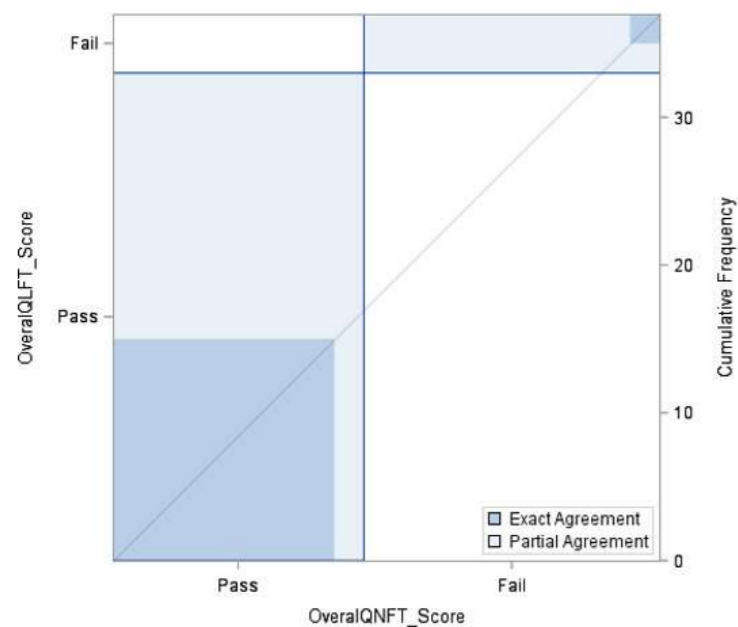
The overall fit-testing scores were then further analysed against their cumulative frequency within the pass and fail categories to produce an agreement plot. An agreement plot, in this case, is a visual representation of a  $K \times K$  contingency table (2x2 table in this case – Table 4) and provides a view of corresponding agreement/disagreement between the two main fit-test methods. The graph is segmented into 2 regions with the y-axis representing the results of the QLFT and the QNFT along the x-axis (Figure 6). In each segment, the dark-blue rectangles represent an agreement between both methods, while the parts where methods do not give the same fit-test results are shown in shades of light-blue. For instance, the 46727 QLFT and QNFT methods both passed about 15 HCWs (40.5%) whereas the QLFT method passed a large number of HCWs (the portion of QLFT<sub>Pass</sub> vs QNFT<sub>Pass</sub>) compared to those passed by the QNFT method. The diagonal line (similar to the concept of diagonal numbers in the contingency matrix mentioned above) shows the extent of disagreement and the direction of agreement.

**Figure 6:** Agreement plot of overall QNFT and QLFT scores in either pass or fail regions.

The graph is segmented into 2 regions (pass/fail) with the y-axis representing the results of the QLFT and the QNFT along the x-axis. In each segment, the dark-blue rectangles represent an agreement between both methods, while the parts where methods do not give the same fit-test results are shown in shades of light-blue.

**Sensitivity and specificity**

Sensitivity and specificity are normally used to provide some indicator of the reliability of an instrument or a test. In this study, a test was considered reliable if both fit-test methods agreed on the result, using QNFT as a reference (Hon, Danyluk,



Bryce, Janssen, Neudorf, Yassi, Shen and Astrakianakis, 2017) (Table 6).

**Table 1:** Fit-test reliability.

Type of Test	
Sensitivity	0.45 (45%)
Specificity	0.50 (50%)

With respect to the sensitivity of the fit-test, the proportion of HCWs obtaining a pass in both tests was roughly 45% (15 of 33 HCWs). Specificity, on the other hand, refers to a proportion of fails in both tests out of the total failures obtained by the QLFT and was about 50%.

**Odds ratio (OR)**

Individuals (HCWs) were 0.8 (80%) more likely to pass a QLFT than a corresponding QNFT. The degree of uncertainty estimated using the 95% confidence interval shows that a true value of the odds ratio can possibly be found in the range between 0.1 and 6.6.

**Table 2:** The odds ratio of passing QLFT compared to QNFT.

Odds Ratio			
Statistic	Value	95% Confidence Limits	
Odds Ratio	0.8	L = 0.1	U = 6.6

**DISCUSSION**

This study compared fit-test results from these two methods with HALYARD Health N95-FFR models 46827 (small) and

46727 (regular). This was to determine if the QLFT and QNFT methods had comparable results with the respirators that had been selected for use within many South African healthcare facilities. This study found that when analysing overall fit-testing scores, the majority of HCWs passed the QLFT compared to the QNFT method (89.2% vs 45.9%). Similarly, 54.5% of those HCWs that passed the QLFT, failed that corresponding QNFT method. This finding suggests that QNFT is more proficient in detecting failures than the QLFT for the types of N95 FFRs tested. Previous studies (Hon *et al.* 2017, Coffey *et al.* 2004) have suggested that QNFT could be prone to errors. Coffey, Lawrence, Campbell, Zhuang, Calvert and Jensen (2004) found that the TSI Portacount instrument can erroneously assign an ill-fitting respirator to a user (Coffey *et al.* 2004). According to the manufacturer of the instrument, a user still passes the overall QNFT despite failing the individual fit-test exercises as long as the overall fit-factor exceeds 100. Hon *et al.* (2017) argued the possibility of QNFT being excessively stringent and failing individuals who should have passed (Hon *et al.* 2017).

In order to ascertain the degree of agreement between the two fit-tests, *K value* was calculated. According to Landis and Koch (1977), the *K value* is a statistical measure of inter-rater reliability and in this instance used to assess the agreement between two methods (Landis and Koch, 1977). According to ANSI a *K value* greater than 0.70 is recommended and suggests agreement between two fit-tests. Results from this study indicated that the fit-test methods consistently disagreed and that the agreement between the fit-tests was worse than random.

The study set out to establish if passing the QNFT corresponded to passing a QLFT. The proportion of HCWs obtaining a pass in both tests was roughly 45% (15 of 33 HCWs). This is below the required threshold of 95% as recommended by ANSI. The degree of uncertainty estimated using the 95% confidence interval shows that a true value of the odds ratio can possibly be found in the range between 0.1 and 6.6. The upper limit of the odds ratio suggested that the HCWs were up to almost 7 times more likely to pass a QLFT test than a corresponding QNFT.

The overall fit-testing scores were then further analysed against their cumulative frequency within the pass and fail categories to produce an agreement plot. An agreement plot is a visual representation of a contingency table and provides a view of corresponding agreement/disagreement between the two main fit-test methods. In this study, the rectangles of the QLFT methods on the agreement plot lay above the 45-degree diagonal line, indicating that all the results were biased towards the models of the QLFT method. With respect to the effect of the N95-FFR model on the fit-test results, this study showed similar results to those of other researchers who reported no difference in fit-test pass rates between various N95-FFRs models using different fit-test methods (Hon *et al.* 2017). However, these results differ from previous studies in the literature that reported a statistically significant difference between models (Coffey *et al.* 2002; 2006). To the researcher’s knowledge, this is the first study to explore the fit-testing pass rates of Halyard Health N95-respirators, models 46827 and 46727.

To determine the effect of respirator models on fit-test outcomes, a contingency matrix (4x4) showing the number of HCWs that were passed or failed by the fit-test methods was plotted, taking into account their corresponding models. The N95-FFR model 46727 both QLFT and QNFT passed about 8 HCWs, however; in general, the QLFT passed a large number of HCWs compared to those passed by the QNFT. The corresponding *K* statistic for 46727 respirator model was -0.01 (95% CI -0.37–1.15) and that for 46827 respirator model was 1 (95% CI 1–1). An overlap in the confidence intervals indicated that there was no statistically significant difference in fit-test outcomes between the N95-FFRs. While the results for the 46827 model were what is expected for a perfect agreement, they were based on a small sample of 5 participants. The odds ratio was irrelevant, since there was no difference between the fit-test results for model 46827.

A critical weakness of this study and many other studies lies in the research design and data collection. The use of a smaller cohort as in the current study with each participant undergoing fit-testing on multiple occasions is problematic. Studies of this nature need to be designed such that that fit-tests are conducted sequentially on the same respirator to allow for direct comparison between the two fit-test methods. The problem with multiple donning is the bias created through users gaining experience with subsequent donning which may result in improved fit-test pass rates.

**CONCLUSION**

This study clearly identified the QNFT as a method of choice due to its sensitivity, however the downside to the excessively stringent nature of this method is that it could result in failing individuals who should have passed. While this interesting phenomenon was beyond the scope of this current study, it warrants further investigations in the future. This is likely to also address whether the TSI Portacount instrument can erroneously assign an ill-fitting respirator to a user.

## LIST OF REFERENCES

- ANSI, 2001. *American National Standard for respirator fit-testing methods. ANSI Z88*. 10th edn. New York: American National Standards Institute.
- BOCK, N.N., JENSEN, P.A., MILLER, B. and NARDELL, E., 2007. Tuberculosis infection control in resource-limited settings in the era of expanding HIV care and treatment. *The Journal of Infectious Diseases*, 196(Supplement\_1), pp. S108-S113.
- CEN, E., 2005. 529: 2005 *Respiratory Protective Devices—Recommendations for Selection, Use, Care and Maintenance—Guidance document*. Brussels: European Committee for Standardization.
- CEN, E., 2001. 149: 2001 *norm: Respiratory protective devices—Filtering half masks to protect against particles—Requirements, testing, marking*. Brussels: European Committee for Standardization.
- CHURCHYARD, G., MAMETJA, L., MVUSI, L., NDJEK, N., HESSELING, A., REID, A. and BABATUNDE, S., 2014. Tuberculosis control in South Africa: Successes, challenges and recommendations. *South African Medical Journal*, 104(3), pp. 244-248.
- COFFEY, C.C., LAWRENCE, R.B., CAMPBELL, D.L., ZHUANG, Z., CALVERT, C.A. and JENSEN, P.A., 2004. Fitting characteristics of eighteen N95 filtering-facepiece respirators. *Journal of occupational and environmental hygiene*, 1(4), pp. 262-271.
- ENGELBRECHT, M., VAN RENSBURG, A.J., KIGOZI, G. and VAN RENSBURG, H.D., 2016. Factors associated with good TB infection control practices among primary healthcare workers in the Free State Province, South Africa. *BMC infectious diseases*, 16(1), pp. 633.
- GRANICH, R., BINKIN, N.J., JARVIS, W.R., SIMONE, P.M., RIEDER, H.L., ESPINAL, M.A., KUMARESAN, J.A. and WORLD HEALTH ORGANIZATION. 1999. *Guidelines for the prevention of tuberculosis in health care facilities in resource-limited settings*. Geneva, Switzerland: World Health Organisation.
- HARRIES, A.D., ZACHARIAH, R., TAYLER-SMITH, K., SCHOUTEN, E.J., CHIMBWANDIRA, F., VAN DAMME, W. and EL-SADR, W.M., 2010. Keeping health facilities safe: one way of strengthening the interaction between disease-specific programmes and health systems. *Tropical Medicine & International Health*, 15(12), pp. 1407-1412.
- HON, C.Y., DANYLUK, Q., BRYCE, E., JANSSEN, B., NEUDORF, M., YASSI, A., SHEN, H. and ASTRAKIANAKIS, G., 2017. Comparison of qualitative and quantitative fit-testing results for three commonly used respirators in the healthcare sector. *Journal of Occupational And Environmental Hygiene*, 14(3), pp. 175-179.
- JANSSEN, L.L., LUINENBURG, M.D., MULLINS, H.E. and NELSON, T.J., 2002. Comparison of three commercially available fit-test methods. *AIHA Journal*, 63(6), pp. 762-767.
- MANGANYI, J., WILSON, K.S. and REES, D., 2017. Quantitative Respirator Fit, Face Sizes, and Determinants of Fit in South African Diagnostic Laboratory Respirator Users. *Annals of work exposures and health*, 61(9), pp. 1154-1162.
- MATUKA, O., SINGH, T.S., BRYCE, E., YASSI, A., KGASHA, O., ZUNGU, M., KYAW, K., MALOTLE, M., RENTON, K. and O'HARA, L., 2015. Pilot study to detect airborne Mycobacterium tuberculosis exposure in a South African public healthcare facility outpatient clinic. *The Journal of Hospital Infection*, 89(3), pp. 192-196.
- MENZIES, D., JOSHI, R. and PAI, M., 2007. Risk of tuberculosis infection and disease associated with work in health care settings. *The International Journal of Tuberculosis And Lung Disease: The Official Journal of The International Union Against Tuberculosis And Lung Disease*, 11(6), pp. 593-605.
- OSHA. 2012. *29 CFR Sect. Respiratory protection*. 1910.134 edn. Washington, DC: United States Government Printing Office.
- OSHA. 2006. *Major requirements of OSHA's Respiratory Protection Standard. Respiratory protection*. 29 CFR 1910.134 edn. Washington, DC: United States Government Printing Office.
- OSHA. 2002. *Major requirements of OSHA's Respiratory Protection Standard. Respiratory protection*. 29 CFR 1910.134 edn. Washington, DC: United States Government Printing Office.
- PILLAY, M. and STURM, A., 2010. Nosocomial transmission of the F15/LAM4/KZN genotype of Mycobacterium tuberculosis in patients on tuberculosis treatment. *The International Journal of Tuberculosis And Lung Disease*, 14(2), pp. 223-230.
- RIM, K. and LIM, C., 2014. Biologically hazardous agents at work and efforts to protect workers' health: a review of recent reports. *Safety And Health At Work*, 5(2), pp. 43-52.
- SABS. 2018. Medical devices: Part 2, Medical respirators. South African National Standard (SANS 1866:2018). Standards South Africa edn., Pretoria: Republic of South Africa: SABS Standards Division.
- SABS 2003. Respiratory protective devices – Filtering half masks to protect against particles – Requirements, testing, marking. (SANS 50149:2003). Standards South Africa edn. Pretoria: Republic of South Africa: SABS Standards Division.
- SANAC. 2017. South Africa's national strategic plan for HIV, TB and STIs 2017-2022.
- TSWANE MUNICIPALITY. 2012. *Gauteng Tshwane District Profile*. [Online] Available at: <https://www.hst.org.za/publications/NonHST%20Publications/Gauteng-%20Tshwane%20District.pdf>. The Tshwane Health District.
- TUDOR, C., VAN DER WALT, M., MARGOT, B., DORMAN, S.E., PAN, W.K., YENOKYAN, G. and FARLEY, J.E., 2014. Tuberculosis among health care workers in KwaZulu-Natal, South Africa: a retrospective cohort analysis. *BMC public health*, 14, pp. 891-2458-14-891.
- WHO. 2019. *WHO guidelines on tuberculosis infection prevention and control: 2019 update*. Geneva, Switzerland: World Health Organisation
- WHO. 2018. *Global tuberculosis report 2018*. Geneva, Switzerland: World Health Organisation.
- WHO. 2009. *WHO policy on TB infection control in health-care facilities, congregate settings and households*. Geneva, Switzerland: World Health Organisation.

# NOT THE "REGULAR" FIT: A SOCIO-TECHNICAL SYSTEMS APPROACH TO DESIGNING EYEWEAR IN SOUTH AFRICA

Marcha Naudé, University of Johannesburg, margarethcharlotte273@gmail.com

Angus Donald Campbell, University of Johannesburg, acampbell@uj.ac.za

## Abstract

*In South Africa, there is a scarcity of prescription glasses manufacturers and the majority of locally available eyewear frames are imported. A significant portion of this imported eyewear comes from a single umbrella organisation, which designs eyewear from a predominantly Eurocentric perspective. For example, there are currently only two types of eyewear fit, the "regular" fit, based on European facial data, and the "Asian" or "global" fit, which was developed in reaction to the inappropriateness of the "regular" fit for this market. In South Africa, a country with a significantly diverse population, there is an opportunity for properly fitting eyewear that is often not accommodated by either of these fits. Improper fitment causes discomfort and leads to blurry vision and long-term vision problems. Fitment is however not the only problem with the currently imported frames. The South African eyewear industry is a complex system, with both social and technical challenges that often influence the process of how someone would go about acquiring prescription glasses.*

*This paper explores a design research study that was undertaken to address some of the local eyewear complexities through the design of a product, guided by theories of socio-technical systems, appropriate technology and human-centred design. The outcome was an adaptable eyewear frame that could be produced locally, whilst better considering the needs of glasses wearers in the South African context. Following such a design research approach ensures that the product outcome is attuned to local needs; such an approach could be beneficial to a wide range of localized industries in the Global South.*

**Keywords:** Appropriate technology, eyewear, human-centred design, industrial design, socio-technical systems

## INTRODUCTION

Generally, humans are acknowledged to have five senses: the ability to hear, smell, taste, touch and see (Bradford, 2017). Although one sense is not more important than the other, our eyes play a vital role in our daily life and are generally considered as one of our primary senses with 80-85% of our learning, perception, cognition and activities arbitrated through vision (Ripley & Politzer, 2010, p. 215). When someone cannot see well, the answer seems simple: give them a pair of glasses. However, the reality that unfolded through our design research study showed that, due to systemic complexities, it is not a straightforward process. In South Africa it seems that there is a wide range of eyewear frames to choose from, especially in terms of style and colour, but the eyewear industry has adopted a relatively standardised product and service and, most problematic, this has been developed mainly from a Eurocentric perspective. The majority of eyewear frames are designed and made for the needs of the Global North, imported by countries such as South Africa, where we find that they are insufficiently meeting the needs of the majority of the population. This paper explores how designing for the context in which a product will be used, guided by theories of appropriate technology (AT), leads to solutions that better meet local needs.

## MOTIVATION AND SIGNIFICANCE

Eyewear is available in various shapes, sizes, colours and styles. With all these options to choose from, one would think that finding the 'perfect' pair would not be such a difficult task. However, the reality is that the choice is not as wide as one may think. In 2018 Luxottica, an Italian eyewear company, merged with Essilor, a lens manufacturing company, to create EssilorLuxottica. EssilorLuxottica controls a significant portion of the world's eyewear market (BBC, 2018). This means they control the price, the design and the distribution of eyewear, and now with the merger, the lenses as well – the whole supply chain, from manufacture to end-user (BBC, 2018; Pollock, 2017). Many eyewear needs are not being accommodated by such monopolisation of the market. One particularly problematic result of this market dominance is that there are only two types of eyewear fits available: "regular fit" and the "Asian fit/alternative fit/global fit" (Thau, 2016; Refinery29, 2016). The "regular fit" is what the majority of eyewear brands offer; this is a fit modelled mainly on Eurocentric facial features. The "Asian fit" was developed in reaction to the inappropriateness of the "regular fit" for the Asian market (Phillips, 2013). Recently, there has been an emergence of eyewear brands that specialise in custom-fit frame designs (Vision Monday, 2019; HOYA Vision Care, 2018; Sfered, 2019), but these frames are not readily available in South Africa. In South Africa, a country with such a diverse population, there seemed to be a large gap for properly fitting eyewear, but a lack of data to support this assumption. Other studies have shown that there are significant facial dimension variations in the African population, who directly import most to all of their eyewear frames (Halladay, Thandiwe, Ayerakwah, Dennis, Joshua & George, 2019). Fit is important since when eyewear does not fit correctly it does not only lead to physical pain but also can distort vision and in the long-term that can lead to vision problems (Brooks & Borish, 1996, p. 415; Mashima, et al., 2011, p. 228; Eyes of the Marina, 2017). Unfortunately, there is no 'one size fits all' frame solution and currently glasses have to be adjusted to suit an individual's needs. Very often, these adjustments are a compromise between the wearer's needs and what the frame allows.

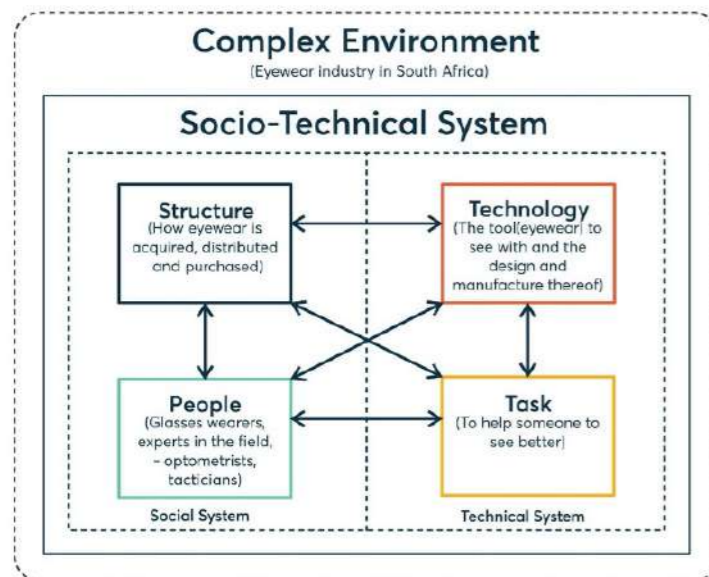
Even though the aesthetics and fitment of eyewear are considered as some of the most important factors when choosing a frame, there are other systemic elements, like cost and the structure of the eyewear/medical industry in South Africa, that also play a significant role. To design and develop the best possible local frame solution, all of these complexities had to be part of the design research process. Therefore, the central research question of the study was: *what are the problems of eyewear currently available in South Africa, and how could eyewear be designed to better consider the social and technical complexities of the South African context?*

## THEORETICAL FRAMEWORK

To answer this research question, an appropriate theoretical framework had to be selected. The theory of socio-technical systems acknowledges that the interaction between social and technical factors determines the success of the whole system (Valdez & Brauner, 2016:484). For this study the socio-technical system referred to the organised system of people and technology that is arranged in a way to accomplish a specific task (Valdez & Brauner, 2016:483); in this case, to improve human sight. The complexity lies in how these elements combine to work together or in opposition towards a specific outcome. A socio-technical model was proposed by Harold Leavitt (1965) that visualises the interaction between variables within an organisational system (Valdez & Brauner, 2016:485; Leonard, Freedman, Lewis & Passmore, 2013). Leavitt (1965:1145; Leonard, et al., 2013), identified four key interacting variables within his model, these being *task, structure, technology* and *people/actors*. An adaption to Leavitt's model divides the interrelation between the variables in two subsystems: a *technical* subsystem and a *social* subsystem (Valdez & Brauner, 2016:484).

The model was adapted to suit this study, in the following ways (Figure 1). The *task* was identified as improving human sight. The *people* in the study were glasses wearers, as well as the people who provide eyewear or play a role in this process. The *structure* referred to how eyewear is acquired, distributed, and paid for, where the eyewear comes from, and how the price is determined. The *technology* was the tool to see with (the eyewear itself), as well as the design and manufacture thereof. As a designer, the opportunity for the design intervention sits in the technology quadrant. However, to arrive at an appropriate technological outcome in the South African eyewear socio-technical system, the other three quadrants of the task, people/actors and structure needed deep engagement for appropriate outcomes.

A limitation of socio-technical system innovation is that it can be too "big picture" (Ceschin & Gaziulusoy, 2016:141), and so we utilised other approaches to help guide the design process towards appropriate outcomes. Leavitt's model helped to establish the broad complexities that had to be researched and considered in the design process, to further orientate the design research process, appropriate technology (AT) and human-centred design (HDC) were integrated into the study. The technical factors of eyewear design were considered through AT, acknowledging the context of



**Figure 1:** Adaption of socio-technical system model to suit the social and technical complexities of this study

product use. The fundamental quality of AT is that the “usefulness or value of a technology must be consolidated by the social, cultural, economic and political milieu in which it is to be used” (Hazeltime & Bull, 2003:4). To address the social factors, the design process was driven by a participatory HCD approach to ensure that the specific needs of the people using or interacting with the product were met (Norman, 2013:219). By addressing the design problem through a framework of socio-technical systems theory, AT and HCD we considered both the social and technical factors in a more holistic approach, that could potentially lead to a more sustainable product outcome (Ceschin & Gaziulusoy, 2016:147).

## RESEARCH PHASES

Although there are various models of HCD (Norman, 2013:221; British Design Council, 2005; IDEO, 2012; IDEO, 2015b; Tschimmel, 2012), *The Human Centered Design Toolkit* by IDEO (2012) was used as a model to undertake this study. IDEO explain that their model allows designers to better connect with and serve the people they are designing for (IDEO, 2012:4). It also can transform data into “actionable ideas” and identify new solutions better (IDEO, 2012:4). According to IDEO’s model, “HCD is uniquely situated to arrive at solutions that are desirable, feasible and viable” (IDEO, 2015a:14). This model of innovation starts with identifying what people desire, want or need (desirability), thereafter a process of investigation starts in terms of what is technically and organisationally possible (feasibility), as well as financially viable (viability) (IDEO, 2012:6). IDEO’s (2012:8) model outlines three main phases of the HCD process that help to achieve innovative outcomes: *Hear*, *Create* and *Deliver*.

## HEAR<sup>1</sup>

The *Hear* phase aimed to investigate the problems of eyewear currently available in South Africa and to determine if current eyewear is meeting the needs of glasses wearers in our country. As per socio-technical systems theory, the variables of *task*, *people/actors*, *structure* and *technology* were used as the main areas of research. Information was gathered through desktop research (Milton & Rogers, 2013:51), in books and journals. Interestingly, the information gathered was mostly from grey literature since there is a lack of credible literature and data relating to eyewear, its design and the eyewear industry itself – especially in the South African context. Additionally, semi-structured interviews (Milton & Rogers, 2013:72), were conducted with four glasses wearers and four experts within the field

<sup>1</sup> This paper provides a brief overview of a one-year Hons project that then expanded into a two-year Master’s in Industrial Design at the University of Johannesburg. Should you be interested in reading more about this study please refer to Naudé (2020).

of optometry and eyewear. All information gathered was thematically colour coded to create affinity diagrams and mindmaps (Martin & Hanington, 2012:12; p. 118). These were used to develop a design strategy that informed the *Create* phase of the HCD process.

## Findings from *Hear* phase

The eye care and eyewear industry in South Africa is a complex system, and not all of the issues that emerged could be addressed. As Industrial designers, the most obvious solution was to design a product, in this case, an eyewear frame to address some of these complexities. We found that the social and technical complexities of the system had a large influence on how or why people selected their prescription glasses. Specific factors of *preference*, *cost*, *fitment* and *eye health need* significantly influenced the process (Naudé, 2020); and to add to the complexity, each of these factors was specific to each eyewear wearer. This meant that the frame solution had to be adaptable to accommodate diverse needs and mass-customisation (Tseng, et al., 1996; Ferguson, et al., 2014) was identified as a way to achieve this. Technologies, such as adaptable manufacturing (Tseng, et al., 1996; Ferguson, et al., 2014), and methods of collecting facial anthropometric data to allow for diverse fitment needs, required further research and testing in the *Create* phase.

## CREATE

The main objective of this phase was to practically explore how technology could be used for eyewear to be more adaptable to the complex socio-technical system identified in the *Hear* phase. There was clear evidence that the available types of frame fit in South Africa – the global fit and alternative/Asian fit – were not suited to the facial structures of the diverse South African population. To better understand the extent of this misfit, data on the facial anthropometrics of the participant group of glasses wearers was needed. Various technologies were explored and 3D scanning technology showed promising possibilities (Lee, et al., 2016; Ball, et al., 2010; Luximon, et al., 2016). However, through experimentation, it was found that this technology is relatively inaccessible and complex to use. In this project, AT was not only a consideration for the outcome, but the technological process of getting to it also needed to be readily available, accessible and suitable to the project timeline. Therefore, a manual measuring method based on the Fairbanks facial measurement gauge (Association of British Dispensing Opticians, 2019) was developed. The facial anthropometric data collected from the group of glasses wearers was converted into visual facial measurement grids to identify key fitment requirements for each of their faces.

By using the facial measurement grid as a sizing guideline, frame profiles were developed for each glasses wearer. These profiles were made into cardboard mock-ups to represent the actual size of the frame design for the wearers to then test the size and fitment of the frame. After the feedback was gathered from each glasses wearer on the initial frame concepts, refinements were made and a final frame design was developed to be tested during the *Deliver* phase.

## Findings from *Create* phase

Our qualitative study used a small sample group of only four glasses wearers, and there was little to no similarity between their facial measurements. However, despite the small sample, what was clear was a significant mismatch of the participants’ facial features with regards to ‘standard’ fit frames.

The Fairbanks facial measurement gauge (Figure 2) was originally developed at City University in London with the teaching of ophthalmic dispensing in mind (Association of British Dispensing Opticians, 2019). The gauge is a single tool that can accurately measure more than 14 facial measurements. It is available to purchase online (Association of British Dispensing Opticians, 2019), but is expensive and cannot be shipped to South Africa. Therefore, we adapted and simplified the multipurpose tool into a collection of six individual measurement tools that were produced by laser-cutting cardboard profiles with measurements printed on them.

From literature describing the use of the Fairbanks facial gauge, it was found that all patients in their examples were Caucasian/European (Bates, 2016a; Bates, 2016b; Optometry Today, 2015; ABDO College, n.d.). When we used it, this was confirmed, with us having to modify our tools to accommodate a wider range of facial structures of the glasses wearers who participated in the study. These adjustments were made specifically to the tools measuring the crest height (B) (Figure 3) and apical radius (C). A further finding was that all the glasses wearers had a negative bridge

projection (F) ranging from -1mm to -4,5mm. Literature showed that the majority of glasses are designed with a positive bridge projection of 2mm (Bates, 2016b), which meant that when people had a negative bridge projection and wore a frame with a positive bridge projection that their eyelashes could touch the lenses (Bates, 2016b). The frontal angle (G) and splay angle (H) were measured on both the left and right side of each participants' noses, it was found that most of these measurements differ (Table 1). The fact that the participants' noses were rarely symmetrical, was also an important finding since these angles influences how the nose pads or bridge of the frame rests on the nose.



Figure 2: Fairbanks facial measurement gauge

To meet the needs of aesthetic preference, cost and eye health needs, we developed a range of frame profile shapes customised to the participants' facial measurements. Instead of developing an expensive computer application, we simply used an existing graphics software package and, with a photograph of each participant, sat with them in a virtual prototyping session to further customise the shape and colour of their frames. The photographs of their faces were taken with consideration for focal length, aperture and camera lens to eliminate any distortion, which was found to be a useful method of confirming physical measurements in the overlaid 2D frames. At this point, we also took the glasses wearers' existing lens prescriptions so that when the new frames were trialled it was with the correct lenses.

To practically test the accuracy of the facial measurements, the new frame fitment and design, cardboard frame mock-ups were made from the participants' chosen 2D frame. This was a low-tech, low-cost, quick and tangible solution for the glasses wearers to evaluate the new frame design, but at the same time, see the problems with their existing frames. They could readily see the significant difference between the frame profiles created according to their measurements and those they were wearing at that time. The new frame profiles had wider nose profiles and the nose bridges were located lower, showing that the nose pads of their current frames were located too high on the rim (Figure 4). Available eyewear frames

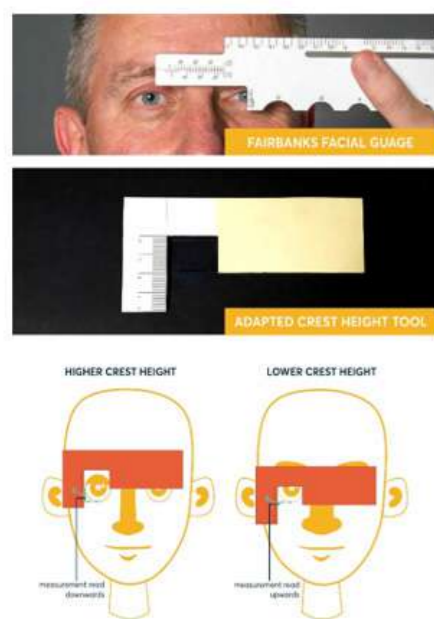


Figure 3: Adaptation of Fairbanks facial measurement gauge to measure crest height

	GW1	GW2	GW3	GW4
A Interpupillary distance	69	62	67	67
B Crest height	-5	-3,5	3,5	2,5
C Apical radius	12	15	11	8
D DBR 10mm	24	27	26	20
E DBR 15mm	32	32	34	29
F Projection type:	negative	negative	negative	negative
F Projection measurement:	-2,5	-4,5	-2	-1
G Frontal angle	L36° R28°	L45° R45°	L44° R44°	L27° R38°
H Splay angle	L25° R35°	L48° R40°	L54° R40°	L47° R36°
I Front to bend	115	100	95	100
J Head width	157	146	150	144
K Temple width	142	131	141	137
L Suggested frame width	136	125	135	130

\*all measurements in mm, unless specified otherwise

Table 1: Facial measurement data collected from each glasses wearer

usually have set temple arm lengths (Hellem, 2019). These lengths are measured from the front of the temple arm to the end of the temple tip; if too long the glasses slide off one's nose, and if too short there is pressure on the top of the ears and the side of the head. Additionally, it causes the pantoscopic tilt<sup>2</sup> of the glasses to sit incorrectly. From the individual measured data, the front to bend measurement (I) was used to create customised temple arms that would accurately fit each wearer, ensuring that the temple tip bent down at the correct location behind the ears. It was found that the front to bend measurements were unique to each glasses wearer's ears and the practical testing confirmed that the front-to-bend measurement worked well to create correctly fitted temple arms.

### Final frame outcome

The final frame consisted of five major parts: the frame front, the two temple arms and two spring steel clips (Naudé, 2017)<sup>3</sup>. The frame front and temple arms were made by laser cutting profiles out of 0,5mm stainless steel sheets. The reason for this was due to the availability and accessibility of both the material and the technology in South Africa (Naudé, 2017). Stainless steel was a more cost-effective solution in comparison to other metals such as titanium (Naudé, 2017). A benefit of the material was that it is corrosion-resistant, hypoallergic, lightweight, durable and is relatively malleable (Naudé, 2017), an ideal property for the adjustability required in eyewear. Laser cutting is a great batch manufacturing process and designs can easily be changed or updated without much difficulty and without adding cost or time to the manufacturing process. When the sizes and profiles have to be changed or updated, it can be done digitally before the cutting process starts. This is a better alternative to injection moulding, where moulds are expensive to change or update. Although 3D printing could be used as a mass manufacture technology, it was not pursued in this project because the technology was not available during the study, as well as its cost.

The clips on the edge of the frame were designed to be made out of 0,7-0,9 mm spring steel wire (Naudé, 2017). They had three functions – to hold the frame together, to keep the lenses securely in place and to function as a hinge<sup>4</sup>. It was found that the most common repair work done on eyewear is replacing screws that fall out or break (Naudé, 2017), but the innovative clip design eliminated this problem. The frame front had slots that were cut into the end pieces, allowing the frame to be opened to insert the lenses (Figure 5).

Nose pads were added to the frame design to allow for better adjustability around the nose bridge area. To make the frame comfortable on the ears and nose, the temple tips and nose pads were designed to be injection moulded silicone parts. Silicone is durable, inexpensive, hypoallergic and easy to clean; it also provides flexibility, which is required in the adjustability and adaptability of the temple arms as well as the nose pads to the glasses wearer's facial structure (Naudé, 2017). Silicone temple tips and nose pads also have non-slip properties, which help to keep the frame from sliding forward (Naudé, 2017). Silicone is also available in a wide variety of colours and textures, adding to potential customisations (Naudé, 2017).

As was explained in the *Hear* phase, the style of the frame design could easily be adapted to the glasses wearer's preferences through experimentation in the virtual graphics interface, with desired modifications made possible through the laser-cutting production method. To accommodate the eye health needs of the patient, the frame carefully considered how a wide range of lenses could be fitted into the frame. Further to this, to add to the resilience of the frame, the design also accommodated the addition of clip-on sunglasses. Across the range of customisation options, a range of price brackets was considered. There was a basic range of frames at prices that allowed those who desperately needed glasses the opportunity to have them, and fully customised frames for those that wanted them. In both cases, the price was significantly lower than the existing frame options on the market.

<sup>2</sup> "Pantoscopic tilt is defined as a lens tilt about the horizontal axis, with respect to primary gaze of a subject" (Kalikivayi, et al., 2018).

<sup>3</sup> The BA Honours mini-dissertation project was not published to protect the intellectual property of the project. The product was provisionally patented in 2017 and filed as a full national patent in 2019. The mini-dissertation is however accessible by contacting the authors of this paper.

<sup>4</sup> In partnership with the University of Johannesburg Technology Transfer Office, this innovation has been patented: ZA National Patent 2019/01244.





Figure 4: Comparison between glasses wearers' cardboard frame profile and their current frames

## DELIVER

The main objective of the *Deliver* phase was to investigate the response of the glasses wearers to their final eyewear prototypes. A final prototype (Martin & Hanington, 2012:138) of each eyewear frame was custom-made for each glasses wearer participant. The frame included the aesthetic elements selected by the wearers through the digital interface and their facial measurements refined through the cardboard mock-ups. To allow the participants to fully test the efficacy of the frames their lens prescriptions were fitted by an optical technician into the prototypes. The silicone nose pads and temple tips were prototyped using 3D printed moulds and soft air-drying clay (*Amos iClay*) (see Figure 6). This solution was in itself also an appropriate technological choice for the production of only four sets of glasses.

### Findings from the *Deliver* phase

The prototypes were taken to an optical technician to fit the lenses. During this process, he evaluated the technical design and functionality of the frame. Although he did make a suggestion to increase the strength and reduce the flexibility of the frame material, the technician confirmed that the newly designed prototype frames could function as prescription eyewear frames since they enabled easy and secure fitment of the lenses. However, a problem that did arise was that the machines used during the lens fitment are manufactured in Europe and only accommodate 'standard' frame sizes. Due to the change in crest height, apical radius and bridge projection outside of the 'standard' parameter of the machines, the technician had to manually calculate the correct optical centre<sup>5</sup> of the lenses. This provided more evidence that



Figure 5: Technicalities of frame design

<sup>5</sup> It is the central point of the lens through which a ray of light passes without suffering any deviation, resulting in the optimum point through which the eye should look to see clearly.

the inappropriateness of the 'standard' frame extended beyond the frames themselves into the broader socio-technical system of the SA eyewear industry.

The overall response from the glasses wearers to the frame designs after wearing them for one week was positive. All the glasses wearers commented on how the frames better suited their faces and fitted more comfortably than their current frames. Further development and refinements are required in the nose pad area, but despite this, the prototype frames were significantly different from their current eyewear frames, especially at the nose bridge area and at the temple arm lengths. It would seem that these are key aspects for appropriate frame fitment for the diversity of the South African population.

## CONCLUSION AND RECOMMENDATIONS

Although this study aimed to address the systemic challenges within the eyewear industry in South Africa, there were a few limitations that have to be acknowledged. The first was, that due to the complexity of the system it was impossible within the timeframe of the study to do in-depth research of the entire eyewear system. Additionally, there was a lack of rigorous data, requiring direct engagement with experts within the eye care field, as well as prescription glasses wearers. The qualitative nature of the study, therefore, necessitated a small sample group of participants so that the depth and complexity of their individual experiences were explored. The participants provided rich and meaningful information, but the data that was collected cannot be generalised. There is, therefore, an opportunity for further quantitative studies to generate more representative data.

To answer this study's central research question, an investigation of the South African eyewear socio-technical system was required. The design research process was guided by Appropriate Technology (Hazeltine & Bull, 2003; Akubue, 2000) and Human-Centred Design (IDEO, 2012). Even with the above limitations, it became evident that locally available eyewear frames do not meet the needs of South African glasses wearers due to a problematic monopolisation of the market (*structure*). Eyewear, the business thereof and the standards attached to the industry are mainly designed from a Eurocentric perspective. Often these Eurocentric products are imported, by countries such as South Africa, which means that they seldom consider the different context in which they will be used. To design a product that would help someone to see better (*task*), it was important to understand the needs of both the people wearing glasses, as well as experts such as optometrists and optical technicians who work in the eye care industry (*people*). It became evident that not all of the socio-technical system complexities could be solved through a single outcome, therefore the needs of glasses wearers during the frame selection process were identified as the main intervention point. Relevant factors included aesthetic preferences, cost, fitment and eye health needs. Although influenced by socio-technical systemic complexities within the eyewear industry, each of these factors is unique to individual glasses wearers, which required an adaptable frame solution. Mass-customisation and adaptable manufacturing methods were identified as ways to achieve such requirements (*technology*). By practically working with a group of eyewear experts and glasses wearers, a customisable frame design that better considers the social and technical needs of South African glasses wearers was locally produced. The practical development of glasses in this study highlighted the problem of technology transfer without consideration for local realities. It is the first stepping-stone in exploring the entire South African socio-technical eyewear system towards the development of other appropriate technological interventions.



Figure 6: 3D printed moulds were used to mould air-drying clay around temple tips

## LIST OF REFERENCES

- ABDO College, n.d. *Fairbanks Facial Measurement Gauge Instruction Booklet*. s.l.:s.n.
- Akubue, A., 2000. Appropriate Technology for Socioeconomic Development in Third World Countries. *The Journal of Technology Studies*, 26(1), pp. 33-45.
- Association of British Dispensing Opticians, 2019. *Fairbanks Facial Measurement Gauge*. [Online] Available at: <https://abdocollege.org.uk/product/facial-measurment-gauge/> [Accessed 31 May 2019].
- Ball, R. et al., 2010. A Comparison Between Chinese and Caucasian Head Shapes. *Applied Ergonomics*, Volume 41, pp. 832-839.
- Bates, S., 2016a. *FQE Regular Bridge Frame Fitting*. [Online] Available at: [https://www.youtube.com/watch?v=XZn\\_48oSWPg](https://www.youtube.com/watch?v=XZn_48oSWPg) [Accessed 15 May 2019].
- Bates, S., 2016b. *PQE Facial Measurements*. [Online] Available at: <https://www.youtube.com/watch?v=GxvjDifWWzU> [Accessed 18 May 2019].
- BBC, 2018. *A Spectacular Merger*. [Online] Available at: <https://www.bbc.co.uk/programmes/w3cswgkn> [Accessed 24 August 2020].
- Bradford, A., 2017. *The Five (and more) senses*. [Online] Available at: <https://www.livescience.com/60752-human-senses.html> [Accessed 7 August 2018].
- British Design Council, 2005. *The Design Process: What is the Double Diamond?*. [Online] Available at: <https://www.designcouncil.org.uk/news-opinion/design-process-what-double-diamond> [Accessed 14 November 2018].
- Brooks, C. & Borish, I., 1996. *System for Ophthalmic Dispensing*. 2nd ed. Oxford: Butterworth-Heinemann.
- Ceschin, F. & Gaziulusoy, I., 2016. Evolution of Design for Sustainability: From Product Design to Design for System Innovations and Transitions. *Design Studies*, Volume 47, pp. 118-163.
- Eyes of the Marina, 2017. *The Importance of Having an Eyeglass Fitting*. [Online] Available at: <https://www.eyesofthamarina.com/blog/2017/10/12/the-importance-of-having-an-eyeglasses-fitting> [Accessed 2 March 2018].
- Ferguson, S., Olewnik, A. & Cormier, P., 2014. A Review of Mass Customization across Marketing, Engineering and Distribution Domains toward Development of a Process Framework. *Research in Engineering Design*, 25(1), pp. 11-30.
- Halladay, A., Thandiwe, M., Ayerakwah, P., Dennis, S., Joshua, M & George, K., 2019. Ophthalmic Anthropometry of an Urban Malawian Population. *Cogent Medicine*, 6(1).
- Hazeltine, B. & Bull, C., 2003. *Field Guide to Appropriate Technology*. San Diego, London: Academic Press.
- Hellem, A., 2019. *Eyeglass Temples: How do you know if they're the right length?*. [Online] Available at: <https://www.allaboutvision.com/eyeglasses/faq/eyeglasses-temple-size.htm> [Accessed 15 December 2019].
- HOYA Vision Care, 2018. *YUNIKU - The Manufacturing of Vision-Centric 3D Tailored Eyewear*. [Online] Available at: <https://www.youtube.com/watch?v=iowVxBTJTPM> [Accessed 22 December 2019].
- IDEO, 2012. *Human Centred Design Toolkit*. 2nd ed. Palo Alto: IDEO.
- IDEO, 2015a. *Field Guide to Human-Centered Design: Design Kit*. 1st ed. Canada: IDEO.org.
- IDEO, 2015b. *The Little Book of Design Research Ethics*. s.l.:s.n.
- Kalikivayi, V., Kannan, K. & Ganesan, A., 2018. Pantoscopic tilt induced higher order aberrations characterization using Shack Hartmann wave front sensor and comparison with Martin's Rule. *Ophthalmology Case Reports*, 2(1), pp. 3-7.
- Leavitt, H. J., 1965. Applied Organisational Change in Industry: Structural, Technological and Humanistic Approaches. In: J. G. March, ed. *Handbook of Organisations*. Chicago: Rand McNally, pp. 1144-1170.
- Lee, W. et al., 2016. Application of Massive 3D Head and Facial Scan Datasets in Ergonomic Head-Product Design. *International Journal of the Digital Human*, 1(4), pp. 344-360.
- Leonard, H. S., Freedman, A. M., Lewis, R. & Passmore, J., 2013. *The Wiley-Blackwell Handbook of the Psychology of Leadership, Change, and Organizational Development*. Chichester: John Wiley & Sons Ltd.
- Luximon, Y., Ball, R. M. & Chow, E. H., 2016. A Design and Evolution Tool Using 3D Head Templates. *Computer-Aided Design & Applications*, 13(2), pp. 153-161.
- Martin, B. & Hanington, B., 2012. *Universal Methods of Design: 100 ways to research complex problems, develop innovative ideas, and design effective solutions*. Beverly: Rockport Publishers.
- Mashima, M., Yoshida, H. & Kamijo, M., 2011. *Investigation of wearing comfort of eyeglasses with emphasis on pain around the ears*. Takamatsu, Kagawa, Japan, s.n.
- Milton, A. & Rogers, P., 2013. *Research Methods for Product Design*. London: Laurence King Publishing Ltd.
- Naudé, M., 2017. *Eyedentity: An Appropriate Technology Design for South African Eyewear*. Johannesburg: Unpublished.
- Naudé, M., 2020. *Eyedentity: A Socio-Technical Systems Approach to Designing Eyewear in South Africa*. Johannesburg: University of Johannesburg
- Norman, D., 2013. *The Design of Everyday Things*. Revised and Expanded ed. New York: Basic Books.
- Optometry Today, 2015. *OT skills guide: Dispensing a handmade frame*. [Online] Available at: <https://www.youtube.com/watch?v=qiexuqwkN1k> [Accessed 15 May 2019].
- Phillips, M., 2013. *Why Oakley's "Asian fit" sunglasses aren't racist, just science*. [Online] Available at: <https://qz.com/138525/why-oakleys-asian-fit-sunglasses-arent-racist-just-science/> [Accessed 28 February 2018].
- Pollock, I., 2017. *Why the merger of Essilor and Luxottica matters*. [Online] Available at: <https://www.bbc.com/news/business-38899892> [Accessed 24 August 2020].
- Refinery29, 2016. *Let me introduce you to "Asian Fit" glasses*. [Online] Available at: [https://www.huffingtonpost.com/refinery29.com/let-me-introduce-you-to-a\\_b\\_11199598.html](https://www.huffingtonpost.com/refinery29.com/let-me-introduce-you-to-a_b_11199598.html) [Accessed February 28 2018].
- Ripley, D. L. & Politzer, T., 2010. Vision Disturbance after Traumatic Brain Injury. *Neurorehabilitation*, 27(3), pp. 215-216.
- Sfered, 2019. *Seferred Intelligence: Making Custom Eyewear Real* [Online] Available at: <https://www.sfered.nl/> [Accessed 18 July 2019].
- Thau, B., 2016. *Globally Minded*. [Online] Available at: <https://www.eyecarebusiness.com/issues/2016/july-2016/globally-minded> [Accessed 28 February 2018].
- Tschimmel, K., 2012. *Design Thinking as an Effective Toolkit for Innovation*. Barcelona, s.n.
- Tseng, M., Jiao, J. & Merchant, E., 1996. Design for Mass Customisation. *CIRP Annals*, 45(1), pp. 153-156.
- Valdez, A. C. & Brauner, P. Z. M., 2016. *Preparing Production Systems for the Internet of Things The Potential of Socio-Technical Approaches in Dealing with Complexity*. Stellenbosch: Global Competitiveness Centre in Engineering, pp. 483-487.
- Vision Monday, 2019. *Megatrend: Personalisation - Customized Options Entice Eyeglass Wearers With Unique Styling and Improved Comfort*. [Online] Available at: <http://www.visionmonday.com/business/article/megatrend-personalization/> [Accessed 19 March 2019].

# WATER SUPPLY SYSTEMS ASSESSMENT AND WASH PROFILE OF PRIMARY HEALTHCARE CENTRES IN PARTS OF SOUTHWEST NIGERIA

Enovwo E. ODJEGBA, Barakat O. LAYI-ADIGUN and Victoria O. DADA

Department of Water Resources Management & Agrometeorology, Federal University of Agriculture, Abeokuta, Ogun State, Southwest Nigeria

Corresponding author: odjegbaee@funaab.edu.ng

## Ab-stract

*The assessment of water, sanitation and hygiene (WASH) facilities in 61 Primary Healthcare Centres (PHCs) and water source quality in urban and rural areas in parts of Southwestern Nigeria was conducted. Sixty-one PHCs were selected using a stratified random sampling technique based on healthcare centre functionality and presence of accessible water source. A WASH profile of the PHCs was conducted based on the water source type, type of toilet facilities and handwashing practice. The WASH profile was classified using the Joint Monitoring Programme service ladder for monitoring WASH facilities in healthcare facilities. Data was collected from primary and secondary sources. Water samples were collected from sources used by the PHCs and tested for pH, EC, TDS, turbidity, chloride, nitrate, and E. coli. Borehole is the most prevalent water source type in urban areas and flush toilets and pit latrines are the two types of toilet facilities used. In rural areas, hand-dug wells are the most prominent water source type, while 16 out of the 27 rural PHCs used flush toilets. All PHCs in the rural areas engaged in handwashing practices. Water quality analysis result for urban and rural areas showed that chloride, nitrate, and turbidity were within the WHO drinking-water standard. In the rural areas, all pH and E. coli values did not meet the recommended drinking-water standard, while pH and E.coli values in 11 and 6 water sources respectively in urban areas were within the recommended standard. Poor water quality and sanitation practices could expose health staff and patients to health care associated infections. The study recommends the construction of water sources and toilet facilities, provision of water treatment facilities and the training of staff and patients on the significance of hand washing practices.*

**Keywords:** COVID-19, healthcare facilities, infections, SDGs, WASH.

## INTRODUCTION

Adequate, functional, and affordable healthcare services is a continuous requirement globally, particularly in the race towards Sustainable Development Goals (SDGs) 2030. The COVID-19 global pandemic has further stretched existing facilities and tested the preparedness of many countries for providing healthcare. For instance, access to healthcare services (especially community-based Primary Health Care) in low and middle-income countries is hampered in part, by insufficient facilities, poor patient-staff ratios and limited or total absence of water, sanitation, and hygiene (WASH) facilities. At the International Conference on Primary Health Care in 1978, 134 member countries of the World Health Organization (WHO) signed the Alma Ata Declaration, seeking to provide health for all by the year 2000 by adopting the declaration as the official health policy of all member countries. The Declaration recognized health as a basic human right and emphasized the need for the provision of affordable and community-based healthcare through the establishment of Primary Healthcare Centres (PHCs). Primary healthcare is aimed at addressing key health issues at community level through the provision of promotive, preventive, curative and rehabilitative services (Bryant and Richmond, 2009).

Nigeria, in line with the global agenda, launched two interventions: The Basic Health Services Scheme and the National Health Policy. The timeframe between the years 1985 -1992 saw giant strides in the development and expansion of PHC

across Nigeria (Lambo, 2015; Aregbeshola and Khan, 2017). Long years of military rule, subsequent dwindling of the budgetary allocation on health and the poor attitude of government towards the development of health facilities has left many PHCs either non-functioning or functioning with poor WASH facilities. As of 2005, PHCs made up over 85% of healthcare facilities in Nigeria (Federal Ministry of Health (FMOH), 2004; Aigbiremolen *et al.*, 2014). Nigeria's healthcare is classified according to a three-tier system, namely tertiary, secondary, and primary healthcare. The tertiary and primary healthcare systems represent the two extremes. The tertiary healthcare system comprises highly specialized health services available at teaching and specialist hospitals, while the secondary healthcare system is designed to cater for referrals from the primary healthcare system (Raheem *et al.*, 2019). However, the primary healthcare system which, through the PHCs, is expected to be the entry point to Nigeria's national healthcare system (Ladi-Akinyemi *et al.*, 2019) has fallen short in many ways. Primary healthcare centres in Nigeria lack capacity to provide health-care services (Aregbeshola and Khan, 2017) and access to WASH facilities are grossly inadequate (UNICEF, 2016).

Water, sanitation, and hygiene facilities are essential in the operations of PHCs. When WASH facilities are absent or inadequate in PHCs, patients and staff are exposed to the risk of health care associated infections (UNICEF, 2016), with new-borns, pregnant women and geriatric patients as the most vulnerable group. Millions of health care associated infections are recorded annually (Allegranzi *et al.*, 2011). Poor WASH facilities have discouraged patients from visiting PHCs, especially pregnant mothers in labour (Velleman *et al.*, 2014). Patients' trust in PHCs can only be restored by improving WASH facilities, an action that would significantly reduce maternal and neonatal mortality rates. Bartram *et al.* (2015) suggests 3 ways of improving WASH in healthcare facilities. The first is the establishment of policies and standards on delivering appropriate services and tracking of progress. Secondly, service delivery support systems are required though the provision of sufficient human and financial resources and lastly, the need for effective leadership (not limited to the health sector) and coordination.

A country's robust health care system, mostly at community level, could have significant impact on its development. For example, Bryant and Richmond (2009) describe primary healthcare as an essential part of a country's health system, contributing to the country's advancement policy. In this study, a comparative assessment of WASH facilities in selected urban and rural communities in parts of Southwest Nigeria was conducted. Emphasis of the study is on government owned and operated PHCs. Nigeria, as a signatory to the SDGs, must commit to the responsibility of providing adequate, affordable, and accessible healthcare for her citizens, especially at community level.

## Description of study area

Ogun State, Southwest Nigeria (latitudes 2°45'E and 4°45'E and longitudes 6°15'N and 7°60'N) covers a land area of 16,409.26 sq.km, with an estimated population of 5,340,113; 50.3% (2,686,077) of which are men and 49.7% (2,654,036) are women at 2.6% annual growth rate (National Population Commission, 2009; World Bank, 2017). The activities of PHCs in Ogun State is overseen by the Ogun State Primary Health Care Development Board. The board was founded in 2009 with the key function of developing a sustainable, high-quality, equitable and affordable Primary Health Care system in partnership with all levels of government and Non-governmental Organizations. The board is also involved in planning, budgetary provisions and monitoring primary health care services in Ogun State and must review the activities of PHCs across all 20 local government areas.

## METHODOLOGY

Sixty-one PHCs across 4 communities (2 urban and 2 rural) were assessed in this study. The PHCs were selected using a stratified random sampling technique based on healthcare centre functionality and presence of accessible water source. The WASH profile of the PHCs was assessed using key indicators: the water source type, type of toilet facilities and handwashing practice. Two methods of data collection were employed in this study (see Figure 1). Data was collected from primary and secondary sources. Observations (non-participant) and interviewing (unstructured) were used in data collection from primary sources, while government publications, earlier research and census documents were used in secondary data collection.

According to Kumar (2011), observation is a decisive, orderly and selective method of watching and listening to a phenomenon or interaction take place and he described non-participatory observation as a method of collecting data where a researcher is not involved in the activities of the group (item or situation being studied) but remains a passive observer. The interview method, Kumar (2011) is used to obtain information from people and the unstructured method allows for flexible interview structure, contents and questions. The unstructured method of interview was chosen to

allow quality interactions between researcher and respondents and enable the collection of in-depth information.

The WASH profile was carried out by assessing each PHC to ascertain the type of water source, type of toilet facility (if any) or, where toilet facilities were absent, what alternative methods were used. Lastly, the PHCs were assessed for the presence and functionality of hand washing stations. The WASH profile of the PHCs was classified using the Joint Monitoring Programme (JMP) service ladder for monitoring WASH facilities in healthcare facilities. The JMP service ladders are designed for monitoring WASH in healthcare facilities for the actualization of SDG criteria. The JMP basic service ladder is presented in Table 1. Water samples from the water sources of the PHCs were collected and tested for pH, turbidity, chloride, nitrate and *E. coli*. The choice of pH, turbidity, nitrate, *E. coli* and chloride as indicator parameters for water quality was based on Howard (2002a).

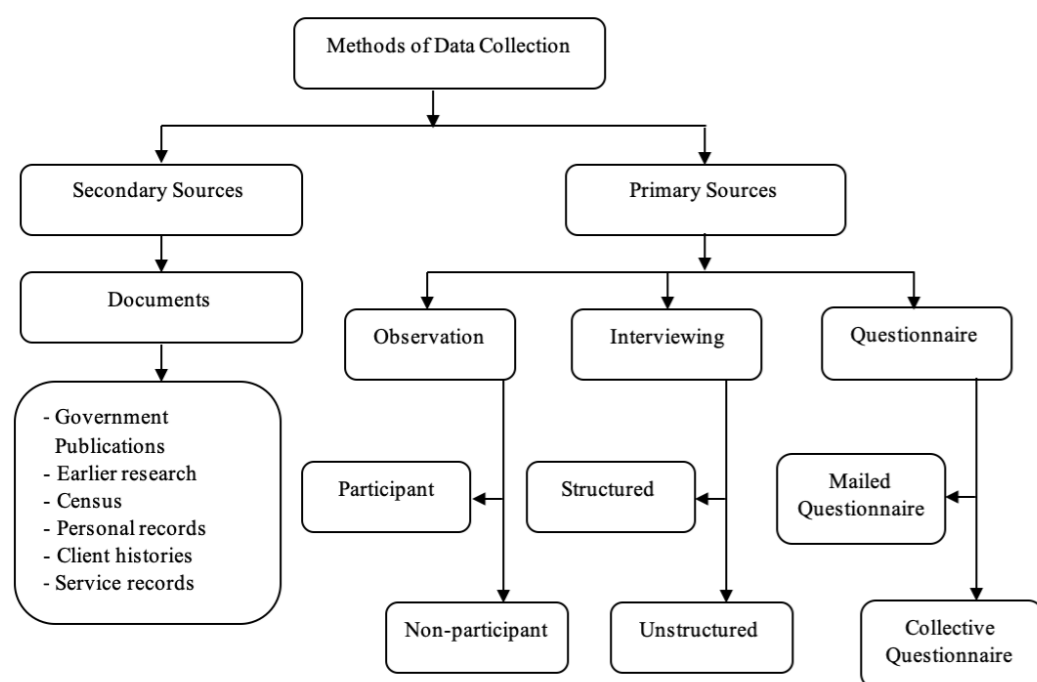


Figure 1: Methods of data collection (Kumar, 2011)

Table 1: Joint Monitoring Programme (JMP) service ladder for monitoring WASH facilities in healthcare facilities (Source: WHO 2019)

	WATER	SANITATION	HYGIENE	WASTE MANAGEMENT	ENVIRONMENTAL CLEANING
BASIC SERVICE	Water is available from an improved source on the premises.	Improved sanitation facilities are usable, with at least one toilet dedicated for staff, at least one sex-separated toilet with menstrual hygiene facilities, and at least one toilet accessible for people with limited mobility.	Functional hand hygiene facilities (with water and soap and/or alcohol-based hand rub) are available at points of care, and within five metres of toilets.	Waste is safely segregated into at least three bins, and sharps and infectious waste are treated and disposed of safely.	Basic protocols for cleaning are available, and staff with cleaning responsibilities have all received training.
LIMITED SERVICE	An improved water source is within 500 metres of the premises, but not all requirements for basic service are met.	At least one improved sanitation facility is available, but not all requirements for basic service are met.	Functional hand hygiene facilities are available either at points of care or toilets but not both.	There is limited separation and/or treatment and disposal of sharps and infectious waste, but not all requirements for basic service are met.	There are cleaning protocols and/or at least some staff have received training on cleaning.
NO SERVICE	Water is taken from unprotected dug wells or springs, or surface water sources; or an improved source that is more than 500 metres from the premises; or there is no water source.	Toilet facilities are unimproved (e.g. pit latrines without a slab or platform, hanging latrines, bucket latrines) or there are no toilets.	No functional hand hygiene facilities are available either at points of care or toilets.	There are no separate bins for sharps or infectious waste, and sharps and/or infectious waste are not treated/disposed of safely.	No cleaning protocols are available and no staff have received training on cleaning.

A limitation of this study is the non-inclusion of waste management and environmental cleaning component of service ladder in the WASH assessment of PHCs. Non-inclusion of the waste management and environmental cleaning components does not in any way deny the importance of both components at efficient service delivery of healthcare facilities. However, the two components were not part of the scope of the study. Depending on the availability of funding, the authors wish to expand the scope of the study to include additional healthcare facilities, with the inclusion of waste management and environmental cleaning components in subsequent studies.

## RESULTS

Figure 2 – 4 shows a comparison of the WASH profile of the PHCs in urban and rural areas. As indicated in Figure 2(a), borehole is the most prevalent water source type in urban PHCs while hand-dug well is the most common source for in rural PHCs. However, 4 PHCs relied on surface water (from a river) as their water source. Based on the JMP service ladder classification Figure 2(b), 97% of the water sources in urban PHCs and 85% of water sources in rural PHCs are classified as basic service (Figure 2b).

\*Two PHCs had flush toilets and pit latrines bringing the total sum of toilet facility to 63.

This implies that water is available on the premises and the water sources are improved. Three percent of the water source in rural PHCs are classified as limited service, as there was no urban PHC water source in this category. No urban PHC water source was classified as no service, while 25% of the water sources of rural PHCs were classified as no service, because 4 PHCs abstracted water from surface water. For the results of water quality analysis, the mean values pH of water sources in urban PHCs and rural PHCs were  $5.49 \pm 1.00$  and  $5.72 \pm 0.19$  respectively, mean turbidity

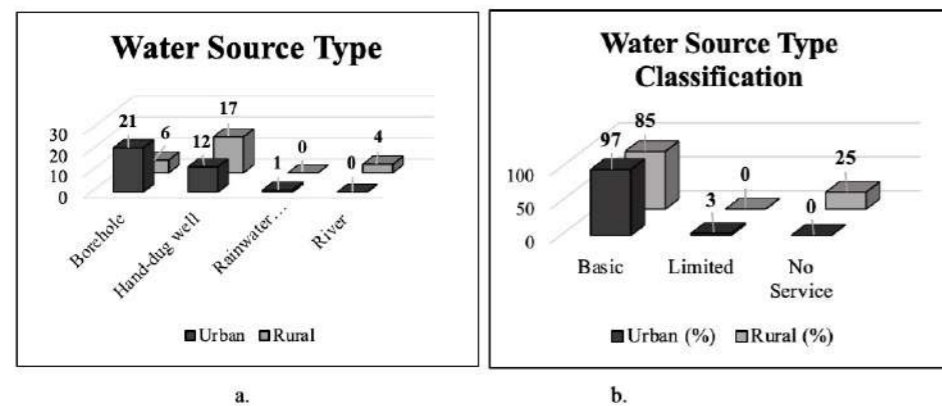


Figure 2: Water source classification in the Primary Healthcare Centres

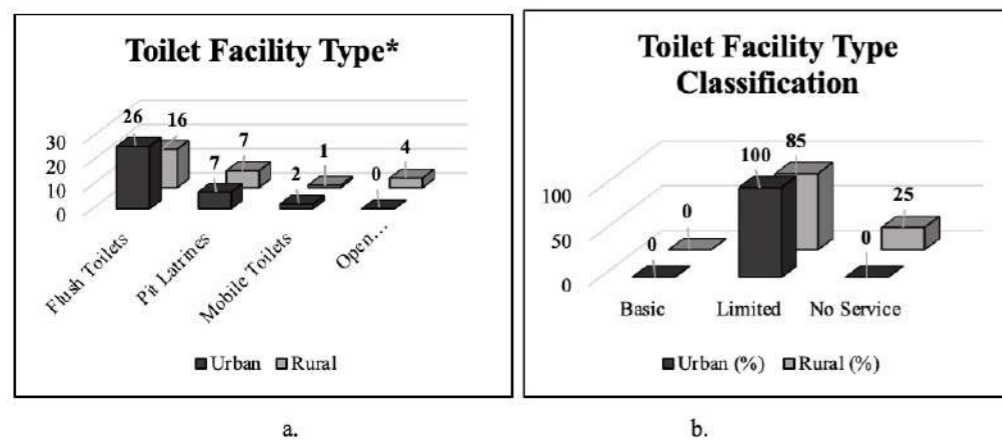


Figure 3: Toilet facility type classification in the Primary Healthcare Centres

values of  $0.36 \pm 0.45$  and  $0.14 \pm 0.48$  respectively; and mean nitrate values of  $1.26 \pm 1.61$  and  $2.38 \pm 2.33$  respectively. For chloride and *E. coli*, mean values of water sources in urban PHCs and rural PHCs were  $49.35 \pm 29.28$  and  $39.96 \pm 30.27$  respectively and  $7.12 \pm 6.4$  and  $10.3 \pm 9.67$  respectively. The values of chloride, nitrate and turbidity were within the WHO drinking-water standard for both urban and rural water sources. In the rural areas, though, all pH and *E. coli*

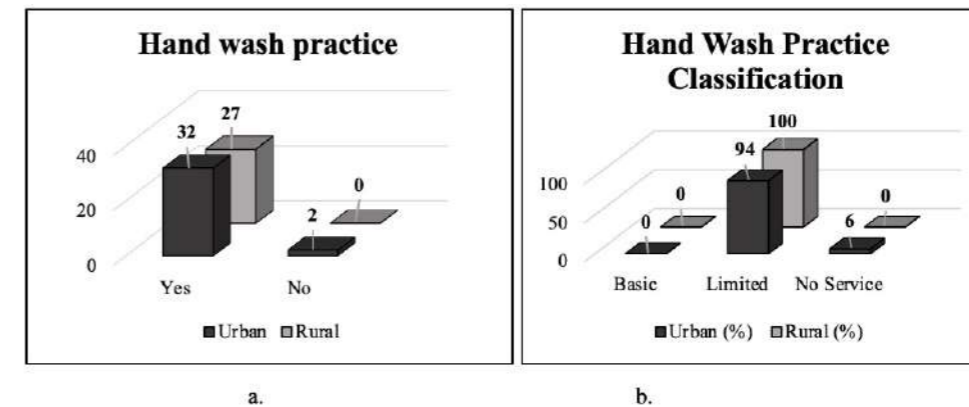


Figure 4: Hand wash practice classification in the Primary Healthcare Centres

values did not meet the recommended drinking-water standard, while pH and *E. coli* values in 11 and 6 water sources respectively in urban areas were within the recommended standard.

Flush toilets and pit latrines are the two types of toilet facilities used in the study area. Four PHCs in the rural area lacked toilet facilities, implying that patients and staff practice open defecation. Toilet facilities captured under sanitation using the JMP classification (Figure 3b) indicates that no toilet facility in both the urban and rural PHCs is classified as basic service, 100% and 85% are classified as limited service in the urban and rural PHCs respectively and 25% in rural PHCs as no service; no facility in the urban PHCs is classified as no service. No toilet facility could be classified as a basic service in this study, though some PHCs had dedicated toilet for staff and were sex-separated but toilet facilities with menstrual supplies and accessible to people with limited mobility were lacking.

Toilet facilities in all urban PHCs are classified as limited service since not all requirements for basic service are met. Unimproved toilet facilities or absence of toilets is classified as no service. Open defecation practice by 4 rural PHCs is classified as no service due to the absence of toilet facilities.

Thirty-two of the 34 urban PHCs engaged in handwashing practices. All PHCs in the rural areas engaged in handwashing practices. Handwashing practice in 94% of urban PHCs and 100% in rural PHCs are classified as limited. No PHCs handwashing practice is classified as basic service, while handwashing practice in 2% of urban PHCs is classified as no service. Absence of functional hand wash stations either at points of care or toilets is classified as no service. Nevertheless, presence of functional hand wash station either at points of care or toilets, but not both, is classified as limited.

## DISCUSSION

The percentages of water sources that are classified as basic service in this study is significantly high. Nevertheless, scores below 100% is an indication for the need for improvement. The implications of improved water sources on premises at healthcare facilities cannot be overemphasized, as inadequate safe and reliable water, or lack of it, is a key hygiene risk and a herald for infections.

Generally, disparities have been reported in the WASH service levels between urban healthcare facilities and rural healthcare facilities (WHO, 2015). For instance, WHO (2015) reports that health facilities in rural areas have disproportionately fewer WASH services than facilities in urban areas. Except for hand wash practice, urban PHCs fared better than rural PHCs in water source and toilet facilities in this study. This outcome mirrors a concentration of improved service delivery of PHCs at urban PHCs, while neglecting rural PHCs. The reason for this disparity is unclear. The overall norm had been that urban areas enjoy better services in all sectors than rural setting, a phenomenon that has increased rural-urban migration and resulting in congestions in urban areas. Nonetheless, international human rights law recognizes WASH in PHCs as a human right, without regard to race, gender, or geographical location. Consequently, the trend of having poorer WASH facilities in rural areas should be discouraged. The World Health Organization and other relevant stakeholders have increasingly provided support for countries around the world to improve the state of their health facilities. However, policy design, implementation and periodic review remains the exclusive responsibility of government and its appropriate agencies.

Nigeria has no existing policy on WASH in PHCs at present. However, a technical guide for WASH in PHC in Nigeria has been published by the National Primary Health Care Development Agency (NPHCDA) with the support of UNICEF and other stakeholders. The technical guide outlines the basic requirements for ensuring a clean and healthy PHC in line with national developmental objectives and international best practices. Compliance with the technical guide requires the combined effort of PHC staff, host community, Ministry of Health, Primary Health Care Development Agencies at National and State levels as well as WASH Consultants. As the WHO (2015) points out, improving WASH services requires leadership from the health sector, strong technical support and political commitment from government. As laudable as the development of a technical guide is, the slow speed of implementation in line with the urgent need for improvement in WASH in PHCs is a concern.

### SENSITIZATION ON COMMUNITY HAND WASHING TECHNIQUES AND DISINFECTION IN PHCS: THE WAKE OF COVID-19

As a follow up to this study and prior to the outbreak of the COVID-19 pandemic, the authors participated in a lecture series organized by the Department of Water Resources Management and Agrometeorology, Federal University of Agriculture, Abeokuta, Nigeria, as part of Community Extension Services and Training. A key component of the lecture series was training of participants on appropriate hand washing techniques (Figure 5). Participants, the authors believe, are currently finding the techniques handy as the battle to contain the COVID-19 pandemic ranges on.



**Figure 5:** The lead author demonstrating the hand washing technique at a lecture series as part of Community Extension Services and Training

Also, in the wake of the COVID-19 pandemic, sensitization of health workers at PHCs on disinfection have been conducted in some of the PHCs assessed in this study. Authors in partnership with a student volunteer group tagged 'Safe Environment' and WaterStep, a United States based donor organization, carried out the sensitization initiative. As part of the initiative, sodium hypochlorite (bleach) was manufactured using a bleach maker (Figure 6) and donated to the PHCs visited (Figure 7).

The bleach maker was donated to the Department of Water Resources Management and Agrometeorology, Federal University of Agriculture, Abeokuta, Nigeria, by WaterStep. The bleach is manufactured using table salt, water, and electricity. The sensitization process is currently ongoing as at the time of submitting this paper.

### CONCLUSION AND RECOMMENDATION

A comparative assessment of water sources in urban and rural PHCs, and the WASH profile of the PHCs has been



**Figure 6:** Bleach making process in operation using the bleach maker donated by WaterStep



**Figure 7:** Bleach donation during the sensitization process

carried out in this study. WASH facilities in urban and rural PHCs were assessed based on the JMP service ladder classification of facilities, and shortcomings were highlighted. The detection of *E. coli* in some water samples tested is a health concern and emphasis on the quality of water from sources in PHCs in compliance with the WHO drinking-water quality guidelines is vital. To improve the quality of water, water treatment facilities should be provided in the PHCs. Safe water is required by healthcare facility staff and patients for administering medicines and for drinking purposes. Consumption of water from questionable sources could slow down healing processes or increase the reoccurrence of water-related ailments in patients. Reoccurring water-related ailments can increase the exposure of healthcare facility staff and patients, thereby contributing significantly to the global disease burden.

The absence of toilet facilities in 4 rural PHCs, and the absence of hand wash stations in 2 urban PHCs indicates the need for improvements in the status of WASH in PHCs for SDGs to be achieved. Failure at speedily improving the status of WASH facilities will translate to poor water quality and sanitation practices, thereby exposing health staff and patients to health care associated infections. Improvement in the status of WASH can be achieved through the implementation of the existing technical guide for WASH in PHC in Nigeria, published by the NPHCDA. Although

as stated in the publication, compliance is premised on the collective responsibility of key stakeholders in the WASH sector as it relates to PHCs.

The current COVID-19 global crisis has brought to the fore the fact that countries cannot over-prepare for a pandemic. The outbreak of the virus has brought world powers to their knees and has further increased the need for more attention to be paid to the health sector. If WASH provision in PHCs is still an illusion with SGD 2030 deadline a few years away, the preparedness to deal with disease outbreaks by these PHCs leaves a big question. COVID-19 has shown that as far as healthcare is concerned, it can no longer be business as usual. Developing nations like Nigeria must wake up to the responsibility that every one of her citizens has a right to effective and affordable healthcare if SGD 2030 is the target.

This study further recommends the construction of water sources and toilet facilities, provision of water treatment facilities and the training of staff and patients on the significance of hand washing practices.

#### Acknowledgements

This study was part of a project funded by the Federal Government of Nigeria through the National Economic Empowerment and Development Strategy (NEEDS). Parts of the outcome have been presented at two international conferences, the 2019 CO-WASH Symposium at the University of Colorado, Boulder, USA and the 2019 Water and Health Conference, University of North Carolina, Chapel Hill, USA. Authors also acknowledge WaterStep, a donor organization based in Louisville, Kentucky, USA for their donation of a bleach maker which contributed as a follow up tool to this project. The support of the Safe Environment group, Ogun State, Nigeria is equally acknowledged for providing frontline manpower in the distribution of bleach and the sensitization of health workers.

#### Conflict of Interest

There is no potential conflict of interest.

#### Ethical Issues

The data collected did not involve any interaction with patients and was strictly based on physical assessment of health care facilities in the respective PHCs and therefore did not require obtaining any form of ethical approval.

#### LIST OF REFERENCES

- Aigbiremolen, A., Alenoghena, I., Eboime, E. & Abejegah, C. 2014. Primary Health Care in Nigeria: from conceptualization to implementation, *Journal of Medical and Applied Biosciences*, **6**, 35-43. [Online] Available at <http://s3.sourceafrica.net.s3.amazonaws.com/documents/120694/PHCFromConceptualization-1.pdf>
- Allegranzi, B., Nejad, S.B., Combescure, C., Graafmans, W., Attar, H., Donaldson, L. & Pittet, D. 2011. Burden of endemic health-care-associated infection in developing countries: systematic review and meta-analysis, *The Lancet*, **377**, 228-241 0140-6736. [Online] [https://doi.org/10.1016/S0140-6736\(10\)61458-4](https://doi.org/10.1016/S0140-6736(10)61458-4)
- Aregbeshola, B.S. & Khan, S.M. 2017. Primary health care in Nigeria: 24 years after Olikoye Ransome-Kuti's Leadership, *Frontiers in public health*, **5**, 48 [Online] Available at <https://www.frontiersin.org/articles/10.3389/fpubh.2017.00048/full>
- Bartram, J., Cronk, R., Montgomery, M., Gordon, B., Neira, M., Kelley, E. & Velleman, Y. 2015. Lack of toilets and safe water in health-care facilities. *SciELO Public Health* [Online] Available at <https://www.who.int/bulletin/volumes/93/4/15-154609.pdf>
- Bryant, J.H. & Richmond, J.B. 2009. Alma-Ata and primary health care: An evolving story, In: Carrin, G., Buse, K., Heggenhougen, H.K., Quah, S.R. (Eds.), *Health Systems Policy, Finance and Organization*. Academic Press, p. 464. [Online] Available at [https://parthealth.3cdn.net/ea9818ff461c9fbd2c\\_89m6bh39v.pdf](https://parthealth.3cdn.net/ea9818ff461c9fbd2c_89m6bh39v.pdf) ISBN 9780123757081.
- Federal Ministry of Health (FMOH). 2004. *Revised National Health Policy*. Abuja, Nigeria: Federal Ministry of Health. [Online] Available at <https://cheld.org/wp-content/uploads/2012/04/Nigeria-Revised-National-Health-Policy-2004.pdf>
- Howard, G. 2002a. *Water quality surveillance: a practical guide*. London: Water, Engineering and Development Centre, [Online] Available at <https://www.lboro.ac.uk/research/wedc/resources/pubs/books/wqs/> ISBN 1843800039
- Kumar, R. 2011. *Research Methodology: A Step-by-Step Guide for Beginners*. New Delhi, India: Sage Publications Ltd., ISBN 978-1-84920-301-2 [Online] Available at [http://www.sociology.kpi.ua/wp-content/uploads/2014/06/Ranjit\\_Kumar-Research\\_Methodology\\_A\\_Step-by-Step\\_G.pdf](http://www.sociology.kpi.ua/wp-content/uploads/2014/06/Ranjit_Kumar-Research_Methodology_A_Step-by-Step_G.pdf)
- Ladi-Akinyemi, T., Daniel, O., Kanma-Okafor, O., Ogunyemi, A. & Onajole, A. 2019. Assessment of health facilities, commodities, and supplies for malaria case management at primary healthcare centres in Ogun state, Nigeria, *Journal of Medicine in the Tropics*, **21**, 56-61 10.4103/jomt.jomt\_29\_17. [Online] <http://www.jmedtropics.org/article.asp?issn=2276-7096;year=2019;volume=21;issue=2;spage=56;epage=61;aualast=Ladi-Akinyemi>
- Lambo, E. 2015. *Primary health care: realities, challenges and the way forward*. Abuja, Nigeria: Paper presented at: 1st Annual Primary Healthcare Lecture organized by the National Primary Healthcare Development Agency. [Online] Available at: [http://nigeriahealthwatch.com/wp-content/uploads/bsk-pdf-manager/1160\\_2015\\_Primary\\_Health\\_Care\\_Presentation\\_Final\\_NPHCDA\\_1216.pdf](http://nigeriahealthwatch.com/wp-content/uploads/bsk-pdf-manager/1160_2015_Primary_Health_Care_Presentation_Final_NPHCDA_1216.pdf)
- National Population Commission. 2009. *Legal Notice on Publication of 2006 Census Final Results*. Federal Republic of Nigeria: Federal Republic of Nigeria Official Gazette pp. 1 – 42 [Online] Available at <https://gazettes.africa/archive/ng/2009/ng-government-gazette-dated-2009-02-02-no-2.pdf>
- Raheem, T., Adewale, B., Adeneye, A., Musa, A., Ezeugwu, S., Yisau, J., Afocha, E., Sulyman, M., Adewoyin, O. & Olayemi, M. 2019. *State of Health Facilities in Communities Designated for Community-Based Health Insurance Scheme in Nigeria: A Case Study of Kwara and Ogun States*, **36**, 1 - 10. [Online] <https://doi.org/10.9734/ijtdh/2019/v36i130132>
- UNICEF. 2016. Technical Guide For Water, Sanitation And Hygiene (WASH) in PHC Centres in Nigeria, p. 85. [Online] Available at [http://www.washpmp.com/files/report\\_file/1\\_58b98380-bd58-4453-abca-4e30176f89ae.pdf](http://www.washpmp.com/files/report_file/1_58b98380-bd58-4453-abca-4e30176f89ae.pdf)
- Velleman, Y., Mason, E., Graham, W., Benova, L., Chopra, M., Campbell, O.M., Gordon, B., Wijesekera, S., Hounton, S. & Mills, J.E. 2014. From joint thinking to joint action: a call to action on improving water, sanitation, and hygiene for maternal and newborn health, *PLoS Medicine*, **11**, e1001771. [Online] <https://doi.org/10.1371/journal.pmed.1001771>
- WHO. 2015. *Water, sanitation and hygiene in health care facilities: status in low and middle income countries and way forward*. [Online] Available at: [https://www.who.int/water\\_sanitation\\_health/publications/wash-health-care-facilities/en/](https://www.who.int/water_sanitation_health/publications/wash-health-care-facilities/en/)
- WHO. 2019. *WASH in health care facilities: global baseline report 2019*. [Online] Available at <https://apps.who.int/iris/bitstream/handle/10665/311620/9789241515504-eng.pdf>
- WHO/UNICEF. 2017. *Safely managed drinking water: Thematic report on drinking water 2017*. [Online] Available at [https://www.who.int/water\\_sanitation\\_health/publications/safely-managed-drinking-water/en/](https://www.who.int/water_sanitation_health/publications/safely-managed-drinking-water/en/)
- World Bank 2017. Population Growth (annual %) [Online] Available at <https://data.worldbank.org/indicator/sp.pop.grow>

# EVALUATION OF INDIGENOUS TECHNOLOGY FOR CAST ALUMINIUM COOKWARE PRODUCTION IN NIGERIA: A CASE STUDY OF USER HEALTH RISKS FROM COOKWARE MADE IN SAKI

1Olufemi Samuel Adelabu & 2Angus Donald Campbell

1,2Industrial Design Department, University of Johannesburg, South Africa

1Industrial Design Department, Federal University of Technology Akure, Nigeria

1osadelabu@uj.ac.za & 2acampbell@uj.ac.za

## Abstract

*Today, the artisanal production of aluminium cookware, which relies solely on secondary (recycled) aluminium, has become a crucial activity of socio-economic significance in Nigeria and other parts of Africa. Despite this development, the impacts of the products lifecycle have gained little or no attention in scientific study. In this study, we considered assessing the potential human health risks of the artisanal cast aluminium cookware produced in Saki, Southwestern Nigeria. Water quality tests and microstructural characterisation were done with two cookware samples produced under different smelting conditions. From the preliminary tests, the water analysis result indicates that with an instant use, the migrations of aluminium (Al), iron (Fe), manganese (Mn) and other metallic ions into the water sample boiled with the cookware were not beyond the acceptable limit set by the World Health Organisation (WHO) for water quality standards. From the SEM-EDX results, no toxic or heavy metallic element like lead was found. Additionally, typical elements which are expected to be found in aluminium alloys were present in the composition of the cookware. This indicates that despite the indigenous method of producing the cookware, contaminants that could be detrimental to the health of users were well-controlled. While further experimental testing is proposed, the study observed the need to gradually refine the overall production processes for indigenous aluminium cookware while leveraging scientific knowledge for advancing local craft techniques in a high technological era.*

**Keywords:** Appropriate strategy, Cast aluminium cookware, Low-cost indigenous technology, Microstructure and chemical analysis, User health risks.

## INTRODUCTION

Following a gradual disappearance of the traditional pottery vessels which were commonly used for culinary purposes in the pre-colonial era in West Africa, cast aluminium cookware has emerged to replace them as essential houseware after the mid-20<sup>th</sup> century. Although metallurgical technologies such as iron blacksmithing or bronze casting using lost-wax casting are older metalworking traditions (Kriger 2000; Nevadomsky 2005), the practice of artisanal aluminium metalwork with sand-casting is relatively recent and has been less explored. Osborn (2009) documented the evolution and diffusion of artisanal production of cast aluminium cookware in West Africa based on the sand-casting method. According to the study, the practice of artisanal aluminium casting began towards the end of World War II as goods made with aluminium became more publicly available (Osborn 2009:377). The common thread of the historical narrative indicates that the original casters were constituted of Senegalese men or men from elsewhere in West Africa

who learnt the craft in Senegal and then migrated. Their newly acquired technical skills created a new market for locally produced cast aluminium products and formed a new sector within the informal economy. The casting of objects with aluminium gradually gained prominence in the region drawing on the intrinsic value of the metal and its unique characteristics: resistance to corrosion, good heat conduction, a high ratio of strength relative to weight, durability and ability to withstand harsh weather conditions (Davis 1993:6–7, 2001:351–52). Of further value to the artisans was the ease of infinitely re-using the metal and its low melting point (660°C). It is now known that secondary production from recycled scrap metal such as aluminium requires up to 90% less energy than primary production (US Energy Information Administration (EIA) 2014). With relatively less energy demand, the availability and circulation of scrap aluminium, as well as fairly basic technological know-how which is disseminated through the apprenticeship system, the craft and trade of aluminium sand-casting has grown and diffused into communities all over West Africa, including Nigeria. In the case of Nigeria, the sand casting method was adopted from neighbouring West African countries by local artisans as a low-cost technology in the production of aluminium cookware for many households, thus serving as an important socio-economic driver within the informal sector. Such activities can easily be defined as important supporters of human development through appropriate technology (Campbell 2013; Smillie 2000:90–103), but it is important that they not only benefit the local community producing the cookware, but also those using it.

Today, the impacts of product life cycle on human and environmental health (Curran 2018; Santangelo 2011; Socolof and Geibig, 2006) has become a salient issue that also needs to be addressed within the artisanal aluminium industry. With growing public concern on the safe use of aluminium cookware and an expanding amount of research showing aluminium as a potential source of toxic contaminations in food, the artisanal aluminium cookware industry is faced with a unique opportunity for technological innovation or face technological discontinuity. The risk of contamination posed by some locally produced cast metal pots in four selected locations in Nigeria was investigated by Lar, Caleb, and Gusikit (2014:37). However, the areas covered excluded aluminium cookware produced from Saki, the town identified for this study. Saki is an agrarian town located at 8°40'N (latitude) 3°24'E (longitude) in the northern part of Oyo state in Southwestern Nigeria (Figure 1). The town is well-known for its long-standing status in the artisanal production of cast aluminium cookware and a major distribution hub of aluminium cookware across the Southwestern region of Nigeria and beyond.



**Figure 1:** Geographic location of Saki, Oyo State in Southwestern Nigeria.

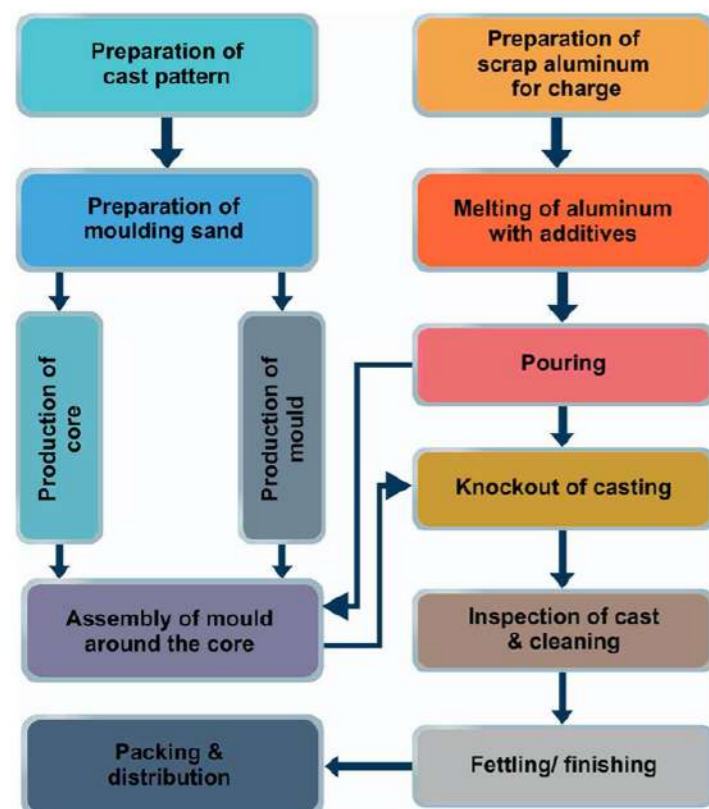
Base map outline by Uwe Dederig at German Wikipedia / CC BY (<https://creativecommons.org/licenses/by/3.0/>)



### Artisanal cast aluminium production

Casting is a type of metalworking that involves pouring molten aluminium into a mould to duplicate a desired pattern. Among the existing methods of casting, sand casting is reported as the most versatile method for producing aluminium products (Runge 2018:206). As described by Runge (2018:206), the process usually begins with a pattern that is a replica of the finished casting. The pattern is pressed into a fine sand mixture to form the mould into which the aluminium is poured. The flow chart in Figure 2 illustrates a production process for the artisanal aluminium casting system. Compared to other methods of casting such as die and permanent mould casting, sand casting is a slow process but it's considered more economical and probably the easiest for intricate designs, small quantities or a very large casting (Runge 2018:206). Sand is used as it can easily be packed to any shape and with other desirable properties such as high permeability and resistance to high temperatures (CustomPartNet 2008; Wang 2014:10).

In Nigeria, sand-casting or sand-cast moulding has become a widely used method of forming aluminium into products by artisans who, through a labour-intensive process, recycle scrap aluminium into a range of functional household products (see Figure 3). Notable among these products is the cast aluminium cookware in different ranges of size and shape. These cooking pots have become ubiquitous for both urban and rural dwellers and used in the kitchens by the middle-class and elite despite the presence of alternative products in the market. Particularly, the big-sized spherical cast aluminium pots are widely used by cooks preparing food for a large number of people in various public spaces including food stalls, eateries, and food processing outlets.



**Figure 2:** A schematic flow of the production process for artisanal cast aluminium cookware.

Illustration by Oluwafemi Adelabu (2020); adapted from Ivanov and Ivanov (2010)



**Figure 3:** The making process and final products of artisanal aluminium sand-casting technique, Saki, Nigeria: a) melting of aluminium scraps in a furnace; b) a sand-filled pot pattern set with a wooden modular flask (drag); c) a two-part split drag packed with sand; d) a sand core with the flask mould separated (arrows pointed at the cope and the split drag); e) final aluminium cast products (pots) waiting to be fettled. Photographs taken for the authors by Jesutoba Gbadegesin (2020), used with permission.

### Aluminium cookware products and health issues

Several health effects have been associated with the impact of exposure to heavy metals especially through aspiration and oral intake (Flora, Gupta, and Tiwari 2012; Taylor, Kordas, Golding and Emond 2017). Manufacturing industries including mineral processing and recycling activities have been identified as a major source of exposure of heavy metals in the environment ( Sepúlveda, Schlupe, Renaud, Streicher, Kuehr and Hagelüken 2010; Street, Mathee, Tanda, Hauzenberger, Naidoo and Goessler 2020). Recycling of scrap metal into artisanal cookware is widespread in poorly resourced countries. The aim of the study was to determine the risk of metal exposure from the use of artisanal cookware available in South Africa. Twenty cookware samples were purchased from local manufacturers and informal traders across South Africa. Aluminum and silicon concentrations were determined using XRF and the total content of 18 elements (Ag, As, Ba, Cd, Co, Cr, Cu, Fe, Hg, Mn, Mo, Ni, Pb, Sb, Se, Sn, V and Zn).

As opposed to iron, magnesium, zinc and some other mineral nutrients, aluminium is a metal that is not essentially needed for humans (Stahl, Falk, Taschan, Boschek and Brunn 2018:2077). However, due to its ubiquity as the most abundant metallic element on earth, human internal exposure and intake through food, water, food additives, pharmaceuticals, food packaging and utensils are inevitable (Ogimoto, Suzuki, Haneishi, Kikuchi, Takashi, Tomioka, Uematsu and Monma 2016:185; Stahl et al. 2018:2078; Stahl, Taschan, and Brunn 2011:1). Apart from food and food ingredients being a major source of aluminium exposure, studies have suggested that an additional source of aluminium intake is through food processing and preparation; this has led to a growing concern about toxic contamination of food from contact materials such as aluminium cookware (Ankar-Brewoo, Darko, Abaidoo, Dalsgaard, Johnson, Ellis and Brimer 2020; Jitaru, Ingenbleek, Marchond, Laurent, Adegboye, Hossou, Koné, Oyedele, Kisito, Dembélé, Eyangoh, Verger, Bizec, Leblanc, and Guérin 2019; Neelam, Bamji, and Kaladhar 2000; Rajwanshi, Singh, Gupta and Dass 1997; Street *et al.* 2020; Verissimo, Oliveira, and Gomes 2006; Weidenhamer, Fitzpatrick, Biro, Kobunski, Hudson, Corbin and Gottesfeld 2017). The German Federal Institute for Risk Assessment (2019:1) and Krewski, Yokel, Nieboer, Borchelt, Cohen, Harry, Kacew, Lindsay, Mahfouz, and Rondeau (2007) have revealed that a high intake of aluminium compounds can cause neurotoxic developmental disorders, bone diseases and as well as the dysfunction of body organs such as the liver and kidney.

The informal sector dealing with recycling of metals has also been identified as one of the potential sources of metal poisoning in developing nations. For instance Lo, Dooyema, Neri, Durant, Jefferies, Medina-Marino, Ravello, Thoroughman, Davis, Dankoli, Samson, Ibrahim, Okechukwu, Umar-Tsafe, Dama, and Brown (2012) investigated an incidence of lead poisoning among children tied to gold ore processing at a village in Zamfara state, Nigeria. Moreover, the artisanal recycling of scrap metal such as aluminium is seen as part of unregulated activities in the informal sector that poses a risk for human health (Street, 2020). The production of aluminium cookware using scrap metals has been investigated in a few African countries where the products are predominantly available. Weidenhamer Weidenhamer, Kobunski, Kuepouo, Corbin and Gottesfeld *et al.* (2014) and Weidenhamer *et al.* (2017) are two studies which investigated the release of metals from artisanal cookware. These studies took samples of cast aluminium pots from Cameroon and 10 other developing countries and revealed that artisanal cookware can be a potential source of multi-metal exposure and lead contamination as high as 260µg per serving. A study by Swaddiwudhipong, Tontiwattanasap, Khunytong, and Sanreun (2013) in Thailand showed that some children who are used to eating from inexpensive pots with no certification had significantly higher blood Pb levels than those who ate food from cookware having quality certification. Other notable studies that have considered the health risk of contaminations from cookware in developing countries include Lar *et al.* (2014), Zhou, Rui, Wang, Wu, Fang, Li and Li (2017), Ankar-Brewoo *et al.* (2020) and Street *et al.* (2020).

Under normal conditions, the Panel on Food Additives, Flavours, Processing Aids and Food Contact Materials (2008:1) agreed that the contribution of aluminium migration from food contact containers only constitutes a small fraction of total dietary uptake. This is deemed to be much lower than the intake which is considered safe following an updated assessment of the Joint FAO/WHO Expert Committee on Food Additives, JECFA (2006). While there is a growing amount of evidence of the release of heavy metals from artisanal cast-ware, more studies are required to establish the extent to which this situation is true in places where the locally made metal cookware is widely produced.

## MATERIALS AND METHOD

Our study adopted an experimental method using two cookware samples and two commonly used additive materials obtained from one of the local foundry workshops in the study area (Figure 4a-d). The artisan in charge was asked to produce one sample using zinc-carbon battery ‘powder’ (identified as sample *S*), a common additive in the casting process, and another sample was produced without it (identified as sample *A*). The artisans claimed that the powdery additive is used to facilitate dirt separation in the process of melting the aluminium scraps.

The two samples were taken to the Water Quality Laboratory and Monitoring Network at the Federal Ministry of Water

Resources in Akure, Ondo State, Nigeria for water quality analysis. The parameters analysed are shown in Table 2 and 3 below. In addition to this, the presence and concentration of elements in the two cookware samples were evaluated using a Zeiss Sigma Field Emission Scanning Electron Microscope (FE-SEM)® equipped with both back-scattered and Oxford energy dispersive X-ray (EDX) detectors. The SEM-EDX analysis was used to identify the elements present in the cookware to confirm whether there are any contaminants, as listed by the World Health Organisation (WHO), other than those expected in the core material.

## Water Quality Testing

The cookware samples were washed and used to boil a water sample of known parameters. The water samples from the cookware were allowed to cool after boiling, collected and tested again to see the changes in the parameters of the raw water sample. To determine the level of contamination in the case of using the cookware for boiling water, changes in the parameters were compared to the recommended values for drinking-water quality by the WHO (2005). Table 1 shows the instrumentation and methods adopted in testing for the listed parameters of the water samples (Rump and Krist 1993).

**Table 1:** Methods used for testing water quality parameters

Parameters	Instrumentation/ Method
Appearance/Colour	Visual observation
Odour	Physical observation
Temperature	Use of a thermometer
pH	Use of a pH meter
Turbidity	Use of a Turbidity meter
Conductivity	Use of a Conductivity meter
Total Dissolved Solids	Derived from the result of conductivity
Calcium Hardness CaCO <sub>3</sub> , Magnesium Hardness CaCO <sub>3</sub> , Total Hardness	EDTA Titrimetric method
Iron (Fe), Aluminium(Al), Manganese (Mn)	Use of Spectrophotometer and DR/890 Colorimeter
Calcium (Ca <sup>2+</sup> ), Magnesium (Mg <sup>2+</sup> )	Derived from the result of Calcium and Magnesium Hardness
Bicarbonate (HCO <sub>3</sub> )	Titration



**Figure 4:** Cookware samples and common additive materials collected from the study area.  
Photographs by Oluwafemi Adelabu (2020)

## RESULTS AND DISCUSSION

### Water Quality Analysis

**Table 2:** Analysis of the aesthetic/physical parameters of water from pot samples

S/N	Parameters	Raw water sample	Water from Sample A	Water from Sample S	WHO standards
	Appearance/Colour	Clear	Clear	Clear	-
	Odour	Odourless	Odourless	Odourless	-
	Temperature (°C)	28.5	28.2	28.2	12 – 25
	pH	5.82	6.43	6.42	6.5 – 8.5
	Turbidity (NTU)	0.00	3.00	4.00	-
	Conductivity (µs/cm)	86.0	156	139	400

**Table 3:** Analysis of the chemical parameters of water from pot samples

S/N	Parameters (in mg/L)	Raw water sample	Water from Sample A	Water from Sample S	WHO standards
	Total Dissolved Solids (TDS)	57.6	105	93.1	500
	Total Hardness	34.0	44.0	48.0	300
	Iron (Fe)	0.03	0.09	0.13	0.3
	Aluminium (Al)	0.30	0.29	0.42	0.2
	Manganese (Mn)	0.007	0.005	0.007	0.1 – 0.5
	Calcium (Ca <sup>2+</sup> )	8.02	8.82	9.62	100
	Magnesium (Mg <sup>2+</sup> )	3.42	5.37	5.86	50
	Bicarbonate (HCO <sub>3</sub> )	10.0	10.0	16.0	125 - 350

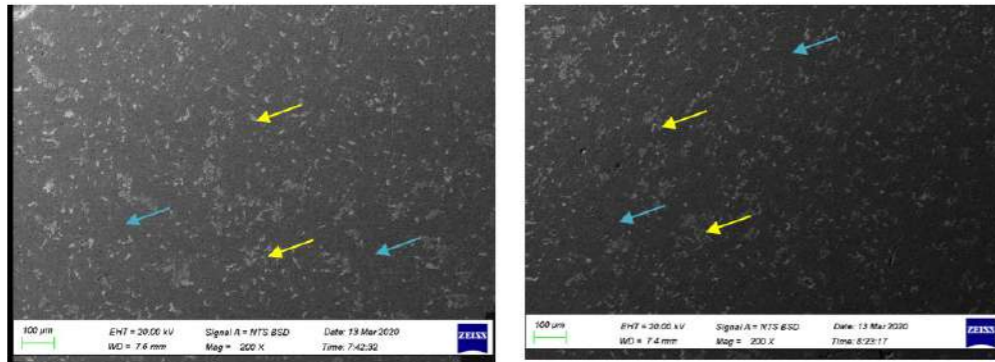
As can be seen in Tables 2 and 3, the results from the water analysis indicate the release of mineral elements and ions from the cookware samples. This agrees with studies that have shown that the use of aluminium utensils in food processing or preparation can result in migration of the aluminium to the food materials (Stahl, Falk, Rohrbeck, Georgii, Herzog, Wiegand, Hotz, Boschek, Zorn, and Brunn 2017a, 2017b, 2017c). In this study, the rate of contamination was higher for cookware sample *S* across almost all the parameters except for the measure of Total Dissolved Solids (TDS) in sample *A* where the factors responsible were not established due to the limited range of tests conducted for the combined total of organic and inorganic substances present in the water sample. Nevertheless, from the analysis of water obtained from boiling in the two cookware samples, the level of migration of metals and metallic ions into the raw water can be considered to be minimal in that their parameter values did not exceed the limit set by the WHO for water quality standards. It was also observed that the transfer limit of 5.00 mg/L for aluminium as recommended by the Council of Europe (EDQM 2013) is not exceeded even with initial raw water sample containing 0.30mg/L of aluminium. Ca, Na, K, Cl, Mg, Fe, Zn, Cu, Cr, I, Co, Mo and Se are mostly essential dietary minerals for human health, although not always available at the same time in drinking water (Olivares and Uauy 2005:43). Despite being indispensable, they also require regulation in dietary intake to avoid deficiencies and toxicosis.

A delimited factor for the water test experiment was that the study did not consider the effects of contaminations from the pots under alkaline and acidic food conditions. Water tends to be relatively pH neutral and aluminium does not react with either cold or hot water (except with steam). Aluminium reacts with oxygen in the air to form a durable outer layer of aluminium oxide (Al<sub>2</sub>O<sub>3</sub>) which tends to inhibit further reaction (Landas 2019; Petrovic and Thomas 2008:3). Further testing is necessary to evaluate the leaching effect that can be caused by cooking acidic foods such as grains, meat, eggs and alkaline foods such as fruits, vegetables, legumes. Fekete, Deconinck, Bolle and Loco (2012:1322) suggested that aluminium migration from aluminium containers could depend on some factors such as temperature, contact time, pH (2.2–7), and salt concentration of extractants. Moreover, some heavy elements such as Pb, Cd, Hg, As, Li and Sn that are cited as potentially toxic for human nutrition and well-being (WHO/FAO/IAEA 1996; WHO International Programme of Chemical Safety 1996) were not tested for in the water samples. A microstructural test further revealed the chemical composition of the cookware material and elements that were not accounted for in the water quality test.

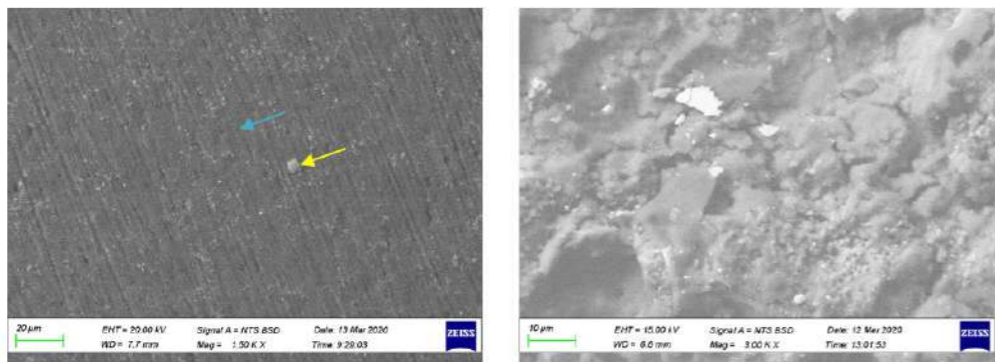
### Characterisation

#### Back-scattered electron imaging

Figure 5 shows the back-scattered electron images of the as-cast aluminium cooking ware. It can be seen that two phases- light and dark, are predominant. The dark phase represents the primary  $\alpha$ -Al matrix while the light phase represents a secondary phase which is thought to be precipitates. These precipitates enhance the mechanical properties and thermal resistance of aluminium alloys. Similar phases were found in the wrought alloy in Figure 6a, but the precipitates preferentially settled at the grain boundaries. Figure 6b shows the microstructure of the black powder taken from the zinc-carbon battery, bright spots which were thought to be contaminants are shown. The EDX analyses of some of these spots as well as that of the aluminium samples are presented below.



a) **Figure 5: SEM-BSE images showing the phases present in as-cast cookware.** b) *sample A; and b) sample S.*

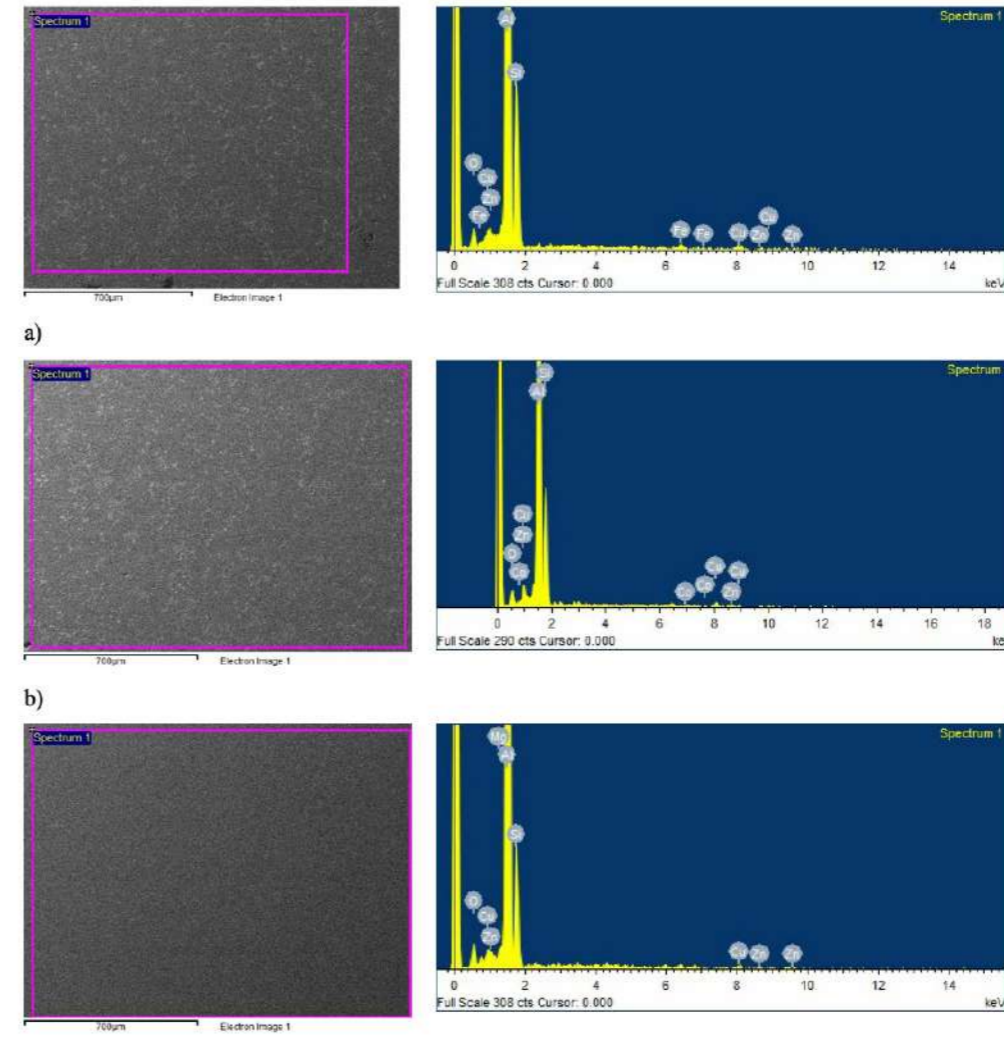


a) **Figure 6: SEM-BSE images of additives for casting the cookware.** b) *wrought Al alloy taken at higher magnification (1500X); and carbon-zinc battery taken at higher magnification (3000X).*

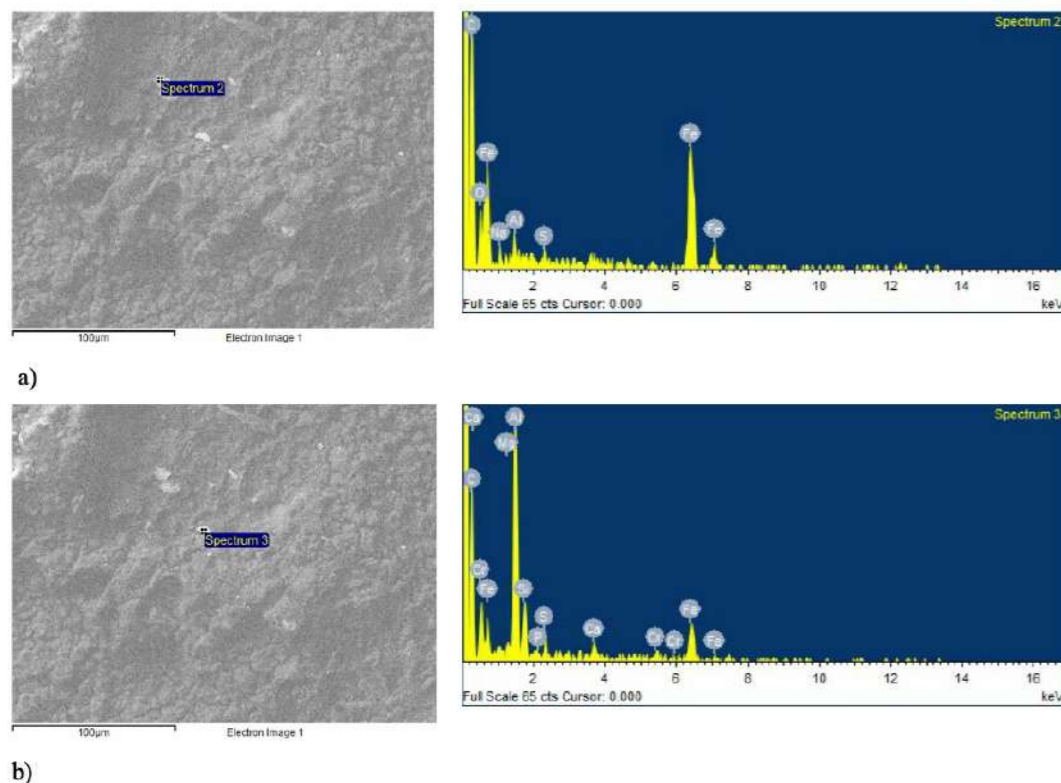
\*Blue arrows point to the dark primary phase representing the aluminium matrix and yellow arrows point at the bright secondary phase which is likely to be precipitates.

### Energy dispersive x-ray spectroscopy

Figure 7 shows the results of the EDX area analyses for the as-cast aluminium cookware and the wrought aluminium alloy that was added as an additive during processing. Also, EDX spot analysis was carried out on the bright spots seen on the black powder from the zinc-carbon battery (Figure 8). In all cases, the spectra show that none of the detrimental elements listed by the WHO were present. This indicates that despite the low-cost technology adopted in producing the cookware, the Al cookware does not contain any potentially toxic contaminants.



a) **Figure 7: SEM-EDX analysis taken at low magnification of 200X for cookware.** b) *sample A; and c) wrought aluminium alloy-additive*



**Figure 8:** SEM-EDX analyses of carbon powder-additive taken at two different spots.

## CONCLUSION

The study has attempted to assess the human health risks of artisanal aluminium cookware produced in Saki, Southwestern Nigeria. The preliminary tests conducted have indicated no significant release of mineral elements from the cookware in case of contact with boiled water. However, further study is necessary to see if there is a significant effect when cooking alkaline or acidic food. The EDX results did not reveal any of the heavy toxic metals declared toxic by the WHO. Although results from previous related studies in Nigeria, Ghana and South Africa (Ankar-Brewoo et al. 2020; Lar et al. 2014; Street et al. 2020) have indicated locally made aluminium cookware as sources of human health risks due to high level of contamination by heavy metals, the findings from this case study have limited evidence to support their results. In the future, further characterisation and testing will be undertaken to ascertain the safe use of aluminium cookware. The authors have no conflicting interest in the results of the study, but we do believe that it shows that high-tech science can be used to evaluate the work of informal artisanal production systems, and thus far, in this case, support local small-scale industrial growth through safe and sustainable practices.

## ACKNOWLEDGEMENTS

The authors wish to acknowledge the University of Johannesburg's Global Excellence and Stature (GES) 4.0 Funding for Postdoctoral Research, for providing the support necessary to undertake the research. Special thanks to Dr. Micheal Oluwatosin Bodunrin for providing technical support with the SEM-EDX experimentation and Miss Deborah Adelakun for assisting in the field work.

## LIST OF REFERENCES

- Ankar-Brewoo, G. M., G. Darko, R. C. Abaidoo, A. Dalsgaard, PN Johnson, W. O. Ellis, and L. Brimer. 2020. Health risks of toxic metals (Al, Fe and Pb) in two common street vended foods, fufu and fried-rice, in Kumasi, Ghana. *Scientific African* 7:1–9.
- Campbell, A. D. 2013. Participatory Technology Design for Urban Agriculture in South Africa. Pp. 8–16 in *Proceedings of the Urban Agriculture: A Growing Field of Research: Workshop at INTERACT 2013 – 14th IFIP TC13 Conference on Human-Computer Interaction*, edited by P. Lyle, J. H. Choi, S. Lawson, C. Lueg, A. Chamberlain, M. Foth, A. Meroni, and M. Brereton. Cape Town: INTERACT 2013.
- Curran, M. A. 2018. Life-Cycle Assessment. *Encyclopedia of Ecology* 359–66.
- CustomPartNet. 2008. Sand Casting Process, Defects, Design. *Sand Casting*. [Online] Available at: (<https://www.custompartnet.com/wu/SandCasting>). Retrieved April 25, 2020
- Davis, J. R. 1993. *ASM Specialty Handbook: Aluminum and Aluminum Alloys*. edited by J. R. Davis. Materials Park, OH: ASM International.
- Davis, J. R. 2001. Aluminum and Aluminum Alloys. Pp. 351–416 in *Alloying: Understanding the Basics*. Materials Park, OH: ASM International.
- EDQM. 2013. *Metals and Alloys Used in Food Contact Materials and Articles: A Practical Guide for Manufacturers and Regulators*. Strasbourg.
- Federal Institute for Risk Assessment (BfR). 2019. *Reducing Aluminium Intake Can Minimise Potential Health Risks*. [Online] Available at: (<https://www.bfr.bund.de/cm/349/reducing-aluminium-intake-can-minimise-potential-health-risks.pdf>). Retrieved April 24, 2020.
- Fekete, V., Deconinck E., Bolle, F., and van Loco, J. 2012. Modelling Aluminium Leaching into Food from Different Foodware Materials with Multi-Level Factorial Design of Experiments. *Food Additives and Contaminants - Part A Chemistry, Analysis, Control, Exposure and Risk Assessment* 29(8):1322–33.
- Flora, G., D. Gupta, and A. Tiwari. 2012. Toxicity of Lead: A Review with Recent Updates. *Interdisciplinary Toxicology* 5:47–58.
- Ivanov, D. P., and V. N. Ivanov. 2010. Foundry Industry. *The Great Soviet Encyclopedia*. [Michigan: The Gale Group, Inc.]
- JECFA. 2006. *Safety Evaluation of Certain Food Additives and Contaminants Prepared by the Sixty-Seventh Meeting of the Joint FAO/WHO Expert Committee on Food Additives (JEFCA)*. Geneva: World Health Organization.
- Jitaru, P., L. Ingenbleek, N. Marchond, C. Laurent, A. Adegboye, S. E. Hossou, A. Z. Koné, A. D. Oyedele, C. S. K. J. Kisito, Y. K. Dembélé, S. Eyangoh, P. Verger, B. L. Bizec, J. C. Leblanc, and T. Guérin. 2019. Occurrence of 30 Trace Elements in Foods from a Multi-Centre Sub-Saharan Africa Total Diet Study: Focus on Al, As, Cd, Hg, and Pb. *Environment International* 133(June):105197.
- Krewski, D., Yokel R A., Nieboer E., Borchelt D., Cohen J., Harry J., Kacew S., Lindsay J., Mahfouz A. M., and Rondeau V. 2007. Human health risk assessment for aluminium, aluminium oxide, and aluminium hydroxide. *Journal of Toxicology and Environmental Health. Part B, Critical Reviews* 10(Suppl 1):1–269.
- Kruger, C. 2000. *Pride of Men: Nineteenth Century Ironworking*. Portsmouth, NH: Heinemann.
- Landas, Trevor. 2019. Reactions of main group elements with water. *Chemistry LibreTexts*. [Online] Available at: ([https://chem.libretexts.org/Bookshelves/Inorganic\\_Chemistry/Modules\\_and\\_Websites\\_\(Inorganic\\_Chemistry\)/Descriptive\\_Chemistry/Main\\_Group\\_Reactions/Reactions\\_of\\_Main\\_Group\\_Elements\\_with\\_Water](https://chem.libretexts.org/Bookshelves/Inorganic_Chemistry/Modules_and_Websites_(Inorganic_Chemistry)/Descriptive_Chemistry/Main_Group_Reactions/Reactions_of_Main_Group_Elements_with_Water)). Retrieved May 13, 2020

- Lar, U., D. Caleb, and R. Gusikit. 2014. Locally made utensils as potential sources of heavy metals contamination of water: a case study of some pots made in Nigeria. *American Journal of Environmental Protection (Special Issue: Integrating Earth Materials, Diet, Water and Human Health)* 3(6–2):35–41.
- Lo, Y. C., C. A. Dooyema, A. Neri, J. Durant, T. Jefferies, A. Medina-Marino, and Et Al. 2012. Childhood lead poisoning associated with gold ore processing: a village level investigation—Zamfara State, Nigeria. *Environmental Health Perspectives* 120:1450–1455.
- Neelam, M. S. Bamji, and M. Kaladhar. 2000. Risk of increased aluminium burden in the Indian population: contribution from aluminium cookware. *Food Chemistry* 70(1):57–61.
- Nevadomsky, J. 2005. Casting in contemporary Benin art. *African Arts* 38(2):66–95.
- Ogimoto, M., K. Suzuki, N. Haneishi, Y. Kikuchi, M. Takanashi, N. Tomioka, Y. Uematsu, and K. Monma. 2016. Aluminium content of foods originating from aluminium-containing food additives. *Food Additives and Contaminants: Part B Surveillance* 9(3):185–90.
- Olivares, Manuel, and Ricardo Uauy. 2005. Essential nutrients in drinking water. Pp. 41–60 in *Nutrients in Drinking Water*. Geneva: World Health Organization.
- Osborn, Emily Lynn. 2009. Casting aluminium cooking pots: labour, migration and artisan production in West Africa's informal sector, 1945–2005. *African Identities* 7(3):373–86.
- Petrovic, J., and G. Thomas. 2008. *Reaction of aluminum with water to produce hydrogen*. [Online] Available at: ([https://www1.eere.energy.gov/hydrogenandfuelcells/pdfs/aluminium\\_water\\_hydrogen.pdf](https://www1.eere.energy.gov/hydrogenandfuelcells/pdfs/aluminium_water_hydrogen.pdf)). Retrieved May 13, 2020.
- Rajwanshi, Poonam, Vibha Singh, M. K. Gupta, and Sahab Dass. 1997. Leaching of aluminium from cookwares - a review. *Environmental Geochemistry and Health* 19(1):1–18.
- Rump, H. H., and H. Krist. 1993. Laboratory manual for the examination of water, waste water and soil, Second Edition. *Journal of Chemical Education* 70(6):A172.
- Runge, Jude Mary. 2018. *The Metallurgy of Anodizing Aluminum: Connecting Science to Practice - Jude Mary Runge* - Google Books. Cham, Switzerland: Springer International Publishing AG.
- Santangelo, Marianne. 2011. Product lifecycle assessment shows true environmental impact. *Advancing Metal Fabrication Together*. [Online] Available at: (<https://www.fmamfg.org/blog/product-lifecycle-assessment-shows-true-environmental-impact>). Retrieved April 24, 2020
- Sepúlveda, A., M. Schluep, F. G. Renaud, M. Streicher, R. Kuehr, C. Hagelüken, and Et Al. 2010. A review of the environmental fate and effects of hazardous substances released from electrical and electronic equipments during recycling: examples from China and India. *Environmental Impact Assessment Review* 30:28–41.
- Smillie, Ian. 2000. *Mastering the Machine Revisited: Poverty, Aid and Technology*. Rugby: Practical Action Publishing.
- Socolof, Maria Leet, and Jack R. Geibig. 2006. Evaluating human and ecological impacts of a product life cycle: the complementary roles of life-cycle assessment and risk assessment. *Human and Ecological Risk Assessment* 12(3):510–27.
- Stahl, T., S. Falk, A. Rohrbeck, S. Georgii, C. Herzog, A. Wiegand, S. Hotz, B. Boschek, H. Zorn, and H. Brunn. 2017a. Migration of aluminum from food contact materials to food—a health risk for consumers? Part I of III: exposure to aluminum, release of aluminum, tolerable weekly intake (TWI), Toxicological effects of aluminum, study design, and methods. *Environmental Sciences Europe* 29(1).
- Stahl, T., S. Falk, A. Rohrbeck, S. Georgii, C. Herzog, A. Wiegand, S. Hotz, B. Boschek, H. Zorn, and H. Brunn. 2017b. Migration of aluminum from food contact materials to food—a health risk for consumers? Part II of III: Migration of aluminum from drinking bottles and moka pots made of aluminum to beverages. *Environmental Sciences Europe* 29(1).
- Stahl, T., S. Falk, A. Rohrbeck, S. Georgii, C. Herzog, A. Wiegand, S. Hotz, B. Boschek, H. Zorn, and H. Brunn. 2017c. Migration of aluminum from food contact materials to food—a health risk for consumers? Part III of III: migration of aluminum to food from camping dishes and utensils made of aluminum. *Environmental Sciences Europe* 29(1).
- Stahl, T., S. Falk, H. Taschan, B. Boschek, and H. Brunn. 2018. Evaluation of human exposure to aluminum from food and food contact materials. *European Food Research and Technology* 244(12):2077–84.
- Stahl, T., H. Taschan, and H. Brunn. 2011. Aluminium content of selected foods and food products. *Environmental Sciences Europe* 23(1):1–11.
- Street, R. A., A. Mathee, S. Tanda, C. Hauzenberger, S. Naidoo, and W. Goessler. 2020. Recycling of scrap metal into artisanal cookware in the informal sector: a public health threat from multi metal exposure in South Africa. *Science of the Total Environment* 699:134324.
- Swaddiwudhipong, W., W. Tontiwattanasap, W. Khunyotying, and C. Sanreun. 2013. Blood lead levels among rural Thai children exposed to lead-acid batteries from solar energy conversion systems. *Southeast Asian Journal of Tropical Medicine and Public Health* 44(6):1079–87.
- Taylor, C. M., K. Kordas, J. Golding, and A. M. Emond. 2017. Effects of low-level prenatal lead exposure on child IQ at 4 and 8 Years in a UK birth cohort study. *NeuroToxicology* 62:162–169.
- The Panel on Food Additives, Flavourings, Processing Aids and Food Contact Materials. 2008. Safety of aluminium from dietary intake - scientific opinion of the Panel on Food Additives, Flavourings, Processing Aids and Food Contact Materials (AFC). *EFSA Journal* 754:1–34.
- US Energy Information Administration (EIA). 2014. Recycling is the primary energy efficiency technology for aluminum and steel manufacturing. *Today in Energy*. [Online] Available at: (<https://www.eia.gov/todayinenergy/detail.php?id=16211>). Retrieved April 20, 2020
- Veríssimo, Marta I. S., João A. B. P. Oliveira, and M. Teresa S. R. Gomes. 2006. Leaching of aluminium from cooking pans and food containers. *Sensors and Actuators, B: Chemical* 118(1–2):192–97.
- Wang, Xin. 2014. Thermal physical and mechanical properties of raw sands and sand cores for aluminum casting. Leoben: Montanuniversität.
- Weidenhamer, Jeffrey D., Meghann P. Fitzpatrick, Alison M. Biro, Peter A. Kobunski, Michael R. Hudson, Rebecca W. Corbin, and Perry Gottesfeld. 2017. Metal exposures from aluminum cookware: an unrecognized public health risk in developing countries. *Science of the Total Environment* 579:805–13.
- Weidenhamer, Jeffrey D., Peter A. Kobunski, Gilbert Kuepouo, Rebecca W. Corbin, and Perry Gottesfeld. 2014. Lead exposure from aluminum cookware in Cameroon. *Science of the Total Environment* 496:339–47.
- WHO/FAO/IAEA. 1996. *Trace Elements in Human Nutrition and Health*. Geneva: World Health Organization.
- WHO. 2005. *Nutrients in Drinking Water*. Geneva: World Health Organization.
- WHO International Programme of Chemical Safety. 1996. *Guidelines for Drinking-Water Quality. Health Criteria and Other Supporting Information 2nd Ed. Vol. 2*. Geneva.
- Zhou, L., H. Rui, Z. Wang, F. Wu, J. Fang, K. Li, and Et Al. 2017. Migration law of lead and cadmium from Chinese pots during the cooking process. *International Journal of Food Properties* 20:S3301–S3310.

# THE USE OF TECHNOLOGY AND ITS INFLUENCE ON THE OBESITY EPIDEMIC IN SOUTH AFRICA

Hema Kesa<sup>1</sup>

<sup>1</sup>Food Evolution Research Laboratory, School of Tourism and Hospitality, University of Johannesburg, South Africa.

Hemak@uj.ac.za

## Abstract

*Currently, more than 2.1-billion people globally are overweight and obese. If the rate of obesity prevalence continues on its current trajectory, almost half of the world's population will be overweight and obese by 2030.*

*In South Africa, obesity has increased in the last 30 years and the country is now considered to be the most obese country in sub-Saharan Africa. Over half of the country's adults are now overweight and obese, with 68% of women and 31% of men being obese. The consumption of fast foods has increased as household income has increased with globalisation and westernisation direct consumption trends. The move away from indigenous or traditional food consumption towards more processed and convenience foods, such as food-away-from-home, is linked to weight gain. These diets, in turn, are related to non-communicable diseases such as high blood pressure, heart disease and diabetes. The major contributing factors to unhealthy weight gain are excess sugar consumption and high caloric energy dense foods. Non-communicable diseases exert an impact on the economic development in South Africa. The accumulated loss of South Africa's gross domestic product between 2006 and 2015 from non-communicable diseases was estimated to be about 1.88-billion USD.*

*The aim of this study was to determine the use of nutrition-related software applications (apps) for promoting healthy diets and improving nutritional knowledge. A quantitative online survey was carried out with 110 participants living in South Africa. Globally, smart phones have achieved a wide reach at a high rate, and nutrition apps have become increasingly prevalent among users. Nutrition-related apps have been found to be effective in improving dietary knowledge, facilitating physical activity and fostering healthier lifestyles. This study showed that the use of nutrition-related apps will continue to rise as smartphones become part of our everyday lives, with the potential to create a health conscious and relatively active society in the decades ahead.*

**Keywords:** nutrition, obesity, technology, nutrition apps.

## INTRODUCTION

The magnitude of malnutrition has been assessed by many experts around the world and it is one of the most significant problems faced globally. The global population is currently estimated to be about 7.7-billion, with 2-billion of that are affected by micronutrient deficiencies (iron, zinc, vitamin A and iodine) (UNICEF, 1990). Close to 795-million people suffer from undernourishment and 2-billion adults are overweight. The percentage of obese people has doubled from 1980 to 2008, and is increasing among children under the age of 5 years old, as well as among adolescents and girls (IFPRI, 2016; Lobstein *et al.*, 2015).

The global population is projected to increase to 9.7-billion by 2050. Of that number, 6-billion people are expected to become urban dwellers (Popkin, 2002). With that shift comes an increase in income and a greater selection of products to eat. Convenient foods are becoming a preferred choice. The global food system is transitioning away from family farms and local producers and moving instead towards industrialised mass commodity production and globalised trade. This then produces an obesogenic environment through over consumption and under nutrition, which therefore increases the risk of non-communicable diseases (Hendricks, Kruger & Puoane; Vorster & Bourne, 2016).

Recently, paying attention to nutritional needs and the monitoring of healthy eating habits have achieved great importance in the wake of an increase in chronic illnesses such as diabetes, cardiovascular disease and other diet-related illnesses that stem from unhealthy eating, unhealthy behaviour and physical inactivity (Franco, Fallaize, Lovegrove & Hwang, 2016:85). With the proliferation of mobile devices, there has been a rise in the number of software apps aimed at improving nutrition and physical fitness (Franco *et al.*, 2016b). However, knowledge about healthy eating is not sufficient on its own to facilitate behavioural changes in eating habits. For this reason, nutrition apps have assumed significant importance as media for monitoring and facilitating lifestyle changes (Griffiths, Harnack & Pereira 2018:1498).

Therefore, this study aimed at looking into how the use of nutrition apps can promote healthy eating and improve nutritional knowledge among South Africans.

## LITERATURE REVIEW

The World Health Assembly (2016) and World Health Organisation (WHO) (2010) adopted eight global nutrition targets for 2025. These targets are:

1. Achieve a 40% reduction of stunting among children under the age of five years old.
2. Achieve a 50% reduction of anaemia among women of reproductive age.
3. Achieve a 30% reduction in low birth weight.
4. Not have any increase in children under the age of five years old becoming overweight.
5. Achieve a 50% increase in exclusive breast feeding for the first six months of infancy.
6. Reduce wasting to and maintain it at less than 5% among children under the age of five years old.
7. Achieve zero increase in obesity and diabetes among adolescents and adults.
8. Achieve a 30% reduction in salt intake globally.

## Analysis of the nutritional landscape of South Africa

Malnutrition is rife in South Africa, with poverty and inequity contributing to it. Ataguba & McIntyre (2014, 9) state that: “WHO projections indicate that by 2030, the death rates from non-communicable diseases such as stroke, ischaemic heart diseases, road injuries and diabetes will be higher than in 2015 in the African region while death rates from communicable diseases particularly HIV/AIDS, respiratory infections, diarrhoeal diseases and malaria will be lower in 2030 than 2015. Given that South Africa is further in its epidemiological transition than many other African countries, the burden of s is likely to be even more dominant in the future”.

The South Africa Demographic and Health Survey (SADHS) (2016, 8) was conducted in collaboration with the National Department of Health (NDoH) and the South African Medical Research Council (MRC). It presents findings from approximately 13 000 households that were interviewed. “The survey observed a drop in the under-5 mortality and the infant mortality rates to 42 deaths and 35 deaths per 1,000 live births, respectively, for the 5 years preceding the survey. The neonatal mortality rate has also dropped to 21 deaths per 1,000 live births, accounting for about half of under-5 deaths. The 2016 SADHS results show that 94% of women who gave birth in the 5 years preceding the survey received antenatal care from a skilled provider at least once for their last birth”.

Koetaan, Smit, Liebenberg, Brits, Halkas, Van Lill & Joubert (2018) stated that in 2013, South Africa had 1.3-million children under the age of nine years old who were underweight and 2.3-million with stunted growth. Between 2009 and 2013, all provinces in South Africa were able to reduce the incidence of severe malnutrition, except the Free State, which showed an increase of 3.9% in 2009 to 10.7% in 2013. Nonetheless, the incidence of malnutrition is still higher than the national target of 10 per 1 000 children under the age of five years old. In 2011, the Free State also had the highest mortality rate for children under five years old, which was 72.1 per 1 000 live births, compared with the mortality rate of the country of 38.5.

### Millennium Development Goals (MDGs) to Sustainable Development Goals (SDGs)

The MDGs came to an end in 2015. Their agenda remained unfinished in terms of “*inequality of income and opportunities, unemployment and malnutrition; gender equality and women empowerment; quality of education and educational attainment; child and maternal health and disparity in access to, and quality of health services. Environmental sustainability is also an area where more investments need to be made going forward. Overall, South Africa has made progress towards reducing extreme and multidimensional poverty, however, more targeted policies and investments are still needed to address entrenched issues of inequality and rampant unemployment*” (South Africa MDG Country Report, 2015).

The SDGs came into effect in January 2016, comprising 17 goals. To achieve these goals, partnerships are required between government, the private sector, citizens and civil society. The SDGs need sustained government investment and policy change. A reduction in stunting in South Africa requires government to strengthen its public health system and to make improvements to primary health care. Community health care workers also need to be trained (South Africa MDG Country Report, 2015).

Diverse and nutritious foods need to be provided for pregnant and lactating women as well as for growing children. Programmes need to be implemented to encourage mothers to breastfeed. Some challenges associated with meeting SDGs include a lack of financial and human resources, as well as a lack of capacity to monitor and evaluate programmes. Most developing countries like South Africa experience the same challenges and problems. Fiscal constraints pose a challenge in developing countries such as South Africa, where there are competing national interests. South Africa needs to invest more in early childhood development, including education, health and nutrition. Without this, South Africa will battle to meet the SDGs by 2030 (South Africa MDG Country Report, 2015).

### The nutrition transition linked obesity and non-communicable diseases

Nutritional transition, driven by dietary change and propelled by economic and technological advances, has been investigated as increasing the risk of non-communicable diseases. Urbanisation is associated with economic advancements and an increase in per-capita available energy, which are factors that are common in low- and middle-income countries (LMICs).

It is estimated that by 2050, 60% of the global population will live in cities. South Africa is urbanising rapidly, with the population growing larger and younger. The United Nations estimates that 71.3% of South Africa’s population will live in urban areas by 2030 (GBD, 2015).

A change of diet has been observed among the South African population. This transition has been from a “traditional diet” to “western diet”, which has led to non-communicable diseases such as heart disease, strokes, cancer, diabetes, and respiratory diseases. Non-communicable diseases place a huge burden on the development, health and economy of South Africa (Spires, Sanders, Hoelzel, Delobelle, Puoane & Swart, 2016).

The historic pattern of nutrition transition is as follows. Initially, the diet would have been high in carbohydrates. During times of famine, a scarcity of food would have led to a lack of dietary diversity. During a receding famine, there would have been an increase in food diversity. Nutrient-related chronic diseases of lifestyle would come about

as a result of the availability of processed and high-energy foods. Behavioural change would then take place because healthy dietary patterns are followed due to scientific knowledge and an increase in physical activity.

### Environmental and behavioural factors

Through this transition, people become more exposed to food marketing and a change in foods available to them. Marketing and advertising such as those seen in the media, food promotions and competitions, could sometimes exert a negative impact on food choices made by consumers. Consumers have changed their dietary patterns from traditional or indigenous staple diets to more processed foods such as convenience foods or fast foods, otherwise labelled as “Western diets” (Vorster & Bourne, 2016:56).

The expansions of supermarkets, fast food outlets and the rise of “big food” producers have influenced the change in diet habits as well. These supermarkets stock cheaper brands, limited healthy foods and limited fresh produce. These foods are energy-dense, low in fibre, fatty, and high in sugar and salt. People living in urban and peri-urban areas, and who follow an unhealthy diet, are physically inactive, live a more sedentary lifestyle, and have a tendency to smoke excessively and drink alcohol. Obesity is growing rapidly, both nationally and globally, with more than 50% of women and 30% of men in South Africa being overweight and obese (Vorster & Bourne, 2016:58). The Chronic Diseases of Lifestyle (CDL) in adults and infectious diseases in children is known as the “double burden of disease.”

### Concept of food away from home

There has been a notable shift in eating culture over the past 40 years. Since the late 1970s, the level of consumption of foods prepared outside the home has steadily grown, from one sixth to almost one third of an individual’s daily dietary intake. A 2012 analysis of 2007-2008 National Health and Nutrition Examination Survey data found that 41% of adults had consumed foods and/or beverages from fast-food-type restaurants, and 27% had consumed food from full-service-type restaurants during the prior 24 hours. With fewer meals being prepared at home, the overall quantity of calories has increased while nutritional quality has declined (Todd, Mancino & Lin, 2010).

Studies have found that those who consume food away from home more frequently have higher intakes of total energy, total fat, saturated fat, cholesterol, sodium, sugar and sugar-sweetened beverages, while simultaneously having lower intakes of fibre and some micronutrients (Ayale, Rogers, Arredondo, Campbell, Baquero, Duerksen, & Elder., 2016).

### The impacts of mobile health intervention in shaping eating behaviour

The rapid developments in mobile technology have encouraged the use of smartphones in the promotion of health, as well as in health research and practice. Although many software apps relating to diet and nutrition are available on major smartphone platforms, relatively few empirical studies have been conducted on their effectiveness in promoting healthy eating behaviour (West, Belvedere, Andreasen, Frandsen, Hall & Crookston, 2017:95)obesity has become a serious public health crisis in the United States. Although the problem of obesity is being addressed through a variety of strategies, the use of mobile apps is a relatively new development that could prove useful in helping people to develop healthy dietary habits. Though such apps might lead to health behavior change, especially when relevant behavior change theory constructs are integrated into them, the mechanisms by which these apps facilitate behavior change are largely unknown. OBJECTIVE The purpose of this study was to identify which behavior change mechanisms are associated with the use of diet- and nutrition-related health apps and whether the use of diet- and nutrition-related apps is associated with health behavior change. METHODS A cross-sectional survey was administered to a total of 217 participants. Participants responded to questions on demographics, use of diet and nutrition apps in the past 6 months, engagement and likability of apps, and changes in the participant’s dietary behaviors. Regression analysis was used to identify factors associated with reported changes in theory and separately for reported changes in actual behavior, after



controlling for potential confounding variables. **RESULTS** The majority of study participants agreed or strongly agreed with statements regarding app use increasing their motivation to eat a healthy diet, improving their self-efficacy, and increasing their desire to set and achieve health diet goals. Additionally, majority of participants strongly agreed that using diet/nutrition apps led to changes in their behavior, namely increases in actual goal setting to eat a healthy diet (58.5%, 127/217. Electronic health (eHealth) and mobile health (mHealth) technologies, which include mobile devices and smartphone apps, provide opportunities for the population-wide promotion of physical activity and healthy eating (Flores,Granado-Font, Ferre-Grau & Carreras, 2015).

Nutrition-related apps are perhaps the most potent medium for delivering healthcare assistance with less of a cost burden and higher mobility. The rapid growth in development of advanced information communication technologies is being propelled by accelerated changes brought about through digitalisation in various areas of health. Many healthcare practitioners and health-conscious individuals are gradually turning their focus towards mHealth, as supported mobile communication tools create greater accessibility and convenience (Free, Phillips, Felix, Galli, Patel & Edwards, 2010). Technological advancements in the 21<sup>st</sup> century have spurred innovative solutions to many social problems. The proliferation of handheld and wearable devices, coupled with apps for managing nutrition and active lifestyles, presents a viable approach to addressing the problem of nutrition-related non-communicable diseases.

## METHODOLOGY

A quantitative research survey was carried out with 110 participants aged 18 years old or above living in South Africa. Random sampling was used to select the respondents in different provinces, along with the snowball sampling method.

A structured online questionnaire was administered to collect data and consisted of four main sections. These sections were: sociodemographic; health; computer and smartphone use experience; nutrition apps and personal experience.

The collected data were exported and coded in an Excel folder. The descriptive statistics of the data collected was performed using the statistical software Statistical Package for Social Sciences, also known as SPSS, version 25.

## ETHICAL CONSIDERATION

The study was reviewed and approved by the Ethics Committee of Research of the University of Johannesburg. All participating respondents voluntarily and anonymously completed the online survey form.

## RESULTS AND DISCUSSION

### 1. Socio-demographic profile of the surveyed population:

Table 1 below depicts the socio-demographic profile of the surveyed population. Among the 110 participants, 27% were males and 72.3% were females; and 36% were between 18 and 25 years old. The majority of respondents were of a tertiary educational level (86.4%) or a secondary educational level (13.6%). The majority lived in urban areas (85.5%), and 55.5% had a total income of R25 000 or more with 80% of the participants residing in the Gauteng province.

**Table 1:** Socio-demographics characteristics of the studied population (n = 110).

Demographic Profile	Frequency (N)	Valid percentage (%)
<b>Gender</b>		
Male	30	27,2
Female	80	72,7
Total	110	100,0
<b>Age</b>		
18-25years old	36	32,7
26-35years old	31	28,2
36-45years old	18	16,4
46-55years old	23	20,9
56-65years old	2	1,8
Total	110	100,0
<b>Ethnicity</b>		
Black	55	50,0
Coloured	18	16,4
Indian	22	20,0
White	15	13,6
Total	110	100,0
<b>Income level</b>		
Less than R5 000	9	8,2
R15 000 – R24 999	25	22,7
R25 000 and above	61	55,5
R5 000 – R14 999	15	13,6
Total	110	100,0
<b>Highest education qualification</b>		
Grade 8-12	15	13,6
Tertiary Education	95	86,4
Total	110	100,0
<b>Region of residence in South Africa</b>		
Eastern Cape	2	1,8
Free State	1	,9
Gauteng	88	80,0
Kwazulu-Natal	4	3,6
Limpopo	1	,9
Mpumalanga	9	8,2
North West	2	1,8
Western cape	3	2,7
Total	110	100,0
<b>Area in region of residence</b>		
Peri-urban	14	12,7
Rural	2	1,8
Urban	94	85,5
Total	110	100,0

2. Use of a smart phone:

All the participants agreed that they owned smartphones and according to Table 2, 50% of them had been using the smartphone for more than 10 years. However, only 35.5% of the participants used nutrition apps on their smartphones. This indicates that there is a need for nutrition and healthy eating awareness among the population.

Table 2: Use of smartphone (Android, iPhone etc.).

		Frequency	Percent	Valid Percent	Cumulative Percent
Valid	1-5 years	12	10,9	10,9	10,9
	6-10 years	43	39,1	39,1	50,0
	More than 10 years	55	50,0	50,0	100,0
	Total	110	100,0	100,0	

3. Nutrition knowledge, apps and software:

Table 3 below shows that the majority of the participants (97.3%) were aware of a balanced diet. However, Table 4 shows that only 52% applied the principles of a balanced diet in their day-to-day lives. The study also revealed that 20% of the participants suffered from non-communicable diseases, but 38% agreed that nutrition apps were useful tools for improving nutrition behaviour (refer to Figure 1). No significant correlation was noticed between the health status of the respondents or their family members and the use of nutrition apps. Nearly 50% of the participants were willing to learn more about nutrition apps to improve their eating behaviour and health outcomes (Figure 2).

Table 3: Nutrition knowledge of a “balanced diet”.

		Frequency	Percent	Valid Percent	Cumulative Percent
Valid	No	3	2,7	2,7	2,7
	Yes	107	97,3	97,3	100,0
	Total	110	100,0	100,0	

Table 4: Application of principles of a “balanced diet” in one’s day-to-day life.

		Frequency	Percent	Valid Percent	Cumulative Percent
Valid	I do not know	4	3,6	3,6	3,6
	No	48	43,6	43,6	47,3
	Yes	58	52,7	52,7	100,0
	Total	110	100,0	100,0	

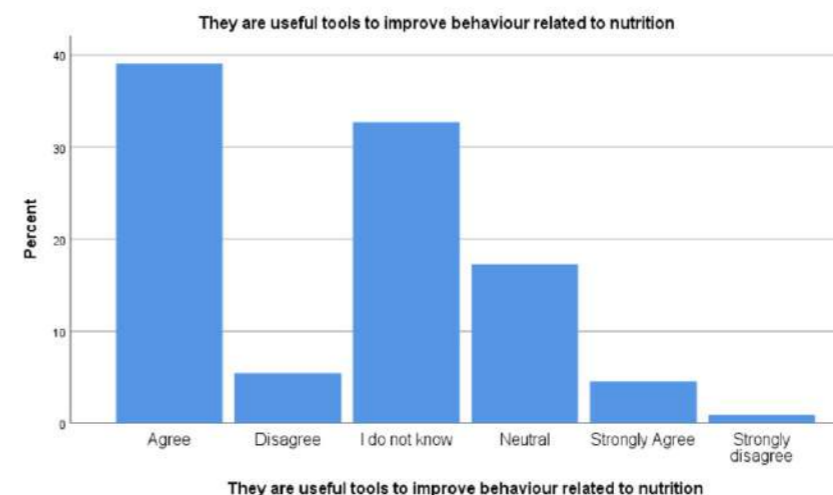


Figure 1: Apps as useful tools.

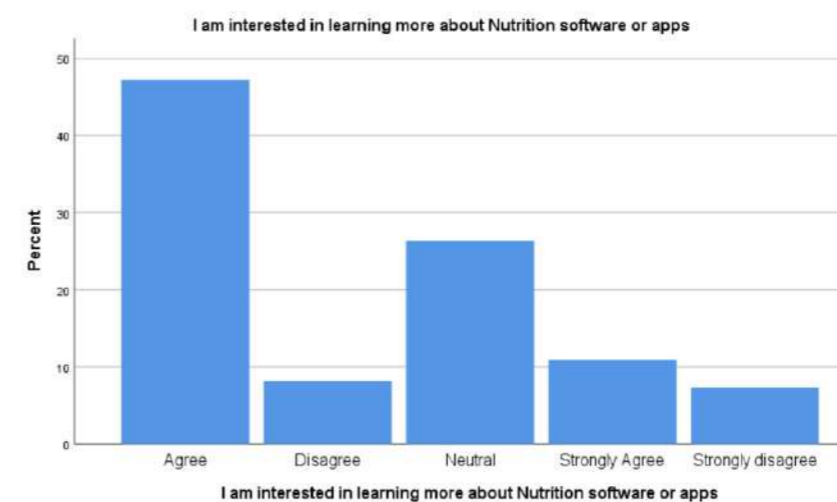


Figure 2: Interest in nutrition apps and software.

In the current technological era, smart phones have achieved a wide reach at an unprecedented rate, and nutrition apps have become increasingly prevalent among users (Zhao, Freeman & Li, 2016:287) mobile phones have achieved wide reach at an unprecedented rate, and mobile phone apps have become increasingly prevalent among users. The number of health-related apps that were published on the two leading platforms (iOS and Android. Globally, the numbers of smartphone used is forecasted to reach 5.8-billion by 2020, with 6-million multimedia apps available for download in app stores (Byambasuren, Sanders & Beller, 2018:2).

Currently, smartphones are used by millions of people not only for fun but for regular communication with friends and family, as well as email access, Internet access, efficiency and connectivity. The continuous improvement of smartphones over the years is one of the main drivers that has contributed to the rapidly growing number of mobile applications, as well as different mobile categories (Poushter, Bishop & Chew 2018).

Changing the health behaviour of individuals is challenging. However, factors such as convenience, cost, culture, social acceptance, comfort, marketing, product placement, store placement, advertising, brand trust, ingredients, allergies, kitchen access, serving size and so much more influence behaviours surrounding food choice (Payne, Lister, West & Bernhardt 2015). Eating healthy has become a challenging ideal that many simply cannot attain. Health-focused smartphone apps have the ability to break through barriers and enable users to make healthier choices (Ipjian & Johnston, 2017). Creating healthy behavioural changes requires making healthy choices with regards to food consumption.

## CONCLUSION

One of the most oft-quoted reasons for South Africa's emerging obesity crisis is the westernisation and urbanisation of the population. Fast-paced urban lifestyles leave little time for physical activity and less time to prepare meals from home. This leads to eating food away from home. Such foods often contain large amounts of fat, sugar and sodium content. This, in turn, leads to obesity and non-communicable diseases.

The results of this study demonstrate that the use of a nutrition-related app is associated with behavioural change, because 38% of South Africans agree that nutrition-related apps are useful tools for improving nutrition-related behaviour, while 48% are willing to learn more about the use of nutrition-related apps and software. Many South Africans are overweight and obese, which is due to nutrition transition and eating food away from home. In addition, this study showed that behaviour change theory was positively associated with actual behavioural change related to the use of nutrition-related apps.

Studies have shown that using nutrition-related apps can successfully lead to health behaviour change, which is related to weight loss and healthy eating behaviour. According to health professionals, nutrition-related apps have the potential to facilitate weight management and a proper eating lifestyle. Therefore, the use of such apps is encouraged. Mobile apps are thus on their way to becoming the dominant technological tool for supporting a healthy lifestyle.

## LIST OF REFERENCES

- Ataguba, J. E., Day, C., McIntyre, D. 2014. Monitoring and evaluating progress towards universal health coverage in South Africa. *Plos Medicine*, 11(9):e1001686.
- Ayala, G. X., Rogers, M., Arredondo, E., Campbell, N., Baquero, B., Duerksen, s & Elder, J.P. 2008. Away-from-home food intake and risk for obesity: examining the influence of context. *Obesity*, 16, (5):1002–1008, 2008.
- Byambasuren, O., Sanders, S., Beller, E & Glasziou. 2018. Prescribable mHealth apps identified from an overview of systematic reviews. *Digital Medicine*, 1(1):1–13.
- Christina, A., Swinburn, B., Hawkes, C., Huang, T., Costa, S. A., Ashe, M., Zwicker, L., Cawley, J.H & Brownell, K.D. 2015. Patchy progress on obesity prevention: emerging examples, entrenched barriers, and new thinking. *Lancet*, 385(9985):2400–2409.
- Dennison, L., Morrison, L., Conway, G & Yardley, L. 2013. Opportunities and challenges for smartphone applications in supporting health behavior change: qualitative study. *Journal of Medical Internet Research*:86. [Online] Available from doi: 10.2196/jmir.2583 [Accessed: 10 June 2020].
- Department of Health. 2017. Annual Report. [Online] Available from: <https://www.gov.za> [Accessed: 12 May 2020].
- Flores Mateo, G., Granado-Font, E., Ferre-Grau, C & Carreras, X.M. 2015. Mobile phone apps to promote weight loss and increase physical activity: A systematic review and Meta-Analysis. *Journal of Medical Internet Research*. JMIR Publications Inc. 17(11):e253. [Online] Available from doi: 10.2196/jmir.4836 [Accessed:2 June 2020].
- Franco, R. Z., Fallaize, R., Lovegrove, J.A & Hwang, F. 2016a. Popular nutrition-related mobile apps: A feature assessment. *JMIR mHealth and uHealth*. JMIR Publications Inc. 4(3):e85. [Online] Available from doi: 10.2196/mhealth.5846 [Accessed: 3 May 2020].
- Griffiths, C., Harnack, L. & Pereira, M. A. 2018. Assessment of the accuracy of nutrient calculations of five popular nutrition tracking applications. *Public Health Nutrition*. Cambridge University Press, 21(08):1495–1502. [Online] Available from doi: 10.1017/S1368980018000393 [Accessed: 12 May 2020].
- Hendricks, M., Kruger, S. & Puoane, T. 2016. *Nutritional management of multiple nutrient deficiencies in community nutrition for developing countries*. Edited by: Temple, N., Steyn, N. Athabasca University. Unisa.
- Hawkes, C., Smith, T.G & Jewell, J. 2015. Smart food policies for obesity prevention. *Lancet*, 385: 2410–2421.
- IFPRI. 2012. Governing the dietary transition: linking agriculture, nutrition and health. *Reshaping Agriculture for Nutrition and Health*. International Food Policy. Washington DC.
- Ipjian, M. L. & Johnston, C. S. 2017. Smartphone technology facilitates dietary change in healthy adults. *Nutrition*:343–347. [Online] Available from doi: 10.1016/j.nut.2016.08.003 [Accessed: 20 May 2020].
- Koetaan, A., Smit, A., Liebenberg, A., Brits, M., Halkas, C., Van Lill, M & Joubert, G. 2018. The prevalence of underweight in children aged 5 years and younger attending primary health care clinics in the Mangaung area, Free State. *African Journal of Primary Health Care & Family Medicine*.
- Lobstein, T., Jackson-Leach, R., Moodie, M.L., Hall, K.d., Gortmaker, S.L., Swinburn, B. A., James, W.P.T., Wang, Y & McPherson, K. 2015. Child and adolescent obesity: part of a bigger picture. *Lancet*; 385:2510–2520.
- Micronutrient Initiative. 2009. Investing in the future: a united call to action on vitamin and mineral deficiencies. *Micronutrient Initiative*. Ottawa, Canada.

- Payne, H. E. Lister, C., West, J.H & Bernhardt, J.M. 2015b. Behavioral functionality of mobile apps in health interventions: A systematic review of the literature. *JMIR mHealth and uHealth*, 3(1):20. [Online] Available from doi: 10.2196/mhealth.3335 [Accessed: August 2020].
- Popkin, B. M. 2002. The shift in stages of the nutritional transition in the developing world differs from past experiences. *Public Health Nutrition*, 5:205-214.
- Ruel, M.T. 2003. Operationalizing dietary diversity: a review of measurement issues and research priorities. *Journal of Nutrition*, 133:S3911-S3926.
- South Africa Demographic and Health Survey. 2016. [Online] Available from: <http://www.hst.org.za/publications/Pages/HSTSouthAfricanHealthReview.aspx> [Accessed: 14 May 2020].
- Spires, M., Delobelle, P., Sanders, D., Puoane, T & Swart, P. R. 2016. *Diet related non-communicable diseases in South Africa: determinants and responses*. In *South African health review*.
- South Africa MDG Country Report. 2015. [Online] Available from: [http://www.statssa.gov.za/MDG/MDG\\_Country%20Report\\_Final30Sep2015.pdf](http://www.statssa.gov.za/MDG/MDG_Country%20Report_Final30Sep2015.pdf) [Accessed: June 2020].
- Temple, J. B. 2006. Household factors associated with older Australians purchasing a varied diet: results from household expenditure data. *Nutrition and Dietetics*, 63:28-35.
- Todd, J. E., Mancino, L. & Lin, B. H. 2010. The impact of food away from home on adult diet quality, *Economic Research Report*. ERR-90. United States Department of Agriculture.
- UNICEF. 1990. Strategy for improved nutrition of children and women in developing countries. New York. UNICEF. [Online] Available from: [http://www.ceecis.org/iodine/01\\_global/01\\_pl/01\\_01\\_other\\_1992\\_unicef.pdf](http://www.ceecis.org/iodine/01_global/01_pl/01_01_other_1992_unicef.pdf) [Accessed: June 2020].
- United Nations Children's Fund. 2013. Improving child nutrition. *The achievable imperative for global progress*. Chapter 4. Interventions to address stunting and other forms of undernutrition. – not sure what kind of source this is?
- Vorster, E. H. & Bourne, L. 2016. The nutrition transition in developing countries. Edited by Temple N.Y & Steyn, N. *Community nutrition for developing countries*. Athabasca University. UNISA PRESS. <https://doi.org/10.15215/aupress/9781927356111.01> [Accessed: July 2020]
- Wiggins S and Keats S. 2014. Future diets: under- and over-nutrition in developing countries. *Common Wealth Partnership*.
- World Health Organization. 2010. *A Conceptual framework for action on the social determinants of health. Social determinants of health Discussion paper 2*. Geneva, Switzerland. ISBN 978 92 4 150085 2

# PUBLIC HEALTH SERVICES DELIVERED THROUGH THE MOBILE PHONE IN THE GREATER ACCRA REGION OF GHANA- A QUALITATIVE STUDY

Alex Hammond, University of Ghana, ebohamm2@yahoo.com

Patience Aseweh Abor, University of Ghana Business School, pabor@ug.edu.gh

## Abstract

*The World Health Organization (WHO) identifies technological applications as one of the pillars of the health system to ensure access and quality of health services for which the universal mobile telephony is identified as a potential healthcare tool due to its high adoption and use by people, including health providers.*

*This study explored public health services that are delivered through the mobile phone (mHealth) in the Greater Accra Region (GAR) of Ghana.*

*The qualitative data collected were transcribed and inductively coded based on thematic analysis using the NVIVO (Version 11) software package.*

*The major findings of the research showed a high technological capacity and digital literacy among healthcare providers who use the mobile phone to deliver aspects of healthcare for the management of public health services. The practice of mHealth by healthcare providers was prevalent but found to be largely informal. The key mHealth services were found in the areas of data collection, digital learning, health emergencies, management and logistics, disease and death surveillance, and laboratory services.*

*Even though positive conditions exist for the uptake of mHealth with the wide adoption of mobile phones among healthcare providers, health policymakers are yet to leverage this opportunity due to its informal nature. It is therefore recommended that mobile phone technology be leveraged to enhance the provision of public health services by healthcare providers.*

**Key Words:** mobile health, mHealth, disease surveillance, public health, cholera, Ghana

## INTRODUCTION

According to the World Health Organization (WHO), there are six health system building blocks for ensuring improved access and coverage of health services. One of these six blocks is the adoption and application of medical technologies for the health sector (WHO, 2010), with the capacity to transform global health systems for the improvement of healthcare delivery (Brinkel, Kramer, Krumkamp, May & Fobil, 2014). Information and Communications Technologies (ICT) have witnessed significant growth over the past decade, leading to socio-economic development that serves as the foundation for the development of electronic health (eHealth) (ITU, 2015). Five billion people are connected to mobile services (2017) and about six billion unique mobile subscribers worldwide are predicted in 2025 (GSM Association, 2019).

This study limits mobile technology to only mobile or cell phones due to its ubiquity, universality, and successful application in other sectors such as finance and banking (ITU, 2015). One of the fastest-growing offshoots of electronic health (eHealth) is mobile health (mHealth) which is the application of mobile and wireless technologies to deliver medical or public health services remotely (Currie & Seddon, 2014; Martin, 2012) of which the mobile phone is a key device. The mobile phone is challenging the way traditional healthcare is delivered (Currie & Seddon, 2014; Gleason, 2015). Mobile phones have been used to deliver various aspects of health services while mHealth is on the ascendancy and being implemented by many countries (WHO, 2009).

The adoption of mhealth in Africa is experiencing a moderate increase similar to other developing countries in the world (African Strategies for Health, 2016; Etzo & Collender, 2010) and is becoming an indispensable health device (Gleason, 2015). Mobile health has the potential to bring life-saving information to the remotest and resource-challenged locations in developing countries while it is useful as an access point for national surveillance systems (Brinkel *et al.*, 2014:1).

The mobile phone consists of two distinct parts; the hardware and software functions. The hardware comprises all the tangible parts while the software includes all the programmes and applications that help to operate the phone. The technology has evolved over three generations comprising a feature phone (first-generation), multimedia phone (second-generation), and smartphone (third-generation) (Mohadis & Ali, 2014). Its evolution is phased into the feature and digital (smart) technology, with the latter offering superior features such as higher speed, smaller size, and lighter weight, among others (Babar, Pervez & Muhammad, 2016).

The Ghana Health Service (GHS) is primarily responsible for the planning and organizing of public health services which is administratively organized at three levels, namely the national, regional, and district levels, while functionally, it is organized into five levels consisting of the national, regional, district, sub-district and community levels (Ghana Health Service, 2017). Actual delivery of public health services commences at the district level as the primary healthcare cadres interact with communities to deliver and promote health sometimes directly or through the sub-districts and Community Health and Planning Services (CHPS) zones or compounds which are the lowest level of public health operations and in collaboration with other relevant agencies and civic societies (Ghana Health Service, 2017).

Evidence has been adduced that mobile phones may be an appropriate tool for disease control interventions in developing countries (Adokiya & Awoonor-Williams, 2016; Déglise, Suggs, & Odermatt, 2012a). It was useful for cholera reporting and outbreak control (Ngwa *et al.*, 2016; Safaie, Mousavi, LaPorte, Goya & Zahraie, 2006), rapid reporting of infectious diseases during earthquakes (Yang, Yang, Luo & Gong, 2009), and mobile phone-based data collection (Mwabukusi, Karimuribo, Rweyemamu & Beda, 2014), among others. Safaie *et al.* (2006:631) specifically recommend its use for communicable disease surveillance, serving as a substitute for the traditional models of surveillance. In Ghana, some studies have been conducted on infectious disease surveillance (Adokiya, Awoonor-Williams, Beiersmann & Muller, 2015) which would be important to public health, for example, coverage of diseases such as febrile illness (Jephcott, Wood & Cunningham, 2017), Ebola virus (Adokiya & Awoonor-Williams, 2016), and lymphatic filariasis (Vroom, 2017), among others. However, the application of mobile phones in these studies was limited except for the research conducted by Vroom (2017) which specifically studied the role of mobile phones in disease surveillance of lymphatic filariasis in the Western region of Ghana. This current study, therefore, focused on exploring the role the mobile phone played in the delivery of public health services for the effective management of infectious diseases in the Greater Accra Region (GAR) region of Ghana using cholera as the default communicable disease. Essential to enhanced mHealth, the study also assessed the level of adoption of mobile phone technology by healthcare providers.

Cholera in Ghana is largely an urban problem, affecting the urban poor who mostly live in peri-urban areas with poor social amenities such as water, sanitation, and others (Ofori-Adjei & Koram, 2014). Cholera ranked second in the risk of contracting diseases of public health emergencies (Ghana Health Service, 2017). Cholera is prevalent in the GAR and accounts for about 29% of the total suspected cases from 2012 to 2016. Public health management of infectious diseases such as cholera and others in Ghana is traditionally conducted through physical outreach programmes offered to the communities and routine paper-based disease surveillance as part of general communicable disease management (Ghana Health Service, 2017:36) with little empirical reporting of the use of mobile phones in their management and prevention. It was this scenario that motivated the study in the selected region.

## METHODOLOGY

The research was set in an interpretivist-social constructionist worldview with a qualitative approach. This approach explored the meanings and lived experiences to obtain deeper insights from the participants regarding the said phenomenon. It adopted an interpretive phenomenological design, which helped to provide rich descriptions of lived experiences and meanings on the phenomenon in the context within which it took place (Giorgi & Giorgi, 2003). A purposive sampling technique facilitated the identification of the participants who were most appropriate to provide in-depth views and insights regarding the phenomenon.

The study strengthened its theoretical rigour by employing the theory of the Technology Acceptance Model (TAM) (Davis, 1989) to underpin it. The TAM is an information systems theory and focuses on predicting technology adoption from a personal or organizational viewpoint and how a technological innovation enhances productivity (Bianchi & de Figueiredo, 2017). Adoption and the use of technology such as a mobile phone are pre-requisites for viable mobile health for public health services as low adoption may also jeopardize its impact as a communication tool (Safaie *et al.*, 2006:631).

The research was placed within the public health care sector of the GAR of Ghana; and collected the perspectives of healthcare providers regarding the use of a mobile phone to deliver public health services for the prevention and management of infectious diseases, with a particular focus on cholera. Three administrative enclaves (Metropolis, Municipality, and District) were selected for data collection. The study collected data through a semi-structured in-depth interview (IDI) guide. The key technique for the IDI was based on an initial question, probes, and follow-up questions (Rubin & Rubin, 2005). Field notes were also taken during all IDIs which captured salient points and themes mentioned by the participants.

The target population comprised doctors, nurses, pharmacists, administrators, public health officers, community health workers, and policymakers, among others, who worked at various levels of the Ghanaian public health system in the GAR. In addition to these core groups, other participants who did not fall within this service delivery structure but whose specialist knowledge was critical to enriching the data required were purposively or through the snowball technique identified for interview. This specialist group has been described by researchers as 'wildcards'. A total of forty (40) participants were purposively selected and interviewed. Three districts were purposively selected using reported incidents of cholera as a default public health threat, namely Accra Metro, Ga West, and Ada East. Figure 1 presents the selected sites.

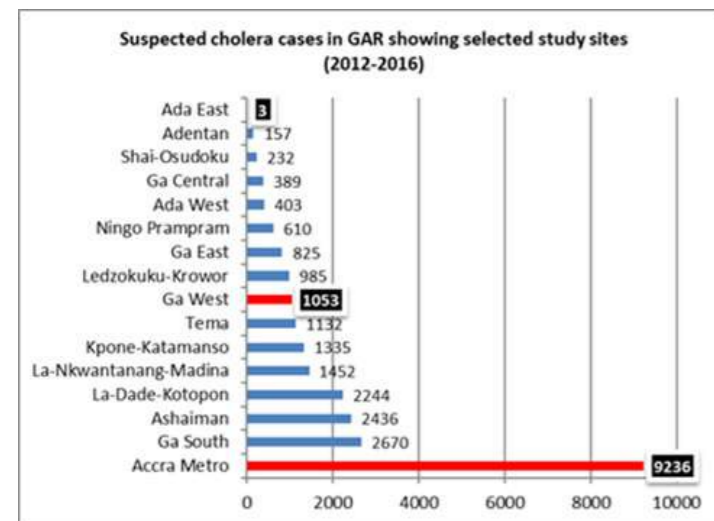


Figure 1: Suspected cholera cases in the selected study sites of GAR

Source: Centre for Health Information Management, Ghana Health Service (CHIM, GHS-2017). Graphical presentation by the researchers.

Fieldwork involved the pretesting of the instruments to help refine them for effective data collection in the Ga South District (with similar characteristics of the three selected sites) of the GAR to support instrumentation rigour and to limit bias, among others. Actual fieldwork interviews were conducted between July 2017 and April 2018. The duration of the interviews ranged from 20 to 55 minutes based on the respondent's depth of knowledge, experience(s), and time constraints. All the interviews were conducted in English. A consent form was administered to all the interviewees for their express consent before their interview; they were assured of anonymity and confidentiality. The use of participant quotations was held anonymously with codes and generic professions. The University of Ghana Ethical Review Board for Humanities granted ethical approval for this study. Raw voice data collected from IDIs were transcribed verbatim for inductive coding with the aid of the NVIVO 11 software to determine emerging themes (Creswell, 2014; Rubin & Rubin, 2005). Data analysis was based on Attride-Stirling's Thematic Network Analysis (2001).

## RESULTS AND DISCUSSION OF BIODATA AND DIGITAL CAPABILITIES ASSESSMENT

### Biodata of the Respondents

The background characteristics of the participants comprised age, gender, academic qualifications, marital status, and religion. The other biodata included ethnicity, profession, mobile phone ownership, and type of device. Refer to the appendix for a summary of all the characteristics. The study however provides a synopsis of the results of the assessment of the digital literacy and capabilities of the respondents linked to the research objectives.

### Assessment of Technological Capabilities and Level of Digital Literacy

The assessment was based on initially determining the ownership and type of mobile phone (smart or feature) held by the respondents and then their ability to perform the various functions of the phone which revealed their digital literacy level and technological capabilities.

Table 1: Ownership and type of phone held by the respondents

Phone Ownership	No.	Phone Type	No.
Yes	40	Smart	38
No	0	Analogue	2
Total	40	Total	40

Source: Researchers' Fieldwork (2018)

Table 2: Technological capabilities and level of digital literacy scores of the respondents

No.	CAPABILITIES	TECHNOLOGICAL LEVEL OF DIGITAL LITERACY	LEVEL OF DIGITAL LITERACY		(% SCORE FOR TECHNOLOGICAL CAPACITY)
			YES	NO	
1	Ability to make a call		40	0	100
2	Ability to receive a call		40	0	100
3	Ability to text a message	PRIMARY	39	1	97.5
4	Ability to receive/retrieve a text message		40	0	100
5	Ability to use any mobile application such as social media	SECONDARY	39	1	97.5
6	Operating of social media account such as Twitter, Facebook, etc.		38	2	95
7	Awareness of other uses of the Internet on mobile phone aside from social media	TERTIARY	38	2	95
8	Ability to conduct searches on mobile phone		38	2	95
9	% AVERAGE TOTAL SCORE				97.5

Source: Researchers' fieldwork (2018)

All the respondents owned a mobile phone (100% (n=40/40)) of which 95% (n=38/40) were smartphones. The respondents were assessed on eight (8) technological capability variables with Yes or No response items. The level of digital capabilities and literacy was measured at primary, secondary, and tertiary levels (refer to Table 2). A high digital capability and literacy level was recorded among the healthcare providers who were interviewed, irrespective of their qualifications, ethnicity, gender, and age. However, a few were found to be limited in their ability to perform the secondary and tertiary level technological functions relating to social media and Internet browsing. All the healthcare providers could, however, perform the primary functions, except for one (n=1/40). In effect, healthcare providers scored an appreciably high percentage average (97.5%) for all levels of digital literacy.

The study, therefore, shows a high level of mobile phone adoption by healthcare providers determined by the level of mobile phone ownership and ability to use the various features, which is generally consistent with the empirical literature and a good prerequisite for leveraging mobile health for the delivery of public health services (Senyo, 2015; Vroom, 2017). Drawing from the work of Prensky (2001), healthcare providers can be described as digital natives due to the high digital literacy reported in the study and are therefore native speakers of the digital language which has positive implications for the effective delivery of mobile phone-based public health services.

## RESULTS AND DISCUSSION OF THE IN-DEPTH INTERVIEWS

### Mobile Data Collection

Some of the respondents indicated that the mobile phone was used to collect various data on public health activities and to report on them. Healthcare providers adopted the use of mobile phones to collect and report on health threats which were normally identified by health staff in the field or when reporting to primary healthcare clinics that offered public health services. Supervisors also demanded the submission of routine public health reports and activities from the health staff at lower-level health facilities through the mobile phone. Some of these reports had digital formats to help ease the burden of manual data entry and submission. Supervisors reported that mobile phones facilitated quick reporting, especially during emergencies, which reduced the staff workload due to too much paperwork, while the phones help to reduce errors and bridge the geographic gap, among others. Managers also provided feedback through the same medium.

Interviewee ID	Citation
Public Health Doctor, 43 years, C2	Mobile phones are used in reporting cases. One of the fastest ways of reporting especially for rare conditions which are suspected...that's one of the most common ways of reporting these days.

Data collection and reporting, analysis, and feedback for various health activities and diseases utilizing a mobile phone have been reported by the literature and noted to have facilitated disease surveillance (Adokiya & Awoonor-Williams, 2016; Ngwa *et al.*, 2016). This study echoes these findings as participants indicated the use of the mobile phone for the data collection of public health threats when identified in the field of primary healthcare clinics. The departing line was that the study revealed that healthcare providers mostly undertook such data collection as part of their routine work rather than as part of a formal mHealth project. Adokiya and Awoonor (2016) and Safaie *et al.* (2006) recommend that the use of mobile phones for disease surveillance was an innovation that should be explored by healthcare managers for which the study reiterates this call.

### m-Library and m-Learning (Digital Learning)

Mobile phones were used to access electronic library resources on health issues, particularly by outreach workers who needed to reference health protocols, disease diagnoses and treatment, and other health databases to aid their fieldwork. Some respondents had pre-installed electronic libraries or had access to health-related information via the Internet to allow them to make quick references for effective diagnoses, treatment, and health promotion when in the field. These mobile (m) resources comprised mobile (m) books, audio recordings, websites, pictures, and videos on health issues:

Interviewee ID	Citation
Community Health Volunteer, 26 years, C10B	We have captured everything on our mobile phones so sometimes it helps us to educate
Community Health Officer, 33 years, C9	There is no need for us to carry a lot of research books along 'cos we can get a lot of things from our phones

Concerning mLearning, some respondents at the peripheral health facilities indicated that they were provided with specialized courses and materials which they could access while in the field. This enabled them to study and prepare to participate in snap quizzes and tests for their continuous professional development programmes for promotion or personal knowledge development. Digital learning did not only provides information on disease management but also personal health such as diet, religion, social information on conflict management, and exercising, among others. Managers explained that digital learning tools were designed to help healthcare providers to overcome boredom in deprived areas.

Interviewee ID	Citation
Innovation Specialist, 38 years B2A	we built special courses to basically improve on their knowledge in certain aspect of health care delivery... they could take a quiz and if they passed, they got credit that actually counted toward their progress (career)

Senyo (2015) reports the use of medical applications (apps) on disease diagnosis for clinical decision-making by junior doctors in the GAR while Leon, Schneider, and Daviaud (2012) report the administration of health quizzes via mobile phones for healthcare providers for continuing professional development (CPD) purposes. Thus, such rural healthcare workers may not be disadvantaged owing to their location while junior doctors can also sharpen their diagnostic knowledge wherever they may be located. Policymakers may need to explore these opportunities further to leverage the power of the mobile device for enhanced remote services, as posited by Brinkel *et al.* (2014). This study supports extant literature as the respondents reported the use of mobile phones for digital learning and information. However, it was also found that the mobile phone was used for para-religious, social, and physical education for rural healthcare providers aimed at preventing boredom and helping to keep them at a post in such isolated rural locations. The CPD opportunities for such healthcare staff should be explored by healthcare managers as a form of human resources development and staff motivation, which have implications for attracting healthcare staff to rural locations to reduce the equitable distribution of human resources in resource-challenged settings in the country.

### Health Emergencies

One of the key health emergencies reported by the respondents was the use of the mobile phone in public health emergencies, the management of referrals during emergencies, and for interactions of the healthcare providers with the affected public through health care hotlines. Much of the public health services delivered through the mobile phone consisted of the provision of health information to the affected community as well as the general population. The information empowered communities to take preventative measures, facilities to seek health assistance, and basic home management of public health threats. Healthcare providers also shared health data and information on the source, the spread of an epidemic, and the mobilization of human resources for health and logistics.

Interviewee ID	Citation
ICT Specialist, 47 years, B7	Wash your food with soap under running water and keep the food warm before you eat it...
Policy Specialist, No Age, B3	Where now with the power of the software, you can have alerts on your mobile phone, thresholds, alert levels, and everything... in real time.

The communication platforms used for managing public health emergencies were SMS, WhatsApp, and Voice as and when appropriate.

Interviewee ID	Citation
Nurse Educator, 35 years, C10B	We send SMS to alert them.
Public Health Specialist, No Age, C1	Yes, even getting it on WhatsApp...in text form
Health Service Administrator, 42 years, C7A	Voice calls are used for emergencies and important but semi-urgent issues are also discussed on various platforms [WhatsApp].

Concerning the effective management of patient referrals to avoid the unnecessary transfer of patients, healthcare providers typically used mobile phones as communication platforms such as voice calls and social media (WhatsApp) to communicate among themselves to manage emergency referrals.

Interviewee ID	Citation
Public Health Specialist, 57 years, B8	If you are referring a patient to a facility, you call and ask if the doctor is around and it's making things very easy.
Telemedicine Specialist, 43 years, D1B	they are using WhatsApp to actually address any unnecessary referrals.

This helped enhance the quality of care, preventing unnecessary deaths, effective management of hospital bed-states, and the reduction of a 'merry-go-round' with patients seeking a hospital when necessary.

Interviewee ID	Citation
Policy Specialist, 57 years, B4	most of the best referrals are those that are communicated as they are referring, otherwise, people are crisscrossing by the time they finish, the patient is dead, so again that is another enhanced form of using mobile phone...

Similar to previous studies (Adokiya & Awoonor-Williams, 2016; Safaie *et al.*, 2006; Yang *et al.*, 2009), the mobile phone was used for monitoring and managing health emergencies as well as reporting a threat of infectious diseases. As reported, the key use of mobile phones during the emergency management of infectious diseases occurred in the management of referrals during such emergencies and interactions of the healthcare providers with the affected public through health hotlines. The use of the mobile phone to manage referrals, using the WhatsApp mobile application, is a unique finding of the study. This mobile communication platform can be further leveraged by healthcare managers as the majority of healthcare workers interviewed had a smartphone (n=40/40), operated a social media account (n=38/40), and could also browse the Internet (n=38/40).

#### Management and Logistics

The mobile phone was used to support general administration, planning, management, and support services such as health logistics. Supervisors, particularly at the lower level, used the mobile phone to conduct remote monitoring, coordination, and supervision of staff activities, assignment of schedules, and the logistics of the delivery of health activities. Healthcare providers were given pre-installed applications on their phones to facilitate some of the activities:

Interviewee ID	Citation
Innovation Specialist, 38 years B2A	We were able to design a mobile application specifically for this...a work planning component that allows the nurses to basically schedule the work

Sharing their experiences on how mobile phones helped Healthcare Providers to schedule and plan their activities such as work schedule, community visitations, public education, vaccination, and others, some respondents at the sub-district level stated:

Interviewee ID	Citation
Community Health Volunteer, 30 years, C10C	we call them (clients) to tell them maybe today or tomorrow we will be coming around this time...
Community Health Officer, C9	Sometimes if they want to know wherever we are or if they need any information, they just use their phones to call us. They don't worry themselves to travel all the way to this place.

Monitoring and supervision on the mobile phone helped to expedite the dissemination of information, track the health staff, ensure productivity and green administration, and to address early warnings, among others.

Interviewee ID	Citation
Innovation Specialist, 38 years B2A)	Their supervisors were able to see the work they were doing and not necessarily having to come to the field to see it...they have the ability to track how well the nurses were doing.
Community Health Officer, C9	Our superiors were monitoring our activities... every month, they will ask us to put our itineraries on the phone.

In managing logistics with the mobile phone, the managers tracked stock levels at the peripheral facilities, managed the staff reporting on stock levels, monitored pharmaceutical drug availability for cholera outbreaks, and coordinated the distribution logistics, especially to places where emergency cholera drugs were reported to be out of stock.

Interviewee ID	Citation
Health Information Technology Specialist, 40 years, B9	... you can use the simple SMS messaging where your facilities can report on the stock level by just texting the number and then you have an aggregator that would aggregate and tell you what is there
Public Health Doctor, 52 years, D9	It's being used also for logistics management to inform managers about stock level at the various peripheral levels... sitting in his office the manager can know the remote places where the stocks are in various places

This study found a unique use of the mobile phone to support the general administration, planning, management, and support services such as health logistics aimed at effective delivery of public health services. The findings confirm the use of three key communication platforms. Healthcare providers used these platforms to communicate among themselves and with clients. Even though the SMS was a default platform for communication (Gleason, 2015), the study found that social media, particularly the use of WhatsApp, was even more prevalent among healthcare providers. The reason for this finding could be that most of the studies had been undertaken much earlier when social media apps had not yet been developed or become prevalent and the development of smartphones and their high adoption by healthcare providers as evidenced in the digital literacy assessment results had not yet been witnessed. This is consistent with the key findings of mHealth studies conducted in Ghana which reveal a high acceptance and willingness to use the mobile phone for health activities (see Senyo, 2015; Vroom, 2017).

#### Disease Surveillance

The mobile phone was used for disease surveillance of case detection, reporting, and tracking. After detection, cases were captured on the phone using video or WhatsApp and reported synchronously (in real-time) or asynchronously (stored and forwarded later). The healthcare providers also placed voice calls while in the field or showed pictures and videos to supervisors to report their findings.

Interviewee ID	Citation
Health Information Technology Specialist, 40 years, B9	...you can send alert messages through your mobile phone
Community Health Volunteer, 30 years, C10C	I do call and then sometimes make video call...you normally take pictures and then we send...so that they can see what exactly we are trying to talk about

The literature reports that Community Health Workers (CHW) report on health threats via text messages or special phone protocols (Adokiya & Awoonor-Williams, 2016; Vroom, 2017). However, this study further reveals the high level of adoption of the smartphone and the emerging use of social media in the mHealth domain, which health policymakers may explore for the design and development of mHealth.

#### Laboratory Services

Cases were normally confirmed by the laboratory. Laboratory case confirmations were sometimes sent through the mobile phone to the healthcare providers to take necessary action or sent them directly to the patient. Healthcare providers also sent information to the laboratory regarding samples in transit for testing and the release of results of cases from the laboratory through the mobile phone via text, voice call, or any appropriate mobile platform. The advantage was that the healthcare providers were able to take proactive measures ahead of receiving the hardcopy paper confirmations.

Interviewee ID	Citation
Disease Control Officer, 35 years, C6B	...was this case positive or negative so he will tell you it is negative before it even goes through national to region before it gets to you so you will get the information earlier than the normal routine through the text
Public Health Specialist, 57 years, B8	A test is done; the results can be sent to the patient via mobile phone. This is very important because it cuts cost

This mLaboratory service was a unique finding of the study in Ghana. The literature on mLaboratory services is scarce besides the work of Safaie *et al.* (2006) which studied the use of the mobile phone to report on cholera in Iran but was virtually non-



existent in the mHealth empirical space of Ghana. This is an area for further exploration by the health sector of Ghana to ensure effective laboratory services during disease outbreaks. The study should however be well-structured to prevent privacy and confidentiality concerns.

#### Death Surveillance

The mobile phone was also used for *Verbal Autopsy* or *Death Surveillance* where deaths occurring in the communities from epidemics and others were reported through mobile phones using special applications installed on the phones. Community health workers would describe the symptoms before the deaths to help ascertain the causes of deaths in the community.

Interviewee ID	Citation
Public Health Doctor, 52 years, D9	Volunteers in the community can alert on suspected cases...using mobile devices; I mean death in communities ...there is an application what we call the verbal autopsy application that we put on the phone and then the CHO will administer the verbal autopsy on the phone...so we can analyze the community deaths...

This is a unique finding of the study which policymakers could further develop to help overcome the challenges of inadequate coverage of deaths and the causes thereof in the communities, especially in rural settings. This would help in effective health policymaking and planning.

#### IMPLICATION

This study contributes to empirical knowledge by providing original in-depth views on the use of the mobile phone to deliver public health services, thus helping to extend knowledge regarding mHealth, particularly in a developing country such as Ghana as espoused by Phillips and Pugh (2010). It adds to the methodological rigour in the development of a uniquely-designed technological capability and digital literacy assessment tool which would help assess the technological abilities of respondents to inform the healthcare providers of their readiness for the provision of mHealth services. It extends the theoretical resilience of the TAM as a model that helps to explain the adoption and use of technology.

#### CONCLUSIONS

The central phenomenon of this study was to explore the viability of using the mobile phone for the delivery of public health services in the GAR. The study revealed a high level of adoption of mobile phone technology among healthcare providers and the prevalence of using it to deliver various public health services in the GAR of Ghana, albeit at an informal level and unstructured form.

The key limitation of the study was that it focused on only the provider-side (supply-side) of mobile health to the exclusion of the client-side (demand-side). The findings, just like all qualitative studies, are not intended for generalization but instead, to provide in-depth empirical insight into the phenomenon based on the rich description of the lived experiences of healthcare providers. Even though the sample size was extensive, it involved only the participants selected at three sites in one of the sixteen regions of Ghana.

Future research may look at the demand-side or comparative studies (supply-side versus demand-side) to help match both sides for a holistic perspective on the phenomenon.

The implication of this study is that policymakers must take advantage of the opportunities presented with the high prevalence and adoption of mobile phones among healthcare providers to leverage its use for effective and enhanced provision of public health services in the GAR of Ghana.

#### LIST OF REFERENCES

- Adokiya, M. N., Awoonor-Williams, J., Beiersmann, C. & Muller, O. 2015. The integrated disease surveillance and response system in northern Ghana: challenges to the core and support functions. *BMC Health Services Research*, 15(288). <https://doi.org/10.1186/s12913-015-0960-7>.
- Adokiya, M. & Awoonor-Williams, J. K. 2016. Ebola virus disease surveillance and response preparedness in northern Ghana. *Global Health Action*, 9(10):1-10.
- African Strategies for Health. 2016. *mHealth Compendium: Special Edition 2016- Reaching Scale*. Arlington, VA: United States Agency for International Development.
- Attride-Stirling, J. 2001. Thematic networks: an analytic tool for qualitative research. *Qualitative Research*, 1(3):385-405.
- Babar, F., Pervez, S. & Muhammad, U. 2016. Compromising health by excessive use of smart phones. *International Journal of Engineering Works*, 3(10):78-82.
- Bianchi, C. G. & de Figueiredo, J. C. 2017. Characteristics of Brazilian scientific research on diffusion of innovations in business administration. In: F. Borini, Ed. *Innovation and management review*, 14 (2017) 311–320, Sao Paulo, Elsevier Editora Ltd. <http://dx.doi.org/10.1016/j.rai.2017.07.004>
- Brinkel, J., Kramer, A., Krumkamp, R., May, J. & Fobil, J. 2014. Mobile phone-based mHealth approaches for public health surveillance in sub-Saharan Africa: a systematic review. *International Journal of Research and Public Health*, 11:11559-11582.
- Creswell, J. W. 2014. *Research design: qualitative, quantitative and mixed methods approaches* (4th ed.). Los Angeles: Sage.
- Currie, W. & Seddon, J. 2014. Social innovation in public health: can mobile technology make a difference? *Special Issue: Social Innovation in the Public Sector*, 31(3):187-199.
- Davis, F. 1989. Perceived usefulness, perceived ease of use, and user acceptance of information technology. *MIS Quarterly*, 13(3):319-340.
- Déglise, C., Suggs, L. & Odermatt, P. 2012a. Short message service (SMS) applications for disease prevention in developing countries. *Journal of Medical Internet Research*, 14(1:e3):doi: 10.2196/jmir.1823.
- Etzo, S. & Collender, G. (2010). Briefing: the mobile phone revolution in Africa: rhetoric or reality? *Oxford Journal: African Affairs*, 109(437):659-668.
- Ghana Health Service. (2017). *2016 Annual Report*. Ghana Health Service. Accra: Ghana Health Service.
- Giorgi, A. & Giorgi, B. 2003. Phenomenology qualitative psychology. In: J. A. Smith (Ed.), *Qualitative Psychology* (pp. 25–50). London: Sage.
- Gleason, A. 2015. mHealth: opportunities for transforming global health care and barriers to adoption. *Journal of Electronic Resources in Medical Libraries*, 12(2):114–125.
- GSM Association. 2019. *Representing the worldwide mobile communications industry*. [Online]. Retrieved from: <https://www.gsma.com/> [Accessed 22 February, 2019].
- ITU. 2015. *ITU releases 2015 ICT figures, statistics confirm ICT revolution of the past 15 years*. [Online]. Retrieved from: ITU: [http://www.itu.int/net/pressoffice/press\\_releases/2015/17.aspx#.VWSlZJPmPYg](http://www.itu.int/net/pressoffice/press_releases/2015/17.aspx#.VWSlZJPmPYg) [Accessed: 26 May 2015].

Jephcott, F. L., Wood, J. N. & Cunningham, A. A. 2017. Facility based surveillance for emerging infectious diseases; diagnostic practices in rural West African settings: Observations from Ghana. (1725, Ed.) *Philosophical Transactions of the Royal Society of London. Series B Biological Sciences*, doi: 10.1098/rstb.2016.0544.

Leon, N., Schneider, H., & Daviaud, E. 2012. Applying a framework for assessing the health system challenges to scaling up mHealth in South Africa. *BMC Medical Informatics & Decision Making*, 12(1):123-134.

Martin, T. 2012. Assessing mHealth: opportunities and barriers to patient engagement. *Journal of Health Care for the Poor and Underserved*, 23(3):935-941.

Mohadis, H. M. & Ali, N. M. 2014. A study of smartphone usage and barriers among the elderly. *2014 3rd i-USEr* (pp. 109-114). Bangi, Malaysia: International Conference on User Science and Engineering (i-USER).

Mwabukusi, M., Karimuribo, E. D., Rweyemamu, M. M. & Beda, E. 2014. Mobile technologies for disease surveillance in humans and animals. *Onderstepoort Journal of Veterinary Research*, 81(2):737-742.

Ngwa, M. C., Liang, S., Mbam, L. M., Mouhaman, A., Teboh, A., Brekmo, K., ... Morris, J. G. 2016. Cholera public health surveillance in the Republic of Cameroon: opportunities and challenges. *Pan African Medical Journal*, 22(222), doi: 10.11604/pamj.2016.24.222.8045.

Ofori-Adjei, D. & Koram, K. 2014. Of cholera and ebola virus disease in Ghana. *Ghana Medical Journal*, 48(3):120.

Phillips, E. M. & Pugh, D. S. 2010. *How to get a PhD: a handbook for students and their supervisors (5th ed.)*. Berkshire, United Kingdom: Open University Press/McGraw-Hill International.

Prensky, M. 2001. Digital natives digital immigrants. *On the Horizon*, 9(5):1-6.

Rubin, H. J. & Rubin, I. S. 2005. *Qualitative interviewing: the art of hearing data*. 2nd ed. London, New York: Sage.

Safaie, A., Mousavi, S. M., LaPorte, R. E., Goya, M. M. & Zahraie, M. 2006. Introducing a model for communicable diseases surveillance: cell phone surveillance (CPS). *European Journal of Epidemiology*, 21(8):627-632.

Senyo, K. Y. (2015). Use of smart phone applications for clinical decision making among junior medical practitioners in selected health facilities in the greater Accra region, Ghana. Masters Thesis. Accra, Ghana: University of Ghana.

Vroom, F. B.-C. 2017. Feasibility of mobile health for treatment coverage reporting: lymphatic filariasis control programme in Ghana. Legon, Greater Accra, Ghana: University of Ghana.

World Health Organisation (WHO). 2009. *Telemedicine: opportunities and developments in member states: report on the second global survey on eHealth 2009*. [Online]. Retrieved from: [http://www.who.int/goe/publications/goe\\_telemedicine\\_2010.pdf](http://www.who.int/goe/publications/goe_telemedicine_2010.pdf) [Accessed: 20 March 2015].

World Health Organisation (WHO). 2010. *Monitoring the building blocks of a health system: a handbook of indicators and their measurement strategies*. [Online]. Retrieved from: [https://www.who.int/healthinfo/systems/WHO\\_MBHSS\\_2010\\_full\\_web.pdf](https://www.who.int/healthinfo/systems/WHO_MBHSS_2010_full_web.pdf) [Accessed: 23, February 2019].

Yang, C., Yang, J., Luo, X. & Gong, P. 2009. Use of mobile phones in an emergency reporting system for infectious disease surveillance after the Sichuan earthquake in China. *Bulletin of the World Health Organization*, 1-6.

## APPENDIX

The summary of the characteristics is captured in Table 1 below:

**Table 1: Background characteristics of respondents' biodata**

Characteristics			
Age	No.	Work Experience	No.
20-29	4	Up-to 5 years	5
30-39	11	6-10 years	2
40-49	9	More than 10 years	33
50-59	13		
60+	1		
Gender	No.	Religion	No.
Male	29	Christianity	40
Female	11	Islam	0
		Traditional	0
		Other	0
Ethnicity	No.	Marital Status	No.
Akan	21	Married	29
Ga Dangme	11	Single	11
Ewe	7		
Guan	1		
Education	No.		
Postgraduate (PhD)			2
Postgraduate (Masters)			21
Bachelor's Degree			10
Diploma			1
Post-Secondary			1
Secondary/SSS			3
Middle School			1

## Assessment of Technological Capacity and Level of Digital Literacy

**Table 2: Respondent phone ownership and type**

Phone Ownership	No.	Phone Type	No.
Yes	40	Smart	38
No	0	Analogue	2
Total	40	Total	40

Source: Researchers' Fieldwork (2018)

# PROMOTION OF INDIGENOUS FOODS CONSUMPTION FOR NON-COMMUNICABLE DISEASES MANAGEMENT: A CHALLENGE FOR SOUTH AFRICA IN THE 4TH INDUSTRIAL REVOLUTION CONTEXT

Alex K. Tchuenchieu<sup>1,2</sup> and Hema Kesa<sup>1</sup>

<sup>1</sup>Food Evolution Research Laboratory, School of Tourism and Hospitality, University of Johannesburg, South Africa

<sup>2</sup>Centre for Food and Nutrition Research, Institute of Medical Research and Medicinal Plants Studies, Cameroon  
kamgaina@uj.ac.za; hemak@uj.ac.za

## Abstract

South Africa is known as one of the countries leading the 4<sup>th</sup> Industrial Revolution and where a 'western' diet is quite usual. Unfortunately, the country is also one of those most affected by non-communicable diseases, mainly diabetes, cancer, cardiovascular diseases and chronic respiratory diseases. These diseases contributed to about 51% of the country's total deaths in 2016. The consumption of indigenous foods is generally recommended for prevention and control due to their nutritional and health properties. This pilot-study aimed to assess the awareness of the population of the healthy values of South African indigenous foods and the current consumption levels. The pilot-study firstly focused on the black population of the Gauteng province, which is the most populated and highly urbanised province of the country. A quantitative survey was carried out with 235 participants, aged 18 years old and above, who had been living in the province for at least two years. Information on the knowledge and consumption of different indigenous foods, as well as their medicinal uses (especially for non-communicable diseases) was collected. The results showed that the overall variety of indigenous food crops that is known and consumed is dominated by sorghum, pearl millet, cowpeas, amadumbe and marula. At least 25% of the population know and consume these food crops. Their consumption for medicinal reasons appeared to be very low (averaging at 2.89%), with sorghum being the most consumed food crop for that purpose (3.4%), especially for treating diabetes. Age, gender, educational level, income and living area – dominated by urban and peri-urban areas – had no significant impact on consumption or knowledge of indigenous foods. However, those living in homes with people suffering with non-communicable diseases knew significantly more about it. There is, therefore, a huge need to take advantage of 4<sup>th</sup> Industrial Revolution tools to enhance the availability of indigenous foods and to promote their inclusion in the eating habits of the population.

**Keywords:** black population, non-communicable diseases, indigenous foods, Gauteng province, South Africa.

## INTRODUCTION

Non-communicable diseases are illnesses that cannot be transmitted from one person to another. They are usually of long duration and slow progression and may result in a sudden or rapid death, such as a fatal stroke. The most common non-communicable diseases are cardiovascular diseases, cancers, diabetes and chronic respiratory diseases such as asthma. These were reported to have accounted for 51% of the total deaths in South Africa in 2016. Sedentary lifestyle, tobacco use, alcohol abuse and unhealthy diet are behavioural causes of non-communicable diseases, with the latter being the most important risk factor (World Health Organization, 2018). The progression of South Africa to the top of the African digital economy – the 4<sup>th</sup> Industrial Revolution – has also been characterised by a nutrition transition

from traditional diets, which are largely based on starchy roots, staple grains, vegetables, fruits, legumes and minimal animal foods, towards a 'western' diet, which involves more processed foods, energy-dense foods, more foods of animal origin, as well as more added sugar, salt and fat. This 'western' diet is known to be unhealthy (Spires, Delobelle, Sanders, Puoane, Hoelzel & Swart, 2016). Indigenous foods represent those foods that are strongly recommended for non-communicable disease prevention or control. They are defined as crops that have their origin in South Africa or were introduced into the country and are now considered to be traditional crops (South African Department Agriculture, Forestry and Fisheries, 2013). Many of these foods are known and treasured due to their uses in treating or preventing diseases as well as for their nutrients and energy supply. Knowledge of these special foods have been passed down from generation to generation (Dweba & Mearns, 2011). They are perceived to be healthier and more nutritional than conventional foods, and are able to boost the immune system and overall health (Taruvinga & Nengovhela, 2015). Among many other 4<sup>th</sup> Industrial Revolution achievements such as the Internet, 3D printers and genetic engineering, digital health solutions have been developed globally to change the cost-quality equation of healthcare by enabling patients to manage their own health. These solutions mainly consist of mobile-phone applications, but do not include information on indigenous foods consumption. With the perspective in mind of how the inclusion of indigenous foods can reduce the prevalence of non-communicable diseases in South Africa, this pilot-study aimed to assess the awareness of the population of the nutritional and health values of indigenous foods, as well as the consumption levels of such foods.

## METHODOLOGY

A quantitative research survey was carried out with 235 participants, aged 18 years old and above, living in the Gauteng province for at least two years. They were randomly selected. This province was chosen since it is the most developed part of the country, and is a place where the impact of the 4<sup>th</sup> Industrial Revolution is obvious. For this pilot-study, only the black population was targeted because their diversity in terms of cultural practices could influence their consumption patterns and their perception of indigenous foods.

A structured questionnaire was administered to collect data on the socio-demographic profile of the respondents, including their knowledge, perceptions and consumption of indigenous food crops. The SPSS software was used to for the descriptive statistics of the collected data. An ANOVA Unequal HSD test was also conducted so as to compare the difference between the average number of indigenous foods known or consumed, depending on the socio-demographic variables involved.

## RESULTS AND DISCUSSION

### Socio-demographic profile of the surveyed population

Among the 235 participants, 62.1% were males and 37.9% were females. Nearly half of them (48.9%) were between 18 and 25 years, with the bulk of the rest between 26 and 45 years old (35.7%). Majority had a tertiary educational level (60.9%) or a secondary educational level (37%). All of them lived in either urban or peri-urban areas. In fact, 44.3% were from a township (locally known as Kasi) and 47.2% from suburbs or the edge of the city. The majority 43% had a total income of below R10 000, 16.2% between R10 000 and R35 000, and 26.8% above or equal to R35 000. The majority (60.4%) lived in a household of 3 to 5 members or above (25.5%).

### Indigenous foods knowledge and consumption

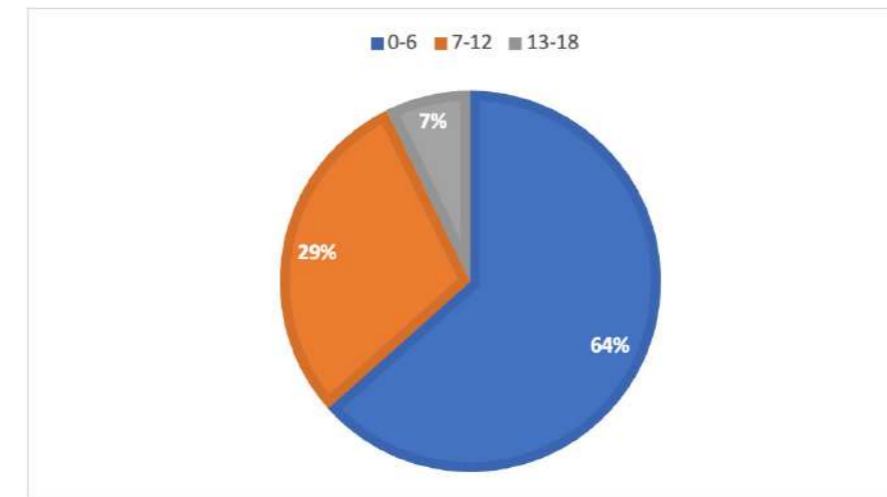
From the list of 18 indigenous foods that were presented, it was noted that the percentage of knowledge of the different crops ranged between 10.6% and 65.1% (Table 1). However, there was always a decrease from the number of people knowing about the crops to those actually consuming the crops. Sorghum, pearl millet, cowpea, amadumbe and marula tended to be the most consumed crops, consumed by at least 25% of the respondents. These crops can be considered to be the most conventional indigenous food crops since they are often commercially produced and relatively widely available in South Africa. The less conventional indigenous food crops such as amaranth, cleome, cassava, blackjack,

Jew mellow, Kei apple, monkey orange, red milkwood, mobola plum, num num and wild medlar, are mostly crops that are predominantly only available seasonally, marketed informally, and are either cultivated on a small scale or collected in wild areas (Cloete & Idsardi, 2013). The low consumption levels that were observed support the findings of Mbhenyane (2017), who noticed that indigenous food crops are consumed more often in areas where they are available, for example, the rural areas and homelands, due to their accessibility. Urbanisation and an increase in the spread of supermarkets, and the consequent increase in the availability of convenient and affordable prepared or semi-prepared foods, are also cited as a reason (Muyonga, Nansereko, Steenkamp, Manley & Okoth, 2017).

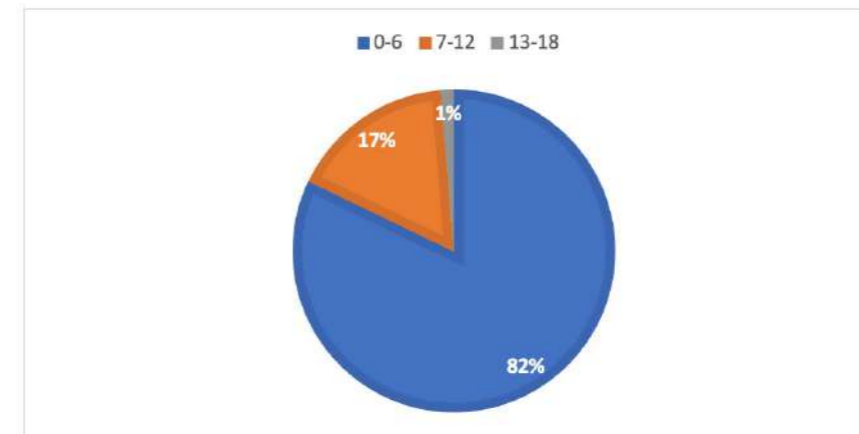
**Table 1:** Knowledge and consumption of South African indigenous foods by the studied populations (N = 235).

Crop		Knowledge (%)	Consumption (%)	Consumption for medicinal purpose (%)
Grain crops	Pearl millet	48.9	36.2	6.4
	Grain sorghum	65.1	49.4	7.2
	Cowpea	36.2	26.0	2.6
	Bambara groundnuts	31.9	21.7	3.4
	Mungbean	19.1	11.5	1.7
Vegetable crops	Cleome	26.8	20.0	2.6
	Amaranth	30.2	21.7	3.4
	Blackjack	27.2	15.7	1.3
	Jews mallow	19.6	14.9	3.8
	Cassava	25.1	16.6	3.0
	Amadumbe	43.0	30.2	3.4
Fruits	Marula	54.9	30.2	3.0
	Red milkwood	15.3	7.7	1.7
	Mobola plum	15.3	7.7	1.7
	Wild medlar	10.6	5.5	1.3
	Num-num	13.6	7.2	2.6
	Kei apple	20.0	12.3	2.6
	Monkey orange	18.3	11.1	2.1

The consumption of indigenous food for medicinal reasons appeared to be very low (averaging at 2.89%), with sorghum being the most consumed for that purpose, especially for diabetes (3.4%). This clearly shows there is very low knowledge of the healthy value of indigenous foods. Sorghum, for example, has been described as helpful for those suffering with diabetes, as it can effectively help to regulate sugar levels in the body (Park, Lee, Chung & Park, 2012). Cowpea leaves are an excellent source of vitamin A. Along with Jews mellow and pumpkin leaves, its consumption can be recommended as a way to reach the recommended daily vitamin A allowance (van Jaarsveld, Faber, van Heerden, Wenhold, van Rensburg & van Averbek, 2014). By grouping participants as a function of the number of crops known among the 18 that are listed, it appeared that 64% only knew of between 0 and 6 indigenous food crops, 29% knew of between 6 and 12 crops, and only 7% knew of between 13 and 18 crops (Figure 1). A similar trend was observed by grouping participants according to the number of crops consumed (Figure 2). The majority (82%) was in the range of 0 to 6 indigenous foods, while 17% were in the range of 7 to 12 indigenous foods. Only 1% of the population were determined to consume 13 to 18 indigenous foods.



**Figure 1:** Classification of the population according to the number of indigenous foods known.



**Figure 2:** Classification of the population according to the number of indigenous foods consumed.

Age, gender, educational level, income and living area played no significant role in determining whether a respondent had knowledge of indigenous foods, nor in whether they consumed them. The labelling of indigenous food crops as being the food of poor people (Taruvinga & Nengovhela, 2015) therefore does not apply to the studied population. Rather, it was people living with someone suffering with non-communicable diseases who tended to be more aware of indigenous foods ( $p \leq 0.05$ ). Indeed, they knew, on average,  $6.64 \pm 4.42$  of the 18 indigenous foods in comparison to those living with healthy people who knew, on average,  $4.80 \pm 4.23$ . This suggests that the advice received by patients with non-communicable diseases might possibly be shared with those living in the same household. There is, therefore, a huge need to communicate and educate people about the healthy values of indigenous foods more widely.

#### Population opinion regarding indigenous foods and the importance of the 4<sup>th</sup> Industrial Revolution

Table 2 presents the perception of the surveyed population concerning traditional foods or indigenous foods. Almost half of them (42%) were neutral when it came to choosing between traditional and modern foods. Only 25% were inclined to consume a modern diet, while 33% were more adapted to traditional foods. A similar tendency was noticed regarding their concerns about the replacement of traditional foods by modern foods. Indeed, 21% were totally against it, while 39% was for it, and 40% were neutral. However, up to 69% of the population agreed that they would consume more indigenous food if they knew more about its healthy values. Meanwhile, 26% remained unconvinced and neutral.

Transforming the food system through digitalisation can be helpful for promoting the availability of indigenous. As mentioned by Raheem, Shishaev and Dikovitsky (2019), the fusion of ‘big data’, the ‘Internet of things’ and advanced analytics is providing manufacturers with unprecedented insights into manufacturing performance, customer behaviour and new product development. Because many people are willing to consume these indigenous foods if they know more about their healthy value, cyber-physical systems research may be helpful to increase the production of these foods through precision agriculture, intelligent water management and more efficient food distribution. Automation, intelligence and collaboration are also relevant, with particular reference to smart manufacturing, smart products and services, as well as smart cities. Further, the development of digital health solutions for people to manage their own health should include the promotion of eating habits based on these indigenous foods.

**Table 2:** Opinion according to different preference statements regarding indigenous foods.

Statement	Strongly Disagree	Disagree	Neutral	Agree	Strongly Agree
<i>I prefer modern food to traditional food</i>	16%	17%	42%	15%	10%
<i>I am not concerned that traditional foods have been replaced by modern foods</i>	14%	25%	40%	13%	8%
<i>I will consume more indigenous foods if I know about their healthy values</i>	2%	3%	26%	25%	44%

## CONCLUSION

The current knowledge and consumption of indigenous foods in the Gauteng province is quite low. However, people will be quite interested to learn more about the nutritional and healthy values of these foods, and will learn to include them in their eating habits. The use of 4<sup>th</sup> Industrial Revolution tools to increase the availability of these foods and to promote their consumption in urbanised cities may therefore be of interest for the prevention or controlling of non-communicable diseases.

## LIST OF REFERENCES

- Cloete, P. C. & Idsardi, E. F. 2013. Consumption of indigenous and traditional food. *Agroecology and Sustainable Food Systems*, 37(8):902-914.
- Dweba, T. P. & Mearns, M. A. 2011. Conserving indigenous knowledge as the key to the current and future use of traditional vegetables. *International Journal of Information Management*, 31:564e571.
- Mbhenyane, X. G. 2017. Indigenous foods and their contribution to nutrient requirements. *South African Journal of Clinical Nutrition*, 30(4):5-7.
- Muyonga, J. H., Nansereko, S., Steenkamp, I., Manley, M. & Okoth, J. K. 2017. Traditional African foods and their potential to Online contribute to health and nutrition: traditional African foods. *IGI Global*. doi.org/10.4018/978-1-5225-0591-4.ch015.
- Park, J. H., Lee, S. H., Chung, I. M. & Park, Y. 2012. Sorghum extract exerts an anti-diabetic effect by improving insulin sensitivity via PPAR-gin mice fed a high-fat diet. *Nutrition Research and Practice*, 6:322–327.
- Raheem, D., Shishaev, M. & Dikovitsky, V. 2019. Food system digitalization as a means to promote food and nutrition security in the Barents Region. *Agriculture*, 9, 168.
- Spires, M., Delobelle, P., Sanders, D., Puoane, T., Hoelzel, P. & Swart, R. 2016. Diet-related non-communicable diseases in South Africa: determinants and policy responses. In: Padarath, A., King, J., Mackie, E. & Casciola, J. *South African Health Review 2016*. Durban: Health Systems Trust.
- South African Department Agriculture, Forestry and Fisheries. 2013. Most common indigenous food crops of South Africa. [Online] Available from: <https://www.nda.agric.za/docs/Brochures/Indigfoodcrps.pdf> [Accessed: 14th June 2019].
- Taruvunga, A. & Nengovhela, R. 2015. Consumers perceptions and consumption dynamics of African leafy vegetables (ALVs). *Evidence from Feni Communal Area, Eastern*. *5th International Conference on Biomedical Engineering and Technology*, 18(1):89-95
- Van Jaarsveld, P., Faber, M., Van Heerden, I., Wenhold, F., van Rensburg, W.J. & van Averbek, W. 2014. Nutrient content of eight African leafy vegetables and their potential contribution to dietary reference intakes. *Journal of Food Composition and Analysis*, 33(1):77–84.
- World Health Organization. 2018. *Non-communicable diseases country profiles 2018*. [Online] Available from: <https://www.who.int/nmh/publications/ncd-profiles-2018/en/> [Accessed: 28<sup>th</sup> May 2019].

# ADAPTATION TO THE IMPACT OF DROUGHT ON WATER AVAILABILITY IN COMMUNITIES: A REVIEW

M.I Mokgadi<sup>1</sup>, L. Esterhuizen<sup>1</sup>, K. Lebelo<sup>1</sup>

<sup>1</sup>Central University of Technology, Free State, Department of Life Sciences, South Africa, mmokgadi@cut.ac.za

## Abstract:

*Drought is considered to be an extreme natural disaster with many uncertainties. Over the past few years, it has been occurring due to climate change. One of the features of drought is the reduction of the availability of water in the affected regions. Many cities lack drought impact adaptation plans to deal with increased water demand. Therefore, it is vital to create drought monitoring models for adaptation in cities that lack the capacity. This paper reviews the literature on drought and its impact on water availability. The different types of droughts are highlighted, including their consequences on different factors such as water resources, the economy and the environment. The impact of droughts may be more severe in certain regions. Therefore, this review discusses strategies that are implemented in different geographical locations. Ultimately, responding to the impact of droughts requires planning, mitigation and innovative methods through the use of predictive tools that assist decision makers to recognise and lessen vulnerability to drought.*

**Keywords:** Droughts, adaptation strategies, water availability, climate change.

## INTRODUCTION

Drought has been known to cause severe water shortages. Over the past 30 years, droughts have become frequent all over the world (Solh & Ginkel, 2014). Drought can be defined as a long period with unusually low rainfall that affects living and growing conditions (Shah, Bharadiya & Manekar, 2015). The timescale of a drought is determined by the time interval from the start of a period of water scarcity to the end of it, and the impacts it has on environmental resources (Provinces, 2016). Haile & Tang (2019) discovered that many of the world's continents have experienced frequent droughts lately. Moreover, Solh and Ginkel (2014) reported that it is a climatic event that cannot be prevented. This natural disaster starts unobserved and develops slowly, with impacts that are not immediately apparent but which seriously interrupt properties and lives (Miyani, 2015; Muller & Cross, 2014). However, it is important to note that El Nino Southern Oscillation sometimes triggers extreme droughts which can reoccur and persist for several years.

Published studies (Provinces, 2016) reveal that droughts have been linked with many epidemics. Drought is a prevailing and routine feature of the Australian climate (Kiem & Austin, 2013). Further, South Asian regions are known to be prone to regular droughts (Miyani, 2015). Droughts have several features. One notable feature is the reduction of water availability over an area in a particular region (Muller & Cross, 2014). Considering the number of people found to be affected, drought ranks high among all-natural disasters. It is a damaging and costly climatic extreme due to its spatial extent (Ahmadalipour & Moradkhani, 2018; Dilling, Daly, Kenney, Klein, Miller, Ray, Travis & Wilhelmi, 2019). In addition, more than half of global deaths related to natural hazards are caused by drought events (Dilling *et al.*, 2019). It can be concluded that droughts challenge societies and the environment globally (Haile & Tang, 2019).

According to Mera (2018), when seasonal precipitation is less than the long term or normal average, drought occurs. The gross domestic product growth of many African countries has decreased due to frequent drought conditions (Shiferaw, Tesfaye, Kassie, Abate, Prasanna & Menkir, 2014). A poor economy has long lasting effects on any nation. The primary challenge in many developing nations is the issue of sustainable development. Water scarcity management requires intelligent systems in order for it to have any meaningful impact. The migration to and global population dynamics of urban centres threatens the sustainability of urban water supplies in the face of droughts (Dilling *et al.*, 2019). Reiterating the devastating effects of droughts, Olmstead (2014) has alluded that the long-term availability of water resources in many regions is affected by climate change.

## THE INFLUENCE OF CLIMATIC VARIATION ON DROUGHTS

Some of the impacts of climate change experienced worldwide could be increased occurrences of severe droughts with prolonged changes in precipitation and temperature. In France, climate change is having an impact on important ecosystem services that are supplied by the mountain social-ecological systems (Lavorel, Collo, Locatelli, Gordard, Prober, Gabillet, Devaux, Laforgue & Peyrache-gadeau, 2019). However, there has been a significant increase in the adaptation of planning and research due to the impacts of climate change (Aguiar, Bentz, Silva, Duarte, Penha-lobes, Fonseca & Swart, 2018). To strengthen the ability of the country to combat the impacts of climate change such as drought, capacity building should be enhanced (Haida, Chapagain, Rauch & Riede, 2019). Bottom-up approaches have encouraged people to become change agents by reducing their levels of water-use significantly, so as to be capable of adapting to the impacts of climate change (Haida *et al.*, 2019). This, in turn, ensures an approach that is participative and needs continuous evaluation.

Climate change has affected the water sector significantly (IPCC, 2013). In Africa, it has been shown that, in terms of the anticipated impacts of climate change, wet areas will experience fewer uncertainties than dry areas (Faramarzi, Abbaspour, Ashraf, Reza, Zehnder, Srinivasan & Yang, 2013). This has indicated that the climate change scenarios of various regions have projected the same direction of change in terms of water resources, resulting in an increase in drought events and their duration in future. It has been revealed that community management of water system usage is also influenced by seasons, meaning that they benefit from less support during natural disasters and are unable to carry out maintenance on the systems or operate them (Kelly, Shields, Cronk, Lee, Behnke, Klug & Bartram, 2018). Drainage will be reduced by 17% by 2050, when the average rainfall of sub-Saharan Africa decreases by 10% (Misra, 2014). Discouragingly, South Africa is prone to droughts as it is located in the southern region of Africa (Baudoin, Vogel, Nortje & Naik, 2017).

In low income areas, adaptation to climate change is faced with many challenges. For example, aspects such as impact models, climate data and adaptation finance are insufficient for supporting adaptation (Adenle, Ford, Morton, Twomlow, Alverson, Cattaneo, Cervigni, Kurukulasuriya, Huq, Helfgott & Ebinger, 2017; Shezi, Mathee, Siziba, Street, Naicker, Kunene, Z & Wright, 2019). Adjusted institutional design propositions are important when facilitating the learning process in terms of dealing with uncertainties related to the impact of climate change (Huntjens, Lebel, Pahl-wostl, Camkin, Schulze & Kranz, 2012). For low cost household water treatment to be effective, large tanks with a large roof size are recommended for use during seasons that are most affected by water security and savings (Kisakye & Bruggen, 2018). It is also suggested that the engagement of community members should take place regularly during water committee training sessions (Kelly *et al.*, 2018).

## WATER SCARCITY

Water demands for regular use have exceeded the amount of available freshwater in Cyprus (Papadaskalopoulou, Katsou, Valta, Moustakas, Malamis & Dodou, 2015). Even though adaptation measures have been enhanced to assist in combating climate change effects on water resources and the availability of water, it has also been proven that the general susceptibility is still high when droughts are experienced globally. Overall vulnerability is still high because water demand in certain areas is still not met during drought seasons (Papadaskalopoulou *et al.*, 2015; Thomas, Needoba, Kaberia, Butterworth, Adams, Oduor, Macharia, Mitheu, Mugo & Nagel, 2019). An evaluation of two predicted drought

periods in India revealed that there was a massive reduction in the groundwater boost and runoff share (Reshmidevi, Kumar, Mehrotra & Sharma, 2018). This could lead to further aggravated water stress. Welfare suggestions for urban water control in response to drought were assessed in North America. It was found that current policies target water use by the residents, but households are willing to pay for the scarce water at market value despite the prices influenced by droughts (Mansur & Olmstead, 2012).

South Africa does not have enough freshwater resources to meet population demands (Environmental Affairs, 2017). It is seen as the 30<sup>th</sup> most water scarce country globally (Department of Water Affairs, 2012). In the year 2012, through operational water resources planning and active service delivery, South Africa was reportedly restoring its water resources with support from the society and a concrete economy, regardless of the challenges (Department of Water Affairs, 2012). South Africa needs to adapt a smart and advanced approach to water management to be able to deal with issues concerning resource quality, pollution, social development, service quality, and water securing. Approaches must focus mainly on prioritising active use, demand management, re-use and protecting water resources for sustainable management (Department of Water Affairs, 2012).

For the water sector to be able to address these water challenges, technology development is needed. Technical innovation should be greatly encouraged. This technology should be appropriate to the economic, cultural and environmental aspects of the water sector. However, the focus of technology development should be on rural areas with low-income backgrounds because this is where much funds are used for operation services (Water Research Commission, 2018). The management of the then Department of Water Affairs and Forestry held a conference with engineering, institutional and social consultants to discuss the sustainability of and appropriate technologies for water services delivery in 2001 (Department of Water and Sanitation, 2016). It was discussed that technology must be easily comprehensible and its use should be physically within the ability of the people who are responsible for the maintenance and operation of the water treatment plants. Further, it was suggested that the equipment and spare parts of the new technology should be readily available in South Africa and that the service level delivered should be prominent and culturally suitable for end users. Lastly, it was discussed that the appropriate technology should not be a low-cost option (Department of Water Affairs, 2012). Water institutions such as the Department of Water and Sanitation and the Water Research Commission are responsible for the running of awareness campaigns so that water users and water institutions can be knowledgeable on water-related climate change issues, and therefore be able to handle them. Stakeholders should also be consulted by the Department of Water and Sanitation about suitable strategies for climate change response.

## TYPES OF DROUGHTS

Droughts can be classified into different types, depending on various viewpoints. Drought indicators are needed in order to distinguish between the changing natures of certain drought types. Meteorological drought is defined as a condition where the annual rainfall over an area is less than usual for a prolonged period, such as a month, season or year. Meteorological drought occurs first and then leads to the occurrence of other types of drought (Himayoun & Roshni, 2019). A variety of studies on drought types need to be conducted as shown in Table 1. Some researchers have noted that there are limited studies on hydrological droughts in East Africa (Haile & Tang, 2019). Hydrological droughts are connected with the effects that periods of precipitation shortage have on water supply. Typically, a drought of a 12- to 24-month period is attributable to hydrological impacts (Bae, Ji, Lim, Ryu, Kim & Kim, 2019). One of its features is decreasing groundwater levels and very low flow streams resulting from low evapotranspiration in the absence of rainfall (Miyan, 2015). In addition, severe hydrological unevenness can also be caused in the affected area.

Agricultural drought mostly affects food production and also results from rain deficiencies (Miyan, 2015; Wickham, Bathke, Abdel-monem, Bernadt, Bulling, Pytlik-zillig, Stiles & Wall, 2019). Drought of a one- to six-month scale results in agricultural impacts. This type of drought has environmental effects such as insufficient soil moisture for crops in the agricultural sector. It impacts on nursery production and hay, and may put stress on athletic fields and lawns. It may lead to new patterns of disease and pests, a loss of livestock, and a lack of planting material and seeds. There are different techniques for measuring droughts on vegetation. The most common technique for quantifying vegetative drought uses a Normalised Difference Vegetative Index (Haile & Tang, 2019). Socioeconomic droughts result from

precipitation conditions that affect the available supply insofar as it cannot meet demand (Wan, Zhao, Li, Mishra, Hejazi, Lu, Demissie & Wang, 2018). Drought that lasts for one to two years has been shown to result in socioeconomic impacts (Haile & Tang, 2019). Commercial shipping can be halted when basin water levels are lowered due to the drought. The main cause of socioeconomic instability in African countries is drought, which results in food insecurities. Miyan (2015) also noted that its monitoring and diagnosis is important because the relation of drought to food and nutrient security is intimate. During the 2015/2016 hydrological year, the South African government declared the Free State province a drought disaster area (Provinces, 2016). Droughts have serious developmental, environmental, economic and social consequences, irrespective of the types (Miyan, 2015).

## IMPACT OF DROUGHT ON WATER RESOURCES

Water resources are at the centre of the anticipated climate change impacts within the climate change matrix (Kusangaya, Warburton, Archer, Garderen & Jewitt, 2014). Water is a substance that can be found in a solid, liquid and gas state. It is composed of hydrogen and oxygen chemical elements. However, the chemical and physical properties of water are more complex. According to Boholm and Prutzer (2017), climate change is resulting in the unstable supply of safe drinking water. This is becoming a global problem, causing many human health risks. The usefulness of water as a solvent is important to all living organisms. Water is one of the most essential and plentiful compounds in the world. Moreover, water is being given less attention, even though the number of studies on urban metabolism have increased (Jeong & Park, 2020). At room temperature, water is an odourless and tasteless liquid. Water affordability is of vital importance when it comes to achieving household water security globally (Stoler, Pearson, Staddon, Wutich, Mack, Brewis, Adams, Ahmed, Alexander, Balogun, Boivin, Carrillo, Chapman, Cole, Collins, Escobar-vargas, Freeman, Asiki, Ghattas & Zinab, 2019). Interestingly, water is blue in colour at red wavelength owing the light absorbed, even though it appears to be colourless in small quantities.

**Table 1:** Summary of drought types and their descriptions.

Drought Type	Description	References
Meteorological	Meteorological drought is determined by a lack of precipitation and how conditions such as temperature and wind, affect the amount of moisture. It is expressed in relation to the average conditions for a region. Meteorological drought is region specific, since precipitation is highly variable from region to region.	(Bae <i>et al.</i> , 2019; Diasso & Abiodun, 2018; Himayoun & Roshni, 2019; Thomas <i>et al.</i> , 2019; Wickham <i>et al.</i> , 2019; Zhang, AghaKouchak, Yang, Wei & Wang, 2019)
Agricultural	This type of drought links the characteristics of meteorological drought to agriculture or landscapes. Agricultural drought focuses on precipitation shortages, evaporative demand and soil moisture deficits. This type of drought is also dependent upon plant type, stage of growth and soil properties.	(Miyan, 2015; Wan <i>et al.</i> , 2018; Wickham <i>et al.</i> , 2019)
Hydrological	Hydrological drought is associated with the effects of rain and snow shortfalls on streamflow, reservoir and lake levels, and on groundwater. Because it takes longer for precipitation deficiencies to show up in other components of the hydrological system, this type of drought can be out of phase with other types of drought.	Forootan, Khaki, Schumacher, Wulfmeyer, Mehrnegar, van Dijk, Brocca, Farzaneh, Akinluyi, Ramillien, Shum, Awange & Mostafaie, 2019; Wickham <i>et al.</i> , 2019)
Socio-economic	Socio-economic drought includes the impact of drought on the economy, related to supply and demand. While people typically think of agricultural loss, drought can also affect hydroelectric energy generation, ethanol production and numerous other items. In addition, drought impacts tourism, public health, infrastructure and many other components of society.	(Haile & Tang, 2019; Salvador, Nieto, Linares, Díaz & Gimeno, 2020; Wan <i>et al.</i> , 2018; Wickham <i>et al.</i> , 2019)
Ecological	This type of drought results from prolonged and widespread deficits in naturally available water supplies that create multiple stresses across ecosystems. Also, this type of drought emphasises the link between people and nature in the context of drought. It captures the environmental consequences of drought and its feedback into natural and human systems.	(Sankaran, 2019; Wang, Ren, Yu, Hu, Chen, He & Jiang, 2017; Wang & Yuan, 2018; Wickham <i>et al.</i> , 2019)

The supply of water is affected by higher temperatures and droughts. The importance of water cannot be overstated. Water has played a religious role throughout history because of its prominence. Biologically, aqueous solutions such as digestive juices and blood are fundamental to human survival. Further, water is vital for recreation, habitat, as well as

transportation for both animals and plants because it occurs as a liquid on the surface of the earth (Boholm & Prutzer, 2017). Dolnicar, Hurlimann and Grün, (2012) anticipated that the reliability of water supplies will decrease because of reduced rainfall.

On the surface of the earth, water is found mostly in the ocean, with sea water having dissolved salts in large quantities. The rest is found in glaciers, ice caps, rivers, groundwater and freshwater lakes. Several studies have noted the increasing risk of outbreaks of waterborne diseases. The chemical and physical properties of water are very complicated, even though its molecules are simple in structure: H<sub>2</sub>O. Water has a boiling point of 100 °C and a melting point of 0 °C, which is much higher than comparative analogous compounds (Boholm & Prutzer, 2017). The recycling and purification of water has become increasingly crucial as the global population continues to grow and the demand for water increases in parallel. For cities, optimal use and internal recycling are important goals insofar as water efficiency and water resources are concerned (Jeong & Park, 2020). Water is a very important resource, the decline of which can result in water shortages that are closely related to drought events. Drought events that are frequent exacerbate water scarcity, which affects the level of groundwater severely.

The understanding of drought conditions can be helpful in dealing with future drought episodes more successfully. Water resources have been hindered by frequent drought events that are not quantified and are misunderstood. The impact of drought on water resources is that it can cause deteriorating water quality (Haile & Tang, 2019). Drought impacts on water supply result in: tailwater consumers having insufficient water; decreased growth of aquatic-plants, and the interruption of water supply to non-essential users. For the effective and environmentally sustainable management of water supplies in municipalities, it is critical to conserve water resources (Dolnicar *et al.*, 2012). The water bodies of aquatic systems have also been impacted by drought to a large extent (Haile & Tang, 2019). This has resulted in a loss of habitat in many water bodies. In tampering with the aquatic biota, drought affects both flowing and standing water (Haile & Tang, 2019). The reduction of streamflow in general is a result of drought. It is thus important to monitor and manage lakes, rivers and dam resources for the early detection of warning signs of impending drought.

#### IMPACT OF DROUGHT ON THE ENVIRONMENT

The environment is the land, water or air on or in which humans live. It is described as the collective surroundings, conditions or things that could influence the life of an individual. It could also constitute the complex of biotic, physical and chemical factors such as soil and living things that affect an ecological community. More so than other natural hazards, the impact of drought can span great expanses of geographic areas (Wickham *et al.*, 2019). Drought affects the environment and society because humans, animals and plants are dependent on water to survive. Drought also reduces groundwater levels and freshwater availability (Diasso & Abiodun, 2018). Such effects are largely felt in certain parts of Africa such as South Africa, where drought causes habitats to be greatly reduced and food supplies to dwindle. This could be irreversible or temporary (Baudoin *et al.*, 2017).

Drought could exert an impact on safety and health. It could result in many living organisms experiencing great incidences of heat stroke and death (Sankaran, 2019). Where there are severe water shortages, conflicts may arise among these living organisms. Drought even causes living organisms to engage in less recreational activities than normal. The risk to wildlife is also greatly increased by drought conditions. Following a lack of precipitation, as well as increased disease and insect infestations, trees and plants wither and die from drought. This results in them becoming fuel for wildfires (Bae *et al.*, 2019). The longer the drought conditions last, the more intense wildfires could become, with habitats, crops and neighbourhoods being destroyed.

Droughts do not often display the same dramatic and immediate visual effects. The severity of the impacts of drought will differ depending on the location, duration and the season in which it occurs. Shah *et al.* (2015) discovered that drought can have a significant impact on social, environmental, economic, agricultural and hydrological systems. Miyan (2015) said that drought could cause a moisture shortfall, which has serious effects on human, animals and vegetation over a large area. Poor land management practices have been found to result in irreversible soil and land degradation (Spinoni, Barbosa, Jager, McCormick, Naumann, Vogt, Magni, Masante & Mazzeschi, 2019).



## ECONOMIC IMPACT OF DROUGHTS

The economy is the state of a region or a country in terms of the supply of money and the consumption of services and goods. It could also be referred to as the careful management of resources. The impact of drought in South Africa during 2015 and 2016 resulted in a great reduction of harvested crops (Baudoin *et al.*, 2017). The economy can be the movement of goods and services between many different entities and companies, which sell and buy them. The impact of drought on a reservoir in Brazil resulted in severe socio-economic strain for the community (Martins, Kaleita, Barbosa, Fassoni-andrade, Lucia & Novo, 2019). The main purpose of the economy is to control production and distribution so that the needs of households are met, for example, food and water, which are important to sustain human life. The national and local economy of South Africa has been affected by drought (Baudoin *et al.*, 2017). The global economy needs generous and responsible managers to look after the groups or countries that they live in. It is not only about money, although money is a facilitator that enables access to the resources that are available on the earth.

An active economy is viewed as a growth-based activity in areas such as impact investment, social entrepreneurship and sustainable development. In the southern African region, food insecurity is affected by high prices and market demand (Baudoin *et al.*, 2017). A growing economy is a humane model of capitalism that mainly looks at tackling development challenges globally, including rising inequality and poverty. A balanced inflation rate indicates the presence of a healthy economy. A good economy needs the government and communities to collaborate with investors and businesses, so as to warrant sufficient housing, proper healthcare and adequate jobs. The impact of drought as a result of climate change will reduce international trade patterns in South Africa (Calzadilla, Zhu & Rehdanz, 2014). A good economy prospers on wide inclusion and dynamism. The aspects of economic life include creativity, entrepreneurship and innovation. In order to understand drought, we need to understand the impacts of drought. The economic impacts of drought can be understood through different methods and may be direct or indirect (Shiferaw *et al.*, 2014). Droughts can cause the suspension of economic activities, such as farming, resulting in weakened finances (Haile & Tang, 2019). In economic terms, the impacts of drought are difficult to measure.

## STRATEGIES IMPLEMENTED TO COMBAT DROUGHT IMPACT

The millennium drought emphasised the importance of strong drought adaptation strategies (Kiem & Austin, 2013). Adaptation strategies and numerous government policies that have been implemented in the past have proven to be unsuccessful due to anthropogenic climate change and the estimates for increased drought risk across many parts of Australia (Kiem & Austin, 2013). South Africa has world-leading legislation in the form of the National Disaster Management Act of 2002, which has been improved over the years (Baudoin *et al.*, 2017). Water management in the Mangaung region is challenging due to limited water availability in relation to demands. The dependable supply and access to sufficient water has been identified as one of the most important issues in the city, according to the Integrated Development Plan (IDP) (Department of Water Affairs, 2013). About 20% of the total water used is able to be conserved, as indicated by the Water Reconciliation Strategy Study for Large Bulk Water Supply Systems.

The uncertainties around the causes and effects of drought exerts pressure on the demand for enhanced strategies for adapting to drought. Shah *et al.* (2015) advised that having information on the impacts of drought is important for planning, mitigation and responses to of drought. This will in turn, assist decision makers to recognise and lower vulnerability to drought. The diagnosis of drought is also important for drought projection through the use of climate modelling facilities for the stakeholders and planners of a country (Masinde, 2014; Masinde, Mwagha & Tadesse, 2018). Having an accurate rainfall forecast is important for the prediction and analysis of drought (Haile & Tang, 2019; Masinde, 2014; Masinde *et al.*, 2018). Moreover, to decrease the health impacts associated with drought, all levels of government should learn to adapt (Austin, Ross, Ford, Berrang-ford & Biesbroek, 2019).

South Africa has a drought forum in place that regulates agricultural drought and other developmental dimensions that are impacted by drought (Baudoin *et al.*, 2017). As a result, countries worldwide have begun to set up national drought strategies that include the development of comprehensive drought monitoring systems that are capable of providing early warnings of the onset of droughts. They can also determine the expected severity and spatial extent of the drought, so as

to convey the information to decision-makers in a timely manner (Masinde *et al.*, 2018). Such information can be used to reduce or avoid the imminent negative impacts of drought.

## RECOMMENDATIONS

The following are the recommended future directions:

- Adopt clear response strategies and policies to avoid adverse drought outcomes on the economy;
- Stimulate community-led adaptative initiatives through large-scale adaptation and recognition of the local impacts of climate change;
- Maintain drought management plans that support the building of economic and social security on national, regional and local levels; and
- Refurbish meteorological departments by revising mission statements with regards to climate change, training and agriculture.

## CONCLUSION

Extensive literature on drought and adaption can assist many countries and cities in terms of planning for drought events and dealing with its impacts on water availability. Great improvements in drought prediction capabilities have been observed over the past few decades in Africa. Across sub-Saharan Africa, varying degrees of effectiveness in terms of climate risk management is experienced. An African research network programme that involves researchers, meteorologists (with their respective departments), farmers and local communities should be encouraged to participate in data collection. South Africa has key contact departments, strategies and plans that are in place and should be mobilised more efficiently. However, there is lack of funding for these adaptative activities in many regions of the country. Usable knowledge, such as knowledge of water conservation activities, could also be shared with communities. Thus, further research should be conducted on drought prediction so as to mitigate its impact upon societies.

## ACKNOWLEDGEMENTS

A special vote of gratitude is extended to the Central University of Technology, Free State, the Department of Life Sciences: Environmental Health Programme.

## DECLARATION OF CONFLICTING INTERESTS

The authors declare no potential conflicts of interest with respect to the research, authorship, and/or publication of this article.

## LIST OF REFERENCES

- Adenle, A.A., Ford, J.D., Morton, J., Twomlow, S., Alverson, K., Cattaneo, A., Cervigni, R., Kurukulasuriya, P., Huq, S., Helfgott, A. & Ebinger, J. O. 2017. Managing climate change risks in Africa - A global perspective. *Ecological Economics*, 141:190–201. [Online] Available from: <https://doi.org/10.1016/j.ecolecon.2017.06.004> [Accessed: 2020/05/05].
- Adenle, A.A., Ford, J.D., Morton, J., Twomlow, S., Alverson, K., Cattaneo, A., Cervigni, R., Kurukulasuriya, P., Huq, S., Helfgott, A. & Ebinger, J. O. 2017. Managing climate change risks in Africa - A global perspective. *Ecological Economics*, 141:190–201. [Online] Available from: <https://doi.org/10.1016/j.ecolecon.2017.06.004> [Accessed: 2019/01/29].
- Aguiar, F.C., Bentz, J., Silva, J. M.N., Duarte, F., Penha-lobes, G., Fonseca, A.L. & Swart, R. 2018. Adaptation to climate change at local level in Europe: An overview. *Environmental Science and Policy*, 86(May):38–63. [Online] Available from: <https://doi.org/10.1016/j.envsci.2018.04.010> [Accessed: 2019/01/29].
- Ahmadalipour, A. & Moradkhani, H. 2018. Science of the total environment multi-dimensional assessment of drought vulnerability in Africa: 1960 – 2100. *Science of the Total Environment*, 644:520–535. [Online] Available from: <https://doi.org/10.1016/j.scitotenv.2018.07.023> [Accessed: 2019/07/10].
- Austin, S. E., Ross, N.A., Ford, J.D., Berrang-ford, L. & Biesbroek, R. 2019. Social science & medicine enabling local public health adaptation to climate change. *Social Science & Medicine*, 220(October 2018):236–244. [Online] Available from: <https://doi.org/10.1016/j.socscimed.2018.11.002> [Accessed: ].
- Bae, H., Ji, H., Lim, Y.J., Ryu, Y., Kim, M.H. & Kim, B. J. 2019. Characteristics of drought propagation in South Korea: relationship between meteorological, agricultural, and hydrological droughts. *Natural Hazards*, 99(1):1–16. [Online] Available from: <https://doi.org/10.1007/s11069-019-03676-3> [Accessed: ?].
- Baudoin, M., Vogel, C., Nortje, K., & Naik, M. 2017. International journal of disaster risk reduction living with drought in South Africa: lessons learnt from the recent El Niño drought period. *International Journal of Disaster Risk Reduction*, 23(May):128–137. [Online] Available from: <https://doi.org/10.1016/j.ijdr.2017.05.005> [Accessed: 2020/08/08].
- Boholm, Å., & Prutzer, M. 2017. Climate risk management experts' understandings of drinking water risk management in a climate change scenario. *Climate Risk Management*, 16:133–144. [Online] Available from: <https://doi.org/10.1016/j.crm.2017.01.003> [Accessed: 2019/01/29].
- Calzadilla, A., Zhu, T., & Rehdanz, K. 2014. Climate change and agriculture: Impacts and adaptation options in South Africa. *Water Resources and Economics*, 5:24–48. [Online] Available from: <https://doi.org/10.1016/j.wre.2014.03.001> [Accessed: ].
- Department of Water Affairs. 2012. *Annual Report: 1 April 2011-31 March 2012*. Pretoria: Department of Water Affairs.
- Department of Water Affairs. 2013. *National Water Resource Strategy - 2nd edition 2013*. Pretoria: Department of Water Affairs.
- Department of Water and Sanitation. 2016. *Inland water-Aquatic ecosystems in South Africa include rivers and streams, estuarine systems, marine systems, wetlands, floodplains, lakes and dams and groundwater systems*. Inland. Pretoria: Government printer.
- Diasso, U. & Abiodun, B. J. 2018. Future impacts of global warming and reforestation on drought patterns over West Africa. *Theoretical and Applied Climatology*, 133(3–4):647–662. [Online] Available from: <https://doi.org/10.1007/s00704-017-2209-3> [Accessed: 2020/06/06].
- Dilling, L., Daly, M.E., Kenney, D. A., Klein, R., Miller, K., Ray, A.J., Travis, W.R., & Wilhelmi, O. 2019. Climate risk management drought in urban water systems: Learning lessons for climate adaptive capacity. *Climate Risk Management*, 23(August 2018):32–42. [Online] Available from: <https://doi.org/10.1016/j.crm.2018.11.001> [Accessed: 2019/06/24].
- Dolnicar, S., Hurlimann, A. & Grün, B. 2012. Water conservation behavior in Australia. *Journal of Environmental Management*, 105, 44–52. [Online] Available from: <https://doi.org/10.1016/j.jenvman.2012.03.042> [Accessed: 2019/07/12].
- Environmental Affairs. 2017. *National Climate Change Adaptation Strategy Republic of South Africa*. Issue October. Pretoria: Government printer
- Faramarzi, M., Abbaspour, K. C., Ashraf, S., Reza, M., Zehnder, A. J.B., Srinivasan, R. & Yang, H. 2013. Modeling impacts of climate change on freshwater availability in Africa. *Journal of Hydrology*, 480:85–101. [Online] Available from: <https://doi.org/10.1016/j.jhydrol.2012.12.016> [Accessed: 2019/01/29].
- Forootan, E., Khaki, M., Schumacher, M., Wulfmeyer, V., Mehrnegar, N., van Dijk, A.I.J.M., Brocca, L., Farzaneh, S., Akinluyi, F., Ramillien, G., Shum, C.K., Awange, J. & Mostafaie, A. 2019. Understanding the global hydrological droughts of 2003–2016 and their relationships with teleconnections. *Science of the Total Environment*, 650(September 2018):2587–2604. [Online] Available from: <https://doi.org/10.1016/j.scitotenv.2018.09.231> [Accessed: 2020/05/16].
- Haida, C., Chapagain, A. K., Rauch, W. & Riede, M. 2019. Land use policy from water footprint to climate change adaptation: Capacity development with teenagers to save water. *Land Use Policy*, 80(July 2017):456–463. [Online] Available from: <https://doi.org/10.1016/j.landusepol.2018.02.043> [Accessed: 2019/01/29].
- Haile, G.G. & Tang, Q. 2019. Earth-science reviews droughts in East Africa: Causes , impacts and resilience. *Earth-Science Reviews*, 193(June 2018):146–161. [Online] Available from: <https://doi.org/10.1016/j.earscirev.2019.04.015> [Accessed: 2019/06/24].
- Himayoun, D. & Roshni, T. 2019. Spatio-temporal variation of drought characteristics, water resource availability and the relation of drought with large scale climate indices: a case study of Jhelum basin , India. *Quaternary International*, 525(July):140–150. [Online] Available from: <https://doi.org/10.1016/j.quaint.2019.07.018> [Accessed: 2020/08/08].
- Huntjens, P., Lebel, L., Pahl-wostl, C., Camkin, J., Schulze, R., & Kranz, N. 2012. Institutional design propositions for the governance of adaptation to climate change in the water sector. *Global Environmental Change*, 22(1):67–81. [Online] Available from: <https://doi.org/10.1016/j.gloenvcha.2011.09.015> [Accessed: 2019/01/29].
- IPCC. 2013. *Climate change 2013;The physical basis*. Cambridge: Cambridge University Press.
- Jeong, S. & Park, J. 2020. Resources , conservation & recycling evaluating urban water management using a water metabolism framework: A comparative analysis of three regions in Korea. *Resources, Conservation & Recycling*, 155(July 2019):104597. [Online] Available from: <https://doi.org/10.1016/j.resconrec.2019.104597> [Accessed: 2020/01/29].
- Kelly, E., Shields, K. F., Cronk, R., Lee, K., Behnke, N., Klug, T. & Bartram, J. 2018. *Science of the total environment seasonality , water use and community management of water systems in rural settings : Qualitative evidence from Ghana , Kenya , and Zambia*. 629:715–721. [Online] Available from: <https://doi.org/10.1016/j.scitotenv.2018.02.045> [Accessed: 2019/01/29].
- Kiem, A.S. & Austin, E.K. 2013. Drought and the future of rural communities: Opportunities and challenges for climate change adaptation in regional Victoria , Australia. *Global Environmental Change*, 23(5):1307–1316. [Online] Available from: <https://doi.org/10.1016/j.gloenvcha.2013.06.003> [Accessed: 2019/07/30].
- Kisakye, V. & Bruggen, B. 2018. Resources , conservation & recycling effects of climate change on water savings and water security from rainwater harvesting systems. *Resources, Conservation & Recycling*, 138(July):49–63. [Online] Available from: <https://doi.org/10.1016/j.resconrec.2018.07.009> [Accessed: 2019/01/29].
- Kusangaya, S., Warburton, M.L., Archer, E., Garderen, V. & Jewitt, G.P.W. 2014. Impacts of climate change on water resources in southern Africa: a review. *Physics and Chemistry of the Earth*, 67–69:47–54. [Online] Available from: <https://doi.org/10.1016/j.pce.2013.09.014> [Accessed: 2019/01/15].
- Lavorel, S., Collo, M. J., Locatelli, B., Gordard, R., Prober, S.M., Gabillet, M., Devaux, C., Laforgue, D. & Peyrache-gadeau, V. 2019. *Mustering the power of ecosystems for adaptation to climate change*. 92(July 2018):87–97. [Online] Available from: <https://doi.org/10.1016/j.envsci.2018.11.010> [Accessed: 2019/01/29].
- Mansur, E. T. & Olmstead, S. M. 2012. The value of scarce water: Measuring the inefficiency of municipal regulations. *Journal Of Urban Economics*, 71(3):332–346. [Online] Available from: <https://doi.org/10.1016/j.jue.2011.11.003> [Accessed: 2019/01/29].
- Martins, V.S., Kaleita, A., Barbosa, C.C.F., Fassoni-andrade, A.C., Lucia, F.D. & Novo, E.M.L.M. 2019. Remote sensing applications: Society and environment remote sensing of large reservoir in the drought years: Implications on surface water change and turbidity variability of Sobradinho reservoir ( Northeast Brazil ). *Remote Sensing Applications: Society and Environment*, 13(October 2018):275–288. [Online] Available from: <https://doi.org/10.1016/j.rsase.2018.11.006> [Accessed: 2020/08/08].
- Masinde, M. 2014. Artificial neural networks models for predicting effective drought index: Factoring effects of rainfall variability. *Mitigation and Adaptation Strategies for Global Change*, 19(8):1139–1162. [Online] Available from: <https://doi.org/10.1007/s11027-013-9464-0> [Accessed: 2020/04/04].

- Masinde, M., Mwagha, M. & Tadesse, T. 2018. Downscaling Africa's drought forecasts through integration of indigenous and scientific drought forecasts using fuzzy cognitive maps. *Geosciences (Switzerland)*, 8(4): 1-25. [Online] Available from: <https://doi.org/10.3390/geosciences8040135> [Accessed: 2020/04/04].
- Mera, G.A. 2018. Drought and its impacts in Ethiopia. *Weather and Climate Extremes*, 22(November 2017):24–35. [Online] Available from: <https://doi.org/10.1016/j.wace.2018.10.002>. [Accessed: 2020/08/07].
- Misra, A.K. 2014. Gulf Organisation for research and development. *International Journal of Sustainable Built Environment*, 3(1):153–165. [Online] Available from: <https://doi.org/10.1016/j.ijbsbe.2014.04.006> [Accessed: 2019/01/24].
- Miyan, M.A. 2015. Droughts in Asian least developed countries: Vulnerability and sustainability. *Weather and Climate Extremes*, 7:8–23. [Online] Available from: <https://doi.org/10.1016/j.wace.2014.06.003> [Accessed: 2019/07/12].
- Muller, J. C. & Cross, R. 2014. Adapting to climate change and addressing drought – learning from the Red Cross Red Crescent experiences in the Horn of Africa. *Weather and Climate Extremes*, 3:31–36. [Online] Available from: <https://doi.org/10.1016/j.wace.2014.03.009> [Accessed: 2019/07/10].
- Olmstead, S.M. 2014. Climate change adaptation and water resource management : a review of the literature. *Energy Economics*, 46:500–509. [Online] Available from: <https://doi.org/10.1016/j.eneco.2013.09.005> [Accessed: 2019/01/29].
- Papadaskalopoulou, C., Katsou, E., Valtas, K., Moustakas, K., Malamis, D. & Dodou, M. 2015. Resources , conservation and recycling review and assessment of the adaptive capacity of the water sector in Cyprus against climate change impacts on water availability. *Resources, Conservation & Recycling*, 105:95–112. [Online] Available from: <https://doi.org/10.1016/j.resconrec.2015.10.017> [Accessed: 2019/01/29].
- Provinces, N.W. 2016. *Characteristics of Droughts in South Africa : A Case Study of Free State and North West Provinces. October*. [Online] Available from: <https://doi.org/10.3390/w8100439> [Accessed: 2019/06/12].
- Reshmidevi, T.V, Kumar, D.N., Mehrotra, R. & Sharma, A. 2018. Estimation of the climate change impact on a catchment water balance using an ensemble of GCMs. *Journal of Hydrology*, 556:1192–1204. [Online] Available from: <https://doi.org/10.1016/j.jhydrol.2017.02.016> [Accessed: 2019/01/29].
- Salvador, C., Nieto, R., Linares, C., Diaz, J. & Gimeno, L. 2020. Effects of droughts on health: Diagnosis, repercussion, and adaptation in vulnerable regions under climate change. Challenges for future research. *Science of the Total Environment*, 703: 134912. [Online] Available from: <https://doi.org/10.1016/j.scitotenv.2019.134912> [Accessed: 2020/04/19].
- Sankaran, M. 2019. Droughts and the ecological future of tropical savanna vegetation. *Journal of Ecology*, 107(4):1531–1549. [Online] Available from: <https://doi.org/10.1111/1365-2745.13195> [Accessed: 2020/06/08].
- Shah, R., Bharadiya, N. & Manekar, V. 2015. Drought index computation using standardized precipitation index (SPI) method for surat district ,Gujarat. *Aquatic Procedia*, 4(Icwrcoe):1243–1249. [Online] Available from: <https://doi.org/10.1016/j.aqpro.2015.02.162> [Accessed: 2019/07/10].
- Shezi, B., Mathee, A., Siziba, W., Street, R.A., Naicker, N., Kunene, Z. & Wright, C. Y. 2019. Environmental health practitioners potentially play a key role in helping communities adapt to climate change. *BMC Public Health*, 19(1):1–8. <https://doi.org/10.1186/s12889-018-6378-5> [Accessed: 2020/04/04].
- Shiferaw, B., Tesfaye, K., Kassie, M., Abate, T., Prasanna, B.M., & Menkir, A. 2014. Managing vulnerability to drought and enhancing livelihood resilience in sub-Saharan Africa: Technological, institutional and policy options. *Weather and Climate Extremes*, 3:67–79. [Online] Available from: <https://doi.org/10.1016/j.wace.2014.04.004> [Accessed: 2019/07/12].
- Solh, M. & Ginkel, M. Van. 2014. Drought preparedness and drought mitigation in the developing world's drylands. *Weather and Climate Extremes*, 3:62–66. [Online] Available from: <https://doi.org/10.1016/j.wace.2014.03.003> [Accessed: 2019/07/10].
- Spinoni, J., Barbosa, P., Jager, A.D., McCormick, N., Naumann, G., Vogt, J.V, Magni, D., Masante, D. & Mazzeschi, M. 2019. Journal of Hydrology: Regional studies a new global database of meteorological drought events from 1951 to 2016. *Journal of Hydrology: Regional Studies*, 22(October 2018):100593. [Online] Available from: <https://doi.org/10.1016/j.ejrh.2019.100593> [Accessed: 2019/07/12].
- Stoler, J., Pearson, A. L., Staddon, C., Wutich, A., Mack, E., Brewis, A., Adams, E., Ahmed, J. F., Alexander, M., Balogun, M., Boivin, M., Carrillo, G., Chapman, K., Cole, S., Collins, S. M., Escobar-vargas, J., Freeman, M., Asiki, G., Ghattas, H., & Zinab, H. 2019. Science of the total environment cash water expenditures are associated with household water insecurity, food insecurity, and perceived stress in study sites across 20 low- and middle-income countries. *Science of the Total Environment*, 135881. [Online] Available from: <https://doi.org/10.1016/j.scitotenv.2019.135881> [Accessed: 2020/01/29].
- Thomas, E. A., Needoba, J., Kaberia, D., Butterworth, J., Adams, E.C., Oduor, P., Macharia, D., Mitheu, F., Mugo, R. & Nagel, C. 2019. Quantifying increased groundwater demand from prolonged drought in the East African rift valley. *Science of the Total Environment*, 666(February):1265–1272. [Online] Available from: <https://doi.org/10.1016/j.scitotenv.2019.02.206> [Accessed: 2020/05/17].
- Wan, W., Zhao, J., Li, H.Y., Mishra, A., Hejazi, M., Lu, H., Demissie, Y. & Wang, H. 2018. A Holistic view of water management impacts on future droughts: A global multimodel analysis. *Journal of Geophysical Research: Atmospheres*, 123(11):5947–5972. [Online] Available from: <https://doi.org/10.1029/2017JD027825> [Accessed: 2020/05/05].
- Wang, H., Ren, L., Yu, X., Hu, J., Chen, Y., He, G. & Jiang, Q. 2017. Antibiotic residues in meat, milk and aquatic products in Shanghai and human exposure assessment. *Food Control*, 80:217–225. [Online] Available from: <https://doi.org/10.1016/j.foodcont.2017.04.034> [Accessed: 2020/06/07].
- Wang, L. & Yuan, X. 2018. Two Types of flash drought and their connections with seasonal drought. *Advances in Atmospheric Sciences*, 35(12):1478–1490. [Online] Available from: <https://doi.org/10.1007/s00376-018-8047-0> [Accessed: 2020/05/17].
- Water Research Commission. 2018. *The South African water innovation story* (Issue 1). [Online] Available from: <https://doi.org/10.16309/j.cnki.issn.1007-1776.2003.03.004> [Accessed: 2020/05/05].
- Wickham, E.D., Bathke, D., Abdel-monem, T., Bernadt, T., Bulling, D., Pytlik-zillig, L., Stiles, C. & Wall, N. 2019. Risk reduction conducting a drought-specific THIRA (Threat and Hazard Identification and Risk Assessment): a powerful tool for integrating all-hazard mitigation and drought planning efforts to increase drought mitigation. *International Journal of Disaster*, 39(July). [Online] Available from: <https://doi.org/10.1016/j.ijdr.2019.101227> [Accessed: 2020/06/07].
- Zhang, B., AghaKouchak, A., Yang, Y., Wei, J. & Wang, G. 2019. A water-energy balance approach for multi-category drought assessment across globally diverse hydrological basins. *Agricultural and Forest Meteorology*, 264(October 2018):247–265. [Online] Available from: <https://doi.org/10.1016/j.agrformet.2018.10.010> [Accessed: 2020/05/12].

9TH INTERNATIONAL CONFERENCE ON APPROPRIATE TECHNOLOGY

# JOB CREATION

# PRODUCT INNOVATION AS A CATALYST FOR JOB CREATION – THE CASE OF BOTSWANA’S SMALL, MICRO AND MEDIUM ENTERPRISES (SMMES)

Mr Polokano Sekonopo, University of Botswana, Botswana. polokano.sekonopo@mopipi.ub.bw

Prof Richie Moalosi, University of Botswana, Botswana. moalosi@mopipi.ub.bw

Dr Olefile Molwane, University of Botswana, Botswana. molwaneob@ub.ac.bw

Dr Herbert Mapfaira, University of Lincoln, United Kingdom. HMapfaira@lincoln.ac.uk

## Abstract

*Small, Micro and Medium Enterprises (SMMEs) are an integral part of the global economy, and developmental theorists argue that development of this sector is a good strategy towards economic development, industrialisation and poverty eradication. The literature indicates that this sector constitutes the dominant form of business organisation, accounting for over 90% of enterprises, depending on the country. This, in turn, translates to SMMEs being the largest employers in most economies, especially in developed countries. The success of manufacturing SMMEs depends on the quality of the products they produce and sell to the market. Botswana’s manufacturing SMMEs have had a hard time producing competitive products. This is despite the multitude of government interventions aimed at building the capability of local enterprises. This paper seeks to study the product innovation landscape of Botswana’s manufacturing SMMEs as a precursor to manufacturing performance by identifying areas for improvement to enable the sector to be competitive and stimulate job creation opportunities. The paper adopted a mixed-method approach. 96 small micro enterprises involved in the business of wood, metal and leather manufacturing participated in the study across the country. The results show that there is a lack of product innovation capability within the small micro enterprises, thus preventing the sector from reaching its full potential in terms of job creation.*

**Keywords:** Botswana, job creation, manufacturing, product innovation, small, micro and medium enterprises (SMMEs)

## INTRODUCTION

Globally, there is a need for countries to find ways of improving the livelihoods of their citizens. Job creation is one of those ways as it enables individuals to earn an income which in turn will enable them to have an improved standard of living. Holmes et al (2013:2) state that [t]he prioritisation of employment creation is informed by a prevalent assumption that employment has a positive impact on both poverty reduction and stability”(. Faced with intense competition coupled with difficult current market conditions of ever- demanding customers, job creation in developing countries is an uphill battle. Whenever an entity experiences market difficulties, one of their first calls of action is retrenchment. This is clearly an undesirable outcome.

Governments, in a bid to create entities which will create and maintain employment for their citizens, have turned to devising means of empowering SMMEs in the hope that they will assist in job creation. The focus on SMMEs is premised on a number of facts about their performance in the marketplace. SMMEs have the potential to grow into large enterprises and thus help the government in providing employment. Definitions of SMMEs often vary by country and are usually based on the number of employees, the annual turnover or the value of assets of the enterprises (ILO, 2015:2). In Botswana, SMMEs are classified by the number of employees an entity has; i.e. 1-5 people (micro), 6-24 (small), 25-99 (medium) and 100 and above (large) enterprises (Botswana Government, 1999).

Botswana’s economy is largely based on the mining sector. Low commodity prices are forcing most of Botswana’s mines to close, resulting in massive job losses. In order to diversify the economy from over-reliance on mining, the government is promoting the “knowledge-based economy” as a panacea to its challenges. It remains to be seen if Botswana’s innovation ecosystem in its present form will be able to support such an initiative. This study aims to investigate how product innovation within the manufacturing SMMEs sector can be used as a catalyst for job creation and to diversify the economy from a mineral-based to a knowledge-based one.

## Small, medium and micro enterprises

Since the First Industrial Revolution, industrialisation has been seen as a way to lift a country out of poverty (Mehrotra & Delamonica, 2007; Jin, 2020) because manufacturing industries have the capability of employing a large number of people. There are several examples to attest to this feature of industrialisation, with China being the most cited one. Countries which are less industrialised tend to be bedevilled with all sorts of social ills including poverty and unemployment. Developing nations are currently grappling with efforts to diversify their economies, and manufacturing has been identified as amongst the best options to do this. This is being achieved through empowering SMMEs. There is agreement among economists and policymakers that without a well-organised system of SMMEs, the foundations of industrialisation cannot be laid (Al Haddad et al., 2019).

SMMEs make crucial contributions to job creation and income generation (Page & Soderbom, 2012; Ngeek & van Aardt Smith, 2013; ILO, 2015; Pasnicu, 2018). Although SMMEs create a considerable number of jobs, they are characterised by a higher failure rate (Page *et al.*, 2012; Ngeek *et al.*, 2013; ILO, 2015). Holmes *et al.* (2013) identify three broad categories of employment creation: emergency employment creation; long-term employment creation through enabling macro-policies; and self-employment. The ideal situation is to have the latter two, thus having no need for the first one. Holmes *et al.* (2013) outline the following as employment creation programmes that can be adopted by states:

- Direct short- or long-term job creation by state or non-state actors
- Policies to promote self-employment
- Policies to stimulate employment growth, for example, by improving the quality of labour supply
- Job subsidies to sectors with high employment elasticity.

All the above approaches have been implemented by the Government of Botswana, but the results are not forthcoming, and instead, unemployment is spiralling out of control. This points to a missing link somewhere, either in the kind of jobs being created or in the services being provided (having no market). There seems to be general agreement among scholars that the available labour do not have the appropriate skills (Reigner, n.d). This view is echoed by Siphambe (2007) who observes that it is quite absurd that the private sector in Botswana still lacks some of the key skills that they need and which they have to import from outside, while the economy has a large pool of educated workers whose skills do not match the requirements of the labour market. Mismatched skills tend to defeat the government’s objective of educating the masses for future employment, the result of which is unsustainable employment. As Holmes *et al.*, (2013:5) point out:

*The quality of employment in terms of the type of job, the sector in which it is located, duration, wage levels and terms of employment, etc., as well as the scale of employment, its spatial distribution, and its allocation across the income distribution, are significant factors in determining the extent to which employment contributes to poverty reduction.*

The small population of Botswana is sometimes blamed for lacking a market for its produce, hence contributing to unemployment. This is bound to be the case if producers are unable to satisfy foreign markets. Ngeek and van Aardt Smit (2013) paint a gloomy picture of South Africa when they observe that if 5,979,510 small businesses create 7.8 million jobs, it clearly indicates that on average each small business creates less than 2 jobs. They further state that 94% of South African small businesses have less than five employees with up to 67% having no employees at all. This is an alarming situation considering the fact that South Africa has a huge population which should translate into a market for SMMEs’ products and services. Moreover, South Africa, having access to the sea, has lower operational input costs compared to Botswana, thus contributing to a favourable environment for entrepreneurship.

Though data from Botswana are outdated, they show that SMMEs employed 125 000 people and contributed 30-45% of the Gross Domestic Product in 1998 (Ministry of Commerce and Industry . 1998). According to the Central Statistics Office [CSO] (2007, there were 245 000 jobs in the formal sector. The *Botswana Institute for Development Policy Analysis Brief Report* (2009) estimates that employment in Botswana is distributed as follows: government (36%), large firms (32%) and

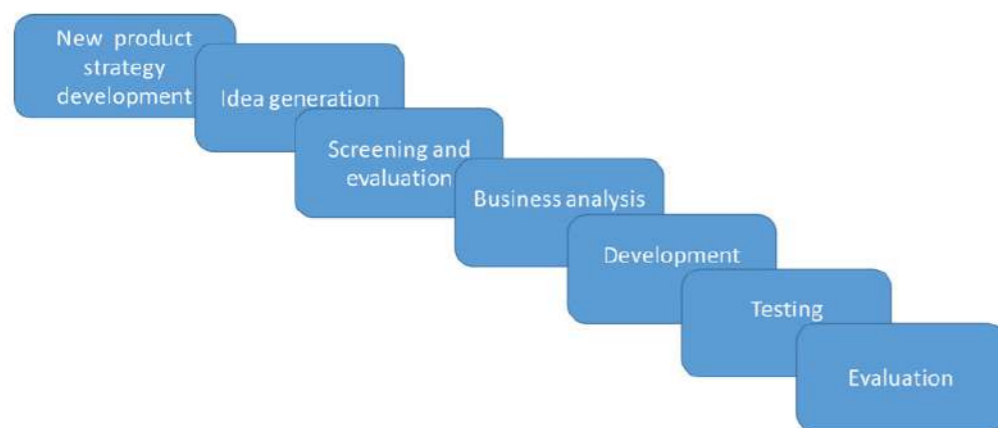
SMMEs (32%). Employment contribution by SMMEs is spread as follows: micro (14%), small (14%) and medium (4%). These statistics show that SMMEs play a crucial role in employment creation, improvement of household incomes and poverty alleviation (Industrial Development Policy, 1997).

Ngek and van Aardt Smit (2013) observe that it is not about the quantity of SMMEs required for job creation but their quality. The question that remains unanswered is, “How do we produce quality SMMEs?” The authors answer this question by identifying a number of best practices of high growth firms, such as innovation, networking, market orientation, teamwork, human capital, organisational structure and entrepreneurial growth ambitions.

Page and Soderbom (2012) observe that capabilities are a critical constraint in the growth of firms and jobs in Africa, and note that aid agencies can support the acquisition and dissemination of the firm’s capabilities by supporting government efforts to attract Foreign Direct Investment (FDI) and through management training. Al Haddad *et al.* (2019) comment that such aid could be in the form of managerial talent to enable SMMEs to compete globally. In the case of Botswana, such assistance is currently being offered through institutions such as Local Enterprises Authority (LEA) and Botswana Exporters and Manufacturers Association (BEMA). However, not much fruit is being borne from such interventions, thus pointing to something that is missing. The premise of this paper is that the missing component for manufacturing SMMEs is product innovation capability.

### Product innovation

Product innovation, also known as New Product Development (NPD), is the process of conceiving of a new product. This is a result of creative thinking, i.e. devising novel ways of doing things. A creative idea has to be exploited commercially for it to be an innovation. As Reguia (2014:140) observes, “[p]roduct innovation is an important driver of economic growth and productivity”. There are various methods used by different companies to think of and develop new products. For example, IDEO uses the IDEO method whilst Toyota uses Set-Based Concurrent Engineering (SBCE). There are indeed many different types of product innovation models. The model which is probably best known in Botswana is the Booz, Allan and Hamilton method as it is taught in the Botswana secondary schools’ subject of Design and Technology.



**Figure 1:** New product development model (Booz, Allen & Hamilton, 1982)

New product development is a complex task (Khan *et al.*, 2011; Edgett, 2014; Majava, 2014; Sarja, 2015), hence the need for determination and dedication. Not only is a product innovation model essential, but it should be a good quality one (Cooper, 2001). A product innovation model comprises the steps that one takes when developing with a product. For example, the Booz, Allen and Hamilton method (Figure 1), shows the traditional way of coming up with a new product.

A number of product innovation models are in existence and can be classified as those for developed nations and those for the ‘base of the pyramid’ nations. This is because no particular single model is sufficient in all situations. Multinational companies have premised their product innovation on certain models. For example, Toyota Motor Corporation utilises the Set-Based Concurrent Engineering (SBCE) product innovation model (Khan *et al.*, 2011). The model is coupled with other company-wide best practices to deliver high quality products (Liker & Morgan, 2006). There is scant literature on the use of innovation

models from the ‘base of the pyramid’ countries. On assessment of innovation, the Bogota manual bemoans the lack of innovation in the ‘base of pyramid’ countries and believe that the approach in those countries should be innovation teaching rather than assessment (Jaramillo, Lugones & Salazar, 2001). The teaching will result in standard indicators of innovation which can be quantified and compared across nations. For innovation teaching to be effective, first and foremost, the status quo should be established and intervention measures developed.

Product innovation approach or strategy is necessary as it is the basis upon which the company’s new product development is premised. The strategy forms the basis upon which the culture of the company is centred. To identify a firm product innovation approach, two things must be identified; i) the adopted product innovation model, and ii) the product innovation best practices. These two aspects have been gleaned from various studies. The same need to be established from local SMMEs to determine their innovativeness level and how that innovativeness or lack thereof is impacting on the business. To sum up the situation, a firm that has a positive product innovation capability will produce marketable products, thus translating into income and sustainable employment, whilst the opposite is true for a firm with negative product innovation capability.

### Research method

This paper explores the relationship between product innovation and how it could lead to job creation by Botswana’s SMMEs. The study was exploratory in nature as the area being studied has not been extensively studied. Holmes *et al.* (2013) made a number of recommendations to guide future job creation studies, some of which specify that; i) the study should be robust, employing both qualitative and quantitative approaches; ii) the study should evaluate job creation impacts in the medium and long term, rather than assessing immediate results. Accordingly, this study utilised both quantitative and qualitative approaches. The Raosoft online survey sample calculator was used to determine the number of participants for the survey. Since the population of Botswana is very small at about 2 million people (Worldometre, 2020), thus suggesting that the manufacturing entities will be fewer, the confidence level of 10% when the population is unknown was adopted. This gave a number of 96 SMMEs. The survey was meant to provide a snapshot of Botswana’s product innovation status quo, and also to identify firms which could be engaged for the qualitative aspect of the interviews. Wood, metal and leather processing are the main sectors adopted by SMMEs.

The survey questionnaire sought to establish the product innovativeness of Botswana’s SMMEs by way of establishing the procedure adopted when conceptualising their products. Botswana’s Local Enterprise Authority and Statistics Botswana, who are the custodians of SMMEs data, were contacted to get information on the locations of SMMEs. From the provided list, snowball sampling (Naderifar, et al., 2017) was used to identify other likely participants. A total of 96 questionnaires were administered in big villages and towns in the following areas: Maun, Francistown, Selibe Phikwe, Gaborone, Lobatse, and Kanye. The survey questionnaire had four sections: i) the company general background; ii) product innovation practices; iii) product innovation best practices; and iv) equipment owned. Fifty-four questionnaires were returned, equating to a 56% response rate. A structured, open-ended interview tool (Weller, et al., 2018) was also used to further interrogate respondents on what they answered on the survey questionnaire. This also aided in triangulation of tools, thus leading to conformability of the findings. A total of eight interviews were conducted.

### Results

The results to be discussed were obtained from the quantitative survey, and the semi-structured interviews. Figure 2 below shows an excel sheet of the computed average scores of the responses per participant from the survey on the following components: B1-11 (product innovation elements); C1 (product innovation best practices). The questionnaire attained a Cronbach’s alpha of 0.94, thus showing that it was credible.

CODE	CONTACT	B1	B2	B3	B4	B5	B6	B7	B8	B9	B10	B11	C1	AVERAGE	ROUNDED
FT1		0	42	89	39	78	67	20	42	0	20	22	25	37	37
FT2		0	67	67	50	89	67	20	17	0	40	39	29	40.4167	40
FT3		0	67	78	44	78	67	20	13	0	50	39	27	40.25	40
FT4		0	50	78	22	67	67	20	4	0	37	17	29	32.5833	33
FT5		25	50	100	94	78	67	20	17	20	57	61	27	51.3333	51
FT6		22	67	100	78	67	67	20	29	20	37	67	44	51.5	52
FT7		8	67	100	61	78	67	20	13	20	50	72	44	50	50
FT8		0	50	100	61	67	67	20	4	20	33	50	60	44.3333	44
FT9		0	42	78	28	78	67	20	8	0	27	44	33	35.4167	35
FT10		0	67	89	72	78	67	20	8	0	30	50	46	43.9167	44
FT11		0	67	89	56	78	67	20	8	20	50	100	63	51.5	52
FT12		0	50	89	33	67	67	20	8	0	37	39	56	38.8333	39
FT13		0	50	89	50	89	67	20	0	0	30	28	38	38.4167	38
FT14		0	25	78	33	89	67	20	4	0	23	17	17	31.0833	31
FT15		0	42	78	28	78	56	20	4	20	27	50	27	35.8333	36
FT16		17	58	89	61	78	67	20	4	20	40	56	29	44.9167	45
FT17		17	58	78	72	77	67	20	29	0	34	55	52	46.5833	47
FT18		0	33	89	56	78	67	20	0	0	23	33	42	36.75	37
FT19		0	58	66	66	24	67	20	0	0	23	33	50	40.6667	41
MN1		0	33	89	39	56	56	20	29	0	17	17	6	32.1667	32
MN2		0	67	89	33	67	67	20	0	13	17	17	60	36.5833	37
MN3		25	67	67	56	89	67	20	17	0	33	33	25	41.5833	42
MN4		25	67	67	39	67	67	20	56	33	4	0	23	37.0833	37
MN5		0	50	67	56	89	56	20	33	7	47	28	50	38.1667	38
MN6		25	42	67	39	100	33	20	38	0	30	0	31	35.4167	35
MN7		0	25	67	22	56	67	20	4	0	27	33	25	41.67	42
MN8		0	25	89	17	44	44	20	0	0	37	33	29	26.8333	27
MN9		0	67	89	72	78	67	20	8	27	47	61	50	48.8333	49
SP1		0	75	78	61	100	67	20	25	25	47	78	65	53.4167	53
SP2		0	58	89	44	67	67	20	4	0	33	39	54	39.5833	40
SP3		0	50	89	56	78	67	20	13	0	33	35	35	39.5	40
SP4		17	67	89	67	89	67	20	8	20	47	47	48	50.9167	51
PLN1		25	50	100	61	89	67	20	42	7	53	78	67	54.9167	55
TMG1		42	83	89	33	89	56	20	63	0	63	22	63	51.9167	52
GCN1		8	16	78	22	78	67	20	0	0	13	0	15	26.4167	26
GCN2		0	8	89	22	89	67	20	4	0	23	0	13	27.9167	28
GCN3		0	8	89	28	89	67	20	4	0	20	0	15	28.3333	28
GCN4		0	8	67	28	67	67	20	0	0	20	0	19	24.6667	25
GCN5		8	25	89	33	89	67	20	4	0	23	0	10	30.6667	31
GCN6		17	89	89	22	89	67	20	4	0	27	0	13	30.29	29
GCN7		17	33	89	50	89	67	20	0	0	20	0	15	33.3333	33
GCN8		0	25	89	28	67	67	20	0	0	23	0	13	27.6667	28
GCN9		0	33	89	28	78	67	20	4	0	27	0	10	29.6667	30
GCN10		0	33	89	33	89	67	20	17	0	37	11	13	34.75	35
GCN11		0	75	100	89	67	67	20	13	47	43	72	88	56.75	57
GCN12		0	75	89	78	100	78	20	63	0	40	56	40	57.6667	58
GCN13		0	17	100	39	78	33	20	3	20	23	0	17	28.9167	29
GCN14		0	67	100	67	100	67	20	35	0	70	50	56	58.25	58
GCL15		0	17	89	44	89	56	20	0	0	30	11	17	30.8333	30
GCL16		0	17	78	33	67	56	20	8	13	33	28	21	29.0833	29
GCL17		0	17	78	33	67	56	20	0	0	37	33	50	32.5833	33
GCL18		0	25	78	39	56	67	20	0	0	23	33	33	32.5833	33
GCL19		0	8	67	0	67	55	20	4	0	30	17	13	29.4167	29
GC20		0	17	89	0	67	56	20	4	7	37	17	21	27.9167	28
AVERAGE		5.2037	44.0185	83.8704	44.4259	76.963	63.037	20	14.6481	9.24074	33.7407	31.5	34.9259	38.4645	38
ROUNDED		5	44	84	44	77	63	20	15	9	34	32	35	38	38

### Firm background information

Regarding the background information of the enterprises, it shows 53 enterprises had 1-5 employees in business, and only one company had 6-24 employees (Table 1). This also shows that 98% of the enterprises who participated in the study were micro enterprises. The number of employees' question had four alternatives; 1-5 (scored at 25%), 6-24 (scored at 50%), 25-99 (scored at 75%) and 100 and above (scored at 100%). The alternatives implied that a company was either a micro, small, medium or large enterprise.

Table 1: Number of employees per enterprise

No of employees	1-5	6-24	25-99	100 and above
Number of enterprises	53	1	0	0

The collected results show that 98% (53 out of 54) of the firms were micro enterprises, having a staff complement of less than 6. It also shows that there was only 1 small enterprise and no medium and large enterprises in the sector under study.

The number of years in business question had four alternatives; 1-4 (scored at 25%), 5-10 (scored at 50%), 11-15 (scored at 75%) and 16 and above (scored at 100%). Only 13% had over 16 years in business (Table 2).

Table 2: Years in business

No. of Years	1-4	5-10	11-15	16 and above
Number of Enterprises	32 (59%)	10 (19%)	5 (9%)	7(13%)

This shows that the bulk of the firms (59%) were still in their infancy or start-up stage (1-4 years).

### Product innovation process

The second and third part (B1-B11 and C1) of the survey sought to find out the innovation capabilities of the SMMEs. The following factors (Section B - product innovation elements) formed the innovation framework of the SMMEs; B1- Product innovation model used; B2- Fuzzy front loading; B3- Conceptualisation driver; B4- Customer requirements; B5- Ideation; B6- Idea selection; B7- No of ideas per project; B8- Ideation enhancing strategies; B9- ICT tools used; B10- Development; B11- Pre-production; and C1 comprised of Product innovation best practices.

On product innovation practices (Section B), only one enterprise scored an average of 58% for all the innovation practices (B1 – B11, Figure 2) against the average score of 38%. Only 11 enterprises (20%) scored an average of 50% and above, whilst 43 enterprises (80%) scored below 50%. On product innovation best practices, the average score was 34%, thus showing a low performance across the board (Figure 2, C1).

### Product innovation best practices

Apart from the quantitative data, the study also used interviews and the questions were based on the best practices of large product manufacturing companies who were used as a benchmark to determine the gap between their practices and those of SMMEs. This is because in addition to a good quality product innovation practice, an entity needs some best practices to govern the operation of the innovation process. The best practices were obtained from the literature and these include: a) surpassing client expectations; b) infusing value opportunities; c) company strategy; d) time to market; and e) product differentiation; etc. Their application was tested with the SMMEs. These were collected and the average percentage score computed per participant.

Below are some of the findings from the participants:

a) Surpassing client expectations - Enterprises knew that they had to produce an attractive product, but not that it had to surpass the client's expectations. This is supported by the following participants: Participant FT3 and SP1 stated that;

*"We make the product more interesting so that word of mouth can be spread by the satisfied client"* (Participant FT3).

*"The product has to be a quality product, especially through craftsmanship"* (Participant SP1).

b) Infusing value opportunities - Enterprises were not aware of the various ways of infusing value opportunities into a product. For example, Participant GCL11 echoed that;

*"Making a quality product is central to value!"*

c) Company strategy - Of the 8 firms visited, only 2 had a company strategy as outlined in their product roadmaps and the company mission and vision statements.

d) Time to market - This was not seen as a necessary, high priority aspect by all companies. Their approach was not aggressive, which is attributable to the relaxed approach they have adopted. Participant GCL13 stated that;

“I usually agree on delivery times with my clients, and such depends on the size of the project.”

e) Product differentiation - Participants believed in producing a quality product and offering some limited after-sales services. The basics of horizontal and or vertical differentiation were not applied. Participant GCL11 supported the former by saying:

“Like I said previously, the quality of my craftsmanship speaks volumes of my products and I also act on feedback from clients.”

Section D sought to find out the equipment owned by the SMMEs. This was made to assist in evaluating if the equipment at SMMEs' disposal had any bearing on their innovative capability. The results show that most SMMEs had basic machinery such as grinders, drills, welders and compressors. These did affect their ability to mass produce considering the fact that state-of-the-art equipment puts one at an advantage when it comes to mass production, thus benefitting from the economics of scale.

#### Discussion

The sad reality that emerged from this study is that SMMEs were losing out on the bigger piece of the pie. The study has brought to the fore the unpleasant state of product innovation in Botswana's manufacturing SMMEs. The product innovation state is in conflict with the intervention measures provided by the government, as, for example, there were fewer people trained in product innovation though it was offered in the high school subject of Design and Technology. The findings also show that the scenario found in South Africa by Ngek and van Aardt Smit (2013), concerning the bulk of SMMEs employing fewer people, is also true for Botswana.

From the sectors of this study, leather manufacturing had the least number of firms. This is despite the country having beef as its major export, which should translate to availability of hides for leather processing. This could be helped by development of hide-processing industries so as to have cheap, readily accessible leather. The bulk of firms (59%) were still in their infancy stage (1-4 years) which was a red flag, as it points to low transition of firms to maturity. The new product innovation practices of SMMEs were seriously lacking and need some intervention. There was a tendency to carry out certain stages and leave out others. This occurred mostly because of a lack of knowledge of the importance of skipped steps. As regards the best practices to be observed during product innovation, there was lack of knowledge on their existence and their importance. This was also attributed to the outlook of local SMMEs as they were not focussing on the external market but only on a few local clients. This stifles innovative potential. Whilst it cannot be disputed that there was a dire lack of resources amongst these firms, the little they had had the potential to deliver good products. Botswana firms should be alive to the fact that international companies are unfazed by competition as they know that they are here to stay and the only way out is through innovation.

#### CONCLUSION

It is evident that SMMEs have a place in the Botswana economy as in other economies. They are able to provide valuable offerings to differing target markets. Despite the intense competition posed by imports they are not giving up as they believe they can obtain a portion of the pie. The interactions with participant SMMEs show that there is the potential to grow this sector if resources can be targeted at the right interventions; for example, product innovation. Interventions should have continuous monitoring and development to ensure they are up to date. Without good product innovation strategies in place, there is a high likelihood that the SMMEs' products will not appeal to the customers, hence there will be no market, and this will not assist in growing the enterprise. Lack of sales usually results in the winding up of the enterprise and retrenchment of employees. There is a need for the government and other stakeholders in Botswana to intervene and sensitise SMMEs in the area of product innovation, helping to build their capability to innovate. The prevailing state shows that the SMME products certainly are of low quality, and that is why they are facing difficulties in the market. This in turn means the producing SMMEs will not earn enough money to sustain their operations and will not be able to fund any further product innovation and/or grow the entity. Therefore, there is a need to develop programmes which will assist SMMEs to build their capability to produce innovative products and services. It is anticipated that this would lead to the development of the sector and it would become an engine for job creation as in other developed countries.

#### LIST OF REFERENCES

- Al-Haddad L., Sial S.M., Ali I., Alam R., Khuong N.V. & Khanh T.H.T. 2019. The role of small and medium enterprises (SMEs) in employment generation and economic growth: A study of marble industry in emerging economy. *International Journal of Financial Research*, Vol. 10, No. 6; 2019, accessed from <http://ijfr.sciedupress.com>.
- Botswana. 2019. *Promoting SME competitiveness in Botswana: A bottom-up approach to economic diversification*. International Trade Centre, Gaborone.
- Booz, Allen & Hamilton, Inc. 1982. *New product management for the 1980's*. Booz and Company, New York.
- Botswana Institute for Development Policy Analysis brief report. 2009. Retrieved April 18, 2020 from <http://www.bidpa.bw/Bbrief3.PDP>.
- Central Statistics Office [CSO]. 2007. *Labour Force Survey Report 2005/06*, Gaborone: Government Printers.
- Edgett, S. 2014. Innovation: A critical capability. *The European Business Review*, 10-12. Retrieved August 13, 2016, from [http://www.prod-dev.com/downloads/wp/wp\\_51.pdf](http://www.prod-dev.com/downloads/wp/wp_51.pdf).
- Holmes, R., McCord, A., Hagen-Zanker, J., Berg, G. & Zanker, F. 2013. *What is the evidence on the impact of employment creation on stability and poverty reduction in fragile states - A systematic review*. Accessed from <https://www.odi.org/sites/odi.org.uk/files/odi-assets/publications-opinion-files/8386.pdf>.
- International Labour Office (ILO). 2015. *Small and medium-sized enterprises and decent and productive employment creation*. International Labour Conference, Report IV, 104<sup>th</sup> Session, Geneva. [Online] Available from [https://www.ilo.org/wcmsp5/groups/public/---ed\\_norm/---relconf/documents/meetingdocument/wcms\\_358294.pdf](https://www.ilo.org/wcmsp5/groups/public/---ed_norm/---relconf/documents/meetingdocument/wcms_358294.pdf) [Accessed: 18 March 2020].
- Jin, B. 2020. *Industrialization of China*. China: Social Sciences Press.
- Jaramillo, H., Lugones, G. & Salazar, M. 2001. Standardisation of indicators of technological innovation in Latin American and Caribbean countries (Bogota Manual). COLCIENCIAS/OCYT. Retrieved from [http://www.ricyt.org/manuales/doc\\_view/149-bogota-manual](http://www.ricyt.org/manuales/doc_view/149-bogota-manual).
- John, P. & Mans, S. 2015. Is small beautiful? Small enterprise, aid and employment in Africa. *African Development Review*, 27(S1), 2015, 44-55. Accessed from <https://www.brookings.edu/wp-content/uploads/2016/06/12-learning-to-compete-page.pdf> [Accessed: 18 March 2020].
- Khan, M., Al-Ashaab, A., Shehab, E., Haque, B., Ewers, P., Sorli, M. & Sopelana, A. (2011). Towards lean product and process development. *International Journal of Computer Integrated Manufacturing*, 26(12), 1105-1116.  
doi:<http://dx.doi.org/10.1080/0951192X.2011.608723>.
- Liker, J. K. & Morgan, J. M. 2006. *The Toyota product development system: Integrating people, process and technology* (1st ed.). Productivity Press.
- Majava, J. 2014. *Product development: Drivers, stakeholders, and customer representation during early development*. Doctoral Thesis. Finland: Acta University.
- Mehrotra, S. & Delamonica, E. 2007. *Eliminating human poverty*. London: Zed Books Ltd.



- Ministry of Commerce and Industry. 1997. *Industrial Development Policy*. Gaborone: Government Printers.
- Ministry of Commerce and Industry. 1998. *Task Force on the Policy on Small Medium Micro Enterprises in Botswana*. Gaborone: Government Printers.
- Naderifar, M., Goli, H. & Ghaljaie, F. 2017. Snowball sampling: A purposeful method of sampling in qualitative research. *Strides Dev Med Educ*. 2017 September, 14(3):e67670.
- Ngek, N. B. & van Aardt, S. A. 2013. Will promoting more typical SME start-ups increase job creation in South Africa? *African Journal of Business Management*, 7(31),3043-3051.
- Pasnicu, D. 2018). Supporting SMEs in creating jobs. *Journal of Economic Development, Environment and People*, Vol.7, Issue 1, 2018. URL: <http://jedep.spiruharet.ro>.
- Reguia, C. 2014. Product innovation and the competitive advantage. *European Scientific Journal*, June 2014, Special Ed. Vol 1, accessed from <https://pdfs.semanticscholar.org/cd0e/15435f3e8b04804f56f3be91883fd4a84d68.pdf>.
- Reigner, A. n.d. *Creating employment opportunities and improving employability*. Berlin. Accessed from <http://www.oecd.org/cfe/leed/39985486.pdf>.
- Sarja, J. 2015. Explanatory definitions of the technology push success factors. *Journal of Technology Management and Innovation*, 10(1),204-214. Accessed from <http://www.scielo.cl/pdf/jotmi/v10n1/art15.pdf>.
- Siphambe, H.K. 2007. *Growth and employment dynamics in Botswana: A case study of policy coherence, policy integration and statistics*. Department International Labour Office Geneva. Working paper No.2, October 2007. Accessed from [http://www.oit.org/wcmsp5/groups/public/---dgreports/---integration/documents/publication/wcms\\_088432.pdf](http://www.oit.org/wcmsp5/groups/public/---dgreports/---integration/documents/publication/wcms_088432.pdf) [Accessed 15/4/2020]
- Sven, A. 2007. Product innovation process: Conceptual and methodological considerations. Licentiate Thesis, Lulea University of Technology, Sweden. Accessed from <https://www.diva-portal.org/smash/get/diva2:999162/FULLTEXT01.pdf>
- Weller, S.C., Vickers, B., Bernard, R., Blackburn, A.M., Stephen Borgatti, S., Gravlee, C.C. & Johnson, J.C. 2018. Open-ended interview questions and saturation *PLUS ONE* - <https://doi.org/10.1371/journal.pone.0198606>. June 20, 2018:1-18

9TH INTERNATIONAL CONFERENCE ON APPROPRIATE TECHNOLOGY

# KNOWLEDGE AND TECHNOLOGY

# LEARNING FROM THE GROUND UP: COMMUNITY-DRIVEN RENOVATIONS OF AN OCCUPIED BUILDING IN JOHANNESBURG, SOUTH AFRICA

Suzette van der Walt, Tshwane University of Technology, South Africa, [suzettevdwalt@gmail.com](mailto:suzettevdwalt@gmail.com)

Amira Osman, Tshwane University of Technology, South Africa, [OsmanAOS@tut.ac.za](mailto:OsmanAOS@tut.ac.za)

Afua Wilcox, Tshwane University of Technology, South Africa, [afuawilcox@gmail.com](mailto:afuawilcox@gmail.com) Abstract

## Abstract

*As part of a National Research Foundation (NRF) Community Engagement project, a collaboration between the Tshwane University of Technology and the University of Johannesburg in South Africa led to a collaboration with an NGO which was tasked to facilitate the implementation of construction work on an informally-occupied building in Bertrams, Johannesburg. Because of prescribed funding structures, which were based on an initial proposal developed by the project team, there was great pressure to achieve set milestones within the first year of the three-year project. Critical decisions had to be taken within tight timeframes; this was a learning experience for the team and a strategy had to be developed where progress could be made, while still achieving the intentions of community involvement and consultation. The management of the relationships between the professional teams and the target community was an important aspect to ensure the success of the project despite the time restrictions.*

*The project posed great challenges for the project team, mostly for those members of the team tasked on being at the frontline; what followed was a valuable experience, some difficult encounters, and many learning opportunities. This paper serves to capture and document these experiences and extract lessons for similar future projects.*

*Two major themes emerge from these explorations, one being that of problematic inherent power dynamics and the other being the important role of service learning in academia.*

*By pursuing community engagement projects, academics can command resources, affect change and promote practice that supports justice and empowerment of vulnerable communities. In doing so, these projects afford a voice and agency to those who are affected by historic spatial injustice. The power to effect this change and support this development, however, is due to the tacit power afforded these individuals and institutions. These projects may thus make us complicit in enforcing traditional economic and political power dynamics.*

*The paper concludes by stating that as long as we remain aware and critical of how we engage with community engagement projects in real settings with real communities, to allow us a testing ground for ways in which these dynamics may be addressed and how these processes may be improved and supported to ensure appropriate and professional interventions. In the process, we are able to deliver real, tangible services to communities, improve the negotiating power of these communities and ensure that our teaching methods and content remain relevant.*

**Keywords:** community engagement, self-help, renovations, occupied buildings

## INTRODUCTION

The discourse around grassroots driven development is largely in support of strategic and tactical human rights organisations who support the mobilisation and capacity building of community-based organisations and grass roots cooperatives who seek to advocate for their rights to housing and spatial justice (Mitlin, 2008; Appadurai, 2011; Baptist & Bolnick, 2012; Patel & Bartlett, 2016)

Often, the notion of ‘for the people by the people’ is romanticised and the involvement of professional or academic support in these movements is left out of the narrative to portray these groups as being purely grass-roots driven and thus somehow more notable. “Self-help” is the mandate of many of these organizations, and the extent of these energies can be seen to echo in many struggles of South African development discourse.

It is not to discredit the value the ability of these organisations to self-mobilise and the irrelevance of professionals and academia in these processes that this paper tells a different narrative, but rather to provide insight into a process where the academy and professional (through the authors’ hybrid representation of both) strategically channelled resources available to them because of their presence in these spheres to support this self-help, grass roots development.

This paper discusses the process undertaken to conceptualise, develop, implement and manage the upgrading of an occupied government-owned building, referred to throughout as Building-X. The residents do not pay rent or utilities and have no formal tenure. By occupying this building, they are in effect demanding their right to adequate, well located and inclusive housing. The renovation of the building reinforces two messages. Firstly, the residents of the Bertrams Priority Block are able to tactfully mobilise and improve their own livelihoods, and secondly, the interventions reveal that the residents are not resigned to a state of dependency and anticipation of state support without active participation.

The paper also shares the challenges and lessons the authors take away from the process, and makes recommendations for similar future engagements, acknowledging the valuable learning exchange that may occur when academia and professionals abandon traditional positions of authority and act with willingness to learn and to be useful.

## BACKGROUND TO THE PROJECT: BERTRAMS PRIORITY BLOCK

The suburb of Bertrams is located east of the Ellis Park Stadium in Johannesburg. The area was declared an affordable housing region for white mine workers in 1902. It devolved into slum conditions in the 1930s until the 1948 group areas act saw it declared a whites-only area with forced removals sending non-white occupants to respective racially-allocated townships (Stephen, 1988).

Although Bertams became more racially integrated as early as the 1970s, with the *White Flight* out of the city centre during the 1980s, the area became less dense and was not occupied by a black majority until the 1990s (Stephen, 1988). The phenomenon of landlords of inner-city buildings abdicating led to many of the buildings gradually falling into disrepair; rent was no longer collected and rates and taxes were no longer being paid. Eventually, they were considered to be illegally occupied and management fell entirely into the hands of the residents who formed informal cooperatives.



Figure 1a

In 2006, the Johannesburg Development Agency (JDA) began preparing the greater Ellis Park precinct for the 2010 Football World Cup, leading to the demolition of some buildings and the displacement of some of the residents (now scattered throughout Bertrams). The area was declared a new development zone with existing buildings to be reconfigured and empty plots to be developed into mixed-use affordable housing typologies (JDA feasibility study, 2018).



Figure 1: Aerial identifying the priority block and significant landmarks in the area. (JDA feasibility study, 2018)

The Bertrams Priority Block, so called by the JDA when the block was earmarked for development, consists of 21 erven, 10 of which are owned by the Johannesburg Property Company and serve as the starting point for the proposed development of the area. Towards the east of the block, medium residential buildings are occupied by rent-paying tenants. Further east are legally occupied private houses, many with small businesses operating from the premises. On the southern side of the block, some semi-detached single-storey homes have been turned into student housing by a private property developer. Erven 88-92 and erf 119 and 120 are owned by the City of Johannesburg. The remainder of the properties are privately owned, and their occupation status is assumed to be legal.

Despite the demolition of some of the structures and the development of student housing nearby, the priority block remains undeveloped and the residents are well mobilised in opposition to their eviction. This mobilisation partly stems from natural self-organisational structures within the community, but largely due to the strategic support from the Inner City Resource Centre (ICRC).



Figure 2: The highlighted erven comprise the Priority Block. Erf 90 & 91 house Josanna Court. (JDA Feasibility Study, 2018)

The ICRC has been supporting inner-city residents in their pursuit of adequate shelter, security, proper sanitation, and freedom of privacy for almost 20 years. Through engagement with the ICRC, the Bertrams priority block was identified as a suitable site for a design studio, where students were exposed to designing housing typologies within an inner-city context.

The ICRC often makes use of support from universities, a strategy for advocating for young professionals to understand the realities of the urban poor and a tactic to leverage the workforce, collective energy and power present in the academy. The team also included a partnership with 1to1 Agency of Engagement, a socio-technical support agency working with ICRC to facilitate building upgrades in the Priority Block.



Figure 3: The Facade of Building-X where residents have declared their intention to remain in the face of eviction (2019)

## HOUSING & URBAN ENVIRONMENTS (H-UE): A DESIGN STUDIO

The National Research Foundation (NRF) Community Engagement project presented in this paper is a collaboration between the Tshwane University of Technology and the University of Johannesburg in South Africa. The Community Engagement Project evolved from an elective design module hosted by the Architecture Department at the University of Johannesburg (UJ). The design module was situated within the Housing and Urban Environments (H-UE) Studio, a travelling studio initiated in the early 2000s at the University of Pretoria (Osman, 2016). The H-UE aims to introduce innovative thinking on urban housing. It also aimed to dissolve the distinction between architecture and urban design. In the H-UE studios, students gain exposure to real-life contexts and implemented real-life projects through the building of multi-year partnerships with proximate communities.

In 2016, it thus became meaningful to implement a H-UE studio at the UJ Department of Architecture as part of its elective system. This process was instituted to allow students to gain unique, subject-specific design experience. The design module was repeated over three years in different configurations as the elective programme was adjusted and improved upon. In 2017, the module was hosted twice during the year with almost 50 students completing the course. In 2018, another 45-50 students completed the course through participating in one of the two rounds of its offering. The final module was hosted for an entire semester in 2019, focusing on the Bertrams Priority Block within its precinct. This allowed for a broadening of the project and limited the repetition and overlaps with the outcomes of the previous iterations of the project. This is also a core focus of the H-UE studio which places emphasis on exploring the broader urban context as a critical component of the housing issue.



Figure 4: A Feedback workshop from one of the H-UE studios, with students and residents in attendance.

This particular project, as a component of the on-going H-UE studio, set out to investigate whether informally-occupied inner-city buildings in Johannesburg can become catalysts for inclusive housing, and contribute to discourse regarding housing that is truly inclusive, as opposed to the proudly loaded affordable and inclusionary housing policy that continues to exclude the lowest earners (Nkateko & Mthetwa, 2019).

## THE NATIONAL RESEARCH FOUNDATION (NRF) AND COMMUNITY ENGAGEMENT PROJECTS (CEP) AT UNIVERSITIES

Early in the engagement with the Priority Block and more specifically Building-X in the block, the project was registered as an official Community Engagement Project at UJ which opened the avenues for increasing the potential impact by what could have remained a purely academic inquiry. This also ensured its legitimacy and endorsement by the University which helped achieve recognition for the project and ensure additional support and financing through the NRF Community Engagement Programme, from where a call circulated in 2018.

The value of universities' engagement in community-based projects is significant in the careers of staff who, to a degree, can remain present in practice while their focus remains on academia. These projects expose students to real life contexts, engagement with real clients/users and allow for the focus of the architectural pedagogy to include the qualitative aspects of design, which is often only achievable through "life experience, something that cannot be taught in a classroom" (Fisher & Clarke, 2011). Such projects also have the potential to positively impact the spaces and residents where the projects are located, improving relations between institutions and the city.

The inherent problematic power dynamics that emerge are acknowledged by the project team. Academics and institutions can command resources that are not available to those who are negatively affected by historic spatial injustice. This places academics and researchers in a position where they can become allies for equal rights to space and opportunity in the city. If not handled carefully, this power and authority could be used to further reinforce existing economic and political power dynamics.

To address these imbalances, the project team adopted an approach of service learning, premised on the principles of community engagement defined by PennState College as a right for all community members to be consulted and involved; the team also set out to establish trust between the different stakeholders (PennState College of Agricultural Sciences, 2020). Our adopted research method could be defined as "community-based participatory action research", a methodology which considers both the education of the research team as well as the participants (Herr & Anderson, 2015; p67).

Because of prescribed funding structures, which were based on an initial proposal developed by the project team, there was great pressure to achieve set milestones within the first year of the project. Critical decisions were taken within tight timeframes; this was a learning experience and a strategy had to be developed where progress could be made while still achieving the intentions of community involvement and consultation. The management of the relationships between the professional teams and the target community was an important aspect to ensure the success of the project despite time restrictions.

### THE 2019 CRITICAL DELIVERABLES – IMPLEMENTATION OF THE PROJECT

As part of the 2019 design module within the annual H-UE studio, a snag list of Building-X was created by the students detailing the critical design and structural problems in the building. A list of critical interventions was developed, and the studio coordinator and the students prepared drawings for the renovations. The planned interventions prioritised the safety and liveability of the building with these being considered the key aspects to be addressed in the first year of funding. In October 2019 1to1 Agency of Engagement (represented by Suzette van der Walt) was appointed to facilitate the implementation of the building work which commenced on the 21<sup>st</sup> October 2019. The following critical deliverables were decided:

#### 1. Roof to be made waterproof

The concrete roof slab (was not adequately protected from water penetration) and had begun to suffer structural damage due to long periods of being waterlogged and subsequent delamination of the reinforcing from below. This is above the obvious damage to residents' belongings and health risks of living in damp spaces below.

#### 2. Exposed electrical wires to be made safe

Several electrical connections from the building's main supply ran haphazardly across the surface of the roof, partially submerged in the layers of sand. The wiring would have to be removed to address the roof and would have to be reinstated in a manner that is safe and insulated.

#### 3. Fire Escape to be made safe

The steel fire escape staircase, which provides access to the roof level (which has rooms occupied by residents, washing lines and ad hoc social space) had been eroded over time. Loose, missing and smoothly worn tread required replacement and repair. In places, the bolts of the balustrades had pulled away, adding to the falling hazard.

#### 4. Balustrades to be made safe

Attention to an additional falling hazard in the form of damaged brick balustrades along walkways and balconies was also prioritised.

The preparation for site work involved understanding the design proposals, sourcing materials, revisiting proposed solutions, meeting with engineering professionals on site and assembling the team of resident volunteers who would be executing the work. Despite taking the time to prepare beforehand, the nature of the project saw strategic, ad hoc decisions being made on site with off-site support from the other members in the form of design guidance and financial management.

### CHALLENGES OF ENGAGEMENT – THE IMPORTANCE OF EXISTING NETWORKS

The residents of Building-X had already been self-organised and mobilised through support from ICRC. The density of the area also made the student/resident ratios more favourable for an exchange, which was a carefully curated to avoid overwhelm by either group. It is also believed that engagement over time builds the much-needed trust, a condition for success of community engagement projects (Hamdi, 2010).

Initial engagement with the residents of Bertrams priority black, in particular, the residents of Building-X, was arranged by the ICRC who facilitated the meetings, introductions and were present at student site visits and workshops. Without this facilitation, it would most likely not have been as smooth an engagement process. Over time, the project team built their own relationship with the residents and the need for a facilitated exchange was no longer necessary. A rapport was established with the residents and the project team.

One of the challenges that emerged was that of space: it was important to carefully consider the size of student groups so as not to overwhelm the spaces and residents. The students needed to be briefed on how to interact respectfully and not to be noisy or intrusive, bearing in mind that these are private residential spaces.

The project team also learnt to favour good working relationships rather than the product of their work. This was especially important to consider when new students or team members were introduced to the project.

Throughout the implementation of the construction work, despite the basic tasks associated with managing a construction project (administration of funds, design development, logistics etc.), the challenge of ensuring resident buy-in was created and maintained, remained a major portion of the challenge. Intuitively, the authors favoured beginning with the large tasks first, ones that involved maximum resident participation as an attempt to achieve a few things. These were to:

- Ensure maximum buy-in from residents through a *grand gesture*.
- Ensure that the maximum number of volunteers be included and involved as well as benefit.
- Attempt to complete large portions of work first, in the anticipated event that volunteers may lose interest over time.

This approach led to the work being executed in an untraditional manner; the first tasks were not necessarily the most critical. But this decision also afforded the opportunity to contemplate more complex tasks, source materials, suppliers, and professional support. During this initial time, while brickwork (the largest of the tasks) was ongoing, additional professionals, private sector construction companies and material suppliers were consulted.

## PAID LABOUR AND SKILLS DEVELOPMENT AS A MECHANISM OF ENGAGEMENT

Many of the residents of Building-X are unemployed. The key project partner, ICRC, promotes the concept of ‘self-help’. These two factors led to the consideration of community-driven building upgrades as a sensible avenue for the implementation of the building repairs. Skills audits and training thus became an important component of the project. It was also an opportunity to support the community through offering compensation for participating in the project, a decision which led to a host of other challenges.

It was agreed early in the process that, to improve the impact of the funding, volunteers would receive an honorarium for their time and work on the project as well as daily lunch. This nominal compensation was intended to correct the traditional power dynamic of external parties expecting service of *the community*, and to express appreciation for the willingness of the volunteers to forfeit other income earning opportunities that may present themselves during the implementation of the project. As usual, however, when money begins to change hands, certain challenges emerged which will need to be managed in the future:

- *Payment* in the construction industry occurs weekly as wages. Since this was an expectation, it was complex and difficult to navigate, largely because of how research funding works (on a claims basis), whereas payment of wages requires a degree of upfront cashflow.
- Once obliging to make the first weekly payment, the precedent had been established and it became difficult to maintain the correct pace of work on site, as there hadn’t been an agreed time per task, which can be attributed to lack of experience in managing construction work.
- A final issue that was raised in informal discussion between ICRC and 1to1 was that the ICRC relies heavily on a ‘self-help’, a ‘do it yourself model’; the organisation has a good relationship with the residents who are supported through the organisation. The residents volunteer with the knowledge that their work is for their own benefit. The danger of an external party such as an academic-driven research initiative providing payment (albeit small), is that it could set a precedent that makes ICRC’s request for volunteer labour difficult in the future.

The expectation was for a local contractor to provide skills training and certification to volunteers. Unfortunately, due to his other work commitments he could offer less than a few hours’ guidance and oversight, the nature of his work being that any time spent away from a paying construction site was money lost. Fortunately, one of the residents was a skilled bricklayer and he quickly stepped in to take the lead on the work and guide the other volunteers in how to further improve their existing skills. Volunteering was open to all interested residents of the Priority Block and those identified through a skills audit. The audit revealed that the majority of the volunteers were already fairly capable in the skills required; a value-add to be considered is a formal certification of participation in the training process that might lend legitimacy to their skills when looking for future employment.

The notion of learning and skills development is highly politicised in South Africa (Lubner, 2017). As an attempt at economic redress, skills development is becoming a universal agenda in industry. The idea that academics and architectural professionals are able to provide training in construction skills or certification of these skills claims a degree of expertise that we do not necessarily possess. Additionally, it is most likely not the absence of skills that results in the unemployment of under-resourced urban residents but the absence of opportunities (e.g. transport or awareness of available work), formal qualifications or necessary permits relating to work (in the case of foreign nationals, for example).

Perhaps the reality is that the usefulness of skills training lies not in the perpetuation of construction sector level skills (which are simple, easy to learn and not in need of formal qualifications per se). Perhaps the real value in learning these skills may be for academics and professionals to learn these skills in order to gain an appreciation for the theoretical knowledge being turned to practice?

## THE ACADEMY AS AN AVENUE FOR IMPACT (AND THE RISKS TO BE MITIGATED)

Exposing students to real-world scenarios, wherein the urban realities of the relevant themes in are studied, is incredibly important and the complexity of these realities can often be understood only from real life experience since they are difficult to teach and require an empathetic response that cannot be taught in a classroom (Fisher & Clarke, 2011). Thus, there lies immense value in Community Engagement projects and socially responsive studies for students (especially in the spatial disciplines). Combrinck (2018) articulates that the importance of balancing a traditional design process with grounded knowledge of the complexities of real-world conditions (informed by thorough research into relevant conditions) is critical in the South African context. She continues that these conditions teach students the valuable skills of weighing resources, goals and needs which is invaluable in the architectural profession today.

The importance of exposing students to, and grounding their studies in, these realities and advocating for more socially engaged practitioners is one thing; but what of the academy itself? It is not uncommon that lecturers are expected to have practised in the disciplines either before or while simultaneously being in the academy. However, realistically, the demand placed on academics often sees them withdraw from practice to focus primarily on teaching and research outputs. Although this produces full-time academics who are dedicated and committed to furthering knowledge, there is an obvious risk of losing touch with research by practice which would allow them to maintain community engagement projects.

The benefits for students to learn about complex situations and develop an empathy in harsh realities is not lost on the academics who are able to engage with their students in these spaces or as part of furthering their research outputs. It is important to leverage research activities in a manner that is socially responsive and achieves impact through knowledge exchange, while also instilling a degree of humility in the academic and professional, who sees the exchange as one of mutual learning: “this process could contribute to the development of a more enlightened approach to professionalism – challenging elitist, expert-driven approaches of the past” (Osman, 2007).

Opper (2014) describes how the *Informal Studio*, a project for Master of Architecture students, which was critically grounded in the real-world context of Johannesburg, allowed for meaningful engagement with the landscape of the city (historic issues, existing inequalities, and spatial disconnects). He speaks not only of the value of this for students as outlined by Combrinck (2018) and Osman (2007) but also for creating relationships between professionals and the university, the university as an entity within the city and the residents of the city, and between different departments in the university.

The notion of academics using both the world as a testing ground and contributing to it is engrained in the practice-led research that occurs when academia engages with real-world scenarios. This allows new thought to occur in a less urgent context (as opposed to traditional practice where clients and costs are the major drivers) allowing for experimentality in how design responses are developed and implemented (Blass & Hayward, 2014). The interdisciplinary nature of these academic exercises allows collaboration between different academic streams of inquiry (e.g. engineering and architecture) which is uncommon in the academy. Additionally, the introduction of multiple years and fields of study allows for lateral learning where students learn from one another and facilitators learn from the students.

Furthering his work on the value of bringing the design studio into the city, Opper (2014) introduces ideas of coproduction and the support professionals (and by extension students and academics) can lend to self-organised groups in their plight regarding housing – specifically in the South African context where informality is most often the response to perpetual spatial inequality which manifests, among others, as a severe housing shortage.

Writing about the potential of self-organised citizen organisations spatial development in their plight, Mitlin engages with the role of professionals (2013) and her own role as an academic (Mitlin, 2008) to be supportive and legitimise these movements. She muses about the possibility of practitioners, who are willing to engage in a process of co-learning and abandoning their reputation as technocrats, to be able to engage in the political nature of issues such as the housing demands of self-organised groups (Mitlin, 2013). She describes this role as being supportive of creating relationships of trust and able to elicit meaningful production of new ideas and practices, which speaks to the very nature of innovation and which is required at design schools to push the boundaries of the field (ibid.).

Before one can interrogate the best position for professionals and academia in supporting grass roots initiatives, it is important to understand, even if only broadly, how mobilised grass roots movements typically operate. As an example, Slum Dwellers International (SDI) provides an insightful framework into how well functioning grass roots or community-based organisations can mobilise at scale to amplify the impact of bottom up development processes. Through exchanged data and information, the impact of a single organisation can be echoed by the impact of others and their association with one another. The SDI is only a single example of such a network; many others operate adjacent to it on a global or national scale. The similarity between many of these networks is that, despite their portrayal as a network of community based people-for-the-people organisations, they do not primarily represent the urban poor. The SDI definition of a mature affiliate federation is one where the federation has begun engaging successfully with its government to secure and develop land for the urban poor. This definition, in itself, implies that the mandate of SDI and its affiliates is intrinsically linked to a process of cooperation and engagement of outside stakeholders. In fact, to create useful relationships that benefit their constituents, *SDI engages with governments, international organisations, academia and other institutions* (Slum Dwellers International, n.d.). The belief is that these tactical partnerships allows situations to unfold wherein *the urban poor are able to play a central role in “co-producing” access to land, services, and housing* (ibid.).

The ICRC itself began as a citizen-led human rights organisation advocating for housing rights and rallying against unconstitutional evictions and poor treatment of immigrants etcetera. Under Shereza Sibanda, who began a self-funded organisation in 1995, the organisation has grown from strength to strength. Sibanda speaks of the value of early support by the Centre of Applied Legal Studies (CALS) at WITS, an example of a hybrid professional and academic collaboration in support of community-based action (Sack & Tshuwa, 2013).

Sibanda is a passionate and tactful master who uses her own experience as an inner-city resident to support the organisation and mobilisation of other under-resourced inner-city residents. A critical element of this self-organisation at the grass-roots level is the tactical partnering with other reorganisations or individuals, which often exchange learning opportunities for humanpower or resources (Vardy, 2009). Sibanda, for 20 years, has enjoyed using selective partnerships with professionals and academics willing to support her work to advance the interests of the ICRC to an organisation with several victories during its 20 years of existence.

Consultation with the ICRC representative throughout the renovation of Building-X was instrumental. Her understanding of the dynamics of the communities of the inner-city occupier and individual livelihood struggles were used to inform how the project proceeded. It was her decision to offer Building-X as a site to the H-UE studio, because she realised that by allowing students and the university into the space she could leverage the energy (and other resources) that stems from the academy to serve the interests of the ICRC, that of making the spaces in which their supported inner-city residents live safe and habitable. This touches on concepts mentioned by Opper (2014) who speaks of the importance of working with and through existing community networks in Ruimsig to ensure that the Community Engagement project remained relevant to the residents, although not always following the anticipated trajectory of the learning experience of his students.

When the architect becomes a researcher/learner, contractor and community engagement practitioner, there is a surrendering of traditional authority and power in favour of a co-produced product where everyone works together to try to best solve the challenges with the given resources at hand. The academic in a community engagement project must adopt a receptive and explorative approach, where experimentation and testing allows for learning and an exchange of information with community members.

### LESSONS FOR FUTURE COMMUNITY ENGAGEMENT PROJECTS

Academics and researchers can command resources which can be harnessed to effect change in the lives of vulnerable communities. The tacit power afforded these individuals and institutions may lead to reinforcing traditional economic and political power dynamics. Yet, the importance of service learning compared with traditional methods of education cannot be undermined. Service learning offers an opportunity to deliver real, tangible services to communities, to improve their negotiating power and ensure that the teaching methods and content remain relevant.

Having said that, and based on the experience of this particular project thus far, there are some important considerations to take into account:

1. It is critical, when embarking on CEPs, to work within existing networks – time must be set aside to understand the existing dynamics and relationships and to build trust between the various stakeholders.
2. Suitable ethics and sensitivity briefings must be included in the preparation of researchers who will enter these spaces. This may be carried out collectively with community and HROs to ensure a well-rounded understanding of the expected behaviour is developed.
3. While the project may set out with a clear vision, it is important to remain agile and flexible – adaptability may be the best way to ensure that stakeholders remain on-board – even if this leads to some delays in implementation. This buy-in ensures continuity and the sustainability of the project – it also helps in generating trust among the stakeholders.
4. Participation in decision-making and skills development is key in CEPs; yet both pose difficult challenges and they may be perceived to be condescending ways of assuming power over those who do not necessarily lack knowledge or skills but merely their access to resources or agency. Skills audits may also lead to the creation of differences and hierarchies within the community that might disrupt existing power structures, which needs to be handled with great sensitivity.
5. Clarity needs to be ensured between the team members and the community about when payments are made for services and when a service is to be offered voluntarily. Expectations need to be managed and the roles and responsibilities must be clearly communicated. While payments can and should be made in some cases, it is important to note that volunteerism and self-help is the mandate of many organisations that we partner with, and consultation and co-development of a suitable remuneration system beforehand is critical.
6. It is important to harness the will of many different participants who may have an interest in or benefit from participating; for example, the private sector is often willing to be involved in CEPs, either for altruistic intentions or for meeting Corporate Social Responsibility targets and tax benefits.
7. It is important to maintain the essence of CEP and not to exploit the poor for research gains or to ‘build a career’ out of community engagement – this is easier said than done as it must be declared that there are career benefits for academics and researchers who work in contexts of poverty.

In society, the degree of respect and rapport commanded by tertiary institutions resonates throughout. This perception that academic institutions are to be respected, though often grounded in false beliefs of grandeur of the academy, afford it a degree of power that cannot be obtained by other means. Within the academy, this power affords academics the ability to channel funding opportunities like that of the NRF to make a contribution to their fields and improve the conditions for other academics and their students. Outside of the academy, these resources, if channelled correctly, possess the potential to exert a large impact on the city. For academics concerned with the manner in which cities function, it is tempting to channel these resources towards this impact.

Haphazard experiments within the real world may lead to unstructured learning outcomes and engagements with the city (and its people) that are harmful to the students and the communities in that it may create tensions, conflict and unnecessary harm to livelihoods. Apart from these short-term risks, a haphazard inflow of resources (through time, money, knowledge) may be inefficiently contributing to these spaces and the lives with whom projects engage, in a way that limits the degree to which the input of resources might catalyse future change. To introduce resources into circumstances in a way that doesn’t add value is to do a disservice. It is akin to mining for resources with no regard for the environment in that the wealth that academics extract from these engagements has endless potential for growth in the form of academic publications and providing subject matter for performing the duties of teaching students. It is only ethical to be aware and careful of the impact these engagements have beyond the classroom and the discourse, on the lives of those involved.

To maintain long-term impact and an involvement in these networks is also beneficial to the academy in that it allows for repeated engagements, it allows for the ability to track and monitor change over time and for research to build on research – thus enriching the quality of the experiment as well. However, as with all experiments it is critical that we remain conscientious with how the experiment is developed, facilitated, and documented.



## CONCLUSION

The experience of developing and implementing a CEP in the Bertrams Priority Block has thus far been an incredibly rich learning experience for the authors who are not only convinced of the value of their engagement in real-world contexts as a means to provide learning opportunities for their students and themselves, but also as a way to support their beliefs in the advocacy for inclusive housing. To abandon one's role as a professional with the ability to effect change by adopting the role of an academic who is merely critical without being engaged is to do a disservice to one's own learning and to society. In the perpetually unequal South African urban context, it is critical that those of us who believe in the power of spatial intervention to effect positive change use our skills and knowledge as well as access resources to achieve the second layer of impact on society beyond that of facilitators of learning for future practitioners.

However, it is important that we remain critical of our roles and expertise as well as our privilege as well as understand and respect existing networks and the power of agency as a device for societal change. We must acknowledge that there is as much to be learnt from these engagements as there is to be contributed. By adopting the practice of service learning, with acknowledgment of the inherent skills and resources that we may contribute, we are able to learn and support simultaneously and through creativity co-develop new ways of practice that allude to new strategies and methods for how spatial inequality in South Africa may be.

## LIST OF REFERENCES

- Combrinck, C. (2018). Socially responsive research-based design in an architecture studio. Appadurai, A. (2011) 'Environment and Urbanization Deep democracy : urban governmentality politics', *Environment and Urbanisation*, 13(2), pp. 23–43. doi: 10.1177/095624780101300203.
- Baptist, C. and Bolnick, J. (2012) 'Participatory enumerations, in situ upgrading and mega events: The 2009 survey in Joe Slovo, Cape Town', *Environment and Urbanization*, 24(1), pp. 59–66. doi: 10.1177/0956247811435888.
- Blass, E. and Hayward, P. (2014) 'Innovation in higher education; will there be a role for "the academe/university" in 2025?', *European Journal of Futures Research*. Springer Science and Business Media LLC, 2(1), pp. 1–9. doi: 10.1007/s40309-014-0041-x.
- Hamdi, N. (2010) *The Placemaker's guide to building community*. Oxon: Earthscan.
- Lubner, M. (2017) 'OPINION: How we can fix South Africa's skills development crisis', Independent Online. Available at: <https://www.iol.co.za/business-report/opinion/opinion-how-we-can-fix-south-africas-skills-development-crisis-11891803> (Accessed: 18 May 2020).
- Mitlin, D. (2008) 'With and beyond the state - Co-production as a route to political influence, power and transformation for grassroots organizations', *Environment and Urbanization*, pp. 339–360. doi: 10.1177/0956247808096117.
- Nkateko, M. and Mthetwa, A. (2019) 'The City of Johannesburg takes a cautious step towards...'. *Daily Maverick*. Available at: <https://www.dailymaverick.co.za/article/2019-03-15-the-city-of-johannesburg-takes-a-cautious-step-towards-inclusionary-housing/> (Accessed: 18 May 2020).
- Patel, S. and Bartlett, S. (2016) "'We beat the path by walking" Part II: Three construction projects that advanced the learning and credibility of the Indian Alliance', *Environment and Urbanization*. SAGE Publications Ltd, 28(2), pp. 495–514. doi: 10.1177/0956247816644399.
- PennState College of Agricultural Sciences (2020) What is Community Engagement? — Center for Economic and Community Development, Centre for Economic and Community Development. Available at: <https://aese.psu.edu/research/centers/cecd/engagement-toolbox/engagement/what-is-community-engagement> (Accessed: 20 April 2020).
- Frontiers of Architectural Research. <https://doi.org/10.1016/j.foar.2018.01.002>
- Fisher, R., & Clarke, N. (2011). RED in architecture - an ecotropic approach. 0–3.
- Mitlin, D. (2013). A class act: Professional support to people's organizations in towns and cities of the global South. *Environment and Urbanization*, 25(2), 483–499. <https://doi.org/10.1177/0956247813488862>
- Opper, A. (2014). Productive Leakage and the Folding of the Studio into the Field. In *SLUM Lab. Sustainable Living Urban Model. Made in Africa.*, 9, 141–142.
- Osman, A. (2007). Building a bridge from the studio to the townships. *Innovate*, 2, 26–30.
- Osman, A. (2016). H-UE | Housing & Urban Environments. *Housing & Urban Environments*. <http://h-ue.co.za/>
- Sack, M., & Tshuwa, L. (2013). Interview with Shereza Sibanda Shereza. In C. Bénit-Gbaffou (Ed.), *Community activists tell their stories: Driving change in Johannesburg & Ekurhuleni* (pp. 71–84).
- Slum Dwellers International. (n.d.). Our Practices for Change - Know Your City - SDI. Retrieved April 13, 2020, from <http://knowyourcity.info/our-practices-for-change/>
- Stephen, P. (1988). Racial Residential Integration in Bertrams, Johannesburg. *South African Geographical Journal*, 70(1), 69–72.
- Vardy, S. (2009). Spatial agency: Tactics of self-organisation. *Architectural Research Quarterly*, 13(2), 133–139. <https://doi.org/10.1017/S1359135509990224>

# THE SIGNIFICANCE OF MATURITY MODELS APPLICATION IN MANUFACTURING TOWARDS ADAPTATION OF INDUSTRY 4.0: A REVIEW

Meshack Mazibuko<sup>1\*</sup>, Lagouge Tartibu<sup>2</sup>, Robert Mutyavavire<sup>3</sup> and Able Mashamba<sup>4</sup>

<sup>1,2,3</sup>Department of Industrial and Mechanical Engineering, University of Johannesburg, South Africa

<sup>4</sup>Sesiway Engineering Pty Ltd, South Africa

e-mails: meshaelmazibuko@gmail.com

## Abstract

*Industry 4.0 comes with complexities that require new business strategies to be developed and deployed, not only at a technological level but also across the entire value chain. The main focus of Industry 4.0 is to connect every aspect of the value chain holistically with the goal of promoting flexibility and agility for better response to internal and external matters of the business as well as to changing customer demands. Contemporary business strategies and their rigid business hierarchies will be defied by Industry 4.0. For manufacturing entities to remain abreast of the dynamics of the latter, they will be forced to perform introspection on their current business operations, especially if they still desire to remain relevant to current and future customer requirements. The implementation of Industry 4.0 and its scope is highly dependent on the entity's capabilities, thus assessing the current state of the company is critical for its survival. Prior to transforming and transitioning contemporary manufacturing companies towards Industry 4.0, each company should first assess its present state before leapfrogging to its desired future state capabilities. The application of maturity models can assist companies in this regard. Maturity models as tools of assessment play a vital role in helping companies in assessing their status quo and determining their own competitive path in the market rather than assuming that they are prepared for anything. Thus as most companies are preparing and planning for transitioning towards Industry 4.0, the use of maturity models can enrich their decision-making process. This paper highlights the significance of utilizing maturity models as a tool of assessment in preparation for Industry 4.0.*

**Keywords:** Decision-making, Industry 4.0; Industry 4.0 pillars, manufacturing, maturity models.

## INTRODUCTION

The concept of a fourth industrial revolution (4IR) was proposed and launched in Germany a decade ago, as Industry 4.0. Industry 4.0 has become the main focus of manufacturing organizations, academics, and research centers. The contemporary manufacturing philosophy is undergoing tremendous transformation. 4IR was initiated by the advancement of information and communication technologies (ICT) (Rojko, 2017). Industry 4.0 is a subset of the 4IR, initially developed for manufacturing industries. Industry 4.0 envisions a new approach to business operations for production industries (Erol, Schumacher and Sihni, 2016). Industry 4.0 is built on the digital capabilities of the third industrial revolution (Schwab and Davis, 2018). There are several pillars of Industry 4.0 which include Big Data and Analytics, Autonomous Robots, Simulation, Systems Integration (both horizontal and vertical), Industrial Internet of Things, Cyber Security, Cyber-Physical Systems (CPS), Cloud, Additive Manufacturing and Augmented Reality (Erol *et al.*, 2016). However, Industry 4.0 is not only a technologically-driven revolution, but a system that integrates customized production models, digital products and

real-time interactive services (Schwab and Davis, 2018; Zhou, Liu and Zhou, 2015). Manufacturing industries must move beyond technological innovation alone, but include their organizational structures, business processes, and newly introduced business models and development of employee skills (Erol *et al.*, 2016).

The 4IR presents the manufacturing sector with new challenges arising from environmental, societal, economic and technological advancements (Schumacher, Erol and Sihni, 2016). In order to successfully meet these challenges, the manufacturing sector is required to develop new capabilities to manage the entire value chain, (Schumacher *et al.*, 2016). At this moment, some manufacturing organizations are anchored in the third industrial revolution.

As the journey has already begun for most countries in preparation for Industry 4.0, the South African manufacturing sectors should embark on transitional strategies and models towards Industry 4.0. Industry 4.0 enhances global competitiveness (Pillay, Ori and Merkofer, 2017). However, the road to success towards Industry 4.0 cannot be haphazardly executed without properly assessing the “as is” and the desired future success state of the organization. As the concept of Industry 4.0 is currently at an inception stage for most manufacturing organizations, there is a need for an assessment of an organization's capabilities for transformation towards Industry 4.0 status (Schumacher *et al.*, 2016). Therefore, the purpose of this paper is to review the literature on the significance of maturity models in planning and decision support for manufacturing industries seeking Industry 4.0 status.

## LITERATURE REVIEW

### Maturity Models

Maturity in a system can be understood as a progressive development of a system from its inception stage to its end-stage, with the end-stage implying the “desired future state” of the system. The system is said to have reached its full-grown state when it has reached its end-stage (Simpson & Weiner, 1989). A maturity model is a tool that assists an organization to achieve its end-stage as dictated by the people's culture, processes/structures, and objects/technologies, etc. The model should be made up of sequential steps that can be easily followed by users (Mettler, 2011). Prior to reaching a full-grown state, an organization must undergo various stages of growth also known as maturity levels (De Carolis, Macchi, Negri and Terzi, 2017). The growth levels are: (a) sequential in nature; (b) their occurrence is in a form of hierarchical progression, which can be hardly reversible, and (c) their evolution contains a variety of organizational activities and structures (Baumgartner & Ebner, 2010). The bottom level in the maturity model represents the initial state characterized by having less capability in the domain, whereas the highest level represents a conception of complete maturity (Becker, Knackstedt and Pöppelbuß, 2009). The levels or stages are vital components of a maturity model as they also include a scale range within their development levels to aid users in tracking their progress (Schäffer, Leyh, Bley and Schimmele, 2018).

Furthermore, the intent of these levels is to assess the fullness of objects (organizations or processes) as analyzed through diverse criteria. The assessment provides the organization with an overall state of progress towards the end-state (Becker *et al.*, 2009). Specification of the criteria is critical to proper assessment. Apart from the criteria, the maturity model should have characteristics that it must fulfill to reach the desired maturity level (Becker *et al.*, 2009). The identified characteristics are evaluated for purposes of highlighting suitable customized maturity level for the organization.

The maturity model is a vital instrument utilized to characterize the current system (Becker *et al.*, 2009 and De Carolis *et al.*, 2017). Maturity levels include information such as a descriptor (a meaningful name that is given for each level), characteristics descriptions (summary of each level based on the characteristics), number of dimensions (identified process areas), number of elements and individual activity description (activities that should be performed at each level of maturity) (Fraser, Moultrie and Gregory, 2002).

Maturity model purposes are categorized under three areas of application which include, descriptive purpose, prescriptive purpose and comparative purpose (De Bruin *et al.*, 2005). The descriptive purpose is used as a “diagnostic tool” for assessing the “as-is” state of the organization or process, where the current capabilities of the organization that is investigated are assessed with respect to given criteria (Becker *et al.*, 2009). This type of model is practically useful at the initial stage where the organization is clueless about its maturity level and does not know where to begin with an assessment. The prescriptive purpose provides the organization with an indication of how to identify the desired maturity level as well as the guidelines that should be followed when implementing improvement measures (Becker *et al.*, 2009). This type of model is applicable once the organization has assessed its current state and now begins working towards achieving the desired future state. The comparative purpose is focused on enabling benchmarking to take place

across industries or companies. These types of models often compare similar practices across industries with the intent of benchmarking maturity within various industries (De Bruin *et al.*, 2005 and De Carolis *et al.*, 2017). Although the comparative model is useful in practice, it usually poses challenges across the business spectrum as most organizations might be threatened in allowing their information to be used by other organizations or their competitors. The application of these three model purposes should not be thought of being distinct from each other but users should understand that they are interlinked and complement each other at different stages of application.

#### Significance of maturity model application in Industry 4.0

Current business dynamics are such that organizations are under constant competitive pressure, therefore, there is a need for new maturity models to be developed as they support decision-makers to manage these dynamics (Mettler, 2011). Furthermore, the requirement of new maturity models will not diminish, provided they continue supporting decision-makers (Mettler, 2011). As it was in the 1st, 2nd and 3rd industrial revolutions, organizations have been faced with challenges of introducing new business models that led to new maturity models being developed to assist organizations to gauge themselves and better prepare for the future needs of both the organization and that of its customer. The application of maturity models can significantly contribute to the planned transformation of an organization as well as renewing its key competencies through a change process that the organization initiates (Mettler *et al.*, 2010). Maturity models assist organizations to achieve the desired end state by assessing its organizational culture, processes, structures, objects and technologies (Mettler, 2011). The model should be made up of transparent sequential steps/levels/stages that can be followed.

Maturity models are considered valuable to organizations undergoing a business transformation. They help organizations identify the need for improvement as change occurs (Cimini, Pinto and Cavalieri, 2017). The maturity model can be useful for the organization at this first step of planning to transform and adapting to the Industry 4.0 concept. For organizations seeking to examine and gain insight into their current business operations, a maturity model can serve in achieving that purpose (Akdil, Ustundag and Cevikcan, 2018). Supporting this notion, Duffy (2001) mentions that maturity models are designed to assist organizations in identifying the need as to when and why they should consider moving forward and which actions have to be taken in order to progress. Furthermore, maturity models provide clarification and insights to organizations highlighting necessary actions that need to be taken with the purpose to achieve advanced maturity level (Duffy, 2001). In the case of increasing market dynamics faced by organizations, Asdecker and Felch (2018) argue that maturity models can be utilized to enhance organizational excellence and assist organizations in dealing with market dynamics. Besides, the maturity model allows the organization to measure itself with respect to other best practices in the same business environment. Therefore, maturity models can be used by the manufacturing sector to determine their readiness level and capabilities in the advent of Industry 4.0 (De Carolis *et al.*, 2017).

#### Deficiencies of maturity models

In as much as there has been an increase in the number of maturity models from multiple domains, maturity models have been countered by criticism as well. The characterization of these models has been defined as “step-by-step recipes” that overgeneralize reality and lack empirical foundation (Benbasat, Dexter, Drury and Goldstein, 1984; De Bruin *et al.*, 2005 and Röglinger, Pöppelbuß and Becker, 2012). Numerous maturity models are almost identical in the formulation and lack of proper documentation (Becker *et al.*, 2012). García-Mireles, Moraga and García (2012) support this claim, mentioning that developed maturity models have little documentation on how the model was developed and there is a lack of theoretical robustness, testing and acceptance of these models. With such criticism at hand, when selecting a maturity model, an organization should be cautious about some maturity models that provide little guidance on the prerequisite steps that must be undertaken in order to achieve improvement and advance to higher maturity levels (Van Looy, De Becker and Poels, 2011).

The development of maturity models demands a critical analysis of the purpose of the model. Such analysis will support the organization by providing a better understanding of the model’s intended use and how the model can be evaluated and validated for application. During model development, organizations should document detailed steps taken in formulating the model. This will give credibility and provide guidance during the validation of the model. In addition, reliable methodology for developing maturity models should be adopted to eliminate arguments that such models lack a sound theoretical basis and methodology (De Carolis *et al.*, 2017).

#### Developed maturity models in Industry 4.0

Maturity models can be applied in assessing different business areas in preparation for Industry 4.0, depending on the entity’s area of interest. The concept of Industry 4.0 promotes a holistic approach for the entire value chain, from inbound, manufacturing and outbound logistics, impacting both upstream and downstream phases of value creation in manufacturing organizations. This section presents an analysis performed on some existing maturity models that support Industry 4.0. Table I presents some of the existing maturity models with their area of focus and formulated features.

Table I. Developed Industry 4.0 maturity models.

Authors	Area of focus and features
De Carolis <i>et al.</i> , (2017)	Developed a Digital Readiness Assessment Maturity Model (DREAMY). The model was focused on manufacturing companies that aspire to digital transformation. The key objective of the DREAMY model was aimed at assisting manufacturing companies to assess their current readiness level and identifying strengths, weaknesses as well as opportunities that can be supported in developing their transformational roadmap. The design of the models is made up of five maturity levels (initial, managed, defined, integrated and interoperable, and digitally-oriented). The digital readiness for manufacturing companies was decided and evaluated on four dimensions (process, monitoring and control, technology and organization).
Leyh, Bley, Schäffer and Forstehäusler (2016)	Proposed a System Integration Maturity Model Industry 4.0 (SIMMI 4.0) consists of five stages (basic digitalization level, cross-departmental digitization, horizontal and vertical digitalization, full digitalization and optimized full digitization) where each stage defines the characteristics of digitization. The model has four dimensions and aims to assist manufacturing organizations in assessing their IT system landscape. The design of the IT system landscape should focus on meeting Industry 4.0 requirements.
Rockwell Automation (2016)	Constructed the Connected Enterprise Maturity Model that consists of five stages (assessment, secure and upgraded network and controls, defined and organized working data capital, analytics and collaboration) and four dimensions focused on technology readiness. The maturity model is centered on the assessment of connections of operations technology to information technology in promoting continuous collaboration across the entire enterprise from suppliers, to manufacture and to customers. Also, the model has been designed to ensure change that is effective for the enterprise reinforcing two areas: technologies and enterprise cultures.
Lichtblau, Stich, Bertenrath, Blum, Bleider, Mil-lack, Schmitt, Scmitz and Schröter (2015)	Formulated an IMPULS – Industrie 4.0 Readiness model. The objective of the model is to promote individual assessment from the organization concerning Industry 4.0 readiness and once that is achieved the organization can then draw a comparison by classifying itself as a newcomer or learner or leader in Industry 4.0. The model is made up of six levels of maturity (outsider, beginner, intermediate, experienced, expert and top performer) and six identified Industry 4.0 dimensions that take into consideration the horizontal integration that includes customers and suppliers as key role players in the organization.
Schumacher <i>et al.</i> , (2016)	Proposed a maturity model that has 62 maturity items which were clustered into nine dimensions and consists of five levels of maturity where the first level is defined as a “complete lack of attributes” and the fifth level being the “state-of-the-art attribute”. The intent of this maturity model is to assess the implementation of Industry 4.0 maturity in the domain of discrete manufacturing.
Ganzarain and Errasti (2016)	Constructed a three-stage process maturity model that focused on providing manufacturing enterprises with guidance and training so they can identify breakthroughs for diversification in various aspects within Industry 4.0. Also, the model provides guidance by reinforcing the identification of a vision and strategy finding the process as key elements. The model suggests five stages (initial, managed, defined, transformed and detailed business model (DBM)) and three dimensions.
Gökalp, Şener and Eren (2017)	Developed an Industry 4.0 – Maturity Model purposed to support manufacturers in assessing their present maturity stage with regards to Industry 4.0. Moreover, the model aims to assist manufacturers to identify solid measures that will be executed in order to reach a mature level that can maximize profits in Industry 4.0. The model is composed of six stages (incomplete, performed, managed, established, predictable and optimizing) and five dimensions.

<i>Authors</i>	<i>Area of focus and features</i>
Weber, Königsberger, Kassner and Mitschang (2017)	Formulated a Maturity Model for Data-Driven Manufacturing (M2DDM) that can help manufacturing organizations in transforming their IT architectures for the advent of Industry 4.0. The formulated maturity model is made up of six levels (non-existent IT integration, data and system integration, integration of cross-life-cycle data, service orientation, digital twin and self-optimization factory). The M2DDM can support manufacturing organizations in assessing the maturity level of their IT architecture concerning data-driven manufacturing and Industry 4.0.
Jæger and Halse (2017)	Presented a maturity model that focused only on measuring the maturity level of an Internet of Things (IoT) technological aspect of a manufacturing enterprise. The model is composed of one dimension and eight levels of maturity (3.0 maturity, initial to 4.0 maturity, connected, enhanced, innovation, integrated, extensive and 4.0 maturity).
Schuh <i>et al.</i> , (2017)	Formulated a maturity index that assesses a manufacturing enterprise's position regarding its technology, organization and cultural viewpoint, concentrating on the entire business process. The model emphasizes the importance of identifying the enterprise's weaknesses and opportunities first, as a base from which it can be assisted in formulating a specific Industry 4.0 strategy implementation that is aligned to the enterprise's business strategy. The model contains six stages (computerization, connectivity, visibility, transparency, predictive capacity and adaptability) and four key areas as dimensions.
Sjödin, Parida, Leksell and Petrovic (2018)	Proposed a preliminary maturity model that focuses on three key areas that support Industry 4.0, namely smart factory, cultivated digital people, introduction to agile processes and configured modular technologies. The maturity model consists of four maturity levels (connected technologies, gathering and sharing of structured data, real-time process analytics and optimization and smart predictable manufacturing) for each key area. The maturity model involves only one dimension, the IT system. The maturity model was developed for guiding manufacturing organizations for implementing the Industry 4.0 smart factory and how they can achieve digital transformation for their production processes.
Asdecker and Felch (2018)	Built a Delivery Process Maturity Model (DPMM) 4.0 that focuses on the outbound logistics for manufacturing firms in preparation for Industry 4.0. The maturity model introduces five stages (basic digitization, cross-department digitization, horizontal and vertical digitization, full digitization and optimized full digitization). The stages of the DPMM4.0 are applied to three dimensions (order processing, warehousing and shipping). The model aims to develop a corporate vision that is focused on promoting excellence in the delivery logistics as well as the direction towards the development path to Industry 4.0.
Scremin, Armellini, Brun, Solar-Pelletier and Beaudry (2018)	Designed the Adopted Maturity Model (AMM) composed of 35 maturity items with 8 maturity indicators which have been organized into three axes that center around; strategy, maturity and performance. The proposed model is intended to assess the organization's adoption process during its transitioning phase to Industry 4.0.

## DISCUSSION AND CONCLUSION

The paper has highlighted the significance of using maturity models prior to executing the concept of Industry 4.0 proposed for manufacturing entities. However, most of the proposed maturity models presented in the literature that have contributed enormously towards Industry 4.0 are mostly anchored in, and give much attention to, information technology in manufacturing systems, enabling technologies for communication, automation and data transfer. However, this suggests that they do not understand that the overall function of an organization is not limited to these functions. Industry 4.0 will enormously affect the entire organization including its external stakeholders, and therefore each enterprise should have a holistic view of its operations and aim at assessing them. The development of maturity models in the advent of Industry 4.0 should go beyond assessing these limited areas and should consider assessing the main features of Industry 4.0 which focus on horizontal integration through the value networks, vertical integration and networked manufacturing systems as well as on end-to-end engineering that covers the entire value chain.

Some of the formulated maturity models are generalized and their promoters believe that they can be applied across manufacturing entities. However, this cannot be true, as organizations have unique needs, business models and goals that vary significantly. Thus, each maturity model developed cannot have the same design features or dimensions, levels and development framework. The notion of "one-size-fits-all" is not applicable at this point, especially in the case of transforming, implementing and adapting to Industry 4.0. Overgeneralizing the characteristics of enabling technologies and enabling factors of Industry 4.0 for each manufacturing industry is not desirable, and thus each manufacturing

organization should be treated and addressed distinctively under the Industry 4.0 concept. In the South African context, the concept of Industry 4.0 is still at its inception phase. As a result, some manufacturing entities are still daunted by the task of embracing this concept due to a lack of knowledge about how to assess their capabilities and plan for the future. In this context, maturity models can best be used as tools of assessment by organizations in understanding their current state.

In summary, digital transformation is an evolution that requires manifold steps to be followed until the desired end state is achieved by the organization, but this transformation is not the only feature that runs the entire organization. An organisation should focus not only on one feature which is technology but should also consider other areas that support the entire organization such as management structure, skills, entire value chain, product life cycle, etc. If organizations continue to think that Industry 4.0 is anchored only in technology and this is the only area to be assessed, then they are setting themselves up for failure. Industries that will remain competitive in the advent of Industry 4.0 are industries that assess their entire operation at all levels. Assessing the entire organization will assist in identifying grey areas that need improvement and alignment concerning the features of Industry 4.0. Also, maturity models should be developed for all key areas of the organization in support of both internal and external operations.

Organizations aspiring to develop their own maturity models in assessing their preparedness toward Industry 4.0 that have no idea where to begin. In this case they can use the currently developed maturity models as a point of reference to assist them in formulating their own maturity models that meet their specific needs. Also, organizations should be cautious about adopting a generalized maturity model without understanding its original intent and formulation structure: doing so might result in obtaining outcomes that can be misleading to decision-makers in the organization. Hence it is imperative for organizations that are not intending to develop their specific maturity models from scratch but are willing to adopt the existing generalized maturity models for assessments, to critically evaluate the existing models before implementing them.

In conclusion, organizations that will be undertaking the task of developing their own specific maturity models or adopting existing maturity models should keep in mind that there is currently no standardized methodology for assessing Industry 4.0 preparedness, and therefore organizations are advised to develop their own.

## LIST OF REFERENCES

- Akdil, K.Y., Ustundag, A. and Cevikcan, E. 2018, Maturity and Readiness Model for Industry 4.0 Strategy in *Industry 4.0: Managing The Digital Transformation*. Springer Series in Advanced Manufacturing. Cham, Springer, pp. 61-94.
- Asdecker, B. and Felch, V. 2018, Development of an Industry 4.0 maturity model for the delivery process in supply chains, *Journal of Modelling in Management*, vol. 13, no. 4, pp. 840-883.
- Automation, R., 2014. The connected enterprise maturity model. *Rockwell Automation*, 12. [Online] Available from: [http://literature.rockwellautomation.com/idc/groups/literature/documents/wp/ciewp002\\_-en-p.pdf](http://literature.rockwellautomation.com/idc/groups/literature/documents/wp/ciewp002_-en-p.pdf) [Accessed: 5 November 2019].
- Baumgartner, R.J. and Ebner, D. 2010, Corporate sustainability strategies: sustainability profiles and maturity levels, *Sustainable Development*, vol. 18, no. 2, pp. 76-89.
- Becker, J., Knackstedt, R. and Pöppelbuß, J. 2009, Developing maturity models for IT management, *Business & Information Systems Engineering*, vol. 1, no. 3, pp. 213-222.
- Benbasat, I., Dexter, A.S., Drury, D.H. and Goldstein, R.C. 1984, A critique of the stage hypothesis: theory and empirical evidence, *Communications of the ACM*, vol. 27, no. 5, pp. 476-485.
- Cimini, C., Pinto, R. and Cavalieri, S. 2017, The business transformation towards smart manufacturing: a literature overview about reference models and research agenda, *IFAC-PapersOnLine*, vol. 50, no. 1, pp. 14952-14957.
- De Bruin, Tonia, et al. "Understanding the main phases of developing a maturity assessment model." *Australasian Conference on Information Systems (ACIS)*. Australasian Chapter of the Association for Information Systems, 2005.
- De Carolis, A., Macchi, M., Negri, E. and Terzi, S. 2017, Guiding manufacturing companies towards digitalization: a methodology for supporting manufacturing companies in defining their digitalization roadmap, 2017 *International Conference on Engineering, Technology and Innovation (ICE/ITMC)* IEEE, pp. 487.
- Duffy, J. 2001, Maturity models: Blueprints for e-volution, *Strategy & Leadership*, vol. 29, no. 6, pp. 19-26.
- Erol, S., A. Schumacher, and W. Sihn. 2016. "Strategic Guidance towards Industry 4.0—A Three-Stage Process Model." Proceedings of International Conference on Competitive Manufacturing (COMA16), Stellenbosch, South Africa, pp. 495.
- Fraser, P., Moultrie, J. and Gregory, M. 2002. *The use of maturity models/grids as a tool in assessing product development capability*. In IEEE international engineering management conference 2002 August: Vol. 1, pp. 244-249. IEEE.
- Ganzarain, J. and Errasti, N., 2016. Three stage maturity model in SME's toward industry 4.0. *Journal of Industrial Engineering and Management (JIEM)*, 9(5), pp.1119-1128.
- García-Mireles, G.A., Moraga, M.A. and García, F., 2012. "Development of maturity models: a systematic literature review". *16<sup>th</sup> International Conference on Evaluation & Assessment in Software Engineering (EASE 2012)*, pp. 279-283.
- Gökalp, E., Şener, U. and Eren, P.E., 2017, October. Development of an assessment model for industry 4.0: Industry 4.0-MM. In *International Conference on Software Process Improvement and Capability Determination* (pp. 128-142). Cham.Springer.
- Jæger, B. and Halse, L.L. 2017. *The IoT technological maturity assessment scorecard: a case study of norwegian manufacturing companies*. In IFIP International Conference on Advances in Production Management Systems 2017, September. pp. 143-150. Cham. Springer.
- Leyh, C., Bley, K., Schäffer, T. and Forstehäusler, S. 2016. *SIMMI 4.0—a maturity model for classifying the enterprise-wide it and software landscape focusing on Industry 4.0*. In 2016 Federated Conference on Computer Science and Information Systems (FedCSIS), 2016, September, pp. 1297-1302. IEEE.
- Lichtblau, K., Stich, V., Bertenrath, R., Blum, M., Bleider, M., Millack, A., Schmitt, K., Schmitz, E. and Schröter, M. 2015. IMPULS-industrie 4.0-readiness. *Impuls-Stiftung des VDMA*. Aachen-Köln.
- Mettler, T., Rohner, P. and Winter, R. 2010. Towards a classification of maturity models in information systems. In *Management of the interconnected world* (pp. 333-340). Physica-Verlag HD.
- Mettler, T. 2011, Maturity assessment models: a design science research approach, *International Journal of Society Systems Science (IJSSS)*, vol. 3, no. 1/2, pp. 81-98.
- Pillay, K., Ori, A. & Merkofer, P. 2017, *Industry 4.0: Is Africa ready for digital transformation*. [Online] Available from: <https://www2.deloitte.com/content/dam/Deloitte/za/Documents/manufacturing/za-Africa-industry-4.0-report-April14.pdf> [Accessed: 5 November 2019].
- Rojko, A. 2017, Industry 4.0 concept: background and overview, *International Journal of Interactive Mobile Technologies (IJIM)*, vol. 11, no. 5, pp. 77-90.
- Röglinger, M., Pöppelbuß, J. and Becker, J. 2012, Maturity models in business process management, *Business process management journal*, vol. 18, no. 2, pp. 328-346.
- Schäffer, T., Leyh, C., Bley, K. and Schimmele, M. 2018, Towards an Open Ecosystem for Maturity Models in the Digital Era: The Example of the Data Quality Management Perspective. [Online] Available from: [https://tu-dresden.de/bu/wirtschaft/isih/ressourcen/dateien/isih\\_team/pdfs\\_team/Towards-an-Open-Ecosystem-for-Maturity-Models-in-the-Digital-Era\\_.pdf?lang=en](https://tu-dresden.de/bu/wirtschaft/isih/ressourcen/dateien/isih_team/pdfs_team/Towards-an-Open-Ecosystem-for-Maturity-Models-in-the-Digital-Era_.pdf?lang=en) [Accessed: 24 October 2019].
- Schuh, G., Anderl, R., Gausemeier, J., ten Hompel, M. and Wahlster, W. 2017. *Industrie 4.0 Maturity Index. Managing the Digital Transformation of Companies*. Munich: Herbert Utz.
- Schumacher, A., Erol, S. & Sihn, W. 2016. A maturity model for assessing Industry 4.0 readiness and maturity of manufacturing enterprises, *Procedia CIRP*, vol. 52, pp. 161-166.
- Schwab, K. & Davis, N. 2018, *Shaping the future of the fourth industrial revolution: A guide to building a better world*, Penguin, United Kingdom.
- Scremin, L., Armellini, F., Brun, A., Solar-Pelletier, L. and Beaudry, C., 2018. Towards a framework for assessing the maturity of manufacturing companies in Industry 4.0 adoption. In *Analyzing the Impacts of Industry 4.0 in Modern Business Environments* (pp. 224-254). IGI Global.
- Simpson, J. & Weiner, E. 1989. Quotation from The Oxford English Dictionary. Clarendon, .
- Sjödin, D.R., Parida, V., Leksell, M. and Petrovic, A., 2018. Smart factory implementation and process innovation: a preliminary maturity model for leveraging digitalization in manufacturing moving to smart factories presents specific challenges that can be addressed through a structured approach focused on people, processes, and technologies. *Research-Technology Management*, 61(5), pp.22-31.
- Van Looy, A., De Backer, M. and Poels, G. 2011. Questioning the design of business process maturity models. In *Enterprise Information Systems 2011*, October (pp. 51-60).
- Weber, C., Königsberger, J., Kassner, L. and Mitschang, B., 2017. M2DDM—a maturity model for data-driven manufacturing. *Procedia CIRP*, 63, pp.173-178.
- Zhou, K., Liu, T. & Zhou, L. 2015, Industry 4.0: Towards future industrial opportunities and challenges, *Fuzzy Systems and Knowledge Discovery (FSKD)*, 2015 12th International Conference on IEEE, pp. 2147.

# ANALYTICAL REVIEW OF TECHNOLOGY TRANSFER IN CONSTRUCTION IN DEVELOPING COUNTRIES – A PERSPECTIVE FROM SUDAN

Akram Elkhaliifa , Faculty of Architecture, University of Khartoum, Sudan  
akrelk@uofk.edu, akram.ahmed.elkhalifa@gmail.com

## Abstract

*The literature lists many barriers that hinder the process of transferring successful technologies in construction to developing countries (DCs). This paper aims at highlighting the role of innovation and technology transfer in the development of the construction industry in Sudan and the extent of its effectiveness. It focusses on the role and efforts of national and international organisations in building the capacity of actors in the field of construction as a way of attaining sustainable development. The study relied on case studies to highlight the attempts at transfer of technology in construction. It also employed a questionnaire – targeting the stakeholders of the Sudanese Construction Industry (SCI) – to investigate their perceptions of selected factors influencing the transfer of technology. Through the analysis of the collected data, using the Statistical Package for the Social Sciences (SPSS), it was possible to examine the relative importance of these factors along with the correlation between the variables subject to the analysis.*

**Keywords:** construction industry, developing countries, Sudan, sustainable development, technology transfer

## INTRODUCTION

Sudan, like many other DCs, is characterised by low figures of technological and scientific development indicators. The weak status of research is a major contributory factor in this regard as the total expenditure on scientific research is estimated at 0.15% of total GDP compared to 2.8% in developed countries and 0.2% in the Arab Region. Along with the low expenditure on research and development programmes, lack of planning, organisation and coordination between different research institutes and governmental authorities contributes to the weakness of technological capacity of the country (Ahmed, 2009).

In Sudan, the construction industry (CI) in general, and the building material industry (BMI), in particular, lack adequate research and development programmes. Few research studies have been undertaken to assess the possibility of introducing innovative materials, improving conventional ones and substituting some of the expensive and imported materials with available low-cost indigenous materials. The main research achievements in building materials and technologies included research on the application of earth (rammed earth, compressed earth blocks (CEBs) and stabilised soil blocks (SSBs)), low-cost roofs, low-cost foundations, foundations in clay soils, brick production using gas kilns, cement replacement with lime and pozzolana as well as research on block-making machines. Most of this research focussed on the economic aspects of the introduced technologies; few studies considered other important aspects that affect the appropriateness of these technologies including environmental impact, thermal performance and energy consumption (Elkhalifa & Balila, 2010; Elkhalifa, Balila & Abubakr, 2010; Elkhalifa, 2014).

Technological capacity in the application of appropriate building materials and technologies, especially for housing, remains at a very low level as a result of the absence and/or ineffectiveness of knowledge dissemination channels. Most of the research performed, regardless of its viability, remains stored and hidden in the libraries of various ministries and institutions, unused.

This paper aims at highlighting the role of innovation and technology transfer (TT) in the development of the construction industry in Sudan and the extent of its effectiveness. It also aims to list the main challenges confronting the successful transfer of technology and to investigate their magnitude.

## Methodology

For the purpose of highlighting the role of technology transfer in applying innovative and appropriate technologies in construction in developing countries, a set of case studies in Sudan are illustrated in this paper. These case studies were conducted for the purpose of understanding the mechanisms through which innovative and appropriate technologies are transferred. The case studies were selected to cover as wide a spectrum as possible including projects implemented by research institutes, governmental authorities, national and international non-governmental organisations (NGOs), private sector companies and individual practitioners. Some of these examples were based on technologies transferred from abroad where the developers believed in their suitability for the country and the community. The review and background of these case studies were based on literature and interviews with the providers of technologies subject to study.

In addition, a set of questions was designed as part of a questionnaire survey conducted to investigate the challenges facing the Sudanese Construction Industry (SCI). The questions were developed in an ordinal form of a five-point Likert-scale as shown below.

very high influence	high influence	medium influence	low influence	very low influence
+2	+1	0.0	-1	-2

The questionnaire asked the respondents to reveal their perceptions on the magnitude of the possible factors that negatively affect the transference of successful technologies in the SCI. The questionnaire was circulated to 352 of the SCI stakeholders, including consultants, contractors, building materials (BMs) manufacturers, BMs suppliers, professional institutes, unions and associations, governmental authorities, clients, researchers and academics, financial institutes and NGOs. It is important to note that the survey focussed on the actors in the formal sector.

The data was processed using the Statistical Package for the Social Sciences (SPSS). For the analysis of collected data, the study adopted non-parametric methods; namely the Friedman chi-square test ( $X^2$ ) and the Kendall's coefficient of concordance (W) to measure the relative importance of different factors and rank them accordingly. The study relied on the Spearman's rho (Spearman's rank correlation coefficient) and the Kendall rank correlation coefficient (Kendall's tau ( $\tau$ ) coefficient) as non-parametric methods to measure the statistical dependence between any two factors in order to test the presence and the magnitude of correlations between these variables.

## Technology transfer of appropriate and innovative building materials and technologies in Sudan

Research on appropriate and innovative building materials and technologies in Sudan started a couple of decades ago. Most of these studies were applied practically, either in pilot projects or in projects for a specific interest group. Most of these studies were applied either directly or indirectly through international organisations (United Nations, UNDP, UN-Habitat, UNESCO, UNIDO) and non-governmental organisations (Practical Action, Homes for Sudan, Sudanese Organization for Building Materials and Construction (SOBMC)). Research institutions are recruited by these

organisations and/or governmental authorities to answer the needs for a specific construction problem through research. The next section demonstrates some of the attempts to apply, disseminate and transfer knowledge about the outcome of these studies as well as introducing new and innovative technologies which are believed to be appropriate for Sudan. These examples are based on case studies conducted for the purpose of this research; to demonstrate the extent of effectiveness of technology transfer in the provision of housing as well as identifying the tools of its application.

### Mud bricks (timberless houses)

In 2006, Practical Action – an international organisation – launched a project aimed at providing shelter for the internally displaced persons (IDPs) who had fled the conflict areas in Northern Darfur. The project was supposed to assist the IDPs, upon their return, in building and rebuilding their houses in a durable manner, as permanent. The project aimed to overcome the problems of BMs availability, lack of skilled labour, and the environment which had been depleted and degraded, with wood being used in vast quantities for brick burning. It was estimated that one third of the forests in Darfur was lost between 1973 and 2006 (UN-Habitat, 2009d). The organisation introduced the mud dome house as an alternative house for the returnees, instead of timber. The same technology was disseminated under the name “Woodless Construction Programme” in West Africa in Burkina Faso, Mali, Mauritania and Niger as a response to the declining availability of organic resources used in construction. Over the years, through training and demonstration, skills have been developed to ensure technical and organisational sustainability: local builders use the woodless construction techniques and their acquired skills to build for their own local clients, using local resources (Norton, 1999).

The organisation held many activities as part of the project to promote the acquisition of knowledge and skills. These activities included:

**Survey:** in 2006 in Abu Showk IDP camp in El-Fashir to identify building designs and types of materials used by the IDPs in their home villages.

**One day workshop:** convened in El-Fashir at the beginning of 2006. The participants were 56 persons representing government institutions, local NGOs, INGOs, UN agencies and IDPs community leaders.

**Training programme:** consisting of theoretical and practical parts to help the returnees build permanent houses depending on local materials, labour and skills. To this effect 70 trainees were selected and received training for 21 days on alternative building designs and BMs. The training finished with the completion of four demonstration housing units which were different in design and utilised different BMs. Through this technical training period in constructing these timberless houses, some of the trainees gained the skills that assisted them in creating job opportunities that provided a source of income.

### Compressed and stabilised soil blocks

Adam (2007) listed the main research efforts regarding the application of compressed and stabilised soil blocks (CSSB) in Sudan. Generally, the CSSB block technology is the most widely applied technology among other new technologies introduced to Sudan (Adam & Alagib, 2001). It has been adopted and applied by many governmental authorities and organisations. The first widespread application of the production and use of stabilised soil blocks was experienced in the construction of El-Haj Yousif model school, which was funded by UNESCO. The same technology was employed for the reconstruction of Dongola in northern Sudan, which was seriously destroyed by the floods of 1998. More than 30 block machines were employed in the construction of walling that was more than 20km long. The reconstruction at Dongola influenced the management of Dongola University to use SSBs for building eight senior staff houses. Stabilised soil blocks (SSBs) were used to construct two tourist compounds; the first was in Bejrawia tourist village north of Khartoum and the second was in Dinder National Park tourist village. Twelve houses were constructed using SSBs for police staff housing in Abuseed in Khartoum. Another school – Holm English School – was built using SSBs. The project was regarded as one of the biggest, using this technology.

The UN-Habitat launched a project in 2008 intending to introduce the SSB technology in the regions of Darfur. The overarching objective of the project was to raise awareness of and build consensus on the adoption of alternative building technologies. SSB technology has been identified as the most viable alternative technology for the reconstruction challenges facing the returning population in Darfur (UN-Habitat, 2009d). The UN-Habitat performed a couple of training workshops to train the trainers in order to facilitate the dissemination of skills in the major cities, towns and villages in Darfur. More than 1,800 persons received training – training of trainers and on-the-job training – at the pilot demonstration buildings and public utilities built employing this technology. These projects included 14 SSB workshops, 19 latrines, 44 classroom, six houses, two boundary walls and one clinic. 120 SSB machines were purchased and imported for the project. The project covered the cities of Nyala Zalingei, Geneina, El-Fashir and some villages. Table 1 shows the mechanisms of disseminating the technology and presents their corresponding number of trainees. The project involved the State Ministry of Physical Planning and Public Utilities (SMPPPU) in Nyala, local academia, local NGOs, and International NGOs (Table 2).

**Table 1:** Training and pilot demonstration buildings (PDB) per region in Darfur performed by UN-Habitat

Area	Training of trainers	On-job training	Total	PDB
Nyala	410	240	650	11
Zalingei	147	150	177	2
Geneina			120	9
El-Fashir	263	225	488	16
Villages	60	320	380	48
Total	880	935	1815	86

Source: UN-Habitat (2009d, p. 9)

**Table 2:** Training and pilot demonstration buildings (PDB) per implementing partner in Darfur performed by UN-Habitat

Area	Training of trainers	On-job training	Total	PDB
Local academia	550	199	749	16
SMPPPU	270	216	486	14
Local NGOs	0	300	300	17
International NGOs	60	220	280	39
Total	880	935	1815	86

Source: UN-Habitat (2009d, p. 10)

Another attempt to overcome the problems of providing the poor with adequate shelter has been made by UN-Habitat in Khartoum. This organisation helped the residents of El-Rasheed village in Jabal Awlia locality, which was selected to settle the inhabitants of the squatters of Soba and Al-Salama, building their homes. The target group was mostly made up of the poor who were living in illegal settlements and were unable to develop their properties in an adequate manner. At the beginning, six demonstration houses were built to convince the prospective users of the viability of the CSSBs. Block-making machines were imported from Kenya at a cost of around \$1200 per machine. A single, manually operated machine produces about 6,350 blocks every six hours. Every five households were sharing a machine and using it interchangeably. The UN-Habitat aimed at producing these machines locally in order to reduce the cost of

production. As part of the project, about 450 workers received training for a period of 18 days on the application of the technology. The training included the preparation of the mix and the use of the machine as well as its regular maintenance (Rayaam, 2010).

### **Interlocking stabilized soil blocks**

The interlocking SSBs, as a newer version of stabilised block technology, has been adopted and applied in many parts of the country, mainly in Malakal (now part of South Sudan), Kassala (East), Nyala (West) and Khartoum (Centre). The technology was employed in southern Sudan for the construction of a building for UNICEF in Malakal in 2006. Two private houses were constructed to introduce the technology in Khartoum North in 2007 and 2008. A training workshop was organised targeting the workers of Qatar Charity Organization (QCO) in Khartoum in 2007. A prototype model was built in Nyala for the Resettlement and Rehabilitation Commission (RRC) in Nyala. A house model of interlocked SSBs was constructed in Khartoum in 2008 for the NFHR to show the viability of the technology.

A project including 30 houses, three schools with dormitories, a health centre, mosque, and police station were built in Kassala employing SSB technology. The project was part of a donation made by the Qatari government to rebuild two villages and complete the regional road that links Sudan and Eritrea. It involved about 200 workers from the local community who were trained to apply the technology. Twenty-six workers from Ethiopia, who were familiar with the technology in Addis Ababa, were engaged in the project to help train the local labourers. Several public lectures and seminars were organised to communicate the technology to architects, engineers, and contractors. Six block-making machines were imported from South Africa and transported from Khartoum to the site.

Another housing project was executed in December 2009 employing the interlocking SSBs in Southern Darfur state in Fasha village near Nyala. The project was donated by the Kuwaiti Government and funded jointly by the International Islamic Charitable Organization (IICO) and the Kuwaiti Joint Relief Committee (KJRC). The project, which involved eight engineers, aimed to build 40 housing units for the residents of the village. A couple of public lectures and seminars were organised to communicate the technology to architects, engineers, and contractors.

### **Ferrocement roofing**

According to Adam and Alagib (2002) and Adam (2007), ferrocement roofing technology has been applied in many projects. The technology was employed in El-Haj Yousif model school, Dongola reconstruction project, University of Dongola staff housing project, El-Bejarawia tourist village, Dinder National Park tourist village, a police staff housing project in Abuseed and the Holm English School. The technology was also applied for the construction of eight basic schools in Southern Darfur State in Shataya and Gardoud villages as well as for women development centres in Kassala, El-Gadarif and El-Fashir.

In 2002, Practical Action executed a project which was carried out as part of its efforts for improving shelter in the camps for the IDPs in Kassala (Saeed, 2007). Practical Action focused on cheap or low-cost housing through minimising the amount of materials and costs. Therefore, the target was to use commonly available and energy intensive materials like cement and steel but in a highly efficient manner, thus saving scarce material resources. A model composed of two bedrooms, a kitchen with a lobby and a verandah, was built. To involve the target group in the project implementation, Practical Action helped in the establishment and formation of Sawa Sawa and Kada Self Help Groups for housing. A participatory approach had been followed to reach a consensus on the agreed upon model. The following points illustrate how the project had come into being:

**Workshops:** in 2002, two workshops were organised to address adequate, appropriate and affordable housing issues. The participants of the workshop included concerned governmental institutions, academic institutions, non-governmental organisations (NGOs), community-based organisations (CBOs), civil society organisations (CSOs) and the private sector.

**Survey:** a market and quantity survey was conducted to ensure the viability of the vaulted roof compared to the traditional *baladi* (roof).

**Participatory approach:** a set of alternative designs were discussed thoroughly with the community members, artisans, builders and local consultants from Kassala town. Besides, the community was engaged in the production of local building materials.

**Training:** Practical Action provided training for 21 builders to help establishing their work to build houses of similar designs.

**Demonstration Models:** The project involved building two houses to demonstrate the new type of housing in Kassala.

### **Problems of successful technology transfer in construction in Sudan**

Despite all the attempts being made by different entities to disseminate knowledge about the application of innovative and improved traditional technologies, most of these technologies have not found their way for application on a wide scale. The application has been limited to a few projects and demonstration models constructed for testing or introducing the technology. Most of the efforts made to transfer some of the building technologies for the housing sector in particular have been carried out by international organisations and NGOs. The efforts made by these organisations have focussed on areas of conflict and crisis such as Darfur, southern Sudan and eastern Sudan. The UN agencies have made significant contributions in this regard. Other organisations, such as Practical Action, have worked on the improvement of some BMs and the dissemination of knowledge about new and innovative building technologies. Individual engineers who are interested in low-cost BMs and technologies for housing have contributed to the invention of new materials and technologies as well as the improvement of traditional methods of construction. Research institutes in Sudan have been playing a pivotal role in introducing, testing and evaluating new building materials and technologies. However, most of the research projects carried out by these institutes were performed in isolation from each other with each institution performing its own research programme and only marginally considering other institutions' programmes and/or results.

The problems that might possibly be hindering the process of transferring successful technologies in building to DCs are manifold. Elkhalfifa (2012) listed the main factors influencing the transference of technology in the SCI. At the top of this list is the weak role of the government in adopting, financing and encouraging the application of research results on a wide scale. However, the situation is not exclusive to the CI; the expenditure of the government on research in general is very low. Additionally, the public investment in training, education and R&D programmes is very low. Also, the country lacks the technological capacity that facilitates the transfer of knowledge and the dissemination of research results. Neglecting the development of local technological capabilities seriously affects the ability to employ imported technologies effectively and efficiently.

The SCI is characterised by a weak structure that allows the introduction of any materials or technologies for construction no matter how inappropriate they are. There is no single entity responsible for the screening, testing, evaluation and approval of new materials to be used for construction. The existence of such a central body would facilitate the dissemination of knowledge about new and appropriate materials to be adopted and applied.

Aggravating the situation, the role of the private sector, which dominates the SCI, is very poor in research, adoption, application, and dissemination of appropriate technologies. The sector marginally takes any initiative for the development of traditional appropriate materials and the investment made by the sector in this regard is negligible. Local contractors, in order to avoid risk and keep their reputation, are reluctant to apply and adopt new technologies unless these technologies are widespread and have proved to be successful. Therefore, most of the performed research results remain in libraries and the closed cabinets of research institutions.



Apparently, most of the housing provision activities are carried out by the informal sector. Consequently, targeting the informal sector when introducing new technologies and/or materials, is paramount to the success of transferring those technologies. Furthermore, the owners finance most of the construction costs of their houses through their life savings. Therefore, the owners are usually reluctant to risk applying new technologies. On the contrary, they prefer to go on applying the traditional technologies they have been using for decades or technologies they have tested by themselves even if those technologies have turned out to be inappropriate. This situation creates a gap between research and application, so there is no chance of demonstrating a technology through application. The weakness or even the non-existence of linkages between the enterprises in the CI and various agents further aggravates the situation. Therefore, technological capability building takes place on a non-lasting basis and easily gets lost when information about successful technologies is not distributed and assimilated. Furthermore, each of the SCI stakeholders performs in isolation without any collaboration, cooperation or coordination with other parties.

Some appropriate materials and technologies which are locally available, affordable, and applicable might not be socially acceptable. For instance, it is quite difficult to convince the community to apply earth technology as earth is perceived to be a building material for poor people. Apparently, technology transfer in building with local materials and building technologies (i.e. earth) is hindered by the association of these materials with poverty and low-socio-cultural status. Hence, research on social acceptability should go hand-in-hand with the research on technical aspects in order to ensure the availability of a market for tested materials.

The transfer of some building technologies and methods of construction have been adversely affected by the shift from the focus on understanding, accepting, adopting, and disseminating knowledge about those technologies to the intention of reducing the costs of these new technologies. The shift towards producing the machinery and equipment used in a technology before accepting the technology itself may possibly lead to the failure of successfully introducing that technology on a wide scale. In the case of CSSBs, for example, the National Council for Research (NCR) with the intention to reduce the costs of producing CEBs had started manufacturing the block-making machines before the viability of the technology was communicated and/or the prospect users were convinced. The produced machines were of poor performance producing blocks of inferior quality. Therefore, when an opportunity appeared for the extensive application of the technology, involving thousands of houses in Dar Al-Salam neighbourhood in Omdurman and Al-Kalakla neighbourhood in Khartoum, the projects were aborted due to the inefficiency of compressing machines as well as managerial complications (Ahmed, 2007). The technology has been applied mainly in Khartoum and a few other cities around the country. Till now, it cannot be said that the technology has been effectively absorbed and applied.

In conclusion, it appears that the SCI lacks awareness of the benefits associated with the transfer of knowledge and technologies. The government, at the highest level, does not support the endeavour of disseminating knowledge about appropriate building materials and technologies. TT can be exploited to improve the production of some materials and develop new capacity in others. It is the role of professional institutions to educate the government, professionals and the public about the possible benefits to be gained from TT. It is necessary to establish a national professional body to bring together all the organisations, institutions, corporations, companies as well as individuals, and indeed SOBMC has been founded as an NGO for this purpose; however, its role has been weak. Such a body, if run effectively, could help to facilitate the exchange of information and experience with the aim of arriving at better alternatives for building materials and technologies. It would help to improve the standards and specifications and provide training and capacity for building programmes. The first responsibility of this body is to raise awareness of the benefits of TT and to share knowledge.

#### Questionnaire results and discussion

Out of the 352 respondents targeted, 213 (60.5%) responded to the questionnaire. The results indicated that the lack of government's funding and policies (9.7) is perceived as the most important factor affecting the transfer of technology in construction in Sudan, followed by low investment in training, education, and R&D (9.1), lack of scientific and technological infrastructure (8.9) and poor linkage between research and application (8.9). Lack of documentation and dissemination of results (6.3) is perceived to be the least important factor among all the 15 factors subject to the analysis.

**Table 3:** Ranking of the problems of TT in Sudan

Factor	Mean Rank	Rank
Lack of awareness	8.2	7
Lack of government's fund and policies	9.7	1
Weak role of public projects	7.9	9
Lack of scientific and technological infrastructure	8.9	3
Lack of professional bodies for screening and diffusion	8.4	5
Ineffectiveness of technology diffusion networks	7.6	11
Lack of capability to innovate and benefit from TT	7.2	13
Lack of linkages between various agents	6.9	14
Low investment in training, education, and R&D	9.1	2
Poor linkage between research and application	8.9	4
Lack of documentation and dissemination of results	6.3	15
Lack of information	8.2	6
Poor social image of local materials	7.2	12
Reluctance to apply new materials and technologies	8.0	8
Concentration on cost minimisation	7.7	10

Test Statistics	
N	184
Kendall's W <sup>a</sup>	0.058
Chi-Square	148.724
df	14
Asymp. Sig.	0.000

a. Kendall's Coefficient of Concordance

According to the analysis of the responses received from the questionnaire, a matrix of correlation has been developed for the factors influencing the transfer of technology in the SCI (Appendix 1 & 2). The interpretation of these correlations follows the rule of thumb that:  $\rho$  values greater than 0.5 indicate strong correlations;  $\rho$  values greater than 0.3 indicate moderate correlations; and  $\rho$  values less than 0.2 indicate weak correlations (Bannaga, 2010). A total of 105 correlations have been derived for this group in addition to the other 15 correlations for each variable with itself. The number of correlations that are statistically significant at 1% and 5% is 103 and 1 respectively. Only two correlations were found to be statistically insignificant. This implies that the factors are interrelated. Lack of government funding and policies is positively correlated with lack of awareness (0.403), lack of technological infrastructure (0.406), role of public projects (0.434), lack of professional bodies for screening and diffusion of technologies (0.407), ineffectiveness of technology diffusion networks (0.464) and lack of capability to innovate and benefit from TT (0.486). The ineffectiveness of technology diffusion networks is correlated with lack of professional bodies for screening and diffusion of technologies (0.499), lack of capability to innovate and benefit from TT (0.495), lack of linkages between various agents (0.406), investment in training, education and research (0.452) and poor linkage between research and application (0.452). The poor linkage between research and application is strongly correlated with investment in research and development (0.550) and lack of documentation and dissemination of results (0.439). The reluctance to apply new materials and technologies is correlated with lack of linkages between stakeholders (0.420).

## CONCLUSION

This study highlighted some of the efforts aimed at applying innovative building materials and technologies. Case studies were conducted to emphasise the role of TT in introducing innovative building materials and technologies for low-cost housing. NGOs are believed to be active actors in transferring technology for construction to other stakeholders. The governmental authorities are only marginally involved in the process. The problems of transferring and disseminating knowledge about innovative and appropriate building materials and technologies in Sudan are broadly demarcated. The analysis indicated that the problems confronting the successful transfer of technology are interrelated. Hence, cooperative efforts should be made to overcome these shortcomings.

Raising awareness about the benefits of TT would possibly result in sustainably exploiting the resources available for the CI. Failure to link research and practice is a cited hindrance to the development of the SCI and the SBMI, application of appropriate materials and technologies and successful TT. Hence, investing in collaborative, focussed research that answers real life needs is seen as an effective way of overcoming the difficulties of the SCI. Exploiting the benefits of technology transfer associated with the participation of foreign firms seems a potentially effective way of offsetting the expected drawbacks. The government's support seems to be an important factor in the development of the SCI. It is highly recommended that a national professional body for screening, testing, transferring, adapting and adopting appropriate technologies for housing in the country be established.

## LIST OF REFERENCES

- Adam, A. A. 2007. Previous healthy and affordable houses experience. *Proceedings of National Workshop on "Low-Cost and Healthy Homes"*, (pp. 78-88). 7th February. Khartoum.
- Adam, A. A. & Alagib, A. A. 2001. *Compressed stabilised earth block manufacture in Sudan*. Paris: United Nations Educational, Scientific and Cultural Organization (UNESCO).
- Adam, A. A. & Alagib, A. A. 2002. *Roofing systems in Sudan*. Paris: United Nations Educational, Scientific and Cultural Organization (UNESCO).
- Ahmed, A. A. 2009. *Expenditure on scientific research in Sudan: A knight without a horse*. Retrieved 11/3/2010, from Sudan News Agency (SUNA): <http://www.sunanews.net/the-news/3043-proportion-expenditure-not-exceeding-20-0-national-income-scientific-research-sudan-knight-without-horse-.html>
- Ahmed, A. E. 2007. Proposed low-cost and healthy homes. *Proceedings of National Workshop on "Low-Cost and Healthy Homes"*, (pp. 61-77). 7th February. Khartoum.
- Bannaga, S. A. 2010. *Expected impact of globalization on the overall setting of Sudanese construction industry*. Unpublished PhD, Faculty of Architecture, University of Khartoum, Sudan.
- Elkhalifa, A. 2012, January. *The construction and building materials industries for sustainable development In developing countries: "Appropriate and Innovative Building Materials and Technologies for Housing in Sudan*. Camerino, Italy: PhD Thesis, Faculty of Architecture, University of Camerino, Italy.
- Elkhalifa, A. 2014. Comparative analysis on the thermal performance of selected building materials and technologies for housing in Sudan. *Journal of Building and Roads Research*, 16,31-56.
- Elkhalifa, A. A. & Balila, A. M. 2010. Appropriate technology for housing in Sudan: Evaluation of selected innovative building materials and technologies. *Proceedings of the Second International Conference on Sustainable Architecture & Urban Development (SAUD 2010)*. 12-14 July, Amman-Jordan: The Center for the Study of Architecture in the Arab Region (CSAAR).
- Elkhalifa, A. A., Balila, A. M. & Abubakr, R. A. 2010. Technology transfer for sustainable housing in Sudan. *Proceedings of the Second International Conference on Sustainable Architecture & Urban Development (SAUD 2010)*. 12-14 July, Amman-Jordan: The Center for the Study of Architecture in the Arab Region (CSAAR).
- Fredricks, G. A. & Nelsen, R. B. 2007. On the relationship between Spearman's rho and Kendall's tau for pairs of continuous random variables. *Journal of Statistical Planning and Inference*, 137,2143-2150.
- Friedman, M. 1937. The use of ranks to avoid the assumption of normality implicit in the analysis of variance. *American Statistical Association*, 32(200),675-701.
- Hill, T. & Lewicki, P. 2007. *Statistics: Methods and applications*. Tusla, OK: StatSoft.
- Kendall, M. G. 1938. A new measure of rank correlation. *Biometrika*, 30(1/2),81-93.
- Likert, R. 1932. A technique for the measurement of attitudes. *Archives of Psychology*, 140,1-55.
- Norton, J. 1999. Sustainable architecture: A definition. *Habitat Debate*,5(2).
- Rayaam. 2010, November 1. Poor Palaces. *Rayaam*, p. 14.
- Saeed, Y. Y. 2007. Practical action experience in Kassala in Eastern Sudan: Improving urban environment projects. *Proceedings of National Workshop on "Low-Cost and Healthy Homes"*, (pp. 51-60). 7th February. Khartoum.
- Spearman, C. 1904. The proof and measurement of association between two things. *The American Journal of Psychology*, 15(1),72-101.
- UN-Habitat. 2009d. *Darfur early recovery: Stabilized soil blocks for sustainable urban growth*. Mioch, J. & Murillo, F. (eds.) Nairobi: United Nations Human Settlements Programme (UN-Habitat).

Appendix 1: Correlation between factors influencing successful TT - Kendall's tau\_b

Factor	D1_1	D1_2	D1_3	D1_4	D1_5	D1_6	D1_7	D1_8	D1_9	D1_10	D1_11	D1_12	D1_13	D1_14	D1_15
Kendall's tau_b	D1_1 Lack of awareness	1													
	D1_2 Lack of government's fund and policies	0.403**	1												
	D1_3 Weak role of public projects	0.384**	0.434**	1											
	D1_4 Lack of scientific and technological infrastructure	0.359**	0.406**	0.463**	1										
	D1_5 Lack of professional bodies for screening and diffusion	0.303**	0.407**	0.337**	0.374**	1									
	D1_6 Ineffectiveness of technology diffusion	0.344**	0.464**	0.386**	0.369**	0.499**	1								
	D1_7 Incapability to innovate and benefit from TT	0.314**	0.486**	0.255**	0.297**	0.375**	0.495**	1							
	D1_8 Lack of linkages between various agents	0.376**	0.282**	0.350**	0.314**	0.297**	0.406**	0.442**	1						
	D1_9 Low investment in training, education, and R&D	0.310**	0.371**	0.377**	0.285**	0.408**	0.452**	0.392**	0.391**	1					
	D1_10 research and application	0.229**	0.378**	0.386**	0.260**	0.286**	0.452**	0.337**	0.370**	0.550**	1				
	D1_11 dissemination of results	0.290**	0.290**	0.283**	0.366**	0.306**	0.402**	0.291**	0.373**	0.288**	0.439**	1			
	D1_12 Lack of information	0.287**	0.264**	0.261**	0.273**	0.331**	0.387**	0.351**	0.303**	0.293**	0.282**	0.477**	1		
	D1_13 Poor social image of local materials	0.354**	0.227**	0.283**	0.306**	0.202**	0.206**	0.287**	0.350**	0.296**	0.321**	0.296**	0.346**	1	
	D1_14 Reluctance to apply new materials and technologies	0.232**	0.225**	0.297**	0.243**	0.253**	0.248**	0.372**	0.420**	0.357**	0.195**	0.242**	0.243**	0.354**	1
	D1_15 Concentration on cost minimization	0.279**	0.205**	0.313**	0.322**	0.213**	0.128	0.212**	0.270**	0.288**	0.166**	0.127	0.252**	0.357**	0.352**

Appendix 2: Correlation between factors influencing successful TT - Spearman's rho

Factor	D1_1	D1_2	D1_3	D1_4	D1_5	D1_6	D1_7	D1_8	D1_9	D1_10	D1_11	D1_12	D1_13	D1_14	D1_15
Spearman's rho	D1_1 Lack of awareness	1													
	D1_2 Lack of government's fund and policies	0.403**	1												
	D1_3 Weak role of public projects	0.384**	0.434**	1											
	D1_4 Lack of scientific and technological infrastructure	0.359**	0.406**	0.463**	1										
	D1_5 Lack of professional bodies for screening and diffusion	0.303**	0.407**	0.337**	0.374**	1									
	D1_6 Ineffectiveness of technology diffusion	0.344**	0.464**	0.386**	0.369**	0.499**	1								
	D1_7 Incapability to innovate and benefit from TT	0.314**	0.486**	0.255**	0.297**	0.375**	0.495**	1							
	D1_8 Lack of linkages between various agents	0.376**	0.282**	0.350**	0.314**	0.297**	0.406**	0.442**	1						
	D1_9 Low investment in training, education, and R&D	0.310**	0.371**	0.377**	0.285**	0.408**	0.452**	0.392**	0.391**	1					
	D1_10 research and application	0.229**	0.378**	0.386**	0.260**	0.286**	0.452**	0.337**	0.370**	0.550**	1				
	D1_11 dissemination of results	0.290**	0.290**	0.283**	0.366**	0.306**	0.402**	0.291**	0.373**	0.288**	0.439**	1			
	D1_12 Lack of information	0.287**	0.264**	0.261**	0.273**	0.331**	0.387**	0.351**	0.303**	0.293**	0.282**	0.477**	1		
	D1_13 Poor social image of local materials	0.354**	0.227**	0.283**	0.306**	0.202**	0.206**	0.287**	0.350**	0.296**	0.321**	0.296**	0.346**	1	
	D1_14 Reluctance to apply new materials and technologies	0.232**	0.225**	0.297**	0.243**	0.253**	0.248**	0.372**	0.420**	0.357**	0.195**	0.242**	0.243**	0.354**	1
	D1_15 Concentration on cost minimization	0.279**	0.205**	0.313**	0.322**	0.213**	0.128	0.212**	0.270**	0.288**	0.166**	0.127	0.252**	0.357**	0.352**

# TRANSLATING AUTHORSHIP IN ARCHITECTURE

Wihan Hendrikz, Tshwane University of Technology, South Africa, wihanhendrikz@gmail.com

## Abstract

During the early 20th century, architects were inspired by intellectual shifts within the arts and architecture as well as by technological advancements of the Technological Revolution. These shifts helped them to adopt the role of experts in people's everyday life. Opposing this in the 1970s, The Design Methods Movement sought to make architects obsolete by giving users all the tools necessary to design their own spaces. However, users lacked the knowledge and experience to conceptualise these spaces, since these are skills that architects develop over time through education and apprenticeship. These skills resit being rationalised into a simple-to-follow process.

This paper uses literature to explore authorship in the relationship between the professional and the patron during the making of architecture. It limits its scope to focus on one-on-one engagements that establishes a co-authorship paradigm. How scale affects this relationship and its forms of engagement would require further in-depth study.

The paper investigates two forms of authorship, the first from the viewpoint of the architect as the sole author, a 'director', and the second from the perspective of the user as sole author where the architect is relegated to a 'facilitator' role. It then posits a third relationship, 'a curator', where there is a negotiated distribution of authority. This form of authorship recognises the inherent self-knowledge of the user – as an expert in their own rituals, expectations and wishes, as well as the conceptual and technical knowledge of the architect. The user's engagement in the making of media – such as drawings, models, and montages, brings them into the authority structures typically held by the architect. This translation establishes a co-authorship that relies on the user's involvement in the design process as well as the architect's insight into the user's context. This form presents an architect's role as a weaver of knowledge.

**Keywords:** Architecture, authorship, user, participation, tacit knowledge

## ARCHITECTURAL ORGANISATIONS

Language is a principal technology we use to construct relationships with other people. A successful architectural project relies on effective communication within the relationships of its actors. These actors include all the participants involved including the client, user, architect, builder, draughtspersons, municipal authorities, neighbours, and even passers-by. This organisation evolves as the relationships between the participants are redefined throughout the project's lifetime. This paper focuses on the relationship between the architect and the client (which is synonymous with the user in this paper). The first part of this paper, *Three Kinds of Authorship*, identifies two relationships between the architect and the user from literature and concludes by proposing a third relationship that invites the client into the design process as a co-author. Although this idea is not new, how these engagements occur is central to its success. The second part, *Misexpression and Authority*, focuses on communication methods that translate the different kinds of knowledge held by the architect and client to allow them to influence one another. This translation is essential to bring the third kind of relationship to fruition.

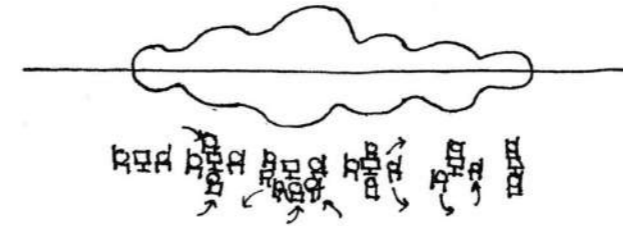


Figure 1: Diagrammatic representation of an architectural project as an organisation over the project timeline. By author. 2019

## PART 1: THREE KINDS OF AUTHORSHIP

The architect and the client are the two creative poles that dominate an architectural organisation. How their relationship is defined colours the character of a project from its inception to its end and beyond. We can describe three kinds of architects with regards to how they approach their own authority and the authority of the client. The architect as a 'director' (which we borrow from Jonathan Hill (2003, pp. 16-18)); as a 'facilitator' (from Jeremy Till (2005, p. 27)); and what we will call a 'curator' (similar to an art curator).

In the case of the architect as a director, the intent of the architect is dominant in the architecture, and its interpretation is limited thereto. In this case, the architecture instructs the user of its use and interpretation and the user is a performer within the script of the building.

In the case of a facilitator architect, the architect's intent is non-existent. The architecture is a product of others' influence and little (or none) of the architect's conceptual interpretations are legible in it. A typical example of this would be community projects where the individual and collective narratives are told by those who live there through their architecture. The architect's role in this process is as a facilitator or consultant. The authorial intent exists fully with the user.

A curator architect exists as a third model between the director and the facilitator. We use the term 'curator' similar to how we would it to describe an art or museum curator, who is assigned to acquire works for various collections. In an architectural sense, we can view a curator architect as one who collects, interprets, and researches the knowledge of the project with the aim to guard that knowledge. Thus, a curator architect uses their expertise along with knowledge gathered from individual subjects (of people and things) to weave the main narrative. Therein, the authorial intent of the architect lives in the main narrative, which is a collection of individual narratives present in their own right.



Figure 2: Director architect. By author. 2019.



Figure 3: Facilitator architect. By author. 2019.

## The Director Architect

In the introduction to *The Story of Modern Architecture* (2012), author Paolo Favole describes the beginnings of Modernism in architecture. From this description, we can recognise two intellectual shifts giving rise to the director architect: a sense for abstracting reality, from movements in the arts, and faith in the objectivity of scientific and technological processes.

The first shift has its roots in early Impressionist art of the nineteenth century, which erupted into various art movements like Cubism, Futurism, and Suprematism at the turn of the twentieth century (Favole, 2012, p. 5). These movements reject classical conventions in favour of new narrative territories not bound to reality by abstracting (turn into an idea) fundamental properties like perspective, scale and geometry.

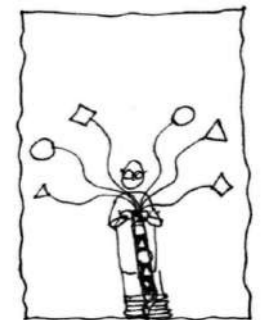


Figure 4: Curator architect. By author. 2019.

Architecture went on to follow these art movements, as can be seen in Expressionism, whose adherents believed that a building could express a singular idea without architectural conventions (Melvin, 2018, p. 98). This radical change brought to architecture a conceptual freedom and formed the foundation of Modernism and its relationship with users.

The second shift stemmed from the Technological Revolution (1870-1914) and is noticeable in what we retrospectively label Protectorialism. It favoured a new architectural language “inspired by engineering techniques... Frank Lloyd Wright and the English Arts and Crafts movement” (Favole, 2012, p. 5). Unlike in the arts, this shift trusted in the objectivity of science and engineering and its adherents believed that architecture could be produced from similarly objective processes. Apart from architectural forms being generated by structural limitations and new materials from the Technological Revolution, architects now also needed to design buildings that housed more machines than people.

**Figure 5: Cubism.** *Brick Factory at Tortosa, Pablo Picasso. 1909.*



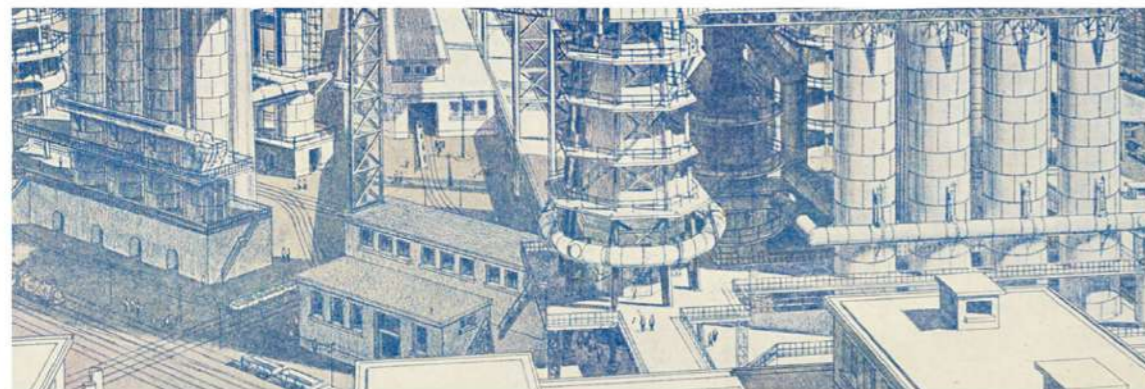
**Figure 6: Futurism.** *Grattacieli e tunnel, Fortunato Depero. 1930.*



**Figure 7: Suprematism.** *Suprematist Composition, Iankov Chernokov. 1922.*



**Figure 8: Protectorialism.** *Une Cite Industrielle, Tony Garnier. 1917.*



Architecture entered the realm of social construction. It was spurred on by visions of a new society made possible by technology through the advent of mass production after the Technological Revolution (Nuttgens, 1983, p. 266). In an interview, Denise Scott Brown satirised the Modernist approach to design by saying that “[architects] don’t have to listen to people, they don’t know what they want. We can tell them what they ought to want...” (Brown, 2018). In this new world, a society could

be optimised as much as a machine and it is this belief that allowed for the abstraction of people into predictable actors that the architect could script into the building. Through this, the architect became an expert in people and technology by assuming the role of the sole creative agent.

Pieter Eisenman exemplified turning the user into a marionette in his experimental *House VI*, completed in 1975. His approach rejected Functionalism and its idea that ‘form follows function’ by bringing form and function into conflict. *House VI* was designed to fully disrupt the habits of clients, Dick and Suzanne Frank. The clients were open to the idea of an experimental project for their holiday home; thus, they gave Eisenman creative licence. His exploration, however, led to a series of nuisances for the client. The worst being a slot in the bedroom floor that divided the bed in two. “This forced us to sleep in separate beds, which was not our custom” (Frank, 1994). It took the Franks fourteen years to renovate the house. They bought a bed that spanned the length of the slit and returned to their normal way of life.



**Figure 9: Bedroom split in half.** *House VI, Peter Eisenman 1975. Photo by Dick Frank.*



**Figure 10: Bedroom after renovation 1990.** *Photo by Dick Frank.*

In his book, *Actions of Architecture* (2005), Professor Jonathan Hill presents three models of authorship in architecture from the perspective of the user. They range from a passive user to a reactive user and lastly a creative user. A passive user corresponded directly with a “director” architect who casts the user as an actor in the architecture and scripts their experience. A reactive user responds to cues the architect leaves in the design whereupon the user may enact creative agency in a predictable manner. An example of this is Alejandro Aravena’s *Half a House* in Chile, where the project allows each owner to expand their house under an extended roof. Finally, the creative user appropriates a space and enacts their agency in an unpredictable manner, beyond the control of the architect.

The creative users may seem as though they do not fit under a director architect, because of the degree of freedom they have. However, in each of these cases the architect may design independent from the user. The user’s engagement would improve the design; but it is not necessary for a design to be produced. The architect assigns a role to the user (passive, reactive, or creative) and the user thus becomes an abstraction – idea of a person – when considered during the design process. The engagement between the architect and the user occurs after the building is occupied.

The central drawback of this relationship is that the architect relies not on the client’s knowledge of what they want or need, but projects onto the client a role to play in the architecture. Although this is not intrinsically negative, it has the potential to undermine the project and erode the public’s trust in the humanity of the architectural profession.

### The Facilitator Architect

The scenario of *House VI* plays out in architectural projects where the client’s input is set aside. It is most acute in community projects, where the architect must contend with diverse opinions as well as the requirements from external centres of power. Most often, the range of opinions from the community is set aside in favour of those from external powers (funders, local governments and



**Figure 11: Half a House, Chile.** *Elemental 2013.*

associations) whose needs are more straightforwardly articulated. It is a scaled-up version of what occurs between the architect and client around the meeting table, encompassing the same challenges in communication and balance of authority.

Political scientist Carol Pateman set out forms of participation based on where the decision-making authority lies. She ascribes the majority of practice in communities as pseudo-participation, where the participants are persuaded to agree with an outcome the experts have already decided on. This process only creates a ‘feeling’ of participation, with no opportunity to influence the outcome. The second kind, she notes, is full participation “where each individual member of a decision-making body has equal power to determine the outcome of the decisions” (Pateman, 1976). Full participation is a contrast to pseudo-participation.

In the 1970s, the *Design Method Movement* took this contrast to the extreme as it sought to render the architect obsolete. It merged the fields of participatory theory and systems design with those of computer programmes. Its proponents hoped that in rationalising the design process with computer-aided design it “will become transparent and the non-expert will be able to engage more fully in the design process” (Till, 2005). The closest we have come to achieving this is through video games like the Electronic Arts’ game series *The Sims* (1998-present).

The video game presents the player with a rudimentary set of construction tools (such as walls, floors, roofs, stairs, doors, and windows, among others). The virtual construction is also set in predetermined modules that govern lengths and heights. The tool is simple and so is the product, regardless of the design skill of the player. However, it is passable for its purpose and illustrates why the production of architecture – aside from the habitation of virtual people – calls for complex tools that take time to master.

Another reason users find it difficult to be designers lies in navigating the design process itself. Reading upon the subject of design processes and methods prove unfruitful for those who have not engaged in the act of designing enough to recognise its value. It is a skill that architects develop through experience and apprenticeship. Design methods are personal and have unique qualities that resist translation (Pressman, 2012). The supporters of the *Design Methods Movement* mistakenly believed that they could rationalise a design process without it losing the unique qualities that make it effective.

The failure of the movement points to the usefulness of experienced designers. Professor Jeremy Till warns against stripping the designer from their influence. He explains how community activists often remove the decision-making authority from professionals and “reduce them to being technical facilitators, there to deliver the desires of the community without imposing on them” (2005). The professional is thus an instrument of the community and the project is bound to the “symmetry of ignorance” as the professional’s knowledge is not utilised and does not evolve to understand the needs and concerns of the community. He further notes that even though full participation is ideal, it is not possible in architecture as it “relies on each party being in possession of the requisite knowledge and in there being transparent channels of communication” (2005). Till continues to remark that the expert knowledge of the architect and the tacit (unarticulated) knowledge of the user are of different kinds and require negotiation to integrate.

What the director and facilitator have in common is the way they deal with the different kinds of knowledge. They both neglect one or the other’s knowledge to negotiate the decision-making process. Under the director, the knowledge of the client is neglected and under the facilitator the architect’s expert knowledge is neglected. A fairer distribution of authorship requires effective negotiation of these different kinds of knowledge so that both the client’s and the architect’s knowledge can be called upon and evolve.

### A Curator Architect

To construct the curator architect, we begin with what Pateman describes as ‘partial participation’, where in her model it fills the polar forms of pseudo- and full participation. It exists where all individuals have influence over the outcome of decisions, however, “the final power to decide rests with one party only” (Pateman, 1976). This is due to the varying skills and expertise of individuals. The curator architect demonstrates a relationship between the professional and the patron, where the patron is afforded greater authorship, yet the architect becomes fully engaged in the context of the patron. This relationship relies on the client having sufficient opportunity to “actively transform the knowledge of the architect” (Till, 2005) and the architect recognising the knowledge of the client as an expert in their everyday life.

The client gives input into the type of building being designed, for example, “I want a place to live and do my work;” the

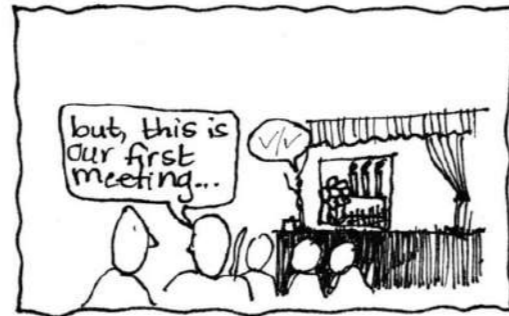


Figure 12: Pseudo-participation. By author. 2019.

budget, “I don’t want to spend much on it;” and time within which they expect the building to be completed, “I want it done before I get too busy again.” This skeletal framing of the project’s constraints defines its character and the beginning of the house’s narrative. Other factors such as the site, its climate, and the broader economic, social, and political aspects are beyond the architect’s control and form external narratives affecting the project. These parameters are part of the explicit information of the project and can easily be jotted down into diagrams and lists. They form the context of the project but do little to say what the architecture ought to be like. To capture the essence of the project, a great deal of insight must be obtained from the client.

The role of the architect is thus to skilfully interpret the client’s desires – and augment them with possibilities the client may not have imagined – so it may be fulfilled in built form. This insight into the client’s needs and expectations typically develops over regular, close conversations with the client. However, the client may not be able to articulate their needs exhaustively – another significant reason the *Design Method Movement* failed in rationalising the design process into sets of parameters. This relates to the notion of tacit (un-articulatable) knowledge, which “is a non-linguistic, non-numerical form of knowledge that is highly personal and context specific and deeply rooted in individual experiences, ideas, values and emotions” (Gourlay, 2002). These aspects – to which we add expectations, needs, and wishes – can be sensed, but resist being verbalised or written down and thus, are difficult to communicate.

This gap between what the client needs and what they can articulate, demands of the architect to be attentive to what the client does not verbalise. This attentiveness is a skill an architect gains through experience. Another such skill is the ability to ‘read’ drawings and other artefacts such as conceptual models. If we were to recognise the unarticulated knowledge of the client as another source of influence and give them a greater voice in the decision-making process, the focus shifts to how we access this unarticulated knowledge.

## PART 2: MISEXPRESSON AND AUTHORITY

We often mean things we do not say, or we simply do not know how to say what we mean. This complication also occurs in the meetings between architects and clients throughout the life of a project. We encounter it through the unsaid “oh, that’s not how I imagined that window, but okay...” or, even worse, “remember that window you just ordered, I’ve been meaning to say I hate it...” In either case, the client had not expressed their opinion, or objection, as they may not feel entitled to it or, simply because they did not know how to express their expectations. In such a case, the client is either left with a window they did not want, or the architect must cancel orders and rework that part of the project. Simply put, the expectations and desires of the client have not surfaced in the engagements, as words are often a poor medium for the communication of expectations, emotions, and wants. The question, “what do you want?” – even if not meant as an insult – causes anxiety. It asks of a person to distil their aspirations into a few neatly chosen words and hope that their neatly few would accurately convey their meaning.

This effect is worsened by the presence of an imbalance in authority. Authority makes for an uneasy engagement between people, regardless of whether this authority stems from social dynamics or the relationship between a patron and professional – where the authority is derived from expert knowledge. In the case of architecture, the architect and the client generate a skewed distribution of power where the architect is the expert and, in most cases, the client a layperson. However, this dispensation is opposed by the client being the funder of the project who pays for the architect’s service. These opposed authorities do not average out as if on a spectrum because, as Till noted, they are different in kind and thus have a seeming autonomy from one another. The architect, as the bearer of expert knowledge, is the authority figure within this assembly as the engagement is framed by the “architect’s knowledge system and specialised modes of communication” (Till, 2005). The architect is the one who constructs the engagement with the client and already sets the framework for what could be discussed before the conversation has even begun. However, if this skewed nature of influence is unresolved, the issue of misexpression only serves to deepen the division between the patron and professional.

This skewed balance of authority is negotiated in the conversations between the architect and the client. We often augment these conversations with other modes of communication that are outside the experience of the client, such as drawings, models, renders, and plans.

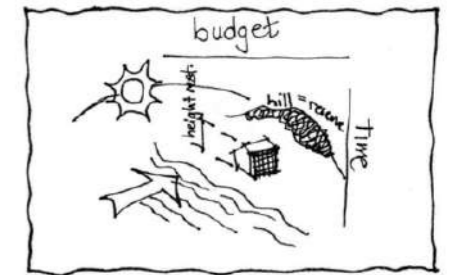


Figure 13: Explicit information of a project represented as a diagram. By author. 2019.

## Accessing Tacit Knowledge

The act of making is the act of knowing. Some organisations use indirect methods of communication to gather, translate and distribute tacit knowledge between its members. In this context, this knowledge typically includes experiences, skills, and technical know-how. Haghirian and Chini (2002) explored the use of storytelling as a management tool for tacit knowledge in corporate settings and stressed the use of metaphors and allegories to access insights and intuitions. Creative processes such as drawing a picture, assembling a collage, or building a model gives us to express tacit knowledge in a similar way to how a metaphor and allegory as Haghirian and Chini suggested. They present a different way to structure and translate thoughts and feelings that the interpreter accesses indirectly.



Figure 14: Cartoon explaining the creative part of art therapy. Medium.com. 2019.

The architect's skills of attentiveness and reading media, makes it possible to use other mediums (such as drawings, models, montages, among others) to illuminate the client's unspoken expectations. This is not a new notion and is also found within art therapy in psychology. According to art psychotherapist Carol Hammel, the client (in this case of a psychologist) expresses their thoughts and feelings in the piece of work. "You put out your unconscious mind on that piece of paper and that piece of paper becomes a representation of your unconscious" (Hammal, 2015). Through this, the client is asked to engage not only in words but also with their hands, in terms of drawing and creating.

The artefacts become repositories of the client's knowledge that the architect may interpret as ancillary information for the project (Mäkelä, 2007). Thus, the creation of art would allow the architect insight into the client's unspoken and unconscious desires and expectations. This aids the architect in defining the character of the project concerning the quality of spaces, the material palette, and details. The artefacts also have the benefit of being present when the client is not. They form part of the conceptual framework of the project, encapsulating emotions, expectations, and predispositions in ways a brief in words cannot. Art therapy often uses the making process to build confidence in patients. To architecture, this adds another dimension of engagement between the architect and the client and offers a mechanism whereby authority and authorship can be navigated.

To ask a client to draw a sketch is not simple. Recalling the early days of architecture school makes one sympathetic to what the client endures in order to make a mark on the paper. This asks of the architect to step into a guidance role and navigate the creative process with the client. The drawing may or may not look like much, depending on the client's artistic skills, however, the focus lies in the making of the drawing. What is drawn first and what next? Is the drawing inside a frame, and if so, is the frame drawn before or after the rest? Does the client prefer a minimal design or one that is marvellously ornamented? Paying attention to how the client navigates the thinking process in a foreign medium illuminates their predispositions; what they prioritise in terms of space and the use of space. Through reading the drawing the architect can gain insight into that part of the client's character which is difficult to verbalise.

As the client engages with the same media as the architect (drawings, models, or montages) the client gains familiarity

with such structures and no longer sees the conceptual sketches or plans as the sole domain of the architect. This breaks the tension of authority and brings the client into the fold of producing architecture. The medium is no longer as foreign as it once was and grants the client greater opportunity to point out their concerns within the project – or their dislike for a hideous window. The client may feel more empowered in the design process and openly engage with the architect. In doing so, the client avoids being disappointed with their engagement with the architect or the product those engagements, because their expectations were correctly interpreted.

Viewing the client as the co-author of the project may seem as though the architect is handing his or her authority over to the client. However, the knowledge that the architect has is of a different kind to that of the client. The client's drawing is not the architecture and only relies on the client's self-knowledge and not that of the architect's expert knowledge – which would require further conceptual and technical contexts drawn from experience and research. The client's drawing does, however, bring to the surface a great deal of information about the client and the client's expectations. Such a creative process grants the architect greater insight at the onset of the project, leading to better architecture. The most important aspect of such an approach is that it grants the client an opportunity to engage with and enjoy the production of architecture.

## CONCLUSION

Architecture is produced through conversations. Logically, as an architect designs a building that meets the client's needs, the better the architect understands client's needs, the better architecture they will produce. However, verbal language has a limited ability to communicate needs, wishes and expectations. To compensate for this shortcoming, architects read between the lines to grasp what a client fails to verbalise.

A curator architect builds on this skill and takes a different approach to how architects engage with their clients. By seeing the client as a co-author, the architect invites them into the domain of the architect. As a curator architect guides their client through the creative process in media that are typically used by architects, they gain glimpses of the knowledge that the client cannot articulate verbally. In return, the client becomes familiar with the mediums that architects use to represent and understand a project and gains confidence in their engagement. As the languages used between architects and the public to communicate knowledge is broadened, the profession finds a better footing in the public realm. The design of buildings and cities are no longer be considered the sole domain of architects and planners, but also that of the public.

As members of the public themselves, architects can appreciate the importance of having one's voice heard. We are more inclined to participate when we see the effects of our contributions. Apart from seeing the direct result of our contributions, another way to create meaning in participation is for the process to be rewarding in its own right. By making the process of co-authorship meaningful, the architecture gains meaning as well. The public's increased engagement with architecture improves the value of good architecture and so increases the need for it.

## FURTHER DISCUSSION

This paper has focused on literature sources to establish archetypes of engagement between the architect and the client. However, this study will benefit from a detailed case study that supports the existence of the curator relationship in practice.

Further studies are needed in two key areas that are beyond the scope of this paper. The first should deal with the effectiveness of co-authorship on a diversity of clients, since not all clients may be comfortable with participating in the design process to the extent this relationship calls for. In doing so, it can establish in greater detail in which situations this kind of relationship will be most effective. The second area of study should deal with a scaled-up engagement, like in community participation, where the conversations need to be effective whilst dealing with a whole group of diverse clients. This study would be tempted to establish rules of engagement, or pre-manufactured media as a compromise to deal with the number of participants. In doing so, it would venture precariously close to the same pitfalls of current (pseudo-)participation where the media of communication sabotages the influence of the clients well before they participate in the process. Together, these studies can aid in establishing how practical and adaptive the curator relationship is.

## LIST OF REFERENCES

- Brown, D. S., 2018. *Lessons from Las Vegas* [Interview] (04 09 2018).
- Crawford, M., 1991. Can Architects Be Socially Responsible?. *Out of Site: A Social Critique of Architecture*, pp. 27-45.
- Favole, P., 2012. *The Story of Modern Architecture*. 1st ed. Munich: Prestel.
- Frank, S., 1994. *Peter Eisenman's House VI: A Client's Response*. 1st ed. New York: Whitney.
- Gourlay, S., 2002. *Tacit Knowledge, Tacit Knowing or Behaving?*, Kingston upon Thames: Kingston Business School.
- Haghirian, P. & Chini, T. C., 2002. *Storytelling: Transferring Tacit Corporate Knowledge in Different Cultures*, Vienna: Vienna University of Economics and Business Administration.
- Hammal, C., 2015. *Art Therapy a World Beyond Creative Expression*, s.l.: TEDx.
- Hill, J., 2003. *Actions of Architecture: architects and creative users*. 1st ed. London: Routledge.
- Mäkelä, M., 2007. *Knowing Through Making: The Role of the Artefact in Practice-led Research*, Helsinki: Springer Science + Business Media.
- Melvin, J., 2018. *Understanding Architecture*. 1st ed. Brighton: Bloombury Publishing Plc.
- Nuttgens, P., 1983. *The Story of Architecture*. 2nd ed. London: Phaidon.
- Pateman, C., 1976. *Participation and Democratic Theory*. reprint ed. Cambridge: Cambridge University Press.
- Pressman, A., 2012. *Designing Architecture*. 1st ed. Oxon: Routledge.
- Till, J., 2005. *Architecture and Participation*. 1st ed. New York: Routledge.

## LIST OF FIGURES:

- Figure 1: *An architectural project as an organisation that evolves throughout its duration*. By Author. 2019
- Figure 2: *Director architect*. By author. 2019
- Figure 3: *Facilitator architect*. By author. 2019
- Figure 4: *Curator architect*. By author. 2019
- Figure 5: *Cubism. Brick Factory at Tortosa, Pablo Picasso. 1909*. Available from: <https://www.hermitagemuseum.org/wps/portal/hermitage/digital-collection/01.+paintings/28613/?lng=> Accessed on 14 March 2019.
- Figure 6: *Futurism.Grattacieli e tunnel, Fortunato Depero. 1930*. Available from: <https://www.italianmodernart.org/depero-and-the-metropolis/> Accessed on: 14 March 2019.
- Figure 7: *Suprematism.Suprematist Composition, IankovChernokov. 1922*. Available from: <https://www.ourartworld.com/art/abstract-art-suprematist-composition-1922-iankov-chernikhov-from-catmota-com-art-abs/> Accessed on: 14 March 2019.
- Figure 8: *Protorationalism. Une Cite Industrielle, Tony Garnier. 1917*. Available from: <https://www.pencil.com/gallery.php?p=490504414159> Accessed on: 14 March 2019.
- Figure 9: *Bedroom split in half. House VI, Peter Eisenman 1975. Photo by Dick Frank. S.a*. Available from: <https://www.archdaily.com/63267/ad-classics-house-vi-peter-eisenman> Accessed on 14 March 2019.
- Figure 10: *Bedroom after renovation 1990. Photo by Dick Frank. S.a*. Available from: <https://www.archdaily.com/63267/ad-classics-house-vi-peter-eisenman> Accessed on 14 March 2019.
- Figure 11: *Half a House, Chile. Elemental 2013*. Available from: <https://www.archdaily.com/79779/half-a-house-builds-a-whole-community-elementals-controversial-social-housing> Accessed on: 13 March 2019.
- Figure 12: *Pseudo-participation*. By Author. 2019
- Figure 13: *Explicit information of a project represented as a diagram*. By Author. 2019
- Figure 14: *Cartoon explaining the creative part of art therapy. Medium.com. 2019*. Available from: <https://medium.com/@saniyabedi05/my-experience-with-aty-therapy-2124afc9f2f7> Accessed on: 15 March 2019



# RADICAL INNOVATION AND TABOO: HOW TO ENCOURAGE THE ACCEPTANCE OF A NEW MENSTRUAL PRODUCT IN SOUTH AFRICA THROUGH BEHAVIOURAL DESIGN

Ms Pia Findlay, University of Johannesburg, South Africa, piafindlay@gmail.com

Mr Angus Campbell, University of Johannesburg, South Africa, acampbell@uj.ac.za

## Abstract

*This paper initially explores the complexity of trying to introduce a radical innovation and taboo product into the South African market. What makes radical innovations problematic is that they fall outside the frame of reference of potential product users, and therefore often do not reach their full potential when initially introduced. A radically innovative menstrual product adds the complexity of taboo to market acceptance. Methods that have been developed to introduce radical innovations are often post-design and product-centric and do not take the user or their context into account.*

*This paper explores a design honing strategy, which was developed to encourage the acceptance of a new menstrual product in South Africa through the use of Behavioural Design. Behaviour around menstruation is unpacked using Activity Theory as a framework for understanding human action and its influences. The honing strategy was devised as a way of steering a product during its design development phase. The strategy is comprised of four design methods: Appropriate Technology, Designing Affordances, Designing Meaning and Designing Mindfulness. These sit on a spectrum that runs from continuity, in alignment with what already exists, to development, which challenges problematic preconceptions and mindsets. This accommodates the user's cultural and social norms, whilst allowing the designer to encourage appropriate shifts. The strategy is a holistic approach to the participatory design of radical innovations in taboo fields at a systemic level. All methods are aimed at influencing product design and user behaviour to make the acceptance of a new menstrual product more probable. Such an approach is useful for the introduction of any radical innovation which may be considered taboo.*

**Keywords:** Behavioural Design, Menstrual Product, Radical Innovation, Taboo.

## INTRODUCTION

Put simply, menstruation is the shedding of the lining of a woman's uterus that occurs during her reproductive years. Menstruation happens to half the world's population and yet the subject is still taboo. The shame and silence around menstruation is a global phenomenon. *Menstrual health management* is a term that describes a woman's right to sufficient menstrual products (MHM, 2019). It also includes access to water and soap, a private place to dispose of or clean menstrual products, and adequate education on menstruation (MHM, 2019). However, due to the limited attention the design of menstrual products has received, this is not every woman's reality. These rights were investigated in a BA Industrial Design project undertaken at the University of Johannesburg titled *The empathic design of a new menstrual hygiene product for women in the South African context* (Findlay, 2017). The project resulted in the design of a theoretical product. This could be a solution to problems identified in existing products in South Africa

Such problems included the affordability of conventional menstrual products (Chikulo, 2015, p. 1979; House, Mahon & Cavill, 2013); the waste they create (Peberdy, Jones & Green, 2019); and the health risks that accompany them (House, et al., 2013). The product outcome was a reusable, medical-grade silicone pad with a surface of cavities that retained menstrual fluid (Figure 1). It was designed to be easily cleaned with running water and dried with a cloth or towel

before being reinserted into one's underwear for further use. The use of medical-grade silicone in the product reduced health risks, as the material that does not harbour bacteria (Ross, 2015); the product overcame the taboo of needing to be inserted; and was reusable, which benefitted affordability and environmental sustainability.



**Figure 1:** BA Honours Industrial Design Product Outcome, (Findlay, 2017).

While this reusable pad design solved the practical issues of existing period products, the outcome was a radical innovation in the taboo field of menstruation, which potentially made the acceptance of the product difficult. Therefore, a further study was undertaken to explore and manage the complexities of introducing radical innovations and taboo products – which is the focus of this paper. This study aimed to utilise *behavioural design to develop a method of encouraging the acceptance of a new menstrual product in South Africa, which is a radical innovation and falls under the effects of taboo*. To do this, the behaviour around menstruation within South Africa had to be unpacked. Activity Theory was used as a theoretical framework to frame action as systemic, and Behavioural Design was used as a method of investigating the beliefs and practices around menstruation in South Africa from a human-centric perspective. The outcome of the study was a design honing strategy, as well as a revised version of the menstrual product

## RADICAL INNOVATION AND TABOO

What makes radical innovations problematic is that they fall outside the frame of reference of potential product users, and therefore often do not reach their potential when first being introduced (Norman & Verganti, 2014). People desire things that have already been trialled so that the distinction between good and safe, and bad and dangerous, has already been made (Berkun, 2010, p. 55). This reaction is not deliberately formed but rather arises from a place of habit created in one's subconscious (Schumpeter, 1983, p. 84). The habits people have are largely adopted from their societal norms: "Deeply rooted psychological and cultural factors frame the initial response to new technologies" (Juma, 2016, p. 25). It therefore becomes clear that behaviour and the acceptance of innovations are inextricably linked, and understanding human behaviour is a complex undertaking.

The perception of a new product can vary from culture to culture and may be adopted in one place and rejected in another (Berkun, 2010, pp. 60, 66). The reaction an innovation receives is hence greatly influenced by its context. Berkun (2010, p. 118) therefore argues that the acceptance of an innovation relies far more heavily on its alignment with cultural values, than it does on how good its technology is. If an innovation threatens to disrupt cultural identities, it is likely to be rejected (Juma, 2016, pp. 7, 24). It is recommended that radical innovations are revisited through an incremental and human-centred process during the design phase for them to become influential (Norman & Verganti, 2014). Methods that have been developed to introduce radical innovations, however, are often post-design and product-centric processes that do not take the user or their context into account (Rogers, 2003). As South Africa is a complex and diverse context, these methods were deemed inappropriate.

A radically innovative menstrual product adds the complexity of taboo to market acceptance. Taboos are defined as social constraints on an individual's behaviour that prohibit certain actions and even thoughts (Fershtman, et al., 2011, p. 139; Allan, 2015, p. 155). These constraints are experienced culturally and are enforced by social norms, which also means that they differ from culture to culture (Fershtman, et al., 2011, p. 140; Sabri, et al., 2010, p. 62). The universal shame

and stigma associated with menstruation is clear and common. It is often associated with uncleanliness (Allan, 2015, p. 156; Houppert, 1999; Dahlqvist, 2018; Strömquist, 2018), and the silence around menstruation is a further universally expected behaviour (Dahlqvist, 2018, p. viii). As menstruation falls under the category of “conversational taboos,” it in turn, makes menstrual products and their use a taboo (Sabri, et al., 2010, p. 72). Taboos present a barrier to product acceptance since they threaten to disrupt social order (Allan, 2015, p. 162).

Methods of introducing taboo products are limited and in need of further investigation as most are product-centric and disregard context (Sabri, et al., 2010; Yagnik, 2016). Pro-innovation bias can be detrimental for product success, especially in a multicultural environment, which ultimately leads to tension between cultures as they compete for superiority and survival (Yagnik, 2016, p. 36). Due to the multicultural context in South Africa, the introduction of an innovation, particularly one considered taboo, must be carefully considered. For the acceptance of this study’s menstrual product to be encouraged, the design was revisited through a human-centric approach that aimed to deeply understand both the user and their context. This was undertaken by unpacking beliefs and practices around menstruation in South Africa through the systemic lens of Activity Theory.

### ACTIVITY THEORY

Activity Theory is useful in unpacking the concept of activity, by studying human behaviour on both an individual and social level (Kaptelinin & Nardi, 2012, p. 33). The *Activity System Model* is a widely utilised framework developed by Yrjo Engeström in 1987 (Fig. 2). It was built on previous models of activity theory that arose from psychology in the Soviet Union (Vygotsky, 1962). The model depicts action that is undertaken by an individual (*subject*) to fulfil their motive (*object*) (Engeström, 1987). This action is mediated by a *tool*, which enables the subject to execute their motive (Engeström, 1987). Influenced by the other actors in the activity system (*rules*, *community* and *division of labour*) the action leads to an *outcome* (Engeström, 1987). The emphasis of the broader systemic influences of culture and context on human activity is what makes the theory particularly useful (Kaptelinin & Nardi, 2012). *Rules* or social norms, the individual’s social context (*community*), as well as social organisations (*division of labour*), are all considered key supporters or contradictions in the activity system (Engeström, 1987).

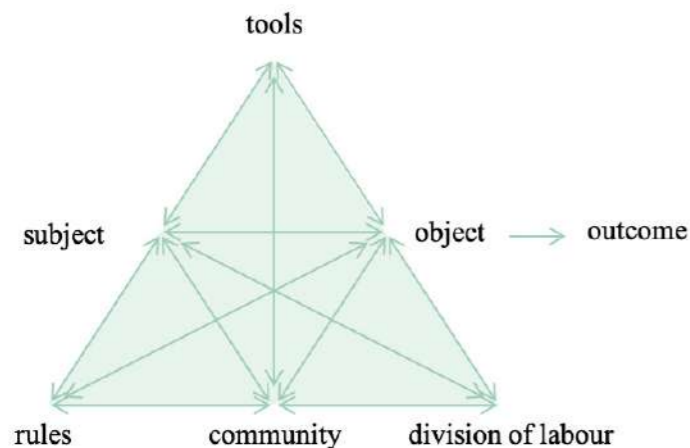


Figure 2: Activity system model, adapted from Engeström, 1987.

### RESEARCH METHOD

Behavioural design (Cash, et al., 2017) was the central method of this study since it allowed for the unpacking of context and culture, with a focus on influencing action. The *tool* in the activity system is key since this is where the designer has some ‘power’ to elicit change. Human action is hindered or supported by what a *tool* can afford (Gibson, 1979). Designing for affordances can, therefore, be used to encourage certain behaviours and is done by aligning visual cues with the users existing knowledge to encourage the desired action (Norman, 2013). Doing this can be considered as *nudging* or using design to change behaviour in a predictable manner (Thaler & Sunstein, 2008).

Behavioural design requires an unpacking of culture, existing knowledge, and an analysis of what behaviour is motivated in relation to a specific product. Through their analysis of twenty design projects, Cash, Hartlev and Durazo (2017) developed a seven-step behavioural design process derived from existing theoretical approaches to behavioural changes. These steps consist of (1) *the definition of a problem or need*, (2) *behaviour mapping*, creating a (3) *behavioural hypothesis*, which is refined through (4) *fieldwork*, and expressed in a (5) *behavioural statement*, (6) *the development of an intervention*, and finally an (7) *iteration of testing and development* of this intervention. For this paper, these have been summarised into three phases (Table 1).

#### Definition of problem or need

Within this phase of the project the behavioural problem was defined (Cash, et al., 2017, p. 116). Primary literature (Ramdhani, et al., 2016) was used as a foundation for defining the difficulties of introducing radical innovations and taboo products.

#### Behaviour mapping

Behaviour mapping includes the investigation of elements such as social norms, environment, social context and personal factors that are related to the identified problem (Cash, et al., 2017, p. 117). Guided by Activity Theory (Engeström, 1987), this exploration took place in two parts. The first part included extensive desktop research (Johnston, 2014, p. 620) of primary and secondary literature (Ramdhani, et al., 2016), field observations (Martin & Hanington, 2012, p. 120; Curedale, 2013, p. 211) of the existing South African menstrual product industry, as well as interviews with five South African menstrual product experts. After thematically analysing the resulting data (Martin & Hanington, 2012, p. 12), a behavioural hypothesis was deduced. To confirm, update and expand on this hypothesis, further interviews were conducted with a culturally diverse group of young South African women, which led to a final behavioural statement.

This paper only covers an aspect of what was a complex two-year Master’s design research study, for more detailed information on the study please read Findlay (2020). Also, please note that the menstrual product presented in this paper has been patented in partnership with the University of Johannesburg Technology Transfer Office: ZA National Patent 2018/08001.

METHODS			
			Participant
1	<b>Definition of problem or need</b>	Primary literature	
2.1	<b>Behaviour mapping</b>	Primary and secondary literature	
		Field observations	
		Interviews with experts	Sharon Gordon (CEO of Dignity Dreams) Susan Barnes (managing director of SubzPads) Zamagela Magoso (project co-ordinator of Subz-Pads) Ivana Merckel (representative of Mina) Kim Windvogel (advocacy officer of FemmeProjects)
2.2	Behavioural hypothesis		
2.3	Field work	Interviews with young South African women	Amaira Anele Hafeezah Kefilwe Laura
2.4	Behavioural Statement		
3.1	<b>Design intervention, testing and development</b>	Feedback from young South African women, Feedback from SAIS 2019 where the product was exhibited	Anele Hafeezah Kefilwe Laura Mia SAIS Tradeshow Conversations
3.2	Development of Honing Strategy		
3.3	Design Iteration		
3.4	Design Evaluation	Feedback from young South African women	Ayanda Hafeezah Hannah Laura Mieke
*All interviewees were presented with information and consent forms which clarified the intent of the study as well as their participation in it. With consent, the identities of the experts were presented in the study. The identities of all young adults were kept anonymous and are referred to by pseudonyms within the study.			

**Table 1: Methods (Findlay 2020).**

### Design intervention, testing and development

To refine the existing menstrual product, a *honing strategy* was developed as a method to encourage the acceptance of the new menstrual product in South Africa. The strategy was developed as a holistic approach to the design of radical

innovations in a taboo field, that addressed both the product and system, as well as the motives of both the user and designer. After conducting a further design iteration, guided by the honing strategy, the menstrual product outcome was evaluated through further feedback sessions with young South African women.

The outcomes of the three phases described above are reported below, forming the core of the paper. To accommodate the complexity of context, the findings are organised under the headings of *rules, community and division of labour*, and *subject and object* from the Activity Systems Model (Fig. 2). The *tool* is the menstrual product, which is explored under the development of the honing strategy and its final refinement.

### Rules, Community and Division of Labour

Due to social and cultural norms, the context into which a product is introduced strongly influences how it is received (Berkun, 2013; Juma, 2016; Conteh, 2003; Vanek, 2003; Yagnik, 2016). The South African context is complex consisting of multiple ethnicities, religions and cultures (Thompson, 2011; McKenna, 2011). The country's context is generally described as conservative and patriarchal (Barnes, 2019; Gordon, 2019; Merckel, 2019; Windvogel, 2019; Magoso, 2019; Karim & Baxter, 2016; Watts & Zimmerman, 2002), leaving menstruation as a taboo topic and shameful experience for many women (Barnes, 2019; Gordon, 2019; Merckel, 2019; Windvogel, 2019; Magoso, 2019; Dahlqvist, 2018; Houppert, 1999).

There is an existing set of *rules* that dictate menstrual taboos that can be traced back to various sources. The description of menstruation in many patriarchal religious texts plays a role in how menstruation is perceived today (Dahlqvist, 2018; Strömquist, 2018; Windvogel, 2019; Merckel, 2019). As South Africa is a context with a strong religious following, these rules have influenced the forming of societal norms and expectations (Denis, 2006). Traditional African religions have also been criticised for their patriarchal attitudes (Rafudeen & Mkasi, 2016; Tapscott, 2012). Because customary law is acknowledged by constitutional law within South Africa (Maluleke, 2012), many traditional patriarchal practices are normalised (Machisa, et al., 2011), often leaving women in a position of subservience (Gordon, 2019; Merckel, 2019; Windvogel, 2019).

The existing *communities* within the South African context are a further strong influence on the taboos associated with menstruation. Within such communities, the position women hold, has framed many of the perceptions of menstruation (Dahlqvist, 2018). Furthermore, the culture that exists within communities plays a role in the experience adolescent girls and women have of menstruation (Magoso, 2019; Merckel, 2019; Barnes, 2019; Windvogel, 2019). These communities include school and home environments, in which individuals perpetuate or dismantle taboos around menstruation (Windvogel, 2019). Teachers, female family members, friends and peers are most commonly the people who directly transfer menstrual rules to the next generation (Magoso, 2019; Merckel, 2019; Barnes, 2019; Windvogel, 2019; Gordon, 2019; Amaira, 2019; Anele, 2019a; Hafeezah, 2019a; Laura, 2019a; Kefilwe, 2019a).

The *division of labour* describes existing competitors in the menstrual and female health product industry, which influence society's perceptions of menstruation. Because human behaviour is influenced by one's existing frame of reference (Berkun, 2010; Juma, 2016; Norman, 2013), the messages sent by largely commercialised industries entrench a norm. The South African menstrual health industry is largely dominated by international companies, with a small sector of locally produced products (Khumalo, 2013; Le Guern, 2018). Disposable pads make up the majority of products supplied on the South African market, followed by tampons, another disposable product (Chikulo, 2015; Beksinska, et al., 2015). This leaves only a small sector selling reusable products such as cloth pads and menstrual cups.

The messages created by these influences within the South African context are repetitive and consistent. The *rules* that are 'written', the *communities* that adapt and implement them and the messages received from the *division of labour* are continuously presenting menstruation as something *unclean*, something in need of *concealment* and something closely linked to *sexuality*.

Menstruation is presented as unclean (Barnes, 2019; Gordon, 2019; Merckel, 2019; Windvogel, 2019; Magoso, 2019). Many patriarchal religions present menstruation as polluting and dirty (Dahlqvist, 2018), which still determines the kinds of religious practices women are, and are not, allowed to perform during menstruation in South Africa today. The result of this belief has gone as far as women being required to isolate themselves during menstruation (Barnes, 2019). The menstrual product industry, which is dominated by disposable products, promotes the idea that menstruation is dirty and must be disposed of (Strömquist, 2018; Dahlqvist, 2018). Uncleanliness is not only a view society has of

periods, but a view that women have of their menses as well (Barnes, 2019; Gordon, 2019; Merckel, 2019; Magoso, 2019; Windvogel, 2019; Anele, 2019a; Hafeezah, 2019a). Some participants were repulsed by menstrual blood and often learnt to practice rigorous hygiene routines during menstruation (Anele, 2019a; Kefilwe, 2019a; Laura, 2019a; Amaira, 2019). Such views led to the rejection of reusable menstrual products due to their need for cleaning (Barnes, 2019; Gordon, 2019; Merckel, 2019; Magoso, 2019). The perception that periods are unclean also caused women to isolate themselves and has created a culture of concealment and silence on the topic. These factors make gaining the acceptance of a new reusable period product challenging.

As it is considered a taboo topic, the *concealment* of menstruation is expected. The existing menstrual product industry perpetuates the idea that menstruation is embarrassing and in need of being concealed (Dahlqvist, 2018; Strömquist, 2018; Houppert, 1999). Men have been removed from the conversation (Merckel, 2019; Barnes, 2019; Windvogel, 2019; Gordon, 2019; Amaira, 2019; Anele, 2019a; Hafeezah, 2019a; Laura, 2019a; Kefilwe, 2019a), making the normalisation of periods nearly impossible. The rule of silence has also affected the realm of education on menstruation in South Africa, where this topic is often neglected in school curriculums and within homes (Merckel, 2019; Barnes, 2019; Windvogel, 2019; Gordon, 2019; Amaira, 2019; Anele, 2019a; Hafeezah, 2019a; Kefilwe, 2019a). As a result, the experience adolescent girls have of their first menstruation involves fear and confusion, and is often kept a secret from others (Barnes, 2019; Windvogel, 2019; Gordon, 2019; Amaira, 2019; Anele, 2019a; Hafeezah, 2019a; Kefilwe, 2019a). Having to conceal the fact that one is menstruating causes girls who don't have access to sufficient menstrual products to avoid attending school during their periods (Barnes, 2019; Dahlqvist, 2018; Chikulo, 2015). The rule of silence and the expectation of concealment around menstruation leads to the experiences of fear and shame, while perpetuating the taboo around periods and making the topic difficult to normalise. Introducing a product that no one wants to admit they use, makes gaining its acceptance challenging.

Menstruation has been linked to *sexuality*, which has continuously caused periods to be presented as “naughty” (Anele, 2019a; Gordon, 2019; Merckel, 2019; Windvogel, 2019). Within South Africa, many adolescent girls were found to believe that the onset of menstruation was linked to sexual activity (Anele, 2019a; Gordon, 2019; Merckel, 2019; Windvogel, 2019). Because the onset of menstruation is strongly linked to womanhood, fears around adolescent girls being subject to gender-based violence has led to practices such as virginity testing in South Africa (Karim & Baxter, 2016; Karim, 2005; Denis, 2006; Barnes, 2019; Merckel, 2019; Windvogel, 2019). Due to the value placed on virginity in many South African cultures, menstrual products that have to be inserted are often restricted (Anele, 2019a; Kefilwe, 2019a; Barnes, 2019; Gordon, 2019; Magoso, 2019; Merckel, 2019; Windvogel, 2019; House, et al., 2013). The link to sexuality has caused young girls to feel ashamed and “naughty”, perpetuating the rule of silence and taboo around menstruation.

### Subject and Object

The *subject* was explored to identify the most suitable target audience to encourage the acceptance of a new menstrual product. We aimed to identify early users, who are most likely to try a new product (Rogers, 2003, p. 36), and hence where a change in mindset may need to happen to improve the acceptance of the product. The subjects we identified were young adult women, but this is not the only *subject* audience that could be explored.

As a group that is open to being guided during their attempt to overcome menstrual taboo, young adult women were identified as the primary target audience. The reason for this is that they reported their experience of menstruation having changed since their adolescence (Amaira, 2019; Kefilwe, 2019a; Anele, 2019a; Hafeezah, 2019a; Laura, 2019a). As they gained more independence from their family home and were exposed to more information in new environments, such as in higher education, they began questioning the norms of menstrual taboos (Amaira, 2019; Kefilwe, 2019a; Anele, 2019a; Hafeezah, 2019a; Laura, 2019a), as well as altering which menstrual products they used (Amaira, 2019; Kefilwe, 2019a; Anele, 2019a; Hafeezah, 2019a; Laura, 2019a).

As the behaviour of the young adult women shifted after adolescence, their motives also changed. Their actions during adolescence showed the intention of concealing their menstruation (Amaira, 2019; Kefilwe, 2019a; Anele, 2019a; Gordon, 2019; Hafeezah, 2019a), to fit in with social norms and to create safety from ridicule. Their actions were determined by other elements in the activity system such as *rules*, *community* and *division of labour*, as well as the products that they had used (*the tool*), which all promoted ideas of uncleanliness and the sexual connotations of menstruation that needed concealment. The change in behaviour around menstruation as these women entered young adulthood showed that their goals shift to wanting to be more open about their periods and overcoming certain taboos (Amaira,

2019; Kefilwe, 2019a; Anele, 2019a; Hafeezah, 2019a; Laura, 2019a). The motive of this behaviour can be interpreted as wanting to overcome gender-based restrictions they had experienced as teenagers, not wanting to feel ashamed of their bodies, wanting to gain independence and a sense of freedom, and not feeling judgement towards this naturally occurring process. Some of them also had the goal of becoming more environmentally friendly, by creating less waste from disposable menstrual products (Hafeezah, 2019a; Laura, 2019a).

The *object/objective* of the *subjects* in this study was to use a menstrual product (*tool*) that could assist them in fulfilling their motives, and hence a menstrual product that could clearly indicate how it fulfils their motives would be more easily accepted.

### Honing strategy

To gain the acceptance of the new menstrual product, the design had to be revisited. A design honing strategy was developed as a method of guiding the design iteration. The honing strategy was created as a means to manage the balance between “continuity” and “development” (Juma, 2016, p. 6) (Fig. 3). It comprised existing design approaches that fall on this spectrum, as per the selection of the subject, but these are by no means the only design approaches that could be applied when introducing a new menstrual product through behavioural design. They were, however, chosen as approaches that represent a range of different opportunities along the continuity-development spectrum.

*Appropriate technology* (Conteh, 2003; Vanek, 2003) and *designing for affordances* (Norman, 2013; Krippendorf, 1989) are the first included methods. These two approaches have a strong focus on the design of a physical product that is being introduced and support continuity by accommodating culture whilst aligning with existing knowledge. However, after unpacking the origin of behaviour and perception around menstruation, it was acknowledged that to gain acceptance of new menstrual products, the spectrum had to be further extended in the direction of development. This extension not only addresses the need for product acceptance but the need for acceptance of menstruation as a whole. The spectrum was lengthened in the direction of development through the addition of a further two design methods: *designing meaning* (Kazmierczak, 2003) and *mindful design* (Niedderer, 2018). Rather than addressing the object being introduced, the intention of including these methods was to encourage more systemic change, than the more physical technological change encouraged through *appropriate technology* and *designing for affordances*. For the acceptance of the new menstrual product, the tool honing strategy presents design methods that encourage behavioural change by not only addressing the need for product design iteration but also the encouragement of a change in mindset around menstruation as a whole.

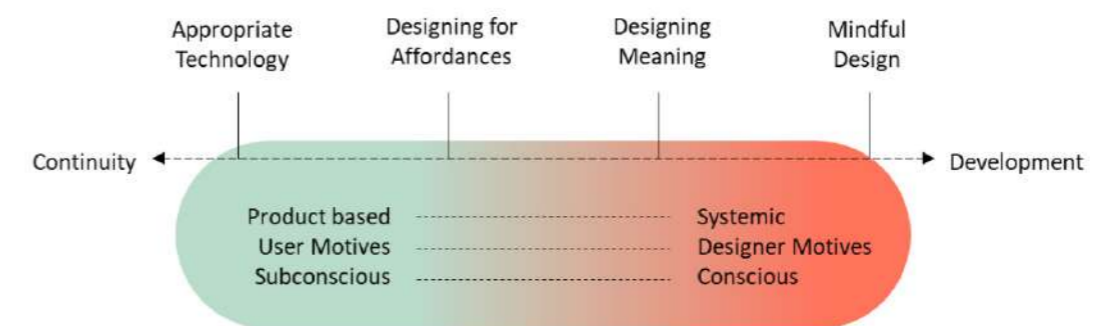


Figure 3: Honing strategy, 2019, Findlay.

The feedback gained from study participants was aligned with each one of the methods presented in the honing strategy. As the first two methods within the honing strategy are aligned with user motives, this is where the most product feedback was gained. The last two methods had not been consciously considered in the initial design outcome, but based on the data gathered around menstrual taboos in South Africa, design choices about these two methods were included in the product iteration. This paper touches on a few prominent design decisions made with the use of the honing strategy.

### Appropriate Technology

The participants raised questions about having to rinse out the pad in a public bathroom, where basins are not usually available within the toilet stalls (Hafeezah, 2019b; Kefilwe, 2019b; Laura, 2019b) or questioned what if no water was available at all (Hafeezah, 2019b). Because of the culture of concealment that exists around menstruation, rinsing one's menses in a public space, even if only in the presence of other women, was not viewed as acceptable behaviour. To mitigate this problem, it was decided that the pad would be split into two components (Figure 4). The user would be provided with a sleeve (a) and two inserts (b). This meant that if the pad was full and they only had access to a toilet stall without a sink inside, they could simply replace the insert with a clean one and store the used insert until they had the opportunity to clean it discreetly. This further use of *appropriate technology* accommodated the culture of concealment and hygiene, allowing users to conceal their used pad insert instead of rinsing it out in front of other people. The need to store the pad then also provided another design opportunity to combine storage and packaging, in the design of a case (see *mindful design* below).

### Designing for Affordances

Another common question from the participants was how the pad remained in place within one's underwear (Anele, 2019b; Hafeezah, 2019b; SAIS, 2019), and if it would stay in place with various underwear materials, such as lace (Anele, 2019b; Kefilwe, 2019b; Laura, 2019b). This function of the product was difficult for the participants to imagine, as no existing pads make use of friction as a method of holding the pad in place within one's underwear, as the new product intended to do. To visually communicate that the pad would remain in place within one's underwear, wings were added to the pad (Figure 5.). These would be moulded in a closed position and could then be flexed open to be placed over one's underwear. This design decision aligned with the method of *designing affordances*. While not affecting the actual function of the product, it visually communicated its use based on the visual reference to an existing product.

### Designing for Meaning

A point of sale unit was designed for a sample of the reusable pad to be displayed next to the purchasable products (Figure 6). The unit allowed for the product to be interacted with so that potential buyers could feel the flexibility and softness of the material. The intention of this display was to make more information available about the function, aesthetics and feeling of the product. The point of sale unit created a change in *meaning*, by openly displaying the product, as opposed to concealing it in packaging as existing disposable products do. This openness aimed to change the *meaning* of a menstrual product from being an object that should be hidden, to a product that is normal and common.



Figure 4: Nula pad, 2019, Findlay.

### Mindful Design

A case was designed to store used inserts. Inside the case, along with the pad sleeve and its two inserts, the user was provided with a booklet that gave more detail of product usage and care, as well as educational information (Fig. 7). The booklet was an element of *mindful design* that provided information on both the biological and experiential aspects of menstruation. It also encouraged users to track their menstrual cycle and any symptoms they experienced, as a platform to promote learning more about one's menstrual cycle. It was also a nudge towards a more holistic approach to menstrual health education, that expanded beyond only educating females on the biological function of menstruation. By providing more information on the experiential aspect of menstruation, the booklet aimed to mitigate part of the culture of silence that exists around the topic, as well as communicating the normality of menstruation and the experiences that accompany it, such as cramps, fatigue and an increased appetite.

The final design outcome was presented for further feedback from the participants, to evaluate the effectiveness of the honing strategy and its implementation. Through this evaluation, the strategy was deemed successful, with the participants indicating a significantly increased acceptance of the new menstrual product.



Figure 5: Nula pad wings, (Findlay 2019).



Figure 6: Nula point of sale, (Findlay 2019).

### CONCLUSION

With a new menstrual product as a case study, this paper explored the problems of radical innovation and taboo. Furthermore, this study provided an analysis of menstrual taboos in South Africa, their origin and the effects they have on the lives of South African girls and women. To overcome the complexity of refining a menstrual product design towards its acceptance, this paper reported on a honing strategy that intended to address the problems created by menstrual taboo. In this case, the menstrual product outcome will require further field-testing and certification as a medical device before realising its full potential to improve the lives of South African girls and women. The honing strategy has the potential to serve as a holistic, human-centred approach to design in the menstrual health industry, whether it is applied to re-addressing existing products or designing and introducing completely new ones. Further to this, the honing strategy also has the potential to benefit the broader design, product development and innovation discourse as a way to address radical innovation within different sets of taboos in different contexts.



Figure 7: Nula product, 2019, Findlay

### ACKNOWLEDGMENTS

Thank you to the experts and participants who participated in interviews during this study. Your openness and willingness to share your personal experiences added valuable information to a field that is generally otherwise under-addressed.

## LIST OF INTERVIEWS

- Amaira, 2019. *Participant Interview* [Interview] (5 September 2019).
- Anele, 2019a. *Participant Interview* [Interview] (5 September 2019).
- Anele, 2019b. *Design Feedback* [Interview] (4 November 2019).
- Anonymous, 2019. *Fluid Dynamics Expert Interview* [Interview] (20 May 2019).
- Anonymous, 2019. *Fluid Dynamics Expert Interview* [Interview] (26 May 2019).
- Ayanda, 2020. *Final Design Feedback* [Interview] (22 January 2020).
- Barnes, S., 2019. *Expert Interview* [Interview] (15 March 2019).
- Gordon, S., 2019. *Expert Interview* [Interview] (14 March 2019).
- Hafeezah, 2019a. *Participant Interview* [Interview] (6 September 2019).
- Hafeezah, 2019b. *Design Feedback* [Interview] (6 November 2019).
- Hafeezah, 2020. *Final Design Feedback* [Interview] (21 January 2020).
- Hannah, 2020. *Final Design Feedback* [Interview] (22 January 2020).
- Kefilwe, 2019a. *Participant Interview* [Interview] (4 September 2019).
- Kefilwe, 2019b. *Design Feedback* [Interview] (5 November 2019).
- Laura, 2019a. *Participant Interview* [Interview] (6 September 2019).
- Laura, 2019b. *Design Feedback* [Interview] (7 November 2019).
- Laura, 2020. *Final Design Feedback* [Interview] (21 January 2020).
- Magoso, Z., 2019. *Expert Interview* [Interview] (15 March 2019).
- Merckel, I., 2019. *Expert Interview* [Interview] (19 March 2019).
- Mia, 2019. *Design Feedback* [Interview] (5 November 2019).
- Mieke, 2020. *Final Design Feedback* [Interview] (22 January 2020).
- SAIS, 2019. *Tradeshaw Conversations* [Interview] (11-13 September 2019).
- Windvogel, K., 2019. *Expert Interview* [Interview] (10 April 2019).

## LIST OF REFERENCES

- Allan, K., 2015. Taboos and Quirks of Human Behaviour. *Sprache und Geschichte in Afrika*, Volume 21, pp. 155-165.
- Barnes, Z., 2015. *Take a Bizarre Look Back at Period Products Used Throughout History*. [Online] Available at: <https://www.womenshealthmag.com/health/g19991273/period-products-through-the-years/> [Accessed 25 January 2020].
- Beksinska, M. et al., 2015. Acceptability and Performance of the Menstrual Cup in South Africa: A Randomized Crossover Trial Comparing the Menstrual Cup to Tampons or Sanitary Pads. *Journal of Women's Health*, 24(2), pp. 151-158.
- Berkun, S., 2010. *The Myths of Innovation*. 1st ed. Sebastopol: O'Reilly.
- Berkun, S., 2013. *The Best Definition of Innovation*. [Online] Available at: <https://scottberkun.com/2013/the-best-definition-of-innovation/> [Accessed 19 December 2019].
- Cash, P. J., Hartlev, C. G. & Durazo, C. B., 2017. Behavioural Design: A Process for Integrating Behaviour Change and Design. *Design Studies*, Volume 48, pp. 96-128.
- Chandra-Mouli, V. & Patel, S., 2017. Mapping the Knowledge and Understanding of Menarche, Menstrual Hygiene and Menstrual Health Among Adolescent Girls in Low- and Middle-income Countries. *Reproductive Health*, 14(30), pp. 1-16.
- Chick, A., 2012. Design for Social Innovation. *Iridescent: Icoграда Journal of Design Research*, 2(1), pp. 78-90.
- Chikulo, B. C., 2015. An Exploratory Study into Menstrual Hygiene Management amongst Rural High School for Girls in North West Province, South Africa. *African Population Studies*, 29(2), pp. 1971-1987.
- Conteh, A., 2003. Culture and the Transfer of Technology. In: B. Hazeltine & C. Bull, eds. *Field Guide to Appropriate Technology*. London: Elsevier Science, pp. 2-7.
- Curedale, R., 2013. *Design Research Methods, 100 Ways to Inform Design*. 1st ed. Topanga: Design Community College.
- Dahlqvist, A., 2018. *It's Only Blood*. Johannesburg: Wits University Press.
- Denis, P., 2006. The Rise of Traditional African Religion in Post-apartheid South Africa. *Missionalia*, pp. 310-323.
- Douglas, M., 1966. *Purity and Danger*. New York: Routledge & Kegan Paul.
- Engeström, Y., 1987. *Learning by Expanding: An Activity-Theoretical Approach to Developmental Research*. Helsinki: Orienta-Konsultit Oy.
- Fershtman, C., Gneezy, U. & Hoffman, M., 2011. Taboos and Identity: Considering the Unthinkable. *American Economic Journal: Microeconomics*, 3(2), pp. 139-164.
- Gibson, J., 1979. *The Ecological Approach to Visual Perception*. New York: Psychology Press.
- Houppert, K., 1999. *The Curse, Confronting the Last Unmentionable Taboo: Menstruation*. New York: Farrar, Straus and Giroux.
- House, S., Mahon, T. & Cavill, S., 2013. Menstrual Hygiene Matters: a Resource for Improving Menstrual Hygiene Around the World. *Reproductive Health Matters*, 21(41), pp. 257-259.
- Johnston, M., 2014. Secondary Data Analysis: Method of Which the Time has Come. *Qualitative and Quantitative Methods in Libraries*, Volume 3, pp. 619-626.
- Juma, C., 2016. *Innovations and its Enemies: Why People Resist New Technologies*. New York: Oxford University Press.
- Kaptelinin, V. & Nardi, B., 2012. Activity Theory in HCI, Fundamentals and Reflections. In: J. M. Carroll, ed. *Synthesis Lectures on Human-Centred Informatics*. s.l.:Morgan & Claypool Publishers.
- Karim, A., 2005. Heterosexual Transmission of HIV - the Importance of a Gendered Perspective in HIV Prevention. In: A. Karim, ed. *HIV/AIDS in South Africa*. Cape Town: Cambridge University Press, pp. 243-261.
- Karim, Q. & Baxter, C., 2016. The dual burden of gender-based violence and HIV in adolescent girls and young women in South Africa. *SAMJ*, 106(12), pp. 1151-1153.
- Kazmierczak, E., 2003. Design as Meaning Making: From Making Things to the Design of Thinking. *Design Issues*, 19(2), pp. 45-59.

- Khumalo, J., 2013. *Always Marketing Strategy*. [Online] Available at: [https://www.academia.edu/10029916/Marketing\\_Strategy\\_Always\\_Assignment](https://www.academia.edu/10029916/Marketing_Strategy_Always_Assignment) [Accessed 19 January 2020].
- Krippendorff, K., 1989. *Product Semantics: A Triangulation and Four Design Theories*. Helsinki: Penn Libraries.
- Le Guern, S., 2018. *Engineering News*. [Online] Available at: [https://m.engineeringnews.co.za/article/lion-match-division-boosts-local-manufacture-of-feminine-personal-care-products-2018-09-27/rep\\_id:4433](https://m.engineeringnews.co.za/article/lion-match-division-boosts-local-manufacture-of-feminine-personal-care-products-2018-09-27/rep_id:4433) [Accessed 21 September 2019].
- Machisa, M., Jewkes, R., Morna, C. & Rama, K., 2011. *Gender Based Violence Indicators Project, Gauteng Research Report, South Africa*, Johannesburg: Gender Links & South African Medical Research Council.
- Magoso, Z., 2019. *Interview with expert* [Interview] (15 March 2019).
- Maluleke, M., 2012. Culture, Tradition, Custom, Law and Gender Equalities. *PER/PELJ*, 15(1), pp. 2-22.
- Martin, B. & Hanington, B., 2012. *Universal Methods of Design*. Beverly: Rockport Publishers.
- McKenna, A., 2011. *The History of Southern Africa*. New York: Britannica Educational Publishing.
- MHM, 2019. *Menstrual Hygiene Day*. [Online] Available at: <https://menstrualhygieneday.org/about/why-menstruationmatters/> [Accessed 20 September 2019].
- Niederer, K., 2018. Facilitating Behaviour Change through Mindful Design. In: *Design for Behaviour Change, Theories and Practices of Designing for Change*. New York: Routledge, pp. 104-115.
- Norman, D., 2013. *The Design of Everyday Things*. Revised and Expanded ed. New York: Basic Books.
- Norman, D. & Verganti, R., 2014. Incremental and Radical Innovation: Design Research vs. Technology and Meaning Change. *Massachusetts Institute of Technology*, 30(1), pp. 78-96.
- Okem, A. et al., 2013. *WASH in Schools Empowers Girls' Education*. New York, UNICEF.
- Peberdy, E., Jones, A. & Green, D., 2019. A Study into Public Awareness of the Environmental Impact of Menstrual Products and Product Choice. *Sustainability*, 11(473), pp. 1-16.
- Rafudeen, A. & Mkasi, L., 2016. Debating Virginity-Testing Cultural Practices in South Africa: A Taylorian Reflection. *Journal for the Study of Religion*, 29(2), pp. 118-133.
- Rajan, N., 2015. 'Flo' Kit to Help Remove Period Stigma Girls Face in Developing Countries. [Online] Available at: [https://www.huffingtonpost.co.uk/2015/08/12/flo-kit-to-help-remove-period-stigma-girls-face-in-developing-countries\\_n\\_7976076.html?guccounter=1&guce\\_referrer=aHR0cHM6Ly93d3cuZ29vZ2xlLmNvbS8&guce\\_referrer\\_sig=AQAAAFxV27daXHYUeHlhBKs6It1KBb-wkh7DEevi75C1O4a](https://www.huffingtonpost.co.uk/2015/08/12/flo-kit-to-help-remove-period-stigma-girls-face-in-developing-countries_n_7976076.html?guccounter=1&guce_referrer=aHR0cHM6Ly93d3cuZ29vZ2xlLmNvbS8&guce_referrer_sig=AQAAAFxV27daXHYUeHlhBKs6It1KBb-wkh7DEevi75C1O4a) [Accessed 25 January 2020].
- Ramdhani, A., Ramdhani, M. & Amin, A., 2016. Writing a Literature Review Research Paper: A Step-by-Step Approach. *International Journal of Basics and Applied Sciences*, 3(1), pp. 47-56.
- Rogers, E., 2003. *Diffusion on Innovations*. New York: The Free Press.
- Ross, E., 2015. *Tired of Tampons? Here are Pros and Cons of Menstrual Cups*. [Online] Available at: <https://health.clevelandclinic.org/tired-of-tampons-here-are-pros-and-cons-of-menstrual-cups/> [Accessed 25 January 2020].
- Sabri, O., Manceau, D. & Pras, B., 2010. Taboo: An Underexplored Concept in Marketing. *Recherche et Applications en Marketing*, 25(1), pp. 59-85.
- Schumpeter, J., 1983. *The Theory of Economic Development*. New Brunswick: Transaction Publishers.
- Stern, H., 2006. *The Economics of Climate Change*. London: HM Treasury.
- Strömquist, L., 2018. *Fruit of Knowledge*. London: Virago Press.
- Tapscott, R., 2012. *Understanding Breast "Ironing": A Study of the Methods, Motivations, and Outcomes of Breast Flattening Practices in Cameroon*, Boston: Feinstein International Center.
- Thaler, R. H. & Sunstein, C. R., 2008. *Nudge*. New Haven & London: Yale University Press.
- Thompson, L., 2011. *The History of South Africa*. Unites States of America: Yale University Press.
- Vanek, F., 2003. Design Philosophies for Appropriate Technology. In: B. Hazeltine & C. Bull, eds. *Field Guide for Appropriate Technology*. London: Elsevier Science, pp. 7-11.
- Vygotsky, L., 1962. *Thought and Language*. Cambridge: MIT Press.
- Watts, C. & Zimmerman, C., 2002. Violence Against Women: Global Scope and Magnitude. *The Lancet*, 359(9313), pp. 1232-1237.
- Windvogel, K., 2019. *Interview with expert* [Interview] (10 April 2019).
- Yagnik, A., 2016. Mis-fitting Menstrual Hygiene Products: An Examination of Advertisements to Identify Gaps in the Diffusion of Innovation. *Journal of Psychology & Behavioural Sciences*, 2(3), pp. 33-45.

# RE-ILLUSTRATING OLD STORYBOOKS FOR MODERN DAY READERS

Etsename, Emmanuel Louis

Ilesanmi, Abayomi Babatunde

Department of Industrial Design, Federal University of Technology, Akure, Ondo State Nigeria.

leetsename@futa.edu.ng

## Abstract

*Pictures in books build the visual imagination of readers and bring the story to life. Illustrations in storybooks therefore play a major role in literature. Although old storybooks contain moral and informative stories that are still very relevant to our present-day society, records show that there is a significant drop in reading books amongst young people. As language and social reality have changed over the years, so have book illustration techniques improved. Therefore, to help revitalize the generational transfer of knowledge and cultural development in readers, there is a need to re-illustrate old storybooks using modern illustration techniques. The aim of this research is to re-develop awareness of the pleasure of reading in readers, particularly young ones who are caught up in today's digital distractions. This paper reports on how, by adopting social design methods, an old book titled: "The Drummer Boy" by Cyprian Ekwensi was re-illustrated to help young readers relate visually to the story, beyond what was written in words. The study adopted digital illustrations and painting methods, as against the line illustrations previously employed. Evaluation and feedback were conducted through a user-centred comparative approach. Feedback revealed that young people polled preferred the newly illustrated book to the old version and most admitted a renewed interest in reading storybooks.*

**Keywords:** design, digital illustration, digital painting, printing, storybooks.

## INTRODUCTION

Book illustration is a form of design that is used to create drawn pictures and images for books. Illustrations reduce visual compositions to the basic elements of intended communication and are meant to be much more stimulating than pictures, and to enhance the story in some way or the other. Hence, illustrations are more commonly found in children's books. Illustrations in storybooks emphasize the appeal of literature. Studies have proven that reading enhances cognitive thinking and brain functionality (Adigun & Oyelude, 2003). Reading is an outlet that can bring families together, uplift a person's mood, and concentration.

According to Tunnell and Jacobs (2005, 26), an "illustration in picture books is meant to delight, to capture attention, to tell a story or teach a concept, and to develop appreciation and awareness in readers because picture books are made up of a series of illustrations that typically tell a story". The illustrator is an interpreter, creating a sequence of pictures that build on one another to illuminate and expand the text. It is this sequential imagery working in concert with the written word that involves the reader's imagination and brings the story to life (Marcus, 2006).

### Statement of the problem

A recent survey by the author revealed that most young people (millennials) find reading uninteresting. This might be caused by the multimedia distractions coming in the form of video and other media. This reticence, author observes, is even more obvious when they are confronted with books written before the turn of the millennium. Most millennials consider books written in the sixties, seventies and eighties as out of date in terms of language, supporting visuals, and social reality.

Pictures make stories understandable (Safer, 2012). With the help of illustrations, stories become easier for every reader to understand and enjoy. However, over the years as the language and social reality of the times change, so have the tools, processes and design used in book illustration. This study attempts to address the problem of millennials' neglect of old storybooks by changing only the illustrations found in them without tampering with the language and social reality. Using modern day drawing techniques, drawings in a storybook titled; "The drummer boy" written by Cyprian Ekwensi (1960) were re-illustrated, to make the book more appealing to modern day readers. The intention was to encourage young people to become interested in old storybooks, and to revitalize the generational transfer of knowledge, culture, morals, imagination and creativity.

In the course of the study the author conducted a series of cultural probes to confirm that illustrated books are perceived as more interesting than non-illustrated ones. and in addition, assessed whether the old books lost readers' interest because the visuals in them were not more contemporary.

## Illustrated visuals

"A picture is worth a thousand words" goes the saying. Although there is some uncertainty about the author of these words, no one is in doubt about their message. There is a maxim that visuals make very complex things and ideas simple, and they also make it possible to absorb large amounts of data quickly, and are therefore economical and time saving (Safer, 2012). In this study pictures and pictorial illustrations are equated. Hence one will tend to infer that illustrations will make stories more understandable and can help to raise cultural awareness amongst young people. "The Drummer Boy" as a storybook and a literature text used in secondary schools (between seventh and ninth grade) in West Africa, has outside its outstanding literary semantic and syntactic attributes, imbedded in it a repository of the socio-cultural makeup of the Yoruba people, seen, for example, in the Oro festival (Ekwensi, 1960, 62). The Yoruba people, though now settled all over the world, have a very rich cultural heritage. In Nigeria, the Yoruba make up 13.9% of the country's population, (CIA World Factbook, 2019), making them one of the largest ethnic groups in Africa.

The strong influence of foreign cultures, propagated by their storybooks and other media, has inundated young people's consciousness in developing countries like Nigeria, inflicting untold damage on their psychic and cultural sensibilities. In a bid to emulate characters illustrated in foreign stories, young readers have most times misinterpreted foreign examples through antisocial behaviours and vices. Such storybooks have also served as pull factors for human migration to foreign lands. Unfortunately, the local counter narratives to such onslaught suffer from challenges of poor visual support. The creation of imaginative and adventurous illustrations would help readers grow both in intellectual and emotional levels. A book supported with new illustrations can also be considered a meme, as it would enable the transfer of knowledge, culture, information and morals from one generation to another. Hence, this study is hinged on the assumption that there is a need to revisit storybooks written on the socio-cultural life of our world, with the intent to visually support them with modern illustrations. This we hope will revitalise the socio-cultural and academic development waning amongst young people today.

## The Concept of Reading

Reading is the ability to interpret and decode an array of words through a cognitive process. Reading is a tool for acquiring knowledge, language, communicating, and sharing of information, including ideas (Ilogho 2015). Adeniji and Omale, (2010) state that reading, a lifelong activity, is the art of making meaning or sense from printed or written words. It is an essential ability required in the 21st century to survive the global systems, be it economic, educational, political, and social. Teachers, school librarians and parents face an enormous task of trying to confront the poor reading culture found in Nigeria today. In-depth understanding and enlightenment about the issues of life is an outcome of the quality of time an individual devotes to reading and learning. Ilogho (2015) submits that reading is a complex cognitive process of decoding symbols with the intention of constructing or deriving meaning. The learners' literacy demands that the individual student must be able to read any subject of interest in school. The workplace literacy also demands that a worker should be able to read materials related to the job they do.

Besides reading for academic purpose and job performance, reading can be engaged in for pleasure and enjoyment. Beach (1996) recommends that children should be immersed in a print-rich environment where they listen to books being read and are encouraged to discuss the stories. Debomita and Gupta (2010) observe that reading is the finest habit a person can have. In the past before the advent of television technology, people spent a greater part of their time reading books. It was through reading books that people tried to get to know the world outside. Many people became members and users of libraries just to have access to reading more books. Currently, with the arrival of the internet, people tend



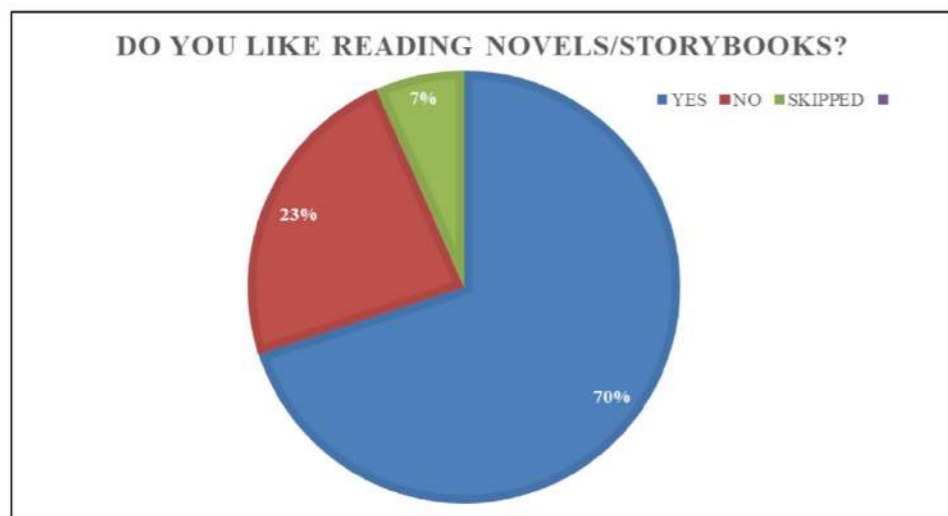


Figure 1: Interest in novel/storybook reading Source: Researcher

to be reading less. This trend tends to affect young millennials. People would rather spend more time chatting than reading. Debomita and Gupa further observe that whoever encourages a child to read is giving that child a valuable gift for life. Furthermore, Fayose (1995) suggests that books have helped bridge the gap between the past and the future, maintaining that books have brought diverse cultures of the world together, creating understanding between man and man. Besides, books contribute in no small measure to children's emotional development.

The oral storytelling or the narrative method has been discovered to have both interpretative and archival attributes (Denzin, Lincoln & Smith, 2008). Mbiti (1966) on the other hand submits that stories are to a certain extent the mirror of life; they reflect what the people do, what they think, how they live and have lived, their values, their joys and their sorrows. Nduka (2014) suggests that even if the younger generation neglect the teachings, they are preserved to ensure that generations yet unborn would have access to them. In that way indigenous knowledge systems can be sustained. Although, Etsename, (2006:37) observes that most of Africa's educational and cultural activities over time have been expressed through graphically rich oral narratives deeply rooted in their folklores, Ekwensi has succeeded in transiting that into written medium without losing the very pictorial essence popular with the African oral narratology.

To contextually understand the problem of this study, an opinion poll was conducted using the SurveyMonkey online application (see link in reference). This helped to generate answers to the study's research questions, thereby reinforcing justification for the research. A total of fifteen research questions were posed to young students of between ages 12 and 15 years and their teachers. The research participants were asked to assess their storybook/novel reading habits. The survey had a total of 61 respondents, of which 85% were students of the Federal University of Technology, Akure Staff Secondary School (FUTA), while 13.33% were their teachers.

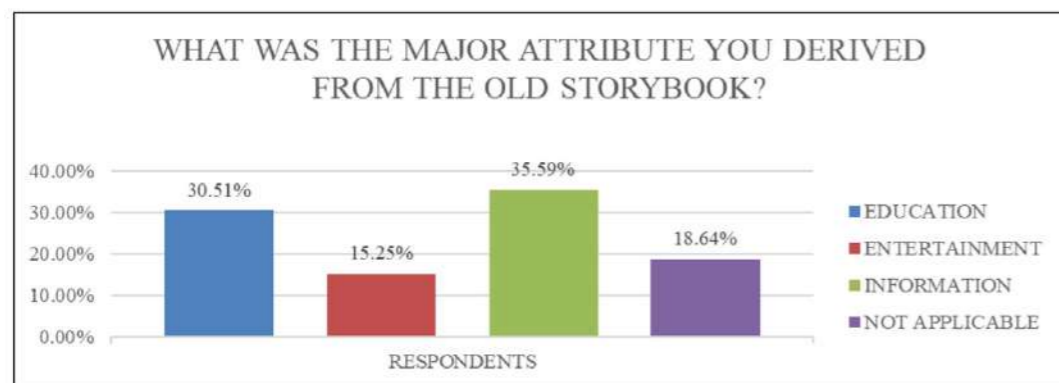


Figure 2: Attributes derived from the old storybook. Source: Researcher

Respondents surveyed revealed that most readers would prefer to read storybooks. 70% of the total respondents liked to read storybooks while 23.33% do not. Respondents also revealed that they read storybooks mainly for educational, information, and entertainment purposes. It was revealed that the majority of respondents had not read books written in the sixties. 61.67% had not read old books while only 38.33% had. Respondents also revealed that benefits gained from the old books are information, education and entertainment.

Figure 3 below suggests that respondents agree that illustrations make storybooks understandable. As 98.33% of the total respondents affirmed that illustrations in a storybook help them understand a story better, while 1.67% disagreed. This suggests that the creation of imaginative and adventurous illustrations make readers grow both in intellectual and emotional levels. This in turn enables the transfer of knowledge, culture, information and morals from one generation to another.

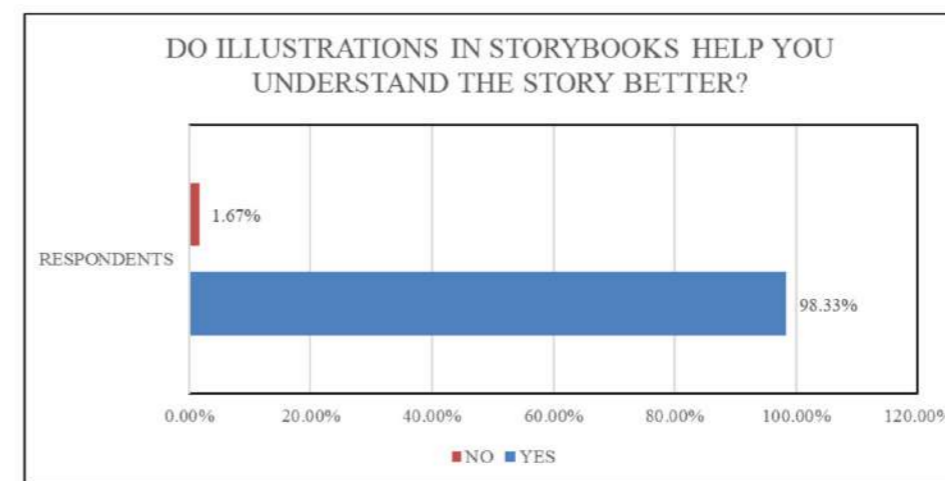


Figure 3: Illustrations in storybooks. Source: Researcher

The students surveyed suggest that readers would prefer more colourful illustrations because they describe more adequately current social realities. Out of the 61 persons who responded, 86.54% were interested in colourful illustrations (see Figure 4).

#### “The Drummer Boy”

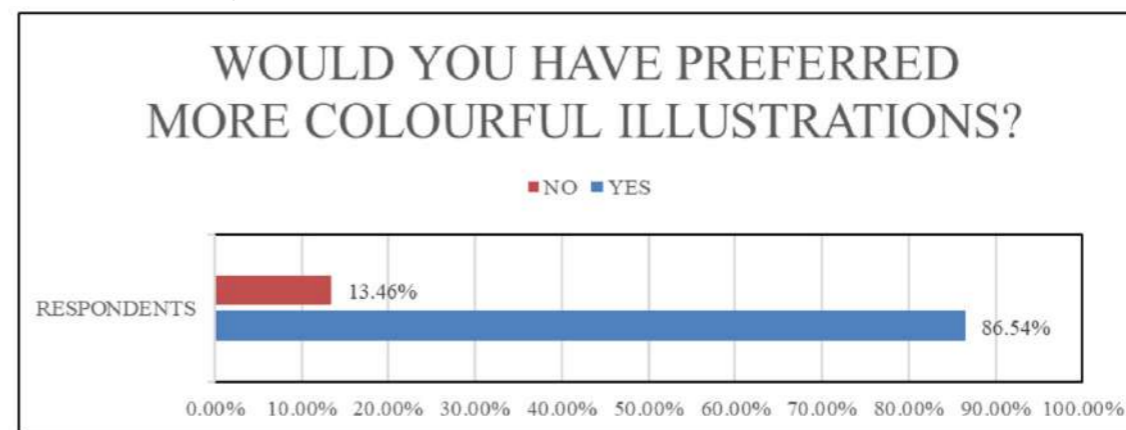


Figure 4: Preference for more colourful Illustrations. Source: Researcher

Ekwensi is a writer who stressed the description of the locale and his episodic style was particularly well suited to the short story. His book “The drummer boy” is a story written for the secondary school at intermediate level. First published

in the year 1960, by Cambridge University Press in England and reprinted over the years till 1981, the book was first published in Nigeria by Heinemann Educational Books (Nigeria) Plc. in 1988 and has been reprinted over the years till 2015. Heinemann Educational Books (Nigeria) Plc, also known as HEBN Publishers, was incorporated in 1969 and has been in the forefront of publishing in Nigeria for over fifty years. The Organization publishes and markets books for all levels of education and has its main branch in Ibadan, Oyo state, Nigeria (HEBN, 2019). The book is designed in A5 size with 91 story pages.

The Book “The Drummer Boy” tells the gripping tale of Akin, a blind young boy, a wanderer, who despite his physical challenge, contributes his quota to the society by radiating joy with his samba. The society, through the likes of Madam Bisi, Ayike, and Mr. Fletcher, helps Akin to overcome his fears, and all ends well with him getting a formal education (Ekwensi, 1960).

The author known as Cyprian Odiatu Duaka Ekwensi, was an African popular novelist versed in the art of storytelling. The author, though a native of Nkwelle Ezunaka in Oyi local government area of Anambra State, Nigeria, was born in Minna in Northern Nigeria in 1921, and educated in Ibadan (Nigeria), Ghana, and London (UK). He taught Biology and Chemistry in Nigeria before joining the Nigerian Broadcasting Corporation where he became Head of Features. He later became director of information in Enugu. He published several other novels and books, which have been translated into many languages. In 1968 he received the Dag Hammarskjold international prize in literature. In 2001, he was made member of the Order of the Federal Republic (MFR) and in 2006 became a fellow of the Nigerian Academy of Letters. Ekwensi died on the 4th of November 2007 (Ukiwe, 2018).

## METHODOLOGY

This research adopted a practice-based approach underpinned by social design methods. This involved appraising today’s readers (users), investigating the process of ideation / illustration of old and modern books, and the conduct of users’ evaluation of the new book. All the above were conducted in collaboration with teenage students of a secondary school in southwestern Nigeria.

Using design systems to address problems outside of the commercial realm has greatly expanded over the decades along with discourse related to social design. Papanek (1971) according to Tonkinwise (2015) believes that ‘social design’ is design practiced by designers as an obligation to lending their skills to improve the quality of life of certain segments of society who normally cannot afford to be design clients and have no financial capital to buy quality products and services. Manzini defines social design as design activities that deal with problems that are not dealt with by the market or by the state, and in which the people involved do not normally have a voice (Manzini, 2015, 65).

Although all designing can be understood as social, “the term ‘social design’ highlights the concepts and activities enacted within participatory approaches to researching, generating and realising new ways to make change happen towards collective and social ends, rather than predominantly commercial objectives” (Armstrong, Bailey, Julier and Kimbell, 2014:15). However, Tonkinwise (2015) feels designing should be more about the consequence of the creations than the created artefact itself.

The above assertions perceive social design as a designing process which highlights the participatory values and not a preconceived product or service alone. Thus, the researchers arrived at the position that materials like media tools that help bring about attitudinal changes can be seen as social design prototypes because it is as much about the process as the end result. The social design innovation in this case study happened because a designer’s re-illustration of an old storybook eventually resulted in encouraging young people to pick up interest in the reading of old storybooks. Hence, the anticipated outcome here is that the designer’s new illustrations have initiated some attitudinal change, as his works have motivated young readers to become attracted to the hitherto ‘old school’ storybooks.

A major consideration during the process of re-illustrating the old storybook was the engagement of students and their teachers. The user’s experience is very important in determining how a product or service add value to a system or solve a problem (Schuler & Namioka, 1993). During this research, the prospective users (teachers and students) participated via a cultural probe, and were involved in testing the solutions. This research followed Kolb’s (1984) iterative research process of “do”, “reflect”, “summarise” and “test” and “repeat”, in a loop.

**Tools used:** The researcher used a graphic tablet to make the illustrations. A graphic tablet is a computer input device that enables users to hand-draw images with a special pen-like stylus, like the way a person draws with a pencil on

paper. Other tools used for the illustrations include a computer system, scanner, digital camera, and printing machine.

**Software used:** The major software used for this research was Adobe Photoshop, which is a tool most suited to make the graphic/painterly illustrations needed for the project. Other software used include CorelDraw Application, Microsoft Word, One Note, and Publisher.

**Illustration method used:** The method used to illustrate the old book was a hand-drawing technique and printed using a relief printmaking technique (possibly by the aid of a block on a letterpress machine). The drawings were cut or inscribed on blocks which were then stamped on the book pages. This accounts for why the drawings contain more linear expressions (See Figure 8). Only one colour (black) was used for the impression which gave it a basic monochromatic print look (Ross, Romano & Ross,1990).

### Stage 1 research: digital illustration

Digital painting is a process of generating/ creating virtual images using a computer. Digital painting is processed electronically using paint software. The processing output is displayed on the screen (Hearn & Baker, 1997). Digital painting adapts traditional painting mediums such as acrylic paint, oils, ink, watercolour, etc. and creates a computer graphic program that uses a virtual canvas and paint box of brushes, colours and other supplies. Digital painting can be done according to the techniques an illustrator wishes to use. Like traditional painting, the creative process usually involves long experimentation and evolution of the artist’s ideas (Wong, 2005). Digital paintings can also be done by lots of other computer software. This phase of the project started when a digital painting method was adopted to produce images using a pointing device such as a tablet or a mouse. In this case a tablet was used due to its flexibility in handling drawings digitally.

### Story interpretation

After reading the storybook thoroughly, the story was deconstructed and interpreted. The purpose was to get a detailed understanding of the 1960s, about life when the book was written, which is quite different today. This involved a visualisation of each environment, event, scene, character, concept, mood, chapter, object and the various features mentioned in the story.

Making the digital illustrations took the following processes:

**Sketches:** The first stage of the illustration process, was to make rough sketches on paper to interpret the story. The sketches were made using reference from internet, books and engagement with elderly people.

**Gestures:** Pictures of gestures were scanned into the computer system where they were digitized. Friends, neighbours, colleagues and relatives volunteered as models and posed for the illustration sessions.

**Picture references:** Relevant pictures from books, magazines or newspapers were scanned into the computer using the scanner.

**Page Setup:** The image size was set to A3 (international paper size having 16.53 inch width by 11.69 inch height). The resolution was set to 300 dpi (Dot Per Inch), which is the standard resolution for printing.

**Line art:** Here, rough sketches were made from scratch on the computer system through the help of scanned pictures/gestures, and clean line art was generated from there. In this process, a lot of corrections were made. The line art served as the base upon which the whole painting was made.



Figure 5: Digital line art drawing

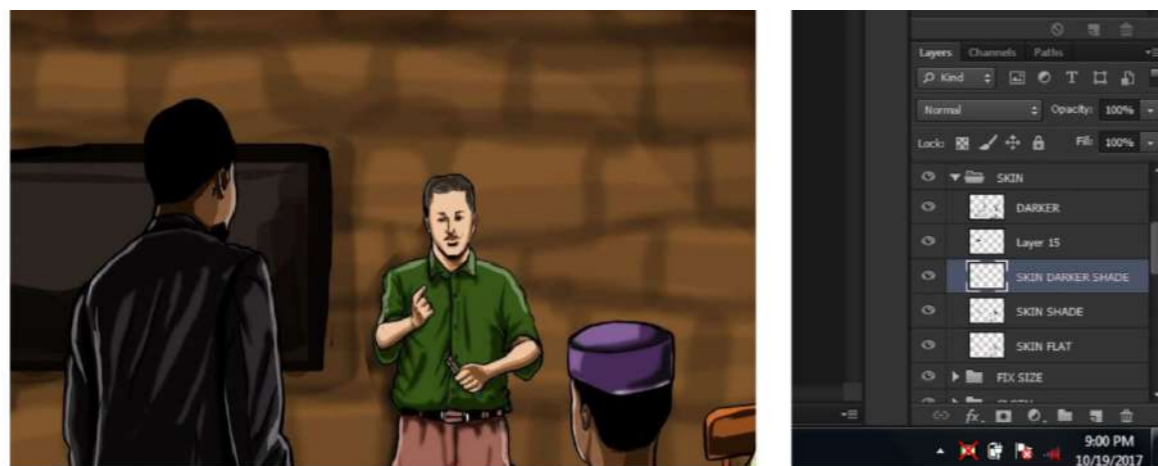


Figure 6: Adding Shadows and Highlights. Source: Researcher

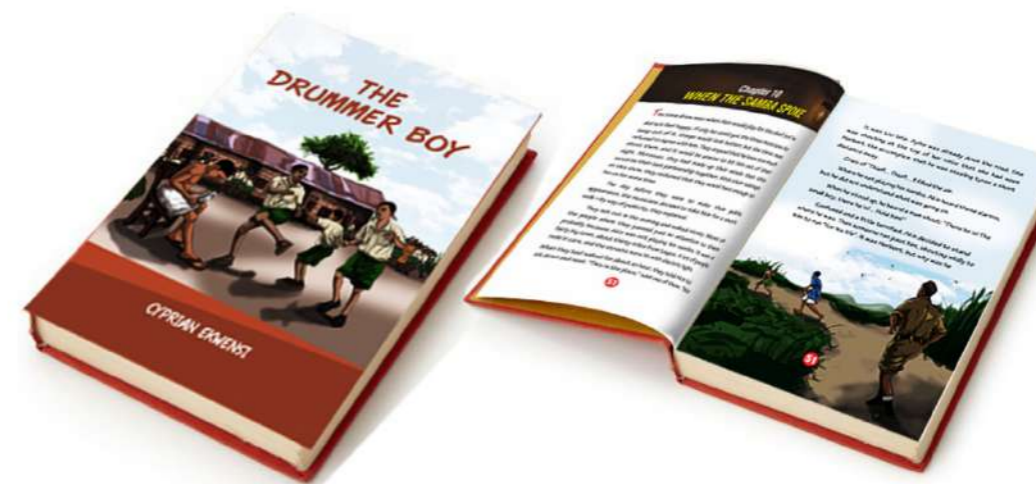


Figure 7: Finished Illustrated Book. Source: Researcher

**Flat painting:** The illustrations at the line stage were basic and flat. Colours were then introduced, for the clothes, skin, and objects like drums, cups, bottles, calabash, etc. These colours were painted in flat form to define them.

**Shadows:** Shadows were then added. Adding shadows gave the visuals a feel of solidity and made the drawings look realistic. Effects like cast shadows and core shadows were used.

**Highlights:** Highlights were also used to depict illumination of the scene and the effect on objects was tremendous. The factors considered before adding highlights were the nature of the scene, the light source and nature of objects, among others.

**Cleaning up/finishing:** Before the painting process was completed, it was necessary to add the little details and make corrections on the previous stages. At this stage, background effects were added like mist (fog), sunlight rays etc. Also, some parts were blurred or filtered out to depict distance, strength, weight, and to smoothe the painting brush's effects on the illustrations. It took a lot of time to achieve this and eventually get the illustrations ready for print.

**Image export:** The digital painter ensures that the files are saved continuously to avoid losing files unsaved. Now at the completion of the illustration stages, the image was saved as a high-quality Portable Network Graphics (PNG) file. From here, the illustrations were fitted into the appropriate locations as the book was being arranged.

### Stage 2 research: book formatting

**Book editing:** At this stage the illustrations made by the researcher were incorporated into the story. The headlines were designed with special effects. The numbering was made right below the texts. Some of the illustrations took a whole page while some others only took a portion of the book page. The book cover was also redesigned. The book now had a total of 135 pages instead of its previous 91.

**Proofing:** This was a stage where the book was checked carefully to detect and fix errors that might have occurred in the design and arrangement process. The texts too were checked in case of typographical errors.

### Stage 3 research: printing and binding

**Printing:** The newly-designed book was sent to a direct image printing machine to print. A dummy was earlier made to serve as a guide for the arrangement of pages and ensure the drawings were fixed in positions intended. The printing was made on high quality concord paper while the book covers were on thick card paper. For mass production, a lithographic print method was adopted for the production.

**Binding and finishing:** The binding method adopted for this book was soft binding. Adhesive was added to the base of the papers to achieve a solid book. Tools used for the binding were polyvinyl alcohol (PVA) glue, binder's glue, thread, cotton/cleaning rag, the printed paper, stencil cutter, straight-edge steel rule, pencil, darning needle, bristle brush, nails, steel clips, folder and G-clamps.

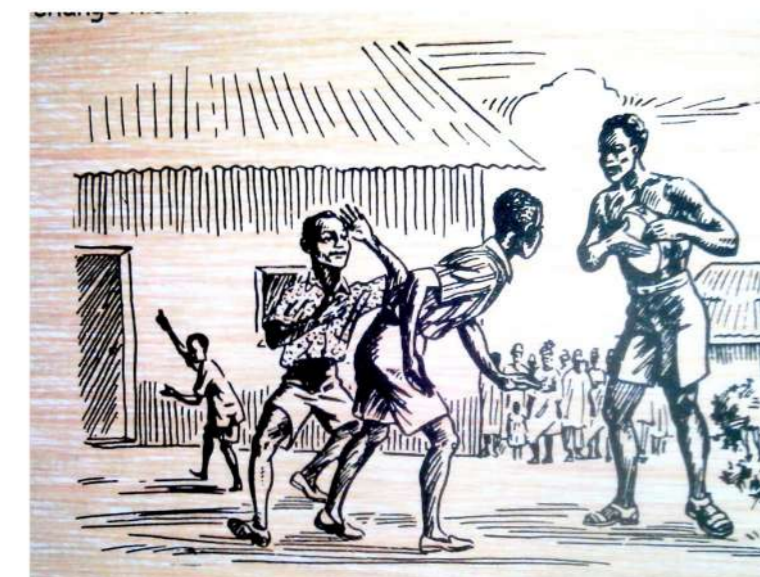


Figure 8: Old illustration used Source: Researcher

## DISCUSSION

At the start of production, before the new illustrations were made, a great deal of reflection was given to the former illustrations used in the storybook. The original "The Drummer Boy" book has a total of eight illustrations. These illustrations were monochrome line drawings, suggesting that the level of technology of the time influenced production. They were carved on wood/blocks (relief impression) and stamped on the pages of the book (see Figure 8).

The new illustrations were achieved by computer digital painting. This involved a computer-based electronic process of using a stylus, (a pen-like structure) to make drawings and paintings on a graphic tablet. Most of the old illustrations were re-illustrated, and some new ones added. On completion of the project, a total of eighteen illustrations were made.

See Figure 9 for one of the new illustrations.



Figure 9: New illustration made Source: Researcher

At the completion of the re-illustrated book, another survey was conducted to ascertain if readers' interest in the storybook had increased. A comparative survey between the old and new storybook was carried out among students of FUTA Staff Secondary School, Akure, Nigeria. A total of 66 students out of the 92 respondents affirmed that they had read the old book, while 26 students have not.

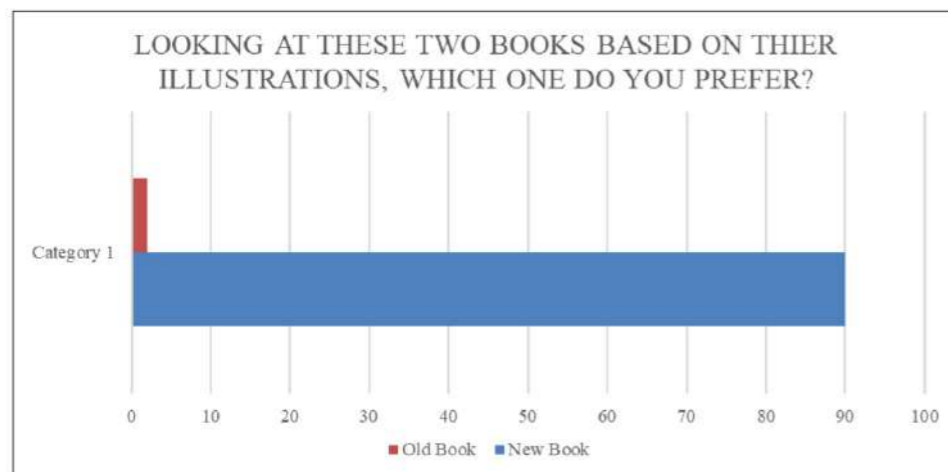


Figure 10: Preference for old book/new book. Source: Researcher

The survey revealed that despite having the same textual content, the majority of students preferred to read the newly illustrated book instead of the old one: 90 out of 92 respondents preferred the new book to the old one. Respondents' reasons for their preference (old or new book) were captured using a mean score format. Students who had a preference for the old book claim illustrations in the book were simple and unbusy. Meanwhile, students who preferred the new book referred to it as fantastic, advanced, modernized, realistic, beautiful, colourful, attractive, fresh, clear, idealistic, and understandable. Respondents were allowed to use more than one term to describe their preference. The terms used were grouped into subheadings in the table below.

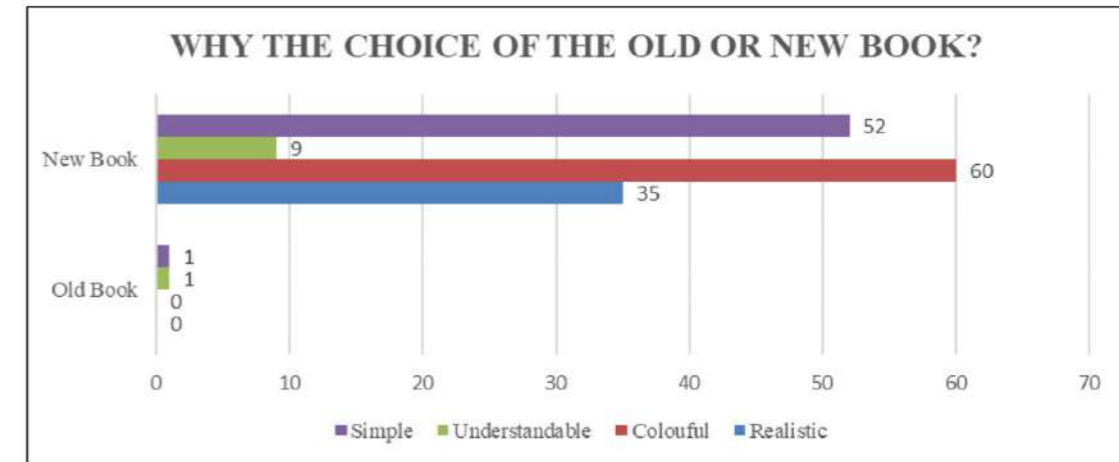


Figure 11: Reasons for preference for old book/new book. Source: Researcher

## CONCLUSION AND RECOMMENDATIONS

Book illustration is a form of design that involves the creation of drawn pictures and images for books. Illustrators create images that elucidate the story and direct attention to the book. Illustrations are more commonly found in children's books. The aim of this research was to fully re-illustrate an old storybook "The Drummer Boy" which attempted to reflect the social reality of the time. The new version was created to encourage modern day readers (millennials) to read the 1960s text. It was hoped that this would help pass information, morals, and history from the past to modern day readers, using modern day illustration and printing techniques. The research findings suggest that book illustration plays a major role in informing, educating and influencing the moral upbringing of young readers.

The researchers' adoption of a practice-based exercise conducted in a social design context was with the sole intention of influencing young millennials to become interested in reading old storybooks. It is worthy to note here that, in the course of re-illustrating the old storybook, a logbook of the researchers' actions, thoughts and production process was kept. This was to help ensure reflexivity and replicability. Ample evidence from the survey suggests that improved illustrations in an old storybook has increased readership. Hence, this study hereby recommends that more old storybooks be re-illustrated to give our young readers access to the social reality of past generations. In addition, such action will afford them visual information on times the books describe, so that modern-day readers can find them more informative, educative and entertaining. Finally, the study of illustration as a design module should be encouraged for design students both at secondary schools and tertiary institutions.

## LIST OF REFERENCES

- Adeniji, M. A. & Omale, A., (2010). Teaching reading comprehension in selected primary schools in Oyo State, Nigeria. *Library Philosophy and Practice (e-journal)*. Paper 349. [Online] Available at: <http://digitalcommons.unl.edu/libphilprac/349> [Accessed 12 February 2018]
- Adigun, M., & Oyelude, A. (2003). Libraries as tools for development: Survey of users of Oyo State Public Library. *Nigerian Libraries* 37 (2):78.
- Armstrong, L., Bailey, J., Julier, G. and Kimbell, L. (2014) Social design futures: HEI research and the AHRC. [online] *University of Brighton*: [Online] Available at: <https://mappingsocialdesign.files.wordpress.com/2014/10/social-design-futures-report.pdf>.
- Beach, S. A., (1996). *I Can Read My Own Story: Becoming Literate in the Primary Grades, Young Children*. ERIC. 52 (1) 22-27. <https://eric.ed.gov/?id=EJ533096>
- CIA World Factbook, (2019). CIA World Factbook. USA. Central Intelligence Agency. [Online] Available at: <https://www.cia.gov/library/publications/the-world-factbook/geos/ni.html>
- Debomita B., & Gupa D., (2010). *Importance of Cultivating Reading as a Habit in Children*. [Online] Available at: <http://indianblogger.com/importance-of-cultivating-reading-as-a-habit-in-children/>
- Denzin, N., K., Lincoln, Y. S., & Smith, L. T. (Eds.). (2008). *Handbook of critical and indigenous methodologies*. Thousand Oaks, CA: Sage.
- Ekwensi, C. O. D. (1960) *The Drummer Boy*, (16th. Ed.). Ibadan: HEBN Publishers Plc.
- Etsename L. E. (2006) *A socio-cultural exposition of the Fulani nomads in Nigeria*. [www.africaemediterraneo.it](http://www.africaemediterraneo.it). 58; 36-44. Bologna: Africa e Mediterraneo
- Fayose B., (1995). *School Libraries Resource Centre for Educational Excellence*, Ibadan: Federal Ministry of Education Federal Republic of Nigeria (2004). *National Policy on Education*. 4th ed. Lagos; Printing Division, Federal Ministry of Information, p.6-7, 47.
- Hearn, D., & Baker, M. P. (1997). *Computer Graphics C Version*. USA: Prentice-Hall International Inc.
- HEBN (2019) HEBN Publishers Plc. <http://hebnpublishers.com>
- Kolb, D. A. (1984) *Experiential Learning: Experience as the Source of Learning and Development*. New Jersey: Prentice Hall.
- Ilogho, J. E., (2015). The role of picture books in promoting reading culture among Nigerian children: implication for libraries and development of leadership qualities. *Inter. J. Acad. Lib. Info. Sci.* 3(2) 65-71.
- Marcus C., (2006). *Side by Side: Five Favorite Picture-Book Teams Go to Work*. Online from: [exploring-picture-books-text-etc.pdf](http://exploring-picture-books-text-etc.pdf).
- Mbiti, J. A. (1966). *Akanba stories*. Oxford, England: Oxford University Press.
- Manzini, E. (2015) *Design, When Everybody Designs: An Introduction to Design for Social Innovation*. London: MIT Press.
- Nduka, E. (2014). Preserving the Igbo cultural dogmas via literature. From Chinua Achebe to Onyeka Nwelue. [Online] Available at: [http://africanhadithi.com/article/1591288599/Preserving\\_The\\_Igbo\\_Cultural\\_Dogmas\\_via\\_Literature\\_From\\_Chinua\\_Achebe\\_to\\_Onyeka\\_Nwelue](http://africanhadithi.com/article/1591288599/Preserving_The_Igbo_Cultural_Dogmas_via_Literature_From_Chinua_Achebe_to_Onyeka_Nwelue) (2019)
- Papanek, V. (1971, 1985) *Design for the Real World: Human Ecology and Social Change*. 2nd ed. London: Thames and Hudson.
- Ross, J., Romano, C. & Ross, T. (1990). *The Complete Printmaker*. New York: The Free Press.1 – 142.
- Safer, A., (2012). *A picture is worth a thousand words*. 48-49 [Online] Available at: [http://www.andrewsafer.com/articles/2012-11\\_simulation\\_picture\\_worth\\_thousand\\_words.pdf](http://www.andrewsafer.com/articles/2012-11_simulation_picture_worth_thousand_words.pdf) .
- Schuler, D. and Namioka, A. (1993) *Participatory design: Principles and practices*. Broadway Hillsdale, New Jersey: Lawrence Erlbaum.
- SurveyMonkey [https://www.surveymonkey.com/analyze/4ASfDzd9D3n\\_2BeOP06X0rIeMiqT6LvTn2DZICKfMWRX8\\_3D](https://www.surveymonkey.com/analyze/4ASfDzd9D3n_2BeOP06X0rIeMiqT6LvTn2DZICKfMWRX8_3D)
- Tonkinwise, C., (2015) *Is Social Design a Thing?* [Online] Available at: [https://www.academia.edu/11623054/Is\\_Social\\_Design\\_a\\_Thing](https://www.academia.edu/11623054/Is_Social_Design_a_Thing).
- Tunnell, M.O, Jacobs, J.S., (2005). *Picture Books* In (ed), *Children's Literature, Briefly*. pp.105-119. 5th ed. Boston, MA: Pearson Education, Inc.
- Ukiwe, U. (2018, Monday, September 24). Remembering Cyprian Ekwensi and his phenomenal works. *The Guardian Nigeria News*. [Online] Available at: <https://guardian.ng/life/748052/> (April 2019)
- Wong, Y. (2005). *Art in digital and digital in art*. Digital Media Curriculum Development Project Vol. 2008. [Online] Available at: <http://digitalmedia.wfu.edu/project/digital-media-curriculum-development/>

# TECHNOLOGY TRANSFER, HUMAN CAPITAL DEVELOPMENT AND CAPACITY BUILDING: THE SONGHAI LEADERSHIP MODEL

John Tharakan, Howard University, USA, [jtharakan@howard.edu](mailto:jtharakan@howard.edu)

## Abstract:

*One of the main reasons for the failure of many top-down development interventions involving technology transfer from developed nations, their aid agencies and multilateral development institutions to developing communities, lies in the neglect of sufficient investment in human capital development and community capacity building. For instance, it has been reported that close to a million hand-powered water pumps have been installed in the developing world over the past several decades but more than half now lie disused or are broken because the local communities in which the water pumps were installed were never provided with the knowledge transfer and capacity building that would have enabled their proper operation and maintenance. These additional failures are in general attributable to the general lack of support for maintenance of the technology, whether through lack of spare parts, local workshop capacity, or insufficient knowledge transfer accompanying the technology transfer.*

*A better model for technology transfer would ensure that human capital development and community capacity building form the central core of any technology transfer activities. The Songhai Leadership Academy (SLA) is foundationally framed as a knowledge enterprise, focused on the development of African human capital that would be capable of creating, producing and disseminating appropriate knowledge. Such knowledge would provide the framework and structure necessary for communities to be able to create the tools and processes to deal efficiently, effectively and sustainably with the numerous and diverse development challenges of the African continent.*

*In this paper we explore the failings of many current technology transfer and development efforts and advocate the holistic, system-wide approach to technology transfer as practised in the SLA and its positive impact on community capacity building, development and empowerment.*

**Keywords:** Africa, capacity building, human capital, leadership, technology transfer, Songhai

## INTRODUCTION

Technology transfer, also called transfer of technology (TOT), is the process of transferring or disseminating technology from the places and groups of its origin and practice to wider distribution among more people and places. It occurs along various axes: among universities, businesses (large and small), governments, across borders, formally and informally, and both openly and covertly. Often it occurs because of concerted efforts to share skills, knowledge, technologies, methods of manufacturing, samples of manufacturing and facilities among governments or universities and other institutions to ensure that scientific and technological developments are accessible to a wider range of users. These users can then further develop and exploit the technology into new products, processes, applications, materials, or services. Technology transfer is closely related to (and may arguably be considered a subset of) knowledge transfer. Horizontal transfer is the movement of technologies from one area to another. At present, transfer of technology (TOT) is primarily horizontal. Vertical transfer occurs when technologies are moved from applied research centres to research and development departments. Horizontal and vertical technology transfer has been studied extensively and numerous books and publications have been written on the best way to do this, a process that is not objective but is enmeshed with and embedded in socio-technological and political systems and economies, and is thus informed and affected by all of these. Hence, the successful implementation of technology transfer is as much an art as it is a science, with clear assumptions, theories and practices (Speser, 2006).

This paper seeks to investigate the intersections of knowledge and technology transfer in relation to rural and community development. It begins with a review of the existing modalities and mechanisms by which technology transfer has occurred in the context of development in the Global South and the current status of these conventional developmental modalities for knowledge and technology transfer. The paper will present instances of failed development projects, providing an interpretation and analysis of the failures, and will situate that failure as a consequence of outdated, top-down, patronising, and devaluing modalities for knowledge and technology transfer in the development ecosystem. Given these failures, the ultimate objective of the paper is to present an alternative approach to achieving successful knowledge and technology transfer, resulting in true, sustainable development in affected communities. This alternative approach is enshrined in the Songhai model for development that has already been extensively described (Tharakan, 2019). The paper will conclude with the description of the Songhai Leadership Academy's programme, which is a critical and essential component of the Songhai model and provides the theoretical and practical model for knowledge and technology transfer that results in on-the-ground capacity building and sustainable community development.

## Background

Knowledge and technology transfer in development aims at improving the quality of life and the standard of living in under-developed communities. In the 21<sup>st</sup> century, the goal of development should be focused on well-being, based on conditions that are necessary for a society to flourish, as posited by the 'survival ethics' model (Verharen, Tharakan, Middendorf, Kadoda and Castro, 2011; Verharen, Tharakan, Middendorf, Kadoda, Fortunak and Bugarin, 2014). This model articulates the critical utilities, services and infrastructure that are essential from moral and ethical, as well as biogeochemical and physical, perspectives, to support a society so that it actually prospers. At the basic, physical level, we need air, water, shelter, food and clothing. To be meaningfully sustainable, this would have to be *clean* air, *clean and safe* water, available, *accessible and safe* food, *temperature-controlled* shelter, and *sustainably renewable* energy. One would have imagined, given the scale and abundance of resources available in the Global North, that fifty years of interventionist development, under the direction of multilateral agencies such as the World Bank, the United Nations Development Program (UNDP) and the United States Agency for International Development (US AID), would have ensured that these minimum requirements for a healthy life would, by now, have easily been met across the planet. After all, none of these services require advanced technologies, and practically the entire population in the developed world, has access to them all.

However, despite being endowed with immense natural and human resources, as well as cultural, economic, ecological and natural diversity and capital, development progress across Africa remains weak, with poverty at 43% and 27 of the 28 poorest countries being located in sub-Saharan Africa. While poverty rates have fallen in many countries, the reverse is often true in many African countries (Joliffe & Prydz, 2016). This is after more than six decades of development interventions by multilateral institutions like the World Bank (WB), International Monetary Fund (IMF), United Nations Development Program (UNDP), national and international development agencies such as the United States Agency for International Development (US AID), the German Development Agency (GIZ) and the United Kingdom's Department for International Development (DFID), as well as regional agencies and institutions like the African Development Bank (ADB) and the African Union (AU). It would appear from this that the current approaches to knowledge and technology transfer and development have been ineffective and inadequate and require radical rethinking in terms of philosophy and approach.

Examples of the failure of development interventions are legion as reported by ABC news<sup>1</sup> which cited examples ranging from the mega to the micro. One example comes from Chad when the World Bank funded a \$4.2 billion oil pipeline project that was supposed to pay for development but instead was taken over by the autocratic government to pay for weapons and keep the regime in power. In another example from Kenya, the Norwegian government funded a fish processing plant for \$22 million to provide livelihoods for the Turkana to process fish for export. However, the Turkana are land-based nomads with no connections to fishing, so although the plant was constructed and opened, it only operated for a few days before being shut down because the demand for electricity and clean water in the desert was too high.

Beginning in 1932, the French government provided \$300 million over 50 years – arguably not a large amount – to irrigate over 2.5 million acres in the desert to grow cotton and rice, forcing over 30,000 people to move to the desert to work. However, the African workers largely ignored French efforts to change traditional agricultural practices and by 1982, only 6% of the region was actually developed. In addition, the infrastructure that had been put in place over the years was falling apart. The WB took over the project in 1985 but has had only limited success. In the Lesotho highlands, the WB along with the European Investment Bank (EIB) and the African Development Bank (ADB) invested \$3.5 billion for a project to divert fresh water from the mountains for sale in South Africa, but the electricity proved too expensive and the diversion of so much water created environmental and economic havoc downstream. In this case, the development fund was actually shut down and the project's chief executive was jailed. Tens of thousands of displaced peoples are still waiting for compensation.

These mega failures are echoed on the ground and in communities on a smaller scale (Banerjee, 2008). The causes of failure are multiple and range from poorly executed programmes to ineffective ones to ones that are actually harmful to the communities they seek to serve. For instance, the Gyandoot programme in India provided computer kiosks in rural areas, but with poor electricity and internet connectivity, only a few kiosks have proved to be even minimally viable. Clearly, the programme was well-intended but was very poorly planned and executed. Ineffective programmes result from assumptions that the developers make about those to be 'developed'; assumptions that indicate there has been no communication with the community being served, and the project is implemented in a disconnected and non-holistic manner. A prime example are water projects that are targeted at reducing incidence of water-borne diseases, but which fail to appreciate the many other ways that water-borne diseases can be transmitted, and thus lead to apparent failure in terms of actually preventing disease and improving health outcomes.

<sup>1</sup> [http://www.nbcnews.com/id/22380448/ns/world\\_news-africa/t/examples-failed-aid-funded-projects-africa/#.XsHiN8Z7n3A](http://www.nbcnews.com/id/22380448/ns/world_news-africa/t/examples-failed-aid-funded-projects-africa/#.XsHiN8Z7n3A)

At the far end of the spectrum are projects that do not simply fail or are ineffective, but which actually cause devastating harm. The DrumNet programme in Kenya was aimed at helping farmers transition from growing local crops (for local consumption) to growing cash crops for export, in order to transform subsistence farmers and local producers into commercially viable farms with a cash crop to bring to market. This the project successfully did. Farmers converted to growing cash crops but, unfortunately, the market for the cash crops disappeared when they could not meet European regulations. Unsellable cash crops had to be wasted, the farmers defaulted on their loans and were left more impoverished than when the 'successful' development programme was launched (Karlan, Nava and Xavier, 20152008).

This kind of scenario also happens on a much smaller scale. Water pumps provide a revealing example. Close to a million hand-powered water pumps have been installed in the developing world over the past several decades but more than half now lie unused or in a state of disrepair. This is largely because the local community where the water pumps were installed was never provided with the knowledge transfer and capacity building that would have enabled their proper operation and maintenance. Additional failures could be attributable to the lack of spare parts and local workshop capacity to conduct the simple tooling and machining operations required to keep the pumps functional.

### Capacity building and human capital development

In the context of this colossal failure on the part of the aforementioned national and multilateral development agencies and institutions, it is clear that a fundamentally new approach is required that will result in actual capacity building and the development of human capital. Capacity building is the process of developing skills and competencies that render community members more knowledgeable in their capacity to engage with their natural, economic and social environments and more able to utilise those ecosystems' products and services efficiently and sustainably. The process of developing human capital pertinent to any development project is the most essential and critical component for successful implementation, operation, maintenance and sustainability, yet it is more often than not the component of a development project to which the least attention is given, and often the single biggest reason for its failure.

The Songhai Center and the agroecological approach implemented and promulgated by Nzamujo (2002; 2018) provide the radical rethinking needed to transform the conventional and patronising twentieth-century development theory and practice. This approach is integrated and community based, engaging sustainable technology research, development, implementation, transfer and dispersion. The model forms the structural and existential fabric of the Songhai approach to development (Tharakan, 2019). The Songhai approach is a self-defined and identified rural growth initiative configured as a real sustainable development model as opposed to those promulgated by the multi-lateral aid and development agencies, which are top-down, interventionist and have, at best, simply failed at achieving development targets. At worst, they have actually aggravated under-development and dependency (Nzamujo, 2017).

It must be recalled that the focus of development attention in de-colonising Africa was on maintaining and expanding the infrastructure so that newly independent African nations could grow, harvest, transport and export fresh agricultural produce as cash crops, or extract, transport and export raw mineral resources. Processing and value addition to both (agricultural produce and mineral resources) occurred in the Global North. The long-term result of that focus has been the impoverishment of many African nations, depletion of resources through transformation to mono-culture cash crops with uncertain markets, and unrestricted and unregulated exploitation and extraction of natural resources. This has often occurred under the auspices of corrupt regimes that enriched themselves at the cost of national development by collusion with former colonial governments and their multinational, corporate partners, to perpetuate the model of extraction and export. Naturally, this has resulted in selective enrichment of the elites, leaving the bulk of the population under-served and impoverished. Transforming this model requires rethinking from the ground up, a process which has been most

clearly developed, articulated and implemented through Nzamujo's Songhai Center development model. This model has been undergirded by the Songhai Leadership Academy that has been conceptualised as the knowledge institution and enterprise that Nzamujo (2002, 2018) sees as fundamental to producing the critical human capital that will make that transformation possible, as evidenced by the success and sustainability of the Songhai Center (Tharakan, 2019).

### **The Songhai Leadership Academy**

The Songhai Leadership Academy (SLA) is an innovative platform for the development of African human capital, capable of producing and continuously disseminating knowledge and creating tools to deal effectively with the challenges of the continent (Nzamujo, 2018). The SLA is emerging as the foundational component of the Songhai Center, critical to accomplishing the mission and realising the Songhai vision.

The SLA is premised on the fact that Africa has apparently succumbed to the logic of poverty and underdevelopment, as evidenced by the state the continent finds itself in today. The main reason for this outcome is the loss of the capability to internally generate the human capital that is critical to constructing and staffing the institutions that enable Africa to produce its own social values, goods and services consistent with African needs and requirements. The SLA also presumes, rightly and based on observation and data, that the conventional approach of piecemeal solutions, adoption of other people's experiences, solutions, and production systems has only demonstrated failure and increased dependence. Thus, the vision of the SLA is founded on a 'new road map, a new compass' (Nzamujo, 2019, 3) that will capacitate a community to unleash its internal forces and build appropriate environments and structures to meet its needs and desires.

Primary to this new road map is the concept of the environment as the relationship between nature and the society living in it, as articulated in the Papal Encyclical of Pope Francis on the 'Safety of the Common House', which beseeches people to understand that:

Given the scale of change, it is no longer possible to find a specific, discrete answer for each part of the problem. It is essential to seek comprehensive solutions, which consider the interactions within natural systems themselves and with social systems. We are faced not with two separate crises, one environmental and the other social, but rather one complex crisis, which is both social and environmental. Strategies for a solution demand an integrated approach to combating poverty, restoring dignity to the excluded and at the same time protecting nature. [Francis, 2015]

The SLA has absorbed this fundamental and comprehensive philosophical re-think and reconfiguration of human perceptions of ourselves, of how we relate, of our relationship with the environment, to production systems and the way we exchange and consume ecosystem goods and services. For the SLA, this reconfiguration begins with the framing of the educational system and programme.

### **The new SLA paradigm**

The SLA philosophy is embedded in a new paradigm that has a completely different technological, organizational and socio-economic orientation. It calls for a new conception of ecology that includes the environment, the economy and society, and further that is both holistic and systemic in approach and analysis. The new paradigms are deeply embedded in modern science and draw upon recent discoveries and learning in various fields including neuroscience, cognitive and biological sciences, environmental sciences, process engineering and information technology, among others. To engage this new paradigm, it is also necessary to create a critical mass of people who have meaningfully appropriated and deployed it. With a critical mass of suitably educated, trained and oriented individuals, it will be possible to commit to creating, designing and inventing the organizations, industries, and economic activities that can be networked in holistic centres that will integrate all of these aspects to solve present day problems. This will form the basis of the 'Third Industrial Revolution' (TIR), which will be characterized by distributed energy regimes, syntrophic connectivity (characterized by synergy, symbiosis, complementarity, collaboration and supplementarity), and a rediscovery and harnessing of the biological capital of the universe (Nzamujo, 2019; Tharakan, 2019).

The SLA is thus envisioned as an innovative platform within the Songhai Knowledge Enterprise that will seed the development of African human capital. This human capital must necessarily be capacitated to produce and disseminate knowledge and to create the requisite tools that can deal effectively with the challenges facing the African continent (Nzamujo, 2019; SLA, 2019). The establishment of SLA as a knowledge enterprise is necessitated because it is clear that the socio-economic state of countries and the development targets that they can attain do not depend purely or singly on their physical resources, but increasingly on having the knowledge and intellectual capital to sustainably develop and utilize physical resources and to do so locally, with local knowledge engaged as well. The old adage 'Knowledge is power' is nowhere more applicable than in the development context. Indeed, economic prosperity, energy supply, industrial capacity, personal and public health and environmental quality are all knowledge-intensive and those with access to more knowledge usually enjoy more benefits and success. The critical importance of the SLA is underscored by the common knowledge that a quality education is not only rare in Africa, but largely elitist and inaccessible to the vast majority of Africans. At the Songhai Center, human capital is a measure of the value of knowledge, know-how, creativity and humanity in an individual, and this human capital can only follow from a substantive investment in education and training. This is what the SLA is all about, designed to produce functional, socio-economic entrepreneurs who will contribute to the creation of the critical mass necessary to effect radical change on the ground.

The implementation strategy for this to come about has required a rethinking of the educational institution and programme. The focus is on developing the knowledge, know-how and attitude within an individual. The programme is neither easy nor short, taking five years of preparation before students have the necessary competence (in terms of domain and experiential skills) to actually run a Songhai Center. The SLA conceives of its training team, first and foremost, as producers and mentors. The mentors have a responsibility and ethical duty to instill a practice of observation, creativity, and entrepreneurship in the Academy's trainees, practices that will enable the trainees to design, contextualise, plan, and implement Third Industrial Revolution projects. The SLA trains Songhai leaders who must have the required administrative, technical, and social competencies to initiate action effectively.

The process is long and requires a multifaceted approach that includes training in mathematics, statistics, all branches of agriculture, economics, environmental management, sociology, administration and town planning, among others. These technical and operational skills are actualised through practicums and mechanical arts and are also complemented with education in the humane liberal arts, which are essential to complete the SLA graduate. The holistic SLA programme requires a complete reorientation of the training into development projects, enshrined in project-based learning, where synergy between action-oriented theory and practice is critical.



The SLA vision is grounded in integrating science and technology with human capacity and has applied this in a distributed socio-economic institution with a mission of promoting the emergence of a pool of leader-entrepreneurs with the capability and capacity to establish the TIR through developing green rural cities. Green rural cities engage circular resource economies and prioritize renewable energy. Philosophically, the institutional mission is centred on developing agents who will engage in this *phrenesis*, which means ‘the wise application of science and technology for the good of humanity’. The SLA’s critical and innovative synthesis of *episteme*, or the ‘know-what’, with the *techne*, or the ‘know-how’, to develop individuals with the *phrenesis*, or the ‘know-why’, will enable individuals to re-engineer production and development systems based on their new systemic and holistic understandings of nature and sustainability.

The programme is an integrated and holistic training one, which is a combination of the Oxbridge (Oxford and Cambridge Universities in the UK) and Berlin (University of Berlin) academic systems. Oxbridge models are focused on general and broad education in the liberal arts to produce good members of society, while in the Berlin model both teaching and research are core components of university education, and the *Bildung*, or cultural development of a person, is the aim (Nzamujo, 2019).

Songhai sees this integrated platform of education, research, enculturation and socialisation as a path out of the present crisis of education. The goal is no less than the creation of a critical mass of balanced social entrepreneurs who will become the seeds for the creation of Songhai centres around the country and across Africa and the developing world.

## CONCLUSION

The Third Industrial Revolution will not happen unless a critical mass of individuals are equipped with the capacity to conceptualise, create, develop and implement an ecosystem that employs the principles of synergy, symbiosis, complementarity and supplementarity, and which harnesses the power of biological systems and capital to deliver the ecosystem goods and services that will address the needs and desires of the community. The Songhai Leadership Academy, under the tutelage and guidance of Rev. Godfrey Nzamujo, is the institutional, academic, and educational framework that has been able to actualise this innovative, radical and necessary re-thinking and re-framing of the educational system in Africa. Through the successful implementation of the SLA, the promise and potential of Africa’s youth to address and solve the critical problems facing them can be realised.

## Acknowledgement

The author wishes to acknowledge the tremendous input and support of Rev. Fr. Godfrey Nzamujo, Director of the Songhai Center in Porto-Novo, Benin, and the organisers of the 8<sup>th</sup> International Conference on Appropriate Technology, held at the Songhai Center in November 2018. His colleague at Howard University, Prof. Charles Verharen, Department of Philosophy, is also acknowledged for his invaluable contribution to the discussions leading to the development of this paper.

## LIST OF REFERENCES

- Banerjee, A. 2007. (ed.) *Making aid work*. Boston, MA, USA, MIT Press.
- Banerjee, A.V., R. Banerji, E. Duflo, R. Glennerster, and S. Khemani. 2008. *Pitfalls of participatory programs: Evidence from a randomized evaluation in education in India*. Poverty Action Lab. Available online at <http://www.povertyactionlab.org/papers/pitfalls.pdf>.
- Francis, Pope, 2015, *Encyclical Letter of the Holy Father on Care for Our Common Home*. Rome, Italy, *Libreria Editrice Vaticana*.
- Jolliffe, D.M. & Prydz, E.B. 2016. *Estimating international poverty lines from comparable national thresholds: Policy Research Working Paper*. WPS 7606. Washington, DC: World Bank Group.
- Karlan, Dean, Nava Ashraf & Xavier Gine. 2008. *Finding missing markets (and a disturbing epilogue): Evidence from an export crop adoption and marketing intervention in Kenya*. Poverty Action Lab. Available online at <http://www.povertyactionlab.org/papers/FindingMissingMarkets-2.pdf>.
- Nzamujo, Godfrey. 2002. *Songhai: Quand L’Afrique releve la tete (Songhai: When Africa (re)raises her head)*. Paris: French Edition du Cerf. (Author’s Translation)
- Nzamujo, Godfrey. 2018. *The African university of the future: A knowledge enterprise for articulating and incubating radical solutions to the formidable challenges on the continent*. Porto-Novo, Republic of Benin: Songhai Press. <http://www.songhai.org/index.php/en/home-en>.
- Nzamujo, Godfrey. 2017. TEDx Talk, *Green Rural Cities*. Available at: Acc. Apr 2019 <https://afrolegends.com/2018/02/09/godfrey-nzamujo-at-tedx-green-rural-cities/>.
- Nzamujo, Godfrey. 2019. *The Songhai Leadership Academy Program*. Porto-Novo, Benin: Songhai Press.
- Speser, P.L. 2006. *The art and science of technology transfer*, Baltimore, MD, John Wiley and Sons.
- Tharakan, J. 2019. *The Songhai Agro-Ecological Sustainable Development Model: Synergy, symbiosis, collaboration and complementarity*. DOI: <http://dx.doi.org/10.5772/intechopen.87929>.
- Verharen, C., J. Tharakan, G. Middendorf, M. Castro-Sitiriche, and G. Kadoda. 2011. *Introducing Survival Ethics into Engineering Education and Practice*. Science and engineering ethics. 19. 10.1007/s11948-011-9332-9.
- Verharen, C., J. Tharakan, G. Middendorf, G. Kadoda, J. Fortunak and F. Bugarin, 2014. Survival ethics in the real world – The research university and sustainable development. *Journal of Science and Engineering Ethics*, 20,135-154, March 2014.

# DEVELOPMENT OF A FIRE DETECTION AND EXTINGUISHING ROBOT

Ilesanmi Daniyana, Vincent Balogunb, Adefemi Adeodun, Edidiong Etudorc, Khumbulani Mporofua  
aDepartment of Industrial Engineering, Tshwane University of Technology, Pretoria, 0001, South Africa.  
bDepartment of Mechanical Engineering, Edo State University, Iyamho, Nigeria.  
cDepartment of Mechanical and Mechatronics Engineering, Afe Babalola University, Ado Ekiti, Nigeria.  
\* Corresponding author. Tel.: +27727021931 E-mail address:afolabiilesanmi@yahoo.com

## Abstract

*Robotic solutions find application in firefighting services. This paper reports on the development of a robot that is suitable for detecting and extinguishing fire. The robot operates automatically, with obstacle-avoiding capabilities, and is capable of detecting, tracking and extinguishing flames. To achieve the best performance with an effective implementation, a modular design strategy was adopted, where the robot is divided into a number of logical modules based on functionality. The design consists of five main modules: the master controller, motor control, proximity control, as well as the fire detection and fire extinguishing modules. Each module is associated with appropriate sensors and actuators. The information from various sensors and key hardware elements are processed via the PIC18F452 microcontroller. This is then interfaced with the master controller which coordinates and schedules the task of the entire robotic system. The performance evaluation indicates the robot's capability to detect and extinguish flames. Hence, this work will generate interest as well as innovation in the field of robotics while working towards practical and obtainable solutions to save lives and mitigate the risk of property damage through fire outbreak.*

**Keywords:** Actuators, Fire-fighting, Microcontrollers, Robotic solutions, Sensors

## INTRODUCTION

In recent years, the advent of the Fourth Industrial Revolution (4IR) has continually promoted the capabilities of robotic solutions as intelligent and autonomous systems for effective service delivery (Ren and Koo, 2007). Robotics has become attractive due to its versatility, making product development and services efficient, easier and comfortable (Sivas and Kalaimani, 2013; Mi-Yusouf, Sani, and Zainal, 2019). Most robots have augmented microcontrollers (a small control system with input and output control capabilities). Robotic systems find useful application in dangerous or hazardous environments as well as in difficult-to-reach areas. Firefighting is an important but dangerous service; fire can cause death of personnel, destruction of property and permanent disabilities if an efficient fire-fighting system is not deployed (Sangaralingam and Sathish, 2014; Nandkishor, Satbhai, Patil and Patil 2016). The associated risks can be mitigated with the deployment of a robot with suitable capabilities for firefighting operations. A firefighting robot must be able to combine a quick emergency response with the ability to get to the scene of a fire quickly, and then safely extinguish it. This will prevent further damage and reduce fatalities (Kim, Jo and Lattimer, 2016; Çakir and Ezzulddin; 2016; Raju, Mohammed, Paul, John, and Nair, 2017). Since technology now allows for more efficient and

effective methods of firefighting, a robot can be designed to function automatically or be controlled from a distance. This means that firefighting and rescue activities could be executed without putting the fire fighters at risk, through the use of robotic technology. The robot employs a microcontroller designed to accept input from a set of electrical signals and give output in the form of electrical signals in response to commands programmed into the device. The microcontrollers, which interpret signals from a human interface and send electrical signals to the rest of the electronic device, are often implemented as small, embedded processors found in many modern electronic devices. The versatility of the microcontrollers stems from the fact that they are tiny, cost effective computers which operate like a single integrated circuit. In addition, they are programmable, affordable, and lightweight, usually requiring minimal power with a wide range of models to suit the service requirements (Khoon, Sebastian and Saman, 2012; Tan, Liew, Alkahari, Ranjit, Said, Chen, Rauterberg, Sivakumar, and Sivarao, 2013; Ali, Shamishev, and Aitmaganbayev, 2018). Firefighting mobile robots are one solution with the capacity to reduce the hazards and risk to a fire fighter (William, Hector, Kevin, and Daisy, 2010; Haksar and Schwager, 2018; Xin, Qiao, Hongjie, Chunhe, and Haikuan, 2018). Xu, Chen, Cai, Guo, Fang, and Sun (2011) designed a firefighting robot capable of searching, detecting and extinguishing a fire in a house with a small floor plan. It also has the capability to move about and avoid obstacles independently. The navigation of the robot is achieved by the data provided by a line tracker and ultrasound transducers. The deployment of the extinguishing device is implemented with a custom arm controlled by servos. Ratnesh, Kumbhare and Kumbhkar. (2012) developed an approach to the implementation of a firefighting robot which employs the concept of environmental sensing and awareness as well as proportional motor control. The robot processes information from its sensors and hardware elements while ultraviolet, infrared and visible lights are used to detect the components of the environment. The robot is capable of fighting tunnel fires, industry fires and also finds application in the military. Saravanan (2015) developed another integrated semi-autonomous firefighting mobile robot. The system controls four D.C. motors controlled by an Atmega2560 microcontroller and it is controlled autonomously by its navigation system. To give another example, Poonam, Rutika, Siddhi and Kaldate (2014) developed an intelligent fire extinguishing system which uses smoke, flame and temperature sensors for fire detection. The system detects the fire location and extinguishes it using the sprinkler method. Many researchers, it is clear from the literature, are working on feasible solutions to help robots think more efficiently, move and navigate in a smoother way (Michie 1985; Barros and Lages, 2012; AlHaza, Alsadoon, Alhusinan, Jarwali, and Alsaif. 2015).

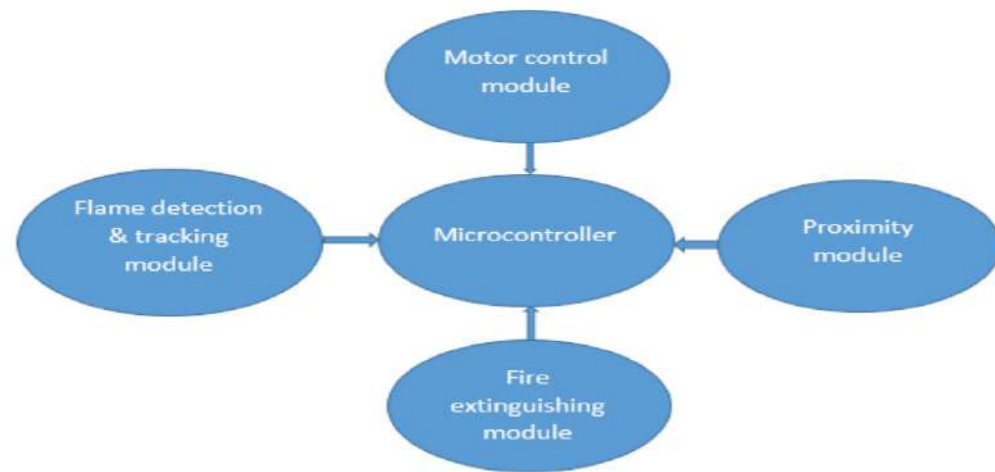
The development of sensor networks and the maturity of robotics suggest that mobile agents can be employed for tasks that involve prompt perception and reaction to an external stimulus, even when the reaction involves a significant amount of mechanical action. This provides the opportunity to pass on to robots the tasks that traditionally done by humans but come with the inherent risks in fire-fighting. Hence, fire-fighting is an obvious candidate for automation in this regard. Given the number of lives lost regularly during firefighting operations, the system can be deployed to mitigate the hazards and associated risks involved in the fire-fighting operation. Due to recent technological advances, the design of a fire-fighting robotic system with sensors is within the reach of current sensor network and mobile agent technologies. Furthermore, the techniques developed in this work will carry over to other areas involving sensing and reaction to stimulus, where it is desired to replace the human with an automated mobile agent. Fire accidents can occur anywhere at any time and without an effective means to contain it, a fire can spread rapidly, causing havoc.

This paper considers the development of a fire detection, tracking and extinguishing robot. The system's capability includes the ability to operate autonomously, avoiding obstacles and at the same time find, track and extinguish flames, by a modular design strategy. The robot has the ability to act and think independently, mimicking humans but with a high degree of flexibility. We envisage that the findings of this work will enhance firefighting operations.

## METHODOLOGY

The design consists of five main modules: the master controller, motor control, proximity control, fire detection and fire extinguishing modules (Figure 1). Each module is associated with the appropriate sensors and actuators. The information from various sensors and key hardware elements are processed via the PIC18F452 microcontroller. This is then interfaced with the master controller which coordinates and schedules the task of the entire robotic system. The following specifications were made for the design of the fire detecting and extinguishing robot: six (6) panels of sensors which give a 360-degree view for flame detection, servos and DC motors, ultrasonic sensors for obstacle detection and a CO<sub>2</sub> fire extinguisher.

The robot has a modular design as illustrated in Figure 1, where the entire task to be performed by the robot are divided.



**Figure 1:** Modular design of the robot.

The flame detection and tracking module comprises of two flame sensors (SKU-9521), with a spectrum range of 760-1100 nm and detection angle ranging from 0-60°, and ultrasonic sensors (HC-SR04) for obstacle detection and avoidance. The signals measured by the sensors in real time serve as input into the micro controller.

For the controller module, the threshold value for flame detection is preset on the microcontroller and the output from the sensors is received as input into the microcontroller. The signal is then amplified and converted into a digital signal on the micro controller using the Analog to Digital Converter (ADC). The digital signal is thereafter processed and compared with the threshold. Once the threshold is exceeded, the micro controller activates the DC motor which moves the robot for firefighting operation.

The motor control module has a 12 V DC motor which is activated by the microcontroller whenever there is need for firefighting operation.

On detecting a flame source, the fire extinguishing module is activated and the robot moves in the direction of the detected flame and stops at a safe distance, which ranges from 0.5-1.0 m depending on the flame intensity. The safe distance is to prevent the flame from damaging the robot. The “stop” action is automatically executed followed by the activation of the fire extinguisher which sprays the flame until the flame intensity falls below the threshold preset on the microcontroller as measured in real time by the flame sensor.

#### Design Constraints and Specifications

Apart from the modular design strategy, some basic constraints were placed on the robot. These constraints served as a design guideline for the implementation of the system.

- The robot must be able to identify and extinguish the flame in less than 5 minutes and return to initial position in less than 2 minutes after extinguishing the flame.
- The robot is designed not to exceed a size of 31 cm width, 31 cm length and 27 cm height.
- The battery must be able to last at least 30 minutes without the need for recharging.
- The fire extinguisher system must work for 30 seconds without the need for a refill.
- The robot will not exceed 11.3 kg in weight.
- The selected carbon dioxide extinguisher was capable of extinguishing fires of classes A, B, and C (Table 1).

**Table 1.** Categories of fire and description.

Class of fire	Description
A	Fires in combustibles such as wood, paper, cloth, plastics, rubber, etc.
B	Fires in flammable liquids, petroleum based products, flammable gases, gasoline, tars, alcohol, solvent, greases
C	Fires in electrical equipment such as servers, motors, transformers, electrical appliances etc.
D	Fires in combustible metals such as magnesium, titanium, zirconium, sodium, lithium and potassium
K	Fires in cooking oils, greases, animal and vegetable fats etc.

(Fire Equipment Manufacturers' Association, n.d.)

#### Mechanical Design

The design was done using Autodesk Inventor Professional 2018. The chassis setup was constructed using Actobotics aluminium. The choice of aluminium stems from its mechanical properties such as excellent weight-to-strength ratio, good formability and excellent corrosion resistance. Its weight-to-strength ratio implies that the robot will be highly sustainable in terms of the cost economics, power requirement as well as environmental friendliness. Figures 2 and 3 present the chassis model of the robot as well as the front view.

#### Motor size determination

Based on the estimate of the total robot's weight, a 12 V motor was found sufficient for the service and functional requirements.

#### The circuit integration and analysis

The Proteus 8.0 was employed for the circuit design and the control boards were made with all circuit components soldered on a strip board (Figure 4). The connections were tested to ensure that no components were connected in the wrong manner. Since the frame of the robot was made of aluminium material and could conduct current, the circuit boards were insulated with rubber standoffs to ensure that the boards were completely isolated from the frame to avoid short circuiting of the system. Figures 4 and 5 show the integrated circuit board for the motor and the controller.

Figure 6 shows the front view of the robot, after assembly and integration of all the necessary components.



**Figure 2:** The chassis model of the robot.



**Figure 3:** The front view of the robot.

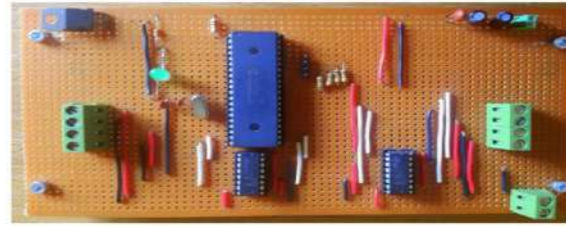


Figure 4: Motor control circuit board.

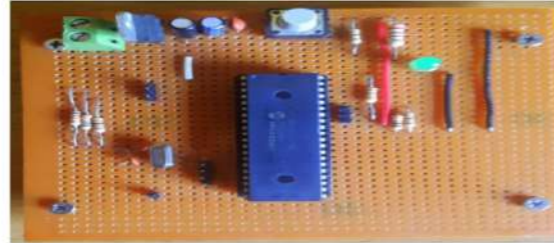


Figure 5: Master control circuit board.

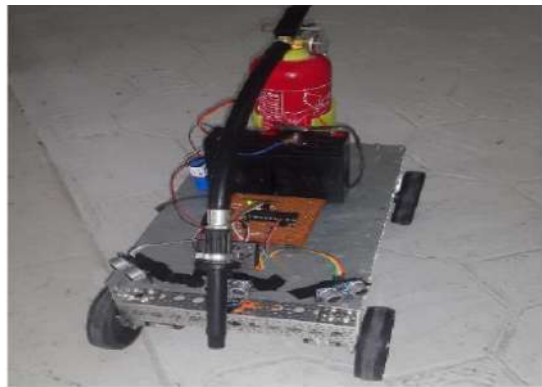


Figure 6: The developed fire detecting and extinguishing robot (front view).

### Performance evaluation

The performance evaluation of the developed fire extinguishing robot was performed under different conditions of class B flames, namely candle, kerosene stove, domestic gas cooker, Bunsen burner, welding flame, furnace and petrol flame in order to evaluate the detection and extinguishing time of the robot (Table 1). The results obtained are presented in Table 2.

### RESULTS AND DISCUSSION

The robot demonstrated excellent navigating and obstacle-avoidance abilities when approaching a flame source for fire extinguishing. Furthermore, in line with the design requirement, the robot could also keep a safe distance ranging between 0.5 - 1.0 m depending on the intensity of the flame. The times taken by the developed robot to detect and extinguish fires of class B are presented in Table 2.

Table 2. The flame source, detection and extinguishing time.

Flame source	Detection time (sec)	Distance from frame (m)	Extinguishing time (sec)
Candle	0	0.5	0
Kerosene stove	20	0.5	15
Domestic gas cooker	18	0.65	30
Bunsen burner	15	0.75	40
Welding flame	15	0.75	45
Furnace	10	1.0	-
Petrol flame	5	1.0	90

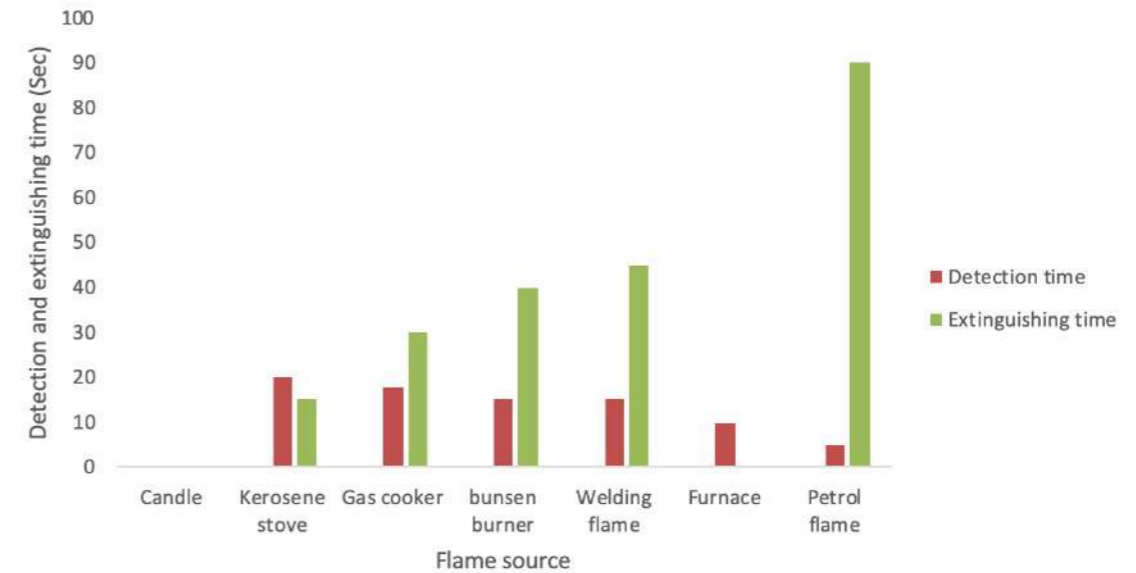


Figure 7: The detection and the extinguishing times.

From Figure 7, it was observed that the detection time decreases with the intensity of the flame. The higher the flame intensity, the faster the detection time and response of the robot. This is due to the fact that the threshold value for the flame detection, which is preset on the micro-controller, forms the basis for the activation of the extinguishing module. On the other hand, the time of extinguishing the fire was observed to increase as the intensity of the flame increases. The intensity of the candle flame at a distance of 0.5 m was far less than the threshold value for the flame intensity, hence, there is no basis for the flame extinguishing. The fuel in the kerosene stove was made to overflow before the extinguisher could detect the presence of the flame after 20 seconds; the robot took a total of 15 seconds to extinguish the flame. The results indicate that the developed fire extinguishing robot has the capacity to detect flame sources early enough to forestall the destruction of lives and property and at a safe distance from the flame, and also possesses the capacity to extinguish the flame promptly.

### CONCLUSION

This study describes the development of a fire detection and extinguishing robot for firefighting. The work was motivated by the desire to develop a system that can detect fires and take appropriate action autonomously. The results obtained indicate that the robot can independently identify and extinguish the flame in less than 5 minutes and return to initial position in less than 2 minutes after extinguishing the fires of class B with at a safe distance ranging from 0.5 m - 1.0 m depending on the flame intensity. The robot can be used in educational institutes, malls, industries, workplaces or indeed, anywhere. It is envisaged that the work will generate interest as well as innovation in the field of robotics while working towards a practical and obtainable solution to save lives and mitigate the risk of property damage during fire outbreak. Future work should consider the performance evaluation of the developed robot with other classes of fire.

## LIST OF REFERENCES

- AlHaza, T., Alsadoon, A., Alhusinan, Z., Jarwali, M. and Alsaif, K. 2015. New concept for indoor firefighting robot. *Procedia - Social and Behavioral Sciences*, 195:2343-2352.
- Ali, M. H., Shamishev, S., and Aitmaganbayev, A. 2018. *Development of a network-based autonomous firefighting robot*. 15th International Conference on Informatics in Control, Automation and Robotics, Porto, pp. 525-532.
- Barros, T. T. T and Lages, W. F. 2012. *Development of a firefighting robot for educational competitions*. 3rd International Conference on Robotics in Education. RiE 2012, Prague.
- Çakir, A. and Ezzulddin, N. F. E. 2016. Fire-extinguishing robot design by using Arduino. *Journal of Computer Engineering*, 18(6):113-119.
- Fire Equipment Manufacturers' Association. [online] Available at <https://www.femalifesafety.org/types-of-fires.html>. Accessed: 20th August, 2020.
- Haksar, R. N. and Schwager, M. 2018. *Distributed deep reinforcement learning for fighting forest fires with a network of aerial robots*. IEEE/RSJ Int'l Conference on Intelligent Robots and Systems (IROS), Madrid. pp. 1067-1074.
- Khoo, T. M., Sebastian, P. and Saman, A. S. 2012. Autonomous firefighting mobile platform. International symposium on robotics and intelligent sensors. *Procedia Engineering*, 41:1145 – 1153.
- Kim, J.-H., Jo, S. and Lattimer, B. Y. 2016. Feature selection for intelligent firefighting robot classification of fire, smoke, and thermal reflections using thermal infrared images. *Journal of Sensors*, pp. 13.
- Michie, D. 1985. *Expert systems and robotics*. New York: Wiley.
- Mi-Yusouf, M. A., Sani, N. S. and Zainal, A. 2019. Development of firefighting robot (QRob). *International Journal of Advanced Computer Science and Applications*, 10(1):142-147.
- Nandkishor, T., Satbhai, R.M.K., Patil, A. V. and Patil, M. 2016. Fire-fighting robot. *Int'l. Journal on Recent and Innovation Trends in Computing and Communication*, 4(4):799-803.
- Poonam, S., Rutika, G., Siddhi, P. and Kaldate, A. 2014. Intelligent fire extinguisher system. *IOSR Journal of Computer Engineering*, XVI (1), pp. 59-61.
- Raju, J., Mohammed, S. S., Paul, J. V., John, G. A. and Nair, D. S. 2017. *Development and implementation of Arduino microcontroller-based dual mode fire extinguishing robot*. IEEE Int'l. Conference on Intelligent Techniques in Control, Optimization & Signal Processing (INCOS), India, 978-1-5090-4778-9/17, pp. 1-5.
- Ratnesh, M., Kumbhare, M. and Kumbhkar, S. S. 2012. Firefighting robot: An Approach. *Indian Streams Research*, II 2012, (2):1-4.
- Ren, C. and Kuo. 2007. *Autonomous fire detection system for intelligent security robot*. IEEE/ASME, Zurich, pp. 274-281.
- Sangaralingam, C. and Sathish, R. 2014. Design of surveillance robot with obstacle sensing and movement control using arm controller. *Int. J. Engg. Res.* 2014, 2(2):201-206.
- Saravanan, P. 2015. Design and development of integrated semi-autonomous firefighting mobile robot. *Int. J. of Eng. Sci. and Innovative Techn.*, March IV (2).
- Sivas, A. and Kalaimani, S. Wireless surveillance robot with motion detection and live video transmission. *Int. J. Engg. Res.* 2013, 1(6):14-22.
- Tan, C. F., Liew, S. M., Alkahari, M. R., Ranjit, S. S. S., Said, M. R., Chen, W., Rauterberg, G. W. M., Sivakumar, D. and Sivarao. 2013. Firefighting mobile robot: state of the art and recent development. *Australian Journal of Basic and Applied Sciences*, 7(10): 220-230.
- William, D., Hector, G., Kevin, B. and Daisy, D. 2010. *An autonomous firefighting robot*. Miami: Florida International University, US.
- Xin, C., Qiao, D., Hongjie, S., Chunhe, L. and Haikuan, Z. 2018. *Design and implementation of debris search and rescue robot system based on internet of things*. International Conference on Smart Grid and Electrical Automation, Changsha, pp. 303-307.
- Xu, H., Chen, H., Cai, C., Guo, X., Fang, J. and Sun, Z. 2011. *Design and implementation of mobile robot remote fire alarm system*. Intelligence Science and Information Eng., Int'l Conference, China, pp. 43-47.

# COMMUNITY ENGAGEMENT, KNOWLEDGE AND TECHNOLOGY EXCHANGE: ACADEMIC REFLECTIONS ON A PROJECT AT BERTRAMS, JOHANNESBURG

Laetitia Lamprecht and Amira Osman, Tshwane University of Technology, South Africa,  
laetitalamprecht10@gmail.com, OsmanAOS@tut.ac.za

## Abstract

*This paper considers how community engagement projects affect residents of buildings and places, thus offering an academic reflection. One such project is the 2019-2021 NRF funded community engagement project, focused on the residents of a building at Bertrams, Johannesburg, which is a collaboration between the Tshwane University of Technology and the University of Johannesburg. The research project aims to share knowledge and provide an opportunity for residents to learn new skills during the process of renovating the building. To achieve this, the project team members are implementing interventions which attempt to engage the residents of the specific building in decision making while at the same time empowering the larger community of Bertrams.*

*The paper begins with furnishing an historical context of the area of Bertrams to the inner-city of Johannesburg and the diverse stakeholders involved with a view to better understand the dynamics of the context and how they affect decision-making processes. A future vision for the area in the context of urban regeneration initiatives in the City of Johannesburg is also posited. Thereafter, the impact of urban acupuncture and “small change” architectural interventions are considered – as are the implications of these project-level decisions on the broader urban context and on debates concerning policy. The project therefore considers how higher-level policy decisions translate into projects, and how projects at a local level may also offer insight into how policy may be transformed to become more responsive to conditions on the ground and the needs of inner-city communities.*

*The paper offers a reflection on the renovation process and demonstrates the changes in perspective and attitude of residents, the sense of ownership and possible resultant socio-economic impacts of the interventions. The effects and influence on the occupants are investigated and assessed based on changes in the residents’ willingness to be more involved in the building and area.*

**Keywords:** community engagement, service learning, urban renewal, inner city housing, occupied buildings

## INTRODUCTION

The importance of community engagement projects in architecture programmes is becoming more relevant as the role of designers and architects is evolving to adapt to societal needs and change. These initiatives have profound impacts, not only on communities, but also on the participating students, volunteers, practitioners and researchers. The 2019-2021 National Research Foundation (NRF) funded community engagement project is one of these initiatives that focused on how incremental change in a building could have a positive impact on its residents. How does “small change” drive action and participation amongst residents? How can immediate architectural design and restoration incentives contribute to a vision for future possibilities, where residents start taking more ownership of the spaces they occupy? Can these initiatives become part of the local policies, where architecture is a mediator for much needed conversation between the local authorities and civil society?

The case study for this project is situated in Bertrams, Johannesburg, an area with significant cultural value relating to the history of Johannesburg (Johannesburg Development Agency, 2008: 10). It has allowed us to explore how community engagement projects could be better integrated in an urban context; it has also allowed for an exploration of possibilities for future engagement and the adoption of effective strategies. By considering re-using, and therefore reintegrating, occupied buildings in the inner city, a better understanding can be developed towards creating affordable inner-city housing. The provision of affordable housing in the inner city contributes to making cities more sustainable, viable and inclusive (Housing and Urban Environments, 2019). By adopting an eco-systemic lens, communities in cities are understood as part of elaborate networks which are vital and influence how cities are being shaped. The unique context, historical background and diversity can be reinforced and supported by community initiatives like this project, ultimately encouraging meaningful place making.

The research project set out to understand the daily realities faced by the residents allowing for the potential to recognise how lives and livelihoods are maintained, as well as how residents could potentially become better equipped to become self-sustaining communities in the future. Can the adoption of architectural strategies contribute to the improvement and development of an adaptable and sustainable model for community engagement and technological exchange? The premise of the study is that the small-scale architectural interventions could have a micro impact on individuals occupying the building, this would look like residents taking ownership of the building. Therefore, considered in the development of a holistic perspective – the individual, the building and the urban context is changed, illustrating that “small changes” in the lives of individuals positively impact the collective. It is critical to understand the influence these initiatives can exert on the individual, the broader community and ultimately the urban context.

There are numerous socio-economic strategies and opportunities that exist due to the proximity to the central business district of Johannesburg and the Ellis Park Stadium. These possibilities could range from integrated mixed-use housing projects to inclusive educational facilities. Considering these future socio-economic possibilities, the area would benefit in retaining a sense of place if these strategies developed a collaborative and inclusive approach to the broader community. This community engagement project only highlights one building. However, the study is premised on a belief that transformation of this one building could have enormous impact, not only on the Bertrams area, but on the City of Johannesburg, by becoming a pilot for how to work with occupied inner-city buildings.

## EXPANDING THE RESEARCH POSSIBILITY: COMMUNITY ENGAGEMENT

Community engagement is “based on principles that respect the right of all community members to be informed, consulted, involved and empowered” through the employment of various tools and strategies, as well as a focus on establishing trust between the different stakeholders (PennState College of Agricultural Sciences, n.d.). Models of community engagement include research methods such as community-based participatory research and community action research – these are sometimes used interchangeably (Ahmed & Palermo, 2010). This project has adopted many of the principles of ‘Action Research’ as a methodology, especially as it considers both the education of the researcher and the participants and because of its focus on leaving behind results that are useful and relevant to the host community (Herr & Anderson, 2015: 67), that is, generating local knowledge fed back into its setting (Herr & Anderson, 2015: ibid; xiii).

The word ‘community’ in the context of this paper refers to the community of an occupied building in the city and its interaction with specific professional and academic communities. Collectively these communities have a central and shared interest in the social and economic well-being and rights of the residents of the occupied building, as well as the general condition of the building, spatially and physically. Herr and Anderson (2015: 41) list this type of collaboration as “Reciprocal Collaboration (insider-outsider teams)” describing it as “Collaborative forms of participatory action research that achieve equitable power relations”. By using community engagement strategies, it is hoped that greater relevance will be achieved as decisions will always be made based on the desires and needs of the community in question. To achieve success in this approach and to build trust between the different participants, this kind of project should have a multi-year plan. The collaboration between the team of academics and the Bertrams community is now in its fourth year. While still not ideal, the contents of this paper needs to be read as an on-going project with a level of flexibility built into it to accommodate for changes that happen over such a long period.

Action research and community engagement are collaborative endeavours – as an academic exercise and as a research endeavour, the process has been cross-disciplinary by nature. This project is a collaboration between various departments at the Tshwane University of Technology and the University of Johannesburg. The project is complex, with numerous other stakeholders and partners; these include the Inner City Resource Centre (ICRC), Plan Act, 1 to 1 Agency of Engagement, the Socio-Economic Rights Institute (SERI) and the City of Johannesburg (CoJ) (Housing and Urban Environments, 2019). Interaction between these diverse stakeholders has ensured, firstly, a richer process as the cross referencing of different academic institutions and non-governmental organisations as well as the city officials has allowed for multiple viewpoints to be considered in the service of the host community. The project provides an ideal scenario for multidisciplinary fieldwork.

This diversity has meant that the project has been engaging both professional and academic communities as well as the host community of the residents of the building. Furthermore, the research investigates how the role of the architect and designer can be better geared towards benefiting society and how this project could serve as an example of how community engagement projects can be improved to facilitate greater engagement from individual level and ultimately to the collective context? This research paper will therefore investigate three main concerns and employ specific methods to achieve this:

- (1) How do community engagement projects allow residents, architects and architecture students to interact in ways that are meaningful ensuring positive future implications for the host community? Answering this question is achieved through a literature survey, observation and documentation of actions taken on site (both qualitative and quantitative).
- (2) How can higher-level policy decisions translate into projects, and how can projects at a local level offer insight into how policy may be transformed to become more responsive to conditions on the ground? Existing policies concerning occupied and dilapidated inner city buildings are considered – as are policies regarding housing in the inner city which may impact on or be influenced by local level interventions. The site-level interventions are then presented within this larger context and some reflections are offered.
- (3) How has “small change” influenced the sentiments and behaviours of residents in the case study building and how might these possibly drive future visions of the area? Residents are interviewed and responses to the interventions carried out are documented in order to answer this question.

By elaborating on these three main concerns regarding this case study, the research aims to propose future possibilities, offer a reflection of the outcomes, and acknowledge what has been learned to add to existing knowledge.

#### UNDERSTANDING THE CONTEXT/COMMUNITY

The area of Bertrams (Figure 1) was established in 1889; the inner city suburb consists of various typologically diverse buildings. The area and the priority block consist of commercial and residential zoning, lending itself to future mixed-use typologies. The priority block (Figure 2) also consists of significant and diverse heritage buildings. The buildings in the context of Bertrams have been identified to have both historic and sociological significance pertaining to Johannesburg (Johannesburg Development Agency, 2008: 10-11).

The priority block is defined within the boundaries of Berea Road (north), Liddle Street (east), Gordon Road (south) and Bertrams Road (west) (Johannesburg Development Agency, 2008: 3). The block is adjacent to the Ellis Park Stadium and is ideally located to the newly established Bus Rapid Transit (BRT) station, the Ellis Park North Station West. Travelling from west to east towards the area of Bertrams, the corner of Bertrams Road and Berea Road provides a glimpse of the possibilities of mixed-use development.

Bertrams is one of the oldest inner suburbs in Johannesburg, originally a portion of the farm, Doornfontein, and was named after the property developer, Robertson Fuller Bertram, who bought the property in 1889; it has been documented in earlier records as Bertram Township, Bertrams Township, Bertram’s Town and Bertramsville. It was an inner suburb for the middle-class at the time and became a popular residential area for affluent members of society, for example, the terraced houses located on Queen and Ascot streets. The land area in total was divided into 350 stands of different

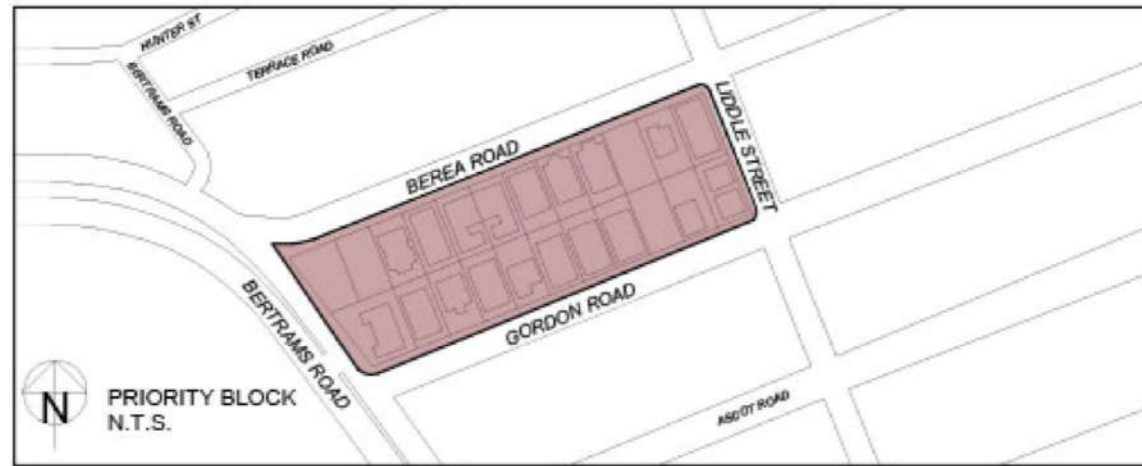
sizes, and records mention that the area consisted of “exceptionally fine buildings” and there is even a mention of one property that comprised “stables for thoroughbred horses” (Ward 66 Johannesburg, 2020). Bertrams was established for middle-class income city dwellers to enjoy a sense of tranquillity while still being close to the central business district of Johannesburg.

In the early twentieth century, Bertrams developed as a “racially mixed residential area”. The area was contravening the “segregation legislation”, known as the Natives (Urban Areas) Act of 1923 and later the Group Areas and Population Registration Acts of 1950. In the 1930s, licences to live in the area were issued by the Johannesburg municipality to non-white citizens. By 1935, the Natives (Urban Areas) Act was implemented and enforced, seeing relocations to areas on the periphery of Johannesburg, namely Orlando. Two years later, in 1937, more evictions and relocations occurred to “make way for a White working-class re-housing scheme”. By the 1970s, the area once again recorded a racially mixed area and was considered a ‘grey’ area (Rule, 1989: 196-202). This brief history of the area of Bertrams provides some context to how the area has been shaped by the realities and consequences of displacement during the Apartheid regime in Johannesburg.

Unemployment and poverty are extensive in the area, yet the streets have a tranquil serenity despite the proximity to the central business district of Johannesburg (South African History Online, 2019a). The area has retained a sense of place and identity; however, it has been one of transition and displacement. Bertrams was identified as one of the areas for development during the Ellis Park precinct upgrade in preparation for the 2010 Soccer World Cup. This upgrade was due to the proximity of the area to the Ellis Park Stadium and new affordable housing was envisioned along with retail, commercial and entertainment opportunities in preparation for the event (South African History Online, 2019a). This was never fully realised; the area’s unemployment rate remains high despite its proximity to the central business district and other economic areas (Figure 1).



Figure 1: The location of Bertrams in proximity to the central business district of Johannesburg and surrounding areas (Lamprecht, 2020).



**Figure 2:** The Bertrams priority block (Lamprecht, 2020).

The area retains a sense of resilience, and despite the past, the area has an unmistakable stillness with a definite character and atmosphere that can be experienced when driving or walking in Berea street. Recognising past displacement could provide opportunities for adaptation and re-use projects involving the broader community, this could lead to stronger networks forming between the inner suburb and the City of Johannesburg. Bertrams has a unique sense of identity, which captures pieces of the past yet evokes an optimistic future. Its history and present-day characteristics can help in visualising a future where the neighbourhood's diversity and inclusivity is not only acknowledged but accepted. By building these characteristics using participatory action research, it is hoped that the project enhances the "genus loci" of the place.

Despite the incredible potential of the site, and its long heritage, the City of Johannesburg (COJ) posted a notification about a demolition on the Bertrams priority block, on the 25th of June 2019. This decision was taken without the involvement of the residents and led to a "WE WON'T MOVE" demonstration by residents and the Inner City Resource Centre (ICRC). The community protested to the COJ that no demolition or building work should take place in the priority block without engaging with the residents first. The City of Johannesburg has since joined the ICRC to ensure that residents are involved in the future decision making. The 2019-2021 NRF funded research project has been able to assist the ICRC and the practitioners on the project namely, 1 to 1 Agency of Engagement in draughting a document that provides the COJ with advice on how future engagement strategies can be implemented before demolition or building work takes place (Housing and Urban Environments, 2019).

The building that is being studied, located within the priority block of Bertrams, is home to approximately 119 residents with 13 children under the age of 18. A socio-economic survey conducted in April 2018 with 39 respondents indicated that most residents have been living in the building for 14 years or more; some residents indicated that they have lived in the building for more than 20 years. Furthermore, 60,5% of residents cited economic opportunity as the reason for moving to the building. A further 31,6% cited affordable rent, 5,3% said they moved to be closer to family and 2,6% moved to the building due to a previous eviction (Housing and Urban Environments, 2018). Residents also noted that the proximity to the inner-city is cost effective. Furthermore, residents have indicated that they have built meaningful networks in the time that they have lived in the building, and that relocation would be detrimental to the bonds they have formed over the years (Dhlakama, 2019).

### INCREMENTAL CHANGE: KNOWLEDGE AND TECHNOLOGY EXCHANGE

An action plan was developed by the TUT Architecture and CARINBE UJ Community Engagement Team. The team collaborated with various practitioners from contractors, engineers and architects to establish the nature of the structural damage of the existing concrete roof along with other design challenges such as the restoration of brick balconies. Various techniques of restoration were considered, ensuring and considering that the residents should avoid being displaced during the process (Housing and Urban Environments, 2019).

Safety was a major consideration, firstly during the process of repairing the brick balconies and later during the pouring of the concrete screed on the roof. The design process depended on the skill and knowledge transfer to residents, but also from residents to students and practitioners. Residents were able to acquire knowledge and skills that could be used in the future, and the various training workshops were open to both male and female residents. The student assistants, practitioners and contractors in turn can learn from residents how practice can be adapted to enable further possibilities and opportunities for engagement. Throughout the process it was noteworthy to see how solutions were found in the moment; this is only possible when residents remain involved in the process. Innovative solutions were found, solutions that would take longer and possibly cost more if executed only by an office-based practice (Housing and Urban Environments, 2019). The innovative solutions included using concrete left over from the roof screed to fix other floor cracks and repair the steel staircase connection (Figure 4).

The main considerations for the renovation and upgrading of the building also corresponded with that which the residents indicated to be in a 'poor' condition. The data analysis and social-economic survey carried out in April 2018 indicated that 86,7% considered the roof to be in a poor condition; 79,5% considered the stairs to be in a poor condition and 100% indicated that the balustrades were in a poor condition (Housing and Urban Environments, 2018).

The response to the above analysis is observed in the changes made in the building during the renovation period, which included the repair of the brick balustrades (Figure 3) and the repair of the steel staircase leading to the roof (Figure 4). However, the most significant repair was the installation of the new screed layer on the roof to allow for the installation of a waterproofing barrier (Figure 5). The brick balustrade repairs, and the steel staircase repair made all the difference in ensuring the safety of all residents while moving around in the building. A change in how residents started using these spaces was noticed. Neighbours could stand closer to balustrades, even resting on them and a feeling of protection could be experienced in the interaction amongst the residents. The roof repair and waterproofing further made an impact on how residents were able to take ownership of the spaces they occupy. Where water leaks and cracks made some living areas unbearable, the waterproofing now enabled residents to paint and fix areas within living spaces themselves.



**Figure 3:** Before and after the repairs to the brick balustrades (Lamprecht, 2019).





**Figure 4:** Before and after of the repairs to the steel staircase (Lamprecht, 2019).

#### SYSTEMIC CHANGE IN EDUCATION AND COMMUNITY SERVICE

The value of this community engagement project is comprehensive. Allowing architecture students who are interested in inner city housing, heritage and the socio-economic impacts of architecture and community engagement a platform to participate and contribute toward this project. This engagement allows for a broader field of participation in the academic community. Creating a forward motion by young architects as they move into practice, realises the benefit of engaging with communities. Vice versa, communities will also be able to engage more with students, with architects providing opportunities for meaningful conversations and knowledge exchange.

In the past, architecture schools have had a notable history where academic bodies were resistant to change. Ideas that have been made relevant by the Modernist Movement are still highly regarded, and prior to that, the idea of the nature of the architect's role. When the architect's role is considered, one begins to realise that the role has many ambiguous meanings. The definitions often range from the architect as master builder to a role clad in the superiority of the makers. When academic bodies started to feel a resistance of students questioning the role of the architect in society today, it was notable that the students, who were *"matured by their struggle"* started to change their perspective. This new attitude allowed students to realise that it was not only the structures of organisation or methods of teaching that needed reform but that the *"purpose of their training and social role"* were fundamentally needed to be interrogated and defined (De Carlo, 2005: 3-5).

By no means are the ideas of the Modern Movement irrelevant. However, it must be recognised that architecture is not static; practice and education cannot remain relevant when only past ideas are recognised or repeated in new ways. Radical shifts are required, yet the word 'radical' in some contexts implies major changes. It may seem that way in the field of architecture but when observed closely it really means that architectural academies and practices merely need to respond to more dynamic societies in authentic ways, by asking the very fundamental question which community engagement projects allow researchers to ask, how can architecture make a meaningful impact?

Architecture has made a few fundamental mistakes in the past and remains so when the capital needs take priority over those of the user. By understanding and shifting the perspective towards the needs of the user and therefore society, the idea of 'radical' change does not seem to be overbearing but merely necessary (De Carlo, 2005: 7).

By understanding the above, consider then that by integrating community engagement projects across architectural knowledge themes and even multi-disciplinary fields, the end user could become the focus, and architecture becomes relevant once more, thus leading to community engagement projects, creating a ripple effect in its context and becoming a catalyst for systemic change.

Contextualising provides acknowledgement and understanding of that which came before, thus leading practitioners to develop informed future possibilities. In the compilation of *Theories and Manifestoes of Contemporary Architecture*, John Habraken (1997: 22-23) refers to the idea of *"supports"* which he suggests can become an alternative to mass

housing. The concept largely considers *"the realities of human relationships"*. Habraken states that for human relationships to be restored, technological advancements need to be considered, otherwise there is a risk of only moving backward, to the past. If, on the other hand, only technical knowledge is considered and developed and human relationships ignored, a scenario such as mass housing becomes a reality. The idea of *"supports"* by John Habraken could possibly be applied to develop lateral thinking. Firstly, the idea speaks of balance and therefore the possibilities of supporting community and advancing technology simultaneously, and that the integration and harmony of both become essential in developing multi-functional cities (Habraken, 1997: 22-23).

#### IMPLICATIONS OF HIGHER-LEVEL POLICIES IN COMMUNITIES

While analysing the data, an important observation was made. Of the respondents, 89,2% indicated that they had previously been threatened with eviction, yet in a follow-up question 54,5% indicated that they did not know who wanted to evict them. This is of further interest when considering that 61,5% of the respondents indicated that they did not know who owned the building. This reflection regarding the evictions and ownership of the property is important in considering how various structures communicate with one another. Community leadership becomes important in a situation like this to communicate relevant information to unit owners regarding the legal status of the building (Housing and Urban Environments, 2018). This also becomes important, then, for local authorities to communicate effectively to community leaders.

Community engagement projects depend on the responsiveness of local policies. Local policies need to be able to respond to what is happening in the community and on the ground. If higher-level policies were to engage with research institutions more dynamically, for instance, being updated by changes or concerns in communities, policies could become more responsive. In the Bertrams project, for example, if the City of Johannesburg consulted with various stakeholders, researchers and community members before posting a notice for demolition, community members would have been spared the uncertainty and anxiety during that time and a protest would have been avoided. Higher-level policies could also be more responsive in implementing and suggesting projects that could benefit areas if resources from various stakeholders are incorporated in decision-making processes.

A city is dependent on the people who make it, and people in turn make the city. Therefore, as people adapt to various environmental, social and technological change, cities inevitably change. Therefore, cities need to be adaptable; where cities allow for diversity, participation not only becomes possible but necessary.

Consider the idea of adaptable and dynamic decision-making by policy makers. Policies based on the study of how the context and therefore the community have developed in the past, clearly defining the constraints of policies and understanding that which has led to the present state of areas such as Bertrams, provide clarity. Understanding past actions provide insight into how development could influence the future state of a site so that reintegration becomes possible. This can be achieved by including the residents in development possibilities. In an area such as Bertrams with a history of past displacement, it becomes vital to acknowledge that further disruption of the place and livelihoods cannot be a solution. It is this understanding that could lead to informed higher-level policy decisions and ultimately implementation of these decisions through a systemic chain.

One of the objectives of the Urban Design Institute of South Africa (UDISA) is *"to promote greater public awareness of the value of urban design"* (Urban Design Institute of South Africa, 2017: 6). In 2016, Dr Kathryn Ewing presented the Roelof S. Uytendogaardt Memorial Lecture. The lecture highlighted seven key lessons about the possibilities of the future of cities and how sustainable development can be encouraged. Although all seven lessons are relevant and highly insightful, two lessons stand out for the purpose of this research. The first lesson talks about knowledge, *"Lesson 1: Educating for real – reflective practice"* (Ewing, 2017). In this lesson, Dr Ewing refers to the theories of Jane Jacobs who talked about how cities should be a laboratory, where the practice and theories can be tested, observed, documented and eventually be improved upon. Dr Ewing further asks, *"how do we build change?"* and can we then design spaces and cities *"to reflect a human approach"* (Ewing, 2017: 7)?

The second lesson that is of great significance here is the fourth lesson, which talks about participation, “*Lesson 4: The participative approach to development*” (Ewing, 2017: 8). Ewing states that cities should look towards that which makes the specific city within which one works unique, because this will provide and lead to site specific opportunities. Dr Kathryn Ewing (2017: 8) goes on to say:

*Great cities don't just happen. They evolve from communities with a strong sense of identity, trust and active participation* (Ewing, 2017: 7-8).

Policies that are too broad and general lead to projects that restrict possibility. As architecture becomes more dynamic and more inclusive of the possibilities of practice and responsibility of architectures, so too policies must adapt to an ever-changing society, where technological, economic, environmental and social factors all influence how people occupy and maintain livelihoods in cities.

The National Development Plan for 2030 outlines the main points of how human settlements and the national space economy can be transformed. In Chapter Eight of the NDP 2030 document, crucial ideas are identified for ensuring this transformation. Considering the main themes broadly, the following points are noted: (1) systemic response to spatial inequality is required, (2) consider the unique needs and potential of place, (3) constitutional housing rights require the state to review housing policies, (4) encouragement of active citizenship, (5) planning to be led by normative principles highlighting the need for social equity, (6) the development of a national spatial framework for South Africa (South Africa. Department: The Presidency, National Planning Commission, n.d.: 259).

The six main points above emphasise what many in the built environment profession already realise and agree need to be addressed. The question now remains, how and when will these policies be seen at the level of planning and development? The number of vacant buildings in South African cities have increased in recent years. Buildings in relatively good condition are left empty and become areas of crime and vandalism, yet it is becoming increasingly difficult to re-use and adapt these empty buildings, as vacant buildings quickly become classified as “bad” buildings. The policies also do not assist in the development of these vacant buildings. How can research based groups possibly become more involved and start implementing the theories of urban laboratories in practice?

Heritage resource agencies and local authorities also need further engagement. If these two spheres can provide responsive and adaptable policies, then ‘identity of place’ can be retained. The importance of these two authorities is to adapt to situations, and to work with research bodies to build on knowledge, so that mass housing, which destroys character, can be avoided. Adjustments, no matter how small, provide opportunities for developers and residents alike to comprehend larger impacts. Instead of spending large amounts on funding or other projects, practitioners could more wisely test ideas on a micro scale and document the potential greater impacts. Interventions undertaken on a small scale and incrementally, require practitioners and researchers in the field to continuously engage with occupants and community members as well as the various stakeholders. It also becomes critical to keep up to date with the policies, and accurately note how policies could become more localised. Understanding that not all areas in a city are the same, nor should the areas be treated the same. Planning perhaps could involve visualising a system or network, where the parts ultimately make the whole. Understanding this interconnected system, planners and developers could become more aware of how policies could be made adaptable to the specific context. Policies further need to balance and ensure that consideration is given to diverse fields of study.

To simplify this idea, one could perhaps also think of policies that are interrelated yet accommodating. For instance, if a general policy requires the re-use and adaptation of buildings, the interest of heritage councils and the various requirements of local authorities need to be added in to ensure that both parts could reach mutual benefit. The above example emphasises the importance of engagement with various stakeholders. It further highlights the importance of ensuring that policies are considered for local situations and should therefore be adaptable to the specific place.

#### IMPACT OF THE INTERVENTIONS: OBSERVING CHANGE

The data analysis and findings were performed using the methodology of structured questionnaires with close-ended questions and analysed using statistical package for social science (Housing and Urban Environments, 2018). The questionnaires were handed out to residents before the renovations started and once again after the renovations. This provided a quantitative approach as noted earlier, but it also allowed for qualitative comparisons of what residents

thought of the development, and how the process influenced their thinking toward the renovations. Furthermore, the research methods relied on observations and documentation of the progress before and during the renovation process. Sketches, photographs and written material were all employed to ensure that the progress was thoroughly documented. These practices are effective, especially when the project is constantly developing in incremental phases. When the information is then reflected on, the effect of small changes becomes more apparent when they are considered over a longer period.

During the process of speaking with the residents and completing the questionnaires, a question was posed to everyone residing in the building, the question that was asked is:

*“With the building’s waterproofing that is being repaired, would this encourage you to start cleaning and fixing the spaces? And if not now do you plan on doing so in the future?”*

Many residents indicated that this would encourage them to start fixing and painting the rooms themselves, other residents indicated that they would do so in the future. The lack of waterproofing on the roof has had a major impact on how the building was viewed by the residents. It is therefore positive to see and hear residents willing to make changes to the spaces themselves. This indicates that the renovation process in the Bertrams case study has been effective in actively engaging residents to participate and even continue after the main interventions stop. The observations made during the screed repair process are noteworthy (Figure 5); participation amongst the residents increased, residents encouraged each other to participate, and curiosity started erupting within the immediate vicinity and soon the sense of ownership became more prevalent. The screed and waterproofing allowed significant and tangible change to the living environments, and the positive change in attitude amongst the residents was noteworthy.



**Figure 5:** During the process of repairing the screed roof before the waterproofing barrier was installed (Lamprecht, 2019).

Considering the change that has been observed, three main areas were identified in this project. Firstly, the physical change of the building which included the renovation work of the project and became a very tangible outcome. Secondly, the change in the response of residents, from scepticism to hope and active participation. This change was observed in the way residents were encouraging one another to help during the process of construction, highlighting not only the importance of participation in the process of renovating the building but also showcasing that the skill development was important and encouraged a sense of pride in the work that was being done. The third observation is perhaps more difficult to articulate, but could be experienced throughout the process; that was the sense of ownership that started to develop amongst the residents. This also speaks of the dignity that architecture can instil in community engagement projects like this. It is because of all three, but perhaps most importantly the third change that is so important to develop in architectural academia and practice. It is also the reason why architecture is still relevant but needs to be open to change and accept the social responsibility.

Colin Ward (2003: xi), in the foreword of *Small Change* by Nabeel Hamdi, references John Turner's, first law of housing. In the book, *Freedom to Build* by John Turner and Robert Fichter, the law resonates with the above sense of ownership that was cultivated during this project:

*When dwellers control the major decision and are free to make their own contribution to the design, construction or management of their housing, both the process and the environment produced stimulate individual and social well-being. (Ward, 2003: xi)*

To further illustrate how practice can benefit from research initiatives and community engagement projects, the example of how the research collaboration made it possible to avoid displacing the residents during the renovation process. Having understood how the history of Bertrams has been shaped by past displacement, this research driven incentive to not displace people during the process of renovation has more significance. This indicates that research led initiatives provide greater insight into how future visions of the area may be developed. The future possibilities of the area therefore rely on the participation of people and communities who live there. Future visions that incorporate the above methods with a focus on community engagement will see active participation from community members. The area's safety could improve, the sense of ownership would most likely be enhanced, and the area's future will ultimately be driven by the residents and community members themselves.

## CONCLUSION

The research investigated three main concerns, and considered: (1) How do community engagement projects allow residents, architects and architecture students to interact in ways that are meaningful while ensuring positive future implications for the host community? (2) How can higher-level policy decisions translate into projects, and how can projects at a local level offer insight into how policy may be transformed to become more responsive to conditions on the ground? (3) How has "small change" influenced the sentiments and behaviours of residents in the case study building and how might these possibly drive future visions of the area?

The project successfully brought together the various stakeholders and participants. While there were immediate academic benefits, the research team also made an effort to ensure inclusivity in the decision-making processes as well as in the actual implementation. This was achieved through constant engagement through workshops, meetings and skills training. These strategies ensured that the resultant interventions were based on the needs of the host community and not the result of an abstract academic exercise conceived far away from the context.

The project has raised interesting questions around the top-down and bottom-up approaches. The researchers have taken the position that site-level interventions can be used to motivate transformation of higher-level policies. This is presented as an alternative approach towards inner city housing provision which retains existing communities and minimises displacement. The complexity of the context under study and its proximity to the CBD means that it has the potential to transform into a thriving and viable community with multiple socio-economic possibilities. Interventions in Bertrams could become catalysts for change in the whole inner city region as there are many illegally occupied buildings offering an opportunity for systemic change via new avenues of participation and new housing solutions.

While the project tried to implement principles of urban acupuncture and "small change" architectural interventions, it has been argued that the scope of the research project could expand to explore how these could impact higher-level debates and holistic visions for an alternative future. Small-scale tangible interventions, as witnessed with the brick repair, and more significantly the screed installed to the roof which allowed the waterproofing to be installed, led to greater intangible outcomes that can only be realised when participation of communities and human relationships are at the forefront of design processes. The architectural interventions also allowed for a conversation on the importance and relevance of the profession in contexts like these. Participatory process and social responsibility have guided the development of the study intentions and methods. The knowledge and skills transfer become necessary tools for the evolution of architecture. These practices of engagement and participation create an opportunity for architecture to learn from, and adapt to, the needs of people and communities.

## LIST OF REFERENCES

- Ahmed, S. M. and Palermo, A-G. S. 2010. *Community Engagement in Research: Frameworks for Education and Peer Review*. [Online] Available from: <<https://www.ncbi.nlm.nih.gov/pmc/articles/PMC2901283/>> [Accessed: 15 April 2020].
- De Carlo, G. 2005. Chapter 01: Architecture's public. In: Blundell J. P., Petrescu, D. & Till, J. (Eds.), *Architecture and Participation*. London & New York: Spon Press Taylor & Francis Group, pp.3-12.
- Dhlakama, T. 2019. Housing and Urban Environments: Residents Testimonials December 2019. [Online] Available from: <<http://h-ue.co.za/2019/12/09/residents-testimonials-december-2019/>> [Accessed: 16 April 2020].
- Ewing, K. 2017. Building(s) for Change. *Architecture South Africa: Journal of the South African Institute of Architects*. January/February (83):7-9.
- Habraken, N. J. 1997. Supports: An Alternative to Mass Housing. In: Jencks, C. and Kropf, K. (Eds.) *Theories and Manifestoes of Contemporary Architecture*. West Sussex: Academy Editions, pp. 22-23.
- Herr, K. & Anderson, G.L. 2015. *The action research dissertation: a guide for students and faculty*. California: Sage Publications, Inc.
- Housing and Urban Environments. 2018. Field data: data analysis and findings for the Bertram's Building Project. Internal data analysis: unpublished.
- Housing and Urban Environments. 2019. *The NRF/TUT/UJ Community Engagement Project 2019-2021*. [Online] Available from: <<http://h-ue.co.za/2019/10/24/the-nrftutuj-community-engagement-project-2019-2021/>> [Accessed: 06 April 2020].
- Johannesburg Development Agency. 2008. Bertrams Priority Block: Draft support documentation to the recommendations to SAHRA for the *Priority Block, Bertrams, Johannesburg*. City of Johannesburg. [Online] Available from: <<https://www.yumpu.com/en/document/view/23346264/draft-support-documentation-johannesburg-development-agency>> [Accessed: 18 April 2020].
- PennState College of Agricultural Sciences, Department of Agricultural Economics, Sociology, and Education, Centre for Economic and Community Development. n.d. *What is Community Engagement?* [Online] Available from: <<https://aese.psu.edu/research/centers/cecd/engagement-toolbox/engagement/what-is-community-engagement/>> [Accessed: 14 April 2020].
- Rule, S.P. 1989. The emergence of a racially mixed residential suburb in Johannesburg: demise of the apartheid city? *The Geographical Journal*, 155(2):196 - 203.
- South Africa. Department: The Presidency, National Planning Commission. n.d. National Development Plan 2030: Our Future - Make it Work. [Online] Available from: <[https://www.gov.za/sites/default/files/gcis\\_document/201409/ndp-2030-our-future-make-it-workr.pdf](https://www.gov.za/sites/default/files/gcis_document/201409/ndp-2030-our-future-make-it-workr.pdf)> [Accessed: 08 April 2020].
- South African History Online. 2019a. *Bertrams, Johannesburg*. [Online] Available from: <<https://www.sahistory.org.za/place/bertrams-johannesburg>> [Accessed: 03 April 2020].
- South African History Online. 2019. *Johannesburg the segregated city*. [Online] Available from: <<https://www.sahistory.org.za/article/johannesburg-segregated-city>> [Accessed: 03 April 2020].
- Urban Design Institute of South Africa. 2017. Roelof S. Uytendogaart UDISA Memorial Lecture. *Architecture South Africa: Journal of the South African Institute of Architects*. January/February (83):6.
- Ward 66 Johannesburg. 2020. *History: Bertrams*. [Online] Available from: <http://ward66jhb.co.za/history/> [Accessed: 03 April 2020].
- Ward, C. 2003. Foreword. In: Hamdi, N. *Small change: about the art of practice and the limits of planning in cities*. New York: Earthscan, x-xiv.

# STATISTICAL MODELLING OF A HIGH ENTROPY ALLOY CLAD GEOMETRY FOR AEROSPACE APPLICATIONS

Modupeola Dada, Chemical, Metallurgical and Materials Engineering, Tshwane University of Technology, South Africa, dadadupeola@gmail.com

Patricia Popoola, Chemical, Metallurgical and Materials Engineering, Tshwane University of Technology, South Africa, popoolaAPI@tut.ac.za

Ntombizodwa Mathe, Council for Scientific and Industrial Research, South Africa, NMathe@csir.co.za

Sisa Pityana, Council for Scientific and Industrial Research, South Africa, Spityana@csir.co.za

Samson Adeosun, Metallurgical and Materials Engineering, University of Lagos, Nigeria, sadeosun@unilag.edu.ng

Olufemi Aramide, Chemical, Metallurgical and Materials Engineering, Tshwane University of Technology, South Africa, aramidefo@tut.ac.za

## Abstract

*In this study, a two factorial model was developed to optimise the laser additive manufacturing parameters used in fabricating an equimolar AlCoCrFeNiCu High Entropy Alloy. This laser deposition method uses several processing parameters which influences the clad geometry and surface quality of the deposits. Therefore, process parameter optimisation is important before deposition. The model using the surface response method was developed to investigate the effect of the laser parameters, namely scan speed and laser power on the clad geometry for aerospace applications. The spot sizes, powder feed rate and overlap were kept constant at 2 mm, 2 rpm and 50 % respectively. While the laser power and scan speed were varied between 600 -1600 W and 4-12 mm/s respectively. The correlation between the clad geometry and the laser power over a range of laser scanning speeds using the model were reported. As the clad width decreases, the dilution rate also decreases at a constant speed and laser power. There was desirable accuracy in the comparison between the model and experimental results. The numerical optimised data showed that the optimum laser power and scan speed is at 900 W at 8 mm/s respectively to synthesise good quality clad geometry between 4.6 mm and 11 mm.*

**Keywords:** high entropy alloys, laser additive manufacturing, clad geometry, process parameters, response surface methodology

## INTRODUCTION

High Entropy Alloys (HEAs) are alloys composed of multi-principal compositions containing five or more metallic elements (Chikumba & Rao, 2015; Gao *et al.*, 2016). This compositional description of HEAs gives the mixture a simple crystal structure of Body-Centred Cubic (BCC), Face-Centred Cubic (FCC) and Hexagonal Closed Packed (HCP) structures. The mixing entropies and enthalpy of formation contribute to the formation of single-phase structures in HEAs (Ye *et al.*, 2016; Yeh *et al.*, 2004). However, in recent times, phase formation and the microstructure of

complex metallic alloys have been investigated by preparing samples through conventional casting methods (Kao *et al.*, 2009; Tong *et al.*, 2005). These methods require many resources and production time making Laser Deposition technique; Laser Additive Manufacturing (LAM) a preferred alternative because this process provides a fabricating route of alloys with greater efficiency, gives design flexibility and innovative repair methodologies of worn parts at a faster rate (Mudge & Wald, 2007; Shon *et al.*, 2015). Thus, varying the powder composition and feed rate can generate a wide range of alloy composition using this process. The process parameters, therefore, affect the properties of the additively manufactured parts (Shibang *et al.*, 2018). More so, the literature on the effect of these parameters on the clad geometries of additively manufactured HEAs is limited. In this study, laser additive manufacturing is used to fabricate compositional libraries of the AlCoCrFeNiCu High Entropy Alloy HEA system and the effect of the laser parameters; laser power and scan speed were examined to determine the role of the manufacturing technique on the deposit geometry; the clad width. LAM synthesises components layer by layer from a three-dimensional computer-aided design file. These include selective laser melting (SLM), laser engineering net shaping (LENS) and electron beam melting (EBM) (Gibson, Rosen & Stucker, 2014; Tofail *et al.*, 2017). These processes use a laser beam that melts the high entropy powder layer by layer with a layer thickness between 20 µm-100 µm, repeating the process until the whole part is completed. LENS and SLM both use a laser beam, thus having a superior surface finish while EBM uses an electron beam to preheat and melt the metal powder composition in an inert chamber (Kumar & Pityana, 2011; Popoola *et al.*, 2016). Although, EBM has a higher build rate than the SLM process. The LENS process records the highest build size up to 300cm<sup>3</sup>/h higher than other LAM techniques (Brückner & Lepski, 2017; Lepski & Brückner, 2009; Shon *et al.*, 2015). Fabrication of materials using simultaneous feeding hoppers can be achieved with a digital automated method, thus making the LENS process a preferred choice. The results showed desirable accuracy in the predictive model, and the experimental data geometry of the laser deposited alloys. This model was useful for building the desired HEA clad layer geometry for prototyping requirements and minimising the high entropy alloy powder wastage during deposition. More so, the approach further endorses the use of laser deposition, as a method for fabricating HEA compositions with good surface quality geometry.

## MATERIAL AND METHODS

The alloy powder mixtures of Al, Co, Cr, Fe, Ni, and Cu with purities above 99.9% were prepared via proprietary solid-state alloying processes from the supplier F.J Brodmann & Co, L.L.C, USA. The as-received powder was deposited on an A301 steel baseplate. Before deposition, the baseplate was sandblasted and cleaned with acetone to increase absorptivity from the laser beam, and this minimises the reflection of the laser radiation with improved bonding strength between the alloy and the baseplate. Table 1 presents the chemical composition of the AlCoCrFeNiCu HEA.

**Table 1: Chemical Composition of AlCoCrFeNiCu HEA in wt.% Percentage**

Element	Al (wt.%)	Co (wt.%)	Cr (wt.%)	Fe (wt.%)	Ni (wt.%)	Cu (wt.%)
Amount	16.6	16.6	16.6	16.6	16.6	16.6

The samples were synthesised using a 3 kW continuous wave ytterbium laser system (YLS) available at the Council for Scientific and Industrial Research Center Pretoria, South Africa. The equipment is fitted with a Kuku robotic arm that moves in a multi-axial direction to control the process as shown in Figure 1(a). The beam diameter and powder feed rate were constant at 2 mm and 2 rpm respectively, while the laser power and scanning speed were varied from 600 W to 1600 W at 4 -12 mm/s each with a 50 % overlap. Figure 1 (b) shows the clad geometry measured using an Olympus BX<sub>51</sub>M light Optical Microscope. Table 2 shows the laser process parameters.

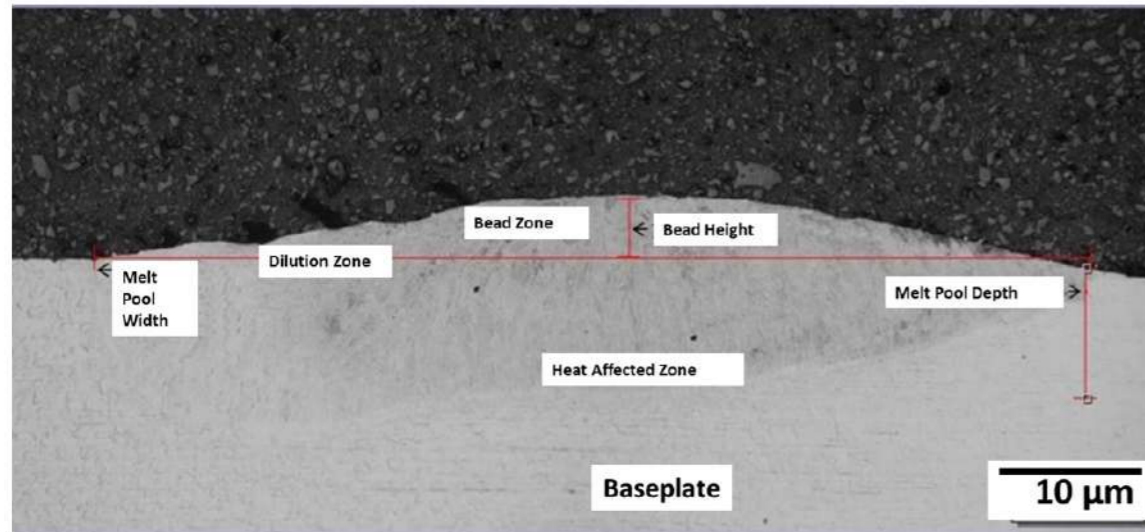


Figure 1: Shows the Clad Geometry Measurement (Dada et al., 2020).

Table 2: Laser Fabrication Parameters of the AlCoCrFeNiCu HEA

Std	Run	Factor 1 A: Laser Power (W) (J/s)	Factor 2 B: Scan Speed (mm/s)	Response 1 Clad Width (mm)
3	1	600	4	4.63616
8	2	600	8	4.75648
5	3	600	12	7.97952
11	4	800	4	4.8128
13	5	800	8	7.22944
7	6	800	12	8.3136
1	7	1000	4	7.82848
4	8	1000	8	8.75648
2	9	1000	12	7.91424
10	10	1200	8	8.90368
9	11	1200	10	8.98048
12	12	1200	12	8.98816
6	13	1400	8	11.860

After fabrication, the samples were sectioned into smaller pieces with a cutting blade machine and the cross-sections of the samples were prepared using standard metallographic procedures, namely mounting, grinding, polishing and etching. Afterwards, the geometry of the coatings, namely width, height and depth, were observed using the Optical Microscope (OM). Stat-Ease Inc. Design expert Software 11, statistical software was used to analyse the results of the experiment, especially the response output of the clad width.

## RESULTS AND DISCUSSION

### Two-Factorial Central Composite Design of Experiment

Response Surface Methodology (RSM) is a statistical method used in modelling and analysing problems where the response output is affected by the variables to optimise the response output. The response output in this model is the clad width, while the variables are the laser power and scan speed (Montgomery, 2005). This model was achieved by estimating the clad geometry features and superimposing the powder flux and thermal models (Taberero et al., 2014). Figure 2(a) shows the normal plot alongside a desirable correlation between the actual experimental values and the model predicted values in Figure 2(b). The diagram displays the clustering of the points diagonally, which implies a good fit (Taberero et al., 2014).

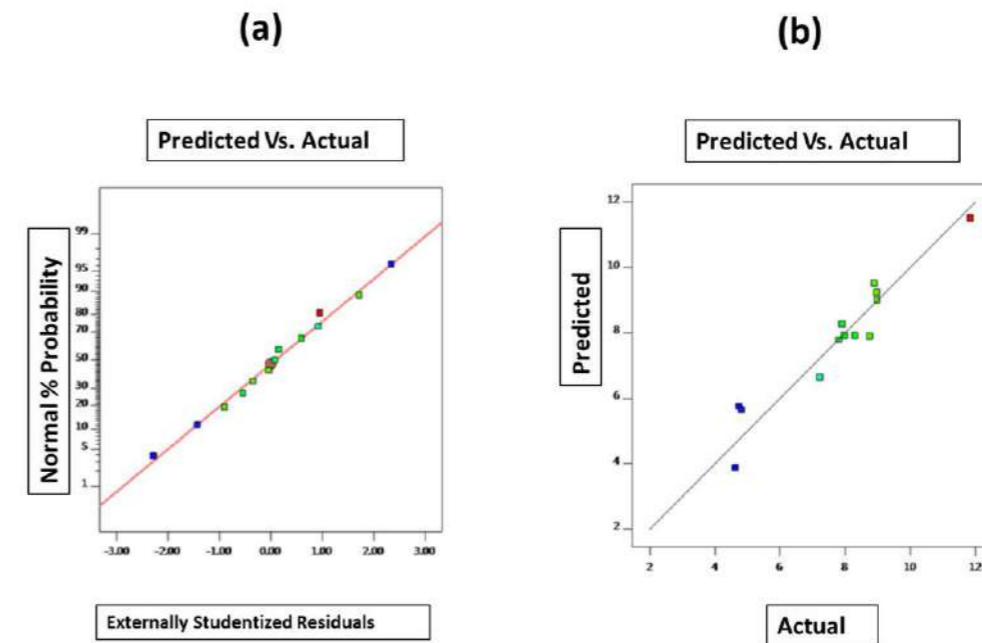
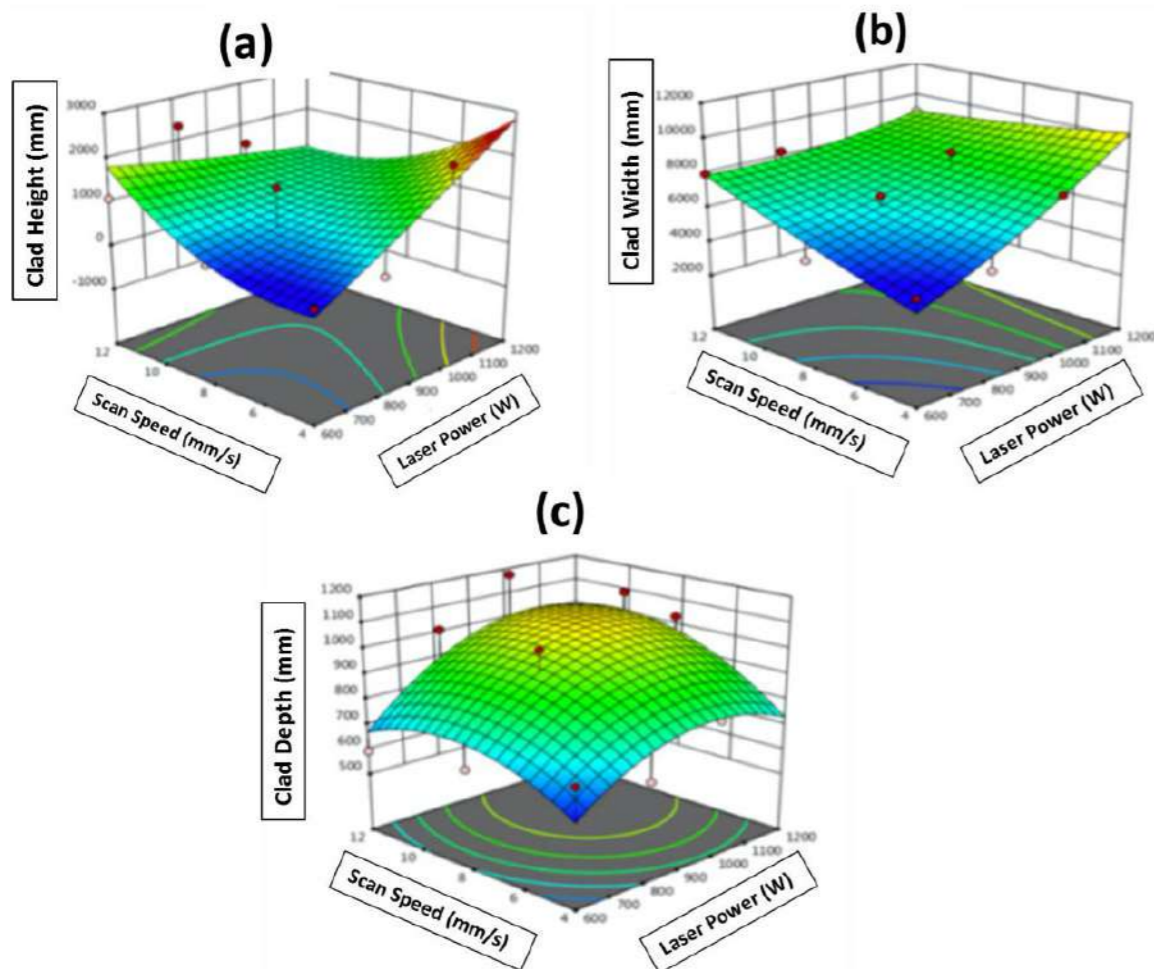


Figure 2: The Plot Showing (a) The normal plot of residuals (b) The Predicted value against the Actual experimental value.

Figure 3 shows the three-dimensional surface plots of the HEA clad geometry obtained from the model, and the optimum clad geometry is shown by the apex of the surface plot. An increase in Laser power and reduction in the scan speed implies that more powder is required during the deposition attributed to an increase in the rate of melting. Therefore, an optimised parameter will give the exact combination to fabricating clad geometry with good quality without powder wastage. Figure 4 depicts that the numerical optimised parameter to achieve optimisation is at 900 W with a scan speed of 8 mm/s.



**Figure 3:** Surface plot showing the effect of laser parameters on the Clad (a) Height (b) Width (c) Depth of AlCoCrFeNiCu HEA.

The clad width response output is a function of the variables of laser power (P) Watts and scan speed (V) in mm/s (Paul & Hiremath, 2013), expressed in Equation 1 as

$$y = \phi(P, V) \quad (1)$$

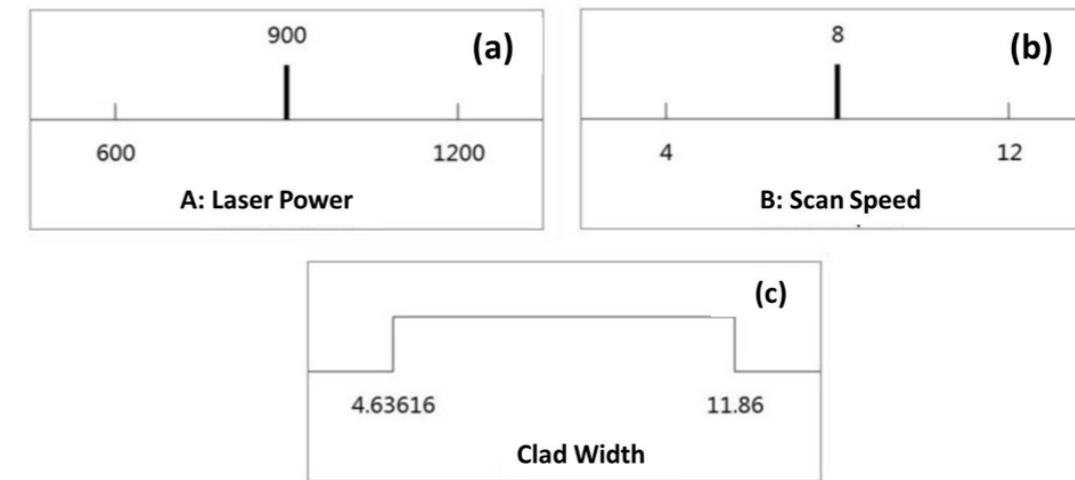
where y is the response and  $\phi$  is the function of the response. The response surface function used in this model was a second order polynomial regression model (Ogunbiyi *et al.*, 2019); therefore, the analytic parameter influence on the response output can be presented in Equation 2. Equation 3 shows the coded equation of the model while Equation 4 shows the actual equation.

$$Y = \beta_0 + \sum_{i=1}^k \beta_i A_i + \sum_{i=1}^k \beta_{ii} A_i^2 + \sum_{i=1}^k \sum_{j=1}^k \beta_{ij} A_i B_{ij} + \varepsilon \quad (2)$$

$$\text{Clad Width} = +7222.10 + 1880.14 * A + 687.11 * B - 1330.82 * AB + 415.06 * A^2 + 135.74 * B^2 \quad (3)$$

$$\text{Clad width} + -3498.91583 + 6.83800 * \text{LaserPower} + 1034.14908 * \text{Scan Speed} - 1.10902 * \text{LaserPower} * \text{Scan Speed} + 0.004612 * \text{Laserpower}^2 + 8.48406 * \text{SpeedScanSpeed}^2 \quad (4)$$

Where A and B are the model variables; Laser power and Scan speed.



**Figure 4:** Numerical Optimization results.

#### Anova of Experimental Response Output

The ANOVA analysis of variance for this model was used to identify the factors affecting the quality of the high entropy alloy clad characteristics presented in Table 3 (Deng & Chin, 2005). The **Model F-value** of 15.24 implies the model is significant. There is only a 0.12% chance that an F-value this large could occur because of noise. Furthermore, the Model P-value less than 0.0500 also indicate that the model is significant. Here, A and AB are significant model terms. This model validates the correlation between the laser processing parameters and the clad width.

**Table 3:** ANOVA for Quadratic model Response to the Clad Width of AlCoCrFeNiCu HEA

Source	Sum of Squares	df	Mean Square	F-value	p-value
<b>Model</b>	4.601E+07	5	9.202E+06	15.24	0.0012
A-Laser Power	2.268E+07	1	2.268E+07	37.56	0.0005
B-Scan Speed	2.990E+06	1	2.990E+06	4.95	0.0614
AB	5.340E+06	1	5.340E+06	8.84	0.0207
A <sup>2</sup>	9.169E+05	1	9.169E+05	1.52	0.2576
B <sup>2</sup>	44278.26	1	44278.26	0.0733	0.7944
Residual	4.227E+06	7	6.038E+05		

#### CONCLUSION

Laser Additive Manufacturing was used to synthesise AlCoCrFeNiCu HEA and the effect of laser parameters on the clad geometry; clad width was studied using response surface methodology. The laser power was varied between 600-1600 W, the laser scan speed was varied from 4-12 mm/s while the powder feed rate and the gas flow rates were kept constant at 2 rpm and 3 l/min, respectively. Stat-Ease Inc. Design-Expert 11 software was used to analyse the results and the response of the clad geometry; which validates the relationship between the laser parameters and the clad width. The clad width was greatly influenced by the laser power; increasing with an increase in laser power and decreasing with the dilution rate at a constant power and scan speed. While the height of the geometry was observed to be influenced by the powder feed rate. The optimum deposition parameters suggested for good clad quality were

at 900W, a scan speed of 8 mm/s respectively for a clad width from 4.63616mm to 11.86mm. Statistical modelling accurately predicted the clad geometry which can be effectively used to navigate the design space, minimise powder wastage and further help with the studies on the effect of surface tension on the clad geometry. After deposition using optimised parameters from this model, the laser additive manufactured AlCoCrFeNiCu HEA showed desirable clad characteristics for aerospace applications.

#### ACKNOWLEDGEMENTS

The authors appreciate the Council for Scientific and Research (CSIR), the National Laser Center (Laser Enabled Manufacturing Resource Group) and the Tshwane University of Technology, Pretoria, South Africa for their technical support.

#### LIST OF REFERENCES

- Brückner, F. & Lepski, D. 2017. Laser cladding: *The Theory of Laser Materials Processing*. Berlin Springer:263-306.
- Chikumba, S. & Rao, V.V. 2015. *High entropy alloys: development and applications*. 7th International Conference, Pretoria. Latest Trends Engineering & Technology.1-5.
- Dada, M., Popoola, P., Mathe, N., Pityana, S., Adeosun, S., Aramide, O. & Lengopeng, T. 2020. Process optimization of high entropy alloys by laser additive manufacturing. New York: *Engineering Reports*:e12252.
- Deng, C.-S. & Chin, J.-H. 2005. Hole roundness in deep-hole drilling as analysed by Taguchi methods. *The International Journal of Advanced Manufacturing Technology*, 25(5-6):420-426.
- Gao, M.C., Yeh, J.-W., Liaw, P.K. & Zhang, Y. 2016. *High-entropy alloys*. Switzerland Springer.
- Gibson, I., Rosen, D.W. & Stucker, B. 2014. *Additive manufacturing technologies* New York. Springer.
- Kao, Y. F., Chen, T. J., Chen, S. K. & Yeh, J. W. 2009. Microstructure and mechanical property of as-cast, -homogenized, and-deformed Al<sub>x</sub>CoCrFeNi (0 ≤ x ≤ 2) high-entropy alloys. *Journal of Alloys and Compounds*, 488(1):57-64.
- Kumar, S. & Pityana, S. 2011. Laser-based additive manufacturing of metals. In: *Advanced materials research*. Trans Tech Publications Ltd, 227: 2-95.
- Lepski, D. & Brückner, F. 2009. Laser cladding. In: *The Theory of laser materials processing*. Berlin Springer:235-279.
- Montgomery, D. C. 2005. Design and analysis of experiments. New York: John Wiley & Sons,
- Mudge, R. P. & Wald, N. R. 2007. Laser engineered net shaping advances additive manufacturing and repair. *Welding Journal-New York*, 86(1):44.
- Ogunbiyi, O., Jamiru, T., Sadiku, R., Adesina, O., Lolu Olajide, J. & Beneke, L. 2020. Optimization of spark plasma sintering parameters of inconel 738LC alloy using response surface methodology (RSM). *International Journal of Lightweight Materials and Manufacture*. 3(2): 177-188
- Paul, L. & Hiremath, S. S. 2013. Response surface modelling of micro holes in electrochemical discharge machining process. *Procedia Engineering*, 64:1395-1404.
- Popoola, P., Farotade, G., Fatoba, O. & Popoola, O. 2016. Laser engineering net shaping method in the area of development of functionally graded materials (FGMs) for aero engine applications: a review. In: *Fiber Laser*. London InTech open.383-399
- Shbibang, M., Zhihao, D., Zhenwei, X., Yang, X., Chao, L. & Houjie, S. 2018. Parameter optimization and microstructure evolution of in-situ TiC particle reinforced Ni-based composite coating by laser cladding. *Journal of Engineering Science & Technology Review*, 11(2).
- Shon, Y., Joshi, S.S., Katakam, S., Rajamure, R.S. & Dahotre, N.B. 2015. Laser additive synthesis of high entropy alloy coating on aluminum: corrosion behavior. *Materials Letters*, 142:122-125.
- Taberero, I., Lamikiz, A., Ukar, E., Martinez, S. & Celaya, A. 2014. Modeling of the geometry built-up by coaxial laser material deposition process. *The International Journal of Advanced Manufacturing Technology*, 70(5-8):843-851.
- Tofail, S. A., Koumoulos, E.P., Bandyopadhyay, A., Bose, S., O'Donoghue, L. & Charitides, C. 2017. Additive manufacturing: scientific and technological challenges, market uptake and opportunities. *Materials Today*., 21(1), pp.22-37
- Tong, C. J., Chen, Y.-L., Yeh, J. W., Lin, S. J., Chen, S. K., Shun, T. T., Tsau, C. H. & Chang, S. Y. 2005. Microstructure characterization of Al<sub>x</sub>CoCrCuFeNi high-entropy alloy system with multiprincipal elements. *Metallurgical and Materials Transactions A*, 36(4):881-893.
- Ye, Y., Wang, Q., Lu, J., Liu, C. & Yang, Y. 2016. High-entropy alloy: challenges and prospects. *Materials Today*, 19(6):349-362.
- Yeh, J. W., Chen, S. K., Lin, S. J., Gan, J. Y., Chin, T.S., Shun, T.T., Tsau, C.H. & Chang, S.Y. 2004. Nanostructured high entropy alloys with multiple principal elements: novel alloy design concepts and outcomes. *Advanced Engineering Materials*, 6(5):299-303.

# KNOWLEDGE LITERACY ON FOURTH INDUSTRIAL REVOLUTION: A SCIENTOMETRIC ANALYSIS OF RESEARCH OUTPUTS FROM THE ECOWAS REGION IN AFRICA

<sup>1</sup> Oluseye O. Jegede & <sup>2</sup> Olufikayo O. Abodunde

<sup>1</sup>DHET-NRF South African Research Chair in Entrepreneurship Education, College of Business and Economics, University of Johannesburg, South Africa

<sup>2</sup> Academic Planning Unit, Federal Polytechnic, Ado-Ekiti, Ekiti State, Nigeria

<sup>1</sup>oluseyej@uj.ac.za

<sup>2</sup>fikayo.abodunde@gmail.com

## Abstract

*The study measured the trend of research output relating to the fourth industrial revolution (4IR) in the ECOWAS region in Africa. It examined the annual growth, the breadth of collaboration and impact of collaboration on the productivity of research compared to the world average. The study reports the findings of a scientometric study of 4IR knowledge production culled from the broad field of specialisation in computer science research in all ECOWAS states. This data were extracted from the Scopus Database using “SciVal” an online analytic tool that allows visualisation of research, benchmarking for comparison and analysis of strategic partnerships (collaborations) among actors in a research system. The analysis extracted from the study provided information on volume and growth of knowledge supply regarding 4IR. It also provided information on the breadth of collaboration by ECOWAS member states on 4IR and the impact of the collaboration of research productivity of the ECOWAS region.*

**Keywords:** ECOWAS region, Fourth Industrial Revolution, knowledge supply, collaborative research, research productivity

## INTRODUCTION

The reality of day-to-day living and working experience is increasingly characterised by adoption of disruptive technologies (National Research Council, 2010). Examples include but are not limited to the Internet of Things (IoT), 5G Mobile Technology, Virtual Reality, Block Chain Technology, Artificial Intelligence (AI), Virtual Reality (VR), Robotics and so forth (PwC Global, 2017). These technologies are pointers to the advent of the fourth industrial revolution (4IR), that is, the current era.

The business environment has recorded a paradigm shift in the way it operates. Entrepreneurs and newer firms entering older industries are causing significant disruptions in the market, creating new markets while destroying the existing markets in some cases. The older firms must successfully adjust to these changes or they will soon die. Indeed, competition is getting fiercer by the day and all businesses must learn to innovate or perish. The business world today has now moved into the digital age where humans and machines interact to bring about greater productivity. Indeed, conventional ways of doing work involving large amounts of labour is phasing out gradually and increasingly being replaced by machines, robots, software, amongst others. The changes in the way businesses now operate have been referred to in recent literature as the Fourth Industrial Revolution or Industry 4.0. The fourth industrial revolution involves the use of digital technologies such as artificial intelligence, sensor technologies and automation in production (manufacturing) and business operation (Shwab, 2016).

History has recorded that the first industrial revolution began in the early 1900s with mechanical production powered by water and steam (Atkeson & Kehoe 2001; Crafts, 2004; Sadeghi, Wachsmann & Waidner, 2015), while the second industrial revolution started in the early 20th century which resulted in mass production powered by electricity. The third industrial revolution was known to have taken place during in the 1970s, resulting in electronics and automated production. Looking critically at the nature of these industrial revolutions, it is noteworthy that the first and second industrial revolutions were characterised by physical systems, that is, involving machinery and equipment. While the third industrial revolution was characterised by cyber systems, that is, it was premised on virtual systems (less physical). The fourth industrial revolution which has just begun, is characterised by the combination or interaction of both physical and cyber systems, which renders it peculiar. The pillars of the fourth industrial revolution include: Artificial Intelligence, Robotics and Autonomous Systems, Modelling and Simulation, Additive Manufacturing, Augmented and Virtual Reality, Data Analytics, amongst others (Ong, 2008; Posada, Toro, Barandiaran, Oyarzun, Stricker, de Amicis, Pinto, Eisert, Döllner & Vallarino, 2015; Li, Hou, Yu, Lu & Yang, 2017)

The fourth industrial revolution allows humans and machines to work together creatively such that the outcome will surpass the output of humans working alone or even machines working alone as witnessed in the previous industrial revolutions (World Economic forum, 2016). However, this paradigm shifts in the way the industry will now operate has many advantages as well as disadvantages. While digitisation will create new job opportunities for high technology industries, it will lead to massive job losses for low and medium-low technology jobs, which may then increase the unemployment rate (Pavon & Brown, 2010; Manyika, Chui, Madgavkar & Lund, 2017).

The importance of knowledge literacy in achieving 4IR cannot be overemphasised. Thus, the present study principally examines the role of the research community in knowledge supply relating to 4IR literacy within the fifteen (15) West African States otherwise referred to as the Economic Community of West African States (ECOWAS) region. The study specifically focuses on the ECOWAS member states because the ECOWAS region has been known for the important developmental role it has played in promoting trade among the members states (Jones, 2002; Zannou, 2010) in the integration and economic growth of economies in Africa (Musila, 2005; Diop, Dufrénot, & Sanon, 2010) and beyond Africa (Busse, Borrmann, Großmann, & Hamburg, 2004; Lang, 2006). The ECOWAS region has also contributed significantly to the growth of Africa in terms of research outputs (Abodunde & Jegede, 2020; Abodunde, Jegede & Oyebisi, 2020), technology (Bankole, Osei-Bryson & Brown, 2015), Foreign Direct Investment (Eregha, 2012), and the value of the Gross Domestic Product (Abubakar, Kassim & Yusoff, 2015). This study thus focuses on knowledge production/supply within this region as previous studies have narrowly focused on trade, regional integration and economic development of the member states in the region. It takes a critical look at collaborative research in the ECOWAS region, from the perspective that modern research focused on proffering solutions to multifaceted problems have a high propensity to be transdisciplinary, trans-institutional and funded by multiple sources.

The present study draws insight from the recent work by Chen, Zhang and Fu (2019). It is thus premised on the ideology that collaboration will yield improved quality of research. It therefore critically assesses the nature of interactions or linkages between these countries and by extension institutions to present an objective assessment of the opportunities, potentials, strengths and weaknesses in 4IR research within the ECOWAS region. It explores the dynamics of the quantity of knowledge produced in the ECOWAS region in 4IR. It assesses the relevance of knowledge supply from the ECOWAS region to the global discuss on 4IR. It ventured further to examine the extent of collaboration intra and inter collaboration for knowledge generation among the ECOWAS members states. Finally, the study attempts to determine the influence of the global North on the knowledge generated in the ECOWAS on 4IR. It then concluded by making policy recommendations that could bolster identified low performance or intensify identified high performance.

The research questions of the study are:

What is the predominant type of publication regarding 4IR literature in the ECOWAS region?

What is the volume and growth rate of 4IR literature in the ECOWAS region?

What is the nature and extent of collaboration at the internal, regional and international levels for research on 4IR?

What is the citation rate (based on number of co-authored collaborative publications) within the ECOWAS region compared to the world average?



## Methodology

This study reports the findings of a scientometric study of 4IR knowledge production culled from the broad field of specialisation in computer science through collaborative research in all ECOWAS states. The 4IR is driven by the fusion of new developments in the application of computing technologies across the science, technology, engineering and mathematical (STEM) disciplines and even non-STEM disciplines. However, critical to building a database of publications most relevant to 4IR research, the study considers the computer science field of specialisation to be most congruent with 4IR literature.

In order to assess the extent and impact of knowledge co-production among ECOWAS states, an analysis of the output and impact of the publications and the frequency of their citations which contributed to each of the countries was performed. This data was extracted from the Scopus Database using SciVal. SciVal is an online analytic tool that allows visualisation of research, benchmarking for the comparison and analysis of strategic partnerships (collaborations) among actors (Countries, Institutions, researcher level) in a research system. The search query: Data Set – Publications in ECOWAS States (ALL 15); Year Range: 2010 – 2019; Subject Classification - All Science Journal Classification (ASJC) Used in Scopus; Filtered by – Computer Science; Type of Publications included – All Publications; Self-citations – Not Allowed; Data Source - Scopus; Date Scopus Last Updated – 25 March 2020; Date Exported – 02 April 2020. The search was limited to articles published between 2010 and 2019. This was to allow for the measurement of metrics over a longitudinal period to observe possible changes in trends or specialisation focus, especially with regard to collaboration. This allowed for a balanced analysis of research among the countries on a regional, continental and international basis. Additional data were collected regarding collaboration information within the ECOWAS community. The queries for the data collected were: Data Set – Countries/Regions collaborating with each ECOWAS State (ALL 15); Entity – ECOWAS State (ALL); Year Range: 2014 – 2019; Subject Classification - All Science Journal Classification (ASJC) Used in Scopus; Filtered by – Computer Science; Type of Publications included – All Publications; Self-citations – Included; Data Source - Scopus; Date Scopus Last Updated – 25 March 2020; Date Exported – 03 April 2020. The study critically notes that the year range in the collaboration module of SciVal is pre-classified and as such, it could not be altered to reflect the entire study period; hence, the study adopted the nearest pre-classified period, which coincided with improved research activity in the ECOWAS community.

## Findings and Discussion

The findings of this study are presented and discussed below.

### 1. Contributions of ECOWAS states to global research output

For the reference period 2010 to 2019, for publications relating to 4IR knowledge literacy, the study identified 4542 journal articles representing 48.25% of the materials used in the analysis and 3326 conference papers representing 45.31% (Table 1). There were also 241 book chapters and 130 reviews representing 3.28% and 1.77% of the total documents used in the analysis (Table 6). Other published documents used in the analysis included nine articles in press, seven books, one data paper, 64 editorials, five erratum, one letter, 12 notes and two short surveys (Table 1). Table 2 shows that Nigeria had the highest volume of publications on 4IR within the reference period; 2558 articles and 2237 conference papers, followed by Ghana which had 450 journal articles and 408 conference papers. Other countries with notable publications were Senegal (157 journal articles and 437 conference papers) and Cote D'Ivoire (157 journal articles and 27 conferences). In Table 3, it is observed that the remaining 11 ECOWAS member states had fewer publications relating to 4IR within the reference period.

**Table 1: Document wise distribution of publications in the ECOWAS region**

Document Type	Number of Publications	Percentage
Article	3542	48.25
Article in Press	9	0.12
Book	7	0.10
Chapter	241	3.28
Conference Paper	3326	45.31
Data Paper	1	0.01
Editorial	64	0.87
Erratum	5	0.07
Letter	1	0.01
Note	12	0.16
Retracted	1	0.01
Review	130	1.77
Short Survey	2	0.03

**Table 2: ECOWAS Country distribution of publication types**

This research indicated that there has been a consistently slight increase in the volume of research output on the theme of fourth industrial revolution over the ten-year period (2010 to 2019) except for the small decline observed in 2013 (Table

	Publication Type												
	Article	Article in Press	Book	Chapter	Conference Paper	Data Paper	Editorial	Erratum	Letter	Note	Retracted	Review	Short Survey
Benin	59			1	85							1	
Burkina Faso	64	1			59								
Cape Verde	7				6							1	
Côte d'Ivoire	157			3	27								
Gambia	5			1	5								
Ghana	450	1		32	408		6	2		1		18	
Guinea	1				1								
Guinea-Bissau	1												
Liberia	7				3		1						
Mali	28				27		1					1	
Niger	20				9								
Nigeria	2558	6	7	189	2237	1	49	2	1	10	1	106	2
Senegal	157	1		14	437		7	1		1		3	
Sierra Leone	13				6								
Togo	15			1	16								

4). This further indicates that knowledge on 4IR from the ECOWAS region has continually been increasing; researchers have been undertaking extensive work while users of the knowledge have access to more information/data/knowledge. The last three years 2017 to 2019 have witnessed the highest volume of publication, which also coincides with the advent of the use of 4IR technologies such as IoTs, Augmented Reality, Big Data analytics, Cloud Computing, Virtual Reality, 5G Mobile Technology, amongst others. This study (Table 3) also found that Nigeria is the largest producer of knowledge for 4IR in the ECOWAS region. In Table 3, Ghana and Senegal together with Nigeria are ranked as the top three while the bottom three were Guinea-Bissau, the Gambia and Carpe Verde.

**Table 3:** Distribution by percentage share of number of publications in the ECOWAS region by country

Country	Number of Publications	Percentage (%)
Benin	146	1.99
Burkina Faso	124	1.69
Cape Verde	14	0.19
Côte d'Ivoire	187	2.55
Gambia	11	0.15
Ghana	918	12.51
Guinea	2	0.03
Guinea-Bissau	1	0.01
Liberia	11	0.15
Mali	57	0.78
Niger	29	0.40
Nigeria	5169	70.41
Senegal	621	8.46
Sierra Leone	19	0.26
Togo	32	0.44

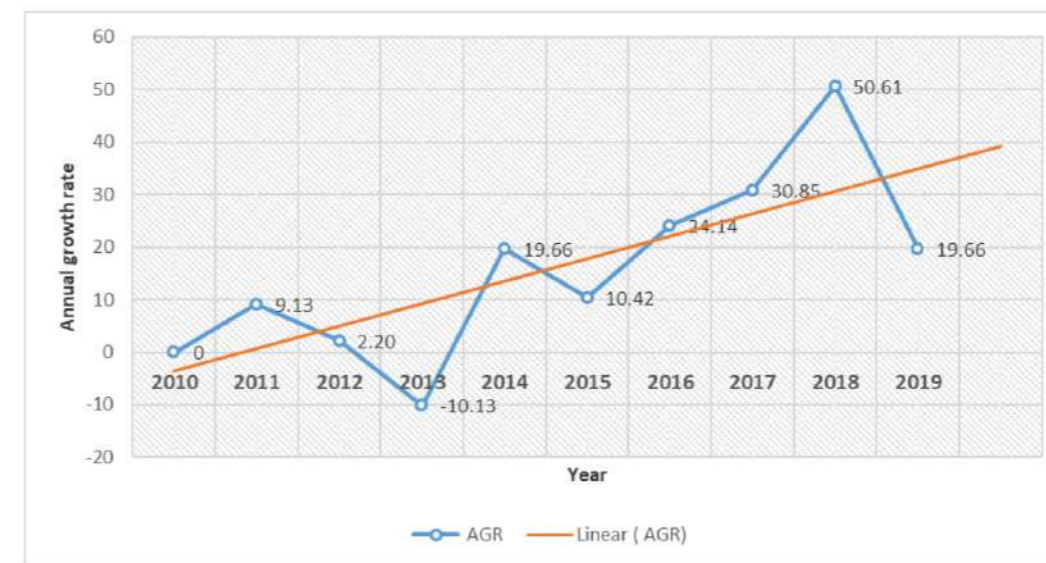
2. *General and specialised volume of research output in the ECOWAS region (Annual Growth Rate, Relative growth Rate and Doubling Time)*

Table 4 and Figure 1 outline the annual growth rate of the number of publications over the ten-year period. It is recorded that there was a 9.13% growth rate in 2011 compared with the 2010 research outputs, while a 2.2% growth rate was recorded in 2013 since the 2012 research output. However, in 2013, there was negative growth rate of 10.13% but the growth rate picked up again in the positive direction in 2014 recording a whopping 19.66% growth rate in 2014. The publications maintained a growth rate for the rest of the period with 10.42% in 2015, 24.14% in 2016, 30.85% in 2017, 50.61% for 2018 and 19.66% in 2019.

The robust growth rates show a growing knowledge literacy regarding 4IR in the ECOWAS region. This also connotes that the knowledge supply on 4IR has not yet reached a saturation point. Hence, much can still be explored regarding 4IR. Table 4 delves deeper into this information by providing the annual growth rate of the knowledge literacy in each of the ECOWAS member states. Three patterns were noticed in the countries mentioned in Table 5. The first pattern draws out the countries that consistently experienced negative growth rates in the knowledge of 4IR over the ten-year period. The second category points out those that experienced a growth rate that fluctuated between positive and negative growth. While the third category includes those countries that had consistent positive annual growth within the ten-year period. Carpe Verde, Guinea, Guinea Bissau all exhibited a consistently negative annual growth rate while Nigeria and Ghana had a consistent annual growth rate apart from 2013, when both countries recorded a decline in the outputs relative to 2012. The majority of the countries had a staggering output, fluctuating between a positive annual growth rate and a negative annual growth rate. The countries that fall into this category were Benin, Burkina Faso, Côte d'Ivoire, Liberia, Mali, Niger, Senegal, Sierra Leone, and Togo.

**Table 4:** Annual growth rate of publication in the ECOWAS region

Year	Number of Publications	AGR
2010	416	0
2011	454	9.13
2012	464	2.20
2013	417	-10.13
2014	499	19.66
2015	551	10.42
2016	684	24.14
2017	895	30.85
2018	1348	50.61
2019	1613	19.66



**Figure 1** Graph showing annual growth rate of publications in the ECOWAS region

**Table 5** Annual growth rate of publications per ECOWAS country

Country	2010	2011	2012	2013	2014	2015	2016	2017	2018	2019
Benin	0.00	14.29	37.50	-9.09	-20.00	62.50	7.69	64.29	-34.78	146.67
Burkina Faso	0.00	0.00	183.33	-35.29	-54.55	180.00	-7.14	-15.38	118.18	-29.17
Cape Verde	0.00	-	-100.00	-	-	-33.33	-100.00	-	0.00	-33.33
Côte d'Ivoire	0.00	-36.96	-3.45	-85.71	25.00	120.00	-81.82	400.00	150.00	8.00
Gambia	0.00	-	-	-	200.00	0.00	-66.67	-100.00	-	-50.00
Ghana	0.00	35.29	45.65	-31.34	41.30	6.15	17.39	28.40	65.38	36.05
Guinea	0.00	-	-	-	-100.00	-	-	-	-100.00	-
Guinea-Bissau	0.00	-	-	-	-100.00	-	-	-	-	-
Liberia	0.00	-	100.00	-100.00	-	-	0.00	0.00	200.00	-33.33
Mali	0.00	-50.00	400.00	40.00	-42.86	50.00	-66.67	200.00	16.67	142.86
Niger	0.00	-50.00	0.00	0.00	200.00	66.67	40.00	-100.00	-	100.00
Nigeria	0.00	13.27	-15.92	3.93	20.62	4.56	39.78	28.65	43.94	18.95
Senegal	0.00	23.81	84.62	-8.33	6.82	25.53	-18.64	47.92	85.92	-5.30
Sierra Leone	0.00	-66.67	0.00	-100.00	-	0.00	0.00	0.00	500.00	-33.33
Togo	0.00	0.00	300.00	-100.00	-	-100.00	-	300.00	50.00	83.33

Table 6 shows the relative growth rate as well as the doubling time for the research output for each year (from 2011 to 2019). The relative growth rates during 2011 and 2012 were the highest, 0.74 and 0.43 years respectively, consequently they had the lowest doubling time for the research outputs (Table 6). The reason for this is because the number of research publications from the ECOWAS member states within the reference period (2010 to 2019) was relatively low. Hence, it will take less effort to double the volume of the 2010 output in 2011 and that of 2011 in 2012. Between 2013 and 2019, the relative growth rate ranged between 0.22 and 0.27, thus doubling the time that ranged between 2.55 and 3.03 years (Table 6). Because the volume of research output increased greatly as the years rolled by, the relative growth rate declined significantly while the time required for the research outputs of a particular year to double the output of the previous year significantly increased (Table 6).

**Table 6:** Relative growth rate of publications in the ECOWAS region

Year	Number of Publications	Cumulative Sum	W1	W2	RGR (W2 - W1)	Dt
2010	416	416	-	6.03	-	-
2011	454	870	6.03	6.77	0.74	0.94
2012	464	1334	6.77	7.20	0.43	1.62
2013	417	1751	7.20	7.47	0.27	2.55
2014	499	2250	7.47	7.72	0.25	2.76
2015	551	2801	7.72	7.94	0.22	3.16
2016	684	3485	7.94	8.16	0.22	3.17
2017	895	4380	8.16	8.38	0.23	3.03
2018	1348	5728	8.38	8.65	0.27	2.58
2019	1613	7341	8.65	8.90	0.25	2.79

3. *Comparison of internal, regional and international research output and collaboration.*

Table 7 shows that all the ECOWAS member states collaborated more with other countries outside of Africa than among African countries for their research. For instance, Guinea collaborated entirely with other countries outside of Africa (with Malaysia) on 4IR between 2014 and 2019. Liberia, for instance, collaborated with 26 of the 32 countries outside of Africa about 4IR within the reference period. Liberia collaborated with only three African countries, all of which are in the ECOWAS region. Liberia collaborated the most with Malaysia, Central African Republic, the United Kingdom and the United States. Sierra Leone collaborated with eight countries, of which seven were outside of Africa; thus, it collaborated with only one African country which is not a member state of ECOWAS. Sierra Leone collaborated the most with China, South Africa and the United States. However, Nigeria collaborated with the highest number (106) of countries, mostly (76) outside of Africa with only a small fraction of the collaboration within the ECOWAS region (7). Within the reference period, Nigeria mostly collaborated with Malaysia, South Africa, the United Kingdom, the United States and India regarding 4IR. Ghana also recorded a high frequency of collaboration. It recorded collaborations with 78 countries within the reference period, of which 51 were situated outside of Africa; of the 19 countries in Africa, only 9 fell in the ECOWAS region. Ghana collaborated mostly with China, the United States and the United Kingdom. Senegal collaborated with 65 countries within the reference period; 40 countries of the 65 were located outside of Africa; only 16 were from African countries and only nine fell the ECOWAS region. Senegal collaborated mostly with France, United States, Canada, Cameroon and China regarding 4IR within the reference period. A conclusion can be drawn from Table 6 that the breadth of collaboration of the member state of ECOWAS was quite strong.

Collaboration was not limited to the ECOWAS region alone but extended to the other regions in Africa and to the rest of the world. The literature indicates that collaboration strengthens research. It also demonstrates the leverage of resources that the researchers had while conducting the research. The strong breadth of collaboration is a positive sign for the research that is being carried out regarding 4IR; it connotes wide dissemination and acceptability of the research outputs emanating from the member states of ECOWAS with respect to knowledge of 4IR within the reference period (2014 to 2019).

Table 8 presents the number of publications co-authored (collaboration) among ECOWAS member countries within the reference period. For instance, a researcher/institution in Benin collaborated on one research output with a researcher/institution in Burkina Faso, one collaboration with a researcher/institution in Cote d'Ivoire, two in Ghana, two in Nigeria and two in Senegal. It is evident in Table 8 that most of the countries had between one to two collaborative outputs with other member states in the ECOWAS region within the period 2014 to 2019 except for Nigeria and Ghana. For instance, Senegal, Ghana and Nigeria collaborated more with other countries in the ECOWAS region. More specifically, Ghana collaborated with Benin on two research outputs, Burkina Faso on two research outputs, Cote d'Ivoire on one research output. There was a paper in which Ghana had collaborated with Niger, yet another publication with Liberia. According to Table 8, Ghana collaborated with Nigeria on 19 research outputs while Ghana had three collaborative research outputs with Senegal and six with Togo

**Table 7: Number of collaborating countries worldwide and the Africa ECOWAS region 2014 -2019**

Country	Number of Collaborating Countries	No. of Other Countries (excluding Africa)	% of Other Collaborating Countries (Africa)	No. in other African Countries/Region	% of Africa Collaborating Countries of the World	No Collaborating in ECOWAS region	% of ECOWAS region of Africa	Top Collaborating Countries (Worldwide)
Benin	39	22	56.41	12	43.59	5	29.41	France  Belgium  Italy  United States
Burkina Faso	37	21	56.76	12	43.24	4	25.00	France  Senegal  Luxembourg  United States  Germany  Portugal  Brazil  Norway
Cape Verde	13	8	61.54	4	38.46	1	20.00	
Côte d'Ivoire	50	35	70.00	10	30.00	5	33.33	France  United States  Cameroon  China  Italy
Gambia	10	7	70.00	2	30.00	1	33.33	United Kingdom
Ghana	78	51	65.38	19	34.62	8	29.63	China  United States  United Kingdom  South Africa  France  Malaysia
Guinea	1	1	100.00	0	0.00	0	n/a	
Guinea Bissau	0	0	n/a	0	n/a	0	n/a	
Liberia	32	26	81.25	3	18.75	3	50.00	Malaysia  Central African Republic  United Kingdom  United States
Mali	35	17	48.57	12	51.43	6	33.33	France  China  United States  Botswana  Kenya
Niger	25	18	72.00	3	28.00	4	57.14	Italy  United States  France
Nigeria	106	76	71.70	23	28.30	7	23.33	Malaysia  South Africa  United Kingdom  United States  India
Senegal	65	40	61.54	16	38.46	9	36.00	France  United States  Canada  Cameroon  China
Sierra Leone	8	7	87.50	1	12.50	0	0.00	China  South Africa  United States
Togo	25	16	64.00	5	36.00	4	44.44	France  Ghana  China  Senegal  United States

**Table 8: Number of co-authored publications in the ECOWAS region 2014- 2019**

Country A (Principal) ECOWAS Country	Country B (Contributing) ECOWAS Country											Total Principal			
	Benin	Burkina Faso	Cape Verde	Côte d'Ivoire	Gambia	Ghana	Guinea	Guinea Bissau	Liberia	Mali	Niger		Nigeria	Senegal	Sierra Leone
Benin		1	1	2							2	3			9
Burkina Faso	1		1	2					1						5
Cape Verde												1			1
Côte d'Ivoire	1	1		1							3	3			9
Gambia												1			1
Ghana	2	2	1					1		1	19	3		6	35
Guinea															0
Guinea Bissau															0
Liberia				1		1						1			3
Mali	1	1				2					2	2		1	9
Niger		2				2					2				7
Nigeria	2		3			19		1	2	2		3			32
Senegal	3	8	1	3	1	3			2		3			3	27
Sierra Leone															0
Togo						6			1	1		3			11
<b>Total Contribution</b>	<b>10</b>	<b>15</b>	<b>1</b>	<b>10</b>	<b>1</b>	<b>38</b>	<b>0</b>	<b>0</b>	<b>2</b>	<b>6</b>	<b>4</b>	<b>32</b>	<b>0</b>	<b>11s</b>	

Country A	Country B	Citations	Citations per Publications	FWCI	Country A	Country B	Citations	Citations per Publications	FWCI
Benin	Senegal	20	6.7	0.98	Mali	Ghana	2	1	0.43
	Ghana	1	0.5	0.43		Nigeria	1	0.5	0.43
	Nigeria	1	0.5	0.43		Senegal	1	0.5	0.43
	Burkina Faso	0	0	0		Benin	1	1	0.86
	Côte d'Ivoire	0	0	0		Burkina Faso	0	0	0
Burkina Faso	Ghana	7	3.5	3.11	Togo	0	0	0	
	Benin	0	0	0	Niger	Burkina Faso	9	4.5	1.54
Côte d'Ivoire	0	0	0	Nigeria		4	2	0.83	
Mali	0	0	0	Ghana		0	0	0	
Cape Verde	Senegal	0	0	0	Togo	0	0	0	
	Senegal	19	6.3	0.9	Nigeria	Ghana	46	2.4	0.76
Côte d'Ivoire	Ghana	1	1	1.14		Liberia	16	16	3.67
	Nigeria	0	0	0		Niger	4	2	0.83
	Benin	0	0	0		Senegal	1	0.3	0.29
	Burkina Faso	0	0	0		Benin	1	0.5	0.43
	Senegal	1	1	0.89		Mali	1	0.5	0.43
Gambia	Nigeria	46	2.4	0.76		Côte d'Ivoire	0	0	0
	Togo	11	1.8	1.61		Senegal	20	6.7	0.98
	Senegal	9	3	2.56		Côte d'Ivoire	19	6.3	0.9
	Burkina Faso	7	3.5	3.11		Burkina Faso	9	1.1	1
Ghana	Benin	1	0.5	0.43		Ghana	9	3	2.56
	Côte d'Ivoire	1	1	1.14	Togo	4	1.3	0.84	
	Liberia	1	1	1.14	Nigeria	1	0.3	0.29	
	Niger	0	0	0	Mali	1	0.5	0.43	
	Nigeria	16	16	3.67	Gambia	1	1	0.89	
	Côte d'Ivoire	1	1	1.14	Cape Verde	0	0	0	
	Ghana	1	1	1.14	Togo	11	1.8	1.61	
					Senegal	4	1.3	0.84	
Liberia				Mali	0	0	0		
				Niger	0	0	0		

**Table 9: Number of citations, citations per publication a- Citation impact of co-authored publications**

4. Contributions of ECOWAS states each other's citation impact based on collaborated publications

One of the critical measurements of scholarly impact is the number of citations a publication receives. Citation analysis measures the relative importance or impact of an author or a publication by counting the number of times that author or publication has been cited by other publications. For this study, citations are counted with a bias for publications that indicated collaboration between ECOWAS countries. This analysis was undertaken to establish the impact of 4IR literature within the region. The study further includes the field weighted citation impact (FWCI), which indicates how the number of citations received by publications compares with the average number of citations received by all other similar publications indexed in the Scopus database (world comparison).

A FWCI = 1.00 indicates that publications have been cited at the world average, if FWCI > 1.00 then publications have been cited more than the expected world average and if FWCI < 1.00 it means that the publication was under-cited based on the world average. Table 9 shows that for the stated period, the publications between Nigeria and Liberia received 267% more citations compared with the world average in its field. Ghana and Burkina Faso received a 211% higher rate of citations compared to the world average. Senegal and Ghana publications received 156% more citations compared to the world average. Other collaborations worthy of mentioning are those of Togo and Ghana, Niger and Burkina Faso, Liberia and Ghana, Liberia and Côte d'Ivoire and Ghana and Côte d'Ivoire with 61%, 54%, 14%, 14% and 14% higher rates of citations than the world average. Publications from Senegal and Burkina Faso were cited at exactly the world publication average. Incidentally, the Benin and Senegal publications, which received the highest citations per publication (CPP) of 6.7 scored a 2% lower rate of citations compared to the world average. Côte d'Ivoire and Senegal, with a comparatively high CPP of 6.3, equally received a 10% lower rate of citations compared to the world average. Overall, Liberia's collaboration with other ECOWAS states (Nigeria, Côte d'Ivoire and Ghana) all had higher rates of citations compared to the world average. Ghana's collaboration with other states equally performed well with Togo, Senegal, Burkina Faso, Côte d'Ivoire and Liberia all obtaining higher rates of citations compared to the world average with only Nigeria and Benin exhibiting lower rates of citations. Nigeria's collaborations did not fair too well based on the field weighted citation impact as all country collaborations except Liberia turned out a lower rate of citations than the expected world average. Finally, Senegal, which tops the chart for the greatest number of ECOWAS state collaborations over the study period, equally exhibits lower citation rates compared to the world average except for Burkina Faso and Ghana.

## CONCLUSION

Adopting the same search query as defined in the methodology of this study, a total of 3,618,609 publications were found worldwide for 4IR literature. As a continent, Africa contributed 88,156 publications (2.44% of World). Further analysis infers that the ECOWAS region contributed only 0.20% of the world's publications over the 10-year period. In comparison with Africa, the ECOWAS region contributed 8.33% of the publications while the closely related Southern African Development Community (SADC) contributed 20.04% to African literature in the field. It was observed in the study that the ECOWAS region could intensify its efforts to increase participation in research focused on the theme of the fourth industrial revolution despite the observed continuous increase in the amount of knowledge supplied during the stated study period. The volume of knowledge supplied within the region had increased in recent years and based on the linear regression trend line (Figure 1), it is projected that the growth of 4IR literature could increase as much as 40% over 2019 publications in 2020 ceteris paribus. The knowledge supply from ECOWAS region is expected to continue to increase.

Although only a few of the ECOWAS member states, Nigeria, Ghana and Senegal, are the chief drivers of knowledge supply in the regions, there is a need to encourage these countries not to stagnate in terms of producing scholarly content. There are strong indications in the literature that other member states such as Guinea, Guinea-Bissau, Liberia, Sierra Leone, Cape Verde, Gambia, Togo, Niger are under-performing in terms of producing publications; hence they need to critically strategise to intensify efforts in increasing scholarly contribution in 4IR research. Other member states such as Benin, Burkina Faso, Côte d'Ivoire, and Mali, which fall into the middle-class performance group also need to consolidate efforts to produce more 4IR research that is more scholarly. Overall, given the general percentage share of contribution, the ECOWAS region needs to consider implementing programmes to encourage more activity within research system of the region.

The breadth of collaboration within the ECOWAS region, which could be said to be interactive, could still benefit from improved activity between the member states in terms of the number of scholarly co-authored publications. The study found that of the 7,341 publications identified for the study only 149 (2.01%) publications were co-authored among ECOWAS members (Table 8) implying a 98% collaboration of member states with countries outside of the region, that is, Africa and the rest of the world. Senegal records the most (9) interaction with member states. Ghana and Nigeria, which collaborated with 8 and 7 countries respectively, rank among the top ECOWAS collaborators. However, this interaction is not reflective in the number of publications co-authored among the states. It is worthy to note that the ECOWAS region comprises both Anglophone and Francophone countries and this could present a potential barrier to collaboration. This could also explain why countries like Benin, Burkina Faso, Côte d'Ivoire, Togo, Niger and Senegal all have France as one of their top collaborating partners. Cape Verde, one of the Portuguese speaking ECOWAS countries, has Portugal as her top collaborator. This potentially raises the argument that colonisation could be playing a major role in influencing collaboration among the ECOWAS states as the study observes that most ECOWAS states have their colonial masters as one of the top collaborators. Incidentally, encouraging research activity within the region could be driven by policy. The region has a functional multilateral organisation (ECOWAS) charged with the responsibility of promoting regional integration to accelerate sustainable development. Effecting policy backed with incentives could engender activity in research such as 4IR that directly affects day-to-day human living. Conversely, it could also be considered a strength that the ECOWAS member states predominantly collaborated with countries considered to be the developed economies of the world such as the United States of America and the United Kingdom as well as emerging economies like China, Malaysia and India, indicating a cross fertilization of ideas, which is essential to research. This furthers the globalisation agenda as sacrosanct with the advent of the fourth industrial revolution.

Finally, the study found that a handful of publications co-authored among the member states had received citations considered to exert high impact in comparison to the those of the rest of the world based on the Scopus field weighted citation impact (FWCI). Liberia and Ghana collaborations dominated this metric while Nigeria and Senegal, despite being part of the top three largest suppliers of publications, underperformed on this metric. This metric compares the citations received by a publication to similar publications in the same research field, thus calculating the world average. It infers the extent of acceptability and degree of importance of those research outputs. Hence, it can be said that the knowledge supplied from those key countries in the ECOWAS region are very important to the world's discussion on 4IR.

## LIST OF REFERENCES

- Abodunde O, Jegede O. 2020. R&D productivity for science, technology and innovation policy development in Nigeria: a scientometric analysis of academic literature. *African Journal of Science, Technology, Innovation and Development*, Mar 4:1-9.
- Abodunde, O., Jegede, O. O. & Oyebisi, T. (in press). A longitudinal assessment of Nigeria's research output for evidence-based science policy development. *International Journal of Big Data Management*, forthcoming.
- Abubakar, A., Kassim, S.H. & Yusoff, M.B. 2015. Financial development, human capital accumulation and economic growth: empirical evidence from the Economic Community of West African States (ECOWAS). *Procedia-Social and Behavioral Sciences*, Jan 27:172:96-103.
- Atkeson, A. and Kehoe, P.J., 2001. *The transition to a new economy after the second industrial revolution* (No. w8676). National Bureau of Economic Research.
- Bankole, F. O., Osei-Bryson, K. M., Brown, I. 2015. The impact of information and communications technology infrastructure and complementary factors on Intra-African Trade. *Information Technology for Development*, Jan 2, 21(1):12-28.
- Busse, M., Borrmann, A., Großmann, H. and Hamburg, J., 2004. *The impact of ACP/EU Economic Partnership Agreements on ECOWAS countries: An empirical analysis of the trade and budget effects*. Friedrich-Ebert-Stiftung.
- Chen, K., Zhang, Y. & Fu, X. 2019. International research collaboration: an emerging domain of innovation studies? *Research Policy*, 48(1):149-68.
- Crafts, N. 2004. Steam as a general-purpose technology: a growth accounting perspective. *The Economic Journal*, 114(495):338-51.
- Diop, A., Dufrénot, G. & Sanon G. 2010. Is per capita growth in Africa hampered by poor governance and weak institutions? An empirical study on the ECOWAS countries. *African Development Review*, 22(2):265-75.
- Eregba, P. B. 2012. The dynamic linkages between foreign direct investment and domestic investment in ECOWAS countries: a panel cointegration analysis. *African Development Review*, 24(3):208-20.
- Jones, B. 2002. Economic integration and convergence of per capita income in West Africa. *African Development Review*, 14(1):18-47.
- Lang, R. 2006. A partial equilibrium analysis of the impact of the ECOWAS-EU Economic Partnership Agreement. [Online] Available from: [https://www.gtap.agecon.purdue.edu/resources/res\\_display.asp?RecordID=2008](https://www.gtap.agecon.purdue.edu/resources/res_display.asp?RecordID=2008) [Accessed: 20/10/2020]
- Li, B. H., Hou, B. C., Yu, W. T., Lu, X. B & Yang, C. W. 2017. Applications of artificial intelligence in intelligent manufacturing: a review. *Frontiers of Information Technology & Electronic Engineering*, 18(1):86-96.
- Manyika, J., Chui, M., Madgavkar, A. & Lund, S. 2017. Technology, jobs, and the future of work. *McKinsey Global Institute*. [Online] Available from: <https://www.mckinsey.com/~media/McKinsey/Featured%20Insights/Employment%20and%20Growth/Technology%20jobs%20and%20the%20future%20of%20work/MGI-Future-of-Work-Briefing-note-May-2017.pdf> [Accessed 20 October 2020].
- Musila, J. W. 2005. The intensity of trade creation and trade diversion in COMESA, ECCAS and ECOWAS: a comparative analysis. *Journal of African Economies*, 14(1):117-41.
- National Research Council, 2010. *Persistent Forecasting of Disruptive Technologies* Report 2. National Academies Press.
- Ong, S. K., Yuan, M. L. & Nee, A. Y. 2008. Augmented reality applications in manufacturing: a survey. *International Journal of Production Research*, 15;46(10):2707-42.

- 
- Pavon, F. & Brown, I. 2010. Factors influencing the adoption of the World Wide Web for job-seeking in South Africa. *South African Journal of Information Management*, 12(1):1-9.
- Posada, J., Toro, C., Barandiaran, I., Oyarzun, D., Stricker, D., de Amicis, R., Pinto, E. B., Eisert, P., Döllner, J. & Vallarino, I. 2015. Visual computing as a key enabling technology for industrie 4.0 and industrial Internet. *IEEE Computer Graphics and Applications*. 35(2):26-40.
- PwC Global. 2020. *The essential eight: Your guide to the emerging technologies revolutionizing business now*, PwC. [Online] Available from: <https://www.pwc.com/gx/en/issues/technology/essential-eight-technologies.html> [Accessed: 07 April 2020].
- Sadeghi, A.R., Wachsmann, C. & Waidner, M. 2015. Security and privacy challenges in industrial internet of things. In: 2015 52nd ACM/EDAC/IEEE Design Automation Conference (DAC) 2015 Jun 8 (pp. 1-6). San Francisco, California, IEEE.
- Shwab, K. 2016. The Fourth Industrial Revolution: what it means, how to respond. In: *World Economic Forum: Coligny, Switzerland*.
- World Economic Forum. 2016. The future of jobs: employment, skills and workforce strategy for the fourth industrial revolution. In: *Global challenge insight report*. Geneva
- Zannou, A. 2010. Determinants of intra-ECOWAS trade flows. *African Journal of Business Management*, 4(5):678-86.

# A COMMUNITY-INFORMED CONCEPT OF A RAINWATER HARVESTING DESIGN WITH POTENTIAL TO REDUCE WATER SCARCITY IN RURAL SOUTH AFRICA

Pertina Nyamukondiwa, Joseph Francis, Marizvikuru Manjoro and Patrick Francis Kapila, University of Venda, South Africa, [pertinam@gmail.com](mailto:pertinam@gmail.com)

## Abstract

*Developing technologies in conjunction with end users is widely recommended across disciplines. Participation of end users is known to ensure that the expectations of the latter are met and a sense of ownership is instilled. A socio-technical study was conducted to co-develop a design concept of a rainwater harvesting (RWH) technology involving representatives of various interest groups of residents of Mabayeni village in Vhembe District of South Africa. The objective of the study was to identify the main design features of the RWH technology, select the best option, and construct models of the preferred options.*

*A combination of case study, participatory action and experimental research designs was used. In order to achieve maximum community participation and inclusiveness, the participants were disaggregated, based on gender and age. Qualitative data were collected through eight facilitated focus group discussions. Each group developed two arbitrarily scale model designs for thatch and zinc-based roofing material. The elements engineering design process guided each group's work. ATLAS.ti version 7 software was used to analyse data and present photographs of the design models that were produced.*

*The inclusive participatory process helped to develop a design manual, specifying the components of the RWH technology perceived to have the potential to reduce water scarcity. Using the guide, 14 models were constructed. The interest groups ably customised the design to address their accessibility and water conservation challenges. This study provides a strong foundation on which multi-disciplinary experts can build technical expertise to implement a technology that addresses community needs and preferences.*

## Keywords

Co-creation, community-informed, design models, rooftop rainwater harvesting technology, South Africa, water scarcity

## INTRODUCTION

Human-centred technology design approaches are regarded as crucial when developing appropriate solutions to the world's pressing challenges, such as water scarcity. Avrahami and Hudson (2002) point out that there have been some significant changes in design practice in the last quarter of the twentieth century. For example, there has been a shift towards placing the consumer rather than the product at the centre of the design process. The International Organization for Standardization (ISO, 2010) explains human-centred design as an approach to systems design and development,

aiming to make interactive systems more usable. This is achieved through focusing on the use of the system and applying human factors or ergonomics, as well as usability knowledge and techniques. The ISO (2010) and Giacomini (2014) recommend adoption of multi-disciplinary skills and perspectives, explicit understanding of users, tasks and environments, user-centred evaluation, consideration of the whole user experience, and involvement of users throughout the process of design and development. These specific characteristics enhance the chances of technologies meeting user needs and expectations.

Christie, Jensen, Buckley, Menefee, Ziegler, Wood and Crawford (2012) contend that engineers, businesspeople or project managers, and end users are crucial in design practice. The three groups have specific interests that should be taken into account in the design process. Engineers seem to focus more on the product. In contrast, project managers are mainly concerned about economic viability of the design project. Lastly, end users prioritise their own needs and preferences when choosing their designs. Gasson (2003) observes that user-centred system development methods fail to promote human interests due to a goal-directed focus on the closure of predetermined, technical problems. Moreover, Krippendorff (2004) believes that the human-centred design is less concerned with assuring that artefacts work to the satisfaction of producers, designers, or other cultural authorities. Thus, it is crucial to ensure that design activity concentrates first and foremost on questions of motivation, consultation, discourse and learning before proceeding to identify means of implementation.

In human-centred design, researchers and designers cooperate with potential users or service providers with the goal of matching users' practices, needs and preferences (Steen, 2011). However, Coughlan, Suri and Canales (2007) note that most designers adopt solution-focused strategies. The latter entails generating solutions first before evaluating the extent to which the problem is addressed to the satisfaction of end-users. In the current study in Mabayeni village of Vhembe District, emphasis was placed on initiating the design process with a detailed analysis of user requirements before examining technical or mechanical elements and functions. It focused on rooftop RWH. Success stories on RWH technologies (Deffner and Mazambani, 2010; Woltersdorf, Jokisch, and Kluge, 2014; National Peace Corps Association, 2015) highlight the importance of active community involvement when developing RWH technologies. Van Vuuren (2013) explains that this originates from the failure of the expert-oriented approach in generating some RWH systems such as the Kleinmond Housing Scheme in South Africa.

Nyamukondiwa (2015) carried out another study in Mabayeni village, in which the local residents revealed that the severe and worsening water shortages experienced there were attributed to the negative effects of climate change. While some community members travelled long distances in search of water, sometimes at night, others resorted to buying from those with boreholes. Thus, a follow-up study was conducted to develop a conceptual model that could be turned into a tangible solution to the pressing problem of potable water scarcity. Thereafter, multi-disciplinary experts would be engaged to address the technical aspects of the design.

## Study area

Figure 1 shows Mabayeni village (23.0840°S and 30.8427°E) in Collins Chabane Local Municipality of Vhembe District. It is one of the 18 villages that make up the Madonsi Traditional Authority. The village is found about 60 km and 20 km to the east of Thohoyandou and Malamulele towns, respectively. Mopani District lies to the south of the village. On average, the area receives approximately 100 mm of rainfall per year. Only the Shingwedzi River, which used to flow throughout the year in the past, supplies most of the water that residents use. Boreholes, municipal taps and rainwater harvesting are the principal sources of water. In addition to these, there are three reservoirs that supply water to the village.

## Methodology

### Research design

A combination of case study, experimental and action research designs was used in the study. Pearson and Bacon (2007) note that action research designs follow a characteristic cycle in which an exploratory investigation is carried out. An understanding of the problem is built leading to development of an intervention. The design process was also regarded as an experiment. Experimentation is of critical importance in science and engineering because it drives innovation in the product realisation process (Montgomery, 2017).

### Sampling procedures

The Collins Chabane Local Municipality, Mabayeni village was identified as one of those experiencing the most severe potable water scarcity. This characteristic compelled its purposive selection for the study. An open invitation was sent to all residents of Mabayeni village who were at least seven years old. It was stated in the invitation that only those who were willing and able to participate in the study were expected to be part of the planned research engagements. On each day of engaging the interest groups, a facilitation programme was used to guide deliberations. Attendance registers were kept to serve as records of who participated.

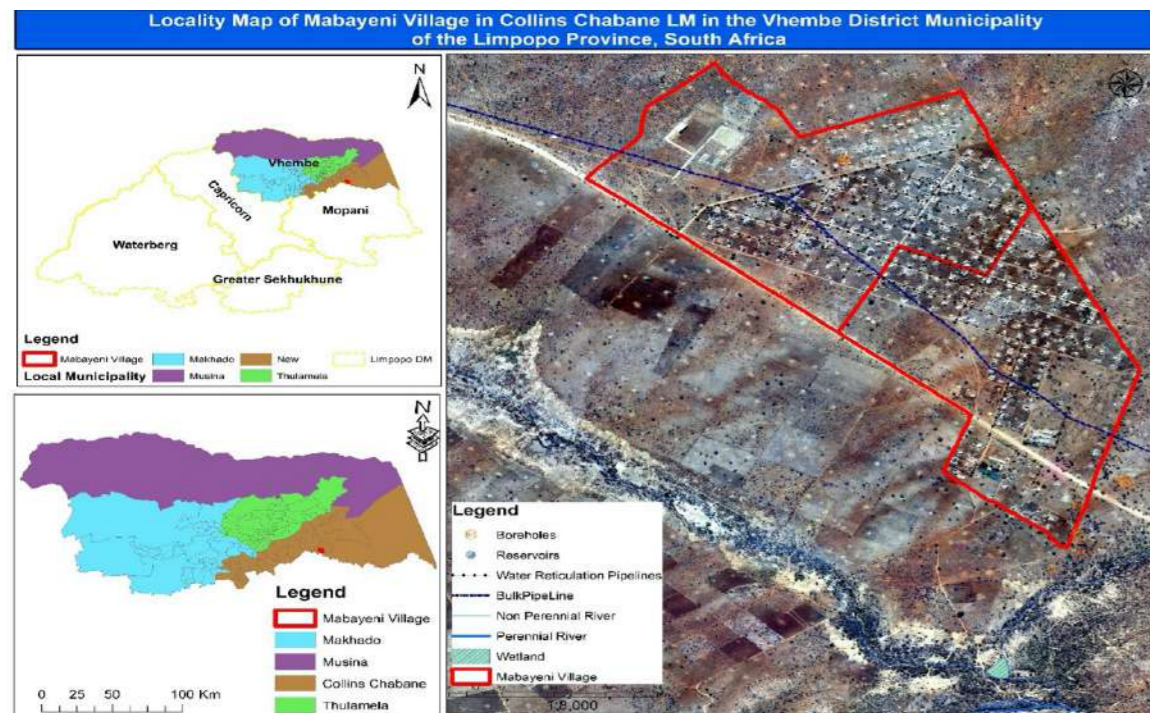


Figure 1: Map of Mabayeni village in Collins Chabane Local Municipality showing local water resources

After the main plenary session, eight separate groups were formed according to age (youth, adults and the elderly) and gender (male and female). Disaggregating the respondents in this way served to triangulate data sources besides ensuring completeness of responses and enabling identification of critical elements of the concept. In Magangeni, which is a component of the village, water scarcity was reported to be more severe because municipal water supply pipes were damaged. Thus, residents of the sub-village walked longer distances to fetch water than others. This situation necessitated engaging the residents of the sub-village separately. As a result, eight groups, namely children (boys and girls), youth (male and female) and adults (men and women), the elderly (women) and community members from Magangeni sub-village were interviewed in focus groups. In total, six engagement sessions were held to identify,

evaluate and design scale models of a rooftop RWH technology. The models were arbitrarily scaled, with the aim of providing a demonstration rather than a working prototype.

### Data collection

Secondary data on the components of rooftop RWH designs were collected from credible internet sources including journal articles, internet-based design manuals, RWH guides, books, book chapters, technical guides and handbooks. Primary data were collected via interviewing and experimentation. The background and purpose of the study, project outline, expected date of completion and possible benefits to the community were explained. It was clarified that only a design concept would be developed. However, actual prototyping would take place later. Assurance was given that participants were free to withdraw at any point in the study. Updates on the progress of the study were provided from start to finish. Participatory designing was facilitated in focus groups. A competitive design approach was adopted. A sketch modelling kit comprising cheap, easy-to-use materials was used to construct design models representing the desired technology. Informed consent to use cameras and tape recorders during engagement proceedings was obtained. This helped strengthen the handwritten notes taken. A six-step engineering design cycle (Hubka and Eder, 2012) was used. The six steps in their logical order were: defining the problem; collecting information; brainstorming and analysing ideas; developing solutions; presenting ideas to others for feedback; and, finally, improving the design.

### Data analysis

Various data analysis techniques were used. Qualitative data were entered into ATLAS.ti version 7 software for analysis and code-based networks were developed to summarise emerging themes. The component features of the rooftop RWH technology which emerged from the ATLAS.ti analysis were ranked according to preference using matrix scoring. When ranking, 1 indicated the most important feature while 8 represented the least important. In order to ascertain the components that were generally considered to be the most important, results were consolidated per component and ranks combined for all interest groups. A separate column was created to display their order of importance. The rooftop RWH tank options which emerged from thematic content analysis were also ranked according to preference to establish the rainwater storage tank option which best suited community needs. For storage tank options, a low rank indicated a feature that was most preferred. Similarly, a column was created to show the technology options in their order of preference. Pictures of completed models for each group were processed and presented using ATLAS.ti version 7.

## Results

Table 1 shows how the eight respondent groups ranked the eight main features of a rooftop RWH concept designs. The most important features were water quality, construction material and security, respectively. Further details are shown in Table 1. Four rooftop RWH technology storage tank options also emerged. The first option was 'slightly elevated brick and mortar tank', followed by 'plastic (*Jojo*) tank elevated by metal stands', then 'galvanised tank elevated by metal stands' and lastly, 'underground tank'. Table 2 displays the four storage tank options and their specific characteristics for each component. Results of the ranking exercise and the explanations for selection of a rooftop RWH design are presented in Table 3. Participants generally preferred a rainwater harvesting technology whose storage tank was slightly elevated from the ground and built using brick and mortar. For the selected storage tank option, participants further provided the preferred materials for constructing each component giving reasons (Figure 2). Some of the security features of the RWH technology included having taps under lock and key to prevent children from playing with water. Moreover, two water access outlets were preferred to cater for different household uses. One pipe would go into the kitchen for the convenience of old people, children and people with disabilities. This water tap would be used for indoor potable uses such as cooking and drinking. The other tap would be left outside for non-potable uses such as washing and bathing.

To ensure that harvested rainwater was potable, participants suggested using gutter screens to trap physical dirt before



it enters the system. A locking mechanism was added to enable easy opening to clean the tank. A filtering system was added above the tank to stop smaller physical particles from entering the storage tank. Participants suggested linking the RWH storage tank with a water-holding structure such as a well or watering trough (*Xikerepe*) through an overflow pipe, to avoid water loss. This water would be used for other non-potable uses such as laundry, gardening or drinking water for animals. All the components of the preferred rooftop RWH technology, the specific characteristics and associated reasons were consolidated into a design guide shown in Table 4. This guide was used to design physical representations of the technology. Research participants also designed a model of a technology for harvesting water for residents who stayed in thatch-roofed houses. Therefore, each interest group constructed two arbitrarily scaled models (from thatch and galvanised roofing material) in three days. Fourteen models (Figure 3) were constructed, a shortfall of two because the Magangeni part of the village did not attend due to other commitments. The next steps in the process included determination of size of the storage tank, average household water use and rainwater harvesting potential, which did not form part of this paper.

**Table 1:** The most important features of rainwater harvesting design as perceived by residents of Mabayeni village of Collins Chabane Local Municipality in Limpopo Province

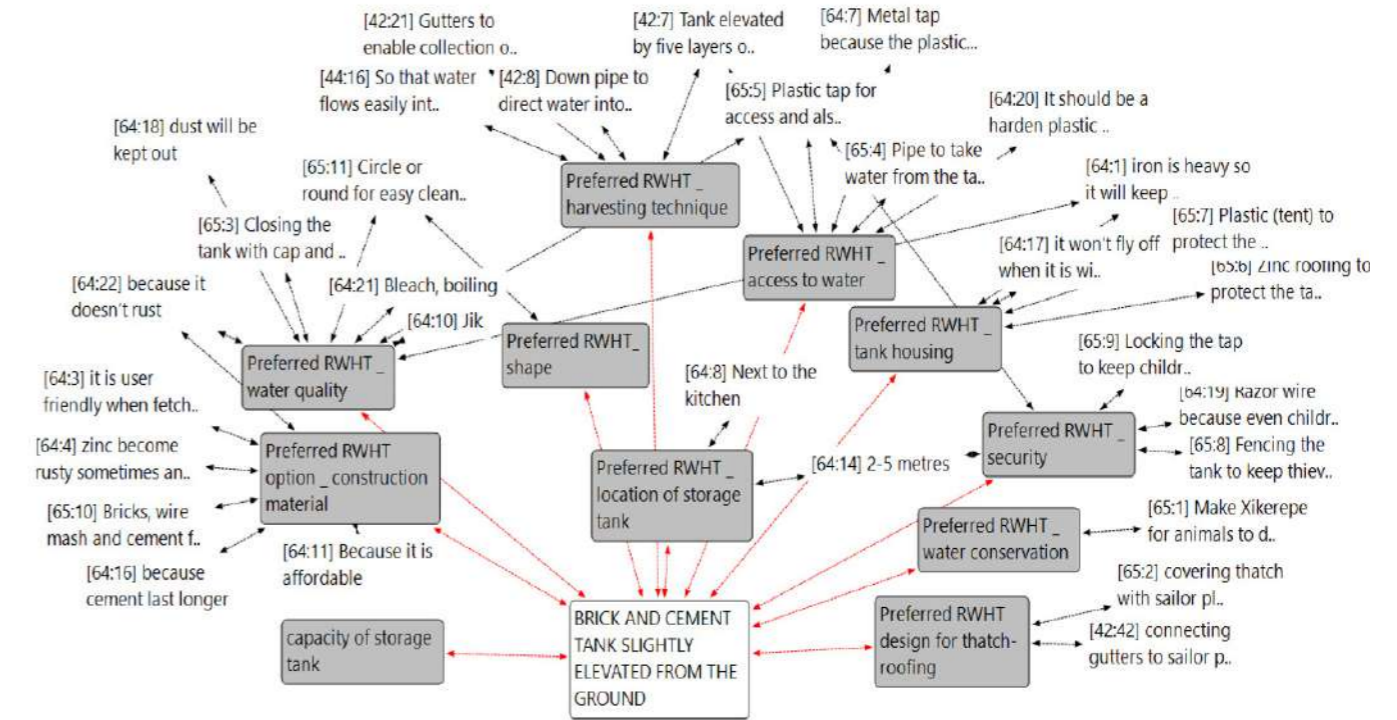
Component	Adults		Elderly people	Youth		Children		Magangeni sub-village	Total rank	Overall rank
	Men	Women		Female	Male	Boys	girls			
a) Water Quality	1	1	1	1	1	1	1	1	8	1
b) Construction material	2	5	6	2	2	2	1	2	22	2
c) Security	3	2	1	4	6	6	4	5	31	3
d) Tank housing	5	4	8	5	3	4	1	7	37	4
e) Water conservation	8	5	6	6	4	2	5	2	38	5
f) Shape of tank	7	2	4	3	6	7	8	5	42	6
g) Access to water	5	7	1	7	5	4	6	7	42	6
h) Delivery System	4	8	4	8	6	8	7	4	49	8

**Table 2:** The different rooftop rainwater harvesting design options emerging in Mabayeni village of Collins Chabane Local Municipality in Limpopo Province

Variable considered	Option 1: Tank on the ground (slightly elevated with five layers of bricks)	Option 2 and 3: Tank elevated by metal stands	Option 4: Underground tank
a) Shape	Circle or round for easy cleaning	Circle or round for easy cleaning	Circle or round for easy cleaning
b) Construction material	Brick and cement for tank and concrete for foundation	Elevated <i>Jojo</i> tank with cement foundation for metal stands	Tank made of galvanised steel sheets, use of glue to seal and paint to prevent rusting
c) Harvesting design	Gutters, tank and downpipe	Gutters, tank and downpipe	Gutters, tank and downpipe
d) Security	Fencing, locking, use of plastic tap	Tank elevated about 6 metres for security reasons Metal stands to elevate tank to increase water pressure, to stabilize tank and protect it from wind and rain. Also durable, would not be affected by termites	Fencing, locking, use of plastic tap
e) Tank housing	Iron sheet roofing	Galvanised roofing because it is cheap and locally available	Not needed.
f) Water access	Pipe to take water from the tank into the house for disabled, children and elderly people; tap to access water from the tank	Pipe to take water from tank to house for disabled, children and elderly	Pipe to take water from the tank into the house for disabled, children and elderly people, Using buckets to fetch water using a rope
g) Water quality	Use of gutter screens; closing the tank with cap and locking for cleaning and maintenance	Gutter screens and cleaning the tank	Gutter screens and cleaning the tank Elevated paving to keep dirty water from flowing into the tank. Covering the tank with galvanised cap
h) Water conservation	Creating a cement water holding structure to collect excess water from the tank	No need to conserve water. Once the tank is full there is no need for more water	Creating a cement water holding structure to collect excess water from the tank Creating a channel to direct water outside the tank when full

**Table 3:** The most preferred rooftop rainwater harvesting design option in Mabayeni village of Collins Chabane Local Municipality in Limpopo Province

Technology Option	Adults		Elderly people	Youth		Magangeni sub-village	Children		Total rank	Overall rank	Explanation for choice
	Men	Women		Female	Male		Boys	Girls			
1. Slightly elevated brick and mortar tank	1	1	1	1	1	1	2	1	9	1	It is durable, affordable, building materials are locally available, can harvest clean water, tank is easy to clean
2. Jojo tank elevated by metal stands	2	3	2	3	2	2	1	2	17	2	Tank is expensive and difficult to clean
3. Zinc tank elevated by metal stands	3	2	3	2	4	3	3	3	23	3	Galvanised steel material does not last long, risk of rusting and contaminating water
4. Underground tank	4	4	4	4	3	4	4	4	31	4	Risk of children drowning, and water can easily be contaminated by fetching with buckets. It would also be difficult to fetch water when water level drops.



**Figure 2** Preferred features of rainwater harvesting designs and their descriptions as perceived by residents of Mabayeni village of Collins Chabane Local Municipality in Limpopo Province

**Table 4:** The description of a Rooftop Rainwater Harvesting Design developed in Mabayeni village of Collins Chabane Local Municipality in Limpopo Province

Structural component	Design characteristics	Reasons
a) Shape and location	a) Round or circle	For easy cleaning
	b) Two metres away from the house	Safety and security
b) Construction material	a) Reinforced brick and cement	Durability
	b) Plastering with cement	To ensure good water quality
	c) Concrete base	Avoid water seepage
c) Conveyance system	a) Painted galvanised gutters	Collection of clean water
	b) Downpipe	Water transportation
d) Security	c) Elevating tank from the ground by five layers of bricks	Obtaining water pressure through gravity
	a) Fencing the tank with razor wire	Secure the tank from thieves
	b) Securing the tank with lock and key	Secure the tank from children
	c) Use of plastic taps	To discourage thieves
e) Tank housing	a) Creating a shade	To avoid exposure to direct sunlight which promotes algae growth
	b) Housing the tank with iron sheets	Protect the tank from physical damage and ensure water quality
f) Water access	Convenience (children, the elderly, disabled)	
	a) Having two water access taps	
	a) Gutter screens	To get clean, potable water
g) Water quality	b) Lock tank with cap	To keep small organisms from entering the water tank
	c) Physically cleaning the tank	To get rid of dirt
	d) Filtering system at mouth of tank	To trap suspended particles
	e) Draining water from the tank	To remove organic debris build-up
h) Water conservation	f) Treating water (chlorination or boiling)	To treat microbial contaminants
	a) Creating water holding structures	To collect water when the tank is full
	b) Creating drains	To direct overflow and get rid of standing water



**Figure 3:** Models of rainwater harvesting that residents of Mabayeni village developed

## Discussion

In the current study, grassroots community members of different ages and gender managed to design a concept of rooftop RWH technology with the potential to solve water scarcity challenges. This confirms Sanders and Simons' (2009) view that all people are creative and will participate in a creative process if they are motivated and provided with the tools to use to demonstrate it. Design models were co-created in line with the Voorberg, Bekkers and Tummers (2015) call for active involvement of end users in various stages of technology production. The current study provides ample evidence of design research with a user-centred approach to co-designing (Sanders & Stappers, 2008).

The current study was empowering because for the first time, university-based researchers co-created design models for RWH technology together with the people who would be the end-users, thereby closing the gap that has traditionally existed between them. During the co-designing process, the external research team relinquished the traditional 'expert' role and served as facilitators. This involved providing guidance in the process and some resources to the designers where possible. On this basis, mutual trust was nurtured as grassroots community representatives took the leading role in crafting what they perceived to be appropriate designs for a technology which would deal with water scarcity. Chambers (1994) coins this paradigm, 'from the periphery to the centre' and answers the question, 'whose reality counts?'. It is worth pointing out that Voorberg *et al.* (2015) are also of the view that policy makers and politicians should consider co-creation or co-production of solutions with citizens as a necessary condition to create innovative public services that meet citizens' needs and expectations. Moreover, the methodology presents evidence of how the Fals-Borda (1995) emancipatory approach to development can be operationalised. Grassroots communities were co-researchers who served as full partners and whose local values, traits and beliefs were understood and respected. Fals-Borda (1995) contends further that science should not necessarily be a mystery nor a monopoly of experts and intellectuals.

The identified features captured the main components of RWH technology, viz. catchment area, transportation or delivery system, and storage (Sturm, Zimmermann, Schütz, Urban and Hartung, 2009; Li, Boyle, and Reynolds 2010; Haque, Rahman, and Samali, 2016; Morey, Dhurve, Haste and Wasnik, 2016). The local residents of Mabayeni village customised the design of the rooftop RWH technology to suit their expectations, which included incorporating additional features that they believed would enhance safety and security, access, quality and conservation of water. For example, apart from using purification

chemicals such as sodium hypochlorite (Jik), physical cleaning of the tank was recommended. Thus, the need for a manhole was highlighted as a necessary feature that would enable access, maintenance and proper cleaning of the tank. Additionally, it was highlighted that the RWH design should be constructed in such a way that water would not be wasted. Thus, they recommended inclusion of a water-holding structure called *Xikerepe* locally to tap excess collected water. Elderly people emphasised the need for technology that took into account the fact that they were not strong enough to fetch water for cooking from outside. For them, this would be a major challenge if they stayed on their own or with people living with disabilities. All these considerations underscore the importance of applying the human-centred design (Steen, 2011) and co-design approaches when seeking solutions to water scarcity.

Halloway (1977) and Rogers (2004) view image and relative advantage as important factors in adoption of RWH technology. Improvement of social status is a criterion that should be considered when determining the value and adoptability of technology. Critchley and Siegert (1991) add that the technology should take into account end users' priorities and infrastructure. This was addressed in the current study via co-designing so that they customised the technology to meet their expectations, which increases net benefit (Castonguay, Urich, Iftekhar and Deletic *et al.*, 2018) and chances of adoption. In the current study, the interest groups' vote of confidence for the RWH technology was their preparedness to contribute their own resources during practical implementation. Co-resourcing practical implementation strengthens ownership, reduces costs and enhances the chances of protecting the technology.

## CONCLUSION

Water quality, construction material and security-related features were identified as the top priority components of preferred rooftop RWH design. The residents preferred rooftop RWH technology that would enable them to harvest clean water without incurring prohibitively high costs. Other attributes were said to be safety and security features, convenience, durability, and the use of locally available materials. The study laid the foundation for involvement of multi-disciplinary design experts to co-design prototypes with local residents.

## Acknowledgements

This work was supported by the South African National Research Foundation under Grant number [UID: 102532]; and the University of Venda Research and Publications Committee Grant number [SARDF/16/IRD/07]. Special gratitude goes to the Mabayeni village leaders and residents for supporting and serving as respondents in the study.

## LIST OF REFERENCES

- Avrahami, D., & Hudson, S. E. 2002. Forming interactivity: A tool for rapid prototyping of physical interactive products. In: *Proceedings of the 4th conference on designing interactive systems: Processes, practices, methods, and techniques*. [Online] Available from <https://doi.org/10.1145/778712.778735>, [Accessed: 4 November 2020].
- Borowski, S. M. 2012. Competitive prototyping in the department of defense: Suggestions for a better approach. In: The Defense Acquisition University Research Symposium, Fort Belvoir, VA.
- Bryman, A. & Becker, S. 2012. Combining quantitative and qualitative research.
- Castonguay, A. C., Urich, C., Iftekhar, M. S. & Deletic, A. 2018. Modelling urban water management transitions: A case of rainwater harvesting. *Environmental Modelling & Software*, 105:270-285.
- Chambers, R. 1994. The origins and practice of participatory rural appraisal. *World Development*, 22(7):953-969.
- Christie, E. J., Jensen, D. D., Buckley, R. T., Menefee, D. A., Ziegler, K. K., Wood, K. L. & Crawford, R. H. 2012. Prototyping strategies: Literature review and identification of critical variables. Conference paper, *American Society for Engineering Education*. DOI: 10.18260/1-2--21848
- Coughlan, P., Suri, J. F. & Canales, K. 2007. Prototypes as (design) tools for behavioral and organizational change: A design-based approach to help organizations change work behaviors. *The Journal of Applied Behavioral Science*, 43(1):122-134.
- Critchley, W., Siegert, K. & Chapman, C. 1991. Water harvesting. Rome: FAO.
- Deffner, J. & Mazambani, C. 2010. *Participatory empirical research on water and sanitation demand in Central-Northern Namibia: A method for technology development with a user perspective*. CuveWaters Papers, No. 7, Institute for Social-Ecological Research (ISOE), Frankfurt/Main, Germany.
- Gasson, S. 2003. Human-centered vs. user-centred approaches to information system design. *The Journal of Information Technology Theory and Application (JITTA)*, 5(2):29-46.
- Giacomin, J. 2014. What is human centred design? *The Design Journal*, 17(4) 606-623.
- Haque, M. M., Rahman, A. & Samali, B. 2016. Evaluation of climate change impacts on rainwater harvesting. *Journal of Cleaner Production*, 137: 60-69.
- Holloway, R. E. 1977. Perceptions of an innovation: Syracuse University's Project Advance. PhD thesis. In Rogers, E. M. 2003. *Diffusion of Innovations* (5th edition). New York: Free Press.
- Hubka, V. & Eder, W.E. 2012. *Design science: Introduction to the needs, scope and organization of engineering design knowledge*. Springer Science & Business Media. London.
- International Organization for Standardization. 2010. ISO 9241- 210: *Ergonomics of Human-centred System Interaction – Part 210: Human-centred Design for Interactive Systems*. Geneva: International Organization for Standardization.
- Krippendorff, K. 2004. Intrinsic motivation and human-centred design. *Theoretic Issues in Ergonomics Science*, 5(1):43-72.
- Li, Z., Boyle, F. & Reynolds, A. 2010. Rainwater harvesting and greywater treatment systems for domestic application in Ireland. *Desalination*, 260(1-3):1-8.
- Montgomery, D. C. 2017. *Design and analysis of experiments*. John Wiley & Sons. Arizona.
- Morey, A., Dhurve, B., Haste, V. & Wasnik, B. 2016. Rainwater harvesting system. *International Research Journal of Engineering and Technology*, 3(4):2158-2162.

- 
- National Peace Corps Association. 2015. *Success stories: Katie Diflippio and water security in rural Karagwe, Tanzania*. [Online] Available from:  
<http://www.peacecorpsconnect.org/karagwesuccess>, [Accessed: 27 January 2016].
- Nyamukondiwa, P. 2015. Resilience of rural communities of Ward 40 of Thulamela Municipality to effects of climate change. Unpublished Masters dissertation. Thohoyandou, University of Venda.
- Rogers, E. M. 2004. A prospective and retrospective look at the diffusion model. *Journal of health communication*, 9(1):13-19.
- Sanders, E. B. N. & Stappers, P. J. 2008. Co-creation and the new landscapes of design. *Co-design*, 4(1):5-18.
- Sanders, L. & Simons, G. 2009. A social vision for value co-creation in design. *Open Source Business Resource*. [Online] Available from: <https://timreview.ca/article/310>, [Accessed: 8 April 2020]
- Steen, M. 2011. Tensions in human-centred design. *CoDesign*, 7(1):45-60.
- Sturm, M., Zimmermann, M., Schütz, K., Urban, W. & Hartung, H. 2009. Rainwater harvesting as an alternative water resource in rural sites in central northern Namibia. *Physics and Chemistry of the Earth, Parts A/B/C*, 34(13-16):776-785.
- Van Vuuren, L. 2013. *Rainwater harvesting from tanks – Useful yes, but can you drink it?* The Water Wheel. [Online] Available from: <http://www.thewaterwheel.com>. [Accessed: 12 May 2015].
- Voorberg, W. H., Bekkers, V. J. & Tummers, L. G. 2015. A systematic review of co-creation and co-production: Embarking on the social innovation journey. *Public Management Review*, 17(9):1333-1357.
- Woltersdorf, L., Jokisch, A. & Kluge T. 2014. Benefits of rainwater harvesting for gardening and implications for future policy in Namibia, *Water Policy* 16:124-143.

# OPEN QUINTUPLE HELIX MODEL AND COMPETITIVE INDUSTRIAL PERFORMANCES: ANALYSIS USING THE INNOVATION SYNERGY INDEX

Bernadin Géraud Comlan Ahodode, University of Yaoundé II, Cameroon, [xbengeraud@gmail.com](mailto:xbengeraud@gmail.com)

Henri Ngoa Tabi, University of Yaoundé II, Cameroon, [ngoahenri@yahoo.fr](mailto:ngoahenri@yahoo.fr)

## Abstract

*Following the triple helix theory, this study aims at evaluating the innovation system effect on the competitive industrial performance of African countries by taking into account external contributions. For this purpose, this work uses the factor analysis, Pearson correlation test and parsimonious regression techniques for the calculation of innovation synergy index scores. It equally relies on the system generalise moment method and generalise estimation equation for the innovation synergy and its component effects estimation on the manufacture value added per capita and the competitive industrial performance respectively. The study takes into account 21 African countries during the period 2013-2016, and uses data from the World Economic Forum, the World Bank and the United Nations Industrial Development Organization. The results reveal that there are no effects of the innovation synergy index on either the manufacture value added per capita or the competitive industrial performance while individual ones reveal only 5% of the social system and 1% of the open system positive effects on the manufacture value added per capita and the competitive industrial performance against a negative effect of political system on the competitive industrial performance at 10% threshold respectively. Thus, it is important in terms of the sustainable competitiveness policy on the continent through the improvement of industrial performance that the African countries lay special emphasis on the innovation system opening up followed by the strengthening of the social system while stepping up its efforts in terms of improvement of the political system to exert a positive effect in the long term.*

**Keywords:** innovation system; innovation; competitiveness; Africa

## INTRODUCTION

Innovation, for countries to progress, is an important factor in the sustainable improvement of their competitive industrial performance. Innovations, particularly in technology, allow the factors of cost reduction, lower prices, increased productivity and product diversity to enhance performance in a country (Salter, 1960; Rosenberg, 1976). The increase of the innovation capacity in a country is therefore necessary for their competitiveness. For example, the World Economic Forum (WEF) innovation capacity index provides information on the political and economic potential of countries to produce innovation (Porter & Stern, 1999, 2001). This index takes into account variables of innovation policy, clusters innovation environments and the links between them (which can be assimilated according to political, economic and educational systems). This follows three theoretical frameworks including the national innovation system approach (Freeman, 1988; Lundvall, 1992; Nelson, 1993) which advocates technological innovation at national level in the light of industries; the triple helix framework that places academia at the centre of the technological innovation process through interactions with industries and governments (Etzkowitz & Leydesdorff, 1995; 1997; and Leydesdorff & Etzkowitz, 2000). It also integrates social and environmental (for quadruple helix and quintuple helix) systems (Carayannis & Campbell, 2009; 2010) and offers the expansion possibilities up to N-tuple Helix following the needs.

Considering the innovation performance of African countries, the latest report of the global innovation index covering 126 countries in the world (including 28 African countries) reveals that many developing countries have posted an impressive performance. Asian countries are particularly well ranked with Singapore (5<sup>th</sup>), Republic of Korea (12<sup>th</sup>), Japan (13<sup>th</sup>), Hong Kong (14<sup>th</sup>) and China (17<sup>th</sup>) appearing in the top 20 while the scores of African countries are modest. The highest ranked countries are South Africa (58<sup>th</sup>), Tunisia (66<sup>th</sup>), Mauritius (75<sup>th</sup>) and Morocco (76<sup>th</sup>) and 13 of the 20 countries with the lowest ranks are African. These results may be the consequence of the poor performance of the innovation capacity (characteristic of the level of innovation system efficiency) in African countries, especially given the fact that the sub-Saharan African region occupies the last place with an average score 28.4 versus the highest score of 58.1 for Europe and North America (WEF, 2018). According to this report, South Africa (being in 46<sup>th</sup> position against 38<sup>th</sup> in 2016), occupies the first place out of 38 African countries in the ranking followed by Seychelles (49<sup>th</sup>), Mauritius (62<sup>nd</sup> against 53<sup>rd</sup> in 2016) and finally, and Egypt in the 64<sup>th</sup> position. This weak institutional collaboration is the basis of low levels of industrial competitive performance among countries (Abramovitz, 1986; Page & Tarp, 2017).

Indeed, the latest report on industrial competitive performance taking into account 31 African countries out of 144 in total shows that the best in the ranking are South Africa (44<sup>th</sup>); Tunisia (65<sup>th</sup>); Morocco (44<sup>th</sup>); Nigeria (83<sup>rd</sup>) and 10 of the last 20 ranked come from Africa (UNIDO, 2017). This low level of competitive industrial performance justifies the low contribution of industry (especially manufacturing) to structural change in Africa (UNIDO, 2014; & Newman *et al.*, 2016). In fact, since 2000, in Africa, only 1 in 5 workers have evolved from the agricultural to the industrial sector. In addition, the average level of manufacturing in the gross domestic product of the large majority of African countries has remained unchanged by about 10% (Rodrik, 2014).

Several reasons lie behind this poor performance, including the divergence of political strategies regarding the innovation system organisation. Indeed, it should be noted that the The Organization for Economic Cooperation and Development is based on the comparison of national statistics while the European Union has focused on the analysis of changes in interactions between members of states in cross-border regions. In terms of interactions between economic actors, it emerges from a certain number of studies that weak innovation capacities can also be linked to possible variations of the innovation system in terms of strength or weakness in its various dimensions across regions or countries. For example, the Cambridge region's innovation system is science-based. In South Korea and the Netherlands, the system is based on the existence of large conglomerates and industries that are connected to technology centres, unlike universities, as a source of knowledge. Those of Taiwan, Singapore and some of the countries of Eastern Europe on the one hand; and Latin America and Norway on the other hand are characterised by strong and weak domination of the State compared to industries and universities (Etzkowitz *et al.*, 2000; Moso & Olazarán, 2002). Finally, those of West African countries are characterised by a strong dominance of foreign actors compared with the domestic and global systems (Mègnigbèto, 2015). Thus, combining the concerns<sup>1</sup> of Carlson (2003) and Bagyo *et al.* (2012), the question in the context of the opening up of the quintuple helix innovation system (i.e. the Open Quintuple Helix "OQiH") is: *What is the sphere resulting from the synergistic organizations of the OQiH which contributes more durably to the competitive industrial performance in Africa*

Thus, the aim of this study is to conduct an empirical analysis of the competitive industrial performance of the innovation synergy index development following the opening of quintuple helix innovation system in African countries. This analysis is carried out by considering the involvement of African countries in science, technology and innovation policies. Thus, the first section focuses on the literature review of innovation systems, innovation, and economic performance. Meanwhile, the second section emphasises the links between the synergy of the open quintuple helix innovation system and the competitive industrial performance of African countries.

## INNOVATION SYSTEMS AND ECONOMIC PERFORMANCE

Several studies have been conducted on innovation system synergy measures as well as their effect on economic performance. Indeed, Park *et al.* (2005) drew a comparison of the knowledge-based economy growth in South Korea and other countries using the mutual information indicator by analysing the relations of triple helix and its dynamics evolution at country level in terms of co-authorship relationships. They found that most countries trend towards low triple helix indicator values over time. In contrast to India, they recorded negative indicator values in South Africa and Brazil. Using the same types of indicators, Fred *et al.* (2013), in the comparative analysis of the triple helix dynamics evolution between developed and developing nations across sectors, found that globalisation has been eroding the local relations of the triple helix and has caused an

<sup>1</sup> That is: which dimension is appropriate to the specificities of innovation systems? At what stage of development are the countries in relation to the creation of innovation systems? and finally to determine if the university could play a leading role in regional innovation systems as in the triple helix?

increased differentiation in national systems since the middle of 1990. Using specific operationalisation in a Japanese case study, Leydesdorff and Sun (2009) point out two major changes in international competition since China opening and Soviet Union suppression. Lengyel and Leydesdorff (2015) show that Hungary's regional innovation systems are differently self-organised following a number of relatively small foreign firms. In addition, Strand and Leydesdorff (2013) find that in Norway, FDI represents the major source of synergy in the development of knowledge-based regions in comparison to the Trondheim and Oslo regions which are dominated by academic centres (Smith & Leydesdorff, 2004). Mègnigbèto (2015a) found that at the domestic level, South Korea's innovation system is more integrated compared with that of West Africa.

Otherwise, Kudryavtseva et al. (2016) in their study of econometric methods for evaluating national open innovation systems, found that the factors related to the organisational culture regarding the quality of informal national institutions exerted an impact on innovation activities. Cai (2011) also analysed the efficiency of the national innovation systems of the BRICS countries in a comparative study based on panel data enveloping and analysis techniques. Their results show that countries differ greatly regarding their NIS efficiency, especially China, India and Russia which are similarly ranked higher, while Brazil and South Africa are classified as weak. Archibugui and Coco (2004) developed the ARCO technology Index to measure the technological capabilities and their impact on the growth of countries. The said authors relied on the ranking from the index to identify four types of countries: leaders, potential leaders, laggards, and the marginalised; they found a positive and significant relationship between the ARCO technology and GDP growth level. Fagerberg and Srholec (2008) also found that the capabilities associated with NIS are key elements in explaining the growth of a nation. Lee and Lee (2019) examined the impacts of national innovation systems and economic complexity index on economic growth through the development of an NIS composite index. Their results confirm the overall importance of NIS in economic growth and justify the policy efforts to improve the NIS.

This study therefore follows the same order of analysis as those presented above. Indeed, it consists of addressing the influence of the open quintuple helix innovation system on the competitive industrial performance in Africa. As a matter of fact, the open quintuple helix assumes the interaction between spheres for the generation of technological innovation. This work uses the characteristic factors of the different spheres for the elaboration of a composite index of technological innovation synergy. Once the index scores are calculated, the analysis of their global and individual effects are carried out on the industrial performance indicators, namely the competitive industrial performance index and the manufacturing value added per capita.

## METHODOLOGY

To support the above ideas, a two-step methodology was adopted for this study. The first step highlights the process of calculating the innovation synergy index for the measurement of interaction synergy between different spheres of the open quintuple helix, for example, the university, economic, political, societal, environmental and openness spheres. The second step presents the econometric specification and methods for estimating its global and individual effects on the industrial performance indicators, namely the competitive industrial performance index and manufacturing value added per capita.

## PROCESS OF CALCULATING THE INNOVATION SYNERGY INDEX

Following the theory of national competitive industrial advantage (Porter, 1990), the construction of the theoretical framework which serves as the basis for the innovation synergy index is that of the open quintuple helix model. The OQiH is a model derived from the triple helix models and its extension models of the quadruple and quintuple helix (Carayannis & Campbell, 2009, 2010) as well as their transformation into an open innovation system. Indeed, it improves the quintuple helix model by taking into account an open helix related to various possible contributions in terms of strengthening the innovation system. Unlike the others, that is the additional helices of social and environmental contributions, this aperture helix does not induce the addition of economic agents at national level for technological innovation development. It consists of transforming the quintuple helix innovation system into an open system. This is achieved through the establishment of different international relationships which could help in reinforcing the quintuple helix innovation system through traditional international innovation sources (international trade, foreign direct investment, labor mobility following Arow and Intriligator (2010)) as well as others capable of fostering innovation (information and communication technologies, natural environment, official development assistance and scientific and technical cooperation following Cincera and Pottelsberghe (2001) and Killer (2004). This set of factors linked by the contractual relations of international technology transfers allows the open helix to reinforce the quintuple helix innovation system. Thus, complementary to the quintuple helix spheres, this open helix contributes to fostering the

coevolution between social, democratic and economic knowledge for the achievement of sustainable competitiveness. In other words, the OQiH model visualises collective interaction and knowledge exchange in countries by means of six different sub-systems or helices, namely the educational system (EDU-SYS), economic system (ECO-SYS), natural environment sub-dynamic (ENV-SYS), sub-dynamic of public media and cultural bases (SOC-SYS), political system (POL-SYS), and the openness system (OPE-SYS).

DIMENSIONS	VARIABLES	SOURCES
EDU-SYS	Quality of Math and Science Education (QMSE)	WEF
	Primary Education Enrollment (PEE); Secondary Education Enrollment (SEE); Tertiary Education Enrollment (TEE)	WDI
ECO-SYS	Financial Markets Development (FMD); Firm-Level Technology Absorption (FLTA); Intensity of Local Competition (ILC)	WEF
	High-Technology Exports as % of Manufactured Exports (HTEME)	ONUUDI
	Manufactures Exports as % of Merchandise Exports (MEME)	WDI
POL-SYS	country Capacity to Retain Talent (CRT); Effect of Taxation on Incentives to Invest (ETII); Regulation of Securities Exchanges (RSE); Strength of Investor Protection (SIP); country Capacity to Attract Talent (CAT)	WEF
	Technical Cooperation Grants (TCG)	WDI
SOC-SYS	Degree of Customer Orientation (DCO); Domestic Market Size (DMS)	WEF
	Individuals Using Internet (IUI)	WDI
ENV-SYS	CO2 Emissions metric tons per capita (CE); Natural Resources Rents as % of GDP (NRR)	WDI
OPE-SYS	Business Impact of rules on FDI (BIFDI); Control of International Distribution (CID); FDI and Technology Transfer (FDITT); Prevalence of Foreign Ownership (PFO); Prevalence of Trade Barriers (PTB); Venture Capital Availability (VCA); Availability of Latest Technologies (ALT)	WEF
	Fixed Broadband Internet Subscriptions (FBISP); Imports as a percentage of GDP (MGDP)	WDI

**Table 1:** Variables of Study

To assess the sources of differences in technological innovation synergy in countries, we have relied primarily on the World Economic Forum competitiveness index database, in addition to the United Nations Industrial Development Organization and the World Bank respectively on industrial development and development indicators around the world. We have selected 2013 as the base year for the development of the innovation synergy index to ensure the representativeness of all the African countries without the Seychelles being taken into account because its score values do not follow the same structure as those of other countries. For the construction of the index, we extracted all the variables from these databases that can be entered into the six OQiH dimensions, namely EDU-SYS, ECO-SYS, POL-SYS, SOC-SYS, ENV-SYS and OPE-SYS (see Table 1 above). We have captured the latter technological innovation on the axis 12 (R&D and innovation) of the global competitiveness index which, in addition to the patent application, is composed of capacity for innovation, quality of scientific research institutions, business expenses in R&D, university-industry collaboration in R&D, government procurement of advanced technology products, availability of scientists and engineers, and protection of intellectual property. This variable was selected as the indicator of technological innovation, unlike patent applications, only because many innovation activities in developing countries (especially in Africa) are not recognised by this approach (Furman et al., 2002; Furman & Hayes, 2004; Fagerberg & Srholec, 2008). The OQiH being the interaction model between the six spheres listed above, and the calculation of the ISI scores, particularly, involve the redundant information among different variables in contrast to the normal process of calculating composite indices which eliminate multi-collinearities through the use of principal component analysis and factorial analysis. For this purpose, we firstly proceeded to identify the variables characterised by the mutual information derived from the factor analysis and the Pearson correlation matrix ( $R_{xy/z}$ ).

Given this fact, we have used the parsimonious regression method on each of the dimensions as the basis for weighting. The weighting values are obtained by again eliminating the explanatory variables of each helix that do not determine technological innovations. This determinant analysis was performed according to the specifications inspired by Furman et al. (2002)<sup>2</sup> which

<sup>2</sup> The specification is part of the national idea production function derived from Romer's (1990) growth model, which is:  $\dot{A}_t = \delta H_{A,t} A_t^\phi$  where:  $\dot{A}_t$  represents the rate of technological progress or new ideas production;  $H_t$  number of ideas workers and  $A_t$  stock of ideas available to these

has been used for innovation capacity determinants analysis for countries. This specification is:

$$\hat{A}_{jt} = \delta_{jt}(V_{jt}^v, W_{jt}^w, X_{jt}^x, Y_{jt}^y, Z_{jt}^z)H_{jt}^{A\lambda}A_{jt}^\phi \quad (1)$$

with:  $i$  unit for country;  $t$  for year;  $\hat{A}_{jt}$  representing the level of technological innovation (INV);  $V_{jt}^v, W_{jt}^w, X_{jt}^x, Y_{jt}^y$  et  $Z_{jt}^z$  the respective vectors of economic, political, social, environmental, and openness systems; and finally  $H_{jt}^{A\lambda}$  et  $A_{jt}^\phi$  corresponding respectively to the number of ideas workers, and the stock of available ideas that are considered as characteristic of the education system. The econometric transformation of the model follows, after the logarithm operator (L) application.

$$L \hat{A}_{jt} = \delta_v LV_{jt}^v + \delta_w LW_{jt}^w + \delta_x LX_{jt}^x + \delta_y LY_{jt}^y + \delta_z LZ_{jt}^z + \lambda LH_{jt}^A + \phi LA_{jt} + \varepsilon_{jt} \quad (2)$$

But, given that data related to different variables are expressed in the form of scores (ranging from 1 to 7) and ratios, it is not necessary for us to linearise them before estimation. In addition, we also neglect the temporal dimension since all the estimates relate to year 2013. To attain this objective, we used the ratio of the GDP of each country compared to that of world GDP (GDPW) as the control variable in each of equations. Thus, we have rewritten the previous equation according to the parsimonious specification in our context as follows:

$$\begin{cases} INV_j = k_1 GDPW + \delta_v V_j^v + \varepsilon_{1j} \\ INV_j = k_2 GDPW + \delta_w W_j^w + \varepsilon_{2j} \\ INV_j = k_3 GDPW + \delta_x X_j^x + \varepsilon_{3j} \\ INV_j = k_4 GDPW + \delta_y Y_j^y + \varepsilon_{4j} \\ INV_j = k_5 GDPW + \delta_z Z_j^z + \varepsilon_{5j} \\ INV_j = k_6 GDPW + \lambda H_j^A + \phi A_j + \varepsilon_j \end{cases} \quad (3)$$

Once the weighting coefficients, or the estimation values related to technological innovation (INV) determining factors of each dimension is obtained, the synergistic index scores are calculated on the set of factors by multiplying their weighting values by their initial values. The scores for each of the six dimensions are obtained by calculating the arithmetic mean of scores from its components. Finally, the degree of synergistic interaction (technological innovation scores) is obtained for each country by the aggregation (summation) of the score values obtained for each of the six dimensions. The validity or the robustness of the innovation synergy scores obtained is apprehended through the analysis of the correlation between these and the scores of the indices of national capacity for innovation and global competitiveness.

## INNOVATION SYNERGY INDEX EFFECTS ON INDUSTRIAL PERFORMANCES

After obtaining the scores, estimates of the global and individual synergistic effects of the six helix on the African countries, competitive industrial performance indicators are provided by the constitution of the panel data for the period 2013 to 2016, considering only the countries<sup>3</sup> which do not suffer from a lack of data. To avoid the problems of multi-collinearity, The estimation process is similar to the one above.

The final specification is:

$$\begin{cases} IP_{it} = \delta \cdot ISI_{it} + g \cdot cv_{it} + \mu 1_{it} \\ IP_{it} = w \cdot IEDUSYS_{it} + g \cdot cv_{it} + \mu 2_{it} \\ IP_{it} = x \cdot IECOSYS_{it} + g \cdot cv_{it} + \mu 3_{it} \\ IP_{it} = y \cdot IPOLSYS_{it} + g \cdot cv_{it} + \mu 4_{it} \\ IP_{it} = z \cdot ISOCSYS_{it} + g \cdot cv_{it} + \mu 5_{it} \\ IP_{it} = v \cdot IENVSYS_{it} + g \cdot cv_{it} + \mu 6_{it} \\ IP_{it} = \lambda \cdot IOPEYSYS_{it} + g \cdot cv_{it} + \mu 7_{it} \end{cases} \quad (4)$$

researchers.

<sup>3</sup> These countries are: Burundi, Botswana, Ivory Coast, Cameroon, Algeria, Egypt, Ethiopia, Ghana, Morocco, Madagascar, Mauritius Island, Malawi, Namibia, Nigeria, Rwanda, Senegal, Tunisia, Uganda, South Africa, Zambia and Zimbabwe.

where:

–  $IP_{it}$ : corresponds to the Industrial Performances of  $i$  countries for a period  $t$ . They are captured as part of this work by the competitive industrial performance index ( $CIP_{it}$ ), but also more specifically by manufacturing value added per capita ( $MVApc_{it}$ ), since the innovation systems mostly operate in competition in terms of value creation rather than the captured value. Indeed, the CIP is a composite index developed by the United Nations Industrial Development Organization with a value in the range [0 1] which measures the competitive industrial performance of countries by considering their production capacity, the intensity of their industrialisation and their impact on the world market:

–  $ISI_{it}$ : is the global innovation synergy index of countries  $i$  for a period  $t$ ;

–  $IEDUSYS_{it}, IECOSYS_{it}, IPOLSYS_{it}, ISOCSYS_{it}, IENVSYS_{it}$  et  $IOPEYSYS_{it}$

are synergistic index scores related to educational, economic, political, societal, environmental, and openness systems respectively;

–  $cv_{it}$ : corresponds to a vector of control variables, namely final consumption expenditure as percentage of GDP (CFE); gross capital formation as percentage of GDP (GCFG); the annual rate of inflation of consumer prices (INF); labor force participation rate, as a percentage of the total population aged 15 to 64 (LF); affordability of financial services (AFS); Infrastructure (IFR) and Local Supplier Quality (LSQ); and

–  $\mu 1_{it}, \mu 2_{it}, \mu 3_{it}, \mu 4_{it}, \mu 5_{it}, \mu 6_{it}, \mu 7_{it}$  the error terms of each equation.

Given the fact that our estimation variables are mostly index-based (and specifically the CIP values range from 0 to 1) and therefore are subject to measurement error in addition to the problem of multicollinearity, and probable relation of simultaneity between dependent and explanatory variables, we have used specific estimation methods for each of our two explained variables to take into account these problems of endogeneity. For the effect of estimates on the CIP, we have used the Generalized Estimating Equation (GEE) method for fitting the population-average panel data models of Liang and Zeger (1986) following the specifications of Papke and Wooldridge (2008) and Wooldridge (2018); while for the MVApc, we have resorted to the System Generalized Moments Method estimation approach (SystGMM) of Arellano-Bover (1995) / Blundell-Bond (1998).

The GEE method is the generalised form of the Generalized Linear Models (GLM) that are fractional logit or probit models. The GEE method has proven to be more robust than the Tobit regression on panel data when the values of the dependent variable changes from 0 to 1 instead of 0 or 1. It consists of using only complete observations in the calculation of time averages and also defining nominal variables indicating the number of periods observed for the different units. These then become explanatory variables in the fractional probit with the temporal averages. It can also be made flexible by these variables interacting with temporal averages and possibly other variables as well. On the other hand, the SystGMM estimator is adequate for solving endogeneity problems and provides more robust results than other forms of estimation in the presence of small samples like the present one and a strong correlation between the explanatory variables (Blundell & Bond, 1998). It consists of combining, for each period, the equation in the first difference with that in the level. In the first difference equation, the variables are then instrumented by their level values being delayed by at least one period. On the other hand, in the level equation, the variables are instrumented by their first differences (Guillaumont and Kangni, 2006). In addition, to better understand our results we have applied correlation and descriptive statistics to our various variables before moving on to the estimates.

## ANALYSIS OF RESULTS

The analysis of the results is performed according to the determining variables of the technological innovation which were used to calculate the innovation synergy index. Then, the analysis of the performances of the various African countries is carried out on the scores and the ranks which they occupied before the evaluation of the effects of the innovation synergy index and its components on the competitive industrial performances and the manufacture value added per capita.

Indeed, after the correlation analysis between different variables, the results of the determinants of the technological innovation show that different estimates are globally significant with good explanatory powers. It should also be noted that, unlike all other variables, the natural resource rent and the fixed broadband Internet subscriptions have negative effects on technological innovation in Africa. Thus, for the contribution of analysis to technological innovation, the variables in descending order of



importance in terms of contribution are: degree of customer orientation (0.474), quality of math and science education (0.446), FDI and technology transfer (0.343), country capacity to retain talent (0.333), intensity of local competition (0.310), control of international distribution (0.285), venture capital availability (0.256), regulation of securities exchanges (0.228), financial markets development (0.226) and high-technology exports as % of manufactured exports (0.025). The latter are therefore taken into account according to their corresponding helix as well as their estimate coefficients which are used as weighting for the innovation synergy index calculation, which finally comprises five dimensions because of the elimination of ENV-SYS due to negative sign of natural resources rents as a percentage of GDP. Indeed, the natural resources rents represents the only characteristic variable of the environment at this stage after the removal of CO2 follows the correlation test.

As the synergistic innovation index scores are known, we now examine the relationship between the latter and its components with the Manufacture Value Added per capita (MVApC) on one hand and the Competitive Industrial Performance (CIP) on the other hand. The results of our different estimates are presented in Table 2 below. We can conclude that the results of the various equations, the estimations are valid according to the harmonised criteria of the two types of estimators that have been used. As a matter of fact, it is noted that at least 63 final observations were made against the 30 required. The number of instruments taken into account is much lower than the number of groups (maximum 18 instruments against 21 groups) and that the statistics of Chi2 and Fisher all have probabilities lower than 1%, justifying the global significance of the different models we used. Specifically, for the two types of estimators used, we could also conclude compliance with other criteria such as the statistics of Sargan, Hansen, ... which allows us to confirm the validity of our instruments. However, it is clear that taking into account the year dummy variable (Y1) led to the non-display of the AR(2) autocorrelation statistic of the error terms.

Our various equations are, by correspondence with the phenomenon of analysis, for the two types of estimators used as follows: equation 1 of Innovation Synergy Index (ISI) effect analysis; equation 2 for analysis of all ISI components effects; and equations 3, 4, 5, 6 and 7 respectively correspond to those of the individual effects analyses of the components EDU-SYS, SOC-SYS, POL-SYS, ECO-SYS and OPE-SYS. Finally, it is worth mentioning that the ISI has no significant effect on both CIP and MVApC. However, the overall estimation of its components reveals on the one hand the positive effects of ECO-SYS and OPE-SYS on CIP at the respective thresholds 10 and 1%, and on the other hand that the positive effect of SOC-SYS on MVApC at the threshold of 5%. These results confirm the embryonic state of the innovation system of the African countries listed in the studies of Gu (1999) and Vanessa and Benlahcen-Tlemceni (2006).

The estimates of individual effects on MVApC allow us to confirm the only positive and significant effect of SOC-SYS compared to other ISI components. Thus, the degree of consumer orientation is the only factor contributing to the improvement of the MVApC in terms of synergistic interaction of technological innovation in Africa. From the point of view of systemic innovation above, this result can be justified by the fact that SOC-SYS represents the dominant helix in terms of technological innovation generation in almost all the African countries involved in this study. On other hand, the estimates of the individual effects of the ISI components on CIP do not reveal the confirmation of the effects recorded for the overall ones. While the OPE-SYS positive effect on CIP was confirmed at the same threshold of 1%, there was a negative effect of the POL-SYS on CIP instead of the ECO-SYS positive effect. This could be justified by the correlation between OPE-SYS and ECO-SYS which is a synonym of multicollinearity and can probably lead to the ECO-SYS positive effect on CIP. These results confirm those obtained by Mègnigbèto (2015) on the strong synergy of the innovation system at the foreign level compared with those obtained nationally and globally in the West African region. Thus, the venture capital availability, the FDI and technology transfer and the control of international distribution are the key factors for improving the competitive industrial performance in terms of the opening up of the innovation system in Africa. But, the combined negative effects of capacity of the countries to retain talent and the regulation of securities exchanges can probably be explained by the fact that their levels have not yet reached the threshold necessary to strengthen the CIP of African countries. In short, no helix contributes more to the MVApC and CIP improvement compared to the others in Africa.

METHODES EQUATIONS	SYSTEMM							GEE						
	1	2	3	4	5	6	7	1	2	3	4	5	6	7
VARIABLES														
LMVApC	1.068*** (0.182)	1.032*** (0.0246)	1.039*** (0.0218)	1.038*** (0.0218)	1.036*** (0.0204)	1.030*** (0.0212)	1.043*** (0.0280)							
ISI	-27.39 (50.99)							0.000729 (0.00134)						
EDUSYS		0.0782 (8.624)	0.829 (8.037)						-0.00213 (0.00255)	0.000427 (0.00187)				
SOCYSYS				15.73** (6.481)		13.33** (6.292)			0.00159 (0.00127)		-0.000425 (0.00113)			
POLSYS									-0.00966 (0.00713)			-0.0103* (0.00621)		
ECOSYS									0.0220* (0.0129)				0.0147 (0.0143)	
OPESYS									0.0186*** (0.00691)					0.0167*** (0.00474)
FCE	-1.914 (3.441)	-0.237 (0.307)	-0.383 (0.300)	-0.301 (0.275)	-0.389 (0.330)	-0.294 (0.343)	-0.386 (0.335)	-0.000183* (0.000105)	-5.93e-05 (6.89e-05)	-0.000181* (0.000105)	-0.000179* (0.000104)	-0.000146 (9.33e-05)	-0.000147 (9.08e-05)	-0.000150 (9.68e-05)
GCFG	-2.477 (4.370)	-0.0939 (0.436)	-0.299 (0.393)	-0.163 (0.379)	-0.338 (0.376)	-0.255 (0.406)	-0.239 (0.456)	4.47e-05 (0.000110)	-1.49e-05 (9.10e-05)	4.91e-05 (0.000109)	5.09e-05 (0.000107)	6.07e-05 (9.56e-05)	5.48e-05 (0.000111)	-3.51e-05 (9.83e-05)
INF	1.974 (4.497)	-0.653 (0.516)	-0.206 (0.491)	-0.353 (0.420)	-0.485 (0.517)	-0.410 (0.501)	-0.189 (0.422)	-0.000364* (0.000213)	-0.000356** (0.000179)	-0.000356* (0.000208)	-0.000352* (0.000211)	-0.000322 (0.000209)	-0.000367* (0.000213)	-0.000367** (0.000184)
LF	2.047 (3.873)	0.206 (0.207)	0.348 (0.288)	0.324 (0.276)	0.253 (0.212)	0.210 (0.241)	0.403 (0.338)	-0.000936*** (0.000299)	-0.000987*** (0.000296)	-0.000939*** (0.000301)	-0.000939*** (0.000301)	-0.000980*** (0.000314)	-0.000944*** (0.000292)	-0.000951*** (0.000290)
AFS	-56.27 (101.4)	-16.95** (7.609)	-17.19* (8.390)	-16.48* (8.653)	-18.18** (7.572)	-17.30** (7.212)	-17.69* (9.083)	-0.00244* (0.00125)	-0.00245* (0.00133)	-0.00232* (0.00120)	-0.00226* (0.00120)	-0.00267 (0.00116)	-0.00261** (0.00132)	-0.00244* (0.00127)
IFR	77.62 (138.8)	-4.038 (6.189)	-0.199 (4.709)	-1.832 (4.633)	-3.341 (6.853)	-1.369 (4.978)	-0.127 (4.673)	-0.00372 (0.00269)	-0.00395* (0.00234)	-0.00347 (0.00254)	-0.00338 (0.00262)	-0.00267 (0.00241)	-0.00369 (0.00249)	-0.00401 (0.00256)
LSQ	-9.343 (18.62)	-0.962 (8.843)	1.510 (4.669)	-1.235 (4.878)	-1.153 (5.364)	1.601 (4.918)	3.497 (7.632)	0.00444* (0.00228)	0.00226 (0.00218)	0.00465** (0.00222)	0.00474** (0.00226)	0.00504** (0.00228)	0.00432** (0.00214)	0.00249 (0.00201)
Y1	0 (0)	0 (0)	0 (0)	0 (0)	0 (0)	0 (0)	0 (0)							
Constant	234.9 (393.9)	31.75 (51.54)	63.75 (43.59)	44.35 (39.81)	67.39 (41.65)	40.97 (49.88)	65.20 (47.31)	0.0967*** (0.0217)	0.0788*** (0.0209)	0.0985*** (0.0226)	0.0988*** (0.0230)	0.103*** (0.0254)	0.0885*** (0.0192)	0.0927*** (0.0207)
Observations	63	63	63	63	63	63	63	84	84	84	84	84	84	84
Groups	21	21	21	21	21	21	21	21	21	21	21	21	21	21
Instruments	13	18	14	14	14	14	14	8	12	8	8	8	8	8
F // chi2	213.9	30356	3894	4631	16900	10224	3426	24.97	409.0	24.16	27.40	47.31	41.33	30.36
F // p	0	0	0	0	0	0	0	0.00157	0	0.00215	0.000604	1.34e-07	1.81e-06	0.000183
Robust standard errors in parentheses														
*** p<0.01, ** p<0.05, * p<0.1														

Table 2: Results of Econometric Estimations of the ISI and its Components Effects on MVApC and CIP

## CONCLUSION

The importance of technological innovations for competitiveness improvement in the light of a knowledge-based economy suggests the establishment of indicators to situate countries in relation to action cohesion undertaken by different actors in technological innovation. This study, which dealt with open quintuple helix synergy analysis of competitive industrial performance (following their implication in Science Technology and Innovation (STI) policies) of African countries was the subject of innovation synergy index development. For this purpose, the WEF, WDI and UNIDO data were used over the 2013-2016 period. Factor and correlation analysis were performed on the variables before using parsimonious estimates in the form of simple regressions (following base year 2013) and panel data by the system generalized moment method and generalized estimating equation for a number of countries during the study period. The overall econometric analysis revealed no effects of ISI on both manufacture value added per capita (MVApc) and competitive industrial performance (CIP) whereas the individual ones showed only positive effects of SOC-SYS at 5% and 1% of OPE-SYS respectively on MVApc and CIP against a negative effect of POL-SYS on CIP at the 10% threshold. Thus, in terms of sustainable competitiveness policy strategies in Africa through the improvement of industrial performance, countries must place a particular emphasis on the opening of the innovation system (through venture capital availability, FDI and technology transfer, and control of international distribution) followed by the strengthening of the SOC-SYS with a degree of customer orientation while stepping up its efforts in terms of POL-SYS so that they can exert a positive effect in the long term.

## LIST OF REFERENCES

- Abramovitz, M. 1986. Catching up, forging ahead, and falling behind. *Journal of Economic History*, 46(2):385-406.
- Archibugi, D. & Coco, A. 2004. A new indicator of technological capabilities for developed and developing countries (ArCo). *World Development*, 32:629-654.
- Arow, K. & Intriligator, M. 2010. Handbook of the economics of innovation. *Elsevier*
- Bagyo, Y., Moeliodihardjo, B. W., Soemardi, S., Brodjonegoro, S. & Hatakenaka, S. 2012. University, industry, and government partnership: its present and future challenges in Indonesia. *SciVerse ScienceDirect: Procedia - Social and Behavioral Science*, 52:307-316.
- Cai, Y. 2011. Factors affecting the efficiency of the BRICSs National Innovation Systems: a Comparative Study Based on Dea and Panel Data Analysis. *Economics Discussion Paper N0 2011-52*, 24.
- Carayannis, E. G. & Campbell, D. F. J. 2010. Triple helix, quadruple helix and quintuple helix and how do knowledgespell out, innovation and the environment relate to each other, A proposed framework for a trans-disciplinary analysis of sustainable development and social ecology. *International Journal of Social Ecology and Sustainable Development*, 41-69.
- Carayannis, E. G. & Campbell, D. F. J. 2009. Mode 3 and quadruple helix: toward a 21st century fractal innovation ecosystem. *International Journal of Technology Management*, 201-234.
- Carayannis, G., Barth, T. D. & Campbell, D. J. E. 2012. The quintuple helix innovation model: global warming as a challenge and driver for innovation. *Journal of Innovation and Entrepreneurship*.
- Chen, D. H. C. & Dahlman, C. J. 2005. The knowledge economy, the KAM methodology and World Bank operations. *The World Bank, Washington DC 20433*.
- Choi, S., Yang, J. S. & Park, H. W. 2015. The triple helix and international collaboration in science. *J Assoc Inf Sci Technol*, 66:201-212.
- Cincera, M. & Pottelsberghe, B. V. 2001. International R&D spillover: a survey. *Brussels Economic Review*, 169:3-31.
- Clercq, P. D. 2012. Mesurer l'Innovation des R gions Europ ennes: un Nouvel indicateur Composite. *Brussels Economic Review-cahiers Economiques de Bruxelles*, 55(4): Winter.
- Desai, M., Fukuda-Parr, S., Johansson, C. & Sagasti, F. 2002. Measuring the technology achievement of nations and the capacity to participate in the network age. *Journal of Human Development*, 3,1.
- Etzkowitz, H. & Leydesdorff, L. 1995. The triple helix: university-industry-government relations: a laboratory for knowledge-based economic development. *EASST Review* 14:14-19.
- Etzkowitz, H. & Leydesdorff, L. 1997. *Universities and the global knowledge economy: a triple helix of university-industry-government relations*. London: Pinter.
- Etzkowitz, H. & Leydesdorff, L. 1999. Whose triple helix? *Science and Public Policy*, 26(2):138-139.
- Etzkowitz, H. & Leydesdorff, L. 2000. The dynamics of innovation: from national systems and 'Mode 2' to a triple helix of university-industry-government relations. *Research Policy*, 29(2):109-123.
- Eustache M gnigb to. 2015. Effect of international collaboration on knowledge flow within an innovation system: a triple helix approach. *Triple Helix Springer Open Journal*, DOI 10.1186/s40604-015-0027-0.
- Fagerberg, J. & Srholec, M. 2008. National Innovation Systems, Capabilities and Economic Development. *Research Policy* 37:1417-1435.
- Fred, Y., Ye Susan, S. Y. & Leydesdorff, L. 2013. The triple Helix of University-Industry-Government relations at the Country Level, and its Dynamics Evolution under the Pressures of Globalization. *Journal of the American Society for Information Science and Technology* 64(11):2317-2325.
- Freeman, C. 1988. Japan: A new national innovation system, In: Dosi, G., Freeman, C., Nelson, R. R., Silverberg G. & Soete L. (eds.). *Technology and economy theory*. London: Pinter.
- Furman, L. J. & Hayes, R. 2004. Catching up or standing still? National innovative productivity among 'follower' countries, 1978-1999. *Research Policy*, 33(9):1329-1354.
- Furman, L. J., Porter, E. M. & Stern, S. 2002. The determinants of national innovative capacity. *Research Policy*, 31:899-933.

- Ivanova, A. I. & Leydesdorff, L. 2014. Redundancy Generation in university-industry-Government relations: the triple helix modeled, measured, and simulated. *Scientometrics*, 99(3):927-948.
- KAM. 2006. *The knowledge assessment methodology and scorecards*. [Online] Available from: <http://vle.worldbank.org/gdln/Programs/kam2001/methodology.htm>. [Accessed: ].
- Keller, W. 2004. International Technology Diffusion. *Journal of Economic Literature* XLII:752-782.
- Khan, F. G. & Park, H. W. 2011. Measuring the triple helix on the Web: longitudinal trends in the university-industry-government relationship in Korea. *J Am Soc Inf Sci* 62:2443-2455.
- Krippendorff, K. 1980. An interpretation of the information theoretical Q-measures. In: Trappl, R., Klir, G. J. & Pichler, F. (eds). *Progress in cybernetics and systems research*, VIII:63-67.
- Krippendorff, K. 2009. W. Ross Ashby's information theory: a bit of history, some solutions to problems, and what we face today. *International Journal of General Systems* 38(2):189-212.
- Kudryavtseva, S. S., Shinkevich, I. A., Pavlova, V. A., Chudnovskiy, D. A., Nikolayeva, N. A., Garipova, R. G., Doronina, F. K. & Ishmuradova, I. I. 2016. The econometric methods for evaluating of open national innovation systems. *International Journal of Economics and Financial Issues*, 2146-4138.
- Kwon, K. S. 2011. The co-evolution of universities' academic research and knowledge-transfer activities: the case of South Korea. *Sci Public Policy*, 38:493-503.
- Kwon, K. S., Park, H. W., So, M. & Leydesdorff, L. 2012. Has globalization strengthened South Korea's national research system, National and international dynamics of the triple helix of scientific co-authorship relationships in South Korea. *Scientometrics*, 90:163-176.
- Lee, K. & Lee, J. 2019. National innovation systems, economic complexity, and economic growth: country panel analysis using the US patent data. *Journal of Evolutionary Economics*
- Lengyel, B. & Leydesdorff, L. 2015. The effects of FDI on Innovation Systems in Hungarian Regions: Where is the Synergy Generated?. *Regional Statistics* 5(1):No1:3-24; DOI: 10.15196/RS05101.
- Leydesdorff, L. & Etzkowitz, H. 2000. Le "Mode 2" et la globalisation des systèmes d'innovation "nationaux": le modèle à Triple hélice des relations entre Université, industrie et gouvernement. *Sociologie et société*, 32(1):135-156.
- Leydesdorff, L. & Sun, Y. 2009. National and international dimensions of the triple helix in Japan: university-industry-government versus international co-authorship relations. *Journal of the American Society for Information Science and Technology*, 60(4):778-788.
- Leydesdorff, L. & Sun, Y. 2009. National and international dimensions of the triple helix in Japan: University-industry-government versus international co-authorship relations. *Journal of the American Society for Information Science and Technology*, 60(4):778-788.
- Leydesdorff, L. & Zhou, P. 2005. Are the contribution of China and Korea upsetting the world system of science, *Scientometrics*, 63(3):617-630.
- Leydesdorff, L. 2006. The knowledge-based economy and the triple helix model. Amsterdam: In: Dolfsma, W. & Soete, L. (eds). *Reading the dynamics of a knowledge economy*. Cheltenham: Edward Elgar, 42-76.
- Leydesdorff, L., Park, H. W. & Lengyel, B. 2014. A routine for measuring synergy in university-industry-government relations: mutual information as a triple-helix indicator. *Scientometrics*, 99(1):27-35.
- Leydesdorff, L., Perevodchikov, E. & Uvarov, A. 2015. Measuring triple helix synergy in the Russian innovation systems at regional, provincial and national levels. *Journal of the Association of Information Science and Technology*, 66(6):1229-1238.
- Lundvall, B. -Å. 1992. *National systems of innovation*. London: Pinter.
- M. R. P. 1990. Endogenous technological change. *Journal of Political Economy*, 98:71-102.
- McGill, W. J. 1954. Multivariate information transmission. *Psychometrika*, 19(2):97-116.
- Mégnigbêto, E. 2014. Efficiency, unused capacity and transmission power as indicators of the triple helix of university-industry-government relationships. *J Informetr*, 8:284-294.
- Mégnigbêto, E. 2015. Correlation between transmission power and some indicators used to measure the knowledge-based economy: case of six OECD countries.
- Mégnigbêto, E. 2015. Profiles of six OECD countries with regard to mutual information and transmission power. *ISSI Newsletter*, 11. 16-23.
- Moso-Diez, M. & Olazarán, M. 2002. Regional technology policy and the emergence of an R&D system in the Basque Country. *Journal of Technology Transfer*, 27(1):61-75.
- Nelson, R. R. 1993. *National Innovation Systems: A comparative study*. New York: Oxford University Press.
- Newman, C. & Page, J. R. J. 2016. *Manufacturing transformation: comparative studies of industrial development in Africa and emerging Asia*. Washington, D. C.: Brookings Institution Press.
- Page, J. & Tarp, F. 2017. *The practice of industrial policy: government-business coordination in Africa and East Asia*. UNU-WIDER Studies in Development Economics. Oxford: Oxford University Press.
- Park H. W. Leydesdorff L. Hong D. H. Hung S. J. (2005). Indicators for the knowledge-based economy: a comparison between South Korea and the Netherlands. *Scientometrics*, 65(1):3-27.
- Pearson, K. 1895. Notes on regression and inheritance in the case of two parents. *Proceedings of the Royal Society of London*, 58:240-242.
- Pellitero, M. M. & Heijs, M. B. Y. J. 2008. The IAIF Index for European Regional Innovation Systems. *Documento de trabajo*, 61.
- Porter, M. E. & Stern, S. 2001. Measuring the 'ideas' production function: evidence from international patent output. *MIT Sloan School of Management, Mimeo*.
- Porter, M. E. & Stern, S. 2001. *National innovative capacity in The global Competitiveness Report 2001-2002*. New York, Oxford University Press, 17.
- Porter, M.E. & Stern, S. 1999. *The new challenge to America's prosperity: findings from the innovation index*. Washington, DC.: Council on Competitiveness.
- Rodrik, D. 2014. An African growth miracle, *NBER Working Paper No. 20188*, Cambridge. MA: National Bureau of Economic Research.
- Romer, P. M. 1990. Endogenous technological change. *Journal of Political Economy*, 98:71-102.
- Rosenberg, N. 1976. *Perspectives on technology*. New York: the Free Press.
- Sajeva, M., Gatelli, D., Tarantola, S. & Hollanders, H. 2005. *Methodology Report on the European Innovation Scoreboard 2005*. European Commission, Enterprise Directorate General.
- Salter, W. E. G. 1960. Productivity and Technical Change, Second edition, with an addendum by Reddaway W. B. *Cambridge University Press*, Cambridge.
- Sanjava, L. 2001. Comparing national competitive performance: an economic analysis of World Economic Forum's competitiveness index. *Working Paper Number 61*.
- Shannon, C. E. 1948. A mathematical theory of communication. *Bell System Technical Journal*, 27:379-423; 623-656.
- Shin, J. C., Lee, S. J. & Kim, Y. 2012. Knowledge-based innovation and collaboration: a triple-helix approach in Saudi Arabia. *Scientometrics*, 90:311-326.
- Smith, H. L. & Leydesdorff, L. 2004. The triple helix in the context of global change: dynamics and challenges. *Prometheus*, 32(4):321-336.
- Strand, R. & Leydesdorff, L. 2013. Where may synergy be indicated in the Norwegian innovation system? Triple helix relations among technology, organization and geography. *Technology Forecasting and Social Change*, 80(3):471-484.
- Ulanowicz, R. E. 2009. The dual nature of ecosystem dynamics. *Ecological modelling*, 220(16):1886-1892.
- Ulanowicz, R. E. 2009. The dual nature of ecosystem dynamics. *Ecological modelling*, 220(16):1886-1892.
- WEF. 2018. *The Global Competitiveness Report*. Geneva: Klaus Schwab World Economic Forum.
- WIPO. 2018. *The Global Innovation Index Report*. Geneva: Johnson Cornell University.
- Yeung, R. W. 2008. *Information theory and network coding*. New York, NY: Springer.

9TH INTERNATIONAL CONFERENCE ON APPROPRIATE TECHNOLOGY

# **POLICY STANDARD AND ETHICS**

# AFRICANA ETHICS: A KEY TO SUSTAINABLE DEVELOPMENT THROUGH APPROPRIATE TECHNOLOGY

\*Verharen C.<sup>1</sup>, Bugarin, F.<sup>2</sup>, Tharakan, J.<sup>3</sup>, Gutema, B.<sup>4</sup>, Wensing, E.<sup>5</sup>, Fortunak, J.<sup>6</sup>, Middendorf, G.<sup>7</sup>

Departments of <sup>1</sup>Philosophy, <sup>2</sup>African Studies, <sup>3</sup>Chemical Engineering, <sup>4</sup>Chemistry and Pharmaceutical Sciences,

<sup>5</sup>Biology, Howard University, Washington, DC 20059 USA; <sup>6</sup>Department of Philosophy, Addis Ababa University,

Addis Ababa, Ethiopia; <sup>7</sup>Old Dominion University, Norfolk, VA 23529 USA

\*cverharen@howard.edu

## Abstract:

*Who has the competence to decide what is ethical? Scientists, engineers, technologists, government officials, community leaders, local and indigenous peoples—or a combination of all of the above? What traditions have the right to issue ethical commands—European, African or a synthesis of global cultures? Globalization’s contemporary ethical code is the UN Declaration of Universal Human Rights. Guided by these declarations, international development actors often deploy technologies that diminish rather than enhance the well-being of Global South communities. Our method combines theoretical ethical speculation with African translation of theory into practice. Our research hypothesis has two aspects. The first theoretical section argues that Africana ethical traditions have the power to guide technologies appropriate to bridging the Global North/South chasm to eliminate disparities. The term Africana here signifies both Africans on the continent and in the Diaspora. Africana philosophers direct the essay’s ethical model. Alain Locke argues that ethics must be a joint project of philosophers and scientists. He also insists that ethics be embedded in every course in the curriculum. W.E.B. Du Bois claims that a key historically Black university mission is to make higher education available to virtually every human being. The essay’s second section examines an applied African model for translating the ethical theories of Locke and Du Bois into practice. Deeply immersed in African American and African ethics, Godfrey Nzamujo developed the Songhaï Centres to solve the problem of rural poverty in seventeen African countries. Nzamujo harnesses biomimicry and deploys appropriate sustainable technologies within a holistic agroecological ecosystem that spans the fields of ethics, information communication technology, microbiology, international development, and mechanical, electrical, civil and biological engineering in a community-based and centred development enterprise. The essay’s third section proposes a global consortium of eco-villages based on Nzamujo’s model. The fourth section explores funding methods for the consortium.*

**Keywords:** Africana ethics, appropriate vs inappropriate technology, funding sources for appropriate technologies, global consortium of eco-villages, Songhaï centres;

## INTRODUCTION: WHO HAS THE COMPETENCE TO DELIVER ETHICAL COMMANDS?

The aim of this paper is to offer Africana-based ethical solutions to profound human problems. This essay’s main hypothesis is that humanity’s collective ethical systems have failed to guarantee life’s future. Climate change, the sixth mass extinction, and weapons of mass destruction threaten humanity’s survival (Kolbert 2014, Gardiner 2011, Schell 2000). The zoonotic Covid-19 pandemic poses a threat of another order. Our solution is to propose an Africana

ethics coupled with social science methods that emerges from an African and African-American response to existential challenges to Africana peoples. We base our response on a reading of Black intellectuals who have largely been ignored in international development and appropriate technology literature. Since many have overlooked the voices of prominent Black thinkers in these areas, our approach is original and relevant to contemporary challenges. Grounded in an African sense of communalism first expressed in ancient Egypt some five thousand years ago (Verharen, Gutema, Tharakan, Bugarin, Fortunak, Kadoda, Liu, Middendorf 2014), this ethics must be the product not simply of philosophers, scientists or engineers, but all stakeholders in the communities that adopt it. This essay’s presupposition is that the task of ethics is to issue commands as to how we should live to guarantee life’s survival and flourishing. Unless an ethics addresses the well-being of every human as well as other organisms together with the environment that makes life possible, life as we know it will have no future on the planet.

This Africana ethics challenges the assumption that only scientists or philosophers are competent to make ethical pronouncements. Scientists like the physicist, Stephen Hawking (2010), the biologist E.O. Wilson (2012, 2014) and the psychologist Stephen Pinker (2011, 2013, 2018) are now so bold as to claim that only science can yield viable answers to the question of how we should live. European and North American philosophers insist to the contrary that three European-derived ethical systems—utilitarianism, virtue and duty ethics—deliver viable answers to the question. The collective United Nations Declarations of Universal Human Rights proposes a direction for humanity’s future but does not elaborate the means to achieve that future.

Do these ethical systems have the power to save life? After five thousand years of speculation on how we should live, perhaps one billion humans are at risk of food insecurity with their children suffering from malnutrition. As many as three billion do not have access to toilets. As many as five thousand children die daily from drinking contaminated water.

Twenty-seven of the poorest countries in the world are in Africa. According to the World Bank, if circumstances continue as expected, global poverty will be 90% African in 2030 (World Bank 2019). Africa is particularly hit hard, since many of its most vulnerable people face abject, multidimensional, and chronic poverty. An estimated 40% of Africans live below 1.90 USD a day.

Populations at extreme risk have the greatest incentive to ask, “How should we live?” The essay’s first section considers the ethical systems of two African-American philosophers, Alain Locke and W.E.B. Du Bois. Both insist that the only path to a viable future is through ethical education.

The second section shows how an African philosopher, Godfrey Nzamujo, has developed a model that translates ethical theory into practice. Nzamujo’s model, the Songhaï Centres, makes primary through post-secondary education, grounded in ethical theory, available to the poorest of the rural poor in Africa. The model establishes eco-villages grounded in a philosophy of sustainability made possible through appropriate technologies in information communication, renewable energy and agroecology. Nzamujo’s villages are rooted in African traditions, enhanced by independence from commercial fertilizers and pesticides, and interlinked with a network of Songhaï Centres and the communities in which the centres are embedded. Starting in Porto Novo in Benin, the Songhaï Centre model has spread to more than fifty sites in seventeen African countries.

The third section outlines a proposal for a global consortium based on the Songhaï model and facilitated through the International Network on Appropriate Technology (INAT). We examine initiatives in Africa, Asia and America grounded in the model’s ethical principles. Critical to an implementation of the Songhaï model is the capital required to establish a global network of eco-villages.

Reflecting on the international aid communities’ systematic application of inappropriate technologies that sustain the Global North/South chasm, the fourth section offers fund-raising proposals to support a global consortium of eco-villages.

The conclusion advocates the implementation of an Africana ethics to guarantee life’s future on earth. For the first time in our ~300,000-year history, inappropriate technologies—fossil fuel, weapons of mass destruction—have given us the power to exterminate life. Appropriate technologies that are made sustainable through the use of biomimicry as the foundational scientific and technological approach implemented within an agroecological ecosystem have the potential to provide every human with a flourishing life. The coronavirus pandemic and its inevitable successors demonstrate the need for a “whole earth” response to threats to life.

## AFRICANA LEADERS PROVIDE CONTRIBUTIONS TO KNOWLEDGE REGARDING APPROPRIATE DEVELOPMENT IN AFRICA: AFRICAN- AMERICAN MODELS FOR A “SURVIVAL ETHICS”

Alain Locke proposed three foundational principles for the practice of ethics (Stewart 2018). First, by reason of its complexity, ethics cannot be the exclusive province of philosophers. Second, ethics, like science, must be an experimental discipline; and third, ethics must serve as the foundation for every course in all curricula.

Unlike previous philosophers who believed that only philosophers are competent to pursue ethics, Locke held that ethics must be grounded in research in anthropology, psychology and sociology (1991:72, 273). Philosophy’s primary task is to develop a ‘panoramic view of man [*sic*] and his place in the universe’ (1991:104). Locke anticipated the concept of “field philosophy,” the idea that a philosopher’s primary task is to pose a problem in ethics to a team of researchers with competence in disciplines like engineering, economics, and political science. The team’s task is to provide collective solutions. The limitation of Locke’s proposal was that he restricted his program to the social sciences and did not include community members and other stakeholders in the search for ethical solutions.

Inspired by the United Nations’ post-war search for a global ethics that came to be the Declarations of Human Rights, Locke developed a method called *Critical Relativism*. Locke modified the theory based on the ideas articulated by Franz Boas and his students in the early 1900s. They argued that cultures should be understood based on their own beliefs, values, traditions, and practices, rather than those of other cultures.

Locke kept the term *relativism* to recognize the value of cultural difference. The term *critical* refers to whether a culture’s values enable the culture to achieve its professed objectives. The theory first describes values as they evolve from their ‘social and cultural backgrounds’ (1989:273); second, it includes a ‘pragmatic test of value adequacy or inadequacy’ for achieving a culture’s goals (ibid.). The other phases examine the hypothesis that selected values may be transcultural. Locke held that ethics is an experimental discipline. He believed that his fusion of philosophical and scientific methods would deliver ‘a more objective confirmation of many basic human values and on a basis of proof approximating scientific validity’ (1991:56). His field philosophy approach ‘could discover beneath expected cultural differentials of time and place such functional “universals” as actually may be there’ (ibid.). Viewing the United Nations Declarations as steps along the path to such universals, Locke insisted that ‘value development and change’ are ‘a dynamic process’ (1991:274).

Locke extended his experimental methods in ethics to the field of education. He believed that every course in every curriculum should be grounded in the ethical conviction that the course’s material, methodology and role in the curriculum should be indispensable for a student’s survival and flourishing (1991:43, 109-128). To be taught effectively, each course should trace its content, methodology and place in the curriculum to the ethical principles that justify the course. Course evaluation, like ethical principles themselves, must be based on longitudinal experimentation.

W.E.B. Du Bois believed that all universities have two ethical responsibilities: first, to execute the research necessary to solve the problems of the communities that support the universities; and second to teach students the skills needed to solve problems whose solutions are well established (Lewis 2000). In addition, he envisioned two distinct ethical obligations for historically black colleges and universities (HBCUs). The first was to instil in their alumni the moral sense that they must employ their problem-solving skills in the underserved communities that gave birth to the idea of HBCUs. The second was to serve as the spearhead for universal higher education (Du Bois 1973).

With respect to the first obligation, Du Bois claims that HBCU alumni owe an extraordinary debt to those who gave their lives to make higher education for African-Americans possible. Howard University law graduates, for example, should practice law ‘not to guide the wealthy and powerful corporations in breaking the law and putting on the statue books laws which discriminate against the poor’ but ‘to see that justice is done’ (1973: 153).

The second task of HBCU alumni is to promote the possibility of universal higher education. Du Bois’ experience with racism and his travels in socialist countries began to convince him that social conditions rather than innate abilities separated the elite from the masses. Reflecting on the mission of HBCUs, he was inspired by the idea that ‘black soldiers of Missouri fighting the last battle of the West’ conceived the ‘idea of systematic education of their fellows in their home state.’ Black educational innovation during Reconstruction made possible in Du Bois’ eyes the ‘public school system of the whole South’ as ‘a gift of black folk’ (1973:129).

Inspired by the Missouri troops, Du Bois began to think of HBCUs as instruments for the universalization of higher education. They ‘can show the majority the way of life’ (ibid. 177). As early as 1941, he became convinced that

‘salvation and culture’ are not created by ‘overwhelming rich and powerful groups’ but by the ‘still small voice of the oppressed and the determined who knew more than to die, and plan more than mere survival’ (ibid.)

Du Bois recognized that his sense of the second mission of HBCUs was untimely. He postponed the realization of the mission: ‘Today there is but one rivalry between culture and vocation, college training and trade and professional education and that is the rivalry of Time. Some day every human being will have college training’ (ibid. 106).

While Global North nations like Norway and Germany move toward realizing Du Bois’ dream by offering free university education, students must qualify in order to be admitted to university. Of all the nations, only Cuba insists that every citizen has a right to a university education. Castro inaugurated ‘municipal universities’ in the most remote areas of Cuba, but Cuba’s impoverishment by the United States’ blockade does not permit the realization of Du Bois’ dream of universal higher education (Verharen 2008). The essay’s next section considers whether appropriate technology has the power to achieve Du Bois’ dream.

## GODFREY NZAMUJO — AN AFRICAN MODEL FOR ETHICAL EDUCATION

Immersed in African-American and African ethics, Professor Godfrey Nzamujo, a Nigerian Dominican priest, developed a model of rural eco-villages that translates Locke’s and Du Bois’ ethical theories into practice. In the spirit of Du Bois’ dream of universal higher education, the eco-villages incorporate the equivalent of a university education. In the spirit of Locke’s insistence that ethics must be a multidisciplinary project, Nzamujo did not restrict his own education to religion and philosophy. He included mathematics, computer systems, development economics and microbiology. Finishing his studies at the University of California/Irvine, Nzamujo taught at Marymount College in Los Angeles, California before returning to Africa to attack the rural poor’s existential crises (Nzamujo 2002).

After Nigerian governments rejected Nzamujo’s petitions for land to start the first eco-village, the Beninese government granted him a tract on the outskirts of Porto Novo with barren soil and useless land. Translating his advanced studies into action, Nzamujo applied agro-ecology, microbiology and biomimicry principles to restore the land to fertility without using chemicals and pesticides. Nzamujo deploys appropriate sustainable technologies within a holistic agroecological ecosystem that spans the fields of ethics, information communication, microbiology, agroecology, international development, and mechanical, electrical, civil and biological engineering in a community-centred development enterprise.

Nzamujo named his model The Songhaï Centre in honour of the Songhaï Empire that took power from the Mali Empire in the early fifteenth century. The Songhaï Centre in Porto Novo led to the founding of three additional sites in Benin. As a measure of its success, fifty four ‘centrally managed Songhaï Centres’ now embody the Songhaï model in Burkina Faso, Chad, Democratic Republic of the Congo, Equatorial Guinea, The Gambia, Ghana, Guinea, Liberia, Malawi, Nigeria, Republic of the Congo, Togo and Uganda (Songhaï Centre 2018: 43).

Three ethical principles guide the development of the Songhaï eco-villages. First, the villages must be *autochthonous*, in the sense of being grounded in the historical traditions of local cultures (Vodouhe & Zoundji 2013). Endogenous knowledge emerging from those long-standing cultural traditions forms the foundation of the village. Humanity’s collective knowledge in the humanities, social sciences and STEM disciplines adds the superstructure. The complementarity of the old and new must be worked out to guarantee the survival and well-being of the community members.

Nzamujo’s second ethical principle is that the village must be *autonomous*. Self-governance and independence depend on extensive knowledge. Nzamujo envisions the eco-village as a ‘knowledge enterprise,’ facilitated by information communication technology (ICT). With local knowledge and ICT access to the global store of information, the village builds the foundation for self-reliance in producing the necessities of a flourishing life: energy, housing, clean air and water, food, healthcare and the advanced education that makes such a life possible. Nzamujo distinguishes between *autonomy* and *independence*. His version of autonomy stresses inter-dependence over independence. The eco-villages form a network of co-operation with one another and with neighbouring communities.

Nzamujo’s third ethical maxim is that the village must be *authentic*. Authenticity has three distinct aspects. First, the village must be dedicated to the well-being of its residents and those of the networked eco-villages as well as the residents of neighbouring communities. Second, the foundation of the village must be ‘authentic technologies... that generate only positive effects/benefits to the producers, consumers and the environment at the same time’ (Nzamujo,

Personal Communication, 05/15/2020). Third, authentic technologies are defined as those ‘aligned with the basic working principles of our planet’ inasmuch as they ‘create synergy, complementarity, supplementarity, cooperation as they operate’ (Nzamujo, *ibid.*) Critical to authenticity is *biomimicry* defined as the attempt to model technologies on natural processes.

The ground of authenticity is ethical education. In addition to educating village members from primary through higher education, Nzamujo initiated the Songhaï Leadership Academy to teach villagers and interested students how to establish their own eco-villages. The Academy’s curriculum encompasses ‘mathematics, statistics, agriculture (all branches), economy, environment, sociology, administrations, town planning, etc.’ (Nzamujo, No Date, 31). In addition to producing scientists, engineers and technologists, the Songhaï curriculum is designed to produce ‘spiritual leaders, mystics, wisdom writers, artists, poets, dancers, musicians, painters, philosophers’ (Nzamujo, Personal Communication, 05/15/2020).

Nzamujo envisions ethical education in the Songhaï Centres to be a counterfoil to university education. He claims that ‘[u]niversity culture today is largely elitist’ (Nzamujo 2018:7). With the University of Bologna’s inauguration in 1088, universities took on the task of creating new knowledge and passing that knowledge on to future generations. However, universities have also helped create the inappropriate technologies that produce catastrophic climate change and the sixth mass extinction.. Nzamujo would like to see African universities restructuring themselves ‘to serve society by spurring efforts to generate knowledge, innovations, ideas and cultures commensurate with the scale, scope and complexity of the challenges that confront Africa today’ (*ibid.* 1). As a millennium of societal inertia makes this reformation problematic, Nzamujo envisions the Songhaï Centre as a community university that is dedicated to solving community problems. The university curriculum is organized on the principle that ‘many of our technological problems have already been solved in nature in elegant, efficient and ecologically sustainable ways’ (*ibid.* 10).

The Songhaï Leadership Academy’s curriculum covers the humanities, social science, and STEM disciplines. The courses are described in the *Songhaï Leadership Academy* bulletin (Nzamujo 2018).The program entails mastery of the techniques of organic agricultural production, including organic fertilizers, soil biology, drip irrigation, mulching, rotation, grafting, pest, parasite and predator control, agricultural machinery, animal, avian and fish husbandry, food production, storage, distribution and export from the eco-villages. Additional courses cover all aspects of ICT.

Nzamujo’s principle of authenticity dictates that the Songhaï curriculum enables the village to be carbon-neutral through appropriate technologies such as photovoltaics, wind turbines, and the use of organic waste to produce biogas and organic fertilizer. The curriculum offers instruction on constructing and maintaining housing for residents, students, and visitors. It also covers basic health care instruction. Specialized courses address manufacture and servicing of agricultural equipment. The Solidarity Fund for Development of French Cooperation helped the Songhaï Centre in Porto Novo set up ‘a foundry to manufacture spare parts for agricultural machinery and food processing equipment that suit the agronomic conditions of the environment’ (Nzamujo 2018, 3).

Extensive capital investment in ICT is key to the Songhaï curriculum. Funding from USAID helped the Songhaï Centre in Porto Novo inaugurate ‘a network of community teleservice operations starting in 1999’ and radio technology ‘to give the population in general and farmers in particular access to new information technologies’ (Vodouhe & Zoundji 2013, 2).

Assessment of the Songhaï Centres finds that they employ ‘local resources, the combination of traditional and modern agricultural practices, technology adaptation and diversification of activities’ (Vodouhe & Zoundji 2013, 3). Through its agroecological technologies, ‘Songhaï integrates “zero waste” and “total productivity” concepts’ (*ibid.*). In recognition of its successes, Benin and the United Nations contributed funding to the centres. Songhaï is acclaimed as a regional centre of excellence by the Economic Community of West African States (UNDP, 2008; Songhaï, 2010).

## **TOWARD A GLOBAL CONSORTIUM GROUNDED IN AFRICANA ETHICS GUIDING APPROPRIATE TECHNOLOGIES TOWARD SUSTAINABLE DEVELOPMENT**

We propose a global consortium of groups working toward sustainable development through appropriate technology. Many other groups throughout Africa and the rest of the Global South engage ethics to address unethical development based on inappropriate technologies. Eco-villages are a growing global force (Brombin 2019, Miller 2018, Xue 2014). The International Network on Appropriate Technology ([www.appropriatetech.net](http://www.appropriatetech.net)) may serve as a base for establishing the global consortium. INAT members have already laid the foundation for the global consortium through their research

efforts and their practical engagement with African and Indian communities. Through networking in INAT’s International Conferences on Appropriate Technology (ICAT), participants like Gada Kadoda, an independent researcher in Khartoum, have worked with Bunker Roy, the founder of the Barefoot College in India. Together, they have worked to solarize villages in Sudan. Howard University professor Joe Fortunak will work with Godfrey Nzamujo to inaugurate production and distribution of pharmaceuticals in the Songhaï Centres. Fortunak will use the model he and his African and United States colleagues established at the St. Joseph College of Pharmacy in Tanzania (Verharen, Tharakan, Bugarin, Fortunak, Kadoda, Middendorf, 2013a).

INAT members are examining eco-village models throughout India to determine whether their ethics would incline them to become members in a global consortium. The idea of an ecological village has roots in the Indian independence movement with Gandhi’s call to use local resources and develop indigenous technologies (Singh, B., Keitsch, M., Shrestha, M., 2019).

The history of the “eco-village” community in India dates back to the establishment of self-sufficient Ashrams where residents grow their own food, engage in small and medium enterprises to produce goods and services, use renewable energy and aspire to zero-waste circular economies and ecosystems.

An eco-village community, the Muni Seva Ashram in Vadodara Gujarat ([www.greenashram.org](http://www.greenashram.org)), is dedicated to health care. The village includes a hospital, a cancer research and treatment centre, and schools devoted to nursing, pre-K-12 through Grade 12, vocational skills, and girls and women of all backgrounds. The Ashram includes a guest house for patient’s families and other guests, as well as residential facilities for the students in the various educational units.

Grounded in the principle of sustainability, the Ashram produces renewable energy through biogas, biomass gasifiers and plasma arc recycling. Both the world’s first solar crematorium and the air-conditioning systems are solar powered. While currently dependent for some power from the Vadodara Gujarat grid, the Ashram is installing a 1.2 MW biogas plant that will render the ecovillage grid-independent and 100% renewable. Organic farming and animal husbandry provide dairy products and manure to power the biogas plants.

In Africa in The Gambia, two models embody the philosophy of the Songhaï model. The first focuses on the beekeeping industry. *BEECause Gambia*, founded in 2009 through a consortium of bee farmers, strives to use beekeeping as a method to improve the lives of the rural poor (Rahman Sallah, 2015; Africa BEECause, 2020). BeeCause Gambia regularly trains both new and old bee farmers to support sustainable bee farming. They address poverty in the region by creating new jobs while also protecting the environment through eco-friendly farming techniques. Available courses in the program include building hives, forest protection, production of bee products, and environmental conservation.

A second strategy designed to help Gambians address food insecurity revolves around the threat of global warming. To combat climate change with an early warning system, the Gambian government, United Nations Environment, and other partners established fourteen pilot villages in 2014 (UN Environment Programme 2020). Each was supplied with cell phones, radios, and loudspeakers to facilitate a mobile network. Forecasting equipment was distributed to stations to share climate information more widely. Trained volunteers transferred knowledge to community members in meetings, home visits, and “theatre” (e.g., through drama groups). With shared lessons regarding the impacts of climate change, communities have developed alternative ways of adapting. In addition to improving and developing appropriate technologies for information communication, projects have focused on community gardens that include supplemental crops to grains that rely solely on rain. They have also tried solar-powered irrigation techniques.

## **GLOBAL NORTH FINANCIAL INITIATIVES TO CAPITALIZE RURAL AND URBAN ECO-VILLAGES**

Economic resources are needed to fund appropriate technologies for a global consortium based on African ethics. Stakeholders at the grassroots level should have a major voice in the management of funds. Historical top-down funding initiatives often arise from Global North investors who direct capital flow and development technologies into the wrong hands. We propose bottom-up funding initiatives controlled by African stakeholders with emphasis on local community member engagement. Since the consortium focuses on ethical education from primary through post-secondary education, it must consider whether sufficient capital can be produced to ensure universal broadband connectivity in the Global South. The education model in Nzamujo’s Songhaï Centres is based on information communication technology (ICT).

A problem for a global eco-village consortium is access to basic texts in all disciplines. ICT solves the problem of the immense cost of physical texts due to their production costs and publishers’ profits. A second problem is access to

published research in all fields. The global consortium’s task would be to encourage open source publication of basic introductory texts and a universal research library.

Perhaps the most significant problem is raising the capital necessary to provide the appropriate technologies that are indispensable to global eco-villages.

## RESEARCH METHODOLOGY

To dismantle the subjectivities and biases of a Western, predominantly white-derived science that supports only ONE scientific format and fails to understand the needs, voices, and perspectives of the poor, particularly in the Least Developed Countries (LDCs) in Africa, we must use the methods established by social scientists who have worked with local and indigenous communities and communities of colour since the early 1900s and who regularly navigate between appropriate technologies and the most vulnerable populations in the world. Derived from applied anthropology and other social science fields (Kedia & van Willigen, eds., 2005; van Willigen, 2002; Bernard, 2013), particularly those who work in international development (Sumner & Tribe, 2008), our proposed methods consist of the following.

First, we recommend establishing small projects that emerge from the ground up. Designed on little to no seed money, they set test conditions that allow us to determine probability of success. Faculty at universities can fund these initiatives through early concept grants, exploratory research grants, or rapid response research grants.

Second, we analyse and test the effectiveness of initial projects through a variety of methods born out of the assessment techniques used by many in international development (e.g., rapid rural and urban assessments, participatory assessments, surveys, and interviews). We collect qualitative and quantitative data that provides meaningful insights about each project. We need to use techniques that measure non-linear, multi-dimensional success that may occur in incremental steps over long periods of time.

Third, we use rigorous analysis and data to demonstrate that our innovative solutions are making a difference that outshines other initiatives. Mathematically, can we predict that the benefits from our efforts will double exponentially as we continue to establish more centres, grow networks, and launch additional projects?

Fourth, we facilitate a convergence of stakeholders and bring aboard the right actors. We ensure that our agenda and projects fit into the goals of local governments as well as different stakeholders within a community.

Fifth, we must recognize that every donor and funding organization has a unique culture. Each has mission statements, goals, and guidelines that determine the allocation of funds. Each has their own experts that abide by the social norms of their organization or discipline. Knowing the donor culture and creating solid relationships with them will enable us to develop fundable projects that nevertheless fit into the ethical and community-driven framework.

Sixth, we must demonstrate that investment into the Songhaï centres serves a global benefit. We must collect data that illustrates how local challenges and hardships impact a universal collective.

Lastly, we can create a brand, market our initiatives, and empower multiple communities to share their successes through growing networks of support. A brand can help supporters remember the Songhaï centres and projects and raise awareness about their significance.

## CONCLUSION: AN AFRICANA ETHICS FOR GLOBAL SURVIVAL AND FLOURISHING

The essay’s “whole earth” ethics is an “Africana Ethics” that emerges from reflection on humanity’s collective ethical systems, starting with the ancient Egyptian ethical system and concluding with recent African and African-American responses to challenges to their communities’ survival and flourishing (Verharen 2012).

As a global ethics, Africana ethics envelops the ethical systems of Asia and Europe that accompanied their cultures’ survival and flourishing for thousands of years. Philosophy in general and ethics in particular exhibit the traits characteristic of speculation at the extreme limits of generalization. The ethical commands proposed by diverse cultures over the past five thousand years must have seemed preposterous at first glance.

Imagine a life directed solely to controlling attention through meditation as the Hindus, Buddhists and Daoists command.

Can we picture other aspects of life as equally or even more important? Should we give credence to the ancient Greek’s focus on reason, Christ’s dedication to universal, unconditional love, or the 19<sup>th</sup> century utilitarian demand for universalized pleasure? Should we value Darwin’s 19<sup>th</sup> century common sense insistence on survival, and the 19<sup>th</sup> century German call for freedom? Especially preposterous are the claims of Christ and Marx that every human being must be included in the definition of “our group.” That definition requires self-sacrifice—to the point of sacrificing one’s life—for the sake of universal freedom and love (Verharen et al., 2013a)

Empirical confirmation of universal claims of value is impossible. Nevertheless, nominal profession of faith in each of these cultural values has accompanied the survival and flourishing of their cultures for 3500 years for the Hindus, 2500 years for the Greeks, and 2000 years for Christians. Nineteenth century European philosophies have been tested over briefer spans, yet they have exerted global influence that shows no signs of diminishing. Our hypothesis is that such powerful and long-lasting values must be indispensable to survival and flourishing. Nevertheless, their contribution to an imminent extinction of life springs from overconcentration on their singular values (Verharen, Tharakan, Middendorf, Castro-Sitiriche, Kadoda. 2013b). Too much of a “good thing” can lead to catastrophe.

The ethical system that anticipates and synthesizes the answers to the question, “How should we live?” comes out of ancient Africa. The ancient Egyptians realized some five thousand years ago that hyper-focus on a single ethical value would be catastrophic. While freedom, pleasure, survival, love, reason and meditation are critical components of survival and flourishing, their exaggeration is perilous and easily dismissed.

Socrates and Christ abandoned survival for the sake of truth and love. European hypertrophy of reason helped create catastrophic climate change and the sixth mass extinction. Utilitarian calculus leads to “death panels” in the time of Covid-19 (see Singer, 2011). Against the monomania of Asian and European cultures, the ancient Africans insisted that only one viable ethical value must harmonize all conflicting values (Verharen et al., 2014). They called for a value that created harmony and balance, and truth and justice. The ancient Egyptians called their single ethical value that embraced all other values *Maat*.

In search of an ethics that may have the best chance of guaranteeing life’s future on earth, we contemplate a return to Africa. The ancient Egyptians astound us with their cultural artifacts that have endured through the centuries (Hornung, 2001/1999). Their greatest creation, their ethical system, can be our best hope for deploying appropriate technology for life’s survival and flourishing.



## LIST OF REFERENCES

- Africa BeeCause. [Online] Available at: [https://africabeecause.org/?page\\_id=14](https://africabeecause.org/?page_id=14), accessed May 5, 2020.
- Bernard, H. 2013. *Social research methods: Qualitative and quantitative approaches*. Los Angeles, California: Sage.
- Bogale, S. 2009. Indigenous knowledge and its relevance for sustainable beekeeping development: a case study in the Highlands of Southeast Ethiopia. *Livestock Research for Rural Development* 21(11):2000. [Online] Available at: <http://lrrd.cipav.org.co/lrrd21/11/boga21184.htm>, accessed May 5, 2020.
- Brombin, A., 2019. The ecovillage movement: New ways to experience nature. *Environmental Values*, 28(2), pp.191-210.
- Du Bois, W. 1973. *The education of black people: Ten critiques, 1906-1960*. Ed. H. Aptheker. New York, NY: Monthly Review Press.
- Gardiner, S. 2011. *A perfect moral storm: The ethical tragedy of climate change*. Oxford: Oxford University Press.
- Hawking, S. & Mlodinow, L. 2010. *The grand design*. New York: Bantam.
- Hornung, E. 2001/1999. *The secret lore of Egypt: Its impact on the West*, transl. D. Lorton, Ithaca, NY: Cornell University Press.
- Kedia, S. and van Willigen, J., eds. 2005. *Applied anthropology: Domains of Application*. Westport, Connecticut: Praeger.
- Kolbert, E. 2014. *The sixth extinction: An unnatural history*. New York: Picador.
- Lewis, D. 2000. *W.E.B. Du Bois: The fight for equality and the American century 1919-1963*. New York: Henry Holt & Company.
- Locke, A. 1991. *The philosophy of Alain Locke: Harlem renaissance and beyond*. Ed. L. Harris. Philadelphia, PA: Temple University Press.
- Miller, F. ed., 2018. *Ecovillages around the world: 20 regenerative designs for sustainable communities*. New York: Simon and Schuster.
- Nzamujo, G. 2002. *Quand l'Afrique relève la tête / When Africa emerges*. Paris: Editions du Cerf.
- Nzamujo, G. No Date. *Songhai stands up: Training, production, research & development in sustainable agriculture*. Unpublished ms., available from author.
- Nzamujo, G. 2017. *Songhai leadership academy*. Unpublished ms., available from author.
- Nzamujo, G. 2018. *The African university of the future: A knowledge enterprise for articulating and incubating radical solutions to the formidable challenges on the continent*. Ibadan Nigeria, November 15. Unpublished ms., available from author.
- Pinker, S. 2011. *The better angels of our nature: Why violence has declined*. New York: Viking.
- Pinker, S. 2013. Science is not your enemy: An impassioned plea to neglected novelists, embattled professors and tenureless historians. *New Republic*, August 6. [Online] Available at: <http://www.newrepublic.com/article/114127/science-not-enemy-Humanities>.
- Pinker, S. 2018. *Reason now: The case for reason, science, humanism, and progress*. New York: Viking.
- Rahman Sallah, A. 2015. Bee Cause Gambia trains bee farmers on ethical bee farming. *The Point*. [Online] Available at: (<http://thepoint.gm/africa/gambia/article/bee-cause-gambia-trains-bee-farmers-on-ethical-bee-farming>), accessed May 5, 2020.
- Schell, J. 2000. *The fate of the earth and abolition*. Palo Alto, CA: Stanford University.
- Singer, P. 2011. *The expanding circle: Ethics, evolution and moral progress*. Princeton, NJ: Princeton University Press.
- Singh, B., Keitsch, M.M. and Shrestha, M., 2019. Scaling up sustainability: Concepts and practices of the ecovillage approach. *Sustainable Development*, 27(2):237-244.
- Songhai Centre 2018. *Agribusiness incubation as a flexible mechanism toward youth empowerment in Africa*. Unpublished ms., available from author.
- Stewart, J. 2018. *The new Negro: The life of Alain Locke*. New York: Oxford University Press.
- Sumner, A. and Tribe, M. 2008. *International development studies: Theories and methods in research and practice*. Thousand Oaks, California: SAGE Publications Ltd.
- United Nations Development Program. 2008. *Regional project for the development of agricultural entrepreneurship: Realization of South-South cooperation*. Newsletter, May 2008.
- Verharen, C. 2012a. Ancient Africa and the structure of revolutions in ethics: A prolegomenon for contemporary African political philosophy, *Philosophia Africana*, 14(2):1-21.
- Verharen, C., Tharakan, J., Bugarin, F., Fortunak, J., Kadoda, G., Middendorf, G. (2013a). Survival ethics in the real world: The research university and sustainable development, *Science and Engineering Ethics*, 20(1):135-154. doi10.1007/s11948-013-0441-8, [Online] Available at: <http://link.springer.com/content/pdf/10.1007%2Fs11948-013-9441-8.pdf>.
- Verharen, C., Tharakan, J., Middendorf, G., Castro-Sitiriche, M., Kadoda, G. 2013b. Introducing survival ethics into engineering education, *Science and Engineering Ethics*, 19(2):599-623.
- Verharen, C., Gutema, B., Tharakan, J., Bugarin, F., Fortunak, J., Kadoda, G., Liu, M., Middendorf, G. 2014. African philosophy: a key to African innovation and development, *African Journal of Science, Technology, Innovation and Development*, 6(1):3-12, DOI: 10.1080/20421338.2014.902565
- UN Environment Programme. 2020. *Sowing hope in The Gambia*. [Online] Available at: <https://www.unenvironment.org/news-and-stories/story/sowing-hope-gambia> (accessed May 5, 2020).
- van Willigen, J. 2002. *Applied anthropology: An introduction*. Westport, Connecticut: Praeger.
- Vodouhe, S. & Zoundji, G. 2013. The Songhai Centre in Benin. *MEAS Case Study Series on Human Resource Development in Agricultural Extension*, #7, January. [Online] Available at: <http://www.measextension.org/meas-offers/case-studies>.
- Wilson, E. O. 2012. *The social conquest of nature*. New York: Liveright.
- Wilson, E. O. 2014. *The meaning of human existence*. New York: Liveright.
- World Bank. 2019. Poverty headcount ratio at national poverty lines (%of population) – The Gambia. [Online] Available at: <https://data.worldbank.org/indicator/SI.POV.NAHC?locations=GM>
- World Food Program USA. 2020. The Gambia. [Online] Available at: <https://www.wfpusa.org/countries/gambia/#>.
- Xue, J., 2014. Is eco-village/urban village the future of a degrowth society? An urban planner's perspective. *Ecological Economics*, 105(C):130-138.

9TH INTERNATIONAL CONFERENCE ON APPROPRIATE TECHNOLOGY

# SECURITY AND SAFETY

# ACCESSIBLE RAIL STATION PLATFORM INDEPENDENT GAP FILLER FOR PERSONS WITH REDUCED MOBILITY

Dr Emmanuel Matsika, Mr. Lingong Li  
Newcastle University, Newcastle, UK, emmanuel.matsika@ncl.ac.uk

## Abstract

*The enactment of the United Kingdom (UK) Disability Discrimination Act 1995/2005 (now Equality Act 2010) and enforcement of the 2008 European Commission (EC) Technical Standards on Interoperability (TSI) for Persons with Reduced Mobility (PRM) (now TSI PRM 2014) have led to an increasing number of PRMs travelling by rail. Despite this, safety concerns remain as infrastructure managers and train operators adapt to new requirements for accessibility. For example, accidents that occur at the platform-train interface (PTI) can result in severe injuries.*

*This paper reviews different gap fillers and provides a new design concept to resolve this challenge. The research applies science and technology to work toward promoting equal access for PRMs in transportation systems. It presents a boarding mechanism that helps PRMs to board and alight independently by means of an automatically actuating platform-based ramp. It applies three degrees of freedom (DoF) for translation motion, and two DoF for angular motion. A combination of these five DoF ensures successful gap filling. Infrared and inductive sensors control the actuations. The system is capable of moving 2 m along the platform. It covers a maximum horizontal gap of 500 mm and has a maximum inclination of 10.2°.*

*The concept aims to reduce dwell time, despite the presence of PRMs. This allows for zero interference in terms of the door usage from all passenger groups. In addition, it facilitates effective crowd-flow management during boarding and alighting. An evaluation based on cost, performance, safety and crowd flow shows the effectiveness of the mechanism. It is recommended that it should be installed at all platforms to help PRMs board independently. Corresponding safety standards and regulations need to be developed to ensure the safety and security of the mechanism. The system can be installed at both retrofitted and newly-built platforms. It therefore has the potential to promote job creation through its design, manufacture, installation, operation and maintenance, thereby contributing to the socio-economic situation of a country.*

**Keywords:** PRMs, PTI gap filler, accessibility, TSI PRM, DoF, socio-economic.

## INTRODUCTION

### Background

Rail transport serves over 1.6-billion passengers annually worldwide. It is regarded as one of the most important modes of transport due to its stability, safety, large capacity and relatively low cost. Its green credentials render it attractive owing to climate change being on top of the global agenda. One of the concerns associated with rail transport is safety in stations, particularly the PTI. Usually, there is a gap at the PTI, which presents a hazard for passengers. Although the

number of accidents that occur at the PTI is low, 20% of weighted injuries and 36% of passenger fatality risks occur at the PTI (RSSB, 2019). The UK rail industry experiences approximately 1 500 PTI incidents annually, with 38 resulting in fatalities per decade. One group of passengers most at risk are PRMs. According to European Union definition, PRMs include not only persons with disabilities, but also the elderly, pregnant women and passengers carrying luggage. A recent survey found that, using this definition, about 50% of rail passengers are PRMs (Lemmerer, Shibayama, Ruger, Seltenhammer, Macoun, Matsika, Logueira, Battista, Khosravi, de Santiago Laporte, Kuzmina, 2018).

The enactment of the UK Disability Discrimination Act 1995/2005 (now incorporated in the Equality Act 2010), and enforcement of the 2008 EC TSI PRM (now updated to TSI PRM 2014) have led to an increasing number of PRMs travelling by rail. Despite this, safety concerns exist as infrastructure managers and train operators adapt to new accessibility requirements. Currently, most PRMs, especially persons with disabilities, cannot board and alight without assistance. They find travelling by rail challenging due to PTI concerns (Matsika, Chirwa & Peng, 2013).

The PTI gap is affected by many factors (Atkins Rail, 2004). Step height is determined by the train floor height and platform height. Floor height is determined by the suspension displacement and wheel diameter. Track radius and speed at the platform also have an influence on the gap stepping distance. Lastly, the cant of the track, which helps the trains to pass the curves, can either have the effect of leaning the train towards a convex platform, thereby reducing stepping distance, or the effect of leaning the train away from a concave platform, thereby increasing stepping distance.

This paper reviews different PTI gap fillers and provides a new design concept to resolve this challenge. The research applies science and technology to work towards promoting equal access to transportation systems for PRMs. The design concept helps PRMs to board and alight independently through an automatically actuating platform-based ramp. This work constitutes Phase II of the research, with Phase I (research background) having been carried out by Guo (2018).

### Aims and Objectives

In this research, previous designs are reviewed in order to develop a new mechanical mechanism to resolve the PTI gap problem to help PRMs to board and alight safely and easily. A recommendation is made for the application of sensors and computer software to enable the operation of the mechanism to compensate for the gaps automatically. Below are the research objectives:

- Review the design concept from the previous researcher (Guo, 2018).
- Select the best solution for further development.
- Design the mechanism and produce computer-aided design (CAD) drawings.
- Make recommendations for the automation of the mechanism.
- Explain how this solution contributes to the socio-economic situation of the wider society.

### Methodology

Firstly, the researchers visited Newcastle Rail Station to collect some information necessary for the new design. This helped with the identifying and recording of different types of trains that the station serves. Measurements were determined for train door dimensions, PTI horizontal (l) and vertical (h) distances, as well as train dwell time (t). The crowd flow and station capacity were also noted. This information augmented secondary data.

Secondly, existing gap-filler designs were reviewed. Their advantages and disadvantages were analysed. A comparison of different designs was done to select the one that was most suitable for further development. The evaluation criteria were based on factors of cost, safety, performance and other indicators.

Thirdly, the detailed dimensions and structure of the parts and assembly of the mechanism was completed using SolidWorks software. The design data came from field primary data and secondary data (literature). The result was a 3D CAD model. An animation was developed to demonstrate the functionality of the design concept.

Fourthly, recommendations were made for the automation of the mechanism. The operational principles were demonstrated.

Fifthly, the design concept was evaluated using factors such as cost, performance, safety crowd flow and station capacity by applying Likert scale evaluation criteria.

Finally, the contribution of the proposed solution to the socio-economic situation of the wider society was discussed.

### REVIEW OF EXISTING GAP FILLER AND BOARDING SOLUTIONS

In most cases, there is a vertical (step) and horizontal (gap) at the PTI. This can be inevitable, especially on curved platforms, and those served by trains with a wide range of floor/step heights. The gap is required to permit for horizontal movement of the train as it passes through the station. In Europe, over 30 000 rail stations have a gap problem (EC FAIR Stations, 2020). Only a small proportion of these have the legislated step free access (<75mm horizontal and <50mm vertical). The UK is among the countries with the largest problem. Where necessary, boarding aids are used to improve PTI safety.

To improve PTI safety, various solutions have been developed. The overall aim of each solution is to compensate for the height and/or horizontal distance differential between the rail vehicle and station platform. Solutions to close the gap between the vehicle and the platform are categorised as platform-based or vehicle-based. In some cases, the optimum resolution is a mix of strategies, such as platform-raising or an extendible footstep. A further differentiation is the use of fixed or active systems. Fixed gap fillers do not move once installed, while active solutions can move, either purely mechanically or by automation. Examples include deployable footsteps or platform edge solutions that may actively extend once a train arrives. The following sections review platform-based solutions (incorporating platform edge devices and track alterations), and train-mounted solutions.

#### Summary of Rail Passenger Boarding Solutions

In Phase I of this research, Guo (2018) discussed various gap filler designs and innovations that have been developed to resolve safety concerns at the PTI. Most of the solutions aim to cover the horizontal gap, when really, the vertical gap also poses injury potential. Gap-filler designs can either be platform-based or vehicle based, as shown in Figure 1 and Figure 2 respectively. Table 1 and Table 2 present specific examples, respectively.

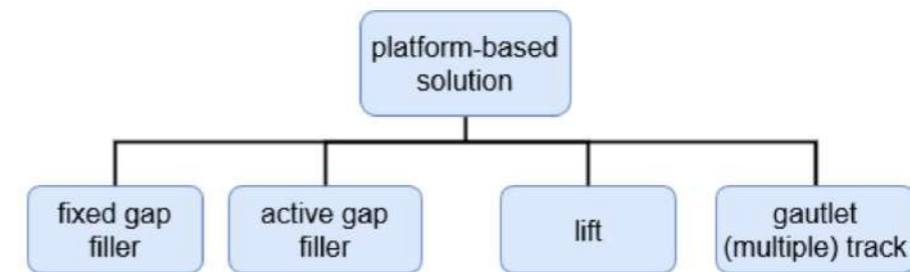


Figure 1: Platform-based solutions.

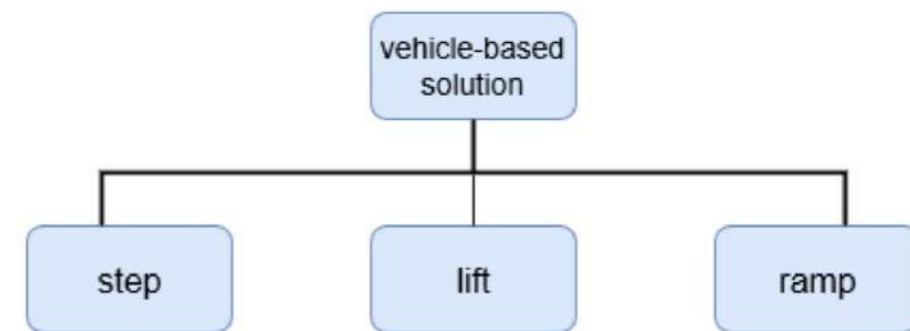


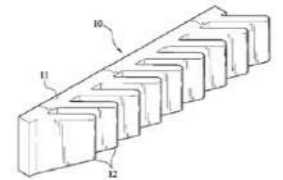




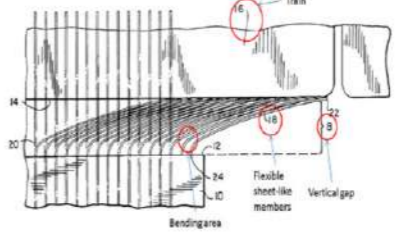
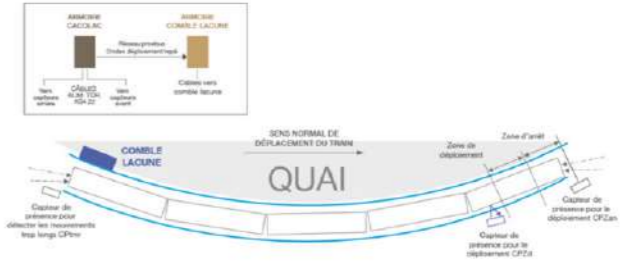
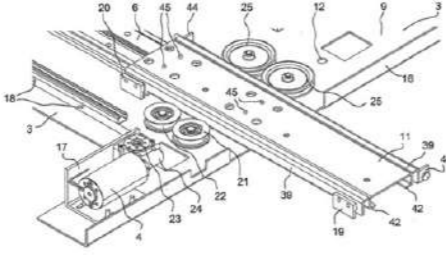

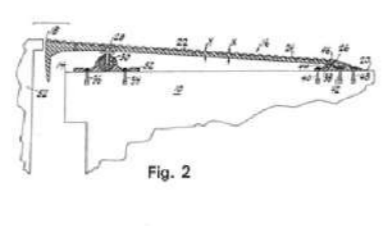
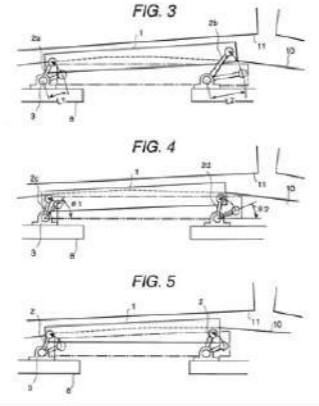
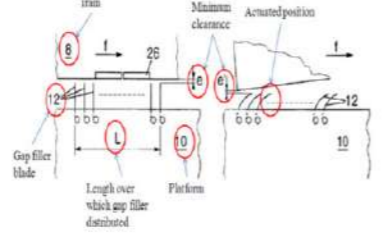


Figure 2: Vehicle-based solutions.

Table 1: Platform-based rail gap filler and boarding designs (Guo, 2018).

Type of Design	Designs	Illustration	
Fixed	Delkor Rail		
	Pipex px gap filler		
	Platform edge device	Safety gap filler for railway platforms	
		CDM Flexibord	
		STRAIL edge	

Type of Design	Designs	Illustration
Active Gap Fillers	Bigorre Ingenierie device	Corrugated platform edge 
		Raised platform 
		Railway platform gap filler 
		CACOLAC 

Type of Design	Designs	Illustration
	Gap-Bridging Device for Train Platforms	 <p>Fig. 2</p>
	Platform edge extender	
	Platform edge warning ramp	 <p>Fig. 2</p>
	Step apparatus for platform	
	Device for reducing gaps	 <p>Train Maximum clearance Adjusted position Gap filler blade Length over which gap filler distributed Platform</p>

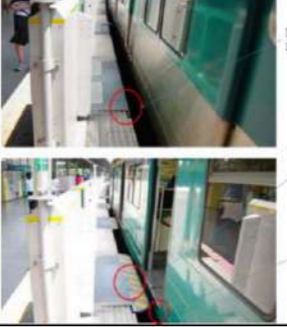
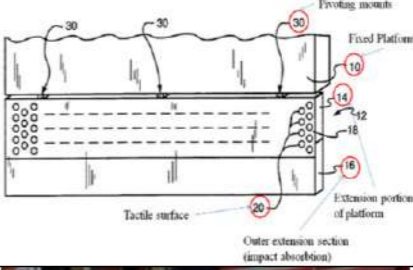





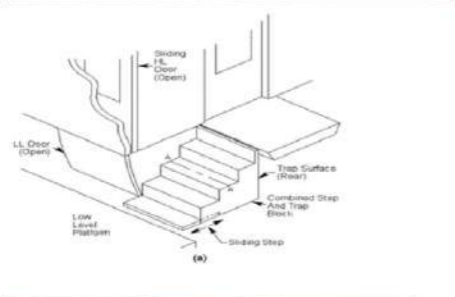


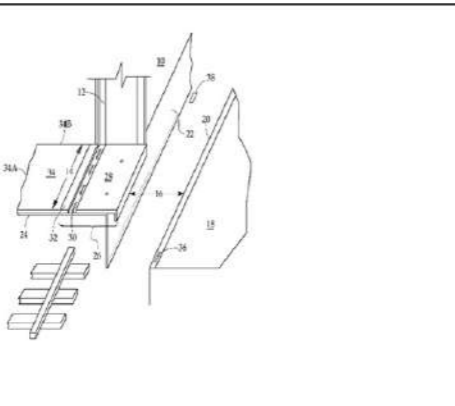


Type of Design	Designs	Illustration
	Removable platform edge	 <p>Deactivated Movable Platform Edge Activated Movable Platform Edge Hazard in Door Opening Position</p>
	Retractable station platform extension	 <p>Pivoting mounts Fixed Platform Tactile surface Extension portion of platform Outer extension section (impact absorption)</p>
	Manual ramp	
Gauntlet (multiple) track	Gauntlet (multiple) track	
The Platform-based Lift	Lift system	

Table 2: Vehicle-based rail gap filler and boarding designs (Guo, 2018).

Type of Design	Designs	Illustration
Foot Steps	Pendolino footstep	
	Stadler deployable footstep	
	Interchangeable step	
Automated Ramps	Brightline train door ramp	
	Glidelok ramp	
	Train-to-platform gap mitigator	

Type of Design	Designs	Illustration
Manual Ramps	Ramp	
Vehicle-based lift	Lift	

### Platform-based systems

Platform-based designs vary from significant platform adjustments to simply devices on the platforms. They are divided into fixed or movable devices.

Fixed designs are mostly flexible, used to partially or fully fill the gap. Most can be used both for straight and curved platforms. Their advantages are:

- Minimal vehicle service delay during installation.
- Less installation and maintenance costs.
- No significant platform alterations required.

The disadvantages of fixed solutions are:

- Requires more design details to match user needs.
- Difficulties in addressing the vertical gap.
- Abrasion because of device-vehicle contact.

Active or moveable systems utilise sensors to detect the location of the vehicle doorway in reference to the platform, and then adjust the device to a predefined position. Like fixed designs, moveable systems are not suitable for vertical gaps. Their main advantage is the application of sensors to improve the accuracy of the device operation and reliability. Disadvantages include: delays in terms of vehicle service because the detecting parts principally actuate only once the vehicle stops; costly installation and maintenance; and the requirement for significant platform alterations.

## Vehicle-based systems

These systems can be fixed or moveable (operated manually or semi-automated). Some of them are suitable for compensating both horizontal and vertical gaps. Most of the vehicle-based designs are intended for horizontal (flat) applications, while a few deploy step-type gap fillers.

Fixed designs have the following advantages:

- Minimal vehicle service delay during installation.
- Less installation and maintenance costs.
- No significant platform alterations required.

Their disadvantages are:

- Limitations in terms of dimensions to suit the vehicle space.
- Difficulties in meeting the dual aim of filling the horizontal and vertical gaps.
- Prone to wear and tear because of physical contact with the train.

Moveable designs utilise sensors to detect moment and location to deploy the gap filler. The advantages of these designs are their suitability for both horizontal and vertical gaps. Disadvantages include delays in vehicle service, as well as costly installation and maintenance.

## EVALUATION OF RAIL PASSENGER BOARDING SOLUTIONS

Considering that there are so many options to choose from, this section provides a guide to the selection of the gap filling solution that meets some pre-determined criteria. An essential expert subjective investigation was performed within this scientific project. The expert group consisted of 10 mobility researchers and transport operators. Subjective evaluation is defined as an emotional judgment supported by non-quantifiable data. For the evaluation criterion, four factors were considered, namely: cost, applicability, operation and implementation. These were further sub-divided as shown in Figure 3.

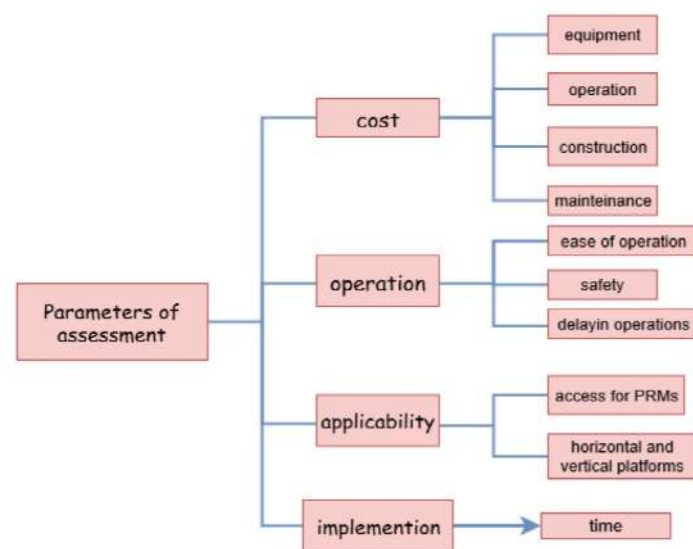


Figure 3: Factors used for the evaluation criterion.

## Factors for evaluation

### Cost

The following cost components were considered:

- *Equipment*: Actual initial cost of the device and associated components.
- *Operational*: Associated with the exploitation of the system. Using electric and control systems increases costs when compared with fixed and mechanical installations.
- *Construction*: From a development perspective, the solution with the slightest alteration to the current setup would be cheaper.
- *Maintenance*: Preventive or planned checks and repairs at regular intervals are cheaper than breakdowns and unplanned works.

### Operations

Factors for evaluation included operational simplicity, safety and delays:

- *Ease of operation*: A simple and easy system saves time and reduces train dwell time.
- *Safety*: This is the primary purpose of gap fillers and boarding systems at the PTI. The solution should adequately compensate for the horizontal and vertical gaps sufficiently enough to avoid PRMs falling or being injured when boarding or alighting.
- *Delay in actuation*: The actual deployment of the system requires time, particularly for moveable systems. There are devices that do not require a deployment time, such as fixed platform-based designs.

### Applicability

Applicability is a factor that alludes to:

- *Access for PRMs*: The gap filler should be positioned primarily to facilitate the easy and safe boarding and alighting of PRMs. Ideally, it should provide a step-free level boarding.
- *Horizontal and vertical gap filling*: The goal of installing a gap filler or boarding system is to fully compensate for the gaps. However, this is not always easy or possible as has been demonstrated by the many different designs in Section 2.

### Implementation

The time needed to install the solution is important. This will determine how long the platform may be out of service while construction takes place. It may also indirectly infer installation labour costs.

## Weighting and rankings

Design solutions were evaluated using the factors discussed earlier. The criteria applied a Likert scale of 1 (low performance or less desirable) to 5 (high performance or most desirable), using the evaluation of 10 experts. Applicability, deemed to be most important for PRMs, accounted for 40%, while cost, operations and implementation each accounted for 20% of the score.



Presented in Table 3 are the overall results of the evaluation.

Table 3: Evaluation Results (Guo, 2018).

	cost(20%)					applicability(40%)					operation(20%)					implementation(20%)		overall	
	equipment	construction	maintenance	operation	total	access for PRMs	horizontal and vertical platforms	total	ease of operation	safety	delay in operations	total	time	total	actual	converted			
																	actual		converted
platform-based solution	5	5	5	5	5	5	5	5	5	5	5	5	5	5	5	5	5	5	100
Delkor Rail	5	5	4	5	19	19	1	1	2	8	5	2	5	12	16	3	3	12	55
Pipex px gap filler	2	3	2	3	10	10	2	1	3	12	4	3	4	11	14.7	2	2	8	44.667
Safety gap filler	5	5	2	5	17	17	2	1	3	12	5	3	5	13	17.3	3	3	12	58.333
CDM Flexibord	5	4	3	5	17	17	1	2	3	12	5	3	4	12	16	2	2	8	53
STRAIL edge	4	3	3	5	15	15	3	1	4	16	5	4	5	14	18.7	3	3	12	61.667
Corrugated platform edge	4	4	3	5	16	16	3	1	4	16	5	2	3	10	13.3	3	3	12	57.333
Platform level access hump	5	4	3	5	17	17	4	1	5	20	4	2	4	10	13.3	3	3	12	62.333
Railway platform gap filler	4	3	4	4	15	15	1	1	2	8	4	1	4	9	12	2	2	8	43
CACOLAC	1	2	2	5	10	10	3	2	5	20	5	2	3	10	13.3	2	2	8	51.333
Bigorre Ingenierie device	3	3	2	4	12	12	2	1	3	12	4	2	4	10	13.3	2	2	8	45.333
Gap-Bridging Device	3	3	2	1	9	9	3	2	5	20	3	4	2	9	12	2	2	8	49
Platform edge extender	4	3	3	5	15	15	3	1	4	16	5	3	4	12	16	3	3	12	59
Platform edge warning ramp	3	2	2	2	9	9	4	3	7	28	3	3	2	8	10.7	2	2	8	55.667
tep apparatus for platform	2	3	2	3	10	10	4	3	7	28	2	3	2	7	9.33	1	1	4	51.333
Retractable station platform extension	2	2	3	3	10	10	3	1	4	16	4	4	2	10	13.3	1	1	4	43.333
Movable platform edge	3	3	3	2	11	11	4	3	7	28	4	3	1	8	10.7	2	2	8	57.667
Gauntlet (multiple) track	4	4	3	4	15	15	2	2	4	16	4	2	1	7	9.33	2	2	8	48.333

	cost(20%)					applicability(40%)				operation(20%)					implementation(20%)		overall		
	equipment	construction	maintenance	operation	total	horizontal and vertical platforms access for PRMs	total	ease of operation	safety	delay in operations	total	time	total	actual	converted				
																actual		converted	actual
vehicle-based solution																			
Pendolino footstep	4	4	4	5	17	17	3	1	4	16	5	1	5	11	14.7	4	4	16	63.667
Stadler deployable footstep	5	4	4	4	17	17	3	1	4	16	4	4	5	13	17.3	5	5	20	70.333
Interchangeable step	3	2	2	3	10	10	4	3	7	28	2	3	2	7	9.33	2	2	8	55.333
Brightline train door ramp	3	3	4	3	13	13	4	3	7	28	3	4	4	11	14.7	3	3	12	67.667
Glidelok ramp	2	4	3	2	11	11	4	5	9	36	4	4	2	10	13.3	3	3	12	72.333
Train-to-platform gap mitigator	2	2	2	2	8	8	3	3	6	24	2	4	2	8	10.7	2	2	8	50.667
Manual Ramps	5	5	5	5	20	20	5	5	10	40	4	4	2	10	13.3	4	4	16	89.333
Lifts	2	4	3	2	11	11	5	5	10	40	3	5	1	9	12	1	1	4	67

Below is a summary of the outcomes of the evaluation.

Ranking based on cost:

1. Manual ramps
2. Delkor Rail

Ranking based on applicability:

1. Manual ramps/lifts
2. Glidelok ramp

Ranking based on operations:

1. STRAIL edge
2. Safety gap filler/Stadler deployable footstep

Ranking based on implementation:

1. Stadler deployable footstep
2. Pendolino footstep/manual ramps

### Overall ranking:

#### 1. Manual ramps (Devadoss, Ahmad & Dhamodharan, 2012)

- Appropriate for both straight and curved platforms.
- Accessibility for PRMs.
- Horizontal and vertical gap filling.
- Minimal costs of installation, operations and maintenance.

#### 2. Glidelok ramp (Fullerton, 2005)

- No vehicle alteration required.
- Appropriate for both straight and curved platforms.
- Accessibility for PRMs.
- Horizontal and vertical gap filling.

#### 3. Stadler deployable footstep (Stadler, 2015)

- Appropriate for both straight and curved platforms.
- Accessibility for PRMs.
- Horizontal and vertical gap filling.

### NEW PROPOSED SOLUTION

The review of the gap filler solutions and boarding systems revealed that they have advantages and disadvantages. In order to provide guidance on the most suitable solution for future development, an evaluation criterion was applied. For accessibility and safety, results show that the manual ramp has more advantages towards meeting the needs of PRMs than the other designs. Although they have many advantages, the greatest disadvantage is the need for staff to operate the ramp, which requires additional labour time. Moreover, manual operation is time consuming and laborious, which is very inconvenient. It also causes delays in terms of train departure, thus increasing the dwell time. Therefore, based on the manual ramp solution, a new concept design has been proposed. This automatic ramp solution solves the problem of extra manpower hours. However, it increases cost and complexity. Automated ramps use equipment such as motors and sensors, which will undoubtedly increase the cost of installation and maintenance. In addition, without staff, safety precautions need to be considered. Nonetheless, the additional cost could be compensated by a reduction in train dwell time, improved crowd flow and safety.

#### Modelling of the boarding system

To complete the 3D model of the whole system, some data and design requirements were collected. The design parameters of trains and platforms were obtained through field measurements and design requirements from European standards and from the TSI PRM. During the period of investigation, the researchers found that there were different

types of platforms at Newcastle railway station, which resulted in a different vertical gap and horizontal gap at the PTI. The research investigated three types of platforms: British Rail Class 221 Super Voyager operated by Cross Country, British Rail Class 156 operated by Northern, and British Rail Class 185 operated by Transpennine Express. The width of train body of Class 221, Class 156 and Class 185 were 2.730 m, 2.730 m and 2.673 m respectively. The Platform offset was nearly 900 mm, resulting in horizontal gaps of 252 mm, 252 mm and 282 mm respectively. The floor height of Class 221, Class 156 and Class 185 were 1.215 m, 1.140 m and 1.247 m, respectively. At Newcastle station, the platform offset is nearly 1000 mm, creating differential vertical gaps of 215 mm, 140 mm and 247 mm, respectively.

The design requirements for automatic ramps provided by European standard and EU TSI PRM 2014 (EC, 2014) are summarised below.

- Level access is provided when the gap between the door and platform does not exceed 75 mm measured horizontally and 50 mm measured vertically.
- Assessment of the ramp angle should be measured between the ramp usable surface and a horizontal plane. The maximum permitted slope allowed for wheelchairs to board independently is 10.2 °.
- The ramp should have a minimum effective clear width of 760 mm.
- The minimum height of raised edges should be 50 mm.
- The upstands at the ends of the ramp should be bevelled and should be a maximum height of 20 mm.
- The ramps should withstand 300 kg, which means no permanent deformation is allowed under the load case.
- The ramp surface should be slip resistant.
- The length on the platform that is required to allow the wheelchair to manipulate on and off the ramp should be 1500 mm.

The data used for the concept design in this project was taken from the train Class 221, shown in Table 4.

**Table 4:** Design parameters for assisted boarding mechanism.

Dimension	Measurement
Height of platform	1 000 mm
Platform offset	900 mm
Vertical gap between train and platform	Nearly 250 mm
Horizontal gap between train and platform	Nearly 300 mm
Width of train door	1 000 mm
Height of train door	2 000 mm
Minimum width of ramp	760 mm
Maximum raised angle	10.2 °
Maximum allowed vertical and horizontal gaps	50 mm and 75 mm

*Note: Some of the dimensions are approximate because this project is a concept only.*

### 3D modelling of train

The modelling of the train was based on the dimensions of Class 221 Super Voyager. The 3D modelling does not match the actual design but shows the main features of the train. The train model consists of the locomotive and the carriage. Modelling of the carriage comprises four parts: the main body; heating, ventilation and air conditioning (HVAC); wheel shaft; and wheel. The dimensions of various components are summarised in Table 5, while Figure 4 shows the 3D modelling of the locomotive and main body. According to the actual dimensions of the train, the lengths of the locomotive and main body are 23.85 m and 22.82 m, respectively. The width and height are 2.73 m and 3.6 m, respectively, while the height of the floor is 1.215 m. The width and height of the train doors, which are the most important parameters for the design, are 1 000 mm and 2 000 mm respectively.

### 3D modelling of the gap filler mechanism

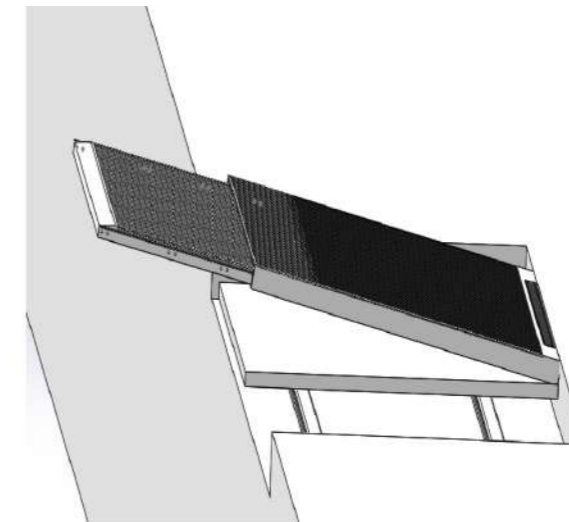
The gap filler mechanism needs to realise X, Y, and Z – three-directional movement – and fill the horizontal gap of 300 mm and the vertical gap of 250 mm. In this project, an automatic ramp was used to solve the problem. The working steps of the mechanism are that, when the train stops at the platform, the mechanism will slide along the track to locate the door. Then the ramp will be raised to the maximum angle and extend forward, closing the gap. Lastly, the ramp will attach to the train. In order to show the mechanism more intuitively; all the parts are presented in Figure 6. The boarding system comprises six parts: the ramp, the base of mechanism, the top of mechanism, the track, the hinge and the slide block. Figure 5 shows the ramp of the mechanism, which will be extended to fill the horizontal gap. The length of the ramp is 840 mm, which depends on the dimension of the wheelchair (<700mm) and the dimension of train door of Class 221 (1 000 mm). The width of the ramp is 1 000 mm and the extendable length is 500 mm, which can fill the different horizontal gap successfully. There are grooves arranged on the surface of ramp, which prevent PRMs from slipping. At the end of the ramp, a 20° bevel is manufactured to help wheelchairs board smoothly.

**Table 5:** Parameters of 3D model of train.

Dimension	Measurement
Length of locomotive	23.87 m
Length of coach	22.82 m
Width of train	2.73 m
Distance between two wheels	1.435 m
Width of train door	1 000 mm
Height of train door	2 000 mm
Length of the wheel shaft	2 300 mm
Diameter of wheel	800 mm

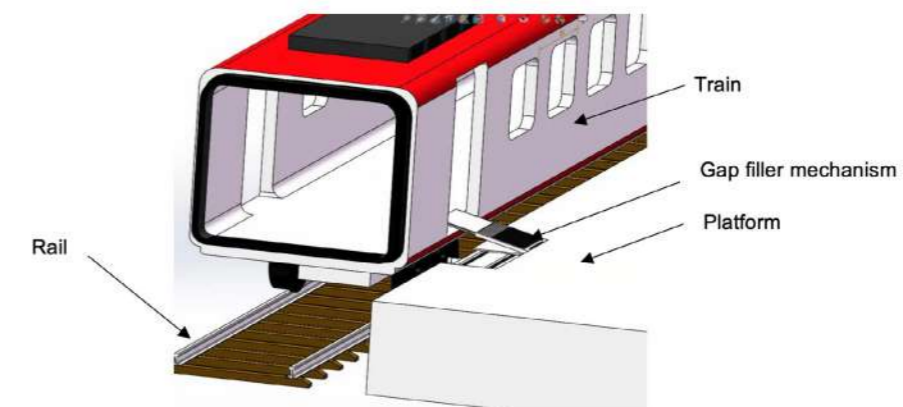


**Figure 4:** Assembly of carriage.



**Figure 5:** Assembly of assisted boarding mechanism.

The assembly of the assisted boarding mechanism is presented in Figure 6.



**Figure 6:** Assembly of whole system.

## AUTOMATION OF THE GAP FILLER MECHANISM

In this section, the concept of a control system is proposed. However, the full control system is not the subject of this paper. In order to achieve fully automatic operation, sensors must inevitably be used in this boarding system. There are three tasks for which different sensors are required. The first task is to detect the approaching of the train, and the second task is to locate the position of door. Thirdly, the mechanism should attach to the train successfully and safely. For the task of detecting the approach of the train and locating the position of the train door, the physical parameter of distance needs to be detected. For the task of deploying the ramp, the sensors need to detect the metal part of the train. Two scenarios are considered, namely: flat or level train floor, and an entrance with steps.

### Sensor to detect the approaching of the train

To detect the approaching of the train, infrared distance sensors and ultrasonic sensors need to be applied. The infrared distance sensor comprises five parts: infrared emitting circuit, infrared receiving circuit, amplifying circuit, single-chip microcomputer, and decoding display circuit. An infrared beam emitted by transmitting unit is reflected after it reaches the train. The signal is received and processed by receiving circuit and amplifying circuit. Thereafter, the distance is calculated by a single-chip microcomputer, where after the result is decoded and displayed by the decoding display circuit.

### Sensor to locate the position of train door

To locate the position of the door, a laser distance sensor must be used in this mechanism. This type of infrared sensor works also based on the principle of time-of-flight. When the train stops, the sensors scan along the train body. By calculating the time that it takes for the receiver to receive the signal, the position of the train door can be detected. The infrared will take a longer time in the position of the door because the door is open, and the infrared will hit the next plane. The mechanism will stop when a long time is calculated.

### Sensor to deploy the ramp

To extend the telescopic plate to the train, inductive proximity sensors must be used in this system. These are used for non-contact detection of metal and are usually composed of a coil, oscillator, demodulator, trigger and output driver. This type of sensor can detect metal objects reliably, so it can measure the distance between the telescopic plate and the train accurately. As the telescopic plate extends forward, the proximity sensors start to work. When the sensors detect the metal on the train, the speed of telescopic plate will slow down. When the telescopic plate touches the train, the motion will stop.

## THE EVALUATION OF THE BOARDING MECHANISM

The gap filler boarding mechanism was evaluated using five factors: cost, performance, safety, crowd flow and station capacity (Figure 7). Comparative evaluation results are shown in Table 6. In the evaluation, a manual ramp got the highest score of 16 in the indicator of cost. The new gap filler mechanism got the highest score of 26 in the indicator of performance. The Brightline train door ramp got the highest score of 27 in the indicator of safety. The new mechanism and Brightline train door ramp both got the highest score of 18 in the indicator of crowd flow and station capacity. The new concept design, based on the manual ramp, obtained the highest score of 78%. From this perspective, it would be reasonable to install the mechanism that has been designed. The new mechanism can be installed in all platforms after a successful test at a platform. It is necessary to develop new regulations and standards to ensure the safety of passengers and the smooth operation of the mechanism. Design, manufacture and installation criteria can be made by relevant departments to simplify the implementation of the mechanism.

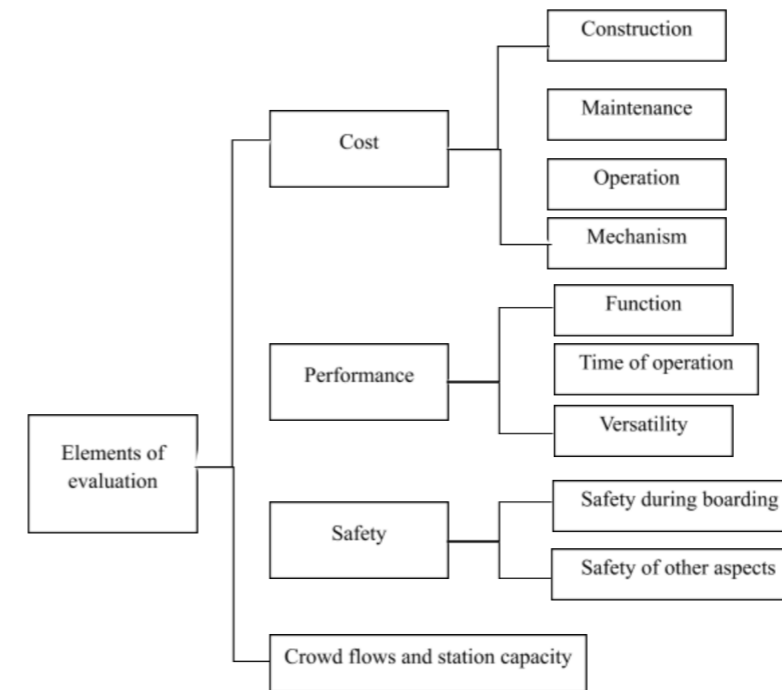


Figure 7: The elements needed for the evaluation of the assisted boarding mechanism.

**Table 6A:** Comparison between different gap fillers.

	Cost (20%)					Performance (30%)			
	Apparatus	Operation	Maintenance	Construction	Total	Function	Time of operation	Versatility	Total
	5%	5%	5%	5%	20%	10%	10%	10%	30%
Platform-based gap filler									
Assisted boarding mechanism by designer	1	3	4	2	10	5	3	5	26
Delkor rail gap filler	5	5	3	4	17	2	3	2	14
Pipex px gap filler	4	5	3	3	15	2	2	2	12
Bigorre Ingenierie Device	2	3	4	3	12	3	4	3	20
Movable platform edge	2	3	4	2	10	3	3	3	18
Vehicle-based gap filler									
Pendolino footstep	2	4	4	1	11	4	3	4	24
Stadler deployable footstep	2	4	4	1	11	4	3	4	24
Brightline train door ramp	2	4	4	1	11	4	3	3	20
Glidelok ramp	2	4	4	2	12	4	4	3	22
Manual ramp	5	1	5	5	16	4	2	4	20

**Table 6B**

	Safety (30%)			Crowd flow and station capacity (20%)			Total (100%)
	Boarding	Other aspects	Total	Crowd flow	Station capacity	Total	
	15%	15%	30%	10%	10%	20%	
Platform-based gap filler							
Assisted boarding mechanism by designer	5	3	24	5	4	18	78
Delkor rail gap filler	2	2	12	2	2	8	51
Pipex px gap filler	2	2	12	2	2	8	47
Bigorre Ingenierie Device	4	3	21	4	3	14	67
Movable platform edge	4	3	21	4	3	14	63
Vehicle-based gap filler							
Pendolino footstep	4	4	24	4	4	16	75
Stadler deployable footstep	4	4	24	4	4	16	75
Brightline train door ramp	5	4	27	5	4	18	76
Glidelok ramp	4	4	24	4	4	16	74
Manual ramp	4	4	24	3	3	12	72

**SOCIO-ECONOMIC BENEFITS**

Although socio-economic evaluation was not part of the scope of this research, this section endeavours to identify the potential opportunities for job creation. This paper has presented a concept design for an accessible gap filler for PRMs, who make up 50% of rail passengers, which is potentially a large market. In addition, it is a universal design, which can be used by the general public, all of whom face similar safety risks at the PTI. It applies the concept of design-for-all for accessible products (Matsika & Peng, 2016). Therefore, the successful commercialisation of the device can create jobs at all stages of the life cycle of the gap filler. This includes, but is not limited to, the following stages: design, manufacture, installation, operations, repair, maintenance, and marketing. In addition, there are many more jobs created in support industries such as tier two suppliers and transportation companies.

**CONCLUSION**

The gap at the platform train interface (PTI) has always been a safety concern in general, and particularly for persons with reduced mobility (PRMs). Regulations require that the horizontal and vertical gaps should not exceed 15 mm and 40 mm, respectively. At present, many countries in Europe do not meet these requirements, since the stations are old. New builds, however, incorporate step-free designs as far as possible.

The review of the gap filler solutions and boarding systems found that these have advantages and disadvantages. In order to provide guidance on the most suitable solution for future development, an expert evaluation criterion was applied. Results show that the manual ramp has more advantages of meeting the needs of PRMs, for accessibility and safety. Although manual ramps have many advantages, the greatest disadvantage is the need for staff to operate the ramp, which requires additional labour hours. Moreover, manual operation is time consuming and laborious, which is very inconvenient. It also causes dwell time delays of up to 400%. The review has also shown that operationally, a PTI solution should aim at improving accessibility, improving the safety of PRMs, while also reducing the train dwell time. Therefore, future developments of the new proposed design or derivatives of existing designs should take this into account.

Through applying the concept of universal design, the new mechanism helps PRMs to board and alight independently by means of an automatically actuating platform-based ramp. It applies three DoF for translation motion, and two DoF for angular motion. A combination of these five DoF ensure successful gap filling. The actuations are controlled by infrared sensors and inductive sensors. The system is capable of moving 2 m along the platform. It covers a maximum horizontal gap of 500 mm and has a maximum inclination of 10.2°. The new concept design reduces the dwell time associated with the presence of PRMs. This allows for zero interference in terms of the door usage by all other passenger groups. In addition, it facilitates crowd flow management during boarding and alighting. An evaluation based on cost, performance, safety and crowd flow shows the effectiveness of the mechanism. It is recommended that the system should be installed at all platforms to help PRMs board independently. Correspondingly, safety standards and regulations need to be developed to ensure safety and security of the mechanism. The system can be installed both at retrofitted and newly built platforms. It therefore has potential to promote job creation through design, manufacture, installation, operations and maintenance, thereby contributing to the socio-economic situation of a country.

#### ACKNOWLEDGMENTS

This research was conducted as part of the EC FAIR Stations Project (2017 – 2019). Further work is being conducted as part of an award by the Royal Academy of Engineering under “Frontiers of Engineering for Development Seed funding Award” (FoE 2021/9/20), which sponsored conference participation.

#### LIST OF REFERENCES

- Atkins, R. 2004. *Significant steps research*. UK Department for Transport.
- Devadoss, R., Ahmad, S. & Dhamodharan, D. R. 2012. *Station platform-train interface for rail passenger - A Technology review*. CRC for Rail Innovation. Project no: R3.115. Project name: Platform access. [Accessed 14 May 2019]. <https://humanrights.gov.au/sites/default/files/ATTACHMENT%20%20PLATFORM%20ACCESS.pdf>.
- EC. European Commission 2014. Commission regulation (EU) on the technical specifications for interoperability relating to accessibility of the Union’s rail system for persons with disabilities and persons with reduced mobility. *Official Journal of the European Union*, 1300/2014.
- EU European Union FAIR Stations. 2020. [Online] Available from: <http://www.fairstations.eu/> [Accessed: 5 September 2020].
- Fullerton, K. 2005. *Glidelok ramp, fresh innovators*. Presented at the Australian Science in Public ‘Fresh Innovators’ competition in 2005 Australia. Accessed 28 August 2010. <<http://www.scienceinpublic.com/freshinnovators/2005/Kevin/kevinfullerton.htm>>.
- Guo, N. 2018. *Independent boarding system for PRMs in train station*. Master’s Degree Dissertation. Newcastle University, Newcastle, U.
- Lemmerer, H., Shibayama, T., Rüger, B., Seltenhammer, K., Macoun, T., Matsika, E., Logueira, D.F., Battista, U., Khosravi, M., de Santiago Laporte, A. & Kuzmina, D. 2018. *D2.1 User needs and expectations of the general public and PRMs*. EU FAIR Stations Project. (777636) — IP/ITD/CCA — IP1, IP3. [Online. Accessed 5 September 2020. <http://www.fairstations.eu/documents/>]
- Matsika, E. & Peng, Q. 2015. Crash safety of a typical bay table in a railway vehicle transport problems. *International Scientific Journal*. Volume 10 Special Edition. pages 97-110. <https://doaj.org/toc/1896-0596>.
- Matsika, E., Chirwa, E.C. & Peng, Q. 2013. *Influence of human related factors on railway vehicle wheelchair occupant crash safety*. Joint Rail Conference – ASME. Knoxville, Tennessee, USA, April 15–18: 1-11. [Online] Available from: doi:10.1115/JRC2013-2406 [Accessed: 14 June 2019].
- Rail Safety and Standards Board (RSSB). 2013. [Online] Available from: <https://www.rssb.co.uk/Library/risk-analysis-and-safety-reporting/2013-report-risk-at-the-platform-train-interface.pdf>. [Accessed: 18 July 2019].
- Stadler, 2015. Private correspondence with project engineer, 11th November 2015.

9TH INTERNATIONAL CONFERENCE ON APPROPRIATE TECHNOLOGY

# SERVICES INDUSTRY

# TRIP DISTRIBUTION ANALYSIS UNDER DEMAND UNCERTAINTY IN FREIGHT RAIL OPERATIONS

Robert Mutyavavire<sup>1</sup>, Meshack Mazibuko<sup>2</sup> 1,2 University of Johannesburg, South Africa  
rmutyavavire@uj.ac.za, meshaelmazibuko@gmail.com

## Abstract

*In this paper we consider freight flow and associated empty vessel capacity allocations under demand uncertainty and in multi-period settings. Freight is spatially distributed across the rail network. Trip distribution analysis is critically important to optimised resource re-positioning strategies in freight rail operational planning. We integrate principles of the gravity model and linear algebra to analyse freight distribution and empty vessel generation. We develop an optimised pre-positioning strategy for empty vessels, making use of secondary freight demand time-series data. Encouraging results are reported.*

**Keywords:** Gravity model; linear algebra; operational planning; rail freight

## INTRODUCTION

Global and regional economic activities frequently involve the shipment of raw materials and goods from production factories to distribution and consumption centres. The factories and population centres are spatially distributed, giving rise to the need for freight transportation. Freight is classifiable as derived demand (Gao, 2016; Ndembe, 2016). Freight transportation is effected through several modes of which the most significant include road, rail, sea and air. Rail freight is generally regarded as unattractive, characterised by a sluggish response to rapid changes in demand (Zunder, Islam & Mortimer, 2012). Rail freight transportation is however well adapted to safe, high bulk, long-distance transportation (Gao, *et al.*, 2016).

In rail freight, a block of wagons pulled by a locomotive constitutes a train. The wagons are the primary load-bearing vessels. A wide range of commodities can be safely handled and shipped in a variety of wagon designs customised to preserve product quality and minimise loss.

Food grain in some form constitutes a food staple for human beings across the globe. Grain producing zones are frequently located far from major population consumption centres. The grain is moved from farmers to silos, and from silos to food processing industries and consumers. Grain rail wagons and trains are custom-designed to handle bulk grain as unit loads.

The Just-in-time (JIT) philosophy is widely practised in modern day industry and commerce. JIT demands synchronised supply chains and efficient freight transportation services. The food supply chain is one of these. Planning and execution of efficient freight transportation critically depends upon well-considered operating systems and optimised decision support systems (DSS).

Freight flow is consequent to the demand for movement of goods. The best freight transport service designs and associated DSS are premised upon systematic data collection and analytics. Analysis of freight demand and traffic flow data yields information on freight flow patterns/trends and provides valuable inputs for optimised freight and traffic management DSS and models. Empty wagons need to be positioned in time for the loading of goods.

Empty flows are a function of freight flow, freight destinations become sources of empty wagons.

In this paper, we make use of secondary data from a Southern African-based freight rail service operator. We carry out a quantitative analysis for grain freight demand to determine freight flow patterns and trends. We also carry out empty wagon trip distribution analysis and determine empty wagon sources and sinks necessary to meet the freight service demand timeously. The output of the study serves as a preliminary step towards the development of an optimised empty vessel re-distribution model. Optimised re-distribution models reduce fleet operating costs and wagon turn-around times.

Independent variables for freight include weight, volume and value. Transport supply variables include fleet strength and route network size (Oegon, 2008). Explanatory variables include capacity, transit times and reliability.

The source database constitutes daily freight tonnage and wagon identity details. The respective data fields include forwarding and receiving stations, commodity type, wagon identity, tonnage per wagon and revenue. Data collected and analysed covered a four- calendar-year period. The sample period was determined so as to capture possible seasonality and trend components (Chase, 2012). The data was further discretised into 52 data points for each calendar year.

There are thousands of farms, more than 200 grain silos, hundreds of agro-processing industries and many distribution centres throughout the region spanned by the rail network. The need for an efficient and agile bulk materials handling system is essential. The fleet strength approximates 6000 wagons.

## Related literature

Efficient freight transportation facilitates reduced cost and smooth flow of goods, positively impacting economic activities and quality of life (Gao, *et al.*, 2016). In this regard, rail freight is critically important to developing economies heavily reliant on the export of primary commodities.

The effort to enhance efficiency of tactical and operational planning in rail freight operations has been investigated by many researchers and a wide range of models and algorithms have been developed and applied (Yang, Li, Gao & Li, 2011). Sufficient data samples and application of good statistical methods are essential to the development of a good transportation plan (Yang, *et al.*, 2011).

To enhance regional competitiveness, there is a global trend towards systematic and quantitative methods based on DSS in freight transportation. Quantitative analysis is critically reliant on the data itself (Holguin-Veras & Ban, 2010). It is essential to develop an accurate and cost-effective freight data collection framework. The critical components of the framework include: identification of freight data needs; relevant data sources; the definition of data collection framework; and data collection costs.

New technological techniques such as Big Data Analytics (BDA) and data mining have great potential for application in efficient real-time data capture and analysis in freight rail transportation (Alawad, Kaewunruen & Min, 2019). The potential benefits include real-time tracking of freight and empty wagons as well as facilitated decision support. Coupled with machine learning (ML), intelligent resources have become a reality.



The rapid growth in computing power coupled with BDA, deep learning, ML, added optimisation techniques and tools yields intelligent assets and results in an agile and efficient rail freight transportation system (Alawad, *et al.*, 2019).

## Methodology

Quantitative methodology, integrating statistical analysis and linear algebra, was applied. For validation purposes, the data capture instruments were scrutinised, and the instruments were judged as systematic and accurate.

The physical size of the rail network under consideration is significant. To facilitate analysis, the network and sub-region were divided into 30 zones. Zonal operations are assumed to be concentrated around the zonal centroid. The origin and destination of each consignment/wagon were tracked to determine zonal trip interchanges per week for each calendar year of the study period. The final output was an aggregated freight (O-D) matrices.

The freight tonnages delivered/exported per specific centroid were aggregated for the entire study period, and the respective freight demand/supply patterns and probability distribution functions were determined using The Statistical Package for Social Sciences (SPSS) statistical analysis tool.

The rectangular data were further re-modelled to facilitate trip distribution analyses i.e. synthesis of trip interchanges across zones. Freight transport fleet operations are dynamic. The trip distribution analysis serves as an input to the empty wagon Production/Attraction (PA) matrices. The PA matrix illustrates the total empty wagon traffic production and demand per region/zone.

## Results

Freight by weight and distance, Tonne-kilometres (TKM), is generally applied to model rail freight demand (Charles, 2014).

The variable TKM constitutes the response variable.

$$= \sum_j \sum_i d_{ij} x_{ij} m_{ij} \quad (1)$$

For empty wagons, we assume  $m_{ij} = 1$ ,

Response variable reduces to

$$= \sum_j \sum_i d_{ij} x_{ij} \quad (2)$$

Table I below illustrates the actual aggregate grain tonnage shipped across the zones. We derive the actual wagon loads conveyed for each year as follows:

The average payload per grain wagon  $= P_l$   
 $= 44$  metric tonnes

Let aggregate tonnage moved per year  $= M_c$

$$\begin{aligned} \text{Let total wagons used} &= N_w \\ \text{Average Turn-around time (TAT), (company source)} &= C_a \\ &= 20 \text{ days} \\ \text{Average loading cycles per month} &= \frac{30}{C_a} \\ \text{Fleet strength, } N_w &= \frac{M_c}{P_l * \left(\frac{30}{C_a}\right) * 12} \quad (3) \\ &= \frac{M_c C_a}{360 P_l} \end{aligned}$$

The formula above was applied to determine inter-zonal wagon movements and, subsequently, total wagons used (fleet strength) for each of the four (4) operating years under study as follows:

$$\begin{aligned} \text{Total wagons 1213, (Table 1)} \quad N_{w1} &= \frac{4145837.8}{792} \\ &= 5238 \text{ wagons} \end{aligned}$$

The formula above was applied to the matrix in Table 1, for the period 1213. The result is a matrix reflecting the total wagon loads in one operational cycle, as illustrated in Table 2 below.

Table 1: Gross annual tonnage recorded

ROW LABELS	COLLINS LABELS	BETH LEH N	DE AAR	DURBAN	HARBOR	EAST LONDON	ISANDHO	JOHANNESBURG	KIMBERLEY	KROONSTADT	KRUGERSDORP	LICHTENBURG	NEWCASTLE	OGES	PETROBRAS	PORT ELIZABETH	PRETORIA	RICHARDSON	RIETBURG	SPRINGS	THABAZIMONTI	VERBODEN	WELCH	WITBANK	WORKERS	GRAND TOTAL		
60354	42160	90529	5466	56017	34541	77978	0	103473	66901	101811	79828	3784	126618	1452	73141	83225	22656	381734	142231	336229	293479	132	0	153455	86	115587	801933	
340256	0	12936	253662	63865	6029	484	19312	0	9555	76192	3520	264	264	0	0	0	0	440	31153	0	0	0	0	0	0	0	0	447700
3784	0	25652	2202	0	28238	176	0	484	0	0	0	0	0	0	0	0	0	2660	35242	0	0	0	0	0	0	0	0	416494
72560	20242	4493	5466	87	2657	10398	25619	0	0	21356	14766	0	0	0	0	0	0	0	3388	3388	3300	3300	3300	3300	3300	3300	0	105689
347	21881	15901	121794	0	0	7661	1727	0	0	47118	16374	0	0	0	0	0	0	0	109863	21816	1540	113174	0	0	0	0	0	520112
0	0	1188	0	0	0	0	2024	132	0	0	0	0	0	0	0	0	0	0	0	0	0	0	0	0	0	0	0	44
0	0	0	0	0	0	0	0	0	0	0	0	0	0	0	0	0	0	0	0	0	0	0	0	0	0	0	0	1013
0	0	0	0	0	0	0	0	0	0	0	0	0	0	0	0	0	0	0	0	0	0	0	0	0	0	0	0	2294
12191	0	15864	0	0	0	17922	0	0	9555	0	0	0	0	0	0	0	0	0	0	0	0	0	0	0	0	0	0	494790
25917	0	11351	0	0	20817	6248	0	6248	0	440	24212	3520	2337	1232	220	220	66513	12897	99845	63144	15069	2772	0	0	0	0	660	349106
13992	264	0	0	0	0	43	18605	0	0	0	0	0	0	0	0	0	0	0	10912	109358	2816	440	0	0	0	0	0	33340
0	0	0	10692	3256	0	0	1232	0	0	0	0	0	0	0	0	0	0	0	4309	0	0	0	0	0	0	0	0	4692
0	0	0	0	0	0	0	0	0	0	0	0	0	0	0	0	0	0	0	5192	0	0	0	0	0	0	0	0	21604
0	0	0	0	0	0	0	0	0	0	0	0	0	0	0	0	0	0	0	0	0	0	0	0	0	0	0	0	5500
0	0	0	1048	0	0	0	56813	0	0	0	0	0	0	0	0	0	0	0	2317	0	0	0	0	0	0	0	0	60178
0	0	44	0	0	158748	0	0	0	0	0	0	0	0	0	0	0	0	0	0	0	0	0	0	0	0	0	0	158878
0	0	0	0	0	0	0	220	968	0	0	0	0	0	0	0	0	0	0	0	0	0	0	0	0	0	0	44	
0	0	0	177532	116916	0	0	0	0	0	0	0	0	0	0	0	0	0	0	31153	0	0	0	0	0	0	0	0	12747
0	0	0	0	0	0	1276	148	0	0	0	0	0	0	0	0	0	0	0	0	0	0	0	0	0	0	0	619081	
0	0	0	0	0	0	0	0	0	0	0	0	0	0	0	0	0	0	0	0	0	0	0	0	0	0	0	18883	
0	0	0	0	0	0	0	0	0	0	0	0	0	0	0	0	0	0	0	0	0	0	0	0	0	0	0	3432	
20704	37	176	0	0	1496	1320	16566	0	0	0	0	0	0	0	0	0	0	0	0	0	0	0	0	0	0	0	148	
2388	0	0	0	0	0	6215	0	0	0	0	0	0	0	0	0	0	0	0	0	0	0	0	0	0	0	0	11011	
1804	0	0	0	0	0	0	0	0	0	0	0	0	0	0	0	0	0	0	0	0	0	0	0	0	0	0	14784	
60354	42160	90529	5466	56017	34541	77978	0	103473	66901	101811	79828	3784	126618	1452	73141	83225	22656	381734	142231	336229	293479	132	0	153455	86	115587	801933	

Table 1 above illustrates freight flow distribution matrices and Table 2 illustrates the average loaded wagon O-D? matrices per cycle for the first year of the period under study. The objective was to determine the empty wagon trip distribution matrix. The following methodology was adopted:

Average wagon fleet cycle time (TAT) is given by:

$$T_c = T_l + T_{ol} + T_e + T_{ld} \tag{4}$$

Where:

$$T_l = \frac{\text{average fleet cycle time}}{\text{average wagon loaded run time}}$$

$$T_{ol} = \text{average wagon off - loading time}$$

$$T_e = \text{average wagon empty run time}$$

$$T_{ld} = \text{average wagon loading time}$$

And

- At the end of the first half cycle (load, run loaded) all loaded wagons, on average, accumulate for offloading at the destination yards. Empty wagon balancing becomes necessary at that estage.
- $(\frac{T_c}{2})$  is considered the most appropriate empties redistribution planning and salvage time period.
- Upon completion of offloading activities, freight destination yards revert to empty wagon source nodes. The freight source nodes switch into empties demand points.

The second half cycle constitutes the empties planning and salvage period, as explained in paragraph above. Upon completion of offloading, freight demand points convert to empty wagon surplus/source nodes. The freight source nodes revert to empties demand nodes. The timeous re-positioning of the wagons is essential. Clients have the option of engaging alternative modes of transport should service be delayed.

The empty wagon Production-Attraction (PA) matrix is determined as a transpose of the Freight O-D matrix. The transpose matrix reflects the magnitude of empty wagon generations as well as empty wagon attractiveness (demand) at the various terminals across the network, (see Table 3 below). The PA matrix illustrates the total productions and demand for wagon numbers at all centroids across the rail network. Productions are empty wagons that become available at a particular centroid.



# APPLICATION OF INTERNET OF POSTAL THINGS (IOPT) FOR COMMUNITY DEVELOPMENT: AN APPROPRIATE TECHNOLOGY AND SUSTAINABILITY DEVELOPMENT PERSPECTIVE

K. Mokgohloa<sup>1\*</sup>, K.R. Ramdass<sup>1</sup>, S. Xaba<sup>2</sup>, J.A. Trimble<sup>3</sup>

<sup>1</sup> Department of Mechanical and Industrial Engineering, University of South Africa

<sup>2</sup> Centre of Excellence, South African Post Office

<sup>3</sup> Department of Industrial Engineering, Tshwane University of Technology

## Abstract

The rise of digitalisation powered by multiple technology has prompted Postal Sector across the world to expand their services well beyond the original service of postal operators, which was the delivery of mail. Industry 4.0 is focused on three key objectives, namely (i) Digitalisation and integration of the vertical and horizontal value chains; (ii) Digitalisation of product and service offerings; and (iii) Digital business models and customer access. The core capabilities of Industry 4.0 are data and analytics aided by digital technologies such as Big Data and the Internet of Things (IoT). Internet of Things is a technology with potential for a multitude of new products and services and its application is almost infinite in enabling a ubiquitous seamless integration of the physical realm and the cyber realm. The Internet of Postal Things (IoPT) refers to the application of the IoT in the postal world where there is pervasive connection between the postal value chain and communities. While IoPT has the potential to serve communities, a plethora of issues needs to be considered to ensure that IoPT is appropriate for the needs of the community. These issues range from sustainability imperatives, privacy assurance, appropriateness of the technology, enabling technologies and finally, energy security. The crux of this paper is to offer insight into the concept of the Internet of Things and its application in the postal services that gave birth to the concept of the Internet of Postal Things. A further aim of the paper is to offer insight into the appropriateness of the Internet of Postal Things as a key emerging technology from Industry 4.0 which could be a pillar of the postal system's contribution to community development in the 21<sup>st</sup> century.

**KEYWORDS:** appropriate technology, community development, Internet of Postal Things

## 1. INTRODUCTION

The world is on the bridge of crossing over to a new digital era. Digitalisation is designed to radically reduce the costs of collecting, storing, and processing data, thus transmuting economic activities around the world. Digital technologies open the way for micro, small and medium-sized enterprises, especially those in developing countries, to participate in global trade through e-commerce. This new digital era requires changes to the prevailing legal and regulatory frameworks, and has tremendous repercussions for the transformation of Posts (Universal Postal Union, 2019a).

The rise of digitalisation, coupled with other long-term social and macroeconomic transformations, has prompted Posts to expand their services well beyond the mere delivery of letters. In this context, the meaning of postal development needs to be refined and further aligned with the United Nations' 2030 Agenda, embodied by the Sustainable Development Goals (SDGs). Examining postal development through the lens of sustainable development matters for both the prosperity of the postal sector and the well-being of societies around the world. Indeed, with a global network of over 677,000 post offices, 5.3 million staff and physical infrastructure covering 192 countries, Posts play a critical socio-economic role (UPU, 2018).

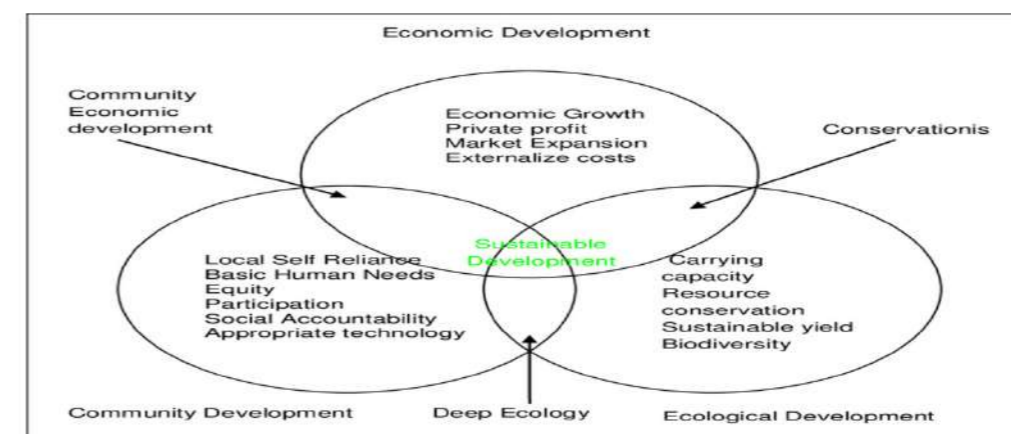
For decades, Posts have been experiencing digital disruption of their core business. At the same time, digital innovation has been at the heart of their efforts to conceive new products, spawn efficiencies, and adapt their organisational culture to the needs of the digital economy (USPS, 2015). The current COVID-19 that has disrupted life on earth as we know it, offers opportunities that the Post could seize with a view to serving communities in which Posts operate better, much more effectively and more efficiently while pursuing community development.

## 2. LITERATURE REVIEW

### 2.1 Community Development

Community development is a conceptual approach to increasing the connectedness, active engagement and partnerships among members of the community, community groups and organisations in order to enhance the social, economic and environmental (natural and built) objectives of the community (Greater Shepparton, 2010). Community development should be both a process and an outcome. Therefore, a working definition of community development is: a process which means developing and enhancing the ability to act collectively, and an outcome which means taking collective action and the result of that action for improvement within a community in any or all realms, namely physical, environmental, cultural, social, political, economic (Phillips, Rhonda, & Pittman, 2009). Empowerment should be the ultimate goal of any community development projects (Sianipar, Yudoko, Adhiutama & Dowaki, 2013).

To further elaborate on community development, Phillips, Rhonda and Pittman (2009) argue that the capacity building (the process of community development) leads to social capital which in turn leads to the outcome, that is, community development. In addition, they hypothesise that communities with social capacity (the ability to act) are inherently more capable of creating good economic development programmes should they choose to do so. They argue that when these communities act (community development outcome), they create and maintain effective economic development programmes that mobilise the resources of the community. They also improve their physical and social circumstances and become more ready for development, which leads to success in business attraction, retention and expansion, and start-up. The community development process is depicted in Figure 1. The link between community development, economic development and ecological development all lead to sustainable development. This paper focuses on the interlink between community development and economic development.



**Figure 1:** Community and economic development chain. (Phillips, Rhonda; Pittman, 2009)

## 2.2 Appropriate Technology

Appropriate Technology (AT) was first conceptualised as ‘intermediate technology’ by the economist E.F. Schumacher in the 1970s in his influential book, *Small is Beautiful: Economics as if People Mattered* (Schumacher, 1973). Schumacher’s principles on economy and development were very much influenced by Buddhist philosophy, as well as his own work in developing countries as an economic adviser. Such experience prompted him to conclude that local self-reliance, meaningful work and development that match local conditions are the necessary requirements of any successful development project (Zelenika & Pearce, 2011).

Appropriate technologies (ATs) refer to simple, typically labour-intensive and local-manufactured, technology solutions that aim to improve the lives and livelihoods of people in resource-constrained environments (Lissenden, Maley, & Mehta, 2015). Appropriate Technology (AT) recognises that social, environmental, cultural, political, and economic concerns are as significant as technical requirements in the design of innovative products and service. Appropriate Technology (AT) is technology that empowers people (INAT, 2020).

Patel *et al.* (2014) suggests that there are many contending theories about what constitutes “appropriate” technology and how to define and balance “people-centred” goals against other dimensions of sustainability. They argue that the difficulty of defining “appropriate” technology has been discussed at length in AT literature for decades. Despite some differences, this discussion has come to some agreement on a core group of design tenets that span from the cultural (e.g., compliance with societal norms), to the consumer (e.g., community ownership model), to the technological (e.g., environmental friendliness).

Conversely, the consequence and intended implications of the principles have evolved with the gradual globalisation of challenges, resources, and economic systems. One of the most significant outcomes, they argue, is that globalisation has been the swift propagation of Information and Communication Technologies (ICTs), which have democratised the creation, access, and utilisation of knowledge. This knowledge, especially when blended with indigenous knowledge, enables individuals and communities to pursue appropriate technology in more ways, co-creating solutions that can improve their collective quality of life (Patel, Maley, & Mehta, 2014). The AT criteria incorporates small scale, sustainable technical innovations, including the theoretical ‘know-how’ or the software components of design and function, as well as traditional knowledge and biomimicry (Zelenika & Pearce, 2011).

Milling (2009) proposes that areas of consideration for implementation of Appropriate Technology projects are:

- Need
- Affordability
- Local materials, local production
- Low ecological impact
- Cultural acceptability, appropriateness for social context
- Fit within infrastructural environment
- Transparency, understandability
- Ease of use, match to local skills
- Durability, reliability
- Maintainability, reparability
- Quality
- Benefits, such as increased production.

(Milling, 2009)

## 2.3 SCOPING INTERNET OF THINGS

### 2.3.1 Industry 4.0 defined

The strategic goal of Industry 4.0 is to leverage the sweeping disruptive technologies such as; big data and big data analytics, Internet of Things, Artificial Intelligence (AI), Augmented and Virtual Reality, Advanced Robotics, Advanced Materials (including Nano materials), Block-chain, and other technologies associated with Industry 4.0.

Industry 4.0 is intended to focus on the collection and application of real time data and information by means of networking all individual rudiments of a system, in order to reduce the complexity of operations, while increasing the efficiency and effectiveness with a long-term cost reduction target. It is affixed in the expansion of research and development in the pervasive applications of Information and Communication Technologies with a goal to put into practical use the promising results on the Internet of Things (IoT), Embedded Systems, Cyber-Physical Systems (CPS) and big data in industries. The plethora of the 21st century technologies and their fusion are distinctive to the notion of Industry 4.0 (Santos, Mehrsai, Barros, Araújo, & Ares, 2017).

Industry 4.0 is defined as the new technological transfiguration for instinctive systems based on the astonishing proliferation of the speed of information processing, digital storing ability and enormous progress of information and communication systems (Selma *et al.*, 2019). The term “Industry 4.0” refers to the smart plants in which smart digitally enhanced devices are remotely connected to enable the communication of resources and materials throughout the business value-chain. This industry is characterized by agility, efficiency and effectiveness (Vuksanović, Ugarak, & Korčok, 2016). Industry 4.0 is defined as a technology-based revolution, the emphasis being on autonomous systems with capacity and capability for quick information processing, big data storing capacity and capability and exponential increase in complex information and communication technologies (ICT) (Selma *et al.*, 2019).

It is already generally recognized that disruptive technologies associated with Industry 4.0 will leave a momentous impression on present businesses and the creation of businesses of the future (Santos, Chaura-Santos & Lima, 2018). Figure 2 presents the Industry 4.0 framework and associated digital technologies at which the core of Industry 4.0 is based on the concept of the three core foundations:

- Digitalization and integration of vertical and horizontal value chains
- Digitalization of product and service offerings
- Digital business models and customer access.

Data and analytics are core capabilities of Industry 4.0 which is enabled by digital technologies such as mobile devices, cloud computing, IoT platforms, augmented reality & wearables, multi-level customer interaction and customer profiling, location detection technologies, advanced human-machine interfaces, big data analytics and advanced algorithms, smart sensors, 3D printing, and authentication and fraud detection (Reinhard, Jesper, & Stefan, 2016).

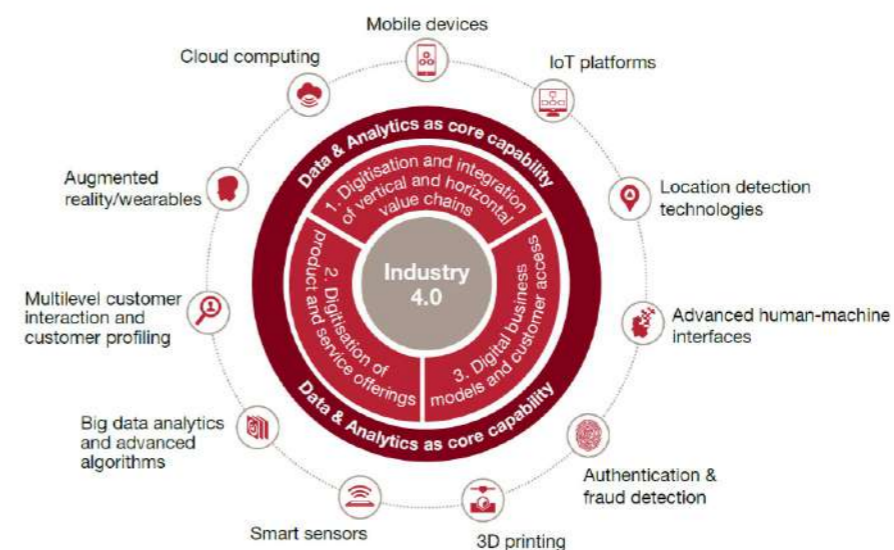


Figure 2: Industry 4.0 framework and contributing digital technologies (Reinhard *et al.*, 2016)

### 2.3.2 IoT defined

The Internet of Things is an intelligent network which concatenates all things to the Internet for the purpose of interchanging information, and communicating via the information sensing devices in conformity with agreed protocols (Perwej, Omer, Sheta, Harb, & Adrees, 2019).

The term Internet of Things generally refers to scenarios where network connectivity and computing capability extends to objects, sensors and everyday items not normally considered to be computers, allowing these devices to generate, exchange and consume data with minimal human intervention. There is, however, no single, universal definition (Rose, Karen; Eldridge, Scott; Chapin, 2015). The Internet of Things (IoT) sometimes referred to as the Internet of Objects, has changed facets of life as we know them and impacts all sectors of society, individuals, communities, organisations, government and so forth (Kamal, Mohammed, Sayed & Ahmed, 2017).

The Internet of Things might be better described as “Things on the Internet”, that are interconnected networks of distinctively identified physical objects entrenched with sensors that collect, communicate, and act upon a wide-ranging assortment of data such as location, temperature, motion, or performance. These “smart objects” gather and communicate data that can be analysed for better tracking and management of assets in real-time, efficiency improvements, and the creation of better and smarter products, services and processes (USPS, 2015). Figure 3 elucidates the key constituents of the IoT value chain.



Figure 3: IoT value chain (USPS, 2015)

The current era of smart technologies signifying a “ubiquitous computing” or “web 3.0”. Internet of Things (IoT) has emerged robustly as a more prosperous era in which to express this kind of a new technology (Zainab, Hesham & Badawy, 2015). The ITU has defined the IoT as “a global infrastructure for the information society, enabling advanced services by interconnecting (physical and virtual) things based on existing and evolving interoperable information and communication technologies” (Biggs, Garrity & LaSalle, 2015).

USPS (2016) argues that the rise of digital technology over the last 30 years has created both threats and opportunities for the postal business. Digital innovation by Posts in industrialised countries has become imperative to slow the decline of mail caused by substitution, increase cost efficiencies, and improve the quality of products and services. It has also provided opportunities to modernise to ensure long-term relevancy and diversify by creating new sources of revenue. Figure 4 depicts the waves of digital innovation that major Posts have undergone and Table 1 describes in detail the different waves (a) Postal automation (b) Revenue-generating services (c) Digital to enhance core business, and lastly, (d) Digital transformation (USPS, 2016).

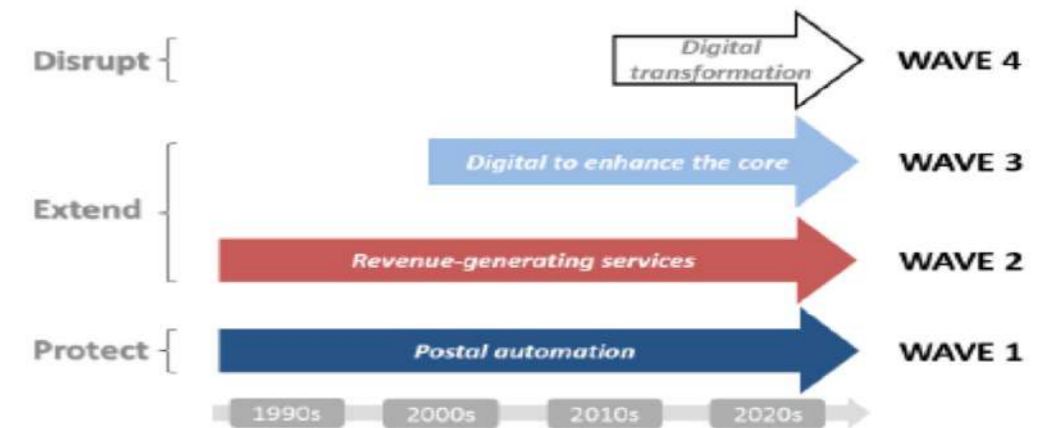


Figure 4: The Four waves of digital innovation in global postal sector (USPS, 2016)

Table 1: Four waves of digital transformation in postal sector (Universal Postal Union, 2019b)

Period	Description
Wave 1 – Postal automation	Starting in the early 1990s, in a context of fast-growing mail volumes, the digital efforts of Posts were primarily focused on rationalizing and automating sorting centers. Mail tracking, then a novel technology, was first introduced for high-end express items, then extended through massive projects like the intelligent mail barcode in the United States. Additionally, machines that sort letters and flats together into carriers' walk sequences have been installed in sorting facilities. Now, with mail volumes shrinking and e-commerce growing, Posts are shifting investments from mail-centered to parcel- and recipient-centered value chains. Robotics, the Internet of Things, and on-demand delivery apps are likely to bring more efficiencies to sorting and delivery soon.
Wave 2 – Revenue-generating services	Many Posts hoped they could replace lost mail revenue with income from digital services. They anticipated a role for themselves in the management of electronic communications and transactions between governments, businesses (such as banks or utilities), and citizens. They would attain that role through their physical proximity to citizens and government, as well as their reputation for trust, reliability, and security. A few Posts have, at least in part, enacted that vision.
Wave 3 – Digital to enhance the core	As broadband penetration and Internet use increased in the early 2000s, so did efforts to digitize parts of the mail chain, in particular the upstream stages of mail creation. The objective was to expand customer access to postal services and create new services at the intersection of physical and digital mediums. Many Posts introduced services that combine elements of a digital first mile – that is, using digital means to enter a piece into the mail stream – and the ubiquity of the physical last mile – such as hybrid mail or print management. These operators also put basic services online (e.g., postcode lookup, change of address, and price calculators) to increase customer convenience and simplify access. More recently, the emergence of mobile apps and new data collection technology, for example, have improved customers' experience. Through these, Posts strive to bridge their digital and core businesses to provide customers with the level of immediacy, control and information granted by the Internet. In the future, by further integrating their information systems with those of mailers, e-merchants, technology partners, and even individuals, Posts will be able to respond to customer needs in real time.
Wave 4 – Digital transformation	Digital transformation is not about any function: rather, it is about updates in technology, processes, culture, and business models. For example, connectivity, cloud, and data analytics can enable faster innovation, more informed data-driven decisions, and quicker execution. These technologies create opportunities to experiment with new models and respond faster to retailers' and consumers' evolving preferences for faster, more flexible delivery options. For postal operators, investing in and implementing digital innovation across the organization is a long-term roadmap, whose impacts are just starting to be felt.

### 2.3.3 The justification of Internet of Postal Things (IoPT)

There are several enthralling motives for the Postal Service to explore the IoT, based on its geographic reach which spans all cities, towns, townships, villages, and remote areas in the country. The long-standing community service of the postal service has extended to communities across the country for decades.

#### 2.3.3.1 Postal development

The UN Sustainable Development Goals (SDGs) are ambitious universal agendas to achieve a better and more sustainable future for all. They aim to address urgent global challenges that we face in relation to poverty, inequality, climate change, environmental degradation, prosperity, peace, and justice. The goals are interlinked and, to leave no one behind, the aim is to achieve each goal and target by 2030. To achieve this ambitious Agenda 2030, 17 goals have been identified, which are further broken down into 169 targets and 244 indicators. As a UN specialised agency, the UPU, with the support of its member countries, is actively researching and analysing the contribution of the postal sector in efforts to achieve the SDGs (UPU, 2019b).

According to the UPU (2019b), the report argues for the expansion of the definition of postal development to align with the United Nations 2030 Agenda embodied by the Sustainable Development Goals (SDGs). The report argues that examining postal development from a sustainable development perspective assumes a strategic foresight beneficial to both the postal sector and importantly the society and planet.

UPU (2019) identifies the SDG indicators that are closely linked to digital postal development and the role of the postal sector in achieving the goals in the UN Agenda 2030. The report further presents the concrete contribution made by the postal sector to advance the implementation of the SDGs using technology to create a social impact. The report focuses on three goals which, according to the UPU (2019b), produced high correlations for postal development as a proxy measure. Figure 5 depicts the 17 SDGs.

The (UPU, 2018) identifies the four SDGs that have a high correlation with postal development.

Table 2:

Appropriate postal related SDG Goal	Postal related explanation
Goal 8 (Decent work and economic development)	<ul style="list-style-type: none"> <li>Goal 8 promotes inclusive decent work and sustainable economic growth for all. It also aims to promote policy actions to eradicate forced labour, slavery, and human trafficking. The UPU postal development report for 2018 shows the postal sector making a major contribution towards the achievement of this goal through trade facilitation for MSMEs by offering products and services tailored to the needs of businesses. Posts serve over 100,000 people per post office; they also provide businesses and consumers alike with access to a massive logistical, financial and communication network. The postal sector is also a valuable contributor to job creation and sustained and inclusive economic growth.</li> <li>In 2016, the postal sector employed 5.32 million staff worldwide, and Posts throughout the world strive to achieve the goal of providing decent work and promoting inclusive economic growth.</li> </ul>
Goal 9 (Industry innovation and infrastructure)	<ul style="list-style-type: none"> <li>This goal promotes the building of a resilient and sustainable infrastructure to foster sustainable development. The SDGs also aim to promote investment in infrastructure and innovation to help build inclusive growth. As an indicator of inclusive innovation, postal services provide universal postal services in 146 countries. Fifty-one Posts worldwide hold 1.6 billion savings and deposit accounts, and 1 billion people are banked through the Post.</li> <li>In Botswana, for example, the postal network is providing digital services that help to provide financial, technological, and technical support to underserved communities.</li> </ul>
Goal 17 (Partnerships for the goals)	<ul style="list-style-type: none"> <li>This goal aims to “strengthen the means of implementation and revitalize the global partnership for sustainable development”, which is closely correlated with postal development. Postal operators act as enablers of communication services and facilitate trade by leveraging partnerships. The goal also has a strong link to the percentage of individuals using the Internet, as the rise of ICTs triggers mail substitution, reducing Posts’ revenues in the traditional letter-post segment. As the Internet drives demand for new products and services through-commerce, the need for a trusted reliable intermediary to deliver orders also increases.</li> </ul>



Figure 5: Sustainable Development Goals (UNDP, 2018)

### 2.3.3.2 Geographic reach

The South African Post Office has an enormous system of assets, human capital, and infrastructure that spreads across the entire country and that touch communities in one way or another daily. The reach of this network has potential unlimited opportunities for IoT application in the postal sector to serve communities effectively and efficiently. Table 2 below depicts the number of postal “things”.

Table 2: Postal “Things”

Resources and Assets	Number
Employees	16,976
Vehicles	2500
Post Offices	2,185
Retail Postal Agencies	696
Delivery Points	14,106,896
Sorting Centres	26
Social Grant Recipients paid by SAPO	7.7 million
Addresses rolled out in rural areas (Geo-referenced)	4.9 million

### 2.3.3.3 Customer demands

With the world embracing digital technology at an ever-faster rate, customers (both senders and receivers) are increasingly expecting to interact directly with the Post through digital channels. In addition, 73% of Posts indicate that they have increased their investment in digital postal services. Therefore, it is clear that the digital postal services landscape will continue to evolve in a number of directions (Universal Postal Union, 2019b). The report further proposes that Posts are therefore at a turning point: they need to adapt in order to remain relevant, competing with digital native companies in different areas of their product portfolio. To be able to compete effectively, Posts need to expedite the digitalisation of their products. This means that postal operators that have not yet fully digitalised need to do so urgently, or risk being excluded as digital service providers for e-government, e-commerce and e-finance services



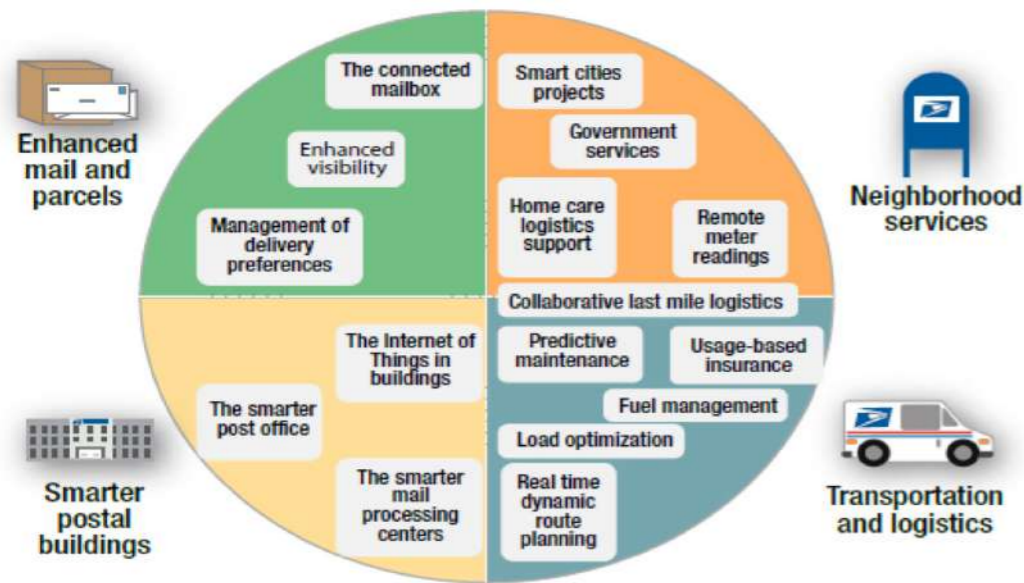


Figure 6: IoPT applications (USPS, 2015)

(Universal Postal Union, 2019b).

Osborn (2020) supports this view and argues that there are three key drivers for digital transformation:

- Changing customer behaviours and expectations –what is wanted, needed, and demanded
- Industry imperatives’ such as security constraints, customs requirements, transparency, data integrity and other regulatory issues
- Technology innovation and applications –what is possible, e.g. digital platforms and applications, Blockchain technology and so on.

Many organisations lack a full understanding of the implications of IoT on their organisations and a comprehensive vision of how their organisations could fully leverage the full potential of IoTs. While many organisations have embraced IoT, their focus tends to be tactical rather than strategic. These organisations focus on developing solutions aimed at solving precise short term issues related to specific areas of their organisations (Marsh & Piscioneri, 2015).

### 2.3.4 Potential Internet of Postal Things applications

The list of potential IoT applications that the Postal Service could develop by leveraging its infrastructure is seemingly endless (Marsh & Piscioneri, 2015). The Postal Service’s infrastructure provides numerous opportunities for interconnection and data collection. The USPS (2015) suggests that interconnecting the vast and rich postal network would provide the Postal Service with the opportunity to develop an “Internet of Postal Things” (IoPT).

The IoPT could help protect the core letter, parcel, and retail businesses by generating cost savings, operational efficiencies, and user value. Over time, it could also create new revenue opportunities and foster new business models. This paper explores a vision for the future, discussing possible areas of IoT applications and next steps for the Postal Service to pursue in order to implement IoPT (USPS, 2015).

USPS (2015) proposes 16 IoPT applications, organised into four different areas (depicted in Figure 6), and how in the coming years they could solve concrete problems and bring significant benefits to the Postal Service and its customers. With postal vehicles and letter carriers going to the same neighbourhoods every day, the Postal Service could combine IoT technologies with its knowledge of and proximity to local communities to provide services to support the initiatives of “smart cities”, help federal and local governments expand access to their services, and provide value-added services to

		Industrialized countries														
		Australia	Austria	Canada	Croatia	France	Germany	Greece	Italy	Luxembourg	Netherlands	New Zealand	Portugal	Spain	Switzerland	USA
E-post and e-government	Postal electronic mailbox	D	O	O	O	O	O			O		O	O	O	O	
	Online direct mail	O	O	O	O	O				O	O	O	O	O	O	O
	Postal registered electronic mail		O		O	O	O		O				O	O	O	O
	E-cards	O	O	O	O		O				O	O	O	O	O	O
	Online burofax		O				O								O	
	E-invoicing		O		O	O			O		O		O	O	O	O
	Hybrid mail	O	O		O	O	O		O	O			O	O	O	O
	Reverse Hybrid mail	O	O				O							O		O
	Online facilitation of hybrid mail	O	O		O	O					O		O	O	O	O
	Electronic postal certification mark		O	O		O	O		O	D			O		O	O
	Digital signature	O	O			O	O		O	D				O	O	D
	Digital identity services	O		O		O	O		O	D		O		O	O	D
	Credentialing services		O	O	O	O	O		O	D		O	O	O	O	D
	Digital archive	O	O	O		O	O		O	D		O	D	O	O	D
	E-health services															O
	E-administration	O				O		O	O	O			O		O	O

Figure 7: Development of digital post in industrialised countries (Universal Postal Union, 2019a)

		Africa																									
		Benin	Botswana	Burkina Faso	Chad	Comoros	Cote d'Ivoire	DR Congo	Gambia	Ghana	Guinea-Conakry	Kenya	Lesotho	Liberia	Madagascar	Malawi	Mozambique	Namibia	Niger	Senegal	South Africa	South Sudan	Tanzania (United Rep.)	Togo	Uganda	Zimbabwe	
E-post and e-government	Postal electronic mailbox					D					D										O						
	Online direct mail																										
	Postal registered electronic mail					D					O		D									O					
	E-cards					D																					
	Online burofax					D																					
	E-invoicing		D	D	D																	O					
	Hybrid mail	D	O	D	O						D	D		D								O	O				
	Reverse Hybrid mail			D	D															D							
	Online facilitation of hybrid mail	D										O							O								
	Electronic postal certification mark					D					O																
	Digital signature		D			D																	O				
	Digital identity services														O								O				
	Credentialing services		O			D																					
	Digital archive																										
	E-health services																										
	E-administration	O									D											O					

Figure 8: Development of digital post in sub Saharan Africa (Universal Postal Union, 2019a)

disadvantaged citizens (Marsh & Piscioneri, 2015; USPS, 2015).

The table below depicts the development of digital Posts in the industrialised countries (Figure 7) and in sub-Saharan Africa (Figure 8).

It comes as no surprise that, according to (UPU, 2019a), Switzerland scores 100 out of 100 points on the Universal Postal Union's Integrated Index for Postal Development (2IPD). The 2IPD is a fused index. It computes and tracks the performance of countries across four key dimensions of postal development: Reliability, Reach, Relevance and Resilience (Mokgohloa, Kanakana-Katumba, Maladzi, & Trimble, 2019). These four dimensions as represented in Figure 9 below, summarize the 2IPD.

According to (Universal Postal Union, 2019a), South Africa leads on the continent having deployed postal electronic mailboxes, postal registered electronic mail, e-invoicing, digital signatures, hybrid mail, digital identity services and the digital signature. This scenario contrasts with that of Switzerland, which offers a full range of digital postal services as depicted in Figure 7. According to (Heierli, 2018), Swiss Post has adopted Industry 4.0 disruptive technologies such as artificial intelligence (AI), advanced robotics, big data and analytics, and digital services that can be trusted, as demonstrated by the following examples:

- Swiss Post offers the Swiss citizens a secured e-voting solution; and
- Swiss Post provides core communities of e-health service providers with a secured electronic platform.

The Universal Postal Union (2019b) report affirms the digital leadership demonstrated by Swiss Post and argues that, unlike many other Designated Postal Operators across the world, Swiss Post has provided transportation services to citizens of Switzerland for over a 100 years, and generates just over 10% of its total revenue from the PostBus unit. The report further argues that in maintaining its digital leadership, two autonomous shuttle buses deployed in June 2016 continue to pick-up and drop off passengers across the 1-mile loop.

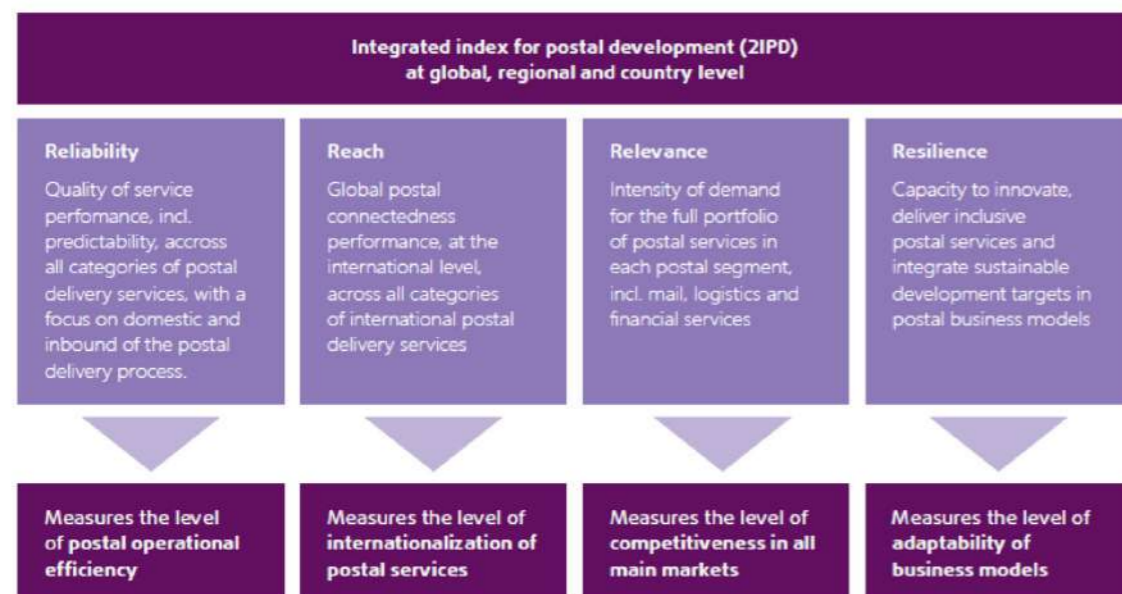


Figure 9: Development of digital post in Sub Saharan Africa (Universal Postal Union, 2019a)

### 2.3.5 Potential challenges of IoT

Rose *et al.*, (2015) suggests that there are five key IoT pressing challenges that need to be addressed with the exponential rise of IoT. These include security; privacy; interoperability and standards; legal, regulatory, and rights; and emerging economies and development (Rose, Karen; Eldridge, Scott; Chapin, 2015). This view is supported by (Jindal, Jamar, & Churi, 2018) who suggest that IoT has materialised to cause major security challenges that have seized the attention of numerous organisations and governments of the world. They argue that the addition of a massive number of new devices and hubs to the systems and the worldwide web will afford hackers with a larger podium to invade the system, particularly as many experience the ill effects of security holes. Hackers have already wreaked havoc by infiltrating connected IoT devices (Jindal *et al.*, 2018). They argue that there are four challenges identified by semiconductor companies relating to the provision of IoT solutions; these challenges are (a) A gap in technical sophistication; (b) Immature security standards; (c) Inability to see full value of IoT security; and (d) Difficulty in monetising security solutions. These four challenges are depicted in Figure 10 below.

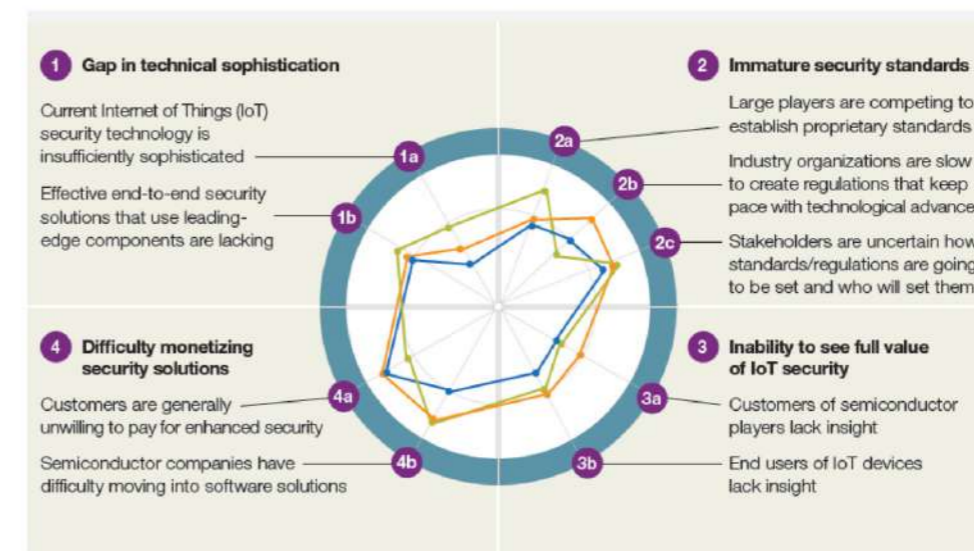


Figure 10: Challenges to providing IoT solutions (Jindal et al., 2018)

### 2.3.6 Proposed theoretical framework

The postal sector has played a vital role in the past 100 years as a pillar of the community in terms of delivery of mail and payment of social grants. Postal development is interwoven with sustainable development as presented earlier. The postal sector has identified four SDGs to which it could directly contribute to the Agenda 2030. These three goals are Goal 8 (Decent work and economic development), Goal 9 (Industry innovation and infrastructure), and Goal 17 (Partnerships for the goals).

Conversely, appropriate technology has a core group of design tenets that span from the cultural (e.g., compliance with societal norms), to the consumer (e.g., community ownership model), to the technological (e.g., environmental friendliness). These design tenets are crucial in the implementation of projects or programmes to support postal development for community development.

The Internet of Postal Things is an ideal candidate for application in the postal industry to better serve the community and empower communities by focusing on e-postal and e-government services:

- Contribution to Smart cities (Installing sensors to measure climatic conditions such as temperature, pressure, wind-speeds, pollution concentrations and feeding back to responsible authorities such as the Weather Service, Municipalities, Department of Environmental Affairs, *et al.*)
- Home care logistics (such as checking on elderly, taking health readings and feeding back to the Department of Health and the Department of Social Services).
- Lost and found e-services (Since postmen and postwomen crisscross the country on a daily basis, touching thousands of delivery points daily, the Post Office, through sensors fitted to its delivery modes of transport, could assist in tracing items that are fitted with transmitters in communities).
- Community Centre/ Wi-Fi connectivity (The is a Post Office even in the most remote areas of the country where communities could use the Post Office as a platform or interface to the digital world).
- E-government services (The Post Office could emulate its Swiss Post counterpart and not only deepen its footprint in the social security arena where it pays 7.7 million people a month but could play a major role in the e-Health platform in anticipation of the National Health Insurance. It could also deepen its footprint on vehicle license renewal by digitalising the service and enter the area of driver's license renewal, passport and identity document issuing, and incrementally become the trusted e-government provider of choice.

The theoretical framework depicted in Figure 11 epitomises the foremost verdicts of this review of literature and industry reports. The theoretical framework based on comprehensions extracted from literature and industry reports, suggests that there are three dimensions to an empowered community. These dimensions are the (a) Community development dimension which is informed by SDGs (Goals 8, 9 and 17) which are informed by appropriate technology design tenets and considerations; (b) Internet of Postal Things Dimension which is an enabler of the (c) Community empowerment dimension which delivers community-based e-services and e-government services to the benefit of communities.

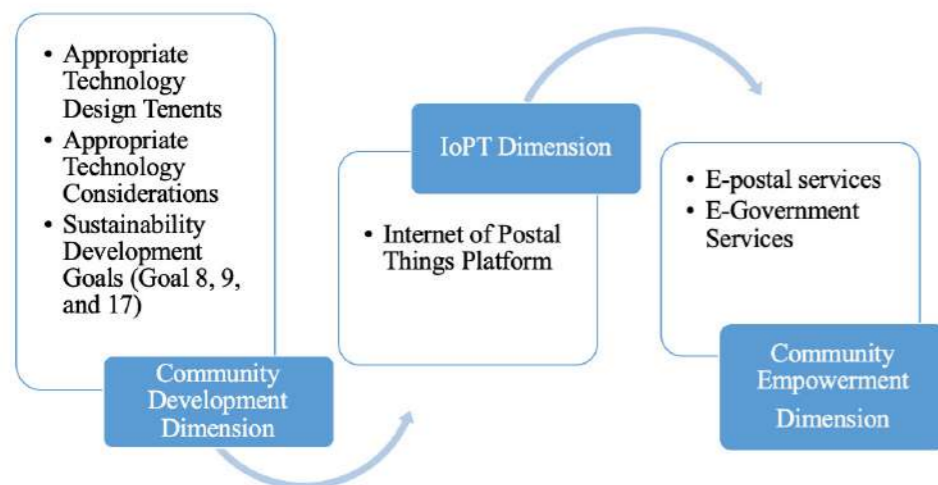


Figure 11: Proposed theoretical framework for community-based Internet of Postal Things

### 3. RESEARCH METHODS

The methodology applied in the study is qualitative in nature and uses a case study to reflect empirical insight. Qualitative research is most applicable in terms of opinions, reflection, and insight into current realities. Conceptual endeavour is gained from understanding human behaviour from the participants' perspective. In qualitative research, it is important that subjects speak for themselves, and this is what provides differentiation in interpretation. In this interactive process, there are lessons to be learnt about the experiences of different phenomena. This information is

used to reflect on the current scenario and provide detailed insight into the subject matter. It is important to note that this vital source of information cannot be replicated; this is where new knowledge is created. The time required for data collection, analysis and interpretation is lengthy but the value in this methodology is insurmountable. Qualitative analysis provides insight into possible relationships, cause and effect analysis, and the dynamism of the interpretation of data.

### 4. CONCLUSIONS

Posts have a long history, and the Post is often the oldest nationwide establishment in existence (Universal Postal Union, 2019a). However, the world is becoming digital as the Fourth Industrial Revolution radically changes business models through 21<sup>st</sup> century digital technologies and the Post is not immune to this radical transformation of digitalisation.

Posts have a long history in serving communities. For hundreds of years Posts have been the pillar of community centred development. Posts should continue to be the beacon of hope for communities in the digital age.

The concept of community development was presented followed by tenets and consideration of appropriate technology which were also presented. The sustainable development goals were presented as well as the SDGs related to the Post were presented and elaborated on. The concept of Internet of Things (IoT) was studied in-depth and revealed in terms of its characteristics, including challenges and opportunities as it relates to Internet of Postal things. Lastly, a theoretical framework for the implementation of e-government and e-community postal services was developed and unveiled.

The proposed theoretical framework is the initial step that the Post Office could take to emulate a leader in e-community service and as an e-government service provider such as Swiss Post. However, this takes into consideration the relevant sustainable development goals appropriate to the postal sector and the appropriateness of the technology (Internet of Postal Things) in advancing empowerment of the community through delivery of e-community services and e-government services that ultimately strengthen the resilience and empowerment of communities in the digital ecosystem and digital age.

The Internet of Postal Things is a technology with potential for a multitude of new products and services. Its application is nearly infinite in enabling ubiquitous seamless integration of the physical realm and the cyber realm and connecting the government (through the Post) via a seamless postal value chain with communities. The proliferation of mobile devices in South Africa, which has steadily increased over the years gives an opportunity for government to be in synch with communities it represents. The Post Office with a long history in serving communities for decades is an ideal partner of choice for government in implementing aggressive e-government services to serve communities better, effectively, and efficiently.

## LIST OF REFERENCES

- Ali, Z.; Ali, H.; Badawy, M. (2015). Internet of Things (IoT): Definitions, Challenges and Recent Research Directions. *International Journal of Computer Applications*, 128(1), 37–47. <https://doi.org/10.5120/ijca2015906430>
- Biggs, P., Garrity, J., & LaSalle, C. (2015). *Harnessing-IoT-Global-Development.pdf*.
- Greater Shepparton. (2010). *Agricultural Community Development Framework*. Shepparton.
- Heierli, J. (2018). SWISS POST IS RIGHT HERE . FOR EVERYONE . ANNUAL REPORT 2018.
- INAT. (2020). Definition of appropriate technology. Retrieved May 17, 2020, from <http://www.appropriatetech.net/index.php/home/about-inat>
- Jindal, F., Jamar, R., & Churi, P. (2018). Future and Challenges of Internet of Things. *International Journal of Computer Science and Information Technology*, 10(2), 13–25. <https://doi.org/10.5121/ijcsit.2018.10202>
- Kamal, Z., Mohammed, A., Sayed, E., & Ahmed, A. (2017). Internet of things applications, challenges and related future technologies. *World Scientific News*, 67(2), 126–148. Retrieved from [www.worldscientificnews.com](http://www.worldscientificnews.com)
- Lissenden, J., Maley, S., & Mehta, K. (2015). An Era of Appropriate Technology: Evolutions, Oversights and Opportunities. *Journal of Humanitarian Engineering*, 3(1). <https://doi.org/10.36479/jhe.v3i1.34>
- Marsh, B., & Piscioneri, P. (2015). The Internet of Postal Things. *2015 International Conference on Collaboration Technologies and Systems, CTS 2015*, 3–4. <https://doi.org/10.1109/CTS.2015.7210387>
- Milling, G. (2009). Appropriate Technology and Intermediate Technology. *Mitopencourseware*, 721, 1–9.
- Mokgohloa, K., Kanakana-Katumba, M. G., Maladzhi, R. W., & Trimble, J. A. (2019). Postal Development: Literature Review into Adoption Models. *IEEE International Conference on Industrial Engineering and Engineering Management*, 2, 764–768. <https://doi.org/10.1109/IEEM44572.2019.8978531>
- Patel, S., Maley, S., & Mehta, K. (2014). Appropriate technologies in the globalized world: FAQs. *IEEE Technology and Society Magazine*, 33(1), 19–26. <https://doi.org/10.1109/MTS.2014.2301855>
- Perwej, Y., Omer, M. K., Sheta, O. E., Harb, H. A. M., & Adrees, M. S. (2019). The Future of Internet of Things ( IoT ) and Its Empowering Technology. *International Journal of Engineering Science and Computing*, 9(3), 20192–20203.
- Phillips, Rhonda; Pittman, R. H. (2009). *An introduction to Community Development*. New York: Routledge.
- Reinhard, G., Jesper, V., & Stefan, S. (2016). *Industry 4.0: Building the digital enterprise. 2016 Global Industry 4.0 Survey*. <https://doi.org/10.1080/01969722.2015.1007734>
- Rose, K; Eldridge, S; Chapin, L. (2015). *The Internet of Things: An overview*. Geneva.
- Santos, B; Chaura-Santos, F; Lima, T. (2018). Industry 4.0: an overview. *Research G*, (July).
- Santos, C., Mehrai, A., Barros, A. C., Araújo, M., & Ares, E. (2017). Towards Industry 4.0: an overview of European strategic roadmaps. *Procedia Manufacturing*, 13, 972–979. <https://doi.org/10.1016/j.promfg.2017.09.093>
- Selma, C., Tamzalit, D., Mebarki, N., Cardin, O., Selma, C., Tamzalit, D., Mebarki, N., Cardin, O., Bruggeman, L., Companies, S., Case, T., Postal, F., & Theodor, S. (2019). Industry 4 . 0 and Service Companies : The Case of the French Postal Service To cite this version : HAL Id : hal-01982994 Industry 4 . 0 and service companies : The case of the.
- Sianipar, C. P. M., Yudoko, G., Adhiutama, A., & Dowaki, K. (2013). Community Empowerment through Appropriate Technology: Sustaining the Sustainable Development. *Procedia Environmental Sciences*, 17, 1007–1016. <https://doi.org/10.1016/j.proenv.2013.02.120>
- UNDP. (2018). *SDG Guide*. Geneva.
- Universal Postal Union. (2019a). *The digital economy and digital postal activities – a global panorama*.
- Universal Postal Union. (2019b). *The digital economy and digital postal activities – a global panorama*. Bern: Universal Postal Union.
- UPU. (2018). *Postal development report*. Berne.
- UPU. (2019a). *Postal Development Report 2019*. Berne.
- UPU. (2019b). *The digital economy and digital postal activities – a global panorama*. Berne. Retrieved from [http://www.upu.int/uploads/tx\\_sbdownloader/theDigitalEconomyAndDigitalPostalActivitiesAGlobalPanoramaEn.pdf](http://www.upu.int/uploads/tx_sbdownloader/theDigitalEconomyAndDigitalPostalActivitiesAGlobalPanoramaEn.pdf)
- USPS. (2015). *The Internet of Postal Things Report Number RARC-WP-15-013*. Virginia. Retrieved from [https://www.usps.gov/sites/default/files/document-library-files/2015/rarc-wp-15-013\\_0.pdf](https://www.usps.gov/sites/default/files/document-library-files/2015/rarc-wp-15-013_0.pdf)
- USPS. (2016). *Riding the Waves of Postal Digital Innovation*. Washington DC. Retrieved from <https://www.usps.gov/sites/default/files/document-library-files/2016/RARC-WP-16-014.pdf>
- Vuksanović, D., Ugarak, J., & Korčok, D. (2016). Industry 4.0: the Future Concepts and New Visions of Factory of the Future Development. *International Scientific Conference on ICT and E-Business Related Research*, (October), 293–298. <https://doi.org/10.15308/sinteza-2016-293-298>
- Zelenika, I., & Pearce, J. M. (2011). Barriers to Appropriate Technology Growth in Sustainable Development. *Journal of Sustainable Development*, 4(6), 11–22. <https://doi.org/10.5539/jsd.v4n6p12>

# APPLICATION OF ARTIFICIAL BEE COLONY (ABC) ALGORITHM IN A BIG-BOX STORE OR RETAIL FACILITY

Modestus O. Okwu<sup>1</sup>, Lagouge K. Tartibu<sup>1</sup> Ifeyinwa Juliet Orji<sup>2</sup>

<sup>1</sup>Department of Mechanical Engineering Technology, University of Johannesburg, Johannesburg, South Africa

<sup>2</sup>Research Center for Smarter Supply Chain, Dongwu Business School, Soochow University, People's Republic of China

mechanicalmodestus@yahoo.com, ltartibu@uj.ac.za, orji@yahoo.com

## Abstract

*This research is focused on the intelligent foraging behaviour of honeybees by designing the ABC algorithm or distributed problem-solving mechanism. A swarm-based metaheuristic algorithm was applied to investigate the effectiveness of product sales in a multi-purpose shopping complex by using dataset from a retail outlet in Delta State. The algorithm was selected due to its superior convergence properties. Dataset obtained from the different sections and units of the facility were used for the study by considering: the number of visits to each section, limiting factors or constraints and maximum possible number of cycles. The bee algorithm model was used to predict the most visited section with optimal sales via stochastic iteration process. Out of sixteen (16) sections selected for this study, it was observed that the most highly rated net source of optimization in the system by onlookers, using the Bee Algorithm model was Section three (3) with the most patronized products. Considering the service sections selected for this study, the most highly rated net source of optimisation was the bakery unit. Conclusively, the heuristic ABC model is highly effective in non-deterministic system prediction.*

**Keywords:** ABC algorithm; swarm-based metaheuristic algorithm; superior convergence

## INTRODUCTION

In computational intelligence, heuristics and meta-heuristic based search techniques have been developed and effectively adopted to solve complex problems in different areas of science and engineering (Kamalam and Karnam, 2013). Optimisation, in a general sense, is the process of finding the best possible solution to a real-world problem, which might be maximising or minimising a function like cost, size, reliability and so on. Given the significant role that optimisation plays in our day-to-day life, it is thus given attention in significant areas like logistics and supply chain management, engineering, accounting, etc. Its importance has resulted in researchers continually working on inventing or improving already existing optimisation tools. Optimisation algorithms are therefore mathematical methods which help in obtaining an optimal solution to a real-world problem, by choosing from a set of possible options in order to satisfy the stated objectives subject to a group of constraints (Yuce et al., 2013).

The concept of artificial bee algorithm was proposed by Karaboga for addressing complex stochastic problems (Desale et al., 2015). Bee Algorithm is an optimisation tool which was first introduced and used by Pham et al in 2005 (Yuce et al., 2013). It is a swarm-based meta-heuristic which mimics the feeding behaviour of honeybees is useful for solving complex engineering problems (Pharm et al. 2014; Pharm et al. 2018). The colony consists of three groups of bees: employed bees, onlookers and

scouts. Also, the Bee Algorithm model consists of essentially three components: employed and unemployed foraging bees, and food sources. We assumed that for each food source there is only one artificial employed bee. This makes the number of employed bees in the colony proportional to the number of food sources found around the hive. Employed bees, upon return from their food source to the hive, dance on this area. Scouts are employed bees. A Scout is formed when an employed bee's food source has been abandoned. A scout, therefore, starts to search for a new food source. The Onlookers are the category of bees that watch the dance of the employed category and choose food sources depending on the dances.

Pham et al., (2015) considered the components individually: Firstly, employed foragers are associated with a food source which they are known to intentionally exploit continually. In other words, they could be referred to as being employed at these food sources. Due to their fondness of a food source, they do carry with them information about this source, such as distance and direction from the hive, and the value of the source. From time-to-time, they share this information with other bees with a certain probability. Secondly, the unemployed foragers are those that are continually searching for an available food source to exploit. They basically two types of unemployed foragers: the scouts and the onlookers. The scouts are those actively searching the environment around the hive for newly available food sources and the onlookers wait back in the nest and assess a food source by the information provided by an employed bee. The value of a food source is assessed based on factors such as the value of the food source, the ease of accessibility of the food source, its proximity to the hive. (Pham et. al., 2015).

## Foraging Behaviour of Honeybee

As stated earlier, the foragers are classified into two - the scouts and the onlookers (Karaboga, 2005). The scout bees move out of the nest and search for good food sources and the onlookers stay back in the nest and evaluate the information brought by the scouts by dancing. In a colony, the total population of the onlookers range from 40 – 90% of the overall forager population. (Nest and Moore, 2012). A good food source represents flower patches with good amounts of nectar or pollen which can be accessed for collection with the least possible effort. This kind of food source is visited by more bees while on the other hand, patches with less nectar or pollen should receive fewer bees (Camazine et al., 2001). According to Ebubekir Koc (2010), the foraging process begins with the scouts going around the hive searching for promising flower patches. They move randomly from one prospective patch to another, evaluating their viability based on certain predetermined quality standards. Upon returning to the nest, the scouts that found a patch that meets the standard deposit the nectar or pollen extracted from these patches and proceed to perform what is known as the “waggle dance” (KoC, 2010). The waggle dance will be discussed in details in the next section of this article. The dance is essentially a form of communication within the colony as it contains three key pieces of information that will enable the colony to evaluate the patch. This information includes the direction of the patch, distance from the nest, and its value (Camazine et al., 2001). With this information, the colony is enriched with enough details to guide bees deployed for foraging.

## Waggle Dance of Honeybees

The waggle dance is a phenomenon whereby the scout bees dance in a wagging pattern. That is, they move their bodies from side to side and produce a loud buzzing sound. This dance is used to pass information about a given food source to the rest of the bee colony such as the quality of the food source, the direction and distance from the nest (Yuce et al., 2013). The waggle dance consists of a path that has the shape of a figure of eight. It begins with the scout vibrating its wing muscles, which in turn produces a loud buzz and runs in a straight line in a direction that indicates the location of the food source relative to both the hive's vertical and the sun's azimuth field. It then circles back, changing the path from left to right. The distance from the food source is determined by the speed or duration of the dance, and the quality of the source, which influences the number of follower bees, is determined by the buzzing (Talbi, 2009). See Figure 1 for pictorial view of bee waggle dance. The bee algorithm flow chat is shown clearly in Figure 2.

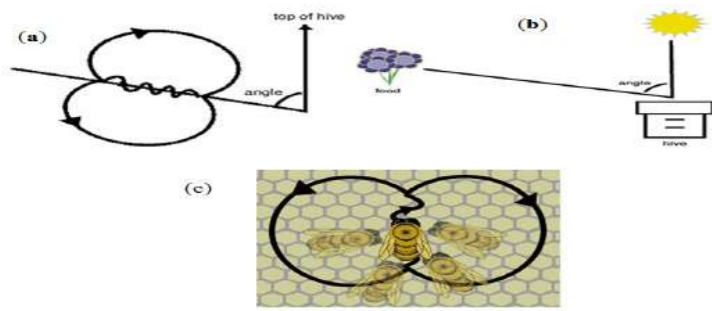


Figure 1: (a) Orientation of waggle dance with respect to the sun; (b) Orientation of waggle Dance with respect to the food source, hive and sun; (c) The Waggle Dance and followers. (Source: Baris et al., 2015).

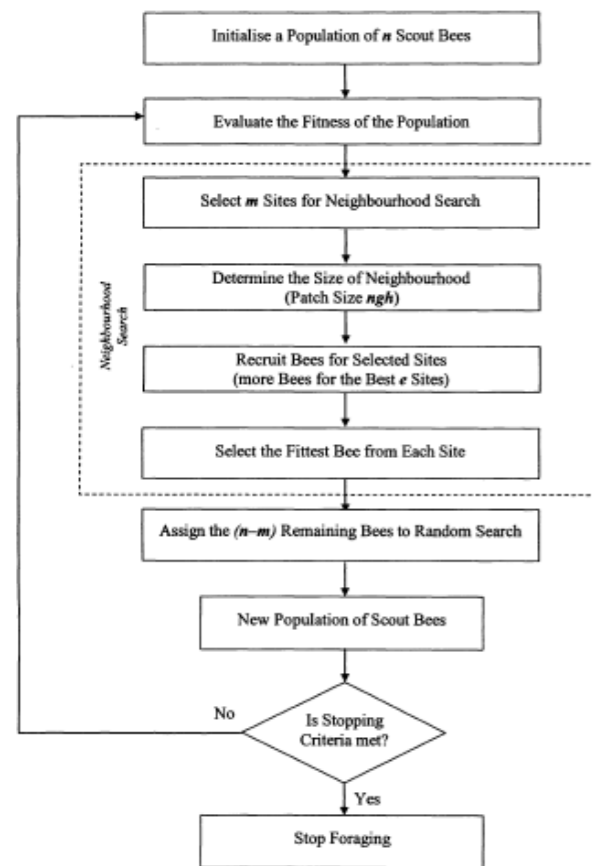


Figure 2. Bee Algorithm Flowchart (Koc, 2010)

#### FURTHER RESEARCH ON BEE ALGORITHM AND OTHER SWARM OPTIMIZATION ALGORITHMS

The bee algorithm falls into the class of optimisation technique referred to as Swarm optimization algorithms. Swarm Algorithms are inspired by the behavioural nature of swarms to search for optimal solutions. Some advantages of bee algorithms include: the ease of use and implementation; ability to combine with other algorithms to improve the efficiency of solved optimisation problems; ability to carry out a global and local search; used in solve a good number of optimisation problems. The disadvantages include modification of parameters and tuning require time and accuracy; It require several parameters and random initialization. A key distinction in the characteristics of Swarm-based Optimisation algorithms is in their usage of a whole population of solutions rather than a single solution (Koc, 2010). Multiple optimal solutions can also be obtained in swarm intelligence, by making use of a greedy criterion to decide which solution to adopt. Solution is accepted if it increases the value of the stated objective functions (Panigrahi et al. 2011). Different researchers have looked at various types of heuristic (H) and meta-heuristic (MH) algorithms (Desale et al. 2015). According to Yuce et al., (2013) In addition to

the Bee Algorithm, other Swarm Optimisation Algorithms, H and MH are: Genetic Algorithm (Bajeh and Abiolarinwa 2011); Harmony Search (Geem, 2010); Fire fly Algorithm (Xin, 2007); Migrating Bird Optimization Algorithm (2012); Bat Algorithm (Yang, 2010); Cuckoosearch Algorithm (Yang and Deb 2009); Ant Colony Optimization (Dorigo et al., 1996). The Bee Algorithm is a robust optimisation technique and has gotten the attention of a good number of researchers and problem solvers. In a research, bee algorithm was compared in terms of its performance with other popular algorithms such as genetic algorithm the aim was to test the ability of the algorithm to carry out a random search for combinatorial and functional optimisation (Koc, 2010). Yuce et al. (2013) carried out a review on the Bee algorithm considering neighbourhood search combined with random explorative search. They further implemented an improved version in order to optimize several functions, and the results were compared with those obtained from different optimization algorithms, bee algorithm proved more effective in solution search. Pham et al. (2015) conducted an experimental study of the performance of the Bee Algorithm by testing the algorithm using 18 customised minimisation benchmarks, and the performance was compared with two other standard swarm-based optimisation algorithms. They concluded that BA has wide range of application and is very effective in solving complex real-world optimisation problems. Tereshko and Lee (2002) conducted an intensive study on how information mapping patterns determine foraging behavior of a honeybee colony. Tereshko and Loengarov (2005) examined collective decision making in honeybee foraging dynamics.

#### MATHEMATICAL MODELLING OF THE BEE ALGORITHM

The mathematical model of the bee algorithm can be developed from the flowchart in Figure1. The ABC algorithm creates a randomly distributed initial population of solutions  $(f = 1, 2 \dots E_b)$ , where 'f' signifies the size of population and 'E<sub>b</sub>' is the number of employed bees. Each solution  $x_f$  is a D-dimensional vector, where D is the number of parameters to be optimized. The position of a food source, in the ABC algorithm, represents a possible solution to the optimization problem, and the nectar amount of a food source corresponds to the quality (fitness value) of the associated solution. After initialization, the population of the positions (solutions) is subjected to repeated cycles of the search processes for the employed, onlooker, and scout bees (cycle = 1, 2, ... MCN), where 'MCN' is the maximum cycle number of the search process. The greedy-selection process is suitable for unconstrained optimization problems. The probability of selecting a food source  $p_f$  by onlooker bees is calculated as follows:

$$P_i = \frac{\text{fitness}_i}{\sum_{f=1}^{E_b} \text{fitness}_f} \quad (1)$$

Where:

$\text{fitness}_i$  is the fitness value of a solution f.

$E_b$  is the total number of food-source positions.

From eq. (1), a good food source will attract more onlooker bees than a bad one. Subsequent to onlookers selecting their preferred food-source, they produce a neighbour food-source position  $f+1$  to the selected one f and compare the nectar amount (fitness value) of that neighbour  $f+1$  position with the old position. The procedure and Eq (1) is used for ABC algorithm with unconstrained optimization problem. In order to produce a candidate food position from the old one in memory, the adapted ABC algorithm uses the expression in eq. (2)

$$v_{ij} = \begin{cases} x_{ij} + \Phi_{ij}(x_{ij} - x_{kj}), & \text{if } R_j < MR \\ x_{ij}, & \text{otherwise} \end{cases} \quad (2)$$

where  $k \in \{1, 2, \dots, SN\}$  is randomly chosen index. k is determined randomly; it has to be different from i.

$R_j$  is a randomly chosen real number in the range  $[0,1]$  and  $j \in \{1, 2, \dots, D\}$ .

$MR$ , modification rate, is a control parameter that controls whether the parameter  $x_j$  will be modified or not. In the version of the ABC algorithm proposed for constrained optimization problems, artificial scouts are produced at a predetermined period of cycles for discovering new food sources randomly. This period is another control parameter called scout production period (SPP) of the algorithm. The control parameters used in the ABC Algorithm: SN = number of food sources = number of employed or onlooker bees; value of limit.

MCN=maximum cycle number. Detailed pseudo-code of the ABC algorithm are: Initialize the population of solutions  $x_{ij}$ ,  $i = 1 \dots SN$ ,  $j = 1 \dots D$ ; Evaluate the population; cycle = 1; repeat; provide new solutions  $v_{ij}$  for the employed bees and evaluate them; apply the greedy selection process; calculate the probability values  $P_{ij}$  for the solutions  $x_{ij}$ ; produce the new solutions  $v_{ij}$  for the onlookers from the solutions  $x_{ij}$  selected depending on  $P_{ij}$  and evaluate them; apply the greedy selection process; determine the abandoned solution for the scout, if exists, and replace it with a new randomly produced solution  $x_{ij}$ ; memorize the best solution achieved so far; cycle=cycle+1; until cycle=MCN.

### Case Study

The company used as case study is a large retail outlet in Delta State. Data collected from different sections are used for analysis. As shown in Figure 1, retail facility has 16 sections namely; Section 1 (Detergents, brush ware, Air Fresheners, All Purpose Cleaners), Section 2 (Baby Foods, Toilet Paper, Baby Toiletries, Manchester Goods), Section 3 (Bath soap, men deodorants, ladies deodorants, toiletries), Section 4 (Eggs, Pasta, Bakery Aids, canned Fruits), Section 5 (Spices, Crockery, Glassware, Condiments), Section 6 (Cooking Oil, Kitchen Ware, Kitchen Utensil, Canned Vegetables), Section 7 (Tea, Coffee, Creamers, Small Appliance), Section 8 (Yogurts, Breakfast Cereal, Breakfast Bars), Section 9 (Juices, Biscuits, Fruit Juices), Section 10 (Sweet, Chocolates), Section 11 (Chips, Snack, Outdoors toys, Puzzles), Section 12 (Girls Toys, Boys Toys), Section 13 (Stationery, Schoolbag, School Stationery, Party Accessories), Section 14 (Luggage, Electric Ware, Motor Accessories, Bathroom), Section 15 (d.i.y, Pet Food, Pool Care, Pet Accessories) and Section 16 (Braai, Garden, Outdoor Living, Gardening Tool). Also, there are 4 Serving units namely: Butchery, Seafood, Delicatessen and Bakery. Information containing the number of customers visiting the various sections of the product-based system is shown in Figure 3. Figure 4 represent customers visiting the service-based sections within the period of investigation. The objective is to know the most highly rated net source of optimization by onlookers using Bee Algorithm.

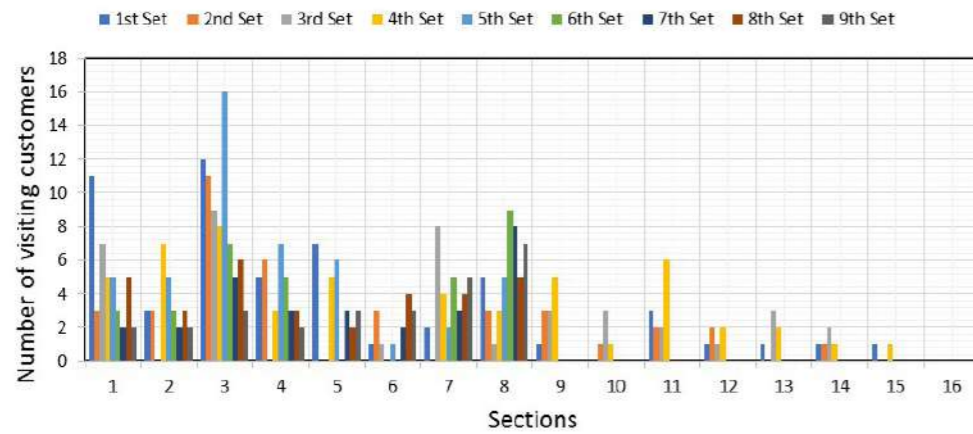


Figure 3: Direction-finding to various sections of the retail facility by customers

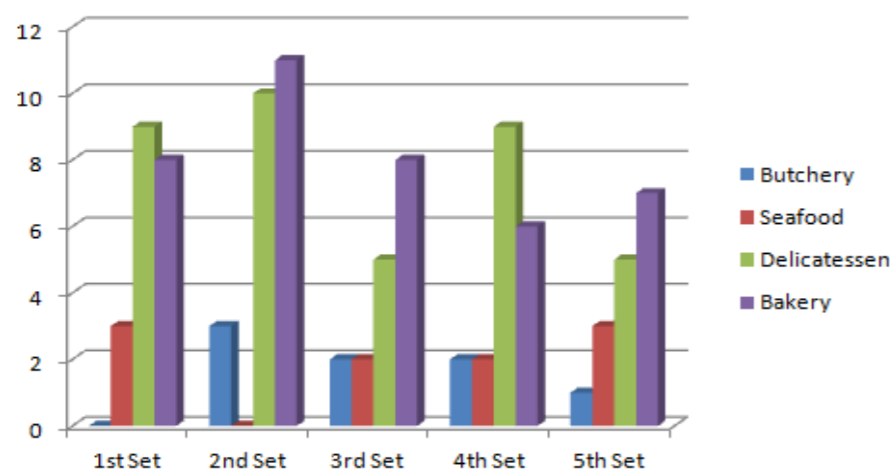


Figure 4: Visit to the Service Unit by Customers

#### Solution Procedure

The probability  $P_i$  of selecting the food source  $i$  is determined by system of eq.(1)  $P_i = \frac{f_i}{\sum_{i=1}^{NS} f_i} P_i = \frac{f_i}{\sum_{i=1}^{NS} f_i}$

$f_i$  = Number of visit per Set,  $NS$  = Total Number of Set  
Total Number of Sets,  $NS = 9$

For the first section, Number of visits per Set  $f_i$ , For 1<sup>st</sup> Set = 11, Probability,  $P_i = \frac{11}{\sum_{i=1}^9 11} = 0.2558$

For 2<sup>nd</sup> Set; Probability,  $P_i = \frac{3}{\sum_{i=1}^9 3} = 0.0697$

For 3<sup>rd</sup> Set; Probability,  $P_i = \frac{7}{\sum_{i=1}^9 7} = 0.1627....$

For the second section,  
Total No. of Sets,  $NS = 9$ , No. of visit per set  $f_i$ , for 1<sup>st</sup> Set = 3

Therefore, Probability,  $P_i = \frac{3}{\sum_{i=1}^9 3} = 0.1071$ , For 2<sup>nd</sup> Set; Probability,  $P_i = \frac{3}{\sum_{i=1}^9 3} = 0.1071$

For 3<sup>rd</sup> Set; Probability,  $P_i = \frac{0}{\sum_{i=1}^9 0} = 0....$

Table 1 shows summary of result in terms of probability of selection of food source by onlookers.

**Table 1.** Probability of Selecting Food Source by Onlookers,  $P_i$  for Table 1.

Sections	1 <sup>st</sup> Set $P_1$	2 <sup>nd</sup> Set $P_2$	3 <sup>rd</sup> Set $P_3$	4 <sup>th</sup> Set $P_4$	5 <sup>th</sup> Set $P_5$	6 <sup>th</sup> Set $P_6$	7 <sup>th</sup> Set $P_7$	8 <sup>th</sup> Set $P_8$	9 <sup>th</sup> Set $P_9$
1 ( Detergents, Brush Ware, Air Fresheners, All Purpose Cleaners)	0.2558	0.0697	0.1627	0.1162	0.1162	0.0697	0.0465	0.1167	0.0465
2 (Baby Foods, Toilet Paper, Baby Toiletries, Manchester Goods)	0.1071	0.1071	0	0.25	0.1785	0.1071	0.0714	0.1071	0.0714
3 (Bath Soap, Toilet Paper, Baby Toiletries, Manchester Goods)	0.1558	0.1429	0.1169	0.1039	0.1078	0.0909	0.0649	0.0779	0.0389
4 (Eggs, Pasta, Bakery Aids, Canned Fruits)	0.1470	0.1764	0	0.0882	0.1058	0.1470	0.0882	0.0882	0.0588
5 (Spices, Crockery, Glassware, Condiments)	0.2692	0	0	0.1923	0.2307	0	0.1153	0.0769	0.1153
6 (Cooking Oil, Kitchen Ware, Kitchen Utensil, Canned Vegetables)	0.0666	0.2	0.0666	0	0.0666	0	0.1333	0.2666	0.2
7(Tea, Coffee, Creamers, Small Appliance)	0.0606	0	0.2424	0.1212	0.0606	0.1515	0.0909	0.1212	0.1515
8 (Yogurts, Breakfast Cereals, Cereals Bars)	0.1086	0.0652	0.0217	0.0652	0.1086	0.1956	0.1739	0.1086	0.1521
9 (Juices, Biscuits, Fruit Juices)	0.0833	0.25	0.25	0.4166	-	-	-	-	-
10 (Sweets, Chocolates)	0	0.2	0.6	0.2	-	-	-	-	-
11 (Chips, Snack, Outdoors Toys, Puzzles)	0.2307	0.1538	0.1538	0.4615	-	-	-	-	-
12 (Girl Toys, Boy Toys)	0.1666	0.3333	0.1666	0.3333	-	-	-	-	-
13( Stationery, School Bag, School Stationery, Party Accessories)	0.1666	0	0.5	0.3333	-	-	-	-	-
14(Luggage, Electric Ware, Motor Accessories, Bathroom)	0.2	0.2	0.4	0.2	-	-	-	-	-
15 ( d.i.y, Pet Food, Pool Care, Pet Accessories)	0.5	0	0	0.5	-	-	-	-	-
16(Braai, Garden, Outdoor Living, Gardening Tool)	0	0	0	0	-	-	-	-	-

**ANALYSIS AND RESULT**

From Figure 5, it was observed that Section 3 (Bath Soap, Men Deodorant, Ladies Deodorant, Toiletries) was the most visited section at the retail outlet. Also, from the Table 1, it was equally observed that Section 1 to 8 has more Visits compared to section 9 to 16. However, visit to each of the sections is dependent on certain observable factors taken into consideration during the experimental study namely: Location of the Sections, number of children that comes along with their guardian or parent which had a great influence in Section 3, 4, 8, 9, 10 and 12; number of probable parents which had an influence in Section 1, 2, 3, 4, 6, and 8 and number of average Singles which had an influence in Section 1, 3, 4, 6, 7, 8, 9 and 11. Considering Table 2, it was observed that the serving unit with much visit is between the delicatessen and the Bakery serving unit. Other units have a smaller number of visits within the period of investigation. Some of the observable factors that influence this number of visits are information about the available products and how fresh the products are. The probability of selecting food source by onlookers is presented in Figure 5

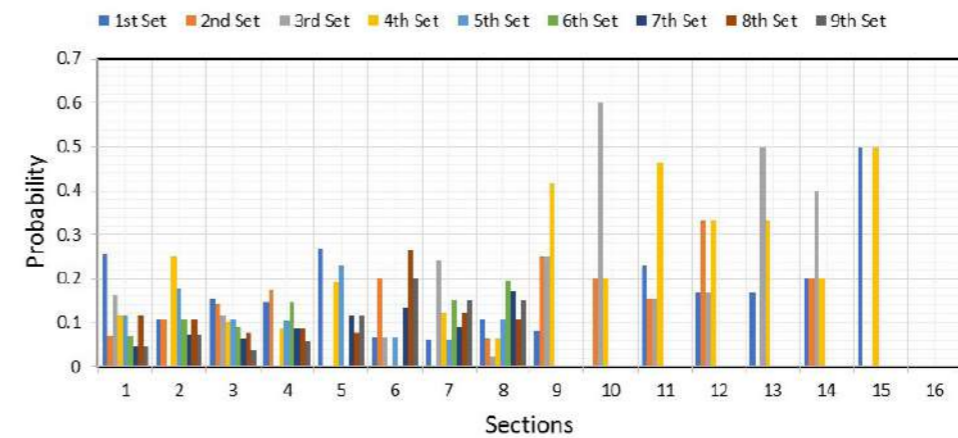


Figure 5: Probability of selecting foodstuff

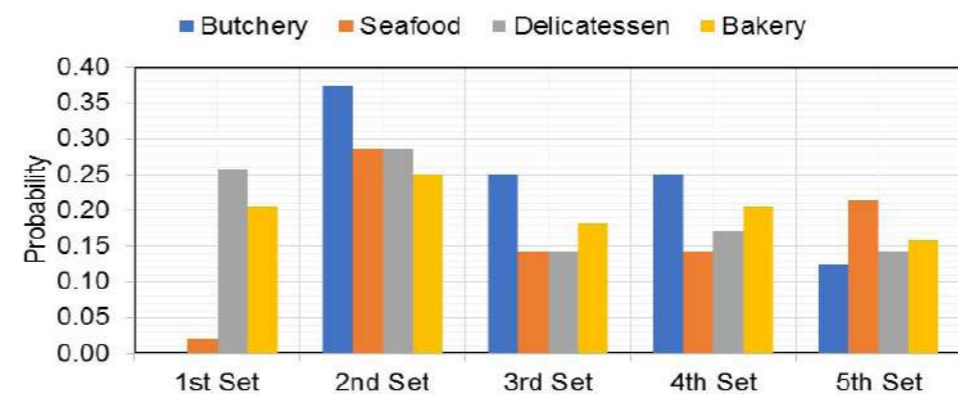


Figure 6. Probability of Visiting Several Service Sections by Customers

From the bar chart of Figures 5 and 6 which represent both the product sections and serving unit respectively, it was observed that the most highly rated net source of optimization at Shoprite is Section 3 for the full sections while the most highly rated net source of optimisation unit at the Serving Unit, is the bakery serving unit. However, by adopting the mathematical model developed from the Bee Algorithm for probability of best food source, a new data table is formulated which is represented in Table 1 and Figure 6 respectively. The devised table shows the probability of best food source by onlookers, it was observed from the chart that the most highly rated net source of optimization at Shoprite by the onlookers using the Bee Algorithm is the Section 3 due to the fully observed cluster at that section out of the 16 different Sections and the Bakery Unit at the serving Unit out of the other four (4) Serving unit due to its optimal values over other units.

**Conclusion**

ABC algorithm is a nature inspired algorithm which play a great role in decision making, especially in non-deterministic real-life activities. Datasets obtained from a well-known retail facility was tested using the modelled equations of the bee algorithm to optimize the movement of customers in and out of the big-box store and to observe the most frequently visited sections in the system. Out of sixteen (16) sections selected for study, it was observed that the most highly rated net source of optimization in the system by the onlookers using the Bee Algorithm model was Section three (3). The products available at the section are the most frequently consumed. They include: Bath Soap, Toilet Paper, Baby Toiletries, and Manchester Goods. For the four (4) service sections, the most highly rated net source of optimisation was the bakery unit. Just like the waggle dance observed by honeybees, it is interesting to note that same exist at the bakery unit when customers must swarm towards the bread section based on information or signal received on availability of hot bread. Conclusively, ABC model is highly useful in effective decision making at strategic and operational level in product and service-based retail and manufacturing systems.



## LIST OF REFERENCES

- Bajeh, A. O. and Abolarinwa, K. O. (2011). Optimization: A Comparative Study of Genetic and Tabu Search Algorithms”, *International Journal of Computer Applications (IJCA)*, Volume 31–No.5.
- Camazine, S., & Sneyed, J. (1991). ). A model of collective nectar source selection by honey bees: self-organization through simple rules. *Journal of Theoretical Biology*, 149:547-571.
- Dorigo M., Maniezzo V. & Colomi A., (1996). “Ant System: Optimization by a Colony of Cooperating Agents”, *IEEE Transactions on Systems, Man, and Cybernetics–Part B*,26, (1): 29-41.
- Desale S., Rasool A., Andhale S., Rane P. (2015) Heuristic and Meta-Heuristic Algorithms and their Relevance to the Real World: A Survey. *International Journal of Computer Engineering in Research Trends* Volume 2,5 (296-304).
- Duman E., Uysal M., Alkaya A.F. (2010) “Migrating Birds Optimization: A New Meta-heuristic Approach”, 2012.
- Geem, Zong Woo (2010). “Research Commentary: Survival of the Fittest Algorithm or the Novelest Algorithm”. *International Journal of Applied Meta-heuristic Computing*1(4): 75–79.
- Kamalam B. & Karnan M. (2013) A comprehensive review of artificial bee colony algorithm, *International Journal of Computers and Technology*, Volume 5, No. 1, ISSN 2277-3061
- Karaboga, D., & Akay, B. (2009). A comparative study of Artificial Bee Colony algorithm. *Applied Mathematics and Computation*, 112-113
- Karaboga, D. (2005). *An idea based on honey bee swarm for numerical optimization*. TR-06.
- Karaboga, D., & Basturk, B. (2007). *A Powerful and Efficient Algorithm for Numerical Function Optimization: Artificial Bee Colony (ABC) Algorithm*. J Glob Optim.
- Karagoba, D. (2005). *An idea based on honey bee swarm for numerical optimization*. Technical Report, Erciyes University, Engineering Faculty, Computer Engineering Department.
- Koc, E. (2010). *The Bees Algorithm: Theory, Improvements and Application*. Postgraduate Thesis Submitted to Manufacturing Engineering Centre, School of Engineering, University of Waes, Cardiff: Cardiff, United Kingdom.
- Panigrahi, B. K., Lim, M. H., & Shi, Y. (2011). *Handbook of Swar, Intelligence-Concepts, Principles and Applications*. Berlin: Springer.
- Pham, D. T., & Castellani, M. (2013). Benchmarking and Comparison of Nature-Inspired Population-Based Continuous Optimisation Algorithms. *Soft Computing*, 1-33.
- Pham, D. T., & Castellani, M. (2015). A Comparative Study of the Bees Algorithm As A Tool for Function Optimisation. *Cogent Engineering* 2(1).
- Pham, D. T., Castellani, M., & Chen, J. (2015). A Comparative Study of the Bees Algorithm As A Tool for Function Optimisation. *Cogent Engineering*, DOI: 10.1080/23311916.2015.1091540.
- Pham D.T., M. Castellani, H.A.L. Thi (2014), Nature-inspired intelligent optimisation using the bees algorithm, in: *Transactions on Computational Intelligence XIII*, Springer, pp. 38–69 .
- Pham D.T., L. Baronti , B. Zhang , M. Castellani (2018). Optimisation of engineering systems with the bees algorithm, *Int. J. Artif. Life Res.* 8 (1) 1–15 .
- Talbi, E. G. (2009). *Metaheuristics: From Design to Implementation*. Hoboken, NJ: Wiley.
- Tereshko CV, Loengarov A (2005), “Collective Decision-Making in Honey Bee Foraging Dynamics”, *Computing and Information Systems Journal*, ISSN 1352-9404, vol. 9, No 3
- Tereshko V (2000), Reaction–diffusion model of a honeybee colony’s foraging behavior, in: M.Schoenauer (Ed.), *Parallel Problem Solving from Nature VI, Lecture Notes in Computer Science*, vol. 1917, Springer–Verlag, Berlin
- Tereshko V, Lee T (2002), How information mapping patterns determine foraging behavior of a honeybee colony, *Open Systems and Information Dynamics* 9 181–193
- Xin-She-Yang (2007) *Nature-Inspired Meta-heuristic Algorithms*.” Frome: Luniver Press. ISBN1-905986-10-6, (2007).
- Yang X.S. (2010) “A New Meta-heuristic Bat-Inspired Algorithm, in: *Nature Inspired Cooperative Strategies for Optimization*”, *Studies in Computational Intelligence*, Springer Berlin, 284, Springer, 65-74.
- Yang X.S., Deb S. (2009). “Cuckoo search via Lévy flights.” *World Congress on Nature & Biologically Inspired Computing. IEEE Publications.*210–214.
- Yuce, B. (2012). *Novel Computational Technique for Determining Depth Using the Bees Algorithm and*. UK: Cardiff University.
- Yuce, B., Packianather, M. S., Mastrocinque, E., Duc, T. P., & Alfredo, L. (2013). *Honey Bees Inspired Optimization Method: The Bees Algorithm*. *insects*.

9TH INTERNATIONAL CONFERENCE ON APPROPRIATE TECHNOLOGY

# TECHNOLOGY RESEARCH AND DEVELOPMENT

# DEVELOPMENT OF SOLAR-POWERED WATER PURIFICATION SYSTEMS

K. Dikgale, D.F. Ntobela, B.G.V. Mendes, L.K. Tartibu, T.J. Kunene, E. Bakaya-Kyahurwa  
University of Johannesburg, South Africa  
ltartibu@uj.ac.za

## Abstract

In this paper, we highlight the effects of contaminated water on humans as well as the crisis of water supply and distribution of potable water in many areas of developing countries. While water is the most important substance on earth and a primary human need, contaminated water can cause and spread diseases. It is, therefore, necessary to ensure that water is purified and decontaminated for daily use at a low cost. The design of solar-powered water purification systems is thus regarded as an important means of producing clean water. Solar energy poses no polluting effect and has become a dependable energy source for usage. The design of a solar-powered water purification system is based totally on the thermal method by using the thermal heating system principle which converts sunlight rays into heat. The most vital aspect is the absorption of heat to induce evaporation of water. Research shows that flat plate collectors produce heat at relatively low temperatures ( $27^{\circ}\text{C}$  to  $60^{\circ}\text{C}$ ) and are commonly used to heat liquids. A solar-powered water purification system consists of a solar collector that absorbs sunlight to ensure vaporisation, which is the first stage of purifying and a filter that removes contaminants. Four different concepts have been developed. A detailed description of the components and the operation of the systems constitute the main contribution of this paper.

**Keywords:** solar collector, solar photovoltaic, thermal, water purification

## INTRODUCTION

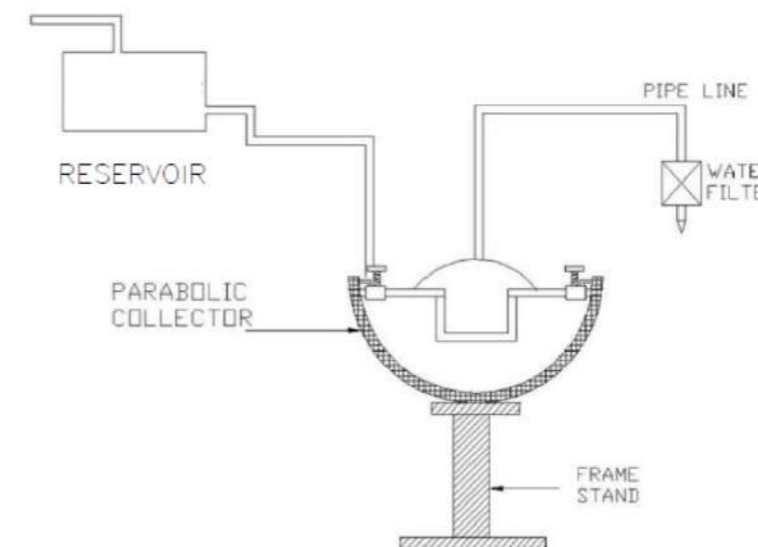
Water is the most important substance on earth. Humans are fully dependent on water to survive and to live healthily. This makes water a very scarce resource since it is used daily. Water purification is the process of removing undesirable chemicals, biological contaminants, suspended solids as well as gases from water. Research shows that to maintain a healthy lifestyle, an average male/female consumes approximately 3.7 litres/2.7 litres of water per day (Sawka, Chevront & Carter, 2005). With many areas not connected to the electricity grid, particularly in developing countries, access to clean, decontaminated water is a critical problem. Therefore, it is necessary to develop a water purification system that disinfects and cleans biologically contaminated water through the utilisation of a readily available energy source, the sun.

The development of a sustainable water purification system which is relatively easy to manufacture and maintain, while relying on a readily available power source (like solar energy) is necessary and important. Although it is not a permanent solution, such a system can assist in improving the quality of human life. Solar energy poses no polluting effect and may be used as a dependable energy source. A solar water purification system consists of a solar collector that absorbs sunlight to ensure boiling which is the first stage of purification; and a filter that removes contaminants.

## Literature review

A power of approximately  $1.8 \times 10^{11}$  MW is intercepted by the earth from the sun (Mohanta, Patel, Bhuvu & Gandhi, 2015). This power is greater than the earthly consumption of all commercial energy sources. This makes solar power reliable as an energy source to power a system which will alleviate diseases and provide clean water for basic needs. There have been several concepts developed in previous studies. The challenges and opportunities of developing Photovoltaic (PV) powered water purification were discussed by Forstmeier, Feichter & Mayer (2007). The fluctuation of the PV energy source was identified as the main challenge for the development of such a system in their study. However, the results reported pointed out the potential of this sustainable water purification approach. A solar-powered portable water purifier was developed by Saraceno (2005). The solar cell was used to supply power which was used to operate a pump and facilitate the supply of water to the purifying radiation source. Wright (2011) proposed a water purification apparatus that consists of a purification filter and solar-power system to purify water. A photovoltaic powered reverse osmosis system (PVRO) was designed and tested in the rural community of Mexico (Elaasad, Bilton, Kelley, Duayhe and Dubowsky, 2015). This study gives an insight into the designing of PVRO systems and their deployment in rural communities. A solar-powered water purification system comprising a distillation unit able to produce potable water using solar radiation was developed by Joseph, Newton, Wandrie & Carter (2012). The performance evaluation of 16 solar PV-powered drinking water systems was performed by Jaskolski, Schmitz, Otter & Pellegrino (2019). While this study shows that the solar PV-powered system removes ion from water successfully, it appears that chlorine levels depend on the location. This literature describes the development of different solar-powered water purification systems and provides evidence of the feasibility of such endeavours.

Solar water purification by the thermal method uses the thermal heating system principle which converts sunlight rays into heat. Flat plate collectors can produce heat at relatively low temperatures ( $< 60^{\circ}\text{C}$ ) and are commonly used to heat liquids (Rockenbaugh, Dean, Lovullo, Lisell, Barker, Hancock & Norton, 2016). The system is powered by the sun to remove contaminants in water. The process consists of boiling water using a solar collector that absorbs heat as a first step of the purification, followed by filtration to remove contaminants (Thorat, 2006). A typical illustration of the water solar-powered water purification process is shown in Figure 1.



**Figure 1:** Typical solar-powered water purification model (Adapted from Thorat, 2006)

Water purification can take place through solar water distillation processes, solar stills as well as solar water disinfection systems. Solar water disinfection (SODIS) was analysed in a study carried out by Fisher, Iriarte & Nelson (2016) which reported promising results related to water disinfection. A solar water disinfection system (SODIS) is a water purification system at the household level based on solar radiation treatment and water distillation with the additional use of solar heating. It is a combination of two water purification processes, the Solar Water Disinfection System (SODIS) and the solar distillation process. SODIS has proven to be effective in disinfecting small quantities of water of low turbidity, and

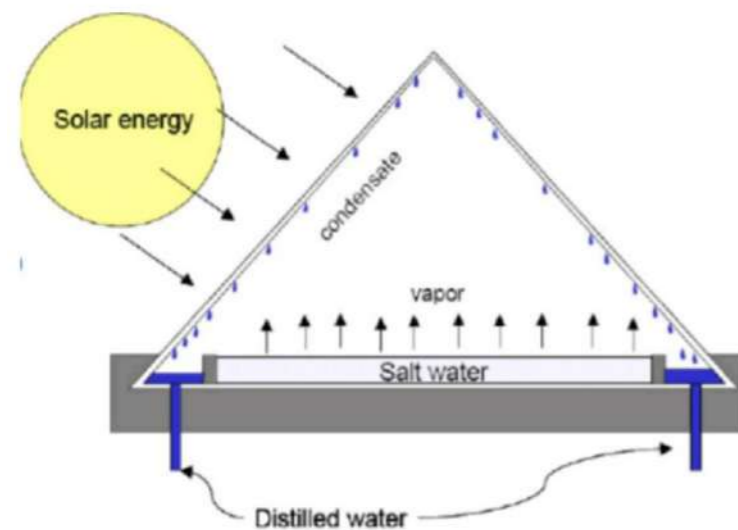
micro-biologically contaminated water (Zhang, Sivakumar, Yang, Enever & Ramezaniapour, 2018). The provision of additional heat makes such a system suitable to deal with heavily contaminated waters such as seawater, water with high turbidity, and water contaminated by heavy metal or pathogenic microorganisms.

### Motivations

Water is described as one of the essential needs for the survival of humans, animals, and plants. Without water, there is no life. The levels of water in the major dams and rivers are often alarmingly low in South Africa, which limits the supply of drinkable water to users, especially in rural areas. Also, the connection to the electricity grid is challenging in many areas. Hence, the development of an efficient, solar-powered water purification system by using the thermal method would be extremely useful.

### Methodology adopted for the development of concepts

Most of the existing water purification systems are based on the distillation method, chemical purifying method and the condensation method with boilers to accelerate purification. The solar water distillation method is illustrated in Figure 2 (Kumar & Bai, 2008). A similar layout was adopted while developing the design concepts described in this paper.



**Figure 2:** Solar water distillation method

The following summarises the disadvantages of the configuration shown in Figure 2 and the features extracted from these existing concepts in the development of our concepts:

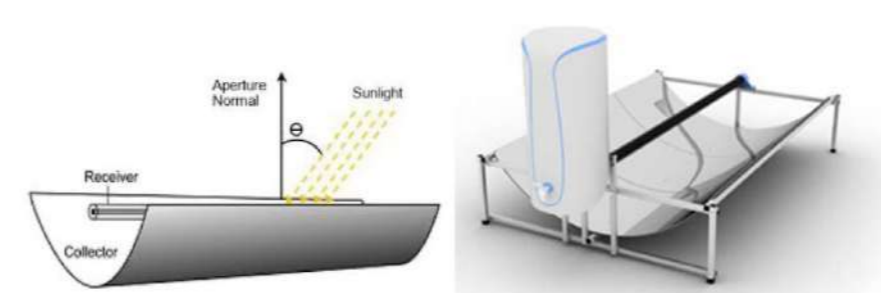
#### Disadvantages of the design shown in Figure 2:

- It is static or immovable
- The purification process is slow as no boiler or heating coils are installed.

#### Advantages and features extracted from the design shown in Figure 2:

- It uses a condensation method for water purification
- The triangular-shaped cover is advantageous for the collection of condensed distilled (or purified) water as it is concentrated in the conical-shaped edge of the cover
- This configuration adopted for the development of concepts 1, 2, and 4 described in this paper.

A parabolic dish configuration is illustrated in Figure 3. This configuration was also adopted for the development of concepts described in this paper.



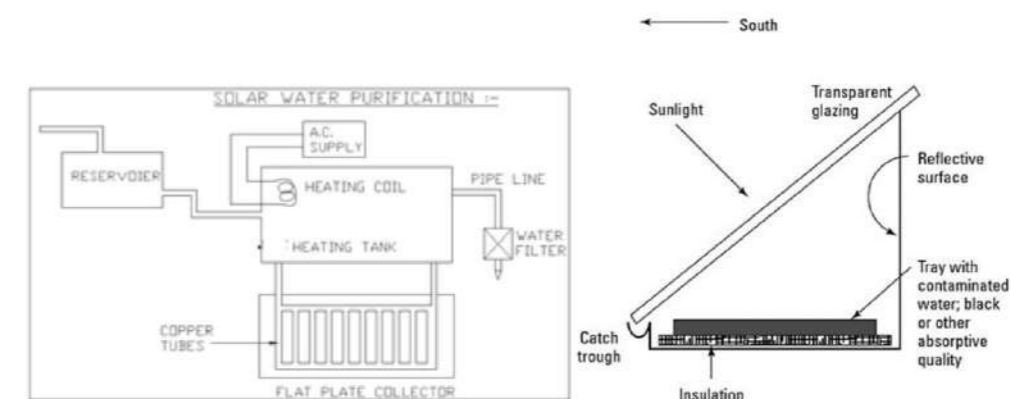
**Figure 3:** Parabolic dish configuration (Adapted from Sommer, Marino, Solarte, Salas, Dierolf, Valiente, Mora, Rechsteiner, Setter, Wirojanagud & Ajarmeh, 1997)

The following summarises the advantages of the configuration shown in Figure 3 and the features extracted from these existing concepts in the development of our concepts:

#### Advantages and features extracted from the design shown in Figure 3:

- Utilisation of a boiler as well as the availability of sunlight through the parabolic dish
- The use of boilers and batteries to ensure heat is retained and stored for proper purification
- This configuration was adopted for the development of concept 4 described in this paper.

A “heating coils” configuration is illustrated in Figure 4. This configuration was also adopted for the development of concepts described in this paper.



**Figure 4:** Heating coils solar water purification system (Adapted from Ghannam, Ayoub & Acra, 1998)

The following summarises the advantages of the configuration shown in Figure 4 and the features extracted from these existing concepts in the development of our concepts:

*Advantages and features extracted from the design shown in Figure 4:*

- The design incorporates heating coils within the heating tank which improves the efficiency of heat supply for water purification
- The heating coil ensures more heat within the process
- This configuration was adopted for the development of all the concepts described in this paper.

The layout of the systems developed in this paper is based on the three configurations described in this section. Four different concepts have been developed from these existing technologies, and desirable features have been extracted and amalgamated to form new concepts.

The methodology adopted in this study can be summarised as follows:

- Step 1 —> Problem definition
- Step 2 —> Literature review: Investigation and observation
- Step 3 —> Concepts generation: Development of models
- Step 4 —> Concept evaluation and selection: Design matrix
- Step 5 —> Final design motivation: Possible promising solution

## Design development

### Specifications and requirements

The following section summarises the specifications and requirements considered for the solar-powered water purification systems (Fahr, 2018):

- The design must comply with South African National Standard drinking water quality (DWQ) as the standard (namely durable and weather-resistant solar collector; lower reactive boiler; high heat conductivity for the condenser; high temperature withstanding condenser; high temperature withstanding boiler).
- The durability and lifespan of the design should be a reasonable number of working years.
- The system is powered by the sun (solar energy).
- The systems should have a filter or collection tank that can remove contaminants.
- The designs must be user friendly and generate a reasonable amount of purified water.
- Conductivity (Ionic Contaminants) should be  $\leq 4.3 \mu\text{s}/\text{cm}$  @  $20^\circ\text{C}$  for potable water.
- Total Organic Carbon (TOC) should be 500 ppb (target) for potable water.
- pH @  $25^\circ\text{C}$  should range between 5 – 9.7 for potable water;
- Heavy metals (toxic to humans) should be  $\leq 0.1$  ppm.

### Concept generation

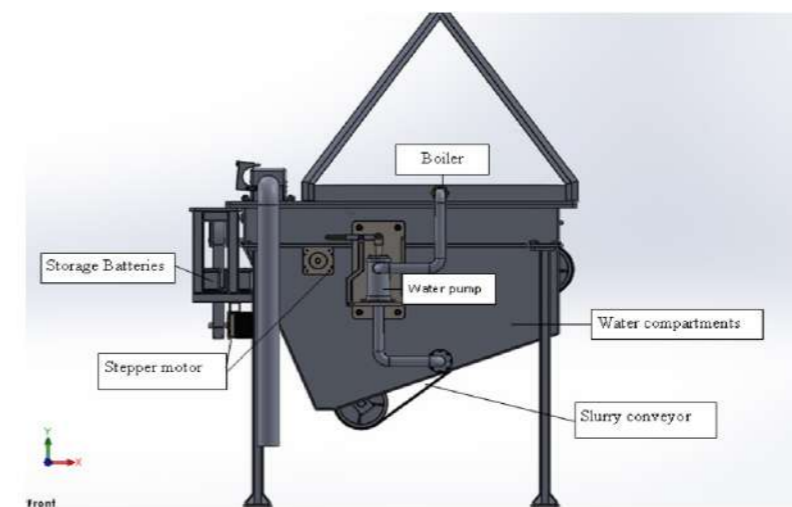
This section provides details about the concepts generated in this study. These concepts have been developed based on the design configurations described in the previous section. Detailed 3D models and working principles are included. However, details about the sizing, specifications of components/modules, and maintenance requirements are beyond the scope of this paper and will form part of future research.

## A. Concept 1

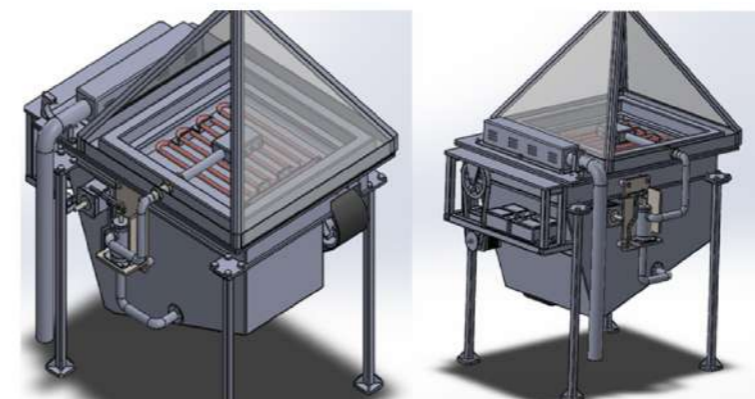
### i. Description

This concept was built based on the solar water distillation method shown in Figure 2. The following features were incorporated into the development of the design concept (Figure 5 & 6):

- *Heating coils* – used for boiling untreated water by solar energy;
- *Manual water pump* – used for pumping water from the reservoir into the boiler;
- *Stepper motor* – used for automatic pumping water and transportation of slurry;
- *Double water tank* – used for separating filtered water and slurry water;
- *Filtering conveyor* – used for removing the slurry from the system;
- *Batteries* – used for storing the solar energy to supply heating coils;
- *Battery casing* – used for holding batteries;
- *Inlet water pipe clamp* – used for clamping pipe of inlet water from the reservoir.



**Figure 5: Design concept 1**



**Figure 6: Design concept 1- side view**

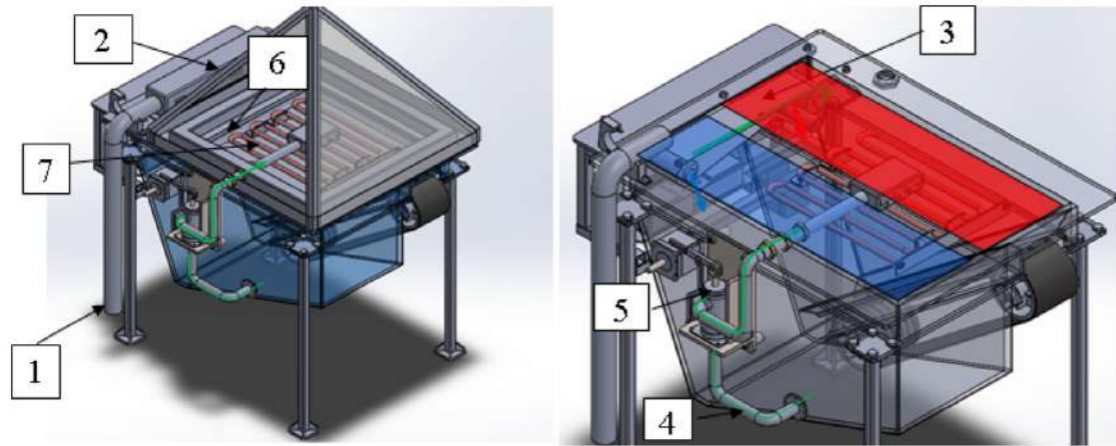


Figure 7: Design concept 1- Working principle

Table 1 provides the details of the main components used for the construction of concept 1.

Table 1: Main components of design concept 1

Item	Description	Drawing
Heating coils	<ul style="list-style-type: none"> <li>Coil diameter estimated: 10mm</li> <li>The material selected: Copper</li> </ul>	
Filtering conveyor	<ul style="list-style-type: none"> <li>4 Conveyor pulleys</li> <li>1 Driving pulley and 3 Driven pulleys</li> <li>The material selected: Carbon steel, Stainless steel, and Fabric (cloth)</li> </ul>	
Manual water pump	<ul style="list-style-type: none"> <li>Internal diameter estimated: 450mm</li> <li>Piston for pumping water estimated: 450mm</li> <li>The material selected: mild steel, stainless steel, brass and rubber.</li> </ul>	

Battery casing	<ul style="list-style-type: none"> <li>Length estimated: 600mm</li> <li>The material selected: mild steel</li> </ul>	
Batteries	<ul style="list-style-type: none"> <li>Voltage estimated: 24V</li> <li>Quantity estimated: 4</li> </ul>	
Stepper motor	<ul style="list-style-type: none"> <li>Voltage estimated: 24V DC</li> <li>Number of phases: 3</li> </ul>	
Inlet water clamp	<ul style="list-style-type: none"> <li>Clamp diameter estimated: 150mm</li> <li>The material selected: mild steel</li> </ul>	

#### ii. Working principle

This concept consists of two water compartments, namely the filtered water compartment (which is represented by the colour blue) and the slurry water compartment (which is represented by the colour red) as shown in Figure 8.

- The contaminated water enters the system through the inlet pipe (1) and is pumped into a fabric conveyor belt (2).
- Water flows over the fabric conveyor belt (2) for filtering and separation of impurities.
- During this process, the conveyor slowly filters the water. Separated impurities are conveyed (3) into the second compartment (red section) while the filtered water is being collected in the first compartment (blue section) for further processing.
- The filtered water is pumped from the first compartment (blue section) through PVC pipe (4) with a manual hand pump (5) following the green path line.
- After pumping the filtered water into a boiling container (6), it is heated by an electric heating coil (7) which receives power from the solar-powered batteries.
- As the water evaporates, it condenses on the plastic cone and drips down against the conical-shaped edges as distilled or drinkable water (8) (as shown in Figure 8).

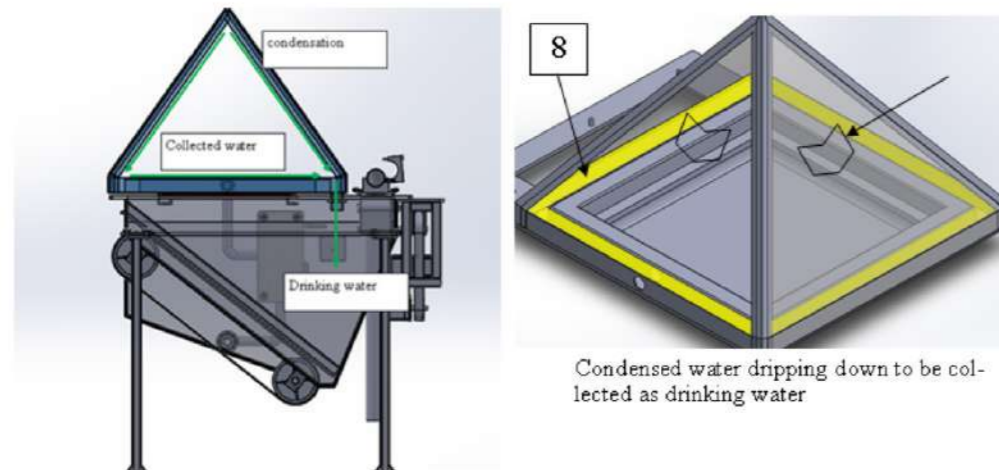


Figure 8: Design concept 1- Distillation process

- The slurry is removed from the second compartment (red section) by using the second conveyor as shown in Figure 9.
- The conveyor design orientation is inclined, to remove all the particles (represented by the brown colour) from the system and transferred into the collecting container which is located outside of the system as shown in Figure 9.

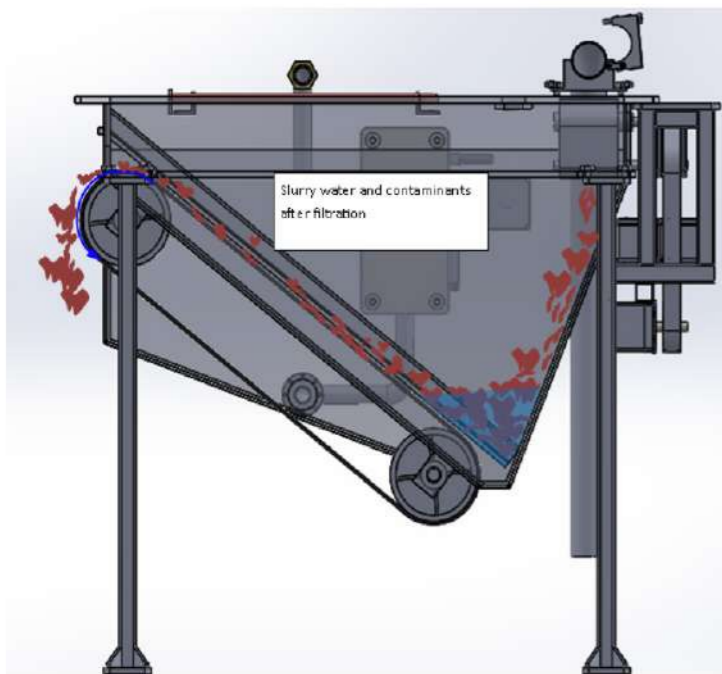
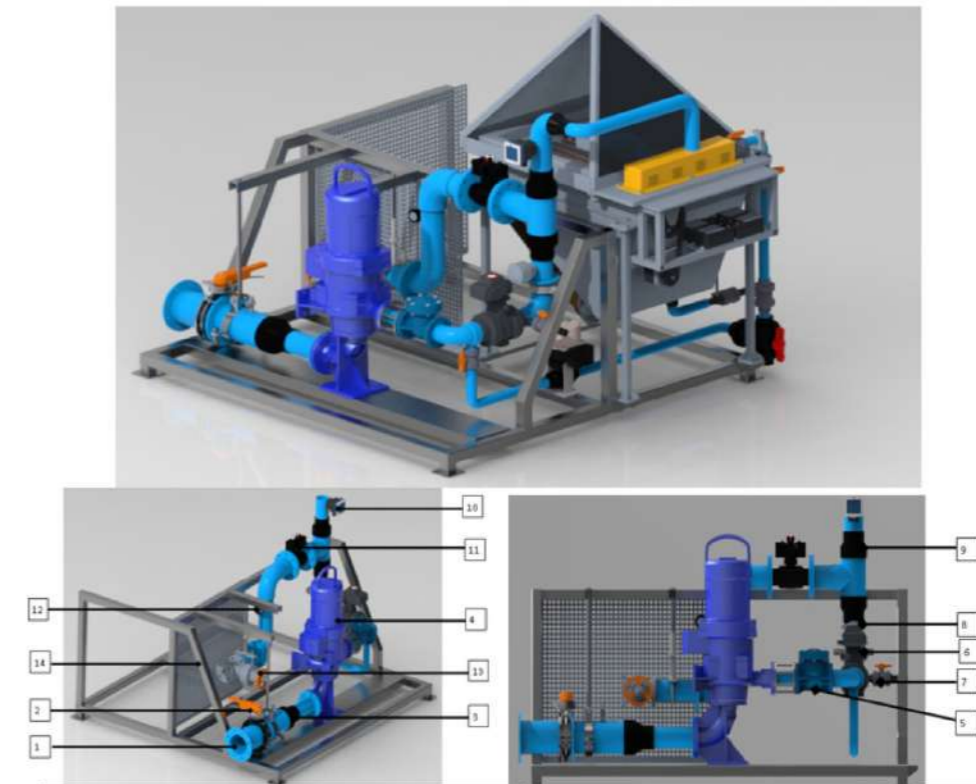


Figure 9: Design concept 1- removal of the slurry

Details of the piping system and external modules not included in the previous figures are shown in Figure 10.



1. Raw water inlet from reservoir/ municipality supply	8. Pressure transmitter
2. Butterfly valve	9. Concentric reducer
3. Concentric reducer	10. Flow indicator/ FIT
4. Submersible pump	11. Pneumatic butterfly valve
5. Lift check valve	12. Pressure indicator (PI)
6. Flow transmitter (FT)	13. Manual diaphragm valve (booster line)
7. Drain/ sampling valve	
8. Pressure transmitter	

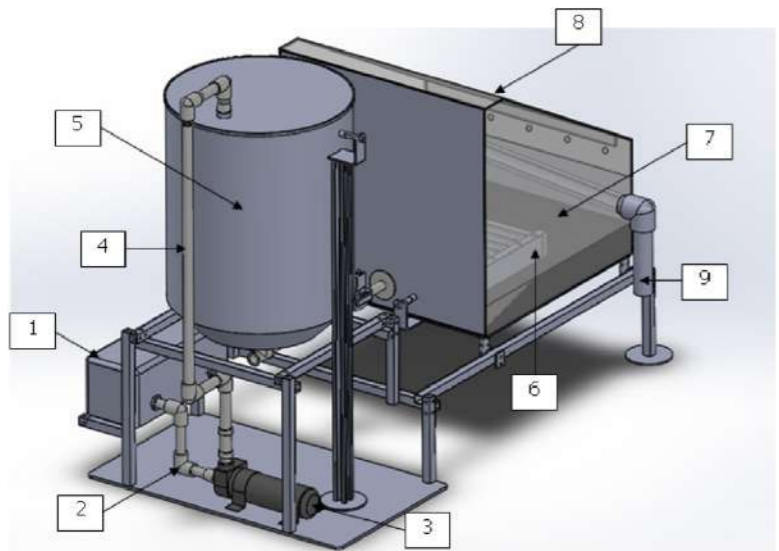
Figure 10: Final design concept 1 and piping system

## B. Concept 2

### i. Description

This concept was developed based on the parabolic dish shown in Figure 3. The main features incorporated in the development of this design concept are shown in Figure 11. It includes:

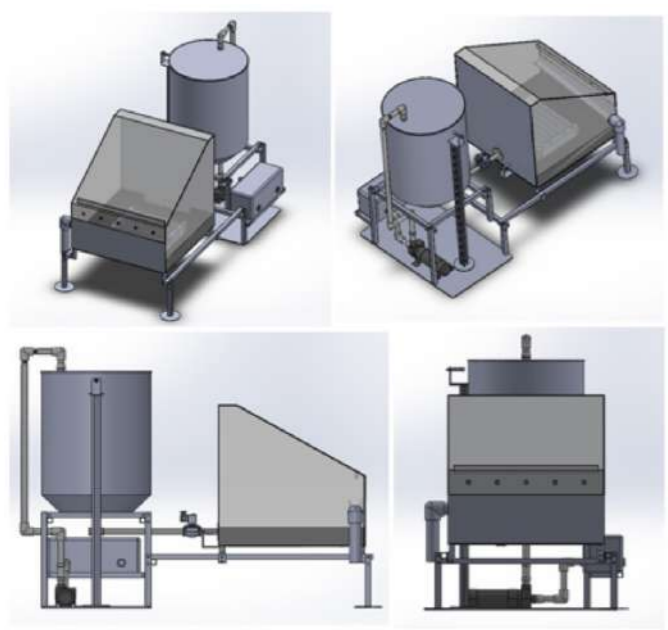
- *Electronic water pump;*
- *Inlet water tank;*
- *Perspex clear plastic cover;*
- *Boiler container;*
- *Piping system.*



- |                                  |
|----------------------------------|
| 1. Inlet water tank.             |
| 2. Inlet filtered water pipe.    |
| 3. Electronic water pump.        |
| 4. Filtered water transfer pipe. |
| 5. Filtered water storage tank.  |
| 6. Heating element.              |
| 7. Boiler container (black).     |
| 8. Perspex clear plastic cover.  |
| 9. Drinking water outlet pipe.   |

**Figure 11:** Design concept 2 with additional features

For clarity, the side views, isometric view, and front view of this design concept are shown in Figure 12.

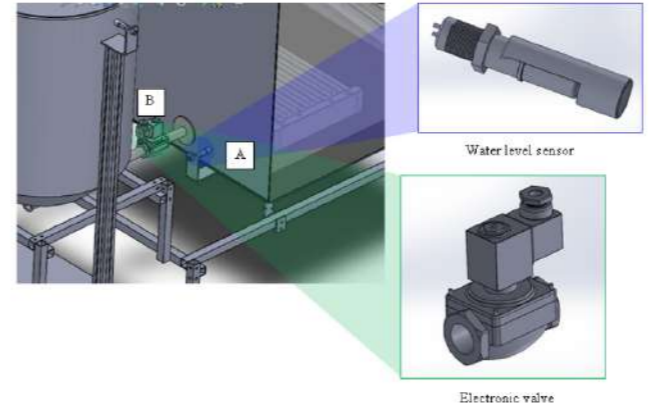


**Figure 12:** Final design concept 2 model views

*ii. Working principle*

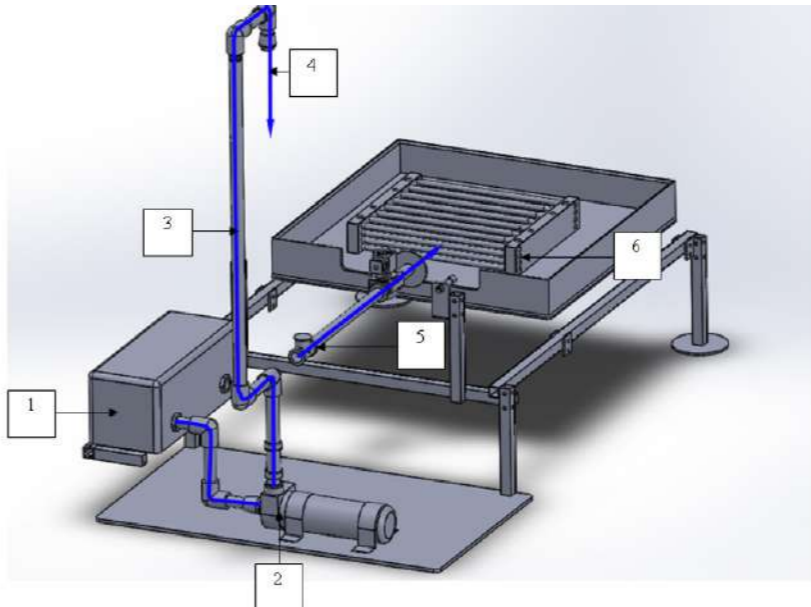
This concept consists of an automatic water refill system to boost the process. When the water in the boiler drops, the sensor (A) triggers an electronic valve (B) to release the flow of water from the water storage tank. When the required level of water is reached, the sensor triggers the electronic valve to close the valve as shown in Figure 13. When the level of water in the water storage tank has dropped to a certain level, the electronic valve sends a signal to the pump through a feedback loop. Water will be pumped from the reservoir/ municipal supply into the water storage tank until the required level of water is reached. Thus, this process is referred to as a closed feedback loop mechanism.

The purification process is almost the same for all design concepts. When the water reaches boiling point, it evaporates and condensate is collected from the perspex plastic cover as shown in Figure 13. As the condensate on the perspex become dense, it drops into a slanting? half-open PVC pipe which is connected to the drinking water outlet pipe.



**Figure 13:** Water level sensor (A) and Electronic valve (B)

The contaminated water (water flow – blue line) is transferred by the piping system from two water storage tanks as shown in Figure 14. The first pipe transfers water from the inlet water filter tank (1) to the water pump (2). The second pipe (3) transfers water from the pump into the water storage tank (4). The third pipe (5) takes water from the water storage tank to the boiler (6).



**Figure 14:** Piping water system



### Concept 3

#### i. Description

This concept was developed based on the method of solar water purification by distillation and the heating coils or solar water purification system shown in Figure 2 and Figure 4 respectively. The main features incorporated in the development of this design concept are shown in Figure 15. It includes:

- Heating coils – to vaporise the water;
- Rotating flat solar panels – to harness the solar energy from the sun;
- Perspex plastic cover – to enable the collection of condensate during the distillation process and transparent glazing;
- Batteries – to store the power from solar panels through solar energy;
- Mild steel – to support structure (plates and square tubes).

For clarity, the side views and front view of this design concept are shown in Figure 15.



Figure 15: Design concept 3 - side and front views

#### ii. Working principle

The untreated water from the reservoir/municipality enters the system at pipe inlet (1). A pump (2) is used to transfer water to the boiler (3) through a water tube (2). The boiler is equipped with copper heating coils (5) to vaporise the water. The heating coils draw energy from the solar panels (6). As the temperature of the water rises, evaporation occurs (Kumar and Bai, 2008). Ultimately, the droplets of water collected on the convex perspex plastic drip down as drinkable water through pipe outlet (7) as shown in Figure 16.

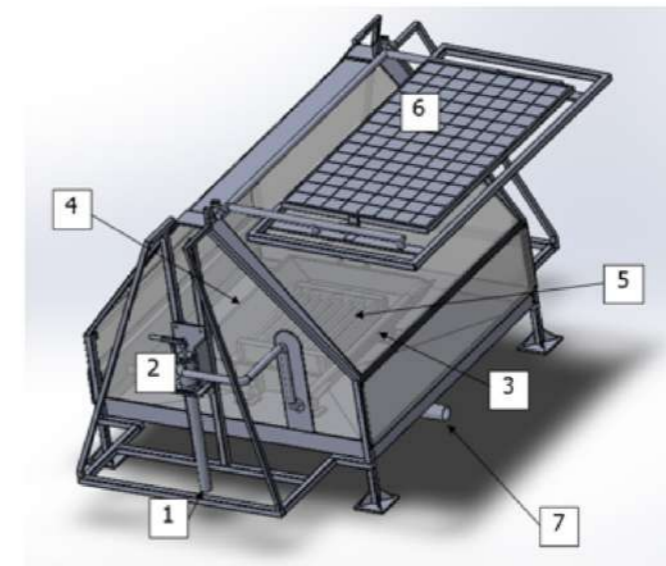


Figure 16: Design concept 3 - working principle

The concept incorporates an automatic solar tracker to increase the efficiency of the solar panels by keeping the flat solar panels aligned with the rotation of the sun. The automatic solar tracking is the mechanised system that tracks the sun's rays' position to increase the power output of the solar panels. The sun rotates  $360^\circ$  on earth in a day, so it rotates  $360^\circ/24 = 15^\circ$  an hour or  $3.75^\circ$  in 15 minutes. Two hours are not counted for tracking because in the first hour after sunrise and the last hour before sunset the temperature sensor does not have enough light to trigger the system. A stepper motor which gives  $3.75^\circ$  rotation in each stepping could be considered. Therefore, approximately  $(180^\circ - 30^\circ)/3.75^\circ = 40$  rotations are required each day to track the sun during daylight (Khan, Tanzil, Rahman & Alam, 2010). The mechanism works as indicated by the series of pictures in Figure 17.

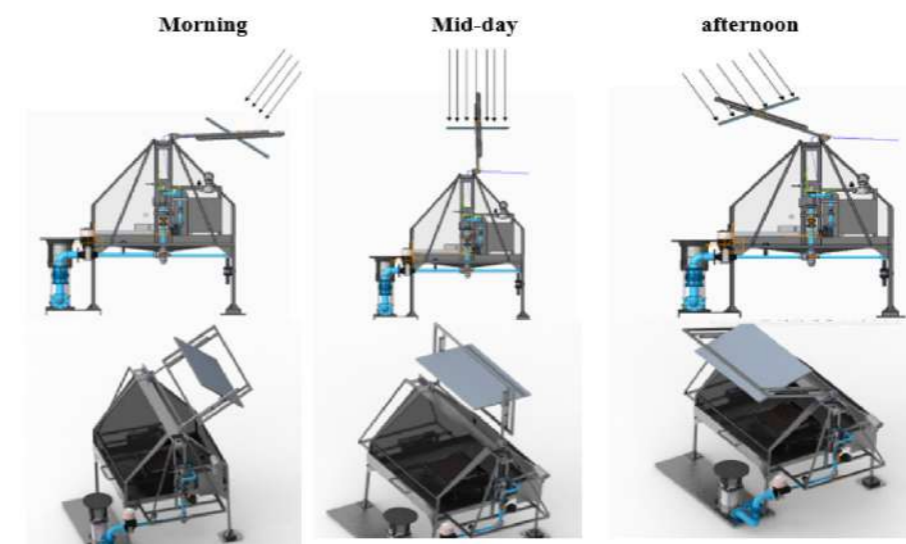


Figure 17: Automatic solar tracking panels

The system is equipped with energy storage for backup power to the heating unit in case there is no sunlight due to bad weather conditions and to supply the boiler with constant power. This storage consists of four 24V solar batteries and a battery charger as shown in Figure 18. The solar batteries are charged by the solar panels and release the energy when it is needed.

The piping system was added to transfer contaminated water from the reservoir to the water tank. The system is designed to make the operation more convenient. Figures 19 & 20 show the details of the final design of concept 3 with a piping system and pipe fittings. This includes ball valves, elbows, pressure regulators, flow transmitters, temperature transmitters and pressure transmitters.

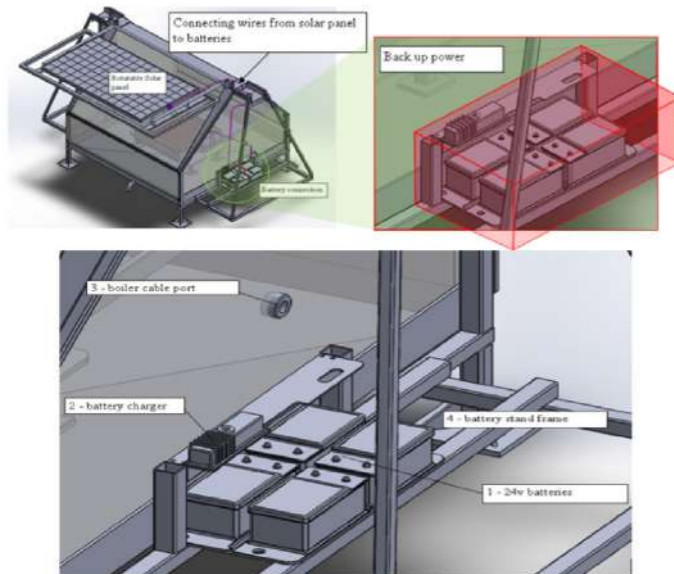
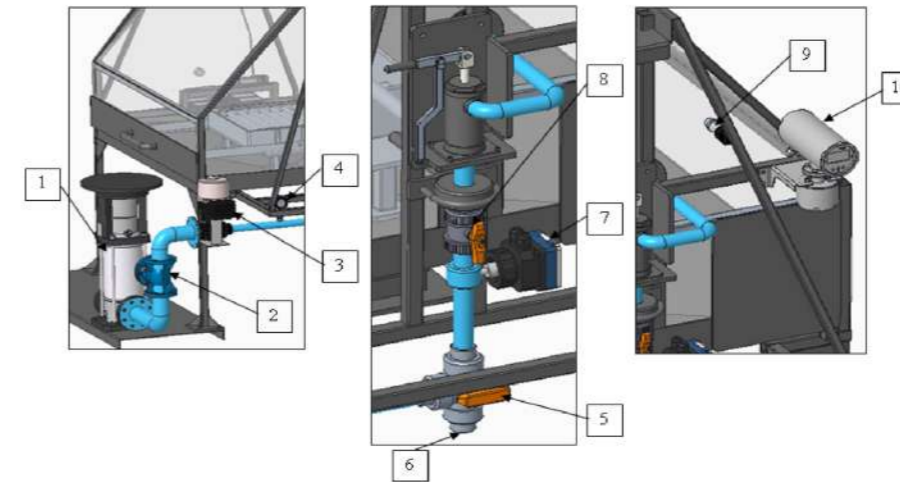


Figure 18: Energy storage in batteries for back-up power



Figure 19: Final design concept 2 with a piping system and fittings



1. Submersible pump – connected to the municipality/ raw water truck/ borehole.
2. Check valve – allows water to flow in one direction, to prevent backwater/ protect the pump.
3. Pressure reducing valve – to reduce the pressure to protect the PVC pipes with small nominal bores.
4. Pressure indicator – to measure the pressure loss/ current after reducing the valve.
5. 3-Way Ball Valve – acts as a Tee to allow water to pass from the pump or point 6 in case the pump is not functional (manual overwrite).
6. Manual water pump inlet – to pump contaminated water straight from borehole/ dam.
7. Pressure transmitter – to measure and read the pressure before the entrance to the boiler.
8. Non-Return Valve (PVC) – to prevent water from running back down due to gravity, since the pipe orientation is facing up.
9. Temperature sensor – to measure the ambient temperature of the entire boiler house.
10. Temperature indicator – to display temperatures.

Figure 20: Piping system and fittings

### C. Concept 4

#### i. Description

This concept was developed based on the heating coils solar water purification system shown in Figure 4. The main features incorporated in the development of this design concept are shown in Figure 21. It includes:

- A circular boiler drum that is equipped with internal heating coils;
- Three-legged trusses – to support the system;
- A rotating mechanism – to convert rotatory motion into linear motion for good performance of the pump;
- Cooling coils – to cool distilled water;
- A metal cover – to cover the boiler during the distillation process;
- A vacuum pump – to vacuum distilled water from the boiler to the water collector and to decrease the boiling temperature by decreasing the pressure within the boiler.

This concept uses concentric aligned solar panels to make the system more compact and minimise space. The principle of purification is the same as the other concepts.

- |                                       |
|---------------------------------------|
| 1. Three-legged truss frame structure |
| 2. Rotating mechanism                 |
| 3. Boiler                             |
| 4. Water supply pipe                  |
| 5. Solar panels                       |
| Metal cover                           |
| 6. Clean water collector              |
| 7. Cooling coil                       |
| 8. Vacuum pump                        |
| 9. Vacuum pump support frame          |

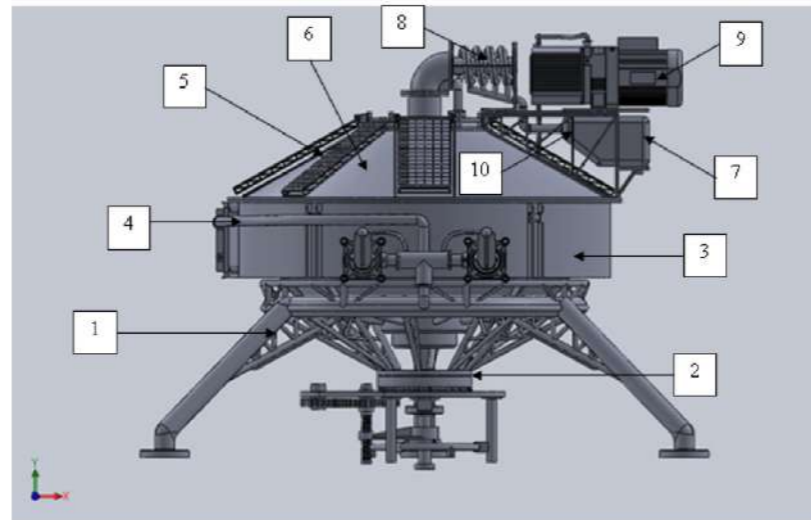


Figure 21: Design concept 4

Details of the subsystems of concept 4 are shown in Figure 22.

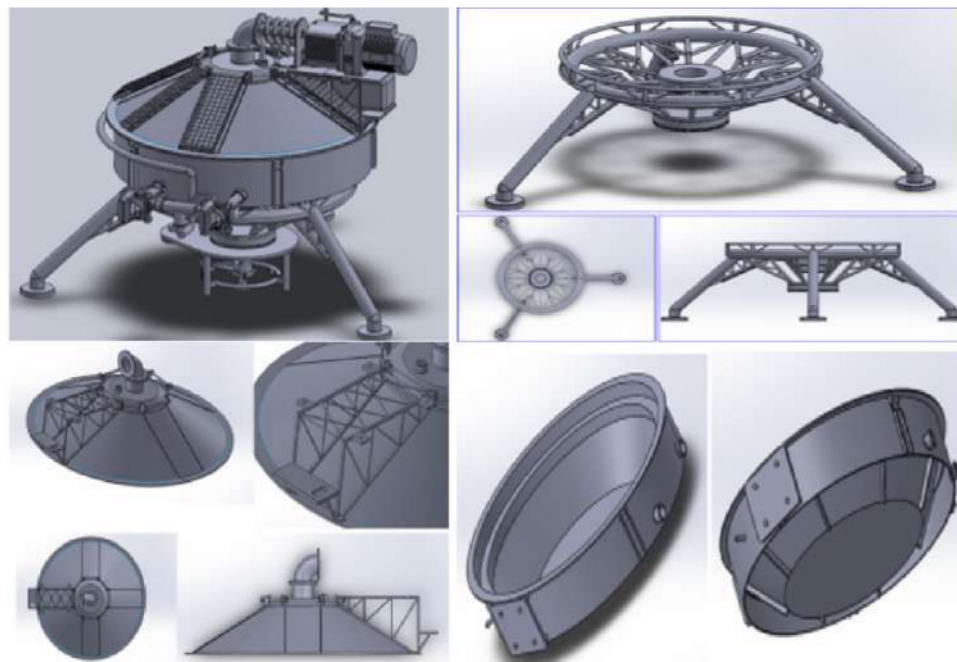


Figure 22: Final design concept 4 and subsystems

ii. Working principle

The working principle of this concept is mostly the same as the previous concepts. The only difference is that this concept utilises a vacuum pump to reduce the pressure in the heating chamber resulting in the boiling time of the contaminated water. The solar panels are mounted on the top of the boiler and aligned to the direction of the sun. The vacuum pump sucks the water from the reservoir/dam through an inlet water pipe (1) and directs it to the boiler following the blue path line as shown in Figure 23. The heaters (3) increase the temperature of the contaminated water inside the boiler (4). The water evaporates and leaves the system via a cooling coil as illustrated in Figure 23 (in yellow).

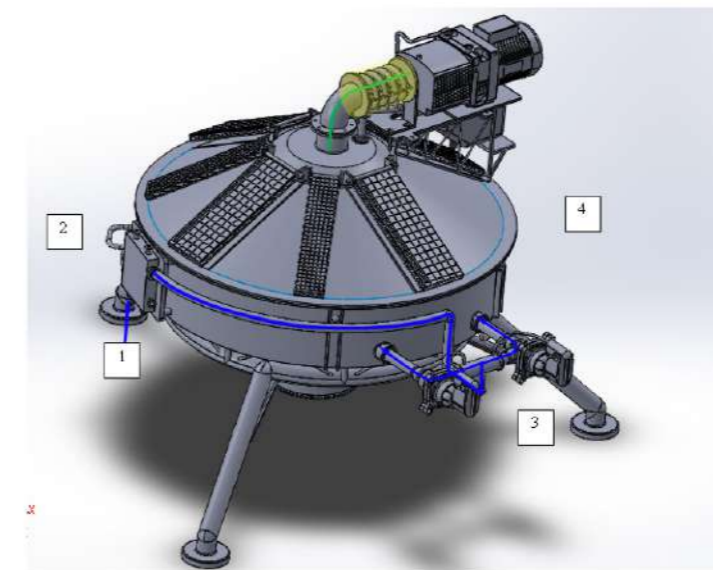


Figure 23: Illustration of the working principle of design concept 4

Design selection and evaluation

The concept selection was based on the criteria as illustrated in the decision matrix (Table 2). Scores of 1-5 were allocated to each design concept to identify the most promising solution. Concept 3 has the highest overall score and value of 27 and 4.6. Therefore, this concept was selected for future analysis.

Table 2: Concept selection and evaluation

Criterion	Weighting Factor	Parameter	Ratings Concept 1		Concept 2		Concept 3		Concept 4	
			Score	Value	Score	Value	Score	Value	Score	Value
Material Cost	0.10	ZAR	3	0.3	4	0.4	5	0.5	2	0.2
Manufacturing Cost	0.2	ZAR	4	0.8	4	0.8	4	0.8	1	0.2
Manufacturing Time	0.10	Hours	4	0.4	5	0.5	4	0.4	4	0.4
Durability	0.15	Experience	3	0.45	3	0.45	5	0.75	4	0.6
Reliability & Maintenance	0.30	Experience	1	0.3	4	1.2	5	1.5	2	0.6
Repairability	0.15	Experience	3	0.45	4	0.6	4	0.6	3	0.45
Overall Score & Value			18	2.7	24	4	27	4.6	16	2.5

\*Legend: 5 = Excellent; 4 = Very good; 3 = Good; 2 = Fair; 1 = Poor

## CONCLUSION

The purpose of this paper was to develop several solar-powered water purification systems. Through a literature review, several existing concepts were identified. These existing concepts (namely solar water distillation method, parabolic dish configuration, and heating coils solar water purification system) were used to develop the concepts presented in this paper. The paper focuses on the design systems that could purify biologically contaminated water by using the thermal method. The first concept was developed based on the solar water distillation method. The proposed design incorporates some features such as heating coils, a manual water pump, a stepper motor, a double water tank, a filtering conveyor, batteries, a battery casing, and an inlet water faucet. The second concept was developed based on the parabolic dish. The main features incorporated in the development of this design concept include an electronic water pump, an inlet water tank, a clear perspex plastic cover, a boiler container, and piping systems. The third concept was built based on the method of solar water purification by distillation and the heating coils solar water purification system. The main features incorporated in the development of this design concept include heating coil, rotating flat solar panel, perspex plastic cover, batteries, and mild steel support structure (plates and square tubes). The fourth concept was developed based on the heating coils solar water purification system. The main features incorporated in the development of this design concept are a circular boiler drum, three-legged trusses, a rotating mechanism, cooling coils, a metal cover, and a vacuum pump. Future work will provide clarity about the materials used, the size of all components/modules, and the maintenance of the proposed systems. Furthermore, the performance of each system could be analysed to improve water purification and minimise design complexity. Based on the concept selection and evaluation, a single system, representing the most promising concept, will be built.

## ACKNOWLEDGMENTS

This Conference paper was partly supported financially by the National Research Foundation of South Africa with Grant number: 127395.

## LIST OF REFERENCES

- Elasaad, H., Bilton, A., Kelley, L., Duayhe, O. and Dubowsky, S., 2015. Field evaluation of a community-scale solar-powered water purification technology: A case study of a remote Mexican community application. *Desalination*, 375, pp.71-80.
- Fahr, A. 2018. *Voigt's Pharmaceutical Technology*. United States, John Wiley & Sons.
- Fisher, M.B., Iriarte, M. & Nelson, K.L. 2012. Solar water disinfection (SODIS) of Escherichia coli, Enterococcus spp., and MS2 coliphage: Effects of additives and alternative container materials. *Water Research*, 46(6),1745-1754.
- Forstmeier, M., Feichter, W. & Mayer, O. 2008. Photovoltaic powered water purification — challenges and opportunities. *Desalination*, 221(1-3),23-28.
- Ghannam, J., Ayoub, G.M. & Acra, A. 1998. A profile of the submarine springs in Lebanon as a potential water resource. *Water International*, 23(4),278-286.
- Jaskolski, M., Schmitz, L., Otter, P. & Pellegrino, Z. 2019. Solar-powered drinking water purification in the oases of Egypt's Western Desert. *Journal of Photonics for Energy*, 9(4),043107.
- Joseph III, T.A., Newton, C.C., Wandrie III, H.M. & Carter, M. 2012. EPIPHANY SOLAR WATER SYSTEMS. *Solar-powered water purification system*. U.S. Patent Application 13/496,951.
- Khan, M.T.A., Tanzil, S.S., Rahman, R. & Alam, S.S. 2010, December. Design and construction of an automatic solar tracking system. In *International Conference on Electrical & Computer Engineering (ICECE 2010)*, 326-329. IEEE.
- Kumar, K.V. & Bai, R.K. 2008. Performance study on solar still with enhanced condensation. *Desalination*, 230(1-3),51-61.
- Mohanta, P.R., Patel, J., Bhuvu, J. & Gandhi, M. 2015. A review on solar photovoltaics and rooftop application of it. *International Journal of Advanced Research in Science, Engineering and Technology*, 2,2394-2444.
- Rockenbaugh, C., Dean, J., Lovullo, D., Lisell, L., Barker, G., Hancock, E. & Norton, P. 2016. *High-performance flat plate solar thermal collector evaluation* (No. NREL/TP-7A40-66215). National Renewable Energy Lab. (NREL), Golden, CO (United States).
- Saraceno, D. 2005. *Solar powered portable water purifier*. U.S. Patent 6,863,827.
- Sawka, M.N., Chevront, S.N. & Carter, R. 2005. Human water needs. *Nutrition reviews*, 63(suppl\_1),S30-S39.
- Sommer, B., Marino, A., Solarte, Y., Salas, M.L., Dierolf, C., Valiente, C., Mora, D., Rechsteiner, R., Setter, P., Wirojanagud, W. & Ajarmeh, H. 1997. SODIS – an emerging water treatment process. *AQUA* (Oxford), 46(3),127-137.
- Thorat, S. 2006. *Solar water purification by using thermal method*. Final year design project. Pune University, India.
- Wright, A.V. 2011. *Solar-powered water purification system*. U.S. Patent Application 13/010,676.
- Zhang, Y., Sivakumar, M., Yang, S., Enever, K. & Ramezani-pour, M. 2018. Application of solar energy in water treatment processes: A review. *Desalination*, 428,116-145.

# DEVELOPMENT OF AN AUTOMATED COCONUT SCRAPING MACHINE

B.G.V. Mendes, K. Dikgale, L.K. Tartibu, T.J. Kunene  
University of Johannesburg, South Africa.  
ltartibu@uj.ac.za

## Abstract

Coconuts are a very popular fruit worldwide. They have a variety of uses, as well as health and nutritional benefits. The uses of coconuts range from cooking and nutrition to skin health, cancer prevention, beauty products, and fuel. Scraping coconut is a laborious and time-consuming process. The manual process requires the operator to both rotate and apply pressure to scrape out the flesh of the coconut. The commercialised coconut scraping machines that are available are not fully automated and still involve manual effort. The semi-automated process requires the operator to hold the coconut half-shell against a rotary blade usually powered by an electric motor. In both methods, the operator is presented with different risks of injury. This paper describes how an automated coconut scraping machine has been developed to solve the well-known challenges regarding grating coconuts. The design proposed in this study eliminates virtually all hazards related to coconut scrapers. It is a fully-automated machine that reduces both risk and effort on the part of the operator. The system incorporates an adjustable blade that allows movement along two axes. A clamping mechanism that moves in the third direction allows a three-dimensional movement. The mounting of the coconut half shell in the clamp takes no more than fifteen seconds. Upon mounting, at the push of a start button, the scraping of the coconut is completely automatic. Details of the design and development of the working model constitute the main contribution of this paper.

**Keywords:** automated, coconut, design, development, scraper

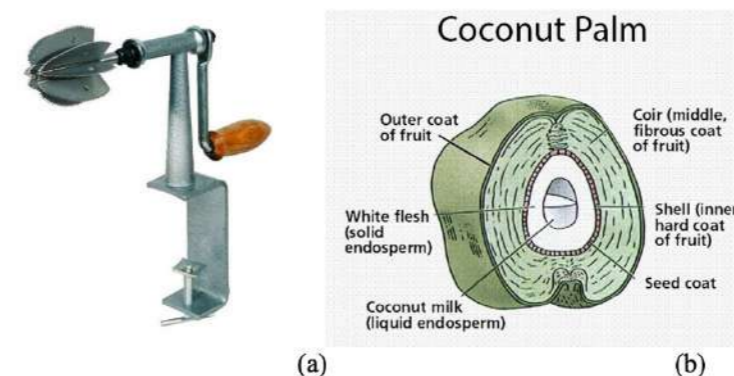
## INTRODUCTION

Coconuts are a very popular fruit worldwide. They have a variety of uses including health and nutritional benefits. The uses of coconut include:

- Cooking and nutrition
- Skin health; cancer prevention
- Beauty products
- Fuel (Charcoal)

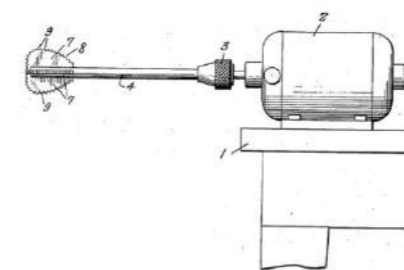
In small-scale coconut processing, coconuts are cracked with the use of a hammer or knife. The kernel is extracted using hand tools or mounted-type coconut scrapers. Even in small-scale coconut processing, the use of manual tools is very tedious and effort is required (Practical Action, 2008). Manually-operated coconut scraper machines are portable and may be used effectively in households, using the clamping screw to clamp the entire mechanism securely on a table. As one rotates the manual handle, the rotation is transferred to the scraping bit (Figure 1a).

The dehusked coconut half-shell is pressed against the sharp bit while in rotation (Figure 1b). This device requires a fair amount of effort to grate a coconut. Attention is required by the operator because if a slip occurs, serious injuries may result.



**Figure 1:** (a) Typical manually-operated coconut scraper machine and (b) Coconut section showing a structure

Many of the semi-automated commercial scrapers use the scraping part of the manually-operated scraper coupled to an electric motor. The scraping bit may have a different design but all perform a similar action and require similar effort to scrape. A typical semi-automated coconut scraper is shown in Figure 2.



**Figure 2:** Semi-automated coconut scraper (Adapted from Mock, 1940)

A compact design for coconut scrapers was proposed by Sajil Raj, Anshadh, Raj & Ahsana (2016) consisting mainly of a clamp (locking mechanism), movers (for lateral and forward feed), a coconut holder, a motor (to rotate the coconut), a plate holder, and blades (for scraping of the coconut). Another design of a coconut breaker extractor grater machine was described by James, Joy, Shaji, Chandy & John (2016) comprising mainly of a motor, breaking tool, grating tool, body, an angle plate, a hanging weight, two pulleys (motor and shaft), bearings and a spring. A review of a multipurpose grating machine was conducted by Bapat, Ballewar, Sarode & Hande (2018). This machine consists mainly of a cylindrical drum, blade, v-belts, motor, and steel frame. Senthil Kumar, Kamaraj, Kaviraju, Mano Bharathi (2018) proposed a multi-blade coconut scraping machine with a single drive. The system consists of a frame, worm shafts, worm gears, blades, a motor, and chain drives. There are several existing patents related to “coconut scraper (grater)” (Thompson & Thompson Noel, 1984; Kannukkaden, 1993; Kumar, 2004; Zaldivar, 2016). All of these offerings are either manual or semi-automatic with specific features. A more flexible device for scraping and extracting coconut flesh from a half coconut with minimal human intervention and greater convenience was proposed by Mattathil (2019). This device incorporates variable-width, variable-movement-control, and variable-opening-entry mechanisms.

## Motivation

Grating coconuts is time-consuming and laborious. For several decades, coconuts have been scraped in the same manner. In this paper, we propose a concept that could make the coconut scraping process fully automated. It is expected that the design proposed in this paper will significantly reduce coconut scraping and – most importantly – mitigate risks linked to the work.

The objective of this paper is to describe the development of an automated coconut scraping machine. Coconuts come in different shapes and sizes. For the design to be automated, it would have to significantly reduce all operator input during operation. In addition, the new design needs to accommodate various sizes and shapes of the coconuts (Table 1). The new scraping machine has to be designed in such a way that it can be self-adjusting, based on the size and shape of the coconut. In conventional coconut scrapers, the sharp bit turns at a high revolution rate. The operator holds the dehusked coconut shell and presses the inside of the shell, containing the flesh, against the rotating sharp bit. This process is time-consuming and poses some safety hazards as well. Designing a mechanism that can mimic the operator during scraping coconuts is therefore necessary. To the authors' knowledge, there are no studies that describe the development of a fully- automated scraping machine. The commercial coconut scraping machines that are available are not fully automated and still require physical involvement by an operator.

**Table 1: Coconut particulars (Adapted from Sabale & Kolhe, 2016)**

Particulars	Dry Coconut
Shape	Ovoid
Length, mm	210-270
Diameter, mm	160-206
Weight, kg	0.62-1.25
Shell Diameter, mm	80-120
Husk Thickness – at pedicel end, mm	62
Husk Thickness – at apex end, mm	34
Husk Thickness – 1/4 <sup>th</sup> distance from pedicel end, mm	32
Husk Thickness – 1/2 <sup>th</sup> distance from pedicel end, mm	24
Husk Thickness – 3/4 <sup>th</sup> distance from pedicel end, mm	28

## Methodology

The approach leading to the concept of the coconut scraping machine described in this paper can be summarised as a five-step process: problem definition and research objective; literature review; development of the scraper mechanism; development of the clamp mechanism; description of the electrical and control systems; detailed design. The problem and objective have been defined in the first two sections of the paper as a preliminary step of the design process. A literature review was conducted to understand how the coconut is structured. Existing concepts of coconut machines have been analysed to identify features that could be incorporated in the proposed model. The scraper mechanism was developed to make provision for movement along at least two axes. The selection of material was done based on existing designs and the coconut kernel requirement. The clamp mechanism was developed to hold the coconut firmly in place and ensure that the time taken to mount the coconut is relatively short. The brief overview of the electrical and control circuits was based on the working of the main sub-systems of the model proposed in this paper.

## Description of the design

## Specifications and requirements

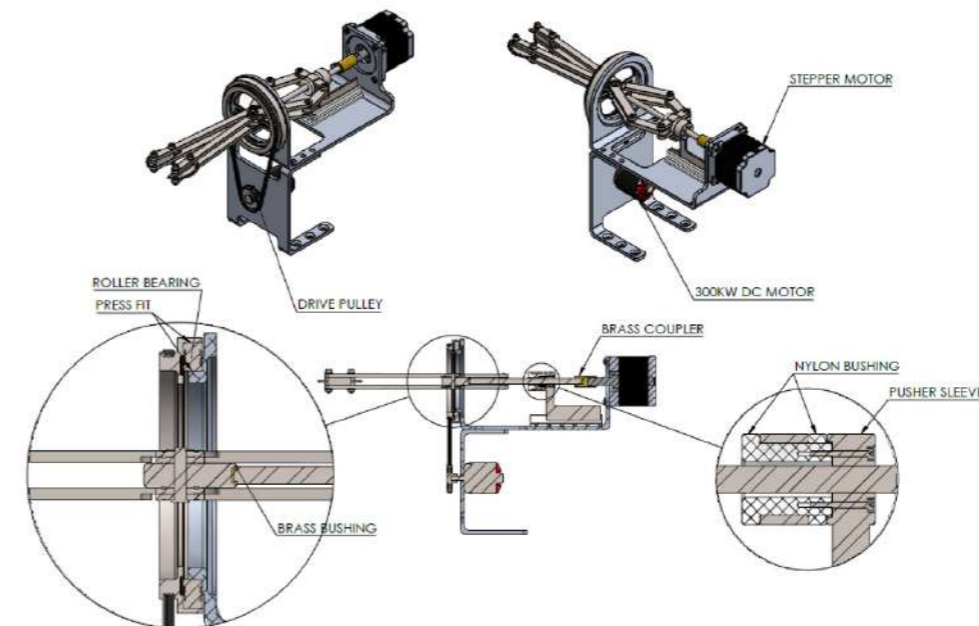
The following section summarises the specifications and requirements considered for the design of the scraper machine:

- The machine must be portable. The size has been estimated to be 1.045 m x 0.46 m x 0.143 m
- The system must be fully automated
- The effort required to grate the coconuts must be reduced significantly
- There must be few to no contacts with moving parts
- The machine must be completely automatic after the half shell coconut is placed in the clamp
- The machine must be capable of running at relatively high speed
- The machine must be robust.

## Development of scraper mechanism

### a. Scraping blade mechanism

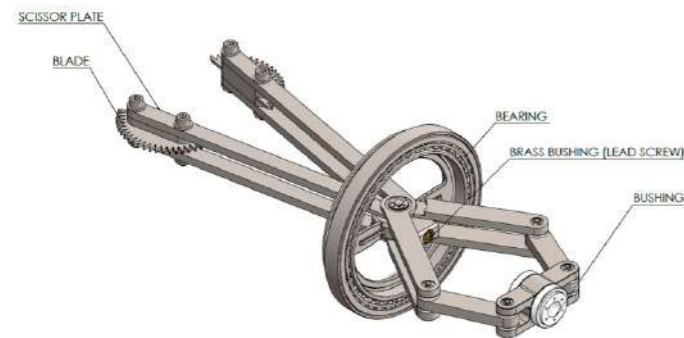
Figure 3 provides the details of the coconut scraping blade mechanism. The stepper motor activates the linear movement of the pusher sleeve. The pusher sleeve, in turn, adjusts the angle of the scraping blade to accommodate the shape of the coconut to be scraped. Underneath a DC motor provides rotation to the blade through the pulley belt.



**Figure 3: Scraping blade mechanism**

### b. Scissor mechanism

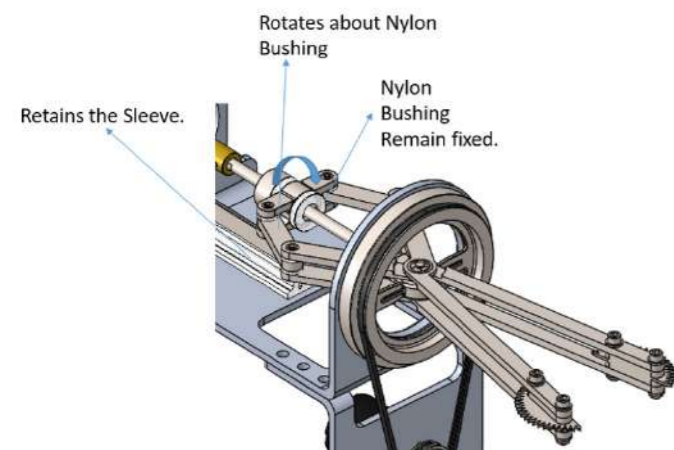
The scissor mechanism allows for the adjustment of the blades at the end. The bearings are press-fitted into the pulley housing. The nylon bushing decreases friction and allows the rotation of the scissor mechanism independently from the stepper motor. The majority of the mechanism is machined from 316ss stainless steel. The pivot joints are firmly held by steel pins and circlips as a retainer. Details of the scissor mechanism are shown in Figure 4.



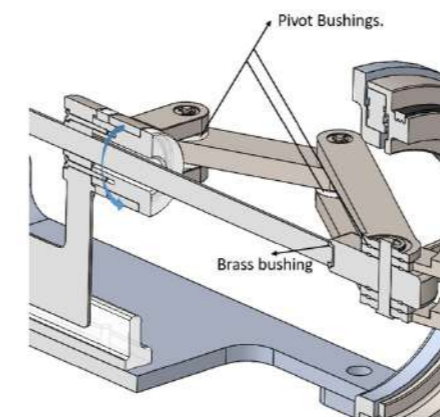
**Figure 4:** Scissor mechanism of the scraper blade

### c. Bushings

The scraper mechanism has several moving parts so a method of reducing friction between moving parts is essential. There are two types of bushing used in the proposed design. The nylon bushings were chosen to take advantage of the self-lubricating properties of nylon. Nylon to steel has a coefficient of friction of 0.4 (*Engineering toolbox*, 2004). The nylon bushings (white coloured parts) in the scraper mechanism allow the scraper blades to rotate about the driven pulley without rotating the stepper motor at the back (Figure 5). It separates the sleeves and the scissor mechanism. The sleeve provides linear movement to allow the scraper blades to adjust to the distance between them. At the bottom of the frame, a retainer prevents the sleeve from rotating. The pivot bushing in Figure 6 is important in the sense that it avoids metal-to-metal contact. A quiet rotation will be the result of including nylon bushings in critical moving parts. The brass bushing is used in the design to centralise the lead screw at the free end. Brass is a material very commonly used as a bushing due to its malleability. Because brass is softer than stainless steel, the brass will adjust its shape while in contact to make up for the tolerance inaccuracies of fabrication and machining.



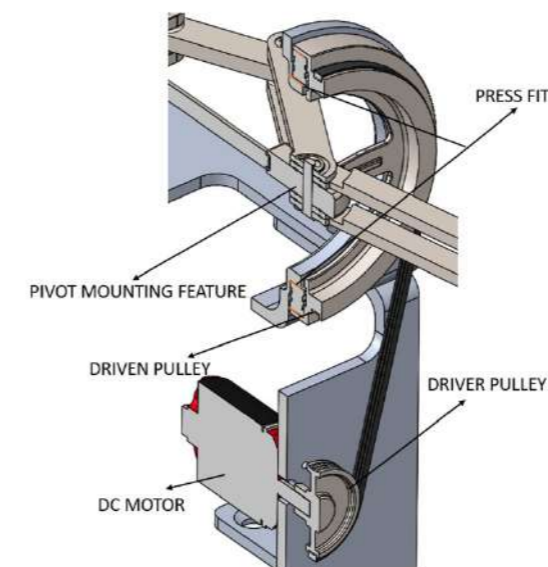
**Figure 5:** View of scraper mechanical bushings



**Figure 6:** Pivot bushings and rotation section view

### d. Pulley system

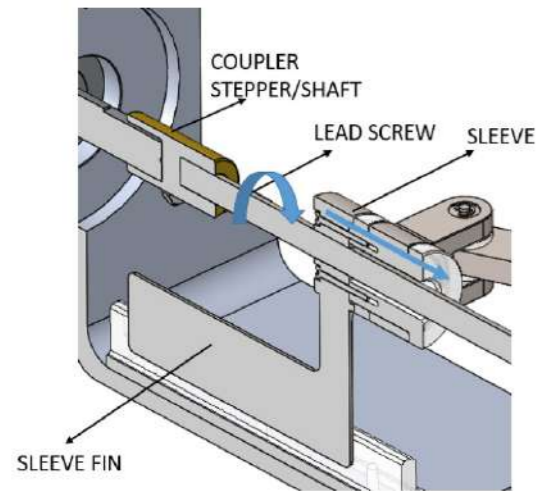
The pulley system was designed in the simplest way possible (Figure 7). The system consists of two pulleys: the driver and the driven pulleys. The driver pulley is mounted directly on the direct current (DC) motor, while the driven pulley system performs three functions: transmission of power, bearing housing, and mounting features for the scissor plates in the pivot section. The bearing is press-fit onto the driven pulley and the frame. The bearing may be taken as the main rotation section of the mechanism.



**Figure 7:** Illustration of the pulley system

### e. Rotation to linear motion conversion

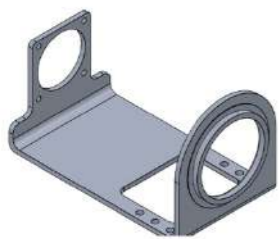
The motor shaft and lead screw are coupled via a brass coupler, the free end of the lead screw is centralised and supported by using a brass bushing as shown in Figures 7 and 8. The motor rotation causes a linear movement of the sleeve which is threaded to the same specifications as the lead screw. The movement of the sleeve is transferred to the scissor mechanism via the nylon bushings.



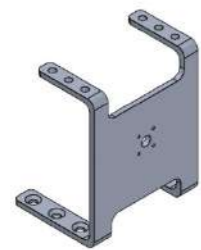
**Figure 8:** Section view of rotation to linear conversion

#### f. Scraper frames

The frames are constructed from aluminium 6068-T6, which is advantageous for its weight-to-strength ratio. The frame shown in Figure 9 will be used to mount the stepper motor. The front part allows for the press-fitting of the bearing and the assembly of the scissor mechanism of the scraper blade. The frame shown in Figure 8 will be fastened to the coupler frame using six M8 screws and nuts. This structure acts as a supporting frame for the DC motor. The DC motor in turn is coupled to a driver pulley as shown in Figure 5. The manufacturing process to adopt for the fabrication of the parts shown in Figure 9 and 10 may be sheet metal bending. The features on the plate may be done by Computer Numerical Control (CNC), plasma cutting, or water jet cutting.



**Figure 9:** Stepper motor and coupler Frame

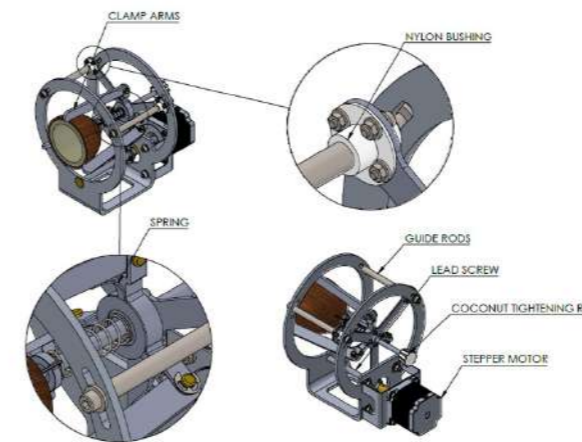


**Figure 10:** DC motor frame

#### Development of the clamp mechanism

#### a. Coconut clamping mechanism

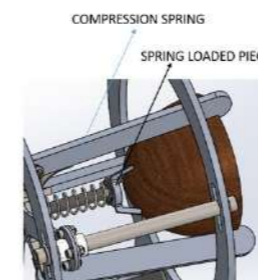
The coconut clamp was designed to hold various sizes or shapes of half-shell dehusked coconut. The design consists of three clamp arms spaced 120° apart. A clamp-tightening rod is part of the design to secure the coconut in place and restrain any movement during scraping. A second stepper motor is used to move the clamp linearly using a lead screw coupled to the stepper motor. With the scraping blade mechanism and clamp mechanism aligned, scraping can be regulated through a suitable control system. Details of the clamping mechanism are shown in Figure 11.



**Figure 11:** Coconut clamping mechanism

#### b. Clamp arms and tightening rod

The clamp arms are part of the clamping mechanism; three clamp arms are separated by 120°. At one end, a pivot hole feature is machined while at the other end is a 90° coconut shell edge retainer feature. A leaf spring, attached to the arms, is used to maintain the arms at an initial position at all times. When inserting a coconut half shell, the spring will deflect, allowing the coconut to enter past the 90° coconut shell edge retainer feature. The spring-loaded end piece is assembled to face the back and perpendicular to the cut section of the half-shell coconut (Figure 12). As the coconut half-shell is inside the clamp, the spring-loaded end piece will deflect and will serve the function of a stopper, so that the coconut is not pushed in too far. The threaded rod that is assembled to the end piece is tightened via the knob. The result is a secured coconut ready for the scraping process. The three-sided plate is assembled to the sleeve that serves multiple functions. The sleeve is designed in such a way that it provides the pivot support required by the clamp arms. It provides a mounting face for the arm springs and the three-sided plate which has the guide rod bushings and stepper motor sleeve mounting features. All components are mounted to a frame made from aluminium 6063-T6 (Figure 13).



**Figure 12:** Spring loaded piece



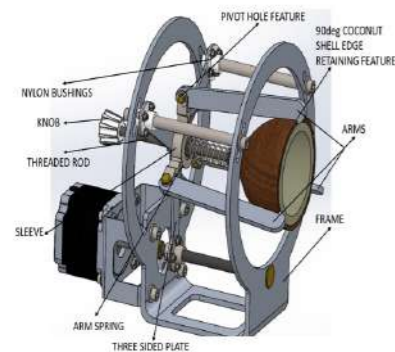


Figure 13: Coconut clamp

### c. A brief overview of the electrical and control systems

When the motor is running at no-load current, the current required by the motor is only to overcome internal friction. The torque load may be assumed to be zero. This zero torque may only be achieved when the scraper mechanism is running without a coconut. The relationship between torque and current tells us that the torque produced by a motor is proportional to the current. As the scraper blades come into contact with the flesh of the coconut, the torque load increases as the coconut react to the force being applied to it. The current range, while the blades are in contact with the fleshy portion of the coconut, is to be programmed on the control circuit as the scraping current. The resistance of the shell is much higher than that of the flesh. Therefore, the torque produced by the motor when in contact with the hard coconut shell will be higher. This hard-shell torque must be taken into account during programming. The control circuit will avoid the hard shell by decreasing the angle of the scissor mechanism. It will increase the angle when it is rotating in free air and the torque is nearly zero. Figure 14 provides the circuit layout that could be used to control the rotation of both clamp stepper motors. This circuit will receive signals from the current sensor and adjust the rotation of the motors accordingly.

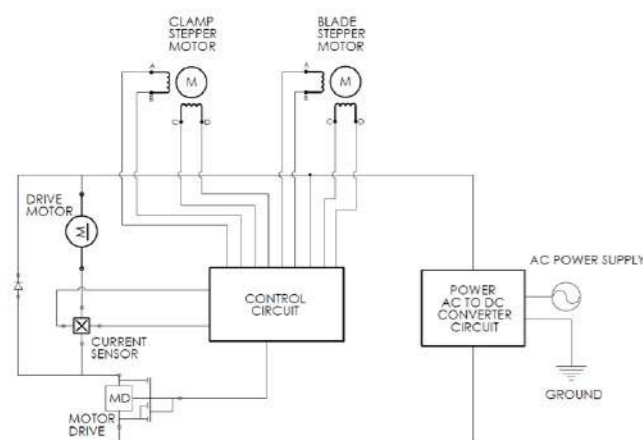


Figure 14: Basic circuit layout of the main components

## Detailed design

### a. Scraper mechanism and clamp mechanism

Both the clamp and scraper mechanisms are mounted to an injection-moulded bottom base and aligned. As seen in Figures 15 and 16, the stepper motors and DC motor are electrically connected to the control circuit containing the current sensor. The control system design falls outside the scope of this paper so a detailed description of the control circuit has not been discussed in this paper. As shown in Figure 15, rubber feet are assembled to the injection-moulded bottom base, providing friction that eliminates any unwanted movement due to the vibrations of the machine. It acts as a vibration absorber.

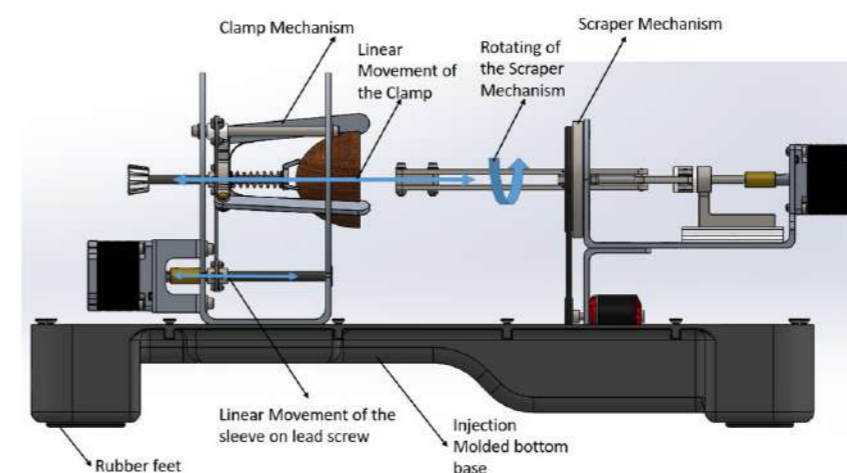


Figure 15: Aligned clamp and scraper mechanisms

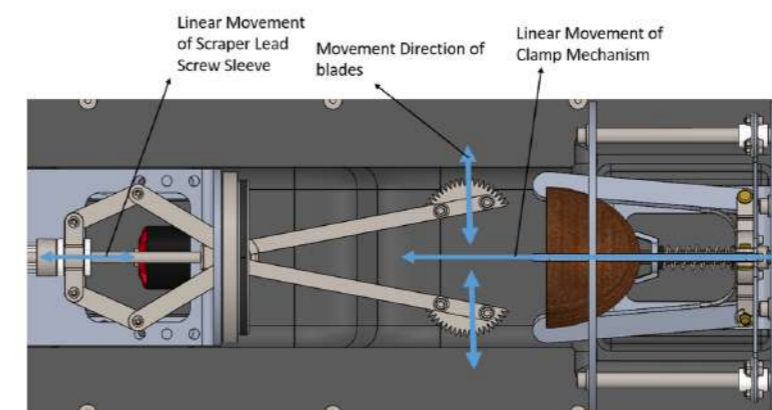


Figure 16: Top view of aligned scraper and clamp mechanisms

### b. Overall design

The concept developed in this paper incorporates a scraping blade mechanism that can be self-adjusting, based on the size of the coconut while in rotation. The spreading of the scraping blade is regulated by an electric stepper motor. A DC motor coupled to a pulley system facilitates the rotation of the blade. The coconut half-shell is then mounted on the coconut clamp. A coconut clamp tightening rod is used to clamp and tighten the coconut shell. The clamp mechanism

is also fitted with a stepper motor to create a linear movement to the clamped coconut. Through a suitable control system, both stepper motors may be controlled so that scraping may take place efficiently. By controlling the current flowing through the DC motor (and subsequently the torque), it is possible to maintain a constant torque which is linked to the steps of both stepper motors. This contact torque is the torque required to overcome friction when the blade is in contact with the coconut flesh. An overview of the automatic coconut scraping machine is shown in Figure 17(a) & (b). The working of each mechanism is described in the following sections.

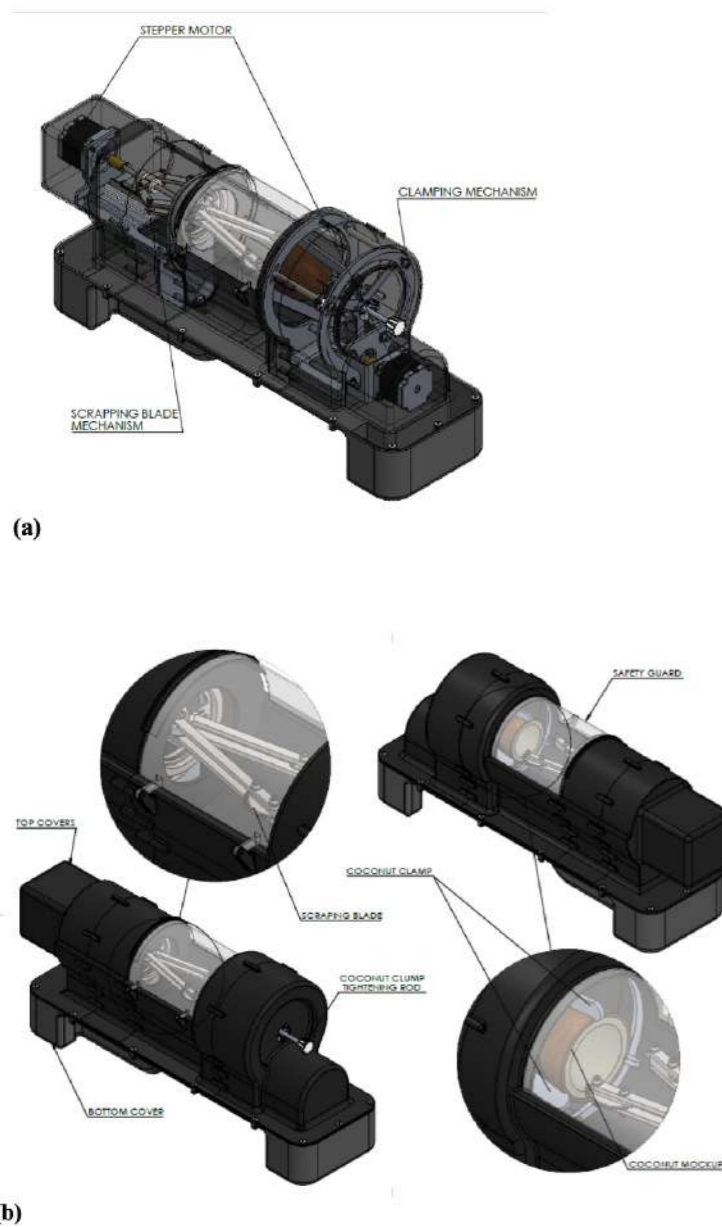


Figure 17: Coconut scraper concept

### Scraping process

Knowing that the coconut flesh has a certain resistance (or rather friction coefficient to overcome the scrape action), the hard shell of the coconut also has a coefficient of friction different from the flesh. The control system can be programmed to assess and detect the differences. The resistance will cause an increase or decrease in torque, which will ultimately cause a change in the current flowing through the DC motor. By knowing the range of resistance caused by the coconut flesh, the blade can be restricted to scrape only the coconut flesh. The following summarises the scraping process:

- Step 1. The rotating blade cuts through the first section of the coconut flesh, made possible by activating the clamp stepper motor moving the clamp forward for contact (Figure 18).
- Step 2. Figure 19 shows the spreading of the scraping blades by activating both stepper motors, the stepper

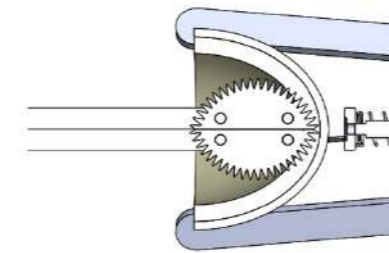


Figure 18: Step 1 of the scraping process

motor in the clamp mechanism, and the stepper motor in the blade mechanism.

- Step 3. The same process is repeated. All the processes are made possible by controlling the friction levels in

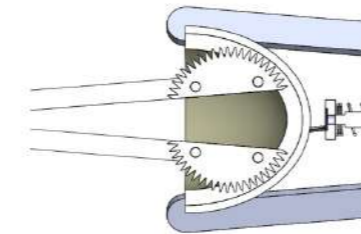


Figure 19: Step 2 of the scraping process

the circuitry that controls all the mechanism (Figure 20).

### CONCLUSION AND RECOMMENDATIONS

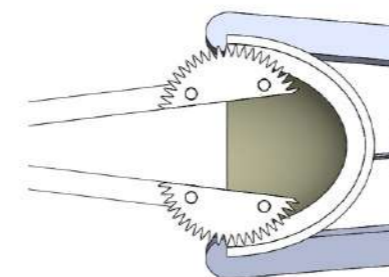


Figure 20: Step 3 of the scraping process

Coconuts are considered to be fruit with a variety of uses. The edible fleshy part of the coconut is one of its softest parts, yet it requires considerable effort to remove it from the coconut shell. Several approaches are proposed to remove the flesh of the coconut more safely and easily. The approaches can be classified as manual, semi-automatic and automatic, corresponding respectively to the manual scraper, semi-automatic scraper, and automated scrapers. This paper's objective was to design an automated scraper that will reduce time and effort, and be more safe and efficient when compared to the manual and semi-automatic scrapers. The design incorporates two stepper motors, a DC motor, a scraping blade mechanism, a clamping mechanism, a scissor mechanism, scraper frames, bushings, pulley systems, clamp arms, a tightening rod and the control circuit. A detailed description of the components, the modules, and the mechanism used to develop the automated system is provided. The coconut clamp was designed to grip various sizes or shapes of half-shell de-husked coconuts. The concept developed in this paper incorporates a scraping blade mechanism that can be self-adjusting, based on the size of the coconut while in rotation. The spreading of the scraping blade is regulated by an electric stepper motor. A DC motor coupled to a pulley system facilitates the rotation of the blade. The coconut half-shell is then mounted on the coconut clamp. A coconut clamp tightening rod is used to clamp and tighten the coconut shell. The clamp mechanism is also fitted with a stepper motor to create a linear movement to the clamped coconut. Through a suitable control system, both stepper motors may be controlled so that scraping may take place efficiently. Future work will provide clarity about the materials used, the size of all components/modules, and the control circuit suitable for this system.

#### ACKNOWLEDGMENTS

This Conference paper was partly supported financially by the National Research Foundation of South Africa with Grant number: 127395.

#### LIST OF REFERENCES

- Bapat, A.M., Ballewar, S.C., Sarode, B.D. & Hande, A.S. 2016. Design and fabrication of multipurpose grating machine: A review. *International Journal of Research in Mechanical Engineering* 4(3),178-182.
- Engineering ToolBox*. (2004). *Friction and Friction Coefficients*. [online] Available at: [https://www.engineeringtoolbox.com/friction-coefficients-d\\_778.html](https://www.engineeringtoolbox.com/friction-coefficients-d_778.html). [Accessed 09 04 2020].
- James, J., Joy, J., Shaji, A., Chandy, B. & John, V.M. 2016. Design and fabrication of coconut breaker extractor grater machine. *International Journal for Innovative Research in Science & Technology*, 2(11),179-184.
- Kannukkaden, J.J. 1993. Coconut grater. U.S. Patent Application 07/587,426.
- Kumar, R.A. 2004. Coconut shredding/grating apparatus. U.S. Patent 6,722,269.
- Mattathil, W.V. 2019. Pumatik Small Kitchen Appliances Private Ltd. 2019. Apparatus to scrape coconut. U.S. Patent 10,251,416.
- Mock, S.H. 1940. Coconut Grater. United States Of America Patent 2,190,105.
- Noble, N. 2008. *Coconut processing*. Technical brief. [Online]. Available from: <https://practicalaction.org/knowledge-centre/resources/coconut-processing/>. [Accessed 09 April 2020].
- Sabale, R.M. & Kolhe, K.P. 2016. Design and development of a coconut dehusker for small scale coir industry and marginal farmers. *International Journal of Science, Engineering and Technology Research (IJSETR)*, 5(2),591-595.
- Sajil Raj, P.R., Anshadh, A., Raj, S.B. & Ahsana, A.N. 2016. Design of an innovative coconut grating machine using Tinkercad. *International Journal of Research in Mechanical Engineering*, 4(3),178-182.
- Senthil Kumar G, Kamaraj K, Kaviraju S, Mano Bharathi T. 2018. Design and Fabrication of Multi Blades Coconut Scraping Machine with Single drive. *International Journal of Recent Engineering Research and Development*. 3(2), 19-23.
- Thompson, N.A. & Thompson Noel A. 1984. Coconut grater. U.S. Patent 4,441,410.
- Zaldivar, V., Monarch Media LLC. 2016. Coconut removal device and method therefor. U.S. Patent Application 15/236,107.

# DEVELOPMENT OF A MODULAR PICK AND PLACE ROBOT/AUTOMATED GUIDED VEHICLE (AGV)

Modestus O. Okwu<sup>1,2</sup>; Oluwayomi .J. Oyejide<sup>1</sup>, Lagouge K. Tartibu<sup>2</sup>, Mosa Machesa<sup>2</sup>

<sup>1</sup>Department of Mechanical Engineering, Federal University of Petroleum Resources Effurun, Nigeria.

<sup>2</sup>Department of Mechanical and Industrial Engineering, University of Johannesburg, South Africa

mechanicalmodestus@yahoo.com, oyejide.joel.fupre.edu.ng, ltartibu@uj.ac.za, mosamachesa@gmail.com

## Abstract

*This research is focused on the development of a modular AGV for moving light materials from one location to another. The development of the system was actualized using light wooden (LW) material with remote sensing carrier which moves at a steady and constant speed by following drawn lines, using infrared sensors for effective path navigation and mapping. The system was developed to pick up and drop light materials at various stations with two degrees of freedom (DOF), using the LW manipulator. Also incorporated in the design is the ultrasonic sensor to detect and avoid obstacles. The microcontroller which serves as the brain of the system was programmed via an Arduino board using an Embedded C language to send specific commands to the system. The capabilities of the developed AGV were explored during preliminary tests. It was observed that the robot is capable of navigating along a planned path from the start point to the destination without colliding with obstacles. The tasks of material handling, especially in hazardous environments, are made easier with a well-developed AGV to enhance efficiency in the delivery of items, especially at centres for palliative care, the nuclear industry and other hazardous environments.*

**Keywords:** Automatic Guided Vehicle (AGV), Infrared Sensor, Material Handling, Path Navigation

## INTRODUCTION

Quite a good number of workers in emerging and developing nations perform tasks in hazardous environments with risks to their health and safety. In recent times, Automated Guided Vehicles (AGVs) have played a productive role in the health sector, production and manufacturing industries, to improve the safety of workers. They are becoming relevant in other fields as delivery or messaging agents for delivery of products from one location to another. They are equally useful in infectious wards of hospitals, oil and gas, nuclear industry and other work settings that are dangerous for human workers. The fourth industrial revolution has steered a shift from the traditional ways of working and there is a total transformation in many aspects of mobility within our society and industries. Especially with the implementation of smart and versatile AGV systems which are appropriate to the need and purpose of respective organizations. Companies are thinking of how best to make their facilities smart and intelligent. The main reason for automation is to increase productivity for companies desiring advantage. Automation has a lot of advantages, such as

the reduction in human error, improvement in the quality of output, increase in productivity and profit for organizations and so on. Other reasons of automation are to save human lives, especially in hazardous environments by getting robots to work in systems which are inimical to health and hazardous working environments, to reduce high costs of human labour in such areas or to complete tasks in less time than a human could, especially in unsafe working conditions.

Complex variables are involved in the design and development process of an AGV system. Some of these variables are path programming and navigation design pattern, guide-path design, vehicle scheduling and routing process, battery management and many more. This contributes to the complexity of the vehicle's management processes. Development of an automated vehicle(s) requires sophisticated computers and microcontrollers on board. These devices provide a lot of advantages, especially to support high-speed vehicles while manoeuvring along a defined path while handling the load.

## THE STATE OF THE ART IN THE APPLICATION OF AGV SYSTEMS

Automatic Guided Vehicles (AGVs) are intelligent systems which facilitate the movement of materials or products from one location to another. Mahaleh and Mirroshandel (2018) presented a technique by adopting a harmony search evolutionary algorithm in solving and addressing real timeline detection robot movement. A two-wheel robotic platform was used for effective implementation. The AGV navigated safely by following a drawn line with a high level of accuracy and highly independent of image resolution during testing.

Lacomme, Larabi and Tchernev (2013) looked at the problem of simultaneous scheduling of machines and identical automated guided vehicles. The problem was modelled considering a job shop where the jobs have to be transported between the machines by the AGVs.

Miljković, Vuković, Mitić and Babić (2013) proposed a new hybrid control of an AGV, the main control algorithm consisted of two independent control loops; positioning based control (PBC). The proposed hybrid control bypasses the need for artificial landmarks or an accurate map of the environment, but there was no additional control module based on reinforcement learning for the exploitation of previous knowledge gathered in experimental processes.

Rozsa and Sziranyi (2018) developed an AGV system with detection capability using a 3-D range sensor for navigation purpose and proposed a solution for an obstacle classification problem for a partial points cloud without shape modelling. This method can solve the problem which arises from partial view and partial shape detection for using the scanned point clouds of an autonomous vehicle. The article considered task where only partial scanning data are available.

Stetter, Witczak and Pazera (2018) designed a virtual diagnostic sensor for determining forces and torques acting on an automated guided vehicle.

Macfarlane, Becker and Niekerk (2016) presented their research on the design, development and elevation of a suspension system for use on a 1.3 m/s, 1000 kg automatic guided vehicle in place of a traditional mechanical spring dampener system.

Vignesh, Rajesh and Lingaraj (2017) developed an intelligent automatic guided vehicle (IAGV) to navigate in a desired path by a visual servo system. This is an intelligent AGV which can work on its own and make decisions based on the changes in the surrounding environment.

Dimitrios, Naoum, Dimitrios and Eleftherios, (2016) provided a critical taxonomy of key decisions for facilitating the adoption of AGV systems into supply chain design, planning and processes.

Bharathi and Phanindra (2015) developed an intelligent dynamic pathfinding/surveillance automated guided vehicle using Ni Myrio.

Deroussi, Gourgand and Tchernevs (2006) address the problem of simultaneous scheduling of machines and vehicles in flexible manufacturing systems. The studied problem is a job shop where the jobs must be transported between the machines by automatic guided vehicles.

Yan, Dunnet and Jackson (2016) researched preliminary hazard analysis of an AGV's critical components conducted by the approach of Failure Modes and Effects Criticality Analysis (FMECA).

Kabir and Suzuki (2018) investigated how the duration of battery charging for AGVs can be varied to increase the flexibility of a manufacturing system.

### Related research on robotic manipulators

Harish, Hushein and Jayavelu (2013) focused on easy control of robotic arm using simple hand movements. The movement control can be used for heavier machinery in a delicate environment like saving lives in earthquake demolished sites.

George and Deshpande, (2014) conducted research on forward and inverse kinematics of a 5 degree of freedom (DOF) robotic arm for simple pick and place application.

Kumar *et al* (2017) provided details of a robotic system that can automate the task of picking and dropping of objects from the rack to a destination in an e-commerce warehouse.

Jasim, Mansoor and Khalil (2011) considered a new method of controlling the position of DC servo motor using PicoBlaze softcore processor on field-programmable Gate Array. The processor is programmed using assembly language.

Faigl, Kulich, and Preucil (2011) developed a sensor placement algorithm for a mobile robot which is useful for planning effective inspection at the workplace.

Gupta and Sukhatme (2012) presented a useful smart system at the workplace by developing a brick sorting automated system using the manipulator.

Other interesting research studies considered design or analysis of pick and place robots or manipulators (Saut, Gharbi, Cort'es, Sidobre, and Simeon 2010; Harada *et al.* 2012; Berenson *et al.* 2007; Jones and Lozano-Perez. 1990 and Dogar, Koval, Tallavajhula, and Srinivasa. 2014). However, this research is unique, with a focus on the development of a lightweight pick and place robot using cost-effective materials.

## MATERIALS AND METHODS

The automated guided vehicle is made of simple and locally-sourced materials. The development phase of the AGV is categorized into problem-solving in the mechanical, electrical, electronic and software components. The components used in the development of the AGV include a robotic arm for picking and placing of objects, a 12V DC geared motor, a driver IC, IR infrared obstacle-avoidance sensor, a magnetic switch, batteries, Arduino microcontroller, Veroboard, electronic components, and fasteners.

### Design consideration

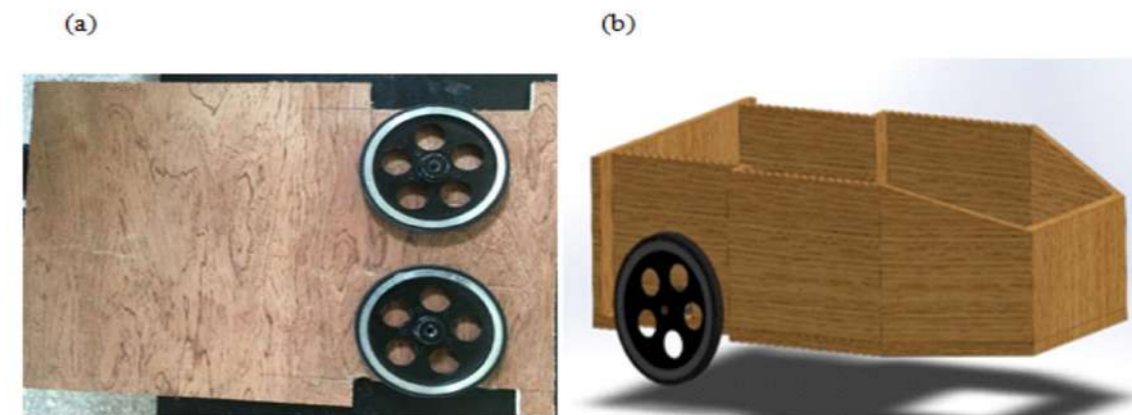
In the design of the AGV system, many decision variables were considered. This agrees with research conducted by Vis (2006), on operational issues and variables to be considered when designing an AGV system for easy workplace manoeuvrability. They include the flow path or route layout, traffic management in the system, effective prediction of obstacle or collision- avoidance, the number of pick-up locations and destination points, vehicle power requirement, battery system management and the probability of system failure. The definitions and functions of the parts are further discussed in this section.

### Mechanical components

**(a) Chassis** The chassis used is a lightweight local wood material with dimensions shown in Table 1. The modular system was designed to carry a load of 6 kg. The wood was cut to specified dimensions as shown in Figure 1. The sides of the chassis were cut to create space for the back wheels with a square hole created close to the chassis to allow access for the front orb wheel and the IR sensors. Aluminium sheets were cut and fastened to the motor on the chassis with the help of a screw and other electronic components were properly glued to the chassis. The material used for the fabrication of the chassis was chosen due to the ease of fabrication, its low cost and availability. It was sprayed to improve appearance. The technical data for the chassis is shown in Table 1.

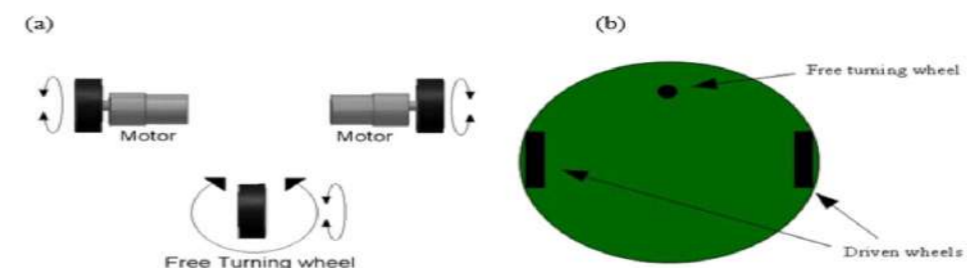
*Table 1: Technical data of chassis*

Features	Data
Length	355 mm
Breadth	250 mm
Height	375 mm
Material	Plywood
Machined dimensions	85 mm, 95 mm & 105 mm



**Figure 1:** (a) Fabricated Chassis (b) Solid Work Design of Chassis

**(b) Steering System:** The developed modular AGV is a three-wheeler robot in which the two rear wheels are connected to two separate DC Motors. The front wheel is a caster wheel which rotates freely through 360°. The differential steering system was implemented where movement is based on two separately driven wheels located at either side of the AGV system. The system was programmed using the microcontroller. The steering system is shown in Figure 2.



**Figure 2:** (a) Differential steering system (b) Turning and driven wheels pattern

**(c) Lifting Mechanism (manipulator):** A lifting mechanism is incorporated on the AGV to help pick and place objects at predetermined locations. Parts of the robotic arm include links and joints, actuators, sensors, servo motors, end-effector and controller. The developed robotic arm is produced from locally sourced wooden material. Wood was chosen over acrylic or any other material because of its lightweight, ease of machining, availability, appearance and conformity. The arm comprising the lot is connected by a joint that is clipped to the AGV casing. This is directly connected to the end of the lower arm affixed to a servo motor and pegged to the bottom frame via the servo motor connection. In the end, the effector is a servo-electric gripper comprising of a servo, used to open and close the manipulator grabber. The gripper is made of acrylic for lifting light objects. Input commands are sent to the gripper through its communication ports, then the command from the robot is received and used to serve the gripper motor. The servo-electric motor reacts to the signal, which in turn makes the shaft rotate to the commanded position, speed or force.

### Electrical and electronic components

**(a) DC motor:** This is used to provide direct current. The system can be adjusted to the desired RPM using the gearbox. A 60 RPM DC motor was considered in this research. It was the best choice for a line following or tracking robot. Motor specification speed was 60 r.p.m., the supply voltage was 12 V, shaft diameter 6 mm, weight 100 grams, torque 22 Kg-cm, no-load current 60 mA, load current 300 mA. Figure 3 shows the diagram of the DC motors connected to the tires.



Figure 3: DC motors connected to the tires

**(b) Battery:** To effectively power the AGV system, a rechargeable lithium battery has been used due to its lightweight. Six lithium batteries of 2V each were connected in series and parallel to supply a voltage of 12V. The battery provides power to two sections of the AGV system, the microcontroller driving unit and the lifting motor. See Figure 4 for the lithium batteries.

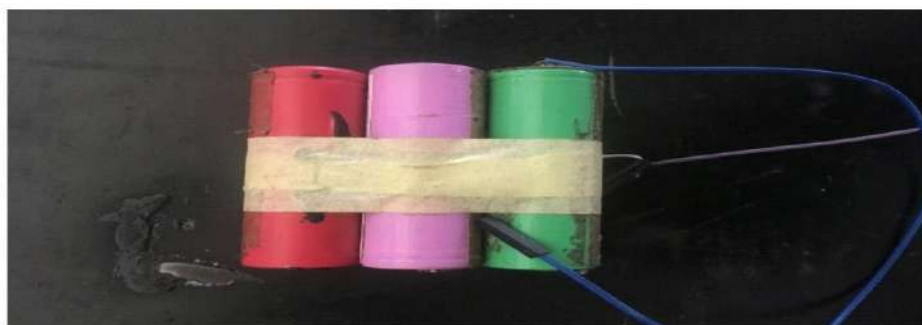


Figure 4: Lithium batteries

**(c) Microcontroller:** The Microcontroller (MC), with the sample shown in Figure 5a, that is used to support the AGV driving system is the ATmega 328MC, a low-power CMOS 8-bit microcontroller based on the AVR RISC architecture. By executing powerful instructions in a single clock cycle, the ATmega8 achieves throughputs approaching 1MIPS per MHz and allowing the system to be designed to optimize power consumption with good processing speed. The microcontroller used is inexpensive, easy to program using the Arduino software. It was programmed in embedded C language to accept data from the sensing unit interpret the data and send a response to the driving and lifting mechanism at the shortest time interval. The specification of ATmega 328.



Figure 5a: Atmega 328

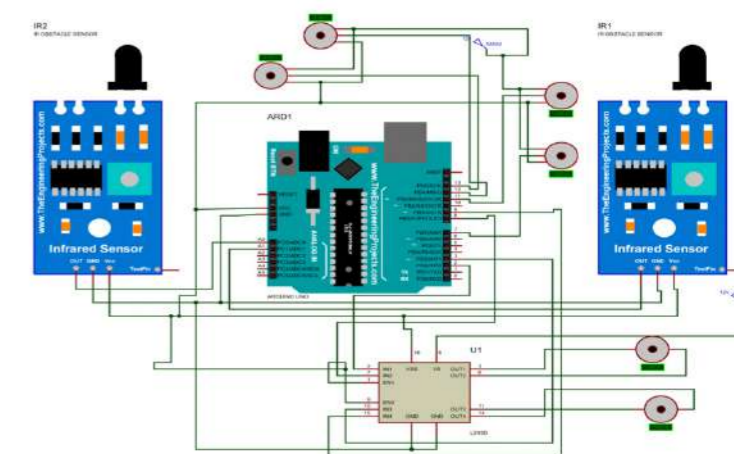


Figure 5b: Circuit connection of the Microcontroller

**(d) Motor Driver:** This is an electronic circuit which enables a voltage to be applied across a load in either direction. It allows a circuit full control over a standard electric DC motor. H bridge was the best choice for the system because of its small size, high-speed switching and low driving voltage. The connection of the microcontroller is shown in Figure 5. A driver IC, L293d, was used to connect the two motors used for the driving mechanism in the developed system. The pulse width modulation (PWM) was used to control the motor speed, applied to one of the pins of the L293d with specifications. PWM is the scheme in which the duty cycle of a square wave output from the microcontroller is varied to provide a varying average DC output as slow, medium or fast.

**(e) Regulator:** The voltage regulators employed in this design is the Regulator 7805 which reduces the voltage from 12 V to 5 V.

**(f) Infrared (IR) Sensors:** They are used for effective path detection. The IR sensors work with the principle of absorption of signals. In this research, two IR sensors were used for path navigation. The sensor has a transmitter and receiver port. The IR sensor works with the principle of absorption of signals, the signal reached at the receiver port after the reflection of light is used to detect the path. A path is marked on a white background using black lines. The sensor detects the white line by the strength of the IR wave. The reflected wave from the white line has a higher strength than that of the black. The IR sensors are placed under the system for easy path detection. Some of the features of the IR sensors include low power consumption, an internal filter for PCM frequency, a photodetector and preamplifier in one package, high immunity against ambient light. The supply voltage is within the range of -0.3 to 6.0 V, the junction temperature is 100 °C and the operating temperature is within the range of -40 to 100 °C with a power consumption of 1 W.

**(g) Ultrasonic sensor.** The Ultrasonic sensor (Figure 9) used in this research is the HC-SR04. The sensor head emits an ultrasonic wave and receives the wave reflected from the target. The ultrasonic sensor then measures the distance to the target by measuring the time between the emission and reception. It is mounted in front of the AGV and can detect transparent and complex shaped objects.

### Procedure for development of the robot

The exploded view of the pick and place AGV system is shown in Figure 6, while the top, front and side views are shown in Figure 7 and the complete design is illustrated in Figure 8. The developed line-following robot can pick or place an object at pre-determined locations. This was achieved using two IR sensors programmed to move the motors connected to the tires. The system is programmed in such a way that the facility layout background is white, and the path programmed for the robot to follow is black lines. Whenever the sensor detects a black line, it follows the path from the start point till it gets to the destination. At the top of the AGV system is a manipulator made of servomotors, which has an end effector of a grabber. An Arduino microcontroller which acts as the brain of the system synchronizes the entire setup. The various parts that make up the entire system are programmed to the desired specification. The Arduino software was used to program the microcontroller based on the ATmega328. It has 14 digital input/output pins (of which 6 can be used as PWM outputs), 6 analogue inputs, a 16 MHz ceramic resonator, a USB connection, a power jack, an ICSP header, and a reset button. It is connected to a computer with a USB cable and could be powered by an AC-to-DC adapter or battery to get started. The program is written in the Arduino software, using Embedded C programming language.

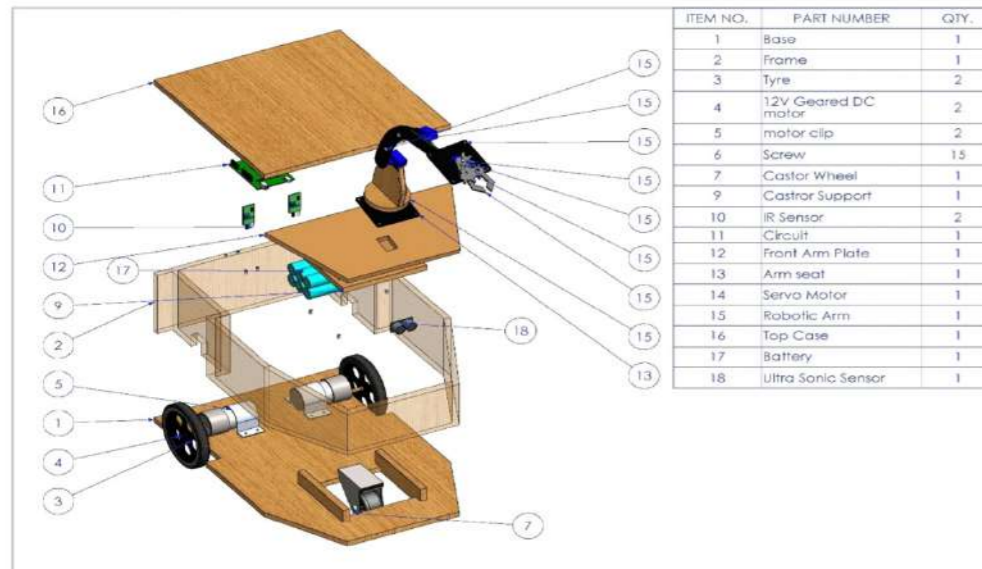


Figure 6. Exploded view of the AGV System

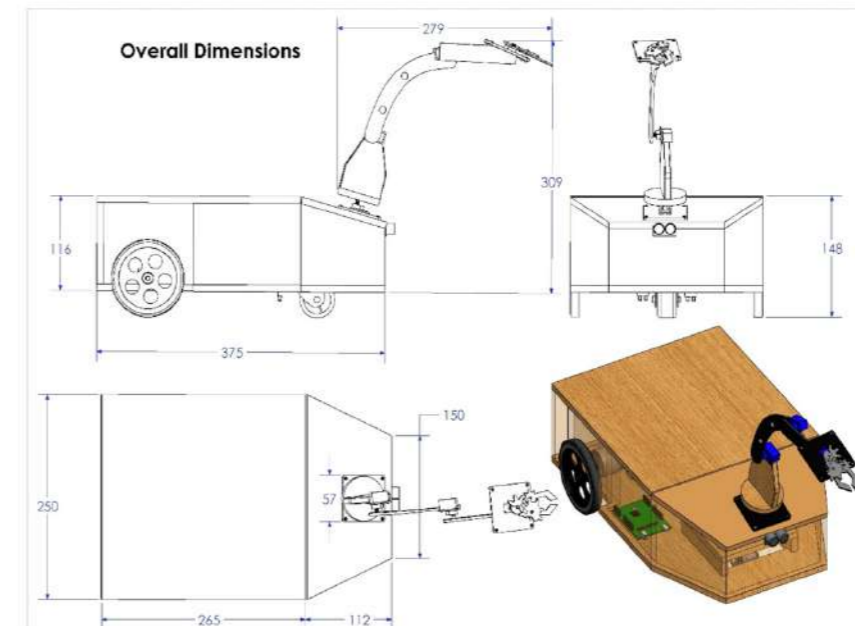


Figure 7. Top, Side and Front View of the AGV System



Figure 8. CAD design of the AGV System

### DESIGN CALCULATIONS, EQUATIONS AND RESULTS

$$\text{Angular Velocity, } \omega = 2\pi N/60 = (2 \cdot \pi \cdot 60)/60$$

$$\text{Rotational Power, } P = T \cdot \omega = 2.157463 \cdot 6.28$$

$$\text{Number of motors available for driving mechanism} = 2$$

$$\text{Total power available for driving} = 2 \cdot P$$

**Table 2:** Value of Parameters obtained by calculation

Torque of the DC Motor, T	2.157463 N-m
Speed of motor, N	60 r.p.m.
Angular Velocity, $\omega$	6.28 rad/sec
Rotational Power, P	13.54866 W
Total power available for driving	27.097 W

**ANALYSIS OF THE ROBOT**

**Performance analysis of the developed AGV system using a creative algorithm**

The pick and place hybrid AGV system was tested after development. Though the process of developing the system is technically complex due to the nature of instructions that are coded into the system, the advantage of the autonomous system is the fact that it is line-following and powered using a light-weight rechargeable lithium battery and there is no need for plugs and cables. It is reliable, efficient and effective. When tested, the autonomous system displayed these key qualities: avoidance of obstacles, ease of movement along pre-determined paths, ease of picking and placing objects using movable robotic arm, efficient battery system, time efficiency and strength efficiency. A Total Intelligence Test was conducted using an analytical hierarchy process to assess the general strength of the developed robot.

**Table 3:** Scale of relative importance

Verbal judgement	Numerical value
Extremely important	9
Very important	7
Important	5
Moderately important	3
Fairly important	1

Six criteria, shown in the first column of Table 4, are considered while conducting the performance analysis test. These are perception, task accomplishment, pick and drop accuracy, path navigation, energy efficiency and obstacle avoidance. This produces a 6 x 6 matrix. The diagonal elements of the matrix are always 1. The scale of the relative importance of the criteria standards is shown in Table 3 while Table 4 represents the upper and lower triangular matrix.

**Table 4:** Upper and lower triangular matrix

	Perception	Task acc.	Pick & drop accuracy	Path navigation	Energy efficiency	Obstacle avoidance
Perception	1.00	0.33	0.20	0.20	0.33	3.00
Task acc.	3.00	1	0.33	0.11	0.33	3.00
Pick & drop accuracy	5.00	3.00	1	0.14	0.33	3.00
Path navigation	5.00	9.00	7.00	1	7.00	9.00
Energy efficiency	3.00	3.00	3.00	0.14	1	5.00
Obstacle avoidance	0.33	0.33	0.33	0.11	0.20	1
Sum	17.33	16.67	11.87	1.71	9.20	24.00

If  $a_{ij}$  is the element of row i and j of the matrix, the upper diagonal matrix is the reciprocal of the value filled in the lower triangular matrix.

**Normalized matrix ( $A_{norm}$ )**

The matrix must be normalised for consistency. Normalisation is achieved by dividing each element in every column by the sum of that column. The normalized matrix is presented in Table 5.

**Table 5:** Normalized Matrix

	Perception	Task acc.	Pick & drop accuracy	Path navigation	Energy efficiency	Obstacle avoidance
Perception	0.06	0.02	0.02	0.12	0.04	0.13
Task acc.	0.17	0.06	0.03	0.07	0.04	0.13
Pick & drop accuracy	0.29	0.18	0.08	0.08	0.04	0.13
Path navigation	0.29	0.54	0.59	0.59	0.76	0.38
Energy efficiency	0.17	0.18	0.25	0.08	0.11	0.21
Obstacle avoidance	0.02	0.02	0.03	0.07	0.02	0.04
Sum	1	1	1	1	1	1

The criteria weight vector is calculated, by averaging entries on each row of  $A_{norm}$ . This is shown in Table 6. The weight sum vector and consistency vector have been equally calculated and presented in the same Table.

**Table 6:** Criteria weight, weight sum vector and consistency vector

Comparisons	Criteria weight	Weight Sum Vector (Ws) $\{Ws\} = [C] \{W\}$	Consistency Vector (Con V.) $\{Con.V\} = \{Ws\} \left\{ \frac{11}{ww} \right\}$
Perception	0.06	0.37	6.02
Task accomplishment	0.08	0.52	6.45
Pick & Drop accuracy	0.13	0.92	6.89
Path navigation	0.52	3.96	7.57
Energy efficiency	0.17	1.23	7.36
Obstacle	0.03	0.22	6.63

To determine the consistency index, CI, and consistency ratio, CR, [to do this, what has to be done? Some text missing here?]. If  $CR < 10\%$ , the ranking is consistent. If  $CR > 10\%$ , the comparison should be recalculated. According to Saaty (1980), the  $RI = 1.25$ . It is equally important to know the average of the element of consistency  $\{Consis\}$  is given by  $\lambda\lambda = 6.82$ . Then  $CI = 0.124$ ,  $CR = 0.0992$ . Note: Since CR is approximately 9.9%, the ranking is consistent.

$$CI = \frac{\lambda - n}{n - 1}, CR = \frac{CI}{RI}$$



### Evaluating the total intelligence system (TIS) of the developed robot

Performance tables for the various tasks during testing of the robot are presented in Table 7 and Table 8 represents the semantic attributes and corresponding values for rating the robot.

$$\text{Equation: } TIS = \sum_{i=1}^n w_i m_i \leq 1$$

Where: TIS = Total Intelligence Score,  $M_i$  = Metrics and  $W_i$  = Weight of metrics

**Table 7:** Performance table for various tasks

S/N	System Intelligence	First Task	Second Task	Third Task	Final Task	Average
1	Perception	0.61	0.61	0.63	0.62	0.6175
2	Accomplishment of task	0.71	0.71	0.72	0.7	0.71
3	Pick & Drop Accuracy	0.75	0.74	0.73	0.72	0.74
4	Path Navigation	0.6	0.65	0.63	0.65	0.63
5	Energy efficiency	0.73	0.75	0.72	0.75	0.74
6	Obstacle Avoidance	0.65	0.68	0.65	0.66	0.66

**Table 8:** Semantic attributes and values for rating the developed AGV

S/N	Corresponding Values	Semantic Attributes
1	0.1 – 0.2	Very low
2	0.2 – 0.4	Moderately low
3	0.4 – 0.6	Low
4	0.6 – 0.7	High
5	0.7 – 0.9	Very high
6	0.9 – 1.0	Very very High

Applying the equation above, the TIS is given by;

1<sup>st</sup> TIS = 0.650

2<sup>nd</sup> TIS = 0.6755

3<sup>rd</sup> TIS = 0.650

4<sup>th</sup> TIS = 0.6721

The total overall TIS of the system after carrying out the task specified above is given as 0.66. This shows the intelligence of the system is HIGH.

### CONCLUSION

The detailed design and construction of an Automated Guided Vehicle for the movement of materials from one station to another by the means of a robotic arm have been presented. The Intelligent Vehicle was designed to improve the safety of workers at their workplace, increase productivity by reducing the time needed to move materials by humans. This reduces the risk and hazards involved in the movement of these materials, especially if the materials are reactive materials that are harmful to humans and if the places these materials are needed constitute a danger to human health. The vehicle was designed to be compact and simple. As the name implies it is automated and this is accomplished by the means of a programmable microcontroller unit, the Arduino Uno. A high system intelligence test result was obtained by performing a TIS test using the creative algorithm. The developed AGV, if scaled up, would play a significant role in addressing repetitive and mundane tasks, especially in manufacturing systems, and sectors such as health, oil and gas, agriculture, and others.

## LIST OF REFERENCES

- Berenson D., R. Diankov, K. Nishiwaki, S. Kagami, and J. Kuffner. 2007. *Grasp planning in complex scenes*. In Proceedings of 2007 IEEE-RAS Int. Conf. on Humanoid Robots, pp. 42–48, 2007.
- Bharathi G and Phanindra R. 2015. Design and development of an intelligent dynamic pathfinding/surveillance automated guided vehicle using Ni myrio, *International Journal of Research in Engineering and Technology*, 4 (5), 2319-1163.
- Deroussi, L. Gourgand M. and Tchernevs N. 2006. A simple metaheuristic approach to the simultaneous scheduling of machines and automated guided vehicles. *International Journal of Production Research*, 46(8), 2143-2164.
- Dimitrios, B. Naoum, T., Dimitrios V. and Eleftherios, I. 2016. Sustainable supply chain management in the digitalisation era: The impact of automated guided vehicles. *Journal of Cleaner Production*, doi.org/10.1016/j.jclepro.2016.10.057.
- Dogar.M.R., M.C. Koval, A. Tallavajhula, and S.S. Srinivasa. 2014. Object search by manipulation. *Autonomous Robots*, Vol. 36, No. 1, pp. 153–167.
- Faigl, J., M. Kulich, and Preucil L. 2011. A sensor placement algorithm for a mobile robot inspection planning. *J. Intelligent Robot Systems*, Vol. 62, pp. 329–353, 2011.
- Gupta M. and G.S. Sukhatme 2012. *Using manipulation primitives for brick sorting in clutter*. In Proceedings of 2012 IEEE Int. Conf. on Robotics and Automation, pp. 3883–3889,
- George P.M and Deshpande, V. 2014. Kinematic modelling and analysis of 5 DOF robotic arm, *International journal of robotics research and development (IJRRD)*, 4 (2), pp 17-24.
- Harish, M. Hushein R. and Jayavelu S. 2013. Control of robotic arm using machine vision, *International Journal of Scientific and Engineering Research*, 4(11).
- Harada K., T. Foissotte, T. Tsuji, K. Nagata, N. Yamanobe, A. Nakamura, and Y. Kawai. *Pick and place planning for dual-arm manipulators*. In Proceedings of 2012 IEEE Int. Conf. on Robotics and Automation, pp. 2281–2286, 2012
- Jasim, O., Mansoor A. and Khalil. M.R. 2011. *Position control of DC servo motors using soft-core processor on FPGA to move robot arm*. *International Electrical Engineering Journal*, 2(3), pp. 555-559.
- Jones J.L and T. Lozano-Perez. 1990. *Planning Two-fingered grasps for pick-and-place operations on polyhedra*. In Proceedings of 1990 IEEE Int. Conf. on Robotics and Automation, Vol. 1, pp. 683–688, 1990.
- Kabir Q. S. and Suzuki Y. 2018, Increasing manufacturing flexibility through battery management of automated guided vehicles *Computers and industrial engineering*, 117, 225-236.
- Kumar S. Majumder, A. Dutta, S. Jotawar, A. Kumar, M. Soni, V. Raju, O. Kundu, E. Hassan, O. Kundu, E. Hassan, H. Behera, K. Venkatesh & R. Sinha. 2017, *Design and development of an automated robotic pick & stow system for an e-commerce warehouse*, Indian Institute of Technology. Kanpur, Uttar Pradesh, India.
- Lacomme P., Larabi M. and Tchernev N. 2013. Job-shop based framework for simultaneous scheduling of machines and automated guided vehicle. *Int. J. Production Economics*, 143, 24-34.
- Macfarlane, A. Becker U. and Niekerk T. 2016. *Oleo strut for use on modular electric automatic guided vehicles*. 2016 Pattern Recognition Association of South Africa and Robotics and Mechatronics International Conference (PRASA-RobMech).
- Mahaleh M. B. B. and Mirroshandel S. A. (2018), Harmony search path detection for vision-based automatic guided vehicle. *Robotics and Autonomous Systems*, 107, 156-166.
- Miljković, Z. Vuković, N., Mitić M. and Babić B. 2013. New hybrid vision-based control approach for automated guided vehicles. *Int J Adv Manuf Technol*, 66, 231-249.
- Rozsa, Z. and Sziranyi, T., 2018. Obstacle prediction for automated guided vehicles based on point clouds measured by a tilted LIDAR sensor. *IEEE Transactions on Intelligent Transportation Systems*, 19(8), pp.2708-2720.
- Saut, M. Gharbi, J. Cortés, D. Sidobre, and T. Simeon. 2010. *Planning pick and place tasks with two-hand regrasping*. In Proceedings of 2010 IEEE/RSJ Int. Conf. on Intelligent Robots and Systems, pp. 4528–4533, 2010.
- Stetter R., Witczak M. and M. Pazera. 2018. Virtual diagnostic sensors design for an automated guided vehicle, *Applied sciences*, 8,702.
- Vignesh, S. Rajesh K. and Lingaraj N. 2017. Intelligent automated guided vehicle using visual servoing. *American Journal of Engineering Research (AJER)*, Vol 6 (11), 16-20.
- Yan, R., Dunnet S.J. and Jackson L.M. 2016. *Reliability modelling of automated guided vehicles by fault tree analysis*. In Hardy, B., Qazi, A. and Ravizza, S. (eds.) 5th Student Conference on Operational Research (SCOR 2016), Nottingham, 8-10th April 2016.

# PROSPECTS OF 3D PRINTING OF HOUSES IN SOUTH AFRICA

J. Mahachi and R Lediga, University of Johannesburg, South Africa, jmahachi@uj.ac.za

## Abstract

The need to eradicate the housing backlog has prompted the government of South Africa and the private sector to investigate and promote effective and innovative ways of delivering housing. The nature of innovation and the benefits arising from the use of non-conventional innovative technologies in the complex government housing production value chain poses a challenge in the rollout and mass scale customisation of houses in South Africa. The main critical consideration for the adoption of innovative technologies is the “construction cost”, and if this cost falls within the provisions of the government housing subsidy quantum, then other issues such as social acceptability are considered. Although construction costs often determine both the rate and degree of substitution of conventional “brick and mortar” construction by technologies, the additional improvements, and benefits associated with these innovative technologies, need to be taken into account. Several innovative walling and roofing systems are in the market in South Africa, although very few have managed to be commercialised. However, the use of 3D printing has not yet been explored in South Africa, although internationally, this technology has been tried and tested. Internationally, many researchers and academics have investigated the use of 3D printing of houses. Examples in the literature where 3D printing has been successfully implemented include the Canal House in Amsterdam; WinSun Company Buildings in China; a castle in Andy Rudenko’s garden, Stupino town in Moscow, and many buildings in China. 3D printing technology has proven to provide environmentally friendly products with unlimited possibilities of complex geometries. The potential of this technology to disrupt the way the house construction process is implemented, the type of skills and labour required will change the housing delivery gameplay. However, such benefits have not yet been researched and/or documented adequately in South Africa. This paper presents the research conducted on the prospects of using 3D printing in houses based on case studies. The potential of using recycled or waste materials is also explored, including the cost-effectiveness of using 3D printing.

**Keywords:** 3D printing houses, innovation, construction technologies, recycled waste

## INTRODUCTION

3D printing is a technology that employs an additive manufacturing process whereby products are built on a layer-by-layer basis, through a series of cross-sectional slices. A 3D printer works like traditional laser or inkjet printers, but instead of using multi-coloured ink, the 3D printer uses substances such as plastic or powder that are slowly built into an object on a layer-by-layer basis (Attaran, 2017).

3D concrete printing uses the same principles as traditional 3D printing but uses concrete as the extrusion material. A 3D concrete printer uses a chemically altered concrete mix, which is pumped through a concrete extruder/nozzle that is

controlled in three dimensions. This extruder is controlled by a computerised gantry system and builds the structure layer by layer. The key components, therefore, are (1) a concrete pump, (2) an extruder, and (3) software. The construction process using this technology is mostly automated and requires minimal labour.

Three-dimensional printing of concrete (3DPC) has the potential for the rapid industrialisation of the housing sector, with benefits of reduced construction time and costs as that no formwork is required, ease of construction of complex geometries, potential high construction quality, and reduced waste (Cho, Kruger, Zeranka & Zijl, 2019).

This paper investigates the prospects of using 3D printing for low-income house construction in South Africa and its financial viability for the housing market. The potential of using waste material for 3DCP for the local market is also explored.

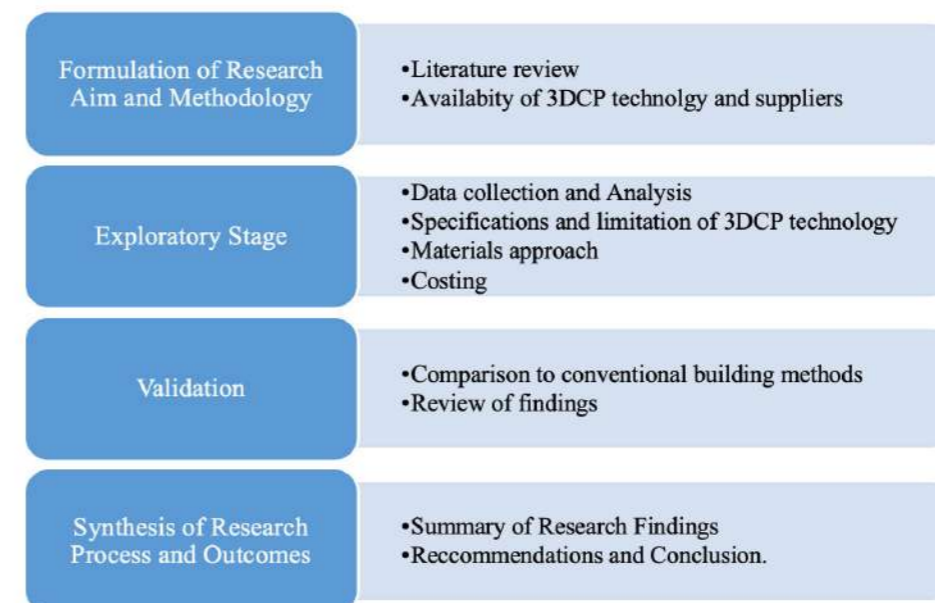


Figure 1: Research Methodology

## PROBLEM STATEMENT

South Africa has a backlog of over 2.3 million houses that requires an estimated R800 billion by the end of 2020 (Africa Check, 2019). An urgent and innovative housing delivery solution is required. A solution to this backlog could be the use of 3DCP. The critical consideration for 3DCP is the construction cost and whether it could fall within the provisions of the government housing subsidy quantum. There are numerous walling technologies in the South African market and few have been successful. Although 3DCP has been tested internationally, it still has not been adequately explored in South Africa. The potential benefits of the type of skills and labour required using 3DCP have not been adequately researched and/or documented in the South African market.

## AIM OF THE STUDY

The purpose of this study is therefore to explore the following:

- The extent of the adoption of 3D printing and the types of technology used through a detailed literature review;
- The viability of the technology in South African; and
- The performance of 3DCP compared with conventional construction methods.

## RESEARCH METHODOLOGY AND DESIGN

To achieve the aim and objectives of the research, the research methodology was broken down into four stages shown in Figure 1. The first stage is to critically review the literature and 3DCP technology that is available in the market today. The second stage is the data collection, the specifications and limitations, materials approach and costing. This data is also based on engagement with suppliers. The third “validation stage” was to draw a comparison between 3DCP technology and conventional methods and review the findings thereof. The final stage is to combine all the data, summarise it, and make recommendations.

## LITERATURE REVIEW ON THE 3D CONCRETE PRINTING INDUSTRY

### 3D Concrete Printers

Although the 3DCP is a relatively young technology, there has been substantial research and development of this technology in the industry. There are two fundamental factors to take into consideration for its success: the 3DCP machines and material design. The following sections present machines and materials that are used in industry today.

There are two approaches for 3D concrete printer designs, that is, the Gantry based systems and Robotic arm type systems. They both have their advantages and disadvantages depending on the purpose of their applications. One of the first industrial printers designed was a gantry based systems (Khoshnevis, 2004). The structure design is based on a standard steel profile used to keep machining to a minimum. The base of the gantry printer is usually a standard universal beam, flat steel base, or an isolated steel base on which a rail is welded for the horizontal movement of the printer assembly. The main specifications of a gantry 3D printer are maximum printable area ( $m^2 m^2$ ), extrusion rate ( $m^3 / sm^3 / s$ ), print speed and nozzle size (mm) (Cobod, 2019). Figure 2 depicts one of the first commercial 3D concrete printers.



Figure 2: BetAbraham 3D Concrete Printer

The following are the advantages and disadvantages of gantry systems:

Advantages:

- Stable and secure for construction;
- Relatively inexpensive; and
- Large print area, suitable for entire buildings.

Disadvantage:

- Not very flexible to move from one place to another.

The other design of the printer is the robotic arm type system. The robotic arm type systems are generally more expensive than the gantry systems. Typically, a robotic arm system is placed on a metal frame that is anchored to the surface (Apis-cor, 2019). The robotic arm is attached to a hose that carries the concrete from the reservoir to the nozzle. The robotic arm then moves the nozzle to the programmed positions. Specifications are similar to the gantry system. Figure 3 depicts a typical robotic arm system.



Figure 3: Apis Cor's 3d concrete printer

The following are the advantages and disadvantages of a robotic arm type system:

Advantages:

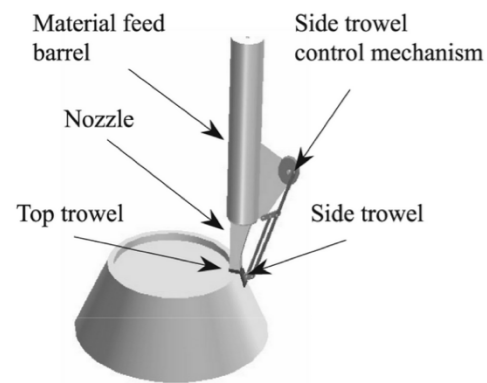
- They are smaller mechanical systems; and
- Easy to move to different places on site.

Disadvantages:

- The higher price and lower stability; and
- Smaller print area and limited reach.

### 3D Concrete Printing projects

This section explores the various 3DCP projects that have been undertaken and the organisations, companies, and countries that were involved in the projects. Contour crafting is one of the first methods to capture the imagination of industry and to display the possibilities of 3D concrete printing technology. It uses conventional construction tools (trowels) to shape the various layers. As illustrated in Figure 4, a nozzle extrudes the material and two trowels shape the layer. A property of the nozzle is that it can build with two different materials at the same time (Khoshnevis, B 2004). Although the technology was innovative, one of the biggest challenges was that the material was expensive and not competitive with conventional methods.



**Figure 4:** Contour crafting system (Khoshnevis, B 2004)

Although China has been lagging behind the U.S and Europe in terms of consumer and manufacturing-based 3D printing, a China-based company entered the race. When it comes to the 3D printing of large-scale structures such as homes, China-based Winsun Decoration Design Engineering Company built 10 homes which were almost entirely 3D printed with recycled concrete material (Winsun, 2018). Winsun also managed to use 3D concrete printing technology to build a multi-story building apartment in China. Figure 5 and Figure 6 shows some of the structures they managed to print. However, due to the technology being new, one of the biggest challenges the company faced was that there were no building codes for the technology, which presented a barrier for large scale adoption.



**Figure 5:** Winsun 3D concrete printed house (Winsun Decoration Design Engineering Co, 2015)



**Figure 6:** Winsun 3D concrete printed apartment block (Winsun Decoration Design Engineering Co, 2015)

The industry has grown over the years and many companies from all over the world are now participating in the development of this technology. Figure 7 depicts companies and organisations that have engaged in noteworthy projects since 1997; the dots indicate the number of projects undertaken each year. Table 1 also offers a comprehensive list of small to large scale projects that have taken place over the years (Buswell, de Silva, Jones & Dirrenberger, 2018).

**Table 1:** List of other 3DCP projects

PROJECTS	DATE OF PROJECT	COMPANY	LOCATION
Counter Crafting	2003/2004	Professor Behrokh Khoshnevis/ University of Southern California	USA
Upstate New York House	2014	D-Shape Enterprises and NYC architect Adam Kushner	USA
Apartment Building in China	2014	Winsun	Province Jiangsu, China
First 3D Printed Castle	2014	Andrey Rudenko	USA
Philippines Hotel	2015	Lewis Yakich, owner of the hotel and material science engineer and Andrey Rudenko	Philippines
XtreeE Lab's	2015	XtreeE	France
Office Building - UAE	2016	Gensler, structural work by Thornton Tomasetti and Syska Hennessy	Dubai, United Arab Emirates.
TU Eindhoven Pavilion	2016	TU Eindhoven University	Netherlands
Apis Cor Lab's	2016	Apis Cor & PIK	Russia
Shamballa Village	2016	Wasp	Massa Lombarda, North Italy
MIT's Digital Construction Platform	2017	MIT	America
Pedestrian Bridge in Madrid	2017	Institute of Advanced Architecture of Catalonia	Madrid, Spain
ICON and New Story	2017	ICON and New Story	El Salvador
The BOD house	2018	COBOD	Denmark
Gaia, a 3D printed house with earth	2018	Alberto Chiusoli, WASP	Italy

### Concrete material mix designs

Material mix design is one of the key aspects of 3DCP projects as it directly affects concrete setting time and therefore printing time. It is also vital that the mix design meets the structural mechanical property requirements in its hardened state as varying the mix design will alter the compressive and tensile strength of the structure. The mix design (water/

cement ratio in particular) is also the main influence on the workability and ultimately the pumpability of fresh concrete. The mix design below has been used in numerous published papers for 3DCP and is shown in Table 2 (Le *et al.*, 2012). The mix design has the following properties:

- 3:2 sand: binder (sand aggregate contains no particles larger than 2 mm).
- Binder: 70% cement, 20% fly ash and 10% silica fumes.
- 1.2 kg/m<sup>3</sup> micro polypropylene fibres (12/0.18 mm in length/diameter).
- 0.26 water-cement (w/c) ratio.
- 1% polycarboxylate – based superplasticiser and 0.5% retarder (amin –tris, citric acid and formaldehyde).

**Table 2:** Composition of high-performance concrete (HPC) in weight % (Le *et al.*, 2012)

Component	Composition (wt. %)
<b>Sand</b>	53.5
<b>Binder</b>	
Cement CEM I 52,5	25.0
Class F Fly Ash	7.1
Silica Fume	3.6
<b>Others</b>	
Water	9.3
Polypropylene	0.05
Superplasticiser	1.0
Retarder	0.5

### Recyclable waste materials

The use of recycled material as the primary material in 3DCP could be game-changing for the technology. This could drastically bring down the cost of materials used in 3DCP and make it very competitive in the industry.

#### 1. Copper tailings waste

During the process of purifying copper from the copper ore, solid waste material is left behind, referred to as copper tailing. The tailings are considered harmful to the ecological environment and are usually disposed of. Copper tailing could be used in 3DCP and possibly reduce the cost of material (Ma, Li, & Wang, 2018).

Ma *et al.* (2018) conducted experiments that replaced sand in six proportions from 0% to 50% with waste copper tailings. The findings were evaluated using important 3DCP properties; namely extrudability, buildability, flowability, open time, fresh and hardened properties.

The experiments showed that the optimum mix occurred when substitution of 30% of copper tailing was used. This displayed much higher mechanical properties and favourable buildability as illustrated in Figure 8 and Figure 9 (R30 sample) respectively, and that recyclable waste can be used in 3DCP materials and its applications.

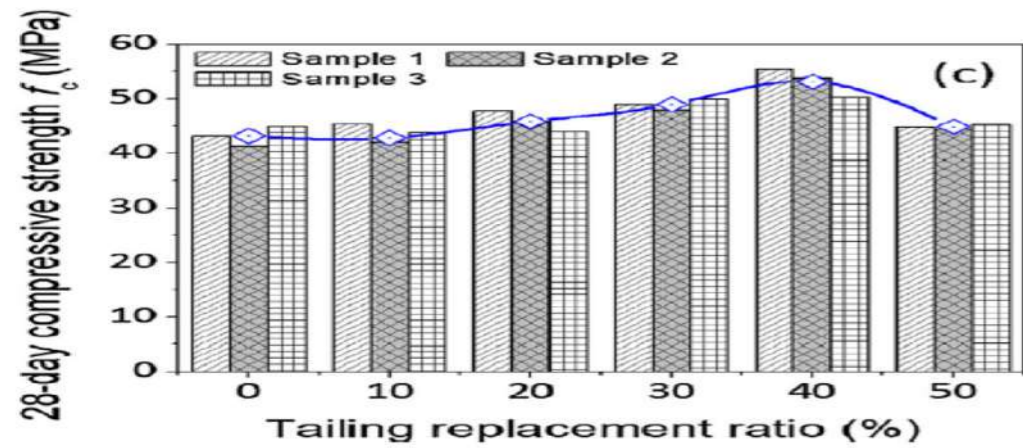


Figure 8: Compressive strength of specimens with different tailing contents at the age of 28 days.

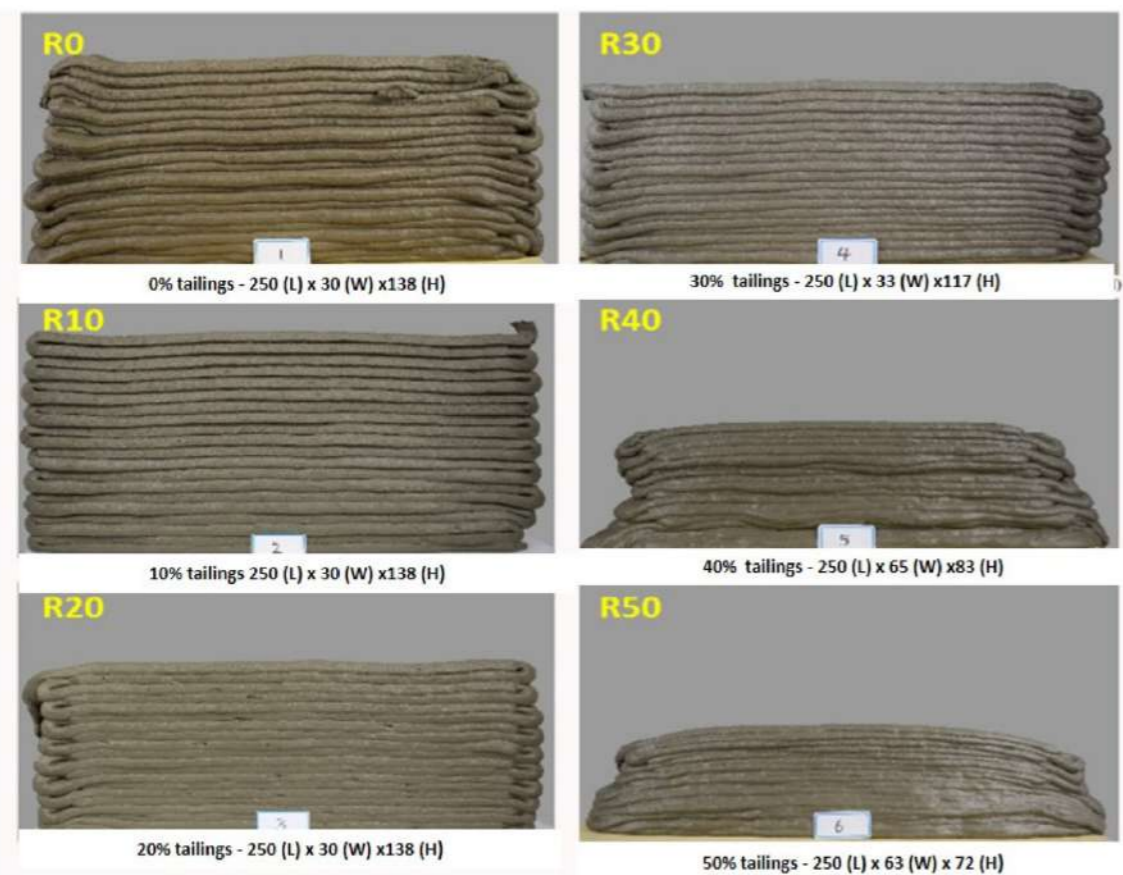


Figure 9: Images of structural build-up with 20 layers

## 2. Recycled glass

Glass can cause bad adverse effects on the environment, and its disposal after usage has been a global issue. Research was conducted to assess the impact of recycled glass on 3DCP material as a substitution fine aggregate in the mix. Previous research has been conducted to analyse the use of recycled glass on concrete. Although concrete with recycled material displays better flow properties, it has been shown that recycled glass has lower mechanical properties compared to sand (Ting, Tay, Qian & Tan, 2019). In the research, the river sand was replaced and compared with recycled glass.

The design mix contained cement, fly ash, silica fume, aggregate and water. The printing nozzle speed was 100 mm/s at a flow rate of 0.037 l/s and a layer printing height of 15 mm.

Table 3: Mix design of both mixtures

Cement to binder ratio	Fly Ash to binder ratio	Silica fume to binder ratio	Aggregate to binder ratio	Water to binder ratio
0.7	0.2	0.1	1.2	0.46

Previous research on 3DCP has shown that pumpability is related to dynamic yield strength and plastic viscosity. Figure 10 shows that the mix with sand has a higher dynamic yield strength and plastic viscosity. It also shows that the mix with recycled glass has a lower static inducing weaker buildability. However, Figure 11 shows that the mechanical properties of the glass mix are lower than that of river sand. The results indicate that the replacement of sand with glass did not show any helpful characteristics for 3DCP in the tests that were conducted.

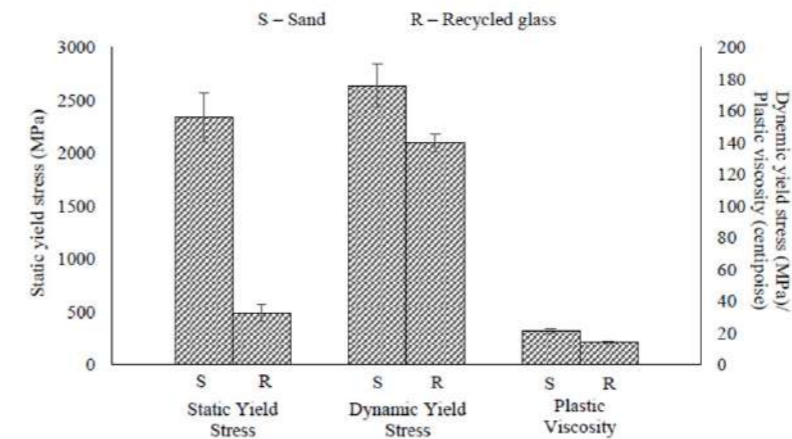


Figure 10: Rheological properties of mixes

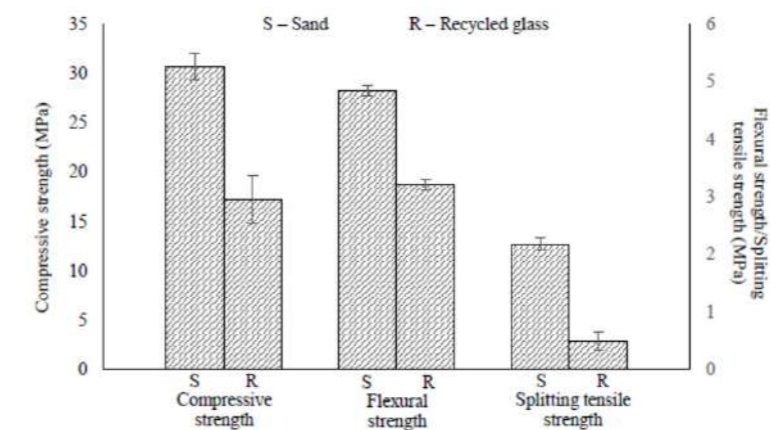


Figure 11: Mechanical properties of both material

Based on the literature review, it is evident that the 3DCP technology has developed over the years. End-users now have the option of a Gantry system and/or Robotic-arm supplied by companies such as Apis-Cor and COBOD. This has had a direct impact on the increase in the number of 3DCP projects in the world. In 2003, Prof. Khoshnevis, the inventor of Countour Crafting, was one of the few people who was involved in 3DCP. By 2016, more than 30 projects had been undertaken using 3DCP technology. Contributions made by Prof. Khoshnevis demonstrated to the world that 3DCP possesses the potential to revolutionise construction. Winsun, with its multi-storey project, showed that the technology could also be used in more complex structures. Both organisations demonstrated that research on material design is essential to make the technology economical and competitive as well as to highlight the need to develop building codes. Contributions by Le *et al.* (2012) helped lay a strong foundation for the understanding of the material design requirements for 3DCP which led to further research in various parts of the world. Research on the use of recycled waste has also been investigated. The use of copper tailing has yielded better mechanical properties and buildability when substitution of 30% of copper tailing was used to replace sand. Unfortunately, the use of recycled glass did not have the same effects. With all considered, it is evident that 3DCP has the potential to be a game-changer in the construction industry.

#### EXPERIMENTAL PROGRAMME AND METHOD

The experimental work was broken down into five phases. The first phase focused on available 3DCP and their categories. The second phase looked into the costs of 3DCP machines. The third phase assessed the material approach of the different technologies and material costs. The fourth compared the labour costs. The final phase compared the total cost of 3DCP technologies with the conventional method per square meter.

#### RESULTS

A standard low-income house plan was selected for this research. It is a 40  $m^2 m^2$  house with two bedrooms, a bathroom, a living area, and a kitchenette. It has a wall height of 2.4 m, a wall area of 92  $m^2 m^2$ , and a wall volume of 12  $m^3 m^3$ .

##### Cost of equipment

###### 1. Conventional building equipment

Brick and mortar construction is one of the most commonly used methods employed to build houses. The building equipment usually consists of a brick, a chisel, brushes, hammers, and spades (Diynetwork, 2018). The estimated cost of equipment is R 1500.00 which amounts to R 17 per square meter (Buildaid, 2019).

###### 2. 3D Concrete printing machines

The available gantry prices when this research was conducted were obtained from COBOD and Rudenko (Aniwa, 2020). The costs of the machines are shown in Table 4 which includes a 20% maintenance cost assuming the equipment will depreciate over 5 years. Of the four models, the most affordable is COBOD's BOD1 printer at a cost of R 2.76 million. This amounts to R 60 per square meter.

Table 4 : Commercial Gantry systems

COMPANY	PRODUCT	COSTS	BUILD AREA/VOLUME
COBOD	BOD 2	R 7,2 Million	9.6 x 7.1 x 3.1 m
	BOD 1	R 2,76 Million	6.7 x 7.5 x 5.1 m
Rudenko	LaByrinth	R 3,24 Million	+/- 5 x 3.5 x 2.5 m
	VenDell 2.1 C	R 7,56 Million	10 x 20 x 4m

Table 5 shows a summary of commercial robotic arm type systems supplied by CyBe and Apis Cor which includes 20% maintenance cost assuming the equipment will depreciate over 5 years. The most affordable of the printers is the CyBe's R 3DP at a cost of R 3.6 Million at R 80 per square meter.

Table 5: Robotic arm type systems

COMPANY	PRODUCT	COSTS	BUILD AREA/VOLUME	USE
1.CyBe	R 3DP	R 3,6 Million	250x 500x 300cm Reach: 265 – 350 cm	Fixed/Lab
	RC 3DP	R 4,32 Million	250 x 250 x 400 cm Reach: 265 – 350 cm	Mobile- Construction site
2.Apis Cor	Standard model	R 4,2 Million	Radius: 5.5 m Height: 3.2 m	Construction and Lab

##### Cost of materials

###### 1. Conventional building material

To assist with the material calculations, the company Cash Builder's calculator that is usually used by contractors to estimate material quantities were used for the brick and mortar method.

The total wall area of the house plan is 92  $m^2 m^2$  for a standard thick brick wall with 140 mm thick bricks and an approximate brick and mortar density of 2000  $kg/m^3 m^3$ . This will require 4 913 units of bricks, 850 kg of cement, and R 3057 kg of sand at a total mass of 25 760 kg. The total cost of the material for the wall is R 12 885 at a cost of R 140.00 per square meter assuming no wastage.

###### 2. 3DCP building materials

The only pre-packaged off the shelf material costs for robotic arm type systems that were available when this research was conducted was from Apis Cor called 3D INK (Apis cor, 2019). The mix proportion is shown in Table 6. It is also important to consider the proposed optimum design approach and recommendation by Apis Cor as shown in Figure 12. This is a guideline to achieve the same functional properties as conventional brick and mortar structures.

Based on the house plan dimensions, the wall area was calculated as 92  $m^2 m^2$ . According to Apis Cor, 1  $m^2 m^2$  of a wall area requires 250 kg of 3D INK. The cost of a 70 kg bag is estimated at R 2340 at 1:18 USD to the rand exchange



rate on the 18<sup>th</sup> of April 2020. A total of 23 000kg of material is required at a total cost of R 83 352 for R 906 per square meter.



Figure 12: Wall design using Apis Cor 3DCP (Apis-cor, 2019)

Table 6: Apis Cor's material composition per 1 metric ton (Apis-cor, 2019)

Material	Quantity	Price
Portland Cement	300 kg	Local price (Apply local price range)
Sand (dried)	630 kg	Local price (apply local price range)
Apis Cor pre-blended additives	70 kg	130 USD dollars + delivery

COBOD proposed an optimum mix proportion of material for their system as presented in Table 7. A calculator for material costing and estimations was also developed by COBOD. This is also based on the wall design with the objective to achieve the same functional properties as conventional brick and mortar structures based on wall area as illustrated in Figure 13. The calculator is based on the inputs outlined in Table 8. Only 8.3  $m^3m^3$  or 19 920 kg of material is required at a total cost of R 8 338 and R 108.00 per square meter as shown in Table 9.

Table 7: Mix design developed by COBOD

Material	Quantity (tons)	Percentage by weight
Cement	6,12	32%
0-2 mm sand	3,5	18%
0-4 mm gravel	3,5	18%
0-4 mm recycled roofing tiles	4,36	23%
Water	1,66	9%
Glenium sky 631 - Superplasticizer	0,04	0%
Crackstop fibers	0,02	0%
<b>Total</b>	<b>19</b>	<b>100%</b>

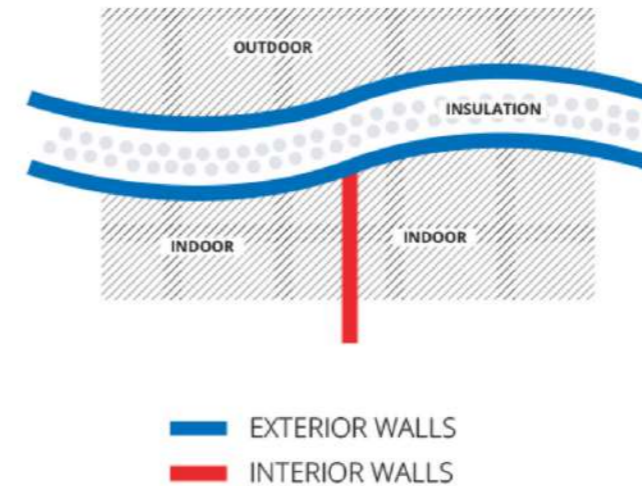


Figure 13: Optimum wall design using COBOD system

Table 8: Inputs required by COBOD cost estimator

INPUTS	ITEM	QUANTITY
BUILDING SPECIFICS	Total wall area $m^2m^2$	92
PRINT LAYER AND SPEED PARAMETER	Wall thickness (cm)	5
	Layer height (cm)	2
	Print speed (cm/s)	30
ECONOMIC INPUT	Price of material per $m^3m^3$	R1 000
	Number of operators	2
	Hourly labour rate	R32
SETUP TIME AND RISK FACTOR	Safety factor (percentage, %)	50
	Setup time of printer on site (h)	8
	Take down time of printer on site (h)	4
	Number of workers involved in setup/take down	2

**Table 9:** Output of COBOD cost estimator

OUTPUT	
ITEM	QUANTITY
Material printed per hour	1,08 $m^3m^3$ /h
Total material use	8,3 $m^3m^3$
Hours of print time theoretical	8 hours
Hours of print time needed	12 hours
<b>Labour cost</b>	<b>R 1632</b>
Total cost per m2 of wall	R 108
<b>Total cost of concrete</b>	<b>R 8 338</b>

**Labour costs**

**1. Conventional building material**

The bricklaying rate for walls is R 1 237.54 per 1000 bricks with 4 913 bricks required. The total labour cost is R 7 370.00 at R 81 per square meter. This typically takes two days (Buildaid, 2019).

**2. 3DCP building materials**

Based on the information provided Apis Cor, the machine has a printing speed of 1.5 metric ton per hour and requires 2 skilled workers to operate the machine. As discussed, 29 tons of material is required amounting to 15.5 hours to complete the project. At a skilled labour rate of R 31.25, the total cost is R 968.75 at R 11 per square meter.

The labour costs using a gantry system is captured in Table 9 and amounts to R 1632 at R 18 per square meter.

The overall results for 3DCP technologies and brick and mortar are presented in Table 10 below.

**Table 10:** Overall summary of results

Technology	Material required (kg)	Delivery time (h)	Material (costs/ $m^2$ )	Labour (costs/ $m^2$ )	Equipment/machine (costs/ $m^2m^2$ )	Total (costs/ $m^2m^2$ )
1. Brick and mortar	25 760	16	R 140	R 81	R 17	R 238
2. Robotic arm system	23 000	15.5	R 906	R 11	R 80	R 1000
3. Gantry System	19 920	12	R 108	R 18	R 60	R 186

**REVIEW OF FINDINGS**

Based on the results, 3DCP technologies require less material compared to brick and mortar. This is because 3DCP technologies have the advantage of geometric flexibility which allows for minimal material usage and achieving the same functional properties as brick and mortar.

The results also indicate that the Robotic arm system’s material costs more than the brick and mortar method and the gantry system approach. This is so because the robotic arm system uses a pre-packaged material that is customised and designed for their system only. The Robotic arm system has limited material flexibility.

The labour cost of brick and mortar is higher than that of the gantry system and robotic arm system. The advantage of 3DCP is that the process is largely automated and requires minimal labour. The delivery time for 3DCP is also shorter than that of brick and mortar.

It is also shown that the cost per square meter of equipment is higher for the 3DCP technologies, because of the high purchase price of the machines.

Finally, the overall costs indicate that the robotic arm system is the most expensive at R1 000 per square meter, the primary reason for this is the higher cost of the material that the system uses and the high cost of the machine. The second highest cost is the brick and mortar method at R 238 per square meter. The primary contributor for this is the higher labour costs as this approach is manual. The gantry system is shown to be the most cost-effective at R 169 per square meter. This is mainly attributed to the lowest material requirement and cost thereof, a shorter delivery time, and a more cost-effective machine cost compared to the robotic arm system.

**CONCLUSION**

This research investigated the prospects of 3D Printing of low-income houses in South Africa. With a backlog of more than 2.3 million houses, an urgent innovative housing solution is required as this is a basic right for every citizen. Innovative Building Technologies (IBTs) may present a solution to the housing problem facing South Africans. The challenges of IBTs are that they are often more expensive and are generally not socially accepted in communities. The 3D printing is a new and innovative building technology that has the advantage of automation that could potentially reduce costs in construction. The technology has developed significantly over the years and could be a game-changer in the construction industry.

Many companies have joined the race in the development of 3D concrete printing technologies over the years. Both gantry based systems and the robotic based system have been optimised to provide faster and more cost-effective solutions for the construction industry. Both of these systems have displayed advantages and disadvantages. The choice of the system is circumstantial and dependent on the objective.

In this study, a standard  $40m^2m^2$  RDP house plan was used and a comparison of using conventional brick, a gantry-based system, and a robotic arm type system was conducted with a focus on the cost of material, labour and equipment. The results indicate that the cost of 3DCP machines contributes significantly to the overall costs. It is also clear that a pre-packaged mix as endorsed by Apis Cor’s robotic arm type system is not competitive nor viable from a cost perspective. The results also show that a mixed design that uses locally (South Africa) sourced material used in the gantry system is a competitive option and more economical than brick and mortar.

Labour costs for brick and mortar are the highest. 3DCP uses an automated process that reduces the labour costs. The

results show that the COBOD gantry system is the most cost-effective from a labour cost perspective and has a shorter delivery time compared to brick and mortar and the robotic arm system. The possibility of making 3DCP even more viable is to be found in the use of recycled waste in the material. In research conducted using copper tailing waste in 3DCP material, the copper tailings replaced sand. The research showed that optimum substitution replacement is at 30%. At this percentage, the material displayed better mechanical properties and favourable buildability. In other research, recycled glass was used as a substitute for fine aggregate. In this research, it was concluded that the mix with the recycled glass had better flow properties. However, the mix with the glass displayed weaker buildability and lower mechanical properties.

3DCP technology is a relatively new technology, with the advantage of automation, minimal labour requirements, and its ability to build complex structures, which still makes 3DCP a technology that could disrupt the construction industry.

### Recommendations and the way forward

Several vital matters were recognised during this investigation. They were not addressed as this research had a particular focus. The following recommendations are therefore suggested for future work:

- A viable and competitive approach could be to have the option to hire 3DCP machines for this technology to be feasible in the industry as the capital cost is too high.
- An investigation into 3DCP pre-packaged commercial mixes would help accelerate the adoption of the technology and if it is competitive to use general-purpose cement.
- The life span of the machines should also be investigated to provide a clearer idea of the machines.
- The durability of 3DCP structures should also be investigated in future research.
- The development of building codes for 3DCP is important. This will lead to more practical problems and solutions.
- A multi-disciplinary approach is very important. The individuals involved should specifically have a strong background in mechanical engineering, electronic engineering, material science, and architecture.

### LIST OF REFERENCES

- ACI Committee 116. 2000. 116R-90: Cement and Concrete Terminology. *American Concrete Institute*, 58. [Online] Available from: [http://dl.mycivil.ir/dozanani/ACI/ACI\\_116R-00\\_Cement\\_and\\_Concrete\\_Terminology\\_MyCivil.ir.pdf](http://dl.mycivil.ir/dozanani/ACI/ACI_116R-00_Cement_and_Concrete_Terminology_MyCivil.ir.pdf) [Accessed: 15/01/20]
- Africa check. 2019. FACTSHEET: The housing situation in South Africa. *Africa Check*. [Online] Available from: <https://africacheck.org/factsheets/factsheet-the-housing-situation-in-south-africa/> [Accessed: 02/02/20].
- Aniwa. 2020. Ultimate guide to construction 3D printers in 2020. *Aniwa*. [Online] Available from: <https://www.aniwa.com/buyers-guide/3d-printers/house-3d-printer-construction/> [Accessed: 02/02/20].
- Apis-cor. 2019. 3D Printed Homes. *Apis Cor*. [Online] Available from: <https://www.apis-cor.com/> [Accessed:15/01/20].
- Attaran, M. 2017. The rise of 3-D printing: The advantages of additive manufacturing over traditional manufacturing. *Business Horizons*, 60(5):677–688. [Online] Available from: <https://doi.org/10.1016/j.bushor.2017.05.011> [Accessed: 12/02/20].
- Buildaid. 2019. Building and pricing guide. [Online] Available from: <https://www.buildaid.co.za/> [Accessed: 12/02/20].
- Buswell, R. A., Leal de Silva, W. R., Jones, S. Z., & Dirrenberger, J. 2018. 3D printing using concrete extrusion: A roadmap for research. *Cement and Concrete Research*, 112(June): 37–49. [Online] Available from: <https://doi.org/10.1016/j.cemconres.2018.05.006> [Accessed: 20/03/20].
- Cho, S., Kruger, J., Zeranka, S. & Zijl, G. Van. 2019. *3D Printable Concrete Technology and Mechanics*, 158(September):11–18. [Accessed: 20/03/20].
- Cobod. n.d. *BOD2 - Modular 3D Construction Printer available now*. [Online] Available from: <https://cobod.com/bod2/> [Accessed: 19 April 2020].
- Diynetwork. 2018. *How to Lay Brick | how-tos | DIY*. [Online] Available from: <https://www.diynetwork.com/how-to-skills-and-know-how/masonry-and-tiling/how-to-lay-brick>. [Accessed: 15/01/20].
- Khoshnevis, B. 2004. Automated construction by contour crafting - Related robotics and information technologies. *Automation in Construction*, 13(1):5–19. [Online] Available from: <https://doi.org/10.1016/j.autcon.2003.08.012>. [Accessed: 15/01/20].
- Le, T. T., Austin, S. A., Lim, S., Buswell, R. A., Law, R., Gibb, A. G. F., & Thorpe, T. 2012. Hardened properties of high-performance printing concrete. *Cement and Concrete Research*, 42(3):558–566. [Online] Available from: <https://doi.org/10.1016/j.cemconres.2011.12.003>. [Accessed: 20/02/20].
- Ma, G., Li, Z. & Wang, L. 2018. Printable properties of cementitious material containing copper tailings for extrusion based 3D printing. *Construction and Building Materials*, 613–627. [Online] Available from: <https://doi.org/10.1016/j.conbuildmat.2017.12.051>[Accessed: 16/12/19].
- Malaeb, Z., AlSakka, F. & Hamzeh, F. 2019. 3D Concrete Printing. In *3D Concrete Printing Technology*. Elsevier Inc. [Online] Available from: <https://doi.org/10.1016/b978-0-12-815481-6.00006-3> [Accessed: 10/02/20].
- Ting, G. H. A., Tay, Y. W. D., Qian, Y. & Tan, M. J. 2019. Utilization of recycled glass for 3D concrete printing: rheological and mechanical properties. *Journal of Material Cycles and Waste Management*, [Online] Available from: <https://doi.org/10.1007/s10163-019-00857-x> [Accessed: 10/03/20].
- Winsun. 2018. *Product Center-Yingchuang Building Technique (Shanghai) Co.Ltd. (WinSun)*. [Online] Available from: <http://www.winsun3d.com/En/Product/prolist/id/1> [Accessed: 10/03/20].

# DESIGN AND IMPLEMENTATION OF A TORQUE AUGMENTED MOBILITY AID

Sinetemba Hlungulu, Tshwane University of Technology, South Africa,nyokasinetemba@gmail.com

Nico Steyn, Tshwane University of Technology, South Africa,steynn@tut.ac.za

Djouani Karim, Tshwane University of Technology, South Africa,djouani@gmail.com

## Abstract

*This paper focuses on the modelling and design of an advanced torque controller that will be used on wheelchairs in an enabling environment. These mobility aid referred to in this study could be devices such as conventional wheelchairs. Mobility aid users often face a number of challenges in their everyday lives such as debilitations in both their upper and lower limbs. The focus of this paper will be on users with general debilitations in their upper body limbs specifically in their shoulders, arms and hands. The modelling and design of a torque controller will enable the interaction of the user and the mobility aid in predicting the user's intended progression. The dynamics from the modelling will indicate the necessary wheel to ground contact forces, in a differential manner, in order to cover the extent of user aid to be generated. The functions pertaining to this modelling and design will aid a person on a mobility device in the following areas angled trajectories and easy mobility aid movement. The wheelchair will use human torque that is delivered from the arms through push-rims with output torque of electrical motors. The torque-augmented wheelchairs will increase the driving torque, responding to the driving environment. It is important for the torque-augmenting devices to be able to sense or extract human input torque through sensors. However sensors can be expensive and heavy. Therefore unknown input observers will be used in this paper to estimate human force into the wheels that will be used for the torque assist control of the wheelchair.*

*In this paper, input torque from the user will be estimated and augmented accordingly responding to the driving environment. All proposed methods are demonstrated by simulation results from the MATLAB software.*

**Keywords:** Differential drive, Mobility aids, Augmented torque, unknown input observer

## INTRODUCTION

Mobility is one the most common human requirements. The wheelchair is a significant mobility aid available for both disabled and elderly people as it offers transportability to mobility impaired people. There are many kinds of wheelchairs that are used to minimize injury during propulsion and ease of maneuver(South African Statistics,2014).Over the years hybrid wheelchairs were manufactured to assist those that still have the ability to propel using their hands. This helps with reducing upper limb pain from the user while proving rehabilitation to the user. Hybrid wheelchairs augment the torque input of the user to help reduce muscle strain on his/her hands. Power assisted wheelchairs were designed to combat the problem stated above as they allow the user to participate in the wheel propulsion. The wheelchair will have two dc motors installed to each of its wheels together with sensors to detect the intended human input. The system will employ human in the loop control as the human torque input will be augmented by the controller for torque assistance. The assist will lighten the burden on the user's upper limbs by providing assistance. The paper will focus on the

observation of both the human input and driving environment to provide a comfortable safe wheelchair propulsion. A feedback system has to be designed to combat the driving on the slope conditions driving on uneven surfaces. The controller must consider reducing the assist torque when the wheelchair is on a downward slope to avoid tipping over of the user and increase augmented torque when driving up the slope to provide more assistance(Hou, R., Shi, X. & Krishnamurthy, M:2012). On a downward slope the controller should decrease the acceleration due to gravity to avoid endangering the user. Therefore before the controller can augment the input torque, it is important for us to know the conditions or environment under which the wheelchair is driven on. Advantages of a torque augmented wheelchair include weighing less, easy control and rehabilitation.

Previous studies have been conducted relating to torque augmentation. A novel drivetrain power assisted wheelchair was developed to match and exceed the conventional wheelchair's performance but with a more intelligent and lower cost design. Instead of using a torque sensor or pressure transducers for measuring and amplifying human force, the proposed drive train controller uses infrared sensors to trigger two Brushless DC hub motors. Using this information in addition to the information from a motion sensor that detects the road conditions, appropriate torque command is generated. The whole drive train system's power is supplied by a Li-battery package. One wheelchair prototype has been built, and conceptual designs are modeled and simulated in MATLAB/Simulink (Hou,R.,Shi, X. & Krishnamurthy, M:2012). The proposed novel drivetrain control strategy essentially includes three main control methods. The use of motion sensor that detects the road angle variation at pitch and roll axes in order to update torque command for either one motor or both motors, is called Environmental Adaptive control (EAC). The novel Push-Go control strategy is to control the motor with human motion feedback generated by infrared sensor. It triggers the motor when pulse is on and shuts down the motor when pulse is off. These two novel control strategies, combined with fundamental six-step motor control strategy, forms the control strategy for the wheelchair. Hall sensors are the essential sensors used to drive motors and provide the actual speed feedback from motors to the digital controller.

This paper will demonstrate the wheelchair and user on it and dc motors for the torque augmented wheelchair. The physical wheelchair system and the lab simulation is described under the methodology. The outcomes of the experiment will be discussed and analysed under the conclusion. Section of the paper.

## METHODOLOGY

### Wheelchair Hardware

The augmented torque wheelchair lightens the burden on the user's upper limbs by providing assistance while encouraging involvement in the propelling of the wheelchair. For this paper, two in-hub motors are attached to each wheel. The physical system includes current sensors to measure the current drawn by the two motors as the wheelchair propels. Sensors such as the gyroscope and encoders will be used to measure the pitch angle and rotational angle of the wheel. An accelerometer is also used to measure the gravitational acceleration especially on slopes. This helps the system to detect whether the wheelchair is driving up or down the slope so that correct control measures can be applied to prevent the wheelchair from over accelerating an tipping over when driving down slope. On the other hand, for the augmented torque to increment as the wheelchair drives uphill. The hardware overall system is shown in Figure 1 below.

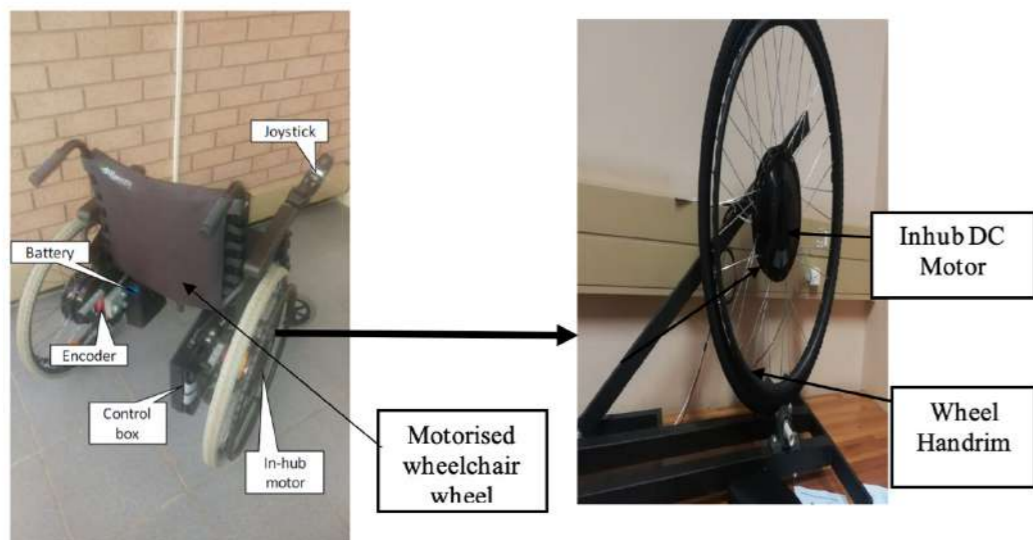


Figure 1: Wheelchair hardware

The BLDC inhub motors are the most important components of the augmented system. They offer assistance torque both in driving and braking modes at all speeds, with the widest possible operating speed range, both forward and reverse direction using the given battery. The detailed information on other components is as following:

Two inhub 180 W electric motors are used for the driving purposes of the mobility aid. Two brushless DC motors are used in the design. BLDC motors are inexpensive and easy to control. Brushless motors are used instead of brush DC motors because they are easy to clean and have less friction during motor braking periods. BLDC have high efficiency and compared to brush motors as some losses occur during the friction of the commutator of the motor and the brushes. BLDC motors have a lot of advantages over many other motors. They have more torque per weight, higher torque per watt, reduced noise, longer lifetime, maintenance free operation. The maximum power that can be applied to a BLDC motor is very high and can only be limited by heat that weakens the magnets. Custom built rotary encoders with magnetic strip were used for speed measurement. The encoders are attached to the in hub dc motors. A 24V lithium battery for this system has been used and a MyRio controller from National Instruments.

### Wheelchair, User and Motor Model

Motion equations of a wheelchair are roughly derived from a wheeled pendulum motion equations as they resemble a similar system. The wheelchair system consists of a wheelchair and a user and two dc motors in each rear wheel. That is the similar system as an inverted pendulum (Oh, S. & Hori, Y:2014).

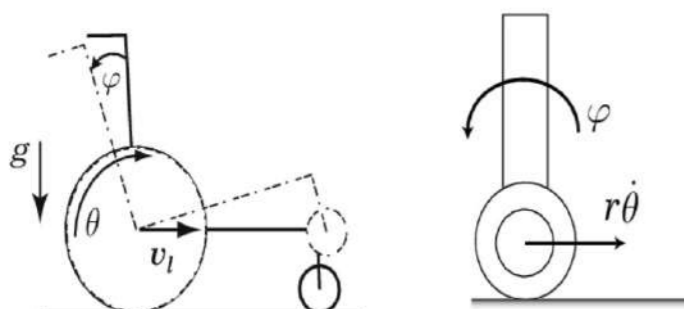


Figure 2: Wheeled inverted pendulum

Figure 2 is used for modelling the wheelchair.  $\theta$  is the rotation angle of each wheel,  $\phi$  is the inclination angle from the vertical axis and is used as the pendulum angle in the study.  $\psi$  is the body angle not the center of gravity angle from the horizon. And  $\psi$  is the body yaw angle. The pitch and wheel (roll) can be described using the following motion equations using Euler Lagrange Differential equations. The wheel angle will be used to calculate the wheel velocity ( $\dot{\theta}$ ) and the pendulum angle will give us a clear estimation of the wheelchair's driving environment. [2]

$$\begin{aligned} \frac{d}{dt} \left( \frac{\partial L}{\partial \dot{\theta}} \right) - \frac{\partial L}{\partial \theta} &= F_{\theta} \\ \frac{d}{dt} \left( \frac{\partial L}{\partial \dot{\phi}} \right) - \frac{\partial L}{\partial \phi} &= F_{\phi} \\ \frac{d}{dt} \left( \frac{\partial L}{\partial \dot{\psi}} \right) - \frac{\partial L}{\partial \psi} &= F_{\psi} \end{aligned} \quad (1)$$

The equations are derived from the detailed wheel model below.

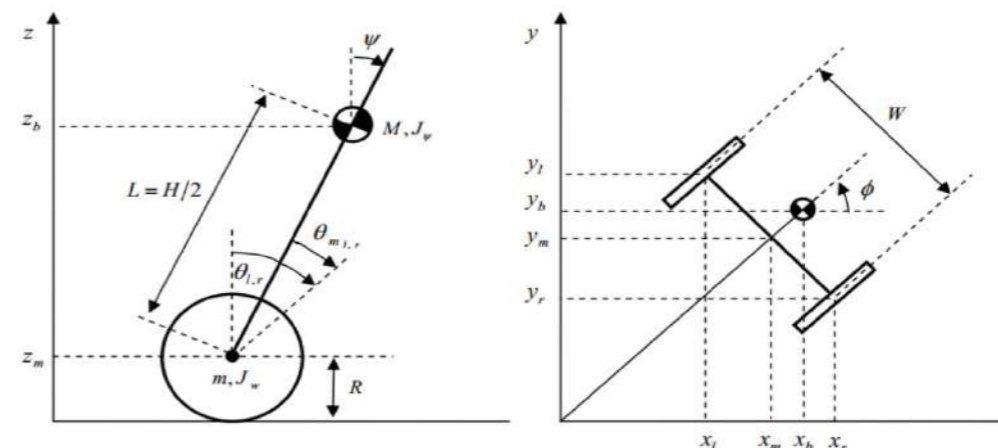


Figure 3: Wheel model parameters

Table 1 Wheel, Motor and User physical parameters

Parameter	Unit	Description
$g = 9.81$	$m/s^2$	Gravity acceleration
$m = 4$	$kg$	Wheel weight
$R = 0.6$	$m$	Wheel Radius
$J_w = mR^2/2$	$kg.m^2$	Wheel inertia moment
$M = 90$	$kg$	Body mass
$l = 0.65$	$m$	Distance of the center of the mass of the wheel axle
$H = 0.91$	$m$	Distance of the center of the mass of the wheel axle
$W = 0.6$	$m$	Distance of the center of the mass of the wheel axle
$J_{\psi} = 0.5$	$kg.m^2$	Body yaw inertia moment
$J_m = 10 \times 10^{-5}$	$kg.m^2$	Body yaw inertia moment
$R_m = 6.69$	$\Omega$	DC motor resistance
$K_b = 0.468$	$Vsec/rad$	DC motor back EMF constant
$K_t = 0.468$	$Nm/$	DC motor torque constant
$f_m = 0.022$		Friction coefficient between the body and dc motor
$f_w = 0$		Friction coefficient between the wheel and ground

The following equations are derived by evaluating the Lagrange equations in equation (1) to (3).

$$F_\theta = \{(M + 2m)r^2 + 2J_w + 2J_m\}\ddot{\theta} + (mlr\cos\varphi - 2J_m)\ddot{\varphi} - mlr\varphi^2\sin\varphi \quad (1)$$

$$F_\varphi = (2J_m + J_\varphi + ml^2)\ddot{\varphi} + (mlr\cos\varphi - 2J_m)\ddot{\theta} - mgl\sin\varphi - ml^2\dot{\varphi}^2\sin\varphi\cos\varphi \quad (2)$$

$$F_\phi = \left[ \left( 0.5mD^2 + J_\phi + \frac{D^2}{2r^2}(J_w + 2J_m) \right) + Mr^2\sin^2\varphi \right] \ddot{\phi} + 2[ML^2\varphi\dot{\phi}\sin\varphi\cos\varphi]\dot{\phi} \quad (3)$$

$\tau_\theta$ ,  $F_\theta F_\theta$  and  $F_\varphi F_\varphi$  are input forces from the user to the pitch angle and body angle. This torque is the user's torque to the wheelchair. The rest of the other parameters of the model are described in Table 1.

As it is difficult to control nonlinear systems, approximate linearization is used for the model. For approximate linearization, the pendulum angle is assumed to be 0 rads as the inverted arm of the pendulum is stationary at the upright position. Linearization of the system allows the system to be easily controlled. The wheel parameters are extracted from Table 1.

$$\cos\varphi \simeq 1, \sin\varphi \simeq \varphi, \dot{\varphi}^2 \ll 1$$

The pendulum linear angle is applied to equations (4) to (6). Equations (7) to (9) will be the new equations of motion.

$$F_\theta = \{(M + 2m)r^2 + 2J_w + 2J_m\}\ddot{\theta} - (mlr - 2J_m)\ddot{\varphi} \quad (7)$$

$$F_\varphi = (2J_m + J_\varphi + ml^2)\ddot{\varphi} - (mlr - 2J_m)\ddot{\theta} - mgl\varphi \quad (8)$$

$$F_\phi = \left[ \left( 0.5mW^2 + J_\phi + \frac{W^2}{2r^2}(J_w + 2J_m) \right) \right] \ddot{\phi} \quad (9)$$

Combining equations (7) to (9), an integrated wheelchair model is obtained.

An observer estimates the state of the wheelchair. It is made up of the real plant simulation, driven by the same input as the plant, in this study that is the human torque exerted on the wheels. The correction term is derived from the difference between the actual output of the plant and the estimated output. [2]

$\hat{x}$  is the estimated state vector of the observer and is calculated as equation (6) and (7).

Considering the system we are controlling, the estimated variables are defined as following variables. Equation 6 to (9) can be expressed in the following state matrix.

### Inputs

User torque input on the left and right hand side

$$u = \begin{bmatrix} \tau_r \\ \tau_l \end{bmatrix} \quad \dot{x} = Ax + Bu \quad (10)$$

$$\dot{x}_1 = [\theta \ \varphi \ \dot{\theta} \ \dot{\varphi}]^T, \dot{x}_2 = [\phi \ \dot{\phi}]^T \quad (11)$$

$\tau_i$  is the user torque to the wheel together with the assistive torques from the electrical motors. This torque will be estimated using a disturbance observer or it can be measured by a torsion sensor that is fitted on the wheel. When finalizing the model, the dc motor equations must also be included in as it is part of the simulation.

$$\alpha = \frac{K_t}{R_m} \alpha = \frac{K_t}{R_m} \text{ and } \alpha = \frac{K_t K_b}{R_m} + f_m \quad (12)$$

One of the methods used for stabilization of wheeled systems like wheelchairs is the PID control method or the LQR optimal control. Both methods are discussed in this section and utilized in the simulation of the overall augmented mobility aid system.

The PID controller bring the wheeled system to equilibrium until a desired position is reached. Here, two PID controllers are used. One PID is used to control and regulate the pitch angle of the wheelchair and the PID 2 is used to regulate the wheel angle. The PID controller equation is given as:

$$u_\theta = K_p \cdot e_\theta(t) + K_i \int e_\theta(t) dt + K_d \frac{d \int e_\theta(t)}{dt} \quad (13)$$

$$u_\varphi = K_p \cdot e_\varphi(t) + K_i \int e_\varphi(t) dt + K_d \frac{d \int e_\varphi(t)}{dt} \quad (14)$$

Here,  $e_\theta$  represents the wheel angle error,  $e_\varphi$  represents the pitch angle error.  $u_\theta$  represents the wheel control signal and  $u_\varphi$  represents the pitch angle control signal. The reference angles are 0 rad/s. The parameters of the controller found through trial and error method. The system using PID controllers is simulated in Matlab.

$$\text{PID 1: } K_p=140 \quad K_i = 5 \quad K_d = 2$$

$$\text{PID 2: } K_p=55 \quad K_i = 0 \quad K_d = 2$$

### Torque Augment Design And Attinuation

It has been seen that when a wheelchair either goes uphill or travels across a path that has a left/right slope, the user typically is required to apply additional strength in order to keep going forward. This could cause serious discomfort to the user due to such environment variations. This approach combining the estimated pitch angle with motor drive has been named the Environmental Adaptive control strategy. The torque is augmented as the pitch angle changes. Using the wheelchair coordinates. The simulations for the change in angles in performed by Matlab . The overall control strategy is shown in Figure 4 .

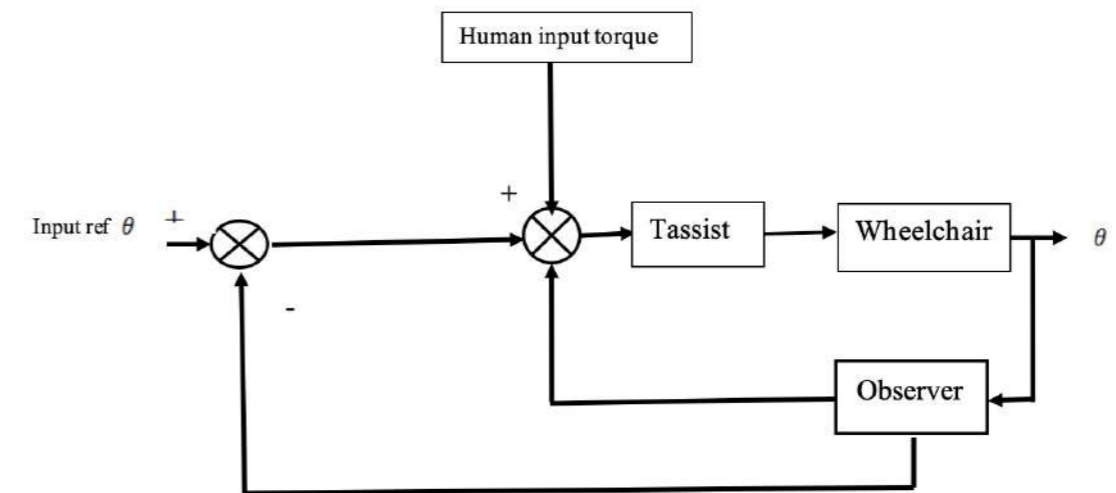


Figure 4: Torque Augmentation Control Strategy

The torque augmentation amplified the user's, annual input from the push rims with first order delay. The equation of power assistance is given by:

$$T_{assist} = \frac{\alpha}{\tau s + 1} T_{human}$$

Where  $\alpha$  is the assistance ratio.  $T_{assist}$  is the amplified torque from  $T_{human}$ .  $\tau$  is the time constant of the first order delay. The controller behaves as there is a change in the wheel angle. The assisting torque decreases and the wheel angle decreases. The power assistance ratio is adjusted as following.

$$\alpha = \alpha_{max} \exp\left(\beta \frac{\omega}{\theta}\right)$$

Where  $\beta$  is the decreasing constant which decides a speed of decreasing power assistance ratio.  $\frac{\omega}{\theta}$  implies the slope from origin, the larger the value the larger the assistance ration for the driving environment. The basic principle of the Environmental Adaptive control strategy is to control the motor with the angle feedback generated by the motion sensor and update the electric torque based on different road angles automatically.

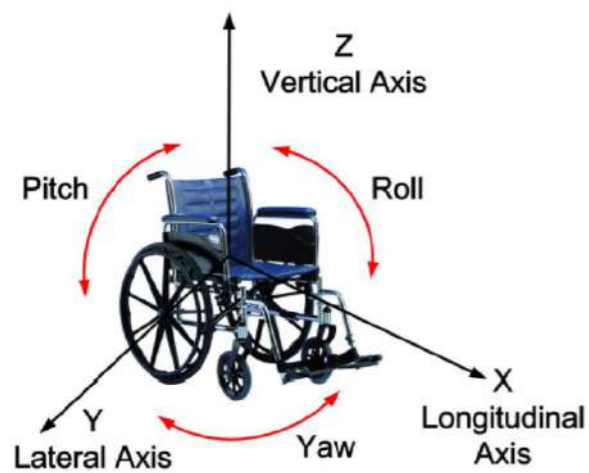


Figure 5: Pitch and Yaw of the wheelchair

This concept can be explained better with reference to the wheelchair in the three coordinate axes. In Figure 5, the X represents the longitudinal axis, the Y represents the lateral axis and Z is the vertical axis. Once the wheelchair goes uphill or downhill, the angle at Roll Plane is changed; once the wheelchair turns left or right, the angle at Yaw Plane is changed; and once the wheelchair is left-leaning or right leaning, the angle at Pitch is varied (Hou, R:2012). The Roll control principle is illustrated as that whenever the wheelchair goes uphill or downhill, the angle of the wheelchair changes along the roll plane. Using this information, the assisted electric torque is increased as the angle increases (uphill) or shuts down motors as the angle decreases (downhill). The Pitch control principle is shown as following, once the wheelchair on the road where has a leaning slope (the angle of the wheelchair changes along the pitch plane. In this situation, the left motor's assisted electric torque is increased if it's a left-leaning slope, and vice versa. Thus, under different road conditions, the wheelchair user can continue going straight with not much fluctuation in applied muscle strength.

## RESULTS

The simulation results show the wheelchair speed and pitch angle. The red line represents the low pass filtered differential output of the encoder. The value is very noisy while the estimation of the proposed observer is fast and not noisy. The gyroscope output (red line in Figure 6) is the estimated pitch angle and the green line shows the noisy observed measurement. The output had to be integrated for better experimental results. The states of the wheelchair

are identified using the estimated values and this information helped with the control of the inclination angle to help us identify the driving environment.

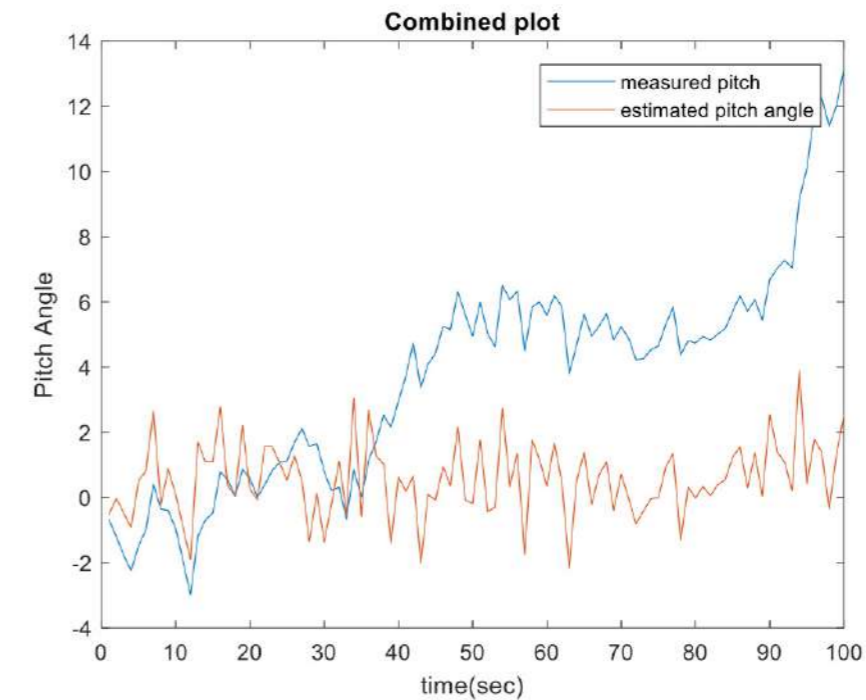


Figure 6: Observed pitch angle

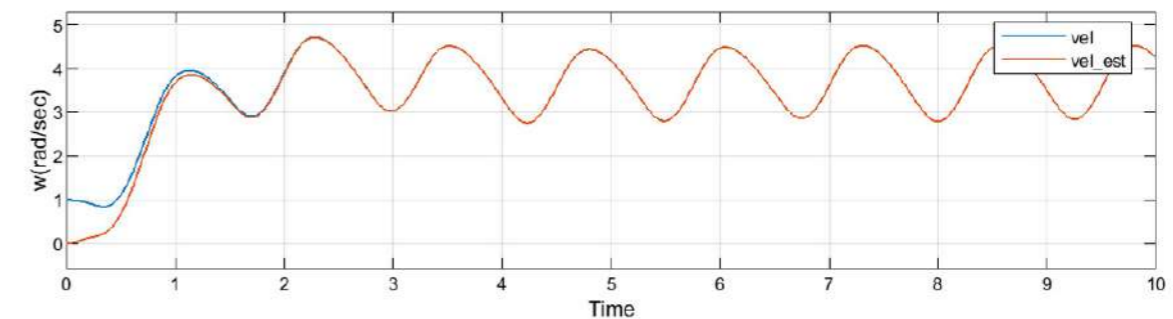
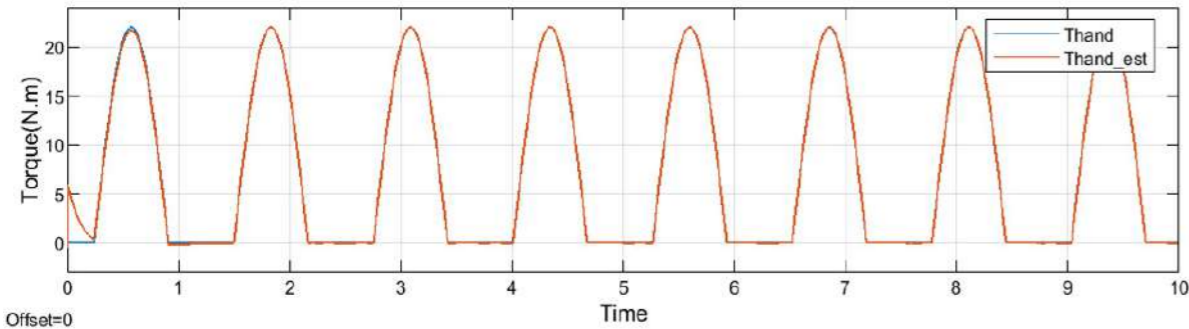


Figure 7: Observed velocity on level ground

Figure 7 shows the velocity of the wheelchair as the wheelchair is propelled by the user. While Figure 8 is the user's torque from the simulation results.



**Figure 8:** User input simulated torque

Motion control of the assistive system is based purely on the control of the speed of the Dc motors. The assistance ratio or gain are designed for every driving environment. The experimental setup by the lab controls the speed of the motors using a PWM and a MyRio controller, which is fed by the encoders and current sensors. The whole system is a closed loop system that feeds back to the system and modify the output as per the user's torque requirements.

## DISCUSSION

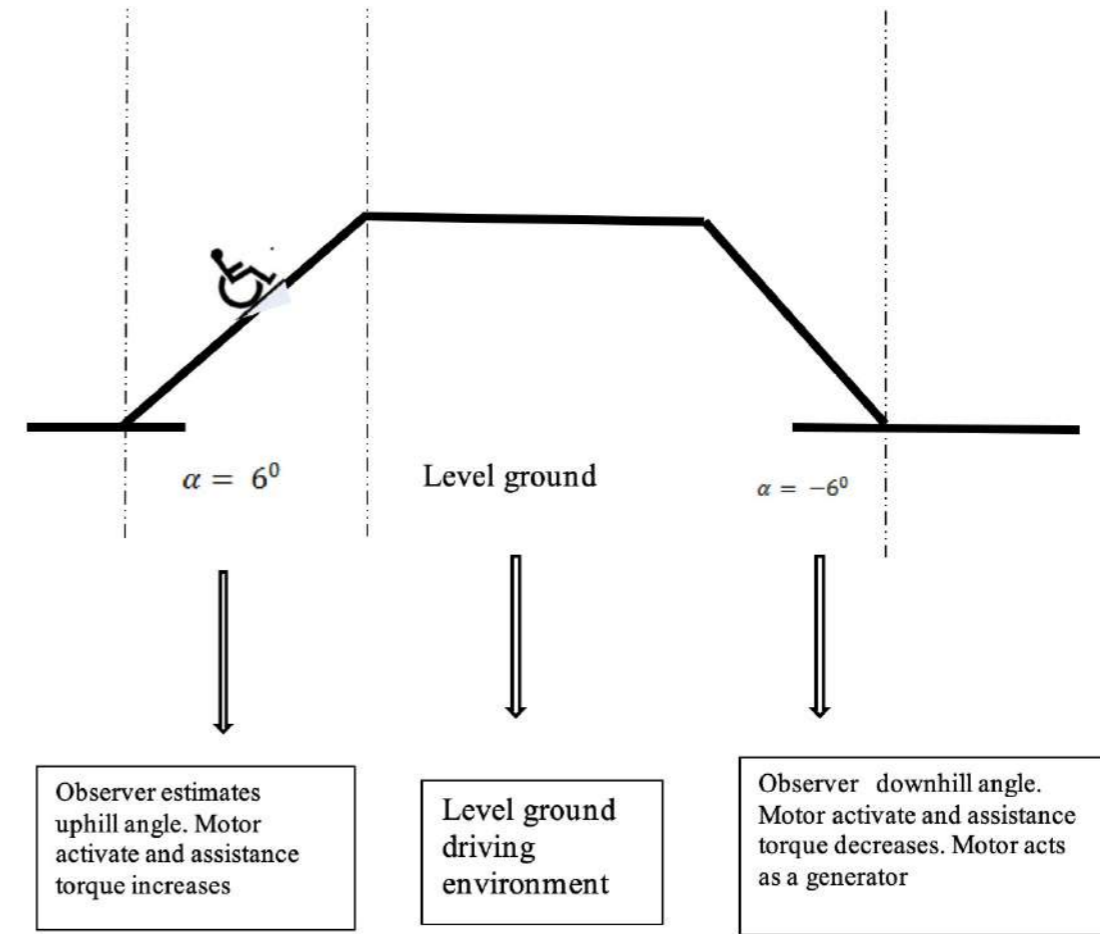
State estimation for the wheelchair human input, wheel velocities and pitch angle was performed using simulations. It is noticeable that from the observer had three outputs. The kalman filter gain theorem was used to calculate the observer gain. The kalman filter used sensor fusion with noise covariance matrix as an adjustable parameter. The noise covariance matrix for the determination of the gain was as follows:

$$Q_x = \text{diag}(Q_{wp}, Q_{wf}, Q_{\theta f}, Q_{\theta f}, Q_{\tau h}, Q_{\tau p}) \quad (15)$$

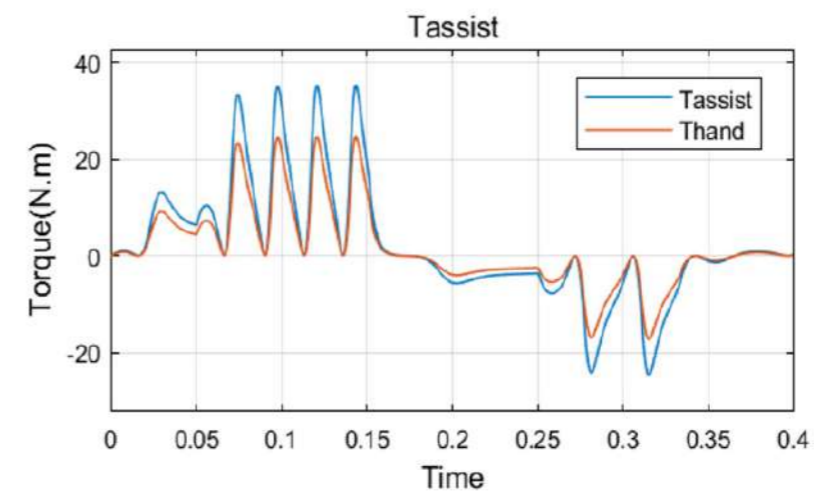
$$R_y = \text{diag}(R_{gyro}, R_{enc}, R_{acc}) \quad (16)$$

The estimated encoder outputs were differentiated and the gyroscope output was integrated. The simulation results show the wheelchair speed and pitch angle. The red line represents the low pass filtered differential output of the encoder.

While Figure 10 demonstrates the augmented torque under various driving conditions in Figure 9. From 0s to 0.008 the wheelchair is on a level ground, minimal augmented toque is required. Under the same drive, the wheelchair approached a slope as per the simulation between 0.09s to 0.16s. More toque is required to propel the wheelchair up the slope therefore more torque augmentation is required to offer more assistance. From 0.25s to 0.35 the wheelchair is driving downwards on the slope, the wheelchair is decelerating and the BLDC motor is acting as a generator. This helps avoid tipping over of the wheelchair.



**Figure 9:** Wheelchair driving environment



**Figure 10:** Augmented torque and user torque in different driving conditions



---

## CONCLUSION

In this paper a wheelchair model with a human riding on it was proposed together with its torque augmentation control algorithm. The wheelchair dynamics were derived for each wheel using an inverted pendulum model. The dynamics were derived on the basis of the Lagrangian method. The linear quadratic regulator was used for the observer design. The paper emphasized on graphical report of the results from both the observer and overall augmented system of the wheelchair system. The results for the wheelchair driving in different driving environments were discussed. All experiments were implemented using Simulink/Matlab simulations. The results focused more on the torque generated by the augmented system.

---

## LIST OF REFERENCES

- Census 2011: Profile of persons with disabilities in South Africa, Statistics South Africa Africa, S. S. and P. Lehohla (2014).
- Samar Mohammed, Juan C. Moreno, Intelligent Assistive Robots for: Recent Advances for everyday, 3rd ed., vol. 2. Oxford: Clarendon, 2009, pp.339–359.
- Sehoon Oh, Yoichi Hori, “Disturbance attenuation control for power assisted wheelchair operation on slopes”, IEEE Transactions on control systems technology, Vol.22, No 3, May 2014.
- Oh, S., Control developments for wheelchairs in slope environments. Proceedings of the 2005, American Control Conference, 2005., IEEE.
- Design and implementation of a novel drivetrain for a wheelchair; Ruoyu Hou, Xiaodong Shi and Mahesh Krishnamurthy, 978-1-4673-1408-4/12©2012 IEEE.

# HADOOP CLUSTER USING RASPBERRY PI

Anthony Adedoyin, Jesse Bemley Bowie State University, United States, Adedoyin.anthony@gmail.com

## Abstract

A Hadoop Cluster is a type of computational cluster that runs a medium-to-large scale analysis designed specifically for storing and analysing huge amounts of unstructured data in an environment of servers that work simultaneously. Consisting of three types of nodes (master, data, client), they all work together to store data in the Hadoop Distributed File System (HDFS) while running the data using MapReduce. Raspberry Pi is a low cost, credit card-sized computer that plugs into a monitor or TV and uses a keyboard and mouse. Combining this with the open-source Hadoop environment, makes it affordable to work with big data. The creation and focus thereof are designed to verify the clusters' computational and distribution power.

**Keywords:** Hadoop cluster, big data, Raspberry Pi, HDFS, MapReduce

## INTRODUCTION

“Big Data” a common buzzword used today to describe a large volume of data, both structured and unstructured, has grown into the day-to-day analytics of multiple businesses. Much so, businesses had to create “Big Data” positions for insight into how to make better decisions and strategic business moves based on user data. “Using big data, Netflix saves \$1 billion per year on customer retention... back in 2009 Netflix invested \$1 million in enhancing their recommendation algorithm” (Petrov 2019). However, the key question surrounding “Big Data” should be, “Where is this data held?” Business spends thousands of dollars on servers to hold this information or invest in a cloud environment to save some money on hardware purchases, still paying monthly for these services and maintenance upkeep. However, there is another way in which a business could enjoy the same processing power and speed of their data, but in a low-cost way, that is, by creating a Hadoop Cluster using Raspberry Pi.

## WHAT IS A HADOOP CLUSTER?

A Hadoop cluster uses the Hadoop software library framework and groups together independent computers, connecting them through a dedicated Local Area Network (LAN). These machines work together as a single centralised data centre designed to store, optimise, and analyse large amounts of data. This data is distributed across all the computers and work together to process that data, which could be structured, semi-structured, or unstructured. Hadoop itself is designed to detect and handle failures at the application layer of the Open Systems Interconnection (OSI) model, to deliver a high availability of storage and computation. Hadoop clusters are also known as shared-nothing systems because nothing is shared between the cluster computers but only the network, which decreases the delay of processing data.

## COMPONENTS OF HADOOP CLUSTER

A Hadoop cluster is divided into different parts and components in order to function. Therefore, Hadoop clusters are quite flexible. This makes it easy to add to or subtract from the architecture when necessary. The main components of the Hadoop Cluster are the data storage, Hadoop Distributed File System (HDFS), and data processing, MapReduce.

HDFS is a distributed file system designed to run on commodity hardware. It has many similarities with existing distributed

file systems. However, the differences from other distributed file systems are significant. HDFS is highly fault-tolerant and is designed to be deployed on low-cost hardware. HDFS provides high throughput access to application data and is suitable for applications that have large data sets. Files are split into blocks, with a size of 64MB, and are sent to the data nodes in the cluster.

MapReduce is a software framework used for distributing and processing large amounts of data. The algorithm, written in Java, is set to split the data and convert it into another set of data, broken into key/value pairs; This is the map phase. The reduce phase takes the output from the map tasks, as an input, makes it into a smaller set of data, and save it to the file system. The Framework manages the appropriate place where the data will be sent in the cluster.

Within the Hadoop Cluster, there are two components: the Master Node and Client Node. The Master Node is responsible for storing data in HDFS, assigning the tasks to the client node, executing parallel computations on the stored data using MapReduce and guide the client node to perform tasks. The Client Node stores the data and preforms computations, usually communicating with the Master Node to report any issues and the status of the stored data.

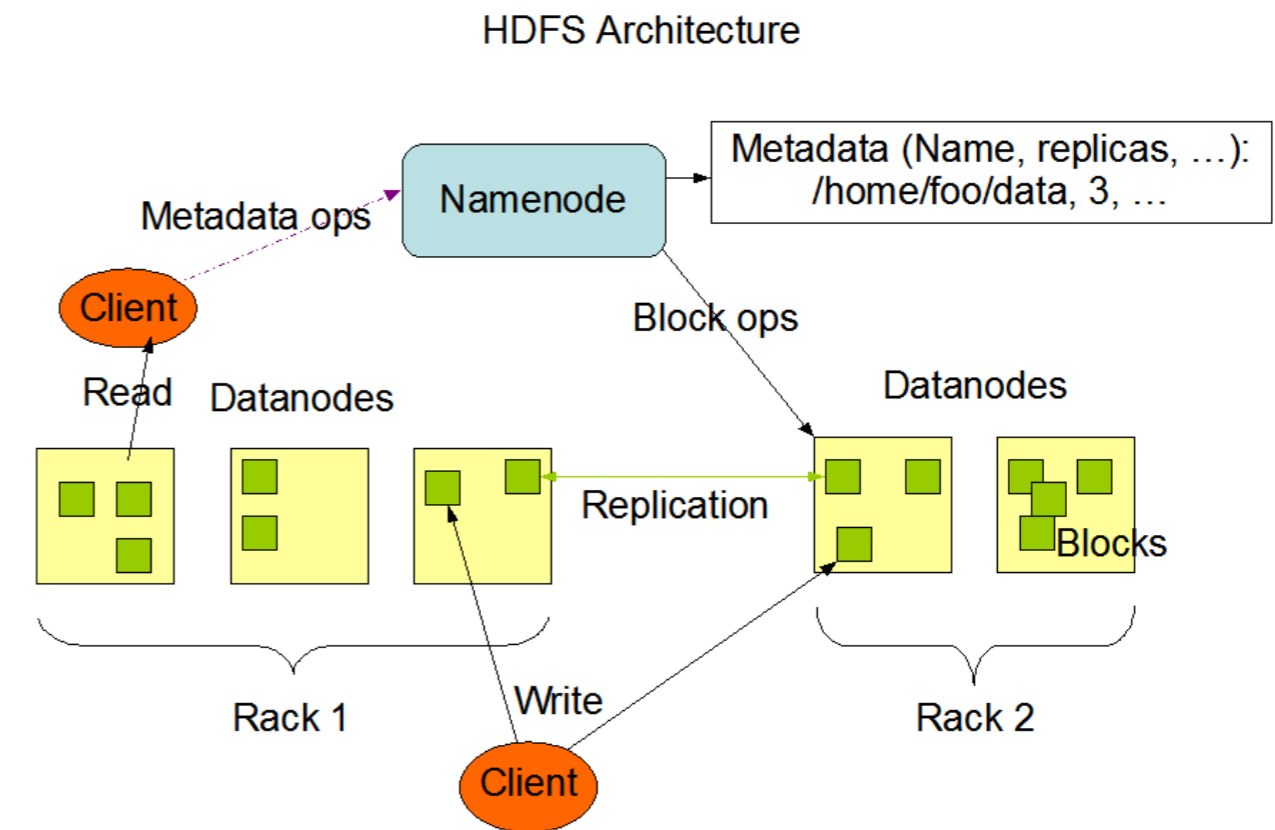


Figure 1: This is how the HDFS Architecture works

The architecture of Hadoop contains five different services that run in the background (daemon). NameNode, Secondary NameNode, and Job Tracker are done in the Master Node, while the DataNode and TaskTracker are installed and perform on each Client Node. NameNode is responsible for maintaining and managing the DataNode, managing the HDFS file system on the cluster, storing the metadata about the blocks of a file, and executing the filesystem namespace operations. Secondary NameNode checks/updates. In the event that the NameNode fails it can be restarted without the need to restart the data nodes. The JobTracker manages MapReduce jobs and distributes them to the nodes in the cluster. The DataNode is responsible for NDFS file storage. Block creation, deletion, and replication are included in the jobs given from the NameNode. TaskTracker runs MapReduce jobs which are received from the JobTracker. This will try to use local data as much as possible, not having to cause any network traffic. Knowing this, the Master and Client Nodes simultaneously work together to store data in a cluster.

## WHY A HADOOP CLUSTER?

As data grows exponentially, parallel processing capabilities of a Hadoop cluster help to increase the speed of the analysis process. Hadoop, theoretically, has unlimited scalability and in the event that processing power becomes inadequate, the Hadoop cluster can be scaled to keep up with the speed of analysis by adding additional nodes. Doing this will not compromise the data or integrity of the cluster.

Hadoop clusters are resilient to failure. Whenever data are sent to a particular node for analysis, it is also replicated to other nodes on the Hadoop cluster. If the node fails, whether the data are structured, semi-structured, or unstructured, the replicated copy of the data present on the other node in the cluster can be used for analysis. The mapping capabilities of the Hadoop Cluster allow for large amounts of data to be processed within a fraction of a second and combine that with the Data Replication on every client

Every node is a backup storage unit, making data loss impossible.

Yahoo began to use Hunk, the Hadoop tool from Splunk, a data analytics company, in 2015. By analysing its IT operation in real time, the firm has saved millions in hardware costs in a year. This information is used to optimise IT operations, applications delivery and security, as well as business analytics to better understand the customer and personalise search results (Carey, 2017).

## WHY RASPBERRY PI?

A Raspberry Pi is a low cost, credit card-sized computer that plugs into a monitor or TV and uses a keyboard and mouse. Costing about \$35, the Raspberry Pi is a powerful and more versatile computer than most of its competitors. It contains a processor, memory, and graphics processors. The 3 B+ model has built in Wi-Fi, Bluetooth, and ethernet. The operating system (OS) that a Raspberry Pi runs is Raspbian, the Debian Linux fork. With a large community, multiple forums, and thousands of accessories and tools, there are numerous online resources available to answer any questions that may occur or any problems that a user may encounter with the Raspberry Pi. Creating a cluster with the Raspberry Pi 3B+ model the size of a credit card, the average power consumption is about 5 to 7 W and the power usage from a machine using an Intel i5 Core Processor ranges from 73 to 95 W. Making a Raspberry Pi more environmentally friendly than traditional computers. With each Raspberry Pi costing about \$35, configuring it and adding it to the existing cluster will not be a problem. Once the network configurations are made, the master node will recognise the new DataNode and start replicating necessary data from the cluster, thus giving more computing resources. The Hadoop cluster setup is inexpensive as the clusters are held down by using a Raspberry Pi. Any organisation can set up a powerful Hadoop cluster without having to spend money on expensive server hardware. With the low cost of Raspberry Pi and using the free OS, Raspbian, users will not spend much money on creating a Hadoop cluster.

Having a Raspberry Pi Hadoop cluster is an extremely beneficial setup for data analysis. By combining the low cost of the Raspberry Pi and the features from the Hadoop Cluster, it will be the right tool for any analysis needed. The Hadoop cluster will optimise the large datasets of any organisation that requires intense data analysis. The Pi uses an SD card storage, which is fast and has no moving parts in comparison to its counterpart machine, thus costing more for an SSD or using HDD which constantly moves. The Pi is small which can allow other devices to be integrated and, with no moving parts, no noise emanates from this cluster.

## LIST OF REFERENCES

- Raspberry Pi. 2020. [Online] Available from: <https://www.raspberrypi.org/products/raspberry-pi-3-model-b-plus/> [Accessed: 15 January 2020].
- Carey, S. 2017. *12 Hadoop case studies in the enterprise*. [Online] Available from: <https://www.computerworld.com/article/3412201/12-hadoop-case-studies-in-the-enterprise.html> [Accessed: 15 January 2020].
- Cluster Setup. 2020. [Online] Available from: [https://hadoop.apache.org/docs/r1.2.1/cluster\\_setup.html](https://hadoop.apache.org/docs/r1.2.1/cluster_setup.html) [Accessed: 15 January 2020].
- Hadoop - MapReduce – Tutorialspoint. 2020.[Online] Available from: [https://www.tutorialspoint.com/hadoop/hadoop\\_mapreduce.htm](https://www.tutorialspoint.com/hadoop/hadoop_mapreduce.htm) [Accessed: 15 January 2020].
- Petrov, C. 2019. *16+ Big data statistics: the information we generate*. [Online] Available from: <https://techjury.net/stats-about/big-data-statistics/> [Accessed: 15 January 2020].
- Power Supply - Raspberry Pi Documentation. 2020. [Online] Available from: <https://www.raspberrypi.org/documentation/hardware/raspberrypi/power/README.md> [Accessed: 15 January 2020].
- Single Node Setup. 2020. [Online] Available from: [https://hadoop.apache.org/docs/r1.2.1/single\\_node\\_setup.html](https://hadoop.apache.org/docs/r1.2.1/single_node_setup.html) [Accessed: 15 January 2020].
- Typical Power Consumption of PC Components - Power Draw in Watts. 2020. [Online Available] from <http://www.buildcomputers.net/power-consumption-of-pc-components.html> [Accessed: 15 January 2020].

9TH INTERNATIONAL CONFERENCE ON APPROPRIATE TECHNOLOGY

# **WATER AND SANITATION**

# A-FRAME WORK FOR GROUNDWATER QUALITY MONITORING BASED ON A PARTICIPATORY APPROACH, IN SUDAN

Sahl Yasin<sup>1</sup>, Awad Ahmed<sup>2</sup>

<sup>1, 2</sup> Sudanese Knowledge Society, Khartoum, Sudan

sahlyasin@hotmail.com, wad.ahmed7788@gmail.com

## Abstract

*Monitoring the level and the quality of the groundwater provides important information about the coverage of the water, the condition of the aquifers, types of water sectors (public or private), the quality of drinking water, and climatic change. To manage water resources needs long term monitoring plans aided by community participation networks.*

*The main aim of this study is to conceptualize a low-cost frame for ground-water quality monitoring draws on community contribution and participation and on young scientists in Sudan, and addressing citizen science approach, and establish large scale network, in addition, this frame model finding possible trends in the change in water quality.*

*Meanwhile, a collaborative community participation approach involving local community has been applied to assess the quality of groundwater in Alkalakla South Khartoum, Sudan. Samples have been collected and conducted while 5 physio-chemical water quality parameters were tested.*

*Conductivity and calcium concentration were recorded high value in selected area.*

*The frame suggested that network participants inter training programs to measure and analysis physio-chemical and biological parameters in their wells by using low-cost instruments such as sensors and smartphones. Data and survey sheets can be received or sent through smart-phones or a web-based portal. Quality control and assurances can be applied to manage the data.*

*The framework suggested that network participants should be trained to measure and analyse physico-chemical and biological parameters in their wells, by using low-cost instruments such as sensors and smartphones. Data and survey sheets can be received or sent through smart-phones or a web-based portal. Quality assurance can be applied to manage the data.*

*The framework is designed to be an extension of government planning information about groundwater quality. Beside, increasing the motivation of participants and their contextual knowledge, this framework can be scaled and extended for monitoring of groundwater quality in Sudan. Moreover, it can be a serious alternative of the classical water monitoring program and can help stakeholders to cope with the inevitable changes in groundwater quality.*

**Keywords:** Groundwater quality, monitoring, a citizen in science, participation

## INTRODUCTION

UNICEF has declared that more than 32% and 22% of the total population don't have access to water in rural and urban areas respectively. In Sudan, reports that more than quarter of the population are still using unsafe drinking water (UNICEF, 2017). The main water resources in Sudan are surface water such as the river Nile, hafier and wadis, while groundwater is considered to be the most used source of drinking water especially in rural areas. Groundwater provides about 45% of the

drinking water from all sources in Sudan (Yasin & Adam, 2016). The number of people in need of humanitarian services increased from 4.8 million in 2018 to 8.5 million in 2019, whereas, the number of people needing water and sanitation increased from 3.5 million to 5.6 million from 2017 to 2019. (OCHA on behalf of the Humanitarian Country Team, 2015; UNOCHA, 2016). Citizen science

The term citizen science appeared early in the twentieth century. The general meaning of citizen science is the engagement of community members in science projects like observing, collecting, processing, responding to data as part of scientific inquiry. One finds good examples in the many fields of ecology and environmental science etc. Since 1900 and every year since then, the national Audubon Society in the USA sustained a project to count certain species of bird at Christmas time; this is done by community members in each count area (Silvertown, 2009). In the last two decades, this term has been applied to many scientific processes, it has been represented in the monitoring of marine and coastal area (Conrad & Hilchey, 2011). Non-professionals also have been engaged in the field of ecology and climate change; Dickinson and his partner describe how they used geospatial technique to understand the distribution, abundance, and life cycles of organisms over time. In addition, ecologists show the contribution of citizen science to building a multi-disciplinary database to respond in change in the environment (Dickinson et al., 2012).

Citizen science has been used in a wide range of studies in the water sector of in studies in the engagement of community members in collecting data, analysis and quality monitoring in groundwater. (Conrad & Hilchey, 2011). A citizen science approach has been used in hydrology to monitor water levels, and to study the condition of rivers. Mobile phones have been used as a tool for transferring data, with photos of rivers showing water levels (dry, medium and full), flow rate (still, slow and fast) and collections of trash being some of that data (Jollymore, Haines, Satterfield, & Johnson, 2017).

Eight water projects based on community participation in four different states in Sudan have been assessed and monitored; the assessment framework used systematic secondary information collection, and analysis (SSICA), while weighted sub-indicator analyses have been checked to calculate the sustainability scores, this study showed that almost half of the water projects (40%) are only moderately sustainable, due to weak organizational and financial support, as well as poor implementation performance (Ibrahim, 2016)

Jollymore and his colleagues designed a program to investigate how human activity affects water quality in rivers and streams, and created a web site for this purpose. They applied a split sampling method to evaluate the data collected by participants and researchers (Jollymore, Haines, Satterfield, & Johnson, 2017). A low-cost water quality monitoring system has been introduced for the Ayeyarwady River in Myanmar, based on the participation of community members. Results from their observations are compared with the measurements collected by lab technicians. (Win, Bogaard, & van de Giesen, 2019)

There are fewer studies of the contribution of citizens in monitoring the quality and level of ground-water. Baalbaki and his team analyzed 12 physical, chemical and biological markers for ground-water quality in Lebanon; the data is collected by citizen science participants, and the results demonstrate that the data collected by volunteers is comparable with data generated by expertise (Baalbaki et al., 2019). Community participation is used to monitor the quality of groundwater in Alberta, Canada this project was studied by Little and his colleagues. Large water level monitoring network of private wells has been created; volunteers are trained to measure the water level in their wells, and enter the data through a web-based data portal. Their monitoring activity is aided by an educational program (Little, Hayashi, & Liang, 2016).

The main goal of this study is to describe a framework for groundwater quality monitoring based on a participatory approach in Sudan. The community participation encompasses a wide range of activities, meeting a diversity of needs, and it could be part of the democratization of science by engaging marginalized communities.

The frame work has four aspects to it. First, it fills the data gap in water quality by creating a long term, credible data set. Second, it raises people's awareness about the water quality issue. Third, it educates people about how and why monitoring is done, and explain the result to them. Finally, help the government to take the decisions about water sectors, and to monitor the changes in water quality.

## The methods

The model starts with describing a study area in terms of its location, population, sewer of wastewater network, economic activities (factories and mining), the annual rainfall, number of wells in every village, the type of well (public or private), and its geological structure. It also considers whether septic tanks pose a serious problem to the quality of groundwater, the government and universities are involved in reviewing the proposal, the data collection forms, and the surveys related to the project.

In this regards a batch study has been applied to test the framework.

Alkalaka Goba selected to be study area. It located in south Khartoum approximately 18 km from downtown between 15.4678° and 32.4856°, at an elevation of 384 m height above sea level. This region characterized by a hot and semi-arid weather, however, the rainy season in this area between July and September.

There is no official sewer network for wastewater sanitation, most of people using septic tank. As a result wastewater may pose problems in the quality of ground water. Beside water Nile, groundwater considered to be the main source of domestic uses, and it regulated by Sudanese National Corporation of water.

30 samples have been selected from Alkalkla Goba blocks 5 to 11. Volunteers were participated by selecting samples from their houses and working places Fig 1. An international guideline for selecting samples for physio-chemical analysis has been followed, to determine conductivity, pH, temperature, and calcium concentration. Announcement has been sent to enhance participation in social media through local groups of Alkalkla in Facebook.

## The need to enhance community participation

Community members can participate in a water quality monitoring program successfully if the management of the project puts in the effort, time and skills. To keep volunteer monitors active inspired and motivated, you can work by the five Rs for volunteer monitoring: Rights, Responsibilities, Recruitment, Recognition and Retention. One of the most common questions asked about this framework is how to engage people that may be unfamiliar and lack skills and training about water quality, especially in a marginalized community. The first step is to understand their cultural values, traditions and language. However, it is also possible that volunteers have the interest to learn new skills, perhaps to help them in school or other professional development. For others, the attraction to the project may be their interest in meeting others with similar interests in outdoor activities. (Herron, Green, & Stepenuck, 2010), (Trani, Ballard, Bakhshi, & Hovmand, 2016)

These are some tips to encourage participants to provide this important service to their community, but they must understand that a monitoring program stands or falls by their ability to collect and send the data to meet our data quality objectives.

The tips start with the agreement of each participant to be part of the work and understand the importance of their services, to cooperate with staff, be able to ask for help, and beyond asking; they should be open-minded and be flexible in recognizing the needs of the monitoring program.

Our study focused on the baseline of water quality condition in Alklakla south Khartoum to measure, analysis, and monitor the quality of the groundwater. Tale 1 summaries the main activities, objectives tools, methods of training, types of monitoring, and data quality, assurance which described by (Baalbaki et al., 2019).



Fig 1 Google earth map for selected samples

Table 1 Participation matrix

Activity	Objective	Tools & equipment	Method of training	Monitoring	Quality control & assurance
Ground water analysis	-Select samples from wells - Analyse physio-chemical parameters -Sending data analysis regularly	-Poly ethylene container -Sensors - Smart phone - light emitting diode LED	- Using standard method of collecting water sample. -Use kits for analysis -How to use field data sheet -Calibration and maintenance of sensors - training of trainers TOT	Depend upon data needs	-Check monitoring plan and methods regularly. -Repeat tests randomly. - Establish quality assurance

## Results and discussion

Volunteers were responded randomly to collect groundwater samples in dry poly ethylene containers after a week. Which 70% were young school students, while the others were adult; teachers, doctors, and accouters. Announcement attached by instructions for collecting the samples. Tale 2 summarizes physio-chemical parameters.

Table 2 summarize physio-chemical parameters Alkalakla Goba

parameters	Max	Min	Mean	Stander value	Stdv
Calcium as (CaCO <sub>3</sub> )	410	117	251.66	75ppm	108.664
Conductivity	1390	110	869.938	500 μs	303.098
TDS	973	77	622.183	500 ppm	212.168
pH	9.5	7	8.2	6.5-8.5	0.66392
Temperature	40	31	34	44 °C	2.62923
Odor					
Color					

Table 2 represents physio-chemical parameters from calcium to conductivity to temperature (n=30). 29 samples showed high conductivity at sampling location 1390 to 590 $\mu$ S which far from WHO standers, on other hand, it showed high correlation with total dissolve salt TDS abut (90.92), due to solubility of minerals in this region, which not meet the accepted stander level of WHO standard. As a result concentration of calcium, TDS and conductivity results analogous with geological structure of the location which dominated alkali rocks. Geologist argued that Khartoum basin is a part of the Blue Nile rift basin system, which located in the north between the White Nile and the Blue Nile and stretches to the southeast across the Blue Nile. The study area formation is an outcrop of Nubian basin sandstone, which contains younger granite from Precambrian-Mesozoic age. (El Tahir, Nyblade, Julià, & Durrheim, 2013) (Nada El Tahir)

There is no high turbidity concentration recorded in all analyzed samples, while seven samples recorded strange odor taste.

### Data management

The challenge is to introduce a system that will give reliable data on groundwater from volunteer participants, and will do over time. Data from water samples, surveys and questionnaires from each water source must be summarised in electronic supplementary material, and captured on a smartphone or website. The table below illustrates the survey form. This is on an app which can be downloaded free from an app store.

Fig 2 Flow application and survey form

The most critical aspect of citizen science is quality assurance and quality control. The process of achieving this quality differs from project to project due to the nature of each one. Five definitions of data quality for monitoring have been established by the United States Environmental Protection Agency (US EPA) as a road map to data management: accuracy, precision, completeness, representativeness, and comparability (Win et al., 2019).

In our project, we have selected accuracy, consistency and completeness as criteria.

- Accuracy: data selected from participants
- Consistency: Participant's data from two different times is compared with two different researchers' analyses to prove that the participant uses the same procedure every time.
- Completeness: All monitoring network data meet. (Sheppard & Terveen, 2011; Win et al., 2019).

Errors can occur in collecting samples, analysing and entering the data. The first step to recover from errors is to enhance the electronic version of the survey form to match what is written in the field sheets. The web-based system should have the ability to correct information automatically, in the case of [no data/ unexpected data] after any submitting new data (Sheppard & Terveen, 2011).

In addition, one of the most effective ways of achieving success is to involve participants in monitoring the programme. The Xanadu programme has demonstrated a design for evaluating participants: it starts with understanding the connection between what we do on the land and how that affects water quality. The programme suggests that the coordinator should hold a meeting with key volunteers and other intended users to discuss the evaluation's findings (Kushner et al., 2012). Participants should know that their data will be linked to the database of the government, to serve as an online document for monitoring groundwater quality and activities that affect it. We believe that this database should be made open access to all researchers and stakeholders. (Kushner et al., 2012)

### Conclusion

This study of the proposed framework aims to illustrate the reliability and usefulness of citizen science as a low-cost means of measuring the quality of groundwater in Sudan. Groundwater quality is dynamic due to its interaction with bedrock and the changing concentration of some chemical elements.

The framework is designed to provide stakeholders with information about the quality of groundwater regularly. The framework suggests building a monitoring network based on community participation and using low-cost tools such as sensors and smartphones for analysis of physico-chemical and biological parameters, linked to the dynamic website. We have proposed a training program for participants, starting from learning how to select samples for analysis, how to operate and use the instruments, and how to communicate with the coordinator by sending the data through a mobile application, SMS or website. To track the monitoring network, the framework explains how can we can manage the data through monitoring and establish quality assurance and quality control, to reach a high degree of accuracy, consistency, and completeness.

## LIST OF REFERENCES

- Baalbaki, R., Ahmad, S. H., Kays, W., Talhouk, S. N., Saliba, N. A., & Al-Hindi, M. (2019). Citizen science in Lebanon-a case study for groundwater quality monitoring. *Royal Society Open Science*, 6(2). <https://doi.org/10.1098/rsos.181871>
- Conrad, C. C., & Hilchey, K. G. (2011). A review of citizen science and community-based environmental monitoring: Issues and opportunities. *Environmental Monitoring and Assessment*, 176(1–4), 273–291. <https://doi.org/10.1007/s10661-010-1582-5>
- Dickinson, J. L., Shirk, J., Bonter, D., Bonney, R., Crain, R. L., Martin, J., ... Purcell, K. (2012, August). The current state of citizen science as a tool for ecological research and public engagement. *Frontiers in Ecology and the Environment*, Vol. 10, pp. 291–297. <https://doi.org/10.1890/110236>
- El Tahir, N., Nyblade, A., Julià, J., & Durrheim, R. (2013). Crustal structure of the Khartoum Basin, Sudan. *Tectonophysics*, 593, 151–160. <https://doi.org/10.1016/j.tecto.2013.02.032>
- Herron, E., Green, L., & Stepenuck, K. (2010). *Volunteer Management and Support*. Retrieved from <http://volunteermonitoring.org/>
- Ibrahim, S. H. (2016). Community-Based Water Projects ` Sustainability : Lessons and Challenges – A Case study from Sudan. *International Journal of World Policy and Development Studies*, 2(6), 38–45. Retrieved from <http://arpgweb.com/?ic=journal&journal=11&info=aims>
- Jollymore, A., Haines, M. J., Satterfield, T., & Johnson, M. S. (2017). Citizen science for water quality monitoring: Data implications of citizen perspectives. *Journal of Environmental Management*, 200(November), 456–467. <https://doi.org/10.1016/j.jenvman.2017.05.083>
- Kushner, J., Klink, J., Stepenuck, K., Genskow, K., Herron, E., & Green, L. (2012). *Evaluating Your Volunteer Water Quality Monitoring Program*.
- Little, K. E., Hayashi, M., & Liang, S. (2016). Community-Based Groundwater Monitoring Network Using a Citizen-Science Approach. *Groundwater*, 54(3), 317–324. <https://doi.org/10.1111/gwat.12336>
- OCHA on behalf of the Humanitarian Country Team. (2015). Humanitarian Response Plan Somalia 2015. In *Humanitarian Response Plan*. Retrieved from [https://docs.unocha.org/sites/dms/Somalia/Somalia 2015 Humanitarian Response Plan.pdf](https://docs.unocha.org/sites/dms/Somalia/Somalia%202015%20Humanitarian%20Response%20Plan.pdf)
- Sheppard, S. A., & Terveen, L. (2011). Quality is a verb: The operationalization of data quality in a citizen science community. *WikiSym 2011 Conference Proceedings - 7th Annual International Symposium on Wikis and Open Collaboration*, 29–38. <https://doi.org/10.1145/2038558.2038565>
- Silvertown, J. (2009). Training Volunteer Water Quality Monitors Effectively. *Trends in Ecology and Evolution*, 467–471. <https://doi.org/10.1016/j.tree.2009.03.017>
- Trani, J. F., Ballard, E., Bakhshi, P., & Hovmand, P. (2016). Community based system dynamic as an approach for understanding and acting on messy problems: a case study for global mental health intervention in Afghanistan. *Conflict and Health*, 10(1), 1–11. <https://doi.org/10.1186/s13031-016-0089-2>
- UNICEF. (2017). *World Water Day : 68 percent of Sudan `s population with access to basic improved*.
- UNOCHA. (2016). *Humanitarian needs overview*. Retrieved from [www.humanitarianresponse.info/en/operations/sudan](http://www.humanitarianresponse.info/en/operations/sudan)
- Win, T. T. N., Bogaard, T., & van de Giesen, N. (2019). A low-cost water quality monitoring system for the Ayeyarwady River in Myanmar using a participatory approach. *Water (Switzerland)*, 11(10). <https://doi.org/10.3390/w11101984>
- Yasin, S., & Adam, M. (2016). Mapping of Groundwater quality in Great Kordufan states with Geochemistry and Health Aspects Mapping of Groundwater quality in Great Kordufan states with Geochemistry and Health Aspects. *7th International Conference on Appropriate Technology November 2016, Victoria Falls (Mosi Oa Tunya), Zimbabwe*, (November).



---

Publisher © Tshwane University of Technology

ISSN: 978-0-9870163-7-9

ISBN: 978-0-9993666-8-4

9th International Conference on Appropriate Technology  
(9th ICAT) Conference Proceedings:

**TECHNOLOGY  
EXCHANGE AND  
EMPLOYMENT CREATION  
FOR COMMUNITY  
EMPOWERMENT:  
CROSS-POLLINATING  
INNOVATIVE MODELS**