

# STUDY OF HIGH - ENERGY LINER COMPRESSION IN HEL-1 EXPERIMENT

V.K.Chernyshev, V.N.Mokhov, V.N.Buzin, O.M.Burenkov, A.M.Bujko, V.V.Vakhrushev, S.F.Garanin, B.E.Grinevich, Y.N.Gorbachev, V.A.Demidov, V.I.Dudoladov, V.V.Zmushko, A.I.Kuzyaev, A.I.Kucherov, B.M.Lovyagin, Y.I.Matsev, P.N.Nizovtsev, A.A.Petrukhin, A.I.Pishchurov, S.S.Sokolov, V.P.Solovjov, A.I.Startsev, V.B.Yakubov

All-Russia Scientific Institute of Experimental Physics, 607200, Sarov< N.Novgorod Region, Russia.

B.G.Anderson, C.A.Ekdahl, D.Gofort, D.Clark, I.R.Lindemuth,  
R.E.Reinovsky, R.Fail, S.M.Younger.  
Los-Alamos National Laboratory, New Mexico, USA.

High-power facilities able to deliver into the load tens megaampers of current for microseconds are applied now world wide to solve a whole set of scientific and applied issues. Now more and more energy and power are required from these facilities. By now several stationary machines have been created such as Pegasus-II (with the energy more than 1 MJ) , Shiva-Star (up to 9 MJ), new Atlas facility (for 25 MJ) is in the process of construction and the idea of creating Jupiter (for ~ 100 MJ). Large experience in creation of single action explosive magnetic generators - EMG has been accumulated. VNIIEF has created EMG which can deliver more than 200 MA of current into the load with the full magnetic energy more than 100 MJ. Stationary facilities are more expensive than EMG, but they enable many experiments to be conducted, because the cost of one shot with a stationary machine is less than EMG cost. However, with the increase of energy, released in one shot on a stationary machine the cost of disposable elements increases, so the cost for one shot increases faster than the energy increases. It is estimated that if the energy of a shot is about 100 MJ (this is equivalent to the explosion of about 25 kg of trotyl), the cost of one shot may exceed the cost of EMG. That is why the use of high-energy EMG is very reasonable not only because the stationary facilities of required energy and power have not been yet created, but for the purpose of saving money now and in future.

The experiments with high-energy liners are interesting in terms of DT-gas compression, to clarify such issues as liner flight stability, substance strength impact on growth of perturbations, interactions between the cylindrical liner end and walls, parameters of substances under high pressures and other. The present paper describes arrangement and the results of the first joint experiment between VNIIEF and LANL with EMG of 1 m diameter and a non-evaporating liner.

The experiment took place in August 22, 1996. The goal of the experiment was to accelerate magnetically cylindrical relatively thin aluminum liner and to get kinetic energy 20 MJ or more.

As the energy source for the experimental device we chose 5-module DEMG of 1000 mm diameter, many times tested in the experiments for rigid and liner loads. This EMG can store more energy than any other EMG created at VNIIEF.

The physical scheme of the liner unit was choosed so that the growth of disturbances would have less influence on the liner shape during flight, especially on the liner's inner surface. The shape of glade plane on which liner slides during flight and the way of contact liner with walls were choosed on the ground of 2-d calculations, proceeded from the necessity to ensure electrical contact during the liner flight.

## 1. SHORT DESCRIPTION OF EXPERIMENTAL DEVICE

The facility tested in HEL-1 consisted of the following:

- five-module disk explosive generator (DEMG) with the diameter 1 m;
- helical explosive magnetic generator (HEMG) of 240mm diameter, powered using magnetic flux capture;
- transition line made of a horizontal and a vertical parts;
- ponderomotive unit with a liner;
- central measuring unit (CMU);
- insulation system.

Fig. 1 shows the photography of the experimental facility on the firing point..

# Report Documentation Page

*Form Approved  
OMB No. 0704-0188*

Public reporting burden for the collection of information is estimated to average 1 hour per response, including the time for reviewing instructions, searching existing data sources, gathering and maintaining the data needed, and completing and reviewing the collection of information. Send comments regarding this burden estimate or any other aspect of this collection of information, including suggestions for reducing this burden, to Washington Headquarters Services, Directorate for Information Operations and Reports, 1215 Jefferson Davis Highway, Suite 1204, Arlington VA 22202-4302. Respondents should be aware that notwithstanding any other provision of law, no person shall be subject to a penalty for failing to comply with a collection of information if it does not display a currently valid OMB control number.

1. REPORT DATE <b>JUN 1997</b>	2. REPORT TYPE <b>N/A</b>	3. DATES COVERED <b>-</b>	
4. TITLE AND SUBTITLE <b>Study Of High - Energy Liner Compression In Hel-1 Experiment</b>		5a. CONTRACT NUMBER	
		5b. GRANT NUMBER	
		5c. PROGRAM ELEMENT NUMBER	
6. AUTHOR(S)		5d. PROJECT NUMBER	
		5e. TASK NUMBER	
		5f. WORK UNIT NUMBER	
7. PERFORMING ORGANIZATION NAME(S) AND ADDRESS(ES) <b>Russia Scientific Institute of Experimental Physics, 607200, Sarov&amp;ltamplt; N.Novgorod Region, Russia.</b>		8. PERFORMING ORGANIZATION REPORT NUMBER	
9. SPONSORING/MONITORING AGENCY NAME(S) AND ADDRESS(ES)		10. SPONSOR/MONITOR'S ACRONYM(S)	
		11. SPONSOR/MONITOR'S REPORT NUMBER(S)	
12. DISTRIBUTION/AVAILABILITY STATEMENT <b>Approved for public release, distribution unlimited</b>			
13. SUPPLEMENTARY NOTES <b>See also ADM002371. 2013 IEEE Pulsed Power Conference, Digest of Technical Papers 1976-2013, and Abstracts of the 2013 IEEE International Conference on Plasma Science. Held in San Francisco, CA on 16-21 June 2013. U.S. Government or Federal Purpose Rights License.</b>			
14. ABSTRACT			
15. SUBJECT TERMS			
16. SECURITY CLASSIFICATION OF:			17. LIMITATION OF ABSTRACT <b>SAR</b>
a. REPORT <b>unclassified</b>	b. ABSTRACT <b>unclassified</b>	c. THIS PAGE <b>unclassified</b>	
			18. NUMBER OF PAGES <b>7</b>
			19a. NAME OF RESPONSIBLE PERSON

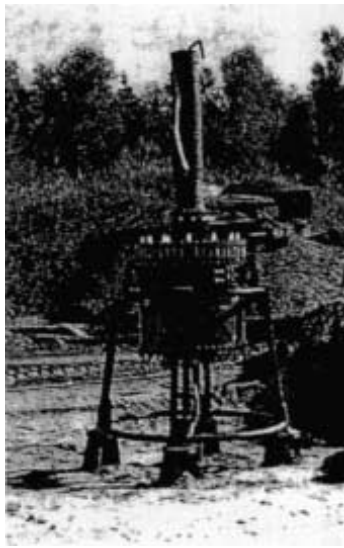

Fig.1

## 2. LINER STRUCTURAL PARAMETERS

Fig.2 gives photography of the liner, have been used in HEL-1 experiment.

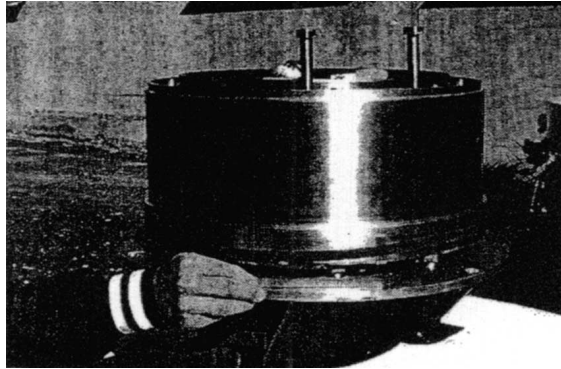

Fig.2

The liner was made of aluminum alloy AMg6, GOST 4784-74.

According to the chemical analysis the impurity percent was: Mg - 6.50; Mn - 0.52; Ti - 0.03; Be - 0.002; Si - 0.005; Fe - 0.34.

Before the liner was fabricated the preliminary ultra-sonic test had been done to check the absence of inner defects in a semiproduct and its mechanical characteristics had been determined: ultimate strength  $\sigma_r = 35 \text{ kg/mm}^2$ , strength yield  $\sigma_{0.2} = 15 \text{ kg/mm}^2$ , relative lengthening  $\delta = 28.4\%$  ( $P=700\text{kg}$ ).

The measurements were done in the working area of the liner in 14 cross sections in 8 mm over the length and in  $90^\circ$  over azimuth and in the cross section 7 in  $15^\circ$  over azimuth.

According to the measurements we got the following data.

Nominal liner thickness is 3.98 mm.

Liner conicity is less than 0.02 mm.

The deviations of a liner outer surface profile in mkm from a conventional average ruling are given in Table 1. each 8 mm over liner length.

Table 1

N sec $\varphi^\circ$	1	2	3	4	5	6	7	8	9	10	11	12	13	14
0	0	0	+1	+2	+2	+1	+1	+1	+1	+1	+1	+1	0	-2
90	+1	+1	+1	+2	-1	-5	-4	-4	-1	0	-3	-1	0	0
180	+4	+4	+4	+4	+2	-2	-1	-2	-1	0	-2	0	+1	0
270	+2	+2	+1	+2	0	-3	-3	0	0	0	-1	+2	+3	-3

Table 2 presents the values of liner thickness tolerance in mkm, measured over the ruling and the circle.

Height measurements of profile non-uniformity in liner working surfaces were done by a digital profilometer of 296 type.

Arithmetic mean of inner surface profile shift did not exceed 0.6 mkm. The measurement was conducted in several arbitrary points within the liner working zone at a distance of 6 mm.

The accuracy was the following: the deviation from the given profile over the length 3 mm did not exceed 0.22 mkm.

After the liner had been fabricated the liner working surfaces were detected for faults and microcracks.

Table 2

Values of liner thickness tolerance in mkm

N sec.	1	2	3	4	5	6	7	8	9	10	11	12	13	14
$\varphi^\circ$														
0	+4	+3	+3	+2	+1	-1	-3	-1	0	+2	+2	+1	+2	0
	0	0	0	0	0	0	0	0	0	0	0	0	0	0
90	+3	+2	+1	+1	-2	-7	-7	-7	-1	+1	-1	+2	0	0
	+8	+10	+10	+8	+13	+14	+9	+9	+13	+16	+16	+10	+15	+16
180	+4	+5	+5	+4	+2	-4	-2	-2	+3	+1	-2	+1	+1	0
	+5	+6	+5	+1	+6	+5	+4	+2	+4	+6	+2	+4	+8	+6
270	-1	0	-3	-3	-5	-9	-9	-7	-4	0	0	+2	+2	0
	+2	+2	+2	-1	+5	+6	+1	0	+5	+3	+3	0	+3	+4

Note:

upper values are those, measured according to the ruling,

lower ones are those, measured according to the circle.

### 3. MEASUREMENTS OF CURRENTS AND CURRENT DERIVATIVES IN HEL-1

The facility and the measuring system are shown in Fig.3.

Fig.4 shows trigger timing scheme of the powering and explosive equipment with the times measured in HEL-1.

PRINCIPAL SCHEME OF THE HEL-1 FACILITY

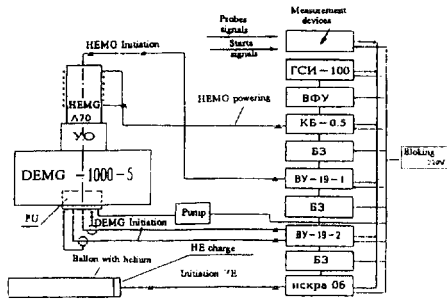

Fig.3

SEQUENCE OF WORK DIFFERENT PARTS OF HEL-1 FACILITY

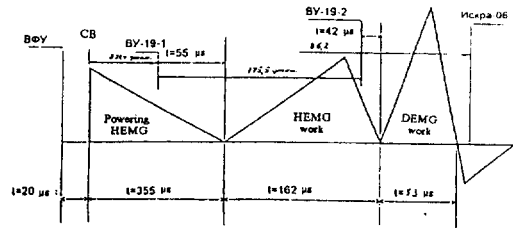

Fig.4

### 3.1 Helical EMG features

To power disk generator with the feed energy helical EMG of the POTOK type (12 MA x 110 nH) was used in the experiment. This generator has inner diameter of turns 24 cm, the length of the helix is 120 cm. Central armature is made of copper, it expands towards the load. HE mass in the generator is 21.5 kg. Initial helix inductance is 122 mkH.

Experimental data of DEMG "POTOK 12 MA x 110 nH" with two-, three-, five-module disk EMG 100 cm in diameter are given in [2]. Generator is able to form up to 15 MA of current in the inductive load with characteristic time 30-40mks for current rise, the maximum magnetic field over the helix turns does not exceed 1 MG.

In HEL-1 HEMG was initially powered by a "flux capture" method, when the capacitor bank KB-0.5 discharged into the coupling coil.

The coupling coil is turned above HEMG by a high voltage wire. Its inner diameter is about 28 cm, its length is 102 cm. Coupling coil inductance is 110 mkH.

The capacitor bank of 480 mkF was charged in the experiment up to 23.6 kV. Coupling coil maximum current with the capacitor bank discharge was 36.9 kA, the magnetic energy was up to 75 kJ. Hence, keeping in mind the coupling factor between the coupling coil and the EMG helix, which is 0.68, the feed magnetic energy of HEMG is about 34.5 kJ, the magnetic flux is about 2.9 W (the expected value of the flux is 3 W).

Current oscillogram in the coupling coil is given in Fig.5.

Measurements of HEMG current derivative was done by ten inductive probes, located in a coaxial path between HEMG and a disk generator. Signals from inductive probes were made by oscilloscopes C1-24 and C1-27 with the sweep from 80 to 120 μs.

Current derivatives obtained by averaging the signals from all the probes and HEMG current are given on the [redacted]. Fig.6 and fig.7 [redacted] as a function of time. Maximum value  $di/dt$  is about  $2 \times 10^{11}$  A/s, maximum current is about 9.1MA.

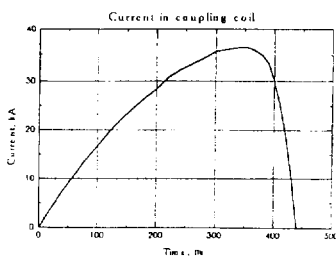

Fig.5

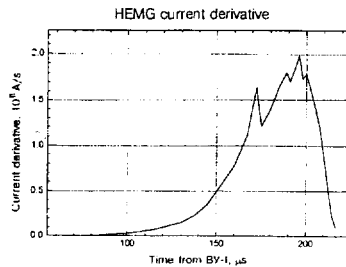

Fig.6

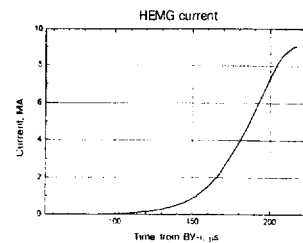

Fig.7

### 3.2 Measurement of current derivative in HEMG of 1000mm diameter

Fig. 8 shows typical current derivatives at the input of disk EMGs horizontal transmission line, obtained by using inductive probes, situated at 12 points on the circuit .

Plot 9 illustrates the experimental data , obtained, when measuring current derivatives at the input to the horizontal transmission line of DEMG and shows the average value of current derivative.

EXPERIMENTAL OSCILLOGRAMS  
(INPUT DEMG)

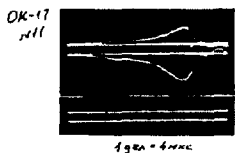

Fig.8

The measurements showed that:

- maximum current derivative at the input to DEMG was  $5,5 \times 10^{12} \text{ A/s}$ ,
- at the  $55 \mu\text{s}$  the current was equal to 104 MA,
- current derivative on plots and oscillograms does not have pockets (rise curve  $I(t)$  is smooth),
- after  $55 \mu\text{s}$  derivative drops are recorded, which is associated with the impact on the transmission line and shock probes, when copper disks fly up to the locations of the probes.

Fig.10 shows typical the traces of DEMG current derivative in the radial transmission line.

Plot 11 illustrates the experimental data, obtained, when measuring current derivatives at the input to the radial transmission line of DEMG and shows the average value of the current derivative.

EXPERIMENTAL OSCILLOGRAMS  
(RADIAL TRANSMISSION LINE)

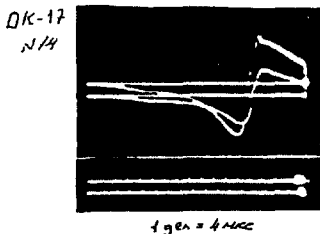

Fig.10

The measurements showed that:

- maximum value of the current derivative in DEMG radial transmission line was  $5.5 \times 10^{12} \text{ A/s}$ ,
- at the  $55.5 \mu\text{s}$  from the beginning of DEMG operation (derivative crosses 0) the current was equal 106 MA,
- plots and oscillograms do not show features testifying about flux pocketing.

Fig. 12 serves to compare the average values of current derivative at the input in horizontal transmission line and in the radial transmission line. The curve of average values is also shown.

Fig.13 shows the average values  $I(t)$ , resulted from measurements of current derivative in DEMG.

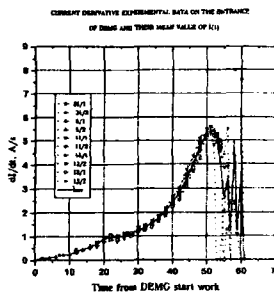

Fig.9

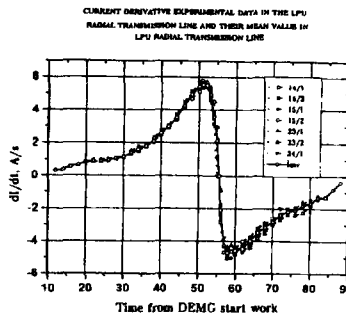

Fig.11

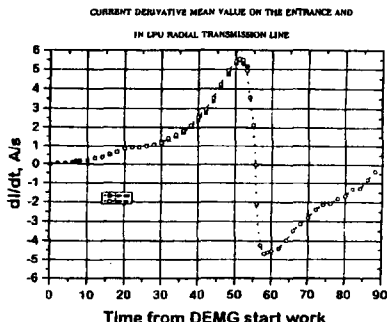

Fig.12

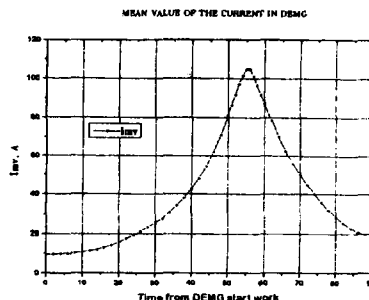

Fig.13

Comparison of the curves at the input and in the radial transmission line showed that:

- current derivatives  $I(t)$  up to the  $53 \mu\text{s}$  practically coincide,
- derivative maximum value was  $5.5 \times 10^{12} \text{ A/s}$ ,

- maximum current value in disk EMG was 105 MA,
- when PU liner imploded the current in the load dropped up to 19.7 MA at the 88  $\mu$ s .

Timing of data recorded by GSI-100, MARTA, VFY and Tektronix was made using the auxiliary signal (from the high-voltage facility ISKRA - 06, ██████████), enabling time of signal passing through the cable to be ignored. For other channels of Tektronix time correction has not been done.

Fig. 14, 15 present the current derivative pulses, recorded from the probes of TL-1 and TL-2 by Tektronix. The maximum current derivative according to the TL-1 probe was 5.45 MA/mks, according to TL-2 probe - 5.5 MA/ $\mu$ s . Fig.16, 17 show the current pulses, flowing through the liner, corresponding to these current derivatives. The maximum current according to TL-1 probe was 103.8 MA, according to TL-2 it was 102.8 MA. All the plots are given in a time scale with the beginning of the counting (t=0) from the time of the signal going from VY-19-1. According to Tektronix data current maximum occurs at the time of 53 $\mu$ s. This time one should consider to be right. Some more time recordered by oscilloscopes is due to nonlinearity of the signal on oscilloscopes screens.

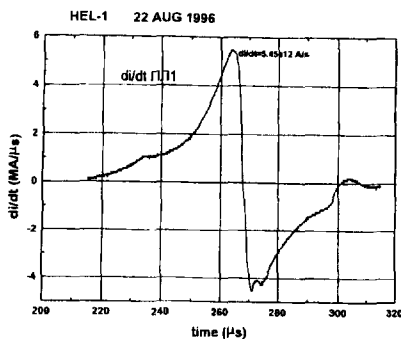

Fig.14

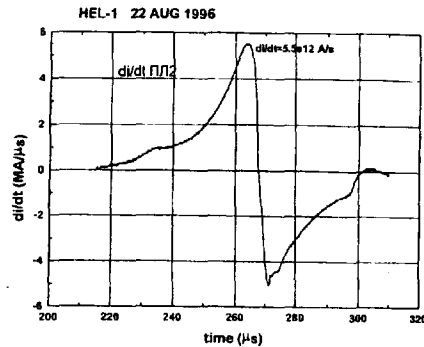

Fig.15

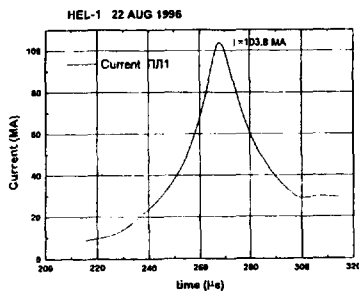

Fig.16

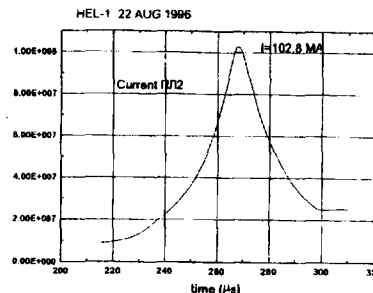

Fig.17

#### 4. LINER ACCELERATION AND FLIGHT CHARACTERISTICS MEASUREMENTS

To measure liner acceleration and flight characteristics different types of probes were used. One part of the probes was displaced on the side wall of the liner ponderomotive unit and other part was displaced in the central measurement unit - close to the axis of collapsing liner.

Inductive probes were situated on the side wall. Pairs of these probes placed after 180 deg. were intended for recording time intervals between liner pass moments of radiuses  $R=130,8\text{mm}$  and  $R=105,5\text{mm}$  at azimuth angles  $\varphi=340$  and  $\varphi=160$  deg.

Signals from these pairs of probes can be used for estimation of the liner outer surface average speed on the flight base from radius  $R=130,8\text{mm}$  to radius  $R=105,8\text{mm}$

On azimuth  $\varphi=340\text{deg.}$   $V=8.1\text{mm}/\mu\text{s}$

On azimuth  $\varphi=160\text{deg.}$   $V=71\text{mm}/\mu\text{s}$

On the side wall piezoelectric probes were also situated. These probes pairs placed after 180 deg. Were intended to record time interval between liner pass moments radiuses  $R=130,8\text{mm}$  and  $R=105,8\text{mm}$  on azimuth angles  $\varphi=25\text{deg.}$  and  $\varphi=205\text{deg.}$

Signals from these pairs of probes can be used for estimation of the liner inner surface average speed on the flight base from radius  $R=130,8\text{mm}$  to radius  $R=105,8\text{mm}$

On azimuth  $\varphi=25\text{deg.}$   $V=6.4\text{mm}/\mu\text{s}$

On azimuth  $\varphi=205^{\circ}$   $V=6.8\text{mm}/\mu\text{s}$

For current recording over liner in CMU body in the area of right side acceleration chamber wall prolongation a ring grooving was made in which 4 inductive probes were installed.

Results of measurements show that there was no penetration of magnetic field under the liner during the whole DEMG work and larger part of liner flight. Signals from probes begin in the time range from  $290\mu\text{s}$  up to  $297\mu\text{s}$ . Calculated moment of liner outer surface flight to maximum radius of probes dielectric shell  $R=69\text{mm}$  is  $294\mu\text{s}$  and corresponds to average time of probes signals beginning spread interval.

## 5. MEASUREMENT OF LINER IMPACT AGAINST CMU CHARACTERISTICS.

The experimental value of the liner velocity before impact against CMU was estimated not only 'experimentally and computationally' through comparison of the experimental and computed (R-t) plots, but also was directly measured on the basis from  $R=56\text{mm}$  to  $R=52\text{mm}$  by two sets of contact probes, positioned inside CMU.

Measurements results are as follows;

(8.36 - 8.36) km/s,  $\varphi = 35^{\circ} - 50^{\circ}$

(8.44 - 7.24) km/s,  $\varphi = 50^{\circ} - 65^{\circ}$

Thus in the angular sector  $\varphi = 35^{\circ} - 50^{\circ}$  velocity equals to  $8.36\text{km/s}$  was measured. This value is slightly more than calculated one -  $8\text{km/s}$ .

We should mention angular time difference of the shock wave in CMU, registered LANLs four light probes, to be not more  $0.7\mu\text{s}$ . VNIIEF data shows similar picture for exception of the two narrow angular sectors  $\varphi=165^{\circ}$  and  $245^{\circ}$ . In these sectors according to VNIIEF data one can see runs ahead of  $1\mu\text{s}$  and  $2\mu\text{s}$  correspondingly.

The shock wave time difference in mentioned angular intervals on the exit of CMU is close to the shock time difference near the outer surface of the CMU.

## CONCLUSIONS

The pulsed power system, consisting of a helical flux compressor and a disk generator, operated as designed delivering output within predicted range.

Helical Out	215 $\mu\text{s}$	9.1MA $\pm$ 0.1MA
Disk Peak	269 $\mu\text{s}$	102MA $\pm$ 2.5MA
Liner impact CMU	296-298 $\mu\text{s}$	

Liner velocity at CMU was between  $6.7\text{km/s}$  and  $8.4\text{km/s}$ .

Liner kinetic energy was between 22 and 35MJ.

The investigators would be pleased to thank all the VNIIEF and LANL employees who participated in the preparation and conducting of the HEL-1 experiment, in the experimental data processing and preparation of this report.