

MICROCOPY RESOLUTION TEST CHART
NATIONAL BUREAU OF STANDARDS 1963-A

ADA 18-983

DIGITAL TROPOSCATTER PERFORMANCE MODEL:
SOFTWARE DOCUMENTATION

Contract No. DCA100-80-C-0030
SIGNATRON Reference A288-16

November 1983

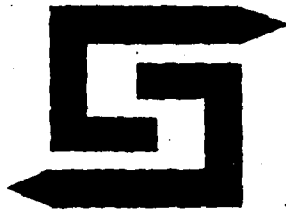

DTIC FILE COPY

DTIC
ELECTE
APR 4 1985
S D

SIGNATRON[®]

This document has been approved
for public release and sale; its
distribution is unlimited.

85 03 15 105



(617)861-1500

**DIGITAL TROPOSCATTER PERFORMANCE MODEL:
SOFTWARE DOCUMENTATION**

**Contract No. DCA100-80-C-0030
SIGNATRON Reference A288-16**

November 1983

Prepared By:

SIGNATRON, Inc.
12 Hartwell Avenue
Lexington, MA 02173

Prepared For:

Defense Communications Agency
Defense Communications Engineering Center
1860 Wiehle Avenue
Reston, Virginia 22090

DTIC
ELECTE
APR 4 1985
S
A

This document has been approved
for public release and sale; its
distribution is unlimited.

UNCLASSIFIED

SECURITY CLASSIFICATION OF THIS PAGE (When Data Entered)

REPORT DOCUMENTATION PAGE		READ INSTRUCTIONS BEFORE COMPLETING FORM
1. REPORT NUMBER	2. GOVT ACCESSION NO.	3. RECIPIENT'S CATALOG NUMBER
4. TITLE (and Subtitle) Digital Troposcatter Performance Model: Software Documentation		5. TYPE OF REPORT & PERIOD COVERED Software Documentation June 1980 - November 1983
7. AUTHOR(s) P. Mosen, S. Parl, A. Malaga, S. Tolman J. Fetteroll		6. PERFORMING ORG. REPORT NUMBER A288-16
9. PERFORMING ORGANIZATION NAME AND ADDRESS SIGNATRON, Inc. 12 Hartwell Avenue Lexington, MA 02173		8. CONTRACT OR GRANT NUMBER(s) DCA100-80-C-0030
11. CONTROLLING OFFICE NAME AND ADDRESS Defense Communications Agency Washington, DC 20305 Attn: Code 680		10. PROGRAM ELEMENT, PROJECT, TASK AREA & WORK UNIT NUMBERS
14. MONITORING AGENCY NAME & ADDRESS (if different from Controlling Office) Defense Communications Agency Defense Communications Engineering Center 1860 Wiehle Ave., Reston, VA 22090 Attn: R220		12. REPORT DATE 28 November 1983
		13. NUMBER OF PAGES 309 Pages
		15. SECURITY CLASS. (of this report) UNCLASSIFIED
16. DISTRIBUTION STATEMENT (of this Report) Approved for public release; distribution unlimited.		15a. DECLASSIFICATION/DOWNGRADING SCHEDULE NA
17. DISTRIBUTION STATEMENT (of the abstract entered in Block 20, if different from Report)		
18. SUPPLEMENTARY NOTES		
19. KEY WORDS (Continue on reverse side if necessary and identify by block number) Troposcatter Propagation Prediction; Diffraction Multipath Prediction MD-918 Modem Error Rate Prediction AN/TRC-170 Link Analysis		
20. ABSTRACT (Continue on reverse side if necessary and identify by block number) The software program for the analysis and evaluation of digital troposcatter communication links is described. The computer program TROPO is intended to provide an accurate prediction model of the troposcatter and/or diffraction propagation path at frequencies between 100 MHz and 10 GHz for all types of diversity receiver configurations used in the DCS, and the prediction of the performance of the MD-918 and AN/TRC-170 troposcatter modems. The program can also evaluate the performance of other modems if a performance (over)		

DTIC
ELECTE
S APR 4 1985 D
A

UNCLASSIFIED

SECURITY CLASSIFICATION OF THIS PAGE(When Data Entered)

19. Abstract (Concluded)

prediction model is provided by the user. TROPO takes into account a number of practical factors such as the effects of RF interference, RF bandwidth constraints, actual diversity antenna geometry, climate and atmospheric characteristics. This document describes the various routines and sub-programs that are used to perform the troposcatter and diffraction path loss, multipath and digital troposcatter link performance calculations.

ORIGINATOR - SUPPLIED KEY WORDS INCLUDE:

FOREWORD

This document is the Software Documentation report for contract DCA100-80-C-0030 prepared by SIGNATRON, Inc. for the Defense Communications Agency. It contains a description of the subprograms used in TROPO to model the performance of digital troposcatter systems. The theory and analytical models used in the calculations are given in the User's Manual and Final Report. The subprogram descriptions have been grouped according to the major functions performed.



Accession For	
NTIS GRA&I	
DTIC TAB	
Unannounced	
Justification	
By	
Digitized by	
for	

A-1

Table of Contents

		<u>PAGE</u>
1.0	INTRODUCTION	1-1
1.1	Report organization	1-1
1.2	Documentation Structure	1-2
1.3	Fortran-4 Plus	1-4
1.4	Input and output units	1-4
1.5	PDP and IBM coding differences	1-5
2.0	DRIVER	2-1
2.1	TROPO	2-3
3.0	INPUT	3-1
3.1	ANTGEO	3-2
3.2	ERRIO	3-5
3.3	INDATA	3-6
3.4	OUTDAT	3-16
3.5	SECTOR	3-25
3.6	UNITCV	3-26
3.7	UNITS	3-31
4.0	ERROR UTILITIES	4-1
4.1	CHKDAT	4-2
4.2	ERROR	4-4
4.3	SUBID	4-5
5.0	TROPOSCATTER CALCULATIONS	5-1
5.1	ANTPAR	5-4
5.2	ANTPTR	5-5
5.3	ATMOS	5-6
5.4	AVTER	5-7
5.5	BEAMPT	5-8
5.6	DELO	5-9
5.7	ERFC	5-10
5.8	FRQSEP	5-11
5.9	GPATT	5-12
5.10	HORANG	5-13
5.11	INTLIM	5-14
5.12	LOOPS	5-17
5.13	LTCORR	5-22
5.14	POWER	5-24
5.15	RGAIN	5-31
5.16	RIPROF	5-32
5.17	STEPAB	5-33
5.18	STEPY	5-34
5.19	STPPAR	5-35
5.20	TGAIN	5-37

		<u>PAGE</u>
5.21	TRANSF	5-38
5.22	TRLOSS	5-41
6.0	DIFFRACTION CALCULATIONS	6-1
6.1	AVAIL	6-3
6.2	CONVOL	6-5
6.3	DIF1	6-6
6.4	DIFSNR	6-7
6.5	INTERP	6-10
6.6	MDIF	6-11
6.7	TANGL	6-13
7.0	CLIMATE VARIABILITY CALCULATIONS	7-1
7.1	CLIFIT	7-2
7.2	CLIME	7-3
7.3	CLIMIL	7-4
7.4	CLIMIX	7-5
7.5	DEIND	7-6
7.6	VARPOL	7-7
7.7	VDECAL	7-8
7.8	YINT	7-9
8.0	BUTTERWORTH FILTER CALCULATIONS	8-1
8.1	A50FCC	8-4
8.2	BUTFIL	8-5
8.3	BWJAM	8-8
8.4	ENRGF	8-11
8.5	FCCMSK	8-12
8.6	FFT	8-13
8.7	FUNBW	8-14
8.8	FUNJAM	8-16
8.9	INTERB	8-17
8.10	PEAK	8-18
8.11	PSPEC	8-19
8.12	PSPEC1	8-20
8.13	PSPEC2	8-21
8.14	PSPJ	8-22
8.15	RTMI	8-24
8.16	SAMPLE	8-25
8.17	SEARCH	8-26
8.18	SPEC	8-28
8.19	SPEC1	8-29
8.20	SPEC2	8-31
9.0	MD-918 MODEM CALCULATIONS	9-1
9.1	BERCAL	9-4
9.2	BOTAC	9-7
9.3	CAC	9-9
9.4	CAJI	9-11
9.5	CAKL	9-12
9.6	CHANGE	9-13
9.7	DINT	9-14
9.8	EIGEN	9-16
9.9	ELMES	9-17
9.10	ERLANG	9-18

	<u>PAGE</u>
9.11	HQR 9-19
9.12	JAMCOM 9-20
9.13	MATA 9-22
9.14	MATCO 9-23
9.15	MOTS 9-26
9.16	MINV 9-29
9.17	ORDER 9-30
9.18	PDFCON 9-31
9.19	PROUT 9-32
9.20	PSINE 9-34
9.21	PWRSPC 9-35
9.22	RJCFCN 9-36
9.23	SASER 9-37
9.24	SIGIN 9-38
9.25	SINC 9-40
9.26	SQTMAT 9-41
9.27	TPSPEC 9-42
9.28	TPSPJ 9-43
9.29	TSINC 9-45
9.30	XNOR 9-46
10.0	AN/TRC-170 MODEM CALCULATIONS 10-1
10.1	AVG 10-4
10.2	EIGV 10-5
10.3	INTERD 10-7
10.4	P2INT 10-8
10.5	PAVERG 10-9
10.6	PDF 10-10
10.7	PDFCOE 10-11
10.8	PDFSUM 10-12
10.9	POUTAG 10-13
10.10	PROFIL 10-15
10.11	TIMAVG 10-16
10.12	TIMEQL 10-17
10.13	TIMPAR 10-18
10.14	TRC 10-19
10.15	TRCIN 10-23
10.16	TXPULS 10-26
10.17	VARW 10-28
11.0	FINAL OUTPUT 11-1
11.1	SIM 11-2
11.2	SUMPAG 11-4
A.0	PDP RELATED INFORMATION A-1
A.1	Subprogram / Module Reference Index A-3
A.2	Module / Subprogram Reference Index A-5
A.3	Common / Include File Reference Index A-10
B.0	CALL CROSS-REFERENCE B-1
B.1	Call Cross-Reference Table B-1
C.0	GLOBAL VARIABLE DICTIONARY C-1
C.1	Global Variable Dictionary C-3
D.0	OUTPUT VARIABLES D-1

PAGE

D.1 Output Variable Definitions D-2

CHAPTER 1

INTRODUCTION

This document is the Software Documentation for the Digital Troposcatter Performance Model Computer Program TROPO. The program performs propagation predictions and modem performance predictions based on the models described in the Final Report.

1.1 Report organization

The report is organized into ten chapters documenting each of the TROPO subprograms grouped according to the types of calculations they perform and four appendices containing cross-reference information about TROPO and its output.

Chapter 2, Driver, describes the driver for the TROPO program and includes a top level flowchart of TROPO.

Chapter 3, Input, describes the routines that input data and do preliminary calculations and output of the input variables.

Chapter 4, Error Utilities, describes the preliminary data checking and error handling routines.

Chapter 5, Troposcatter Calculations, describes the routines performing troposcatter calculations.

Chapter 6, Diffraction Calculations, describes the routines performing diffraction calculations.

Chapter 7, Climate Variability Calculations, describes the routines performing climate calculations.

Chapter 8, Butterworth Filter Calculations, describes the routines performing filter calculations.

Chapter 9, MD-918 Modem Calculations, describes the routines performing calculations for the MD-918 modem.

Chapter 10, AN/TRC-170 and DAR Modem calculations, describes the routines performing calculations for the AN/TRC-170 and DAR modem calculations.

Chapter 11, Final output, describes the routine that outputs SUMFAG.QU1 and

the routine that outputs the simulator tap values.

Appendix A, PDP Related Information, is for users running the PDP version of TROPO. It cross-references information about the various files in three subsections:

- 1) Subprogram / Module Reference Index: This lists each subprogram name alphabetically followed by the file it is in.
- 2) Module / Subprogram Reference Index: This lists each file name alphabetically followed by the subprograms it contains.
- 3) Common / Include File Reference Index: This lists each common name alphabetically followed by the include file it is in.

Appendix B, Call Cross-Reference, lists which TROPO routines and Fortran functions each subprogram calls as well as which has called the subprogram.

Appendix C, Global Variable Dictionary, defines each global variable, identifies its type and the common it is contained in. In addition, below each variable is a list of which subprograms have used it and which have given it a new value.

Appendix D, Output Variables, defines each variable output to the output files FDR002.DAT and SUMPAG.OUT.

The index alphabetically lists each subprogram and the page it is described on.

1.2 Documentation Structure

The documentation in chapters 2 through 11 has been divided into ten major functions:

- 1) Driver
- 2) Data input
- 3) Data checking
- 4) Troposcatter calculations
- 5) Diffraction calculations
- 6) Climate variability calculations
- 7) Kutterworth filter calculations
- 8) MO-918 modem calculations
- 9) AN/TRC-170 and DAR modem calculations
- 10) Final output

Each subprogram falls into at least one of these sections. In some cases, a routine is used by more than one section. So, if a routine is not in the section you expect, the index can quickly direct you to the right page.

Each subprogram description follows the same form:

- 1) Subprogram name: Subroutine or function followed by the name of the routine. This does not include calling arguments
- 2) Purpose: Describes the function the routine performs.
- * 3) Description: This is a more extensive description of the routine's function. Also describes coding conventions that you should be aware of, overall coding structure, etc.
- * 4) Reference: Lists outside reference works usually giving a background for and a more in-depth description of the equations used in the code.
- 5) Calling sequence: Variables used in calling the subprogram.
- 6) Contained in module: The name of the source file the subprogram can be found in.
- 7) Called by: Lists which routines call this one.
- 8) Calls: List which routines this one calls. It does not include system routines such as SIN and SQRT or statement functions. Appendix B gives a full listing.
- 9) Input arguments: All values passed to the routine through the calling arguments. This list may overlap the output arguments since some variables may be used for both input and output.
- 10) Output arguments: All values output from the routine through the calling arguments.
- * 11) Global variables All global variables used by the

outine ANTGEO

TSEP(3)	/IOWATA/	R*4	IOWATA.INC	Separation between transmit antennas in meters.
URH(NR)	/PATHGE/	R*4	TROCOM.INC	Array of receive antennas horizontal offsets from great circle plane in meters.
URL(NR)	/PATHGE/	R*4	TROCOM.INC	Array of receive antennas longitudinal offsets in meters.
URV(NR)	/PATHGE/	R*4	TROCOM.INC	Array of receive antennas vertical offsets in meters.
UTH(NT)	/PATHGE/	R*4	TROCOM.INC	Array of transmit antennas horizontal offsets in meters.
UTL(NT)	/PATHGE/	R*4	TROCOM.INC	Array of transmit antennas longitudinal offsets in meters.
UTV(NT)	/PATHGE/	R*4	TROCOM.INC	Array of transmit antennas vertical offsets in meters.

routine ANTGeo

```

PI          /CONSTA/      R*4    CONSTANTS.INC
           Constant Pi = 3.141592654.
UANGLE     /UNIT/        R*4    IODATA.INC
           Units of angle (deg, rad).
UFREQ      /UNIT/        R*4    IODATA.INC
           Units of frequency (GHz, MHz).
UHITE      /UNIT/        R*4    IODATA.INC
           Units of height and diameter (ft, m).

```

Global variables output to common:

```

AR(NRMX)   /ANTENN/      R*4    TROCOM.INC
           Array of receiver antenna diameters in meters. AR(1)
           is equivalent to RDIAM in the input file.
AT(NTMX)   /ANTENN/      R*4    TROCOM.INC
           Array of transmitter antenna diameters in meters.
           AT(1) is equivalent to TDIAM in the input file.
IBR(NRMX,NRMX) /SYSTRN/    I*2    TROCOM.INC
           Channel complex-envelope correlation and
           cross-correlation calculation indicator array.
           0 = No calculation
           1 = Power (correlation) calculation only
           2 = Power (correlation) per unit delay
              spectrum calculation
IPOLR(NRMX) /ANTENN/      I*2    TROCOM.INC
           Array of receiver antenna polarizations.
IPOLT(NTMX) /ANTENN/      I*2    TROCOM.INC
           Array of transmitter antenna polarizations.
NR          /SYSTRN/      I*2    TROCOM.INC
           Number of receive ports.
NT          /SYSTRN/      I*2    TROCOM.INC
           Number of transmit ports.
PHDIV      /MCOM4/       R*4    MCOM.INC
           Squint angle between upper and lower receiver beams in
           radians. Default is beamwidth.
PSIRA0(NRMX) /ANTENN/     R*4    TROCOM.INC
           Array of receiver beam azimuths in radians.
PSIRE0(NRMX) /ANTENN/     R*4    TROCOM.INC
           Array of receiver beam boresight elevations above
           radio horizon in radians, ie, angle at which each
           antenna is aimed relative to the horizon. PSIRE0(1)
           is the main receive antenna.
PSITA0(NTMX) /ANTENN/     R*4    TROCOM.INC
           Array of transmitter beam azimuths in radians.
PSITE0(NTMX) /ANTENN/     R*4    TROCOM.INC
           Array of transmitter beam boresight elevations above
           radio horizon in radians, ie, angle at which each
           antenna is aimed relative to the horizon. PSITE0(1)
           is the main transmit antenna.
RSEP(3)    /IODATA/     R*4    IODATA.INC
           Separation between receive antennas.

```

3.1 ANTGEO

Subprogram name: Subroutine ANTGEO

Purpose: Compute antenna geometry parameters for chosen diversity configuration (DIVTYP).

Calling sequence:
CALL ANTGEO (BWR, BWT, HR, HT)

Contained in module: ANTGEO

Called by: INDATA

Calls: NONE

Input arguments:
HR R*4 Receiver antenna height above ground.
HT R*4 Transmitter antenna height above ground.

Output arguments:
BWR R*4 Receiver antenna beamwidth in degrees.
BWT R*4 Transmitter antenna beamwidth in degrees.

Global variables input from common:

ACALC	/IOWATA/	I*4	IOWATA.INC
			TRUE if the angles PSITE0 and PSIRE0 are calculated rather than read in.
CMPFT	/CONSTA/	R*4	CONSTANTS.INC
			Meters per foot = 0.3048.
DIVTYP	/MCOM2/	I*2	MCOM.INC
			Diversity configuration indicator. Default is 0.
			0 = 2 receive antennas; 2S 2S/2F 2S/2A 2S/2A/2F
			1 = 1 receive antenna; 2A 2F 2F/2A
			2 = 2 transmit,
			2 receive antennas; 2S/2P 2S/2P/2A
			3 = Not used
			4 = User supplied parameters
			S = Space F = Frequency A = Angle P = Polarization
F	/SYSTRN/	R*4	TROCOM.INC
			Operating frequency in Hz. Model is accurate between 100MHz and 10GHz.
LERR	/LUNS/	I*2	LUNS.INC
			Error output unit.
MET	/UNIT/	R*4	IOWATA.INC
			String 'met' for units output.
MHZ	/UNIT/	R*4	IOWATA.INC
			String 'MHz' for units output.
MRADNS	/UNIT/	R*4	IOWATA.INC
			String 'mrad' for units output.

CHAPTER 3

INPUT

This section describes the initial data handling routines:

Name	Description	User's Manual section
ANTGED	Antenna geometry	NA
ERRIO	I/O Error message output . . .	2.3, 3.4.3
INDATA	Data input	2.2, 3.2
OUTDAT	Output summary of input data .	3.4.1
SECTOR	Sector search	NA
UNITCV	Units conversion	2.2
UNITS	Units decoding/encoding	NA

The main routine for this section is INDATA.

All data input to TROPO comes from the input file, TROPO.DAT, on unit LIN. A complete description of this file can be found in the User's Manual, section 3.2. OUTDAT writes into the file FOR002.DAT on unit LOUT, which is described in section 3.4.1 of the User's Manual.

NOTE

In most cases the sections in the User's Manual describe the coded equations as well as the theory behind them. NA denotes routines that are programming utilities such as finding indices, setting pointers, etc.

Control indicator for entry or calculation of
transmit/receive radio horizon angles THET and THER.
Values have following meanings:

- 0 = Use input THET, THER as reference and
actual horizon (default).
- 1 = Calculate reference horizon using HORANG
and K equals 1.33. (Assuming DLT and DLR
are non-zero.) (Option not available.)
- 2 = Calculate reference horizon using HORANG
and K equals ERFAC. (Assuming DLT and DLR
are non-zero.)
- 3 = Do not change reference horizons from
previous run. (Option not available.)

SEAN

/PROPAR/ R*4 TROCOM.INC
Minimum monthly median of refractivity at sea level.
Used to calculate ERFAC if non-zero.

For DIVTYP = 2:

Q(.,1) Power on path 1 (lower beam) vs. delay.
 Q(.,2) Correlation between convergent paths
 (lower beam) vs. delay.
 Q(.,3) Correlation between divergent paths
 (lower beam) vs. delay.
 Q(.,4) Correlation between parallel paths
 (lower beam) vs. delay.
 Q(.,5) Correlation between crossing paths
 (lower beam) vs. delay.
 Q(.,6) Power on path of upper beam vs. delay.
 Q(.,7) Power on diffraction path vs. delay.

STSNR /SUMP/ R*4 SUMP.INC
 Standard deviation of troposcatter signal long-term
 SNR distribution in dB.

TAPW /MCOM4/ R*4 MCOM.INC
 Normalized tapwidth for MO-918. Default is .5.
 Range is 0.25 through 1.0

TEMPA(NCORMX) /PDATA/ R*4 PDATA.INC
 Array of average troposcatter signal delays for each
 beam relative to straight line in seconds.

TERFAC(3) /ERAD/ R*4 ERAD.INC
 The three values of ERFAC when MDIST is 1.

THER /PATHGE/ R*4 TROCOM.INC
 Radio horizon elevation angle at receive site in
 radians.

THET /PATHGE/ R*4 TROCOM.INC
 Radio horizon elevation angle at transmit site in
 radians.

TODAY(9) /TSTAMP/ L*1 IODATA.INC
 Array used in PDP-11 version to hold date as
 characters.

Global variables output to common:

DELPBZ /RZ1/ R*4
 Resolution of a delay cell in seconds. Same as DELPB
 in /PDATA/.

DELTAR(NRMX) /ANTENN/ R*4 TROCOM.INC
 3dB half-beamwidth of each receive antenna in radians.

DELTAT(NTMX) /ANTENN/ R*4 TROCOM.INC
 3dB half-beamwidth of each transmit antenna in
 radians.

ERFAC /PROPAR/ R*4 TROCOM.INC
 Yearly median value of effective earth radius factor k
 in kilometers. Default is 1.33.

GRDB(NRMX) /ANTENN/ R*4 TROCOM.INC
 Gain of each receive antenna in dBi.

GTDB(NTMX) /ANTENN/ R*4 TROCOM.INC
 Gain of each transmit antenna in dBi.

ITOFF /PROPAR/ I*2 TROCOM.INC

MODPAT /MCOM2/ I#2 MCOM.INC
Propagation/modem flag to select calculation mode.
Default is 1.
0 = Propagation only
1 = Propagation + MO-918 modem
2 = Propagation + AN/TRC-170 or DAR modem
3 = Propagation + user-defined modem

MODSIG /MCOM2/ I#2 MCOM.INC
Interference signal modulation format. Default is 1.
0 = Analog FOM / FM
1 = Digital QPSK

MRAD /ERAD/ I#2 ERAD.INC
Loop limit for MRAD. Default is 1.
(MRAD is 1 for MDIST = 0 and MRAD is 3 for MDIST = 1).

NERT /MCOM2/ I#2 MCOM.INC
Bit error rate threshold indicator for yearly fade
outage probability calculation. Default is 2.
0 = All three thresholds
1 = For 10^{*-3} only
2 = For 10^{*-4} only
3 = For 10^{*-5} only

NOBS /MCOM2/ I#2 MCOM.INC
Number of diffraction obstacles. Maximum is 3,
default is 1.

NOW(8) /TSTAMP/ L#1 IODATA.INC
Array used in PDP-11/70 version to hold time of day as
characters.

NR /SYSTRN/ I#2 TROCOM.INC
Number of receive ports.

NRAD /ERAD/ I#2 ERAD.INC
ERFAC indicator and loop counter. Default is 1.

NT /SYSTRN/ I#2 TROCOM.INC
Number of transmit ports.

Q(NDELX,NCORX) /PDATA/ R#4 PDATA.INC
Matrix of troposcatter signal power and correlation
per unit delay profiles.
For DIVTYP = 0:
Q(.,1) Power on lower beam vs. delay.
Q(.,2) Correlation between lower and
upper beam vs. delay.
Q(.,3) Correlation between lower beams
in antennas 1 & 2 vs. delay.
Q(.,4) Power on upper beam vs. delay.
Q(.,7) Power on diffraction path vs. delay
For DIVTYP = 1:
Q(.,1) Power on lower beam vs. delay.
Q(.,2) Correlation between lower and
upper beam vs. delay.
Q(.,3) Power on upper beam vs. delay
Q(.,7) Power on diffraction path vs. delay.

A /PATHGE/ R*4 TROCOM.INC
Effective earth radius in meters.

AA /PROPAR/ R*4 TROCOM.INC
Atmospheric absorption loss in dB.

BW /SYSTRN/ R*4 TROCOM.INC
Bandwidth in Hertz. Default is 7 MHz.

D /PATHGE/ R*4 TROCOM.INC
Great circle distance between transmitter and receiver
measured at sea level in meters.

DEL /SUMP/ R*4 CURVE.INC
Diffraction path delay relative to a straight line
path in seconds.

DELPB /PDATA/ R*4 PDATA.INC
Resolution of a delay cell in seconds.

DL(3) /MCOM4/ R*4 MCOM.INC
Array containing distance from each obstacle to
transmitter in meters.

DRATE /MCOM4/ R*4 MCOM.INC
Data rate in bits/second. Default is 6.6E6.

DS(3) /MCOM4/ R*4 MCOM.INC
Array of effective obstacle extents along the great
circle path in meters.

EOF /CONTRL/ L*4 TROCOM.INC
End of TROPO.DAT file found if TRUE.

F /SYSTRN/ R*4 TROCOM.INC
Operating frequency in Hz. Model is accurate between
100MHz and 10GHz.

HL(3) /MCOM4/ R*4 MCOM.INC
Array containing elevation of each obstacle above sea
level in meters. HL(1) is elevation of transmitter
radio horizon HLT. HL(NDBS) is elevation of receiver
radio horizon HLR.

HRN /PATHGE/ R*4 TROCOM.INC
Receive antenna height above sea level in meters.

HTN /PATHGE/ R*4 TROCOM.INC
Transmit antenna height above sea level in meters.

IBW /MCOM2/ I*2 MCOM.INC
Switch indicating type of RF bandwidth constraint to
be used on desired signal. Default is 0.
 0 = No RF filtering
 1 = Filter determined from 99% bandwidth constraint
 2 = Filter chosen to meet FCC Mask. (FCC-19311)
 3 = Filters are user specified

LOUT /LUNS/ I*2 LUNS.INC
FOR002.DAT output unit number.

MDIST /ERAD/ I*2 ERAD.INC
Multipath distribution indicator.
 0 = Only median multipath spread used(default)
 1 = Multipath distribution used. (Option not
 currently available.)

2.1 TROPO

Program name: Program TROPO

Purpose: To predict single link digital troposcatter communications system performance for frequencies between 100 Mhz and 10 Ghz.

Description: The routines in TROPO can be grouped into eight major functions:

- 1) Data input and unit conversion: INDATA.
- 2) Data checking and error handling: CHKDAT.
- 3) Troposcatter propagation calculations: ATMOS, TRANSF, ANTPAR, INTLIM, LTCORR, LOOPS and POWER.
- 4) Diffraction propagation calculations: MDIF and DIFSNR.
- 5) Transmitter and receiver filter calculations: BUTFIL.
- 6) MD-918 modem performance calculations: MDTS.
- 7) AN/TRC-170 and DAR modem performance calculations: TRCIN.
- 8) Summary page output: SUMPAG.

The program can perform one of the following functions for each run:

- 1) Troposcatter calculations only
- 2) Troposcatter and diffraction calculations
- 3) Troposcatter and interference calculations
- 4) Propagation (one of above 3) + MD-918 modem
- 5) Propagation + AN/TRC-170 or DAR modem
- 6) Propagation + user defined modem

The input files used are:

Unit no.	File name	Description
LIN = 1	TROPO.DAT	The input file.

The output files used are:

LOUT = 2	FOR002.DAT	The output file.
LERR = 2	FOR002.DAT	The error output file.
LDEBUG = 2	FOR002.DAT	The (debug) output file.
LSUM = 3	SUMPAG.OUT	The summary page file.
LTERM = 4	<user's terminal>	Error messages.

CALL TROPO

Contained in module: TROPO

Calls:

ANTPAR	ATMOS	BUTFIL	CHKDAT	DIFSNR	INDATA	INTLIM	LOOPS	LTCORR
MDIF	MDTS	POWER	SUMPAG	TRANSF	TRCIN			

Global variables input from common:

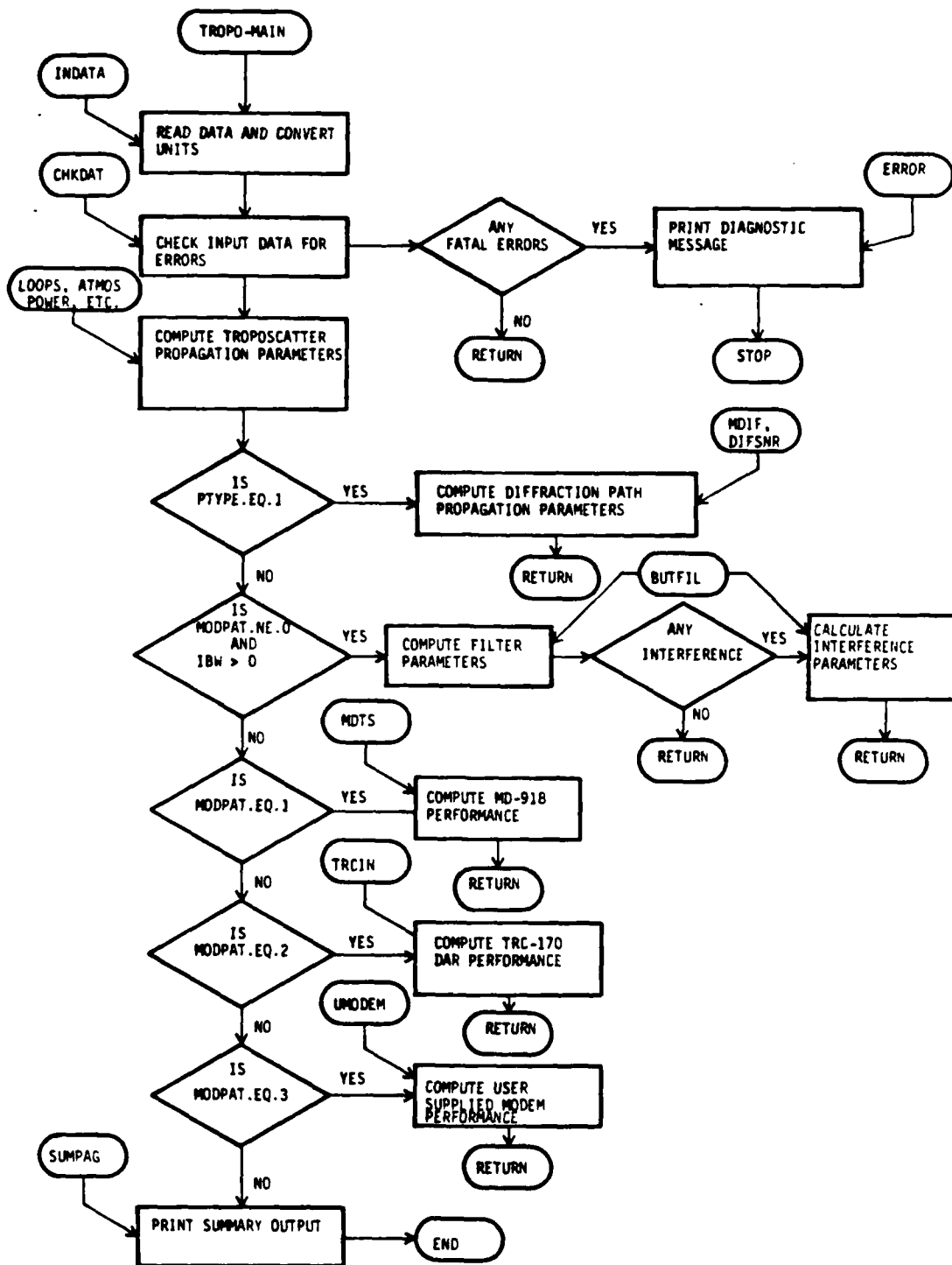

Figure 2-1 Top Level Functional Flow Chart for TROPO Program Calculations

CHAPTER 2

DRIVER

This section describes the driver for the TROPO program. Figure 2-1 is a top level flowchart of the TROPO program at a functional level. In most cases the blocks correspond to one or more subprograms. The test blocks (diamonds), except for "Any Fatal Errors", correspond to logical branches which are decided by the user's choices of input data.

POP version	IBM version	Affects (among others)
PARAMETER	Actual numbers used	TROPAR.INC, TROCOM.INC and DATAINIT.FTN
INCLUDE	Commons already included	Any routine accessing a common
BYTE	LOGICAL*1 data type	Various routines
Leading tab	5 or 6 spaces	All routines
Blank lines	'C' before line	All routines
Separate source files	All sources in 1 file	NA
DATE and TIME	No date and time for output	TROPO, OUTDAT, and SUMPAG
No RETURN in block data	RETURN at end	DATAINIT.FTN

Certain FORTRAN compromises have been made in the code to satisfy FORTRAN-H Extended which are acceptable to, though not optimal for, FORTRAN-IV PLUS:

- 1) IBM does not allow INTEGER*2 variables as arguments to FORTRAN functions which require integer arguments so that INTEGER*4 variables have been used as arguments in such cases.
- 2) The functions of MIN and MAX have been re-coded in some cases as an alternative to such FORTRAN function calls.
- 3) The logical unit numbers, LOU, LIN, etc., are INTEGER*4.
- 4) The variables in common are listed in decreasing storage size.
- 5) Data for each common is initialized in block data only.
- 6) Quoted literals are only used in data statements.
- 7) Arithmetic expressions were not used in WRITEs, GOtOs and DO loops.
- 8) Logical variables are LOGICAL*1 or LOGICAL*4 rather than LOGICAL*2.

The error output file, logical unit LERR, is assigned the same unit number as the output file. This can be changed to a unique number so that the errors are written to a separate file. Note that for the PDP version this would also involve changing the task build command file to increase the number of active files (ACTFIL =) and the largest LUN accessed (UNITS =). Your system manual will have more information on this. Be aware that this will also increase the size of the task.

Logical unit LSUM is explicitly assigned to the file SUMPAG.OUT by the OPEN statement in subroutine SUMPAG.

Output to the terminal is done on logical unit LTERM which has been set to 4. The default for the terminal is 5 but in order to reduce task size it has been assigned to unit 4 in the task build command file. Note that this assignment can be changed to the system disk if TROPO is to be run in background and as such cannot access the terminal. If the disk is used, a file, FDR004.DAT, will be opened for the error messages normally sent to the terminal. Another option is to set LTERM to the same value as LERR in the block data section to have the messages in the same file.

1.5 PDP and IBM coding differences

Throughout this document PDP and IBM refer to versions of the program and not necessarily the computer it is running on. The PDP version was written using many of the features of PDP Fortran that allow SIGNATRON to revise the program easily. The IBM version is more universal since it is closer to ANSI Fortran, which allows it to run on other systems with fewer modifications. The following features are different in the source codes of the two versions:

input from common: routine but not given a new value.

* 12) Global variables All global variables possibly
output to common: given a new value by the
 routine.

All sections of the description, except those marked by a '*', are always present in all routine descriptions whether data follows the section or not.

1.3 Fortran IV-PLUS

TROPO is written in Fortran IV-PLUS; therefore, it is necessary that the program link to the Fortran IV-PLUS library. Though it is possible to compile and run under Fortran-77, the output is not guaranteed since Fortran-77 is not a strict superset of Fortran IV-PLUS and the differences in the versions may change the results.

1.4 Input and output units

The logical units the TROPO program reads from and writes to files whose associated logical unit numbers are variables passed through the common /LUNS/ in file LUNS.INC. The values are set in the block data section to:

Name	LUN	Purpose	File name
----	---	-----	-----
LIN	1	Input file	TROPO.DAT
LOUT	2	Output file	FOR002.DAT
LDEBUG	2	Output file	FOR002.DAT
LERR	2	Error file	FOR002.DAT
LSUM	3	Summary page	SUMPAG.OUT
LTERM	4	Error messages	<user's terminal>

Logical unit LIN is explicitly assigned to the file TROPO.DAT by the OPEN statement in subroutine INDATA.

LOUT is implicitly assigned to the file FOR002.DAT. The PDP-11/70 will assign the default name FOR00n.DAT to any file written to or read from on logical unit n which has not been opened previous to the read or write.

LDEBUG is always assigned to the output file and is present only to distinguish debug write statements from output write statements.

3.2 ERRIO

Subprogram name: Subroutine ERRIO

Purpose: Outputs error number and error message to terminal (unit LTERM) and the output file FOR002.DAT (unit LOUT).

Description: Checking for input errors is done throughout TROPO but the messages written from this routine are for initial testing done in the input routines, INDATA, SECTOR, and UNITS. When a fatal error or data inconsistency is found, processing transfers to this subroutine. Most errors found are fatal so processing branches to line 500 to STOP after outputting the message; others are merely warnings and branch to 600 to return to the calling program and continue processing.

The errors are divided in the source code by calling routine so a check of the code or FORMAT statements reveals in which routine the error was encountered.

Note that for all error 999s the calling program has already printed an error message to the output file FOR002.DAT before calling ERRIO.

Calling sequence:
CALL ERRIO (I)

Contained in module: ERRIO

Called by: INDATA SECTOR UNITS

Calls: NONE

Input arguments:
I I*2 Error number.

Output arguments:
NONE

Global variables input from common:
LOUT /LUNS/ I*2 LUNS.INC
FOR002.DAT output unit number.

3.3 INDATA

Subprogram name: Subroutine INDATA

Purpose: This subroutine reads the data required for TROPO calculations from the input file TROPO.DAT.

Description: Each section in the source code of INDATA is identified by dashed lines around a section header which correspond with each section in the input file, TROPO.DAT.

There are three types of lines in the input file TROPO.DAT:

- 1) Sector header
- 2) Comment
- 3) Data

A sector header identifies the beginning of each section. Before INDATA reads a section of data, SECTOR searches for the sector header by reading lines until the first four letters match the section wanted. This feature makes the data in each section independent which is necessary when, for example, PTYPE = 0. In this case, INDATA reads in all the TROPOSCATTER data. The next section, DIFFRACTION, is only needed for PTYPE = 1. Since it contains data for some of the same variables just initialized, in order to preserve these values, SECTOR is called to search for the DIFFRACTION sector header which skips over these data lines. From this point INDATA goes on to read the diversity data.

A comment line describes the data that should follow, giving defaults and maximums in some cases. Each begins with a '*' to differentiate these lines from the sector headers. In the code, the statement: READ (LIN,1005) skips over the comment lines in the input file. The number of these reads corresponds to the number of comment lines preceding each data line in the input file.

Most data lines are read in list-directed. This type of read will read digits into the variable until a delimiter (space or comma) is found, eliminating the need for data to be lined up in specific columns as in formatted input. The data type is converted on input to the variable type so that integers may be input for reals. Two consecutive commas (or a leading or trailing comma) inputs no data into the corresponding variable, thus preserving its default value. A slash terminates input for all remaining items in the input list, also preserving their default values. Note, the slash cannot be used for logical or literal data.

Literal data is, in most cases, read into REAL*4 variables with an alpha format descriptor (of the form A(w)). This will put one character into each of the four bytes of the real as though it were a BYTE (LOGICAL*1) array of length four.

CAUTION! When adding new variables to the input file, do not insert them before the units section (HDU, ANGU, etc.) if the data is to be converted by UNITCV to and from MKS units. In subsequent runs, the call to UNITCV comes immediately after these units are deciphered so all values in common are treated as though in MKS units.

Calling sequence:

CALL INDATA (JPOW,ASEP,CLIMAT,BWT,BWR,PTYPE,JBW,TRCTYP,FJSEP)

Contained in module: INDATA

Called by: TROPO

Calls: ANTGEO ERRIO OUTDAT SECTOR UNITS

Input arguments:

NONE

Output arguments:

JPOW	R*8	Interference signal power density in dKm/Hz .
ASEP	R*4	Separation between receive antennas in meters.
CLIMAT	R*4	Climate zone indicator.
BWT	R*4	Transmit antenna beamwidth in degrees.
BWR	R*4	Receive antenna beamwidth in degrees.
PTYPE	I*2	Variable which indicates whether propagation mechanism is pure troposcatter (0 or 10) or mixed troposcatter-diffraction (1 or 11).
JBW	R*8	Interfering signal bandwidth in Hz.
TRCTYP	R*4	TRC-170 modem type indicator: 0 = 1 frequency DAK modem 1 = 2 frequency AN/TRC-170
FJSEP	R*4	Frequency separation between desired signal and interference signal in Hertz.

Global variables input from common:

A0	/CONSTA/	R*4	CONSTANTS.INC
			Radius of the earth in meters = 6367650.
C0	/CONSTA/	R*4	CONSTANTS.INC
			Free space velocity of radio waves = 2.998E8 m/sec.
CHTFFT	/CONSTA/	R*4	CONSTANTS.INC
			Meters per foot = 0.3048.
GHZ	/UNIT/	R*4	IODATA.INC
			String 'GHz' for units output.
KM	/UNIT/	R*4	IODATA.INC
			String 'km' for units output.
LERR	/LUNS/	I*2	LUNS.INC
			Error output unit.
MDIST	/ERAD/	I*2	ERAD.INC

Multipath distribution indicator.

0 = Only median multipath spread used(default)

1 = Multipath distribution used. (Option not currently available.)

MHZ /UNIT/ R*4 IODATA.INC
Strings 'MHz ' for units output.
UDIST /UNIT/ R*4 IODATA.INC
Units of distance (smi, nmi, km).
UFREQ /UNIT/ R*4 IODATA.INC
Units of frequency (GHz, MHz).

Global variables output to common:

A /PATHGE/ R*4 TROCOM.INC
Effective earth radius in meters.
ACALC /IODATA/ L*4 IODATA.INC
TRUE if the angles PSITE0 and PSIRE0 are calculated rather than read in.
AR(NRMX) /ANTENN/ R*4 TROCOM.INC
Array of receiver antenna diameters in meters. AR(1) is equivalent to RDIAM in the input file.
AT(NTMX) /ANTENN/ R*4 TROCOM.INC
Array of transmitter antenna diameters in meters. AT(1) is equivalent to TDIAM in the input file.
AVERX /MCOM4/ R*4 MCOM.INC
Average terrain elevation above sea level between receive site and radio horizon, in meters.
AVETX /MCOM4/ R*4 MCOM.INC
Average terrain elevation above sea level between transmit site and radio horizon, in meters.
BW /SYSTRN/ R*4 TROCOM.INC
Bandwidth in Hertz. Default is 7 MHz.
CHGHR /IODATA/ L*4 IODATA.INC
HR set to AR(1) if TRUE.
CHGHR /IODATA/ L*4 IODATA.INC
HRE set to HR if TRUE.
CHGHT /IODATA/ L*4 IODATA.INC
HT set to AT(1) if TRUE.
CHGHT /IODATA/ L*4 IODATA.INC
HTE set to HT if TRUE.
CN2(NPROF) /PROPAR/ R*4 TROCOM.INC
The atmospheric structure constant height profile in meters to the -2/3 power.
CODE /MCOM4/ L*4 MCOM.INC
Flag for coding.
D /PATHGE/ R*4 TROCOM.INC
Great circle distance between transmitter and receiver measured at sea level in meters.
DELH /PROPAR/ R*4 TROCOM.INC
Spacing of CN2 samples in meters.
DEMIN /CURVE/ R*4 CURVE.INC

User supplied minima of the 90th percentile
variability curve, Y0(90).
/MCOM2/ I*2 MCOM.INC
Diversity configuration indicator. Default is 0.
0 = 2 receive antennas; 2S 2S/2F 2S/2A 2S/2A/2F
1 = 1 receive antenna; 2A 2F 2F/2A
2 = 2 transmit,
2 receive antennas; 2S/2P 2S/2P/2A
3 = Not used
4 = User supplied parameters
S = Space F = Frequency A = Angle P = Polarization
DL(3) /MCOM4/ R*4 MCOM.INC
Array contains distance from each obstacle to
transmitter in meters.
DLR /PATHGE/ R*4 TROCOM.INC
Distance from receiver to radio horizon in meters.
DLT /PATHGE/ R*4 TROCOM.INC
Distance from transmitter to radio horizon in meters.
DRATE /MCOM4/ R*4 MCOM.INC
Data rate in bits/second. Default is 6.6E6.
DS(3) /MCOM4/ R*4 MCOM.INC
Array of effective obstacle extents along the great
circle path in meters.
ELANG(10) /MCOM4/ R*4 MCOM.INC
Interferer elevation angles in degrees. Default is 0.
EOF /CONTRL/ L*4 TROCOM.INC
End of TROPO.DAT file found if TRUE.
ERFAC /PROPAR/ R*4 TROCOM.INC
Yearly median value of effective earth radius factor k
in kilometers. Default is 1.33.
ERR /CONTROL/ R*4 TROCOM.INC
Common volume integration resolution. Default is .001.
F /SYSTRN/ R*4 TROCOM.INC
Operating frequency in Hz. Model is accurate between
100MHz and 10GHz.
FCRX /BUTPAR/ R*4 BUTPAR.INC
Normalized JdB cut-off frequency of receiver filter.
FCTX /BUTPAR/ R*4 BUTPAR.INC
Normalized JdB cut-off frequency of transmitter
filter.
GPF /CURVE/ R*4 CURVE.INC
Frequency correction factor for user supplied 90th
percentile variability curve. Default is 1.
HI(155) /MCOM4/ R*4 MCOM.INC
Array contains NPM(1) evenly-spaced terrain
elevation data (in meters) between transmitter and
first obstacle followed by NPM(2) evenly-spaced
terrain elevation data between first and second
obstacle, etc., ending with NPM(NOBS+1) evenly-spaced
terrain elevation data between last obstacle and

receive site. The data should be selected such that:
HI(1) = Terrain elevation above sea level at
transmit site (HTO).
HI(NPM(I)) = HI (NPM(I)+1) = Elevation of Ith
obstacle above sea level (HL(I)).
HI(NPM(NOBS+1)) = Terrain elevation above sea
level at receive site (HRO).

In MDTs, HI is used as work space. It is equivalenced
to local arrays.

HL(3) /MCOM4/ R*4 MCOM.INC
Array contains elevation of each obstacle above sea
level in meters. HL(1) is elevation of transmitter
radio horizon HLT. HL(NOBS) is elevation of receiver
radio horizon HLR.

HLAV(3) /MCOM4/ R*4 MCOM.INC
Array contains average terrain elevation at each
diffraction point in meters.

HLEF(3) /MCOM4/ R*4 MCOM.INC
Array contains effective height of obstacles above
average terrain elevation in meters.

HLOW /PROPAR/ R*4 TROCOM.INC
Lowest height above sea level at which CN2 is
specified in meters.

HLR /PATHGE/ R*4 TROCOM.INC
Receiver radio horizon elevation above sea level in
meters.

HLT /PATHGE/ R*4 TROCOM.INC
Transmit radio horizon elevation above sea level in
meters.

HRE /MCOM4/ R*4 MCOM.INC
Effective receiver antenna height above average
terrain elevation in meters.

HRN /PATHGE/ R*4 TROCOM.INC
Receive antenna height above sea level in meters.

HTE /MCOM4/ R*4 MCOM.INC
Effective transmitter antenna height above average
terrain elevation in meters.

HTN /PATHGE/ R*4 TROCOM.INC
Transmit antenna height above sea level in meters.

IBR(NRMX,NRMX) /SYSTRN/ I*2 TROCOM.INC
Channel complex-envelope correlation and
cross-correlation calculation indicator array.
0 = No calculation
1 = Power (correlation) calculation only
2 = Power (correlation) per unit delay
spectrum calculation

IBW /MCOM2/ I*2 MCOM.INC
Switch indicating type of RF bandwidth constraint to
be used on desired signal. Default is 0.
0 = No RF filtering

1 = Filter determined from 99% bandwidth constraint
2 = Filter chosen to meet FCC Mask. (FCC-19311)
3 = Filters are user specified

ICLINE /MCOM2/ I#2 MCOM.INC
Climate class. Default is 0.
0 = NBS TN-101 climate
1 = MIL-HDBK-417 climate
2 = New, user-supplied climate

IFILRX /BUTPAR/ I#2 BUTPAR.INC
Receiver filter indicator.
0 = MD-918 receiver filter. Also means
filter is a Butterworth cascaded with a
rectangular impulse response filter of
duration equal to symbol duration.
1 = (not allowed)
2 = AN/TRC-170 receiver filter. Also means
filter is a Butterworth.

IFILTX /BUTPAR/ I#2 BUTPAR.INC
Transmitter filter indicator.
0 = MD-918 transmitter filter. Also means
filter is a Butterworth cascaded with a
rectangular impulse response filter of
duration equal to symbol duration.
1 = AN/TRC-170 transmitter filter. Also means
filter is a cascade of Butterworth filter
with rectangular impulse response filter
of duration equal to half symbol duration.
2 = (not allowed)

IOPEND /CONTRL/ I#2 TROCOM.INC
Number of output files opened.

IPOLR(NRMX) /ANTENN/ I#2 TROCOM.INC
Array of receiver antenna polarizations.

IPOLT(NTMX) /ANTENN/ I#2 TROCOM.INC
Array of transmitter antenna polarizations.

ITOFF /PROPAR/ I#2 TROCOM.INC
Control indicator for entry or calculation of
transmit/receive radio horizon angles THET and THER.
Values have following meanings:
0 = Use input THET, THER as reference and
actual horizon (default).
1 = Calculate reference horizon using MORANG
and K equals 1.33. (Assuming DLT and OLR
are non-zero.) (Option not available.)
2 = Calculate reference horizon using MORANG
and K equals ERFAC. (Assuming DLT and DLR
are non-zero.)
3 = Do not change reference horizons from
previous run. (Option not available.)

KLIMAT /PROPAR/ I#2 TROCOM.INC
Climate zone indicator. Default is 0.

0 = User supplied climate

NBS TN101 climates

- 1 = Continental temperate (CT)
- 2 = Maritime temperate overland (MTL)
- 3 = Maritime temperate oversea (MTS)
- 4 = Maritime subtropical overland (MSL)
- 5 = Continental temperate time block 2 (CT2)
(winter afternoon hours) - formerly
Maritime subtropical oversea (MSS)

6 = Desert, Sahara (DS)

7 = Equatorial (EQU)

8 = Continental subtropical (CS)

MIL-HDRK-417 climates

- 9 = Continental temperate (CT)
- 10 = Maritime temperate overland (MTL)
- 11 = Maritime temperate oversea (MTS)
- 12 = Maritime subtropical (MS)
- 13 = Desert, Sahara (DS)
- 14 = Equatorial (EQU)
- 15 = Continental subtropical (CS)
- 16 = Mediterranean (MED)
- 17 = Polar (POL)

KPROF /PROPAR/ I*2 TROCOM.INC
Actual number of samples in height profile of
structure constant CN2. Limited to NPROF samples.

LIN /LUNS/ I*2 LUNS.INC
TROPO.DAT input unit number.

LINKNO /IODATA/ I*2 IODATA.INC
Link number.

LISI /MCOM2/ I*2 MCOM.INC
Number of future Intersymbol Interference (ISI)
contributors considered in MD-918 performance
calculation. Default is 2.

LNAME(20) /IODATA/ I*2 IODATA.INC
Link name. Transmitter site first, receiver site
second. Used as link identifier on output files
FOR002.DAT and SUMPAG.OUT.

MANG /MCOM2/ I*2 MCOM.INC
Number of values of interferer azimuth/elevation pairs
(JANG) for which outage calculations are to be made.
Default is 1.

MLAST /PDATA/ I*2 PDATA.INC
Number of simulator taps. Default is 16.

MODPAT /MCOM2/ I*2 MCOM.INC
Propagation/modem flag to select calculation mode.
Default is 1.

- 0 = Propagation only
- 1 = Propagation + MD-918 modem
- 2 = Propagation + AN/TRC-170 or IAR modem
- 3 = Propagation + user-defined modem

MODSIG /MCOM2/ I*2 MCOM.INC
Interference signal modulation format. Default is 1.
0 = Analog FDM / FM
1 = Digital QPSK

MRAD /ERAD/ I*2 ERAD.INC
Loop limit for MRAD. Default is 1.
(MRAD is 1 for MDIST = 0 and MRAD is 3 for MDIST = 1).

NACCU /CONTRL/ I*2 TROCOM.INC
Parameter used as truncation point for common
volume integration termination. Default is 40.

NANG /RI2/ I*2 RI2.INC
NANG is 1 if there is angle diversity (default).

NCLIME /MCOM2/ I*2 MCOM.INC
Flag set to 1 if ICLIME equals 2.

NERT /MCOM2/ I*2 MCOM.INC
Bit error rate threshold indicator for yearly fade
outage probability calculation. Default is 2.
0 = All three thresholds
1 = For 10^{*-3} only
2 = For 10^{*-4} only
3 = For 10^{*-5} only

NEWCL(4) /MCOM2/ I*2 MCOM.INC
New climate type character string.

NFIG /MCOM4/ R*4 MCOM.INC
Receiver noise figure in dB. Default is 4dB.

NOBS /MCOM2/ I*2 MCOM.INC
Number of diffraction obstacles. Maximum is 3,
default is 1.

NPH(5) /MCOM2/ I*2 MCOM.INC
Array contains number of terrain elevation data
points for calculation of effective antenna heights
for each section of the diffraction path.

NPOLRX /BUTPAR/ R*4 BUTPAR.INC
Number of poles in the receive Butterworth filter.

NPOLTX /BUTPAR/ I*2 BUTPAR.INC
Number of poles in the transmit Butterworth filter.

NR /SYSTRN/ I*2 TROCOM.INC
Number of receive ports.

NT /SYSTRN/ I*2 TROCOM.INC
Number of transmit ports.

NTERR /MCOM2/ I*2 MCOM.INC
Control parameter for entry or calculation of
effective antenna heights (HTE, HRE) and effective
obstacle heights above average terrain elevation
(HLEF).
0 = HTE and HRE supplied directly
1 = AVEIX and AVERX supplied
2 = HI(.) supplied

PHDIV /MCOM4/ R*4 MCOM.INC
Sawnt angle between upper and lower receiver beams in

radians. Default is beamwidth.

PSIRAO(NRMX) /ANTENN/ R*4 TROCOM.INC
Array of receiver beam azimuths in radians.

PSIREO(NRMX) /ANTENN/ R*4 TROCOM.INC
Array of receiver beam boresight elevations above radio horizon in radians, ie, angle at which each antenna is aimed relative to the horizon. PSIREO(1) is the main receive antenna.

PSITAO(NTMX) /ANTENN/ R*4 TROCOM.INC
Array of transmitter beam azimuths in radians.

PSITEO(NTMX) /ANTENN/ R*4 TROCOM.INC
Array of transmitter beam boresight elevations above radio horizon in radians, ie, angle at which each antenna is aimed relative to the horizon. PSITEO(1) is the main transmit antenna.

PULSE /RZ/ I*2 RZ.INC
Switch controllins MD-918 pulse shape after transmitter-receiver filterins.
PULSE = 0 Triangle
 = 1 OQPSK matched filter
 = 2 Sinc pulse, bandwidth equal to 1
 = 5 RF filtering included
Set to 0 if IBW = 0 or KGAIN > 1.
Set to 5 if IBW > 0 and KGAIN = 1.

PXMIT /MCOM4/ R*4 MCOM.INC
Rated transmission power in dBm. Default is 70dBm.

RLL /SYSTRN/ R*4 TROCOM.INC
Receiver line losses in dB. Default is 0 dB.

RSEP(3) /IOWATA/ R*4 IOWATA.INC
Separation between receive antennas.

SCPARM /PROPAR/ R*4 TROCOM.INC
Wavenumber spectrum slope parameter M. Default is 3.66.

SEAN /PROPAR/ R*4 TROCOM.INC
Minimum monthly median of refractivity at sea level. Used to calculate ERFAC if non-zero.

SP /MCOM4/ R*4 MCOM.INC
Service probability. Default is .95.

SPE /PDATA/ R*4 PDATA.INC
Tap spacins in nanoseconds. Default is 67 nsec.

SUPRES /IOWATA/ L*4 IOWATA.INC
Supress long output in SUMPAG if true.
Set to TRUE if PIYPE > 9.

TAPOUT /PDATA/ L*4 PDATA.INC
If true, the simulator tap values are output to the output file, FOR002.DAT. Default is TRUE.

TAPW /MCOM4/ R*4 MCOM.INC
Normalized tapwidth for MD-918. Default is .5.
Range is 0.25 through 1.0

TERFAC(3) /ERAD/ R*4 ERAD.INC

The three values of ERFAC when MDIST is 1.
THER /PATHGE/ R*4 TROCOM.INC
 Radio horizon elevation angle at receive site in
 radians.
THET /PATHGE/ R*4 TROCOM.INC
 Radio horizon elevation angle at transmit site in
 radians.
TLL /SYSTRN/ R*4 TROCOM.INC
 Transmitter line losses in dB. Default is 0 dB.
TSEP(3) /IODATA/ R*4 IODATA.INC
 Separation between transmit antennas in meters.
URH(NR) /PATHGE/ R*4 TROCOM.INC
 Array of receive antennas horizontal offsets from
 great circle plane in meters.
URL(NR) /PATHGE/ R*4 TROCOM.INC
 Array of receive antennas longitudinal offsets in
 meters.
URV(NR) /PATHGE/ R*4 TROCOM.INC
 Array of receive antennas vertical offsets in meters.
UTH(NT) /PATHGE/ R*4 TROCOM.INC
 Array of transmit antennas horizontal offsets in
 meters.
UTL(NT) /PATHGE/ R*4 TROCOM.INC
 Array of transmit antennas longitudinal offsets in
 meters.
UTV(NT) /PATHGE/ R*4 TROCOM.INC
 Array of transmit antennas vertical offsets in meters.
WAVLEN /SYSTRN/ R*4 TROCOM.INC
 Wavelength in meters.
WLT /SYSTRN/ R*4 TROCOM.INC
 Rated transmission power in Watts. Default is 1000 W.
XANG(10) /MCOM4/ R*4 MCOM.INC
 Interferer azimuth angles in degrees. Default is 0.
Y900 /CURVE/ R*4 CURVE.INC
 User supplied value for 90th percentile variability
 curve Y0(90) for DE greater than or equal 900 km.
 Used only when ICLIME is 2. Used to compute the
 equation for the Y0(90) curve fit.
YMIN /CURVE/ R*4 CURVE.INC
 User supplied value for 90th percentile variability
 curve Y0(90) for DE equal to DEMIN. Used only when
 ICLIME is 2. Used to compute the equation for the
 Y0(90) curve fit.

3.4 OUTDAT

Subprogram name: Subroutine OUTDAT

Purpose: Outputs to the output file, FUR002.DAT, parameters read from the input file TROPO.DAT as well as parameters calculated from these in INDATA, UNITS and ANTGEO.

Description: Most numeric values are printed with decimal points lined up. To make formatting easier, the T format is used to place the decimal point in the 57th position. The column to tab to is 57 - the number of integer places, ie, for an I7 format tab to column 50: ...F50,I7.... Therefore the following formulas can be used to calculate x:

Integer	Iw or Iw.m	57 - w
Floating point	Fw.m	57 - (w - (m+1))
Exponential	Ew.m	57 - (w - (m+5))
Exponential	Ew.mEe	57 - (w - (m+e+3))

where x is the value to use wherever Tx will be used.

Calling sequence:
CALL OUTDAT (CLIMAT,ASEP,JPOW,BWT,BWR,HTO,HRO,HT,HR,PTYPE,
JBW,FJSEP,TRCTYP)

Contained in module: OUTDAT

Called by: INDATA

Calls: NONE

Input arguments:

CLIMAT	R*4	Climate zone indicator.
ASEP	R*4	Separation between receive antennas in meters.
JPOW	R*8	Interference signal power density in dBm/Hz.
BWT	R*4	Transmit antenna beamwidth in degrees.
BWR	R*4	Receive antenna beamwidth in degrees.
HTO	R*4	Transmit site elevation above sea level.
HRO	R*4	Receive site elevation above sea level.
HT	R*4	Transmit antenna height above ground.
HR	R*4	Receive antenna height above ground.
PTYPE	I*2	Variable which indicates whether propagation mechanism is pure troposcatter (0 or 10) or mixed troposcatter-diffraction (1 or 11).
JBW	R*8	Interfering signal bandwidth in Hz.
FJSEP	R*4	Frequency separation between signal and interferer in Hz.
TRCTYP	R*4	TRC-170 modem type indicator: 0 = 1 frequency DAR modem 1 = 2 frequency AN/TRC-170 modem

outine OUTDAT

Output arguments:

NONE

Global variables input from common:

ACALC /IODATA/ L*4 IODATA.INC
TRUE if the angles PSITE0 and PSIRE0 are calculated rather than read in.

AR(NRMX) /ANTENN/ R*4 TROCOM.INC
Array of receiver antenna diameters in meters. AR(1) is equivalent to RDIAM in the input file.

AT(NTMX) /ANTENN/ R*4 TROCOM.INC
Array of transmitter antenna diameters in meters. AT(1) is equivalent to YDIAM in the input file.

AVERX /MCOM4/ R*4 MCOM.INC
Average terrain elevation above sea level between receive site and radio horizon, in meters.

AVETX /MCOM4/ R*4 MCOM.INC
Average terrain elevation above sea level between transmit site and radio horizon, in meters.

BW /SYSTRN/ R*4 TROCOM.INC
Bandwidth in Hertz. Default is 7 MHz.

CHGHR /IODATA/ L*4 IODATA.INC
HR set to AR(1) if TRUE.

CHGHRE /IODATA/ L*4 IODATA.INC
HRE set to HR if TRUE.

CHGHT /IODATA/ L*4 IODATA.INC
HT set to AT(1) if TRUE.

CHGHTe /IODATA/ L*4 IODATA.INC
HTE set to HT if TRUE.

CN2(NPROF) /PROPAR/ R*4 TROCOM.INC
The atmospheric structure constant height profile in meters to the -2/3 power.

D /PATHGE/ R*4 TROCOM.INC
Great circle distance between transmitter and receiver measured at sea level in meters.

DEG /UNIT/ R*4 IODATA.INC
String 'deg' for units output.

DELH /PROPAR/ R*4 TROCOM.INC
Spacing of CN2 samples in meters.

DEMIN /CURVE/ R*4 CURVE.INC
User supplied minima of the 90th percentile variability curve, Y0(90).

DIVTYP /MCOM2/ I*2 MCOM.INC
Diversity configuration indicator. Default is 0.
0 = 2 receive antennas; 2S 2S/2F 2S/2A 2S/2A/2F
1 = 1 receive antenna; 2A 2F 2F/2A
2 = 2 transmit,
 2 receive antennas; 2S/2P 2S/2P/2A
3 = Not used

4 = User supplied parameters
S = Space F = Frequency A = Angle P = Polarization

DL(3) /MCOM4/ R*4 MCOM.INC
Array containing distance from each obstacle to transmitter in meters.

DLR /PATHGE/ R*4 TROCOM.INC
Distance from receiver to radio horizon in meters.

DLT /PATHGE/ R*4 TROCOM.INC
Distance from transmitter to radio horizon in meters.

DRATE /MCOM4/ R*4 MCOM.INC
Data rate in bits/second. Default is 6.6E6.

DS(3) /MCOM4/ R*4 MCOM.INC
Array of effective obstacle extents along the great circle path in meters.

ELANG(10) /MCOM4/ R*4 MCOM.INC
Interferer elevation angles in degrees. Default is 0.

ERFAC /PROPAR/ R*4 TROCOM.INC
Yearly median value of effective earth radius factor k in kilometers. Default is 1.33.

ERR /CONTROL/ R*4 TROCOM.INC
Common volume integration resolution. Default is .001.

F /SYSTRN/ R*4 TROCOM.INC
Operating frequency in Hz. Model is accurate between 100MHz and 10GHz.

FT /UNIT/ R*4 IODATA.INC
String 'ft ' for units output.

GHZ /UNIT/ R*4 IODATA.INC
String 'GHz ' for units output.

HI(155) /MCOM4/ R*4 MCOM.INC
Array containing NPM(1) evenly-spaced terrain elevation data (in meters) between transmitter and first obstacle followed by NPM(2) evenly-spaced terrain elevation data between first and second obstacle, etc., ending with NPM(NOBS+1) evenly-spaced terrain elevation data between last obstacle and receive site. The data should be selected such that:
HI(1) = Terrain elevation above sea level at transmit site (HT0).
HI(NPM(I)) = HI (NPM(I)+1) = Elevation of Ith obstacle above sea level (HL(I)).
HI(NPM(NOBS+1)) = Terrain elevation above sea level at receive site (HR0).
In MDTs, HI is used as work space. It is equivalenced to local arrays.

HL(3) /MCOM4/ R*4 MCOM.INC
Array containing elevation of each obstacle above sea level in meters. HL(1) is elevation of transmitter radio horizon HLT. HL(NOBS) is elevation of receiver radio horizon HLR.

HLAV(3) /MCOM4/ R*4 MCOM.INC

CHAPTER 4

ERROR UTILITIES

This section describes the data checking and error handling routines:

Name	Description	User's Manual section
----	-----	-----
CHKDAT	Check data	2.2
ERROR	Error message output	2.3, 3.4.3
SUBID	Subprogram output identifier .	NA

CHKDAT is only a preliminary data checking routine. More testing is done throughout TROPO, ERROR being called when a warning is to be printed or when a fatal error has been found. ERROR writes oth to the user's terminal and the error output file FOR002.DAT, units LTERM and LERR. FOR002.DAT is described in section 3.4.3 of the User's Manual.

NOTE

In most cases the sections in the User's Manual describe the coded equations as well as the theory behind them. NA denotes routines that are programming utilities such as finding indices, setting pointers, etc.

outine UNITS

3.7 UNITS

Subprogram name: Subroutine UNITS

Purpose: Determine combination of measurement units requested by the user. UNITS sets LUNITS to a unique number for the combination of distance (statute miles, nautical miles, kilometers), height/diameter (feet, meters), angle (degrees, milliradians), and frequency (Gigahertz, Megahertz). LUNITS is used in subroutines OUTDAT and SUMPAG to output data in the user's units and in UNITCV to convert back and forth to MKS units.

Calling sequence:
CALL UNITS

Contained in module: UNITS

Called by: INDATA

Calls: ERRIO

Input arguments:
NONE

Output arguments:
NONE

Global variables input from common:

DEG	/UNIT/	R*4	IODATA.INC
	String 'deg' for units		output.
FT	/UNIT/	R*4	IODATA.INC
	String 'ft' for units		output.
GHZ	/UNIT/	R*4	IODATA.INC
	String 'GHz' for units		output.
KM	/UNIT/	R*4	IODATA.INC
	String 'km' for units		output.
LERR	/LUNS/	I*2	LUNS.INC
	Error output unit.		
MET	/UNIT/	R*4	IODATA.INC
	String 'met' for units		output.
MHZ	/UNIT/	R*4	IODATA.INC
	String 'MHz' for units		output.
MRADNS	/UNIT/	R*4	IODATA.INC
	String 'mrad' for units		output.
NMI	/UNIT/	R*4	IODATA.INC
	String 'nmi' for units		output.
SMI	/UNIT/	R*4	IODATA.INC
	String 'smi' for units		output.

Global variables output to common:

antenna is aimed relative to the horizon. PSIRE0(1)
is the main receive antenna.

PSITAO(NTHX) /ANTENN/ R*4 TROCOM.INC
Array of transmitter beam azimuths in radians.

PSITE0(NTHX) /ANTENN/ R*4 TROCOM.INC
Array of transmitter beam boresight elevations above
radio horizon in radians, ie, angle at which each
antenna is aimed relative to the horizon. PSITE0(1)
is the main transmit antenna.

THER /PATHGE/ R*4 TROCOM.INC
Radio horizon elevation angle at receive site in
radians.

THET /PATHGE/ R*4 TROCOM.INC
Radio horizon elevation angle at transmit site in
radians.

THETA0 /PATHGE/ R*4 TROCOM.INC
Scattering angle at bottom of common volume in
radians.

URH(NR) /PATHGE/ R*4 TROCOM.INC
Array of receive antennas horizontal offsets from
great circle plane in meters.

URL(NR) /PATHGE/ R*4 TROCOM.INC
Array of receive antennas longitudinal offsets in
meters.

URV(NR) /PATHGE/ R*4 TROCOM.INC
Array of receive antennas vertical offsets in meters.

UTH(NT) /PATHGE/ R*4 TROCOM.INC
Array of transmit antennas horizontal offsets in
meters.

UTL(NT) /PATHGE/ R*4 TROCOM.INC
Array of transmit antennas longitudinal offsets in
meters.

UTV(NT) /PATHGE/ R*4 TROCOM.INC
Array of transmit antennas vertical offsets in meters.

Y1 /PATHGE/ R*4 TROCOM.INC
Maximum estimated integration length in Y-direction.

HI(NPH(NOBS+1)) = Terrain elevation above sea level at receive site (HRO).

In MDTS, HI is used as work space. It is equivalenced to local arrays.

HL(3)	/MCOM4/	R*4	MCOM.INC	Array contains elevation of each obstacle above sea level in meters. HL(1) is elevation of transmitter radio horizon HLT. HL(NOBS) is elevation of receiver radio horizon HLR.
HLAV(3)	/MCOM4/	R*4	MCOM.INC	Array contains average terrain elevation at each diffraction point in meters.
HLEF(3)	/MCOM4/	R*4	MCOM.INC	Array contains effective height of obstacles above average terrain elevation in meters.
HLOW	/PROPAR/	R*4	TROCOM.INC	Lowest height above sea level at which CN2 is specified in meters.
HLR	/PATHGE/	R*4	TROCOM.INC	Receiver radio horizon elevation above sea level in meters.
HLT	/PATHGE/	R*4	TROCOM.INC	Transmit radio horizon elevation above sea level in meters.
HRE	/MCOM4/	R*4	MCOM.INC	Effective receiver antenna height above average terrain elevation in meters.
HRN	/PATHGE/	R*4	TROCOM.INC	Receive antenna height above sea level in meters.
HTE	/MCOM4/	R*4	MCOM.INC	Effective transmitter antenna height above average terrain elevation in meters.
HTN	/PATHGE/	R*4	TROCOM.INC	Transmit antenna height above sea level in meters.
PHDIV	/MCOM4/	R*4	MCOM.INC	Squint angle between upper and lower receiver beams in radians. Default is beamwidth.
PHI	/PATHGE/	R*4	TROCOM.INC	Diffraction angle in radians.
PHIR	/PATHGE/	R*4	TROCOM.INC	Receive angular distance to minimum scattering point in radians.
PHIT	/PATHGE/	R*4	TROCOM.INC	Transmit angular distance to minimum scattering point in radians.
PSIRAO(NRMX)	/ANTENN/	R*4	TROCOM.INC	Array of receiver beam azimuths in radians.
PSIREO(NRMX)	/ANTENN/	R*4	TROCOM.INC	Array of receiver beam boresight elevations above radio horizon in radians, ie, angle at which each

BETA0 /PATHGE/ R*4 TROCOM.INC
Minimum receive antenna elevation angle measured from
receiver-to-transmitter line to receiver horizon line
in radians.

BETA1 /PATHGE/ R*4 TROCOM.INC
Maximum receive antenna elevation angle measured from
receiver-to-transmitter line to top of common volume
in radians.

D /PATHGE/ R*4 TROCOM.INC
Great circle distance between transmitter and receiver
measured at sea level in meters.

DELH /PROPAR/ R*4 TROCOM.INC
Spacing of CN2 samples in meters.

DL(3) /MCOM4/ R*4 MCOM.INC
Array containing distance from each obstacle to
transmitter in meters.

DLR /PATHGE/ R*4 TROCOM.INC
Distance from receiver to radio horizon in meters.

DLT /PATHGE/ R*4 TROCOM.INC
Distance from transmitter to radio horizon in meters.

DR /PATHGE/ R*4 TROCOM.INC
Receiver distance to minimum scattering point in
meters.

DS(3) /MCOM4/ R*4 MCOM.INC
Array of effective obstacle extents along the great
circle path in meters.

DT /PATHGE/ R*4 TROCOM.INC
Transmit antenna distance to minimum scattering point
in meters.

F /SYSTRN/ R*4 TROCOM.INC
Operating frequency in Hz. Model is accurate between
100MHz and 10GHz.

HCOM /PATHGE/ R*4 TROCOM.INC
Effective height of the bottom of the common volume in
meters.

HHIGH /PATHGE/ R*4 TROCOM.INC
Effective height of the top of the common volume in
meters.

HI(155) /MCOM4/ R*4 MCOM.INC
Array containing NPM(1) evenly-spaced terrain
elevation data (in meters) between transmitter and
first obstacle followed by NPM(2) evenly-spaced
terrain elevation data between first and second
obstacle, etc., ending with NPM(NOBS+1) evenly-spaced
terrain elevation data between last obstacle and
receive site. The data should be selected such that:
HI(1) = Terrain elevation above sea level at
transmit site (HTO).
HI(NPM(I)) = HI(NPM(I)+1) = Elevation of Ith
obstacle above sea level (HL(I)).

Integer value that specifies the set of units requested by the user. These units are for path, antenna location, angle, and frequency parameters. Default is 8. The given units are defined by bit values of LUNITS:

Bit no.	Meaning of value 0 / 1
0	english / metric
1	statute miles / nautical miles
2	feet / meters
3	grad / degrees
4	GHz / MHz

Valid LUNITS values are

0 :	stat. miles	-	feet	-	milliradians	-	GHz
1 :	kilometers	-	meters	-	milliradians	-	GHz
2 :	naut. miles	-	feet	-	milliradians	-	GHz
8 :	stat. miles	-	feet	-	degrees	-	GHz
9 :	kilometers	-	meters	-	degrees	-	GHz
10:	naut.miles	-	feet	-	degrees	-	GHz
16:	stat. miles	-	feet	-	milliradians	-	MHz
17:	kilometers	-	meters	-	milliradians	-	MHz
18:	naut. miles	-	feet	-	milliradians	-	MHz
24:	stat. miles	-	feet	-	degrees	-	MHz
25:	kilometers	-	meters	-	degrees	-	MHz
26:	naut. miles	-	feet	-	degrees	-	MHz

NR	/SYSTRN/	I*2	TROCOM.INC
			Number of receive ports.
NT	/SYSTRN/	I*2	TROCOM.INC
			Number of transmit ports.

Global variables output to common:

ALFA0	/PATHGE/	R*4	TROCOM.INC
			Minimum transmit antenna elevation angle measured from transmitter-to-receiver line to transmit horizon line in radians.
ALFA1	/PATHGE/	R*4	TROCOM.INC
			Maximum transmit antenna elevation angle measured from transmitter-to-receiver line to top of common volume in radians.
AR(NRMX)	/ANTENN/	R*4	TROCOM.INC
			Array of receiver antenna diameters in meters. AR(1) is equivalent to RDIAM in the input file.
AT(NTMX)	/ANTENN/	R*4	TROCOM.INC
			Array of transmitter antenna diameters in meters. AT(1) is equivalent to TDIAM in the input file.
AVERX	/MCOM4/	R*4	MCOM.INC
			Average terrain elevation above sea level between receive site and radio horizon, in meters.
AVETX	/MCOM4/	R*4	MCOM.INC
			Average terrain elevation above sea level between transmit site and radio horizon, in meters.

3.6 UNITCV

Subprogram name: Subroutine UNITCV

Purpose: UNITCV converts data to MKS units if the argument is positive and converts from MKS units to input units (those requested by the user in the input file, TROPO.DAT) if the argument is negative. This allows the user freedom to input in desired units and see the output in the same units but still allow the program to run with the units it expects. MKS units are: meters for height, distance and elevation, seconds for time, radians for angles, and Hz for the operating frequency. Bandwidths and data rates are not converted.

Calling sequence:
CALL UNITCV (IDIR)

Contained in module: UNITCV

Called by: INDATA, SUMPAG

Calls: ERROR

Input arguments:
IDIR I*2 Directive flag:
>0 Convert to MKS units.
<0 Convert to user's units.

Output arguments:
NONE

Global variables input from common:

CDEGR	/CONSTA/	R*4	CONSTANTS.INC
			Radians per degree = 0.017453293.
CE3	/CONSTA/	R*4	CONSTANTS.INC
			1 X 10**3 = 1000.
CHTPFT	/CONSTA/	R*4	CONSTANTS.INC
			Meters per foot = 0.3048.
CHTPHI	/CONSTA/	R*4	CONSTANTS.INC
			Meters per statute mile = 1609.344
CHTPNM	/CONSTA/	R*4	CONSTANTS.INC
			Meters per nautical mile = 1852.
IDM	/UNIT/	I*2	IODATA.INC
			0 if degrees, 1 if milliradians.
IME	/UNIT/	I*2	IODATA.INC
			0 if metric units, 1 if English.
IMG	/UNIT/	I*2	IODATA.INC
			0 if MHz, 1 if GHz.
INS	/UNIT/	I*2	IODATA.INC
			0 if nautical miles, 1 if statute miles.
LUNITS	/UNIT/	I*2	IODATA.INC

3.5 SECTOR

Subprogram name: Subroutine SECTOR

Purpose: Search for a section header.

Description: SECTOR searches for a section header in the input file TROPO.DAT by reading lines until the first four characters on the line match the string passed in Y.

Calling sequence:
CALL SECTOR (Y, X)

Contained in module: INDATA

Called by: INDATA

Calls: ERRIO

Input arguments:
Y R*4 Word to search for.

Output arguments:
X R*4 Word found.

Global variables input from common:
LERR /LUNS/ I*2 LUNS.INC
Error output unit.

Global variables output to common:
LIN /LUNS/ I*2 LUNS.INC
TROPO.DAT input unit number.

INPUT
Subroutine OUTDAT

Page 3-24

- 2 = Calculate reference horizon using MORANG and K equals ERFAC. (Assuming DLT and DLR are non-zero.)
- 3 = Do not change reference horizons from previous run. (Option not available.)

characters.

UANGLE	/UNIT/	R*4	IODATA.INC	Units of angle (deg, rad).
UDIST	/UNIT/	R*4	IODATA.INC	Units of distance (smi, nmi, km).
UFREQ	/UNIT/	R*4	IODATA.INC	Units of frequency (GHz, MHz).
UHITE	/UNIT/	R*4	IODATA.INC	Units of height and diameter (ft, m).
URH(NR)	/PATHGE/	R*4	TROCOM.INC	Array of receive antennas horizontal offsets from great circle plane in meters.
URL(NR)	/PATHGE/	R*4	TROCOM.INC	Array of receive antennas longitudinal offsets in meters.
URV(NR)	/PATHGE/	R*4	TROCOM.INC	Array of receive antennas vertical offsets in meters.
UTH(NT)	/PATHGE/	R*4	TROCOM.INC	Array of transmit antennas horizontal offsets in meters.
UTL(NT)	/PATHGE/	R*4	TROCOM.INC	Array of transmit antennas longitudinal offsets in meters.
UTV(NT)	/PATHGE/	R*4	TROCOM.INC	Array of transmit antennas vertical offsets in meters.
WLT	/SYSTRN/	R*4	TROCOM.INC	Rated transmission power in Watts. Default is 1000 W.
XANG(10)	/MCOM4/	R*4	MCOM.INC	Interferer azimuth angles in degrees. Default is 0.
Y900	/CURVE/	R*4	CURVE.INC	User supplied value for 90th percentile variability curve Y0(90) for DE greater than or equal 900 km. Used only when ICLIME is 2. Used to compute the equation for the Y0(90) curve fit.
YMIN	/CURVE/	R*4	CURVE.INC	User supplied value for 90th percentile variability curve Y0(90) for DE equal to DENIN. Used only when ICLIME is 2. Used to compute the equation for the Y0(90) curve fit.

Global variables output to common:

ITOFF	/PROPAR/	I*2	TROCOM.INC	Control indicator for entry or calculation of transmit/receive radio horizon angles THET and THER. Values have following meanings: 0 = Use input THET, THER as reference and actual horizon (default). 1 = Calculate reference horizon using MORANG and K equals 1.33. (Assuming DLT and DLR are non-zero.) (Option not available.)
-------	----------	-----	------------	---

effective antenna heights (HTE, HRE) and effective
obstacle heights above average terrain elevation
(HLEF).

0 = HTE and HRE supplied directly

1 = AVEFX and AVERX supplied

2 = HI(.) supplied

PHDIV /MCOM4/ R*4 MCOM.INC
Squint angle between upper and lower receiver beams in
radians. Default is beamwidth.

PSIRAO(NRHX) /ANTENN/ R*4 TROCOM.INC
Array of receiver beam azimuths in radians.

PSIREO(NRHX) /ANTENN/ R*4 TROCOM.INC
Array of receiver beam boresight elevations above
radio horizon in radians, ie, angle at which each
antenna is aimed relative to the horizon. PSIREO(1)
is the main receive antenna.

PSITAO(NTHX) /ANTENN/ R*4 TROCOM.INC
Array of transmitter beam azimuths in radians.

PSITEO(NTHX) /ANTENN/ R*4 TROCOM.INC
Array of transmitter beam boresight elevations above
radio horizon in radians, ie, angle at which each
antenna is aimed relative to the horizon. PSITEO(1)
is the main transmit antenna.

PXMIT /MCOM4/ R*4 MCOM.INC
Rated transmission power in dBm. Default is 70dBm.

RLL /SYSTRN/ R*4 TROCOM.INC
Receiver line losses in dB. Default is 0 dB.

SCPARM /PROPAR/ R*4 TROCOM.INC
Wavenumber spectrum slope parameter M. Default is
3.66.

SEAN /PROPAR/ R*4 TROCOM.INC
Minimum monthly median of refractivity at sea level.
Used to calculate ERFAC if non-zero.

SMI /UNIT/ R*4 IODATA.INC
String 'smi' for units output.

SP /MCOM4/ R*4 MCOM.INC
Service probability. Default is .95.

TAPW /MCOM4/ R*4 MCOM.INC
Normalized tapwidth for MD-918. Default is .5.
Range is 0.25 through 1.0

THER /PATHGE/ R*4 TROCOM.INC
Radio horizon elevation angle at receive site in
radians.

THET /PATHGE/ R*4 TROCOM.INC
Radio horizon elevation angle at transmit site in
radians.

TLL /SYSTRN/ R*4 TROCOM.INC
Transmitter line losses in dB. Default is 0 dB.

TODAY(9) /TSTAMP/ L*1 IODATA.INC
Array used in PDP-11 version to hold date as

MODPAT /COM2/ I*2 MCOM.INC
Propagation/modem flag to select calculation mode.
Default is 1.
 0 = Propagation only
 1 = Propagation + MD-918 modem
 2 = Propagation + AN/TRC-170 or DAR modem
 3 = Propagation + user-defined modem

MODSIG /COM2/ I*2 MCOM.INC
Interference signal modulation format. Default is 1.
 0 = Analog FDM / FM
 1 = Digital QPSK

HRADNS /UNIT/ R*4 IOWDATA.INC
String 'hrad' for units output.

NACCU /CONTRL/ I*2 TROCOM.INC
Parameter used as truncation point for common
volume integration termination. Default is 40.

NCLINE /COM2/ I*2 MCOM.INC
Flag set to 1 if ICLINE equals 2.

NERT /COM2/ I*2 MCOM.INC
Bit error rate threshold indicator for yearly fade
outage probability calculation. Default is 2.
 0 = All three thresholds
 1 = For 10**(-3) only
 2 = For 10**(-4) only
 3 = For 10**(-5) only

NEWCL(4) /COM2/ I*2 MCOM.INC
New climate type character strings.

NFIG /COM4/ R*4 MCOM.INC
Receiver noise figure in dB. Default is 4dB.

NMI /UNIT/ R*4 IOWDATA.INC
String 'nmi' for units output.

NOBS /COM2/ I*2 MCOM.INC
Number of diffraction obstacles. Maximum is 3,
default is 1.

NOW(8) /TSTAMP/ L*1 IOWDATA.INC
Array used in PDP-11/70 version to hold time of day as
characters.

NPH(5) /COM2/ I*2 MCOM.INC
Array contains number of terrain elevation data
points for calculation of effective antenna heights
for each section of the diffraction path.

NR /SYSTRN/ I*2 TROCOM.INC
Number of receive ports.

NT /SYSTRN/ I*2 TROCOM.INC
Number of transmit ports.

NTAP /COM2/ I*2 MCOM.INC
Number of adaptive forward equalizer taps (AFE) in
MD-918 modem. Set to 3 in IOWDATA.

NTERR /COM2/ I*2 MCOM.INC
Control parameter for entry or calculation of

1 = Interferer covariance matrix calculation
done in subroutine JAMCOM

KM /UNIT/ R#4 IODATA.INC
Strings 'km' for units output.

KPROF /PROPAR/ I#2 TROCOM.INC
Actual number of samples in height profile of
structure constant CN2. Limited to NPROF samples.

LISI /MCOM2/ I#2 MCOM.INC
Number of future Intersymbol Interference (ISI)
contributors considered in MD-918 performance
calculation. Default is 2.

LNAME(20) /IODATA/ I#2 IODATA.INC
Link name. Transmitter site first, receiver site
second. Used as link identifier on output files
FOR002.DAT and SUMPAG.OUT.

LOUT /LUNS/ I#2 LUNS.INC
FOR002.DAT output unit number.

LUNITS /UNIT/ I#2 IODATA.INC
Integer value that specifies the set of units
requested by the user. These units are for path,
antenna location, angle, and frequency parameters.
Default is 8. The seven units are defined by bit
values of LUNITS:

Bit no.	Meaning of value 0 / 1
0	english / metric
1	statute miles / nautical miles
2	feet / meters
3	rad / degrees
4	GHz / MHz

Valid LUNITS values are

0 :	stat. miles	- feet	- milliradians	- GHz
1 :	kilometers	- meters	- milliradians	- GHz
2 :	naut. miles	- feet	- milliradians	- GHz
8 :	stat. miles	- feet	- degrees	- GHz
9 :	kilometers	- meters	- degrees	- GHz
10:	naut. miles	- feet	- degrees	- GHz
16:	stat. miles	- feet	- milliradians	- MHz
17:	kilometers	- meters	- milliradians	- MHz
18:	naut. miles	- feet	- milliradians	- MHz
24:	stat. miles	- feet	- degrees	- MHz
25:	kilometers	- meters	- degrees	- MHz
26:	naut. miles	- feet	- degrees	- MHz

MANG /MCOM2/ I#2 MCOM.INC
Number of values of interferer azimuth/elevation pairs
(JANG) for which outage calculations are to be made.
Default is 1.

MET /UNIT/ R#4 IODATA.INC
String 'met' for units output.

MHZ /UNIT/ R#4 IODATA.INC
String 'MHz' for units output.

Array contains average terrain elevation at each diffraction point in meters.
HLEF(3) /MCOM4/ R*4 MCOM.INC
Array contains effective height of obstacles above average terrain elevation in meters.
HLOW /PROPAR/ R*4 TROCOM.INC
Lowest height above sea level at which CN2 is specified in meters.
HLR /PATHGE/ R*4 TROCOM.INC
Receiver radio horizon elevation above sea level in meters.
HLT /PATHGE/ R*4 TROCOM.INC
Transmit radio horizon elevation above sea level in meters.
HRN /PATHGE/ R*4 TROCOM.INC
Receive antenna height above sea level in meters.
HTE /MCOM4/ R*4 MCOM.INC
Effective transmitter antenna height above average terrain elevation in meters.
HTN /PATHGE/ R*4 TROCOM.INC
Transmit antenna height above sea level in meters.
IBR(NRMX,NRMX) /SYSTRN/ I*2 TROCOM.INC
Channel complex-envelope correlation and cross-correlation calculation indicator array.
0 = No calculation
1 = Power (correlation) calculation only
2 = Power (correlation) per unit delay spectrum calculation
IBW /MCOM2/ I*2 MCOM.INC
Switch indicating type of RF bandwidth constraint to be used on desired signal. Default is 0.
0 = No RF filtering
1 = Filter determined from 99% bandwidth constraint
2 = Filter chosen to meet FCC Mask. (FCC-19311)
3 = Filters are user specified
ICLIME /MCOM2/ I*2 MCOM.INC
Climate class. Default is 0.
0 = NBS TN-101 climate
1 = MIL-HDBK-417 climate
2 = New, user-supplied climate
IPOLR(NRMX) /ANTENN/ I*2 TROCOM.INC
Array of receiver antenna polarizations.
IPOLT(NTMX) /ANTENN/ I*2 TROCOM.INC
Array of transmitter antenna polarizations.
JFILT /MCOM2/ I*2 MCOM.INC
Interference covariance matrix calculation indicator. Only used when IBW equals 0; otherwise ignored. Default is 0.
0 = Interferer covariance matrix calculation done in subroutine BOTAC

4.1 CHKDAT

Subprogram name: Subroutine CHKDAT

Purpose: Performs a preliminary check of the validity of the data read from the input file TROPO.DAT. Array bounds, path symmetry, and validity of the specified correlations (through the array IBR) are verified. Further checking is done throughout TROPO.

Calling sequence:
CALL CHKDAT

Contained in module: CHKDAT

Called by: TROPO

Calls: ERROR

Input arguments:
NONE

Output arguments:
NONE

Global variables input from common:

AR(NRMX)	/ANTENN/	R*4	TROCOM.INC	Array of receiver antenna diameters in meters. AR(1) is equivalent to RDIAM in the input file.
AT(NTMX)	/ANTENN/	R*4	TROCOM.INC	Array of transmitter antenna diameters in meters. AT(1) is equivalent to TBIAM in the input file.
IBR(NRMX,NRMX)	/SYSTRN/	I*2	TROCOM.INC	Channel complex-envelope correlation and cross-correlation calculation indicator array. 0 = No calculation 1 = Power (correlation) calculation only 2 = Power (correlation) per unit delay spectrum calculation
NR	/SYSTRN/	I*2	TROCOM.INC	Number of receive ports.
NRMX	Parameter	I*2	TROPAR.INC	Maximum number of receive ports.
NT	/SYSTRN/	I*2	TROCOM.INC	Number of transmit ports.
NTMX	Parameter	I*2	TROPAR.INC	Maximum number of transmit ports.
PSIRAO(NRMX)	/ANTENN/	R*4	TROCOM.INC	Array of receiver beam azimuths in radians.
PSIREO(NRMX)	/ANTENN/	R*4	TROCOM.INC	Array of receiver beam boresight elevations above

radio horizon in radians, ie, angle at which each antenna is aimed relative to the horizon. PSIRE0(1) is the main receive antenna.

PSITA0(NTHX) /ANTENN/ R*4 TROCOM.INC
Array of transmitter beam azimuths in radians.

PSITE0(NTHX) /ANTENN/ R*4 TROCOM.INC
Array of transmitter beam boresight elevations above radio horizon in radians, ie, angle at which each antenna is aimed relative to the horizon. PSITE0(1) is the main transmit antenna.

URH(NR) /PATHGE/ R*4 TROCOM.INC
Array of receive antennas horizontal offsets from great circle plane in meters.

URL(NR) /PATHGE/ R*4 TROCOM.INC
Array of receive antennas longitudinal offsets in meters.

URV(NR) /PATHGE/ R*4 TROCOM.INC
Array of receive antennas vertical offsets in meters.

UTH(NT) /PATHGE/ R*4 TROCOM.INC
Array of transmit antennas horizontal offsets in meters.

UTL(NT) /PATHGE/ R*4 TROCOM.INC
Array of transmit antennas longitudinal offsets in meters.

UTV(NT) /PATHGE/ R*4 TROCOM.INC
Array of transmit antennas vertical offsets in meters.

4.2 ERROR

Subprogram name: Subroutine ERROR

Purpose: Outputs error number and error message to terminal (unit LTERM) and the output file FOR002.DAT (unit LOUT).

Description: Checking for input errors is done throughout TROPD. When a fatal error or data inconsistency is found, processing transfers to subroutine ERROR. Most errors found are fatal so processing branches to line 500 to STOP after outputting the message; others are merely warnings and branch to 600 to return to the calling program and continue processing.

The errors are divided in the source code by calling routine so a check of the code or FORMAT statements reveals in which routine the error was encountered.

Note that for all error 999s the calling program has already printed an error message to the output file FOR002.DAT before calling ERROR.

Calling sequence:
CALL ERROR (I)

Contained in module: ERROR

Called by:	ANTPAR	ATMOS	CHANGE	CHKDAT	CLIME	CLIMIL	CLIMIX	DEIND
	LOOPS	MATA	MDIF	MDTS	ORDER	RIPROF	SIGIN	SQTMAT
	TRANSF	TRCIN	TRLOSS	UNITCV	UNITS			SUMPAG

Calls: NONE

Input arguments:
I I#2 Error number.

Output arguments:
NONE

Global variables input from common:
LOUT /LUNS/ I#2 LUNS.INC
FOR002.DAT output unit number.

4.3 SUBID

Subprogram name: Subroutine SUBID

Purpose: Subroutine to identify blocks of output or output variables by writing 'SNAME', the subprogram printing such output, to logical unit, LOUT.

Call sequence:
CALL SUBID (SNAME)

Contained in module: SUBID

Called by:

Calls: NONE

Input arguments:
SNAME R*8 Name of subprogram to output.

Output arguments:
NONE

Global variables input from common:
LOUT /LUNS/ I*2 LUNS.INC
FOR002.DAT output unit number.

CHAPTER 5

TROPOSCATTER CALCULATIONS

This section describes the tropospheric scatter calculation routines:

Name	Description	User's Manual section

ANTPAR	Antenna parameters	2.5.2.1
ANTPTR	Antenna pointers	NA
ATMOS	Atmospheric absorption calculations	2.5.2.4
AVTER	Average terrain height	2.5.4.7
BEAMPT	Beam pointers	NA
DELO	Delay	NA
ERFC	Complimentary error function .	NA
FRQSEP	Frequency separation	2.5.6.3
GPATT	Voltage gain pattern	2.5.2.1
HORANG	Horizon elevation angles . . .	NA
INTLIM	Integration limits	2.5.2.2
LOOPS	Main routine for common volume integration	2.5.6.1
LTCORR	Long term variability correction factor	2.5.7
POWER	Long term RSL and SNR distribution	2.5, 2.5.4.6
RGAIN	Receive antenna voltage gain pattern	2.5.2
RIPROF	Structure constant profile calculation	2.5.2.3
STEPAB	Step size of alpha and beta . .	NA
STEPI	Step size of Y	NA
STPPAR	Step size parameters	NA
TGAIN	Transmit antenna voltage gain pattern	2.5.2
TRANSF	Transform angles and distances	2.5.2, 2.5.2.2
TRLOSS	Theoretical calculation of basic pathloss	NA

The main routines for this section are LOOPS and POWER. The troposcatter calculations are described in section 2.5 of the User's Manual.

Figure 2-2 is a top level flowchart for troposcatter propagation parameter calculations at a functional level. In most cases the blocks correspond to one or more subprograms. The test blocks (diamonds) correspond to logical branches which are decided by the user's choices of input data.

NOTE

In most cases the sections in the User's Manual describe the coded equations as well as the theory behind them. NA denotes routines that are programming utilities such as finding indices, setting pointers, etc.

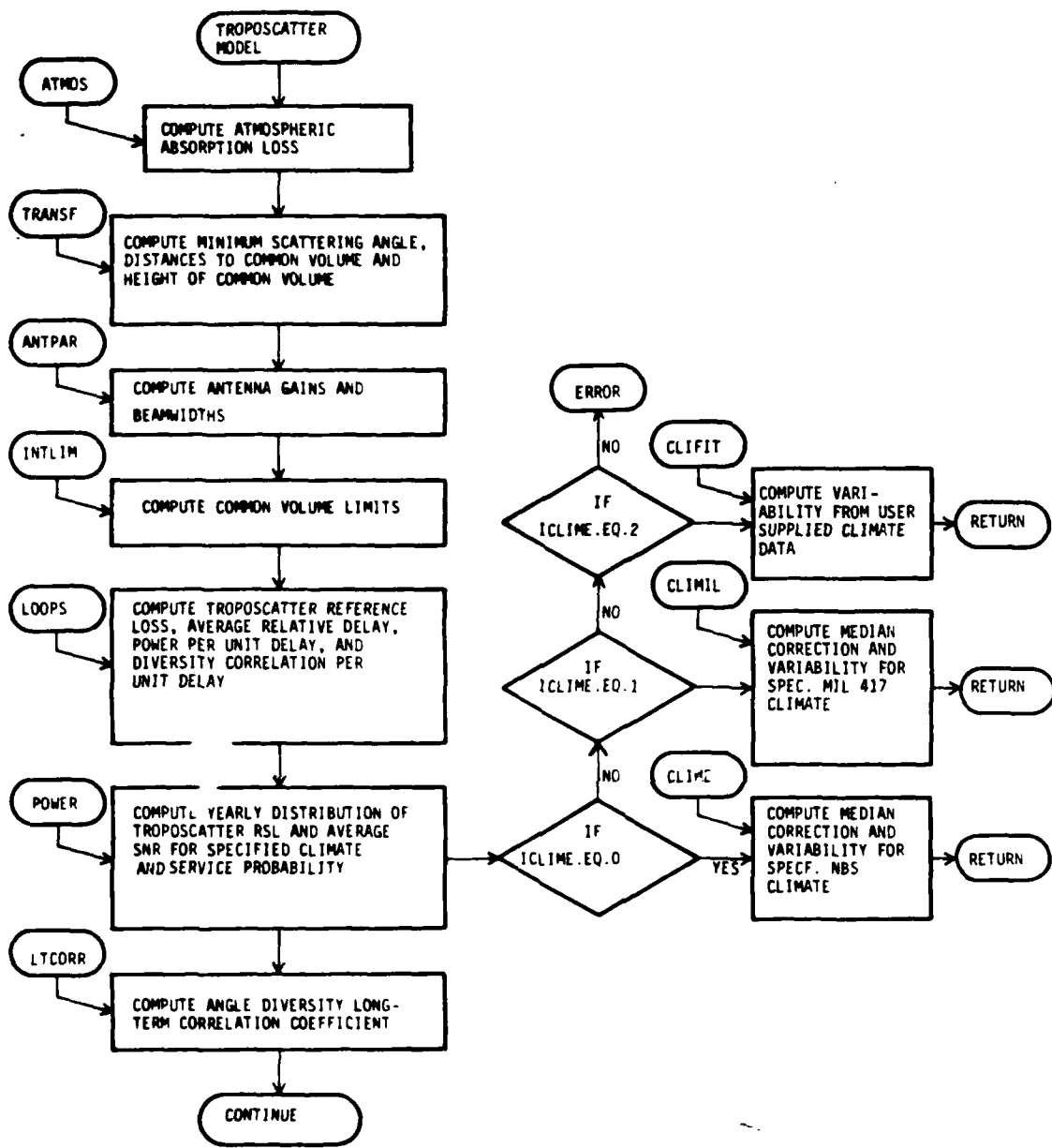

Figure 2-2 Flow Chart for Troposcatter Propagation Parameter Calculations

5.1 ANTPAR

Subprogram name: Subroutine ANTPAR

Purpose: For NPORT>0 ANTPAR returns the gain in dB of transmit antenna number NPORT and the 3dB half-beamwidth in radians. For NPORT<0 the values are for receive beam number -NPORT.

Calling sequence:
CALL ANTPAR (NPORT,GDB,DEL)

Contained in module: ANTPAR

Called by: TROPO

Calls: ERROR

Input arguments:
NPORT I*2 Antenna number.

Output arguments:
GDB R*4 Gain of requested antenna in dB.
DEL R*4 3dB half-beamwidth in radians.

Global variables input from common:

AR(NRMX)	/ANTENN/	R*4	TROCOM.INC	Array of receiver antenna diameters in meters. AR(1) is equivalent to RDIAM in the input file.
AT(NTMX)	/ANTENN/	R*4	TROCOM.INC	Array of transmitter antenna diameters in meters. AT(1) is equivalent to TDIAM in the input file.
NRMX	Parameter	I*2	TROPAR.INC	Maximum number of receive ports.
NTMX	Parameter	I*2	TROPAR.INC	Maximum number of transmit ports.
WAVLEN	/SYSTRN/	R*4	TROCOM.INC	Wavelength in meters.

5.2 ANTPTR

Subprogram name: Subroutine ANTPTR

Purpose: Set up pointers to distinct antenna locations to avoid duplication of operations in the critical parts of LOOPS.

Calling sequence:
CALL ANTPTR (NPORTS, UH, UV, UL, NANT, LOC)

Contained in module: ANTPTR

Called by: LOOPS, SUMPAG

Calls: NONE

Input arguments:

NPORTS	I*2	Number of transmit or receive ports.
UH(NPORTS)	R*4	Horizontal offsets of antennas.
UV(NPORTS)	R*4	Vertical offsets of antennas.
UL(NPORTS)	R*4	Longitudinal offsets of antennas.

Output arguments:

NANT	I*2	Number of distinct antenna locations.
LOC(NPORTS)	I*2	Pointers to location of antenna.

5.3 ATMOS

Subprogram name: Subroutine ATMOS

Purpose: Calculate atmospheric attenuation AA in dB for a troposcatter/
diffraction path of length D in meters at frequency F in Hz. D must be
less than 500 km and F must be less than 35 GHz.

Callings sequence:
CALL ATMOS

Contained in module: ATMOS

Called by: TROPO

Calls: ERROR

Input arguments:
NONE

Output arguments:
NONE

Global variables input from common:

D	/PATHGE/	R*4	TROCOM.INC
			Great circle distance between transmitter and receiver measured at sea level in meters.
F	/SYSTRN/	R*4	TROCOM.INC
			Operating frequency in Hz. Model is accurate between 100MHz and 10GHz.

Global variables output to common:

AA	/PROPAR/	R*4	TROCOM.INC
			Atmospheric absorption loss in dB.

5.4 AVTER

Subprogram name: Subroutine AVTER

Purpose: Routine to calculate average terrain height above sea level at TWO terminal points 1 and 2 given NP evenly spaced terrain elevation data points between them by fitting a straight line to terrain data.

Calling sequence:
CALL AVTER (H1AV,H2AV,HI,NP,X0,X20,D)

Contained in module: AVTER

Called by: DIFSNR, POWER

Calls: NONE

Input arguments:

HI(NP)	R*4	Array of NP evenly spaced terrain elevations in meters above sea level.
NP	I*2	Number of data points used to calculate average heights.
X0	R*4	Distance of first terrain height data point from terminal point 1 in meters.
X20	R*4	Distance of last terrain height point from terminal 1 in meters.
D	R*4	Distance between terminal points 1 and 2 in meters.

Output arguments:

H1AV	R*4	Average terrain height at terminal 1 in meters.
H2AV	R*4	Average terrain height at terminal 2 in meters.

5.5 BEAMPT

Subprogram name: Subroutine BEAMPT

Purpose: Set up pointers to distinct receive antenna beams to avoid duplication of operations in the critical parts of LOOPS. The pointers are used in LOOPS to calculate angle diversity correlations for a troposcatter receiver.

Calling sequence:

CALL BEAMPT (NPORTS, PSIE, PSIA, NBEAM, IBEAM, JBEAM)

Contained in module: BEAMPT

Called by: LOOPS

Calls: NONE

Input arguments:

NPORTS	I*2	Number of transmit or receive ports.
PSIE(NPORTS)	R*4	Beam boresight elevations above radio horizon.
PSIA(NPORTS)	R*4	Beam azimuths.

Output arguments:

NBEAM	I*2	Number of distinct beams.
IBEAM(NPORTS)	I*2	Pointers to antenna ports from beam number. IBEAM(I) identifies the lowest numbered port with antenna pattern number I.
JBEAM(NPORTS)	I*2	Pointers to beam number from antenna port. JBEAM(I) is the antenna pattern of antenna port number I.

5.6 DELO

Subprogram name: Subroutine DELO

Purpose: Calculates the delay, relative to DC, from the transmitter to a scattering point to the receiver. The scattering point is characterized by ALFA, BETA, and DC. This delay value is used in the LOOPS integration for the calculation of the delay profile.

Calling sequence:
CALL DELO (ALFA, BETA, DC, DEL)

Contained in module: DELO

Called by: LOOPS

Calls: NONE

Input arguments:

ALFA	R*4	Angle between the transmitter-receiver line and the transmitter-scatterer line in radians.
BETA	R*4	Angle between the receiver-transmitter line and the receiver-scatterer line in radians.
DC	R*4	Delay between transmitter and receiver (straight line, free space) in seconds.

Output arguments:

DEL	R*4	Transmitter-scatter-receiver delay less the minimum delay DC in seconds.
-----	-----	--

5.7 ERFC

Subprogram name: Function ERFC

Purpose: Complimentary error function approximation.

Reference: Abramowitz and Stegun, Handbook of Mathematical Functions,
1968, p. 299, 7.1.26.

Calling sequence:
ERFC (X,XLIMIT)

Contained in module: ERFC

Called by: CLIMIX DIFSNR PAVERG POUTAG POWER

Calls: NONE

Input arguments:

X	R*4	Lower limit on integration.
XLIMIT	R*4	Cut-off limit on argument beyond which the function value is zero.

Output arguments:

ERFC	R*4	Complimentary error function approximation.
------	-----	---

5.14 POWER

Subprogram name: Subroutine POWER

Purpose: Calculates the long term RSL distribution of the troposcatter signal for the specified climate type. It also calculates and prints out the long term distribution of the SNR per diversity branch for a desired service probability.

Calling sequence:

CALL POWER (JPOW,ASEP,TAU22,TAU23,RH1,ELOSS,ASNR,BWT,BWR, PTYPE)

Contained in module: POWER

Called by: TROPO

Calls: AVTER CLIME CLIMIL CLIMIX ERFC

Input arguments:

JPOW	R*8	Interference signal power density in dBm/Hz.
ASEP	R*4	Separation between receive antennas in meters.
PTYPE	I*2	Variable which indicates whether propagation mechanism is pure troposcatter (0 or 10) or mixed troposcatter-diffraction (1 or 11).
BWT	R*4	Transmit antenna beamwidth in degrees.
BWR	R*4	Receive antenna beamwidth in degrees.

Output arguments:

ELOSS	R*8	Upper beam squint loss for scatter component in dB or sidelobe loss for interference.
TAU22	R*8	Delay spread on lower beam in nsec.
TAU23	R*8	Delay spread on upper beam in nsec.
RH1	R*8	Correlation coefficient between lower and upper beam.
ASNR	R*4	Median and/or yearly average value of troposcatter signal SNR in dB.

Global variables input from common:

AA	/PROPAR/	R*4	TROCOM.INC	Atmospheric absorption loss in dB.
ALFAO	/PATHGE/	R*4	TROCOM.INC	Minimum transmit antenna elevation angle measured from transmitter-to-receiver line to transmit horizon line in radians.
BETAO	/PATHGE/	R*4	TROCOM.INC	Minimum receive antenna elevation angle measured from receiver-to-transmitter line to receiver horizon line in radians.
BW	/SYSTRM/	R*4	TROCOM.INC	Bandwidth in Hertz. Default is 7 MHz.
C	/PDATA/	R*4	PDATA.INC	

PHDIV Error output unit.
 /MCOM4/ R*4 MCOM.INC
 Squint angle between upper and lower receiver beams in
 radians. Default is beamwidth.

THER /PATHGE/ R*4 TROCOM.INC
 Radio horizon elevation angle at receive site in
 radians.

THETA0 /PATHGE/ R*4 TROCOM.INC
 Scattering angle at bottom of common volume in
 radians.

Global variables output to common:

CORRLT /CPLOSS/ R*4 CPL.INC
 Correlation coefficient for long term variability of
 lower and upper beams.

5.13 LTCORR

Subprogram name: Subroutine LTCORR

Purpose: Computes correction factor for SNR due to decorrelation of long term variability between upper and lower beams. (Angle diversity only.)

Calling sequence:
CALL LTCORR (CORFAC)

Contained in module: LTCORR

Called by: TROPO

Calls: NONE

Input arguments:
NONE

Output arguments:
CORFAC R*4 Correction factor computed by LTCORR. CORFAC is used in subroutine BERCAL to scale SFSNR multiplicatively when angle diversity is used.

Global variables input from common:

A	/PATHGE/	R*4	TROCOM.INC	Effective earth radius in meters.
ALFAO	/PATHGE/	R*4	TROCOM.INC	Minimum transmit antenna elevation angle measured from transmitter-to-receiver line to transmit horizon line in radians.
D	/PATHGE/	R*4	TROCOM.INC	Great circle distance between transmitter and receiver measured at sea level in meters.
DIVTYP	/MCOM2/	I*2	MCOM.INC	Diversity configuration indicator. Default is 0. 0 = 2 receive antennas; 2S 2S/2F 2S/2A 2S/2A/2F 1 = 1 receive antenna; 2A 2F 2F/2A 2 = 2 transmit, 2 receive antennas; 2S/2P 2S/2P/2A 3 = Not used 4 = User supplied parameters S = Space F = Frequency A = Angle P = Polarization
MCOM	/PATHGE/	R*4	TROCOM.INC	Effective height of the bottom of the common volume in meters.
HRN	/PATHGE/	R*4	TROCOM.INC	Receive antenna height above sea level in meters.
LERR	/LUNS/	I*2	LUNS.INC	

```
Q(.,7) Power on diffraction path vs. delay
For DIVTYP = 1:
  Q(.,1) Power on lower beam vs. delay.
  Q(.,2) Correlation between lower and
         upper beam vs. delay.
  Q(.,3) Power on upper beam vs. delay
  Q(.,7) Power on diffraction path vs. delay.
For DIVTYP = 2:
  Q(.,1) Power on path 1 (lower beam) vs. delay.
  Q(.,2) Correlation between convergent paths
         (lower beam) vs. delay.
  Q(.,3) Correlation between divergent paths
         (lower beam) vs. delay.
  Q(.,4) Correlation between parallel paths
         (lower beam) vs. delay.
  Q(.,5) Correlation between crossing paths
         (lower beam) vs. delay.
  Q(.,6) Power on path of upper beam vs. delay.
  Q(.,7) Power on diffraction path vs. delay.
QCORR(NCORMX) /PDATA/      R*4      PDATA.INC
Contains elements of covariance matrix, ie, powers and
correlations.
For DIVTYP = 0:
  QCORR(1) Power on lower beam
  QCORR(2) Correlation coefficient between lower
         and upper beam.
  QCORR(3) Correlation coefficient between lower
         beams of antennas 1 and 2
  QCORR(4) Power on upper beam.
For DIVTYP = 1:
  QCORR(1) Power on lower beam
  QCORR(2) Correlation coefficient between lower
         and upper beam.
  QCORR(3) Power on upper beam.
For DIVTYP = 2:
  QCORR(1) Power on path 1 (lower beam)
  QCORR(2) Correlation coefficient between convergent
         paths.
  QCORR(3) Correlation coefficient between divergent
         paths.
  QCORR(4) Correlation coefficient between parallel
         paths.
  QCORR(5) Correlation coefficient between crossing
         paths.
  QCORR(6) Power on upper beam.
TEMPA(NCORMX) /PDATA/      R*4      PDATA.INC
Array of average troposcatter signal delays for each
beam relative to straight line in seconds.
```

TROPOSCATTER CALCULATIONS
Subroutine LOOPS

Page 5-20

C /PDATA/ R*4 PDATA.INC
Proportionality constant in troposcatter path loss
calculation.

DELPB /PDATA/ R*4 PDATA.INC
Resolution of a delay cell in seconds.

FSEP /PDATA/ R*4 PDATA.INC
Frequency separation for uncorrelated frequency
diversity in Hz.

HCOM /PATHGE/ R*4 TROCOM.INC
Effective height of the bottom of the common volume in
meters.

I1CORR(NCORMX) /PDATA/ I*2 PDATA.INC
Array of receiving beams involved in the correlation
calculations.

I2CORR(NCORMX) /PDATA/ I*2 PDATA.INC
Array of receiving beams involved in the correlation
calculations.

IBLOSS(6) /CPLOSS/ I*2 CPL.INC
Beam number corresponding to CPL(I).

ICPL /CPLOSS/ I*2 CPL.INC
Coupling loss count.

INEG /PDATA/ I*2 PDATA.INC
Number of negative delay cells encountered in
troposcatter integration. It is an error if INEG > 0.

IPOS /PDATA/ I*2 PDATA.INC
Number of delay cells exceeding the last allocated
array element. This number should be zero or small.
IPOS > 0 is not a serious error unless the delay
profile calculated has a clear peak in the last delay
cell.

IPROF(NCORMX) /PDATA/ I*2 PDATA.INC
0 if the Ith correlation not wanted, 1 if wanted.

ITER /PDATA/ I*4 PDATA.INC
Number of integration cells in the common volume
integration.

NCORR /PDATA/ I*2 PDATA.INC
Number of receive port correlations.

PLOSSH /PDATA/ R*4 PDATA.INC
Troposcatter path loss from approximate analytic
expression.

Q(NDELMX,NCORMX) /PDATA/ R*4 PDATA.INC
Matrix of troposcatter signal power and correlation
per unit delay profiles.
For DIVTYP = 0:
 Q(.,1) Power on lower beam vs. delay.
 Q(.,2) Correlation between lower and
 upper beam vs. delay.
 Q(.,3) Correlation between lower beams
 in antennas 1 & 2 vs. delay.
 Q(.,4) Power on upper beam vs. delay.

Number of receive ports.
NT /SYSTRN/ I*2 TROCOM.INC
Number of transmit ports.
PSIRAO(NRMX) /ANTENN/ R*4 TROCOM.INC
Array of receiver beam azimuths in radians.
PSIREO(NRMX) /ANTENN/ R*4 TROCOM.INC
Array of receiver beam boresight elevations above
radio horizon in radians, ie, angle at which each
antenna is aimed relative to the horizon. PSIREO(1)
is the main receive antenna.
PSITAO(NTMX) /ANTENN/ R*4 TROCOM.INC
Array of transmitter beam azimuths in radians.
PSITEO(NTMX) /ANTENN/ R*4 TROCOM.INC
Array of transmitter beam boresight elevations above
radio horizon in radians, ie, angle at which each
antenna is aimed relative to the horizon. PSITEO(1)
is the main transmit antenna.
SCPARM /PROPAR/ R*4 TROCOM.INC
Wavenumber spectrum slope parameter M. Default is
3.66.
THET /PATHGE/ R*4 TROCOM.INC
Radio horizon elevation angle at transmit site in
radians.
THETAO /PATHGE/ R*4 TROCOM.INC
Scattering angle at bottom of common volume in
radians.
TWOPI /CONSTA/ R*4 CONSTANTS.INC
2 X Pi = 6.283185307.
URH(NR) /PATHGE/ R*4 TROCOM.INC
Array of receive antennas horizontal offsets from
great circle plane in meters.
URL(NR) /PATHGE/ R*4 TROCOM.INC
Array of receive antennas longitudinal offsets in
meters.
URV(NR) /PATHGE/ R*4 TROCOM.INC
Array of receive antennas vertical offsets in meters.
UTH(NT) /PATHGE/ R*4 TROCOM.INC
Array of transmit antennas horizontal offsets in
meters.
UTL(NT) /PATHGE/ R*4 TROCOM.INC
Array of transmit antennas longitudinal offsets in
meters.
UTV(NT) /PATHGE/ R*4 TROCOM.INC
Array of transmit antennas vertical offsets in meters.
WAVLEN /SYSTRN/ R*4 TROCOM.INC
Wavelength in meters.
Y1 /PATHGE/ R*4 TROCOM.INC
Maximum estimated integration length in Y-direction.

Global variables output to common:

Array of receiver antenna diameters in meters. AR(1) is equivalent to RDIAM in the input file.

BETA0 /PATHGE/ R*4 TROCOM.INC
Minimum receive antenna elevation angle measured from receiver-to-transmitter line to receiver horizon line in radians.

BETA1 /PATHGE/ R*4 TROCOM.INC
Maximum receive antenna elevation angle measured from receiver-to-transmitter line to top of common volume in radians.

BW /SYSTRN/ R*4 TROCOM.INC
Bandwidth in Hertz. Default is 7 MHz.

CO /CONSTA/ R*4 CONSTANTS.INC
Free space velocity of radio waves = 2.998E8 m/sec.

D /PATHGE/ R*4 TROCOM.INC
Great circle distance between transmitter and receiver measured at sea level in meters.

DELREF /PDATA/ R*4 PDATA.INC
Minimum delay through the lowest scattering point (relative to straight line delay) in seconds.

ERR /CONTROL/ R*4 TROCOM.INC
Common volume integration resolution. Default is .001.

HLOW /PROPAR/ R*4 TROCOM.INC
Lowest height above sea level at which CN2 is specified in meters.

HTN /PATHGE/ R*4 TROCOM.INC
Transmit antenna height above sea level in meters.

IBR(NRMX,NRMX) /SYSTRN/ I*2 TROCOM.INC
Channel complex-envelope correlation and cross-correlation calculation indicator array.
0 = No calculation
1 = Power (correlation) calculation only
2 = Power (correlation) per unit delay spectrum calculation

IPOLR(NRMX) /ANTENN/ I*2 TROCOM.INC
Array of receiver antenna polarizations.

IPOLT(NTMX) /ANTENN/ I*2 TROCOM.INC
Array of transmitter antenna polarizations.

KPROF /PROPAR/ I*2 TROCOM.INC
Actual number of samples in height profile of structure constant CN2. Limited to NPROF samples.

NACCU /CONTRL/ I*2 TROCOM.INC
Parameter used as truncation point for common volume integration termination. Default is 40.

NCORMX Parameter I*2 TROPAR.INC
Maximum number of correlations between receive ports.

NDELMX Parameter I*2 TROPAR.INC
Maximum number of delay bins in troposcatter power per unit delay profiles.

NR /SYSTRN/ I*2 TROCOM.INC

5.12 LOOPS

Subprogram name: Subroutine LOOPS

Purpose: This is the key routine performing the integration over the common volume to calculate received power vs. delay at all specified antenna ports and the convolutions between antenna ports vs. delay at all specified antenna ports.

Description: A certain amount of the code is keeping track of which antenna locations are different, es, space diversity; which antenna beams point differently, ie, angle diversity; which correlations involve space-, angle-, or polarization diversity. The number of correlations is NCORR, and for each correlation, ICORR, the arrays I1CORR and I2CORR point to the receiving ports involved in the integration of correlation number ICORR. An analytical path loss estimate, PLOSSM, is evaluated. Power levels and correlation coefficients are stored in the array QCORR. Average delay (normalized) and delay spread are in the arrays TEMPA and TEMPB. The frequency separation which corresponds to a frequency correlation coefficient of .5 is evaluated.

Calling sequence:
CALL LOOPS

Contained in module: LOOPS

Called by: TRCPU

Calls: ANTPTR, BEAMPT, DELO, ERROR, FRQSEP, RGAIN, RIPROF, SJNT,
STEPAB, STEPY, STPPAR, TGAIN, TRLOSS

Input arguments:
NONE

Output arguments:
NONE

Global variables input from common:

A	/PATHGE/	R*4	TROCOM.INC
			Effective earth radius in meters.
ALFA0	/PATHGE/	R*4	TROCOM.INC
			Minimum transmit antenna elevation angle measured from transmitter-to-receiver line to transmit horizon line in radians.
ALFA1	/PATHGE/	R*4	TROCOM.INC
			Maximum transmit antenna elevation angle measured from transmitter-to-receiver line to top of common volume in radians.
AR(NRMX)	/ANTENN/	R*4	TROCOM.INC

TROPOSCATTER CALCULATIONS
Subroutine INTLIM

Page 5-16

Y1

Diffraction angle in radians.
/PATHGE/ R*4 TROCOM.INC
Maximum estimated integration length in Y-direction.

ERR	/CONTROL/	R*4	TROCOM.INC	Common volume integration resolution. Default is .001.
HRN	/PATHGE/	R*4	TROCOM.INC	Receive antenna height above sea level in meters.
HTN	/PATHGE/	R*4	TROCOM.INC	Transmit antenna height above sea level in meters.
NR	/SYSTRN/	I*2	TROCOM.INC	Number of receive ports.
NT	/SYSTRN/	I*2	TROCOM.INC	Number of transmit ports.
PSIRAO(NRMX)	/ANTENN/	R*4	TROCOM.INC	Array of receiver beam azimuths in radians.
PSIREO(NRMX)	/ANTENN/	R*4	TROCOM.INC	Array of receiver beam boresight elevations above radio horizon in radians, ie, angle at which each antenna is aimed relative to the horizon. PSIREO(1) is the main receive antenna.
PSITAO(NTMX)	/ANTENN/	R*4	TROCOM.INC	Array of transmitter beam azimuths in radians.
PSITEO(NTMX)	/ANTENN/	R*4	TROCOM.INC	Array of transmitter beam boresight elevations above radio horizon in radians, ie, angle at which each antenna is aimed relative to the horizon. PSITEO(1) is the main transmit antenna.
SCFARM	/PROPAR/	R*4	TROCOM.INC	Wavenumber spectrum slope parameter M. Default is 3.66.
THER	/PATHGE/	R*4	TROCOM.INC	Radio horizon elevation angle at receive site in radians.
THET	/PATHGE/	R*4	TROCOM.INC	Radio horizon elevation angle at transmit site in radians.
THETA0	/PATHGE/	R*4	TROCOM.INC	Scattering angle at bottom of common volume in radians.

Global variables output to common:

ALFA1	/PATHGE/	R*4	TROCOM.INC	Maximum transmit antenna elevation angle measured from transmitter-to-receiver line to top of common volume in radians.
BETA1	/PATHGE/	R*4	TROCOM.INC	Maximum receive antenna elevation angle measured from receiver-to-transmitter line to top of common volume in radians.
HHIGH	/PATHGE/	R*4	TROCOM.INC	Effective height of the top of the common volume in meters.
PHI	/PATHGE/	R*4	TROCOM.INC	

5.11 INTLIM

Subprogram name: Subroutine INTLIM

Purpose: Calculates the limits of common volume integration.
Calculates the maximum value, ALFA1, of the angle ALFA, the maximum
value, BETA1, of the angle BETA, the maximum height of the common
volume, HHIGH, and the maximum value Y1 of the Y coordinate
(perpendicular to the great circle plane.)

Calling sequence:
CALL INTLIM

Contained in module: INTLIM

Called by: TROPO

Calls: NONE

Input arguments:
NONE

Output arguments:
NONE

Global variables input from common:

A	/PATHGE/	R*4	TROCOM.INC	
				Effective earth radius in meters.
ALFA0	/PATHGE/	R*4	TROCOM.INC	
				Minimum transmit antenna elevation angle measured from transmitter-to-receiver line to transmit horizon line in radians.
BETA0	/PATHGE/	R*4	TROCOM.INC	
				Minimum receive antenna elevation angle measured from receiver-to-transmitter line to receiver horizon line in radians.
D	/PATHGE/	R*4	TROCOM.INC	
				Great circle distance between transmitter and receiver measured at sea level in meters.
DELTAR(NRMX)	/ANTENN/	R*4	TROCOM.INC	
				3dB half-beamwidth of each receive antenna in radians.
DELTAT(NTHX)	/ANTENN/	R*4	TROCOM.INC	
				3dB half-beamwidth of each transmit antenna in radians.
DR	/PATHGE/	R*4	TROCOM.INC	
				Receiver distance to minimum scattering point in meters.
DT	/PATHGE/	R*4	TROCOM.INC	
				Transmit antenna distance to minimum scattering point in meters.

5.10 HORANG

Subprogram name: Subroutine HORANG

Purpose: Compute horizon elevation angle from given horizon distance
and height.

Calling sequence:
CALL HORANG (A, D, H, T)

Contained in module: HORANG

Called by: TANGL, TRANSF

Calls: NONE

Input arguments:

A	R*4	Radius of the earth plus height of the antenna in meters.
D	R*4	Horizon distance in meters.
H	R*4	Horizon height above the antenna height in meters.

Output arguments:

T	R*4	Horizon elevation angle (position above grazing) in radians.
---	-----	--

5.9 GPATT

Subprogram name: Subroutine GPATT

Purpose: Voltage directional pattern type $2J_1(X) / X$. Calculates the voltage gain pattern up to and including the first sidelobe using the formula:

$$G = 2 * J_1(X) / X,$$

Where:

X is $PI * AD * SIN(PSI) / WAVLEN$

AD is the antenna diameter

PSI is the angle

To use other antenna patterns, GPATT may be replaced by other subroutines in RGAIN and TGAIn.

Calling sequence:

CALL GPATT (AD, WAVLEN, PSI, Y)

Contained in module: GPATT

Called by: RGAIN, TGAIn

Calls: NONE

Input arguments:

AD	R*4	Antenna diameter in meters.
WAVLEN	R*4	Wavelength in meters.
PSI	R*4	Off-boresight angle in radians.

Output arguments:

Y	R*4	Relative voltage gain at off-boresight angle PSI.
---	-----	---

Global variables input from common:

PI	/CONSTA/	R*4	CONSTANTS.INC
Constant Pi = 3.141592654.			

5.8 FRQSEP

Subprogram name: Subroutine FRQSEP

Purpose: Compute minimum frequency separation required for uncorrelated frequency diversity operation.

Calling sequence:
CALL FRQSEP (N, Q, DELPB, BW, FSEP)

Contained in module: FRQSEP

Called by: LOOPS

Calls: NONE

Input arguments:

N	I*2	Number of points in DFT.
Q(N)	R*4	Power per unit delay profile.
DELPB	R*4	Delay interval in seconds.
BW	R*4	Signal bandwidth in Hz.
FSEP	R*4	Estimate of coherence bandwidth in Hz.

Output arguments:

FSEP	R*4	Minimum frequency separation in Hz.
------	-----	-------------------------------------

Proportionality constant in troposcatter path loss calculation.

CO /CONSTA/ R*4 CONSTANTS.INC

CORRLT /CPLOSS/ R*4 CPL.INC
Free space velocity of radio waves = 2.998E8 m/sec.

CPL(6) /CPLOSS/ R*4 CPL.INC
Correlation coefficient for long term variability of lower and upper beams.

D /PATHGE/ R*4 TROCOM.INC
Aperture-to-medium couplings loss array in dB.

DELPR /PDATA/ R*4 PDATA.INC
Great circle distance between transmitter and receiver measured at sea level in meters.

DELREF /PDATA/ R*4 PDATA.INC
Resolution of a delay cell in seconds.

DELTAR(NRMX) /ANTENN/ R*4 TROCOM.INC
Minimum delay through the lowest scattering point (relative to straight line delay) in seconds.

DELTAT(NTMX) /ANTENN/ R*4 TROCOM.INC
3dB half-beamwidth of each receive antenna in radians.

DIVTYP /MCOM2/ I*2 MCOM.INC
Diversity configuration indicator. Default is 0.
0 = 2 receive antennas; 2S 2S/2F 2S/2A 2S/2A/2F
1 = 1 receive antenna; 2A 2F 2F/2A
2 = 2 transmit;
2 receive antennas; 2S/2P 2S/2P/2A
3 = Not used
4 = User supplied parameters
S = Space F = Frequency A = Angle P = Polarization

DLR /PATHGE/ R*4 TROCOM.INC
Distance from receiver to radio horizon in meters.

DLT /PATHGE/ R*4 TROCOM.INC
Distance from transmitter to radio horizon in meters.

DRATE /MCOM4/ R*4 MCOM.INC
Data rate in bits/second. Default is 6.6E6.

ERFAC /PROPAR/ R*4 TROCOM.INC
Yearly median value of effective earth radius factor k in kilometers. Default is 1.33.

F /SYSTRN/ R*4 TROCOM.INC
Operating frequency in Hz. Model is accurate between 100MHz and 10GHz.

GRDB(NRMX) /ANTENN/ R*4 TROCOM.INC
Gain of each receive antenna in dBi.

GTDB(NTMX) /ANTENN/ R*4 TROCOM.INC
Gain of each transmit antenna in dBi.

HI(155) /MCOM4/ R*4 MCOM.INC
Array containing NPM(1) evenly-spaced terrain elevation data (in meters) between transmitter and

first obstacle followed by NPM(2) evenly-spaced terrain elevation data between first and second obstacle, etc., ending with NPM(NOBS+1) evenly-spaced terrain elevation data between last obstacle and receive site. The data should be selected such that:

HI(1) = Terrain elevation above sea level at transmit site (HT0).

HI(NPM(I)) = HI (NPM(I)+1) = Elevation of Ith obstacle above sea level (HL(I)).

HI(NPM(NOBS+1)) = Terrain elevation above sea level at receive site (HR0).

In MDT5, HI is used as work space. It is equivalenced to local arrays.

HRN	/PATHGE/	R*4	TROCOM.INC
			Receive antenna height above sea level in meters.
HTN	/PATHGE/	R*4	TROCOM.INC
			Transmit antenna height above sea level in meters.
IRLOSS(6)	/CPLOSS/	I*2	CPL.INC
			Beam number corresponding to CPL(I).
ICPL	/CPLOSS/	I*2	CPL.INC
			Coupling loss count.
ITER	/PDATA/	I*4	PDATA.INC
			Number of integration cells in the common volume integration.
KLIMAT	/PROPAR/	I*2	TROCOM.INC
			Climate zone indicator. Default is 0.
			0 = User supplied climate
			NBS TN101 climates
			1 = Continental temperate (CT)
			2 = Maritime temperate overland (MTL)
			3 = Maritime temperate oversea (MTS)
			4 = Maritime subtropical overland (MSL)
			5 = Continental temperate time block 2 (CT2)
			(winter afternoon hours) - formerly
			Maritime subtropical oversea (MSS)
			6 = Desert, Sahara (DS)
			7 = Equatorial (EQU)
			8 = Continental subtropical (CS)
			MIL-HDBK-417 climates
			9 = Continental temperate (CT)
			10 = Maritime temperate overland (MTL)
			11 = Maritime temperate oversea (MTS)
			12 = Maritime subtropical (MS)
			13 = Desert, Sahara (DS)
			14 = Equatorial (EQU)
			15 = Continental subtropical (CS)
			16 = Mediterranean (MED)
			17 = Polar (POL)
LERR	/LUNS/	I*2	LUNS.INC
			Error output unit.

TROPOSCATTER CALCULATIONS
Subroutine POWER

Page 5-27

LOUT /LUNS/ I*2 LUNS.INC
FOR002.DAT output unit number.

MDIST /ERAD/ I*2 ERAD.INC
Multipath distribution indicator.
0 = Only median multipath spread used(default)
1 = Multipath distribution used. (Option not
currently available.)

NCORR /PDATA/ I*2 PDATA.INC
Number of receive port correlations.

NDELMX Parameter I*2 TROPAR.INC
Maximum number of delay bins in troposcatter power per
unit delay profiles.

NFIG /MCOM4/ R*4 MCOM.INC
Receiver noise figure in dB. Default is 4dB.

NOBS /MCOM2/ I*2 MCOM.INC
Number of diffraction obstacles. Maximum is 3,
default is 1.

NPM(5) /MCOM2/ I*2 MCOM.INC
Array contains number of terrain elevation data
points for calculation of effective antenna heights
for each section of the diffraction path.

NRAD /ERAD/ I*2 ERAD.INC
ERFAC indicator and loop counter. Default is 1.

NTERR /MCOM2/ I*2 MCOM.INC
Control parameter for entry or calculation of
effective antenna heights (HTE, HRE) and effective
obstacle heights above average terrain elevation
(HLEF).
0 = HTE and HRE supplied directly
1 = AVETX and AVERX supplied
2 = HI(.) supplied

PRAD(3) /ERAD/ R*4 ERAD.INC
Fraction of time effective earth radius factor is
greater than ERFAC; Probability that effective earth
radius factor is not exceeded.
For NRAD = 1 PRAD = 0.5
 = 2 = 0.1
 = 3 = 0.01

PSIRE0(NRMX) /ANTENN/ R*4 TROCOM.INC
Array of receiver beam boresight elevations above
radio horizon in radians, ie, angle at which each
antenna is aimed relative to the horizon. PSIRE0(1)
is the main receive antenna.

PSITE0(NTMX) /ANTENN/ R*4 TROCOM.INC
Array of transmitter beam boresight elevations above
radio horizon in radians, ie, angle at which each
antenna is aimed relative to the horizon. PSITE0(1)
is the main transmit antenna.

PXMIT /MCOM4/ R*4 MCOM.INC
Rated transmission power in dBm. Default is 70dBm.

QCORR(NCORMX) /PDATA/ R*4 PDATA.INC
Contains elements of covariance matrix, ie, powers and correlations.
For DIVTYP = 0:
QCORR(1) Power on lower beam
QCORR(2) Correlation coefficient between lower and upper beam.
QCORR(3) Correlation coefficient between lower beams of antennas 1 and 2
QCORR(4) Power on upper beam.
For DIVTYP = 1:
QCORR(1) Power on lower beam
QCORR(2) Correlation coefficient between lower and upper beam.
QCORR(3) Power on upper beam.
For DIVTYP = 2:
QCORR(1) Power on path 1 (lower beam)
QCORR(2) Correlation coefficient between convergent paths.
QCORR(3) Correlation coefficient between divergent paths.
QCORR(4) Correlation coefficient between parallel paths.
QCORR(5) Correlation coefficient between crossing paths.
QCORR(6) Power on upper beam.

RLL /SYSTRN/ R*4 TROCOM.INC
Receiver line losses in dB. Default is 0 dB.

SP /MCOM4/ R*4 MCOM.INC
Service probability. Default is .95.

SPREAD(NCORMX) /PDATA/ R*4 PDATA.INC
Array of delay spreads (2-sigma) for each beam in seconds.

TEMPA(NCORMX) /PDATA/ R*4 PDATA.INC
Array of average troposcatter signal delays for each beam relative to straight line in seconds.

THER /PATHGE/ R*4 TROCOM.INC
Radio horizon elevation angle at receive site in radians.

THET /PATHGE/ R*4 TROCOM.INC
Radio horizon elevation angle at transmit site in radians.

TLL /SYSTRN/ R*4 TROCOM.INC
Transmitter line losses in dB. Default is 0 dB.

Global variables output to common:

AVERX /MCOM4/ R*4 MCOM.INC
Average terrain elevation above sea level between receive site and radio horizon, in meters.

AVETX /MCOM4/ R*4 MCOM.INC

Average terrain elevation above sea level between
transmit site and radio horizon, in meters.

DE /SUMP/ R*4 CURVE.INC
Effective distance for troposcatter path in
kilometers.

DSP1(3) /SUMP/ R*4 CURVE.INC
Lower beam troposcatter signal RMS delay spread in
nanoseconds for percentiles 50, 90 and 99.

DSP2(3) /SUMP/ R*4 CURVE.INC
Upper beam troposcatter signal RMS delay spread in
nanoseconds for percentiles 50, 90 and 99.

HRE /MCOM4/ R*4 MCOM.INC
Effective receiver antenna height above average
terrain elevation in meters.

HTE /MCOM4/ R*4 MCOM.INC
Effective transmitter antenna height above average
terrain elevation in meters.

JQ2M /MCOM4/ I*2 MCOM.INC
Pointer to centroid of lower beam troposcatter signal
power per unit delay profile.

KGAIN /RZ/ I*2 RZ.INC
Integer ratio of bandwidth to data rate.

MODPAT /MCOM2/ I*2 MCOM.INC
Propagation/modem flag to select calculation mode.
Default is 1.
0 = Propagation only
1 = Propagation + MD-918 modem
2 = Propagation + AN/TRC-170 or DAR modem
3 = Propagation + user-defined modem

NDELQ /MCOM4/ I*2 MCOM.INC
Number of non-zero elements of troposcatter power per
unit delay profiles Q(NDELQ,1).

PLOSS1 /ERAD/ R*4 ERAD.INC
Reference troposcatter path loss in dB on lower beam
for NRAD equals 1.

Q(NDELMX,NCORMX) /PDATA/ R*4 PDATA.INC
Matrix of troposcatter signal power and correlation
per unit delay profiles.
For DIVTYP = 0:
Q(.,1) Power on lower beam vs. delay.
Q(.,2) Correlation between lower and
upper beam vs. delay.
Q(.,3) Correlation between lower beams
in antennas 1 & 2 vs. delay.
Q(.,4) Power on upper beam vs. delay.
Q(.,7) Power on diffraction path vs. delay
For DIVTYP = 1:
Q(.,1) Power on lower beam vs. delay.
Q(.,2) Correlation between lower and
upper beam vs. delay.

Q(.,3) Power on upper beam vs. delay
Q(.,7) Power on diffraction path vs. delay.
For DIVTYP = 2:
Q(.,1) Power on path 1 (lower beam) vs. delay.
Q(.,2) Correlation between convergent paths
(lower beam) vs. delay.
Q(.,3) Correlation between divergent paths
(lower beam) vs. delay.
Q(.,4) Correlation between parallel paths
(lower beam) vs. delay.
Q(.,5) Correlation between crossing paths
(lower beam) vs. delay.
Q(.,6) Power on path of upper beam vs. delay.
Q(.,7) Power on diffraction path vs. delay.

STSNR /SUMP/ R*4 SUMP.INC
Standard deviation of troposcatter signal long-term
SNR distribution in dB.

TDIFF /MCOM4/ R*4 MCOM.INC
Normalized relative delay between lower and upper
beam.

TROLOS(3) /SUMP/ R*4 CURVE.INC
Median troposcatter path loss in dB for each value in
ERFAC distribution.

TRORSL(3) /SUMP/ R*4 CURVE.INC
Median troposcatter RSL in dB for each value in ERFAC
distribution.

5.15 RGAIN

Subprogram name: Function RGAIN

Purpose: Relative voltage gain for receive aperture I at the off-boresight angle PSI.

Calling sequence:
RGAIN (I, PSI)

Contained in module: RGAIN

Called by: DIFSNR, LOOPS

Calls: GPATT

Input arguments:

I I*2 Receiving aperture index.
PSI R*4 Off-boresight angle in radians.

Output arguments:

RGAIN R*4 Relative voltage gain for given receive aperture.

Global variables input from common:

AR(NRMX) /ANTENN/ R*4 TROCOM.INC
Array of receiver antenna diameters in meters. AR(1)
is equivalent to RDIAM in the input file.
WAVLEN /SYSTRN/ R*4 TROCOM.INC
Wavelength in meters.

5.16 RIPROF

Subprogram name: Subroutine RIPROF

Purpose: Calculates a normalized CN2 value for a given point ALFA,
BETA. Used when refractive index profile is input by the user.

Calling sequence:
CALL RIPROF (HEIGHT, CN2LOC)

Contained in module: RIPROF

Called by: LOOPS

Calls: ERROR

Input arguments:
HEIGHT R*4 Height above sea level of the current scattering
point.

Output arguments:
CN2LOC R*4 Normalized CN2 value.

Global variables input from common:

CN2(NPROF)	/PROPAR/	R*4	TROCOM.INC	The atmospheric structure constant height profile in meters to the -2/3 power.
DELH	/PROPAR/	R*4	TROCOM.INC	Spacing of CN2 samples in meters.
KPROF	/PROPAR/	I*2	TROCOM.INC	Actual number of samples in height profile of structure constant CN2. Limited to NPROF samples.

5.17 STEPAB

Subprogram name: Function STEPAB

Purpose: Calculates step size of alpha or beta for a given scattering point.

Callings sequence:
STEPAB (THETA)

Contained in module: STEPAB

Called by: LOOPS

Calls: NONE

Input arguments:
THET/ R*4 Scattering angle at bottom of common volume in radians.

Output arguments:
STEPAB R*4 Step size of alpha or beta.

Global variables input from common:

BEAM	/STPCOM/	R*4	STPCOM.INC	Parameter for determining azimuth and elevation angle
				step size in common volume integration.
TFAK	/STPCOM/	R*4	STPCOM.INC	Constant for common volume integration.

5.18 STEPY

Subprogram name: Function STEPY

Purpose: Calculates the step size in the Y direction.

Calling sequence:
STEPY (THETA, Y, ROT, ROR)

Contained in module: STEPY

Called by: LOOPS

Calls: NONE

Input arguments:

THETA	R*4	Scattering angle at point of integration.
Y	R*4	Y coordinate.
ROT	R*4	Distance from transmitter to point of integration.
ROR	R*4	Distance from receiver to point of integration.

Output arguments:

STEPY	R*4	Step size in the Y direction.
-------	-----	-------------------------------

Global variables input from common:

TFAKY1	/STPCOM/	R*4	STPCOM.INC	Constant for common volume integration.
TFAKY2	/STPCOM/	R*4	STPCOM.INC	Constant for common volume integration.
TFAKY3	/STPCOM/	R*4	STPCOM.INC	Constant for common volume integration.
TFAKY4	/STPCOM/	R*4	STPCOM.INC	Constant for common volume integration.

5.19 STPPAR

Subprogram name: Subroutine STPPAR

Purpose: Initializes parameters required to determine step size of alpha, beta and Y in the common volume integration. Refines step size for space diversity correlation.

Calling sequence:
CALL STPPAR

Contained in module: STPPAR

Called by: LOOPS

Calls: NONE

Input arguments:
NONE

Output arguments:
NONE

Global variables input from common:

DELTAR(NRMX)	/ANTENN/	R*4	TROCOM.INC	3dB half-beamwidth of each receive antenna in radians.
DELTAT(NTMX)	/ANTENN/	R*4	TROCOM.INC	3dB half-beamwidth of each transmit antenna in radians.
DR	/PATHGE/	R*4	TROCOM.INC	Receiver distance to minimum scattering point in meters.
DT	/PATHGE/	R*4	TROCOM.INC	Transmit antenna distance to minimum scattering point in meters.
ERR	/CONTROL/	R*4	TROCOM.INC	Common volume integration resolution. Default is .001.
IBR(NRMX,NRMX)	/SYSTRN/	I*2	TROCOM.INC	Channel complex-envelope correlation and cross-correlation calculation indicator array. 0 = No calculation 1 = Power (correlation) calculation only 2 = Power (correlation) per unit delay spectrum calculation
IPOLR(NRMX)	/ANTENN/	I*2	TROCOM.INC	Array of receiver antenna polarizations.
NR	/SYSTRN/	I*2	TROCOM.INC	Number of receive ports.
NT	/SYSTRN/	I*2	TROCOM.INC	Number of transmit ports.

5.20 TGAIN

Subprogram name: Function TGAIN

Purpose: Calculates relative voltage gain for transmit aperture I at
the off-boresight angle PSI.

Calling sequence:
TGAIN (I, PSI)

Contained in module: TGAIN

Called by: DIFSNR, LOOPS

Calls: GPATT

Input arguments:
I I*2 Transmit aperture index.
PSI R*4 Off-boresight angle in radians.

Output arguments:
TGAIN R*4 Relative voltage gain for given transmit aperture.

Global variables input from common:
AT(NTMX) /ANTENN/ R*4 TROCOM.INC
Array of transmitter antenna diameters in meters.
AT(1) is equivalent to TDIAM in the input file.
WAVLEN /SYSTRN/ R*4 TROCOM.INC
Wavelength in meters.

5.21 TRANSF

Subprogram name: Subroutine TRANSF

Purpose: Transform angles and distances to effective earth radius and calculate scattering point assuming that at each site all antennas have a common horizon and minimum scattering point. The different antenna heights are ignored in the calculation of the common volume.

Calling sequence:
CALL TRANSF

Contained in module: TRANSF

Called by: TROPO

Calls: ERROR, HORANG

Input arguments:
NONE

Output arguments:
NONE

Global variables input from common:

A	/PATHGE/	R*4	TROCOM.INC	Effective earth radius in meters.
A0	/CONSTA/	R*4	CONSTANTS.INC	Radius of the earth in meters = 6367650.
D	/PATHGE/	R*4	TROCOM.INC	Great circle distance between transmitter and receiver measured at sea level in meters.
DELTAR(NRMX)	/ANTENN/	R*4	TROCOM.INC	3dB half-beamwidth of each receive antenna in radians.
DELTAT(NTMX)	/ANTENN/	R*4	TROCOM.INC	3dB half-beamwidth of each transmit antenna in radians.
DLR	/PATHGE/	R*4	TROCOM.INC	Distance from receiver to radio horizon in meters.
DLT	/PATHGE/	R*4	TROCOM.INC	Distance from transmitter to radio horizon in meters.
ERFAC	/PROPAR/	R*4	TROCOM.INC	Yearly median value of effective earth radius factor k in kilometers. Default is 1.33.
ITOFF	/PROPAR/	I*2	TROCOM.INC	Control indicator for entry or calculation of transmit/receive radio horizon angles THET and THER. Values have following meanings: 0 = Use input THET, THER as reference and actual horizon (default).

AD-A151 983

DIGITAL TROPOSCATTER PERFORMANCE MODEL: SOFTWARE
DOCUMENTATION(U) SIGNATRON INC LEXINGTON MA
P MONSEN ET AL. 28 NOV 83 A-288-16 DCA100-80-C-0030

2/4

UNCLASSIFIED

F/G 9/2

NL

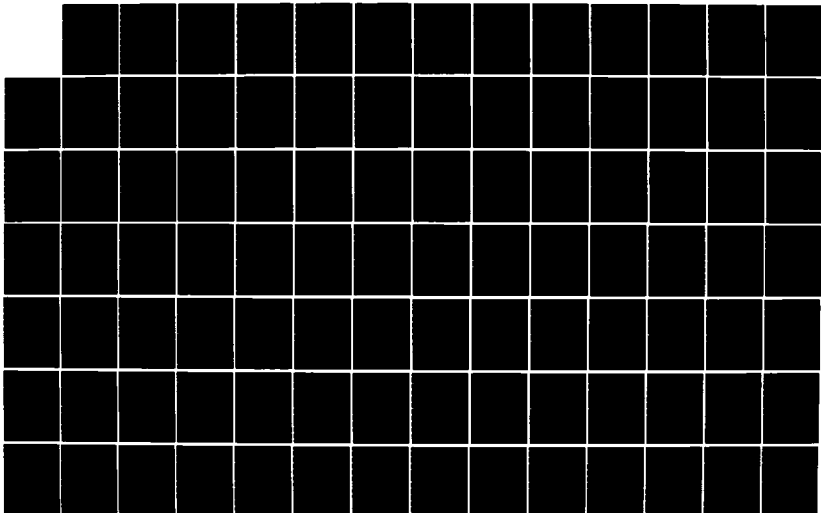

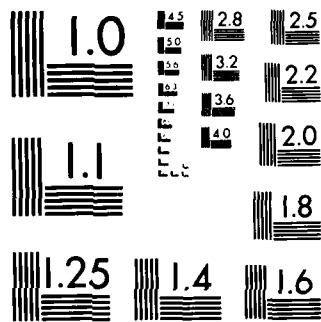

MICROCOPY RESOLUTION TEST CHART
NATIONAL BUREAU OF STANDARDS 1963-A

- 1 = Calculate reference horizon using HORANG and K equals 1.33. (Assuming DLT and DLR are non-zero.) (Option not available.)
- 2 = Calculate reference horizon using HORANG and K equals ERFAC. (Assuming DLT and DLR are non-zero.)
- 3 = Do not change reference horizons from previous run. (Option not available.)

NR	/SYSTRN/	I*2	TROCOM.INC	Number of receive ports.
NT	/SYSTRN/	I*2	TROCOM.INC	Number of transmit ports.
THER	/PATHGE/	R*4	TROCOM.INC	Radio horizon elevation angle at receive site in radians.
THET	/PATHGE/	R*4	TROCOM.INC	Radio horizon elevation angle at transmit site in radians.

Global variables output to common:

ALFA0	/PATHGE/	R*4	TROCOM.INC	Minimum transmit antenna elevation angle measured from transmitter-to-receiver line to transmit horizon line in radians.
BETA0	/PATHGE/	R*4	TROCOM.INC	Minimum receive antenna elevation angle measured from receiver-to-transmitter line to receiver horizon line in radians.
DR	/PATHGE/	R*4	TROCOM.INC	Receiver distance to minimum scattering point in meters.
DT	/PATHGE/	R*4	TROCOM.INC	Transmit antenna distance to minimum scattering point in meters.
HCOM	/PATHGE/	R*4	TROCOM.INC	Effective height of the bottom of the common volume in meters.
HLR	/PATHGE/	R*4	TROCOM.INC	Receiver radio horizon elevation above sea level in meters.
HLT	/PATHGE/	R*4	TROCOM.INC	Transmit radio horizon elevation above sea level in meters.
HRN	/PATHGE/	R*4	TROCOM.INC	Receive antenna height above sea level in meters.
HTN	/PATHGE/	R*4	TROCOM.INC	Transmit antenna height above sea level in meters.
IRF	/PATHGE/	I*2	TROCOM.INC	Parameter which indicates whether reference horizon elevation angles have been calculated (IRF = 1) in

TROPOSCATTER CALCULATIONS
Subroutine TRANSF

Page 5-40

previous run. It has meaning only when JTOFF = 3.
PHI /PATHGE/ R*4 TROCOM.INC
Diffraction angle in radians.
PHIR /PATHGE/ R*4 TROCOM.INC
Receive angular distance to minimum scattering point
in radians.
PHIT /PATHGE/ R*4 TROCOM.INC
Transmit angular distance to minimum scattering point
in radians.
PSIREO(NRMX) /ANTENN/ R*4 TROCOM.INC
Array of receiver beam boresight elevations above
radio horizon in radians, ie, angle at which each
antenna is aimed relative to the horizon. PSIREO(1)
is the main receive antenna.
PSITEO(NTMX) /ANTENN/ R*4 TROCOM.INC
Array of transmitter beam boresight elevations above
radio horizon in radians, ie, angle at which each
antenna is aimed relative to the horizon. PSITEO(1)
is the main transmit antenna.
S /PATHGE/ R*4 TROCOM.INC
Troposcatter path asymmetry parameter.
S1 /PATHGE/ R*4 TROCOM.INC
Troposcatter path asymmetry parameter.
THERRF /PATHGE/ R*4 TROCOM.INC
Receive reference horizon in radians.
THETA0 /PATHGE/ R*4 TROCOM.INC
Scattering angle at bottom of common volume in
radians.
THETRF /PATHGE/ R*4 TROCOM.INC
Transmit reference horizon elevation in radians.

5.22 TRLOSS

Subprogram name: Subroutine TRLOSS

Purpose: Calculates theoretical pathloss using formulas developed by S. Parl.

Reference: S. Parl, "New formulas for tropospheric scatter loss", 1979, Radio Science, Vol. 14, No. 1, pp. 42-57.

Calling sequence:
CALL TRLOSS (I1, X)

Contained in module: TRLOSS

Called by: LOOPS

Calls: ERROR

Input arguments:
I1 I#2 Receiver beam number.

Output arguments:
X R#4 Theoretical pathloss.

Global variables input from common:

ALFA0	/PATHGE/	R#4	TROCOM.INC	Minimum transmit antenna elevation angle measured from transmitter-to-receiver line to transmit horizon line in radians.
BETA0	/PATHGE/	R#4	TROCOM.INC	Minimum receive antenna elevation angle measured from receiver-to-transmitter line to receiver horizon line in radians.
D	/PATHGE/	R#4	TROCOM.INC	Great circle distance between transmitter and receiver measured at sea level in meters.
DELTA0(NRMX)	/ANTENN/	R#4	TROCOM.INC	3dB half-beamwidth of each receive antenna in radians.
DELTA1(NRMX)	/ANTENN/	R#4	TROCOM.INC	3dB half-beamwidth of each transmit antenna in radians.
ICPL	/CPLOSS/	I#2	CPL.INC	Coupling loss count.
PSIRA0(NRMX)	/ANTENN/	R#4	TROCOM.INC	Array of receiver beam azimuths in radians.
PSIRE0(NRMX)	/ANTENN/	R#4	TROCOM.INC	Array of receiver beam boresight elevations above radio horizon in radians, ie, angle at which each antenna is aimed relative to the horizon. PSIRE0(1)

TROPOSCATTER CALCULATIONS
Subroutine TRLOSS

PSITE0(NTMX) is the main receive antenna.
 /ANTENN/ R*4 TROCOM.INC
 Array of transmitter beam boresight elevations above
 radio horizon in radians, ie, angle at which each
 antenna is aimed relative to the horizon. PSITE0(1)
 is the main transmit antenna.
SCPARM /PROPAR/ R*4 TROCOM.INC
 Wavenumber spectrum slope parameter M. Default is
 3.66.

Global variables output to common:

CPL(6) /CPLOSS/ R*4 CPL.INC
 Aperture-to-medium coupling loss array in dB.

CHAPTER 6

DIFFRACTION CALCULATIONS

This section describes the diffraction calculation routines:

Name	Description	User's Manual section
AVAIL	Pathloss variability	2.6.1
CONVOL	Cumulative distribution	2.6.1
DIF1	Knife-edge diffraction loss	2.6.2
DIFSNR	Diffraction RSL and SNR distribution	2.6.1
INTERP	Lagrangean interpolation	NA
MDIF	Multiple edge diffraction loss calculations	2.6, 2.6.2-.3
TANGL	Radio horizon (take-off) angles	2.6.2, 2.6.3

The main routines for this section are DIFSNR and MDIF. Diffraction calculations are described in section 2.6 of the User's Manual.

Figure 2-3 is a top level flowchart for diffraction propagation parameter calculations at a functional level. In most cases the blocks correspond to one or more subprograms. The test blocks (diamonds) correspond to logical branches which are decided by the user's choices of input data.

NOTE

In most cases the sections in the User's Manual describe the coded equations as well as the theory behind them. NA denotes routines that are programming utilities such as finding indices, setting pointers, etc.

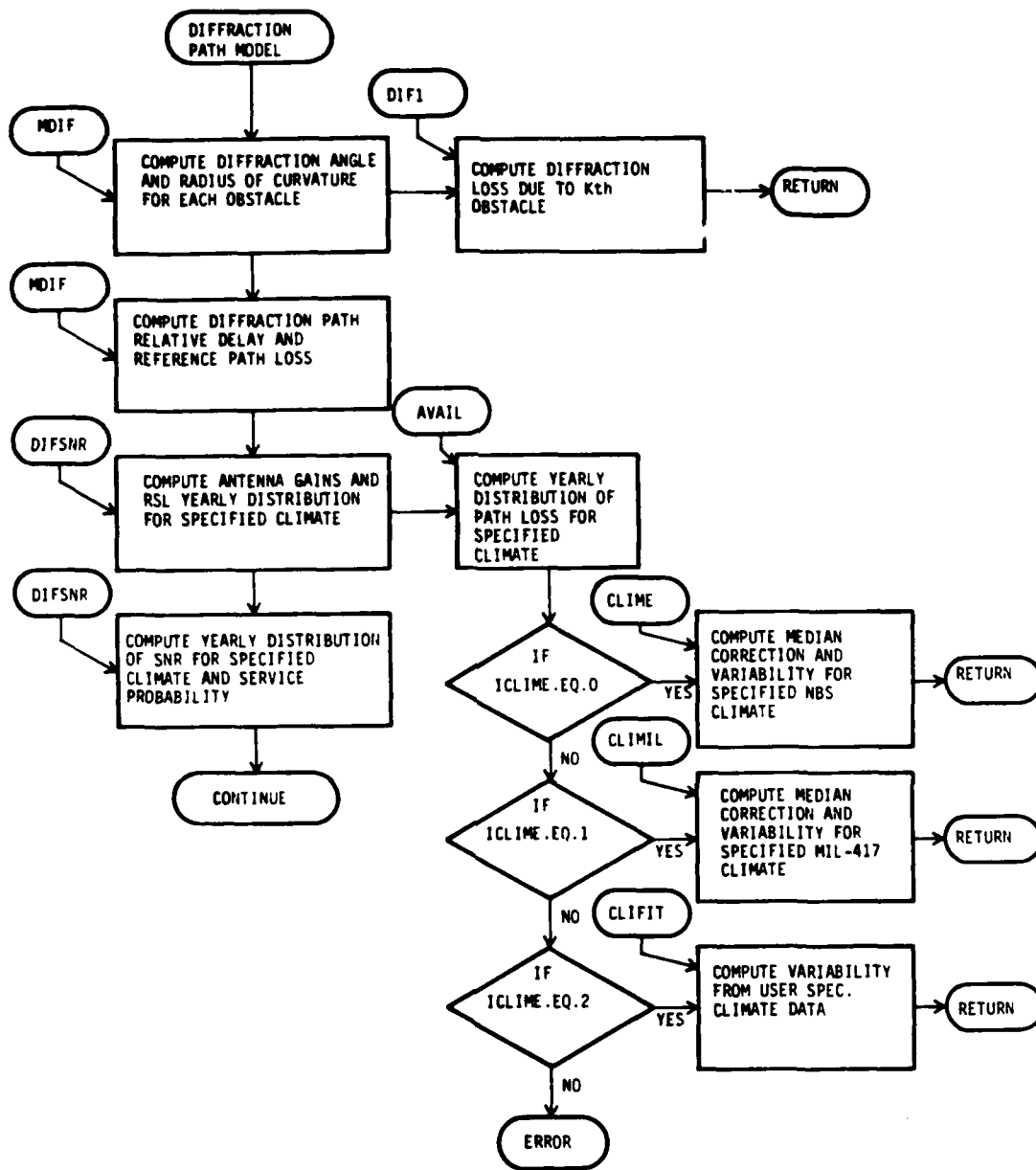

Figure 2-3 Flow Chart for Diffraction Propagation Parameter Calculations

6.1 AVAIL

Subprogram name: Subroutine AVAIL

Purpose: Routine to calculate the distribution of the pathloss variability for multiple edge diffraction paths by convolution of the pathloss variability for each section of the path, for a specified climate (KLIMAT).

Callings sequence:

CALL AVAIL (FMHZ,ND,HTE,HRE,DN,LCR,VDE,Y,QT)

Contained in module: AVAIL

Called by: DIFSNR

Calls: CLIME, CLIMIL, CLIMIX, CONVOL, INTERP

Input arguments:

FMHZ	R*4	Frequency in MHz.
ND	I*2	Number of sections in diffraction path $1 < ND < 6$. Equal to number of edges plus one. No limit set.
HTE(ND)	R*4	Array contains transmitter (horizon) heights in meters above average terrain height for each of the ND sections in the diffraction path.
HRE(ND)	R*4	Array contains receiver (horizon) heights in meters above average terrain height for each of the ND sections in the diffraction path.
DN(ND)	R*4	Array contains great circle path length in meters of each section of path.
LCR	R*4	Long term pathloss reference value in dB

Output arguments:

VDE	R*4	Median correction factor for specified climate in dB. Set to zero when the user specifies yearly median of effective earth radius factor (SEAN = 0).
Y(11)	R*4	Array contains pathloss variability distribution about the median in dB.
QT(11)	R*4	Array contains percent of time pathloss is not exceeded, i.e. time availability

Global variables input from common:

KLIMAT	/PROPAR/	I*2	TROCOM.INC
			Climate zone indicator. Default is 0.
			0 = User supplied climate
			NBS TN101 climates
			1 = Continental temperate (CT)
			2 = Maritime temperate overland (MTL)
			3 = Maritime temperate oversea (MTS)
			4 = Maritime subtropical overland (MSL)

DIFFRACTION CALCULATIONS
Subroutine AVAIL

Page 6-4

- 5 = Continental temperate time block 2 (CT2)
(winter afternoon hours) - formerly
Maritime subtropical oversea (MSS)
- 6 = Desert, Sahara (DS)
- 7 = Equatorial (EQU)
- 8 = Continental subtropical (CS)

MIL-HDBK-417 climates

- 9 = Continental temperate (CT)
- 10 = Maritime temperate overland (MTL)
- 11 = Maritime temperate oversea (MTS)
- 12 = Maritime subtropical (MS)
- 13 = Desert, Sahara (DS)
- 14 = Equatorial (EQU)
- 15 = Continental subtropical (CS)
- 16 = Mediterranean (MED)
- 17 = Polar (POL)

LOUT

/LUNS/ I#2 LUNS.INC
FOR002.DAT output unit number.

SEAN

/PROPAR/ R#4 TROCOM.INC
Minimum monthly median of refractivity at sea level.
Used to calculate ERFAC if non-zero.

6.2 CONVOL

Subprogram name: Subroutine CONVOL

Purpose: Routine to find the cumulative distribution function of the sum of two independent random variables given the complementary cumulative distribution function of each of the random variables.

Calling sequence:
CALL CONVOL (FA,A,IA,FB,B,IB,FC,C,IC)

Contained in module: AVAIL

Called by: AVAIL

Calls: INTERP

Input arguments:

FA(IA)	R*4	Array containing IA values of complementary cumulative distribution of A. Dimensioned to 50.
A(IA)	R*4	Array containing range of values of random variable A. Dimensioned to 50.
IA	I*2	Number of points in distribution A. Maximum is 50.
FB(IB)	R*4	Array containing IB values of complementary cumulative distribution of B. Dimensioned to 50.
B(IB)	R*4	Array containing range of values of random variable B. Dimensioned to 50.
IB	I*2	Number of points in distribution of B. Maximum is 50.

Output arguments:

FC(50)	R*4	Array containing 50 values of cumulative distribution of the sum A + B.
C(50)	R*4	Array containing range of values of the sum A + B.
IC	I*2	Number of elements in cumulative distribution of A+B.

Global variables input from common:

LERR	/LUNS/	I*2	LUNS.INC
			Error output unit.

6.3 DIF1

Subprogram name: Subroutine DIF1

Purpose: Computes the diffraction loss due to a single isolated and rounded obstacle.

Calling sequence:
CALL DIF1 (R, D1, D2, PHI, F, ATT)

Contained in module: MDIF

Called by: MDIF

Calls: NONE

Input arguments:

R	R*4	Radius of curvature of diffracting edge in meters.
D1	R*4	Distance from source (transmitter) to edge in meters.
D2	R*4	Distance from observation point (receiver) to edge in meters.
PHI	R*4	Diffraction angle in radians.
F	R*4	Frequency in MHz.

Output arguments:

ATT	R*4	Diffraction loss in dB.
-----	-----	-------------------------

Global variables input from common:

LERR	/LUNS/	I*2	LUNS.INC
			Error output unit.
PI	/CONSTA/	R*4	CONSTANTS.INC
			Constant Pi = 3.141592654.

6.4 DIFSNR

Subprogram name: Subroutine DIFSNR

Purpose: Routine to calculate the diffraction path loss, RSL and SNR distributions for a given service probability (SP).

Calling sequence:
CALL DIFSNR (LCR, OET, OER, RWR, ASNR, DUPOW)

Contained in module: DIFSNR

Called by: TROPO

Calls: AVAIL, AVTER, EKFC, RGAIN, TGAIn

Input arguments:

LCR	R*4	Reference value of diffraction path loss in dB.
OET	R*4	Horizon elevation angle at transmit site in radians.
OER	R*4	Horizon elevation angle at receive site in radians.
RWR	R*4	Receive antenna beamwidth in degrees.

Output arguments:

ASNR	R*4	Median and/or yearly average value of diffraction path SNR in dB.
DUPOW	R*4	Ratio of diffraction signal on upper beam to that on lower beam.

Global variables input from common:

CDEGR	/CONSTA/	R*4	CONSTANTS.INC	Radians per degree = 0.017453293.
D	/PATHGE/	R*4	TROCOM.INC	Great circle distance between transmitter and receiver measured at sea level in meters.
DL(3)	/MCOM4/	R*4	MCOM.INC	Array contains distance from each obstacle to transmitter in meters.
DRATE	/MCOM4/	R*4	MCOM.INC	Data rate in bits/second. Default is 6.6E6.
F	/SYSTRN/	R*4	TROCOM.INC	Operating frequency in Hz. Model is accurate between 100MHz and 10GHz.
GRDB(NRMX)	/ANTENN/	R*4	TROCOM.INC	Gain of each receive antenna in dBi.
GTDB(NTMX)	/ANTENN/	R*4	TROCOM.INC	Gain of each transmit antenna in dBi.
HI(155)	/MCOM4/	R*4	MCOM.INC	Array contains NPM(1) evenly-spaced terrain elevation data (in meters) between transmitter and first obstacle followed by NPM(2) evenly-spaced

terrain elevation data between first and second obstacle, etc., ending with NPM(NOBS+1) evenly-spaced terrain elevation data between last obstacle and receive site. The data should be selected such that:

HI(1) = Terrain elevation above sea level at transmit site (HTO).

HI(NPM(I)) = HI(NPM(I)+1) = Elevation of Ith obstacle above sea level (HL(I)).

HI(NPM(NOBS+1)) = Terrain elevation above sea level at receive site (HRO).

In MDTs, HI is used as work space. It is equivalenced to local arrays.

HL(3) /MCOM4/ R*4 MCOM.INC
Array containing elevation of each obstacle above sea level in meters. HL(1) is elevation of transmitter radio horizon HLT. HL(NOBS) is elevation of receiver radio horizon HLR.

HLAV(3) /MCOM4/ R*4 MCOM.INC
Array containing average terrain elevation at each diffraction point in meters.

HLEF(3) /MCOM4/ R*4 MCOM.INC
Array containing effective height of obstacles above average terrain elevation in meters.

HRE /MCOM4/ R*4 MCOM.INC
Effective receiver antenna height above average terrain elevation in meters.

HRN /PATHGE/ R*4 TROCOM.INC
Receive antenna height above sea level in meters.

HTE /MCOM4/ R*4 MCOM.INC
Effective transmitter antenna height above average terrain elevation in meters.

HTN /PATHGE/ R*4 TROCOM.INC
Transmit antenna height above sea level in meters.

LERR /LUNS/ I*2 LUNS.INC
Error output unit.

LOUT /LUNS/ I*2 LUNS.INC
FOR002.DAT output unit number.

NFIG /MCOM4/ R*4 MCOM.INC
Receiver noise figure in dB. Default is 4dB.

NOBS /MCOM2/ I*2 MCOM.INC
Number of diffraction obstacles. Maximum is 3, default is 1.

NPM(5) /MCOM2/ I*2 MCOM.INC
Array containing number of terrain elevation data points for calculation of effective antenna heights for each section of the diffraction path.

NTERR /MCOM2/ I*2 MCOM.INC
Control parameter for entry or calculation of effective antenna heights (HTE, HRE) and effective obstacle heights above average terrain elevation

7.8 YINT

Subprogram name: Subroutine YINT

Purpose: Linear interpolation routine to find $Y = A * DE + B$.
Where: $A = (Y2 - Y1) / (X2 - X1)$ and
 $B = Y1 - A * X1$
For $X1 < DE < X2$

Call sequence:
CALL YINT (DE,X1,X2,Y1,Y2,Y)

Contained in module: CLIME

Called by: CLIME

Calls: NONE

Input arguments:

DE	R*4	Effective distance in kilometers.
X1	R*4	Lower limit for distance interpolation in kilometers.
X2	R*4	Upper limit for distance interpolation in kilometers.
Y1	R*4	Path loss variability corresponding to X1 in dB.
Y2	R*4	Path loss variability corresponding to X2 in dB.

Output arguments:

Y	R*4	Path loss variability in dB.
---	-----	------------------------------

7.7 VDECAL

Subprogram name: Subroutine VDECAL

Purpose: Computes the median correction factor, VDE, for the MIL-HDBK-417 climates given the C1, C2, C3, N1, N2, N3, FM, F8 constants in V(I) and the effective distance DE.

Calling sequence:
CALL VDECAL (V, DE, VDE)

Contained in module: CLIMIL

Called by: CLIMIL

Calls: NONE

Input arguments:
V(8) R*4 Array containing the constants used in calculating VDE.
DE R*4 Effective distance in kilometers.

Output arguments:
VDE R*4 Median correction factor V(.5,DE) in dB according to KLIMAT.

7.6 VARPOL

Subprogram name: Function VARPOL

Purpose: Computes the value $X(F)$, $X_2 < X < X_1$ where: $F(X)$ is a normal distribution function with $F(X_1) = F_1$ and $F(X_2) = F_2$. The function requires that $F_2 < F_1$.

Callins sequence:
VARPOL (F,F1,F2,X1,X2,SIGMA)

Contained in module: CLIMIX

Called by: CLIMIX

Calls: NONE

Input arguments:

F	R*4	Function.
F1	R*4	Value of function F at X1.
F2	R*4	Value of function F at X2.
X1	R*4	Variability about median in dB.
X2	R*4	Variability about median in dB.
SIGMA	R*4	

Output arguments:

VARPOL	R*4	Result of interpolation between X2 and X1.
--------	-----	--

Global variables input from common:

PI	/CONSTA/	R*4	CONSTANTS.INC
			Constant Pi = 3.141592654.

7.5 DEIND

Subprogram name: Subroutine DEIND

Purpose: Find DE indices for interpolation of climate variability data
in look up tables.

Calling sequence:
CALL DEIND (DE, I1, I2, LIM, X1, X2, DEINC)

Contained in module: CLIME

Called by: CLIME

Calls: NONE

Input arguments:

DE	R*4	Effective distance in kilometers.
LIM	I*2	DE maximum increment.
DEINC	R*4	DE range increment.

Output arguments:

I1	I*2	Output index for $X1 < DE < X2$.
I2	I*2	Output index for $X1 < DE < X2$ (for $DE = X1$, $I2 = 0$).
X1	R*4	Output DE range, $X1 < DE < X2$, where X1 takes the values 0, DEINC, 2*DEINC, . . . , (LIM-1) * DEINC.
X2	R*4	Output DE range, $X1 < DE < X2$.

Global variables input from common:

LERR	/LUNS/	I*2	LUNS.INC
------	--------	-----	----------

Error output unit.

7.4 CLIMIX

Subprogram name: Subroutine CLIMIX

Purpose: Mixed climate variability distribution and VDE computation.

Calling sequence:

CALL CLIMIX (DE, Y0, KLIM1, KLIM2, FM, VDE)

Contained in module: CLIMIX

Called by: POWER

Calls: CLIME, ERFC, VARPOL

Input arguments:

DE	R*4	Effective distance in kilometers.
KLIM1	I*2	First KLIMAT code to be mixed.
KLIM2	I*2	Second KLIMAT code to be mixed.
FM	R*4	Frequency in MHz.

Output arguments:

Y0(8)	R*4	Variability distribution function Y0(Q).
VDE	R*4	Time variability of basic transmission loss in dB.

Global variables input from common:

LERR	/LUNS/	I*2	LUNS.INC
			Error output unit.
LOUT	/LUNS/	I*2	LUNS.INC
			FOR002.DAT output unit number.

7.3 CLIMIL

Subprogram name: Subroutine CLIMIL.

Purpose: Set the variability about the median, Y0 array, and the median correction factor, VDE, for MIL-HDBK-417 climates according to KLIMAT.

Calling sequence:
CALL CLIMIL (DE, Y0, KLIMAT, F, VDE)

Contained in module: CLIMIL

Called by: POWER, AVAIL

Calls: CLIFIT, VDECAL

Input arguments:

DE	R*4	Effective distance in kilometers.
KLIMAT	I*2	Climate designation.
F	R*4	Frequency in MHz.

Output arguments:

Y0(8)	R*4	Variability about median in dB.
VDE	R*4	Median correction factor V(.5,DE) in dB according to KLIMAT.

Global variables input from common:

LERR	/LUNS/	I*2	LUNS.INC
			Error output unit.

Global variables output to common:

DEMIN	/CURVE/	R*4	CURVE.INC	User supplied minima of the 90th percentile variability curve, Y0(90).
Y900	/CURVE/	R*4	CURVE.INC	User supplied value for 90th percentile variability curve Y0(90) for DE greater than or equal 900 km. Used only when ICLIME is 2. Used to compute the equation for the Y0(90) curve fit.
YMIN	/CURVE/	R*4	CURVE.INC	User supplied value for 90th percentile variability curve Y0(90) for DE equal to DEMIN. Used only when ICLIME is 2. Used to compute the equation for the Y0(90) curve fit.

7.2 CLIME

Subprogram name: Subroutine CLIME

Purpose: Calculate median correction factor VDE and path loss variability about median Y0, given the effective path distance DE, NBS climate designator KLIMAT and frequency F. Set Y0 array and VDE according to climate code KLIMAT.

Reference: C1, C2, C3, N1, N2, N3, FM, F8 constant data for the NBS climates is from Volume II of National Bureau of Standards technical note 101: 'Transmission Loss Predictions for Tropospheric Communication Circuits', revised 1-01-67.

Calling sequence:
CALL CLIME (DE, Y0, KLIMAT, F, VDE)

Contained in module: CLIME

Called by: AVAIL, CLIMIX, POWER

Calls: CLIFIT, DINT, YINT

Input arguments:

DE	R*4	Effective distance in kilometers.
KLIMAT	I*2	Climate designation.
F	R*4	Frequency in MHz.

Output arguments:

Y0(8)	R*4	Variability about median in dB.
VDE	R*4	Median correction factor V(.5, DE) in dB according to climate.

Global variables input from common:

DEMIN	/CURVE/	R*4	CURVE.INC	User supplied minima of the 90th percentile variability curve, Y0(90).
GPF	/CURVE/	R*4	CURVE.INC	Frequency correction factor for user supplied 90th percentile variability curve. Default is 1.
LERR	/LUNS/	I*2	LUNS.INC	Error output unit.

7.1 CLIFIT

Subprogram name: Subroutine CLIFIT

Purpose: Routine to fit $Y_0(90)$ curve given the value for $Y_0(90)$ for effective distance $DE = 0$ (YZERO), the values $Y_0(90)$ and DE for the minima of the curve (YMIN, DEMIN) and the value of $Y_0(90)$ for $DE \geq 900$ km (Y900). Note: DEMIN and DE are in kilometers.

Call sequence:
CALL CLIFIT (DE,Y,DC,IFLAG)

Contained in module: CLIME

Called by: CLIME, CLIMIL

Calls: NONE

Input arguments:

DE	R*4	Effective distance in kilometers.
DC	R*4	Cut-off distance in kilometers.
IFLAG	I*2	Flag to indicate whether variability curve coefficients are to be printed (IFLAG = 1) or not.

Output arguments:

Y	R*4	Magnitude of variability $Y_0(90,DE)$.
---	-----	---

Global variables input from common:

DEMIN	/CURVE/	R*4	CURVE.INC	User supplied minima of the 90th percentile variability curve, $Y_0(90)$.
LOUT	/LUNS/	I*2	LUNS.INC	FOR002.DAT output unit number.
Y900	/CURVE/	R*4	CURVE.INC	User supplied value for 90th percentile variability curve $Y_0(90)$ for DE greater than or equal 900 km. Used only when ICLIME is 2. Used to compute the equation for the $Y_0(90)$ curve fit.
YMIN	/CURVE/	R*4	CURVE.INC	User supplied value for 90th percentile variability curve $Y_0(90)$ for DE equal to DEMIN. Used only when ICLIME is 2. Used to compute the equation for the $Y_0(90)$ curve fit.

CHAPTER 7
CLIMATE VARIABILITY CALCULATIONS

This section describes the climate variability calculation routines:

Name	Description	User's Manual section
CLIFIT	Climate curve fit	2.5.4.5
CLIME	Climate main routine	2.5.3.1
CLIMIL	MIL-HDBK-417 climates	2.5.3.2, 2.5.4.1, 2.5.4.2
CLIMIX	Mixed climates	2.5.3.1
DEIND	DE indices	NA
VARPOL	Interpolation	NA
VDECAL	VDE calculations	2.5.3.1
YINT	Y interpolation	NA

Climate calculations are described in sections 2.5.3 and 2.5.4 of the User's Manual.

NOTE

In most cases the sections in the User's Manual describe the coded equations as well as the theory behind them. NA denotes routines that are programming utilities such as finding indices, setting pointers, etc.

6.7 TANGL

Subprogram name: Subroutine TANGL

Purpose: Calculates radio horizon elevation angles and diffraction angle for a single diffraction path geometry.

Calling sequence:
CALL TANGL (D,HTS,HRS,DLT,DLR,HL,A,OET,DER,AHO,BHO,THETA,DO, X1,X2)

Contained in module: MDIF

Called by: MDIF

Calls: HORANG

Input arguments:

D	R*4	Great circle distance in meters.
HTS	R*4	Transmit terminal elevation above sea level in meters.
HRS	R*4	Receive terminal elevation above sea level in meters.
DLT	R*4	Great circle distance from radio horizon to transmitter (source) in meters.
DLR	R*4	Great circle distance from radio horizon to receiver (observation point) in meters.
HL	R*4	Radio horizon elevation above sea level in meters.
A	R*4	Effective earth radius in meters.

Output arguments:

OET	R*4	Radio horizon elevation angle of transmit terminal above tangent to terminal site in radians.
DER	R*4	Radio horizon elevation angle of receive terminal above tangent to terminal site in radians.
AHO	R*4	Terminal radio horizon angle above straight line intersecting both terminals in radians.
BHO	R*4	Terminal radio horizon angle above straight line intersecting both terminals in radians.
THETA	R*4	Diffraction angle in radians.
DO	R*4	Slant path range in meters.
X1	R*4	Distance from source (transmitter) to diffracting edge in meters.
X2	R*4	Distance from observation point (receiver) to diffracting edge in meters.

Global variables input from common:

LERR	/LUNS/	I*2	LUNS.INC
			Error output unit.

DIFFRACTION CALCULATIONS
Subroutine MDIF

Page 6-12

Free space velocity of radio waves = 2.998E8 m/sec.
DELPH /PDATA/ R*4 PDATA.INC
Resolution of a delay cell in seconds.
LERR /LUNS/ I*2 LUNS.INC
Error output unit.
LOUT /LUNS/ I*2 LUNS.INC
FOR002.DAT output unit number.
NDELPH Parameter I*2 TROPAR.INC
Maximum number of delay bins in troposcatter power per
unit delay profiles.
PI /CONSTA/ R*4 CONSTANTS.INC
Constant Pi = 3.141592654.

Global variables output to common:

DELREF /PDATA/ R*4 PDATA.INC
Minimum delay through the lowest scattering point
(relative to straight line delay) in seconds.
Q(NDELPH,NCORPH) /PDATA/ R*4 PDATA.INC
Matrix of troposcatter signal power and correlation
per unit delay profiles.
For DIVTYP = 0:
Q(.,1) Power on lower beam vs. delay.
Q(.,2) Correlation between lower and
upper beam vs. delay.
Q(.,3) Correlation between lower beams
in antennas 1 & 2 vs. delay.
Q(.,4) Power on upper beam vs. delay.
Q(.,7) Power on diffraction path vs. delay
For DIVTYP = 1:
Q(.,1) Power on lower beam vs. delay.
Q(.,2) Correlation between lower and
upper beam vs. delay.
Q(.,3) Power on upper beam vs. delay
Q(.,7) Power on diffraction path vs. delay.
For DIVTYP = 2:
Q(.,1) Power on path 1 (lower beam) vs. delay.
Q(.,2) Correlation between convergent paths
(lower beam) vs. delay.
Q(.,3) Correlation between divergent paths
(lower beam) vs. delay.
Q(.,4) Correlation between parallel paths
(lower beam) vs. delay.
Q(.,5) Correlation between crossing paths
(lower beam) vs. delay.
Q(.,6) Power on path of upper beam vs. delay.
Q(.,7) Power on diffraction path vs. delay.

6.6 MDIF

Subprogram name: Subroutine MDIF

Purpose: Routine to calculate the diffraction angles, relative delay, and basic path loss of a diffraction path with multiple diffraction points.

Calling sequence:

CALL MDIF (KD,HL,HTN,HRN,DL,D,DS,F,A,LB,DEL,THET,THER, MODPAT,JQDM)

Contained in module: MDIF

Called by: TROPO

Calls: DIF1, ERROR, TANGL

Input arguments:

KD	I*2	Number of diffracting edges. No maximum set.
HL(KD)	R*4	Array contains heights above sea level of the k diffraction points in meters.
HTN	R*4	Transmit antenna height above sea level in meters.
HRN	R*4	Receive antenna height above sea level in meters.
DL(KD)	R*4	Array contains great circle distance from the transmitter to midpoint of each obstacle in meters.
D	R*4	Great circle distance between transmitter and receiver in meters.
DS(KD)	R*4	Array contains effective horizontal extent of each obstacle along great circle path in meters.
F	R*4	Carrier frequency in MHz.
A	R*4	Effective earth radius in meters.
MODPAT	I*2	Indicates whether or not to calculate mode performance. 0 = Propagation only 1 = Propagation + MD-918 mode 2 = Propagation + TRC mode
JQDM	I*2	Index in the multipath profile corresponding to the delay of the specular component.

Output arguments:

LB	R*4	Long term reference basic path loss in dB.
DEL	R*4	Diffraction path delay relative to slant range delay in seconds.
THET	R*4	Horizon elevation angle at transmit site in radians.
THER	R*4	Horizon elevation angle at receive site in radians.

Global variables input from common:

A0	/CONSTA/	R*4	CONSTANTS.INC
			Radius of the earth in meters = 6367650.
C0	/CONSTA/	R*4	CONSTANTS.INC

6.5 INTERP

Subprogram name: Subroutine INTERP

Purpose: Routine to interpolate using nth order Lagrangian approximation.

Calling sequence:
CALL INTERP (IORD, IDIMX, IDIMA, FX, X, FA, A)

Contained in module: AVAIL

Called by: AVAIL, CONVOL

Calls: NONE

Input arguments:

IORD	I*2	Order of interpolation.
IDIMX	I*2	Dimension of input arrays. Maximum is 101.
IDIMA	I*2	Dimension of output arrays. Maximum is 50.
FX(IDIMX)	R*4	Array containing IDIMX values of dependent variable. Dimensioned to 101.
X(IDIMX)	R*4	Array containing IDIMX values of independent variable in ascending order. Dimensioned to 101.
A(IDIMA)	R*4	Array containing IDIMA values of independent variable after interpolation in ascending order. Dimensioned to 50.

Output arguments:

FA(IDIMA)	R*4	Array containing IDIMA values of dependent variable after interpolation. Dimensioned to 50.
-----------	-----	---

(HLEF).

- 0 = HTE and HRE supplied directly
- 1 = AVETX and AVERX supplied
- 2 = HI(.) supplied

PHDIV /MCOM4/ R*4 MCOM.INC
Squint angle between upper and lower receiver beams in radians. Default is beamwidth.

PSIREO(NRMX) /ANTENN/ R*4 TROCOM.INC
Array of receiver beam boresight elevations above radio horizon in radians, ie, angle at which each antenna is aimed relative to the horizon. PSIREO(1) is the main receive antenna.

PSITEO(NTMX) /ANTENN/ R*4 TROCOM.INC
Array of transmitter beam boresight elevations above radio horizon in radians, ie, angle at which each antenna is aimed relative to the horizon. PSITEO(1) is the main transmit antenna.

PXMIT /MCOM4/ R*4 MCOM.INC
Rated transmission power in dBm. Default is 70dBm.

RLL /SYSTRN/ R*4 TROCOM.INC
Receiver line losses in dB. Default is 0 dB.

SP /MCOM4/ R*4 MCOM.INC
Service probability. Default is .95.

THER /PATHGE/ R*4 TROCOM.INC
Radio horizon elevation angle at receive site in radians.

THET /PATHGE/ R*4 TROCOM.INC
Radio horizon elevation angle at transmit site in radians.

TLL /SYSTRN/ R*4 TROCOM.INC
Transmitter line losses in dB. Default is 0 dB.

Global variables output to common:

AVERX /MCOM4/ R*4 MCOM.INC
Average terrain elevation above sea level between receive site and radio horizon, in meters.

AVETX /MCOM4/ R*4 MCOM.INC
Average terrain elevation above sea level between transmit site and radio horizon, in meters.

DIFLOS(3) /SUMP/ R*4 CURVE.INC
Median diffraction path loss in dB for each value in ERFAC distribution.

DIFRSL(3) /SUMP/ R*4 CURVE.INC
Median diffraction signal RSL in dBm for each value in ERFAC distribution.

DSTS NR /SUMP/ R*4 CURVE.INC
Standard deviation of diffracted signal long-term SNR distribution in dB.

CHAPTER 8

BUTTERWORTH FILTER CALCULATIONS

This section describes the Butterworth filter calculation routines:

Name	Description	User's Manual section
-----	-----	-----
A50FCC	FCC filter attenuation relative to 50dB	2.7
BUTFIL	Main filter routine	2.7
BWJAM	Interference power spectrum	2.7.3
ENRGF	Energy of filter cascade	2.7
FCCMSK	FCC 19311 mask compare	NA
FFT	Fast Fourier transform	NA
FUNBW	Bandwidth constraint test	NA
FUNJAM	Degradation test	NA
INTERB	Linear interpolation	NA
PEAK	Impulse response peak	NA
PSPEC	Power spectrum - Butterworth	2.7
PSPEC1	Power spectrum - receiver	2.7
PSPEC2	Power spectrum - interferer- receiver	2.7.3
PSPJ	Power spectrum - interferer	2.7.3
RTMI	Newton's iteration for non- linear equations	NA
SAMPLE	Impulse response	NA
SEARCH	Filter specification	NA
SPEC	Spectrum - Butterworth	2.7
SPEC1	Spectrum - receiver	2.7
SPEC2	Spectrum - transmitter	2.7.3

The main routine for this section is BUTFIL. These calculations are described in section 2.7 of the User's Manual.

Figure 2-4 is a top level flowchart for filter and interference effects calculations at a functional level. In most cases the blocks correspond to one or more subprograms. The test blocks (diamonds) correspond to logical branches which are decided by the user's choices of input data.

NOTE

In most cases the sections in the User's Manual describe the coded equations as well as the theory behind them. NA denotes routines that are programming utilities such as finding indices, setting pointers, etc.

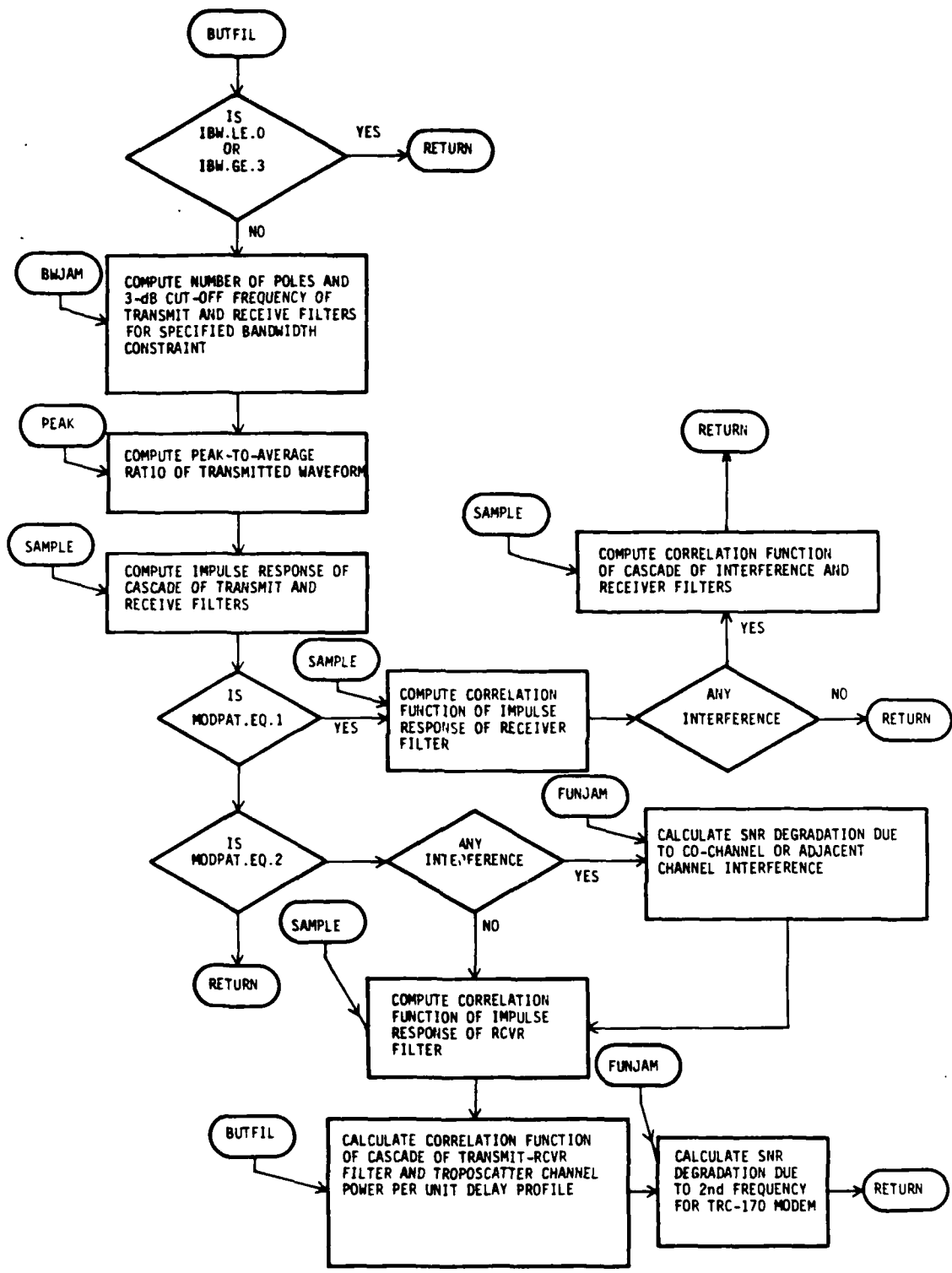

Figure 2-4 Flow Chart for Filter and Interference Effects Calculations

8.1 A50FCC

Subprogram name: Function A50FCC

Purpose: Calculates filter attenuation at normalized frequency F relative to 50dB attenuation.

Calling sequence:
A50FCC (F)

Contained in module: BUTFIL

Called by: FCCMSK, FUNRW

Calls: PSPEC

Input arguments:
F R*4 Frequency relative to the center of the band normalized to the symbol rate.

Output arguments:
A50FCC R*4 Filter attenuation at normalized frequency F relative to 50dB attenuation.

Global variables input from common:

FCTX	/BUTPAR/	R*4	BUTPAR.INC	Normalized 3dB cut-off frequency of transmitter filter.
IFILTX	/BUTPAR/	I*2	BUTPAR.INC	Transmitter filter indicator. 0 = MD-918 transmitter filter. Also means filter is a Butterworth cascaded with a rectangular impulse response filter of duration equal to symbol duration. 1 = AN/TRC-170 transmitter filter. Also means filter is a cascade of Butterworth filter with rectangular impulse response filter of duration equal to half symbol duration. 2 = (not allowed)
NPOLTX	/BUTPAR/	I*2	BUTPAR.INC	Number of poles in the transmit Butterworth filter.
PENERG	/BUTPAR/	R*4	BUTPAR.INC	Normalized energy of filter.
RSDB	/BUTPAR/	R*4	BUTPAR.INC	10 times the base 10 logarithm of the symbol rate minus 60.

8.2 BUTFIL

Subprogram name: Subroutine BUTFIL

Purpose: Calculate filter related parameters for MD-918 and TRC-170 modems.

Calling sequence:
CALL BUTFIL (DRATE,BW,IBW,TAPW,TAU22,JPOW1,JBW1,
FJSEP,MODSI1,MODPAT,TRCTYP)

Contained in module: BUTFIL

Called by: TROPO

Calls: BWJAM, FUNJAM, PEAK, PSPEC1, PSPEC2, SAMPLE, SPEC1, SPEC2

Input arguments:

DRATE	R*4	Data rate in bits/second.
BW	R*4	Signal bandwidth in Hertz.
IBW	I*2	RF bandwidth filtering constraint indicator: 0 = no constraint 1 = 99% bandwidth constraint 2 = FCC 19311 mask 3 = user supplied
TAPW	R*4	MD-918 AFE normalized tap spacings.
TAU22	R*8	RMS delay spread of troposcatter signal in lower beam in nanoseconds.
JPOW1	R*8	Interfering signal power density in dBm/Hz.
JBW1	R*8	Interfering signal bandwidth in Hertz.
FJSEP	R*4	Frequency separation between desired signal and interference signal in Hertz.
MODSI1	I*2	Interference modulation type indicator: 0 = FDM/FM 1 = QPSK
MODPAT	I*2	Indicates whether or not to calculate modem performance. 0 = Propagation only 1 = Propagation + MD-918 modem 2 = Propagation + TRC modem 3 = Propagation + user supplied modem
TRCTYP	R*4	AN/TRC-170 modem type indicator: 0 = 1 frequency DAR modem 1 = 2 frequency AN/TRC-170

Output arguments:

BW	R*4	99% bandwidth of transmit filter specified by user (IBW = 3) in Hertz.
----	-----	--

Global variables input from common:

BUTTERWORTH FILTER CALCULATIONS
Subroutine BUTFIL

Page 8-6

LERR /LUNS/ I*2 LUNS.INC
Error output unit.

LOUT /LUNS/ I*2 LUNS.INC
FOR002.DAT output unit number.

NPOLRX /BUTPAR/ R*4 BUTPAR.INC
Number of poles in the receive Butterworth filter.

NPOLTX /BUTPAR/ I*2 BUTPAR.INC
Number of poles in the transmit Butterworth filter.

NTR /RZ4/ I*2 RZ4.INC
Number of samples for calculating transmit-receive filter impulse response (TRFIL).

PENERG /BUTPAR/ R*4 BUTPAR.INC
Normalized energy of filter.

PI /CONSTA/ R*4 CONSTANTS.INC
Constant Pi = 3.141592654.

PJ /JAMPAR/ R*4 JAMPAR.INC
Normalization constant for interference calculations.

RCOR(32) /RZ4/ R*4 RZ4.INC
Correlation function of the receive filter in steps equal to the tapwidth (TAPW) for MD-918 modem, or equal to 1/RATE for AN/TRC-170 or DAR modem.

Global variables output to common:

CONJAM /JAMPAR/ R*4 JAMPAR.INC
Interference constant.

FCON /BUTPAR/ R*4 BUTPAR.INC
Ratio of bandwidth to twice the symbol rate.

FCRX /BUTPAR/ R*4 BUTPAR.INC
Normalized 3dB cut-off frequency of receiver filter.

FCTX /BUTPAR/ R*4 BUTPAR.INC
Normalized 3dB cut-off frequency of transmitter filter.

FJSEPN /JAMPAR/ R*4 JAMPAR.INC
Normalized frequency separation between the interference signal and the desired signal.

ICON /BUTPAR/ I*2 BUTPAR.INC
1 = 99% bandwidth constraint
2 = FCC-13911 bandwidth constraint

IFILRX /BUTPAR/ I*2 BUTPAR.INC
Receiver filter indicator.
0 = MD-918 receiver filter. Also means filter is a Butterworth cascaded with a rectangular impulse response filter of duration equal to symbol duration.
1 = (not allowed)
2 = AN/TRC-170 receiver filter. Also means filter is a Butterworth.

IFILTX /BUTPAR/ I*2 BUTPAR.INC
Transmitter filter indicator.
0 = MD-918 transmitter filter. Also means

filter is a Butterworth cascaded with a rectangular impulse response filter of duration equal to symbol duration.

1 = AN/TRC-170 transmitter filter. Also means filter is a cascade of Butterworth filter with rectangular impulse response filter of duration equal to half symbol duration.

2 = (not allowed)

JBW /JAMPAR/ R*4 JAMPAR.INC
99% interferer bandwidth in MHz.

JPOW /JAMPAR/ R*4 JAMPAR.INC
Interferer power density in dBm/Hz: -174 or less denotes no interference. Default is -1000 dBm/Hz.

MODSG /JAMPAR/ I*2 JAMPAR.INC
Interference signal modulation format. Default is 1.
0 = Analog FDM / FM
1 = Digital QPSK

NJR /RZ4/ I*2 RZ4.INC
Number of sample points for RJCOR.

PEAKAV /RZ4/ R*4 RZ4.INC
Peak-to-average loss due to RF filtering in dB.

RJCOR(129) /RZ4/ R*4 RZ4.INC
Correlation function of interferer-receiver filters at RATE points per symbol interval.

RSDB /BUTPAR/ R*4 BUTPAR.INC
10 times the base 10 logarithm of the symbol rate minus 60.

SNRBW /RZ4/ R*4 RZ4.INC
Signal to noise ratio adjustment for AN/TRC-170 due to limited receive filter bandwidth.

SNRF2 /RZ4/ R*4 RZ4.INC
Parameter to adjust the signal to noise ratio for degradation due to interference from another frequency. Only for 2-frequency AN/TRC-170 modem.

SNRJAM /RZ4/ R*4 RZ4.INC
Parameter to adjust the signal to noise ratio of AN/TRC-170 for degradation due to colocated/adjacent channel interference.

TRFILT(128) /RZ4/ R*4 RZ4.INC
Transmit-receive filter impulse response.

XTRO /RZ4/ R*4 RZ4.INC
Time origin for transmit-receive filter impulse response (TRFILT); ie, X is TRFILT(X+XTRO).

XTRINC /RZ4/ R*4 RZ4.INC
Sample interval for calculation of transmit-receive filter impulse response (TRFILT).

8.3 BWJAM

Subprogram name: Subroutine BWJAM

Purpose: Specify power spectrum for interference and calculate transmit filter and receive filter parameters. Calculate number of poles and 3dB cut-off frequency of transmit and receive filters for specified bandwidth constraint.

Calling sequence:

CALL BWJAM (MODPAT,TRCTYP,FLOWER,FUPPER,NLOWER,NUPPER, IBW,RW,SRATE)

Contained in module: BUTFIL

Called by: BUTFIL

Calls: ENRGF, FUNBW, FUNJAM, RTMI, SEARCH

Input arguments:

MODPAT	I#2	Indicates whether or not to calculate modem performance. 0 = Propagation only 1 = Propagation + MU-918 modem 2 = Propagation + TRC modem 3 = Propagation + user supplied modem
TRCTYP	R#4	AN/TRC-170 modem type indicator: 0 = 1 frequency IIR modem 1 = 2 frequency AN/TRC-170
FLOWER	R#4	Smallest normalized cut-off frequency of interest for Butterworth filter.
FUPPER	R#4	Largest normalized cut-off frequency of interest for Butterworth filter.
NLOWER	I#2	Smallest number of poles of interest for Butterworth filter.
NUPPER	I#2	Largest number of poles of interest for Butterworth filter.
IBW	I#2	RF bandwidth filtering constraint indicator: 0 = no constraint 1 = 99% bandwidth constraint 2 = FCC 19311 mask 3 = user supplied
BW	R#4	Signal bandwidth in Hertz.
SRATE	R#4	Symbol rate in symbols/second.

Output arguments:

Global variables input from common:

FCTX	/BUTPAR/	R#4	BUTPAR.INC
			Normalized 3dB cut-off frequency of transmitter filter.

IFILTX /BUTPAR/ I#2 BUTPAR.INC
Transmitter filter indicator.
 0 = MD-918 transmitter filter. Also means
 filter is a Butterworth cascaded with a
 rectangular impulse response filter of
 duration equal to symbol duration.
 1 = AN/TRC-170 transmitter filter. Also means
 filter is a cascade of Butterworth filter
 with rectangular impulse response filter
 of duration equal to half symbol duration.
 2 = (not allowed)

JBW /JAMPAR/ R#4 JAMPAR.INC
99% interferer bandwidth in MHz.

JPOW /JAMPAR/ R#4 JAMPAR.INC
Interferer power density in dBm/Hz: -174 or less
denotes no interference. Default is -1000 dBm/Hz.

LERR /LUNS/ I#2 LUNS.INC
Error output unit.

MODSG /JAMPAR/ I#2 JAMPAR.INC
Interference signal modulation format. Default is 1.
 0 = Analog FDM / FM
 1 = Digital QPSK

PENERG /BUTPAR/ R#4 BUTPAR.INC
Normalized energy of filter.

Global variables output to common:

CONJAM /JAMPAR/ R#4 JAMPAR.INC
Interference constant.

FCJ /JAMPAR/ R#4 JAMPAR.INC
Normalized 3dB cut-off frequency of QPSK interference
filter.

FCON /BUTPAR/ R#4 BUTPAR.INC
Ratio of bandwidth to twice the symbol rate.

FCRX /BUTPAR/ R#4 BUTPAR.INC
Normalized 3dB cut-off frequency of receiver filter.

FMI /JAMPAR/ R#4 JAMPAR.INC
Modulation index for FDM/FM interference.

ICON /BUTPAR/ I#2 BUTPAR.INC
 1 = 99% bandwidth constraint
 2 = FCC-13911 bandwidth constraint

NPOLJ /JAMPAR/ I#2 JAMPAR.INC
Number of poles in the QPSK interference filter.

NPOLRX /BUTPAR/ R#4 BUTPAR.INC
Number of poles in the receive Butterworth filter.

NPOLTX /BUTPAR/ I#2 BUTPAR.INC
Number of poles in the transmit Butterworth filter.

PJ /JAMPAR/ R#4 JAMPAR.INC
Normalization constant for interference calculations.

WFM /JAMPAR/ R#4 JAMPAR.INC
Normalization constant for FDM/FM interference.

BUTTERWORTH FILTER CALCULATIONS
Subroutine BWJAM

Page 8-10

8.4 ENRGF

Subprogram name: Subroutine ENRGF

Purpose: To calculate 'energy' of cascade of Butterworth filter and filter with rectangular impulse response by integrating power spectrum of the cascade of the two filters.

Calling sequence:
CALL ENRGF (NPOLE,FCUT,IFILT,PENERG,FINCR,IERR)

Contained in module: BUTFIL

Called by: BMJAM, FUNBW, FUNJAM

Calls: PSPEC

Input arguments:

NPOLE	I*2	Number of poles of Butterworth filter.
FCUT	R*4	Normalized 3-dB cut off frequency of Butterworth filter.
IFILT	I*2	Rectangular impulse response filter duration flag: 0 = symbol duration 1 = half-symbol duration 2 = no rectangular impulse response filter
FINCR	R*4	Normalized frequency increment for integration.

Output arguments:

PENERG	R*4	Energy of cascade of the two filters.
IERR	I*2	Error flag: 0 = no error; 1 = integral did not converge.

8.5 FCCMSK

Subprogram name: Subroutine FCCMSK

Purpose: To compare filter attenuation as a function of frequency with
FCC 19311 mask.

Calling sequence:
CALL FCCMSK (N1,N2,N3,IERR)

Contained in module: BUTFIL

Called by: FUNBW

Calls: A50FCC

Input arguments:

N1	I*2	Number of frequencies to be tested in flat 50 dB region.
N2	I*2	Number of frequencies to be tested in linear attenuation region.
N3	I*2	Number of frequencies to be tested in flat 80 dB region.

Output arguments:

IERR	I*2	Error flag.
------	-----	-------------

Global variables input from common:

F50L	/BUTPAR/	R*4	BUTPAR.INC
			50dB normalized corner frequency.
RSDB	/BUTPAR/	R*4	BUTPAR.INC
			10 times the base 10 logarithm of the symbol rate minus 60.

8.6 FFT

Subprogram name: Subroutine FFT

Purpose: Fast Fourier transform.

Reference: Oppenheim, Shaffer, Digital Signal Processing, p.332.

Calling sequence:
CALL FFT (X,M,INDEX)

Contained in module: BUTFIL

Called by: SAMPLE

Calls: NONE

Input arguments:

X(128)	C*8	Input sequence.
M	I*2	Log base 2 of number of points in the transform.
INDEX	I*2	Processing switch: 1 = Direct FFT -1 = Inverse FFT

Output arguments:

X(128)	C*8	Output (fourier transformed) sequence.
--------	-----	--

Global variables input from common:

PI	/CONSTA/	R*4	CONSTANTS.INC
Constant Pi = 3.141592654.			

8.7 FUNBW

Subprogram name: Function FUNBW

Purpose: To determine whether Butterworth filter with normalized cut-off frequency FC meets 99% or FCC 19311 bandwidth constraint (FUNBW < 0) or not.

Callins sequence:
FUNBW (FC)

Contained in module: BUTFIL

Called by: BUTFIL, BWJAM

Calls: A50FCC, ENRGF, FCCMSK, INTERB, PSPEC

Input arguments:
FC R*4 Normalized cut-off frequency of Butterworth filter.

Output arguments:
FUNBW R*4 Flag whether Butterworth filter with normalized cut-off frequency FC meets 99% or FCC 19311 bandwidth constraint (FUNBW < 0) or not.

Global variables input from common:

FCON	/BUTPAR/	R*4	BUTPAR.INC	Ratio of bandwidth to twice the symbol rate.
ICON	/BUTPAR/	I*2	BUTPAR.INC	1 = 99% bandwidth constraint 2 = FCC-13911 bandwidth constraint
IFILTX	/BUTPAR/	I*2	BUTPAR.INC	Transmitter filter indicator. 0 = MB-918 transmitter filter. Also means filter is a Butterworth cascaded with a rectangular impulse response filter of duration equal to symbol duration. 1 = AN/TRC-170 transmitter filter. Also means filter is a cascade of Butterworth filter with rectangular impulse response filter of duration equal to half symbol duration. 2 = (not allowed)
NPOLTX	/BUTPAR/	I*2	BUTPAR.INC	Number of poles in the transmit Butterworth filter.
PENERG	/BUTPAR/	R*4	BUTPAR.INC	Normalized energy of filter.

Global variables output to common:

FSOL	/BUTPAR/	R*4	BUTPAR.INC	50dB normalized corner frequency.
------	----------	-----	------------	-----------------------------------

8.18 SPEC

Subprogram name: C*8 Function SPEC

Purpose: Evaluate the spectrum (Fourier transform of impulse response) at normalized frequency F of the cascade of a Butterworth filter and a filter with a rectangular impulse response.

Calling sequence:
SPEC (F,NPOLE,FCUT,IFILT)

Contained in module: BUTFIL

Called by: SPEC1, SPEC2

Calls: NONE

Input arguments:

F	R*4	Frequency relative to the center of the band normalized to the symbol rate.
NPOLE	I*2	Number of poles of Butterworth filter.
FCUT	R*4	Normalized 3dB cutoff frequency of Butterworth filter.
IFILT	I*2	Rectangular impulse response filter duration flag: 0 = symbol duration 1 = half-symbol duration 2 = response of filter is an impulse

Output arguments:

SPEC	C*8	Spectrum (Fourier transform of impulse response) at normalized frequency F of the cascade of a Butterworth filter and a filter with a rectangular impulse response.
------	-----	---

Global variables input from common:

PI	/CONSTA/	R*4	CONSTANTS.INC
			Constant Pi = 3.141592654.

WORTH FILTER CALCULATIONS
outine SEARCH

Page 8-27

8.17 SEARCH

Subprogram name: Subroutine SEARCH

Purpose: Specify a Butterworth filter with NPOLE poles, where
NLOWER < NPOLE < NUPPER and 3dB cut-off frequency FCUT is
FLOWER < FCUT < FUPPER to satisfy the constraint FUN < 0 and to
minimize a pulse duration criterion.

Calling sequence:

CALL SEARCH (IFUN,FUN,FLOWER,FUPPER,NLOWER,NUPPER,FCUT, NPOLE,IERR)

Contained in module: BUTFIL

Called by: BWJAM

Calls: RTMI FUNJAM FUNRW

Input arguments:

IFUN	I*2	Process switch:
		1 = specify transmit filter parameters
		2 = specify receive filter parameters
FLOWER	R*4	Lower limit for cut-off frequency, FCUT.
FUPPER	R*4	Upper limit for cut-off frequency, FCUT.
NLOWER	I*2	Lower limit for number of poles, NPOLE.
NUPPER	I*2	Upper limit for number of poles, NPOLE.
FUN	R*4	Function name:
		For IFUN = 1, FUN = FUNRW
		For IFUN = 2, FUN = FUNJAM

Output arguments:

FCUT	R*4	3-dB cut off frequency of Butterworth filter.
NPOLE	I*2	Number of poles of Butterworth filter.
IERR	I*2	Error flag:
		0 = no error
		1 = FLOWER is too large
		2 = FUPPER is too small
		3 = no solution found

Global variables input from common:

LERR	/LUNS/	I*2	LUNS.INC
			Error output unit.
PI	/CONSTA/	R*4	CONSTANTS.INC
			Constant Pi = 3.141592654.

Global variables output to common:

NPOLRX	/BUTPAR/	R*4	BUTPAR.INC
			Number of poles in the receive Butterworth filter.
NPOLTX	/BUTPAR/	I*2	BUTPAR.INC
			Number of poles in the transmit Butterworth filter.

8.16 SAMPLE

Subprogram name: Subroutine SAMPLE

Purpose: Calculate impulse response of filter with spectrum (Fourier Transform of impulse response) WFUN.

Calling sequence:
CALL SAMPLE (WSAMPL,WFUN,RATE,MMIN,MMAX,TMAX,FMAX,NSMPL,IERR)

Contained in module: BUTFIL

Called by: BUTFIL

Calls: FFT

Input arguments:

RATE	R*4	Sampling rate in samples/unit of time.
MMIN	I*2	Log base 2 of minimum FFT length to be considered.
MMAX	I*2	Log base 2 of maximum FFT length to be considered.
TMAX	R*4	Maximum length of impulse response.
FMAX	R*4	Maximum frequency in spectrum.

Output arguments:

WSAMPL(128)	R*4	Impulse response.
WFUN	C*8	Spectrum function name.
NSMPL	I*2	Number of samples in impulse response.
IERR	I*2	Error flag: 0 = no error; 1 = inadequate FFT length.

8.15 RTMI

Subprogram name: Subroutine RTMI

Purpose: IBM SSP Library routine. RTMI solves the general nonlinear equation of the form $FCN(x) = 0$ by Newton's iteration method.

Calling sequence:

CALL RTMI (X,F,FCT,XLI,XRI,EPS,IEND,IER)

Contained in module: BUTFIL

Called by: BWJAM, SEARCH

Calls: NONE

Input arguments:

FCT	R*4	Name of external subroutine used. It computes to given argument X and function value F. Parameter list must be X, F.
XLI	R*4	Smallest value of X.
XRI	R*4	Largest value of X.
EPS	R*4	Input value that specifies the upper bound of the error of result X.
IEND	I*2	Maximum number of iteration steps specified.

Output arguments:

X	R*4	Resultant root of equation $f(x) = 0$.
F	R*4	Resultant function value at root X.
IER	I*2	Resultant error code: 0 = No error. 1 = No convergence after IEND iteration steps.

UTTERWORTH FILTER CALCULATIONS
unction PSPJ

Page 8-23

PI	/CONSTA/	R#4	CONSTANTS.INC
	Constant Pi = 3.141592654.		
WFM	/JAMPAR/	R#4	JAMPAR.INC
	Normalization constant for FDM/FM interference.		

8.14 PSPJ

Subprogram name: Function PSPJ

Purpose: Power spectrum of interferer at frequency F.

Calling sequence:
PSPJ (F)

Contained in module: BUTFIL

Called by: FUNJAM, PSPEC2, PWRSPC

Calls: PSPEC

Input arguments:
F R*4 Frequency relative to the center of the band
normalized to the symbol rate.

Output arguments:
PSPJ R*4 Power spectrum of interferer at frequency F.

Global variables input from common:

FCJ	/JAMPAR/	R*4	JAMPAR.INC	Normalized 3dB cut-off frequency of QPSK interference filter.
FCTX	/BUTPAR/	R*4	BUTPAR.INC	Normalized 3dB cut-off frequency of transmitter filter.
FMI	/JAMPAR/	R*4	JAMPAR.INC	Modulation index for FDM/FM interference.
IFILTX	/BUTPAR/	I*2	BUTPAR.INC	Transmitter filter indicator. 0 = MD-918 transmitter filter. Also means filter is a Butterworth cascaded with a rectangular impulse response filter of duration equal to symbol duration. 1 = AN/TRC-170 transmitter filter. Also means filter is a cascade of Butterworth filter with rectangular impulse response filter of duration equal to half symbol duration. 2 = (not allowed)
MODSG	/JAMPAR/	I*2	JAMPAR.INC	Interference signal modulation format. Default is 1. 0 = Analog FDM / FM 1 = Digital QPSK
NPOLJ	/JAMPAR/	I*2	JAMPAR.INC	Number of poles in the QPSK interference filter.
NPOLTX	/BUTPAR/	I*2	BUTPAR.INC	Number of poles in the transmit Butterworth filter.

8.13 PSPEC2

Subprogram name: C#8 Function PSPEC2

Purpose: To calculate power spectrum of interferer-receiver filters at normalized frequency F.

Calling sequence:
PSPEC2 (F)

Contained in module: BUTFIL

Called by: BUTFIL

Calls: PSPEC, PSPJ

Input arguments:
F R#4 Frequency relative to the center of the band normalized to the symbol rate.

Output arguments:
PSPEC2 C#8 Power spectrum of interferer-receiver filters at normalized frequency F.

Global variables input from common:

FCRX	/BUTPAR/	R#4	BUTPAR.INC	Normalized 3dB cut-off frequency of receiver filter.
FJSEPN	/JAMPAR/	R#4	JAMPAR.INC	Normalized frequency separation between the interference signal and the desired signal.
IFILRX	/BUTPAR/	I#2	BUTPAR.INC	Receiver filter indicator. 0 = MD-918 receiver filter. Also means filter is a Butterworth cascaded with a rectangular impulse response filter of duration equal to symbol duration. 1 = (not allowed) 2 = AN/TRC-170 receiver filter. Also means filter is a Butterworth.
NPOLRX	/BUTPAR/	R#4	BUTPAR.INC	Number of poles in the receive Butterworth filter.

8.12 PSPEC1

Subprogram name: C*8 Function PSPEC1

Purpose: To calculate power spectrum of receiver filter at normalized frequency F.

Calling sequence:
PSPEC1 (F)

Contained in module: BUTFIL

Called by: BUTFIL

Calls: PSPEC

Input arguments:

F R*4 Frequency relative to the center of the band
normalized to the symbol rate.

Output arguments:

PSPEC1 C*8 Power spectrum of receiver filter at normalized
frequency F.

Global variables input from common:

FCRX /BUTPAR/ R*4 BUTPAR.INC
Normalized 3dB cut-off frequency of receiver filter.

IFILRX /BUTPAR/ I*2 BUTPAR.INC
Receiver filter indicator.
0 = MD-918 receiver filter. Also means
filter is a Butterworth cascaded with a
rectangular impulse response filter of
duration equal to symbol duration.
1 = (not allowed)
2 = AN/TRC-170 receiver filter. Also means
filter is a Butterworth.

NPOLRX /BUTPAR/ R*4 BUTPAR.INC
Number of poles in the receive Butterworth filter.

8.11 PSPEC

Subprogram name: Function PSPEC

Purpose: To calculate power spectrum of cascade of Butterworth filter
with rectangular impulse response filter at normalized frequency F.

Calling sequence:
PSPEC (F,NPOLE,FCUT,IFILT)

Contained in module: BUTFIL

Called by: A5OFCC, ENRGF, FUNBW, FUNJAH, PSPEC1, PSPEC2, PSPJ, PWRSPC

Calls: NONE

Input arguments:

F	R*4	Frequency relative to the center of the band normalized to the symbol rate.
NPOLE	I*2	Number of poles of Butterworth filter.
FCUT	R*4	Normalized 3-dB cut off frequency of Butterworth filter.
IFILT	I*2	Rectangular impulse response filter duration flag: 0 = symbol duration 1 = half-symbol duration 2 = impulse response is an impulse.

Output arguments:

PSPEC	R*4	Power spectrum of cascade of Butterworth filter with rectangular impulse response filter at normalized frequency F.
-------	-----	---

Global variables input from common:

PI	/CONSTA/	R*4	CONSTANTS.INC
Constant Pi = 3.141592654.			

8.10 PEAK

Subprogram name: Subroutine PEAK

Purpose: To calculate the peak of the transmitted waveform impulse response.

Calling sequence:
CALL PEAK (XMAX,IMAX,X,N)

Contained in module: BUTFIL

Called by: BUTFIL

Calls: NONE

Input arguments:
X(N) R*4 Impulse response of transmitted waveform. Dimensioned to 128.
N I*2 Number of samples in impulse response. Maximum is 128.

Output arguments:
XMAX R*4 Peak value of impulse response.
IMAX I*2 Index of peak sample.

8.9 INTERB

Subprogram name: Subroutine INTERB

Purpose: Linear interpolation in a table of N pairs (XX,YY).

Calling sequence:
CALL INTERB (Y,X,YY,XX,N,IERR)

Contained in module: BUTFIL

Called by: FUNBW

Calls: NONE

Input arguments:

X	R*4	Value of x-coordinate for which y-coordinate is desired.
YY(N)	R*4	Tabulated values of y-coordinate corresponding to tabulated x-coordinate. Dimensioned to 30.
XX(N)	R*4	Tabulated value of x-coordinate in decreasing order. Dimensioned to 30.
N	I*2	Number of tabulated values over which interpolation is to be performed. Maximum is 30.

Output arguments:

Y	R*4	Value of y-coordinate corresponding to x-coordinate.
IERR	I*2	Error flag: 0 = no error 5 = x-coordinate value greater than largest tabulated value 6 = x-coordinate value less than smallest tabulated value

8.8 FUNJAM

Subprogram name: Function FUNJAM

Purpose: To determine whether adjacent channel interference power within receiver bandwidth, calculated by integrating over the product of the interference power spectrum and the receiver filter power spectrum, degrades the SNL by less than 1 dB.

Calling sequence:
FUNJAM (FC)

Contained in module: BUTFIL

Called by: BUTFIL, BWJAM

Calls: ENRGF, PSPEC, PSPJ

Input arguments:
FC R*4 Normalized cut-off frequency of Butterworth filter.

Output arguments:
FUNJAM R*4 Flags whether adjacent channel interference power within receiver bandwidth degrades the SNL by less than 1 dB.

Global variables input from common:

CONJAM	/JAMPAR/	R*4	JAMPAR.INC
			Interference constant.
FJSEPN	/JAMPAR/	R*4	JAMPAR.INC
			Normalized frequency separation between the interference signal and the desired signal.
IFILRX	/BUTPAR/	I*2	BUTPAR.INC
			Receiver filter indicator.
			0 = MD-918 receiver filter. Also means filter is a Butterworth cascaded with a rectangular impulse response filter of duration equal to symbol duration.
			1 = (not allowed)
			2 = AN/TRC-170 receiver filter. Also means filter is a Butterworth.
NPOLRX	/BUTPAR/	K*4	BUTPAR.INC
			Number of poles in the receive Butterworth filter.
PJ	/JAMPAR/	R*4	JAMPAR.INC
			Normalization constant for interference calculations.

BUTTERWORTH FILTER CALCULATIONS
Function FUNBW

Page 8-15

FCTX

/BUTPAR/ R*4 BUTPAR.INC
Normalized 3dB cut-off frequency of transmitter
filter.

8.19 SPEC1

Subprogram name: C*8 Function SPEC1

Purpose: Evaluate the spectrum (Fourier transform of impulse response) at normalized frequency F of the receiver filter.

Calling sequence:
SPEC1 (F)

Contained in module: BUTFIL

Called by: BUTFIL

Calls: SPEC

Input arguments:
F R*4 Frequency relative to the center of the band normalized to the symbol rate.

Output arguments:
SPEC1 C*8 Spectrum (Fourier transform of impulse response) at normalized frequency F of the receiver filter.

Global variables input from common:

FCRX /BUTPAR/ R*4 BUTPAR.INC
Normalized 3dB cut-off frequency of receiver filter.

FCTX /BUTPAR/ R*4 BUTPAR.INC
Normalized 3dB cut-off frequency of transmitter filter.

IFILRX /BUTPAR/ I*2 BUTPAR.INC
Receiver filter indicator.
0 = MD-918 receiver filter. Also means filter is a Butterworth cascaded with a rectangular impulse response filter of duration equal to symbol duration.
1 = (not allowed)
2 = AN/TRC-170 receiver filter. Also means filter is a Butterworth.

IFILTX /BUTPAR/ I*2 BUTPAR.INC
Transmitter filter indicator.
0 = MD-918 transmitter filter. Also means filter is a Butterworth cascaded with a rectangular impulse response filter of duration equal to symbol duration.
1 = AN/TRC-170 transmitter filter. Also means filter is a cascade of Butterworth filter with rectangular impulse response filter of duration equal to half symbol duration.
2 = (not allowed)

BUTTERWORTH FILTER CALCULATIONS
Function SPEC1

Page 8-30

NPOLRX	/BUTPAR/	R#4	BUTPAR.INC
		Number of poles in the receive Butterworth filter.	
NPOLTX	/BUTPAR/	I#2	BUTPAR.INC
		Number of poles in the transmit Butterworth filter.	

8.20 SPEC2

Subprogram name: C*8 Function SPEC2

Purpose: To calculate the spectrum (Fourier transform of impulse response) at normalized frequency F of the transmitter filter.

Calling sequence:
SPEC2 (F)

Contained in module: BUTFIL

Called by: BUTFIL

Calls: SPEC

Input arguments:
F R*4 Frequency relative to the center of the band
normalized to the symbol rate.

Output arguments:
SPEC2 C*8 Spectrum (Fourier transform of impulse response) at
normalized frequency F of the transmitter filter.

Global variables input from common:

FCTX /BUTPAR/ R*4 BUTPAR.INC
Normalized 3dB cut-off frequency of transmitter
filter.

IFILTX /BUTPAR/ I*2 BUTPAR.INC
Transmitter filter indicator.
0 = MD-918 transmitter filter. Also means
filter is a Butterworth cascaded with a
rectangular impulse response filter of
duration equal to symbol duration.
1 = AN/TRC-170 transmitter filter. Also means
filter is a cascade of Butterworth filter
with rectangular impulse response filter
of duration equal to half symbol duration.
2 = (not allowed)

NPOLTX /BUTPAR/ I*2 BUTPAR.INC
Number of poles in the transmit Butterworth filter.

CHAPTER 9
MD-918 MODEM CALCULATIONS

This section describes the MD-918 modem performance calculation routines:

Name	Description	User's Manual section
----	-----	-----
BERCAL	Short term performance calculation	2.8.1
BOTAC	Interference covariance matrices	2.8.1
CAC	Cascade of filter and channel power impulse response	NA
CAJI	Thermal noise covariance matrix	NA
CAKL	Signal covariance matrix C(K,L)	NA
CHANGE	Matrix utility	NA
DINT	Double integration	NA
EIGEN	Eigenvalues and eigenvectors	2.8.1
ELMES	Matrix conditioner	2.9.4
ERLANG	Butterworth filter calculation	NA
HQR	Eigenvalues	2.9.4
JANCOM	Interference covariance matrix	NA
MATA	Matrix multiplication	NA
MATCO	Covariance matrices	NA
MDTS	MD-918 modem performance	2.8
MINV	Matrix inversion	NA
ORDER	Order values in vector	NA
PDFCON	Coefficients of PDF	2.8.1.3
PROUT	Print out outages and BER	NA
PSINE	Sine product	NA
PWRSPC	Power spectrum - receiver-interferer	2.7.3
RJCFCN	Receiver-interferer correlation function	2.7.3
SASEQ	Chip sequence	NA
SIGIN	Set parameters	NA
SINC	SINC function	NA
SQTHAT	Matrix square root	2.8.1

TPSPEC	Power spectrum - Butterworth	. 2.7
TPSPJ	Power spectrum - interferer	. . 2.7.3
TSINC	Triangle and SINC convolution	. NA
XNOR	Gaussian PDF NA

The main routine for this section is MDT5. The MD-918 calculations are described in section 2.8 of the User's Manual.

Figure 2-5 is a top level flowchart for MD-918 modem performance calculations at a functional level. In most cases the blocks correspond to one or more subprograms. The test blocks (diamonds) correspond to logical branches which are decided by the user's choices of input data.

NOTE

In most cases the sections in the User's Manual describe the coded equations as well as the theory behind them. NA denotes routines that are programming utilities such as finding indices, setting pointers, etc.

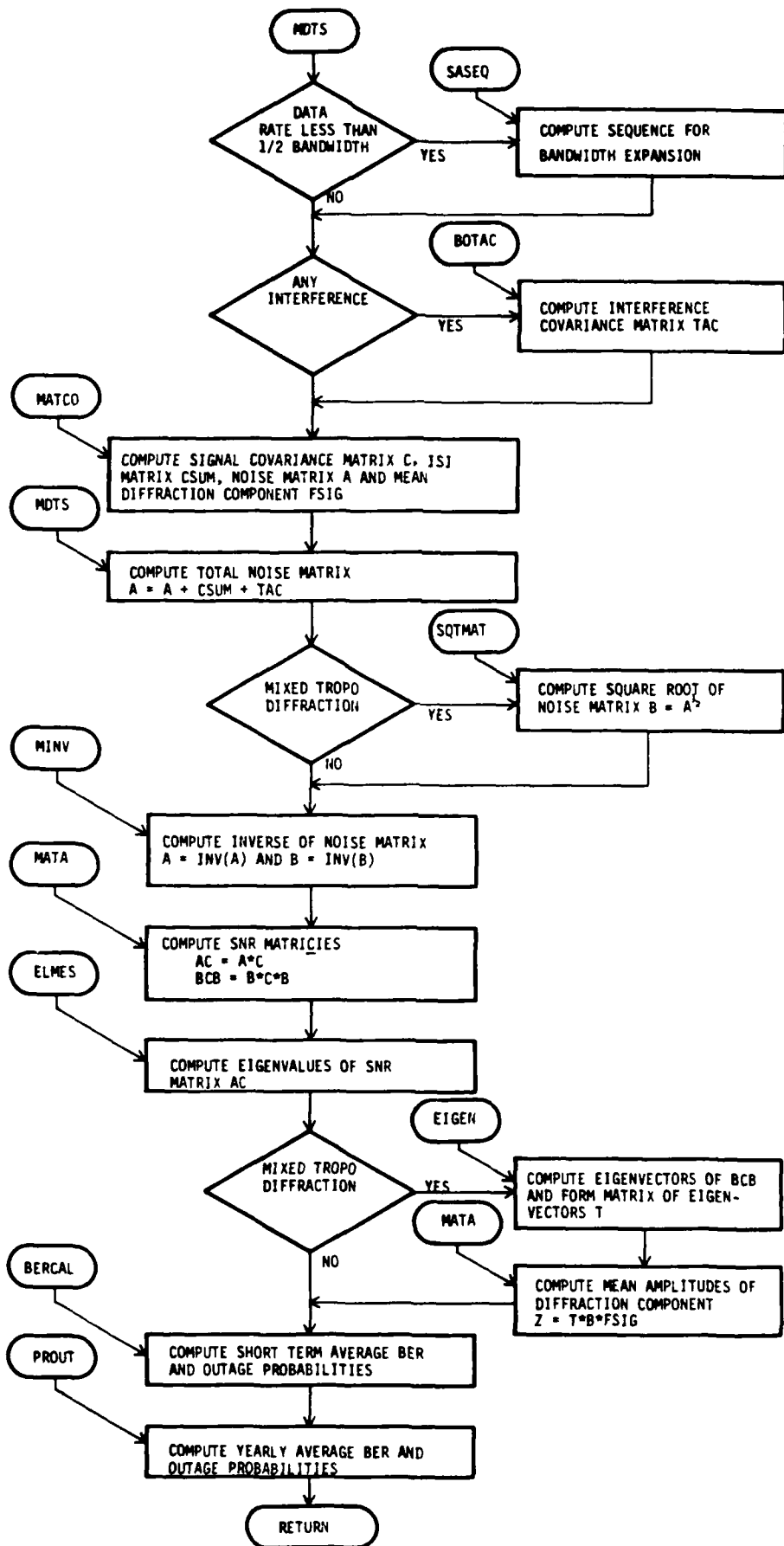

Figure 2-5 Flow Chart for the MD-918 Modem Performance Calculations

9.1 BERCAL

Subprogram name: Subroutine BERCAL

Purpose: BERCAL computes the outage probability, fade outage per call minute, average bit error rate and 1000-bit block error probability as a function of mean hourly scatter SNR, specular component SNR, DSNR, for the MD-918 modem. This version accounts for decorrelation of long term fading of main and elevated beams.

Reference: P. Mosen 'Theoretical and measured performance of a DFE modem on a fading multipath channel.', IEEE Transactions on Communications, Vol. COM-25, No. 10, October, 1977, pp. 1144-1153.

Calling sequence:

```
CALL BERCAL(VJ4, JPOW, JSR, CRATE, IBER, SNR, U, BOUT, ABE,  
SOUT, NOUT, V, F, K3, K6, ASNR, STSNR, FOUT, CGAIN, CORFAC, IFPKAV,  
XSCAT, XDIFR, G, DSNR, ADSNR, DSTSNR, PTYPE, IFDSNR)
```

Contained in module: BERCAL

Called by: MDT5

Calls: ERLANG PDFCON XNOR

Input arguments:

VJ4	R*4	Gain of strongest implicit diversity branch of elevated beam.
JPOW	R*8	Interferer power density in dBm/Hz. If JPOW is less than -174 dBm (background noise level), BERCAL assumes no interference.
JSR	R*8	Interferer to signal power ratio in dB.
CRATE	R*4	Code rate.
IBER	I*2	Integer counter used to indicate the completion of averaging over distributions of SNR and DSNR (IBER = 2).
SNR	R*4	Mean hourly SNR in dB at which outage probability is to be calculated.
F	R*4	Scatter SNR as a ratio. Includes modem degradation.
K3	I*2	Pointer, with K6, to blocks of eigenvalues.
K6	I*2	Pointer, with K3, to blocks of eigenvalues.
ASNR	R*4	Mean of long term distribution of scatter SNR (Eb/No) in dB.
STSNR	R*4	Standard deviation of long term distribution of scatter SNR (Eb/No) in dB.
CGAIN(3)	R*4	Coding gain for each BER threshold.
CORFAC	R*4	Correction factor for STSNR due to decorrelation of long term variability for angle diversity.

IFPKAV	I*2	Switch to print outage probability as a function of peak scatter SNR (E_p/N_0) when IFPKAV = 1, or average scatter SNR (E_b/N_0) when IFPKAV = 0.
XSCAT	R*4	Scatter SNR as a fraction of total power.
XDIFR	R*4	Specular component SNR as a fraction of total power.
G	R*4	Specular component SNR as a ratio.
DSNR	R*4	Specular component SNR in dB.
ADSNR	R*4	Mean of long term distribution of specular component SNR in dB.
DSTSNR	R*4	Standard deviation of long term distribution of specular component SNR in dB.
PTYPE	I*2	Indicates whether path is pure scatter (PTYPE = 0) or mixed scatter/diffraction (PTYPE = 1).
IFDSNR	L*4	Flags indicating which values of DSNR to output.

Output arguments:

U(49)	R*4	Eigenvalues which are the gains of the implicit diversity paths. The first three gains correspond to the main beam path.
BOUT(3,4)	R*4	Yearly average outage probabilities for the different BER thresholds and diversity configurations specified (see table).
ABE(4)	R*4	Yearly average 1000-bit block error probability for each diversity configuration specified (see table).
SOUT	R*4	Normalization constant for averaging over yearly distribution of SNR and DSNR.
NOUT	R*4	Number of terms in numerical integration over distribution of SNR and DSNR.
V(196)	R*8	Inverse of SNR per implicit diversity.
FOUT(3,4)	R*4	Yearly average fade outage per call minute for the different BER thresholds and diversity configurations specified (see table).

Global variables input from common:

APOW	/MCOM4/	R*4	MCOM.INC
			Angle diversity squint loss as a ratio.
BER(3)	/ERAD/	R*4	ERAD.INC
			Bit error rate thresholds of interest. Set to 1E-3, 1E-4 and 1E-5 in data statement.
DIVTYP	/MCOM2/	I*2	MCOM.INC
			Diversity configuration indicator. Default is 0.
			0 = 2 receive antennas; 2S 2S/2F 2S/2A 2S/2A/2F
			1 = 1 receive antenna; 2A 2F 2F/2A
			2 = 2 transmit,
			2 receive antennas; 2S/2P 2S/2P/2A
			3 = Not used

4 = User supplied parameters
S = Space F = Frequency A = Angle P = Polarization
LOUT /LUNS/ I*2 LUNS.INC
FOR002.DAT output unit number.
NERT /MCOM2/ I*2 MCOM.INC
Bit error rate threshold indicator for yearly fade
outage probability calculation. Default is 2.
0 = All three thresholds
1 = For 10^{*-3} only
2 = For 10^{*-4} only
3 = For 10^{*-5} only

9.2 BOTAC

Subprogram name: Subroutine BOTAC

Purpose: Initialize C(KK, KK), A(KK, KK), BOUT(3, 4), and ABE(4) arrays.
Compute interferer covariance matrix TAC(KK, KK) for JPOW > -174
according to RF filtering specified through parameters IBW and JFILT.
IBW specifies whether the receiver has an RF/IF filter (IBW > 0) or
not (IBW = 0). If the receiver does not have an RF filter, JFILT
indicates whether the interference covariance matrix calculation
includes ground reflections (JFILT = 1) or not (JFILT = 0).

Calling sequence:

CALL BOTAC (K, KK, K1, JPOW, JBW, TZ, C, A, TAC, BOUT, NOUT, ABE, FOUT,
BWR, ASEP, JANG)

Contained in module: BOTAC

Called by: MDTS

Calls: JAMCOM, RJCFCN, TSINC

Input arguments:

K	I#2	Flag: = 1 for K1 = 3; = 0 for K1 = 1.
JPOW	R#8	Interference power density in dBm/Hz.
JBW	R#8	Interference normalized bandwidth.
TZ	R#4	Time delay between interference signal received on two horizontally spaced antennas. It is a function of antenna separation and interferer angle of arrival. (See MDTS.)
BWR	R#4	Receive antenna beamwidth in degrees.
ASEP	R#4	Separation distance between receiving antennas in meters.
JANG	R#8	Interference off-borsight angle of arrival in degrees.

Output arguments:

KK	I#2	Dimension of A, C, and TAC arrays. Maximum is 14.
K1	I#2	Number of taps in forward equalizer.
C(KK, KK)	R#4	Signal covariance matrix initialized to zero. Dimensioned as 14x14.
A(KK, KK)	R#4	Noise covariance matrix initialized to zero. Dimensioned as 14x14.
TAC(KK, KK)	R#4	Interferer covariance matrix calculated according to RF filtering specified through IBW and JFILT parameters. Dimensioned as 14x14.
BOUT(3, 4)	R#4	Outage probability array initialized to zero.
NOUT	R#4	Number of short term outage probability

calculations initialized to zero.
ABE(3,4) R*4 Average block error array initialized to zero.
FOUT(3,4) R*4 Fade outage array initialized to zero.

Global variables input from common:

IBW /MCOM2/ I*2 MCOM.INC
Switch indicating type of RF bandwidth constraint to
be used on desired signal. Default is 0.
0 = No RF filtering
1 = Filter determined from 99% bandwidth constraint
2 = Filter chosen to meet FCC Mask. (FCC-19311)
3 = Filters are user specified

JFILT /MCOM2/ I*2 MCOM.INC
Interference covariance matrix calculation indicator.
Only used when IBW equals 0; otherwise ignored.
Default is 0.
0 = Interferer covariance matrix calculation
done in subroutine ROTAC
1 = Interferer covariance matrix calculation
done in subroutine JAMCOM

LOUT /LUNS/ I*2 LUNS.INC
FOR002.DAT output unit number.

NJR /RZ4/ I*2 RZ4.INC
Number of sample points for RJCOR.

TAPW /MCOM4/ R*4 MCOM.INC
Normalized tapwidth for MD-918. Default is .5.
Range is 0.25 through 1.0

9.3 CAC

Subprogram name: Function CAC

Purpose: Computes $G(XZ-SK) * G(XZ-SL) * ZR(T0-XZ)$ when $SIGMA > 0$ and $G(XZ-SK)$ when $SIGMA < 0$. $G(X)$ is the impulse response of the cascade of the transmitter and receiver filters and $ZR(X)$ is the power per unit delay or correlation per unit delay of the perceived scatter signal component.

Call sequence:
CAC (XZ,SK,SL,SIGMA,T0,Z0)

Contained in module: DINT

Called by: DINT MATCO

Calls: FILSIX SINC

Input arguments:

XZ	R*4	Normalized time at which function is to be evaluated.
SK	R*4	Tap sampling time relative to AFE center tap.
SL	R*4	Same as SK.
SIGMA	R*4	Normalized delay spread of scatter component.
T0	R*4	Normalized sampling time for center tap relative to centroid of power per unit delay profile.
Z0	R*4	Power per unit delay or correlation per unit delay profile for scatter signal.

Output arguments:

CAC	R*4	Value of $G(XZ-SK) * G(XZ-SL) * ZR(T0-XZ)$.
-----	-----	--

Global variables input from common:

DELPBZ	/RZ1/	R*4	Resolution of a delay cell in seconds. Same as DELPR in /PDATA/.
DIVTYP	/MCOM2/	I*2	MCOM.INC Diversity configuration indicator. Default is 0. 0 = 2 receive antennas; 2S 2S/2F 2S/2A 2S/2A/2F 1 = 1 receive antenna; 2A 2F 2F/2A 2 = 2 transmit, 2 receive antennas; 2S/2F 2S/2F/2A 3 = Not used 4 = User supplied parameters S = Space F = Frequency A = Angle P = Polarization
DRATE	/MCOM4/	R*4	MCOM.INC Data rate in bits/second. Default is 6.6E6.
DU(256)	/RZ/	R*8	RZ.INC Signal response after PN sequence correlation.
ICORR	/MCOM2/	I*2	MCOM.INC

Multipath profile correlation indicator. Default is 2.
0 = Profile of the form $X * \exp(-A*X)$ -- used for debussins
1 = Computed multipath profile; no beam correlation
2 = Computed multipath profile; beam correlation.

IFILE /MCOM2/ I*2 MCOM.INC
Pointer to multipath profile.

JQ2H /MCOM4/ I*2 MCOM.INC
Pointer to centroid of lower beam troposcatter signal power per unit delay profile.

KGAIN /RZ/ I*2 RZ.INC
Integer ratio of bandwidth to data rate.

NDELO /MCOM4/ I*2 MCOM.INC
Number of non-zero elements of troposcatter power per unit delay profiles Q(NDELO,1).

NIP /RZ/ I*2
Initialization constant for numerical equalizer covariance matrix calculation.

NTR /RZ4/ I*2 RZ4.INC
Number of samples for calculating transmit-receive filter impulse response (TRFILT).

PCON /RZ/ R*8 RZ.INC
Normalization factor for probability integral.

PULSE /RZ/ I*2 RZ.INC
Switch controlling MD-918 pulse shape after transmitter-receiver filtering.
PULSE = 0 Triangle
= 1 QPSK matched filter
= 2 Sinc pulse, bandwidth equal to 1
= 5 RF filtering included
Set to 0 if IBW = 0 or KGAIN > 1.
Set to 5 if IBW > 0 and KGAIN = 1.

TRFILT(128) /RZ4/ R*4 RZ4.INC
Transmit-receive filter impulse response.

XTR0 /RZ4/ R*4 RZ4.INC
Time origin for transmit-receive filter impulse response (TRFILT), ie, X is TRFILT(X+XTR0).

XTRINC /RZ4/ R*4 RZ4.INC
Sample interval for calculation of transmit-receive filter impulse response (TRFILT).

9.4 CAJI

Subprogram name: Subroutine CAJI

Purpose: Calculate thermal noise covariance matrix for AFE taps.

Calling sequence:
CALL CAJI (K,A)

Contained in module: CAJI

Called by: MATCO

Calls: NONE

Input arguments:
K I*2 Number of taps on either side of center tap
of AFE.

Output arguments:
A(14,14) R*4 Thermal noise covariance matrix.

Global variables input from common:

DU(256) /RZ/ R*8 RZ.INC
Signal response after PN sequence correlation.

NB /RI2/ I*2 RI2.INC
Number of elements accessed in arrays DU, DX and DY.

PULSE /RZ/ I*2 RZ.INC
Switch controlling MD-918 pulse shape after
transmitter-receiver filtering.
PULSE = 0 Triangle
= 1 QPSK matched filter
= 2 Sinc pulse, bandwidth equal to 1
= 5 RF filtering included
Set to 0 if IBW = 0 or KGAIN > 1.
Set to 5 if IBW > 0 and KGAIN = 1.

RCOR(32) /RZ4/ R*4 RZ4.INC
Correlation function of the receive filter in steps
equal to the tapwidth (TAPW) for MD-918 modem, or
equal to 1/RATE for AN/TRC-170 or DAR modem.

TAPW /MCOM4/ R*4 MCOM.INC
Normalized tapwidth for MD-918. Default is .5.
Range is 0.25 through 1.0

DEM CALCULATIONS
e MATCO

Page 9-25

Pointer to multipath profile.

IFPRNT I*2 Switch to enable debug print out (=1).
 DUPDW R*4 Ratio of diffraction signal component on upper
 beam to that on lower beam.
 IFDSNR L*4 Switch to enable print out of covariance
 matrices for mixed scatter/diffraction
 propagation conditions.

Output arguments:

C(14,14) R*4 Scatter signal covariance matrix for AFE taps.
 C0(7,7) R*4 Scatter signal covariance sub-matrix for lower
 beam AFE taps.
 C1(7,7) R*4 Scatter signal covariance sub-matrix for upper
 beam AFE taps.
 C2(7,7) R*4 ISI covariance matrix for lower beam taps.
 C3(7,7) R*4 ISI covariance matrix for upper beam taps.
 C4(7,7) R*4 Scatter signal correlation sub-matrix for
 lower/upper beam (DIVTYP = 0,1) or crossed
 paths (DIVTYP = 2).
 CSUM(14,14) R*4 ISI covariance matrix for AFE taps.
 AF(14,14) R*4 Thermal noise covariance matrix for AFE taps.
 A(14,14) R*4 Same as AF.

Global variables input from common:

DIVTYP /MCOM2/ I*2 MCOM.INC
 Diversity configuration indicator. Default is 0.
 0 = 2 receive antennas; 2S 2S/2F 2S/2A 2S/2A/2F
 1 = 1 receive antenna; 2A 2F 2F/2A
 2 = 2 transmit,
 2 receive antennas; 2S/2F 2S/2P/2A
 3 = Not used
 4 = User supplied parameters
 S = Space F = Frequency A = Angle P = Polarization
 LDEBUG /LUNS/ I*2 LUNS.INC
 Debug output unit. Always the same as LOUT but used
 to uniquely identify the write statements.
 LISI /MCOM2/ I*2 MCOM.INC
 Number of future Intersymbol Interference (ISI)
 contributors considered in MU-918 performance
 calculation. Default is 2.
 LOUT /LUNS/ I*2 LUNS.INC
 FOR002.DAT output unit number.
 TAPW /MCOM4/ R*4 MCOM.INC
 Normalized tapwidth for MU-918. Default is .5.
 Range is 0.25 through 1.0
 TDIFF /MCOM4/ R*4 MCOM.INC
 Normalized relative delay between lower and upper
 beam.

Global variables output to common:

IFILE /MCOM2/ I*2 MCOM.INC

9.14 MATCO

Subprogram name: Subroutine MATCO

Purpose: To compute the troposcatter signal covariance matrix C and sub-matrices C0, C1, C4; thermal noise covariance matrices A and AF; ISI covariance matrix CSUM, and ISI sub-matrices C2 and C3; and mean diffraction amplitude vector FSIG for the MD-918 AFE taps.

Calling sequence:

CALL MATCO (SIGMA, SIGM1, C, C0, C1, C2, C3, C4, CSUM, Q, AF, A, K, K1,
KK, TO, TA, TSCAT, JPOW, ELOSS, XSCAT, XDIFR, PTYPE, IQDM, IFPRNT, DUPOW, IFDSNR)

Contained in module: MATCO

Called by: MDTS

Calls: CAC, CAJI, CAKL

Input arguments:

SIGMA	R*4	Normalized delay spread of scatter signal in lower beam.
SIGM1	R*4	Normalized delay spread of scatter signal in upper beam.
Q(100,7)	R*4	Power per unit delay and correlation per unit delay for scatter signal in each receiving aperture.
K	R*4	Flag: 1 for K1 = 3, 0 for K1 = 1.
K1	R*4	Number of taps in AFE.
KK	R*4	Total number of correlated taps (dimension of covariance matrix) for angle and/or space diversity.
TO	R*4	Normalized sampling time (relative to scatter component mean time of arrival) for lower beam.
TA	R*4	Normalized sampling time (relative to scatter component mean time of arrival) for upper beam.
TSCAT	R*4	Normalized relative delay between scatter and diffraction component.
JPOW	R*8	Interference power density in dBm/Hz.
ELOSS	R*8	Sawint loss for scatter signal in upper beam in dB.
XSCAT	R*4	Fraction of scatter signal power.
XDIFR	R*4	Fraction of diffraction signal power.
PTYPE	R*4	Indicates whether pure scatter (PTYPE = 0) or mixed scatter/diffraction path (PTYPE = 1).
IQDM	R*4	Index in power per unit delay profile corresponding to delay bin of the specular (diffraction) component.

9.13 MATA

Subprogram name: Subroutine MATA

Purpose: IBM routine for matrix multiplication:
 $S(M,N) * T(N,L) = ST(M,L).$

Calling sequence:
CALL MATA (S,T,ST,M,N,L,NSR,NSC,NTR,NTC,NSTR,NSTC)

Contained in module: MATOPS

Called by: MDT5, SQTMAT

Calls: ERROR

Input arguments:

S(NSR,NSC)	R*4	Input matrix to be right multiplied by T.
T(NTR,NTC)	R*4	Input matrix.
M	I*2	Number of actual rows of matrices S and ST.
N	I*2	Number of actual columns of matrix S and rows of matrix T.
L	I*2	Number of actual columns of matrices T and ST.
NSR	I*2	Row dimension of matrix S. No maximum set.
NSC	I*2	Column dimension of matrix S. No maximum set.
NTR	I*2	Row dimension of matrix T. No maximum set.
NTC	I*2	Column dimension of matrix T. No maximum set.
NSTR	I*2	Row dimension of matrix ST. No maximum set.
NSTC	I*2	Column dimension of matrix ST. No maximum set.

Output arguments:

ST(NSTR,NSTC)	R*4	Matrix product of S(.) and T(.).
---------------	-----	----------------------------------

TAPW is the main receive antenna.
 /MCOM4/ R*4 MCOM.INC
 Normalized tapwidth for MD-918. Default is .5.
 Range is 0.25 through 1.0
THER /PATHGE/ R*4 TROCOM.INC
 Radio horizon elevation angle at receive site in
 radians.

Global variables output to common:

A /PATHGE/ R*4 TROCOM.INC
 Effective earth radius in meters.

9.12 JAMCOM

Subprogram name: Subroutine JAMCOM

Purpose: Calculate covariance matrix for one interferer with one direct path and one reflected path. (Reflections off a horizontal surface.) Angles of arrival and delay are assumed identical for both antennas.

Callins sequence:

CALL JAMCOM (TAC, BWR, ASEP, JANG)

Contained in module: JAMCOM

Called by: BOTAC

Calls: TSINC

Input arguments:

BWR	R*4	3dB beamwidth of receiving antenna in degrees.
ASEP	R*4	Separation between receiving antennas in meters.
JANG	R*8	Interferer angle of arrival in degrees.

Output arguments:

TAC(14,14)	R*4	Covariance matrix.
------------	-----	--------------------

Global variables input from common:

ATTEN	/MCOM4/	R*4	MCOM.INC	Ratio of interferer signal amplitude on antenna 2 to that at antenna 1. Set to 1 internally.
BW	/SYSTRN/	R*4	TROCOM.INC	Bandwidth in Hertz. Default is 7 MHz.
DRATE	/MCOM4/	R*4	MCOM.INC	Data rate in bits/second. Default is 6.6E6.
ELANG(10)	/MCOM4/	R*4	MCOM.INC	Interferer elevation angles in degrees. Default is 0.
HRN	/PATHGE/	R*4	TROCOM.INC	Receive antenna height above sea level in meters.
JREFL	/MCOM2/	I*2	MCOM.INC	Indicates whether specular reflection is to be included in interferer covariance matrix calculation (JREFL = 1) or not (JREFL = 0). Default is 0.
LANG	/MCOM2/	I*2	MCOM.INC	Pointer to data array elements contains interferer azimuth and elevation angles.
PI	/CONSTA/	R*4	CONSTANTS.INC	Constant Pi = 3.141592654.
PSIRE0(NRMX)	/ANTENN/	R*4	TROCOM.INC	Array of receiver beam boresight elevations above radio horizon in radians, ie, angle at which each antenna is aimed relative to the horizon. PSIRE0(1)

9.11 HQR

Subprogram name: Subroutine HQR

Purpose: Find eigenvalues of matrix H.

Calling sequence:
CALL HQR (NM,N,LOW,IGH,H,WR,WI,IERR)

Contained in module: ELMES

Called by: EIGV, MDTS

Calls: NONE

Input arguments:

NM	I*2	Dimension of matrix H. No maximum set.
N	I*2	Dimension of matrix H and arrays WR and WI. No maximum set.
LOW	I*2	Pointer to first row (or column) of square sub-matrix of H.
IGH	I*2	Pointer to last row (or column) of square sub-matrix of H.
H(NM,N)	R*8	Square matrix whose eigenvalues are to be found.

Output arguments:

H(NM,N)	R*8	Square matrix whose eigenvalues are to be found.
WR(N)	R*8	Real part of eigenvalue.
WI(N)	R*8	Imaginary part of eigenvalue.
IERR	I*2	Error flag. 0 for no error; > 0 for error

9.10 ERLANG

Subprogram name: Function ERLANG

Purpose: For $I = 1, 2, 3$ or 4 $ERLANG = X^{(I-1)} * EXP(-A*X) / (I-1)!$
otherwise $ERLANG = 10^{*38}$ for precision limits. If $A*X > 85$
 $ERLANG = 0$. (Where: $I = \text{Integer}$; $X = \text{Real}$.)

Calling sequence:
ERLANG (I,A,X)

Contained in module: ERLANG

Called by: BERCAL, PDF, PDFSUM

Calls: NONE

Input arguments:

I	I*2	Argument of factorial and power in ERLANG function.
A	R*8	Parameter of exponent in ERLANG function.
X	R*8	Argument of ERLANG function.

Output arguments:

ERLANG	R*8	Value of $X^{(I-1)} * EXP(-A*X) / (I-1)!$.
--------	-----	---

9.9 ELMES

Subprogram name: Subroutine ELMES

Purpose: Conditions matrix A prior to HQR finding eigenvalues and
eigenvectors.

Call sequence:
CALL ELMES (NM,N,LOW,IGH,A,INT)

Contained in module: ELMES

Called by: EIGV, MDTS

Calls: NONE

Input arguments:

NM	I*2	Row dimension of matrix A. No maximum set.
N	I*2	Column dimension of matrix A. No maximum set.
LOW	I*2	Pointer to first row (or column) of square sub-matrix.
IGH	I*2	Pointer to last row (or column) of square sub-matrix. Also, dimension of vector INT. No maximum set.
A(NM,N)	R*8	Matrix to be conditioned.

Output arguments:

A(NM,N)	R*8	Conditioned matrix.
INT(IGH)	I*2	Pointer to lowest value in each row of A.

9.8 EIGEN

Subprogram name: Subroutine EIGEN

Purpose: Compute eigenvalues and eigenvectors of a real symmetric matrix.

Reference: The process used is the diagonalization method originated by Jacobi and adapted by Von Neuman for large computers as found in 'Mathematical Methods for Digital Computers', edited by A. Ralston and H.S. Wilf, John Wiley and Sons, New York, 1962, Chapter 7.

Callins sequence:
CALL EIGEN (A,R,N,MV)

Contained in module: EIGEN

Called by: MDTS SQTHTAT

Calls: NONE

Input arguments:

A(N)	R*4	Original matrix (symmetric). Destroyed in computation. Resultant eigenvalues are stored in diagonal of matrix A in descending order. This matrix must be real symmetric and must not be in the same location as matrix R. Matrix A must also be stored in Storage Mode 1, which means that only the upper right triangle is stored by columns through each diagonal element: A(1,1), A(1,2), A(2,2), A(1,3), etc. into vector form.
N	I*2	Order of matrices A and R. No limit set on size.
MV	I*2	Input code. 0 = Compute eigenvalues and eigenvectors. 1 = Compute eigenvalues only. (R need not be dimensioned but must still appear in callins sequence.)

Output arguments:

A(N)	R*4	Original matrix (symmetric). Destroyed in computation. Resultant eigenvalues are stored in diagonal of matrix A in descending order. This matrix must be real symmetric (storage mode 1) and must not be in the same location as matrix R.
R(N)	R*4	Resultant matrix of eigenvectors. Stored columnwise, in same sequence as eigenvalues.

NDELO /MCOM4/ I*2 MCOM.INC
Number of non-zero elements of troposcatter power per
unit delay profiles Q(NDELO,1).

PULSE /RZ/ I*2 RZ.INC
Switch controlling MD-918 pulse shape after
transmitter-receiver filtering.
 PULSE = 0 Triangle
 = 1 OQPSK matched filter
 = 2 Sinc pulse, bandwidth equal to 1
 = 5 RF filtering included
Set to 0 if IBW = 0 or KGAIN > 1.
Set to 5 if IBW > 0 and KGAIN = 1.

TDIFF /MCOM4/ R*4 MCOM.INC
Normalized relative delay between lower and upper
beams.

9.7 DINT

Subprogram name: Subroutine DINT

Purpose: Integrates $CAC = G(X-BK)G(X-RL)Q(TO-X)$ over (XL, XH) where:
G(X) = Fixed filter response.
Q(X) = Multipath profile.

Calling sequence:
CALL DINT (SIGMA, BK, BL, Y, TO, Q, PTYPE, JQDM)

Contained in module: DINT

Called by: MDTS CAKL

Calls: CAC

Input arguments:

SIGMA	R#4	Normalized delay spread of scatter component.
BK	R#4	Tap sampling time relative to AFE center tap.
RL	R#4	Same as BK.
TO	R#4	Normalized sampling time for center tap relative to centroid of power per unit delay profile.
Q	R#4	Power per unit delay profile or correlation per unit delay profile.
PTYPE	I#2	Indicates whether path is mixed scatter/diffraction (PTYPE = 1) or pure scatter path (PTYPE = 0).
JQDM	I#2	Index in power per unit delay profile corresponding to delay bin of the specular (diffraction) component.

Output arguments:

Y	R#4	Result of integration.
---	-----	------------------------

Global variables input from common:

DELPBZ	/RZ1/	R#4	Resolution of a delay cell in seconds. Same as DELPB in /PDATA/.
DRATE	/MCOM4/	R#4	MCOM.INC Data rate in bits/second. Default is 6.6E6.
ICORR	/MCOM2/	I#2	MCOM.INC Multipath profile correlation indicator. Default is 2. 0 = Profile of the form $X * \exp(-A*X)$ -- used for debussins 1 = Computed multipath profile; no beam correlation 2 = Computed multipath profile; beam correlation.
JQ2M	/MCOM4/	I#2	MCOM.INC Pointer to centroid of lower beam troposcatter signal power per unit delay profile.
KGAIN	/RZ/	I#2	RZ.INC Integer ratio of bandwidth to data rate.

9.6 CHANGE

Subprogram name: Subroutine CHANGE

Purpose: Matrix utility operations defined by flag KIND.

Calling sequence:
CALL CHANGE (ARRAY,VECTOR,NACT,NDIM,KIND)

Contained in module: MATOPS

Called by: MDT5, SQTMAT

Calls: ERROR

Input arguments:

ARRAY(NACT,NACT)	R*4	Two-dimensional array (matrix). No limit set on size.
VECTOR(1)	R*4	One-dimensional array (vector). No limit to size set.
NACT	I*2	Actual physical dimensions of ARRAY in calling program. No maximum set.
NDIM	I*2	Number of rows and columns in input (output) matrix ARRAY.
KIND	I*2	Input flag: 1 = Pack symmetric matrix, ARRAY, into VECTOR by columns through each diagonal element. 2 = Copy VECTOR into doubly-subscripted ARRAY. 3 = Copy only diagonal elements from VECTOR into ARRAY and zero off-diagonal elements (as in a unitary matrix).

Output arguments:

ARRAY(NACT,NACT)	R*4	Two-dimensional array (matrix). No limit set on size.
VECTOR(1)	R*4	One-dimensional array (vector). No limit to size set.

9.5 CAKL

Subprogram name: Subroutine CAKL

Purpose: Compute scatter signal covariance matrix $C(K,L)$ where:
 $K,L = (-KK,-KK+1,-KK+2,\dots,+KK)$.
Number of rows and columns (AFE taps) is therefore equal to $2*KK+1$.
Covariance matrix is defined as integral of:

$$G_i(X-KT) * G_j(X-LT+(j-i)*DIFF) * Q(TO-X)$$

where G_i and G_j are the impulse response of the cascade of transmitter and receiver filters for diversity ports i and j . $Q(X)$ is the power per unit delay function of the scatter component if $i = j$ and the correlation per unit delay profile otherwise.

Calling sequence:

CALL CAKL (KK,SIGMA,C,TO,DIFF,Q,PTYPE,JQDM)

Contained in module: DINT

Called by: MATCO

Calls: DINT

Input arguments:

KK	I*2	Number of taps on either side of the center tap of the AFE.
SIGMA	R*4	Normalized delay spread of scatter component.
TO	R*4	Normalized sampling time relative to centroid of scatter component power per unit delay profile. TO > 0 increases future ISI.
DIFF	R*4	Delay compensation for angle diversity systems.
Q	R*4	Power per unit delay profile or correlation per unit delay profile.
PTYPE	I*2	Indicates whether path is mixed scatter/diffraction (PTYPE = 1) or pure scatter path (PTYPE = 0).
JQDM	I*2	Index in power per unit delay profile corresponding to delay bin of the specular (diffraction) component.

Output arguments:

C	R*4	Scatter signal covariance matrix for AFE taps.
---	-----	--

Global variables input from common:

TAPW	/MCOM4/	R*4	MCOM.INC
			Normalized tapwidth for MD-918. Default is .5. Range is 0.25 through 1.0

9.15 MDT5

Subprogram name: Subroutine MDT5

Purpose: Computes MD-918 modem performance assuming LISI symbols of intersymbol interference (ISI). Performance under mixed scatter/diffraction propagation conditions also includes the ISI due to the 4th and 5th past symbols. Assumes ISI is Gaussian.

Reference: P. Mosen "Theoretical and measured performance of a DFE modem on a fading multipath channel," IEEE Transactions on Communications, Vol. COM-25, No. 10, October, 1977, pp. 1144-1153. See also "Link analysis plan", Interim technical report no. CSA-76-8085-3, October 1978, Contract #DAAB07-76-C-8085.

Calling sequence:
CALL MDT5 (TAU22,TAU23,ELOSS,RHO,ASNR,ADSNR,Q,DUPOW,JPOW,
JBW,BWT,BWR,ASEP,CORFAC,BOUT,FOUT,FJSEP,PTYPE,TEMPA,JQDM)

Contained in module: MDT5

Called by: TROPO

Calls: BERCAL BOTAC CHANGE DINT EIGEN ELMES ERROR HQR
 MATA MATCO MINV ORDER PROUT SASEQ SIGIN SINT
 SQTMT XNOR

Input arguments:

TAU22	R*8	Delay spread on lower beam in nsec.
TAU23	R*8	Delay spread on upper beam in nsec.
ELOSS	R*8	Upper beam squint loss for scatter component in dB or sidelobe loss for interference.
RHO	R*8	Correlation between lower and upper beam long-term variability of scatter component.
ASNR	R*4	Median and/or yearly average value of scatter path SNR in dB.
ADSNR	R*4	Yearly average value of diffraction path SNR in dB.
Q(100,7)	R*4	Multipath delay/correlation profile array.
DUPOW	R*4	Ratio of diffraction component on upper beam to diffraction component on lower beam.
JPOW	R*8	Interference signal power density in dBm/Hz.
JBW	R*8	Interfering signal bandwidth in Hz.
BWT	R*4	Transmit antenna beamwidth in degrees.
BWR	R*4	Receive antenna beamwidth in degrees.
ASEP	R*4	Receiver antenna separation in meters.
CORFAC	R*4	Correction factor computed by LTCORR. CORFAC is used in subroutine BERCAL to scale STSNR multiplicatively when angle diversity is used.
FJSEP	R*4	Frequency separation between desired signal and interference signal in Hertz.

PTYPE I*2 Variable which indicates whether propagation
mechanism is pure troposcatter (0 or 10) or mixed
troposcatter-diffraction (1 or 11).
TEMPA(7) R*4 Average relative delay of scatter component.
JQDM I*2 Index in the multipath profile corresponding to
the delay of the specular component.

Output arguments:

BOU(3,4) R*4 Yearly average outage probability for each
bit error rate threshold specified and 2S/2F
and 2S diversity configurations.
FOU(3,4) R*4 Yearly average fade outage per call minute for
each bit error rate threshold specified and
2S/2F and 2S diversity configurations.

Global variables input from common:

CODE /MCOM4/ L*4 MCOM.INC
Flag for codings.
DEL /SUMP/ R*4 CURVE.INC
Diffraction path delay relative to a straight line
path in seconds.
DIVTYP /MCOM2/ I*2 MCOM.INC
Diversity configuration indicator. Default is 0.
0 = 2 receive antennas; 2S 2S/2F 2S/2A 2S/2A/2F
1 = 1 receive antenna; 2A 2F 2F/2A
2 = 2 transmit,
2 receive antennas; 2S/2P 2S/2P/2A
3 = Not used
4 = User supplied parameters
S = Space F = Frequency A = Angle P = Polarization
DRATE /MCOM4/ R*4 MCOM.INC
Data rate in bits/second. Default is 6.6E6.
DSTS NR /SUMP/ R*4 CURVE.INC
Standard deviation of diffracted signal long-term SNR
distribution in dB.
ELANG(10) /MCOM4/ R*4 MCOM.INC
Interferer elevation angles in degrees. Default is 0.
IBW /MCOM2/ I*2 MCOM.INC
Switch indicating type of RF bandwidth constraint to
be used on desired signal. Default is 0.
0 = No RF filtering
1 = Filter determined from 99% bandwidth constraint
2 = Filter chosen to meet FCC Mask. (FCC-19311)
3 = Filters are user specified
ICORR /MCOM2/ I*2 MCOM.INC
Multipath profile correlation indicator. Default
is 2.
0 = Profile of the form $X * \exp(-A*X)$ -- used for
debussins
1 = Computed multipath profile; no beam correlation

2 = Computed multipath profile; beam correlation.

KGAIN /RZ/ I*2 RZ.INC
Integer ratio of bandwidth to data rate.

LERR /LUNS/ I*2 LUNS.INC
Error output unit.

LOUT /LUNS/ I*2 LUNS.INC
FOR002.DAT output unit number.

MANG /MCOM2/ I*2 MCOM.INC
Number of values of interferer azimuth/elevation pairs
(JANG) for which outage calculations are to be made.
Default is 1.

NANG /RI2/ I*2 RI2.INC
NANG is 1 if there is angle diversity (default).

NERT /MCOM2/ I*2 MCOM.INC
Bit error rate threshold indicator for nearly fade
outage probability calculation. Default is 2.
0 = All three thresholds
1 = For 10**(-3) only
2 = For 10**(-4) only
3 = For 10**(-5) only

STSNR /SUMP/ R*4 SUMP.INC
Standard deviation of troposcatter signal long-term
SNR distribution in dB.

XANG(10) /MCOM4/ R*4 MCOM.INC
Interferer azimuth angles in degrees. Default is 0.

Global variables output to common:

APOW /MCOM4/ R*4 MCOM.INC
Angle diversity squint loss as a ratio.

IFILE /MCOM2/ I*2 MCOM.INC
Pointer to multipath profile.

LANG /MCOM2/ I*2 MCOM.INC
Pointer to data array elements containing interferer
azimuth and elevation angles.

NIP /RZ/ I*2
Initialization constant for numerical equalizer
covariance matrix calculation.

PCON /RZ/ R*8 RZ.INC
Normalization factor for probability integral.

PEAKAV /RZ4/ R*4 RZ4.INC
Peak-to-average loss due to RF filtering in dB.

TDIFF /MCOM4/ R*4 MCOM.INC
Normalized relative delay between lower and upper
beam.

9.16 MINV

Subprogram name: Subroutine MINV

Purpose: IBM SSP Library routine. Matrix inversion.

Calling sequence:
CALL MINV (C,N,D,NC,ICON,B)

Contained in module: MINV

Called by: MDTS

Calls: NONE

Input arguments:

C(NC,NC)	R*4	Matrix to be inverted. Also may be returned here. No limit set on size.
N	I*2	Matrix order.
NC	I*2	Size of matrix C. No maximum set.
ICON	I*2	Control flag. 0 = Invert C and return determinant in D. 1 = Return determinant in D and leave C as is. 3 = On output for determinant = 0 4 = Ignore determinant = 0

Output arguments:

C(NC,NC)	R*4	Matrix to be inverted. Also may be returned here. No limit set on size.
D	R*4	Determinant returned.
B(1)	R*4	Workings matrix.

9.17 ORDER

Subprogram name: Subroutine ORDER

Purpose: Store largest N values of R(K) in V(K) in decreasing size and order. For $K < I < N+1$ $V(I) = 0.0$.
--> NOTE: Do NOT use for $K = N = 1$!!!!

Calling sequence:
CALL ORDER (K,R,V,N)

Contained in module: ORDER

Called by: EIGV, MDTS

Calls: ERROR

Input arguments:

K	I*2	Dimension of arrays R and V. No maximum set.
R(K)	R*8	Input array.
N	I*2	Number of values to return.

Output arguments:

V(K)	R*8	Output array.
------	-----	---------------

Global variables input from common:

LERR	/LUNS/	I*2	LUNS.INC
			Error output unit.

9.18 PDFCON

Subprogram name: Subroutine PDFCON

Purpose: Calculate coefficients in partial fractions expansion of Laplace transform $F(S)$ of PDF for SNR, from list of negatives of roots of $F(s)$. On return, roots are in descending order. Coefficients $C((N-1)*NDIV + I)$ are such that the following two expansions for $F(s)$ are equivalent:

$$F(s) = (R(1) / (S + R(1)))^{*NDIV} * \dots * (R(NR) / (S + R(NR)))^{*NDIV}$$

and,

$$F(s) = \dots C((N-1)*NDIV + I) / (S + R(N))^{*NDIV - I + 1} \dots$$

for $N = 1, 2, \dots, NR$; $I = 1, 2, \dots, NDIV$.

Reference: K. Miller, "Engineering Mathematics", Dover Publications, 1963, pp. 214-215.

Calling sequence:
CALL PDFCON (NR,R,NDIV,C)

Contained in module: BERCAL

Called by: BERCAL

Calls: NONE

Input arguments:

NR	I*2	Number of roots. Dimension of vectors R and C. No maximum set on vector sizes but see NDIV for limitations on values.
R(NR)	R*8	Array of NR positive numbers, which are the negatives of the roots of $F(s)$. These are positive numbers. On return, they are ordered in descending order.
NDIV	I*2	Multiplicity of roots. Must be 1, 2 or 4. For $NDIV = 4$, NR must be 1 or 3. For any illegal combination of NDIV and NR, PDFCON returns $C(I) = 0.00$ for $I = 1$ through $NR*NDIV (= NC)$.

Output arguments:

C(NR*NDIV) R*8	Output array into which PDFCON puts the calculated coefficients. Dimensioned to 24, therefore, $NR*NDIV$ must be no more than 24.
----------------	---

9.19 PROUT

Subprogram name: Subroutine PROUT

Purpose: To output to file FOR002.DAT yearly average outage probability, fade outage per call minute, and 1000-bit block error probability of MD-918 modem for each specified BER threshold and diversity configuration.

Calling sequence:

CALL PROUT (JPOW, DIVTYP, NOUT, N1, N2, SOUT, BOUT, FOUT, ABE, CGAIN, PTYPE)

Contained in module: PROUT

Called by: MDTS

Calls: NONE

Input arguments:

JPOW	R*8	Interference power density in dBm/Hz.
DIVTYP	I*2	Diversity configuration indicator.
NOUT	I*2	Total number of short term calculations performed.
N1	I*2	Index of largest BER threshold of interest.
N2	I*2	Index of smallest BER threshold of interest.
SOUT	R*4	Normalization for averaging of short term outage probabilities.
BOUT(3,4)	R*4	Outage probability for each BER threshold and diversity configuration (see table).
FOUT(3,4)	R*4	Fade outage per call minute for each BER threshold and diversity configuration: I = Index for BER threshold J = Index for varying diversity types, depending on the value of DIVTYP
ABE(4)	R*4	Average 1000-bit block error probability for each diversity configuration.
CGAIN	R*4	Coding gains for each BER threshold.
PTYPE	I*2	Indicates whether pure scatter (= 0) or mixed scatter/diffraction path (= 1).

Output arguments:

BOUT(3,4)	R*4	Outage probability for each BER threshold and diversity configuration (see table).
FOUT(3,4)	R*4	Fade outage per call minute for each BER threshold and diversity configuration: I = Index for BER threshold J = Index for varying diversity types, depending on the value of DIVTYP
ABE(4)	R*4	Average 1000-bit block error probability for each diversity configuration.

Global variables input from common:

BER(3) /ERAD/ R*4 ERAD.INC
 Bit error rate thresholds of interest. Set to 1E-3,
 1E-4 and 1E-5 in data statement.

LOUT /LUNS/ I*2 LUNS.INC
 FOR002.DAT output unit number.

MDIST /ERAD/ I*2 ERAD.INC
 Multipath distribution indicator.
 0 = Only median multipath spread used(default)
 1 = Multipath distribution used. (Option not
 currently available.)

NRAD /ERAD/ I*2 ERAD.INC
 ERFAC indicator and loop counter. Default is 1.

PFACT(3) /ERAD/ R*4 ERAD.INC
 Cumulative probability distribution for effective
 earth radius factor.
 For NRAD = 1 PFACT = 0.89
 = 2 = 0.1
 = 3 = 0.01

Global variables output to common:

ABEL(4) /ERAD/ R*4 ERAD.INC
 Cumulative block error probability for each diversity
 configuration as specified by DIVTYP (averaged over
 multipath distribution, if any).

BOUTL(3,4) /ERAD/ R*4 ERAD.INC
 Cumulative outage probability for each diversity
 configuration and error rate threshold (averaged
 over multipath distribution, if any).

FOUTL(3,4) /ERAD/ R*4 ERAD.INC
 Cumulative fade outage per call minute for each
 diversity configuration and error rate threshold
 (averaged over multipath distribution, if any).

9.20 PSINE

Subprogram name: Function PSINE

Purpose: Calculates the product $\sin(.01 * XJ) * \sin(.01 * DIN)$.

Calling sequence:
PSINE (XJ,DIN)

Contained in module: SINT

Called by: SINT

Calls: NONE

Input arguments:

XJ	R*8	100 times the argument of the sine function.
DIN	R*8	Difference between the arguments of the two sine functions.

Output arguments:

PSINE	R*4	The product $\sin(.01 * XJ) * \sin(.01 * DIN)$.
-------	-----	--

9.21 PWRSPC

Subprogram name: Function PWRSPC

Purpose: Power spectrum at F for cascade of receiver-interferer filters.

Callins sequence:
PWRSPC (F)

Contained in module: ROTAC

Called by: RJCFCN

Calls: TPSPEC, TPSPJ

Input arguments:
F R*4 Normalized frequency.

Output arguments:
PWRSPC R*4 Power spectrum at F for cascade of receiver-interferer filters.

Global variables input from common:

FCRX	/BUTPAR/	R*4	BUTPAR.INC	Normalized 3dB cut-off frequency of receiver filter.
FJSEPN	/JAMPAR/	R*4	JAMPAR.INC	Normalized frequency separation between the interference signal and the desired signal.
IFILRX	/BUTPAR/	I*2	BUTPAR.INC	Receiver filter indicator. 0 = MD-918 receiver filter. Also means filter is a Butterworth cascaded with a rectangular impulse response filter of duration equal to symbol duration. 1 = (not allowed) 2 = AN/TRC-170 receiver filter. Also means filter is a Butterworth.
NPOLRX	/BUTPAR/	R*4	BUTPAR.INC	Number of poles in the receive Butterworth filter.

9.22 RJCFCN

Subprogram name: Function RJCFCN

Purpose: Calculate receiver-interferer correlation function by direct Fourier transform. PWRSUM is calculated as base value for FJSEPN = 0.0 Numerically integrate product of power spectrum, PWKSPC(FREQ), and $\cos(\text{TWOPI} * \text{FREQ} * \text{TARG})$ over frequency interval [0.0, 10.0*FCRX].

Calling sequence:
RJCFCN (TARG,INIT)

Contained in module: BOTAC

Called by: BOTAC

Calls: PWRSPC, TPSPEC

Input arguments:

TARG	R#4	Normalized time argument.
INIT	I#2	Flag to perform initializations and to calculate normalization constant, PWRSUM, during first function call to RJCFCN for each interferer angle.

Output arguments:

RJCFCN	R#4	Receiver-interferer correlation function.
INIT	I#2	Flag to perform initializations and to calculate normalization constant, PWRSUM, during first function call to RJCFCN for each interferer angle.

Global variables input from common:

FCRX	/BUTPAR/	R#4	BUTPAR.INC
			Normalized 3dB cut-off frequency of receiver filter.
TWOPI	/CONSTA/	R#4	CONSTANTS.INC
			$2 * \text{Pi} = 6.283185307.$

Global variables output to common:

FJSEPN	/JAMPAR/	R#4	JAMPAR.INC
			Normalized frequency separation between the interference signal and the desired signal.

9.23 SASEQ

Subprogram name: Subroutine SASEQ

Purpose: To set the chip sequence ASEQ as a function of the number of chips per thermal bit KGAIN.

Calling sequence:
CALL SASEQ (ASEQ)

Contained in module: SASEQ

Called by: MDTS TRCIN

Calls: NONE

Input arguments:
NONE

Output arguments:
ASEQ(30) I*2 Chip sequence for bandwidth spreading.

Global variables input from common:
KGAIN /RZ/ I*2 RZ,INC
Integer ratio of bandwidth to data rate.
LOUT /LUNS/ I*2 LUNS,INC
FOR002.DAT output unit number.

9.24 SIGIN

Subprogram name: Subroutine SIGIN

Purpose: Set pulse shape switch PULSE, number of taps K, lower and upper delay spread ratios SIGMA and SIGM1, number of future ISI considered LISI, and the proportionality constant SPOWR.

Call sequence:
CALL SIGIN (K,SIGMA,SIGM1,TAU22,TAU23,SPOWR)

Contained in module: SIGIN

Called by: MDT5

Calls: NONE

Input arguments:

TAU22 R*8 Delay spread in lower beam in nanoseconds.
TAU23 R*8 Delay spread in upper beam in nanoseconds.

Output arguments:

K I*2 Number of taps in either side of AFE center tap.
SIGMA R*4 Ratio of lower beam delay spread to symbol duration.
SIGM1 R*4 Ratio of upper beam delay spread to symbol duration.
SPOWR R*4 Proportionality constant used in ISI calculation.

Global variables input from common:

DRATE /MCOM4/ R*4 MCOM.INC
Data rate in bits/second. Default is 6.6E6.

IBW /MCOM2/ I*2 MCOM.INC
Switch indicating type of RF bandwidth constraint to be used on desired signal. Default is 0.
0 = No RF filtering
1 = Filter determined from 99% bandwidth constraint
2 = Filter chosen to meet FCC Mask. (FCC-19311)
3 = Filters are user specified

ICORR /MCOM2/ I*2 MCOM.INC
Multipath profile correlation indicator. Default is 2.
0 = Profile of the form $X * \exp(-A*X)$ -- used for debussing
1 = Computed multipath profile; no beam correlation
2 = Computed multipath profile; beam correlation.

KGAIN /RZ/ I*2 RZ.INC
Integer ratio of bandwidth to data rate.

LERR /LUNS/ I*2 LUNS.INC
Error output unit.

NTAP /MCOM2/ I*2 MCOM.INC
Number of adaptive forward equalizer taps (AFE) in

MD-918 modem. Set to 3 in INDATA.

Global variables output to common:

LISI /MCOM2/ I*2 MCOM.INC
Number of future Intersymbol Interference (ISI)
contributors considered in MD-918 performance
calculation. Default is 2.

PULSE /RZ/ I*2 RZ.INC
Switch controlling MD-918 pulse shape after
transmitter-receiver filtering.
 PULSE = 0 Triangle
 = 1 QPSK matched filter
 = 2 Sinc pulse, bandwidth equal to 1
 = 5 RF filtering included
Set to 0 if IBW = 0 or KGAIN > 1.
Set to 5 if IBW > 0 and KGAIN = 1.

TAPW /MCOM4/ R*4 MCOM.INC
Normalized tapwidth for MD-918. Default is .5.
Range is 0.25 through 1.0

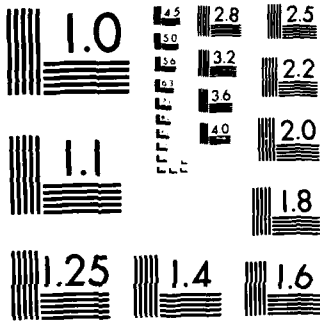

MICROCOPY RESOLUTION TEST CHART
NATIONAL BUREAU OF STANDARDS 1963-A

9.25 SINC

Subprogram name: Function SINC

Purpose: $SINC = \sin(\pi X) / (\pi X)$. For $X = 0$ or
 $ABS(\text{Numerator} - \text{Denominator}) < 1.0E-6$ $SINC = 1$.

Calling sequence:
SINC (X)

Contained in module: SINC

Called by: CAC, FILSIX, TSINC

Calls: NONE

Input arguments:
X R*4 Argument of SINC function.

Output arguments:
SINC R*4 Value of $\sin(\pi X) / \pi X$.

Global variables input from common:
PI /CONSTA/ R*4 CONSTANTS.INC
Constant Pi = 3.141592654.

9.26 SQTMAT

Subprogram name: Subroutine SQTMAT

Purpose: Subroutine to take square root of a symmetric, positive-definite matrix D of order ≤ 7 by computing:
$$\text{SQRT}(D) = (\text{EMODAL}) * \text{SQRT}(\text{UNITRY}) * (\text{TRANSP}(\text{EMODAL})),$$
Where EMODAL is the matrix containing the eigenvectors of D (the 'modal' matrix) and UNITRY is the matrix containing the eigenvalues of D in its diagonal (the 'unitary' matrix).

Calling sequence:
CALL SQTMAT (D,SQRTD,K1)

Contained in module: MATOPS

Called by: MDTS

Calls: CHANGE, EIGEN, ERROR, MATA

Input arguments:

D(K1,K1)	R*4	Original matrix: real, symmetric, undisturbed. Dimensioned as 7 X 7.
K1	I*2	Dimensions of matrix D. Maximum is 7.

Output arguments:

SQRTD	R*4	Square root matrix.
-------	-----	---------------------

9.27 TPSPEC

Subprogram name: Function TPSPEC

Purpose: Power spectrum at F for Butterworth * IFILT-type filter.

Calling sequence:
TPSPEC (F,NPOLE,FCUT,IFILT)

Contained in module: BOTAC

Called by: PWRSPC, TPSPJ

Calls: NONE

Input arguments:

F	R*4	Normalized frequency.
NPOLE	R*4	Number of poles of Butterworth filter.
FCUT	R*4	Normalized 3-dB cut-off frequency of Butterworth filter.
IFILT	I*2	Switch that indicates whether rectangular impulse response filter is cascaded with Butterworth filter (= 0;1) or not (= 2).

Output arguments:

TPSPEC	R*4	Power spectrum for Butterworth * IFILT-type filter.
--------	-----	---

Global variables input from common:

PI	/CONSTA/	R*4	CONSTANTS.INC
Constant Pi = 3.141592654.			

9.28 TPSPJ

Subprogram name: Function TPSPJ

Purpose: Power spectrum of interferer at frequency F.

Calling sequence:
TPSPJ (F)

Contained in module: BOTAC

Called by: PWRSPC

Calls: TPSPEC

Input arguments:
F R*4 Normalized frequency.

Output arguments:
TPSPJ R*4 Power spectrum of interferer at frequency F.

Global variables input from common:

FCJ	/JAMPAR/	R*4	JAMPAR.INC	Normalized 3dB cut-off frequency of QPSK interference filter.
FCTX	/BUTPAR/	R*4	BUTPAR.INC	Normalized 3dB cut-off frequency of transmitter filter.
FMI	/JAMPAR/	R*4	JAMPAR.INC	Modulation index for FDM/FM interference.
IFILTX	/BUTPAR/	I*2	BUTPAR.INC	Transmitter filter indicator. 0 = MD-918 transmitter filter. Also means filter is a Butterworth cascaded with a rectangular impulse response filter of duration equal to symbol duration. 1 = AN/TRC-170 transmitter filter. Also means filter is a cascade of Butterworth filter with rectangular impulse response filter of duration equal to half symbol duration. 2 = (not allowed)
MODSG	/JAMPAR/	I*2	JAMPAR.INC	Interference signal modulation format. Default is 1. 0 = Analog FDM / FM 1 = Digital QPSK
NPOLJ	/JAMPAR/	I*2	JAMPAR.INC	Number of poles in the QPSK interference filter.
NPOLTX	/BUTPAR/	I*2	BUTPAR.INC	Number of poles in the transmit Butterworth filter.
PI	/CONSTA/	R*4	CONSTANTS.INC	

WFM

Constant Pi = 3.141592654.
/JANPAR/ R*4 JANPAR.INC
Normalization constant for FDM/FM interference.

9.29 TSINC

Subprogram name: Function TSINC

Purpose: TSINC = B * convolution of triangular impulse response filter
and waveform with impulse response sinc(R*X) evaluated at the point X.

Calling sequence:
TSINC (B,X)

Contained in module: BOTAC

Called by: BOTAC, JAMCOM

Calls: SINC

Input arguments:
B R*8 Normalized bandwidth of SINC waveform.
X R*8 Normalized time argument.

Output arguments:
TSINC R*4 Convolution.

9.30 XNOR

Subprogram name: Function XNOR

Purpose: Gaussian PDF with mean SPA and standard deviation SPS. Note, the arguments are single precision though the output is double.

Calling sequence:
XNOR (SPX,SPA,SPS)

Contained in module: XNOR

Called by: BERCAL, MDTS, TRC

Calls: NONE

Input arguments:

SPX	R*4	Value of Gaussian random variable at which PDF is to be calculated.
SPA	R*4	Mean of distribution.
SPS	R*4	Standard deviation of distribution.

Output arguments:
XNOR R*8 Gaussian PDF.

CHAPTER 10

AN/TRC-170 MODEM CALCULATIONS

This section describes the AN/TRC-170-DAR modem performance calculation routines:

Name	Description	User's Manual section
AVG	Short-term ABER and outage probabilities	2.9.5
EIGV	Implicit diversity eigenvalues	2.9.4
INTERD	Linear interpolation	NA
P2INT	Correlation of response with itself	2.9.4
PAVERG	Conditional average bit error probability	2.9.5
PDF	PDF of detection SNR	2.9.4
PDFCOE	PDF coefficients	2.9.4
PDFSUM	PDF integration of SNR	NA
POUTAG	Conditional outage probability	2.9.5
PROFIL	Power/delay profile	2.9.4
TINAVG	Short-term ABER and outage probability	2.9.5
TIMEQL	Sampling times	2.9.3
TIMPAR	Steady state sampling time	NA
TRC	Main TRC routine	2.9.1, 2.9.2
TRCIN	TRC parameters	2.9.1, 2.9.4
TXPULS	Tx-Rx impulse response	2.9.4
VARW	ISI variance	2.9.5

The main routine for this section is TRC. The TRC modem performance calculations are described in section 2.9 of the User's Manual.

Figure 2-6 is a top level flowchart for AN/TRC-170-DAR modem performance calculations at a functional level. In most cases the blocks correspond to one or more subprograms. The test blocks (diamonds) correspond to logical branches which are decided by the user's choices of input data.

NOTE

In most cases the sections in the User's Manual describe the coded equations as well as the theory behind them. NA denotes routines that are programming utilities such as finding indices, setting pointers, etc.

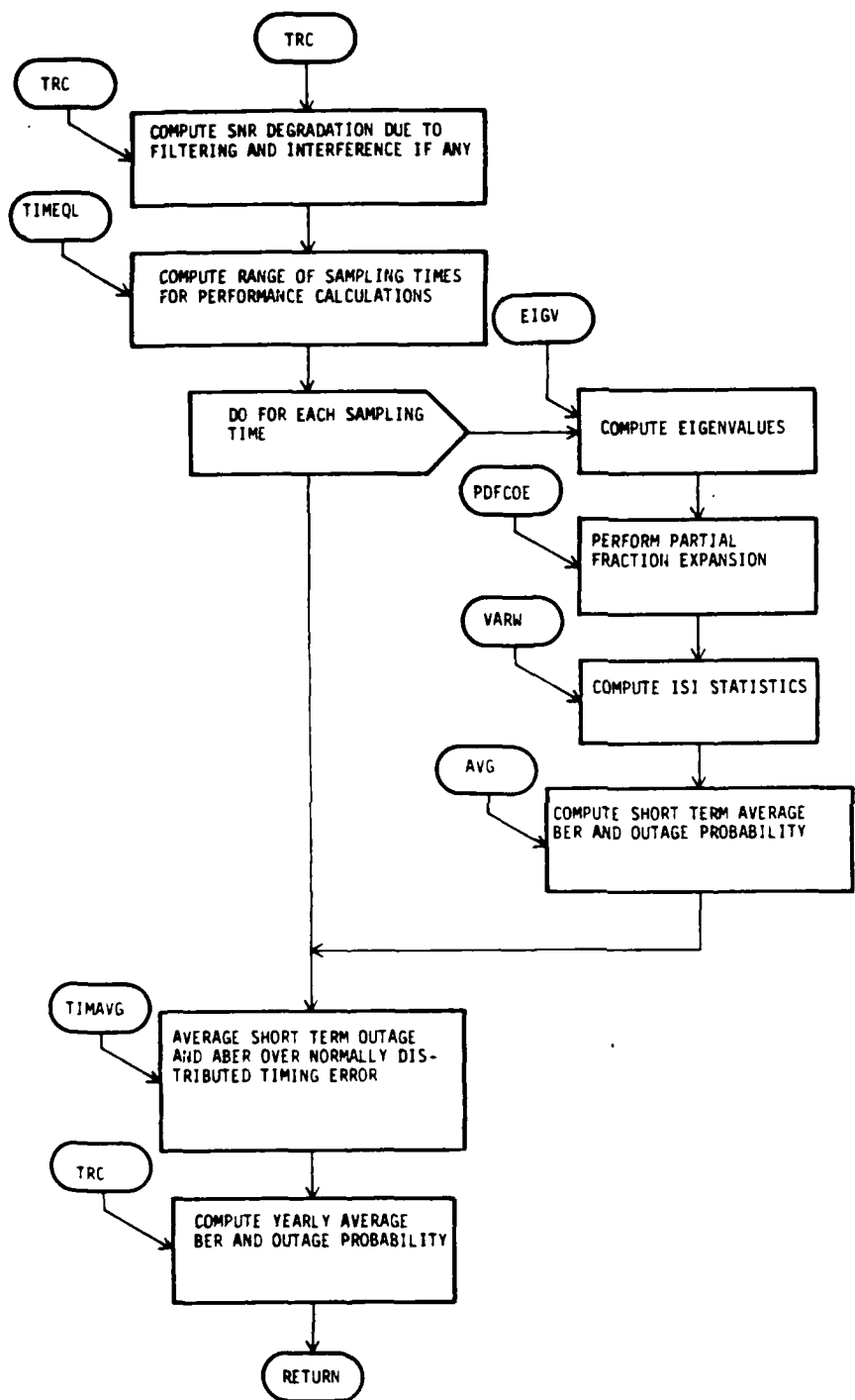

Figure 2-6 Flow Chart for AN/TRC-170-DAR Modem Performance Calculations

10.1 AVG

Subprogram name: Subroutine AVG

Purpose: To calculate short-term average bit error rate and short-term outage probability of AN/TRC-170 given the short term average SNR per bit by integrating over the statistics of the instantaneous detection SNR of the modem.

Calling sequence:
CALL AVG (YRUTIN, Y, IERR)

Contained in module: TRC

Called by: TRC

Calls: PDF, YRUTIN

Input arguments:
YRUTIN R*4 Function name. May be PAVERG or POUTAG.

Output arguments:
Y R*4 Twice the average bit error rate if the function requested is PAVERG and outage probability if the function requested is POUTAG.
IERR I*2 Error flag.

Global variables input from common:

COEFF	/ANSWER/	R*8	ANSWER.INC	Partial fraction expansion coefficients for calculation of AN/TRC-170 outage probability.
NDIVS	/SYSPAR/	I*2	SYSPAR.INC	Number of explicit diversity channels for AN/TRC-170. Equal to 4 for 2S/2F and 2 for 2S or 2F.
NEIGEN	/ANSWER/	I*2	ANSWER.INC	Number of implicit diversity eigenvalues (stored in array VEIGV) used in calculation of AN/TRC-170 performance.
VEIGV(20)	/ANSWER/	R*8	ANSWER.INC	Implicit diversity eigenvalues for AN/TRC-170.
X3INCR	/NUMPAR/	R*4	NUMPAR.INC	Step increment for numerical integration.

10.2 EIGV

Subprogram name: Subroutine EIGV

Purpose: Calculates the implicit diversity eigenvalues of the AN/TRC-170.

Calling sequence:
CALL EIGV (X2INCR, NV, EIGMIN, IERR)

Contained in module: TRC

Called by: TRC

Calls: ELMES, HQR, ORDER, PROFIL, TXPULS

Input arguments:
X2INCR R*4 Step increment for numerical integration.
NV I*2 Number of eigenvalues to be computed.
EIGMIN R*4 Ratio of smallest to largest eigenvalue of interest.

Output arguments:
IERR I*2 Error flag.

Global variables input from common:
IPROFL /SYSPAR/ I*2 SYSPAR.INC
Parameter that indicates whether troposcatter power per unit delay profile of the form $X \exp(-AX)$ is to be used (IPROFL = 0) or not. Set to zero in TRCIN.
SIGMA /SYSPAR/ R*4 SYSPAR.INC
Half the RMS lower beam delay spread normalized relative to the symbol duration.
TO /SYSPAR/ R*4 SYSPAR.INC
Normalized sampling time for lower beam.

Global variables output to common:
DIVIMP /ANSWER/ R*4 ANSWER.INC
Ratio of square of mean signal energy to variance for AN/TRC-170.
ENMEAN /ANSWER/ R*4 ANSWER.INC
Average received energy.
ENVAR /ANSWER/ R*4 ANSWER.INC
Variance of received energy.
NEIGEN /ANSWER/ I*2 ANSWER.INC
Number of implicit diversity eigenvalues (stored in array VEIGV) used in calculation of AN/TRC-170 performance.
VEIGV(20) /ANSWER/ R*8 ANSWER.INC
Implicit diversity eigenvalues for AN/TRC-170.

10.14 TRC

Subprogram name: Subroutine TRC

Purpose: To calculate the short-term BER and outage probability of the AN/TRC-170 or DAR modem as a function of SNR for the specified diversity configuration and BER threshold and the yearly outage probability given the yearly median of the troposcatter signal SNR and its standard deviation.

Calling sequence:
CALL TRC (TRCTYP,IBW,PYEAR)

Contained in module: TRC

Called by: TRCIN

Calls: AVG, EIGV, PAVERG, PDFCOE, PDFSUM, POUTAG, TIMAVG, TIMEQL,
TIMPAR, VARW, XNOR

Input arguments:

TRCTYP	R*4	TRC-170 modem type indicator: 0 = 1 frequency DAR modem 1 = 2 frequency AN/TRC-170 modem
IBW	I*2	Switch indicating which type of RF bandwidth constraint to be used on desired signal. 0 = No RF filtering 1 = Filter determined from 99% bandwidth constraint 2 = Filter chosen to meet FCC Mask. (FCC-19311) 3 = Filters are user specified.

Output arguments:

PYEAR(2,3)	R*4	Yearly statistics. PYEAR(1,.) is yearly outage probability and PYEAR(2,.) is yearly fade outage probability per call minute for each BER threshold.
------------	-----	---

Global variables input from common:

ASNR	/SYSPAR/	R*4	SYSPAR,INC	Yearly median value of troposcatter short-term average SNR, ie, Eb/No, in dB.
CDUR	/SYSPAR/	R*4	SYSPAR,INC	Duration of transmitted pulse for AN/TRC-170 normalized to signaling interval duration.
COEFF	/ANSWER/	R*8	ANSWER,INC	Partial fraction expansion coefficients for calculation of AN/TRC-170 outage probability.
EIGMIN	/NUMPAR/	R*4	NUMPAR,INC	

10.13 TIMPAR

Subprogram name: Function TIMPAR

Purpose: To calculate sampling time at steady state from early-late state loop.

Calling sequence:
TIMPAR (X2INCR,XINCR)

Contained in module: TRC

Called by: TIMEQL, TRC

Calls: PROFIL, P2INT

Input arguments:
X2INCR R*4 Step increment for numerical integration.
XINCR R*4 Step increment for numerical integration.

Output arguments:
TIMPAR R*4 Sampling time at steady state from early-late state loop.

Global variables input from common:
IPROFL /SYSPAR/ I*2 SYSPAR.INC
Parameter that indicates whether troposcatter power per unit delay profile of the form $X \exp(-A*X)$ is to be used (IPROFL = 0) or not. Set to zero in TRCIN.
SIGMA /SYSPAR/ R*4 SYSPAR.INC
Half the RMS lower beam delay spread normalized relative to the symbol duration.
TO /SYSPAR/ R*4 SYSPAR.INC
Normalized sampling time for lower beam.

10.12 TIMEQL

Subprogram name: Subroutine TIMEQL

Purpose: To determine the various sampling times for the short-term performance of the AN/TRC-170.

Calling sequence:

CALL TIMEQL (TOT0, IT, TPAR, TDEV, X2INCR, XINCR, IERR)

Contained in module: TRC

Called by: TRC

Calls: TIMPAR

Input arguments:

TDEV	R*4	Standard deviation of sampling time.
X2INCR	R*4	Step increment for numerical integration.
XINCR	R*4	Step increment for numerical integration.

Output arguments:

TOT0(20)	R*4	Array of sampling times (normalized to symbol duration) for calculation of short term TRC-170 performance.
IT	I*2	Number of different sampling times to be used in calculation of TRC-170 short term performance.
TPAR(20)	R*4	Sampling times at steady-state for early-late state loop.
IERR	I*2	Error flag.

Global variables output to common:

T0	/SYSPAR/	R*4	SYSPAR.INC
----	----------	-----	------------

Normalized sampling time for lower beam.

10.11 TIMAVG

Subprogram name: Subroutine TIMAVG

Purpose: To average the short-term average bit error rate and short-term outage probability over Gaussian distributed timing jitter.

Calling sequence:
CALL TIMAVG (PERF, TOT0, IT, TDEV, PERAVG, IERR)

Contained in module: TRC

Called by: TRC

Calls: INTERD

Input arguments:

PERF(20)	R*4	Performance measure for each sampling time.
TOT0(20)	R*4	Array of sampling times (normalized to symbol duration) for calculation of short term TRC-170 performance.
IT	I*2	Number of different sampling times to be used in calculation of TRC-170 short term performance.
TDEV	R*4	Standard deviation of timing jitter.

Output arguments:

PERAVG	R*4	Average of performance measure over Gaussian distributed timing jitter.
IERR	I*2	Error flag: 0 = no error; 1 = error in performance measure calculation.

10.10 PROFIL

Subprogram name: Function PROFIL

Purpose: To calculate the power per unit delay profile of received troposcatter signal. Presently only an exponential profile of the form $A * X * \exp(-B * X)$ is allowed. Power per unit delay profiles calculated in propagation module may be added later.

Callings sequence:
PROFIL (X, IPROFL, SIGMA)

Contained in module: TRC

Called by: EIGV, TIMPAR, VARW

Calls: NONE

Input arguments:

X	R*4	Normalized delay at which profile is to be sampled.
IPROFL	I*2	Switch: 0 = exponential power per unit delay profile to be used.
SIGMA	R*4	Lower beam normalized delay spread.

Output arguments:

PROFIL	R*4	Power per unit delay profile.
--------	-----	-------------------------------

Standard deviation of future ISI for AN/TRC-170.

10.9 POUTAG

Subprogram name: Subroutine POUTAG

Purpose: Calculates the conditional outage probability for a given instantaneous SNR by averaging over ISI due to up to two past and two future symbols.

Calling sequence:
CALL POUTAG (X, OUTISI, IERR)

Contained in module: TRC

Called by: TRC

Calls: ERFC, INTERD

Input arguments:
X R*4 Instantaneous detection SNR.

Output arguments:
OUTISI R*4 Conditional outage probability.
IERR I*2 Error flag.

Global variables input from common:

IRSN	/NUMPAR/	I*2	NUMPAR.INC	Number of values in SNR array RSNRSN(30). Used to calculate ISI statistics for AN/TRC-170. Initially set to 30.
KISI	/NUMPAR/	I*2	NUMPAR.INC	Parameter for calculation of AN/TRC-170 outage probability. Set to 6 in data statement.
NTHR	/SYSPAR/	I*2	SYSPAR.INC	Pointer to bit error rate threshold for AN/TRC-170 outage probability calculation.
RSNMHIN(3)	/NUMPAR/	R*4	NUMPAR.INC	SNR threshold corresponding to each bit error rate threshold for AN/TRC-170.
RSNRSN(30)	/NUMPAR/	R*4	NUMPAR.INC	Set of SNR values for which solution of transcendental function (UPISIM) is tabulated.
SNR	/SYSPAR/	R*4	SYSPAR.INC	Signal to noise ratio.
UPISIM(30,3)	/NUMPAR/	R*4	NUMPAR.INC	Solution of transcendental equation for each value of RSNRSN and bit error rate threshold of interest in AN/TRC-170 outage probability calculation.
XAVAR	/ANSWER/	R*4	ANSWER.INC	Standard deviation of past ISI for AN/TRC-170.
XBVAR	/ANSWER/	R*4	ANSWER.INC	

10.8 PDFSUM

Subprogram name: Function PDFSUM

Purpose: Integration of the probability density function of the detection SNR.

Calling sequence:
PDFSUM (NDIVS, NEIGEN, VEIGV, COEFF, XINCR)

Contained in module: TRC

Called by: TRC

Calls: ERLANG, PDF

Input arguments:

NDIVS	I*2	Number of explicit diversities.
NEIGEN	I*2	Number of eigenvalues in array VEIGV. Maximum is 20.
VEIGV(NEIGEN)	R*8	Implicit diversity eigenvalues for AN/TRC-170. Dimensioned to 20.
COEFF(40)	R*8	Partial fraction expansion coefficients.
XINCR	R*4	Step increment for numerical integration.

Output arguments:

PDFSUM	R*4	Integration of the probability density function of the detection SNR.
--------	-----	---

10.7 PDFCOE

Subprogram name: Subroutine PDFCOE

Purpose: Find partial fraction expansion coefficients of signal gain distribution, $C((N-1)*ID + I)$, of
$$F(s) = (R(1) / (S + R(1)))^{*ID} * \dots * (R(NU) / (S + R(NU)))^{*ID}$$
$$F(s) = \dots C((N - 1) * ID + I) / (S + R(N)) * ID - I + 1 \dots$$
for $N = 1, 2, \dots, NU$; $I = 1, 2, \dots, ID$

Calling sequence:
CALL PDFCOE (NR, R, NDIVS, C, IERR)

Contained in module: TRC

Called by: TRC

Calls: NONE

Input arguments:

R(NR)	R*8	Input root array. $R(K) > 0$, $K = 1, NR$. Dimensioned to 20.
NR	I*2	Size of R array. Maximum is 20. Also $NR \times NDIVS$ must be less than or equal to 40.
NDIVS	I*2	Number of explicit diversity branches. Value must be such that $NR \times NDIVS$ is less than or equal to 40.

Output arguments:

C(NR*NDIVS)	R*8	Partial fraction expansion coefficients. Dimensioned to 40.
IERR	I*2	Error flag.

10.6 PDF

Subprogram name: Function PDF

Purpose: Computes the probability density function of the detection SNR for the AN/TRC-170.

Calling sequence:
PDF (X, NEIGEN, NDIVS, VEIGV, COEFF)

Contained in module: TRC

Called by: AVG, PDFSUM

Calls: ERLANG

Input arguments:

X	R*4	SNR at which PDF is to be evaluated.
NEIGEN	I*2	Number of eigenvalues in array VEIGV. Maximum is 20.
NDIVS	I*2	Number of explicit diversities.
VEIGV(NEIGEN)	R*8	Implicit diversity eigenvalues for AN/TRC-170. Dimensioned to 20.
COEFF(40)	R*8	Partial fraction expansion coefficients.

Output arguments:

PDF	R*4	Probability density function of the detection SNR for the AN/TRC-170.
-----	-----	---

10.5 PAVERG

Subprogram name: Subroutine PAVERG

Purpose: To calculate twice the instantaneous bit error rate (or conditional bit error rate) of the AN/TRC-170 given the instantaneous detection SNR and variance of the ISI.

Calling sequence:
CALL PAVERG (X, AVGISI, IERR)

Contained in module: TRC

Called by: TRC

Calls: ERFC

Input arguments:
X R#4 Instantaneous detection SNR.

Output arguments:
AVGISI R#4 Twice the instantaneous bit error rate.
IERR I#2 Error flag

Global variables input from common:
SNR /SYSPAR/ R#4 SYSPAR.INC
Signal to noise ratio.
VARISI /ANSWER/ R#4 ANSWER.INC
Total ISI variance for AN/TRC-170.

10.4 P2INT

Subprogram name: Function P2INT

Purpose: Correlates the transmitter-receiver filter impulse response with a delayed version of itself.

Calling sequence:
P2INT (A, B, XL, XU, XINCR)

Contained in module: TRC

Called by: TIMPAR, VARW

Calls: TXPULS

Input arguments:

A	R*4	Sampling time at the output of the receiver filter.
B	R*4	Delay between correlator inputs.
XL	R*4	Lower integration limit.
XU	R*4	Upper integration limit.
XINCR	R*4	Step increment for numerical integration.

Output arguments:

P2INT	R*4	Correlation of the transmitter-receiver filter impulse response with a delayed version of itself.
-------	-----	---

Global variables input from common:

IPULS	/SYSPAR/	I*2	SYSPAR.INC	Switch to indicate whether pulse shape at input of the AN/TRC-170 detector includes the effects of RF filters (IPULS = 2) or not (IPULS = 0 or 1). Set to 2 internally. If IBW is 0, set to 1.
NCHIP	/SYSPAR/	I*2	SYSPAR.INC	Number of chips in PN sequence used to expand bandwidth in AN/TRC-170.
PDUR	/SYSPAR/	R*4	SYSPAR.INC	Symbol pulse duration.

10.3 INTERD

Subprogram name: Subroutine INTERD

Purpose: Linear interpolation in a table of N pairs (XX,YY).

Calling sequence:

CALL INTERD (Y, X, YY, XX, N, IERR)

Contained in module: TRC

Called by: POUTAG, TIMAVG

Calls: NONE

Input arguments:

X	R*4	Value of x-coordinate for which y-coordinate is desired.
YY(N)	R*4	Tabulated values of y-coordinate corresponding to tabulated x-coordinate. Dimensioned to 30.
XX(N)	R*4	Tabulated values of x-coordinate corresponding to tabulated y-coordinate. Dimensioned to 30.
N	I*2	Number of tabulated values over which interpolation is to be performed. Maximum is 30.

Output arguments:

Y	R*4	Value of y-coordinate corresponding to X.
IERR	I*2	Error flag. 0 = no error 5 = x-coordinate value greater than largest tabulated value 6 = x-coordinate value less than smallest tabulated value

AN/TRC-170 MODEM CALCULATIONS
Subroutine EIGV

Page 10-6

Ratio of smallest to largest eigenvalue in AN/TRC-170 performance calculations.

ENMEAN /ANSWER/ R*4 ANSWER.INC
Average received energy.

ICHIP(30) /SYSPAR/ I*2 SYSPAR.INC
PN sequence for spectrum spreading when the data rate is much smaller than the bandwidth.

IOPERF /IOUT/ I*2 IOUT.INC
Switch for calculation of performance of AN/TRC-170.
0 = ABER and outage probability
1 = ABER (average bit error rate) only
2 = Outage probability only

Set to 0 internally.

IOTIME /IOUT/ I*2 IOUT.INC
Switch for calculation of performance of AN/TRC-170.
0 = Short term performance assuming various sampling times.
1 = Short term performance assuming Gaussian timing jitter.
2 = Yearly average performance assuming Gaussian timing jitter.

Set to 2 internally.

IPROFL /SYSPAR/ I*2 SYSPAR.INC
Parameter that indicates whether troposcatter power per unit delay profile of the form $X \exp(-A^*X)$ is to be used (IPROFL = 0) or not. Set to zero in TRCIN.

IPULS /SYSPAR/ I*2 SYSPAR.INC
Switch to indicate whether pulse shape at input of the AN/TRC-170 detector includes the effects of RF filters (IPULS = 2) or not (IPULS = 0 or 1). Set to 2 internally. If IBW is 0, set to 1.

ISN /IOUT/ I*2 IOUT.INC
Number of SNR values for which short-term performance of AN/TRC-170 is to be performed. Set to 17.

IT /IOUT/ I*2 IOUT.INC
Number of different sampling times to be used in calculation of AN/TRC-170 short term performance.

KISI /NUMPAR/ I*2 NUMPAR.INC
Parameter for calculation of AN/TRC-170 outage probability. Set to 6 in data statement.

LERR /LUNS/ I*2 LUNS.INC
Error output unit.

LOUT /LUNS/ I*2 LUNS.INC
FOR002.DAT output unit number.

NCHIP /SYSPAR/ I*2 SYSPAR.INC
Number of chips in PN sequence used to expand bandwidth in AN/TRC-170.

NDIVS /SYSPAR/ I*2 SYSPAR.INC
Number of explicit diversity channels for AN/TRC-170. Equal to 4 for 2S/2F and 2 for 2S or 2F.

NEIGEN /ANSWER/ I*2 ANSWER.INC
Number of implicit diversity eigenvalues (stored in
array VEIGV) used in calculation of AN/TRC-170
performance.

NPOINT /NUMPAR/ I*2 NUMPAR.INC
Number of points for numerical integration.

NTH1 /IOUT/ I*2 IOUT.INC
Pointer to largest bit error rate threshold of
interest for AN/TRC-170 outage probability
calculation.

NTH2 /IOUT/ I*2 IOUT.INC
Pointer to smallest bit error rate threshold of
interest for AN/TRC-170 outage probability
calculation.

NTHR /SYSPAR/ I*2 SYSPAR.INC
Pointer to bit error rate threshold for AN/TRC-170
outage probability calculation.

NV /NUMPAR/ I*2 NUMPAR.INC
Normalization parameter for calculation of AN/TRC-170
signal gain. Set to 18.

PEAKAV /RZ4/ R*4 RZ4.INC
Peak-to-average loss due to RF filtering in dB.

SIGMA /SYSPAR/ R*4 SYSPAR.INC
Half the RMS lower beam delay spread normalized
relative to the symbol duration.

SNDB(2) /IOUT/ R*4 IOUT.INC
Signal to noise ratio in dB.

SNRBW /RZ4/ R*4 RZ4.INC
Signal to noise ratio adjustment for AN/TRC-170 due to
limited receive filter bandwidth.

SNRF2 /RZ4/ R*4 RZ4.INC
Parameter to adjust the signal to noise ratio for
degradation due to interference from another
frequency. Only for 2-frequency AN/TRC-170 modem.

SNRJAM /RZ4/ R*4 RZ4.INC
Parameter to adjust the signal to noise ratio of
AN/TRC-170 for degradation due to colocated/adjacent
channel interference.

STSNR1 /SYSPAR/ R*4 SYSPAR.INC
Standard deviation of troposcatter signal long-term
SNR distribution in dB. Same as STSNR in /SUMP/.

TOT0(20) /IOUT/ R*4 IOUT.INC
Array of sampling times (normalized to symbol
duration) for calculation of short term AN/TRC-170
performance.

TDEV /NUMPAR/ R*4 NUMPAR.INC
Standard deviation of sampling times for AN/TRC-170
performance calculations.

Global variables output to common:

PAVG(20,20)	/ANSWER/	R*4	ANSWER.INC	Short-term average bit error rate for each sampling time and short-term average SNR.
PDUR	/SYSPAR/	R*4	SYSPAR.INC	Symbol pulse duration.
POUT(20,20,3)	/ANSWER/	R*4	ANSWER.INC	AN/TRC-170 outage probability and average bit error rate as a function of sampling time, short-term average SNR and error rate threshold.
SNR	/SYSPAR/	R*4	SYSPAR.INC	Signal to noise ratio.
T0	/SYSPAR/	R*4	SYSPAR.INC	Normalized sampling time for lower beam.
TPAR(20)	/ANSWER/	R*4	ANSWER.INC	Timing parameter for AN/TRC-170. Calculated when IOTIME is 0.
VARAIS	/ANSWER/	R*4	ANSWER.INC	Past ISI variance for AN/TRC-170.
VARBIS	/ANSWER/	R*4	ANSWER.INC	Future ISI variance for AN/TRC-170.
VARISI	/ANSWER/	R*4	ANSWER.INC	Total ISI variance for AN/TRC-170.
VEIGV(20)	/ANSWER/	R*8	ANSWER.INC	Implicit diversity eigenvalues for AN/TRC-170.
X2INCR	/NUMPAR/	R*4	NUMPAR.INC	Step increment for numerical integration.
XAVAR	/ANSWER/	R*4	ANSWER.INC	Standard deviation of past ISI for AN/TRC-170.
XBVAR	/ANSWER/	R*4	ANSWER.INC	Standard deviation of future ISI for AN/TRC-170.
XINCR	/NUMPAR/	R*4	NUMPAR.INC	Step increment for numerical integration.

10.15 TRCIN

Subprogram name: Subroutine TRCIN

Purpose: To define parameters for calculation of the AN/TRC-170 or DAR modem troposcatter performance for the data rate and bandwidth specified by the user.

Calling sequence:

CALL TRCIN (TRCTYP, BW, IBW, TAU22, DRATE, ASNR1, DSTSNR, NERT, BOUT, FOUT)

Contained in module: TRC

Called by: TROPO

Calls: ERROR SASEQ TRC

Input arguments:

TRCTYP	R*4	TRC-170 modem type indicator: 0 = 1 frequency DAR modem 1 = 2 frequency AN/TRC-170 modem
BW	R*4	Bandwidth in Hz.
IBW	I*2	Switch indicating which type of RF bandwidth constraint to be used on desired signal. 0 = No RF filtering 1 = Filter determined from 99% bandwidth constraint 2 = Filter chosen to meet FCC Mask. (FCC-19311) 3 = Filters are user specified.
TAU22	R*8	Delay spread on lower beam in nsec.
DRATE	R*4	Data rate in bits per seconds.
ASNR1	R*4	Median and/or yearly average value of troposcatter signal SNR in dB.
DSTSNR	R*4	Standard deviation of troposcatter signal long-term SNR distribution in dB.
NERT	I*2	Bit error rate threshold indicator for yearly outage probability calculations. 0 = All three thresholds 1 = For 10^{*-3} only 2 = For 10^{*-4} only 3 = For 10^{*-5} only

Output arguments:

BOUT(3,4)	R*4	Yearly average outage probability for each bit error rate threshold specified and 2S/2F and 2S diversity configurations.
FOUT(3,4)	R*4	Yearly average fade outage per call minute for each bit error rate threshold specified and 2S/2F and 2S diversity configurations.

Global variables input from common:

KGAIN /RZ/ I#2 RZ.INC
 Inteser ratio of bandwidth to data rate.
LOUT /LUNS/ I#2 LUNS.INC
 FOR002.DAT output unit number.
NTHR /SYSPAR/ I#2 SYSPAR.INC
 Pointer to bit error rate threshold for AN/TRC-170
 outase probability calculation.

Global variables output to common:

ASNR /SYSPAR/ R#4 SYSPAR.INC
 Yearly median value of troposcatter short-term average
 SNR, ie, Eb/No, in dB.
CDUR /SYSPAR/ R#4 SYSPAR.INC
 Duration of transmitted pulse for AN/TRC-170
 normalized to signaling interval duration.
ICHIP(30) /SYSPAR/ I#2 SYSPAR.INC
 PN sequence for spectrum spreading when the data
 rate is much smaller than the bandwidth.
IOPERF /IOUT/ I#2 IOUT.INC
 Switch for calculation of performance of AN/TRC-170.
 0 = ABER and outase probability
 1 = ABER (average bit error rate) only
 2 = Outase probability only
 Set to 0 internally.
IOTIME /IOUT/ I#2 IOUT.INC
 Switch for calculation of performance of AN/TRC-170.
 0 = Short term performance assuming various
 sampling times.
 1 = Short term performance assuming Gaussian
 timing jitter.
 2 = Yearly average performance assuming
 Gaussian timing jitter.
 Set to 2 internally.
IPROFL /SYSPAR/ I#2 SYSPAR.INC
 Parameter that indicates whether troposcatter power
 per unit delay profile of the form $X \exp(-A^*X)$ is to
 be used (IPROFL = 0) or not. Set to zero in TRCIN.
IPULS /SYSPAR/ I#2 SYSPAR.INC
 Switch to indicate whether pulse shape at input of the
 AN/TRC-170 detector includes the effects of RF filters
 (IPULS = 2) or not (IPULS = 0 or 1). Set to 2
 internally. If IBW is 0, set to 1.
ISN /IOUT/ I#2 IOUT.INC
 Number of SNR values for which short-term performance
 of AN/TRC-170 is to be performed. Set to 17.
NCHIP /SYSPAR/ I#2 SYSPAR.INC
 Number of chips in PN sequence used to expand
 bandwidth in AN/TRC-170.

NDIVS	/SYSPAR/	I*2	SYSPAR.INC	Number of explicit diversity channels for AN/TRC-170. Equal to 4 for 2S/2F and 2 for 2S or 2F.
NTH1	/IOUT/	I*2	IOUT.INC	Pointer to largest bit error rate threshold of interest for AN/TRC-170 outage probability calculation.
NTH2	/IOUT/	I*2	IOUT.INC	Pointer to smallest bit error rate threshold of interest for AN/TRC-170 outage probability calculation.
PEAKAV	/RZ4/	R*4	RZ4.INC	Peak-to-average loss due to RF filtering in dB.
SIGMA	/SYSPAR/	R*4	SYSPAR.INC	Half the RMS lower beam delay spread normalized relative to the symbol duration.
SNDB(2)	/IOUT/	R*4	IOUT.INC	Signal to noise ratio in dB.
SNR	/SYSPAR/	R*4	SYSPAR.INC	Signal to noise ratio.
STSNR1	/SYSPAR/	R*4	SYSPAR.INC	Standard deviation of troposcatter signal long-term SNR distribution in dB. Same as STSNR in /SUMP/.

10.16 TXPULS

Subprogram name: Function TXPULS

Purpose: Calculates the impulse response of the cascade of transmitter and receiver filters at time X.

Calling sequence:
TXPULS (X)

Contained in module: TRC

Called by: EIGV, P2INT

Calls: NONE

Input arguments:
X R#4 Normalized sampling time.

Output arguments:
TXPULS R#4 Impulse response of the cascade of transmitter and receiver filters at time X.

Global variables input from common:

CDUR	/SYSPAR/	R#4	SYSPAR.INC	Duration of transmitted pulse for AN/TRC-170 normalized to signaling interval duration.
ICHIP(30)	/SYSPAR/	I#2	SYSPAR.INC	PN sequence for spectrum spreading when the data rate is much smaller than the bandwidth.
IPULS	/SYSPAR/	I#2	SYSPAR.INC	Switch to indicate whether pulse shape at input of the AN/TRC-170 detector includes the effects of RF filters (IPULS = 2) or not (IPULS = 0 or 1). Set to 2 internally. If IRW is 0, set to 1.
NCHIP	/SYSPAR/	I#2	SYSPAR.INC	Number of chips in PN sequence used to expand bandwidth in AN/TRC-170.
NTR	/RZ4/	I#2	RZ4.INC	Number of samples for calculating transmit-receive filter impulse response (TRFILT).
PDUR	/SYSPAR/	R#4	SYSPAR.INC	Symbol pulse duration.
TRFILT(128)	/RZ4/	R#4	RZ4.INC	Transmit-receive filter impulse response.
XTRO	/RZ4/	R#4	RZ4.INC	Time origin for transmit-receive filter impulse response (TRFILT), ie, X is TRFILT(X+XTRO).
XTRINC	/RZ4/	R#4	RZ4.INC	Sample interval for calculation of transmit-receive

filter impulse response (TRFILT).

10.17 VARW

Subprogram name: Function VARW

Purpose: Variance of the ISI due to the kth past or future symbol.

Call sequence:
VARW (K,XINCR,X2INCR)

Contained in module: TRC

Called by: TRC

Calls: PROFIL, P2INT

Input arguments:

K	I*2	ISI symbol indicator: past if positive, future if negative.
XINCR	R*4	Step increment for numerical integration.
X2INCR	R*4	Step increment for numerical integration.

Output arguments:

VARW	R*4	Variance of the ISI due to the kth past or future symbol.
------	-----	---

Global variables input from common:

IPROFL	/SYSPAR/	I*2	SYSPAR.INC	Parameter that indicates whether troposcatter power per unit delay profile of the form $X \exp(-A*X)$ is to be used (IPROFL = 0) or not. Set to zero in TRCIN.
NDIVS	/SYSPAR/	I*2	SYSPAR.INC	Number of explicit diversity channels for AN/TRC-170. Equal to 4 for 2S/2F and 2 for 2S or 2F.
SIGMA	/SYSPAR/	R*4	SYSPAR.INC	Half the RMS lower beam delay spread normalized relative to the symbol duration.
T0	/SYSPAR/	R*4	SYSPAR.INC	Normalized sampling time for lower beam.

CHAPTER 11
FINAL OUTPUT

This section describes the summary page output routines:

Name	Description	User's Manual section
----	-----	-----
SIM	Simulator tap gains	2.5.7
SUMPAG	Summary page output	3.4.2

The main routine for this section is SUMPAG. SUMPAG writes to the file SUMPAG.OUT on unit LSUM. A complete description of this file can be found in section 3.4.2 of the User's Manual.

NOTE

In most cases the sections in the User's Manual describe the coded equations as well as the theory behind them. NA denotes routines that are programming utilities such as finding indices, setting pointers, etc.

11.1 SIM

Subprogram name: Subroutine SIM

Purpose: Calculates troposcatter path simulator tap gains in dB,
normalized so MAX TAP = 0 dB.

Calling sequence:
CALL SIM

Contained in module: SIM

Called by: SUMPAG

Calls: NONE

Input arguments:
NONE

Output arguments:
NONE

Global variables input from common:

DELPB	/PDATA/	R*4	PDATA.INC
		Resolution of a delay cell in seconds.	
DIVTYP	/MCOM2/	I*2	MCOM.INC
		Diversity configuration indicator. Default is 0.	
		0 = 2 receive antennas; 2S 2S/2F 2S/2A 2S/2A/2F	
		1 = 1 receive antenna; 2A 2F 2F/2A	
		2 = 2 transmit,	
		2 receive antennas; 2S/2P 2S/2P/2A	
		3 = Not used	
		4 = User supplied parameters	
		S = Space F = Frequency A = Angle P = Polarization	
I1CORR(NCORMX)	/PDATA/	I*2	PDATA.INC
		Array of receiving beams involved in the correlation calculations.	
I2CORR(NCORMX)	/PDATA/	I*2	PDATA.INC
		Array of receiving beams involved in the correlation calculations.	
I PROF(NCORMX)	/PDATA/	I*2	PDATA.INC
		0 if the Ith correlation not wanted, 1 if wanted.	
LOUT	/LUNS/	I*2	LUNS.INC
		FOR002.DAT output unit number.	
MLAST	/PDATA/	I*2	PDATA.INC
		Number of simulator taps. Default is 16.	
NCORMX		I*2	TROPAR.INC
		Parameter I*2 TROPAR.INC	
		Maximum number of correlations between receive ports.	
NCORR	/PDATA/	I*2	PDATA.INC
		Number of receive port correlations.	

```
NDELMX      Parameter      I#2      TROPAR.INC
Maximum number of delay bins in troposcatter power per
unit delay profiles.
Q(NDELMX,NCORMX) /PDATA/      R#4      PDATA.INC
Matrix of troposcatter signal power and correlation
per unit delay profiles.
For DIVTYP = 0:
  Q(.,1) Power on lower beam vs. delay.
  Q(.,2) Correlation between lower and
         upper beam vs. delay.
  Q(.,3) Correlation between lower beams
         in antennas 1 & 2 vs. delay.
  Q(.,4) Power on upper beam vs. delay.
  Q(.,7) Power on diffraction path vs. delay
For DIVTYP = 1:
  Q(.,1) Power on lower beam vs. delay.
  Q(.,2) Correlation between lower and
         upper beam vs. delay.
  Q(.,3) Power on upper beam vs. delay
  Q(.,7) Power on diffraction path vs. delay.
For DIVTYP = 2:
  Q(.,1) Power on path 1 (lower beam) vs. delay.
  Q(.,2) Correlation between convergent paths
         (lower beam) vs. delay.
  Q(.,3) Correlation between divergent paths
         (lower beam) vs. delay.
  Q(.,4) Correlation between parallel paths
         (lower beam) vs. delay.
  Q(.,5) Correlation between crossing paths
         (lower beam) vs. delay.
  Q(.,6) Power on path of upper beam vs. delay.
  Q(.,7) Power on diffraction path vs. delay.
SPE          /PDATA/      R#4      PDATA.INC
Tap spacings in nanoseconds. Default is 67 nsec.
```

11.2 SUMPAG

Subprogram name: Subroutine SUMPAG

Purpose: Outputs the summary file SUMPAG.OUT.

Description: The data on the first page is the principal link data. A second page is printed for modem information, if one was specified. The third page contains additional information relating to the common volume integration.

Subsequent pages list the delay power impulse response or cross-power (correlation) versus delay. One page is printed for each delay profile requested in the input data (JBR). The units are those specified by LUNITS.

Calling sequence:
CALL SUMPAG (PTYPE, ROUT, FOUT, JPOW, CLIMAT)

Contained in module: SUMPAG

Called by: TROPO

Calls: ANTPTR, ERROR, SIM, UNITCV

Input arguments:

PTYPE	I*2	Variable which indicates whether propagation mechanism is pure troposcatter (0 or 10) or mixed troposcatter-diffraction (1 or 11).
BOUT(3,4)	R*4	Yearly average fade outage probability for each bit error rate threshold specified and 2S/2F and 2S diversity configurations.
FOUT(3,4)	R*4	Yearly average fade outage probability per call minute for each bit error rate threshold specified and 2S/2F and 2S diversity configurations.
JPOW	R*8	Interference signal power density in dBm/Hz.
CLIMAT	R*4	Climate zone indicator.

Output arguments:

Global variables input from common:

AA	/PROFAR/	R*4	TROCOM.INC
			Atmospheric absorption loss in dB.
ALFA0	/PATHGE/	R*4	TROCOM.INC
			Minimum transmit antenna elevation angle measured from transmitter-to-receiver line to transmit horizon line in radians.
AR(NRMX)	/ANTENN/	R*4	TROCOM.INC
			Array of receiver antenna diameters in meters. AR(1)

is equivalent to RDIAM in the input file.

AT(NTMX) /ANTENN/ R*4 TROCOM.INC
Array of transmitter antenna diameters in meters.
AT(1) is equivalent to TDIAM in the input file.

BER(3) /ERAD/ R*4 ERAD.INC
Bit error rate thresholds of interest. Set to 1E-3,
1E-4 and 1E-5 in data statement.

BETA0 /PATHGE/ R*4 TROCOM.INC
Minimum receive antenna elevation angle measured from
receiver-to-transmitter line to receiver horizon line
in radians.

BW /SYSTRN/ R*4 TROCOM.INC
Bandwidth in Hertz. Default is 7 MHz.

C /PDATA/ R*4 PDATA.INC
Proportionality constant in troposcatter path loss
calculation.

D /PATHGE/ R*4 TROCOM.INC
Great circle distance between transmitter and receiver
measured at sea level in meters.

DE /SUMP/ R*4 CURVE.INC
Effective distance for troposcatter path in
kilometers.

DEL /SUMP/ R*4 CURVE.INC
Diffraction path delay relative to a straight line
path in seconds.

DELPR /PDATA/ R*4 PDATA.INC
Resolution of a delay cell in seconds.

DIFLOS(3) /SUMP/ R*4 CURVE.INC
Median diffraction path loss in dB for each value in
ERFAC distribution.

DIFRSL(3) /SUMP/ R*4 CURVE.INC
Median diffraction signal RSL in dB for each value in
ERFAC distribution.

DIVTYP /MCOM2/ I*2 MCOM.INC
Diversity configuration indicator. Default is 0.
0 = 2 receive antennas; 2S 2S/2F 2S/2A 2S/2A/2F
1 = 1 receive antenna; 2A 2F 2I/2A
2 = 2 transmit,
 2 receive antennas; 2S/2P 2S/2P/2A
3 = Not used
4 = User supplied parameters
S = Space F = Frequency A = Angle P = Polarization

DLR /PATHGE/ R*4 TROCOM.INC
Distance from receiver to radio horizon in meters.

DLT /PATHGE/ R*4 TROCOM.INC
Distance from transmitter to radio horizon in meters.

DSTS NR /SUMP/ R*4 CURVE.INC
Standard deviation of diffracted signal long-term SNR
distribution in dB.

ERFAC /PROPAR/ R*4 TROCOM.INC

LOOPS .FTN contains the following subprograms:
LOOPS , Subroutine

LTCORR.FTN contains the following subprograms:
LTCORR, Subroutine

MATCO .FTN contains the following subprograms:
MATCO , Subroutine

MATOPS.FTN contains the following subprograms:
CHANGE, Subroutine
MATA , Subroutine
SQTMAT, Subroutine

MDIF .FTN contains the following subprograms:
TANGL , Subroutine
DIF1 , Subroutine
MDIF , Subroutine

MDTS .FTN contains the following subprograms:
MDTS , Subroutine

MINV .FTN contains the following subprograms:
MINV , Subroutine

ORDER .FTN contains the following subprograms:
ORDER , Subroutine

OUTDAT.FTN contains the following subprograms:
OUTDAT, Subroutine

POWER .FTN contains the following subprograms:
POWER , Subroutine

PROUT .FTN contains the following subprograms:
PROUT , Subroutine

RGAIN .FTN contains the following subprograms:
RGAIN , Function

RIPROF.FTN contains the following subprograms:
RIPROF, Subroutine

SASEQ .FTN contains the following subprograms:
SASEQ , Subroutine

SIGIN .FTN contains the following subprograms:
SIGIN , Subroutine

Subprogram Reference Index

VARPOL, Function

DELO .FTN contains the following subprograms:
 DELO , Subroutine

DIFSNR.FTN contains the following subprograms:
 DIFSNR, Subroutine

DINT .FTN contains the following subprograms:
 CAKL , Subroutine
 DINT , Subroutine
 CAC , Function

EIGEN .FTN contains the following subprograms:
 EIGEN , Subroutine

ELMES .FTN contains the following subprograms:
 ELMES , Subroutine
 HQR , Subroutine

ERFC .FTN contains the following subprograms:
 ERFC , Function

ERLANG.FTN contains the following subprograms:
 ERLANG, Function

ERRIO .FTN contains the following subprograms:
 ERRIO , Subroutine

ERROR .FTN contains the following subprograms:
 ERROR , Subroutine

FRQSEP.FTN contains the following subprograms:
 FRQSEP, Subroutine

GPATT .FTN contains the following subprograms:
 GPATT , Subroutine

HORANG.FTN contains the following subprograms:
 HORANG, Subroutine

INDATA.FTN contains the following subprograms:
 INDATA, Subroutine
 SECTOR, Subroutine

INTLIM.FTN contains the following subprograms:
 INTLIM, Subroutine

JAMCOM.FTN contains the following subprograms:
 JAMCOM, Subroutine

PDFCON, Subroutine

BOTAC .FTN contains the following subprograms:

ROTAC , Subroutine
TPSPEC, Function
TPSPJ , Function
PWRSPC, Function
RJCFCN, Function
TSINC , Function

BUTFIL.FTN contains the following subprograms:

BUTFIL, Subroutine
A50FCC, Function
BWJAM , Subroutine
ENRGF , Subroutine
FCCMSK, Subroutine
FFT , Subroutine
FUNRW , Function
FUNJAM, Function
INTERB, Subroutine
PEAK , Subroutine
PSPEC , Function
PSPEC1, Function
PSPEC2, Function
PSPJ , Function
RTMI , Subroutine
SAMPLE, Subroutine
SEARCH, Subroutine
SPEC , Function
SPEC1 , Function
SPEC2 , Function

CAJI .FTN contains the following subprograms:

CAJI , Subroutine

CHKDAT.FTN contains the following subprograms:

CHKDAT, Subroutine

CLIME .FTN contains the following subprograms:

CLIME , Subroutine
CLIFIT, Subroutine
YINT , Subroutine
DEIND , Subroutine

CLIMIL.FTN contains the following subprograms:

CLIMIL, Subroutine
VDECAL, Subroutine

CLIMIX.FTN contains the following subprograms:

CLIMIX, Subroutine

TGAIN , Function	TGAIN .FTN
TIMAVG, Subroutine	TRC .FTN
TIMEQL, Subroutine	TRC .FTN
TIMPAR, Function	TRC .FTN
TPSPEC, Function	BOTAC .FTN
TPSPJ , Function	BOTAC .FTN
TRANSF, Subroutine	TRANSF.FTN
TRC , Subroutine	TRC .FTN
TRCIN , Subroutine	TRC .FTN
TRLOSS, Subroutine	TRLOSS.FTN
TROPO , Main program	TROPO .FTN
TSINC , Function	BOTAC .FTN
TXPULS, Function	TRC .FTN
UNITCV, Subroutine	UNITCV.FTN
UNITS , Subroutine	UNITS .FTN
VARPDL, Function	CLIMIX.FTN
VARW , Function	TRC .FTN
VDECAL, Subroutine	CLIMIL.FTN
XNOR , Function	XNOR .FTN
YINT , Subroutine	CLIME .FTN

A.2 Module / Subprogram Reference Index

ANTGEO.FTN contains the following subprograms:
ANTGEO, Subroutine

ANTPAR.FTN contains the following subprograms:
ANTPAR, Subroutine

ANTPTR.FTN contains the following subprograms:
ANTPTR, Subroutine

ATMOS .FTN contains the following subprograms:
ATMOS , Subroutine

AVAIL .FTN contains the following subprograms:
AVAIL , Subroutine
CONVOL, Subroutine
INTERP, Subroutine

AVTER .FTN contains the following subprograms:
AVTER , Subroutine

BEAMPT.FTN contains the following subprograms:
BEAMPT, Subroutine

BERCAL.FTN contains the following subprograms:
BERCAL, Subroutine

INTLIM, Subroutine	INTLIM.FTN
JAMCOM, Subroutine	JAMCOM.FTN
LOOPS, Subroutine	LOOPS.FTN
LTCORR, Subroutine	LTCORR.FTN
MATA, Subroutine	MATOPS.FTN
MATCO, Subroutine	MATCO.FTN
MDIF, Subroutine	MDIF.FTN
MDTS, Subroutine	MDTS.FTN
MINV, Subroutine	MINV.FTN
ORDER, Subroutine	ORDER.FTN
OUTDAT, Subroutine	OUTDAT.FTN
P2INT, Function	TRC.FTN
PAVERG, Subroutine	TRC.FTN
PDF, Function	TRC.FTN
PDFCOE, Subroutine	TRC.FTN
PDFCON, Subroutine	BERCAL.FTN
PDFSUM, Function	TRC.FTN
PEAK, Subroutine	BUTFIL.FTN
POUTAG, Subroutine	TRC.FTN
POWER, Subroutine	POWER.FTN
PROFIL, Function	TRC.FTN
PROUT, Subroutine	PROUT.FTN
PSINE, Function	SINT.FTN
PSPEC, Function	BUTFIL.FTN
PSPEC1, Function	BUTFIL.FTN
PSPEC2, Function	BUTFIL.FTN
PSPJ, Function	BUTFIL.FTN
PWRSPC, Function	BOTAC.FTN
RGAIN, Function	RGAIN.FTN
RIPROF, Subroutine	RIPROF.FTN
RJCFCN, Function	BOTAC.FTN
RTMI, Subroutine	BUTFIL.FTN
SAMPLE, Subroutine	BUTFIL.FTN
SASEQ, Subroutine	SASEQ.FTN
SEARCH, Subroutine	BUTFIL.FTN
SECTOR, Subroutine	INDATA.FTN
SIGIN, Subroutine	SIGIN.FTN
SIM, Subroutine	SIM.FTN
SINC, Function	SINC.FTN
SINT, Subroutine	SINT.FTN
SPEC, Function	BUTFIL.FTN
SPEC1, Function	BUTFIL.FTN
SPEC2, Function	BUTFIL.FTN
SQTMAT, Subroutine	MATOPS.FTN
STEPAB, Function	STEPAB.FTN
STEPY, Function	STEPY.FTN
STPPAR, Subroutine	STPPAR.FTN
SURID, Subroutine	SURID.FTN
SUMPAG, Subroutine	SUMPAG.FTN
TANGL, Subroutine	MDIF.FTN

P RELATED INFORMATION

bprogram / Module Reference Index

A.1 Subprogram / Module Reference Index

A50FCC, Function	BUTFIL.FTN
ANTGEO, Subroutine	ANTGEO.FTN
ANTPAR, Subroutine	ANTPAR.FTN
ANTPTR, Subroutine	ANTPTR.FTN
ATMOS, Subroutine	ATMOS .FTN
AVAIL, Subroutine	AVAIL .FTN
AVG, Subroutine	TRC .FTN
AVTER, Subroutine	AVTER .FTN
BEAMPT, Subroutine	BEAMPT.FTN
BERCAL, Subroutine	BERCAL.FTN
BOTAC, Subroutine	BOTAC .FTN
BUTFIL, Subroutine	BUTFIL.FTN
BWJAM, Subroutine	BUTFIL.FTN
CAC, Function	DINT .FTN
CAJI, Subroutine	CAJI .FTN
CAKL, Subroutine	DINT .FTN
CHANGE, Subroutine	MATOPS.FTN
CHKDAT, Subroutine	CHKDAT.FTN
CLIFIT, Subroutine	CLIME .FTN
CLIME, Subroutine	CLIME .FTN
CLIMIL, Subroutine	CLIMIL.FTN
CLIMIX, Subroutine	CLIMIX.FTN
CONVOL, Subroutine	AVAIL .FTN
DEIND, Subroutine	CLIME .FTN
DELO, Subroutine	DELO .FTN
DIF1, Subroutine	MDIF .FTN
DIFSNR, Subroutine	DIFSNR.FTN
DINT, Subroutine	DINT .FTN
EIGEN, Subroutine	EIGEN .FTN
EIGV, Subroutine	TRC .FTN
ELMES, Subroutine	ELMES .FTN
ENRGF, Subroutine	BUTFIL.FTN
ERFC, Function	ERFC .FTN
ERLANG, Function	ERLANG.FTN
ERRIO, Subroutine	ERRIO .FTN
ERROR, Subroutine	ERROR .FTN
FCCMSK, Subroutine	BUTFIL.FTN
FFT, Subroutine	BUTFIL.FTN
FRQSEP, Subroutine	FRQSEP.FTN
FUNBW, Function	BUTFIL.FTN
FUNJAM, Function	BUTFIL.FTN
GPATT, Subroutine	GPATT .FTN
HORANG, Subroutine	HORANG.FTN
HQR, Subroutine	ELMES .FTN
INDATA, Subroutine	INDATA.FTN
INTERB, Subroutine	BUTFIL.FTN
INTERD, Subroutine	TRC .FTN
INTERP, Subroutine	AVAIL .FTN

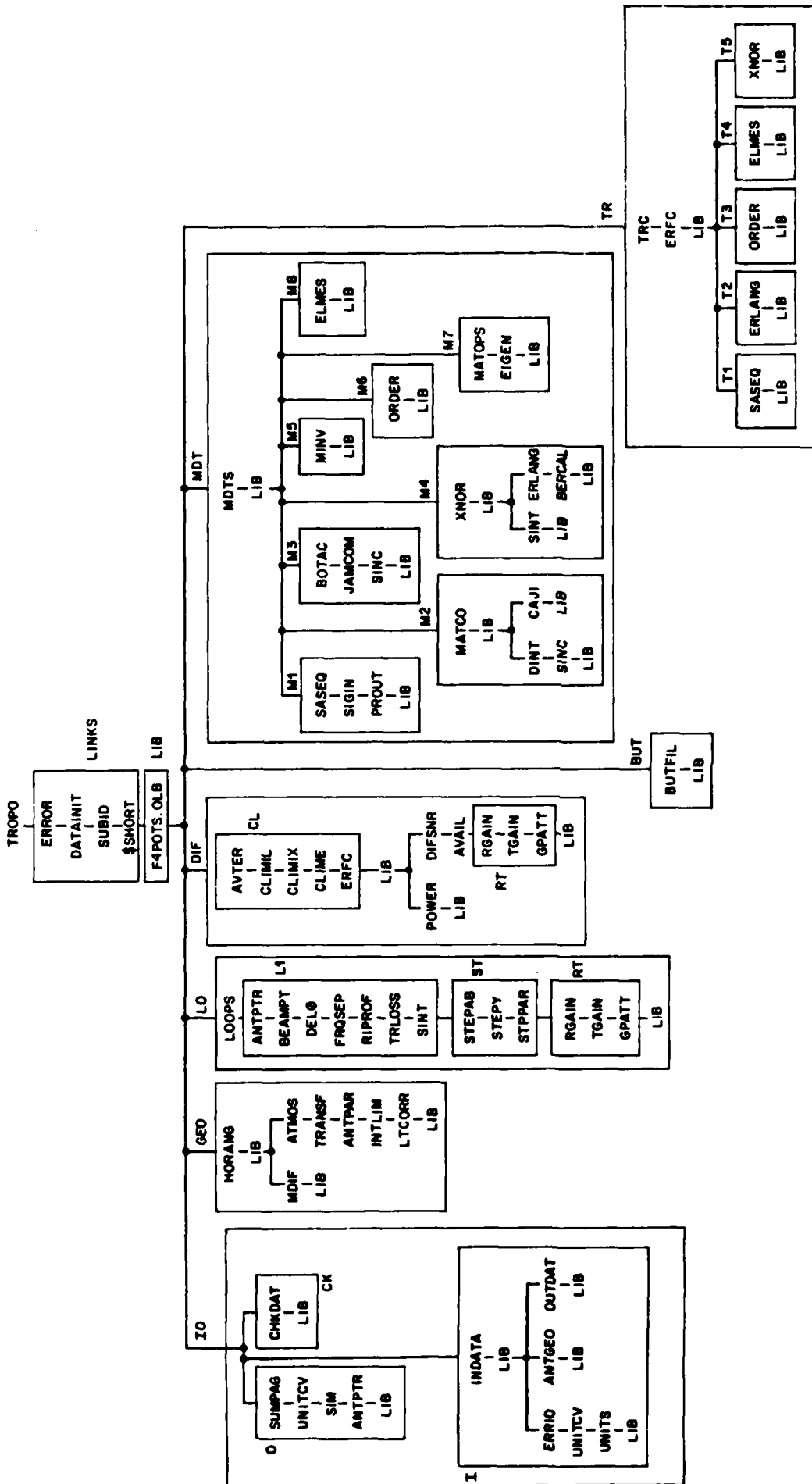

Figure A-1 Diagram of Overlay for PDP-11 Version of TROPO

APPENDIX A

PDP RELATED INFORMATION

The following information is only for those who are using the PDP version of TROPO (as opposed to the IBM version). If you are not sure which version you have, see the introduction to this document which describes the differences.

Figure A-1 is a chart of the overlay. The names refer to modules (source file names) rather than subprogram names. (The table in section A.3 lists the subprograms in each module.) TROPO is written in F4P Fortran so it must access the F4POTS module (Fortran library routines). The default library is whatever current version of Fortran is installed on your system. In order to insure that all modules are accessing F4P library functions and not F77 or other version functions, LIB is placed explicitly throughout the overlay. It is not sufficient to have it just in the root. It must be at the end of each branch.

This appendix will also aid in finding a particular subprogram or common. Since the PDP version is divided into modules or source files, finding a particular subprogram that is included in a module of a different name can be difficult. The following three tables will help:

- 1) The Subprogram / Module Reference Index
This lists each subroutine or function alphabetically by name followed by the module it is in.
- 2) The Module / Subprogram Reference Index
This lists each module and the subprograms it contains.
- 3) The Common / Include File Reference Index
This lists each common followed by the include file it is in.

UDIST	/UNIT/	R*4	IODATA.INC	Units of distance (smi, nmi, km).
UFREQ	/UNIT/	R*4	IODATA.INC	Units of frequency (GHz, MHz).
UHTE	/UNIT/	R*4	IODATA.INC	Units of height and diameter (ft, m).
URH(NR)	/PATHGE/	R*4	TROCOM.INC	Array of receive antennas horizontal offsets from great circle plane in meters.
URL(NR)	/PATHGE/	R*4	TROCOM.INC	Array of receive antennas longitudinal offsets in meters.
URV(NR)	/PATHGE/	R*4	TROCOM.INC	Array of receive antennas vertical offsets in meters.
UTH(NT)	/PATHGE/	R*4	TROCOM.INC	Array of transmit antennas horizontal offsets in meters.
UTL(NT)	/PATHGE/	R*4	TROCOM.INC	Array of transmit antennas longitudinal offsets in meters.
UTV(NT)	/PATHGE/	R*4	TROCOM.INC	Array of transmit antennas vertical offsets in meters.
WLT	/SYSTRN/	R*4	TROCOM.INC	Rated transmission power in Watts. Default is 1000 W.

Global variables output to common:

IOPEND	/CONTRL/	I*2	TROCOM.INC	Number of output files opened.
--------	----------	-----	------------	--------------------------------

paths.
QCORR(4) Correlation coefficient between parallel paths.
QCORR(5) Correlation coefficient between crossing paths.
QCORR(6) Power on upper beam.

RLL	/SYSTRN/	R*4	TROCOM.INC	Receiver line losses in dB. Default is 0 dB.
S	/PATHGE/	R*4	TROCOM.INC	Troposcatter path asymmetry parameter.
SCPARM	/PROPAR/	R*4	TROCOM.INC	Wavenumber spectrum slope parameter M. Default is 3.66.
SPREAD(NCORMX)	/PDATA/	R*4	PDATA.INC	Array of delay spreads (2-sigma) for each beam in seconds.
STSNR	/SUMP/	R*4	SUMP.INC	Standard deviation of troposcatter signal long-term SNR distribution in dB.
SUPRES	/IODATA/	L*4	IODATA.INC	Suppress long output in SUMPAG if true. Set to TRUE if PTYPE > 9.
TAPOUT	/PDATA/	L*4	PDATA.INC	If true, the simulator tap values are output to the output file, FOR002.DAT. Default is TRUE.
TEMPA(NCORMX)	/PDATA/	R*4	PDATA.INC	Array of average troposcatter signal delays for each beam relative to straight line in seconds.
THER	/PATHGE/	R*4	TROCOM.INC	Radio horizon elevation angle at receive site in radians.
THET	/PATHGE/	R*4	TROCOM.INC	Radio horizon elevation angle at transmit site in radians.
THETA0	/PATHGE/	R*4	TROCOM.INC	Scattering angle at bottom of common volume in radians.
TLL	/SYSTRN/	R*4	TROCOM.INC	Transmitter line losses in dB. Default is 0 dB.
TODAY(9)	/TSTAMP/	L*1	IODATA.INC	Array used in PDP-11 version to hold date as characters.
TROLOS(3)	/SUMP/	R*4	CURVE.INC	Median troposcatter path loss in dB for each value in ERFAC distribution.
TROSL(3)	/SUMP/	R*4	CURVE.INC	Median troposcatter RSL in dB for each value in ERFAC distribution.
UANGLE	/UNIT/	R*4	IODATA.INC	Units of angle (deg, rad).

is the main transmit antenna.
Q(NDELMX,NCORMX) /PDATA/ R*4 PDATA.INC
Matrix of troposcatter signal power and correlation
per unit delay profiles.
For DIVTYP = 0:
Q(.,1) Power on lower beam vs. delay.
Q(.,2) Correlation between lower and
upper beam vs. delay.
Q(.,3) Correlation between lower beams
in antennas 1 & 2 vs. delay.
Q(.,4) Power on upper beam vs. delay.
Q(.,7) Power on diffraction path vs. delay
For DIVTYP = 1:
Q(.,1) Power on lower beam vs. delay.
Q(.,2) Correlation between lower and
upper beam vs. delay.
Q(.,3) Power on upper beam vs. delay
Q(.,7) Power on diffraction path vs. delay.
For DIVTYP = 2:
Q(.,1) Power on path 1 (lower beam) vs. delay.
Q(.,2) Correlation between convergent paths
(lower beam) vs. delay.
Q(.,3) Correlation between divergent paths
(lower beam) vs. delay.
Q(.,4) Correlation between parallel paths
(lower beam) vs. delay.
Q(.,5) Correlation between crossing paths
(lower beam) vs. delay.
Q(.,6) Power on path of upper beam vs. delay.
Q(.,7) Power on diffraction path vs. delay.
QCORR(NCORMX) /PDATA/ R*4 PDATA.INC
Contains elements of covariance matrix, ie, powers and
correlations.
For DIVTYP = 0:
QCORR(1) Power on lower beam
QCORR(2) Correlation coefficient between lower
and upper beam.
QCORR(3) Correlation coefficient between lower
beams of antennas 1 and 2
QCORR(4) Power on upper beam.
For DIVTYP = 1:
QCORR(1) Power on lower beam
QCORR(2) Correlation coefficient between lower
and upper beam.
QCORR(3) Power on upper beam.
For DIVTYP = 2:
QCORR(1) Power on path 1 (lower beam)
QCORR(2) Correlation coefficient between convergent
paths.
QCORR(3) Correlation coefficient between divergent

Propagation/modem flag to select calculation mode.
Default is 1.
0 = Propagation only
1 = Propagation + MD-918 modem
2 = Propagation + AN/TRC-170 or DAR modem
3 = Propagation + user-defined modem

MODSIG /MCOM2/ I#2 MCOM.INC
Interference signal modulation format. Default is 1.
0 = Analog FDM / FM
1 = Digital QPSK

NACCU /CONTRL/ I#2 TROCOM.INC
Parameter used as truncation point for common
volume integration termination. Default is 40.

NCORR /PDATA/ I#2 PDATA.INC
Number of receive port correlations.

NDELX Parameter I#2 TROPAR.INC
Maximum number of delay bins in troposcatter power per
unit delay profiles.

NERT /MCOM2/ I#2 MCOM.INC
Bit error rate threshold indicator for yearly fade
outage probability calculation. Default is 2.
0 = All three thresholds
1 = For 10^{*-3} only
2 = For 10^{*-4} only
3 = For 10^{*-5} only

NEWCL(4) /MCOM2/ I#2 MCOM.INC
New climate type character string.

NOW(8) /TSTAMP/ L#1 IODATA.INC
Array used in PDP-11/70 version to hold time of day as
characters.

NR /SYSTRN/ I#2 TROCOM.INC
Number of receive ports.

NT /SYSTRN/ I#2 TROCOM.INC
Number of transmit ports.

PLOSSH /PDATA/ R#4 PDATA.INC
Troposcatter path loss from approximate analytic
expression.

PSIRAO(NRMX) /ANTENN/ R#4 TROCOM.INC
Array of receiver beam azimuths in radians.

PSIREO(NRMX) /ANTENN/ R#4 TROCOM.INC
Array of receiver beam boresight elevations above
radio horizon in radians, ie, angle at which each
antenna is aimed relative to the horizon. PSIREO(1)
is the main receive antenna.

PSITAO(NTMX) /ANTENN/ R#4 TROCOM.INC
Array of transmitter beam azimuths in radians.

PSITEO(NTMX) /ANTENN/ R#4 TROCOM.INC
Array of transmitter beam boresight elevations above
radio horizon in radians, ie, angle at which each
antenna is aimed relative to the horizon. PSITEO(1)

troposcatter integration. It is an error if INEG > 0.

IPOLR(NRMX) /ANTENN/ I*2 TROCOM.INC
Array of receiver antenna polarizations.

IPOLT(NTMX) /ANTENN/ I*2 TROCOM.INC
Array of transmitter antenna polarizations.

IPOS /PDATA/ I*2 PDATA.INC
Number of delay cells exceeding the last allocated array element. This number should be zero or small. IPOS > 0 is not a serious error unless the delay profile calculated has a clear peak in the last delay cell.

I PROF(NCORMX) /PDATA/ I*2 PDATA.INC
0 if the Ith correlation not wanted, 1 if wanted.

ITER /PDATA/ I*4 PDATA.INC
Number of integration cells in the common volume integration.

LINKNO /IODATA/ I*2 IODATA.INC
Link number.

LNAME(20) /IODATA/ I*2 IODATA.INC
Link name. Transmitter site first, receiver site second. Used as link identifier on output files FOR002.DAT and SUMPAG.OUT.

LSUM /LUNS/ I*2 LUNS.INC
SUMPAG.OUT output unit number.

LUNITS /UNIT/ I*2 IODATA.INC
Integer value that specifies the set of units requested by the user. These units are for path, antenna location, angle, and frequency parameters. Default is 8. The given units are defined by bit values of LUNITS:

Bit no.	Meaning of value 0 / 1
0	english / metric
1	statute miles / nautical miles
2	feet / meters
3	rad / degrees
4	GHz / MHz

Valid LUNITS values are

0 :	stat. miles	- feet	- milliradians	- GHz
1 :	kilometers	- meters	- milliradians	- GHz
2 :	naut. miles	- feet	- milliradians	- GHz
8 :	stat. miles	- feet	- degrees	- GHz
9 :	kilometers	- meters	- degrees	- GHz
10:	naut. miles	- feet	- degrees	- GHz
16:	stat. miles	- feet	- milliradians	- MHz
17:	kilometers	- meters	- milliradians	- MHz
18:	naut. miles	- feet	- milliradians	- MHz
24:	stat. miles	- feet	- degrees	- MHz
25:	kilometers	- meters	- degrees	- MHz
26:	naut. miles	- feet	- degrees	- MHz

MODPAT /MCOM2/ I*2 MCOM.INC

Yearly median value of effective earth radius factor k
in kilometers. Default is 1.33.

ERR /CONTROL/ R*4 TROCOM.INC

Common volume integration resolution. Default is .001.

F /SYSTRN/ R*4 TROCOM.INC

Operating frequency in Hz. Model is accurate between
100MHz and 10GHz.

FSEP /PDATA/ R*4 PDATA.INC

Frequency separation for uncorrelated frequency
diversity in Hz.

GRDB(NRMX) /ANTENN/ R*4 TROCOM.INC

Gain of each receive antenna in dBi.

GTDB(NTHX) /ANTENN/ R*4 TROCOM.INC

Gain of each transmit antenna in dBi.

HCOM /PATHGE/ R*4 TROCOM.INC

Effective height of the bottom of the common volume in
meters.

HHIGH /PATHGE/ R*4 TROCOM.INC

Effective height of the top of the common volume in
meters.

HLR /PATHGE/ R*4 TROCOM.INC

Receiver radio horizon elevation above sea level in
meters.

HLT /PATHGE/ R*4 TROCOM.INC

Transmit radio horizon elevation above sea level in
meters.

HRN /PATHGE/ R*4 TROCOM.INC

Receive antenna height above sea level in meters.

HTN /PATHGE/ R*4 TROCOM.INC

Transmit antenna height above sea level in meters.

I1CORR(NCORMX) /PDATA/ I*2 PDATA.INC

Array of receiving beams involved in the correlation
calculations.

I2CORR(NCORMX) /PDATA/ I*2 PDATA.INC

Array of receiving beams involved in the correlation
calculations.

IBR(NRMX,NRMX) /SYSTRN/ I*2 TROCOM.INC

Channel complex-envelope correlation and
cross-correlation calculation indicator array.

0 = No calculation
1 = Power (correlation) calculation only
2 = Power (correlation) per unit delay
spectrum calculation

ICLIME /MCOM2/ I*2 MCOM.INC

Climate class. Default is 0.

0 = NBS TN-101 climate
1 = MIL-HDBK-417 climate
2 = New, user-supplied climate

INEG /PDATA/ I*2 PDATA.INC

Number of negative delay cells encountered in

SIM .FTN contains the following subprograms:
SIM , Subroutine

SINC .FTN contains the following subprograms:
SINC , Function

SINT .FTN contains the following subprograms:
SINT , Subroutine
PSINE , Function

STEPAR.FTN contains the following subprograms:
STEPAR, Function

STEPY .FTN contains the following subprograms:
STEPY , Function

STPPAR.FTN contains the following subprograms:
STPPAR, Subroutine

SUBID .FTN contains the following subprograms:
SUBID , Subroutine

SUMPAG.FTN contains the following subprograms:
SUMPAG, Subroutine

TGAIN .FTN contains the following subprograms:
TGAIN , Function

TRANSF.FTN contains the following subprograms:
TRANSF, Subroutine

TRC .FTN contains the following subprograms:
AVG , Subroutine
EIGV , Subroutine
INTERD, Subroutine
PAVERG, Subroutine
PDF , Function
PDFCOE, Subroutine
PDFSUM, Function
FOUTAG, Subroutine
PROFIL, Function
P2INT , Function
TIMAVG, Subroutine
TIMEQL, Subroutine
TIMPAR, Function
TRC . Subroutine
TRCIN , Subroutine
TXPULS, Function
VARW , Function

Module / Subprogram Reference Index

TRLOSS.FTN contains the following subprograms:

TRLOSS, Subroutine

TROPO .FTN contains the following subprograms:

TROPO , Main Program

UNITCV.FTN contains the following subprograms:

UNITCV, Subroutine

UNITS .FTN contains the following subprograms:

UNITS , Subroutine

XNOR .FTN contains the following subprograms:

XNOR , Function

A.3 Common / Include File Reference Index

/ANSWER/	ANSWER.INC
/ANTENN/	TROCOM.INC
/BUTPAR/	BUTPAR.INC
/CONSTA/	CONSTANTS.INC
/CONTRL/	TROCOM.INC
/CPLOSS/	CPL.INC
/CURVE/	CURVE.INC
/ERAD/	ERAD.INC
/IODATA/	IODATA.INC
/IOUT/	IOUT.INC
/JAMPAR/	JAMPAR.INC
/LUNS/	LUNS.INC
/MCOM2/	MCOM.INC
/MCOM4/	MCOM.INC
/NUMPAR/	NUMPAR.INC
/PATHGE/	TROCOM.INC
/PDATA/	PDATA.INC
/PROPAR/	TROCOM.INC
/RI2/	RI2.INC
/RZ/	RZ.INC
/RZ1/	RZ1.INC
/RZ4/	RZ4.INC
/STPCOM/	STPCOM.INC
/SUMP/	SUMP.INC
/SYSPAR/	SYSPAR.INC
/SYSTRN/	TROCOM.INC
/TSTAMP/	IODATA.INC
/UNIT/	IODATA.INC

APPENDIX B

CALL CROSS-REFERENCE

The subprogram cross-reference shows which subprograms call the described subprogram and which subprograms it calls. A similar list appears for each subprogram in the main description of it but the following list also includes system routines such as SIN as well as statement functions. In the following list MAIN refers to the driver or main routine, TROPO.

B.1 Call Cross-Reference Table

ANTGEO

Is called by the following subprograms:
INDATA

ANTPAR

Is called by the following subprograms:
TROPO
Calls the following subprograms:
ALOG10 ERROR

ANTPTR

Is called by the following subprograms:
LOOPS SUNPAG

ATMOS

Is called by the following subprograms:
TROPO
Calls the following subprograms:
ERROR

AVAIL

Is called by the following subprograms:
DIFSNR
Calls the following subprograms:
CLIME CLIMIL CLIMIX CONVOL INTERP SORT SUBID

AUG

Is called by the following subprograms:

TRC

Calls the following subprograms:

PDF YRUTIN

AVTER

Is called by the following subprograms:

DIFSNR POWER

ASOFCC

Is called by the following subprograms:

FCCMSK FUNBW

Calls the following subprograms:

ALOG10 PSPEC

BEAMPT

Is called by the following subprograms:

LOOPS

BERCAL

Is called by the following subprograms:

MDTS

Calls the following subprograms:

ALOG10 DABS DLOG DLOG10 DMAX1 ERLANG EXP PDFCON
SUBID XNOR

BOTAC

Is called by the following subprograms:

MDTS

Calls the following subprograms:

JAMCOM RJCFN SUBID TSINC

BUTFIL

Is called by the following subprograms:

TROFO

Calls the following subprograms:

ABS ALOG10 AMAX1 BWJAM EXP FUNBW FUNJAM F1
F2 PEAK PSPEC1 PSPEC2 SAMPLE SIN SPEC1 SPEC2
SQRT SUBID

BWJAM

Is called by the following subprograms:

BUTFIL

Calls the following subprograms:

ALOG10 ENRGF FUNBW FUNJAM RTMI SEARCH

CAC

Is called by the following subprograms:

DINT MATCO

Calls the following subprograms:

ABS DSQRT SINC

CAJI

Is called by the following subprograms:

MATCO

Calls the following subprograms:

ABS AMAX1 IABS

CAKL

Is called by the following subprograms:

MATCO

Calls the following subprograms:

DINT

CHANGE

Is called by the following subprograms:

MDTS SQTMAT

Calls the following subprograms:

ERROR

CHKDAT

Is called by the following subprograms:

TROPO

Calls the following subprograms:

ABS ERROR

CLIFIT

Is called by the following subprograms:

CLIME CLIMIL

Calls the following subprograms:

ABS EXP F1 F2 SUBID

CLIME

Is called by the following subprograms:

AVAIL CLIMIX POWER

Calls the following subprograms:

ALOG10 CLIFIT DEIND ERROR EXP F2 SIN YINT

CLIMIL

Is called by the following subprograms:

AVAIL POWER

Calls the following subprograms:

ALOG10 CLIFIT ERROR SIN VDECAL

CLIMIX

Is called by the following subprograms:

AVAIL POWER

Calls the following subprograms:

ABS CLIME ERFC ERROR SQRT SUBID VARPOL

CONVOL

Is called by the following subprograms:

AVAIL

Calls the following subprograms:

INTERP

DEIND

Is called by the following subprograms:

CLIME

Calls the following subprograms:

ERROR

DELO

Is called by the following subprograms:

LOOPS

Calls the following subprograms:

COS SIN

DIFSNR

Is called by the following subprograms:

TROPO

Calls the following subprograms:

ABS ALOG10 AVAIL AVTER ERFC RGAIN SIGN SQRT
SUBID TGAIN

DIF1

Is called by the following subprograms:

MDIF

Calls the following subprograms:

ABS ALOG10 ATAN COS SQRT

DINT

Is called by the following subprograms:

CAKL MDTS

Calls the following subprograms:

CAC DFLOAT

EIGEN

Is called by the following subprograms:

MDTS SQTMAT

Calls the following subprograms:

ABS FLOAT SQRT

EIGV

Is called by the following subprograms:

TRC

Calls the following subprograms:

ELMES HQR ORDER PROFIL TXPULS

ELMES

Is called by the following subprograms:

EIGV MDT5

Calls the following subprograms:

DABS

ENRGF

Is called by the following subprograms:

BWJAM FUNRW FUNJAM

Calls the following subprograms:

PSPEC

ERFC

Is called by the following subprograms:

CLIMIX DIFSNR PAVERG POUTAG POWER

Calls the following subprograms:

EXP SIGN

ERLANG

Is called by the following subprograms:

BERCAL PDF POF5UM

Calls the following subprograms:

DABS DEXP

ERRIO

Is called by the following subprograms:

INDATA SECTOR UNITS

ERROR

Is called by the following subprograms:

ANTPAR ATMOS CHANGE CHKDAT CLIME CLIMIL CLIMIX DEIND
LOOPS MATA MDIF MDT5 ORDER RIPROF SIGIN SQTMT
SUMPAG TRANSF TRCIN TRLOSS UNITCV VARPOL

FCCMSK

Is called by the following subprograms:

FUNRW

Calls the following subprograms:

ALOG10 A5OFCC

FFT

Is called by the following subprograms:

SAMPLE

Calls the following subprograms:

CMPLX COS SIN

FRQSEP

Is called by the following subprograms:

LOOPS

Calls the following subprograms:

ABS COS SIN SQRT

FUNBW

Is called by the following subprograms:

RUTFIL RWJAM

Calls the following subprograms:

A50FCC ENRGF FCCMSK INTERB PSPEC

FUNJAM

Is called by the following subprograms:

RUTFIL RWJAM

Calls the following subprograms:

ALOG10 ENRGF F1 F2 PSPEC PSPJ

GPATT

Is called by the following subprograms:

RGAIN TGAJN

Calls the following subprograms:

ABS SIN

HORANG

Is called by the following subprograms:

TANGL TRANSF

Calls the following subprograms:

ASIN SIN SQRT

HQR

Is called by the following subprograms:

EIGV MCTS

Calls the following subprograms:

DABS DSIGN DSQRT

INDATA

Is called by the following subprograms:

TROPO

Calls the following subprograms:

ALOG10 AMOD ANTGEO ERR10 EXP OUTDAT SECTOR TRC
UNITCV UNITS

INTERB

Is called by the following subprograms:

FUNBW

INTERD

Is called by the following subprograms:

POUTAG TIMAUG

INTERP

Is called by the following subprograms:

AVAIL CONVOL

Calls the following subprograms:

ESTF

INTLIM

Is called by the following subprograms:

TROPO

Calls the following subprograms:

AMAX1 ANIN1 COS SIN SQRT

JAMCOM

Is called by the following subprograms:

ROTAC

Calls the following subprograms:

ACOS ATAN COS SIN SQRT TAN TSINC

LOOPS

Is called by the following subprograms:

TROPO

Calls the following subprograms:

ABS ANTPTR ASIN BEAMPT COS DELO ERROR EXP
 FROSEP RGAIN RIPROF SIN SINT SQRT STEPAB STEPY
 STPPAR TGAIN TRLOSS

LTCORR

Is called by the following subprograms:

TROPO

Calls the following subprograms:

EXP SIN SQRT

TROPO

Calls the following subprograms:

ANTPAR ATMOS BUTFIL CHKDAT DATE DIFSNR INDATA INTLIM
 LOOPS LTCORR MDIF MDTS POWER SUBID SUMPAG TIME
 TRANSF TRCIN

MATA

Is called by the following subprograms:

MDTS SOTMAT

Calls the following subprograms:

ERROR

MATCO

Is called by the following subprograms:

MDTS

Calls the following subprograms:

CAC CAJI CAKL SUBID

MDIF

Is called by the following subprograms:

TROPO

Calls the following subprograms:

ABS ALOG10 AMIN1 COS DIF1 ERROR SIN SUBID
TANGL

MDTS

Is called by the following subprograms:

TROPO

Calls the following subprograms:

ACOS AMOD BERCAL BOTAC CHANGE COS DINT DLOG10
DSIN EIGEN ELMES ERROR HQR MATA MATCO MINV
ORDER PROUT SASEQ SIGIN SINT SQTMAT SUBID XNOR

MINV

Is called by the following subprograms:

MDTS

Calls the following subprograms:

DABS

ORDER

Is called by the following subprograms:

EIGV MDTS

Calls the following subprograms:

ERROR

OUTDAT

Is called by the following subprograms:

INDATA

Calls the following subprograms:

DATE SUBID TIME

PAVERG

Is called by the following subprograms:

TRC

Calls the following subprograms:

ERFC EXP SQRT

PDF

Is called by the following subprograms:

AVG PDFSUM

Calls the following subprograms:

ERLANG

PDFCOE

Is called by the following subprograms:

TRC

Calls the following subprograms:

EXP

PDFCON

Is called by the following subprograms:

BERCAL

Calls the following subprograms:

DABS

PDFSUM

Is called by the following subprograms:

TRC

Calls the following subprograms:

ERLANG PDF

PEAK

Is called by the following subprograms:

BUTFIL

Calls the following subprograms:

ABS

POUTAG

Is called by the following subprograms:

TRC

Calls the following subprograms:

ERFC INTERD

POWER

Is called by the following subprograms:

TROPO

Calls the following subprograms:

ABS ALG10 AVTER CLIME CLIMIL CLIMIX ERFC SIGN
SQRT SUBID

PROFIL

Is called by the following subprograms:

EIGV TIMPAR VARW

Calls the following subprograms:

EXP

PROUT

Is called by the following subprograms:

MDTS

Calls the following subprograms:

SUBID

PSINE

Is called by the following subprograms:

SINT

Calls the following subprograms:

DSIN F1 F2

PSPEC

Is called by the following subprograms:

A50FCC ENRGF FUNBW FUNJAM PSPEC1 PSPEC2 PSPJ

Calls the following subprograms:
SIN

PSPEC1

Is called by the following subprograms:
BUTFIL

Calls the following subprograms:
CMPLX PSPEC

PSPEC2

Is called by the following subprograms:
BUTFIL

Calls the following subprograms:
CMPLX PSPEC PSPJ

PSPJ

Is called by the following subprograms:
FUNJAM PSPEC2

Calls the following subprograms:
EXP PSPEC SORT

PWRSPC

Is called by the following subprograms:
RJCFN

Calls the following subprograms:
TPSPEC TPSPJ

P2INT

Is called by the following subprograms:
TIMPAR VARW

Calls the following subprograms:
TXPULS

RGAIN

Is called by the following subprograms:
DIFSNR LOOPS

Calls the following subprograms:
GPATT

RIPROF

Is called by the following subprograms:
LOOPS

Calls the following subprograms:
ERROR

RJCFN

Is called by the following subprograms:
ROTAC

Calls the following subprograms:
COS PWRSPC

RTMI

Is called by the following subprograms:

BWJAM SEARCH

Calls the following subprograms:

ABS SIGN

SAMPLE

Is called by the following subprograms:

BUTFIL

Calls the following subprograms:

FFT REAL

BASEQ

Is called by the following subprograms:

MDTS TRCIN

Calls the following subprograms:

MOD

SEARCH

Is called by the following subprograms:

BWJAM

Calls the following subprograms:

RTMI SIN

SECTOR

Is called by the following subprograms:

INDATA

Calls the following subprograms:

ERRIO

SIGIN

Is called by the following subprograms:

MDTS

Calls the following subprograms:

ERROR EXP

SIM

Is called by the following subprograms:

SUMFAG

Calls the following subprograms:

ALOG10 IABS SQRT SUBID

SINC

Is called by the following subprograms:

CAC TSINC

Calls the following subprograms:

ABS SIN

SINT

Is called by the following subprograms:

LOOPS MDT5

Calls the following subprograms:

IABS PSINE SUBID

SPEC

Is called by the following subprograms:

SPEC1 SPEC2

Calls the following subprograms:

CMPLX COS SIN

SPEC1

Is called by the following subprograms:

BUTFIL

Calls the following subprograms:

SPEC

SPEC2

Is called by the following subprograms:

BUTFIL

Calls the following subprograms:

SPEC

SQTMAT

Is called by the following subprograms:

MDTS

Calls the following subprograms:

CHANGE EIGEN ERROR MATA SQRT

STEPAB

Is called by the following subprograms:

LOOPS

STEPY

Is called by the following subprograms:

LOOPS

Calls the following subprograms:

SQRT

STPPAR

Is called by the following subprograms:

LOOPS

Calls the following subprograms:

ABS AMIN1 SQRT

SURID

Is called by the following subprograms:

AVAIL BERCAL BOTAC BUTFIL CLIFIT CLIMIX DIFSNR TROPO
MATCO MDIF MDT5 OUTDAT POWER PROUT SIM SINT
TRC TRCIN

- Used but not changed in the following subprograms:
INTLIM STPPAR

256) /RZ/ R*8 RZ.INC
Signal response after PN sequence correlation.
- Possibly given a new value in the following subprograms:
SINT
- Used but not changed in the following subprograms:
CAC CAJI

256) /RZ4/ R*4 RZ4.INC
Impulse response of cascade of transmitter and receiver filters, and cascade of interferer and receiver filters.
-- Not used --

256) /RZ4/ R*4 RZ4.INC
Autocorrelation of receiver filter.
-- Not used --

MIN /NUMPAR/ R*4 NUMPAR.INC
Ratio of smallest to largest eigenvalue in AN/TRC-170 performance calculations.
- Used but not changed in the following subprograms:
TRC

ANG(10) /MCOM4/ R*4 MCOM.INC
Interferer elevation angles in degrees. Default is 0.
- Possibly given a new value in the following subprograms:
INDATA
- Used but not changed in the following subprograms:
JANCOM MDTS OUTDAT

MEAN /ANSWER/ R*4 ANSWER.INC
Average received energy.
- Possibly given a new value in the following subprograms:
EIGV
- Used but not changed in the following subprograms:
TRC

VAR /ANSWER/ R*4 ANSWER.INC
Variance of received energy.
- Possibly given a new value in the following subprograms:
EIGV
/CONTRL/ L*4 TROCOM.INC
End of TROPO.DAT file found if TRUE.
- Possibly given a new value in the following subprograms:
INDATA
- Used but not changed in the following subprograms:
MAIN

RAC /PROFAR/ R*4 TROCOM.INC
Yearly median value of effective earth radius factor k in kilometers. Default is 1.33.
- Possibly given a new value in the following subprograms:
INDATA MAIN
- Used but not changed in the following subprograms:
OUTDAT POWER SUMPAG TRANSF

.T OUTDAT POWER SUMPAG TRANSF
 /PATHGE/ R*4 TROCOM.INC
 Distance from transmitter to radio horizon in meters.
 - Possibly given a new value in the following subprograms:
 INDATA UNITCV
 - Used but not changed in the following subprograms:
 OUTDAT POWER SUMPAG TRANSF
 R /PATHGE/ R*4 TROCOM.INC
 Receiver distance to minimum scattering point in
 meters.
 - Possibly given a new value in the following subprograms:
 TRANSF UNITCV
 - Used but not changed in the following subprograms:
 INTLIM STPPAR
 RATE /MCOM4/ R*4 MCOM.INC
 Data rate in bits/second. Default is 6.6E6.
 - Possibly given a new value in the following subprograms:
 INDATA
 - Used but not changed in the following subprograms:
 CAC DIFSNR DINT JAMCOM MAIN MDT5 OUTDAT POWER
 SIGIN
 S(3) /MCOM4/ R*4 MCOM.INC
 Array of effective obstacle extents along the great
 circle path in meters.
 - Possibly given a new value in the following subprograms:
 INDATA UNITCV
 - Used but not changed in the following subprograms:
 MAIN OUTDAT
 SF1(3) /SUMP/ R*4 CURVE.INC
 Lower beam troposcatter signal RMS delay spread in
 nanoseconds for percentiles 50, 90 and 99.
 - Possibly given a new value in the following subprograms:
 POWER
 SF2(3) /SUMP/ R*4 CURVE.INC
 Upper beam troposcatter signal RMS delay spread in
 nanoseconds for percentiles 50, 90 and 99.
 - Possibly given a new value in the following subprograms:
 POWER
 STSNR /SUMP/ R*4 CURVE.INC
 Standard deviation of diffracted signal long-term SNR
 distribution in dB.
 - Possibly given a new value in the following subprograms:
 DIFSNR
 - Used but not changed in the following subprograms:
 MDT5 SUMPAG
 T /PATHGE/ R*4 TROCOM.INC
 Transmit antenna distance to minimum scattering point
 in meters.
 - Possibly given a new value in the following subprograms:
 TRANSF UNITCV

variability curve, Y0(90).

- Possibly given a new value in the following subprograms:

CLIMIL INDATA

- Used but not changed in the following subprograms:

CLIFIT CLIME OUTDAT

IFLOS(3) /SUMP/ R*4 CURVE.INC

Median diffraction path loss in dB for each value in ERFAC distribution.

- Possibly given a new value in the following subprograms:

DIFSNR

- Used but not changed in the following subprograms:

SUMPAG

IFRSL(3) /SUMP/ R*4 CURVE.INC

Median diffraction signal RSL in dBm for each value in ERFAC distribution.

- Possibly given a new value in the following subprograms:

DIFSNR

- Used but not changed in the following subprograms:

SUMPAG

IVIMP /ANSWER/ R*4 ANSWER.INC

Ratio of square of mean signal energy to variance for AN/TRC-170.

- Possibly given a new value in the following subprograms:

EIGV

IVTYP /MCOM2/ I*2 MCOM.INC

Diversity configuration indicator. Default is 0.

0 = 2 receive antennas; 2S 2S/2F 2S/2A 2S/2A/2F

1 = 1 receive antenna; 2A 2F 2F/2A

2 = 2 transmit,

2 receive antennas; 2S/2P 2S/2P/2A

3 = Not used

4 = User supplied parameters

S = Space F = Frequency A = Angle P = Polarization

- Possibly given a new value in the following subprograms:

INDATA

- Used but not changed in the following subprograms:

ANTGEO BERCAL CAC LTCORR MATCO MDTS OUTDAT POWER
SIM SUMPAG

IL(3) /MCOM4/ R*4 MCOM.INC

Array containing distance from each obstacle to transmitter in meters.

- Possibly given a new value in the following subprograms:

INDATA UNITCV

- Used but not changed in the following subprograms:

DIFSNR MAIN OUTDAT

ILR /PATHGE/ R*4 TROCOM.INC

Distance from receiver to radio horizon in meters.

- Possibly given a new value in the following subprograms:

INDATA UNITCV

- Used but not changed in the following subprograms:

DEG /UNIT/ R*4 IODATA.INC
String 'deg' for units output.
- Used but not changed in the following subprograms:
 OUTDAT UNITS

DEL /SUMP/ R*4 CURVE.INC
Diffraction path delay relative to a straight line
path in seconds.
- Used but not changed in the following subprograms:
 MAIN MDT5 SUMPAG

DELH /PROPAR/ R*4 TROCOM.INC
Spacing of CN2 samples in meters.
- Possibly given a new value in the following subprograms:
 INDATA UNITCV
- Used but not changed in the following subprograms:
 OUTDAT RIPROF

DELPB /PDATA/ R*4 PDATA.INC
Resolution of a delay cell in seconds.
- Possibly given a new value in the following subprograms:
 LOOPS
- Used but not changed in the following subprograms:
 MAIN MDIF POWER SIM SUMPAG

DELPBZ /RZ1/ R*4
Resolution of a delay cell in seconds. Same as DELPB
in /PDATA/.
- Possibly given a new value in the following subprograms:
 MAIN
- Used but not changed in the following subprograms:
 CAC DINT

DELREF /PDATA/ R*4 PDATA.INC
Minimum delay through the lowest scattering point
(relative to straight line delay) in seconds.
- Possibly given a new value in the following subprograms:
 MDIF
- Used but not changed in the following subprograms:
 LOOPS POWER

DELTAR(NRMX) /ANTENN/ R*4 TROCOM.INC
3dB half-beamwidth of each receive antenna in radians.
- Possibly given a new value in the following subprograms:
 MAIN
- Used but not changed in the following subprograms:
 INTLIM POWER STPPAR TRANSF TRLOSS

DELTAT(NTMX) /ANTENN/ R*4 TROCOM.INC
3dB half-beamwidth of each transmit antenna in
radians.
- Possibly given a new value in the following subprograms:
 MAIN
- Used but not changed in the following subprograms:
 INTLIM POWER STPPAR TRANSF TRLOSS

DEMIN /CURVE/ R*4 CURVE.INC
User supplied minima of the 90th percentile

- Used but not changed in the following subprograms:
 OUTDAT RIPROF

CODE /MCOM4/ L*4 MCOM.INC
 Flag for coding.

- Possibly given a new value in the following subprograms:
 INDATA

- Used but not changed in the following subprograms:
 MDTS

COEFF /ANSWER/ R*8 ANSWER.INC
 Partial fraction expansion coefficients for
 calculation of AN/TRC-170 outage probability.

- Used but not changed in the following subprograms:
 AVG TRC

CONJAM /JAMPAR/ R*4 JAMPAR.INC
 Interference constant.

- Possibly given a new value in the following subprograms:
 BUTFIL BWJAM

- Used but not changed in the following subprograms:
 FUNJAM

CORRLT /CPLOSS/ R*4 CPL.INC
 Correlation coefficient for long term variability of
 lower and upper beams.

- Possibly given a new value in the following subprograms:
 LTCORR

- Used but not changed in the following subprograms:
 POWER

CPL(6) /CPLOSS/ R*4 CPL.INC
 Aperture-to-medium coupling loss array in dB.

- Possibly given a new value in the following subprograms:
 TRILOSS

- Used but not changed in the following subprograms:
 POWER

D /PATHGE/ R*4 TROCOM.INC
 Great circle distance between transmitter and receiver
 measured at sea level in meters.

- Possibly given a new value in the following subprograms:
 INDATA UNITCV

- Used but not changed in the following subprograms:
 ATMOS DIFSNR INTLIM LOOPS LTCORR MAIN OUTDAT POWER
 SUMPAG TRANSF TRILOSS

DALT /RZ4/ R*4 RZ4.INC
 Sampling interval.
 -- Not used --

DE /SUMP/ R*4 CURVE.INC
 Effective distance for troposcatter path in
 kilometers.

- Possibly given a new value in the following subprograms:
 POWER

- Used but not changed in the following subprograms:
 SUMPAG

normalized to signaling interval duration.

- Possibly given a new value in the following subprograms:
TRCIN

- Used but not changed in the following subprograms:

TRC TXPULS

CE3 /CONSTA/ R*4 CONSTANTS.INC

1 X 10**3 = 1000.

- Used but not changed in the following subprograms:

UNITCV

CHGHR /IOWATA/ L*4 IOWATA.INC

HR set to AR(1) if TRUE.

- Possibly given a new value in the following subprograms:

INDATA

- Used but not changed in the following subprograms:

OUTDAT

CHGPRE /IOWATA/ L*4 IOWATA.INC

HRE set to HR if TRUE.

- Possibly given a new value in the following subprograms:

INDATA

- Used but not changed in the following subprograms:

OUTDAT

CHGHT /IOWATA/ L*4 IOWATA.INC

HT set to AT(1) if TRUE.

- Possibly given a new value in the following subprograms:

INDATA

- Used but not changed in the following subprograms:

OUTDAT

CHGHTTE /IOWATA/ L*4 IOWATA.INC

HTE set to HT if TRUE.

- Possibly given a new value in the following subprograms:

INDATA

- Used but not changed in the following subprograms:

OUTDAT

CHTPFT /CONSTA/ R*4 CONSTANTS.INC

Meters per foot = 0.3048.

- Used but not changed in the following subprograms:

ANTGEO INDATA UNITCV

CHTPMI /CONSTA/ R*4 CONSTANTS.INC

Meters per statute mile = 1609.344

- Used but not changed in the following subprograms:

UNITCV

CHTPNM /CONSTA/ R*4 CONSTANTS.INC

Meters per nautical mile = 1852.

- Used but not changed in the following subprograms:

UNITCV

CN2(NPROF) /PROPAR/ R*4 TROCOM.INC

The atmospheric structure constant height profile in meters to the -2/3 power.

- Possibly given a new value in the following subprograms:

INDATA

BER(3) /ERAD/ R*4 ERAD.INC
 Bit error rate thresholds of interest. Set to 1E-3,
 1E-4 and 1E-5 in data statement.
 - Used but not changed in the following subprograms:
 BERCAL PROUT SUMPAG

BETA0 /PATHGE/ R*4 TROCOM.INC
 Minimum receive antenna elevation angle measured from
 receiver-to-transmitter line to receiver horizon line
 in radians.
 - Possibly given a new value in the following subprograms:
 TRANSF UNITCV
 - Used but not changed in the following subprograms:
 INTLIM LOOPS POWER SUMPAG TRLOSS

BETA1 /PATHGE/ R*4 TROCOM.INC
 Maximum receive antenna elevation angle measured from
 receiver-to-transmitter line to top of common volume
 in radians.
 - Possibly given a new value in the following subprograms:
 INTLIM UNITCV
 - Used but not changed in the following subprograms:
 LOOPS

BOU TL(3,4) /ERAD/ R*4 ERAD.INC
 Cumulative outage probability for each diversity
 configuration and error rate threshold (averaged
 over multipath distribution, if any).
 - Possibly given a new value in the following subprograms:
 PROUT

BW /SYSTRN/ R*4 TROCOM.INC
 Bandwidth in Hertz. Default is 7 MHz.
 - Possibly given a new value in the following subprograms:
 INDATA
 - Used but not changed in the following subprograms:
 JAMCOM LOOPS MAIN OUTDAT POWER SUMPAG

C /PDATA/ R*4 PDATA.INC
 Proportionality constant in troposcatter path loss
 calculation.
 - Possibly given a new value in the following subprograms:
 LOOPS
 - Used but not changed in the following subprograms:
 POWER SUMPAG

CO /CONSTA/ R*4 CONSTANTS.INC
 Free space velocity of radio waves = 2.998E8 m/sec.
 - Used but not changed in the following subprograms:
 INDATA LOOPS MDIF POWER

CDEGR /CONSTA/ R*4 CONSTANTS.INC
 Radians per degree = 0.017453293.
 - Used but not changed in the following subprograms:
 DIFSNR UNITCV

CDUR /SYSPAR/ R*4 SYSPAR.INC
 Duration of transmitted pulse for AN/TRC-170

MDTS
 - Used but not changed in the following subprograms:
 BERCAL

AR(NRMX) /ANTENN/ R*4 TROCOM.INC
 Array of receiver antenna diameters in meters. AR(1)
 is equivalent to RDIAM in the input file.
 - Possibly given a new value in the following subprograms:
 ANTGED INDATA UNITCV
 - Used but not changed in the following subprograms:
 ANTPAR CHKDAT LOOPS OUTDAT RGAIN SUMPAG

ASNR /SYSPAR/ R*4 SYSPAR.INC
 Yearly median value of troposcatter short-term average
 SNR, ie, Eb/No, in dB.
 - Possibly given a new value in the following subprograms:
 TRCIN
 - Used but not changed in the following subprograms:
 TRC

AT(NTMX) /ANTENN/ R*4 TROCOM.INC
 Array of transmitter antenna diameters in meters.
 AT(1) is equivalent to TDIAM in the input file.
 - Possibly given a new value in the following subprograms:
 ANTGED INDATA UNITCV
 - Used but not changed in the following subprograms:
 ANTPAR CHKDAT OUTDAT SUMPAG TGAİN

ATTEN /MCOM4/ R*4 MCOM.INC
 Ratio of interferer signal amplitude on antenna
 2 to that at antenna 1. Set to 1 internally.
 - Used but not changed in the following subprograms:
 JAMCOM

AVERX /MCOM4/ R*4 MCOM.INC
 Average terrain elevation above sea level between
 receive site and radio horizon, in meters.
 - Possibly given a new value in the following subprograms:
 DIFSNR INDATA POWER UNITCV
 - Used but not changed in the following subprograms:
 OUTDAT

AVETX /MCOM4/ R*4 MCOM.INC
 Average terrain elevation above sea level between
 transmit site and radio horizon, in meters.
 - Possibly given a new value in the following subprograms:
 DIFSNR INDATA POWER UNITCV
 - Used but not changed in the following subprograms:
 OUTDAT

BEAM /STPCOM/ R*4 STPCOM.INC
 Parameter for determining azimuth and elevation angle
 step size in common volume integration.
 - Possibly given a new value in the following subprograms:
 STPPAR
 - Used but not changed in the following subprograms:
 STEPAB

GLOBAL VARIABLE DICTIONARY

C.1 Global Variable Dictionary

A /PATHGE/ R*4 TROCOM.INC
Effective earth radius in meters.
- Possibly given a new value in the following subprograms:
 INDATA JAMCOM
- Used but not changed in the following subprograms:
 INTLIM LOOPS LTCORR MAIN TRANSF

AO /CONSTA/ R*4 CONSTANTS.INC
Radius of the earth in meters = 6367650.
- Used but not changed in the following subprograms:
 INDATA MDIF TRANSF

AA /PROPAR/ R*4 TROCOM.INC
Atmospheric absorption loss in dB.
- Possibly given a new value in the following subprograms:
 ATMOS
- Used but not changed in the following subprograms:
 MAIN POWER SUMPAG

ABEL(4) /ERAD/ R*4 ERAD.INC
Cumulative block error probability for each diversity
configuration as specified by DIVTYP (averaged over
multipath distribution, if any).
- Possibly given a new value in the following subprograms:
 PROUT

ACALC /IOWATA/ L*4 IOWATA.INC
TRUE if the angles PSITE0 and PSIRE0 are calculated
rather than read in.
- Possibly given a new value in the following subprograms:
 INDATA
- Used but not changed in the following subprograms:
 ANTGEO OUTDAT

ALFA0 /PATHGE/ R*4 TROCOM.INC
Minimum transmit antenna elevation angle measured from
transmitter-to-receiver line to transmit horizon line
in radians.
- Possibly given a new value in the following subprograms:
 TRANSF UNITCV
- Used but not changed in the following subprograms:
 INTLIM LOOPS LTCORR POWER SUMPAG TRLOSS

ALFA1 /PATHGE/ R*4 TROCOM.INC
Maximum transmit antenna elevation angle measured from
transmitter-to-receiver line to top of common volume
in radians.
- Possibly given a new value in the following subprograms:
 INTLIM UNITCV
- Used but not changed in the following subprograms:
 LOOPS

APOW /MCOM4/ R*4 MCOM.INC
Angle diversity squint loss as a ratio.
- Possibly given a new value in the following subprograms:

IBM version has been preprocessed to do the including of these files that the PDP compiler will do automatically.

The description gives the definition of the variable as well as the maximum, default value, and units where appropriate. In the case of flags all possible legal values are described. Note, the units listed are those used in TROPO for calculations and not necessarily those used for input or output.

The last two sections describe where the variable is given a new value and where it is otherwise used. These sets are mutually exclusive. A subprogram is included in the first list if the variable is used in one or more of the following:

- 1) on the left side of an arithmetic assignment
- 2) data statement
- 3) parameter statement (meaningful only in PDP version)
- 4) READ or ACCEPT statement

In addition, it may be used in one or both of the following ways, but it MUST have been used in at least one of the above. On the other hand, a subprogram is included in the second list if it is not used in one of the above but is used in one of the following:

- 1) on the right side of an arithmetic assignment
- 2) WRITE or TYPE statement

Both lists were generated by a DECUS (Digital Equipment Corporation User's Group) supplied program. Its limitations are that neither list includes:

- 1) use as arguments in subprogram calls
- 2) use in any statement when the variable is equivalenced to a common variable. The variables in common /RZ4/ are an example of this.
- 3) in the case of parameters, use as a dimension of an array.

For these reasons, some variables are listed as 'Not used'. They are actually used in one or more of the limitations just listed. Additionally, any variable apparently not set in any routine has either been used as an argument or has been set in the block data section (file DATAINIT.FTN).

APPENDIX C

GLOBAL VARIABLE DICTIONARY

The dictionary describes all variables in common. Each description is of the form:

```
<variable name> /<common name>/      type   <include file>
      Description.
      - Possibly given a new value in the following subprograms:
        (List of subprograms)
      - Used but not changed in the following subprograms:
        (List of subprograms)
```

The name is the common variable or parameter name. If the variable is a matrix, the name is followed by dimensions. In some cases these dimensions are parameters. When the PDP compiler finds such a variable in the code it replaces the parameters with their actual numeric values (as given in the file TROPAR.INC). For the IBM version, the code has already been preprocessed by SIGNATRON to use the numeric values so the actual commons will not show the parameters as dimensions but their values.

The common name is the name of the common the variable is contained in. For parameters, the word 'Parameter' is in this spot since these are not in a common.

The type, for variables and parameters, is given as three characters:

L*1	1 byte LOGICAL (BYTE in the PDP version)
L*4	4 byte LOGICAL
I*2	2 byte INTEGER
I*4	4 byte INTEGER
R*4	4 byte REAL
R*8	8 byte REAL
C*8	8 byte COMPLEX

The include file name is only meaningful to the PDP users. It is the name of the file containing the common with the variable being described. Again, the

CLIMIX

Calls the following subprograms:

ERROR EXP F1 F2 SORT

VARW

Is called by the following subprograms:

TRC

Calls the following subprograms:

PROFIL P2INT

VDECAL

Is called by the following subprograms:

CLIMIL

Calls the following subprograms:

EXP F2

XNOR

Is called by the following subprograms:

BERCAL MDTS TRC

Calls the following subprograms:

DABS DEXP DSORT

YINT

Is called by the following subprograms:

CLIME

Is called by the following subprograms:

TROPO

Calls the following subprograms:

ABS ASIN ATAN COS ERROR HORANG SIN SQRT

TRC

Is called by the following subprograms:

INDATA TRCIN

Calls the following subprograms:

ABS ALOG10 AVG EIGV PAVERG PDFCOE PDFSUM POUTAG
SQRT SUBID TIMAVG TIMEQL TIMPAR VARW XNOR

TRCIN

Is called by the following subprograms:

TROPO

Calls the following subprograms:

ALOG10 ERROR SASEQ SUBID TRC

TRLOSS

Is called by the following subprograms:

LOOPS

Calls the following subprograms:

ABS ALOG10 AMAX1 ERROR

TSINC

Is called by the following subprograms:

ROTAC JAMCOM

Calls the following subprograms:

DABS SINC

TXPULS

Is called by the following subprograms:

EIGV P2INT

Calls the following subprograms:

SQRT

UNITCV

Is called by the following subprograms:

INDATA SUMPAG

Calls the following subprograms:

ERROR

UNITS

Is called by the following subprograms:

INDATA

Calls the following subprograms:

AMOD ERRID

VARPOL

Is called by the following subprograms:

SUMPAG

Is called by the following subprograms:

TROPO

Calls the following subprograms:

ABS ALOG10 ANTPTR ERROR SIM UNITCV

TANGL

Is called by the following subprograms:

MDIF

Calls the following subprograms:

ABS ASIN COS HORANG SIN SQRT

TGAIN

Is called by the following subprograms:

DIFSNR LOOPS

Calls the following subprograms:

GPATT

TIMAVG

Is called by the following subprograms:

TRC

Calls the following subprograms:

EXP INTERD

TIMEQL

Is called by the following subprograms:

TRC

Calls the following subprograms:

ABS TIMPAR

TIMPAR

Is called by the following subprograms:

TIMEQL TRC

Calls the following subprograms:

PROFIL P2INT

TPSPEC

Is called by the following subprograms:

PWRSPC TPSPJ

Calls the following subprograms:

SIN

TPSPJ

Is called by the following subprograms:

PWRSPC

Calls the following subprograms:

EXP SQRT TPSPEC

TRANSF

ERR /CONTROL/ R*4 TROCOM.INC
Common volume integration resolution. Default is .001.
- Possibly given a new value in the following subprograms:
 INDATA
- Used but not changed in the following subprograms:
 INTLIM LOOPS OUTDAT STPPAR SUMPAG

F /SYSTRN/ R*4 TROCOM.INC
Operating frequency in Hz. Model is accurate between
100MHz and 10GHz.
- Possibly given a new value in the following subprograms:
 INDATA UNITCV
- Used but not changed in the following subprograms:
 ANTGEO ATMOS DIFSNR MAIN OUTDAT POWER SUMPAG

F50L /BUTPAR/ R*4 BUTPAR.INC
50dB normalized corner frequency.
- Possibly given a new value in the following subprograms:
 FUNBW
- Used but not changed in the following subprograms:
 FCCMSK

FCJ /JAMPAR/ R*4 JAMPAR.INC
Normalized 3dB cut-off frequency of QPSK interference
filter.
- Possibly given a new value in the following subprograms:
 BWJAM
- Used but not changed in the following subprograms:
 PSPJ TPSPJ

FCON /BUTPAR/ R*4 BUTPAR.INC
Ratio of bandwidth to twice the symbol rate.
- Possibly given a new value in the following subprograms:
 BUTFIL BWJAM
- Used but not changed in the following subprograms:
 FUNBW

FCRX /BUTPAR/ R*4 BUTPAR.INC
Normalized 3dB cut-off frequency of receiver filter.
- Possibly given a new value in the following subprograms:
 BUTFIL BWJAM INDATA
- Used but not changed in the following subprograms:
 PSPEC1 PSPEC2 PWRSPC RJCFCN SPEC1

FCTX /BUTPAR/ R*4 BUTPAR.INC
Normalized 3dB cut-off frequency of transmitter
filter.
- Possibly given a new value in the following subprograms:
 BUTFIL FUNBW INDATA
- Used but not changed in the following subprograms:
 A50FCC BWJAM PSPJ SPEC1 SPEC2 TPSPJ

FILLER(88) /RZ4/ R*4 RZ4.INC
Dummy array to align commons.
-- Not used --

FJSEPN /JAMPAR/ R*4 JAMPAR.INC
Normalized frequency separation between the

interference signal and the desired signal.
 - Possibly given a new value in the following subprograms:
 BUTFIL RJCFN
 - Used but not changed in the following subprograms:
 FUNJAM PSPEC2 PWRSPC

FMI /JAMPAR/ R*4 JAMPAR.INC
 Modulation index for FDM/FM interference.
 - Possibly given a new value in the following subprograms:
 BWJAM
 - Used but not changed in the following subprograms:
 PSPJ TPSPJ

FOUTL(3,4) /ERAD/ R*4 ERAD.INC
 Cumulative fade outage per call minute for each
 diversity configuration and error rate threshold
 (averaged over multipath distribution, if any).
 - Possibly given a new value in the following subprograms:
 PROUT

FSEP /PDATA/ R*4 PDATA.INC
 Frequency separation for uncorrelated frequency
 diversity in Hz.
 - Possibly given a new value in the following subprograms:
 LOOPS
 - Used but not changed in the following subprograms:
 SUMPAG

FT /UNIT/ R*4 IODATA.INC
 String 'ft ' for units output.
 - Used but not changed in the following subprograms:
 OUTDAT UNITS

GHZ /UNIT/ R*4 IODATA.INC
 String 'GHz ' for units output.
 - Used but not changed in the following subprograms:
 INDATA OUTDAT UNITS

GPF /CURVE/ R*4 CURVE.INC
 Frequency correction factor for user supplied 90th
 percentile variability curve. Default is 1.
 - Possibly given a new value in the following subprograms:
 INDATA
 - Used but not changed in the following subprograms:
 CLIME

GRDB(NRXX) /ANTENN/ R*4 TROCOM.INC
 Gain of each receive antenna in dBi.
 - Possibly given a new value in the following subprograms:
 MAIN
 - Used but not changed in the following subprograms:
 DIFSNR POWER SUMPAG

GTDB(NTMX) /ANTENN/ R*4 TROCOM.INC
 Gain of each transmit antenna in dBi.
 - Possibly given a new value in the following subprograms:
 MAIN
 - Used but not changed in the following subprograms:

DIFSNR POWER SUMPAG
 HCOM /PATHGE/ R*4 TROCOM.INC
 Effective height of the bottom of the common volume in meters.
 - Possibly given a new value in the following subprograms:
 LOOPS TRANSF UNITCV
 - Used but not changed in the following subprograms:
 LTCORR SUMPAG

HHIGH /PATHGE/ R*4 TROCOM.INC
 Effective height of the top of the common volume in meters.
 - Possibly given a new value in the following subprograms:
 INTLIM UNITCV
 - Used but not changed in the following subprograms:
 SUMPAG

HI(155) /MCOM4/ R*4 MCOM.INC
 Array contains NPM(1) evenly-spaced terrain elevation data (in meters) between transmitter and first obstacle followed by NPM(2) evenly-spaced terrain elevation data between first and second obstacle, etc., ending with NPM(NOBS+1) evenly-spaced terrain elevation data between last obstacle and receive site. The data should be selected such that:
 HI(1) = Terrain elevation above sea level at transmit site (HT0).
 HI(NPM(I)) = HI(NPM(I)+1) = Elevation of Ith obstacle above sea level (HL(I)).
 HI(NPM(NOBS+1)) = Terrain elevation above sea level at receive site (HR0).
 In MDTS, HI is used as work space. It is equivalenced to local arrays.
 - Possibly given a new value in the following subprograms:
 INDATA UNITCV
 - Used but not changed in the following subprograms:
 DIFSNR OUTDAT POWER

HL(3) /MCOM4/ R*4 MCOM.INC
 Array contains elevation of each obstacle above sea level in meters. HL(1) is elevation of transmitter radio horizon HLT. HL(NOBS) is elevation of receiver radio horizon HLR.
 - Possibly given a new value in the following subprograms:
 INDATA UNITCV
 - Used but not changed in the following subprograms:
 DIFSNR MAIN OUTDAT

HLAV(3) /MCOM4/ R*4 MCOM.INC
 Array contains average terrain elevation at each diffraction point in meters.
 - Possibly given a new value in the following subprograms:
 INDATA UNITCV
 - Used but not changed in the following subprograms:

HLEF(3) DIFSNR OUTDAT
 /MCOM4/ R*4 MCOM.INC
 Array contains effective height of obstacles above
 average terrain elevation in meters.
 - Possibly given a new value in the following subprograms:
 INDATA UNITCV
 - Used but not changed in the following subprograms:
 DIFSNR OUTDAT

HLOW /PROPAR/ R*4 TROCOM.INC
 Lowest height above sea level at which CN2 is
 specified in meters.
 - Possibly given a new value in the following subprograms:
 INDATA UNITCV
 - Used but not changed in the following subprograms:
 LOOPS OUTDAT

HLR /PATHGE/ R*4 TROCOM.INC
 Receiver radio horizon elevation above sea level in
 meters.
 - Possibly given a new value in the following subprograms:
 INDATA TRANSF UNITCV
 - Used but not changed in the following subprograms:
 OUTDAT SUMPAG

HLT /PATHGE/ R*4 TROCOM.INC
 Transmit radio horizon elevation above sea level in
 meters.
 - Possibly given a new value in the following subprograms:
 INDATA TRANSF UNITCV
 - Used but not changed in the following subprograms:
 OUTDAT SUMPAG

HRE /MCOM4/ R*4 MCOM.INC
 Effective receiver antenna height above average
 terrain elevation in meters.
 - Possibly given a new value in the following subprograms:
 INDATA POWER UNITCV
 - Used but not changed in the following subprograms:
 DIFSNR

HRN /PATHGE/ R*4 TROCOM.INC
 Receive antenna height above sea level in meters.
 - Possibly given a new value in the following subprograms:
 INDATA TRANSF UNITCV
 - Used but not changed in the following subprograms:
 DIFSNR INTLIM JAMCOM LTCORR MAIN OUTDAT POWER SUMPAG

HTE /MCOM4/ R*4 MCOM.INC
 Effective transmitter antenna height above average
 terrain elevation in meters.
 - Possibly given a new value in the following subprograms:
 INDATA POWER UNITCV
 - Used but not changed in the following subprograms:
 DIFSNR OUTDAT

HTN /PATHGE/ R*4 TROCOM.INC

Transmit antenna height above sea level in meters.
 - Possibly given a new value in the following subprograms:
 INDATA TRANSF UNITCV

- Used but not changed in the following subprograms:
 DIFSNR INTLIM LOOPS MAIN OUTDAT POWER SUMPAG

I1CORR(NCORMX) /PDATA/ I#2 PDATA.INC
 Array of receiving beams involved in the correlation calculations.
 - Possibly given a new value in the following subprograms:
 LOOPS
 - Used but not changed in the following subprograms:
 SIM SUMPAG

I2CORR(NCORMX) /PDATA/ I#2 PDATA.INC
 Array of receiving beams involved in the correlation calculations.
 - Possibly given a new value in the following subprograms:
 LOOPS
 - Used but not changed in the following subprograms:
 SIM SUMPAG

IBLOSS(6) /CPLOSS/ I#2 CFL.INC
 Beam number corresponding to CPL(I).
 - Possibly given a new value in the following subprograms:
 LOOPS
 - Used but not changed in the following subprograms:
 POWER

IBR(NRMX,NRMX) /SYSTRN/ I#2 TROCOM.INC
 Channel complex-envelope correlation and cross-correlation calculation indicator array.
 0 = No calculation
 1 = Power (correlation) calculation only
 2 = Power (correlation) per unit delay spectrum calculation
 - Possibly given a new value in the following subprograms:
 ANTGED INDATA
 - Used but not changed in the following subprograms:
 CHKDAT LOOPS OUTDAT STPPAR SUMPAG

IBW /MCOM2/ I#2 MCOM.INC
 Switch indicating type of RF bandwidth constraint to be used on desired signal. Default is 0.
 0 = No RF filtering
 1 = Filter determined from 99% bandwidth constraint
 2 = Filter chosen to meet FCC Mask. (FCC-19311)
 3 = Filters are user specified
 - Possibly given a new value in the following subprograms:
 INDATA
 - Used but not changed in the following subprograms:
 BOTAC MAIN MDTS OUTDAT SIGIN

ICHIP(30) /SYSPAR/ I#2 SYSPAR.INC
 PN sequence for spectrum spreading when the data rate is much smaller than the bandwidth.

- Possibly given a new value in the following subprograms:
TRCIN

- Used but not changed in the following subprograms:
TRC TXPULS

ICLIME /MCOM2/ I*2 MCOM.INC
Climate class. Default is 0.
0 = NBS TN-101 climate
1 = MIL-HDBK-417 climate
2 = New, user-supplied climate

- Possibly given a new value in the following subprograms:
INDATA

- Used but not changed in the following subprograms:
OUTDAT SUMPAG

ICON /BUTPAR/ I*2 BUTPAR.INC
1 = 99% bandwidth constraint
2 = FCC-13911 bandwidth constraint

- Possibly given a new value in the following subprograms:
BUTFIL BWJAM

- Used but not changed in the following subprograms:
FUNRW

ICORR /MCOM2/ I*2 MCOM.INC
Multipath profile correlation indicator. Default
is 2.
0 = Profile of the form $X \exp(-AX)$ -- used for
debussings
1 = Computed multipath profile; no beam correlation
2 = Computed multipath profile; beam correlation.

- Used but not changed in the following subprograms:
CAC DINT MDTS SIGIN

ICPL /CPLOSS/ I*2 CPL.INC
Coupling loss count.

- Possibly given a new value in the following subprograms:
LOOPS

- Used but not changed in the following subprograms:
POWER TRILOSS

IDM /UNIT/ I*2 IODATA.INC
0 if degrees, 1 if milliradians.

- Possibly given a new value in the following subprograms:
UNITS

- Used but not changed in the following subprograms:
UNITCV

IFILE /MCOM2/ I*2 MCOM.INC
Pointer to multipath profile.

- Possibly given a new value in the following subprograms:
MATCO MDTS

- Used but not changed in the following subprograms:
CAC

IFILRX /BUTPAR/ I*2 BUTPAR.INC
Receiver filter indicator.
0 = MD-918 receiver filter. Also means

filter is a Butterworth cascaded with a rectangular impulse response filter of duration equal to symbol duration.

1 = (not allowed)
 2 = AN/TRC-170 receiver filter. Also means filter is a Butterworth.

- Possibly given a new value in the following subprograms:
 BUTFIL INDATA

- Used but not changed in the following subprograms:
 FUNJAM PSPEC1 PSPEC2 PWRSPC SPEC1

IFILTX /BUTPAR/ I*2 BUTPAR.INC
 Transmitter filter indicator.

0 = MD-918 transmitter filter. Also means filter is a Butterworth cascaded with a rectangular impulse response filter of duration equal to symbol duration.

1 = AN/TRC-170 transmitter filter. Also means filter is a cascade of Butterworth filter with rectangular impulse response filter of duration equal to half symbol duration.

2 = (not allowed)

- Possibly given a new value in the following subprograms:
 BUTFIL INDATA

- Used but not changed in the following subprograms:
 ASOFCC BWJAM FUNBW PSPJ SPEC1 SPEC2 TPSPJ

IME /UNIT/ I*2 IODATA.INC
 0 if metric units, 1 if English.

- Possibly given a new value in the following subprograms:
 UNITS

- Used but not changed in the following subprograms:
 UNITCV

IMG /UNIT/ I*2 IODATA.INC
 0 if MHz, 1 if GHz.

- Possibly given a new value in the following subprograms:
 UNITS

- Used but not changed in the following subprograms:
 UNITCV

INEG /PDATA/ I*2 PDATA.INC
 Number of negative delay cells encountered in troposcatter integration. It is an error if INEG > 0.

- Possibly given a new value in the following subprograms:
 LOOPS

- Used but not changed in the following subprograms:
 SUMPAG

INS /UNIT/ I*2 IODATA.INC
 0 if nautical miles, 1 if statute miles.

- Possibly given a new value in the following subprograms:
 UNITS

- Used but not changed in the following subprograms:
 UNITCV

IOPEND /CONTRL/ I#2 TROCOM.INC
 Number of output files opened.
 - Possibly given a new value in the following subprograms:
 INDATA SUMPAG

IOPERF /IOUT/ I#2 IOUT.INC
 Switch for calculation of performance of AN/TRC-170.
 0 = ABER and outage probability
 1 = ABER (average bit error rate) only
 2 = Outage probability only
 Set to 0 internally.
 - Possibly given a new value in the following subprograms:
 TRCIN
 - Used but not changed in the following subprograms:
 TRC

IOTIME /IOUT/ I#2 IOUT.INC
 Switch for calculation of performance of AN/TRC-170.
 0 = Short term performance assuming various
 sampling times.
 1 = Short term performance assuming Gaussian
 timing jitter.
 2 = Yearly average performance assuming
 Gaussian timing jitter.
 Set to 2 internally.
 - Possibly given a new value in the following subprograms:
 TRCIN
 - Used but not changed in the following subprograms:
 TRC

IPOLR(NRMX) /ANTENN/ I#2 TROCOM.INC
 Array of receiver antenna polarizations.
 - Possibly given a new value in the following subprograms:
 ANTGEO INDATA
 - Used but not changed in the following subprograms:
 LOOPS OUTDAT STPPAR SUMPAG

IPOLT(NTMX) /ANTENN/ I#2 TROCOM.INC
 Array of transmitter antenna polarizations.
 - Possibly given a new value in the following subprograms:
 ANTGEO INDATA
 - Used but not changed in the following subprograms:
 LOOPS OUTDAT SUMPAG

IPOS /PDATA/ I#2 PDATA.INC
 Number of delay cells exceeding the last allocated
 array element. This number should be zero or small.
 IPOS > 0 is not a serious error unless the delay
 profile calculated has a clear peak in the last delay
 cell.
 - Possibly given a new value in the following subprograms:
 LOOPS
 - Used but not changed in the following subprograms:
 SUMPAG

IPROF(NCORMX) /PDATA/ I#2 PDATA.INC

0 if the Ith correlation not wanted, 1 if wanted.
 - Possibly given a new value in the following subprograms:
 LOOPS

- Used but not changed in the following subprograms:
 SIM SUMPAG

IPROFL /SYSPAR/ I#2 SYSPAR.INC

Parameter that indicates whether troposcatter power per unit delay profile of the form $X \exp(-AX)$ is to be used (IPROFL = 0) or not. Set to zero in TRCIN.

- Possibly given a new value in the following subprograms:
 TRCIN

- Used but not changed in the following subprograms:
 EIGV TIMPAR TRC VARW

IPULS /SYSPAR/ I#2 SYSPAR.INC

Switch to indicate whether pulse shape at input of the AN/TRC-170 detector includes the effects of RF filters (IPULS = 2) or not (IPULS = 0 or 1). Set to 2 internally. If IBW is 0, set to 1.

- Possibly given a new value in the following subprograms:
 TRCIN

- Used but not changed in the following subprograms:
 P2INT TRC TXPULS

IRF /PATHGE/ I#2 TROCOM.INC

Parameter which indicates whether reference horizon elevation angles have been calculated (IRF = 1) in previous run. It has meaning only when ITOFF = 3.

- Possibly given a new value in the following subprograms:
 TRANSF

IRSN /NUMPAR/ I#2 NUMPAR.INC

Number of values in SNR array RSNRSN(30). Used to calculate ISI statistics for AN/TRC-170. Initially set to 30.

- Used but not changed in the following subprograms:
 POUTAG

ISN /IOUT/ I#2 IOUT.INC

Number of SNR values for which short-term performance of AN/TRC-170 is to be performed. Set to 17.

- Possibly given a new value in the following subprograms:
 TRCIN

- Used but not changed in the following subprograms:
 TRC

IT /IOUT/ I#2 IOUT.INC

Number of different sampling times to be used in calculation of AN/TRC-170 short term performance.

- Used but not changed in the following subprograms:
 TRC

ITER /PDATA/ I#4 PDATA.INC

Number of integration cells in the common volume integration.

- Possibly given a new value in the following subprograms:

LOUPS
 - Used but not changed in the following subprograms:
 POWER SUMPAG

ITOFF /PROPAR/ I*2 TROCOM.INC
 Control indicator for entry or calculation of
 transmit/receive radio horizon angles THET and THER.
 Values have following meanings:
 0 = Use input THET, THER as reference and
 actual horizon (default).
 1 = Calculate reference horizon using HORANG
 and K equals 1.33. (Assuming DLT and OLR
 are non-zero.) (Option not available.)
 2 = Calculate reference horizon using HORANG
 and K equals ERFAC. (Assuming DLT and DLR
 are non-zero.)
 3 = Do not change reference horizons from
 previous run. (Option not available.)
 - Possibly given a new value in the following subprograms:
 INDATA MAIN OUTDAT
 - Used but not changed in the following subprograms:
 TRANSF

JBW /JAMPAR/ R*4 JAMPAR.INC
 99% interferer bandwidth in MHz.
 - Possibly given a new value in the following subprograms:
 BUTFIL
 - Used but not changed in the following subprograms:
 BWJAM

JFILT /MCOM2/ I*2 MCOM.INC
 Interference covariance matrix calculation indicator.
 Only used when IBW equals 0, otherwise ignored.
 Default is 0.
 0 = Interferer covariance matrix calculation
 done in subroutine BOTAC
 1 = Interferer covariance matrix calculation
 done in subroutine JAMCOM
 - Used but not changed in the following subprograms:
 BOTAC OUTDAT

JPOW /JAMPAR/ R*4 JAMPAR.INC
 Interferer power density in dBm/Hz: -174 or less
 denotes no interference. Default is -1000 dBm/Hz.
 - Possibly given a new value in the following subprograms:
 BUTFIL
 - Used but not changed in the following subprograms:
 BWJAM

JQ2M /MCOM4/ I*2 MCOM.INC
 Pointer to centroid of lower beam troposcatter signal
 power per unit delay profile.
 - Possibly given a new value in the following subprograms:
 POWER
 - Used but not changed in the following subprograms:

JREFL CAC DINT
 /MCOM2/ I*2 MCOM.INC
 Indicates whether specular reflection is to be included in interferer covariance matrix calculation (JREFL = 1) or not (JREFL = 0). Default is 0.
 - Used but not changed in the following subprograms:
 JAMCOM

KGAIN /RZ/ I*2 RZ.INC
 Interer ratio of bandwidth to data rate.
 - Possibly given a new value in the following subprograms:
 POWER
 - Used but not changed in the following subprograms:

KISI CAC DINT MDTS SASEQ SIGIN SINT TRCIN
 /NUMPAR/ I*2 NUMPAR.INC
 Parameter for calculation of AN/TRC-170 outase probability. Set to 6 in data statement.
 - Used but not changed in the following subprograms:
 POUTAG TRC

KLIMAT /PROPAR/ I*2 TROCOM.INC
 Climate zone indicator. Default is 0.
 0 = User supplied climate
 NBS TN101 climates
 1 = Continental temperate (CT)
 2 = Maritime temperate overland (MTL)
 3 = Maritime temperate oversea (MTS)
 4 = Maritime subtropical overland (MSL)
 5 = Continental temperate time block 2 (CT2)
 (winter afternoon hours) - formerly
 Maritime subtropical oversea (MSS)
 6 = Desert, Sahara (DS)
 7 = Equatorial (EQU)
 8 = Continental subtropical (CS)
 MIL-HDBK-417 climates
 9 = Continental temperate (CT)
 10 = Maritime temperate overland (MTL)
 11 = Maritime temperate oversea (MTS)
 12 = Maritime subtropical (MS)
 13 = Desert, Sahara (DS)
 14 = Equatorial (EQU)
 15 = Continental subtropical (CS)
 16 = Mediterranean (MED)
 17 = Polar (POL)
 - Possibly given a new value in the following subprograms:
 INDATA
 - Used but not changed in the following subprograms:
 AVAIL POWER

KM /UNIT/ R*4 IOWDATA.INC
 Strings 'km ' for units output.
 - Used but not changed in the following subprograms:
 INDATA OUTDAT UNITS

ROF /PROPAR/ I*2 TROCOM.INC
 Actual number of samples in height profile of
 structure constant CN2. Limited to NPROF samples.
 - Possibly given a new value in the following subprograms:
 INDATA
 - Used but not changed in the following subprograms:
 LOOPS OUTDAT RIPROF

NG /MCOM2/ I*2 MCOM.INC
 Pointer to data array elements containing interferer
 azimuth and elevation angles.
 - Possibly given a new value in the following subprograms:
 MDTS
 - Used but not changed in the following subprograms:
 JAMCOM

EBUG /LUNS/ I*2 LUNS.INC
 Debug output unit. Always the same as LOUT but used
 to uniquely identify the write statements.
 - Used but not changed in the following subprograms:
 MATCO

RR /LUNS/ I*2 LUNS.INC
 Error output unit.
 - Used but not changed in the following subprograms:
 ANTGEO RUTFIL BWJAM CLIME CLIMIL CLIMIX CONVOL DEIND
 DIFSNR DIF1 INDATA LTCORR MDIF MDTS ORDER POWER
 SEARCH SECTOR SIGIN TANGL TRC UNITS

N /LUNS/ I*2 LUNS.INC
 TROPO.DAT input unit number.
 - Possibly given a new value in the following subprograms:
 INDATA SECTOR UNITS

NKNO /IODATA/ I*2 IODATA.INC
 Link number.
 - Possibly given a new value in the following subprograms:
 INDATA
 - Used but not changed in the following subprograms:
 SUMPAG

SI /MCOM2/ I*2 MCOM.INC
 Number of future Intersymbol Interference (ISI)
 contributors considered in MD-918 performance
 calculation. Default is 2.
 - Possibly given a new value in the following subprograms:
 INDATA SIGIN
 - Used but not changed in the following subprograms:
 MATCO OUTDAT

IAHE(20) /IODATA/ I*2 IODATA.INC
 Link name. Transmitter site first, receiver site
 second. Used as link identifier on output files
 FOR002.DAT and SUMPAG.OUT.
 - Possibly given a new value in the following subprograms:
 INDATA
 - Used but not changed in the following subprograms:

OUTDAT SUMPAG
T /LUNS/ I*2 LUNS.INC
 FOR002.DAT output unit number.
 - Used but not changed in the following subprograms:
 AVAIL BERCAL BOTAC BUTFIL CLIF1Y CLIMIX DIFSNR ERRIO
 ERROR MAIN MATCO MDIF MDTS OUTDAT POWER PROUT
 SASEQ SIM SINT SUBID TKC TRCIN
M /LUNS/ I*2 LUNS.INC
 SUMPAG.OUT output unit number.
 - Used but not changed in the following subprograms:
 SUMPAG
ITS /UNIT/ I*2 IODATA.INC
 Integer value that specifies the set of units requested by the user. These units are for path, antenna location, angle, and frequency parameters. Default is 8. The seven units are defined by bit values of LUNITS:
 Bit no. Meaning of value 0 / 1
 0 english / metric
 1 statute miles / nautical miles
 2 feet / meters
 3 rad / degrees
 4 GHz / MHz
 Valid LUNITS values are
 0 : stat. miles - feet - milliradians - GHz
 1 : kilometers - meters - milliradians - GHz
 2 : naut. miles - feet - milliradians - GHz
 8 : stat. miles - feet - degrees - GHz
 9 : kilometers - meters - degrees - GHz
 10: naut. miles - feet - degrees - GHz
 16: stat. miles - feet - milliradians - MHz
 17: kilometers - meters - milliradians - MHz
 18: naut. miles - feet - milliradians - MHz
 24: stat. miles - feet - degrees - MHz
 25: kilometers - meters - degrees - MHz
 26: naut. miles - feet - degrees - MHz
 - Possibly given a new value in the following subprograms:
 UNITS
 - Used but not changed in the following subprograms:
 OUTDAT SUMPAG UNITCV
G /MCOM2/ I*2 MCOM.INC
 Number of values of interferer azimuth/elevation pairs (JANG) for which outage calculations are to be made. Default is 1.
 - Possibly given a new value in the following subprograms:
 INDATA
 - Used but not changed in the following subprograms:
 MDTS OUTDAT
ST /ERAD/ I*2 ERAD.INC
 Multipath distribution indicator.

0 = Only median multipath spread used(default)
 1 = Multipath distribution used. (Option not currently available.)

- Used but not changed in the following subprograms:

INDATA MAIN POWER PROUT
 /UNIT/ R*4 IODATA.INC

String 'met' for units output.

- Used but not changed in the following subprograms:

ANTGEO OUTDAT UNITS
 /UNIT/ R*4 IODATA.INC

String 'MHz' for units output.

- Used but not changed in the following subprograms:

ANTGEO INDATA OUTDAT UNITS
 /PDATA/ I*2 PDATA.INC

Number of simulator taps. Default is 16.

- Possibly given a new value in the following subprograms:

INDATA

- Used but not changed in the following subprograms:

SIM

/MCOM2/ I*2 MCOM.INC

Propagation/modem flag to select calculation mode.

Default is 1.

0 = Propagation only

1 = Propagation + MD-918 modem

2 = Propagation + AN/TRC-170 or BAR modem

3 = Propagation + user-defined modem

- Possibly given a new value in the following subprograms:

INDATA POWER

- Used but not changed in the following subprograms:

MAIN OUTDAT SUMPAG

/JAMPAR/ I*2 JAMPAR.INC

Interference signal modulation format. Default is 1.

0 = Analog FDM / FM

1 = Digital QPSK

- Possibly given a new value in the following subprograms:

RUTFIL

- Used but not changed in the following subprograms:

RWJAM PSPJ TPSPJ

/MCOM2/ I*2 MCOM.INC

Interference signal modulation format. Default is 1.

0 = Analog FDM / FM

1 = Digital QPSK

- Possibly given a new value in the following subprograms:

INDATA

- Used but not changed in the following subprograms:

MAIN OUTDAT SUMPAG

/ERAD/ I*2 ERAD.INC

Loop limit for MRAD. Default is 1.

(MRAD is 1 for MDIST = 0 and MRAD is 3 for MDIST = 1).

- Possibly given a new value in the following subprograms:

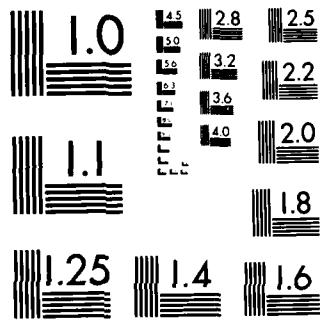

MICROCOPY RESOLUTION TEST CHART
NATIONAL BUREAU OF STANDARDS 1963 A

INDATA
 - Used but not changed in the following subprograms:
 MAIN

HRADNS /UNIT/ R*4 IODATA.INC
 String 'hrad' for units output.
 - Used but not changed in the following subprograms:
 ANTGEO OUTDAT UNITS

NACCU /CONTRL/ I*2 TROCOM.INC
 Parameter used as truncation point for common
 volume integration termination. Default is 40.
 - Possibly given a new value in the following subprograms:
 INDATA
 - Used but not changed in the following subprograms:
 LOOPS OUTDAT SUMPAG

NANG /RI2/ I*2 RI2.INC
 NANG is 1 if there is angle diversity (default).
 - Possibly given a new value in the following subprograms:
 INDATA
 - Used but not changed in the following subprograms:
 MDT5

NB /RI2/ I*2 RI2.INC
 Number of elements accessed in arrays DU, DX and DY.
 - Used but not changed in the following subprograms:
 CAJI

NCHIP /SYSPAR/ I*2 SYSPAR.INC
 Number of chips in PN sequence used to expand
 bandwidth in AN/TRC-170.
 - Possibly given a new value in the following subprograms:
 TRCIN
 - Used but not changed in the following subprograms:
 P2INT TRC TXPULS

NCLINE /MCOM2/ I*2 MCOM.INC
 Flag set to 1 if ICLINE equals 2.
 - Possibly given a new value in the following subprograms:
 INDATA
 - Used but not changed in the following subprograms:
 OUTDAT

NCORMX Parameter I*2 TROPAR.INC
 Maximum number of correlations between receive ports.
 - Used but not changed in the following subprograms:
 LOOPS SIM

NCORR /PDATA/ I*2 PDATA.INC
 Number of receive port correlations.
 - Possibly given a new value in the following subprograms:
 LOOPS
 - Used but not changed in the following subprograms:
 POWER SIM SUMPAG

NDELMX Parameter I*2 TROPAR.INC
 Maximum number of delay bins in troposcatter power per
 unit delay profiles.

- Used but not changed in the following subprograms:
 LOOPS MDIF POWER SIM SUMPAG

NDELO /MCOM4/ I*2 MCOM.INC
 Number of non-zero elements of troposcatter power per unit delay profiles Q(NDELO,1).
 - Possibly given a new value in the following subprograms:
 POWER

- Used but not changed in the following subprograms:
 CAC DINT

NDIVS /SYSPAR/ I*2 SYSPAR.INC
 Number of explicit diversity channels for AN/TRC-170. Equal to 4 for 2S/2F and 2 for 2S or 2F.
 - Possibly given a new value in the following subprograms:
 TRCIN

- Used but not changed in the following subprograms:
 AVG TRC VARW

NEIGEN /ANSWER/ I*2 ANSWER.INC
 Number of implicit diversity eigenvalues (stored in array VEIGV) used in calculation of AN/TRC-170 performance.
 - Possibly given a new value in the following subprograms:
 EIGV

- Used but not changed in the following subprograms:
 AVG TRC

NERT /MCOM2/ I*2 MCOM.INC
 Bit error rate threshold indicator for yearly fade outage probability calculation. Default is 2.
 0 = All three thresholds
 1 = For 10**(-3) only
 2 = For 10**(-4) only
 3 = For 10**(-5) only
 - Possibly given a new value in the following subprograms:
 INDATA

- Used but not changed in the following subprograms:
 BERCAL MAIN MDTS OUTDAT SUMPAG

NEWCL(4) /MCOM2/ I*2 MCOM.INC
 New climate type character strings.
 - Possibly given a new value in the following subprograms:
 INDATA

- Used but not changed in the following subprograms:
 OUTDAT SUMPAG

NFIG /MCOM4/ R*4 MCOM.INC
 Receiver noise figure in dB. Default is 4dB.
 - Possibly given a new value in the following subprograms:
 INDATA

- Used but not changed in the following subprograms:
 DIFSNR OUTDAT POWER

NIP /RZ/ I*2
 Initialization constant for numerical equalizer covariance matrix calculation.

- Possibly given a new value in the following subprograms:
MDTS

- Used but not changed in the following subprograms:
CAC

NJR /RZ4/ I*2 RZ4.INC
Number of sample points for RJCOR.

- Possibly given a new value in the following subprograms:
BUTFIL

- Used but not changed in the following subprograms:
ROTAC

NMI /UNIT/ R*4 IODATA.INC
String 'nmi' for units output.

- Used but not changed in the following subprograms:
OUTDAT UNITS

NOBS /MCOM2/ I*2 MCOM.INC
Number of diffraction obstacles. Maximum is 3,
default is 1.

- Possibly given a new value in the following subprograms:
INDATA

- Used but not changed in the following subprograms:
DIFSNR MAIN OUTDAT POWER

NOW(8) /TSTAMP/ L*1 IODATA.INC
Array used in PDP-11/70 version to hold time of day as
characters.

- Used but not changed in the following subprograms:
MAIN OUTDAT SUMPAG

NPH(5) /MCOM2/ I*2 MCOM.INC
Array containing number of terrain elevation data
points for calculation of effective antenna heights
for each section of the diffraction path.

- Possibly given a new value in the following subprograms:
INDATA

- Used but not changed in the following subprograms:
DIFSNR OUTDAT POWER

NPOINT /NUMPAR/ I*2 NUMPAR.INC
Number of points for numerical integration.

- Used but not changed in the following subprograms:
TRC

NPOLJ /JAMPAR/ I*2 JAMPAR.INC
Number of poles in the QPSK interference filter.

- Possibly given a new value in the following subprograms:
BWJAM

- Used but not changed in the following subprograms:
PSPJ TPSPJ

NPOLRX /BUTPAR/ R*4 BUTPAR.INC
Number of poles in the receive Butterworth filter.

- Possibly given a new value in the following subprograms:
BWJAM INDATA SEARCH

- Used but not changed in the following subprograms:
BUTFIL FUNJAM PSPEC1 PSPEC2 PWRSPC SPEC1

NPOLTX /BUTPAR/ I*2 BUTPAR.INC
 Number of poles in the transmit Butterworth filter.
 - Possibly given a new value in the following subprograms:
 BWJAM INDATA SEARCH
 - Used but not changed in the following subprograms:
 A50FCC BUTFIL FUN8W PSPJ SPEC1 SPEC2 TPSPJ

NPROF Parameter I*2 TROPAR.INC
 Dimension of array containing the structure constant
 height profile (CN2).
 -- Not used --

NR /SYSTRN/ I*2 TROCOM.INC
 Number of receive ports.
 - Possibly given a new value in the following subprograms:
 ANTGEO INDATA
 - Used but not changed in the following subprograms:
 CHKDAT INTLIM LOOPS MAIN OUTDAT STPPAR SUMPAG TRANSF
 UNITCV

NRAD /ERAD/ I*2 ERAD.INC
 ERFAC indicator and loop counter. Default is 1.
 - Used but not changed in the following subprograms:
 MAIN POWER PROUT

NRHX Parameter I*2 TROPAR.INC
 Maximum number of receive ports.
 - Used but not changed in the following subprograms:
 ANTPAR CHKDAT

NT /SYSTRN/ I*2 TROCOM.INC
 Number of transmit ports.
 - Possibly given a new value in the following subprograms:
 ANTGEO INDATA
 - Used but not changed in the following subprograms:
 CHKDAT INTLIM LOOPS MAIN OUTDAT STPPAR SUMPAG TRANSF
 UNITCV

NTAP /MCOM2/ I*2 MCOM.INC
 Number of adaptive forward equalizer taps (AFE) in
 MD-918 modem. Set to 3 in INDATA.
 - Used but not changed in the following subprograms:
 OUTDAT SIGIN

NTERR /MCOM2/ I*2 MCOM.INC
 Control parameter for entry or calculation of
 effective antenna heights (HTE, HRE) and effective
 obstacle heights above average terrain elevation
 (HLEF).
 0 = HTE and HRE supplied directly
 1 = AVETX and AVERX supplied
 2 = HI(.) supplied
 - Possibly given a new value in the following subprograms:
 INDATA
 - Used but not changed in the following subprograms:
 DIFSNR OUTDAT POWER

NTH1 /IOUT/ I*2 IOUT.INC

Pointer to largest bit error rate threshold of interest for AN/TRC-170 outage probability calculation.
 - Possibly given a new value in the following subprograms:
 TRCIN
 - Used but not changed in the following subprograms:
 TRC

NTH2 /IOUT/ I*2 IOUT.INC
 Pointer to smallest bit error rate threshold of interest for AN/TRC-170 outage probability calculation.
 - Possibly given a new value in the following subprograms:
 TRCIN
 - Used but not changed in the following subprograms:
 TRC

NTHR /SYSPAR/ I*2 SYSPAR.INC
 Pointer to bit error rate threshold for AN/TRC-170 outage probability calculation.
 - Used but not changed in the following subprograms:
 POUTAG TRC TRCIN

NTMX Parameter I*2 TROPAR.INC
 Maximum number of transmit ports.
 - Used but not changed in the following subprograms:
 ANTPAR CHKDAT

NTR /RZ4/ I*2 RZ4.INC
 Number of samples for calculating transmit-receive filter impulse response (IRFILT).
 - Used but not changed in the following subprograms:
 BUTFIL CAC TXPULS

NUMVC /SYSTRN/ I*2 TROCOM.INC
 Number of voice channels in analog troposcatter system. Default is 72.
 -- Not used --

NV /NUMPAR/ I*2 NUMPAR.INC
 Normalization parameter for calculation of AN/TRC-170 signal gain. Set to 18.
 - Used but not changed in the following subprograms:
 TRC

PAVG(20,20) /ANSWER/ R*4 ANSWER.INC
 Short-term average bit error rate for each sampling time and short-term average SNR.
 - Possibly given a new value in the following subprograms:
 TRC

PCON /RZ/ R*8 RZ.INC
 Normalization factor for probability integral.
 - Possibly given a new value in the following subprograms:
 MDTs
 - Used but not changed in the following subprograms:
 CAC

PDUR /SYSPAR/ R*4 SYSPAR.INC

Symbol pulse duration.
 - Possibly given a new value in the following subprograms:
 TRC
 - Used but not changed in the following subprograms:
 P2INT TXPULS

PEAKAV /RZ4/ R*4 RZ4.INC
 Peak-to-average loss due to RF filtering in dB.
 - Possibly given a new value in the following subprograms:
 BUTFIL MDTS TRCIN
 - Used but not changed in the following subprograms:
 TRC

PENERG /BUTPAR/ R*4 BUTPAR.INC
 Normalized energy of filter.
 - Used but not changed in the following subprograms:
 ASOFCC BUTFIL BWJAM FUNBW

PFACT(3) /ERAD/ R*4 ERAD.INC
 Cumulative probability distribution for effective
 earth radius factor.
 For NRAD = 1 PFACT = 0.89
 = 2 = 0.1
 = 3 = 0.01
 - Used but not changed in the following subprograms:
 PROUT

PHDIV /MCOM4/ R*4 MCOM.INC
 Squint angle between upper and lower receiver beams in
 radians. Default is beamwidth.
 - Possibly given a new value in the following subprograms:
 ANTGED INDATA UNITCV
 - Used but not changed in the following subprograms:
 DIFSNR LTCORR OUTDAT

PHI /PATHGE/ R*4 TROCOM.INC
 Diffraction angle in radians.
 - Possibly given a new value in the following subprograms:
 INTLIM TRANSF UNITCV

PHIR /PATHGE/ R*4 TROCOM.INC
 Receive angular distance to minimum scattering point
 in radians.
 - Possibly given a new value in the following subprograms:
 TRANSF UNITCV

PHIT /PATHGE/ R*4 TROCOM.INC
 Transmit angular distance to minimum scattering point
 in radians.
 - Possibly given a new value in the following subprograms:
 TRANSF UNITCV

PI /CONSTA/ R*4 CONSTANTS.INC
 Constant Pi = 3.141592654.
 - Used but not changed in the following subprograms:
 ANTGED BUTFIL DIF1 FFT GPATT JAMCOM MDIF PSPEC
 PSPJ SEARCH SINC SPEC TPSPEC TPSPJ VARPOL

PJ /JAMPAR/ R*4 JAMPAR.INC

Normalization constant for interference calculations.
 - Possibly given a new value in the following subprograms:
 RWJAM
 - Used but not changed in the following subprograms:
 BUTFIL FUNJAM

PLOSS1 /ERAD/ R*4 ERAD.INC
 Reference troposcatter path loss in dB on lower beam
 for NRAD equals 1.
 - Possibly given a new value in the following subprograms:
 POWER

PLOSSM /PDATA/ R*4 PDATA.INC
 Troposcatter path loss from approximate analytic
 expression.
 - Possibly given a new value in the following subprograms:
 LOOPS
 - Used but not changed in the following subprograms:
 SUMPAG

POUT(20,20,3) /ANSWER/ R*4 ANSWER.INC
 AN/TRC-170 outage probability and average bit error
 rate as a function of sampling time, short-term
 average SNR and error rate threshold.
 - Possibly given a new value in the following subprograms:
 TRC

PRAD(3) /ERAD/ R*4 ERAD.INC
 Fraction of time effective earth radius factor is
 greater than ERFAC; Probability that effective earth
 radius factor is not exceeded.
 For NRAD = 1 PRAD = 0.5
 = 2 = 0.1
 = 3 = 0.01
 - Used but not changed in the following subprograms:
 POWER

PSIRAO(NRMX) /ANTENN/ R*4 TROCOM.INC
 Array of receiver beam azimuths in radians.
 - Possibly given a new value in the following subprograms:
 ANTGEO INDATA UNITCV
 - Used but not changed in the following subprograms:
 CHKDAT INTLIM LOOPS OUTDAT SUMPAG TRLOSS

PSIREO(NRMX) /ANTENN/ R*4 TROCOM.INC
 Array of receiver beam boresight elevations above
 radio horizon in radians, ie, angle at which each
 antenna is aimed relative to the horizon. PSIREO(1)
 is the main receive antenna.
 - Possibly given a new value in the following subprograms:
 ANTGEO INDATA TRANSF UNITCV
 - Used but not changed in the following subprograms:
 CHKDAT DIFSNR INTLIM JAMCOM LOOPS OUTDAT POWER SUMPAG
 TRLOSS

PSITAO(NTMX) /ANTENN/ R*4 TROCOM.INC
 Array of transmitter beam azimuths in radians.

- Possibly given a new value in the following subprograms:
 ANTGEO INDATA UNITCV

- Used but not changed in the following subprograms:
 CHKDAT INTLIM LOOPS OUTDAT SUMPAG

PSITEO(NTMX) /ANTENN/ R*4 TROCOM.INC
 Array of transmitter beam boresight elevations above radio horizon in radians, ie, angle at which each antenna is aimed relative to the horizon. PSITEO(1) is the main transmit antenna.

- Possibly given a new value in the following subprograms:
 ANTGEO INDATA TRANSF UNITCV

- Used but not changed in the following subprograms:
 CHKDAT DIFSNR INTLIM LOOPS OUTDAT POWER SUMPAG TRLOSS

PULSE /RZ/ I*2 RZ.INC
 Switch controlling MD-918 pulse shape after transmitter-receiver filtering.

PULSE = 0 Triangle
 = 1 OQPSK matched filter
 = 2 Sinc pulse, bandwidth equal to 1
 = 5 RF filtering included

Set to 0 if IBW = 0 or KGAIN > 1.
 Set to 5 if IBW > 0 and KGAIN = 1.

- Possibly given a new value in the following subprograms:
 INDATA SIGIN

- Used but not changed in the following subprograms:
 CAC CAJI DINT SINT

PXMIT /MCOM4/ R*4 MCOM.INC
 Rated transmission power in dBm. Default is 70dBm.

- Possibly given a new value in the following subprograms:
 INDATA

- Used but not changed in the following subprograms:
 DIFSNR OUTDAT POWER

Q(NDELMX,NCORMX) /PDATA/ R*4 PDATA.INC
 Matrix of troposcatter signal power and correlation per unit delay profiles.

For DIVTYP = 0:

Q(.,1) Power on lower beam vs. delay.
 Q(.,2) Correlation between lower and upper beam vs. delay.
 Q(.,3) Correlation between lower beams in antennas 1 & 2 vs. delay.
 Q(.,4) Power on upper beam vs. delay.
 Q(.,7) Power on diffraction path vs. delay

For DIVTYP = 1:

Q(.,1) Power on lower beam vs. delay.
 Q(.,2) Correlation between lower and upper beam vs. delay.
 Q(.,3) Power on upper beam vs. delay
 Q(.,7) Power on diffraction path vs. delay.

For DIVTYP = 2:

Q(.,1) Power on path 1 (lower beam) vs. delay.
 Q(.,2) Correlation between convergent paths
 (lower beam) vs. delay.
 Q(.,3) Correlation between divergent paths
 (lower beam) vs. delay.
 Q(.,4) Correlation between parallel paths
 (lower beam) vs. delay.
 Q(.,5) Correlation between crossing paths
 (lower beam) vs. delay.
 Q(.,6) Power on path of upper beam vs. delay.
 Q(.,7) Power on diffraction path vs. delay.

- Possibly given a new value in the following subprograms:
 LOOPS MDIF POWER
- Used but not changed in the following subprograms:
 MAIN SIM SUMPAG

QCORR(NCORMX)

/PDATA/ R*4 PDATA.INC

Contains elements of covariance matrix, ie, powers and correlations.

For DIVTYP = 0:

QCORR(1) Power on lower beam
 QCORR(2) Correlation coefficient between lower
 and upper beam.
 QCORR(3) Correlation coefficient between lower
 beams of antennas 1 and 2
 QCORR(4) Power on upper beam.

For DIVTYP = 1:

QCORR(1) Power on lower beam
 QCORR(2) Correlation coefficient between lower
 and upper beam.
 QCORR(3) Power on upper beam.

For DIVTYP = 2:

QCORR(1) Power on path 1 (lower beam)
 QCORR(2) Correlation coefficient between convergent
 paths.
 QCORR(3) Correlation coefficient between divergent
 paths.
 QCORR(4) Correlation coefficient between parallel
 paths.
 QCORR(5) Correlation coefficient between crossing
 paths.
 QCORR(6) Power on upper beam.

- Possibly given a new value in the following subprograms:
 LOOPS
- Used but not changed in the following subprograms:
 POWER SUMPAG

RCOR(32)

/RZ4/ R*4 RZ4.INC

Correlation function of the receive filter in steps
 equal to the tapwidth (TAPW) for MD-918 modem, or
 equal to 1/RATE for AN/TRC-170 or DAR modem.

- Used but not changed in the following subprograms:

RJCOR(129) BUTFIL CAJI
 /RZ4/ R*4 RZ4.INC
 Correlation function of interferer-receiver filters at
 RATE points per symbol interval.
 - Possibly given a new value in the following subprograms:
 BUTFIL

RJCOR(129) /RZ4/ R*4 RZ4.INC
 Not used anymore but retained to align commons.
 -- Not used --

RLL /SYSTRN/ R*4 TROCOM.INC
 Receiver line losses in dB. Default is 0 dB.
 - Possibly given a new value in the following subprograms:
 INDATA
 - Used but not changed in the following subprograms:
 DIFSNR OUTDAT POWER SUMPAG

RSDB /BUTPAR/ R*4 BUTPAK.INC
 10 times the base 10 logarithm of the symbol rate
 minus 60.
 - Possibly given a new value in the following subprograms:
 BUTFIL
 - Used but not changed in the following subprograms:
 A50FCC FCCMSK

RSEP(3) /IODETA/ R*4 IODETA.INC
 Separation between receive antennas.
 - Possibly given a new value in the following subprograms:
 ANTGEO INDATA

RSNMIN(3) /NUMPAR/ R*4 NUMPAR.INC
 SNR threshold corresponding to each bit error rate
 threshold for AN/TRC-170.
 - Used but not changed in the following subprograms:
 POUTAG

RSNRSN(30) /NUMPAR/ R*4 NUMPAR.INC
 Set of SNR values for which solution of transcendental
 function (UPISIM) is tabulated.
 - Used but not changed in the following subprograms:
 POUTAG

S /PATHGE/ R*4 TROCOM.INC
 Troposcatter path asymmetry parameter.
 - Possibly given a new value in the following subprograms:
 TRANSF
 - Used but not changed in the following subprograms:
 SUMPAG

S1 /PATHGE/ R*4 TROCOM.INC
 Troposcatter path asymmetry parameter.
 - Possibly given a new value in the following subprograms:
 TRANSF

SCPARM /PROPAR/ R*4 TROCOM.INC
 Wavenumber spectrum slope parameter M. Default is
 3.66.
 - Possibly given a new value in the following subprograms:

INDATA
 - Used but not changed in the following subprograms:
 INTLIM LOOPS OUTDAT STPPAR SUMPAG TRILOSS

SEAN /PROPAR/ R*4 TROCOM.INC
 Minimum monthly median of refractivity at sea level.
 Used to calculate ERFAC if non-zero.
 - Possibly given a new value in the following subprograms:
 INDATA MAIN

SIGMA /SYSPAR/ R*4 SYSPAR.INC
 Half the RMS lower beam delay spread normalized
 relative to the symbol duration.
 - Possibly given a new value in the following subprograms:
 TRCIN

SMI /UNIT/ R*4 IODATA.INC
 String 'smi' for units output.
 - Used but not changed in the following subprograms:
 OUTDAT UNITS

SNDR(2) /IOUT/ R*4 IOUT.INC
 Signal to noise ratio in dB.
 - Possibly given a new value in the following subprograms:
 TRCIN

SNR /SYSPAR/ R*4 SYSPAR.INC
 Signal to noise ratio.
 - Possibly given a new value in the following subprograms:
 TRC TRCIN

SNRBW /RZ4/ R*4 RZ4.INC
 Signal to noise ratio adjustment for AN/TRC-170 due to
 limited receive filter bandwidth.
 - Possibly given a new value in the following subprograms:
 BUTFIL

SNRF2 /RZ4/ R*4 RZ4.INC
 Parameter to adjust the signal to noise ratio for
 degradation due to interference from another
 frequency. Only for 2-frequency AN/TRC-170 modes.
 - Possibly given a new value in the following subprograms:
 BUTFIL

SNRJAM /RZ4/ R*4 RZ4.INC
 Parameter to adjust the signal to noise ratio of

AN/TRC-170 for degradation due to colocated/adjacent channel interference.

- Possibly given a new value in the following subprograms:

RUTFIL

- Used but not changed in the following subprograms:

TRC

SP /MCOM4/ R*4 MCOM.INC

Service probability. Default is .95.

- Possibly given a new value in the following subprograms:

INDATA

- Used but not changed in the following subprograms:

DIFSNR OUTDAT POWER

SPE /PDATA/ R*4 PDATA.INC

Tap spacing in nanoseconds. Default is 67 nsec.

- Possibly given a new value in the following subprograms:

INDATA

- Used but not changed in the following subprograms:

SIM

SPREAD(NCORMX) /PDATA/ R*4 PDATA.INC

Array of delay spreads (2-sigma) for each beam in seconds.

- Used but not changed in the following subprograms:

POWER SUMPAG

STSNR /SUMP/ R*4 SUMP.INC

Standard deviation of troposcatter signal long-term

SNR distribution in dB.

- Possibly given a new value in the following subprograms:

POWER

- Used but not changed in the following subprograms:

MAIN MDTS SUMPAG

STSNR1 /SYSPAR/ R*4 SYSPAR.INC

Standard deviation of troposcatter signal long-term

SNR distribution in dB. Same as STSNR in /SUMP/.

- Possibly given a new value in the following subprograms:

TRCIN

- Used but not changed in the following subprograms:

TRC

SUPRES /IODATA/ L*4 IODATA.INC

Suppress long output in SUMPAG if true.

Set to TRUE if PTYPE > 9.

- Possibly given a new value in the following subprograms:

INDATA

- Used but not changed in the following subprograms:

SUMPAG

TO /SYSPAR/ R*4 SYSPAR.INC

Normalized sampling time for lower beam.

- Possibly given a new value in the following subprograms:

TIMEQL TRC

- Used but not changed in the following subprograms:

EIGV TIMPAR VARW

SASEQ (Subroutine) outputs to FOR002.DAT the following variables:

IASEQ	I*2	LOC	PN chip sequence.
-------	-----	-----	-------------------

SIM (Subroutine) outputs to FOR002.DAT the following variables:

I	I*2	LOC	Beam number.
IC1	I*2	LOC	Beam pointer of tap correlation calculation.
IC2	I*2	LOC	Beam pointer of tap correlation calculation.
IQ1	I*2	LOC	Beam pointer of tap gain calculation.
IQ2	I*2	LOC	Beam pointer of tap gain calculation.
ISPE	I*2	LOC	Tap spacing in nanoseconds.
I1CORR	I*2	GLO	Array of receiving beams involved in the correlation calculations.
I2CORR	I*2	GLO	Array of receiving beams involved in the correlation calculations.
PCF	R*4	LOC	Power correction factor in dB.
SNEG	R*4	LOC	Attenuation in dB.
TEMP1	R*4	LOC	Correlation coefficient.

SINT (Subroutine) outputs to FOR002.DAT the following variables:

DU	R*8	GLO	Signal response after PN sequence correlation.
----	-----	-----	--

SUBID (Subroutine) outputs to FOR002.DAT the following variables:

SNAME	R*8	ARG	Name of the subprogram that called SUBID.
-------	-----	-----	---

SUMPAG (Subroutine) outputs to SUMPAG.OUT the following variables:

AA	R*4	GLO	Atmospheric absorption loss in dB.
ALFA0	R*4	GLO	Minimum elevation angle measured from transmitter-to-receiver line to transmit horizon line in radians.
AR	R*4	GLO	Array of receiver antenna diameters in meters. AR(1) is equivalent to RDIAM in the input file.
AT	R*4	GLO	Array of transmit antenna diameters in meters. AT(1) is equivalent to TDIAM in the input file.
BER	R*4	GLO	Bit error rate thresholds of interest. Set to 1E-3, 1E-4 and 1E-5 in data statement.
BETA0	R*4	GLO	Minimum elevation angle measured from receiver-to-transmitter line to receiver horizon line in radians.
BOUT	R*4	ARG	Yearly average fade outage probability for each bit error rate threshold specified and 2S/2F and 2S diversity configurations.
CLIMAT	R*4	ARG	Climate zone indicator.
D	R*4	GLO	Great circle distance between transmitter and receiver measured at sea level in meters.
DE	R*4	GLO	Effective distance for troposcatter path in kilometers.
DIFLOS	R*4	GLO	Median diffraction path loss in dB for each value in ERFAC distribution.
DIFRSL	R*4	GLO	Median diffraction signal RSL in dBm for each value in ERFAC distribution.

			UPPER beam.
RSL	R*4	LOC	Received signal level distribution of scatter component.
SNR	R*4	LOC	SNR per bit distribution of scatter component in dB.
SP	R*4	GLO	Service probability. Default is .95.
STSNR	R*4	GLO	Standard deviation of troposcatter signal long-term SNR distribution in dB.
TAU22	R*8	ARG	Delay spread on lower beam in nsec.
TAU23	R*8	ARG	Delay spread on upper beam in nsec.
TEMP1	R*4	LOC	Reference pathloss of scatter component on lower beam.
TEMP2	R*4	LOC	Reference pathloss of scatter component on upper beam.
THER	R*4	GLO	Radio horizon elevation angle at receive site in radians.
THET	R*4	GLO	Radio horizon elevation angle at transmit site in radians.
TLOSS	R*4	LOC	Pathloss distribution of scatter component in dB.
VDE	R*4	ARG	Time variability of basic transmission loss in dB.
YO	R*4	LOC	Variability in the RSL and the path loss about the median.

PROUT (Subroutine) outputs to FOR002.DAT the following variables:

ABE	R*4	ARG	Average 1000-bit block error probability for each configuration.
ABEL	R*4	GLO	Cumulative block error probability for each diversity configuration as specified by DIVTYP (averaged over multipath distribution, if any).
BER	R*4	GLO	Bit error rate thresholds of interest. Set to 1E-3, 1E-4 and 1E-5 in data statement.
BOUT	R*4	ARG	Outage probability for each BER threshold and diversity configuration.
BOUTL	R*4	GLO	Cumulative outage probability for each diversity configuration and error rate threshold (averaged over multipath distribution, if any).
FOUT	R*4	ARG	Fade outage per call minute for each BER threshold and diversity configuration.
FOUTL	R*4	GLO	Cumulative fade outage per call minute for each diversity configuration and error rate threshold (averaged over multipath distribution, if any).
NOUT	I*2	ARG	Total number of short term calculations performed.
P	R*4	LOC	Same as BER above.

OUTDAT (Subroutine) outputs to FOR002.DAT the following variables:
 (This output is merely a summary of the input variables which are fully described in section 3.2 of the User's Manual.)

POWER (Subroutine) outputs to FOR002.DAT the following variables:

AA	R*4	GLO	Atmospheric absorption loss in dB.
ASNR	R*4	ARG	Median and/or yearly average value of troposcatter signal SNR in dB.
AVERX	R*4	GLO	Average terrain elevation above sea level between receive site and radio horizon, in meters.
AVETX	R*4	GLO	Average terrain elevation above sea level between transmit site and radio horizon, in meters.
BWR	R*4	ARG	Transmit antenna beamwidth in degrees.
BWT	R*4	ARG	Receive antenna beamwidth in degrees.
CORRLT	R*4	GLO	Correlation coefficient for long term variability of lower and upper beams.
CPL	R*4	GLO	Correlation coefficient for long term variability of lower and upper beams.
DE	R*4	GLO	Effective distance for troposcatter path in kilometers.
DEL1	R*4	LOC	Relative average delay of lower beam in nanoseconds.
DEL2	R*4	LOC	Relative average delay of upper beam in nanoseconds.
DSP1	R*4	GLO	Lower beam troposcatter signal RMS delay spread in nanoseconds for percentiles 50, 90 and 99.
DSP2	R*4	GLO	Upper beam troposcatter signal RMS delay spread in nanoseconds for percentiles 50, 90 and 99.
ERFAC	R*4	GLO	Yearly median value of effective earth radius factor k in kilometers. Default is 1.33.
HRE	R*4	GLO	Effective receiver antenna height above average terrain elevation in meters.
HTE	R*4	GLO	Effective transmitter antenna height above average terrain elevation in meters.
IBLOSS	I*2	GLO	Beam number corresponding to CPL(I).
ITER	I*2	GLO	Number of integration cells in the common volume integration.
PHED	R*4	LOC	Short term median pathloss.
PRAD	R*4	GLO	Fraction of time effective earth radius factor is greater than ERFAC; Probability that effective earth radius factor is not exceeded. For NRAD = 1 PRAD = 0.5 = 2 = 0.1 = 3 = 0.01
RH1	R*8	ARG	Correlation coefficient between lower and

MATCO (Subroutine) outputs to FOR002.DAT the following variables:

A	R*4	ARG	Noise matrix for AFE taps.
C	R*4	ARG	Covariance matrix for AFE taps.
CSUM	R*4	ARG	ISI matrix for AFE taps.

MDIF (Subroutine) outputs to FOR002.DAT the following variables:

AV1	R*4	LOC	Diffraction loss in dB.
AV2	R*4	LOC	Diffraction loss in dB.
DELE9	R*4	LOC	Diffraction path relative delay in nsec.
DIE3	R*4	LOC	Reference delay in nsec.
K	I*2	LOC	Edge number.
LB	R*4	ARG	Long term reference basic path loss in dB.
LDIF	R*4	LOC	Diffraction loss in dB.
LF	R*4	LOC	Free-space loss in dB.
PHI	R*4	LOC	Diffraction angle.
RC	R*4	LOC	Radius of curvature in meters.

MDTS (Subroutine) outputs to FOR002.DAT the following variables:

ASEP	R*4	ARG	Receiver antenna separation in meters.
ASEQ	I*2	LOC	PN chip sequence.
CGAIN	R*4	LOC	Coding gain at specified error rate threshold.
CRATE	R*4	LOC	Code rate.
DBLOSS	R*8	LOC	Attenuation of interference due to sidelobes of receiving antenna.
DEL	R*4	GLO	Diffraction path delay relative to a straight line path in seconds.
DEX	R*8	LOC	Determinant of SNR matrix.
DGRMOD	R*4	LOC	Modem degradation in dB.
DSNR	R*4	LOC	Diffraction component SNR in dB.
FSIG	R*4	LOC	Mean tap amplitudes.
JANG	R*8	LOC	Interference angle of incidence.
JBWX	R*8	LOC	Interfering signal bandwidth.
KGAIN	I*2	GLO	Integer ratio of bandwidth to data rate.
PEAKAV	R*4	GLO	Peak-to-average loss due to RF filtering in dB.
SNR	R*4	LOC	Scatter component SNR in dB.
TDIFF	R*4	GLO	Normalized relative delay between lower and upper beam.
TEMPA	R*4	ARG	Average relative delay of scatter component.
TSCAT	R*4	LOC	Normalized relative delay of scatter component.
TZ	R*4	LOC	Interferer normalized delay difference on two antennas.
TO	R*4	LOC	Normalized sampling time for AFE center tap.
U	R*8	LOC	Implicit diversity eigenvalues.
XDIFR	R*4	LOC	Fraction of received power due to diffraction component.
XSCAT	R*4	LOC	Fraction of received power due to scatter component.
Z	R*4	LOC	Transformed mean tap values.

			1 = (not allowed)
			2 = AN/TRC-170 receiver filter. Also means filter is a Butterworth.
IFILTX	I#2	GLO	Transmitter filter indicator.
			0 = MD-918 transmitter filter. Also means filter is a Butterworth cascaded with a rectangular impulse response filter of duration equal to symbol duration.
			1 = AN/TRC-170 transmitter filter. Also means filter is a cascade of Butterworth filter with rectangular impulse response filter of duration equal to half symbol duration.
			2 = (not allowed)
NPOLRX	I#2	GLO	Number of poles in the receive Butterworth filter.
NPOLTX	I#2	GLO	Number of poles in the transmit Butterworth filter.
PEAKAV	R#4	GLO	Peak-to-average loss due to RF filtering in dB.
TEMP1	R#4	LOC	99% bandwidth in MHz.

CLIFIT (Subroutine) outputs to FOR002.DAT the following variables:

ALFA	R#4	LOC	Constant in user defined 90% variability curve.
BETA	R#4	LOC	Constant in user defined 90% variability curve.
CF	R#4	LOC	Constant in user defined 90% variability curve.
C0	R#4	LOC	Constant in user defined 90% variability curve.
C1	R#4	LOC	Constant in user defined 90% variability curve.
C2	R#4	LOC	Constant in user defined 90% variability curve.

DIFSNR (Subroutine) outputs to FOR002.DAT the following variables:

ASNR	R#4	ARG	Median and/or yearly average value of diffraction path SNR in dB.
DLOSS	R#4	LOC	Diffraction path loss distribution.
DSTSNR	R#4	GLO	Standard deviation of diffracted signal long-term SNR distribution in dB.
DUPOWL	R#4	LOC	Ratio of diffraction signal on upper beam to that on lower beam in dB.
QT	R#4	LOC	Percentile not exceeded.
RSL	R#4	LOC	Received signal level distribution of diffraction component in dBm.
SNR	R#4	LOC	SNR per bit distribution of diffraction component in dB.
SP	R#4	GLO	Service probability. Default is .95.

ERRIO (Subroutine) outputs to FOR002.DAT the following variables:

I	I#2	ARG	Error number. This is followed by the corresponding error message.
---	-----	-----	--

ERROR (Subroutine) outputs to FOR002.DAT the following variables:

I	I#2	ARG	Error number. This is followed by the corresponding error message.
---	-----	-----	--

UTPUT VARIABLES

D.1 Output Variable Definitions

AVAIL (Subroutine) outputs to FOR002.DAT the following variables:

I	I*2	LOC	Section of diffraction path with Fresnel zone blockage.
PLDSS	R*4	LOC	Pathloss distribution of diffraction component.
QT	R*4	ARG	Array containing percent of time pathloss is not exceeded, i.e. time availability.
SIG	R*4	LOC	Standard deviation of predicted pathloss.
V1	R*4	LOC	Variability distribution about reference pathloss for diffraction component.
Y	R*4	ARG	Array containing pathloss variability distribution about the median in dB.

BERCAL (Subroutine) outputs to FOR002.DAT the following variables:

BERAV	R*4	LOC	Short term average bit error rate.
DSNR	R*4	ARG	Specular component SNR in dB.
FCMIN	R*4	LOC	Fade outage per call minute.
ID	I*2	LOC	Explicit diversities on the main beam.
ITOT	I*2	LOC	Total number of explicit diversities.
JPOW	R*8	ARG	Interferer power density in dBm/Hz.
JSR	R*8	ARG	Interferer to signal power ratio in dB.
P	R*8	LOC	Error rate outage threshold.
PFO	R*8	LOC	Probability that bit error rate exceeds threshold; short term outage probability.
SNR	R*4	ARG	Mean hourly SNR in dB at which outage probability is to be calculated.
SUM2	R*4	LOC	2 times average bit error probability if only one independent diversity. Otherwise 1000-bit block error probability.
XTYPE	R*8	LOC	Outputs the string identifying the diversity type.

BOTAC (Subroutine) outputs to FOR002.DAT the following variables:

K1	I*2	ARG	Number of taps in forward equalizer.
TAC	R*4	ARG	Interferer covariance matrix calculated according to RF filtering specified through IBW and JFILT parameters.
TAPW	R*4	GLO	Normalized tapwidth for MD-918. Default is .5. Range is 0.25 through 1.0

BUTFIL (Subroutine) outputs to FOR002.DAT the following variables:

FCUT	R*4	LOC	Transmission bandwidth in MHz.
FCUT1	R*4	LOC	Cut-off frequency for the transmitter.
FCUT2	R*4	LOC	Cut-off frequency for the receiver.
IFILRX	I*2	GLO	Receiver filter indicator. 0 = MD-918 receiver filter. Also means filter is a Butterworth cascaded with a rectangular impulse response filter of duration equal to symbol duration.

APPENDIX D

OUTPUT VARIABLES

This appendix describes all variables written to the output files, FOR002.DAT and SUMPAG.OUT. In the following descriptions each variable is identified by type and where it came from, ie, LOC for local, GLO for global, ARG for arguments.

The type, for variables is given as three characters:

L*1	1 byte LOGICAL (BYTE in the PDP version)
L*4	4 byte LOGICAL
I*2	2 byte INTEGER
I*4	4 byte INTEGER
R*4	4 byte REAL
R*8	8 byte REAL
C*8	8 byte COMPLEX

Y1 CAC TXPULS
/PATHGE/ R*4 TROCOM.INC
Maximum estimated integration length in Y-direction.
- Possibly given a new value in the following subprograms:
 INTLIM UNITCV
- Used but not changed in the following subprograms:
 LOOPS

Y900 /CURVE/ R*4 CURVE.INC
User supplied value for 90th percentile variability
curve Y0(90) for DE greater than or equal 900 km.
Used only when ICLIME is 2. Used to compute the
equation for the Y0(90) curve fit.
- Possibly given a new value in the following subprograms:
 CLIMIL INDATA
- Used but not changed in the following subprograms:
 CLIFIT OUTDAT

YMIN /CURVE/ R*4 CURVE.INC
User supplied value for 90th percentile variability
curve Y0(90) for DE equal to DEMIN. Used only when
ICLIME is 2. Used to compute the equation for the
Y0(90) curve fit.
- Possibly given a new value in the following subprograms:
 CLIMIL INDATA
- Used but not changed in the following subprograms:
 CLIFIT OUTDAT

YZERO /CURVE/ R*4 CURVE.INC
User supplied value for 90th percentile variability
curve Y0(90) for DE equal to 0. Used only when ICLIME
is 2.
- Possibly given a new value in the following subprograms:
 CLIMIL INDATA
- Used but not changed in the following subprograms:
 CLIFIT OUTDAT

PSPJ TPSPJ
WLT /SYSTRN/ R*4 TROCOM.INC
 Rated transmission power in Watts. Default is 1000 W.
 - Possibly given a new value in the following subprograms:
 INDATA
 - Used but not changed in the following subprograms:
 OUTDAT SUMPAG

X2INCR /NUMPAR/ R*4 NUMPAR.INC
 Step increment for numerical integration.
 - Possibly given a new value in the following subprograms:
 TRC

X3INCR /NUMPAR/ R*4 NUMPAR.INC
 Step increment for numerical integration.
 - Used but not changed in the following subprograms:
 AVG

XANG(10) /MCOM4/ R*4 MCOM.INC
 Interferer azimuth angles in degrees. Default is 0.
 - Possibly given a new value in the following subprograms:
 INDATA
 - Used but not changed in the following subprograms:
 MDTS OUTDAT

XAVAR /ANSWER/ R*4 ANSWER.INC
 Standard deviation of past ISI for AN/TRC-170.
 - Possibly given a new value in the following subprograms:
 TRC
 - Used but not changed in the following subprograms:
 POUTAG

XBVAR /ANSWER/ R*4 ANSWER.INC
 Standard deviation of future ISI for AN/TRC-170.
 - Possibly given a new value in the following subprograms:
 TRC
 - Used but not changed in the following subprograms:
 POUTAG

XINCR /NUMPAR/ R*4 NUMPAR.INC
 Step increment for numerical integration.
 - Possibly given a new value in the following subprograms:
 TRC

XTR0 /RZ4/ R*4 RZ4.INC
 Time origin for transmit-receive filter impulse
 response (TRFILT), ie, X is TRFILT(X+XTR0).
 - Possibly given a new value in the following subprograms:
 BUTFIL
 - Used but not changed in the following subprograms:
 CAC TXPULS

XTRINC /RZ4/ R*4 RZ4.INC
 Sample interval for calculation of transmit-receive
 filter impulse response (TRFILT).
 - Possibly given a new value in the following subprograms:
 BUTFIL
 - Used but not changed in the following subprograms:

Array of transmit antennas horizontal offsets in meters.
 - Possibly given a new value in the following subprograms:
 ANTGEO INDATA UNITCV
 - Used but not changed in the following subprograms:
 CHKDAT LOOPS OUTDAT STPPAR SUMPAG

UTL(NT) /PATHGE/ R*4 TROCOM.INC
 Array of transmit antennas longitudinal offsets in meters.
 - Possibly given a new value in the following subprograms:
 ANTGEO INDATA UNITCV
 - Used but not changed in the following subprograms:
 CHKDAT LOOPS OUTDAT SUMPAG

UTV(NT) /PATHGE/ R*4 TROCOM.INC
 Array of transmit antennas vertical offsets in meters.
 - Possibly given a new value in the following subprograms:
 ANTGEO INDATA UNITCV
 - Used but not changed in the following subprograms:
 CHKDAT LOOPS OUTDAT SUMPAG

VARAIS /ANSWER/ R*4 ANSWER.INC
 Past ISI variance for AN/TRC-170.
 - Possibly given a new value in the following subprograms:
 TRC

VARBIS /ANSWER/ R*4 ANSWER.INC
 Future ISI variance for AN/TRC-170.
 - Possibly given a new value in the following subprograms:
 TRC

VARISI /ANSWER/ R*4 ANSWER.INC
 Total ISI variance for AN/TRC-170.
 - Possibly given a new value in the following subprograms:
 TRC
 - Used but not changed in the following subprograms:
 PAVERG

VEIGV(20) /ANSWER/ R*8 ANSWER.INC
 Implicit diversity eigenvalues for AN/TRC-170.
 - Possibly given a new value in the following subprograms:
 EIGV TRC
 - Used but not changed in the following subprograms:
 AVG

WAVLEN /SYSTRN/ R*4 TROCOM.INC
 Wavelength in meters.
 - Possibly given a new value in the following subprograms:
 INDATA
 - Used but not changed in the following subprograms:
 ANTPAR LOOPS RGAIN STPPAR TGAJN

WFM /JAMPAR/ R*4 JAMPAR.INC
 Normalization constant for FDM/FM interference.
 - Possibly given a new value in the following subprograms:
 BWJAM
 - Used but not changed in the following subprograms:

Units of angle (deg, mrad).
 - Possibly given a new value in the following subprograms:
 UNITS
 - Used but not changed in the following subprograms:
 ANTGED OUTDAT SUMPAG

UDIST /UNIT/ R*4 IODATA.INC
 Units of distance (smi, nmi, km).
 - Possibly given a new value in the following subprograms:
 UNITS
 - Used but not changed in the following subprograms:
 INDATA OUTDAT SUMPAG

UFREQ /UNIT/ R*4 IODATA.INC
 Units of frequency (GHz, MHz).
 - Possibly given a new value in the following subprograms:
 UNITS
 - Used but not changed in the following subprograms:
 ANTGED INDATA OUTDAT SUMPAG

UHITE /UNIT/ R*4 IODATA.INC
 Units of height and diameter (ft, m).
 - Possibly given a new value in the following subprograms:
 UNITS
 - Used but not changed in the following subprograms:
 ANTGED OUTDAT SUMPAG

UFISIM(30,3) /NUMPAR/ R*4 NUMPAR.INC
 Solution of transcendental equation for each value of
 RSNRSN and bit error rate threshold of interest in
 AN/TRC-170 outase probability calculation.
 - Used but not changed in the following subprograms:
 POUTAG

URH(NR) /PATHGE/ R*4 TROCOM.INC
 Array of receive antennas horizontal offsets from
 great circle plane in meters.
 - Possibly given a new value in the following subprograms:
 ANTGED INDATA UNITCV
 - Used but not changed in the following subprograms:
 CHKDAT LOOPS OUTDAT STPPAR SUMPAG

URL(NR) /PATHGE/ R*4 TROCOM.INC
 Array of receive antennas longitudinal offsets in
 meters.
 - Possibly given a new value in the following subprograms:
 ANTGED INDATA UNITCV
 - Used but not changed in the following subprograms:
 CHKDAT LOOPS OUTDAT SUMPAG

URV(NR) /PATHGE/ R*4 TROCOM.INC
 Array of receive antennas vertical offsets in meters.
 - Possibly given a new value in the following subprograms:
 ANTGED INDATA UNITCV
 - Used but not changed in the following subprograms:
 CHKDAT LOOPS OUTDAT SUMPAG

UTH(NT) /PATHGE/ R*4 TROCOM.INC

INTLIM LOOPS LYCORK SUMPAG
 THETRF /PATHGE/ R*4 TROCOM.INC
 Transmit reference horizon elevation in radians.
 - Possibly given a new value in the following subprograms:
 TRANSF

TLL /SYSTRN/ R*4 TROCOM.INC
 Transmitter line losses in dB. Default is 0 dB.
 - Possibly given a new value in the following subprograms:
 INDATA
 - Used but not changed in the following subprograms:
 DIFSNR OUTDAT POWER SUMPAG

TODAY(9) /TSTAMP/ L*1 IODATA.INC
 Array used in PDP-11 version to hold date as
 characters.
 - Used but not changed in the following subprograms:
 MAIN OUTDAT SUMPAG

TPAR(20) /ANSWER/ R*4 ANSWER.INC
 Timing parameter for AN/TRC-170. Calculated when
 IOTIME is 0.
 - Possibly given a new value in the following subprograms:
 TRC

TRFILT(128) /RZ4/ R*4 RZ4.INC
 Transmit-receive filter impulse response.
 - Possibly given a new value in the following subprograms:
 BUTFIL
 - Used but not changed in the following subprograms:
 CAC TXPULS

TROLOS(3) /SUMP/ R*4 CURVE.INC
 Median troposcatter path loss in dB for each value in
 ERFAC distribution.
 - Possibly given a new value in the following subprograms:
 POWER
 - Used but not changed in the following subprograms:
 SUMPAG

TRORSL(3) /SUMP/ R*4 CURVE.INC
 Median troposcatter RSL in dB for each value in ERFAC
 distribution.
 - Possibly given a new value in the following subprograms:
 POWER
 - Used but not changed in the following subprograms:
 SUMPAG

TSEP(3) /IODATA/ R*4 IODATA.INC
 Separation between transmit antennas in meters.
 - Possibly given a new value in the following subprograms:
 ANTGEO INDATA

TWOPI /CONSTA/ R*4 CONSTANTS.INC
 $2 \times \text{Pi} = 6.283185307$.
 - Used but not changed in the following subprograms:
 LOOPS RJCFCN STPPAR

UANGLE /UNIT/ R*4 IODATA.INC

TFAKY1 STEPAB
 /STPCOM/ R*4 STPCOM.INC
 Constant for common volume integration.
 - Possibly given a new value in the following subprograms:
 STPPAR
 - Used but not changed in the following subprograms:
 STEPY

TFAKY2 /STPCOM/ R*4 STPCOM.INC
 Constant for common volume integration.
 - Possibly given a new value in the following subprograms:
 STPPAR
 - Used but not changed in the following subprograms:
 STEPY

TFAKY3 /STPCOM/ R*4 STPCOM.INC
 Constant for common volume integration.
 - Possibly given a new value in the following subprograms:
 STPPAR
 - Used but not changed in the following subprograms:
 STEPY

TFAKY4 /STPCOM/ R*4 STPCOM.INC
 Constant for common volume integration.
 - Possibly given a new value in the following subprograms:
 STPPAR
 - Used but not changed in the following subprograms:
 STEPY

THER /PATHGE/ R*4 TROCOM.INC
 Radio horizon elevation angle at receive site in
 radians.
 - Possibly given a new value in the following subprograms:
 INDATA UNITCV
 - Used but not changed in the following subprograms:
 DIFSNR INTLIM JAMCOM LTCORR MAIN OUTDAT POWER SUMPAG
 TRANSF

THERRF /PATHGE/ R*4 TROCOM.INC
 Receive reference horizon in radians.
 - Possibly given a new value in the following subprograms:
 TRANSF

THET /PATHGE/ R*4 TROCOM.INC
 Radio horizon elevation angle at transmit site in
 radians.
 - Possibly given a new value in the following subprograms:
 INDATA UNITCV
 - Used but not changed in the following subprograms:
 DIFSNR INTLIM LOOPS MAIN OUTDAT POWER SUMPAG TRANSF

THETA0 /PATHGE/ R*4 TROCOM.INC
 Scattering angle at bottom of common volume in
 radians.
 - Possibly given a new value in the following subprograms:
 TRANSF UNITCV
 - Used but not changed in the following subprograms:

TOTO(20) /IOUT/ R*4 IOUT.INC
 Array of sampling times (normalized to symbol duration) for calculation of short term AN/TRC-170 performance.
 - Used but not changed in the following subprograms:
 TRC

TAPOUT /PDATA/ L*4 PDATA.INC
 If true, the simulator tap values are output to the output file, FOR002.DAT. Default is TRUE.
 - Possibly given a new value in the following subprograms:
 INDATA
 - Used but not changed in the following subprograms:
 SUMPAG

TAPW /MCOM4/ R*4 MCOM.INC
 Normalized tapwidth for MD-918. Default is .5.
 Range is 0.25 through 1.0
 - Possibly given a new value in the following subprograms:
 INDATA SIGIN
 - Used but not changed in the following subprograms:
 BOTAC CAJI CAKL JAMCOM MAIN MATCO OUTDAT

TDEV /NUMPAR/ R*4 NUMPAR.INC
 Standard deviation of sampling times for AN/TRC-170 performance calculations.
 - Used but not changed in the following subprograms:
 TRC

TDIFF /MCOM4/ R*4 MCOM.INC
 Normalized relative delay between lower and upper beam.
 - Possibly given a new value in the following subprograms:
 MDT5 POWER
 - Used but not changed in the following subprograms:
 DINT MATCO

TEMPA(NCORMX) /PDATA/ R*4 PDATA.INC
 Array of average troposcatter signal delays for each beam relative to straight line in seconds.
 - Possibly given a new value in the following subprograms:
 LOOPS
 - Used but not changed in the following subprograms:
 MAIN POWER SUMPAG

TERFAC(3) /ERAD/ R*4 ERAD.INC
 The three values of ERFAC when MDIST is 1.
 - Possibly given a new value in the following subprograms:
 INDATA
 - Used but not changed in the following subprograms:
 MAIN

TFAK /STPCOM/ R*4 STPCOM.INC
 Constant for common volume integration.
 - Possibly given a new value in the following subprograms:
 STPPAR
 - Used but not changed in the following subprograms:

DIVTYP	I*2	GLO	Diversity configuration indicator. Default is 0.
DLR	R*4	GLO	Distance from receiver to radio horizon.
DLT	R*4	GLO	Distance from transmitter to radio horizon.
DSTSNR	R*4	GLO	Standard deviation of diffracted signal long-term SNR distribution in dB.
ERFAC	R*4	GLO	Yearly median value of effective earth radius factor k in kilometers. Default is 1.33.
ERR	R*4	GLO	Integration resolution. Default is .001.
F	R*4	GLO	Operating frequency in Hz.
FOUT	R*4	ARG	Yearly average fade outage probability per call minute for each bit error rate threshold specified and 2S/2F and 2S diversity configurations.
HCOM	R*4	GLO	Effective height of the bottom of the common volume.
HHIGH	R*4	GLO	Effective height of the top of the common volume.
HLR	R*4	GLO	Receiver radio horizon elevation above sea level.
HLT	R*4	GLO	Transmit radio horizon elevation above sea level.
ITER	I*2	GLO	Number of integration cells in the common volume integration.
JPOW	R*8	ARG	Interference signal power density in dBm/Hz.
LNAME	I*2	GLO	Link name. Transmitter site first, receiver site second. Used as link identifier on output files FOR002.DAT and SUNPAG.OUT.
LUNITS	I*2	GLO	Integer value that specifies the set of units requested by the user. These units are for path, antenna location, angle, and frequency parameters. Default is 8.
NACCU	I*2	GLO	Parameter used as truncation point for common volume integration termination. Default is 40.
NEWCL	I*2	GLO	New climate type character strings.
NDW	L*1	GLO	Array used in PDP-11 version to hold time of day as characters.
NPAG	I*2	LOC	Page number.
NT	I*2	GLO	Number of transmit ports.
PSIRE0	R*4	GLO	Array of receiver beam boresight elevations above radio horizon in radians, ie, angle at which each antenna is aimed relative to the horizon. PSIRE0(1) is the main receive antenna.
PSITE0	R*4	GLO	Array of transmitter beam boresight elevations above radio horizon in radians, ie, angle at which each antenna is aimed relative to the horizon. PSITE0(1) is the main transmit antenna.
QCORR	R*4	GLO	Contains elements of covariance matrix, ie,

powers and correlations.

S	R*4	GLO	Troposcatter path asymmetry parameter.
SCPARM	R*4	GLO	Wavenumber spectrum slope parameter M. Default is 3.66.
STSNR	R*4	GLO	Standard deviation of troposcatter signal long-term SNR distribution in dB.
THER	R*4	GLO	Radio horizon elevation angle at receive site in radians.
THET	R*4	GLO	Radio horizon elevation angle at transmit site in radians.
THETA0	R*4	GLO	Scattering angle at bottom of common volume.
TODAY	L*1	GLO	Array used in PDP-11 version to hold date as characters.
TROLOS	R*4	GLO	Median troposcatter path loss in dB for each value in ERFAC distribution.
TRORSL	R*4	GLO	Median troposcatter RSL in dBm for each value in ERFAC distribution.
UANGLE	R*4	GLO	Units of angle (deg, rad).
UDIST	R*4	GLO	Units of distance (smi, nmi, km).
UFREQ	R*4	GLO	Units of frequency (GHz, MHz).
UHITE	R*4	GLO	Units of height and diameter (ft, m).
URV	R*4	GLO	Array of receive antennas vertical offsets.
UTV	R*4	GLO	Array of transmit antennas vertical offsets.

TRC (Subroutine) outputs to FOR002.DAT the following variables:

DAUX1	R*8	LOC	Implicit diversity eigenvalues for AN/TRC-170.
ENMEAN	R*4	GLO	Average received energy.
PAVG	R*4	GLO	Short-term average bit error rate for each sampling time and short-term average SNR.
POUT	R*4	GLO	AN/TRC-170 outage probability and average bit error rate as a function of sampling time, short-term average SNR and error rate threshold.
PYEAR	R*4	ARG	Yearly statistics. PYEAR(1,.) is yearly outage probability and PYEAR(2,.) is yearly fade outage probability per call minute for each BER threshold.
SNDB	R*4	GLO	Signal to noise ratio in dB.
SNRLOS	R*4	LOC	SNR loss in dB.
TO	R*4	GLO	Normalized sampling time for lower beam.
TOTO	R*4	GLO	Array of sampling times (normalized to symbol duration) for calculation of short term AN/TRC-170 performance.
VEIGV	R*8	GLO	Implicit diversity eigenvalues for AN/TRC-170.
X	R*4	LOC	Error rate threshold.

TRCIN (Subroutine) outputs to FOR002.DAT the following variables:

BW99	R*4	LOC	
CDUR	R*4	GLO	Duration of transmitted pulse for AN/TRC-170 normalized to signaling interval duration.

IPULS	I*2	GLO	Switch to indicate whether pulse shape at input of the AN/TRC-170 detector includes the effects of RF filters (IPULS = 2) or not (IPULS = 0 or 1). Set to 2
NCHIP	I*2	GLO	Number of chips in PN sequence used to expand bandwidth in AN/TRC-170.
NDIVS	I*2	GLO	Number of explicit diversity channels for AN/TRC-170. Equal to 4 for 2S/2F and 2 for 2S or 2F.
PEAKAV	R*4	GLO	Peak-to-average loss due to RF filtering in dB.
X	R*4	LOC	2*sigma multipath spread/symbol interval.
TROPO	(Program) outputs to FOR002.DAT the following variables:		
MRAD	I*2	GLO	Loop limit for MRAD. Default is 1. (MRAD is 1 for MRIST = 0 and MRAD is 3 for MDIST = 1).
NOW	L*1	GLO	Array used in PDP-11 version to hold time of day as characters.
NRAD	I*2	GLO	ERFAC indicator and loop counter. Default is 1.
TODAY	L*1	GLO	Array used in PDP-11 version to hold date as characters.

SUBPROGRAM INDEX

ASOFCC	8-4
ANTGEO	3-2
ANTPAR	5-4
ANTPTR	5-5
ATMOS	5-6
AVAIL	6-3
AVG	10-4
AVTER	5-7
BEAMPT	5-8
BERCAL	9-4
BOTAC	9-7
BUTFIL	8-5
BWJAM	8-8
CAC	9-9
CAJI	9-11
CAKL	9-12
CHANGE	9-13
CHKDAT	4-2
CLIFIT	7-2
CLIME	7-3
CLIMIL	7-4
CLIMIX	7-5
CONVOL	6-5
DEIND	7-6
DELO	5-9
DIF1	6-6
DIFSNR	6-7
DINT	9-14
EIGEN	9-16
EIGV	10-5
ELMES	9-17
ENRGF	8-11
ERFC	5-10
ERLANG	9-18
ERRID	3-5
ERROR	4-4

FCCMSK	8-12
FFT	8-13
FRQSEP	5-11
FUNBW	8-14
FUNJAM	8-16
GPATT	5-12
HORANG	5-13
HQR	9-19
INDATA	3-6
INTERB	8-17
INTERD	10-7
INTERP	6-10
INTLIM	5-14
JAMCOM	9-20
LOOPS	5-17
LTCORR	5-22
MATA	9-22
MATCO	9-23
MDIF	6-11
MDTS	9-26
MINV	9-29
ORDER	9-30
OUTDAT	3-16
P2INT	10-8
PAVERG	10-9
PDF	10-10
PDFCOE	10-11
PDFCON	9-31
PDFSUM	10-12
PEAK	8-18
POUTAG	10-13
POWER	5-24
PROFIL	10-15
PROUT	9-32
PSINE	9-34
PSPEC	8-19
PSPEC1	8-20
PSPEC2	8-21
PSPJ	8-22
PWRSPC	9-35

RGAIN	5-31
RIPROF	5-32
RJCFCN	9-36
RTMI	8-24
SAMPLE	8-25
SASEQ	9-37
SEARCH	8-26
SECTOR	3-25
SIGIN	9-38
SIM	11-2
SINC	9-40
SPEC	8-28
SPEC1	8-29
SPEC2	8-31
SQTMAT	9-41
STEPAR	5-33
STEPY	5-34
STPPAR	5-35
SUBID	4-5
SUMPAG	11-4
TANGL	6-13
TGAIN	5-37
TIMAVG	10-16
TIMEQL	10-17
TIMPAR	10-18
TPSPEC	9-42
TPSPJ	9-43
TRANSF	5-38
TRC	10-19
TRCIN	10-23
TRLOSS	5-41
TROPO	2-3
TSINC	9-45
TXPULS	10-26
UNITCV	3-26
UNITS	3-31
VARPOL	7-7
VARW	10-28
VDECAL	7-8
XNOR	9-46
YINT	7-9

END

FILMED

4-85

DTIC