

2

REPORT CONTROL SYMBOL DD-M(A)1592

AD-A259 313

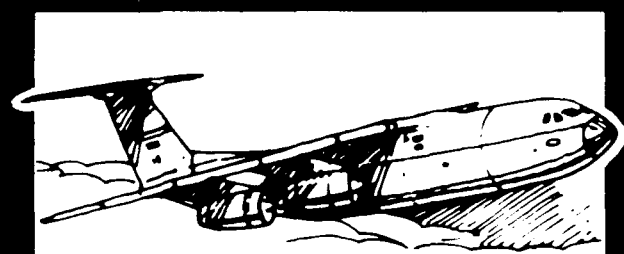
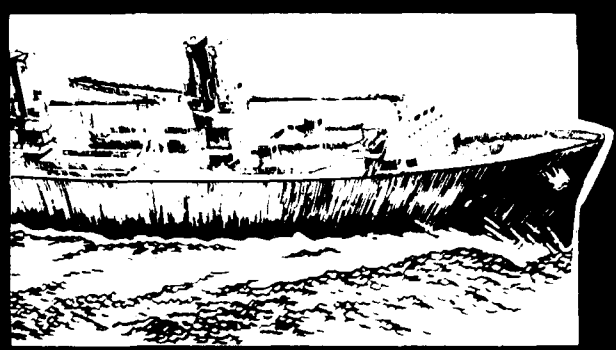
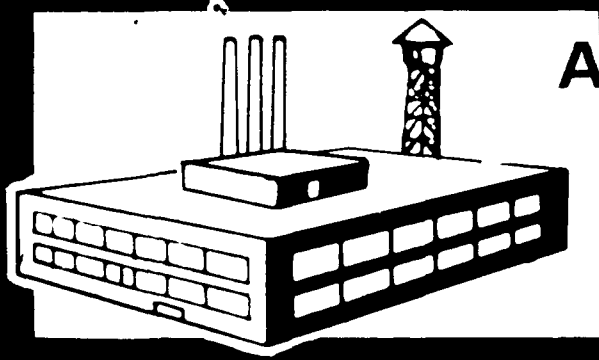

93-00282



148pa



DTIC
ELECTE
S C D
JAN 5 1993

1992 CONTAINER SYSTEM HARDWARE

STATUS REPORT



y

Distribution is unlimited.

Intermodal Schematic

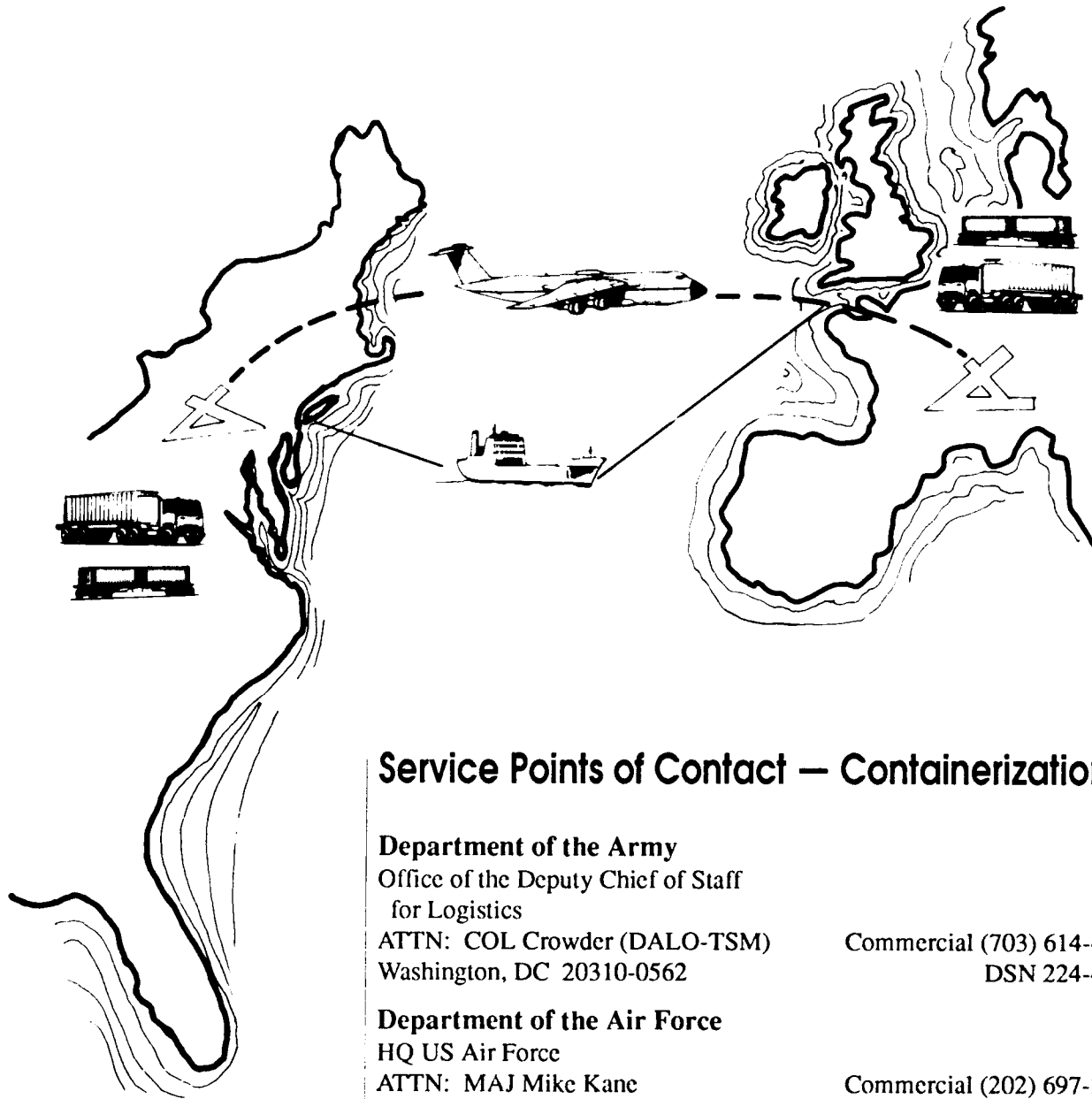

Service Points of Contact – Containerization

Department of the Army

Office of the Deputy Chief of Staff
for Logistics

ATTN: COL Crowder (DALO-TSM)
Washington, DC 20310-0562

Commercial (703) 614-4128
DSN 224-4128

Department of the Air Force

HQ US Air Force

ATTN: MAJ Mike Kane
Washington, DC 20330-5130

Commercial (202) 697-3371
DSN 227-3371

US Marine Corps

Commanding General
Systems Command

ATTN: Mr. Spires (Code SSCGP)
Quantico, VA 22134-5080

Commercial (703) 640-4354
DSN 278-4354

Department of the Navy

Naval Supply Systems Command

ATTN: Mr. Crawmer (Code SUP441C)
Washington, DC 20376-5000

Commercial (703) 607-2410
DSN 327-3991

Foreword

Today, virtually all of the commercial products and equipment shipped overseas, as well as by rail, are shipped using some form of intermodal container. The Merchant Marine Industry has made the transition from the breakbulk fleet of the past to the current containership fleet. Because of the Merchant Marine Industry's impact on the transportation of supplies by sea, the Department of Defense (DOD) has placed an increasing emphasis on containers to deploy and support forces in overseas contingency situations.

This publication was initiated in 1977 by the former office of the Project Manager, Army Container Oriented Distribution System, to provide information to Army activities. The Joint Intermodal Steering Group requested that the status of the other Services' containerization programs be included, beginning with the January 1979 issue. In November 1981, publication responsibility was transferred to the US Army Belvoir Research, Development and Engineering Center (BRDEC). BRDEC has published the report yearly, except for 1987 and 1988, in accordance with DOD Directive 4500.37 (Management of the DOD Intermodal Container System).

Within DOD, the deployments within the past few years have resulted in increased visibility of containers and the equipment used to handle the containers. The deficiencies in the containerization system within DOD are being addressed and efforts made to correct the deficiencies to ensure an efficient movement of cargo through the intermodal containerization system. In addition to the deficiencies, the deployments have resulted in the changing role of the intermodal container from a strategic container providing a mode of transport to the theater to a strategic as well as tactical container.

Mr. Norman Fertman is the project director and Mr. William Brower is the technical coordinator for this report. Mr. Brower may be reached at DSN 654-3613, Commercial (703) 704-3613, or FAX (703) 704-2306. Comments on this report are welcomed and may be submitted to:

Commander
US Army Belvoir RD&E Center
ATTN: SATBE-FMR
Fort Belvoir, VA 22060-5606

Comments or questions on particular pieces of equipment should be referred to the point of contact shown for that particular program.



NORMAN H. FERTMAN
Project Director
Logistics Equipment Directorate
Belvoir RD&E Center

1992 Container System Hardware

Contents

	Page
PART I. CONTAINERS	1
MILVAN—Ammunition Restraint.....	3
MILVAN—General Cargo	5
20' ISO End-Opening Container	7
Deployable Medical (DEPMED) Container	9
20' Shipping/Storage Container (Bulk and Configured).....	11
20' ISO Side-Opening Container.....	13
Refrigerated Container	15
20' Half-Height Container.....	17
ISO Tactical Shelter	19
Mobile Facility (MF) Program.....	21
TRICON-Shipping/Storage Container (Bulk and Configured).....	23
Quadruple Container (QUADCON)	25
Equipment Deployment and Storage System (EDSS)	27
Shipping Frame, 4' x 6 ² / ₃ ' x 8'.....	29
Shipping Frame, 8' x 8' x 10'.....	31
Palletized Load System (PLS) Logistics.....	33
20' Flatrack	35
40' Heavy Duty Flatrack	37
Load and Roll Pallet (LRP).....	39
PART II. CONTAINER UNLOADING EQUIPMENT	41
4,000-Pound Capacity Forklift Truck	43
4,000-Pound Capacity Rough Terrain, Forklift Truck (4K RTFLT).....	45
Mobile Loading Ramp	47
6,000-Pound Capacity Variable Reach Rough Terrain Forklift Truck (VVRTFLT)	49
All Terrain Lifter, Articulated System (ATLAS)	51
Extendable Boom Forklift (EBFL)	53
PART III. CONTAINER HANDLING EQUIPMENT	55
Spreader Bars, Intermodal Container Handling	57
Crane, 14-Ton, Wheel-Mounted, ISO Container Handling	59
Rough Terrain Container Crane (RTCC)	61
140-Ton, Truck-Mounted Container Handling Crane	63
Lightweight Amphibious Container Handler (LACH)	65
Container Lifting Semitrailer	67
50,000-Pound Capacity Container Handler, Rough Terrain (RTCH)	69

	Page
20/40' Container Sideloader	71
Palletized Load System (PLS)	73
Logistics Vehicle System	75
PART IV. GROUND TRANSPORTATION EQUIPMENT	77
Chassis, Semitrailer: Coupleable, MILVAN Container Transporter	79
Semitrailer, Linehaul, Breakbulk/Container, M872 Series	81
Semitrailer, Tactical, Dual Purpose Breakbulk/ Container Transporter, 22 ¹ / ₂ -Ton, M871 Series.....	83
Truck Tractor, Yard Type, 4 x 2, M878A1	85
Truck Tractor, Linehaul, 6 x 4, M915 Series	87
5-Ton Truck Bed with ISO-Configured Locking Devices	89
Truck, Stake, 6 x 6, 15-Ton, 46,000 GVW, with ISO Lock	91
Railway Car, Flat (Heavy Duty), 150-Ton Capacity, Domestic Service.....	93
PART V. LOTS, HARBOR, AND CONTAINER OFFLOADING AND TRANSFER EQUIPMENT	95
SEASHED System	97
Floating Causeway (FC)	99
Elevated Causeway, Modular (ELCAS (M))	101
Roll-On/Roll-Off Discharge Facility (RO/RO DF)	103
Causeway Section, Powered (CSP).....	105
Modular Causeway Ferry (MCF).....	107
Lighter Air Cushion Vehicle, 30 Ton (LACV-30).....	109
Pontoon Air Cushion Kit (PACK).....	111
Landing Craft, Utility (LCU) 2000	113
Logistics Support Vessel (LSV).....	115
Fast Logistic Ship (T-AKR) Program	117
Auxiliary Crane Ship (T-ACS).....	119
High Sea State Container Transfer System (HISEACOTS)	121
Automated All-weather Cargo Transfer System (AACTS)	123
Cantilevered Lift Frame (CLF).....	125
PART VI. AERIAL PORT/TERMINAL EQUIPMENT	127
Avionics Intermediate Shop (AIS) Shelter Movement	129
Elevator Loader.....	131
25,000-Pound 463L Aircraft Loader.....	133
40,000-Pound 463L Aircraft Loader.....	135
35-Ton Bridge Crane.....	137
PART VII. DELETED PROGRAMS	139
ACRONYMS AND ABBREVIATIONS	143

Part I Containers

THIS QUALITY EXPECTED 1

Accession For	
NTIS Serial	<input checked="" type="checkbox"/>
DTIC TAB	<input type="checkbox"/>
Unannounced	<input type="checkbox"/>
Justification	
By	
Distribution/	
Availability Codes	
Dist	Avail and/or Special
A-1	

MILVAN - Ammunition Restraint

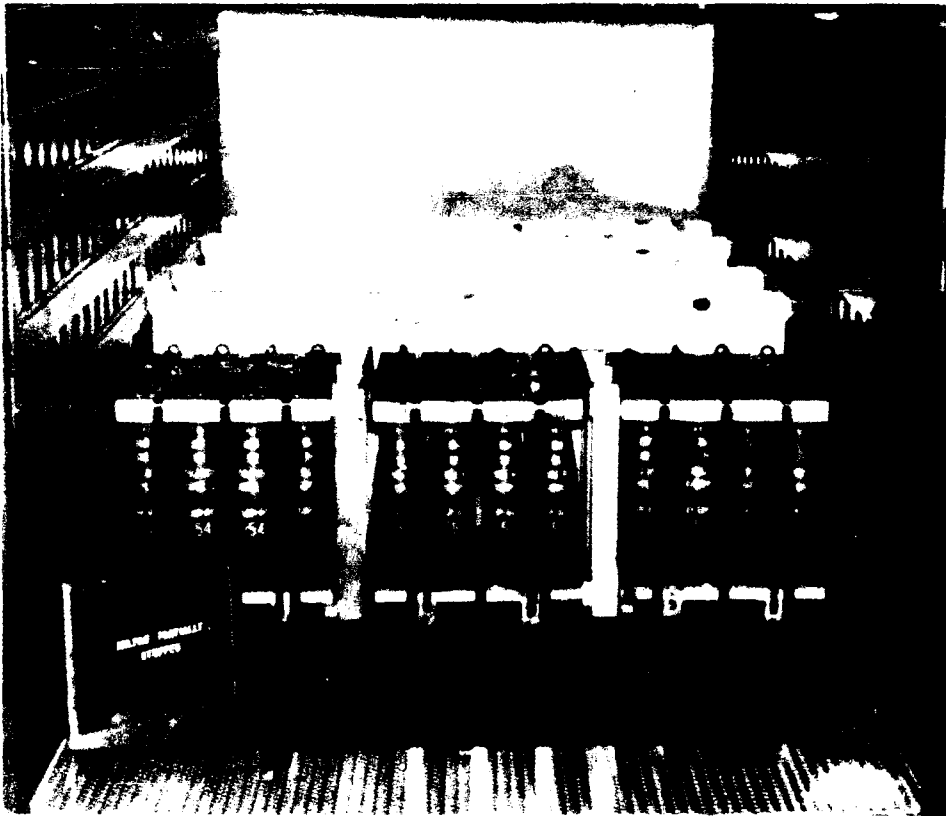

LENGTH	20'
WIDTH	8'
HEIGHT	8'
WEIGHT (EMPTY)	5,785 pounds
GROSS WEIGHT (DESIGNED)	44,800 pounds

MILVAN - Ammunition Restraint

POINT OF CONTACT

Mr. Philip Barickman
US Army Belvoir RD&E Center, SATBE-FMR
Fort Belvoir, VA 22060-5606
DSN 654-2297/Commercial (703) 704-2297

ITEM DESCRIPTION

The MILVAN ammunition restraint container is an American National Standards Institute (ANSI)/International Organization of Standardization (ISO) container equipped with restraint hardware capable of handling approximately 20 long tons of ammunition. The restraint system consists of eight slotted steel rails permanently installed on each side wall and 25 adjustable crossbars that can be inserted in the slotted rails. Its use at full rated load has been approved by the US Coast Guard and the Association of American Railroads. The MILVAN container is 8' x 8' x 20', and weighs 5,785 pounds including 1,300 pounds for the restraint system. Some 8' x 8.5' x 20' containers have been procured and are currently in the Army inventory. Both the 8' and 8.5' MILVANs were procured.

STATUS

The Army procured 4,500 MILVAN ammunition restraint containers and there are 4,241 in the present inventory. A total of 249 MILVANs, each 8' x 8.5' x 20' with composite flooring and corrosion resistant steel, were procured. A total of 1,395 MILVANs, each 8' x 8' x 20', have been procured from American Coastal Industries under a contract awarded on 30 September 1989. As of 31 January 1992, 1,253 containers have been delivered to the Army.

PROGRAM PLAN

Monitor and provide engineering assistance during the remaining period of performance of the contract. The remaining 142 containers should be delivered during FY93.

NSNs

8' x 8' x 20': 8115-00-151-9953
8' x 8.5' x 20': 8115-01-220-9527

MILVAN - General Cargo

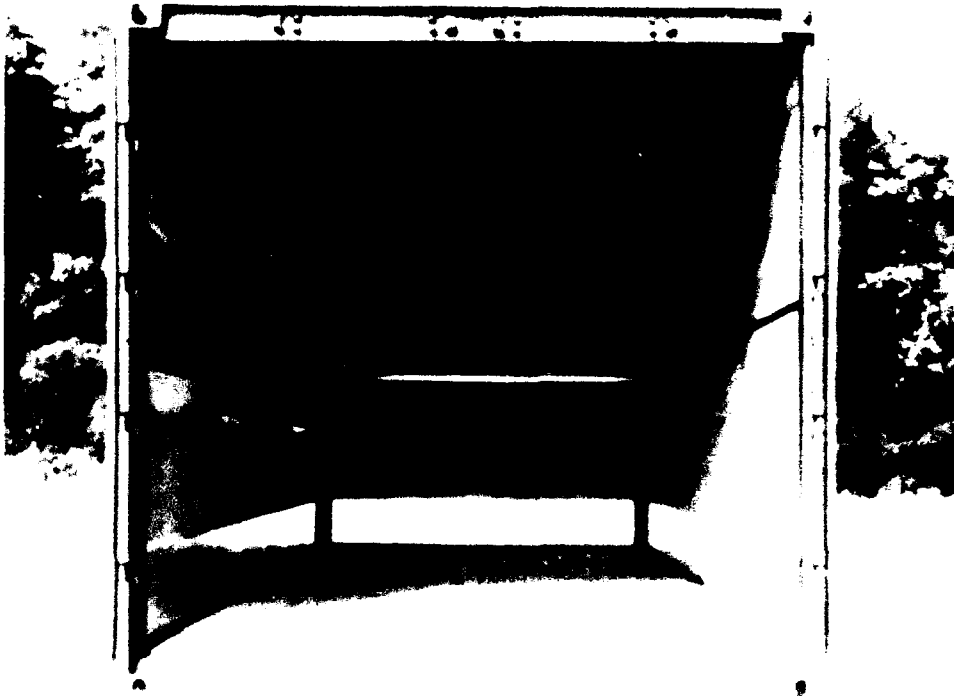

LENGTH	20'
WIDTH	8'
HEIGHT	8'
VOLUME INSIDE	1,060 cubic feet
WEIGHT (EMPTY)	4,700 pounds
GROSS WEIGHT (DESIGNED)	44,800 pounds

MILVAN - General Cargo

POINT OF CONTACT

Mr. Philip Barickman
US Army Belvoir RD&E Center, SATBE-FMR
Fort Belvoir, VA 22060-5606
DSN 654-2297/Commercial (703) 704-2297

ITEM DESCRIPTION

The MILVAN provides a capability of handling up to 20 long tons of general cargo. It is used to transport and temporarily store military cargo. The MILVAN dimensions are 8' x 8' x 20', weighs 4,770 pounds when empty, and has an internal volume of 1,060 cubic feet. The MILVAN is designed to ANSI/ISO standards and procured to military performance specification MIL-C-52661. The container is of steel construction with hardwood flooring and the walls are lined with plywood.

STATUS

The Army has procured a total of 2,200 MILVAN general cargo containers. The International Convention for Safe Containers (CSC) was ratified by the United States 3 January 1978. The US Coast Guard, as the implementing agency, issued approval to the Army for the existing MILVAN fleet on 9 November 1978. With depot participation, the container inventory was refurbished and the CSC approval plate mounted beginning in 1978.

PROGRAM PLAN

There is no current plan to procure additional quantities of MILVANs.

NSN

8115-00-168-2275

20' ISO End Opening Container

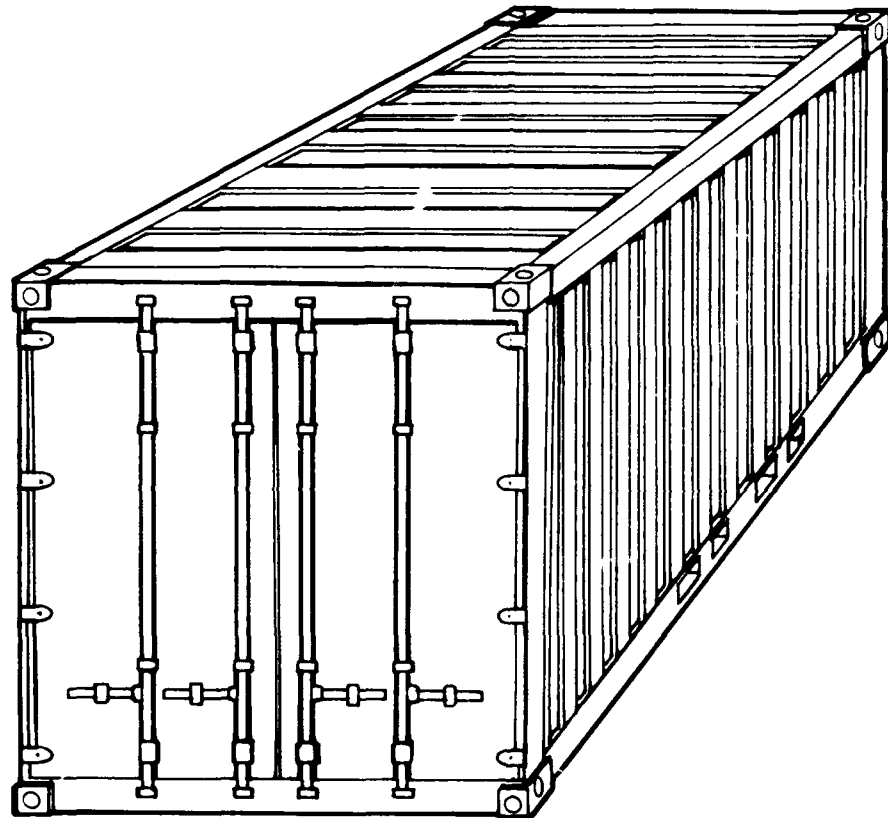

20' ISO End Opening Container

POINT OF CONTACT

Mr. Doug Chesnulovitch
PM-AMMOLOG, AMCPM-AL
Picatinny Arsenal, NJ 07806-5000
DSN 880-4737/Commercial (201) 724-4737

ITEM DESCRIPTION

The 20' ISO end opening container is a non-developmental item being used by the US Army to transport munitions. Since the container is ISO, it can be transported readily by commercial and military conveyances and handled by container handling equipment from the top by the corner fittings or from the bottom by the forklift pockets. The door end corner posts have been modified with angle iron to enhance blocking and bracing for munitions. The container does not have a permanent restraint system like the Restraint MILVAN. A new system of wooden blocking and bracing is being used to restrain all types of munitions within the container.

STATUS

In FY91, 3,950 containers were procured by Military Sealift Command for the US Army to support the retrograde of munitions from Southwest Asia during FY92. The containers are under control of the Joint Container Control Office.

PROGRAM PLAN

Program completed.

NSN

Not assigned

Deployable Medical (DEPMED) Containers

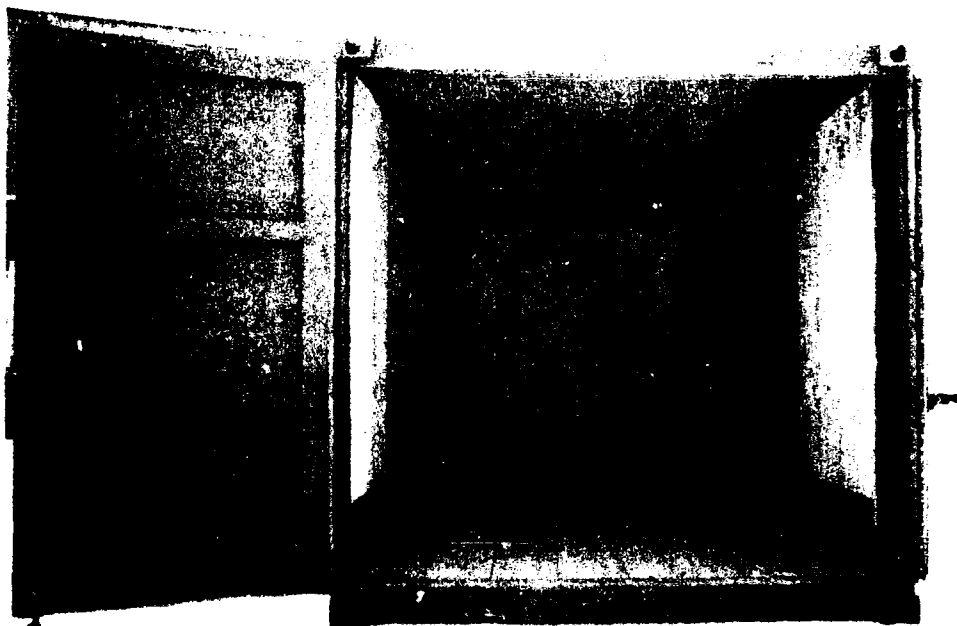

LENGTH	20'
WIDTH	8'
HEIGHT	8'
TARE WEIGHT	5,150 pounds
GROSS WEIGHT	44,800 pounds

Deployable Medical (DEPMED) Containers

POINT OF CONTACT

Mr. Tom Lavin
US Army Aviation and Troop Command, AMSAT-W-TV
4300 Goodfellow Blvd.
St. Louis, MO 63120-1798
DSN 693-2567/Commercial (314) 263-2667

ITEM DESCRIPTION

The DEPMED containers are used in direct support of the Surgeon General's fielding of the Deployable Medical Systems. They are used for shipping and storage of components for various operating rooms, medical support, and laboratories which comprise the Deployable Medical Systems. The DEPMED Container is an 8' x 8' x 20' ISO container with both end and side doors. The DEPMED container is designed to ANSI/ISO standards and is produced from a military performance specification. The container is constructed of steel with hardwood flooring, and the interior walls are lined with plywood.

STATUS

A contract was awarded to Mid-States Metal Lines, Grandview, MO, for 4,339 containers on 11 May 1988. A fourth year option of 1,171 containers has not been exercised on this contract. As of 29 February 1992, 2,958 containers have been delivered.

PROGRAM PLAN

Continue to receive and field the DEPMED containers.

NSN

8115-01-241-7524

20' Shipping/Storage Container

(Bulk & Configured)

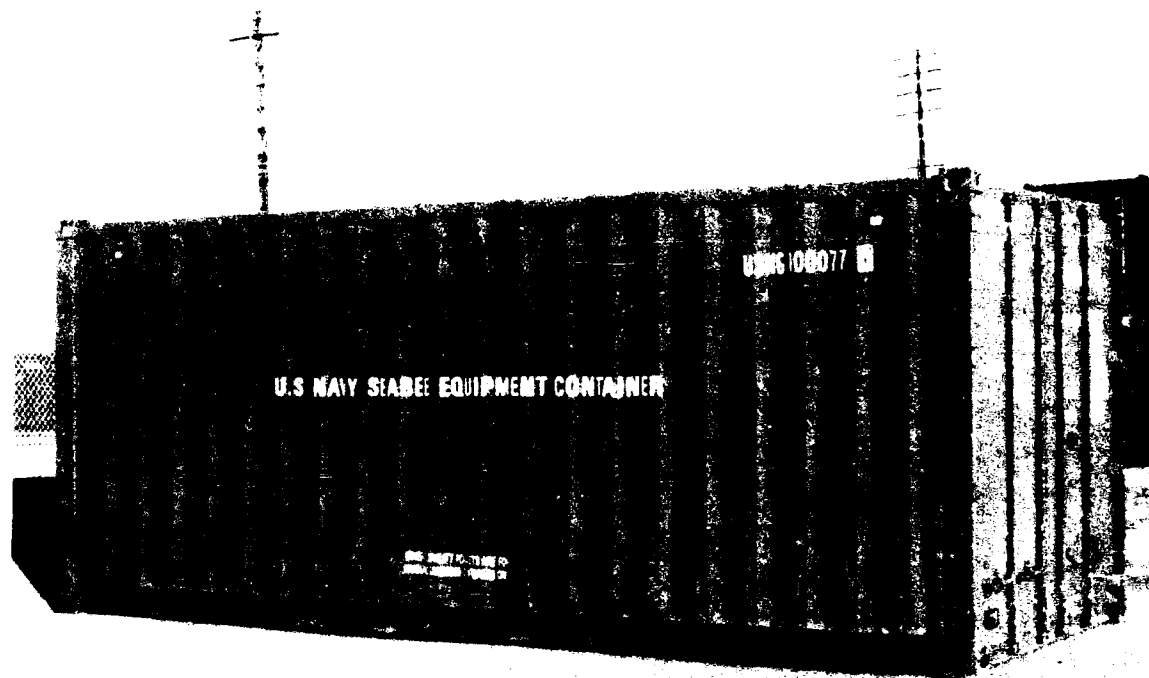

20' Shipping/Storage Container

(Bulk & Configured)

POINT OF CONTACT

Mr. Jamie Cannon
Naval Construction Battalion Center (CESO Code 1573)
Port Huene, CA 93043-5000
DSN 551-1895/Commercial 805-982-1895

ITEM DESCRIPTION

The 20' storage container is an 8' high x 8' wide x 20' long lockable, watertight, reusable container. It is of all steel construction with standard ISO corner fittings and two sets of forklift pockets for moving empty or loaded containers. Containers are designed to ISO standards. Two types of containers are being procured: Bulk and Configured. Configured containers may consist of cabinets with drawers or shelves, rifle racks, or a combination thereof to make up storerooms and armories.

- Cabinets with drawers or shelves are available in three sizes: 30" wide x 27 3/4" deep
45" wide x 27 3/4" deep
60" wide x 27 3/4" deep
- Usable drawer heights range from 2" to 13"
- Shelf heights are adjustable in 1" increments.

Currently, six different styles of storeroom configurations plus an armory configuration are being procured.

STATUS

A contract was awarded in May 1986 to J. D. Bertolini Industries, Limited, for 1,171 Bulk and 641 storeroom/armory Configured containers. Deliveries began in FY89 and were completed in FY91. A second contract was awarded in September 1991 to LBCO, Inc., for 389 Bulk and 44 Configured containers. Deliveries began in July 1992.

PROGRAM PLAN

Upon completion of the second contract, no further procurement actions are planned.

NSNs

Bulk: 8145-01-287-8567

20' ISO Side-Opening Container

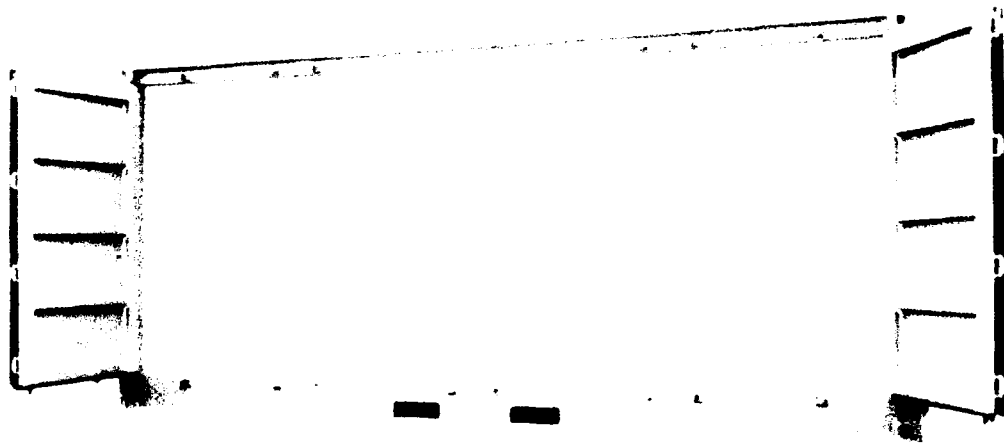
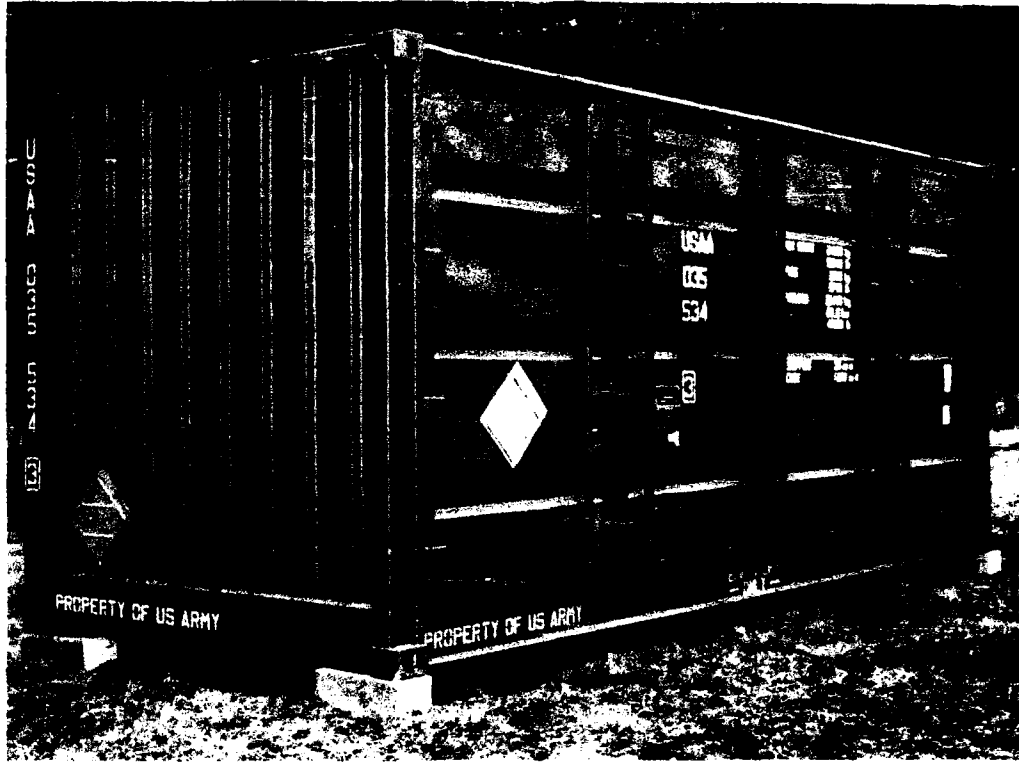

20' ISO Side-Opening Container

POINTS OF CONTACT

CAPT Jurgen Smith
HQ, US Air Force Europe, LGWRX, Unit 3050 Box 105
Ramstein AB, GE, APO AF 09094-5000
DSN 480-6688/Commercial 011-49-6371-47-6688

Mr. Philip Barickman
US Army Belvoir RD&E Center, SATBE-FMR
Fort Belvoir, VA 22060-5606
DSN 654-2297/Commercial (703) 704-2297

ITEM DESCRIPTION

The 20' ISO side-opening container is an ISO container with two double doors located on one side of the container which fully opens to allow unobstructed access to its contents. The side-opening container is a non-developmental item and can be transported by commercial and military conveyances. The container has internal tiedown rings which can be used to secure cargo during shipment.

STATUS

Due to an urgent need to improve munitions storage and handling capability in USAFE, HQ USAFE released a Request for Proposal (RFP) to purchase 20' side-opening ISO containers in FY86. A total of 1,200 side-opening containers were procured by USAFE and are being used to store and transport munitions.

During FY91, Military Sealift Command procured 625 side-opening containers from American Coastal Industries for the Army. The containers were procured in support of the retrograde of munitions from Southwest Asia and are now under control of the Joint Container Control Office.

PROGRAM PLAN

HQ USAFE submitted a Procurement Objective Memorandum initiative for the purchase of 1,500 ISO containers per year from FY94 through FY97. If funded, the 6,000 additional containers will provide USAFE the capability to ship All-Up-Round, containerized ordnance to any place on the globe. The Army has no plans to procure additional side-opening containers.

NSNs

USAF: 2 Fork Pockets: 8145-L900411D
USAF: 4 Fork Pockets: 8145-L900412D
Army: Not yet assigned

Refrigerated Container

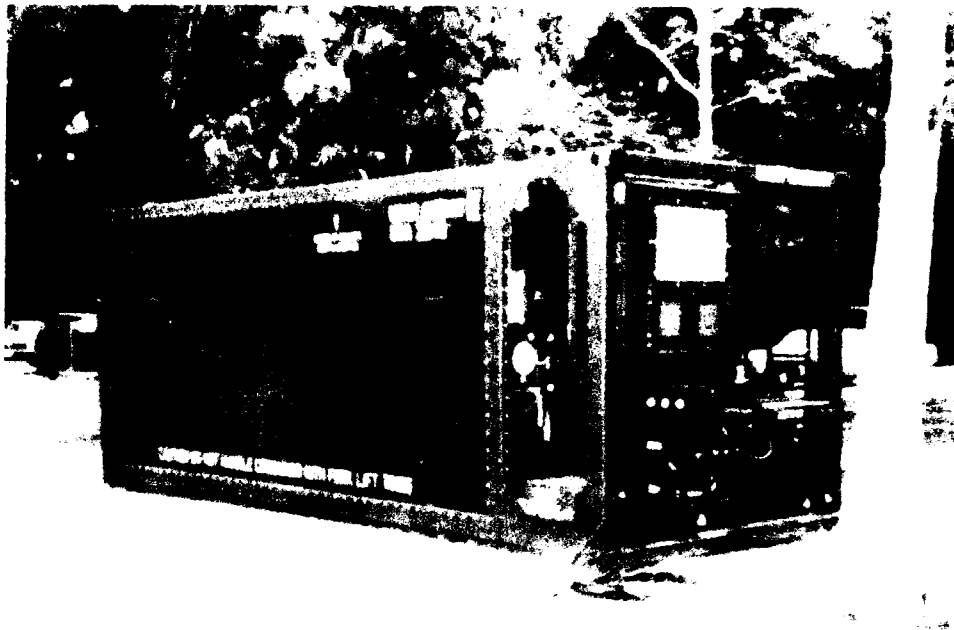

LENGTH	20'
WIDTH	8'
HEIGHT	8'
TARE WEIGHT	8,000 pounds
DOOR OPENING HEIGHT	82"
DOOR OPENING WIDTH	89"

Refrigerated Container

POINT OF CONTACT

Mr. Philip Barickman
US Army Belvoir RD&E Center, SATBE-FMR
Fort Belvoir, VA 22060-5606
DSN 654-2297/Commercial (703) 704-2297

ITEM DESCRIPTION

The refrigerated container provides a capability to transport, temporarily store, and distribute temperature-sensitive cargo. The container, including the refrigeration unit, is nominally 8' x 8' x 20' and weighs approximately 8,000 pounds. The unit is powered by a military standard 10kW diesel engine generator set or by an external electrical power supply. The refrigerated container is a modified commercial design and procured to a military specification. It meets all ISO requirements for intermodal shipments.

STATUS

A total of 665 containers, including 24 for the US Navy, were purchased and delivered by 1980. The Navy procured an additional 49 units in FY85. The Army Surgeon General procured 43 refrigerated containers from Engineered Air Systems in FY91. Delivery was completed in FY92.

PROGRAM PLAN

The Army Surgeon General has plans to procure 108 refrigerated containers in FY93. The Navy is planning on procuring 20 refrigerated containers in the future.

NSN

8115-01-015-7039

20' Half-Height Container

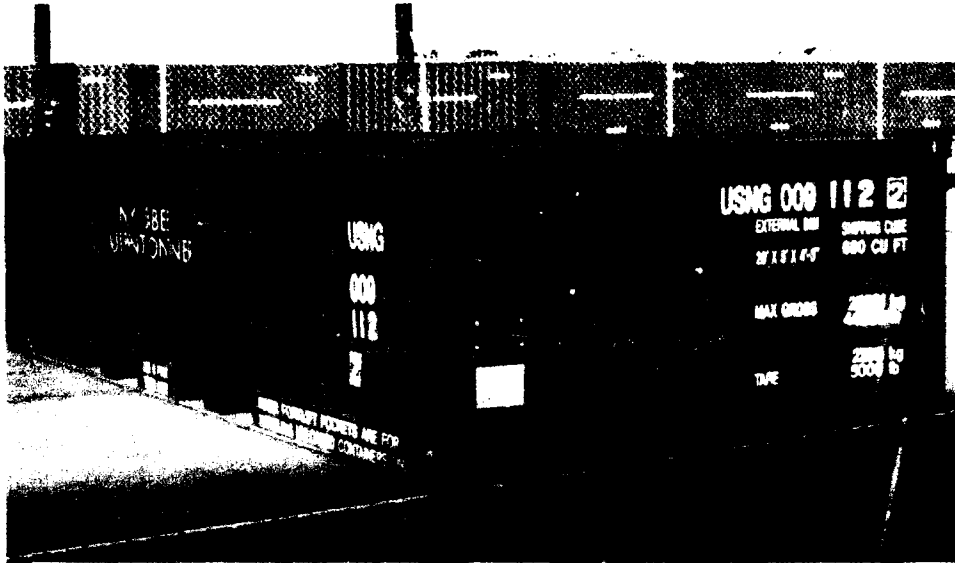

20' Half-Height Container

POINTS OF CONTACT

Mr. Jamie Cannon
Naval Construction Battalion Center (CESO Code 1573)
Port Hueneme, CA 93043-5000
DSN 551-1895/Commercial 805-982-1895

Mr. Philip Barickman
US Army Belvoir RD&E Center, SATBE-FMR
Fort Belvoir, VA 22060-5606
DSN 654-2297/Commercial (703) 704-2297

ITEM DESCRIPTION

The Half-Height container is 20' long by 8' wide by 4' 3" high with fixed sides, open top, and one drop-end opening to allow access to material by either material handling equipment or crane. Bows and tarpaulins are provided with the containers for cover during shipping and storage. The Navy uses the Half-Height containers primarily to ship drummed oils and lubricants. The Army uses the Half-Height containers primarily to ship ammunition having a high weight to volume ratio such as 155mm projectiles.

STATUS

In August 1989, the Navy awarded a contract to Shoals American Industries, Inc., for 194 Half-Heights. Deliveries to the Navy began and were completed in FY90.

During July and August 1991, Military Sealift Command procured 1,100 Half-Height containers for the Army in support of the retrograde of munitions from Southwest Asia. Deliveries were completed by the end of 1991 and the containers are under the control of the Joint Container Control Office.

PROGRAM PLAN

There is no current plan to procure additional quantities.

NSNs

Navy: Unknown
Army: Not yet assigned

ISO Tactical Shelter

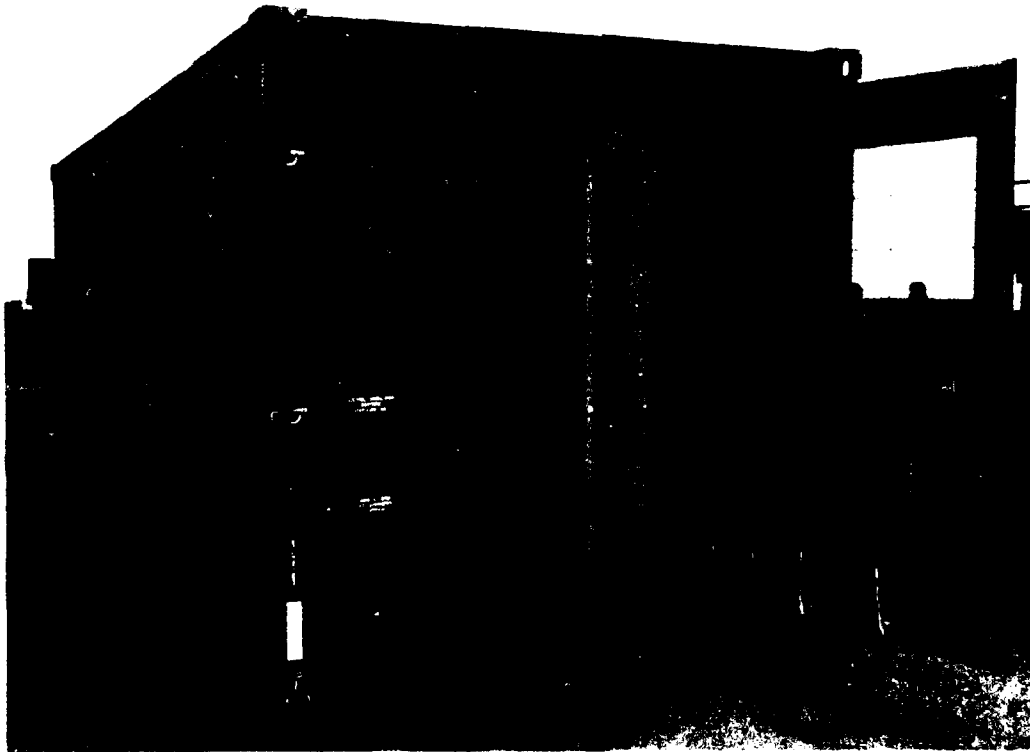
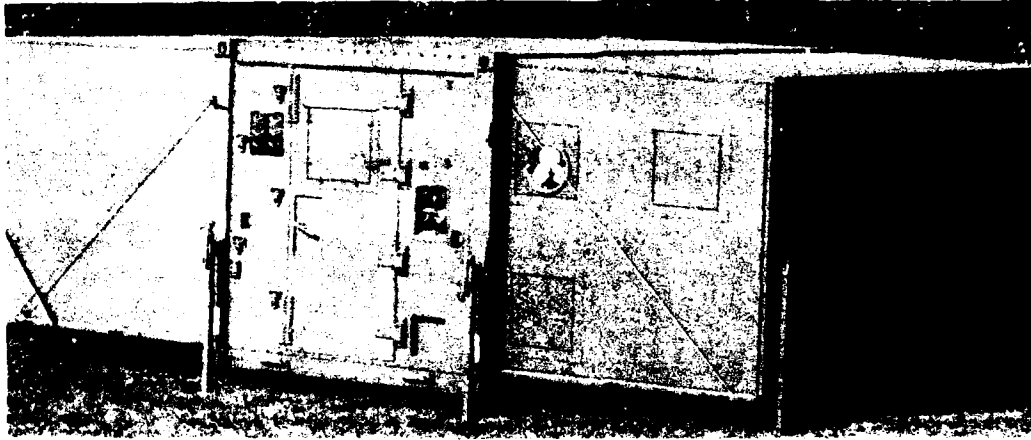

ISO Tactical Shelter

POINT OF CONTACT

Mr. Art Murphy
US Army Natick RD&E Center (SATNC-UST)
Natick, MA 01760-5017
DSN 256-5246/Commercial (508) 651-5246

ITEM DESCRIPTION

An ISO Tactical Shelter is a presized, transportable structure designed for a functional requirement and provides live-in, work-in, or container capability. This structure can be either expandable or non-expandable and conforms to applicable ANSI/ISO container standards. All services are increasing their utilization of the shelter concept, and the impact of shelters on the transportation and material handling system will become more significant in coming years. A standard family of 20' rigid wall ISO shelters has been developed by the US Army Natick Research, Development and Engineering Center for DOD use. The shelter family includes three types:

- Non-Expandable Shelter, Tactical (11,100-pound payload)
- One-Side Expandable Shelter, Tactical (9,700-pound payload)
- Two-Side Expandable Shelter, Tactical (8,300-pound payload)

STATUS

ISO Tactical Shelters have completed development and a Technical Data Package is finalized. Two production contracts have been awarded to date: the first in April 1984 for 1,739 units; the second in August 1988 for 722 units, with a 100% option. The following quantities represent Army standard ISO shelters procured for specific new Navy, Air Force, and Army ISO sheltered systems to date:

ISO Tactical Shelter	Quantity
Non-Expandable	31
One-Side Expandable	1,762
Two-Side Expandable	1,307

A number of enhancements to the ISO shelter are being designed to provide threat protection and to increase its functional workspace. The ISO shelter enhancement programs currently in development include Chemical/Biological (CB) Protection, Electro-Magnetic Interference (EMI) shielding, and a 1,000 square foot Modular Extendable Rigid Wall Shelter (MERWS) kit. Two enhancement programs have completed development. The CB Non-Expandable shelter Milestone III In Process Review (IPR) was completed in August 1990, and the complexing passageway Milestone III IPR was completed in November 1989. A third production contract was awarded 11 September 1992 to Atlantic Industries, Inc. This contract is a 3 year requirements type of contract thereby allowing funds to be obligated against the contract as shelter requirements are received into ATCOM.

PROGRAM PLAN

Continue to monitor production contracts and field ISO shelters.

NSNs	60 Amp	100 Amp
Non-Expandable:	5411-01-136-9837	5411-01-294-6390
One-Side Expandable:	5411-01-124-1377	5411-01-295-3433
Two-Side Expandable:	5411-01-136-9838	5411-01-294-9866

Mobile Facility (MF) Program

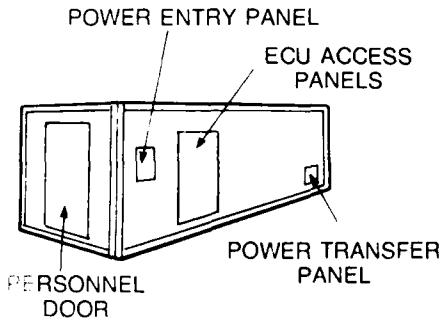

BASIC MF

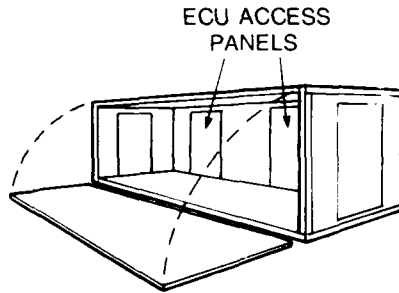

SIDE OPENING MF TYPE A

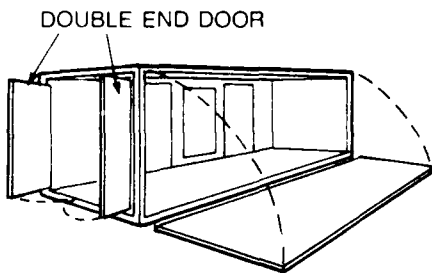

SIDE OPENING MF TYPE B (MODIFIED)

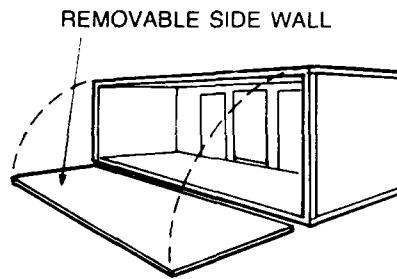

SIDE OPENING MF TYPE B

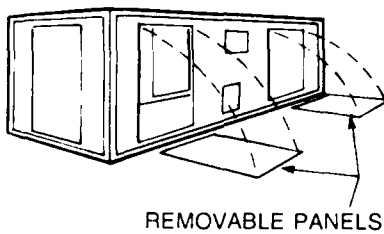

INTEGRATION UNIT

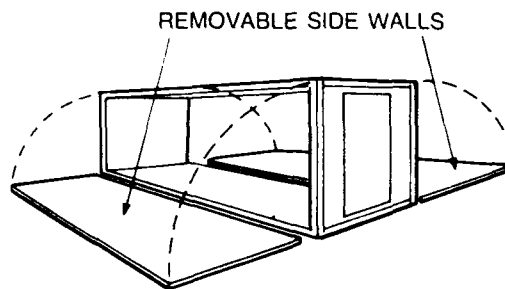

SIDE OPENING MF TYPE C

LENGTH	20'
WIDTH	8'
HEIGHT	8'

Notes:

- All meet ISO/ANSI Specifications for shipping containers
- All are Certified to meet Conference for Safe Container Requirements

Mobile Facility (MF) Program

POINTS OF CONTACT

Mrs. Kathy Clark/MAJ Ken Karlson, USMC
Naval Air Systems Command, AIR-41712A/AIR-41712B
Washington, DC 20361-4170
DSN 222-2344/Commercial (703) 692-2344

ITEM DESCRIPTION

The Naval Air Systems Command (NAVAIR) Mobile Facility (MF) Program utilizes a family of rigid walled ISO containers as habitable tactical shelters principally to contain aviation weapons system maintenance, tactical operational, logistical, and administrative functions. These shelters, referred to as MFs, are widely utilized by Navy and Marine Corps aviation units and to a lesser degree by other intraservice and interservice units within DOD. There are six MF types, all of which meet ISO 668/1161/1496 and ANSI MH5.1.1M specifications and have external dimensions of 8' wide, 8' high, and 20' long. Gross shipping weight is 20,000 pounds with a tare weight of approximately 5,200 pounds. MFs may be integrated into complexes by a variety of methods utilizing standard MF program ancillary equipment. MFs are mainly aluminum, foam, and beam construction having a 15-year service life. NAVAIR is the DOD Primary Inventory Control Activity for MFs.

STATUS

The MF Program is a mature program with procurement of ISO/ANSI specification MFs since 1975. Currently, over 5,000 MF units are in service. Recent contract awards are as follows:

Contract Number	Year	Quantity
N00140-84-3251	1984	1,308
N00140-86-5994	1986	337
N00140-87-9326	1987	874
N00140-89-SA03	1989	243
N00140-89-2812	1989	640
N68335-91-C-0257	1991	200

PROGRAM PLAN

Contracts are expected to be awarded in 1992 with total procurement quantity of all MF types to be 600.

NSN

No NSNs are assigned, although the part numbers are listed below (CAGE Code 30003):

Type MF	Part Number
Basic MF (60/400Hz)	1339AS701-1
Basic MF (60Hz only)	1339AS700-1
Integration Unit MF	1339AS900-2
Side Opening MF Type A	1339AS500-1
Side Opening MF Type B	1339AS501-1
Side Opening MF Type C	1339AS1100
Side Opening MF Type B (Modified)	1339AS1000-1

TRICON - Shipping/Storage Container

Bulk and Configured

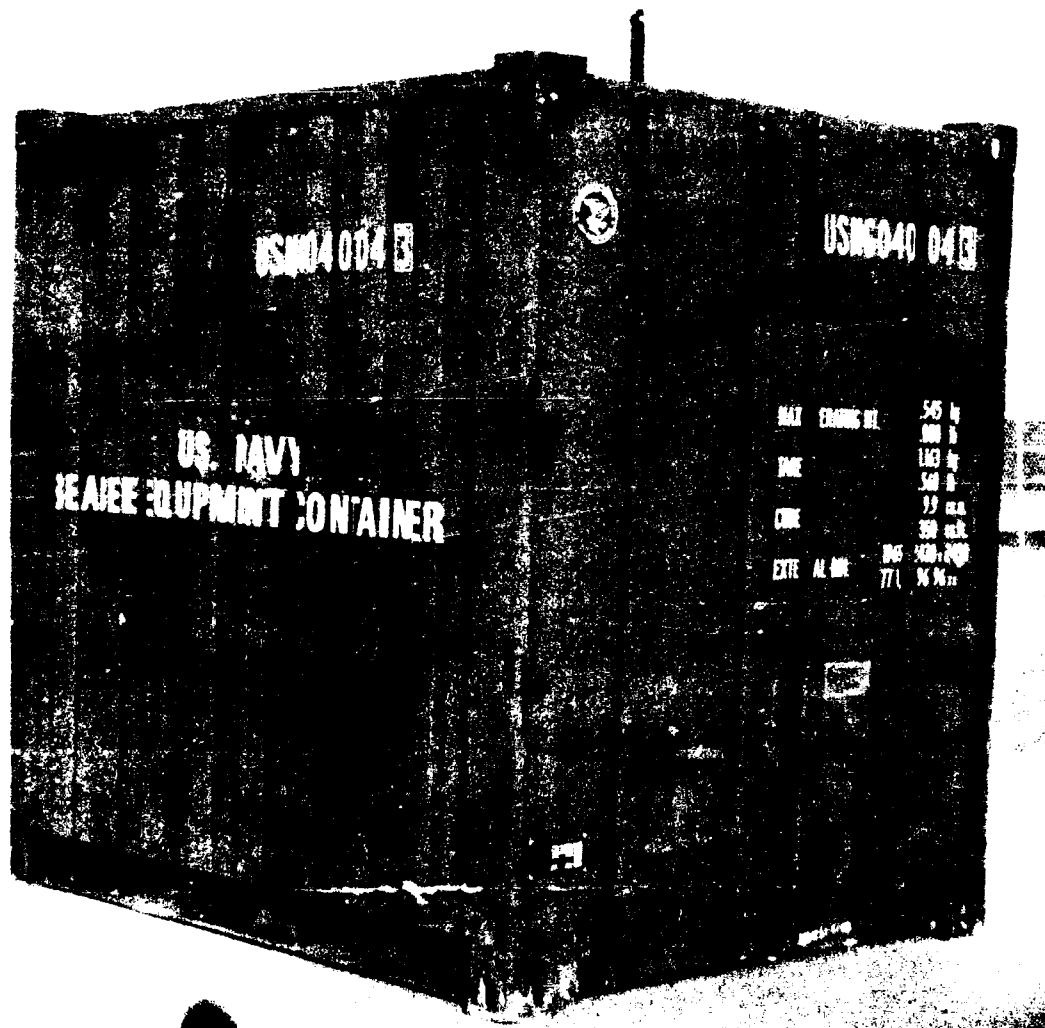

LENGTH	77.5'
WIDTH	96.0'
HEIGHT	96.0'

TRICON - Shipping/Storage Container

Bulk and Configured

POINTS OF CONTACT

Mr. Jamie Cannon
Naval Construction Battalion Center (CESO Code 1573)
Port Hueneme, CA 93043-5000
DSN 551-1895/Commercial (805) 982-1895

ITEM DESCRIPTION

The TRICON is an 8' high x 8' wide x 6.5' long lockable, watertight, reusable container. It is of all steel construction with standard ISO corner fittings and 3-way forklift pockets (sides and back). Two styles of containers are being procured: Bulk and Configured. Configured containers consist of cabinets with drawers or shelves, rifle racks, or a combination thereof, to make up storerooms or armories.

- Cabinets with drawers or shelves are available in five sizes:
 - 30" wide x 22 3/4" deep
 - 60" wide x 22 3/4" deep
 - 30" wide x 27 3/4" deep
 - 45" wide x 27 3/4" deep
 - 60" wide x 27 3/4" deep
- Usable drawer heights range from 2" to 13"
- Shelf heights are adjustable in 1" increments.

Currently, three different styles of storeroom configurations, plus an armory configuration, are being procured. Three containers may be coupled together into a nominal 20' modular assembly for ocean shipping purposes.

STATUS

A contract was awarded in May 1986 to J. D. Bertolini Industries, Limited, for 119 Bulk and 243 Configured containers. Deliveries began in FY89 and were completed in FY91. A second contract was awarded in September 1991 to LBCO, Inc., for 405 Bulk and 16 Configured TRICONS. Deliveries on the second contract began in July 1992.

PROGRAM PLAN

Upon completion of the second contract, no further procurement actions are planned.

NSN

Bulk: 8145-01-287-3294

Quadruple Container (QUADCON)

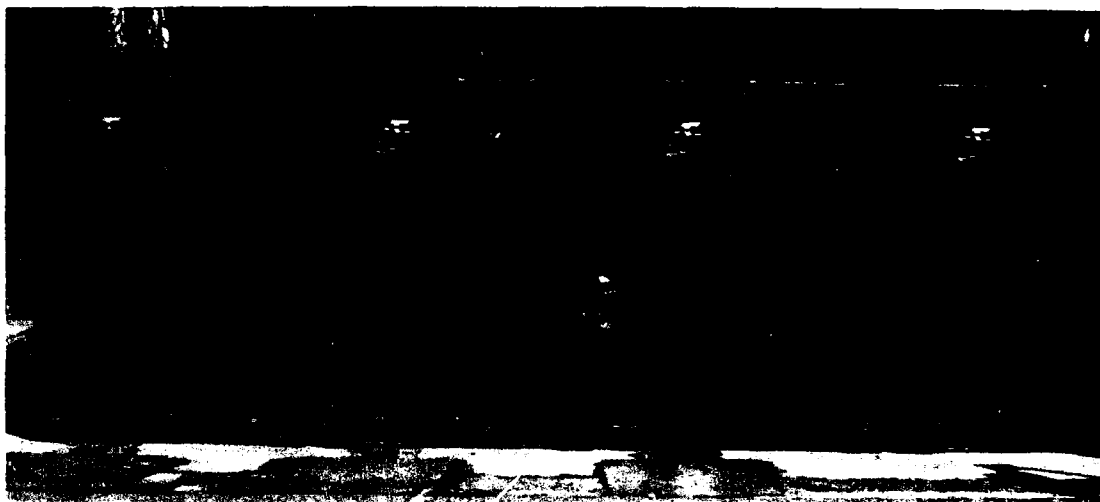

LENGTH	96.0'
WIDTH	57.38'
HEIGHT	82.0'
CARGO CAPACITY (approx.)	8,200 pounds

Quadruple Container (QUADCON)

POINT OF CONTACT

Mr. Jim Spires
CG, Marine Corps Systems Command, Code SSCGP
Quantico, VA 22134-5080
DSN 278-4354/Commercial (703) 640-4354

ITEM DESCRIPTION

The QUADCON is part of the Marine Corps Family of Intermediate Size Containers. The QUADCON has ISO corner fittings to allow for coupling of the QUADCONs into arrays of up to four units. An array of four QUADCONs has the same dimensions as a 20' ISO container (except for height) and will be certified to meet all ISO standards and CSC approvals. The container is lockable, weatherproof, reusable, and has a gross weight of 10,000 pounds. The QUADCON has double doors on each end to provide full access to the contents. To accommodate smaller items, a small item storage cabinet can be installed or removable inserts may be placed on shelves inside the QUADCON.

STATUS

In August 1984, 560 first generation QUADCONs were procured. A field evaluation of these QUADCONs was completed in May 1987. On 30 September 1991, a multi-year contract was awarded to Keco Industries, Inc. for procurement of the second generation QUADCON.

PROGRAM PLAN

Contractor conducted First Article Testing began in April 1992 with production deliveries to begin in FY93. A follow-on contract is currently planned for FY95 or later to meet the Marine Corps Acquisition Objective.

NSN

8115-01-194-4017 (old)
8115-01-354-0797 (new)

Equipment Deployment and Storage System (EDSS)

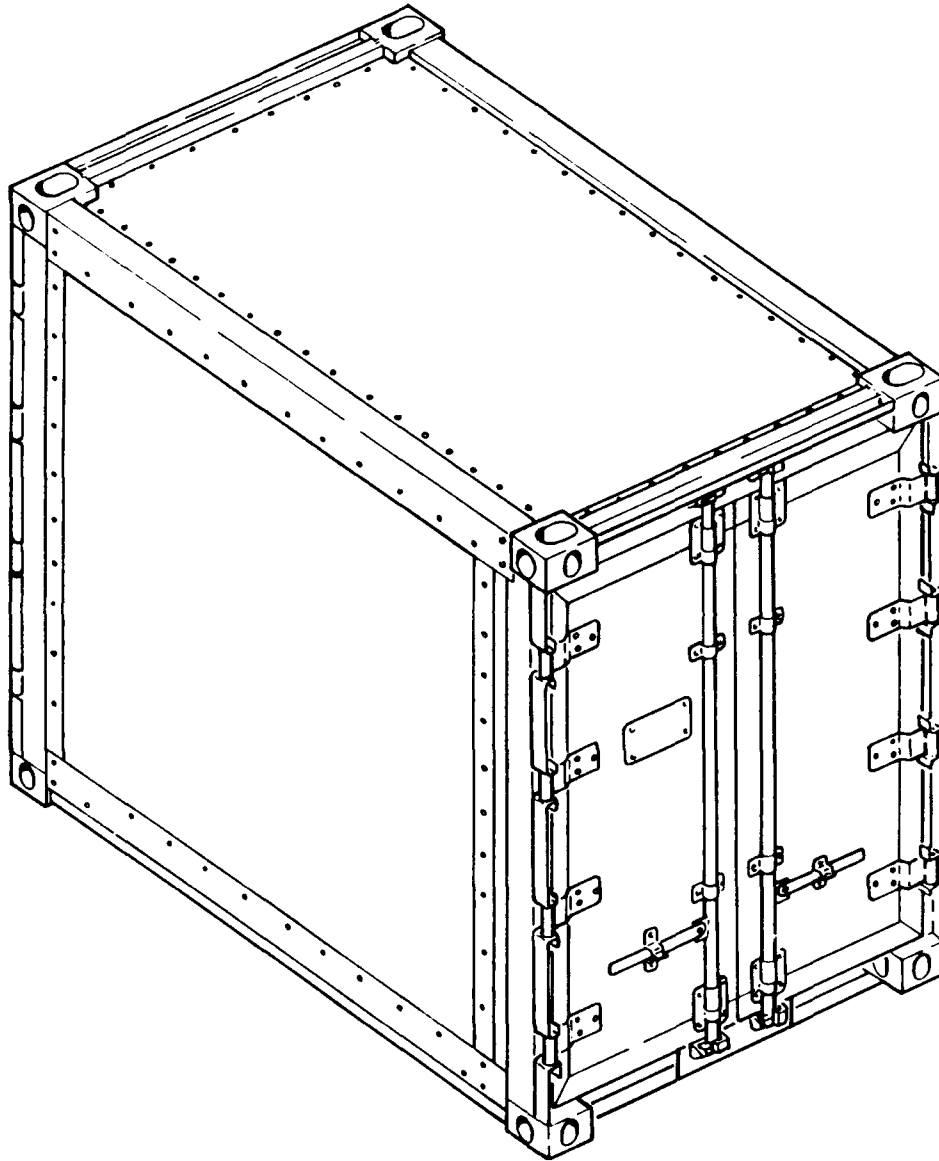

Equipment Deployment and Storage System (EDSS)

POINT OF CONTACT

Mr. William Brower
US Army Belvoir RD&E Center, SATBE-FMR
Fort Belvoir, VA 22060-5606
DSN 654-3613/Commercial (703) 704-3613

ITEM DESCRIPTION

The Equipment Deployment and Storage System (EDSS) is a new requirement for the Army and consists of two types of containers. One container is designed for primary transport by ground and sea transportation assets, and the other is designed for primary transport by air transportation assets.

The EDSS for ground and sea transport will be fully ISO compatible yet be able to be broken down into smaller containers for use on organic transportation. Three or four containers will be capable of being joined together to form a 20' long equivalent ISO container. The joined containers will meet all ISO requirements and obtain CSC approval. The containers will have doors on both ends to allow for full access to the contents even when joined together. The individual containers will be weatherproof, four-way forkliftable, capable of External Air Transport (EAT), and configurable with shelves.

STATUS

A draft Operational Requirement Document (ORD) for the EDSS has been prepared by the Quartermaster Center and School. Other service containers are being investigated to meet Army requirements.

PROGRAM PLAN

A technical data package will be prepared and the EDSS containers procured beginning in FY94, pending the availability of funds.

NSN

Not assigned

Shipping Frame, 4' x 6²/₃' x 8' (SIXCON)

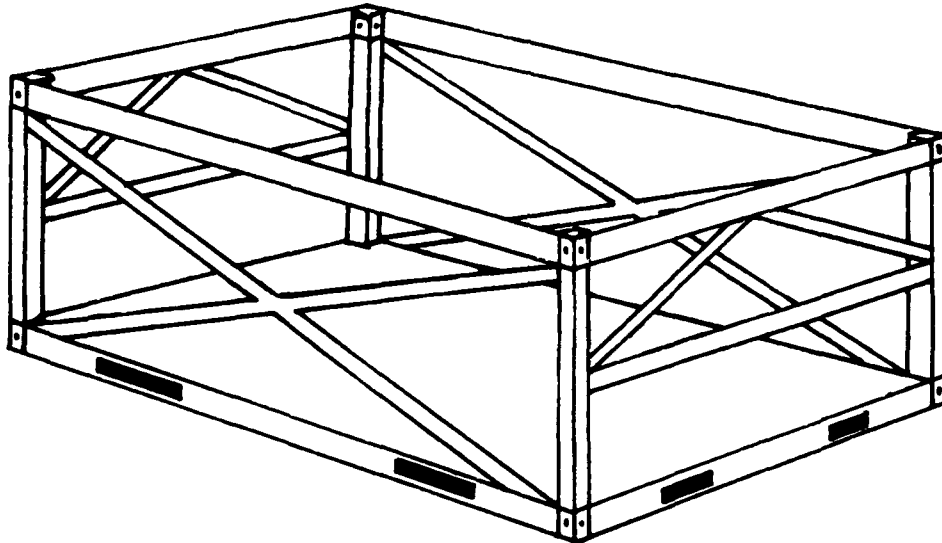

LENGTH	6 ² / ₃ '
WIDTH	8'
HEIGHT	4'
ARRAYED CONFIGURATION	8' x 8' x 20'

Shipping Frame, 4' x 6²/₃' x 8' (SIXCON)

POINT OF CONTACT

Mr. Jim Spires
CG, Marine Corps Systems Command, Code SSCGP
Quantico, VA 22134-5080
DSN 278-4354/Commercial (703) 640-4354

ITEM DESCRIPTION

The SIXCON Shipping Frame is a reusable open top cargo carrier with four-way forklift handling capability with ISO standard corner fittings. Can be arrayed up to six, forming an 8' x 8' x 20' configuration to fit the cell of a containership. Capability objective is to provide an open container of intermediate size compatible with US Navy amphibious ships and the Merchant Fleet. The frame is used as an integral component of SIXCON fuel/water storage and pump modules though it could be used for general cargo and organizational property.

STATUS

A procurement contract for 402 shipping frames was conducted and the shipping frames are now in use with the fuel and water modules.

PROGRAM PLAN

There are no plans for future procurements since the item was for one unique application.

NSN

Not applicable

Shipping Frame, 8' x 8' x 10'

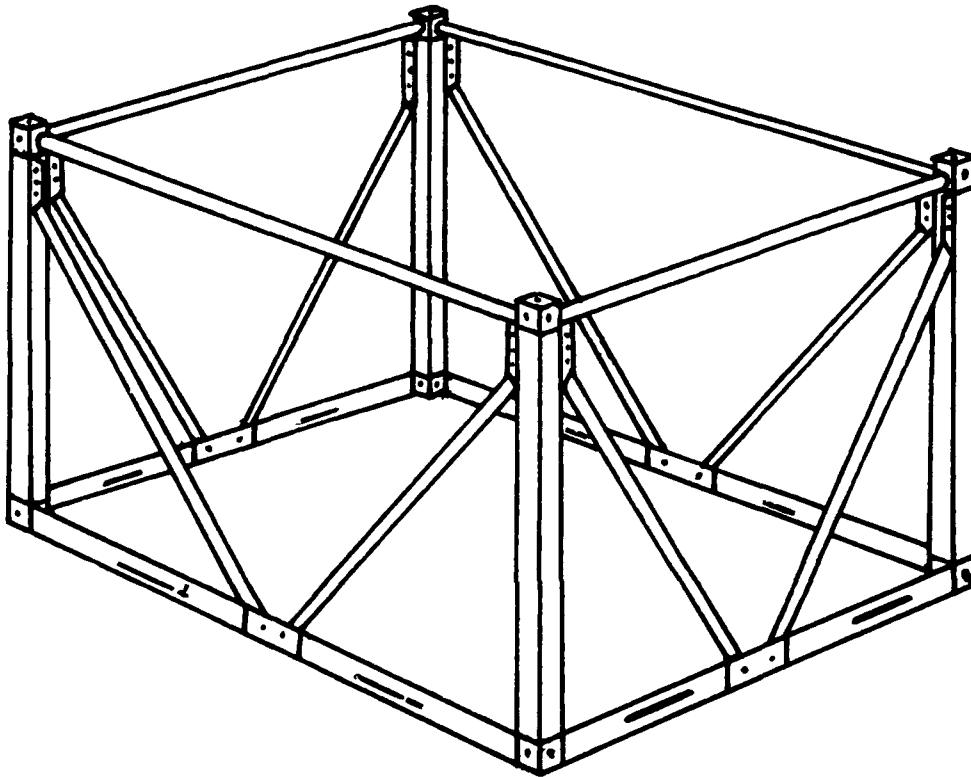

LENGTH	10'
WIDTH	8'
HEIGHT	8'
ARRAYED CONFIGURATION	8' x 8' x 20'

Shipping Frame, 8' x 8' x 10'

POINT OF CONTACT

Mr. Jim Spires
CG, Marine Corps Systems Command, Code SSCGP
Quantico, VA 22134-5080
DSN 278-4354/Commercial (703) 640-4354

ITEM DESCRIPTION

The 10' Shipping Frame is an open top cargo carrier of steel construction which features a four-way forklift handling capability and standard ISO corner fittings. An array of two frames forms an 8' x 8' x 20' configuration and fits the 20' cells of a containership. The frame is used to support the mounting and movement of the reverse osmosis water purification unit (ROWPU).

STATUS

Approved for service use was obtained in May 1981. An Army contract was awarded 30 September 1983 for the procurement of 496 frames which satisfied Marine Corps requirements.

PROGRAM PLAN

There are no plans for future procurements since the item was for one unique application.

NSN

Not applicable

Palletized Load System (PLS) Logistics

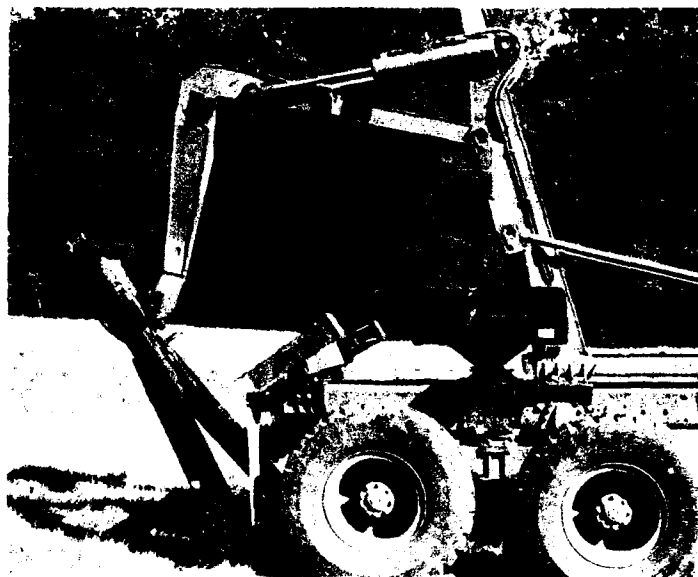

Hooklift Interface Kit (HIK)

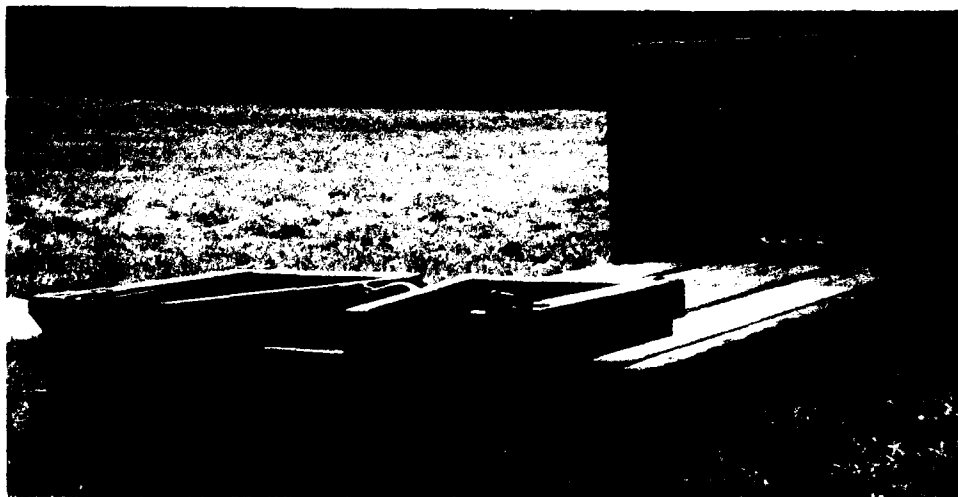

Ammunition Container (AMCON)

Palletized Load System (PLS) Logistics

POINT OF CONTACT

Mr. Doug Chesnulovitch
PM-AMMOLOG, AMCPM-AL
Picatinny Arsenal, NJ 07806-5000
DSN 880-4737/Commercial (201) 724-4737

ITEM DESCRIPTION

The present ammunition logistics system in the theater of operations must overcome material handling and transportation shortfalls associated with the delivery of Class V (ammunition) materials to combat units. The Palletized Load System (PLS) (see page 73) is the Army's approach to overcome these deficiencies. Two different concepts are currently being examined to provide PLS the capability to directly handle ISO containers. The concept of PLS Logistics is to demonstrate a direct connectivity between PLS and strategic transportation assets.

One concept, Hooklift Interface Kit (HIK), is a device that enables the PLS truck to directly lift, transport, and download any commercial 8' x 20' container. HIK is made up of two components: an X-frame that attaches to the hook on the PLS load handling system, and a support frame mounted to the rear of the truck.

Another concept, Enhanced PLS Flatrack (EPF), is based on a commercial 20' ISO flatrack design, modified to interface directly with PLS. With this design, the possibility exists for EPFs to be loaded in CONUS and shipped to the weapon system on the battlefield without additional ammunition handling.

STATUS

As a result of an Ammunition Container (AMCON) demonstration and a requirement from Training and Doctrine Command's (TRADOC) Transportation School, the PM for Heavy Tactical Vehicles (PM-TVH) asked BRDEC to conduct an EPF Evaluation. The evaluation assessed the technical feasibility and costs of a series of enhanced flatrack designs. The result of the evaluation was a Technical Analysis and Cost Assessment Report which recommended that the user accept the HIK as the best approach for handling commercial ISO containers with the PLS and also recommended the incorporation of an Enhanced PLS Flatrack design into the existing production schedule for the flatracks. The Transportation School is in the process of modifying the PLS requirement document to include the need for a HIK. An EPF prototype contract was awarded on 31 August 1992 for 11 containers.

PROGRAM PLAN

PM-AMMOLOG will continue to support the PM-TVH for and the Transportation School on the PLS program.

NSN

Not assigned

20' Flatrack

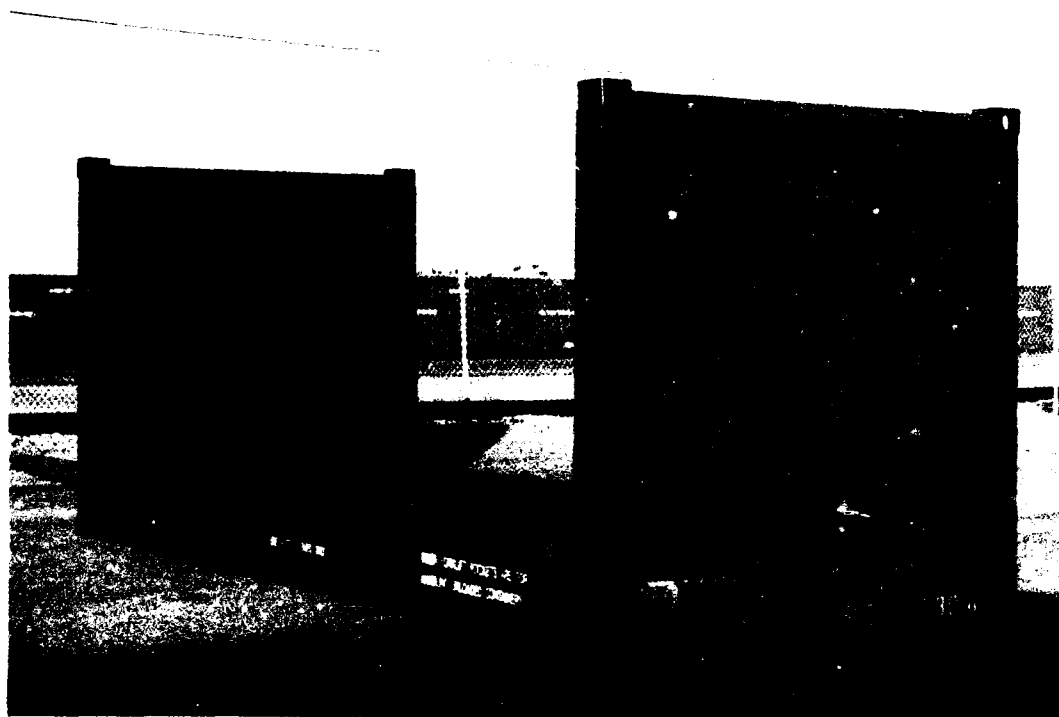

20' Flatrack

POINTS OF CONTACT

Mr. Jamie Cannon
Naval Construction Battalion Center (CESO Code 1573)
Port Hueneme, CA 93043-5000
DSN 551-1895/Commercial (805) 982-1895

Mr. Doug Chesnulovitch
PM-AMMOLOG, AMCPM-AL
Picatinny Arsenal, NJ 07806-5000
DSN 880-4737/Commercial (201) 724-4737

ITEM DESCRIPTION

The Flatrack is a 20' long by 8' wide by 8' high shipping platform with fixed endwalls, open sides and top. The Flatrack is easily accessible to material handling equipment or cranes and is used by the Navy to ship bulky items such as lumber, steel products, and piping. The Army is using the 20' Flatrack to transport high cube munitions such as Lance Main Motor Assemblies.

STATUS

A contract was awarded in August 1989 to Shoals American Industries, Inc., for Flatracks. Deliveries began and were completed in FY90.

During FY91, the Military Sealift Command procured 100 Flatracks for the Army. The Flatracks were procured in support of the retrograde of munitions from Southwest Asia and are now under the control of the Joint Container Control Office.

PROGRAM PLAN

There is no current plan to procure additional quantities by either the Army or the Navy.

NSN

Navy: Unknown
Army: Not yet assigned

40' Heavy Duty Flatrack

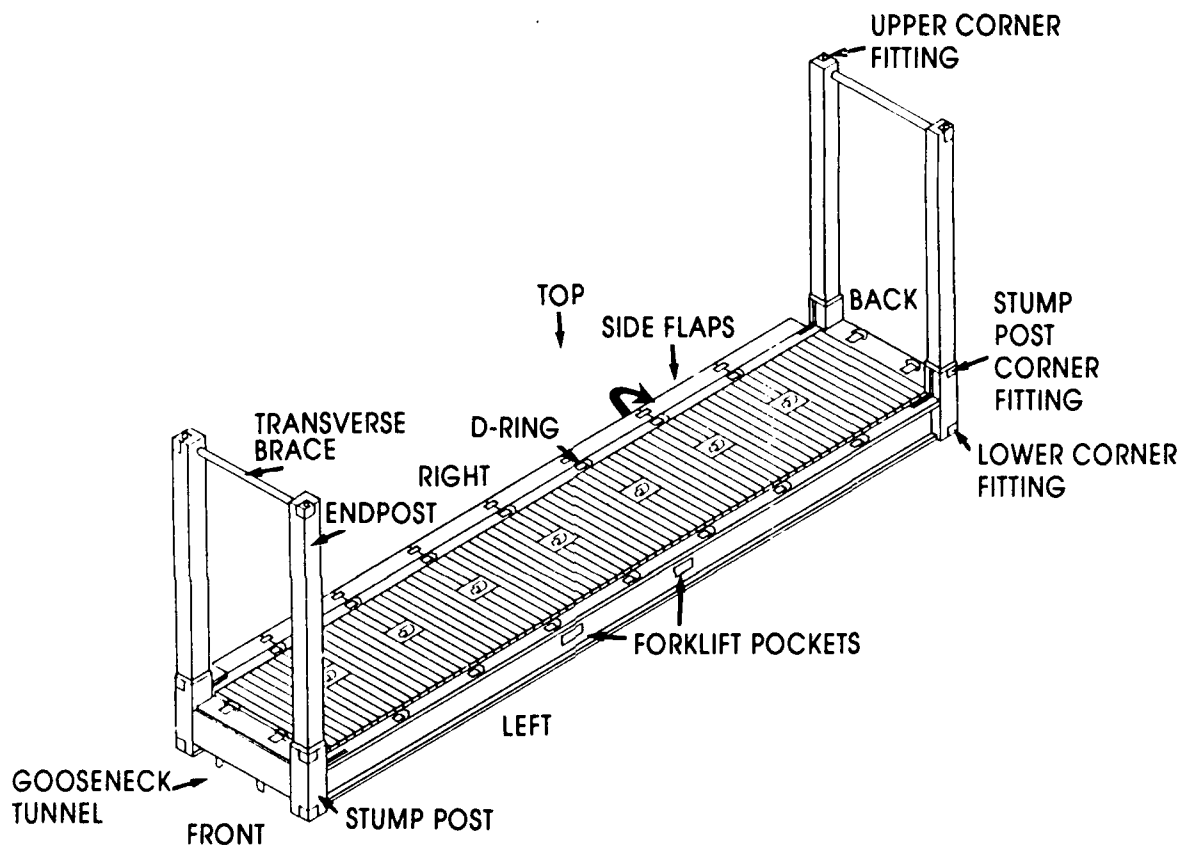

LENGTH	40'
WIDTH	8'
CLEAR HEIGHT FOR CARGO	10'6"
MAXIMUM OVERALL HEIGHT	13'

40' Heavy Duty Flatrack

POINT OF CONTACT

Mr. Marty Fink
Naval Sea Systems Command, PMS-3853
Washington, DC 20362-5101
DSN 332-0920/Commercial (703) 602-0920

ITEM DESCRIPTION

The 40' heavy duty flatrack was developed to provide a breakbulk capability to containerships for the carriage of tanks and other heavy and/or oversized cargo. The 40' heavy duty flatrack is a relatively uncomplicated structural steel frame, decked over and fitted with tiedown points. There are two types of flatracks, each having a different cargo capacity. The first type of flatrack has a maximum cargo capacity of 67.2 short-tons and has telescoping corner posts which are adjustable from 8.5' to 13' for various cargo heights. The second type of flatrack has a maximum cargo capacity of 72 short-tons and has corner posts 13' high. The corner posts on both types fold down to facilitate stacking and storage. The flatracks may be inserted/removed into/from the containership cells empty or loaded at a not-to-exceed cargo weight of 30 long-tons (67,200 pounds).

STATUS

The heavy duty flatrack was initially authorized in the FY83 budget for 223 units; the FY84 budget was for 135 units. Delivery of the 358 flatracks was completed during 2QFY86. Two contracts for the second type of flatrack were awarded during 2QFY88. The last flatracks were delivered in September 1992, bringing the total flatrack inventory to approximately 2,360 units. The inventory is at three storage locations: MOT, Bayonne, NJ; NWS, Charleston, SC; and CBC, Port Hueneme, CA.

PROGRAM PLAN

Program completed.

NSN

0910-LP-248-8600

Load and Roll Pallet (LRP)

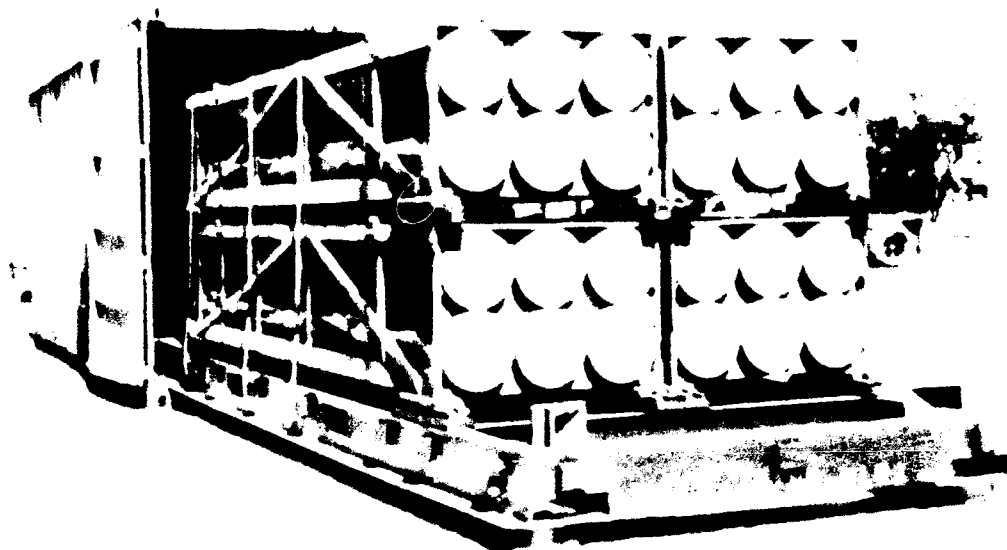

LENGTH	227'
WIDTH	89'
HEIGHT	10'
WEIGHT (empty)	1,970 pounds

Load and Roll Pallet (LRP)

POINT OF CONTACT

Mr. Doug Chesnulovitch
PM-AMMOLOG, AMCPM-AL
Picatinny Arsenal, NJ 07806-5000
DSN 880-4737/Commercial (201) 724-4737

ITEM DESCRIPTION

The Load and Roll Pallet (LRP) is a steel frame platform, with rollers, that measures 89" wide x 227" long x 10" high, weighs 1,970 pounds empty and fits inside of a standard 20' ANSI/ISO container. The LRP allows the user to unload a complete load of four Multiple Launch Rocket System (MLRS) Pods (each weighing 5,078 pounds) or four Army Tactical Missile System (ATACMS) pods from an end opening container. Two 6,000-pound capacity forklifts, or one 10,000-pound capacity or larger forklift, or a tactical cargo vehicle with a winch, or a wrecker, lifts up one end of the fully loaded LRP just high enough to clear the floor of the container and rolls the entire load out of the container. Once outside of the container, the load is fully accessible from the sides to allow rapid unloading of the cargo.

STATUS

Testing of the LRP concept was conducted during November 1987 at Miesau Army Depot and the results were favorable. Ten LRPs were bought and delivered to the US Army Defense Ammunition Center and School in 2QFY89 where a follow-on evaluation was performed. Based on the Containerized Ammunition Missile Distribution Executive Group's recommendation and approval by the Army's Deputy Chief of Staff for Logistics, 500 LRPs were procured by Military Sealift Command from the Trailer Repair and Fabrication Company, Inc., in August 1991. Delivery of the LRPs was completed in November 1991 and they are under the control of the Joint Container Control Office.

PROGRAM PLAN

Future needs may require the development of a generic LRP capable of handling a wider variety of ammunition.

NSN

Not yet assigned

Part II

Container

Unloading

Equipment

4,000-Pound Capacity Forklift Truck

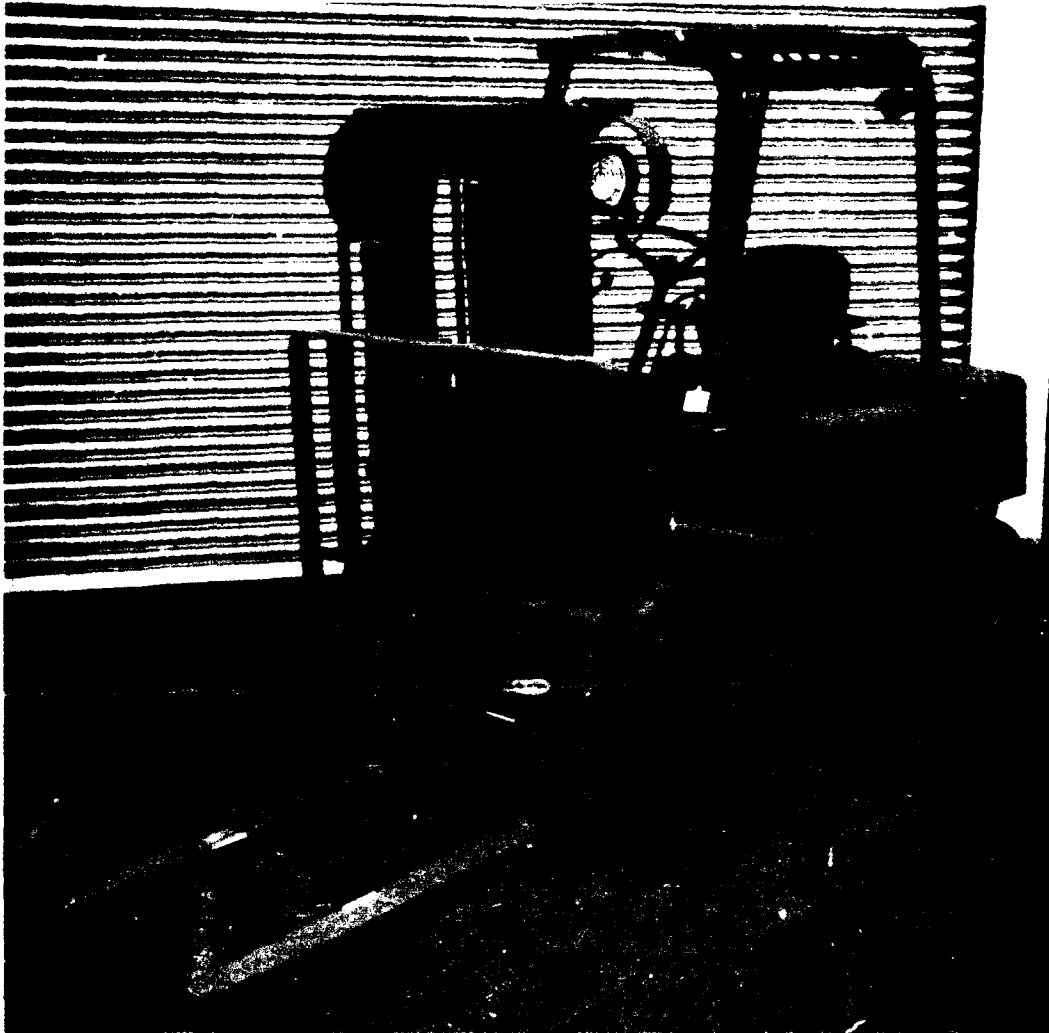

CAPACITY	4,000 pounds at 24' load center
LENGTH WITH FORKS	145'
WIDTH	45'
HEIGHT WITH ROPS	81'

4,000-Pound Capacity Forklift Truck

POINTS OF CONTACT

Mr. Rolland Riley
US Army Belvoir RD&E Center, SATBE-FMR
Fort Belvoir, VA 22060-5606
DSN 654-2317/Commercial (703) 704-2317

COL Larry R. Kearns
Warner Robins Air Logistics Center, WRALC/LV
Robins AFB, GA 31098-5345
DSN 468-2062/Commercial (912) 926-2062

ITEM DESCRIPTION

This forklift provides Air Force bases and Army depots the capability to load and unload palletized cargo from ISO containers. It is a commercial type pneumatic tired forklift with a lift height of at least 144". The forklift has a capacity of 4,000 pounds at a 24" Load Center.

STATUS

The Army has an inventory of approximately 1,700 gasoline engine powered units. In FY85, the Army awarded a 5-year contract to Hyster to procure approximately 1,300 clean-burn, diesel engine powered units. Deliveries of the Hyster trucks were completed during 1991. A Defense Logistics Agency (DLA)-managed indefinite quantity type of contract was awarded in July 1989, although it could not handle the Air Force requirements. DLA is currently in solicitation to meet the Air Force requirements. FY86-91 Air Force requirements were for 785 units.

PROGRAM PLAN

The Army will continue to support the fielded forklifts. The Air Force is planning to receive deliveries from the DLA contract beginning in March 1993.

NSN

3930-01-172-7891

4,000-Pound Capacity, Rough Terrain Forklift Truck (4K RTFLT)



J. I. Case Co.

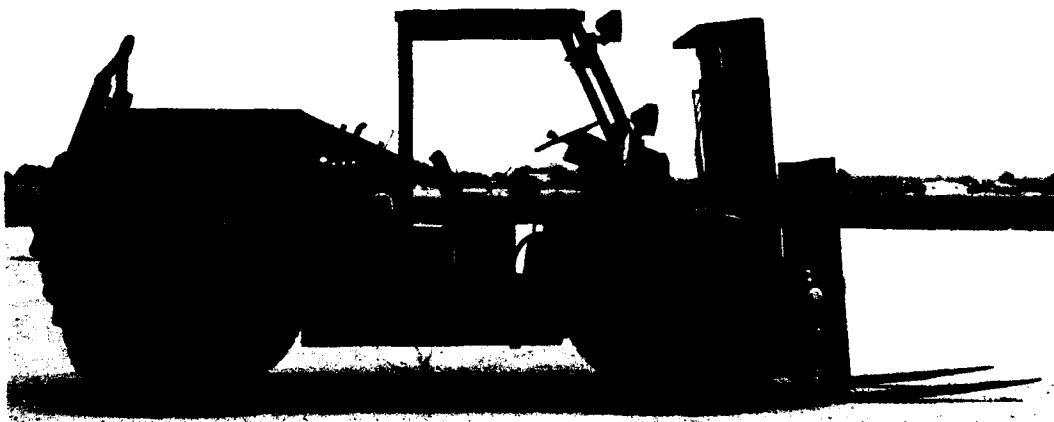

The Enwistle Co.

CAPACITY	4,000 pounds at 24' load center
LENGTH WITH FORKS	205'
WIDTH	79'
HEIGHT WITH ROPS	80'
WEIGHT	10,000 pounds

4,000-Pound Capacity, Rough Terrain Forklift Truck (4K RTFLT)

POINTS OF CONTACT

Mr. William Brower
US Army Belvoir RD&E Center, SATBE-FMR
Fort Belvoir, VA 22060-5606
DSN 654-3613/Commercial (703) 704-3613

CWO3 Ed Deering
Dcp CG, Marine Corps Systems Command, SSEA
Quantico, VA 22134-5080
DSN 278-2022/Commercial (703) 640-2022

ITEM DESCRIPTION

The 4,000-Pound Capacity, Rough Terrain Forklift Truck (4K RTFLT) provides the capability of stuffing and stripping the 8' wide family of ISO containers under field conditions. The vehicle is sized to effectively operate within the ISO container including placing two pallet loads side by side and two high within the container. The vehicle weighs approximately 10,000 pounds, is 79" wide, 80" high, and 165" long, excluding forks. The diesel engine powered vehicle is four-wheel drive for rough terrain operation and has freelif and side shift capabilities for operating within the confines of a container.

STATUS

The Army awarded a multi-year contract to J. I. Case Company during FY78. A total of 1,910 forklifts were delivered between August 1980 and July 1984. On 29 October 1990, the Tank-Automotive Command (TACOM) awarded a multi-year contract to the Entwistle Company for a total of 714 vehicles for the Army, with options for an additional 557 vehicles. Preproduction qualification testing of four vehicles is currently being performed. The Marine Corps bought 280 forklifts from J. I. Case Company during the mid-1970s. In FY85, the Marine Corps awarded a contract to Defense Technology (subsequently a subsidiary of The Entwistle Company) for a quantity of 560 forklifts. The Marine Corps began fielding in June 1990 and completed fielding in January 1991.

PROGRAM PLAN

Perform necessary actions as required to support the fielded forklifts. Following completion of the Army's preproduction qualification testing, production qualification testing will be conducted during 1993, with production deliveries following.

NSNs

Army J. I. Case:	3930-01-076-4237
Marine Corps J. I. Case:	3930-00-415-0098
Marine Corps new:	3940-01-275-6420
Army Entwistle:	3930-01-330-8907

Mobile Loading Ramp

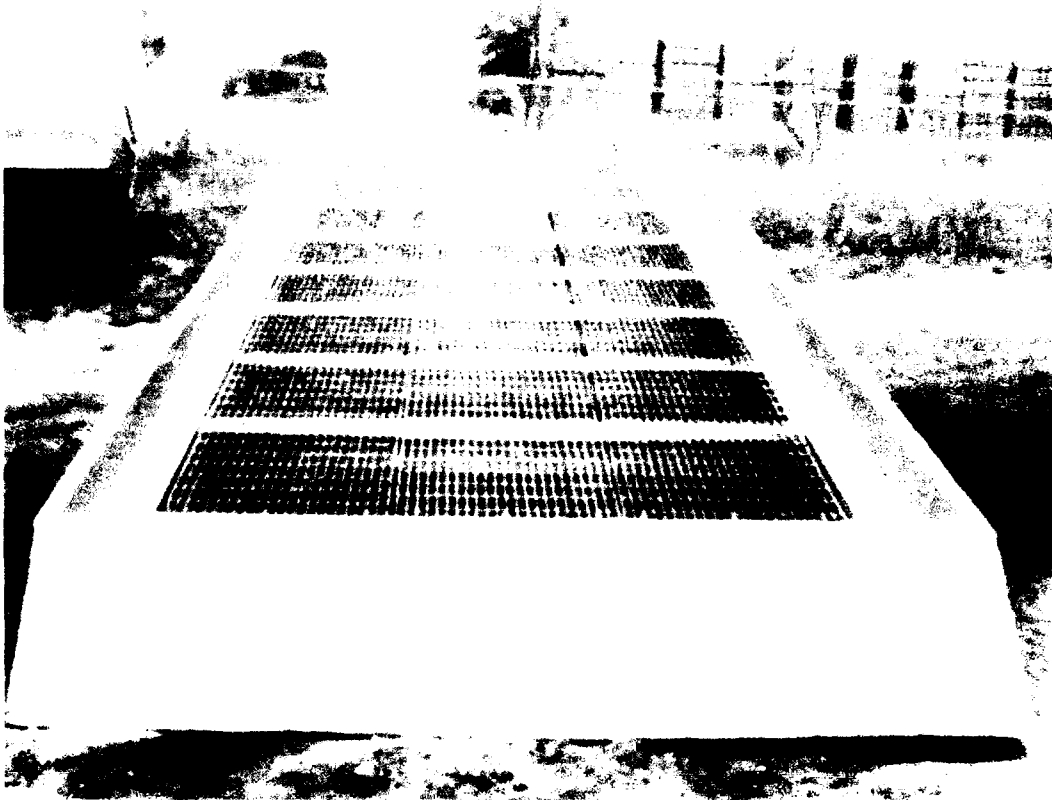

CAPACITY	16,000 pounds
LENGTH	36' including 6' level-off section
WIDTH	8' approximately
HEIGHT	adjustable from 46" to 65"
WEIGHT	6,000 pounds approximately

Mobile Loading Ramp

POINT OF CONTACT

Mr. William Brower
US Army Belvoir RD&E Center, SATBE-FMR
Fort Belvoir, VA 22060-5606
DSN 654-3613/Commercial (703) 704-3613

ITEM DESCRIPTION

The Mobile Loading Ramp is used in conjunction with the 4,000-Pound Capacity Rough Terrain Forklift Truck (RTFLT) for stuffing and stripping the 8' wide family of containers when the container is on a semitrailer or truck chassis. The ramp is 96" wide and 36' long, including a 6', level-off section, and weighs approximately 6,000 pounds. The bed height is adjustable from 45 to 65". The ramp is capable of safely supporting loads up to 16,000 pounds. The specification for the Mobile Loading Ramp is MIL-R-52899.

STATUS

A firm fixed price contract was awarded to Magline, Inc., for 83 commercial units. The preproduction testing was completed in March 1976. Production delivery took place as scheduled, from June 1976 through April 1977. A contract was negotiated with Magline, Inc., to increase the curb height to 12" on the 83 fielded ramps to overcome safety deficiencies. A second multi-year contract was awarded in November 1977 to Brooks and Perkins, Inc., to provide an additional quantity of 346 ramps. Under the option in the Brooks and Perkins contract, additional quantities of 346 units were procured. A two-step multi-year procurement contract was awarded to Magline, Inc., in July 1981 for a total of 828 ramps. In all, approximately 1,600 ramps were fielded.

PROGRAM PLAN

Support fielded ramps. There are no plans for additional procurements.

NSNs

3990-01-026-1575—Brooks and Perkins, Inc.
3990-01-059-0104—Magline, Inc.
3990-01-121-7758—Magline, Inc.

**6,000-Pound Capacity, Variable Reach
Rough Terrain Forklift Truck (6K VRRTFLT)**



6,000-Pound Capacity, Variable Reach Rough Terrain Forklift Truck (6K VRRTFLT)

POINT OF CONTACT

Mr. David Krawchuk
US Army Belvoir RD&E Center, SATBE-FMR
Fort Belvoir, VA 22060-5606
DSN 654-2314/Commercial (703) 704-2314

ITEM DESCRIPTION

The 6,000-Pound Capacity, Variable Reach Rough Terrain Forklift Truck (6K VRRTFLT) provides the capability of loading and unloading 8' x 8' x 20' MILVANs and ISO containers located on the ground or mounted on a trailer under field conditions. The 6K VRRTFLT is also designed to unload the Multiple Launch Rocket System (MLRS) pods from ISO containers.

The 6K VRRTFLT can handle 6,000 pounds at a reach of 15' and 4,000 pounds at a reach of 23.5'. The vehicle weighs 27,100 pounds, is 102" high, 100" wide, and 262" long without forks. The 6K VRRTFLT is replacing the aging fleet of Military Design 6,000-Pound Capacity Rough Terrain Forklifts.

STATUS

The Army Type Classified the 6K VRRTFLT for use in November 1984. TACOM awarded a production contract in January 1988 to TRAK International for 1,686 vehicles. Two contract options have been exercised, bringing the total number of vehicles to 2,050. The Air Force exercised an option for 163 vehicles from the Army's contract. The Air Force vehicles will be nuclear certified for handling munitions and will also be used to tow munitions trailers. Deliveries of the Air Force vehicles were completed 29 May 1992.

PROGRAM PLAN

The Army's production is scheduled to end during 2QFY94.

NSN

3930-01-158-0849

**All Terrain Lifter,
Articulated System (ATLAS)**

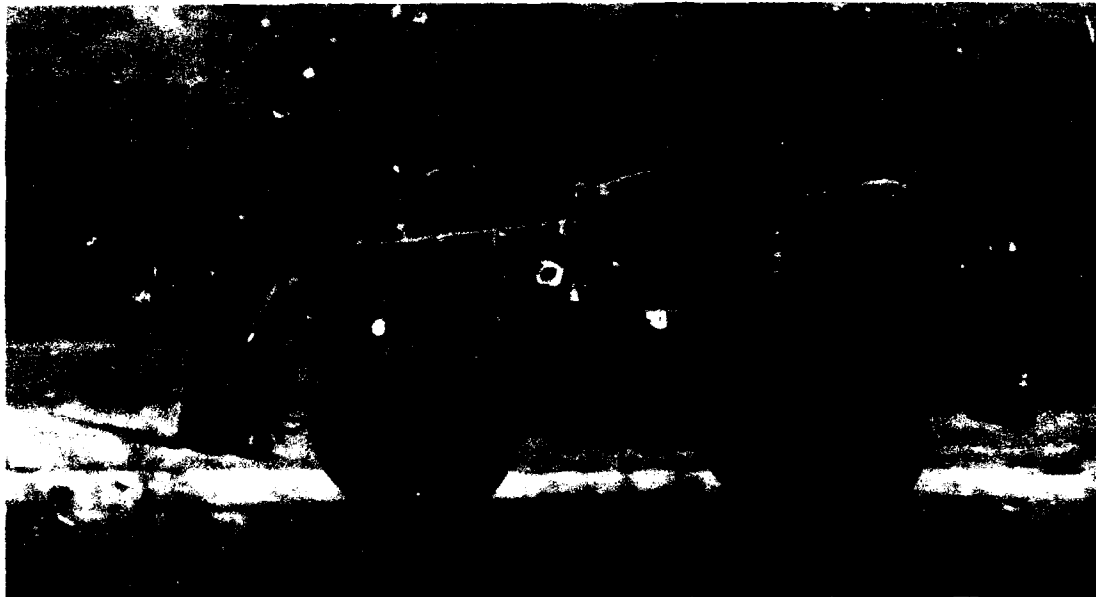

All Terrain Lifter, Articulated System (ATLAS)

POINT OF CONTACT

Mr. David Krawchuk
US Army Belvoir RD&E Center, SATBE-FMR
Fort Belvoir, VA 22060-5606
DSN 654-2314/Commercial (703) 704-2314

ITEM DESCRIPTION

The All Terrain Lifter, Articulated System (ATLAS) is a rough terrain variable reach forklift with a maximum lift capacity of 10,000 pounds at a load center of 48" and a reach of 4'. The ATLAS also has lift capacities of 6,000 pounds at 13' and 4,000 pounds at 23.5', both with a load center of 24". These lift capacities will allow the ATLAS to load and unload 20' long end opening ISO containers located on the ground or on a trailer, up to 5' from the end of the trailer. The ATLAS is self-deployable at speeds up to 45 mph to reduce the need for organic transportation. The ATLAS will be equipped with a micro-cooling unit to allow for sustained operations in an NBC contaminated environment.

STATUS

The O&O Plan for the program was approved in May 1986. A contract for the Proof of Principle (POP) prototype vehicle was awarded in September 1987 to FMC Corporation. The prototype vehicle was delivered in July 1989 and has completed testing at Aberdeen Proving Ground, MD.

PROGRAM PLAN

Award three Engineering & Manufacturing Development (EMD) contracts in FY94 for four each prototype vehicles. These vehicles will be tested at Aberdeen Proving Ground, MD, and the vehicles which complete testing will be eligible for the Production Contract which will be awarded in FY97.

NSN

Not assigned

Extendable Boom Forklift (EBFL)



Extendable Boom Forklift (EBFL)

POINT OF CONTACT

CWO3 Ed Deering
Dep CG, Marine Corps Systems Command, SSEA
Quantico, VA 22134-5080
DSN 278-2022/Commercial (703) 640-2022

ITEM DESCRIPTION

The Extendable Boom Forklift (EBFL) provides the Marine Corps the capability of loading and unloading 8' x 8' x 20' MILVANs and ISO containers located on the ground or trailer mounted, under field conditions. One of the main uses of the EBFL is to unload the Multiple Launch Rocket System (MLRS) pods from ISO containers.

The EBFL has two different carriages. The smaller carriage can handle 4,000 pounds at a reach of 20' and 6,000 pounds at a reach of 10', both measured to the load center. The larger carriage can handle 10,000-pound loads at a reach of 6'. The vehicle weight is 25,600 pounds, and it is 101" high, 102" wide, and 315" long.

STATUS

The Marine Corps awarded a contract to LULL Corporation on 30 September 1988 for 734 EBFLs. First Article Testing was approved during August 1989 and first deliveries began in May 1990. During production, the contract was terminated for default. The Marine Corps still has a requirement for approximately 104 EBFLs. Initial fielding of the EBFL was begun during 2QFY92.

PROGRAM PLAN

Fill the requirement for the vehicles not received under contract.

NSN

3930-01-305-2111



Part III

Container

Handling

Equipment

Spreader Bars, Intermodal Container Handling

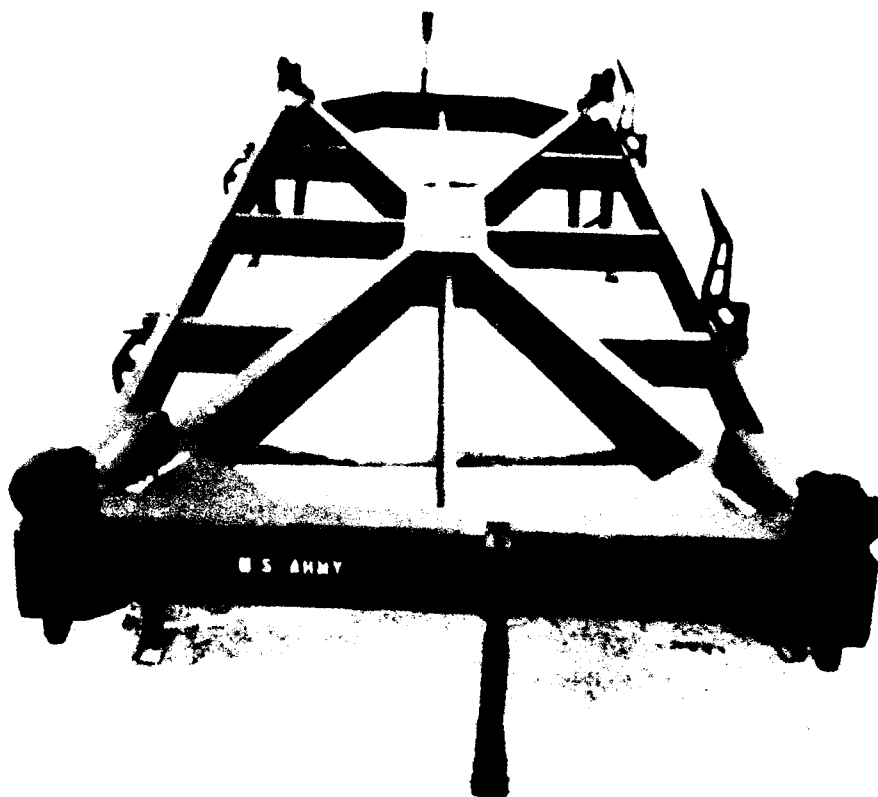

	20 FOOT	40 FOOT
CAPACITY	44,800 pounds	67,200 pounds
LENGTH	19' 10"	40'
WIDTH	7' 11"	7' 11"
HEIGHT	1' 6"	1' 6"
WEIGHT	3,000 pounds	5,000 pounds

Spreader Bars, Intermodal Container Handling

POINT OF CONTACT

Mr. Rolland Riley
US Army Belvoir RD&E Center, SATBE-FMR
Fort Belvoir, VA 22060-5606
DSN 654-2317/Commercial (703) 704-2317

ITEM DESCRIPTION

The Spreader Bars are connected by slings to the hook of a crane such as the Rough Terrain Container Crane (RTCC) or the 140-Ton Truck-Mounted Container Handling Crane and are used to handle ISO and other intermodal containers. The Army has two types of the Spreader Bars. One type is for handling 20' long containers and the other type is for handling 40' long containers. Both Spreader Bar types conform to the requirements of the Military Specification MIL-S-52713. Both types are of a fixed frame design and have manually locking twist locks.

STATUS

A contract was awarded in FY87 to Isometrics, Inc., for 476 20' spreaders and 154 40' spreaders. These spreaders were procured in support of the RTCC, currently in production. First Article Testing of the spreaders was conducted in two phases: the first phase was successfully conducted at the manufacturers facilities, and the second phase was conducted in conjunction with the First Article Test for the RTCC.

PROGRAM PLAN

No additional procurement actions are scheduled.

NSNs

20': 3990-01-258-2010
40': 3990-01-258-2011

Crane, 14-Ton, Wheel-Mounted ISO Container Handling

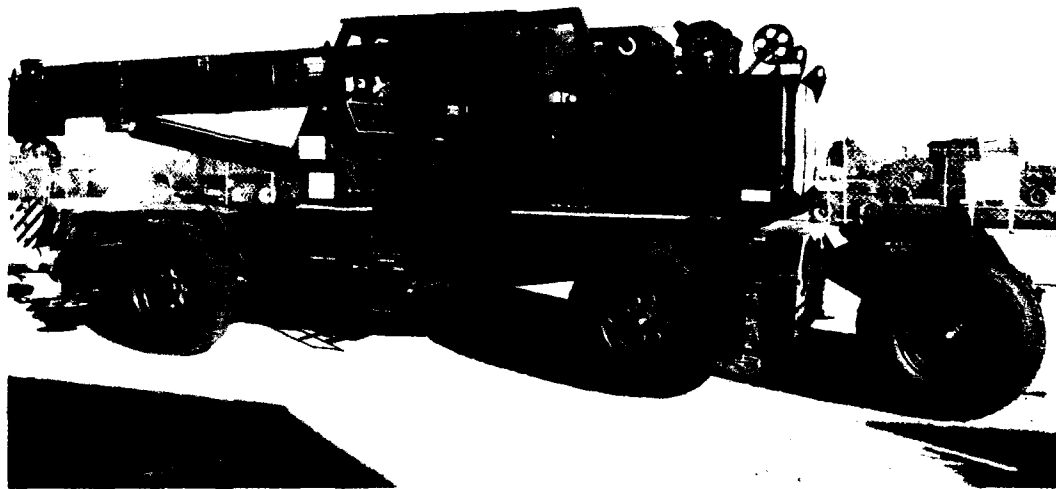

Crane, 14-Ton, Wheel-Mounted ISO Container Handling

POINT OF CONTACT

Mr. David Ha
Naval Construction Battalion Center (CESO Code 1532CP)
Port Hueneme, CA 93043-5000
DSN 551-3161/Commercial (805) 982-3161

ITEM DESCRIPTION

This crane is designed to handle 20' ISO containers with a 25,000 pound maximum gross weight in loading and off-loading trucks/trailers under field conditions. Powered by hydrostatic drive to the front wheels, it provides a self-propelled speed of 5 mph and a maximum towed speed of 5 mph. The crane is air transportable in C-130 aircraft via the use of a swing down center weight equipped with a third axle to distribute the vehicle weight over three axles.

STATUS

A contract was awarded in January 1990 to SpanDeck, Inc., for 44 units. Delivery of all units expected to be completed in 1992.

PROGRAM PLAN

There are no further program plans.

NSN

Unknown

Rough Terrain Container Crane (RTCC)

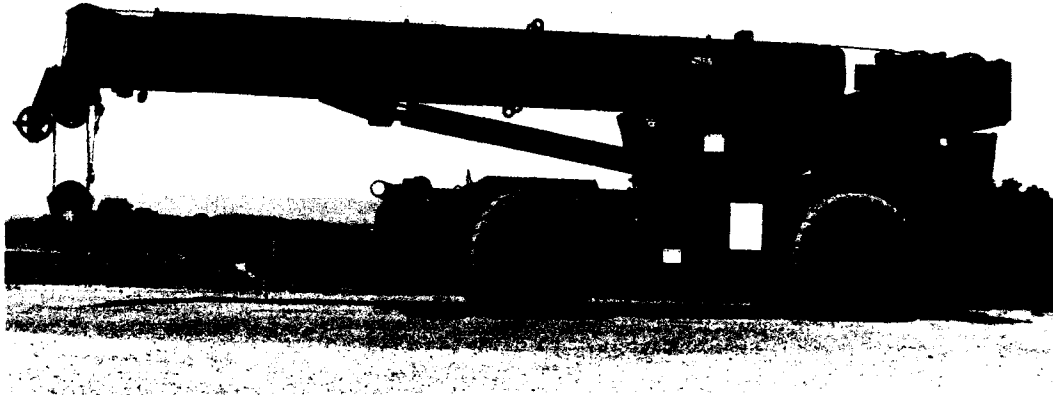

CAPACITY	44,800 pounds at 27'
LENGTH	548'
WIDTH	145'
HEIGHT	153'
WEIGHT	108,750 pounds

Rough Terrain Container Crane (RTCC)

POINT OF CONTACT

Mr. Victor Batson
US Army Belvoir RD&E Center, SATBE-FMR
Fort Belvoir, VA 22060-5606
DSN 654-2315/Commercial (703) 704-2315

ITEM DESCRIPTION

The RTCC is a commercially designed wheel-mounted crane. The RTCC is capable of lifting a 20' container weighing 44,800 pounds at a radius of 27' and a 35'/40' container weighing 67,200 pounds at a radius of 22'. General Support (GS) ammunition units use the RTCC "from a fixed position" for transfer of 20' ANSI/ISO containers from one mode of transportation to another or to ground/load containers from/to waiting transportation in the Theater and Corps ammunition storage areas. Transportation units use the crane to augment the 50,000-Pound Rough Terrain Container Handler in the transfer and handling of 20', 35', or 40' containers and other cargo between transportation modes and in storage areas.

STATUS

A Market Investigation was completed in FY85 and a purchase description prepared in FY86. Two candidate cranes were leased and evaluated during 3QFY85. The crane was type classified standard in August 1985, and was transitioned to the US Army TACOM. A contract was awarded to Grove Manufacturing Company on 24 November 1986 for 254 vehicles. Preproduction testing was conducted 1QFY88 to 4QFY88. Initial production testing was completed 2QFY89. Delivery of the RTCC commenced during June 1989 and was completed in January 1992.

PROGRAM PLAN

Support fielded cranes.

NSN

3810-01-205-2716

140-Ton, Truck-Mounted, Container Handling Crane



CAPACITY	140 tons approximately 12'
LENGTH WITH 50' BOOM	873.0'
WIDTH	132.5'
HEIGHT	157.8'
WEIGHT WITH 120' BOOM	195,000 pounds

140-Ton, Truck-Mounted, Container Handling Crane

POINT OF CONTACT

Mr. Eugene Rodrick
US Army Belvoir RD&E Center, SATBE-FMR
Fort Belvoir, VA 22050-5606
DSN 654-2316/Commercial (703) 704-2316

ITEM DESCRIPTION

The 140-ton crane is a commercial designed crane. It is truck-mounted, and has 140-ton maximum capacity at a reach of 12'. It has an 8' x 4' truck chassis and a 50' basic boom which can be extended in length up to 130' with the use of various lengths of lattice boom. The crane is used in the loading and unloading of containers from ships in a fixed port operation or landing craft in a Logistics-Over-The-Shore (LOTS) operation and for handling containers in a marshalling area and terminal sites. In a LOTS operation, the 140-ton crane is used on causeway sections to transfer containerized cargo from displacement craft to transport vehicles and on the beach to transfer containerized cargo from hovercraft to the beach.

STATUS

Initially, two cranes were procured from Harnischfeger Corporation (P&H) for testing in FY75. Two additional cranes were procured from Harnischfeger Corporation in FY77. A multi-year contract was awarded to FMC Corporation in September 1980 for 28 cranes. Deliveries began in January 1982 and were completed during FY85.

PROGRAM PLAN

There are no plans for additional procurements.

NSN

P&H—3950-01-027-9254
FMC—3950-01-110-9224

Lightweight Amphibious Container Handler (LACH)



Lightweight Amphibious Container Handler (LACH)

POINT OF CONTACT

CWO3 Ed Deering
Dep CG, Marine Corps Systems Command, SSEA
Quantico, VA 22134-5080
DSN 278-2022/Commercial (703) 640-2022

ITEM DESCRIPTION

The LACH is a straddle-lift type, towed, two-wheel mounted, container handler. The LACH is capable of lifting and carrying containers, ramp entry into large landing craft, and loading and unloading containers onto/from cargo trailers during amphibious operations. The LACH, when propelled by its prime mover (medium size bulldozer), can be maneuvered in the surf zone in up to 5' of water with a 20' container weighing up to 50,000 pounds.

STATUS

FY81 funds were appropriated for the production procurement of 56 LACHs to complete the Marine Corps inventory objective. All LACHs have been delivered to MCLBs. Each Maritime Prepositioning Ship Squadron were equipped with four LACHs.

PROGRAM PLAN

No additional procurement actions are planned.

NSN

3920-01-143-9607

Container Lifting Semitrailer

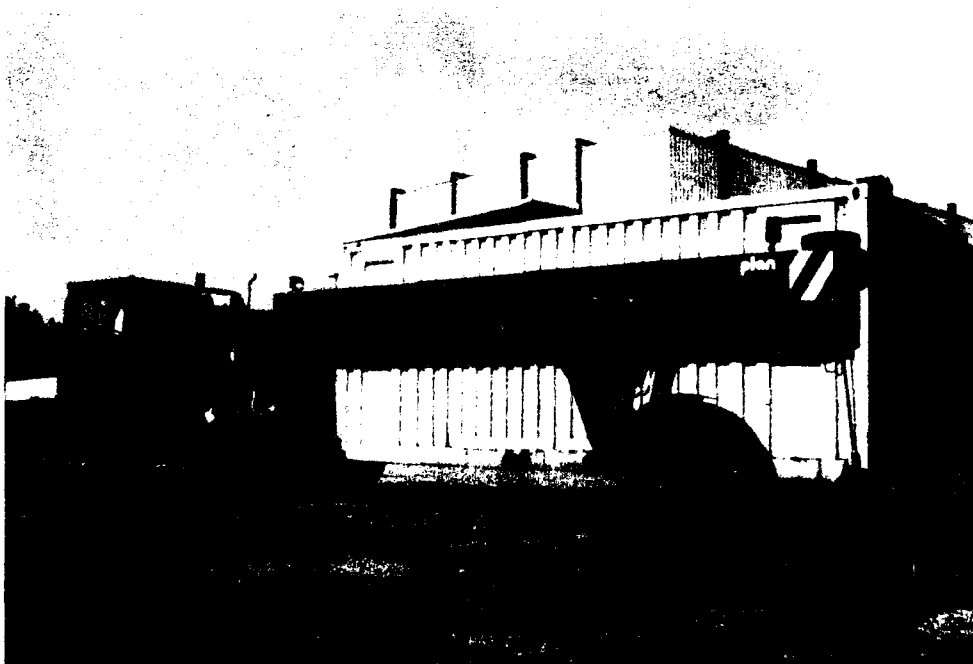

Container Lifting Semitrailer

POINT OF CONTACT

ZB-7 Hauk
6930th Civilian Support Center, AETS-SC-LS-I
APO AE 09160-0305
DSN 426-4565/Commercial 0791-45-565

ITEM DESCRIPTION

The Container Lifting Semitrailer is a U-shaped transporter which is capable of lifting a 20' long ISO container off of the ground and moving it to another location. The Container Lifting Semitrailer has guide wheels to protect the container from damage as it is backed around the container prior to loading. Quick connect couplings are attached to the lifting cables to allow for ease in lifting a container by the lower corner fittings. The container is lifted using hydraulics on the semitrailer which raise the entire frame of the semitrailer. The prime mover for the semitrailer, including hydraulics, is a specialized 4 x 2 yard tractor with a hydraulic-lift fifth wheel.

STATUS

The Container Lifting Semitrailer and prime mover were procured in early FY86 from PLAN Industries GmbH, to meet the need of moving ISO containers within the Civil Support Center. The Container Lifting Semitrailer has been in continuous use by the 2043rd Civilian Support Group, 2044th Civilian Support Group, and the 2045th Civilian Support Group (Ordnance).

PROGRAM PLAN

There are no plans to procure additional Container Lifting Semitrailers. As the force structure in Europe changes, the Container Lifting Semitrailer may be redistributed to accommodate changing needs for moving containers.

NSN

Not assigned

50,000-Pound Container Handler, Rough Terrain (RTCH)



CAPACITY	50,000 pounds at 48' load center
LENGTH WITH FORKS	420"
WIDTH	138"
HEIGHT	167"
WEIGHT WITHOUT TOP HANDLER	103,000 pounds
TOP HANDLER WEIGHTS:	
20'	3,800 pounds
35'	9,120 pounds
40'	9,927 pounds

50,000-Pound Container Handler, Rough Terrain (RTCH)

POINTS OF CONTACT

Mr. Eugene Rodrick
US Army Belvoir RD&E Center, SATBE-FMR
Fort Belvoir, VA 22060-5606
DSN 654-2316/Commercial (703) 704-2316

CWO3 Ed Deering
Dep CG, Marine Corps Systems Command, SSEA
Quantico, VA 22134-5080
DSN 278-2022/Commercial (703) 640-2022

COL Larry R. Kearns
Warner Robins Air Logistics Center, WRALC/LV
Robins AFB, GA 31098-5345
DSN 468-2062/Commercial (912) 926-2062

ITEM DESCRIPTION

The RTCH provides a capability of handling the 8' wide family of containers weighing up to 50,000 pounds and 20', 35', and 40' long. It is a rough terrain truck designed for operating on soft soil conditions such as unprepared beaches. The RTCH is four wheel drive and capable of fording in up to 5' of saltwater. The RTCH is a modified commercial design and procured to a military specification. The vehicle weighs approximately 103,000 pounds, is 138" wide, 167" high, and 35' long. Top handlers—20', 35', or 40' long—are placed on the forks of the RTCH to allow for handling the three different lengths of ISO containers.

STATUS

The Army awarded a multi-year contract to the Caterpillar Tractor Company for 177 vehicles in September 1978 and then exercised options bringing the total number of vehicles procured to 344. Of this number, the Air Force procured three for use with Containerized Ammunition Distribution Systems (CADS) shipments, and the Marine Corps procured 21. The Marine Corps increased their quantity to a total of 106 by awarding a contract for the additional RTCHs which were delivered in FY88. In FY89, the Air Force procured and fielded nine additional vehicles. In February 1991, the Air Force awarded a contract to Lift King for six vehicles and then exercised an option for six additional vehicles. On 12 March 1992, Volpe National Transportation System Center awarded a contract to Caterpillar for 62 fork kits for the Army's vehicles. These fork kits allow the RTCH to pick up half-height containers from the ground and were fielded between April and September 1992.

PROGRAM PLAN

The Air Force is scheduled to receive delivery of the vehicles in February 1993.

NSNs

Army/Marine Corps: 3930-01-082-3758
Air Force: 3930-01-307-3658CT

20'/40' Container Sideloader

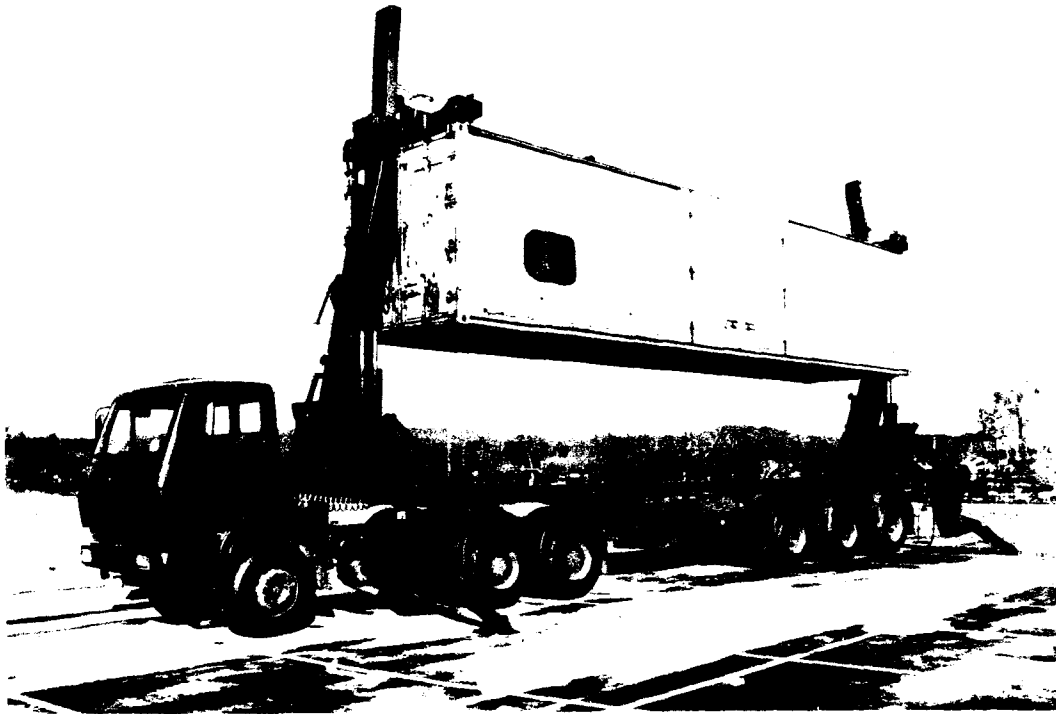

20'/40' Container Sideloader

POINT OF CONTACT

Mr. Walt Allenbacher
HQ US Air Force Europe, LGTT
Ramstein AB, GE, 3050 Box 105, APO AE 09094
DSN 480-6321/7468/Commercial 06371-47-6321/7468

ITEM DESCRIPTION

This diesel-powered container sideloader is capable of transferring or self-loading and transporting 20' through 40' ISO containers or tactical shelters. Maximum lifting capability is 66,150 pounds, with an additional 10 percent safety factor built-in. The unit has a telescopic spreader bar for 20', 35', and 40' containers, and can also lift containers with slings. The sideloaders can transport containers within maximum road height limitations. They also have an air ride suspension making them viable to transport ISO containers carrying delicate equipment. The unit is self-deployable by road and by C-5 military airlift. An optional 26-ton tractor is used to pull the sideloader.

STATUS

Four Klaus handlers were procured by the Army for Miesau Army Ammo Depot in 1972 to meet an urgent requirement for container handling. A BeSima/Marmon handler and a Steadman handler were procured by the Army and evaluated by Belvoir RD&E Center in 1975-76. The Steadman handler was subsequently provided to ASP-1 Vilseck, Germany. In August 1978, four additional Klaus handlers with tractors were procured for Army use at ASP-1. In 1982, the Air Force successfully tested the use of a sideloader (on loan from the Army) during an Air Force Containerized Ammunition Distribution System (CADS) movement to Germany. USAFE purchased two sideloaders in early 1984 under the Productivity Investment Program. These sideloaders were used successfully to support several CADS movements in both MILVANs and SEAVANs during 1984. USAFE bought 27 additional 40' sideloaders between FY86 and FY88. The sideloaders are used throughout Europe to support CADS and ISO container movements. USAFE bought and fielded six 20' capacity sideloaders during FY90. The 20' sideloaders have enabled USAFE to increase maneuverability in close areas. USAFE has a total of 35 sideloaders in use at 15 bases (29 each 20/40' and 6 each 20'). The Army has obtained additional sideloaders and has met its inventory objective of eighteen 20' containers, 44,800-pound capacity sideloaders for use in Germany.

PROGRAM PLAN

There are no additional plans for procurement.

NSNs

40': 3810-01-228-0190CT
20': Unknown

Palletized Load System (PLS)

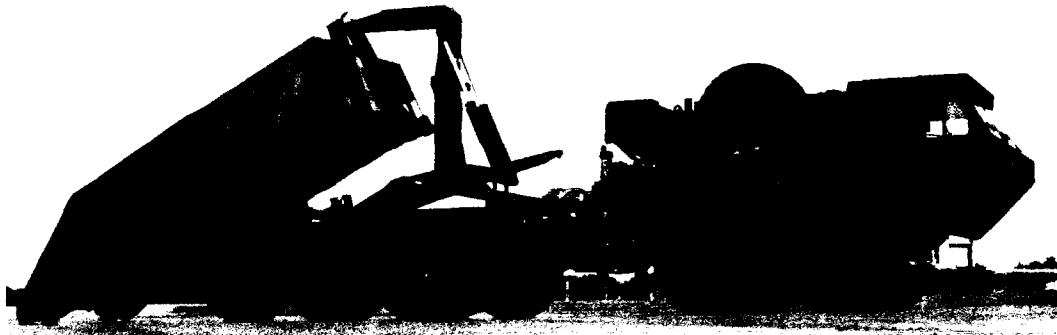

Palletized Load System (PLS)

POINT OF CONTACT

COL W. John Stoddart
US Army Tank-Automotive Command, SFAE-CS-TVH
Warren, MI 48397-5000
DSN 786-5800/Commercial (313) 574-5800

ITEM DESCRIPTION

The Palletized Load System (PLS) consists of a standard mobility heavy truck chassis, an integral hydraulic load handling mechanism, a compatible trailer, and a number of flatracks. The system is capable of self-loading and self-unloading the flatracks from the ground onto the truck chassis using the integral load handling system. The vehicle-mounted load handling system also has the capability to load and unload flatracks onto the companion trailer. Both the truck and the companion trailer have a 16.5-ton payload capacity.

STATUS

Three heavy (15-ton payload) PLSs were evaluated for 2 years by ADEA and the 9th ID at Fort Lewis, WA. Three additional heavy and 15 medium (7.5-ton payload) PLSs were evaluated by ADEA between 2QFY85 and 2QFY86. Under a separate program, the TACOM leased 46 PLSs of 10- and 15-ton payloads for use in Force Development Test and Evaluation (FDTE) at Fort Hood, TX, during 1QFY87. The results showed the advantages of PLS in the distribution of ammunition. In January 1989, TACOM awarded three prototype contracts to General Motors, PACCAR and Oshkosh. Competitive testing between the three contractors was conducted from September 1989 through March 1990 at Aberdeen Proving Ground (APG), MD, Yuma Proving Ground (YPG), AZ, and Fort Carson, CO. This testing involved nine trucks, six trailers, and 30 flatracks from each of the three contractors. Based on the test results, system costs, and production proposals, the Source Selection Board chose the Oshkosh vehicle over the other two competitors' vehicles. In September 1990, the Defense Acquisition Board (DAB) approved and released funds for the PLS. The PLS contract is a 5-year multi-year, \$860 million contract for approximately 2,626 PLS trucks, 1,050 trailers, and 11,030 flatracks with Oshkosh.

Shakedown testing was conducted 4QFY91-1QFY92 at the Nevada Automotive Test Center (NATC). Following shakedown testing, more than 120,000 miles of endurance testing was conducted at APG and YPG. Operational testing was conducted at Fort Hood from May to August 1992.

PROGRAM PLAN

A Milestone III review at the Army System Acquisition Review Council (ASARC) level is scheduled for 1QFY93 and will authorize Full Rate Production.

NSNs

Truck with MHE Crane:	2320-01-304-2277
Truck:	2320-01-304-2278
Trailer:	2330-01-303-5197
Flatrack:	3990-01-307-7676

Logistics Vehicle System

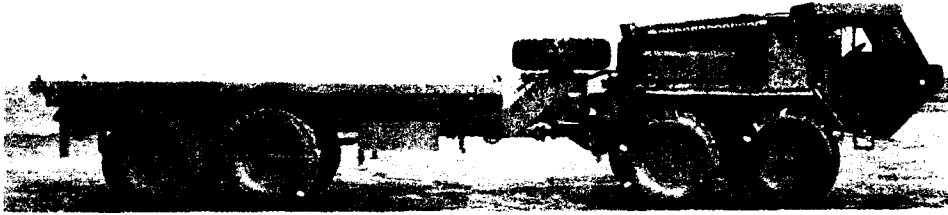

MK 48/MK 14

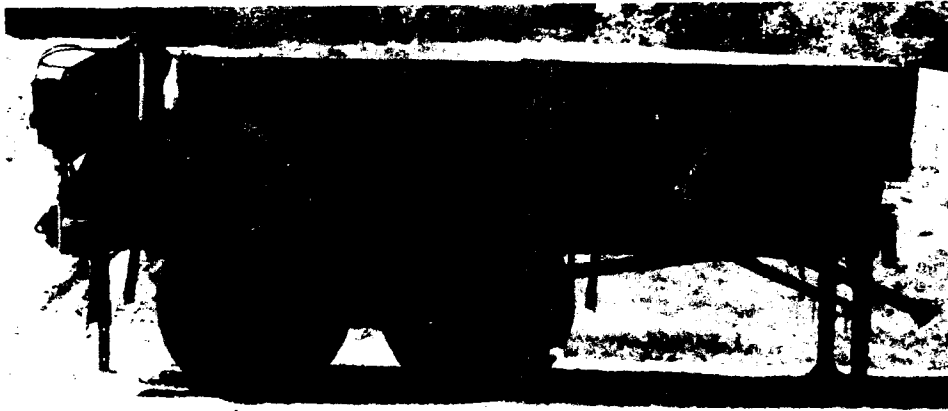

MK 17



MK 18

Logistics Vehicle System

POINT OF CONTACT

MAJ John Wozniak
Marine Corps Systems Command, Code SSCMT
Quantico, VA 22134-5080
DSN 278-4291/Commercial (703) 640-4291

ITEM DESCRIPTION

The Logistics Vehicle System consists of one front power unit (MK48) and any one of five rear body unit configurations. The MK14 Container Hauler is an ISO twist-lock equipped, 22.5-ton capacity; rear body unit designed to transport standard ISO 8' x 8' x 20' containers, shelters, and modules. The MK17 Dropside Cargo with crane is a rear body unit with an 8' x 16' loading area designed as a troop carrier as well as a carrier for fuel/water modules, and 8' x 8' x 10' shelters/containers. The MK18 Self-Loading Ribbon Bridge Transporter/Container Handler is a hydraulically powered tilt bed rear body unit designed to load/offload ISO containers, ribbon bridge components or fill material without the assistance of material handling equipment.

STATUS

Approval for service use for the MK48 Front Power Unit and MK14 Container Hauler Rear Body Unit was obtained in July 1982. Approval for the MK17 Dropside Cargo variant was obtained in August 1983. A 5-year letter contract was signed in September 1983 for 1,433 units with options extending the total to 1,686 total Logistics Vehicle Systems. The Logistics Vehicle System consisting of the MK48/14/17 began delivery to selected units in August 1985 with a subsequent Initial Operational Capability (IOC) of March 1986. Production deliveries were completed September 1989. The MK18 R&D prototype testing commenced 3QFY88 and a Milestone III was held on 9 January 1990. Production contract award for a base quantity of 100 units occurred in February 1990; the first option for 110 units was exercised in July 1990. Delivery of production vehicles commenced January 1991. A second option for 110 units was exercised 1QFY92 bringing the total to 320 units under contract.

PROGRAM PLAN

Delivery of 320 production vehicles will continue at a rate of approximately 15 per month until April 1993. A requirement exists for 168 units in FY93 pending the availability of funds. A rebuy of the Logistics Vehicle System is planned for FY94-95.

NSNs

MK48: 2320-01-177-5162
MK14: 2320-01-176-0469
MK17: 2320-01-176-0468
MK18: 2320-01-324-5915

Part IV

Ground

Transportation

Equipment

Chassis, Semitrailer: Coupleable, MILVAN Container Transporter

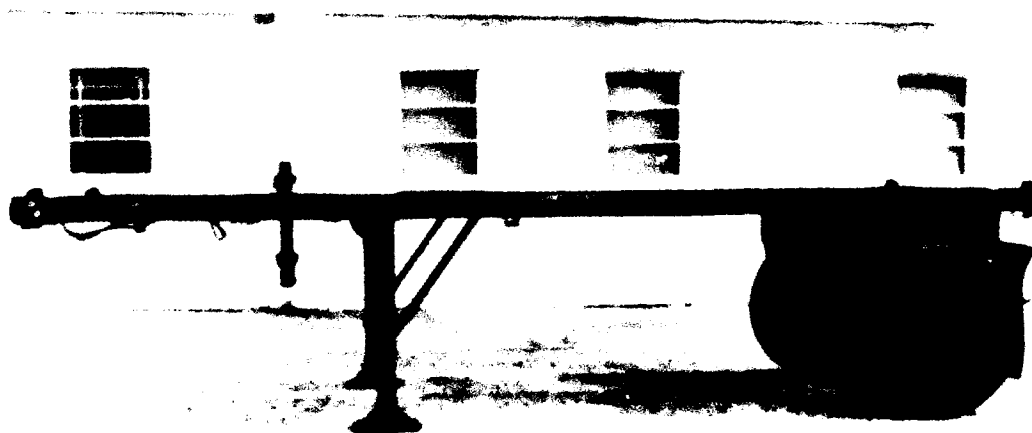

	20' UNIT SINGLE BOGIE	20' UNIT DOUBLE BOGIE	40' UNIT DOUBLE BOGIE
LENGTH	242'	242'	484'
WIDTH	96'	96'	96'
HEIGHT*	53.5'	53.5'	53.5'
WEIGHT	4,000 pounds	5,850 pounds	8,000 pounds

*Height when unloaded and supported on landing legs with deck level.

Chassis, Semitrailer: Coupleable, MILVAN Container Transporter

POINT OF CONTACT

Mr. Walt Newell
US Army Tank-Automotive Command, AMSTA-FHS
Warren, MI 48397-5000
DSN 786-6677/Commercial (313) 574-6677

ITEM DESCRIPTION

The MILVAN chassis was procured to attain a military owned, centrally controlled fleet for movement of military and commercial ISO containers over primary hard surface roads principally in CONUS. The chassis consists of a 20' frame, landing gear, and single-axle bogie. The bogie is movable along the length of the frame. The frame has provisions for coupling two 20' units to form a 40' chassis, with the bogies under the rear frame to form a tandem-axle configuration. Each frame has twist locks to accept ISO containers. There is provision for lowering the twist locks flush with the top of the frame so that 40' containers can be transported on a coupled chassis. The MILVAN chassis was competitively procured from industry utilizing a military performance specification.

STATUS

The MILVAN chassis is currently deployed. From 1969-71, 5,620 were procured; 1,479 are currently in inventory. A 4-year overhaul program for 700 units was begun in FY84, and was completed in December 1989.

PROGRAM PLAN

There is no current plan to procure additional units or initiate additional overhauls.

NSN

2300-00-168-2259

Semitrailer, Linehaul, Breakbulk/Container, M872 Series

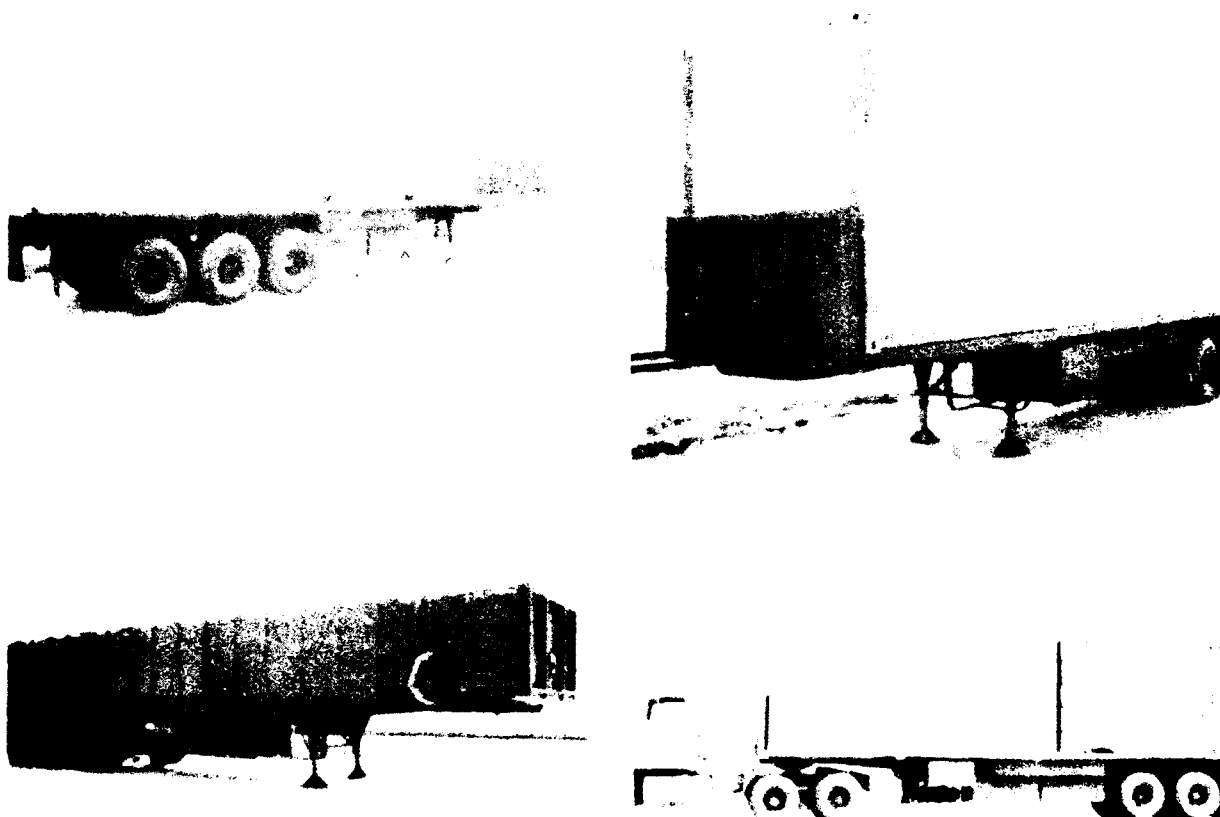

CURB WEIGHT	17,400 pounds	TIRES	10:00 X 20 tube type
RATED PAYLOAD	67,200 pounds	BRAKES	cam/air
GROSS WEIGHT	84,600 pounds	ELECTRICAL	12/24 volt
OVERALL LENGTH	489'	LANDING GEAR	hand/mechanical
OVERALL WIDTH	96'	SIDE PANEL HEIGHT	48"
PLATFORM HEIGHT	59**	CONTAINER LOCKS	20', 35', 40', 24', 5', 6 ² / ₃ ', and 10'
FIFTH WHEEL HEIGHT	50' loaded		

**Height when unloaded and supported on landing legs with deck level*

Semitrailer, Linehaul, Breakbulk/Container, M872 Series

POINT OF CONTACT

Mr. Michael Decker
US Army Tank-Automotive Command, AMSTA-FTH
Warren, MI 48397-5000
DSN 786-5606/Commercial (313) 574-5606

ITEM DESCRIPTION

The M872 Series Semitrailers are commercial design flatbed semitrailers of 34-ton capacity used in the linehaul of containers, breakbulk cargo, and M113 Armored Personnel Carriers (APCs). The M915/M915A1 truck tractor is the prime mover.

STATUS

Procurement of the total requirement of 8,656 semitrailers was accomplished by five separate contracts as follows:

Model	Contractor	Quantity
M872	Theurer	1,364
M872	Southwest	1,304
M872A1	Theurer	2,713
M872A1	Heller	212
M872A2*	Theurer	125
M872A2*	Heller	125
M872A3	Southwest	<u>2,813</u>
		8,656 Total

* Model M872A2 has a tapered gooseneck configuration which has been modified by installing a saddle to the gooseneck.

All contracts are complete. All medium transportation companies have 100% fill of the M872.

PROGRAM PLAN

Provide support for fielded items.

NSNs

M872: 2330-01-039-8059
M872A1: 2330-01-109-8006

M872A2: 2330-01-119-5837
M872A3: 2330-01-142-1385

Semitrailer, Tactical, Dual Purpose Breakbulk/Container Transporter, 22¹/₂-Ton, M871 Series

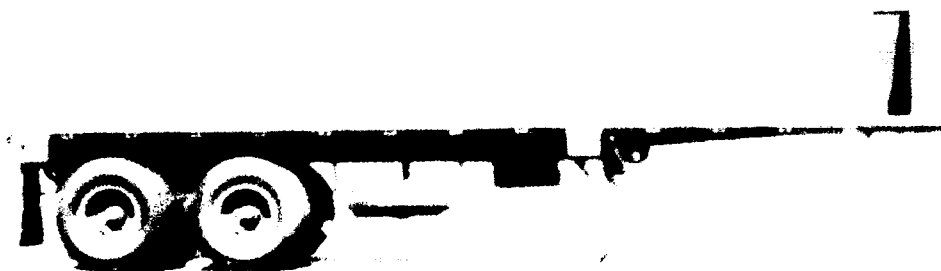

RATED PAYLOAD	44,800 pounds	TIRES	11:00 X 20
OVERALL LENGTH	358'	ELECTRICAL	12/24 volt
OVERALL WIDTH	96'	LANDING GEAR	hand/mechanical
PLATFORM HEIGHT	55**	CONTAINER LOCKS	20', 10', 6 ² / ₃ ', and 5'

**Height when unloaded and supported on landing legs with deck level*

Semitrailer, Tactical, Dual Purpose Breakbulk/Container Transporter, 22¹/₂-Ton, M871 Series

POINT OF CONTACT

Mr. Michael Decker
US Army TACOM, AMSTA-FTH
Warren, MI 48397-5000
DSN 786-5606/Commercial (313) 574-5606

ITEM DESCRIPTION

The M871 is a commercial design tactical semitrailer whose primary application will be the delivery and retrograde of ISO containers and shelters up to 20' long, and breakbulk cargo in an overseas theater of operation between the Corps General Support Supply Activities (GSSA) and the Division Support Command (DISCOM). On occasion it may also be used to deliver containers to forward distribution points or to using units. The prime movers in these roles will be the M818, M915, and M932 truck tractors. The tactical semitrailer will also be used on the linehaul mission as a means of clearing 20' or smaller containers from the port area. The prime mover in this role will normally be the M915 linehaul tractor.

STATUS

A flatbed configuration was selected by the Logistics Center in December 1977, after consideration was given to the conflicting requirements dictated by breakbulk and container transport mission. A quantity of 3,325 trailers was procured and fielded under a 5-year multi-year contract awarded to Southwest Truck Body in March 1979. A quantity of 246 M871A1 trailers was procured and fielded under a contract awarded in May 1985 to Shoals American Industries, Inc. Deployment of the M871/M871A1 has been completed. A 3-year contract for the M871A2 was awarded in September 1988 to Dynaweld, Inc., for 1,089 units with 100% options per year. Initial Production Testing of the M871A2 was completed in September 1990 and delivery began in October 1990.

PROGRAM PLAN

Provide support for fielded items.

NSNs

M871: 2330-00-122-6779
M871A1: 2330-01-226-0701
M871A2: 2330-01-294-3367

Truck Tractor, Yard Type, 4 x 2, M878A1



CURB WEIGHT	16,280 pounds
OVERALL LENGTH	182.5'
OVERALL WIDTH	98.125'
OVERALL HEIGHT	120"
WHEEL BASE	116"
FIFTH WHEEL HEIGHT	8' to 64'

Truck Tractor, Yard Type, 4 x 2, M878A1

POINT OF CONTACT

Mr. David Hilliter
US Army Tank-Automotive Command, AMSTA-FTM
Warren, MI 48397-5000
DSN 786-6141/Commercial (313) 574-6141

ITEM DESCRIPTION

The yard type truck tractor is primarily used to provide a capability to shuttle semitrailers loaded with containers or breakbulk cargo within fixed ports, on prepared beaches during Logistics-Over-The-Shore (LOTS) operations, and in trailer transfer areas. The vehicle is a highly maneuverable commercial tractor with an automatic locking, hydraulic-lift fifth wheel which facilitates semitrailer coupling and disengagement, and allows movement of the semitrailer/chassis without retracting the landing legs. It is capable of moving vehicles weighing between 21,000 and 60,000 pounds.

STATUS

Twenty-eight trucks were competitively procured from Ottawa Truck Company for use during Joint-Logistics-Over-The-Shore (J-LOTS) testing in 1977. Based on the favorable results of this test, 16 additional trucks were ordered. The truck passed all First Article Tests, and a third buy contract was awarded to Ottawa Truck Company for a quantity of 175 trucks. Of these 175 vehicles, 56 were issued in 1983 to fill initial CONUS requirements. A full AR 700-34 release of the M878A1 was granted in October 1985. Forty-three trucks have been deployed to USAREUR and nine deployed to Korea. Twenty-six vehicles were fielded to CONUS units in FY90, and 27 were issued in support of Operation Desert Shield/Desert Storm.

PROGRAM PLAN

Continue to fully support fielded vehicles. There are no current plans for additional procurements.

NSN

2320-01-121-2102

Truck Tractor, Linehaul 6 x 4, M915 Series



Truck Tractor, Linehaul 6 x 4, M915 Series

POINT OF CONTACT

Mr. Mario Musotto
US Army Tank-Automotive Command, SFAE-CS-TVH
Warren, MI 48397-5000
DSN 786-8065/Commercial (313) 574-8065

ITEM DESCRIPTION

The M915 Series tractors are military adaptations of commercial 6 x 4 tractors. The M915 is the on-road prime mover for the M872 series Breakbulk/Container Transporter Semitrailer (105,000-pound Gross Combination Weight Rating) and is used in linehaul operations from the port of debarkation to the division rear boundary. It partially replaces or augments the M818/M931 5-ton Tactical Tractor fleet. The M915 was part of a single procurement action which fielded a six-vehicle family. The other vehicles within the combined procurement were the M916 Light Equipment Transporter, M920 Medium Equipment Transporter, M917 20-Ton Dump Truck, M918 Bituminous Distributor, and M919 Concrete Mobile.

The M915A1 is a rebuy of the M915 and it has been improved to include state-of-the-art advances in heavy truck technology. It is intended for linehaul operation from the port of debarkation to the division rear boundary. While the M915A1 is used primarily with the M872 series semitrailers, it is capable of operating with a variety of military and commercial trailers.

The M915A2 is a later version of the M915A1. It has a dual purpose of being the prime mover for the M1062, a 7,500 gallon petroleum tanker, as well as the M872 semitrailers.

STATUS

Four M915s with companion M872 semitrailers satisfactorily completed Force Development Test and Evaluation (FDTE) at Fort Campbell, KY, between January and April 1979. Production was completed in June 1980 and the entire fleet of 2,498 M915 tractors has been fielded. AM General produced 2,342 M915A1s. Deployment to USAREUR, US Army Reserves, and Army National Guard was made between August 1983 and July 1984 to 37 Medium Transportation Companies.

In September 1988, a contract was awarded to Freightliner Corp. to produce the M915A2 tractor. There are 769 M915A2s on contract with options for more. Production Approval was granted to Freightliner in December 1990.

Production has been completed on the M915A2.

PROGRAM PLAN

Handoff of the M915A2s to the field will be completed during FY93.

NSNs

M915: 2320-01-028-4395
M915A1: 2320-01-272-5029
M915A2: 2320-01-028-4396

5-Ton Truck Bed with ISO-Configured Locking Devices



5-Ton Truck Bed with ISO-Configured Locking Devices

POINT OF CONTACT

CAPT John H. Mayles
CG, Marine Corps Systems Command, Code SSCMT
Quantico, VA 22134-5080
DSN 278-4281/Commercial (703) 640-4281

ITEM DESCRIPTION

The ISO-configured truck bed is a modification to the cargo beds of the existing 5-ton trucks to facilitate the transport of ISO-configured containers. The 14' bed will transport two SIXCON containers while the 20' bed will transport one 20' long ISO container, two 10' long ISO containers, or four QUADCONs.

STATUS

A letter contract was awarded during June 1988. Contract was definitized on 26 March 1990 and is for a total of 1,198 5-ton truck beds; 1,182 14' beds; and 16 20' beds.

PROGRAM PLAN

Shipment of the beds will commence by 4QFY92. The truck beds will be delivered to the 5th echelon depots where the beds will be placed on the trucks during the inspect and repair program. Plans are to outfit all of the Marine Corps 5-ton trucks over the next 5 years.

NSNs

M813A1: 2320-01-329-7162
M923: 2320-01-333-4129
M927: 2320-01-333-2956

**Truck, Stake, 6 x 6, 15-Ton,
46,000 GVW, with ISO Lock**



Truck, Stake, 6 x 6, 15-Ton, 46,000 GVW, with ISO Lock

POINT OF CONTACT

Mr. Ponciano (Chano) Peralta
Naval Construction Battalion Center (CESO Code 1532CP)
Port Hueneme, CA 93043-5000
DSN 551-3190/Commercial (805) 982-3190

ITEM DESCRIPTION

Truck, Stake, 6 x 6, 15-ton, 46,000 GVW with 34,000 pound rear axles, 12,000 pound front axles minimum, diesel engine-driven (DED), automatic transmission, trailer towing package. Limited slip differentials, lifting and tiedown brackets. Fold down troop seats and cargo bed cover with bows. Bed is 20' in length with ISO twist lock in corners of body capable of accepting a 20' ISO container. Air transportable in C-130 aircraft.

STATUS

The Navy has procured 186 trucks in prior years through multiple contracts. A contract was awarded in FY91 to Navistar International, Inc., for 47 trucks. The contract contains options that could be exercised to obtain additional quantities.

PROGRAM PLAN

The Navy has programmed for procurement the following quantities of trucks during the years indicated:

FY92	FY93	FY94	FY95
126	50	50	50

NSN

Unknown

**Railway Car, Flat (Heavy Duty),
150-Ton Capacity, Domestic Service**

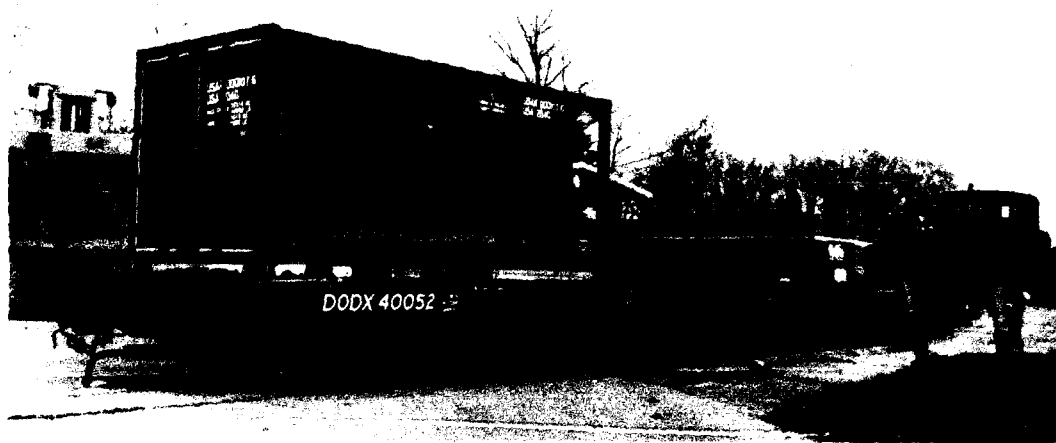

Railway Car, Flat (Heavy Duty), 150-Ton Capacity, Domestic Service

POINT OF CONTACT

Mr. Harold Ranslem
US Army Belvoir RD&E Center, SATBE-FMT
Fort Belvoir, VA 22060-5606
DSN 654-2325/Commercial (703) 704-2325

ITEM DESCRIPTION

The 150-ton flat car is designed for unrestricted interchange use while transporting both oversized tracked and wheeled vehicles and multiple ANSI/ISO containers loaded with Class A explosives and other commodities. The all-steel car is equipped with integral securement systems to restrain both tracked/wheeled vehicles and ISO containers. For ISO containers, the securement system accommodates a single 40' container, three 20' containers, or a combination of both sizes. The twist locks are of the pedestal type that lock automatically when the container is set in place and release automatically when the containers are lifted. The flat car is approximately 68' long; 10' 5" wide; and is supported by two three-axle trucks. The car is designed to carry a capacity of 150 tons.

STATUS

Four production contracts yielding 574 cars have been completed. These cars have been fielded and are managed by MTMC. A contract for 20 150-ton capacity cars was awarded in FY90 to General Railroad, Group. These cars will be used by the Navy and will not have the same securement systems as the previous cars. These cars will be used to transport special loads using the Navy's securement system. Production of the 20 cars began in FY91.

PROGRAM PLAN

All 20 cars should be fielded by the end of FY93.

NSN

2220-01-058-6377

Part V

LOTS, Harbor, and Container

Offloading and Transfer Equipment

SEASHED System

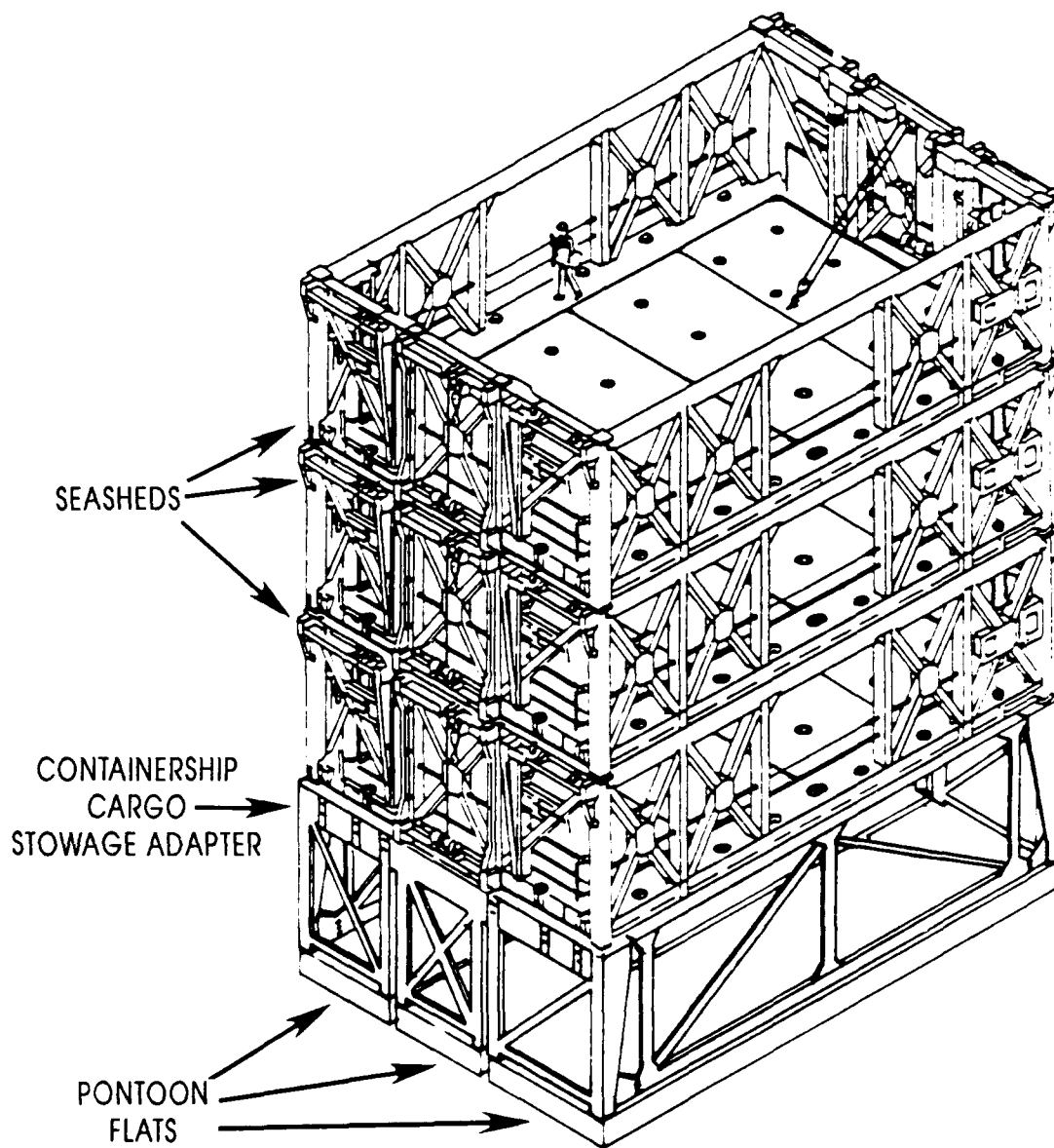

SEASHED System

POINT OF CONTACT

Mr. Marty Fink
Naval Sea Systems Command, PMS-3853
Washington, DC 20362-5101
DSN 332-0920/Commercial (703) 602-0920

ITEM DESCRIPTION

The SEASHED System consists of a stack of up to three SEASHEDs on a Containership Cargo Stowage Adapter (CCSA).

SEASHEDs are open-topped large cargo containers that fit into the container cells of a containership to provide the capability to carry large, heavy or oversized cargo such as Army and Marine Corps tanks and helicopters. Each SEASHED occupies the space of three 40' containers in width and has the overall height of 1-1/2 containers, having dimensions of 25' wide, 40' long, and 12-1/2' high. The maximum cargo capacity of each SEASHED is 220,000 pounds. Each SEASHED weighs 76,000 pounds. The floor of the SEASHED opens to allow cargo to be lowered through to the SEASHED or CCSA below. The clear opening of the floor is 30' x 18'. The CCSA has two elements—the adapter frame and three pontoon flats—which provide the same storage capability as a SEASHED. The quantity to be procured is to satisfy contingency logistics requirements for heavy lift shipment via Ready Reserve Force (RRF), US Flag, and allied containerships.

STATUS

In 1989, contracts were awarded for the SEASHED and CCSA units. The last deliveries were received during 3QFY92 bringing the approximate totals to 1,058 SEASHED and 359 CCSA units. The inventory is at three storage locations: MOT, Bayonne, NJ; NWS; Charleston, SC; and Port Hueneme, CA.

PROGRAM PLAN

Program completed.

NSNs

SEASHED: 0910-LP-433-9400
CCSA: 0910-LP-248-8700

Floating Causeway (FC)

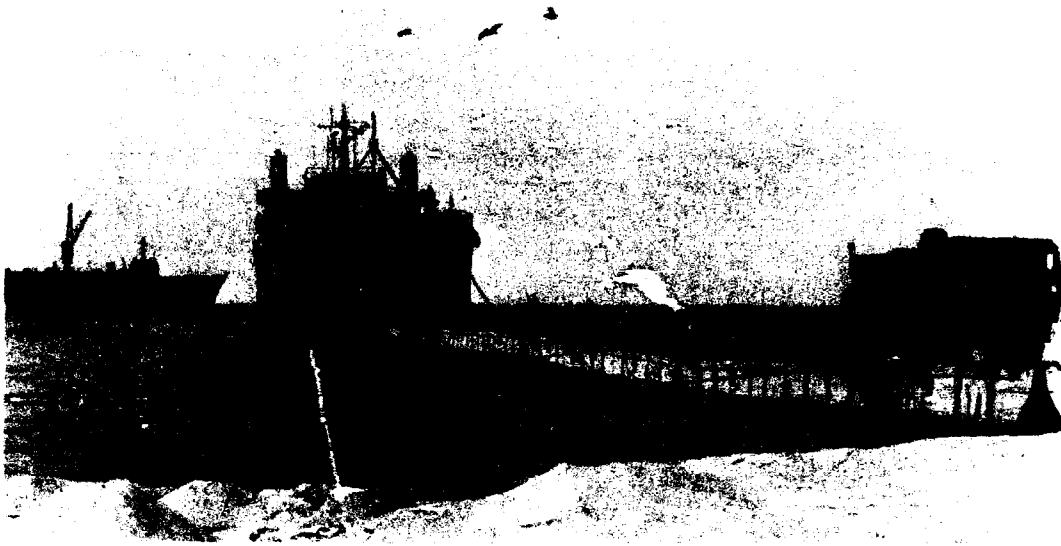

Floating Causeway (FC)

POINTS OF CONTACT

Mr. Ben Oh
US Army Belvoir RD&E Center, SATBE-FMS
Fort Belvoir, VA 22060-5606
DSN 654-3623/Commercial (703) 704-3623

Mr. Greg Walker
Naval Facilities Engineering Command, Code 0632
Alexandria, VA 22332
DSN 221-8535/Commercial (703) 325-8535

ITEM DESCRIPTION

The Floating Causeway (FC) consists of non-powered intermediate, offshore and beach end sections, and an Anchor Mooring System (AMS). It extends from the high water line out into the surf zone to a mean low water depth of 8'. The maximum working length of an FC is approximately 1,500'. The beach end sections include transition ramps from the roadway surface to the beach. The offshore end incorporates an adapter end for the discharge of cargo from displacement lighters onto the roadway. The offshore end uses the "Rhino" horn to mate with lighters, so equipped. The FC uses an AMS to retain an emplaced FC. The AMS uses large marine anchors placed perpendicular to the roadway, offshore, and dry beach anchors to secure the FC to the beach. Two Side Loadable Warping Tugs (SLWTs) are Associated Support Items of Equipment (ASIOE). The SLWTs are used to insert, retract, and tender the FC and to emplace and remove the larger AMS anchors. The FC is used as a dry bridge in the transfer of cargo (primarily rolling cargo) from displacement lighters to the shoreside logistics operation.

STATUS

The FC facility was granted Type Classification (TC) Limited Procurement Urgent (LPU) in February 1988 by HQ, DA direction. The Army FC hardware is being procured under multiple Army and Navy competitive procurement contracts, in accordance with an Interservice Support Agreement. The Army FC requirement is for four systems. This quantity is identified in the Army Watercraft Master Plan. Currently, the Army has two FC systems of the Navy Lighterage (NL) configuration and two systems configured using modular ISO-compatible components.

PROGRAM PLAN

Army Initial Operational Capability (IOC) is expected to be 1QFY93.

NSN

1945-01-218-7268

Elevated Causeway, Modular (ELCAS (M))

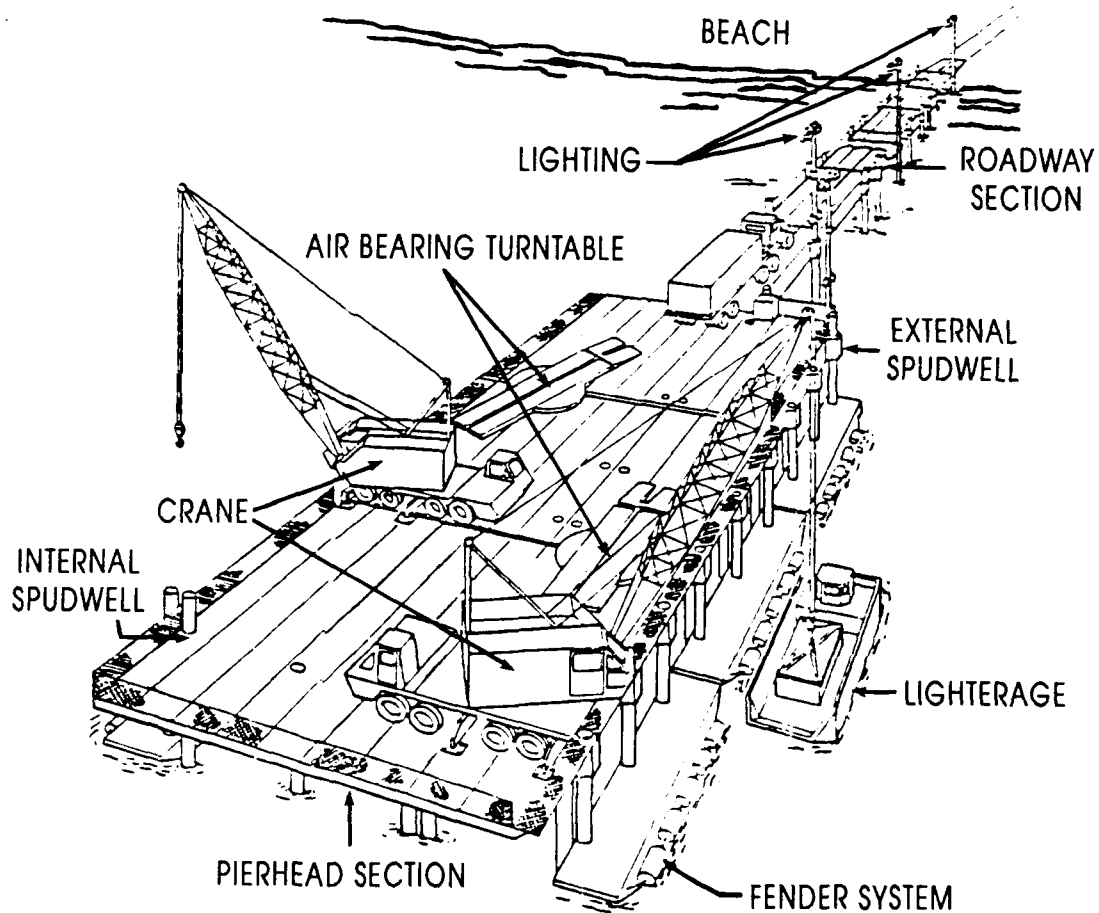

Elevated Causeway, Modular (ELCAS (M))

POINTS OF CONTACT

Mr. Ben Oh
US Army Belvoir RD&E Center, SATBE-FMS
Fort Belvoir, VA 22060-5606
DSN 654-3623/Commercial (703) 704-3623

Mr. Greg Walker
Naval Facilities Engineering Command, Code 0632
Alexandria, VA 22332
DSN 221-8535/Commercial (703) 325-8535

ITEM DESCRIPTION

The Elevated Causeway, Modular (ELCAS (M)) is a modular pier facility, composed of container-compatible modules, providing an interface between displacement craft carrying containers and the beach. The ELCAS (M) will have a nominal length of up to 3,000', as required, to reach a 20' water depth at the pierhead and is 15' above the mean low water level. The pierhead will be 72' wide by 240' long. The two long sides of the pierhead will have a fendering system to accommodate unscathed, lighter interface. The ELCAS (M) is constructed by erecting initial section(s) and mounting a construction crane on top of them. Subsequent sections will be cantilevered from the previously erected sections and secured in place with piles. An ELCAS (M) roadway section measures 24' x 40', consisting of three ISO pontoons, each measuring 40' x 8' x 4.5'. Emplaced on the ELCAS (M) pierhead are two vehicle turntables for truck turnarounds which are supported by air bearings. Two container-handling cranes will be stationed on the ELCAS (M) pierhead to transfer cargo from lighters to container handling vehicles for subsequent transport to shore. The constructed ELCAS (M) will be equipped with a lighting system. Side-Loadable Warping Tugs and Modular Causeways will be used to install, maintain, and retrieve the ELCAS (M) system.

STATUS

An Army Operational and Organizational (O&O) Plan for the Elevated Causeway (ELCAS) was approved by the Commanding General, TRADOC, on 9 August 1985. A draft Operational Requirement (OR) for the ELCAS (M) has been prepared by the Naval Facilities Engineering Command and Army requirements for the ELCAS (M) have been incorporated into the Navy's OR. The Navy awarded a contract for the ELCAS (M) on 18 September 1992 to Jered Brothers, Inc.

PROGRAM PLAN

The Navy will test the ELCAS (M) being fabricated and will receive delivery in September 1994. The Army Watercraft Master Plan identifies the requirement for two ELCAS (M); funding for the Army ELCAS (M) is currently in the Program Objective Memorandum (POM) for FY95-99.

NSNs

Not assigned

Roll-On/Roll-Off Discharge Facility (RO/RO DF)

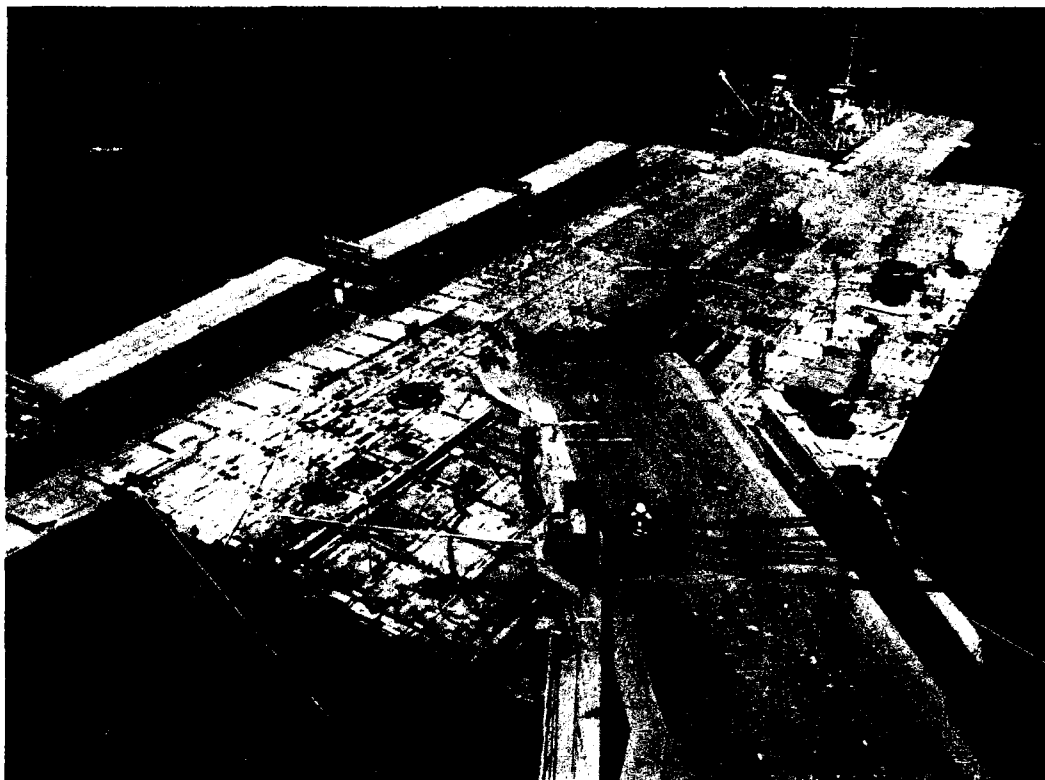

Roll-On/Roll-Off Discharge Facility (RO/RO DF)

POINTS OF CONTACT

Mr. Ben Oh
US Army Belvoir RD&E Center, SATBE-FMS
Fort Belvoir, VA 22060-5606
DSN 654-3623/Commercial (703) 704-3623

Mr. Greg Walker
Naval Facilities Engineering Command, Code 0632
Alexandria, VA 22332
DSN 221-8535/Commercial (703) 325-8535

Mr. Ted Vaughters
David Taylor Research Center, DTRC-1235
Annapolis, MD 21402-5067
DSN 281-2261/Commercial (301) 267-2261

ITEM DESCRIPTION

The Roll-On/Roll-Off Discharge Facility (RO/RO DF) consists of a RO/RO platform, a "B" or Sea End section with provisions for "Rhino" horn, a Calm Water Ramp (CWR), a fendering system, a lighting system, and an emergency anchoring system. The RO/RO DF provides an interface between RO/RO ships and displacement type lighterage. It will support self-sustaining and non-self-sustaining RO/RO ships. The Platform is approximately 65' wide by 180' long. The "B" or Sea End provides an interface between the RO/RO platform and displacement craft. The CWR and fender system are used with non-self-sustaining ships. The lighting system is used during night operations and includes integral power generation and distribution. An emergency anchoring system is under development and is used when the ship being serviced is required to depart due to enemy actions or adverse weather conditions. The RO/RO DF is tendered by two Side Loadable Warping Tugs (SLWTs). The SLWT is an Associated Support Item of Equipment (ASIOE) for the RO/RO DF. The SLWT has a deck-mounted "A" frame and winch for hoisting/lifting and assembly of the RO/RO DF hardware and components. The SLWT also has a stern anchor.

STATUS

A RO/RO DF was granted Type Classification (TC) - Standard on 21 March 1985 at the Milestone I/III In Process Review (IPR). Three RO/RO DFs were procured through an Interservice Support Agreement (ISA) with the Navy under multiple competitive contracts and were delivered to the Army in FY89. Five RO/RO DFs have been delivered to the Navy. A developmental effort is underway by the Navy to increase the operational capability of the RO/RO DF to Sea State 3.

PROGRAM PLAN

Army Initial Operational Capability (IOC) is expected to be 4QFY92. The Navy will test the Sea State 3 operational capability during the 1993 J-LOTS III test.

NSN

1945-01-219-2109

Causeway Section, Powered (CSP)

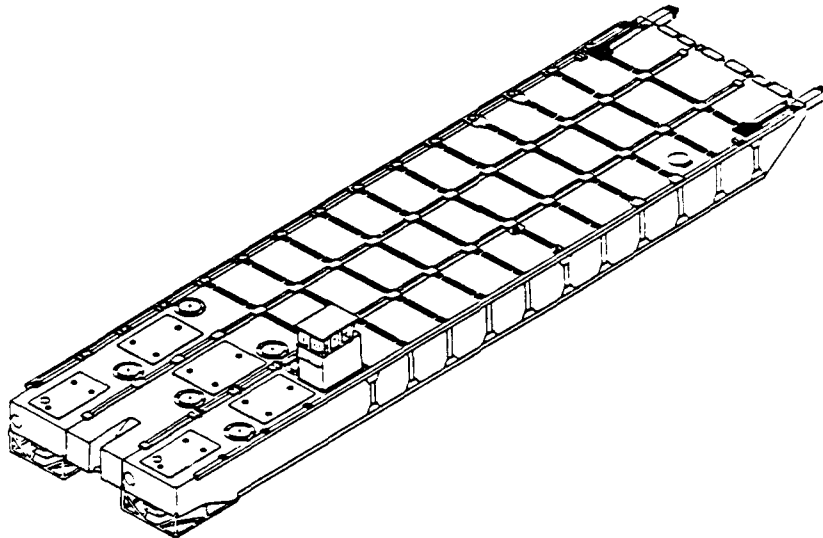

Causeway Section, Powered

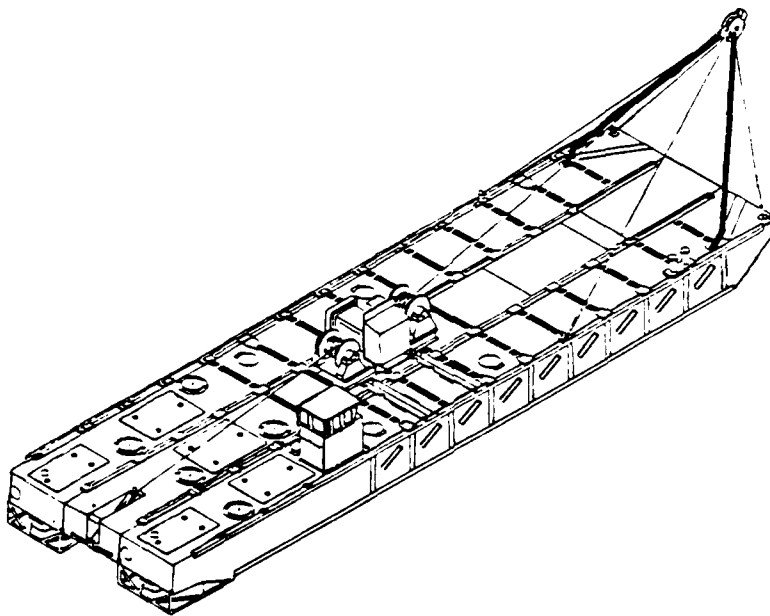

Side-Loadable Warping Tug

Causeway Section, Powered (CSP)

POINTS OF CONTACT

Mr. Greg Walker
Naval Facilities Engineering Command, Code 0632
Alexandria, VA 22332
DSN 221-8535/Commercial (703) 325-8535

Mr. Ben Oh
US Army Belvoir RD&E Center, SATBE-FMS
Fort Belvoir, VA 22060-5606
DSN 654-3623/Commercial (703) 704-3623

ITEM DESCRIPTION

The Causeway Section, Powered (CSP) Navy Lighterage (NL) version will be procured by the Army through the Navy. The NL version of the CSP and the Side Loadable Warming Tug (SLWT) are shown. The NL versions are constructed with 5' x 5' x 7' NL pontoons and three Waterjet Propulsion Assemblies. Propulsion modules consist of a drive engine and a waterjet pump system. The SLWT can be side carried on a Landing Ship Tank (LST). The CSP can carry 40 tons of cargo and is used to push Causeway Ferries. A Causeway Ferry consists of a CSP and Causeway Sections, Non Powered (CSNPs). Each CSNP carries 100 tons of cargo.

STATUS

The Navy awarded a contract in 4QFY87 to Costal Engineering and Manufacturing Co. for 37 SLWT/CSP NL version units. A contract to procure 11 additional SLWT/CSP NL version units was awarded in 4QFY89. The first delivery was received in November 1990. These contracts are for both Navy and Army requirements and include CSNPs distributed as shown below:

	Navy	Army	TOTALS
CSP/SLWT	34	14	48
CSNP	96	26	122

PROGRAM PLAN

Monitor contract and field the delivered units. Delivery of the SLWT/CSP NL version and the CSNP units will continue through 4QFY92.

NSNs

CSP: 1945-01-213-7235
SLWT: 1945-01-218-4669

Modular Causeway Ferry (MCF)

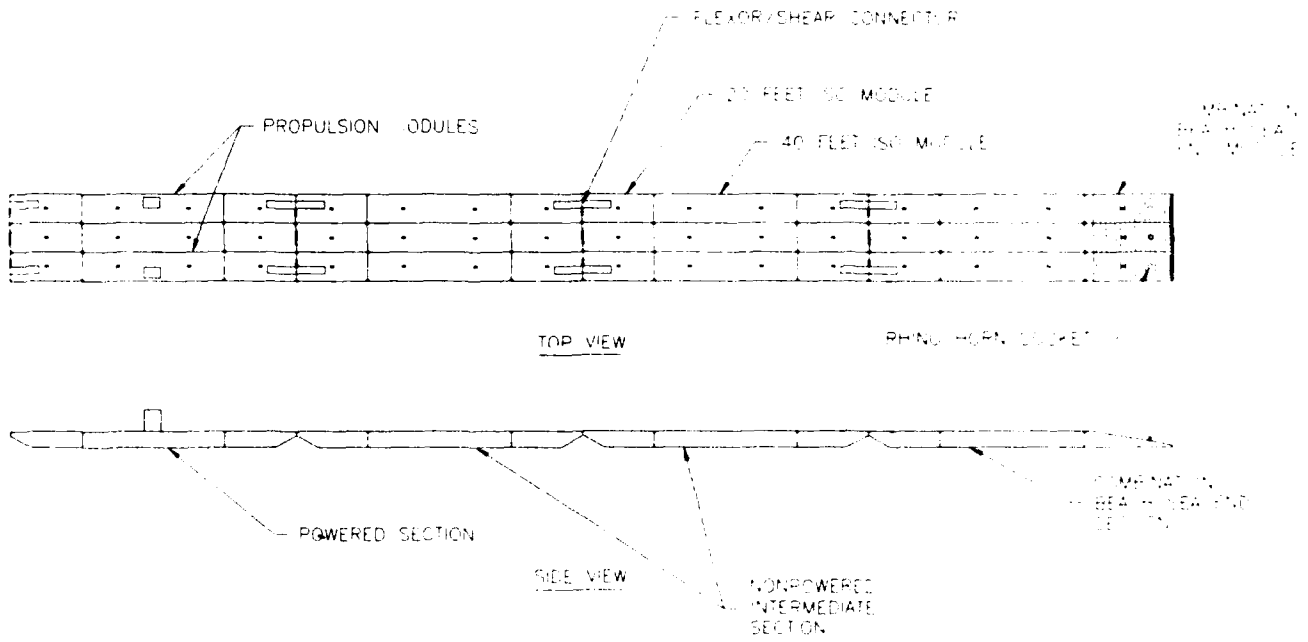

Modular Causeway Ferry (MCF)

POINT OF CONTACT

Mr. Ben Oh
US Army Belvoir RD&E Center, SATBE-FMS
Fort Belvoir, VA 22060-5606
DSN 654-3623/Commercial (703) 704-3623

ITEM DESCRIPTION

The Modular Causeway Ferry (MCF) consists of a powered section, two non-powered intermediate sections, and a non-powered combination beach/sea end section joined end-to-end. It has a loaded capacity of 100 short-tons per non-powered section and approximately 50 short-tons for the powered section. It carries a total cargo capacity of 350 short-tons with approximately 12" of freeboard. The powered section is composed of powered modules with internal propulsion and control components connected to non-powered modules. The MCF will operate in the J-LOTS environment between RO/RO and lift-on/lift-off ships and shoreside logistics operations. Upon arrival in the operational area, the MCF components will be offloaded and assembled for use. Each operational system includes pilot-to-operator, operator-to-commercial ship, and operator-to-command and control communication equipment.

STATUS

A Limited Procurement Urgent (LPU) message was released in December 1991 for immediate procurement of the MCF.

PROGRAM PLAN

The Army will pursue a Non-Developmental Item (NDI) procurement approach for the MCF. The Army requirement is for 16 MCFs per the Army Watercraft Master Plan. Currently, there are six MCFs funded: two in FY92 and four in FY93. The MCF contract is anticipated to be awarded in November 1992.

NSN

1990-01-280-3692 (NL configuration)

Lighter Air Cushion Vehicle, 30-Ton (LACV-30)

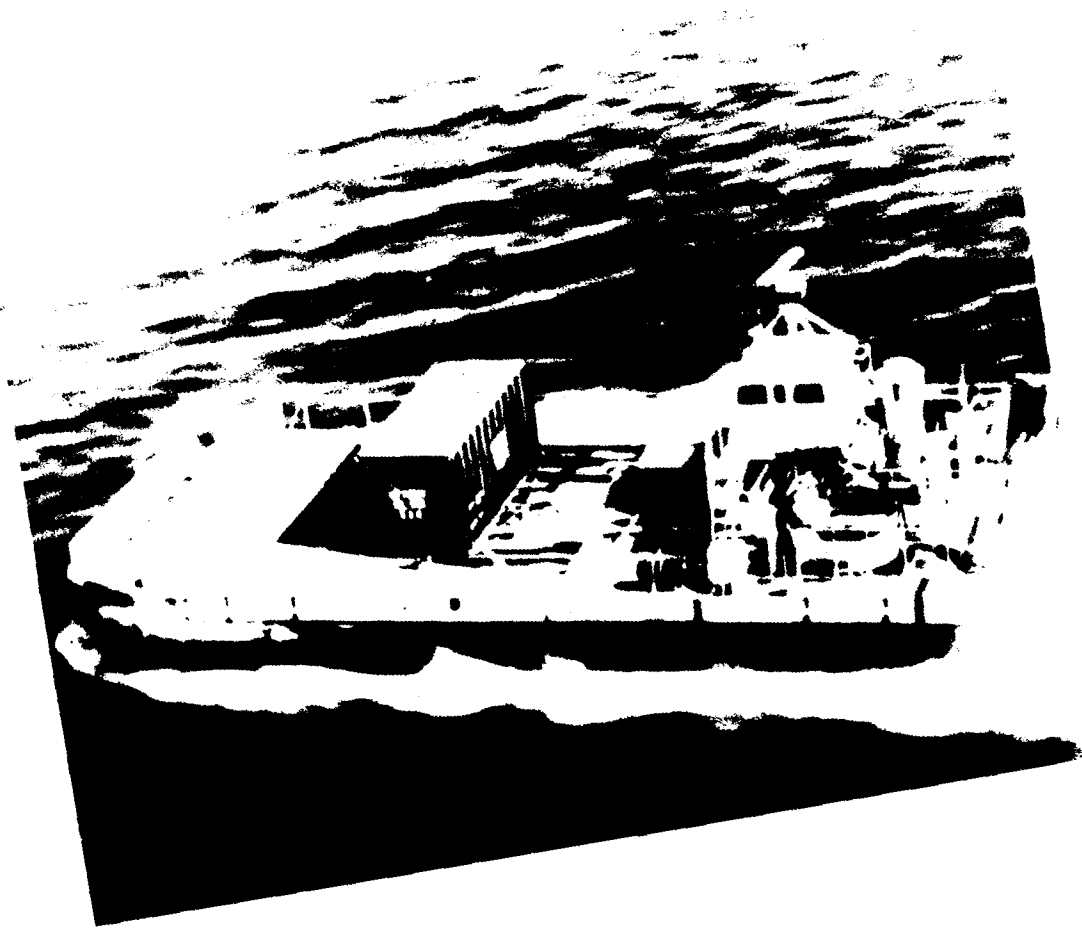

LENGTH	76' 3"	DESIGN GROSS WEIGHT	57,344 pounds
WIDTH	36' 8"	SPEED AT MAX CONTINUOUS POWER	40 mph at all-up weight
DECK LENGTH	51' 6"	ENDURANCE	approx 5 hours of LOTS with 25-ton payload
HEIGHT (HOVERING)	28' 11"	DECK WIDTH	36' 6"
CARGO DEC. HEIGHT	3' 11.5"		

Lighter Air Cushion Vehicle, 30-Ton (LACV-30)

POINT OF CONTACT

Mr. John Walter
US Army Belvoir RD&E Center, SATBE-FMD
Fort Belvoir, VA 22060-5606
DSN 654-2311/Commercial (703) 704-2311

ITEM DESCRIPTION

The LACV-30 is a military adaptation of the Bell Aerospace Company air cushion vehicle *Voyageur* and is used primarily in Logistics-Over-The-Shore (LOTS) operations. It is used to provide the logistical system with a rapid lift capability of moving cargo and equipment over water, marsh areas, beaches, ice, snow, and land. The LACV-30 provides a method of augmenting congested port facilities or compensating for lost or reduced port capabilities. The LACV-30 is also intended to support secondary missions such as coastal, harbor, inland waterway operations, support of amphibious operations, ship-to-shore operations, transport operations, and search and rescue operations. The LACV-30 can negotiate Sea State 2 and 8' plunging surf.

STATUS

Two prototype craft were built and successfully passed operational and developmental tests. The LACV-30 was subsequently Type Classified. Twenty-four production craft have been built under two separate contracts with Bell Aerospace. The first 12 craft were assigned to the 331st Transportation Company and the second 12 craft to the 8th Transportation Company. All of the LACV-30s are stationed at Fort Story, VA. The last craft was delivered in 1986. There are ongoing Materiel Changes (MCs) to improve operational capabilities and maintainability.

PROGRAM PLAN

Complete MCs and retrofit all craft in the 331st and 8th Transportation Companies with the improvements. Currently, there is no planned procurement of additional LACV-30s, but a craft Service Life Extension Program is under consideration.

NSN

2305-01-061-6230

Pontoon Air Cushion Kit (PACK)

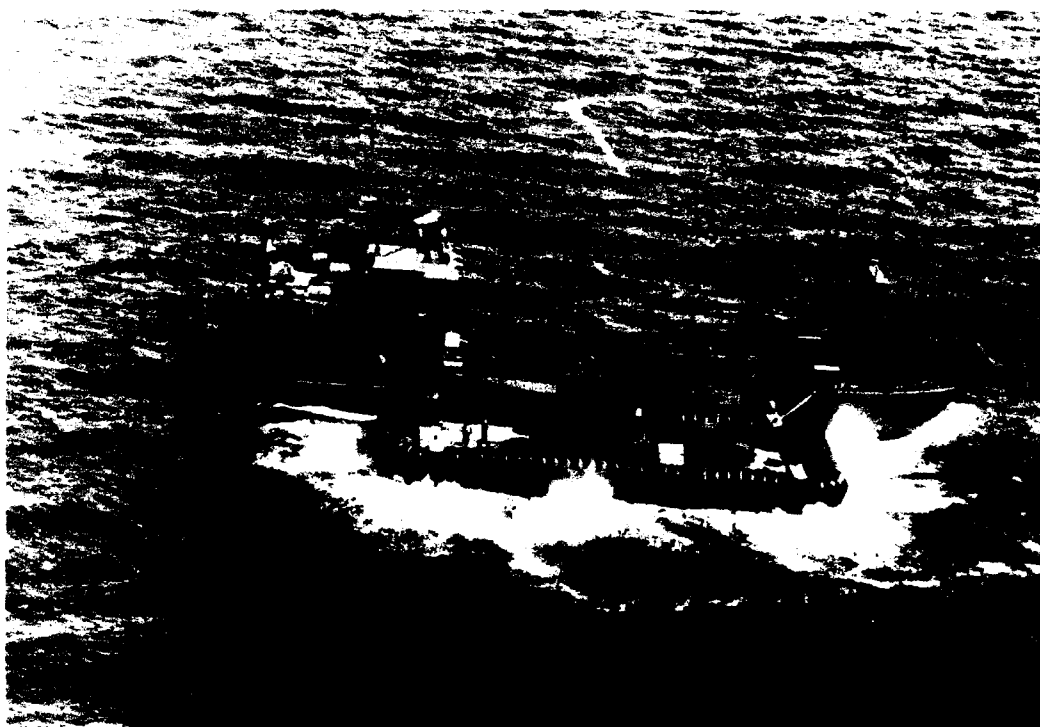

LENGTH	80.0' (hard structure) 97.0' (inflated)	BEAM	32' (hard structure) 49' (inflated)
HEIGHT	4.5' (hard structure)	HEIGHT	11' (inflated)
CUSHION HEIGHT	3.0'	CUSHION AREA	3,145 sq ft
LIGHTSHIP DISPLACEMENT	198,500 pounds	CUSHION PERIPHERAL LENGTH	241'
FULL LOAD DISPLACEMENT	410,500 pounds		
KIT WEIGHT	32,500 pounds (without pontoons)		

Pontoon Air Cushion Kit (PACK)

POINT OF CONTACT

Mr. Brian David
US Army Belvoir RD&E Center, SATBE-FMD
Fort Belvoir, VA 22060-5606
DSN 654-2309/Commercial (703) 704-2309

ITEM DESCRIPTION

The PACK consists of a lightweight peripheral skirt system with autonomous air supply units that can be attached in the field to a Modular Causeway barge (80' x 32') converting it into an air cushion supported platform capable of carrying 140 short-tons of cargo. There are two skid mounted diesel engine (GM 8V-9LTA) centrifugal fan units which supply pressurized air to the skirt system. The PACK has "pusher knees" that can be attached to one end of the causeway section to facilitate warping operations with US Army lighters. The PACK (excluding Modular Causeway) is transportable in a 40' ISO container.

The PACK was developed by the Army Belvoir RD&E Center to provide enhanced mobility and an amphibious capability to inventory Modular Causeway sections for LOTS operations. The current Modular Causeway sections are incapable of traversing shallow beach gradients or LOTS sites that have restrictive hydrographic features (i.e., offshore sandbars, coral reefs). The Army and Navy presently utilize modular pontoons, which are bolted and welded together, to construct field-assembled causeways, causeway ferries, warping tugs, and Roll-On/Roll-Off (RO/RO) discharge platforms for use in a LOTS operation. The Army has 40' x 8' x 4.5' modular pontoons which are compatible with container handling equipment and are capable of being shipped by containership. Retractable pin connectors enable fast and rigid connection of the modules.

The Army also currently does not have the amphibious capability to carry heavy, outsized cargo in a LOTS operation. The current heavy lift amphibian—the Lighter, Resupply Cargo - 60 ton (LARC-LX)—is unable to carry the Army's heaviest piece of LOTS equipment, the 140-ton capacity crane (92 short-ton tactical disassembly weight).

STATUS

A full-scale PACK technology demonstrator was fabricated and tested in a 3-week Concept Evaluation Program (CEP) user test at Fort Eustis, VA, 25 June-13 July 1990 and at Fort Story, VA, 23-26 September 1990. The PACK was tested over water using the Landing Craft, Mechanized (LCM-8) and the Lighter, Air Cushion Vehicle-30 Ton (LACV-30) as prime movers. The PACK was tested over land using the D-7 bulldozer and the 50K Rough Terrain Container Handler (RTCH) as prime movers. The total payload carried by the PACK was 130 short-tons. The PACK was also demonstrated in the J-LOTS III exercise, September 1991, at Fort Story, VA. The PACK was successfully deployed on a T-ACS crane ship. The PACK also carried various heavy outsized pieces of equipment including two M1A1 tanks and the 140-ton capacity container crane.

PROGRAM PLAN

Possible testing of the PACK with a modular propulsion system may be conducted in the future. The design of the non-powered PACK is being preserved in a Technical Data Package so that the PACK may be readily fabricated in the future if it is required.

NSN

Not assigned

Landing Craft, Utility (LCU) 2000



Landing Craft, Utility (LCU) 2000

POINT OF CONTACT

Mr. Joseph Wersching
US Army Belvoir RD&E Center, SATBE-FMS
Fort Belvoir, VA 22060-5606
DSN 654-2302/Commercial (703) 704-2302

ITEM DESCRIPTION

The LCU 2000 is the latest in the evolution of the landing craft designs, succeeding the 1646 Class LCU and replacing the 1466 Class in the Active Army and Reserve inventories. The mission of the LCU 2000 is to provide transportation of rolling and tracked vehicles, containers, and outsized and general cargo in support of LOTS operations as well as Coastal, Harbor, and Inland (CHI) waterway missions. The LCU 2000 has an overall length of 184', a beam of 42', and a full load design draft of 8'. It is capable of carrying up to 30 20' or 12 40' ISO freight containers secured on its 3,000 plus square foot cargo deck, and can carry a full load of 350 short-tons. It is configured to deliver 175 short-tons through its 16' wide bow ramp to shallow 1/30 gradient beaches without exceeding a 4' bow draft. The LCU's 2 Cummins V16 turbo-charged diesels with 2,500 installed HP provides a full load speed of 10 knots, and a light delivery speed of 12 knots. The 300 HP Cummins powered Bow Thruster provides added maneuverability during docking or undocking operations. It is classed by the American Bureau of Shipping (ABS) for full ocean service and one-man engine room operations, and is built to US Coast Guard standards. LCUs are equipped with the latest navigation, communication, and electronic equipment including an automatic pilot and steering system. The LCU 2000 is capable of sustaining its crew of two warrant officers and 11 enlisted personnel for periods of up to 18 days and over 6,000 nautical miles, without refueling.

STATUS

The procurement of the LCU 2000 utilizes the Non-Developmental Item (NDI) acquisition strategy, and is managed by the Product Office for Amphibians and Watercraft (PO-AWC) with specifications prepared by the Belvoir RD&E Center. The LCU 2000 is in full production and is being constructed by Halter Marine, Inc., a division of Trinity Marine Industries, at the Moss Point Marine Shipyard, Escatawpa, MS, as part of a 5-year multi-year firm fixed price contract awarded in June 1986. The lead vessel, LCU 2001, *US Army Runnymede*, was launched on 14 August 1987 and sea trials were conducted 12-14 July 1988 and the vessel delivered 16 February 1990. By the end of 1991, LCUs through 2024 had been delivered to the following Army units: 97th and 329th Transportation Companies; Fort Eustis, VA (16); the 481st National Guard Unit in Rio Vista, CA (2); the 824th National Guard Unit in Morehead City, NC (2); Panama (2); and Kwajalein (2). The proposed ramp modification proved unacceptable. A proposed Materiel Change list has been prepared and distributed for comment. The Materiel Changes will address correction of the ramp issue and other technical deficiencies.

PROGRAM PLAN

The last LCU is presently scheduled for delivery in early 1993.

NSN

1905-01-154-1191

Logistics Support Vessel (LSV)

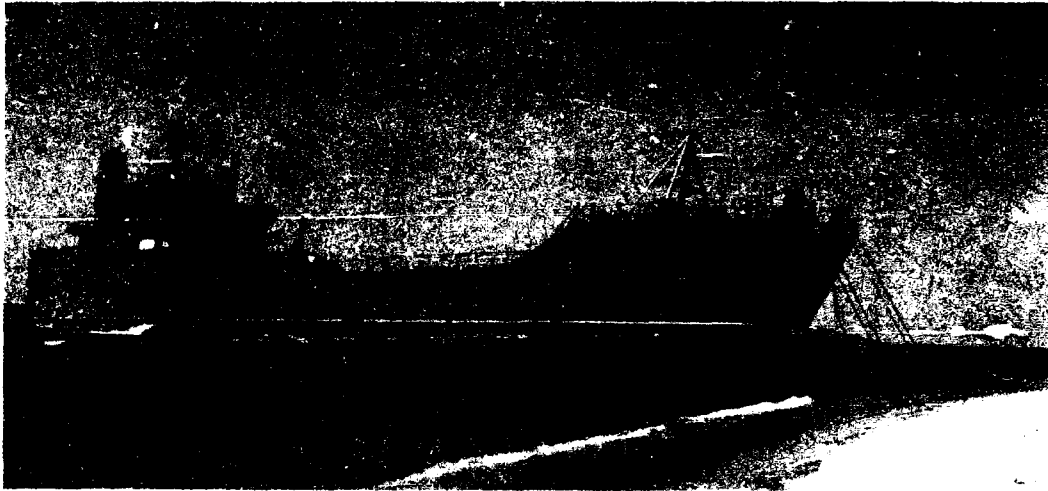

Logistics Support Vessel (LSV)

POINT OF CONTACT

Mr. Scott Story
US Army Belvoir RD&E Center, SATBE-FMS
Fort Belvoir, VA 22060-5606
DSN 654-2303/Commercial (703) 704-2303

ITEM DESCRIPTION

The LSV has the capability of intra-theater linehaul of cargo to support the unit deployment/ relocation, tactical and sustained resupply to remote, undeveloped areas along coastlines and on inland waterways. Additionally, the LSV is capable of self-delivery to a theater of operations. Mission requirements include the capability to assist in discharging and backloading ships in a roll-on/roll-off or LOTS operations with its drive-through capability and of transporting heavy, oversized cargo. The vessel has a self-delivery range of 6,500 nautical miles at service speed of 11.5 knots and is capable of sustaining a crew of 29 for a minimum of 30 days. Utilizing 10,500 square feet of deck cargo space, the LSV can transport 2,000 short-tons of cargo consisting of rolling stock, general cargo or ISO containers. Principal characteristics of the LSV are: length (overall), 273'; beam (molded), 60'; beaching draft, 4' at the bow, with 900 tons of cargo distributed uniformly over the deck; twin screw diesel propulsion; 3,900 shaft HP; bow thruster; bow and stern ramps; and deck sockets to secure all types of cargo transported.

STATUS

The LSV was Type Classified Standard, Logistics Control Code (LCC) A in September 1983. After a competitive solicitation, contract for four LSVs was awarded to Moss Point Marine Shipyard, Escatawpa, MS, on 19 September 1986. The LSV was initially fielded in November 1987 and was commissioned as a US Army vessel. The original contract was later modified on 19 September 1989 to include construction of a fifth LSV. The LSVs' delivery dates are shown below:

Hull No.	Name	Delivery Date	Gaining Command
LSV-1	GEN Frank S. Besson, Jr.	November 1987	FORSCOM
LSV-2	CW3 Harold C. Clinger	February 1988	WESTCOM
LSV-3	GEN Brehon B. Sommervell	April 1988	NGB
LSV-4	LTG William B. Bunker	May 1988	FORSCOM
LSV-5	MG Charles P. Gross	January 1991	WESTCOM

PROGRAM PLAN

Continue to support the fielded vessels.

A Materiel Change program is underway to upgrade and modernize systems and components of the total inventory of five LSVs.

NSN

1915-01-153-8801

Fast Logistic Ship (T-AKR) Program



Fast Logistic Ship (T-AKR) Program

POINT OF CONTACT

Mr. Marty Fink
Naval Sea Systems Command, PMS-377K
Washington, DC 20362-5101
DSN 332-0920/Commercial (703) 602-0920

ITEM DESCRIPTION

The Fast Logistic Ship (T-AKR) Program involved the procurement of eight SL-7 class high-speed (33 knots) containerships and their subsequent conversion into a combination RO/RO-Container configuration specifically designed for the rapid transport of military vehicles and equipment, including tanks and helicopters. The conversion design includes installation of decks midship to permit roll-on/roll-off of vehicles, addition of a flight deck for helicopter operations, and retention of the existing container cells aft. The T-AKR provides the capability to transport 78 special-purpose heavy-duty flatracks in the aft part of the ship: 53 (35' long x 8' wide x 13.5' high), 22 (35' long x 8' wide x 10.5' high), 3 (35' long x 8' wide x 8.5' high), 46 containers (20' long x 8' wide x 8' high)*, and eight SEASHEDs (35' long x 25' wide x 12.5' high). The 35' special-purpose flatracks were designed specifically for use on-board the T-AKR and are capable of carrying a maximum cargo weight of 134,400 pounds. These flatracks have been designed with hinged edge flaps installed along one side to provide the ability to span the gaps between flatracks in container cells resulting basically in a series of 'tween decks. The ships have ramps for the discharge of rolling stock, and cranes for lift-on/lift-off operations.

STATUS

In reduced operating status under operational control of the Military Sealift Command. The eight ships are: USNS ALGOL (T-AKR 287); USNS CAPELLA (T-AKR 293); USNS ALTAIR (T-AKR 294); USNS BELLATRIX (T-AKR 288); USNS REGULUS (T-AKR 292); USNS DENEbola (T-AKR 289); USNS ALTAIR (T-AKR 291); and USNS POLLUX (T-AKR 290).

PROGRAM PLAN

Program completed.

NSN

Not assigned

* 44 containers (20' long x 8' wide x 8' high) on USNS ALGOL (T-AKR 287), USNS BELLATRIX (T-AKR 288), and USNS REGULUS (T-AKR 292).

Auxiliary Crane Ship (T-ACS)

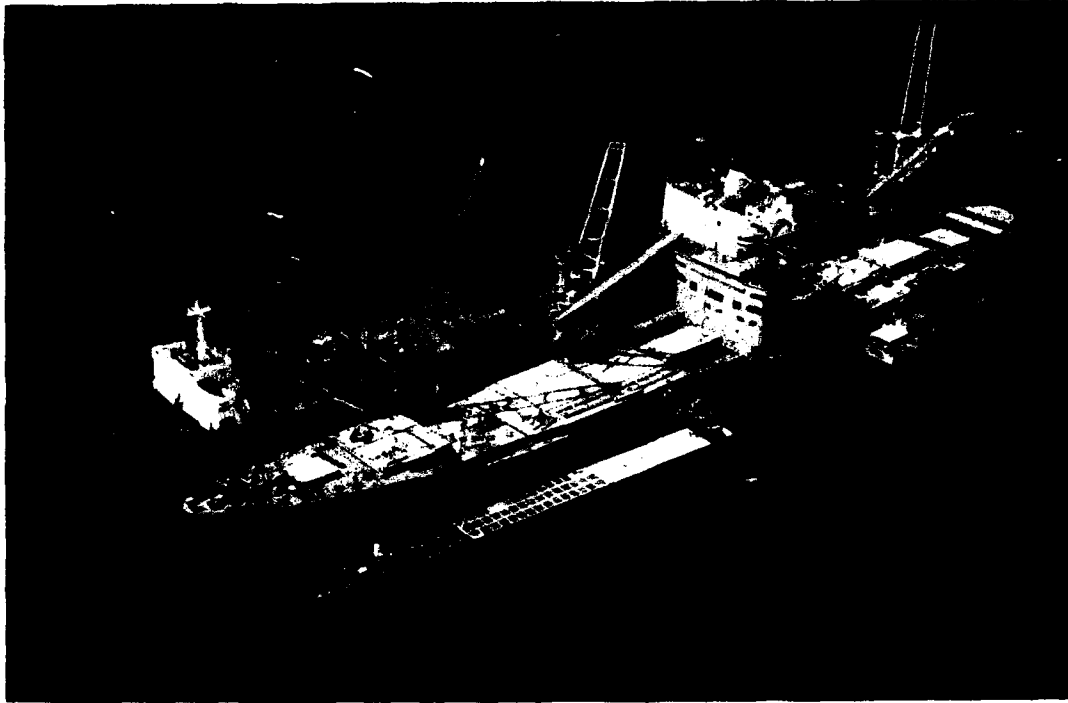

Auxiliary Crane Ship (T-ACS)

POINT OF CONTACT

Mr. Mirza Baig
Naval Sea Systems Command, PMS-377V
Washington, DC 20362-5101
DSN 332-7881/Commercial (703) 602-7881

ITEM DESCRIPTION

The T-ACS is a converted containership from the MARAD Reserve Force modified by the installation of twin-boom marine cranes. Auxiliary features supporting crane operation include upgraded or supplementary living quarters, upgraded messing facilities, upgraded communications suites, additional generator capacity, semi-permanent or permanent ballast, modification of some container cells to permit installation of SEASHEDs, lightering stowage capability, and upgraded mooring and fendering capabilities.

The primary mission of the ship is to offload non-self-sustaining cargo (container) ships moored alongside with offload operations conducted at anchor, in the stream, or in an underdeveloped or damaged port. The ship also has the capability to discharge its own cargo.

The cranes on the T-ACS are evolutionary variations of the level luffing type crane already in widespread merchant service. All T-ACS classes have twin boom rotating pedestal cranes. The T-ACS 1 class has three twin cranes capable of offloading 30 long-tons with a single boom, 60 long-tons with twin booms, and 105 long-tons in tandem (four booms). The T-ACS 4 class has two twin cranes capable of offloading 30 long-tons with a single boom, 60 long-tons with twin booms, and 120 long-tons in tandem. T-ACS 7 through T-ACS 10 will have the same crane design and capability as the T-ACS 4, except T-ACS 7 and T-ACS 8 have three twin cranes.

STATUS

T-ACS 1, SS KEYSTONE STATE, began conversion in March 1983 by Bay Shipbuilding Corporation, and was delivered in May 1984. The ship successfully completed J-LOTS II exercises in October 1984. The second ship, T-ACS 2, SS GEM STATE, began conversion in September 1984 at Continental Maritime of San Francisco, Inc., and was delivered in October 1985. Dillingham Ship Repair began conversion of T-ACS 3, SS GRAND CANYON STATE, in September 1985 and delivered the ship in October 1986. The conversion contract for T-ACS 4, SS GOPHER STATE, T-ACS 5, SS FLICKERTAIL STATE, and T-ACS 6, SS CORNHUSKER STATE, was awarded to Norfolk Shipbuilding and Drydock Corporation in August 1986. Redeliveries of T-ACS 4, 5, and 6 were October 1987, February 1988, and April 1988, respectively. The conversion contract for T-ACS 7, SS DIAMOND STATE, and T-ACS 8, SS EQUALITY STATE, was awarded to Tampa Shipyards, Inc., in September 1987. T-ACS 7 and T-ACS 8 were redelivered in February 1989 and May 1989, respectively. The conversion contract for T-ACS 9, SS GREEN MOUNTAIN STATE, and T-ACS 10, SS BEAVER STATE, was awarded to Norfolk Shipbuilding and Drydock Corporation in January 1989. T-ACS 9 was redelivered in September 1990. The T-ACS 10 contract was terminated in January 1990 to allow sufficient funds to complete the conversion of T-ACS 9. T-ACS 10 underwent lay-up for a 1-year period so that the Navy could seek funding to complete the vessel. T-ACS 10 funding has been identified and MARAD will complete conversion.

PROGRAM PLAN

The T-ACS program calls for conversion of a total of 12 ships from the MARAD Reserve Force. As directed by Congress, the Navy did not budget for T-ACS 11 and 12 in the FY91 or future budgets. MARAD is to plan for the T-ACS 11 and 12 conversions as part of the Department of Transportation (DOT) budget request.

NSN

Not assigned

High Sea State Container Transfer System (HISEACOTS)

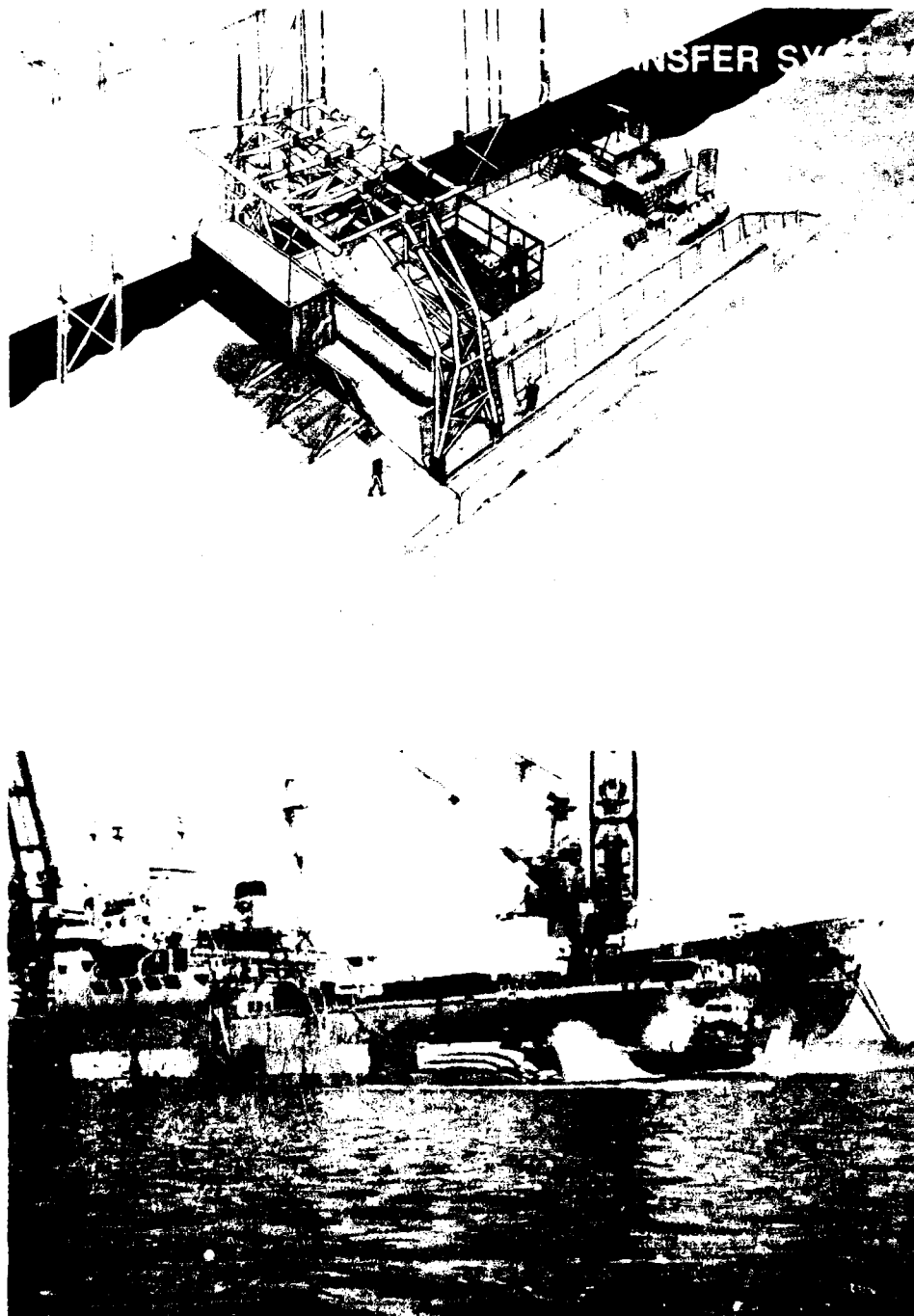

High Sea State Container Transfer System (HISEACOTS)

POINT OF CONTACT

Ms. Kathleen Krawchuk
US Army Belvoir RD&E Center, SATBE-FMD
Fort Belvoir, VA 22060-5606
DSN 654-2319/Commercial (703) 704-2319

ITEM DESCRIPTION

The HISEACOTS is a system that has been developed to stabilize the offloading/lighter interface in high Sea States (SS 3/4). The system consists of a floating platform made up of modular ISO pontoons (160' x 72'), with fore and aft ramps and batterboards to guide air cushion vehicles (i.e., US Army LACV-30) onto the platform. This platform is fitted with a specially designed gantry crane that is used to offload containers/vehicles. The gantry crane has a pendulation attenuator bar that mitigates all pendulation motions through friction forces generated at the bar by the container slings. A positive lock/spar device further reduces any heave motions present and allows the offload of eccentrically loaded containers. The HISEACOTS is designed to offload ISO containers and cargo weighing up to 50,000 pounds in SS 4 conditions.

STATUS

The HISEACOTS is currently in the concept exploration phase. A Small Business Innovation Research (SBIR) Program contract was awarded (Phase I) in 1986 for concept design. A Phase II SBIR contract was awarded in 1988 for a detailed HISEACOTS system design and additional fabrication and testing of the special gantry crane. Land based testing of the gantry crane was successfully completed April 1990. A joint Army/Navy technology demonstration of an air cushion "fly-on/fly-off" platform was completed October 1990. A Phase III SBIR contract was awarded in 1990 for: (1) a pierside demonstration of the gantry crane mounted to a modular platform and an auxiliary crane ship; (2) full-scale demonstration in the J-LOTS III exercise scheduled for May 1991. A pierside demonstration was successfully completed in April 1991. The HISEACOTS was damaged during J-LOTS III and was not tested. An abbreviated test was conducted during Ocean Venture 92.

PROGRAM PLAN

Additional testing is planned for FY93 pending availability of funding.

NSN

Not assigned

Automated All-weather Cargo Transfer System (AACTS)

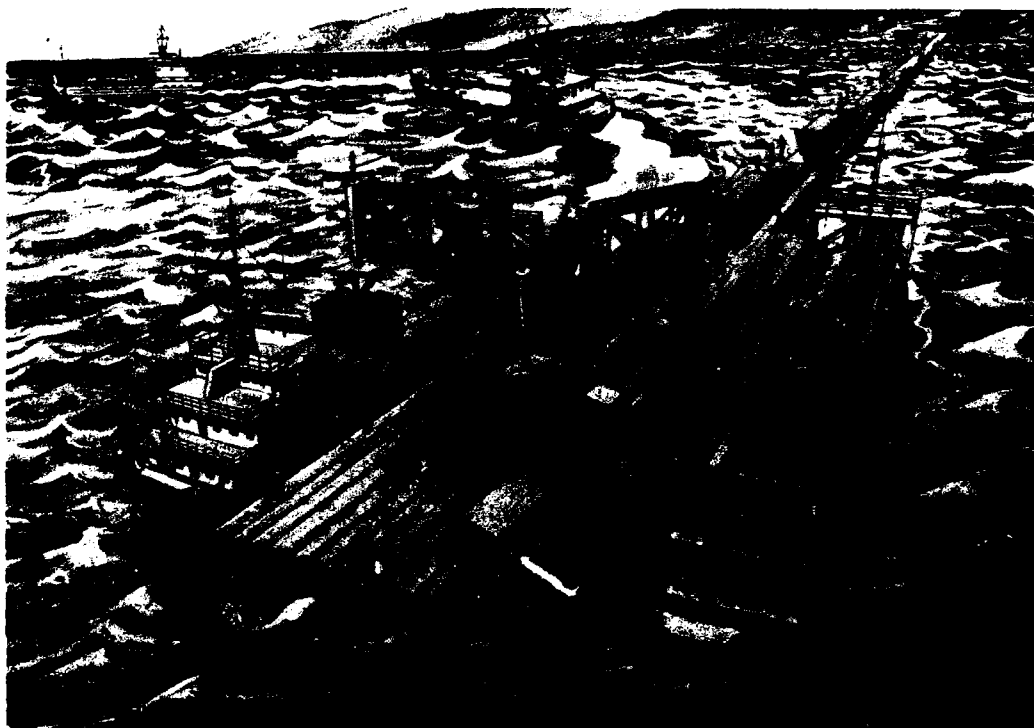

Automated All-weather Cargo Transfer System (AACTS)

POINT OF CONTACT

Mr. William Brower
US Army Belvoir RD&E Center, SATBE-FMR
Fort Belvoir, VA 22060-5606
DSN 654-3613/Commercial (703) 704-3613

ITEM DESCRIPTION

The AACTS is an automated system which will be used to transfer ISO containers between containerships and lighterage in stream or between lighterage and transportation assets at shoreside in support of LOTS operations. AACTS is capable of compensating for the relative motion differences between a containership and lighterage and between lighterage and shore-based causeways. AACTS may replace the conventional cable type of crane found shoreside such as the 140-Ton Crane or the ship-mounted container cranes.

The system has the ability to identify, track, and engage an ISO container using a built-in vision system. This system allows the container to be engaged even under conditions of severe relative motion differences between the container and the AACTS. These capabilities will allow AACTS to increase the number of containers transferred from ship-to-shore during Sea States (SS) 1 and 2 and provide the new capability to efficiently transfer containers in SS 3 and 4. In addition, personnel can be eliminated from hazardous tagline operations, thereby increasing safety.

STATUS

AACTS was established under the Small Business Innovative Research (SBIR) Program. August Design, Inc. submitted the SBIR and has been performing the effort under the SBIR Program. Phase I consisted of a feasibility study and was completed during FY87. Phase II was initiated during FY88 and completed at the end of FY90. Phase II resulted in a working 1/10th scale model which proved the concept of picking containers autonomously from a simulated LACV-30 in SS 3 and 4 conditions. A Phase III contract was awarded on 28 February 1992 to further develop the technology explored in Phase II by completely simulating the AACTS at a reduced scale.

PROGRAM PLAN

Conduct testing of the Phase III hardware in a wave tank during 3QFY93.

NSN

Not assigned

Cantilevered Lift Frame (CLF)

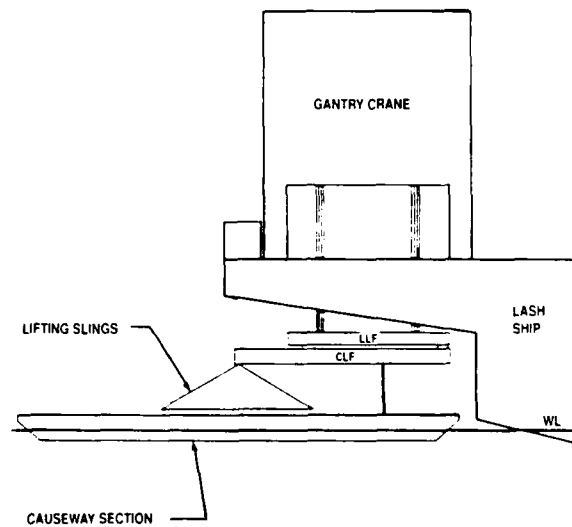
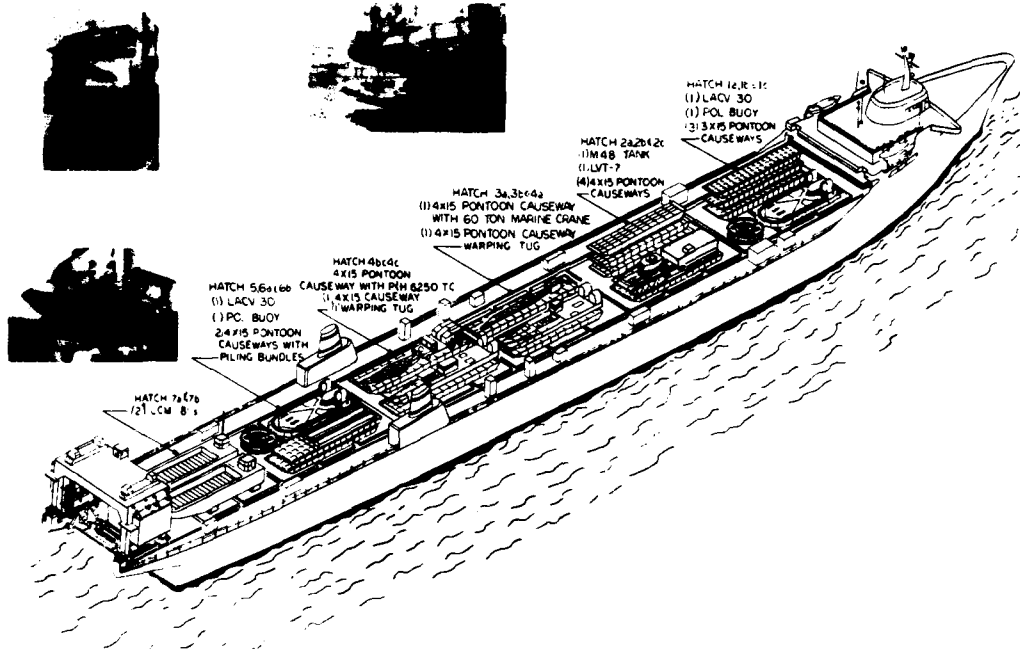

TYPICAL DECK STORAGE FOR OUTSIDE CARGO COMPONENTS FOR G9 LASH VESSEL

LASH CAUSEWAY LIFTING OPERATIONS

Cantilevered Lift Frame (CLF)

POINTS OF CONTACT

Mr. Greg Walker
Naval Facilities Engineering Command, Code 0632
Alexandria, VA 22332
DSN 221-8535/Commercial (703) 325-8535

Mr. Ted Vaughters
David Taylor Research Center, DTRC-1235
Annapolis, MD 21402-5067
DSN 281-2261/Commercial (301) 267-2261

ITEM DESCRIPTION

The CLF has the capability to deploy commercial LASH vessels with heavy, oversized equipment and to offload offshore during LOTS operations. This special lifting device attaches to the LASH ship's gantry crane (designed to lift 30' x 60' barges up to 500 short-tons) and enables the lift of non-barges, eccentric loads up to 150 tons approximately 60' wide x 90' long. The frame was designed to be mated to the four lifting sockets of either the Morgan or Alliance lighter crane lifting frames. The design concept, called the *Cantilevered Lift Frame*, has been accepted as a National Defense feature by MARAD. Certification by the American Bureau of Shipping is based on the capacity of the eccentric loaded crane.

STATUS

Development is ongoing to provide quick-release devices for the rigging gear to assist SS 3 offload of causeways from a LASH ship. A shock absorber to protect the gantry crane machinery is also being investigated. Existing design is under procurement for a total of 13 CLF units. Prototype quick-release devices were tested during LOGEX 88 on a T-ACS ship.

PROGRAM PLAN

Complete procurement of 13 CLF units. Change rigging design if development is successful and continue procurement of device with lift beam, when available. Test quick-release devices on a LASH ship during J-LOTS III test scheduled for 1993.

NSN

3950-LL-LCA-0115

Part VI

Aerial

Port/Terminal

Equipment

Avionics Intermediate Shop (AIS) Shelter Movement



Note: Due to the unavailability of a 25,000 pound capacity forklift, shown above is the 22,100 pound capacity forklift.

Avionics Intermediate Shop (AIS) Shelter Movement

POINT OF CONTACT

Mr. Paul Larkin
HQ Air Combat Command/LGTV
Langley AFB, VA 23665-5541
DSN 574-3417/Commercial (804) 764-3417

ITEM DESCRIPTION

This is a new requirement within Central Command's area of responsibility. The forklift will have a lifting capacity of 25,000 pounds at a 48" load center and will be utilized to handle tactical ISO shelters and containers. It will be a diesel engine driven, rough terrain, four wheel drive, pneumatic tired forklift with either four wheel (rigid frame) or articulated frame steering. The 25,000 pound forklift has a side shift carriage and is air transportable on C-130, C-141, and C-5 aircraft.

STATUS

The 25,000 pound capacity forklift is a replacement for the 22,100 pound capacity forklift which was air transportable only by the C-5 Galaxy. The Air Force procured 58 of the 22,100 pound capacity forklifts from Clark Material System Technology Company, with 19 fielded within the former Tactical Air Command. Procurement specifications were prepared for the 25,000 pound capacity forklift and a solicitation was released in March 1992.

PROGRAM PLAN

A contract is scheduled to be awarded in September 1992 for 26 forklifts. Deliveries of the 25,000 pound capacity forklifts are scheduled to commence in September 1993.

NSN

3930-01-294-9912

Elevator Loader

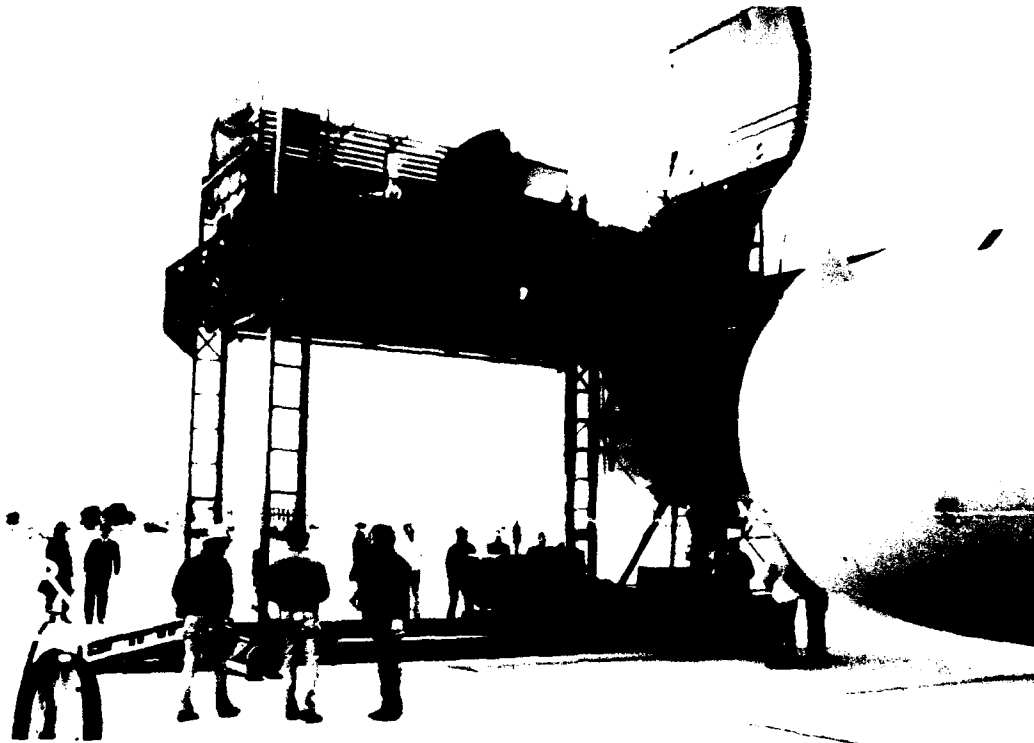

Elevator Loader

POINT OF CONTACT

COL Larry R. Kearns
Warner Robins Air Logistics Center, WRALC/LV
Robins AFB, GA 31098-5345
DSN 468-2062/Commercial (912) 926-2062

ITEM DESCRIPTION

There are three models of Elevator Loaders currently in the Air Force inventory. The Cochran Model 316A has a two 463L pallet, 25,000-pound capability. The Cochran Model 316E and the Wilson have a three 463L pallet, or one air/land container, 40,000-pound capability. The Elevator Loader can also be used to load/unload rolling stock up to its capacity. It is compatible with wide-body aircraft upper deck nose doors and side doors, with maximum transfer height of 18', 6". The Elevator Loaders are transportable in C-130 aircraft. They are used at major aerial ports for efficient mechanized loading/offloading of cargo between wide-body aircraft and other materials handling equipment.

STATUS

The Air Force has 101 Elevator Loaders on hand. Fifty-nine CL3 Elevator Loaders were recently refurbished. A refurbishment/overhaul contract for the remaining 42 Elevator Loaders was awarded in September 1991 to DeVal Corporation.

PROGRAM PLAN

Monitor the refurbishment contract. The Elevator Loaders will eventually be replaced by the 60,000-pound Capacity Loader which is scheduled for production delivery in 2QFY95.

NSN

3930-01-069-1026 CT

25,000-Pound 463L Aircraft Loader

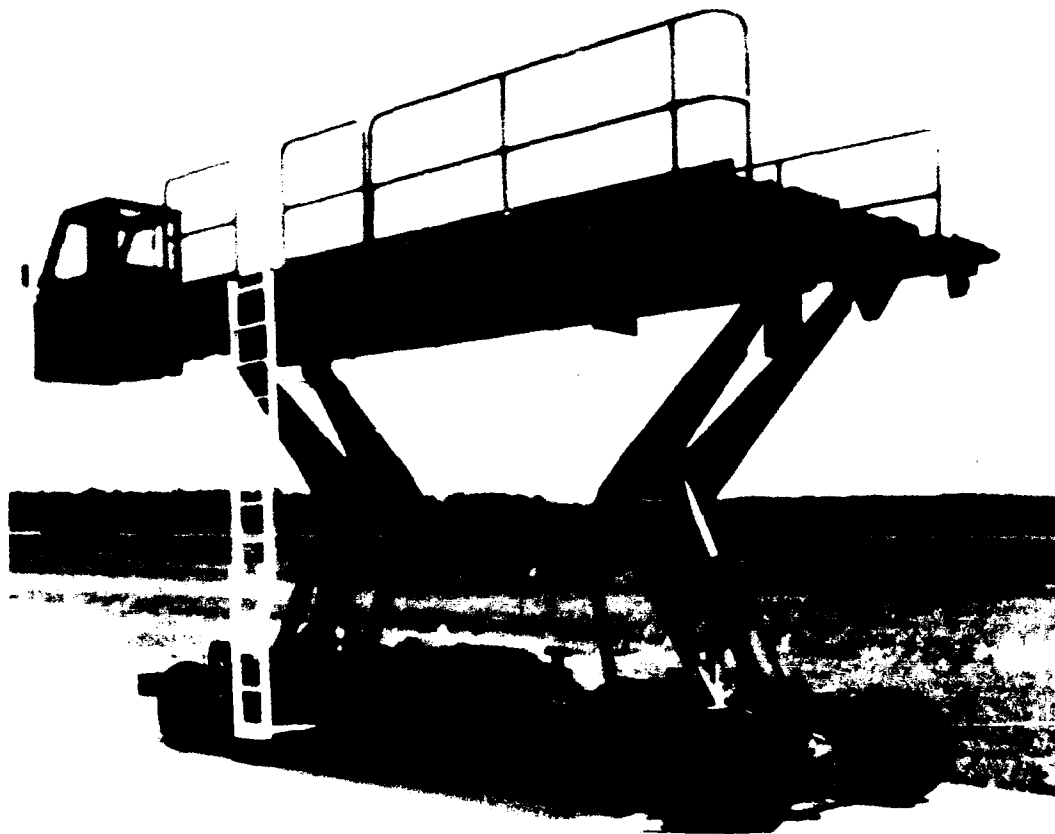

25,000-Pound 463L Aircraft Loader

POINT OF CONTACT

COL Larry R. Keams
Warner Robins Air Logistics Center, WRALC/LV
Robins AFB, GA 31098-5345
DSN 468-2062/Commercial (912) 926-2062

ITEM DESCRIPTION

This diesel-powered loader has the capacity to transport 25,000-pound palletized aircraft loads to and from cargo aircraft. It has a platform length of 24', a width of 10', and can accommodate three 463L pallets. The 25,000-pound loader is air transportable by C-130 aircraft and available at major aerial ports. The 25,000-pound loader can accommodate ISO containers with gross weight—including 463L adapter systems—of 25,000 pounds.

STATUS

The Air Force currently has 475 of the Aircraft Loaders on hand. A contract was awarded 1 July 1987 for 191 additional 25,000-pound capacity Aircraft Loaders and later exercised an option for 49 more, thus bringing the contract total to 240. Deliveries began in May 1992 with 9 received by 1 September 1992.

PROGRAM PLAN

The inventory objective is 861 units. Continue to receive and field the Aircraft Loaders from the contract.

NSN

3930-00-955-3293 CT

40,000-Pound 463L Aircraft Loader

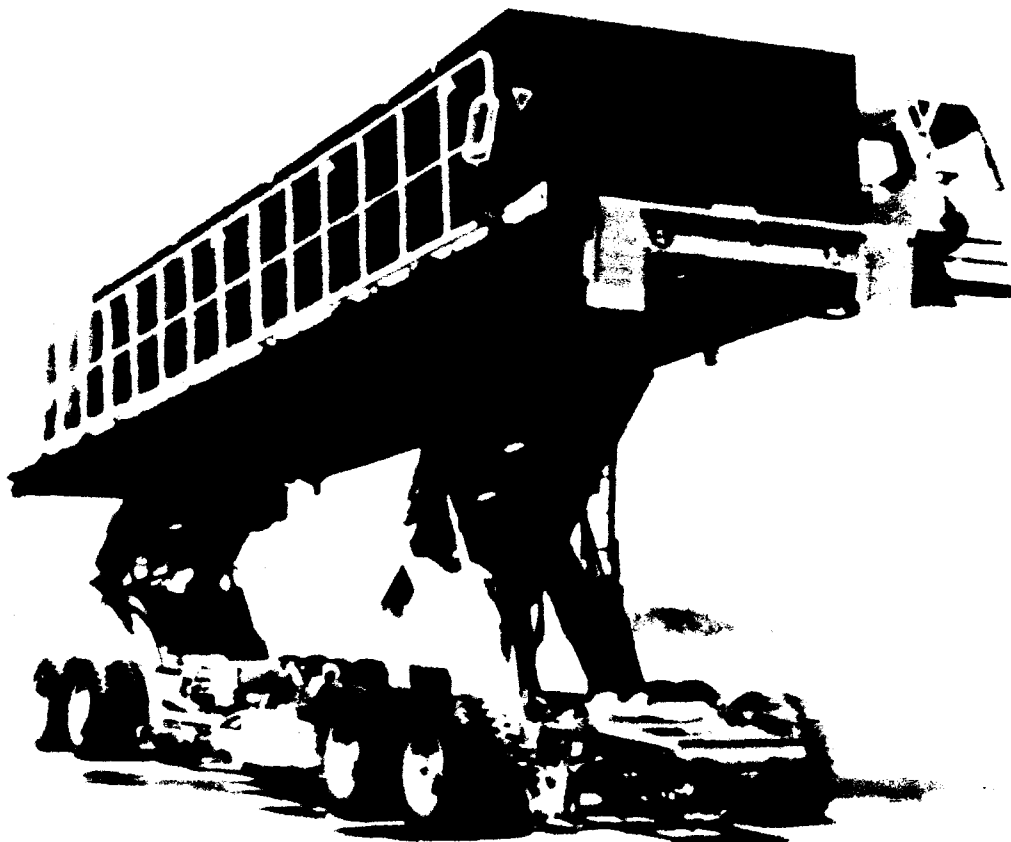

40,000-Pound 463L Aircraft Loader

POINT OF CONTACT

COL Larry R. Kearns
Warner Robins Air Logistics Center, WRALC/LV
Robins AFB, GA 31098-5345
DSN 468-2062/Commercial (912) 926-2062

ITEM DESCRIPTION

This Aircraft Loader has the capacity to transport 40,000-pound 463L palletized loads to and from cargo aircraft. It has a platform length of 41¹/₂', a width of 10', and a lifting range of 3¹/₃' to 13' at 10 feet per minute. The unit will accommodate five 463L pallets. The loaders are air transportable and are available at all major aerial ports. The 40,000-pound loader can also accommodate an ISO container loaded on married 463L pallets or other adapter systems.

STATUS

The Air Force has 286 40,000-pound loaders on hand.

PROGRAM PLAN

The 40,000-pound loader will be replaced by the 60,000-pound Capacity Loader which is scheduled for production delivery in 2QFY95. The 60,000-pound Capacity Loader will be air transportable, a member of the 463L Material Handling System, and capable of loading all aircraft including the C-17. A depot overhaul contract for the 40,000-pound capacity loader is currently in place to assure operational readiness.

NSN

3930-00-800-3929 CT

35-Ton Bridge Crane

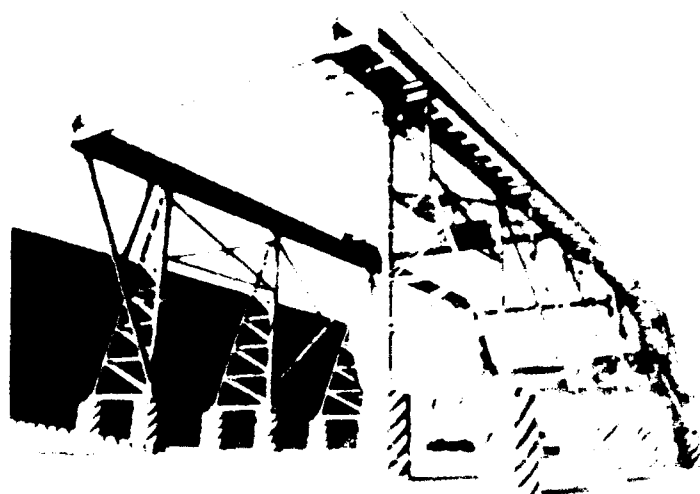
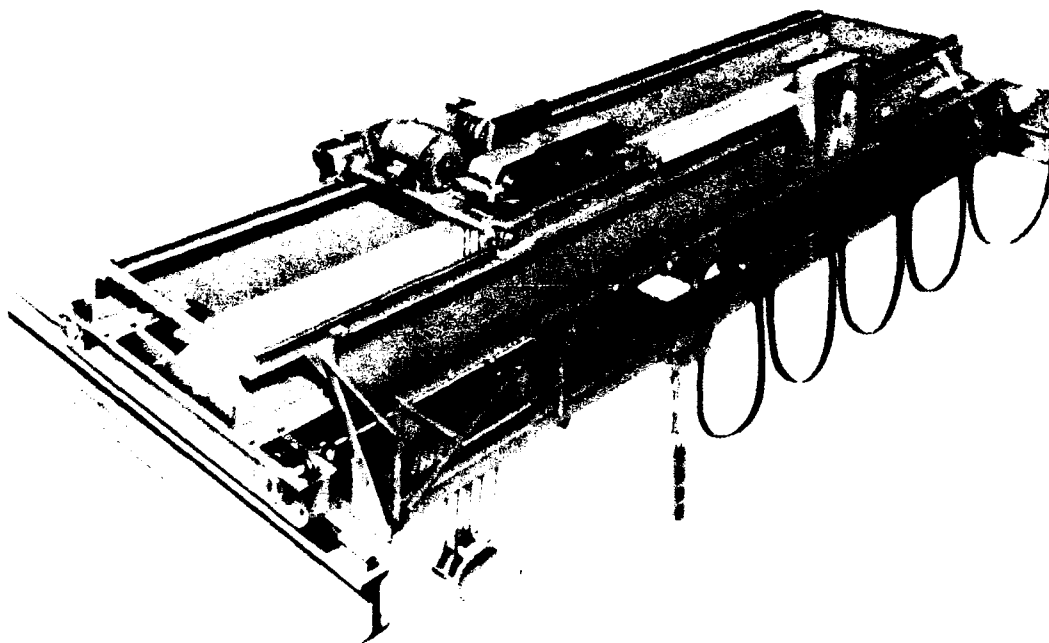

35-Ton Bridge Crane

POINT OF CONTACT

LTC Mike Day
HQ Air Mobility Command, XORPE
Scott AFB, IL 62225-5001
DSN 576-4951/Commercial (618) 256-4951

ITEM DESCRIPTION

The 35-Ton Bridge Crane provides major aerial ports the capability to build up pallets for air drop missions and to transfer fully loaded ISO shelters, air/land and surface containers from trucks/trailers to adapter systems and aircraft loaders. The Bridge Crane is not mobile and provides the capability to support limited container movements.

STATUS

Bridge Cranes are installed at the following aerial ports: Dover, Travis, Mildenhall, Ramstein, Rhein-Main, Clark, and Kadena.

PROGRAM PLAN

Install the Bridge Cranes as new facilities are constructed.

NSN

Not applicable

Part VII

Deleted

Programs

Over time, many programs have been added and deleted from the Container System Hardware Status Report. Listed below are the programs which have been deleted. These programs are listed under the edition of the report from which they were deleted. The programs were deleted from the report for many reasons, including: lack of funding; lack of user support; completion of the program; individual service program combined into a joint service program; or, in rare cases, the POC could not be contacted to determine the status of the program.

July 1976 Status Report

Aerocrane, Ultra Heavy, Vertical Lift
Container Handling in Terminal Operations (CHITO) Equipment
Klemp Klamp Detachable Container Clamp
Lightweight Top Lift Attachments
Logistics-Over-The-Shore (LOTS)
Ship-to-Shore Balloon Transport System (BTS)
10,000-Pound Capacity Forklift Rough Terrain
Type "B" Restraint System for Commercial Containers (Value Engineering)
Type "C" Restraint System for Commercial Containers (Foster Miller)
Type "C" Restraint System for Commercial Containers (Kappa Sys Inc)
US Coast Guard Actions

January 1977 Status Report

Automatic Air Valving Surface Effects Device (ASVSED)
Container Condensation Test
Tug, Large, Inland and Coastal
Tug, Small, Harbor and Inland Waterway

January 1978 Status Report

50,000-Pound Capacity Container Handler, Side Loader (Cochran Western)
Railcar, Modified Flatbed
300-Ton Self-Discharging, Beaching Lighter (BDL)
Type "A" Restraint System for Commercial Containers (Brooks & Perkins)
Type "B" Restraint System for Commercial Containers (Brooks & Perkins)

July 1978 Status Report

4,000-Pound Capacity Forklift Truck, Conventional

January 1979 Status Report

CCIRRS
Container Insert
Lancer Boss Sideloader

January 1980 Status Report

67,000-Pound Capacity Container Handler

July 1980 Status Report

40-Foot Platform Container, Military (Flatrack)
Mobile Port Modules

January 1982 Status Report

Aircraft Mobile Loader

January 1983 Status Report

Conventional Multi-Purpose Barges (Trans Hydro Barges)
INSERT
Navy Internal Restraint System (IRS Kit) for Commercial Containers
Pallet Container (PALCON)
Shore Side Trafficability and Storage Facility Construction
Wood Dunnaging Restraint System (Savanna)

January 1984 Status Report

Container Offloading and Transfer Systems (COTS) Relative Motion Mitigation

January 1985 Status Report

None

1986 Status Report

Barge, Knockdown, Rapid Deployable (BK)
Container Offloading and Transfer System (COTS); COD and TCDF COTS Crane Support
Container Offloading and Transfer System (COTS); Temporary Container
Discharge Facility (TDCF)

1989 Status Report

Air/Surface Intermodal General Purpose Container
Container Offloading and Transfer System (COTS), Crane on Deck (COD)
Container Offloading and Transfer System (COTS), Helicopter Offloading
50,000-Pound Capacity Depot and Terminal Container Handler, Front Loader
40-Foot Flatrack—Army
Lightweight Container Handler
Pre-Staged Ammunition Loading System (PALS)
Slip Sheets for Unstuffing Containerized Ammunition
Spreader Bars, Remote Control
Super Jack Mobile Loading System

1990 Status Report

PLS Container (COMPODS)
Rough Terrain Container Transporter (RTCT)
Temporary Container Discharge Facility (TCDF)

1991 Status Report

Basic Merchant Ship Naval Augmentation Program (MSNAP) Module
Habitability and Utility Support System (HUSS)
Modular Mobile Repair System (MMRS)
Ammunition Containerization Evaluation (Follow-On Efforts)
Crane Rotator
Containership Strike-Up System (CSUS)
463L/ISO Adapter System

1992 Status Report

20' Flatrack, Project Easy ISO
Top Handler, Intermodal Container Handling, Lightweight Expandable
250-Ton, Truck-Mounted, Container Handling Crane
Lighter, Amphibian, Heavy-Lift (LAMP-H)
Mobile Straddle Crane

Acronyms and Abbreviations

AACTS	Automated All-weather Cargo Transfer System
ABS	American Bureau of Shipping
ACC	Air Combat Command
AD	Armament Division
AIS	Avionics Intermediate Shop
AMC	Army Materiel Command
AMC	Air Mobility Command
AMCON	Ammunition Container
AMS	Anchor Mooring System
ANSI	American National Standards Institute
APC	Armored Personnel Carrier
APG	Aberdeen Proving Ground, MD
AR	Army Regulation
ASARC	Army System Acquisition Review Council
ASIOE	Associated Support Items of Equipment
ASP	Ammunition Supply Point
ATLAS	All Terrain Lifter, Articulated System
ATACMS	Army Tactical Missile System
ATCOM	Aviation and Troop Command
BOE	Bureau of Explosives
BRDEC	Belvoir Research, Development and Engineering Center
CADS	Containerized Ammunition Distribution System
CB	Chemical/Biological
CCSA	Containership Cargo Stowage Adapter
CEP	Concept Evaluation Program
CHI	Coastal, Harbor, Inland
CLF	Cantilevered Lift Frame
CONUS	Continental United States

CSC	Convention for Safe Containers
CSNP	Causeway Sections, Non Powered
CSP	Causeway Section, Powered
CWR	Calm Water Ramp
DAB	Defense Acquisition Board
DED	Diesel Engine Driven
DEPMED	Deployable Medical
DISCOM	Division Support Command
DLA	Defense Logistics Agency
DOD	Department of Defense
DOT	Department of Transportation
DPO	Development Prove-Out
DSN	Defense Switched Network (formerly Autovon)
EAT	External Air Transport
EBFL	Extendable Boom Forklift
EDSS	Equipment Deployment and Storage System
ELCAS (M)	Elevated Causeway, Modular
EMD	Engineering and Manufacturing Development
EMI	Electro-Magnetic Interference
EPF	Enhanced PLS Flatrack
FC	Floating Causeway
FDTE	Force Development Test and Evaluation
FUE	First Unit Equipment
FY	Fiscal Year (Oct 1 - 30 Sept)
GS	General Support
GSSA	General Support Supply Activities
GVW	Gross Vehicle Weight
HIK	Hooklift Interface Kit
HISEACOTS	High Sea State Container Transfer System

HP	Horsepower
HQ	Headquarters
Hz	Hertz
IOC	Initial Operational Capability
IPR	In Process Review
ISA	Interservice Support Agreement
ISO	International Organization for Standardization (French translation)
J-LOTS	Joint-Logistics-Over-The-Shore
K	thousand(s)
kW	kilowatt
LACH	Lightweight Amphibious Container Handler
LACV-30	Lighter Air Cushion Vehicle, 30 Ton
LB	pound(s)
LC	Load Center
LCC	Logistics Control Code
LCU	Landing Craft Utility
LOTS	Logistics-Over-The-Shore
LPU	Limited Procurement Urgent
LRP	Load and Roll Pallet
LST	Landing Ship Tank
LSV	Logistics Support Vessel
MC	Materiel Change
MCF	Modular Causeway Ferry
MERWS	Modular Extendable Rigid Wall Shelter
MF	Mobile Facility
MILVAN	Military Van
MLRS	Multiple Launch Rocket System
MM	millimeter(s)
NATC	Nevada Automotive Test Center
NAVAIR	Naval Air Systems Command
NDI	Non-Developmental Item

NL	Navy Lighterage
ISN	National Stock Number
O, O	Operational and Organizational
ORL	Operational Requirement Document
PACK	Pontoon Air Cushion Kit
PLS	Palletized Load System
PM	Product/Project Manager
PO-AWC	Product Office for Amphibians and Watercraft
POC	Point of Contact
POM	Program Objective Memorandum
POP	Proof of Principle
Q	quarter
QUADCON	Quadruple Container
RBTS	Rider Block Tagline System
RD&A	Research, Development and Acquisition
RD&E	Research, Development and Engineering
RFP	Request for Proposal
ROC	Required Operational Capability
RO/RO DF	Roll-on/Roll-off Discharge Facility
ROWPU	Reverse Osmosis Water Purification Unit
RRF	Ready Reserve Force
RTCC	Rough Terrain Container Crane
RTCH	Rough Terrain Container Handler
RTFLT	Rough Terrain Forklift Truck
SBIR	Small Business Innovative Research
SIXCON	Six Containers
SLWT	Side Loadable Warming Tugs
SON	Statement of Operational Need
SS	Sea State
SS	Steam Ship

TACOM	Tank-Automotive Command
T-ACS	Auxiliary Crane Ship
T-AKR	Vehicle Cargo Ship
TC	Type Classification
TRADOC	Training and Doctrine Command
TRICON	Triple Container
US	United States
USAREUR	US Army Europe
USCG	US Coast Guard
VRRTFLT	Variable Reach Rough Terrain Forklift Truck
YPG	Yuma Proving Ground, AZ